

Who's Who in Broadcasting

Radio Digest

Thirty-Five Cents



Official
**Call Book
and Log**
Complete This Issue

New Radio Map; Will Rogers Announcing; Our Russian Conquerors

TK 6540
.R4

SENTINEL of your baby's PLAYGROUND "POSITIVE AGITATION"

YOU mothers know the thrill with which you watch your baby's first clumsy attempts to creep—and the fear. For you know that from now on your baby faces a new danger—the menace of germs that lurk in rugs, waiting to be transferred on chubby fingers to an indiscriminating mouth.

You can't gamble with half-way cleaning measures when a baby's health is at stake.

There's but one thing to do—keep rugs and carpets scrupulously, thoroughly *clean*.

The Hoover will do it. It removes more *dirt per minute* than other cleaners. And it gets not only the surface dirt, lint and threads, but the deeply-embedded, dangerous dirt—the germs that menace health.

"Positive Agitation" is responsible for this ability of the Hoover to out-clean ordinary cleaning methods. "Positive Agitation" shakes loose from the bottom of the rugs the heavy, destructive dirt that usual cleaning methods fail to touch. And by its thorough dirt removal, "Positive Agitation" restores to rugs their original beauty, lifting the nap and brightening the colors.

The amazing efficiency of this exclusive Hoover cleaning principle—the outstanding ability of the Hoover to remove the most *dirt per minute*—has been proved by repeated tests made under actual home conditions. We will gladly demonstrate it to you, in your own home on your own rugs. Because *d. p. m.* represents the real gauge of electric cleaner capacity, you should see this test which is an accurate measure of efficiency, before purchasing *any* cleaner. Telephone your Authorized Hoover Dealer.

Cash prices, Model 700 Hoover, \$75. Model 543, \$59.50. Dusting tools, \$12.50. Easy payments if desired. Only \$6.25 down. Prices slightly higher west of the Rockies and in Canada. Hoover Dealers will make you an allowance on your old machine.

THE HOOVER COMPANY
NORTH CANTON, OHIO

The oldest and largest maker of electric cleaners . . . The Hoover is also made in Canada, at Hamilton, Ontario



The HOOVER

It BEATS... as it Sweeps as it Cleans

more
d. p. m.
—DIRT PER MINUTE
The accurate measure of
electric cleaner efficiency
is *dirt per minute*



The tall can, diluted, makes an overflowing quart of pure, rich milk

Table service by courtesy of Marshall Field & Company, Chicago

© 1928, Carnation Milk Products Co.

A marvelous dish, you'll say! What makes it so good? The sauce. And what makes the sauce so exceptional—silky smooth and thickly creamy? The milk—Carnation!

Carnation is the milk for sauces. For this pure, double-rich milk is "homogenized"—its double helping of cream distributed evenly, in finest-grained particles, making every single drop double-creamy. That is why Carnation sauces are so indescribably smooth—

why all cooking with Carnation achieves a surpassing delicacy of texture. You should know this convenient, economical, superior milk.

Carnation Capers Sauce— $\frac{1}{2}$ cup Carnation Milk, $\frac{1}{2}$ cup water, 2 tbsp. butter, 2 tbsp. flour, 1 small onion, $\frac{1}{2}$ tsp. salt, $\frac{1}{8}$ tsp. pepper, $\frac{1}{4}$ cup capers. Scald Carnation and water together. Cook chopped onion in melted butter; add flour and let brown. Add salt, pepper, and scalded milk, stirring constantly. Cook about 5 minutes and add drained capers. Serve hot.

Write for Mary Blake Cook Book

CARNATION MILK PRODUCTS COMPANY
469 Carnation Bldg., Oconomowoc, Wis.
569 Stuart Bldg., Seattle; New York; Aylmer, Ont.!

1163 21 III 136

Radio Digest

Illustrated

E. C. Rayner, Publisher

Member Audit Bureau
of Circulations

VOL. XXIII

THE NATIONAL BROADCAST AUTHORITY

No. 2

ONCE more Hollywood furnishes the charming theme for a Radio Digest cover. Those who look, listen and sometimes stop will of course recognize the alluring features of Miss May McAvoy.



A princess in Cineland, she oftentimes visits her admirers by way of Radio. She belongs to the Warner

Brothers royal line and it is therefore logical that she is best known to the KFWB listeners. However, she is a gay young thing, fitting hither and yon, and has been introduced to various Radio audiences through Eastern studios.

Miss McAvoy was born in New York and is probably best remembered for her leading part in Sentimental Tommy, The Enchanted Cottage, and more recently as a star with Al Jolson in The Jazz Singer. And here's a secret; did you know it was her early ambition to become a school teacher?

THAT there are a multitude of listeners who adhere strongly to their favorite orchestra organizations is indicated by the great number of votes received in the Radio Digest orchestra popularity contest to date.

It is the first national contest of the kind ever held. The trophies will prove of increasing value in years to come when other contests have come and gone—these were the first awards.

DOUBTLESS every reader will find a place for this issue of Radio Digest in his permanent library. Besides an alphabetical Who's Who of all the known Radio artists, it contains a handy reference to the most familiar operas and musical numbers heard over the air. It also affords a picture album of wide scope. All future issues will enlarge on this comprehensive compendium.

CONTENTS

When Will Rogers Was "President".....	7
Major Bowes' Family Affairs—By Dorothy Brister Stafford.....	8
Damrosch Achieves Ambition.....	11
Russia's Good Will Conquest.....	13
Elsie Thiede, lyric soprano.....	17
Irving Berlin Song Biography.....	18
Anna Case Self Made.....	19
Lovely Devora Nadworney.....	20
High Power Reserves at WJZ.....	21
Radio Clubs Save Young.....	24
Radio Personalities—Four Picture Pages.....	28 to 31
Orchestra Dominates Programs.....	32
Mother Greets Son in Arctic—By George R. Wood.....	37
Programs and Regular Features.....	40 to 48
Chain Broadcast Features Schedule.....	48
Telling Fortunes with Foods.....	51
Woman's Program Index.....	52
WHO'S WHO IN BROADCASTING.....	53
Miyoshi Sugimachi wins Milan Scholarship.....	62
Opera Favorites in Radio.....	63
Great Artists on the Air.....	67
POPULAR SONGS OF YESTERDAY AND TODAY.....	72
Lives of Old Masters.....	73
OFFICIAL CALL BOOK AND LOG.....	74 to 89
NEW BROADCAST MAP (Insert at 81)	
Simple Explanation of Broadcasting—By Marvin W. Thompson.....	90
Hot Spot Fourteen—Marvelous for Selectivity.....	92
Voice of the Reader.....	96
Canadian Wave Lengths.....	98
Log of Foreign Stations.....	100
Listener's Evening at Home, in Eastern Time.....	102
Listener's Evening at Home, in Central Time.....	108
Marcella.....	117

Radio Digest, Illustrated, Volume XXIII, No. 2, published Chicago, Ill., March 1st, 1928. Published four times a year by Radio Digest Publishing Co., (Incorporated), 510 North Dearborn Street, Chicago, Illinois, and is on sale on the newsstands approximately the first of January, March, September and November. Subscription rates yearly, One Dollar and Twenty-five cents; Foreign Postage, One Dollar additional; single copies, Thirty-five cents. Entered as second-class matter September 6, 1927, at the post office at Chicago, Illinois, under the Act of March 3, 1879. Title Reg. U. S. Patent Office and Dominion of Canada. Copyright, 1928, by Radio Digest Publishing Co. All rights reserved. Eastern Representative, H. F. Campbell, 116 W. 39th St., New York, N. Y.

Numbers 5 and 6 **Coupon Ballot** TWO VOTES World's Most Popular Orchestra Contest

POPULAR ORCHESTRA Editor, Radio Digest,
510 N. Dearborn St., Chicago, Ill.
Please credit this ballot to

..... of Station.....
(Orchestra's Name) (Call Letters)

Signed.....

Address.....

City..... State.....

3-31

Newsstands Don't Always
Have One Left

BE SURE OF
EACH ISSUE

The Official
Call Book and
Log

Subscribe Today

Publisher Radio Digest,
510 N. Dearborn St.,
Chicago, Illinois.

Please find enclosed check M. O. for One
Dollar and Twenty-Five Cents (Two Twenty-
Five Foreign) for One Year's Subscription
to Radio Digest, Illustrated.

Name.....

Address.....

City..... State.....

3-31

Pledged to endure, —this *better* STUCCO



TO appraise the enduring quality of Oriental Stucco, think in terms of more than one lifetime.

Think of the age-old structures in Europe which attest the endurance of stucco. Oriental Stucco is basically the same material. But through careful research and scientific methods, it has been developed and improved to meet the more exacting demand of the present.

This modern stucco is the complete answer to the problem of color. In specifying Oriental, you may select just the tint desired and be sure of a beautiful and uniform result.

In every respect, Oriental Stucco runs true to form. Every ingredient is mixed in at the mill under conditions that permit of no variation from standard. The product comes backed by the reputation of the United States Gypsum Company, the world's authority on wall finishing materials.

Complete architectural data will be gladly forwarded in response to your request. Just mail the coupon.

UNITED STATES GYPSUM COMPANY
General Offices: Dept. 266, 300 West Adams Street, Chicago, Illinois

ORIENTAL ^{UgS} STUCCO

Reg. U. S. Pat. Off.

EXTERIOR STUCCO

Made by the United States Gypsum Company

..... MAIL THIS TODAY!

Gentlemen:

Please forward "How to Obtain Period Textures in Oriental Stucco" and Specification 16.

Name.....

Address.....

UNITED STATES GYPSUM COMPANY

Dept. 266, 300 W. Adams Street
Chicago, Illinois

With the Publisher

Notice to Our Readers

BEGINNING with this issue, in its new and improved form, Radio Digest will be published four times a year and will be on sale at all newsstands approximately the first of September, November, January and March. The newsstand price will be thirty-five cents. The mail subscription price will be a dollar and a quarter yearly in the United States, possessions, and Canada. Foreign postage will be one-dollar additional. All present subscriptions will be extended issue for issue for the number subscribed.

Our readers will find in this new Radio Digest many new and valuable departments. We call your particular attention to the new features, "Who's Who in Broadcasting," listing all the important broadcast artists, orchestras, etc., in the country and the Musical Department, giving a list of popular songs, directory of abridged operettas, etc. You will find a map in color, giving the location and power of all broadcasting stations. In addition, the "Official Call Book and Log" and the "Listener's Evening at Home" have been improved and amplified. Future issues will be even more complete.

The National Stentor

MERLIN HALL AYLESWORTH of the National Broadcasting Company in a Cyrus Fogg Brackett lecture before the Engineering Faculty and students of Princeton University, under the title of "The Modern Stentor, Radio Broadcasting in the United States," gives a vivid picture of Radio in the scheme of things. Mr. Aylesworth said:

"Once upon a time a wise man said: 'There is nothing new under the sun.' He was right. There is nothing fundamentally new. True, there are improvements and refinements, revisions and alterations, fresh interpretations and novel presentations: but, nevertheless, the basic ideas remain much the same throughout the forward march of civilization.

"And so it is with Radio broadcasting. The basic idea—mass communication—is as old as civilization itself, having had its origin around the tribal camp fire when the spokesman addressed his eager listeners. Word-of-mouth contact between leaders and people has had its influence on history. Century upon century found the homogeneous state largely dependent upon how many individuals could be addressed at one time by a spokesman. Putting the same idea another way, the man with the most powerful voice commanded the greatest audience and consequently the largest following. His might not be words of rare wisdom, yet if he had the necessary physical strength to fling those words to the gathered listeners, he became a greater leader than the wiser man who lacked in physical equipment. Bellows, rather than brains, obviously carried the day.

"It did not take long for advancing civilization to appreciate the enormous handicap of combining the powerful voice and the deep thinker in one. The Romans were perhaps the first to appreciate that the great brain was only too often accompanied by a weak voice. The Romans, practical people that they were, soon introduced a satisfactory system of mass communication or broadcasting, whereby the thoughts and the very words of their greatest thinkers might be made known to the people. The transmitting medium was a professional announcer, or Stentor, with lungs like bellows and a voice like a fog horn. It is said that in the Colosseum, where a hundred thousand Romans gathered to witness gladiators engaged in mortal combat or to enjoy the thrills of a chariot race, the Stentor addressed the multitude, speaking the words supplied by others.

"In light of our present-day magic called electricity, we may well smile at the idea of the Roman Stentor. Yet we have retained the basic idea, namely, that a powerful voice be made available to the man with something worthy to say. We have, however, improved materially on the Roman Stentor technique by enabling the very words, the very voice, the very personality, if you please, of the thinking man to be passed on to the listening multitudes, via the public address system. And going a step further, we have provided wings, called carrier waves, to those words and voice and personality, in order that they might be carried to listeners in their homes, thus making our forum one of unlimited proportions.

"**E**VEN prior to the human voice, before the grunts that gave birth to our spoken language, there must have been a sign language. In the endless repetition of history, therefore, it was but natural that the sign language technique should reappear in the refined form of the written word. In the shape of manuscripts, the written word played an important role in bringing the views and the wishes of leaders and

thinkers before far-flung people, despite the handicaps of laborious duplication and limited readers. Further refinement brought the movable types of Guttenberg as well as the printing press during the late Middle Ages, giving enormous impetus to the written word and contributing not a little in the renaissance or rebirth of civilization. Yet if we analyze this situation critically, we note that the printed word was still another step removed from the personal appeal of the individual addressing the multitude. From the personal voice, the technique had passed on to the personally written word and from the personally written word to the impersonal and cold printed word.

"Refinement followed refinement in printing. There came larger and faster presses. Wood pulp and the Fournier paper machine came into existence in providing no end of inexpensive paper to carry the printed word. The automatic composing machine or linotype of Mergenthaler came to take the place of hand type laboriously assembled, printed and distributed, over and over again, by human fingers. Printed matter became commonplace, and with it the acquiring of the reading ability and habit became widespread.

"And so a half-dozen years ago, the press was the logical method of weaving a community or nation into a homogeneous body politic. True, it was and it remains an analytical and synthetic method of conveying intelligence. It is an indirect method for the thinker to get before his invisible audience. It is a decided step backward from the old days of the Roman forum, when the leader faced his audience in person. It is certainly mass communication by proxy. Yet it has served in an age when the audience has grown far beyond the power of the unaided voice to address. Mass communication, up till six years ago, was hopelessly outdistanced by the growing magnitude of communities, states and nations.

"**A**LL of which serves to provide the proper setting for the consideration of this thing called Radio broadcasting. Here is an art, new in details, but old in principle, which is little more than a reversion to the spoken word and the direct appeal of the prehistoric days of the tribal camp fire. Once more we have the forum of the people, gathered to hear their leaders. Again we have the spokesman, delivering his own words by means of his own voice. We are back to the direct word-of-mouth contact between leader and followers, which civilization lost during a period of thousands of years while substituting more elaborate yet really less efficient means.

"Broadcasting, therefore, is not the rival of the printed word. It is far more elementary in conception than the printed word. It is a vehicle for spontaneous thought, for the expression of personality, flung out into space so that all who care to listen may do so. It reaches the listeners wherever they may be—near or far, in cities or in rural districts, in homes or in public gathering places. Radio broadcasting is a marked step forward in the art of mass communication.

"Now the broadcast word is a spontaneous thing. It is born, it lives, and it dies in the space of a second or less. It is not preserved for future review, except in the impression it may make on its listeners. It might be supposed that the broadcast word was seriously handicapped by being presented alone, without sign of the speaker; yet, as a matter of cold fact, the broadcast word is actually aided by being alone. Without the presence of the speaker, without the distractions of a large gathering, without the discomforts attendant upon being gathered in a theatre or hall or public park, the broadcast word stands alone, ready to command one-hundred per cent attention. It can be, and is, more thoroughly analyzed by its public than any other form of public utterance. Little wonder, then that the few remaining politicians of the old days, with their barn-storming ways, have religiously avoided broadcasting in their campaigns.

"The printed word, on the other hand, is not spontaneous thought by the time it reaches the public. It is several steps removed from the original spontaneous thought. It is printed at any time and read at any time. It is preserved, rather than living, thought. Nevertheless, it has the advantage of being recorded thought, in convenient form, for reading and re-reading, at the option of the public.

"Hence there can be no conflict between the printed word and the broadcast word. Both serve individual and distinctive functions."

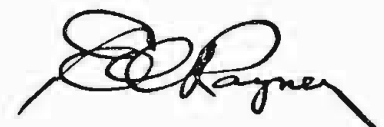



MAJOR EDWARD BOWES, head of the famous Capitol Family, was the first Broadway showman to utilize the Radio to broadcast his productions. He is a typical New Yorker and always "meticulously groomed," says Dorothy Brister Stafford in this issue. He also is a master of diplomacy in his manner of dealing with temperamental artists and the Radio audience. His hour on the Red net has always been a favorite with a great army of listeners.



IF YOU really have a voice the world will find you no matter where you are or what you do. Take the case of Allen McQuhae, the celebrated tenor who sings with the best of them and better than the rest of them. You never would have predicted in the youth of Allen McQuhae that the fates had picked him out for an oratorio artist to be singing the Messiah and the likes. Sure and blithe enough of a boy was he when he took to railroading, breaking the freights, wiping the engine, and his ambition set for to be the engineer.

But the voice of him kept chirping and proclaiming him the great man that he was no matter whether it was mushing in

the Klondike for gold or pinch-hitting for the tenor with the frazzled epiglottis at McDougal's Vaudeville Emporium.

Now 'twas only at the beginning of the great war that the world really took hold of Allen and says, says he, "Me boy, you're an artist and I've found you at last, and begorra you're mine. Now stop fiddlin' your time away with twaddle but go over and settle the war, and then come back and settle down to serious business with that voice that's laggin' behind the tongue of ye."

So Allen did go over and do a man's share in helping America win the war, and when he came back he took up with the

(Continued on page 16)

When Rogers Was "President"

*FORTY MILLION AMERICANS Can't Be Wrong
Unless It's While Follies Cowboy Broadcasts As "Calvin Coolidge"*

IMAGINE this: You are in a room with a lot of Radio apparatus. Telegraph instruments are clicking. Graham McNamee sits in a chair a few feet from your knees, his eyes glued to a watch. A microphone hangs in front of your nose. Now the telegraph instrument is going a monotonous ding-a-ding-ding, ding-a-ding-ding and then of a sudden it hesitates and gives one final bing!

You've been warned! You are on the air. A string of the most powerful broadcasting stations strung across the continent is catching your breath. You are facing not less than 40,000,000 people—probably more, for the range goes far beyond the boundaries.

There you are with eighty or a hundred million ears perked toward YOU. And you start introducing yourself as **PRESIDENT COOLIDGE**.

It's not a dream, it's a fact.

What would YOU do?

And what would YOU do, Will Rogers?

You had better scratch your head and hoist a quizzical eyebrow.

But, of course, everybody knows you did do it, William, so there is no use pretending.

Maurice Wetzel of the National Broadcasting Company anticipated that a thousand-dollar-a-minute program was worth keeping, so he hooked up a dictaphone and took down all that was said. His record, in part, of that momentous colloquy follows:

Will Rogers

At NBC Microphone, Los Angeles

HELLO, folks. I'm the town crier, tonight. They could of got a printed program, but they got me cheaper. It's the easiest job I ever had, sittin' here at home by your own fire-side. Oh, I shouldn't a mentioned fire; we are not supposed to let outsiders know that we have fires in California.

I am glad to appear at this benefit for such a worthy cause. I want to thank the Dodge Brothers and their wonderful new car for arranging this financial testimonial for Al Jolson, Paul Whiteman and Fred Stone. This will help the boys meet their first income tax installment in good shape.

I've just been down to Mexico on some outside business for (Calvin?). He heard that they were shootin' presidential candidates and he sent me down to get the recipe. So if you hear of any of our presidential candidates up here bein' shot, you will know that my mission to Mexico has been a partial success. The only thing, we ain't got enough ammunition up here.

Mexico's a great country, though, and this fellow Morrow is doin' a fine work. Mexico is hooked in on this eavesdroppin' thing here tonight, so I want to say a few words to 'em in their native tongue. (14 seconds of Spanish phrases.)

It's spoilin' my English. I wish I had never learned this language a-tall.

I wish I could describe to you the scene here tonight in my home in Beverly Hills. This is Beverly Hills, the home of all the movie stars. It's wonderful here tonight. Mary and Doug are right here, Pauline Frederick and Gloria and Irene Rich and Harold Lloyd and Rin Tin Tin, John Barrymore, Bull Montana and Dolores del Rio and Ben Turpin, all of 'em are right here. Say—oh, it's great. All right within fifteen or twenty blocks of where I am right now. I'd call some of

'em to the microphone if I knew their telephone numbers.

But, sure enough, right here in my house, I wish you could see it. All the kids are sore as boils because their mother wouldn't let 'em go to the show tonight. Out of respect for their father she wanted them to stay at home and listen to father. Jimmie said, "I've heard the jokes so much I could do 'em myself, for a third of the money."

By the way, he just come runnin' in from the room where they've got a receiving set and he whispered over here to his mother. He says:

"Mamma, we can't get anything in there but static."

His mamma said:

"Hush, that ain't static; that's your father."

Now, folks, we've got a real surprise for you tonight. Something that we didn't put on the program because of the nature of it, we couldn't advertise it. And because he thinks that automobiles has contributed to the success and prosperity of the country, we have a real treat in store for you, so get ready for a real surprise. A real announcer should announce this, but I have to do it, and it's nobody but Mr. Coolidge. Mr. Calvin Coolidge from Washington, who wants to take the opportunity to deliver a short message to America. All right. Washington, are you ready? A—ah—all right, Mr. Coolidge, Mr. Coolidge.

LADIES and gentlemen, it's the duty of the President to deliver a message to the people on the condition of the country. I am proud to report that the condition of the country as a whole is prosperous. I don't mean that the whole country is prosperous, but as a whole it's—a prosperous. That is, it's prosperous for a hole. A hole is not s'posed to be prosperous and this country is certainly a whole. There is not a whole lot of doubt about that. Everybody that I come in contact with seems to be doin' well—Hoover, Dawes, Lowden, Curtis, Al Smith, McAdoo—they're all doin' well. Of course, not as they'd like to be doin' by this time next year.

"I sent Dwight Morrow down to Mexico. A smart boy, Dwight. He's one of the smartest boys in our class at Amherst. One of the two smartest boys, in fact, in our class at Amherst where we were preparing for college. Lindbergh is busy in Central America. We seem to get in wrong faster than that boy can get us out. I wish he was twins. I made a statement last fall in which I said I didn't choose to run. It seems to have been misunderstood, or not understood or som'thin', so about a month ago I clarified it by saying 'I still don't choose to run.' If they misunderstood the first 'choose,' I certainly can't see how they could misunderstand this 'un again.

"Farm relief. For farm relief, I give 'em rain and a good crop. That beats all the McHaugen bills for relief you can invent. Fill a farmer up. That'll stop him from hollerin' quicker'n anything.

"Foreign debts. I am sorry to state that they are just as foreign as ever. In fact, more so.

"Cuba and South American Relations. I am goin' down there at once to try and show them that we are not as bad as we might've been.

"Nicaragua. We're still havin' a little trouble down there, (Continued on page 118)



Will Rogers, Follies Cowboy

His Family Is Yours

Major Edward Bowes Is First of
to Present His Talented

By Dorothy

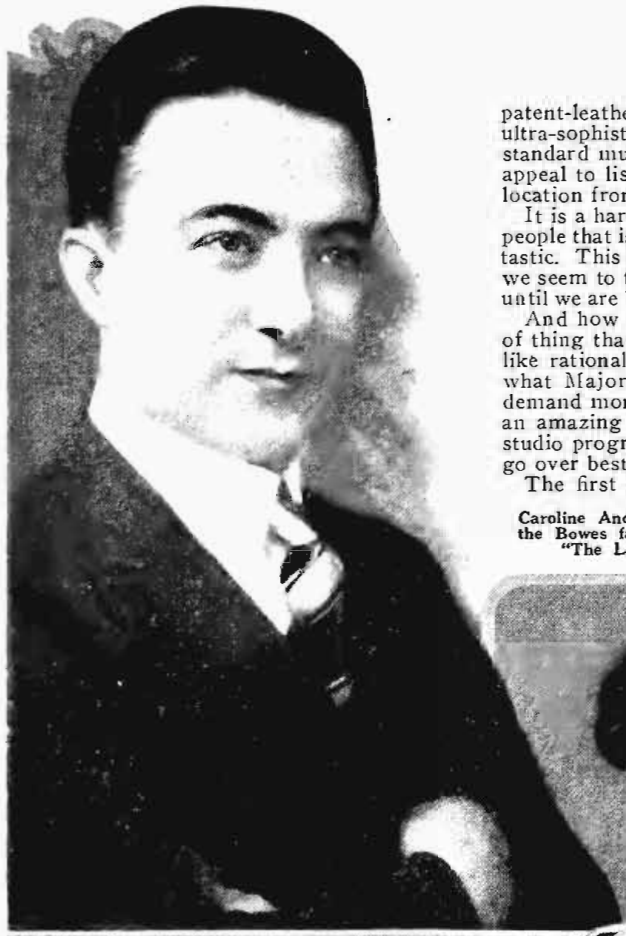

William Robyn, better known to the Bowes neighbors as "Wee Willie"—tenor soloist and recording artist.

HE LIVES in a bungalow on top of a theatre which looks down on the hardest-boiled street in the world, has a famous actress for a wife, his life, his friends, his business, all teem of Broadway, and yet his name is a household word in hundreds of conservative little communities where all the interests with which he is associated are commonly regarded as works of the devil.

He is Major Edward Bowes, Managing Director of the Capitol Theatre, whose vision made possible the first broadcast of entertainment direct from a metropolitan show house to eager listeners in the hinterland.

When other Broadway managers were laughing at Radio, at the same time just a bit apprehensive as to what it was going to do to their interests, Major Bowes' acute business sense told him that the rumored menace of the baby science might be turned into an asset, and led him to co-operate with WEA-F in putting the programs from the Capitol upon the air.

And what these programs have developed into furnishes one of the most curious paradoxes in the amusement world today. Gazing up Broadway at eight o'clock on a Sunday night to where the lights of the Capitol gleam through the haze from millions of other lights, with the bedlam of Times Square traffic seething and boiling in our ears, jostled on all sides by hundreds of perfumed ladies with over-carmined lips and hard, bright eyes; cane-swinging, narrow-shouldered youths, with

patent-leather hair and pasty faces, we've tried to realize that out of this welter of ultra-sophistication there is going upon the air a clean, wholesome entertainment of standard music, old time songs and even an occasional hymn or two, designed to appeal to listeners at quiet firesides so far removed from the tawdry ideals of the location from whence it springs as though they were on another planet.

It is a hard thing to grasp. To us there is an unreality about Broadway and its people that is so utterly foreign to a standard, sane way of living as to be almost fantastic. This street is so hectic, artificial and feverish, particularly at theatre time, that we seem to think in terms of jazz, and can never get our feet firmly on the ground until we are back in the semi-obscurity of the side streets of the less-roaring Forties.

And how any man living year after year in this atmosphere can sense the sort of thing that is going to appeal to those far removed millions, who live and think like rational human beings is beyond our comprehension. And yet that is just what Major Bowes seems to be able to do. No matter if the metropolis does demand more sophisticated entertainment in the theatre (and this winter has seen an amazing livening up of the programs at the Capitol), the Major has kept his studio programs strictly to the lines which his intuition originally told him would go over best with the Radio public.

The first pick-ups from the theatre were, we understand pretty bad, and the studio hour was put on as an experiment. When we discovered Radio back in 1924, the feature, under Roxy's breezy, informal guidance was firmly established in the East, and about that time WWJ first brought it west of Schenectady. As the network expanded (though it wasn't called a network then, and do you remember back when Frank Moulan made jingles out of the station calls and the ballet-girls recited them?) many thousands of listeners came to look on this, then a novel feature, as the high spot in the Radio week.

And then came that hot summer's night a couple of years ago, when Roxy, barnstorming out in Detroit, broke the news to his flock that he was leaving the Capitol. This announcement caused almost as much excitement among devoted followers of the hour as would the news today that Col. Lindbergh was going to give up flying and settle down to raise chickens. The telephone buzzed with inquiries. "Who is going to take his place? Will they give up broadcasting?"

And when, stepping calmly out of his character of the power behind the throne, Major Bowes modestly took his place at the microphone, no one dreamed that a man of such wide interests would continue permanently at the work of presenting programs, or that a brand new personality had come into Radio. While carrying on the informal method of presentation inaugurated by Roxy, the Major made no attempt at imitation, and brought to the work a more dignified delivery, which, together with his happy appellation, "The Family," his courteous manner and an evidently sincere desire to please went over big with the Radio audience.

As one listener expressed it at the time, he felt as though a very well bred gentleman had walked into his living room with an offer to entertain the family. And if Major Bowes had entered upon his new profession with some misgiving, the letters which immediately began to pour into the Capitol convinced him he had fallen into the most interesting work of his career.

About this time one of the wise ones along Times Square made this prophecy to us. "Aw, he'll soon get tired of it. Catch a movie magnate tying



Caroline Andrews, a smiling singer of the Bowes family, affectionately called "The Lark" by Papa Bowes.

for Evening of Play

the Great Broadway Showmen
Household to Listeners

Brister Stafford

himself up every Sunday night talking to a bunch of Radio bugs over in Joisey."

He didn't realize that the "radio bugs" extended much farther west than "Joisey," the horizon of his Manhattan mind, or that Major Bowes might find something quite worth while concealed in that great polyglot mass known as the "invisible audience." He tells you quite frequently what the personal contact means to him, of the thousands of grateful letters he gets every week, but almost every day one hears the query, "What does the theatre get out of it?" What, indeed?

THE last time we were at the Capitol we were struck by the very un-New Yorkish appearance of the audience, and it wasn't until we heard a woman whisper, "There's 'Our David,'" as Mr. Mendoza entered and took up his baton, that we realized it was made up in great part of Radio listeners from out of town.

Of course this was during the summer tourist season. As a direct result of the broadcasting, thousands of people living in remote regions, to whom a trip to New York is the event of a lifetime, now put the Capitol down on their lists as a place to be visited along with those time honored attractions for the tourist, Grant's Tomb, the Aquarium and the Statue of Liberty. It is the only New York theatre many of them have ever heard of, and it is perfectly natural they should wish to see the people whose voices they have heard so many times at home.

Should you be one of those almost unbelievably trusting listeners (and there are many), who accept all great Radio programs as bread cast upon the waters by kind-hearted souls who expect no reward on this earth beyond thank-you letters, we hate to disillusion you.

It is the greatest publicity since the beginning of time, and the shrewd minds back of our amusement interests know it. The remarkable 'hing about Major Bowes is that HE recognized it five years ago. Roxy knew so much about it from his experience at the Capitol that he had a broadcasting unit before he had a theatre, and report says he moved heaven and earth in an effort to get the Capitol time on the Sunday night hook-up, but WEA F remained loyal to the man who had co-operated with them at the beginning.

The "pepping up" of the theatre programs this winter, many of which are broadcast in their entirety, has brought a new element into the Radio audience. Some who were looking for livelier entertainment than had heretofore been coming over on the Sunday night broadcast are now eagerly watching for the all-star bills from the auditorium.

Up until last winter the Capitol had things pretty much their own way. They were the largest movie house in New York, and no other theatre attempted the elaborate ballets, stage presentations and opera bits as adjuncts to the pictures. But with the opening of the new Paramount (which sprawls all over Times Square and is so big you couldn't miss it if you tried) and Roxy's huge "cathedral" things were different.

Features became as common as actors out of work around Forty-seventh street. Roxy, of course led in the extravagance of



Youngest in the family are Edward Axt, 12, saxophone soloist, and Sylvia Miller, 16, soprano.

his productions, and presently we found the Capitol in the competition with even higher-priced stars than the Roxy was featuring. The Capitol already had a theatre orchestra that was conceded by critics to be the best in the country, but Roxy also had a famous jazz band. So the Capitoliens—an aggregation of artists of syncopation was organized, and drilled, we believe, originally by Paul Specht.

This performs weekly with guest conductors—such virtuosos as Vincent Lopez and Ben Bernie being among those who have wielded the baton for a week and goodness knows how much money. Then there is a revue, featuring some well known act from vaudeville or musical comedy, and the Radio audience hears them all, with a few exceptions, such as Van and Schenk, who could not be broadcast, as they have exclusive Radio contracts.

There has never been entertainment of such variety pre-

sented upon one program in a New York theater as these now shown weekly at the so-called movie palaces, and the managers of the legitimate and vaudeville houses are sitting back, wondering just where it is going to end.

Apropos of the situation they are telling a story along Broadway of the vaudeville actor who had striven for years to get a week's booking at that goal of the two-a-day, the Palace. He finally achieved his ambition this winter, and when he found himself at last on the bill of the greatest vaudeville house in the country—lo, all the stars were at the Capitol!

With all this tremendous expense Major Bowes is keeping his great stock troupe of artists intact, and if—as one listener said the other night—his voice doesn't sound as cheerful as usual, one's private opinion is that he had just had a look at the pay-roll. These favorites of the Radio audience, many of whom have been at the Capitol for years, include William Robyn, who started out as a phenomenal boy tenor, and has developed until today he is the theaters' most popular soloist and makes records for all the leading phonograph companies; David Mendoza, conductor, who is extremely popular with New York audiences, and his capable assistant, Eugene Ormandy; Dr. William Axt, who is responsible for the fine orchestral arrangements; Yasha Bunchuk, whose 'cello is as much an expected part of the Radio program as the Major's poem; Max Hersberg, pianist, and the versatile Westell Gordon, who composes, sings, and plays the 'cello.

Preserving harmony in such a group of temperamental geniuses through the years would seem to require as much diplomacy on the part of the managing director as he has shown in his handling of the Radio audience, and the fact that he has ever been alert to recognize a ability and give it its opportunity has endeared Major Bowes no less to his performers than to his listeners. A striking example of this occurred recently when he featured on the studio program, twelve-year-old Eddie Axt, a youthful prodigy on the saxophone, and the son of Dr. Billy. Accompanied by his talented father the young musician made a surprisingly creditable debut, and Major Bowes seemed as much gratified by his success as the father.

The directing genius of this great array of Radio and stage entertainment has long been an outstanding figure in the amusement world. Identified with moving picture interests for years, together with Messmore Kendall, he built the Capitol theater in 1918, and has served in a number of executive capacities with the Metro-Goldwyn-Mayer Corporation in which he is interested. He numbers among his personal friends all the more prominent in the world of the stage, pictures and music. He is married to beautiful Margaret Illington, long a favorite of the legitimate stage. In appearance he is the typical successful New Yorker, always meticulously groomed, and as to his personality, it is superfluous to comment upon that to the Radio audience, for if any man has succeeded in "putting himself across" with the listening public, it is Major Edward Bowes, paterfamilias of a very happy tribe.

Radio Finds Gold Pirates Missed

JUST now the world seems on the verge of many new revelations of a scientific nature. Practical television, still in an experimental stage, is promised to the public in a short time. From there it will be but a step to stage productions in the home. All the startling electrical wizardry shown in the Radio shows will soon be a part of our every day lives.

Not the least strange of the new inventions is the application of Radio to mineral prospecting—especially gold. Many letters were received by Radio Digest from all quarters following publication of the announcement by President Max Mason, University of Chicago, that prospecting by Radio had been proven entirely practical.

A letter from Lieutenant George Williams of Ancon, C. Z., Panama, tells of his own experience with a Radio prospector of his own invention with which he has unearthed part of the buried treasure hidden from the pirate Morgan, centuries ago, when he ravished the Panama coast.

"We have a four-year concession under the supervision of a government inspector," writes Lieut. Williams, "and so far our machine has never lied. Where it has indicated gold to be found, digging disclosed the gold. Thousands of dollars' worth

of ancient treasures hurried by priests in subterranean caverns have thus been recovered.

"The machine consists of a generator, transmitter, receiver, amplifier and two aerials. The aerials consist of many thousands of feet of wire wound on a hoop. The generator supplies the power to the transmitter and into the first aerial causing the lines of force to form a circle from one aerial to the other, cutting through the earth. The current is directed through a receiver and amplifying valve. Different sounds are given off according to the deposit under the ground which are observed through the headphones. In the case of gold which is a very bad conductor a very high pitched note is heard. In the case of lead a very dull sound is heard. Gold is the highest pitch heard while lead is the harshest."

The Panama newspaper reporting the explorations made by Lieut. Williams with his prospector says: "Exquisite golden ornaments and engraved precious stones were first brought to light in old Panama by Lieut. Williams, Thursday evening

at 5 o'clock. Treasure continued to be brought up from what is believed to be a subterranean tunnel at the corner of St. Joseph convent to the fourth block of the Empedrada street. It is the old church of the Golden Altar and the flames of Morgan did not touch it.

"The work of bringing up the treasure continued until dark when Adriano Robles, the President's general secretary, ordered his private police to remain on the scene throughout the night. The treasure was taken to the President and for two hours he looked it over and shook hands and congratulated Lieut. Williams on his first find. The President retained a piece of the treasure—a large butterfly shaped pendant inlaid

(Continued on page 126)



A moment's pause between numbers to permit you to meet face to face Miss Mathilde Harding and Arcadie Birkenholz, who present those especially interesting Sunday evening sonatas over the Red net. Yes, Miss Harding, the ring is obvious.

Damrosch Achieves Ambition

FATHER AND SON Struggle Against Many Adversities to Win National Leadership—Told in Autobiography

AT last we have the long heralded school of the air! It has been a tremendous task organizing and perfecting the mechanical details to carry out the ambition of Walter Damrosch to broadcast musical instruction to classes that would number millions.

That is one of the great things for Radio to do, to give to the millions advantages that hitherto have been accorded only to a privileged few.

Of course there is a great host of people who have no tolerance for Damrosch nor the type of culture he represents. They are totally unreconciled to music that has been hand picked by experts from the ruck of stuff that swells our annual production. They prefer the popular air that holds the pinnacle for the day.

But in the long run Damrosch and the classics will stand, of course, and it is for the far-seeing broadcaster to supply a demand that has a firm foundation. The schools are taking it up throughout the country by installing suitable receivers and amplifiers.

In New York City alone nearly 200 public schools are taking advantage of the course. Mail from across the continent indicates that nearly one thousand public and private schools are presenting the course with auxiliary and personal instruction. Besides the schools and the studios of the small individual music teachers there are thousands of homes where students and professionals have set aside the hour for these broadcasts as part of the individual study curriculum.

ONE may imagine the glow of satisfaction in the heart of the grand old maestro, Walter Damrosch, as he stands at the head of the New York Symphony lecturing and demonstrating to a class that stretches across the continent. Lessons in Musical Appreciation is the theoretical text book. The orchestra is the demonstration blackboard and ears are all that the student needs to reap the benefits of the instruction.

Walter Damrosch is indeed a national figure now. Perhaps a little personal history would be of interest to the listener and reader. He has written an autobiography called *My Musical Life*. He introduces himself as follows:

"I am an American musician and have lived in this country since my ninth year. I was born in Breslau, Silesia, January 30, 1862, and my first memories are connected with the war, the Austro-Prussian War of 1866. I was four years old and remember being with my mother in a room in our apartment

in Breslau, which was filled with flowers and growing plants (mother always had a marvelous gift for maintaining and nursing plants) and various friends coming in to condole with her over the death of my baby brother, Hans, who had died of cholera, which was then raging in Breslau. The second child of my parents had been christened Richard, after Richard Wagner, who had officiated as godfather at the ceremony. This child lived but a short time, and Wagner had vowed that he never again would stand as godfather for

the children of any of his friends, as the ill luck which had pursued him all of his life was thus carried even into their families."

He then relates his experiences in seeing the soldiers march to war and hearing the cannons boom and how his mother threw a wreath "which fell on the neck of the horse carrying King William and he, looking up, saluted her."

MMUSICAL conditions when his father first came to Breslau in 1858 were miserable enough but shortly thereafter the Breslau Orchester Verein was organized and "a regular symphonic orchestra was established with a series of subscription concerts.

"All the great artists of the day came to Breslau to take part in these concerts, and generally they stayed at our house, although our quarters were very simple—Liszt, Wagner, von Bulow, Clara Schumann, Tausig, Joachim, Auer, Haenselt, Rubinstein. Some of them I can remember vaguely, but of course many

stories and anecdotes were current in the family concerning their visits."

Many amusing incidents are told of the visits of the great men of that day and his boyhood experiences. That the senior, Dr. Leopold Damrosch was a strict disciplinarian he recalls thus:

"I think I was somewhat afraid of my father in those days. He was rather stern and taciturn. Life was hard and the struggle for existence difficult. He was somewhat severe about my studies and as those were the days when whipping children for naughtiness was considered an essential of their education I received my share of such punishment. In fact, sometimes I was whipped in school and then I had to take my school report home to my father and he would perhaps repeat the dose. But with all that I was very proud of him and used to enjoy trotting by his side along the promenade on the banks of the Oder, because so many people would take off their hats to him deferentially as he passed.



WALTER DAMROSCH stands before the microphone to teach his class Musical Appreciation. His class room extends across the nation. He demonstrates his theories with the aid of the New York Symphony Orchestra. He is on the threshold of his life-long ambition.

WHT--Coming Strong With Improved Conditions



"HE also gave us children a good deal of his time in reading to us books that would stimulate our imaginations and cultivate our instincts for the beautiful—Grimm's and Andersen's Fairy Tales and Arabian Nights, and some of the parables from the New Testament."

Living conditions in Breslau became more and more precarious until one day a letter came offering the elder Damrosch the leadership of an orchestra in New York. He accepted the offer and found America the real land of opportunity. He furnished a home and sent for his family and Walter Damrosch began his career as an American citizen by starting all over again in public school until he had mastered the language. His first appearance in an orchestra at the age of 14 was recorded as a failure as he had been directed to sound the cymbals at a certain place. When the time came to perform he was too frightened to move.

A period of rivalry soon grew up between Theodore Thomas and Dr. Damrosch for leadership. And it was not until 1879 that success dawned suddenly on the Damrosch horizon. The author states:

"But all this was changed like a flash when my father decided to perform *The Damnation of Faust* by Berlioz, until then unknown in America. This concert, which was held at Steinway Hall, in East Fourteenth street, necessitated the services of solo singers, the New York Symphony orchestra, the chorus of the New York Oratorio society and the male chorus of the Arion society.

"The work and the performance made a sensation. All New York buzzed with it, and during that winter, 1879, it was given five times in succession to crowded houses, creating an excitement such as New York never before had seen in the concert field.

"I played in all these performances at the last stand of the second violins, as my father considered it of the utmost value to me as a future conductor to be able to follow the conductor's beat as one of the orchestra."

THERE'S a new spirit of progress in WHT, Chicago, which faithful Pat Barnes has guided steadfastly and true through the storms and vicissitudes common to many broadcasting stations of late. WHT is getting better hours and more to do with. Pat, at the left, is almost smiling and Al Carney on the other side has even a broader grin than usual. In the center are the new WHT Dunnaway Sisters and Miss Doris Wittich, staff pianist and program director.

Upon the death of his father, Walter Damrosch continued with the work well started. Gifted with boundless energy and a desire for work, he assumed his new responsibilities without noticeable slack.

In 1887 he sailed for Europe to spend the summer in study with Hans von Bulow, an old intimate of the elder Damrosch.

"And on the steamer," writes Mr. Damrosch, "I met Andrew Carnegie and his young wife, Louise. They were on their wedding trip and on their way to Scotland, where Mr. Carnegie had rented Kilgraston, a lovely old place near Perth. . . . He invited me to come for a visit to Scotland after my studies with Von Bulow were over.

"In the late summer I accordingly sailed in a small steamer from Hamburg to Leith and was received with great friendliness by Mr. and Mrs. Carnegie at Kilgraston. Among their guests were James G. Blaine, his wife, and two of their daughters. My acquaintance with this remarkable family soon ripened very fortunately for me into close friendship and resulted finally in my marriage

to Margaret, one of the daughters—but I am progressing too fast."

From this romance Mr. Damrosch deviates to tell of his love for Scotch music and his long walks and talks with Mr. Carnegie.

During the World War he eagerly sought some way by which he could aid the cause of America and the Allies. He was finally assigned to the Y. M. C. A. to conduct an orchestra of fifty pieces in a tour of the army camps in France.

WHEN Walter Damrosch wrote his autobiography he had not yet become identified with Radio broadcasting. He had not realized the possibilities that were to come to him when he said:

"I have climbed a few hills, but only to see the mountains beyond rising higher and higher, the path upward often indiscernible through the mists surrounding the peaks.

"I love the people among whom my father settled because he firmly believed that in America his children would find a greater opportunity for development than in Europe.

"The musical field in America is certainly wonderful in its possibilities, and all my life I have reached out with both hands and have worked incessantly and enthusiastically in my calling. In part, at least, I have tried to repay what I owe to my compatriots for their confidence and help. But the power of the individual is comparatively small, and, while our musicians have already accomplished miracles within the short period that music has played a part in our civilization, so much remains yet to be done that I long for at least one hundred more years of life, partly to continue my work but still more to satisfy my eager curiosity as to the musical future of our people."

And now with his great national school for musical appreciation perhaps Mr. Damrosch will realize more than he could have at that time imagined could be accomplished during the next hundred years with the facilities he then had at his command.

Russia's Good Will Conquest

*AMERICA Shudders at Bolshevism
But Slavic Radio Artists Win All Hearts*

By Harold P. Brown

IS RUSSIA going to conquer us by Radio? Will America go Bolshevik lured by siren voices and intriguing rhythm of the dance and orchestra?

We can't deny but we are interested. We gather the family about the parlor Radio receiver and smile comfortably while we listen to Leo Ornstein and his piano, or the Russian Cathedral choir, or Maria Kurenko and her seductive coloratura voice.

They come to us in our homes direct from Russia. We sit entranced and perhaps wonder a little. Russia—the land of mystery; the country with a past, and a future that is the enigma of all historians.

We read today that they take the dolls away from little girls because they want to destroy the spirit that makes little girls want to play with dolls. What a crazy idea! But we rave over the Russian comedy Chauve Souris, though we understand not a word of it. And we choose for our very own their Parade of the Wooden Soldiers.

"But the revolution still goes on, and will go on until a practical government has crystalized into a nation," said Eliah Laveter, ex-political prisoner with Leon Trotsky in a Petrograd jail, then a fugitive, and now the Chicago printer whose hands set these lines of type.

Great, stumbling, blundering Russia with eyes in the sky and heels in the mud! What contrasts! What surprises! The uncertainties hold us breathless for what is to come next. Who will write into song the opera of the ages—the incomparable fugue of intolerance between the high and the low? Did ever a master conceive more romantic and tragic characters than Lenine who dethroned the Czar and turned the nation upside down for a murdered brother; the mystic monk Rasputin swept to the palace from the unfathomable murk of



ROXY likes Russian talent in his gang and one of his twinkling stars is Maria Gambarelli, formerly premier ballerina with Kossloff and Anna Pavlova. She's on her toes at the left. Beside her is Leo Ornstein, famous Russian pianist, heard during the classical programs over the Blue network.



ABOVE is the famous Russian Cathedral choir frequently heard of a Monday evening over WJZ and the Blue net. They are all real Russians and noted for their melodious basses.



Alexander Sklarevski, formerly of Imperial Conservatory, now of Peabody conservatory, and WBAL. Gregory Besrodny (center), brilliant student of Leopold Auer.

Marie Rosonoff, whose magic 'cello also is familiar to the Sunday night listeners.



Paul Kochanski, world-renowned violinist, whose Stradivarius is familiar to listeners of the Atwater Kent hour.

peasant ignorance; the Czarina's mother love for her delicate son, miraculously saved from death by the weird monk; the nobles who conspired to kill the monk; the generals removed from the fighting front by this uncouth interloper; the distracted monarch torn between dictates of spouse and the more practical counsel of his advisers, and the ghastly climax in the basement prison in Ekaterinburg?

Here is color aplenty for pageantry and every emotional whim, the verity that truth is indeed stranger than fiction.

WHO are some of these Radio legions who now sweep all before them with their exotic graces and charms?

We have spoken of Maria Kurenko. She is a native of Tomsk, Siberia. While she was still a wide-eyed and wondering little girl of 12 she was taken to Moscow to begin the shaping of her musical career. It was very quickly discovered that she had more than an ordinary voice. And after the early preliminary training she came under the special care of Mazetti at the Moscow conservatory.

But art sometimes goes hungry—even in Russia where at that time it was more highly appreciated than now. So the little lass from Siberia decided she would take a course in law. She pursued both lines of study and graduated from the two schools at practically the same time.

She placed her law diploma in the moth balls for the time being and made her debut as a professional singer with the Kharkoff opera company. From there it was but a step to the Grand Opera House at Moscow, and she was an acknowledged star of the first rank. Her first operatic appearance in the United States took place in Los Angeles. She has appeared in concerts through the principal cities. Since her premiere as one of the NBC stars on the national hook-ups she has come into very wide favor in the United States.

One of the greatest Russian features of the current season has been the Russian Cathedral choir of the Roxy gang. This organization was developed from the old Russian cathedral in East Ninety-seventh street, New York City, which was known as one of the best.

When the choir disbanded, its conductor, Nicholas Vasilieff, organized the Cathedral Quartet, and later almost all of the tenors and basses from the old Cathedral choir joined the new organization.

One of the most notable facts about this organization is the deepness of the notes of the bass singers. Russians, it has been pointed out, have the deepest bass voices in the world, and two of the best double basses are said to be members of the Cathedral Choir.

The conductor himself was born in Petrograd of a musical family. His father and seven brothers, like himself, were all

tenors. Nicholas Vasilieff began his musical career as a boy soloist in a Petrograd Cathedral, and was brought to this country to sing in the Russian Cathedral in East Ninety-seventh street.

CHAUVE-SOURIS netted \$93,000 in three weeks in San Francisco, according to a recent letter from Balieff to Ashton Stevens, dramatic critic of the Chicago Herald and Examiner.

"I wish you could read all of Mr. Balieff's 2,000 word letter," writes Mr. Stevens, "but much of it is intimate as only a Russian can be intimate, and some of it is sad as only a Russian can be. And perhaps Hollywood is a paradise to Balieff because he has found the

studios so Russianized."

A part of the Balieff letter is quoted as follows:

"It seems as if America were being bloodlessly conquered by Russia. Here we are in the coronation hall of the Mikhailovsky Palace, where the Czar, Paul I, was strangled. Historically Paul was different to the character portrayed by Jannings—he was small of stature—but how could the great Jannings be anything small?"

We made our way through this coronation hall as if in a dream. Couples in the costumes of the period of Paul I were dancing a slow, mining step. Through the small windows of the palace we could catch a glimpse of St. Petersburg of old, the St. Petersburg before the revolution. Walking from set to set in the studio where "The Patriot" is being filmed, we were given an unforgettable pictorial lesson of what we had been taught in childhood. Though the stage version of "The Patriot" did not meet with success, I am sure that the screen version, as directed by Lubitsch, will be one of the outstanding pictures of the year."

Balieff went to United Artist studios to inspect the making of "Tempest," a play of the Russian Bolshevik revolution. There he saw with ironic eyes—

"The almost unbelievably handsome Barrymore taking the part of a bolshevik involved in the horrors of 1917. . . . In a set supposed to represent the Cheka stand a group of horrible-looking bolsheviks. Irony of fate! These bolsheviks for the most part are played by Russian people who ran away from Soviet rule and cannot return to their own country. Now, for \$7.50 a day, they stand before the camera and repeat over and over again the horrors from which they fled."

RADIO audiences are familiar with some of the noted artists who have suffered even as Balieff has said. Consider Rosa Raisa, prima donna of the Chicago Civic opera and Alexander Sklarevski, formerly of the Imperial Conservatory at Petrograd, now of the Peabody Conservatory of Music, Baltimore, and frequent guest artist of WBAL.

During the great cataclasm of the first revolutionary onslaught Sklarevski became separated from his wife and children. He was a professor in the Sarator conservatory at the time. One day he found himself groping about in almost hopeless confusion. There was not a trace of his family to be found. For six years he followed one fruitless clue after another until at last he located them in Greece destitute and starving. They were happily reunited and came to America, where Sklarevski quickly gained recognition through a concert tour and eventually affiliated himself with the Baltimore conservatory.

Through the Thursday night broadcasts of the Chicago Civic opera thousands of Radio audiences became better acquainted with the rare voice of Rosa Raisa. She had been heard on occasion as the special guest artist of WGN, the Chicago Tribune. The opera revealed her real perfection as the prima donna. The Tribune, in telling of her courageous career and persistence, says:

"Rosa Raisa brings to the Radio audience one of the superbly artistic bits of salvage saved from the Russian maelstrom—a glorious, dramatic soprano voice. Born of wealthy Jewish parents in Bailystock, Poland, in 1893, Rosa Raisa passed through the tortures of Jewish persecution as her father's fortune became depleted, and finally escaped, after bitter hardships, to Naples, where she arrived as a young girl with nothing but a loaf of stale bread, a bundle of ragged clothing—and a voice.

"Today she is one of the foremost sopranos of the concert and opera stage and occupies a distinctive position in the field of modern ingenue singers because of her type—that of a soprano of the old "grand style," like Nordica and Patti. But two decades of work and struggle lie behind her.

"In Naples she abandoned the study of dentistry, which she had started with a cousin in Poland as her father's fortune waned, and fought her way to recognition as a singer under Madame Marchisio. After singing in Milan, Rome, and other Italian cities, she appeared at Covent Garden, London, and was instantly successful. Her voice attracted the attention of the great Campanini and it was he who first brought her to the United States."

SO we find them in the theater, on the screen and on the concert stage. They are the special entertainers in the cafes and the night clubs. They haunt the greatest of the Radio broadcast studios. Here is a typical announcement sent to the press of the country from one of the New York studios, which has featured many Muscovite artists:

"Leo Ornstein, Russian pianist, will be the guest artist in the Ampico Hour of Music which will be broadcast through stations associated with the NBC Blue Network on Thursday

evening, February 2, at 8:30 o'clock, Eastern Standard Time (7:30 o'clock, Central Standard Time).

"Ornstein was born in 1896 near Odessa, Russia. At an early age he gave evidence of unusual musical gifts. Talent in composition went hand-in-hand with his pianistic ability, and he soon made a name for himself in Russia, France, England and Norway.

"He gained his first fame as an exponent of the excessively modern in music. His compositions defined every convention, and he made free use of dissonance to obtain his effects. Today he is acclaimed by many critics as a virtuoso of delicate color sense and mastery of tonal character.

"Leschetizky's 'Barcarola' is the selection which Ornstein will play in this Ampico Hour of Music. This composition, a boat song, is of sombre character and suggests the famous 'Song of the Volga Boatmen' in the strange chant-like song

which is accompanied by the rippling water.

Frederick R. Huber, director of the Baltimore station, WBAL, announced a special program of the famous composer, Tschaikowski in the following words:

"The tense, emotional music of the Russian people will be heard over WBAL when the WBAL Concert Orchestra will present a program composed of the compositions of Peter I. Tschaikowski, one of the most celebrated of the Russian composers. Radio audiences need but little introduction to Tschaikowski, his compositions frequently being heard over the air, but lovers of music of this type will delight in the announcement that an entire program, rather than mere snatches of this popular musical writer's works, will be presented.

"Tschaikowski's career is one of the most interesting of all the great composers. Not displaying any marked degree of musical talent up until he was in his twenties, Tschaikowski studied law and held a judicial position for several years. However, his great love for music began to definitely assert itself and a few years afterward he left the courts for the conservatory, soon

becoming known as one of Russia's foremost composers.

"The following program of Tschaikowski's works will go on the air from 7 to 8 o'clock, Eastern Standard Time:

1812 Overture Solenne

Meditation

The Enchanted Lake (Ballet Suite)

One Who Yearned Alone

Allegro Grazia from the "Pathetique" Symphony

Selection from the opera "Eugene Onegin"

Nutracker Suite:

(a) Danse Russe Trepak

(b) Danse de la Fee Dragee

(c) March

(d) Dance Arabe



WHEN the sands of the desert grow cold Joseph Negeim looks at his wrist watch and figures it is just about time for him to be at the KMBC studio in Kansas City for some of his native folk songs. He should know a desert song or two—he's been there.

THUS we have a bit of the cross section showing how the better side of the Russian national is reaching out and gaining the good will of America. The forces in power there were quick to recognize the ingratiating influence of Radio broadcasting. The Soviets now control more broadcasting stations than any other country in the world outside of America. They have among their super-power stations forty-five varying from 20,000 to 40,000 watts and wave lengths from 150 to 1,117 meters. Most of the stations are owned by the government, labor unions or local Soviets.

Today Trotsky, the genius who wanted to rule or ruin the whole world, is banished from the scene of activities, and there seems a tendency to swing the government into established and proven lines. But tomorrow Trotsky may return, and then what? Our printer friend declares the revolution is still in progress. He has been through the thick of it himself, and to him Russia is a colossal tragedy, full of uncertainties. The spectacle still is in progress.

Thunders of war roll into the distance for the rest of the world but blood-blanching Russia shivers in terror through revolution and counter-revolution. The comic wobbles of America have become slaughtering monsters over there. Mass executions and nameless horrors come out of the night. Red hatred grips the slipping flag of state and rushes forward to set the world aflame again.

But we, too, have suffered and there is no foothold here.

So Father America gathers with his family about the parlor Radio. The evening lamp casts a mellow glow 'round about, the day's work is done and there's a good program on the air. He smiles a little grimly when the announcer mentions Russia but there is a flicker in his eye.

Be careful, you who would conquer him. He does not wish to be unnecessarily disturbed. He will muse on all the vivid thoughts that come leaping forward with mention of that name—Russia. Let him think of Russia through the



AMY GOLDSMITH is one of the promising debutantes in the Radio art circles of New York. She has been heard over the net stations and her lyric coloratura voice promises her a brilliant future. She is 18 years old, and sang in the finals of the Atwater Kent national contest. She has also appeared in a number of important concerts.

voice of a Chaliapin singing the Volga Boatman, or Marie Kurenko and her Shadow Song. Let him hear Jascha Heifetz, Mischa Elman or Rachmaninoff. But beware of those doubtful doctrines of disarmament whereby you would strip him to make an easy prey to mischievous plots. The dial is at his finger ends and he has plenty of interference troubles of his own.

Come on, You Television Wizards

OH you television experts, do your stuff! Not until the television apparatus is installed in the average home receiver will Miss Charlee Watts of KYW get all the credit that is due her for her ability. She swims and dives like a mermaid. Just now, however, she is crooning Southern folk songs—and how she can croon! She nestles up to mike confidently and whispers sweet nothings that come out of the loud speakers as though delivered to each listener personally.

Discovering the Voice of McQuahae

(Continued from page 6)

study of Mozart, Handel and Haydn and such others as were considered smart, not forgetting the while all the pretty Irish airs for which he was famous.

Today the highbrows, waggin' the world by the chin, shout loud enough for anybody to hear that Allen McQuahae is one of the few masters of the art of bel canto who sing the old masters as they should be sung and at the same time interpret with such authority the songs of the modern composers.



CHARLEE WATTS has other charms than her soft crooning voice. She's the pride of Father Neptune and has many aquatic feats to her record. But KYW fans love her for that Virginia drawl and the velvety softness to her voice as she sings the songs of the Southland.



THOSE who know their Radio A B Cs are well acquainted with the lovely voice of L C T D (Elsie Thiede), the charming lyric soprano who broadcasts regularly over the Columbia Broadcasting System.

Like so many other great singers, Miss Thiede began her musical career as a pianist of unusual ability. A graduate of the Philadelphia Conservatory of Music when 15, she was regarded as a child prodigy and received a gold medal for her pianistic accomplishments.

But sweet sixteen saw Elsie Thiede the pianist fade from view, and Elsie Thiede the singer come to the fore. A voice had been discovered and steps were taken to bring out its full beauty.

At the age of 18 the young soprano began her first concertizing, and she has been before the public ever since. Miss Thiede has appeared with big orchestras in this country and abroad. Many music lovers will (Continued on page 120)



IRVING BERLIN, the dark dreamy-eyed young gentleman in the circle, probably has created more popular songs that have gone around the world than any other American. He was born in Russia but has been a New Yorker since childhood. A review of his life as revealed by his songs was broadcast by the Columbia system.

One of the fair interpreters of his songs from a Chicago studio is Miss Melba Caldwell of WJBT, at the left.



FEW American singers have attained the rare distinction that belongs to Anna Case, described by many as America's favorite soprano. She represents a splendid example of the American quality of grit and determination.

Anna Case was born in the hamlet of Clinton, N. J. Her father was the local blacksmith and the family dated back to the earliest settlers in that section. Shortly after her birth, the family moved to South Brach, N. J., miles away from a railroad station. It was here that she attended a modest country school and sang in the choir of the Reformed (Continued on page 119)



BEHOLD the lovely Devora Nadworney!

Few artists among women have done more for Radio than Miss Nadworney. She is the premiere of the great chain artists, and was the first person to broadcast over a national hook-up—that historic Radio date of January 4, 1923. She has since been affiliated with the WJZ blue net of the National Broadcasting company.

She was born in New York City of Russian antecedents. Her singing career began as a church soloist. She won first prize in a national contest conducted by the National Federation of Musicians' clubs and gained her first wide recognition. Later she was a member of the Chicago Civic opera, guest artist of the Washington opera and member of the San Carlos grand opera company.

High Power Reserves At WJZ

*CALAMITIES MAY HIT Featured Artists
But---Sylvania Foresters Are Prepared to Fill All Gaps*

IF, perchance, some bleak and blizzardy night all the busses and taxicabs should suddenly stop running on Fifth avenue, and a combination of circumstances make it impossible for the featured artists of the great Blue Network of the NBC to arrive at the studio for their evening stunt at entertaining, there would scarcely be much consternation around headquarters. This absurd notion popped into our mind while we were an interested spectator of the multitudinous activities of the chains in the elaborate new building on the Avenue at Fifty-fifth street. Could such a contingency arise we felt the outcome would be something like the following:

Instead of gathering around the microphone and singing "There'll Be No Show To-Nite," we could fancy Mr. Keith McLeod picking out a nice cozy studio, dusting off the vibraphone and piano, and calling to Mr. Ludlow to bring his famous fiddle. Then after Mr. Cross and Mr. Sherris had run a few scales to limber up their voices, they would be all set and ready to go with almost any type of entertainment that had been scheduled for that evening. For while we have come to expect musical versatility from many of our announcers and studio directors, the talent and ability represented in the staff of WJZ, the key station of the Blue Network, has long been a matter of comment. Nothing has ever been allowed to go to waste around this studio, and everyone connected with the organization has always seemed ready and willing to take his place at the microphone.

As far back as we can remember WJZ, the Sunday night recitals of Godfrey Ludlow, violinist, with Keith McLeod at the piano, stand out as highly enjoyable events, and our only fear has been that with the advancement that comes with the years—you know, Mr. McLeod is now musical supervisor of the whole NBC, and Mr. Ludlow a featured concert artist—they might have less time for broadcasting. And one observing the musical supervisor at the manifold duties he has accumulated since the expansion of the great chains might reasonably wonder that he has the energy or ambition to turn himself into a broadcast artist on occasion, when so much of his time is given to directing others. When pondering upon the apparently inexhaustible powers of some of these more prominent people around our great studios, one

recalls the famous character in one of Hutchinson's novels, who was forever declaiming, "I'm a gardener, I am, not a bloomin' coachman"—or plumber, or whatever capacity he had been asked to fill, and thinks what a total loss one with his attitude of mind would be around a Radio station.

Likewise there is Milton J. Cross, whose pleasing tenor has become as familiar to listeners as the deep rounding tones of his announcing voice. He is always being sent hither and yon

for special broadcasts—he is the senior announcer of the Blue Network, you know—and is constantly in demand for work where sound musical training is an essential in presenting an important program. And Marley Sherris, who runs a close second to Mr. Cross in studio duties, has a resounding bass baritone to which one could listen throughout an entire evening's recital without the slightest effort. Ofttimes, while watching these men painstakingly presenting some commercial hour, which neither through its novelty nor musical value seemed likely to burn up the wires over which it was going, we've been moved to ask them why on earth they didn't build up an act of their own and sell it to some advertiser, and then the kind Fate which sometimes restrains our foolish impulses has stepped in and told us to mind our own business. Whether some telepathic current got over, or Mr. McLeod just naturally decided his home talent was as good as anything registered with the Artists' Bureau, that is exactly what happened last fall, and the delightful commercial half-hour of the Sylvania Foresters took the air.



SYLVANIA Foresters. Top left—Milton J. Cross, Marley Sherris and Walter Preston. Lower—Keith McLeod, Maurice Tyler and Godfrey Ludlow.

WE have made the surprising discovery this winter that in spite of all that has been printed about commercial broadcasting and the importance of its features, about nine-tenths of the Radio audience hasn't the slightest conception of how it gets its carefully prepared programs, or what an outlay of thought, energy and money these publicity stunts represent. Success of the expenditure depends on the attention gained. You will find the average listener assumes that when a manufacturer of Radio sets or automobiles or baking powder wants a little publicity for his product, he collects a few musicians out of work, herds them before a microphone and tells them to entertain. Heaven help our Radio programs if this were the pro-



From the reported sums received by a number of musical comedy and vaudeville stars for their appearance before the microphone this winter, they seem to be laboring under the delusion that they are appearing in the movies, and you will find by a canvass of listeners, that, aside from the appeal of a famous name, with a very few exceptions—we would nominate Will Rogers, Marie Cahill and Joe Cook—the Radio audience gets more enjoyment out of the microphone-trained entertainers on the regular staffs of the big studios.

A morning spent in the producing department of the NBC is a most illuminating experience. One meets program directors, assistant program directors, musical supervisors, and the like in bewildering array, sees doors labeled Artists' Bureau, hears talk of auditions, orchestrations and arrangements, an opera troupe is rehearsing in this studio, an orchestral unit is being monitored in another.

So much for the commercial feature in general. Now for the Sylvania Foresters—one of the newest, and by reason of the Radio audience's familiarity with its personnel, one of the most popular. This combination was worked out, arranged and cast by Keith McLeod personally. It consists of a male quartette, with violin and vibraphone soloists. Mr. McLeod plays the vibraphone himself. Godfrey Ludlow, with his famous De Rougemont Stradivarius, is the violinist,

and the quartette is composed of Milton J. Cross, first tenor; Marley Sherris, bass; Walter Preston, baritone, and Maurice Tyler, second tenor.

ON THIS page are three young men better known by their voices than by their faces. They are three of the "stand-bys" of the National Broadcasting company and sometimes have a voice in the Foresters' programs.

At the upper left is Norman Sweetser, who studied architecture at the university of Pennsylvania to become a broadcaster by the route of singing and acting. During the war he was a first lieutenant, U. S. A., and in the air service. After the war he appeared in the original Blossom Time company, Ginger, Beggar on Horseback, Annie Dear, Louie the Fourteenth, and Mayflower. He is with WJZ.

cedure. We usually start out to set the erring one right by quoting a few figures on the cost of the various hook-ups. Most people are impressed by money. And in case you haven't the current rates of the NBC pasted in your hat you may be interested in knowing just what the advertiser is paying for the privilege of entertaining you.

If he wishes to use the nine stations constituting the main artery of the Blue Network, the charge for broadcasting his program is \$2,800.00 per hour. The fifteen stations of the Red Network are sold for the trifling sum of \$3,770.00 per hour. Supplementary stations, the Mid-West, South and Pacific groups are all additional. We don't happen to have the rate sheet of the new Columbia Chain on hand, but we know they are not giving anything away either. Now, it is rather obvious that when it is costing a man a sum like this to hire a hall, he isn't likely to have his program put on by the Firemen's Band or the High School Quartette. He wants artists of ability to whom the Radio public will listen, and besides, the NBC has something to say about what it will use.

All commercial features, or acts, as we might as well call them, are originated, directed, cast and rehearsed by the capable heads of the program departments of the National Broadcasting Company. Often a clever play on the name of the product to be advertised, such as the Sylvania Foresters, sponsored by the Sylvania Products company, gives the feature its name; sometimes a complete scenario is composed, and when the act has been shaped and rehearsed it is presented to the sponsor for his approval. After that all he has to do is to pay the artists' salaries.



HERE are the thumbnail prints of the roguish looking gentry in the above threesome: Norman Sweetser (peekin' round), five feet seven; 170 pounds, light blue eyes; blonde. Curt Peterson (front center), 6 feet, 160 pounds; complexion, light; hobby, golf. Yes'm, he is. Two, both girls. Marley R. Sherris 5 ft. 8; 165 lbs; brown hair, fair skin, no appetite. Couldn't say, ma'am.



Curt Peterson is the gentleman in lower center. He was born in Albert Lea, Minn., February 12, 1898. He graduated from University of Oregon with a B. S. and from the army after the World War with rank of lieutenant of infantry. He taught voice in an academy. He is married, has two children—Stephanie, six, and Janeth, three. Both children are singers in the NBC children's hour. Madge Tucker says both tots sing baritone like their father.

As for the dignified looking Marley R. Sherris—he with the nifty bow tie and the cheaters—his features are perhaps better known, as he has traveled throughout the United States and Canada as concert singer of the baritone persuasion. He was born in Toronto, sang in the choirs, studied in London and settled in New York.

Chief Summons Dogs by Air

*CHEE WEE, Canine Comedian,
Entertains, but Q-tail "hogs the air"*

MORE animals on the air! Children everywhere have come to regard the Radio children's hour as one of the prime necessities of life. They do not need to "see to believe" if only they can hear.

So when a lion roars over the loud speaker they clearly envision Mr. Lion with spreading jaws, gleaming teeth and terrifying eyes. But lions are almost too temperamental even for a broadcasting studio, although they have been broadcast from some of the big movie studios in California.

Of course the Radio "Uncles" and "Big Brothers" and "Aunties" and "Big Sisters" never try such tricks as imitating cats and dogs—oh no, never—why should they when dogs and cats are so jolly and friendly to everybody?

Take Chief, the big police dog at Atlantic City, who delights entertaining Radio audiences over WPG. Incidentally he slips in a fraternal "woof" now and then for canine listeners who may be sitting about listening in with the children.

Chief has chosen for his mistress Miss Jeanette Mille. And Miss Jeanette has for her father Mr. Robert C. Miller. Mr. Miller is better known to the people of Atlantic City as "Chief" because he formerly was chief of police there. Naturally Chief, the dog, feels he is entitled to some special dignity and respect.

So it becomes his duty at certain times of the year to take the microphone and call together all the dogs of the nation for solemn convention at Atlantic City for the annual Dog Show. That the summons reaches far across the continent is indicated by the enthusiastic yips from thousands of shaggy throats, even so far as Los Angeles, California.

If you don't believe that behold this picture of Chee Wee, four-year-old pet of Mrs. Jacob Greenberg, who not only is at all times a delighted listener but often puts on his own recitals. He is a comedian.

Needless to say that cats are not so keen about the bow-wow hours over the Radio. Sometimes they indicate their distaste for such programs by ruffling up their tails and spines and spitting disdainfully. But that's all in a dog's life, and cats are reminded that they can have their own shows by themselves.

We hear a great deal about "hogging the air," and the children often wonder just where the "little pig that went to market" has his share—and what if he

Chief and Mistress at WPG mike and Chee Wee putting over a dog laugh at KFI



does "hog the air" and aren't hogs entitled to some rights anyway?

Well, here's Q-Tail, a college bred piggie at the Oklahoma A. and M. taking a few minutes off at the lunch hour to broadcast his philosophy over a KVOO remote control microphone. Realizing the greedy dispositions of his brothers and sisters and the indifferent attitude of his mother, one must give great credit for the self-sacrifice of this sturdy little porker in taking such a time to "hog the air" for a Radio audience.

Several listeners, not familiar with barnyard chatter, did not get the drift of Q-Tail's vernacular and made unprintable exclamations as they started lifting out tubes and making readjustments of

rheostats and controls to get rid of extraneous "noises," as they called it. In the picture Q-Tail's caudal appendage drapes gracefully to meet the angle of his knees, but when he get's worked up to real oratory the string (that in reality is a tail) becomes highly animated and twists into almost unbelievable contortions. This amazing fact is unfortunately lost to appreciative Radio audiences and the boys and girls who are listening to him.

Even snakes have a chance at the microphone. Many people maintain that a hissing snake is only a myth—that snakes never hiss. In fact they maintain that the snake is totally dumb, and all that smart talk about being as "wise as the serpent" is just snake talk. However, the curator of the New York zoo recently set a microphone in front of a diamond back rattler's nest and the rattler shook his "buttons" to show that at least some snakes are not dumb.

Once at KFWB in Hollywood a ferocious wildcat came snooping around where he was not supposed to be and found a microphone. A wildcat has a most peculiar voice, very highly pitched, and he might be easily mistaken for a simple little house cat. Well, sir, he found this microphone and began to air his feelings in a most aggravating way.

"I wonder if it is a rat or a mouse or a catbird?" said a little boy listening by his set a few blocks away. He put on his cap and went to investigate. Well, when he saw the wildcat, and the wildcat saw him—but that's another story.

Only this is a good tip to the directors of Radio studios. More animals on the air! Let them tell their own stories and make real parrots do the announcing.

Q-Tail "hogging the air" over KVOO, Oklahoma

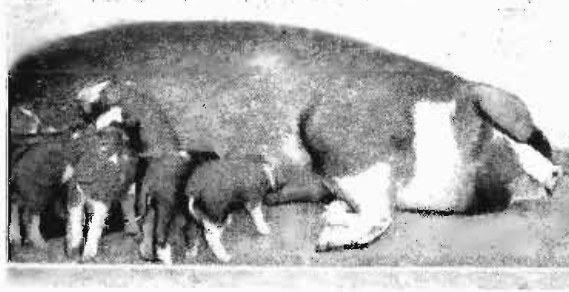

Radio Clubs Save Young Lives

*MARKED DECREASE Is Shown in Accidental Deaths
Where Children Organize Societies for Safety First*

FRIGHTFUL as the casualties to children from automobile accidents truthfully are in the course of a year there is not the slightest doubt but they would be even more terrible to a considerable degree except for the kindly influence of children entertainers over the Radio.

Practically every large broadcasting station has on its program a children's hour. It falls to the Uncles and Aunts and Big Brothers who conduct these periods to impress upon the small listeners the real dangers that crouch in the shadows beyond the curb stone to destroy boys and girls not on watch.

It would be impossible to describe

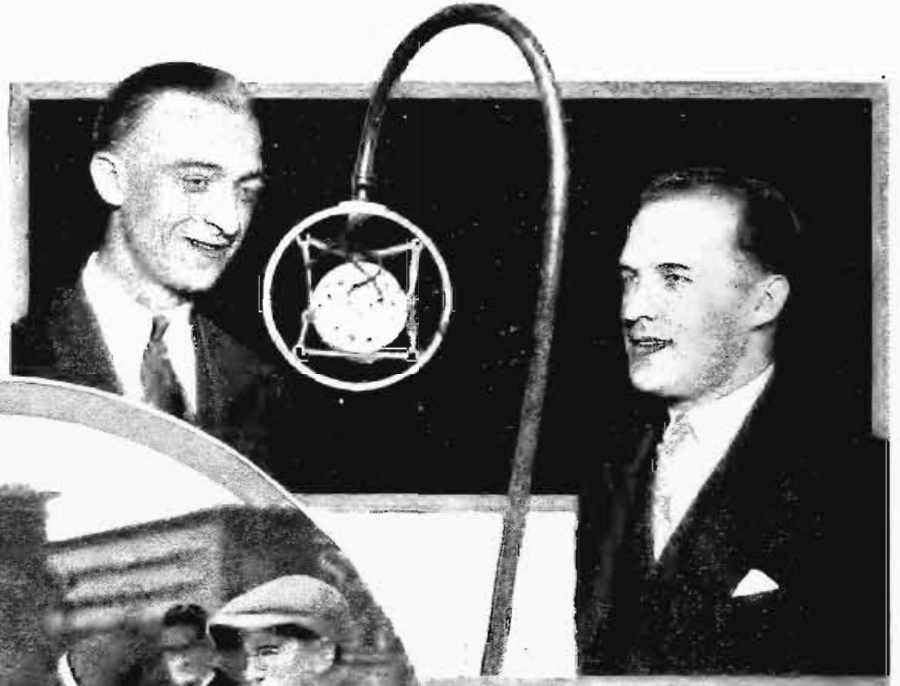

SCORES and possibly hundreds of children are alive today because of friendly warnings by Ready Eddie and Handy Andy (above) of KMOX, and Uncle Bob (left) of KYW.



or so of that, and Uncle Bob achieved the idea of promoting a safety slogan for the thousands of youngsters who very faithfully heeded his many admonishings. Don't play in the street, Uncle Bob told them. "Watch out for automobiles, won't you?" All of that suddenly brought the million-dollar idea to Uncle Bob—"I'm going to start a Radio club and call it 'THE CURB IS THE LIMIT CLUB' and any child can join who takes the pledge not to play in the street, count up to ten and look both ways before crossing a street, and to always befriend others.

No sooner said than done. Uncle Bob and KYW became the media of forming what has become one of the greatest institutions of its kind. A few weeks ago the 300,000th member joined the club, which means that actually that vast number of children have taken the pledge and become members of the club. Each has received a membership card too.

the work of all the good people who are engaged in this work. Two good examples will suffice. Probably the original prophet of "The curb is the limit" slogan is Uncle Bob of KYW, Chicago.

The director of KYW was asked for a story about Uncle Bob. Here it is:

A STORY concerning "Safety" can hardly be better introduced than to start with Uncle Bob (Walter Wilson) of KYW. Nearly six years ago, KYW, then the only station in Chicago and the pioneer of the West introduced a bedtime story feature for children, and of course "Uncle Bob" had to be the jolly good fellow who would be Uncle to millions of youngsters. The stories were told—thousands of kiddies imagined themselves before the log-fire while Uncle Bob told them of Indians, bears, wolves, prairie schooners, hunting trips and of how the different kinds of fish were caught. A year

That this most wonderful work has taken firm root is evidenced by the fact that not only parents have been heartily thankful to Uncle Bob, saying, their children heed Uncle Bob more than the folks; but The Curb Is the Limit Club, has become a slogan of business institutions, Kiwanis Clubs throughout the country, various organizations, schools, and the matter has been brought to the attention of gubernatorial bodies in Washington D. C. as well as various states. Then too, it is noted that in several instances other Radio stations have picked up the idea and are carrying on a similar good cause along the same lines born of Uncle Bob's big humanitarian work. Perhaps Uncle Bob is indirectly responsible for the many lives they too have saved.

Too much cannot be said of the great value The Curb Is The Limit Club has done toward reminding youngsters about the many dangers beset for them and perhaps no other Radio entertainer in the world has so large a steady audience as

Uncle Bob who has received 9,000 letters in one day's mail.

Ruel McDaniel sends a very interesting article of how a safety club was organized at KMOX in St. Louis. The writer apparently was unfamiliar with the work of Uncle Bob, Uncle Wip, Big Brother Bob Emery, Uncle Joe Fassen and many of the others but the enthusiasm of the story shall not be dampened because of that.

THE SAFETY CLUB OF KMOX

By Ruel McDaniel

IN the fall of 1926 the directors of the Safety Council in St. Louis tried a unique experiment in life-saving. For several years that organization had been diligently working along industrial lines of safety. It had cut down by more than 100 per cent the deaths by accident in factories and among adults in general.

One thing, however, was disturbing. The accidental death rate was increasing with a tormenting consistency. Something must be done to curb these needless deaths and the maiming of helpless boys and girls. Someone suggested Radio broadcasting as a means of teaching safety to the city's children and their parents.

One evening Girard C. Varnum, secretary-manager of the local Safety Council, secured permission to talk a few minutes on child safety over station "KMOX." Varnum was at something of a loss as to what to do or say when he reached the studio. He considered several lines of reasoning. The formation of some sort of Radio safety club among the children persisted in his mind.

In his short talk that first evening, he mentioned such a club. The first mail delivery the next morning abruptly brought back to Varnum what he had said the evening before, because it loaded his desk with letters and cards and memorandums. Some were from mothers, others from fathers, and a lot from children. Each mail delivery that day brought other cards and letters.

Out of that mass of mail and the vague conception of some sort of safety club grew the plans that created what is without a doubt the most unique safety club in the world, and provided a means of Radio broadcasting performing one of the noblest tasks that an industry or a medium can be called upon to perform.

SOON thereafter there came upon the ethereal scene three odd characters whose voices and names have become familiar not only in nearly every city in the United States but in some of the far-corners of the earth. Safety Sam and the Safety Twins, Handy Andy and Ready Eddie, began appearing daily at six o'clock in the evening to talk over "KMOX" about safety. For five evenings every week since that time this cheerful trio has talked over this broadcasting station to children and their parents all over the world about how to prevent accidents and deaths to children.

Without finances or any conception of where the thing would

lead, the trio, under the direction of the St. Louis Safety Council (the trio was in reality Mr. Varnum and two associates in the local council, William F. Yorger and H. J. Brammier) announced over the Radio that they had organized the Careful Children's Club and invited members.

They made it clear that any child under 14 years of age could join; that it cost nothing and the only thing necessary to become a member was to write a card to Safety Town, the designation given the home of the mythical club, signifying that the writer wanted to join. The applicant then would receive a card which bore the pledge of the club, a button for the member to wear, and a copy of the Safety Song. Safety Sam, Handy Andy or Ready Eddie—whoever happened to make the talk—would always explain that a boy or girl who asked to be made a member obligated himself or herself to read the pledge and live by it. That was all there was to joining.

The Safety Council had a few hundred of the cards and buttons printed and began mailing them out as the cards came in. It was totally unprepared for the 10,000 requests for membership that poured in the first week! Today the mythical club has nearly 500,000 members, all boys and girls under 14 years old. Safety Sam says that they could get 1,500,000 members in three months if the council had the money to pay for printing the cards and buttons and mailing them out.

THE Careful Children's Club has a member in South Africa who listens in to follow the instructions of Safety Sam and the Safety Twins every time it is possible for him to get the distant "KMOX" on his receiving set. There are several active members in Mexico; a score in Cuba; several in Alaska; some in England, and a dozen in Hawaii. Obviously the greater part of the membership is in St. Louis and other

cities and towns within a reasonable radius of St. Louis.

In St. Louis is little Francis Fucmmler, 12 years old and an invalid. He has not walked in several years. He heard about the club through a friend. He applied for membership. Although he did not have a Radio receiving set, the club gave the little fellow something to live for and he became its most enthusiastic member. He sent in hundreds of names of other children whom he had influenced to join.

Eventually his work for the club became known to a local business man, who presented the child with a five-tube Radio set. Being then able to listen in on Safety Sam and his twins, Francis became a booster in earnest. About that time the sponsors of the club decided to put on a membership drive, having secured a reasonable supply of cards and buttons. It offered a prize to the member who would send in or bring in the most applications for membership. Invalid Francis Fucmmler sent in 20,000!

That is how much interest boys and girls are taking in Safety Sam and his Careful Children's Club.

And has the club accomplished its objective?

Well, in 1926 during the months of August, September,

(Continued on page 120)



"OH mother, let us sit up just a little longer," pleads little Vonny and wee Marie Taylor when the sandman hour draws to a close at KMBC, Kansas City. "Let us hear Billy and His Uke, and then we will go to bed." From Billy's smile in the picture he has heard Vonny's and Marie's plea.

Everybody Mike's Friend Now

*Paris, New York, Wichita; Mountain or Plain
Voice of Radio Is Always Present*



RUTH ELDER could not fly away from Mike, even in Paris. She is seen here broadcasting greetings to all France. Later she was heard on the air from various American stations.

WAS ever there a time in history when an instrument of any kind achieved such conspicuous and instantaneous attention as has the microphone?

It took the small hand camera, the kodak and finally the moving picture camera years to find a place of familiarity in the public eye. The telephone instrument set a fast pace once it got started but it did not compare with the microphone.

Nothing of consequence happens any more unless one to a dozen microphones are on hand to make a report of the proceedings for countless thousands beyond the scene of action. We know this but we scarcely pause to consider how vast and significant a fact it is.

What a gift to all America was the broadcast of Colonel Lindbergh's return! Even in the most remote communities groups gathered around the loud speaker to hear all the breathless details caught in the moment of action and heard instantly in every corner of the land.

And on the other side of the ocean he had made his bow to all the European continent through a microphone in Paris. Ruth Elder, whose beauty and femininity made her a nine day wonder to the people of the French republic, also had her turn at the microphone in Paris.

In England it was the same. However, the British Broadcasting company does not seem to be as freely aggressive in packing up all matters of interest to the general public. It holds to the traditional British stolidity.

DISTINGUISHED Americans, going abroad, are introduced to the people through the microphone. In America if the visitor finds it inconvenient to go to the microphone the microphone goes

to him. The banquet table is spread in the golden banquet hall. The elite of the world gather about. And among those present at the speaker's place is our little friend whom we have familiarly begun to call "Mike." What would a speech be worth to the hundred or so gathered in the ordinary banquet hall? A lot of effort wasted, most speakers would maintain. So Mike takes his place at the table with perhaps half a dozen members of his family. The feast of reason that follows the demi-tasse is shared by the hoi polloi et al.

There is no place too holy to give Mike a welcome. He sits in the White House, the Senate, the governor's mansion, the bishop's chamber or the pulpit of the Rev. Mr. Averagechurch. He may even go to the street corner or squat in a belfry to hear the chimes. He goes into the heart of a mountain to report a tunnel blast. He goes up in an

airplane or to the frigid Arctic. He goes to the sick room and proclaims the heart beat of a human being to a specialist a thousand miles away.

Where was Mike a decade ago? The chances are you, Mr. Reader, had never heard of him. When Colonel Lindbergh swooped around the thinly inhabited countries of the Carribean the reports show that people came down out of the mountains and places where it had been thought he was an unknown person.

But somehow the people knew about him. Even in the half wild villages some of the people had Radio receivers and the fame of Colonel Lindbergh was shown to have penetrated jungles and highlands through the voices of the air.

NOW comes the great presidential campaign with floods of oratory from the big convention halls. Of course, carefully detailed preparations have been made to see that Mike is posted at the most important points. The last convention was the first one he ever attended and it was one of the greatest boosts he had had up to that time.

Radio stores and shops and all the neighbors who had Radio receivers entertained crowds day and night listening to the proceedings of the convention. This time the broadcasting will take place under more favorable conditions as the result of four years of experience. Fervid speakers will not be permitted to wander away from earshot in the heat of their inspired flights. Neat little pens will be arranged to keep them in appropriate proximity to Mr. Microphone.

Almost everyone owns a Radio receiver these days and, although there will be crowds at the public places, many thousands of listeners will follow the broadcasts for the first time.

The Radio listeners will know who's nominated and how as soon as the delegates themselves, which is a great boon to the voter.

Each new season marks a vast expansion of the realm of the microphone. The short wave transmitter promises a great stride for the near future. It is possible even now for voices to be heard more than half way around the globe.

Mike is truly ubiquitous. He is everywhere. What will the next decade show?

HUNDREDS of thousands who had stopped going to church long ago now tune in for religious services every Sunday. They find a solace for the troubled spirit in words from devout and inspired leaders. Nor do they have to go to the great metropolitan centers for Radio church service. The photo shows Rev. Dr. W. H. Rogers preaching over KFH, Wichita, Kan.



Radio Unites Rival Resorts

*Clearwater and St. Petersburg Stand Together in
Proclaiming Advantages of Gulf Coast*



Zona Gale Thaden, Staff Pianist and WFLA Cheer Leader.

be if you all take a 590 channel, hold down to 750 watts and divide time? What do you think of that?"

"Working for both stations it appears we ought to have a little more power," said Mr. Tison, "but we want to be perfectly fair. If St. Petersburg is agreeable to this arrangement I'll vouch for Clearwater. How about it?"

Mayor Baskin expressed sentiments of approval. In a little while they were traveling South again with the long wave tucked away in their mutual portfolio.

THE thing that pleased the St. Petersburgers most was that they had nailed down that "Sun" for their call. They boast of more sunshine per diem the year round than any other city in the United States. St. Petersburg rests its fame on the slogan "Sunshine City."

"Guess everything's jake now," said Mr. Tison when he had returned to the station. He called in his assistants and explained the situation.

"You are to be congratulated, sir," said Rocco Grella, director of the Clearwater Scarlet Guards, whose band concerts are enjoyed by DX listeners in Chicago and the Middle West. "Of course I understand it is way over to the other extreme of the dial, but there will be less interference for those who deliberately set their dials to get us. I shall

"YOU tell 'em," said Walter Tison, directing Mayor Baskin to a chair.



ALMOST the next best thing to going down to Florida during the cold snaps in the North is to listen to the Florida open air concerts over the Radio.

After WJAX, at Jacksonville, probably the strongest station heard from the Land of Flowers is the one at Clearwater on the Gulf Coast and about half way down to the Keyes. Dividing time with WFLA at Clearwater comes the newer station, WSUN at St. Petersburg, out on the tip of the peninsula of Tampa bay. They both use the WFLA transmitter and thereby dissipate a fictitious rivalry for the winter tourist business. United they stand and together they broadcast for the superior advantages of the Gulf Coast as against the alleged more tempestuous vagaries on the Atlantic side.

St. Petersburg stood aloof during the mad scramble for favorable wave lengths at the time the federal Radio commission was organized.

"We want a wave," said the St. Petersburgers, "but we want it peaceably. When they get all through scratching, biting and pulling hair we'll step in like gentlemen and ask for whatever we are entitled to."

That was the attitude of Mayor Ham Baskin as he discussed the matter with W. Walter Tison, director of WFLA at Clearwater. But when noses were wiped and teeth set straight again even peace loving WFLA found it had been gouged out of its 820 kilocycle channel. Mayor Baskin and Mr. Tison packed their bags and hied post haste to Washington. In short order they appeared before the commission and delivered the Voice of the Gulf Coast at close range.

The commissioners scratched their heads, chewed their pencils and started figuring again.

"Tell you what," was the ultimate conclusion, "how'd it

Rocco Grella, director of Scarlet Guards.



begin preparations for a series of open air concerts at once. We will lure the shivering North down here with our music 'underneath the sheltering palms.'"

Miss Zona Gale Thaden, accompanist and staff artist, stepped over to the piano and dashed off a few bars of Dixie.

"We'll make 'em wish they were in Dixie," she said.

It was Mr. Kerrick who had sponsored the plan of Radio consolidation with Clearwater. He was elated at the report. Soon he had a committee arranging details for a gala performance to open the new WSUN for the edification of a listening world.

Thus Radio brought two rival cities into a strong alliance and set a worthy example for Minneapolis and St. Paul in the zone of ice and snow.



"BUFF and Van" is a short way of saying Forrest Buffington and Jack Van Cleve, the twin troubadours who sing or play any number of a dozen instruments at WJBL, Decatur, Ill.



HOO-HOO! C'mon over, quick! Sally's found! Yeah, thir! Right up in the corner she is—Sally Wisner—and she sings over WOW, Omaha. Sally's pal is Phyllis Reiff, violinist.



MAURICE WETZEL, veteran KYW announcer who wandered into the wildWOOD of Furnitureville, Mich. Now he is back again as chief announcer at Westinghouse, KYW.



PRETTY, huh? Say, you should see the original! Louise Fordham, balladier at KGO, gets more desperate love letters than any other artist ever heard at this popular station.



CHARLOTTE and Mary are the gentle pair who breathe and sigh contentment over the WLW microphone. Mary Tudor is the queenly miss above and Miss Meyers is nearest to you.



THESE are Three Prodigals of the WLAC "Thrift Station." They are prodigals with their choice brand of Radio entertainment. Names—Frank, Claude and Hal (Hal's a gal).



ISHAM JONES, the one and only Isham, world famous orchestra leader who swings a chipper baton for the Riverside Trail Blazers through the Blue net from NBC Chicago studios.



LISTEN, Mike, it's my turn now," says Miss Mildred Bailey at KPO. "But you know me, Mike," insists black haired Refa Miller. "I give you both the air," answers Mike.



MANY a good yarn comes from WSKC, World's Star Knitting company station at Bay City, Mich. Announcer S. F. Northcott seems to be spinning one here with the aid of Fred Gunsell.



SO this is Mademoiselle Armand! Ah, ees it not zee great pleasiere to meet so charming la femme! She brings back old times of France through the NBC network.



MARIA KURENKO is one of those Russian Radio artists capturing American listeners with her voice. She's from Moscow Conservatory.



HERE is one whose voice never fails to charm Radio audiences from coast to coast, and really it is quite the best photo of Mary Lewis we ever received.



ONE of the most sparkling glints of the scintillating hour of frolic on the KYW program is The Duo-ukesters, Gay and Lou. And here they are just as they look in action.



THEY may clinch a trifle on dignity, but WTIC at Hartford does have merry moments when the Variety Entertainers are turned loose in the studio with "mike" aside.



THIS is Topsy Turvy Gertrude of KOIN, Portland News, Ore. She's a big hit with the little Oregonians, and comes along just ahead of the Sandman in time to send them happily to bed.



ARE you happy? Do you get up in the morning with the song of the lark in your soul? Maybe something's wrong. Better consult Dr. Palmer's Happy Hour Twins, WOC, Davenport. Here they are, Pat Flanagan and Sunshine, administering health doses to the "patients."

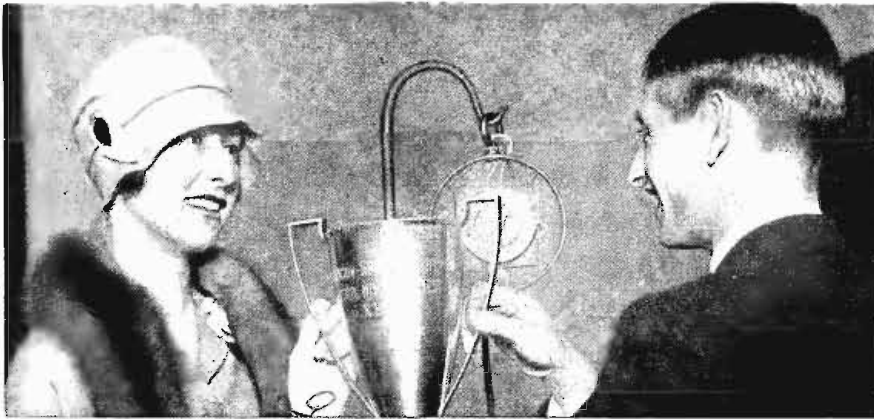

OH for a memory like Hilda M. Greninger! Don Lee, owner of KFRC, San Francisco, promised a silver loving cup to the person who remembered the most of a series of old time songs to be broadcast. Hilda jotted down the correct names of 35 out of 36—lucky girl!



EDGAR GUEST, the beloved poet-philosopher of Detroit—sometimes leaves the home nest and broadcasts at WBAL. He is said to be the only newspaper man in the world whose employer has publicly stated he would pay him any salary he asked.



WHEN the call of the cows and chickens stirs your soul to vague longings for the old farm and scenes and sounds pastoral, don't hesitate. Just roll out of bed and tune in the Barnyard Twins of KOIL, Council Bluffs, and you'll be there. The boys are right by the barn door. Old Bess, the bell cow, jingles by to the left and Robinson, the rooster, is flapping his wings for a morning gesture on the horse trough near.



MANY old friends turned DXers when J. R. Foster left WBCN, Chicago, to become manager of CKLC and CJCR, Canada. Scarcely a day passes that J. R. does not receive mail from those who formerly heard him in the States.



HUSH! 'Tis Toscha Seidel, and when he brings that bow down you are going to hear some real music. Toscha, as you probably know, is another of those Russian air conquerors. He came to America, armed with a violin, and found invasion a path of flowers, so to speak.

MANY listeners think of WGR, Buffalo, as a pretty girl like Miss Edna Zahn, one of the station favorites. Wait until Miss Edna gazes into the telemike and you see those eyes roll while she sings!



MUST have the whole Dahm family in Radio—one in Detroit, Clearwater, Chicago, and here's Cornelius G. in St. Louis. The St. Louis Dahm is still a junior in college—but it's the Dahm quality that counts, they say.

WALL street and the great American money market are just outside old Trinity church where Channing Lefebvre sits at the organ and plays those delightful interludes one hears during the Seiberling Singers' hour of the NBC. Perhaps this is where those gold(en) notes originated.



DEVOTEES from the Baldheaded-row listened avidly and recalled old scenes when Frank Daniels broadcast "The Ameer." He played the original lead and the support was all that could be desired.

CONTACT! The new Varsity Drag—that dance you have heard so much about—G and Zelma O'Neil is the little lady who's doing it. Just follow her example and you'll be doing it, too. The gentlemen with her are Hal Kemp, B. A. Rolfe and Vincent Lopez, dance orchestra maestro.

Orchestras Dominate

Deluge of Votes in International Proves That Listeners Have and Are Willing to Vote for



LOOK, Lindberg! No wonder he gets over the air so well! He's Ben Lindberg, KFPY, uke and songster.

MUSIC, music, music everywhere!

Never was the world so filled with music. Wherever you are—in the heart of the city, in the arctic, the tropics or the heart of the wilderness—swirling about you, over you and through you are ten thousand melodies.

Whether we actually hear them or not the thought that music is there somehow gives one a feeling of satisfaction. It seems much better to think of pervading tunes being present like happy thoughts than to conceive the surrounding atmosphere an impotent void. Receivers have been made so compact and portable that it is not unusual to see them being carried along like cameras to be set up on a restaurant table or in a tourists' camp.

So the music sweeps on wrapping the entire earth in tides of harmony. Correspondence in this Radio Digest shows that the Eskimos in the North, so far that contact with the rest of the world comes but once a year, pick up the tunes of the old fiddlers' contests at KDKA and play them for the Canadian Mounted Police in their isolated outposts before the supply ship arrives with its annual contribution of phonograph records.

Dominating all the music that dances its way around the world and out into space is the variegated music of the orchestra. Songs there are and a few speeches but the orchestra furnishes the motif of the average program. No broadcasting station could hold one dial for a minute without its mead of orchestral music.

While this fact is pleasing to those who are professionally interested it also is a fact quickly seized upon by greedy-eyed racketeers as an opportunity for graft. For instance all the Chicago broadcasters were called together recently and given orders by the walking delegate of the musicians union that they must hire so many persons or pay so much license or give up their musicians.

It is not believed the rank and file of Chicago musicians are behind this maneuver and many have expressed resentment.

But by and large the orchestras throughout America are doing a noble and worth while service to humanity. They give the best that is in them, they put the spirit of the age into their instruments, they broadcast music because music is life to them.

That which is life to them comes to the listener as an offering, a moment of pleasure that cost the individuals who gave it years of devotion to the art.

And so an orchestra—especially the Radio orchestra—comes to possess an individual personality. The personality generally takes the form of the leader of the orchestra. It is easier to think of one than of a score of faces. Or it may individualize an institution. These

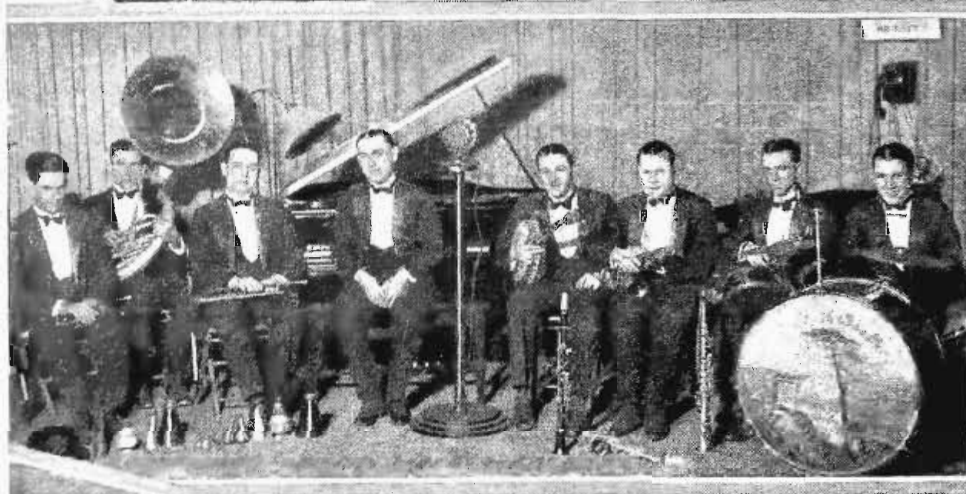

DIXOLA Novelty orchestra at WSMB, New Orleans. They are making a good run for Southern honors in the contest.



OLD MISSOURIANS at KFPY—a happy-go-lucky bunch of Radio listeners who got together to show the regulars how to broadcast. Jean Starr was the star of the performance, blue singin'.

in All Radio Programs

Popularity Contest Their Preferences Favorites

individualities or personalities come to represent to the unseeing listener a source of pleasure. Mention of the name identified with the organization stimulates a desire to be friendly and, possibly of service.

Thus it has happened that the first great international popularity contest for Radio orchestras has awakened a keen interest among the listeners of certain favored orchestras. These listeners believe the orchestra to which they have respectively attached their affections are of course ideal. It is unthinkable that anyone should presume to believe that other people might consider another orchestra more popular. Perceiving that this situation would naturally interest Radio listeners in every community Radio Digest decided to call for a vote.

Which are the seven most popular orchestras in the United States and Canada? Which one of these seven is the most popular of all?

That has been the idea of the Radio Digest contest. It has been taken into account that leading orchestras in each of the geographical divisions of the contest cannot be heard by all those who vote. Therefore it is not presumed that all the listeners can compare the respective merits of these orchestras playing in direct competition with each other. But it can be shown how many listeners are sufficiently interested to vote for each orchestra.

Maurie Sherman got the first quick response from the listeners of WLS, Chicago. Sherman's orchestra plays for one of the most popular cafes in Chicago. He has made a careful study of the kind of music the people within range of his music like. The call for votes in support of his judgment in selecting and presenting the kind of music the people of the Chicago area preferred was promptly acknowledged by a swarm of ballots in his favor.

When the results were subsequently published in Radio Digest a score friends of the WBAP Seven Aces were astonished. They talked the matter over and decided to raise the next count in favor of the Texas boys. It was done accordingly, and the following month the Seven Aces topped the list while Paul Christensen's orchestra at WHO, Des Moines, suddenly began to make an emphatic gain.

EVERYBODY'S talking about the rapid growth of Portland, Ore. Perhaps Herman Kenin and his guitar is one reason and his Multonomah orchestra another. Look 'em over, girls, most all of 'em are eligible and susceptible.



ALL winter long shivering denizens of the North tune in their DX calls and hear the alluring Springtime Serenaders at WFLA, Clearwater, Fla.

RANDALL'S Royal Fontenelle orchestra is said to be responsible for the wow in WOW. Art seems to have the boys' attention every minute. Thousands have declared this to be the most popular orchestra in the United States.



The following month it was nip and tuck between these three orchestras and their defenders. Those in favor of the Christensen orchestra then put forward such a mighty wave of determination they swept all before them in such volume the other orchestras looked helplessly lost in the distance.

For the first three tallies Irvin Plumm's orchestra at CNRW held a clear field over all the other Canadian entries. Then came a new Goliath in the person of Mr. Guy Watkins and his Art Harmony Seven, CFQC, Saskatoon who outstripped the Winnipeggers unmercifully.

WNAX Yankton, S. D. Leads National Orchestra Popularity Vote

letters from Cliff Jones, announcer and director for CFQC, Saskatoon, Sask. He is hustling the votes for Guy Watkins and His Art Harmony Seven. That he is able to get the same snap into the Microphone that he does in his letters doubtless has something to do with the fact that Guy Watkins' boys are making a strong bid for the international leadership. They are only 125 behind Krausgrill who is in second place.

"Some of the boys are saying," writes Mr. Jones, "that no doubt the newsstands down there would have plenty of customers for maps and books to help them locate the little village of Sas-



YOU can't make real music from hard-boiled shirts and undertaker's raiment. It's what you have in your chest and between your ears that counts when you are trying to earn a reputation as the world's most popular orchestra. That's what the Gurney orchestra at WNAX, Yankton, South Dakota, thinks and does. Here they are just the way they did it when they rolled up 43,270 votes in the Radio Digest popularity contest for the world's most popular Radio orchestra. "What's the fork for?" asked a prominent farmer of the leader. "We get our pitch with it," was the prompt answer. "And we're going to put Yankton on the map of North America."

While Iowa voters have taken several of the Radio Digest trophies in recent years it seems according to the latest vote that the center of activity has crept up into South Dakota and the Gurney Radio orchestra at WNAX, Yankton, registered to 43,270.

But the Mid-westerns have a close contender in Walter Krausgrill's Balconades Ballroom orchestra at KFRC, San Francisco. Krausgrill developed sudden strength at the third count and has been growing by leaps and bounds.

There is still time to go for the final ballot. Past records prove that there is no guessing what surprises are in store. Many listeners have been saving their coupons to gain the bonus advantages. These will come in in floods when the contest ends at midnight of April 10. Double count ballots are found in this issue.

Russel E. Shantz has strong hopes for the Century Orchestra of WMAK, Buffalo. In his letter with 2,500 votes he says:

"We think these boys have the best Radio band in the East at least, and certainly want to see them head their division in this novel contest. We are just beginning. Watch our smoke!"

Hyde R. Randall, director-announcer

at WSMB, New Orleans, where the Dixola Novelty orchestra broadcasts, writes that "we are giving the contest a two-hour shot every Monday night." That means votes and prospects are good for the Dixola Novelty orchestra.

Charles FitzGerald and his Rythm Kings at WJR, Detroit, sends a batch of letters and votes from friends who are pulling for the Kings to win in the Detroit area. They are each keenly interested in gathering votes for their favorite.

D. B. Gurney, president of the Gurney Seed & Nursery Company, and sponsor for the Gurney WNAX orchestra now at the head of the national list, is personally assisting in the call for votes for this enterprising organization. The listeners are all staunch in their support of the WNAX programs as shown by a recent survey by disinterested individuals. A great deal more is to be heard from this station in a national way in the future.

Down Texas way the Seven Aces "All 'leven of 'em" are still holding the West district, yielding the international leadership to the Yankton boys of the North. Listeners to WBAP believe that the Seven Aces are still destined to win the gold plaque.

There always is a good chuckle in the

katoon where Guy Watkins and his orchestra hold forth, but, believe me, the Radio fans in this part of the country know where Saskatoon is, and they seem ready to back us with plenty of votes."

At another time he writes, "This is Saturday afternoon, and we do not work on Saturdays but lay off and drink beer, some day you will be free. Gosh, I'll bet you hate that guy Volstead!"

It was Irvin Plumm's orchestra at CNRW, Winnipeg, which first held the Canadian honors. And there still is a possibility that Little Jack Horner may stick his thumb into the Contest pie and pull out a Plumm for the Sixth district.

"The confidence that our friends throughout the country have in our winning this contest is overwhelming," writes Mr. Christensen of WHO. "The local Junior Chamber of Commerce is backing us to a man, and I think every paper in the state had something nice to say about us the day after the February issue of Radio Digest hit the newsstands. Again I want to thank Radio Digest for a movement that will benefit every orchestra in the country that is taking an active part in it."

The standings of the leaders at the last count before this edition of Radio Digest goes to press is shown in the adjoining lists:

WORLD'S MOST POPULAR RADIO ORCHESTRAS

Leading America West

Gurney's Radio WNAX orchestra	43,270
By Districts	
No. 1 East, Century Orchestra, WMAK	3,223
No. 2 South, Dixola Novelty Orchestra, WSMB	5,643
No. 3 Midwest, Paul Christensen, WHO	25,089
No. 4 West, Seven Aces, WBAP	28,292
No. 5 Far West, Walter Krausgrill's Balconades Ballroom orchestra, KFRC	30,828
No. 6 Canada, Guy Watkins, CFQC	30,703

Krausgrill of KFRC
And His Balconades in Second Place

Cock-a-Doodle-Do orchestra, KTHS	512
Majestic Club orchestra, WRVA	505
DISTRICT No. 3—MIDDLE WEST	
Comprising: Ohio, Indiana, Illinois, Michigan, Wisconsin, Minnesota, Iowa and Missouri.	
Paul Christensen's orchestra, WHO	25,089
Maurie Sherman's orchestra, WLS	4,142
Charles Fitz-Gerald and his Rythm Kings, WJR	2,815

WOS Radio Ramblers	2,692
Chief Razzberry's orchestra, KOIL	1,268
WENR Studio orchestra	1,141
Crosley Cossacks, WLW	1,032
Kentucky Serenaders, KYW	998
Fred Hamm's Victor orch., WLIB	890
Coon-Sanders orchestra, WBBM	862

DISTRICT No. 4—West	
Comprising: North and South Dakota, Nebraska, Kansas, Oklahoma, Texas, Montana, Wyoming, Colorado and New Mexico.	
Gurney's Radio WNAX orchestra	43,270
Seven Aces, WBAP	28,292
Randall's Royal Fontenelle orchestra, WOW	15,228
Chief Gonzales and his Arabian Room orchestra, KOA	1,143
Henry Lange's Gunter Hotel orchestra, WOAI	1,099
Ernest Loomis' Victor Recording orchestra, KOA	1,093
Joc Willrich's orchestra, KPFC	1,013
Howard Fordham's orchestra, KFH	879
Arlington concert orchestra, KTHS	780
Collegians, WFAA	773

DISTRICT No. 5—FAR WEST	
Comprising: Idaho, Arizona, Utah, Nevada, California and Washington.	
Walter Krausgrill's Balconades Ballroom orchestra, KFRC	30,828
Vic Meyer's orchestra, KJR	9,888
Max Dohn's studio orchestra, NBC	2,651
Andy Wallace and his band, KFVI	1,299
Herman Kenin's Multnomah Hotel Victor Recording orchestra, KEX	1,037
Majestic Ballroom orchestra, KPON	942
Cole McElroy's Columbia Recording dance band, KOIN	932

District Leaders

DISTRICT No. 1—EAST	
Comprising: Maine, New Hampshire, Vermont, Massachusetts, Rhode Island, Connecticut, New York, New Jersey, Pennsylvania, Delaware, Maryland and District of Columbia.	
Century Orchestra, WMAK	3,223
Dok Eisenburg and his Sinfonians, WNAC	2,853
Vincent Lopez' orchestra, WEA	2,281
Crosley Moscow Art orchestra, WEA	1,895
Freddie Rich's orchestra, WJZ	1,704
Palais D'Or orchestra, WEA	1,399
Roxy's symphony, WJZ	1,087
Ipana Troubadours, WEA	1,052
Al Steele's Musical Vagabonds, WMCA	958
Club Worthy Hills orchestra, WTIC	884
DISTRICT No. 2—SOUTH	
Comprising: Virginia, West Virginia, North and South Carolina, Georgia, Florida, Louisiana, Mississippi, Alabama, Tennessee, Arkansas and Kentucky.	
Dixola Novelty Orchestra, WSMB	5,643
Andrew Jackson Hotel orch., WSM	1,147
Chas. Dornberger's orchestra, KTHS	1,098
Kentucky Hotel orchestra, WHAS	938
Tennessee Collegians, WLAC	779
Ruby Brown and his orchestra, WSB	763
Nick Rose and his Revellers, WLAC	655
Hotel Richmond Orchestra, WRVA	551



WALTER KRAUSGRILL (center) and his gallant Balconades Ballroom orchestra members who have forged ahead in the international orchestra popularity contest. The Krausgrill contingent got just a bit of a late start but they made fast strides to overtake the leaders. A dark horse from South Dakota then came dashing out of the dust, running neck and neck with the Californians. The race is still on.

Joe Mendel and his Pep band, KFRC	928
Silver King Revelers, KGW	917
KPO Orchestra	770

DISTRICT No. 6—CANADA	
Comprising: The entire Dominion of Canada.	
Guy Watkins and his Art Harmony Seven, CFQC	30,703
Irvin Plumm and his orchestra, CNRW	4,477
Chateau Laurier concert orch., CNRO	587
Danny Yates' Hotel Windsor orchestra, CKNC	463
Jack Denny's orchestra, CFCF	397
Harold Rich-Morris London Versatile Canadians, CFCA	358
Eveready orchestra, CKNC	304
Jackie Souders and his orch., CNRV	153
Palm Room orchestra, CKCL	104
Cabaret Belmont orchestra, CNRV	99

In the book size form of the new Radio Digest an edition de luxe has been produced to give the standings of these orchestras a prominent position in the family libraries for months to come.

Subscriptions taken in the contest will be extended issue for issue.

Ancient Hu-chin Plays Jazz

Two-Stringed Fiddle From Time of Confucius Comes to Life for Service of Young Moderns

CHINA is very old. Archaeologists are constantly making new discoveries of its past. They are reaching back into forgotten ages and unearthing vestiges of a civilization that are all but astounding.

Bob Casey, reporter and explorer for the Chicago Daily News, and author of the Step on the Stairs, written especially for Radio Digest, has, since the first of the year, broken his way alone through an almost impregnable jungle to discover a new citadel in southern China—a city that once teemed with a million population and within which, it appears, no white man ever before had set his foot.

This strange and amazing background gives the modern China an air of mystery. Something is happening over there which the rest of the world understands but little. The Chinese are taking on the Western civilization. They attend our schools and universities and that accounts for C. L. Hsiang and J. S. Yong, both of Peking, now attending the University of Minnesota, and their curious two string fiddles heard occasionally over WCCO at Minneapolis.

The Chinese name for the two stringed fiddle is hu-chin. The two students are not very proud of it. They think it is

too primitive. But it has proved very interesting to American audiences. Either modern music is going back or the very old time music of China is catching up, as the hu-chin seems to be regaining favor in the younger set of the Celestial Kingdom.

"We would blush to be seen playing the hu-chin if we were at home," said young Mr. Hsiang. "It's much too old fashioned. But after all it is amusing and we get quite a kick out of it, as you say."

"No, it is not so venerable as some of our real curios. I believe it was brought into general use among the musical circles of the period from one of the northern provinces at about the time of Confucius."

That it survived at all is attributed to the use made of it by the more ignorant classes. Almost anyone could have a hu-chin in the home—and, certainly, any human being with a human soul must have a certain amount of music in the course of a lifetime. So it was up to the hu-chin to satisfy the musical longings of those who could not afford more complicated

and more expensive instruments. Every cottage had a hu-chin. "But with the jazz epidemic sweeping over China, as it did (Continued on page 123)

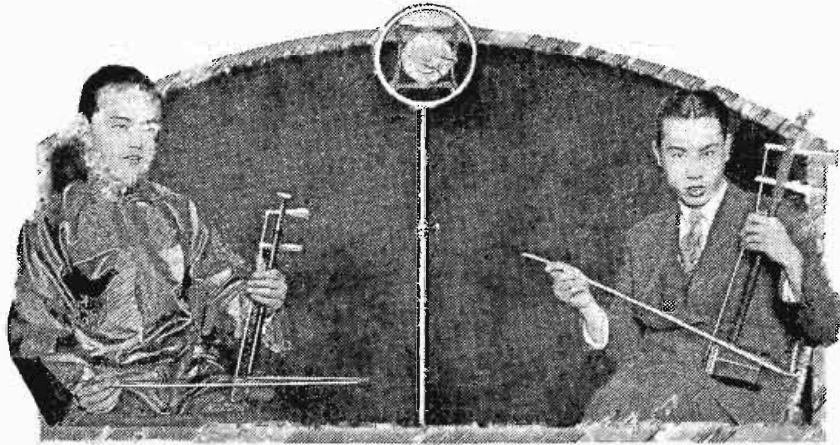

THERE'S a plaintive sweetness in the tone of the Chinese hu-chin—a two stringed fiddle. C. L. Hsiang (right) and J. S. Yong of Peking played for the WCCO audience. Mr. Yong sings. Both of the young Celestials are students at the University of Minnesota. To play the hu-chin at home and in public would put them in disgrace. But it's a great little fiddle for Chinese jazz and Mr. Hsiang says he gets a great kick out of it. It came into vogue in China at the time of Confucius.

Song of Peter Rabbit

DID you know that a bear can sing?
Or did you know that a rabbit could croon a lullaby?

If you don't believe they can you had better tune in WBAL at Baltimore during the Sandman hour. That is the



time Miss Edna Burhemm comes to the children with all kinds of favorite stories from the most popular story books. And instead of reading just the way the book says she sings.

So when she tells the story of the Three Bears or Peter Rabbit it's all done in song.



WAY down in New Orleans there's a snappy, wide-awake broadcasting station known to a great fan-shaped area of listeners as WSMB. There's a touch of the romantic South and the vivacious French to the programs. Typical of the fair feminine artists heard from that station is Miss Myrza Mayer Bonligny, concert pianiste, and accompanist extraordinary.

Boy Prodigy at WBAL

MANY good authorities maintain that Shura Cherkassky is the greatest boy piano prodigy since the youth of Joseph Hofmann. He was "discovered" by Frederick R. Huber, director of WBAL, Baltimore, about five years ago.

He seems born with a natural sense of all the feeling to be derived from piano



harmony. His study of technique has greatly enhanced this gift until now he has achieved considerable fame in the musical centers of the East.

Mother Greets Son in Arctic

*DR. LANGFORD WITH McMILLAN Labrador Expedition
Hears Parent and Sister over KOIL*

By George R. Wood
(News Director-Announcer, KOIL)

"HELLO, EARL—I hope you hear me. This is mother talking to you from KOIL at Council Bluffs; and, Earl, this is one time I can talk to you and you can't talk back. We are all well and happy here in Omaha, so don't worry about us. Take good care of yourself and we'll hope to see you next October. Your father is listening in to the broadcast at Grand Island, Nebraska. Good night," Mrs. W. I. Langford, mother of Dr. Earl K. Langford, chief physician and surgeon with the Donald McMillan expedition in the Arctic regions, told her son over KOIL Thursday evening, February 9, at 11:30 o'clock, central standard time. Then the doctor's sister, Mrs. A. W. Elsasser, also of Omaha, played her own accompaniment while singing a number for her brother.

Just before the time for the broadcast the studio telephone rang and a woman's voice said, "Please send greetings to my cousin, Charles Sewell, botanist with the expedition." The voice was that of Mrs. Wood Allen of Council Bluffs, who also is a personal friend of McMillan. A rush trip by automobile to the home of Mrs. Allen brought her to the studio and she spoke to Mr. Sewell.

These speakers who never before had faced a microphone were not affected by "mike fright," as so many are on their first appearance before the microphone. They seemed to forget there was anyone in the studio excepting themselves—they were talking to loved ones "snowed in" in the far north, who always were in their thoughts. The women's voices were firm, not the least trace of nervousness was shown, when they stepped up to the announcer's desk to greet their loved ones with the arctic expedition. The realization that the whole world could be listening to their conversation did not enter their thoughts. They only visualized two grizzly-bearded men dressed in heavy fur clothing, with strained ears to catch just one precious word from home—and the speakers were using every effort to send that word out on the wings of the clear crisp night to the ones they loved best.

So, far into the thousands and thousands of acres of ice and snow in the arctic wastes, these two men heard relatives speaking to them from home. After the relatives had spoken, KOIL then introduced every artist on the station staff and for the next two hours a program in which 20 artists participated was broadcast for the McMillan party. The program included classical numbers, popular numbers, vocal and solo numbers, orchestras and a xylophone solo, with Bob Hall, Don Searle, Howie Martin and

George Wood announcing the program. Knowing that Dr. Langford's parents resided in Omaha, just across the Muddy Missouri from Council Bluffs, KOIL tried for many weeks to get in touch with the operators of WNP, the station of the expedition, located 90 miles inland from Nain, Labrador. After the several weeks' trial, the station was rewarded with a message received from Dr. Langford and relayed through short wave station 9DZW, through the assistance of the American Relay Radio league. The message from Dr. Langford stated: "Was reminded that I never thanked you for your radio log you sent me last fall. While

MRS. A. W. ELSASSER talks to her brother, Dr. Earl Langford, with McMillan in Labrador.



DR. EARL K. LANGFORD
with McMillan Arctic
Expedition.

listening to your good program the other evening, we all enjoyed it very much. Enough volume to make the loudest speaker complain." H. W. Kerr, owner and operator of 9DZW, Little Sioux, Iowa, relayed the message to KOIL, and the station immediately asked his co-operation in sending a message to the doctor that his mother would speak to him over the station, which Mr. Kerr did and then the entire membership of the A. R. R. L. got busy relaying the message to Labrador, and all stood by faithfully to pick up a return message that the expedition heard the program. Facilities of KOIL have been offered to Mrs. Langford and Mrs. Allen for the purpose of communicating with their relatives. The station also has set aside 12 o'clock Monday nights to broadcast a program for the explorers and to send any message from relatives of any of the party.

In the photograph appears Mrs. Elsasser speaking to Dr. Langford 3,000 miles away, and the picture of the doctor as he appeared when leaving last June for the arctic and as he now appears in the fur clothing necessary in the far north.

The short wave station at Little Sioux, 9DZW, played a big part in putting over the broadcast, and on several occasions has relayed messages to the doctor's mother in Omaha. The A. R. R. L. also played a big part in the work.

An interesting sequel to the experiment was a radiogram from WNP through the Radio Relay League stating, "Heard the program, ten to eleven, and except for part of announcement it was O. K. Later we heard last half of the expedition program, which came in perfect. Everyone enjoyed it very much. (Signed) Dr. Langford."

ON the following evening KYW broadcast its final program of the season to the listeners of the far north with Maurice Wetzel at the microphone. About fifty letters were read to friends and relatives scattered almost all the way around the Arctic circle.

The editor of Radio Digest accepted an invitation to tell those isolated behind the snow barriers of the latest improvements in Radio. The listeners were informed of the successful development in television and the prospect of being able in the near future to see their friends and relatives as well as hear them while they are shut in at their dark winter quarters. A resumé of the news of the day was read by E. L. Gross of the KYW staff and subsequent messages indicated that broadcasts reached their destinations.

Wendt Advanced Radio in Arctic

WHEN the story is written in full of the penetration of Radio into the land where about half the year is night probably the greatest amount of credit will rightfully go to George A. Wendt of the Canadian Westinghouse company in Montreal. He has never been forgetful of those brave men who have crossed the Circle of the Pole.

He has watched the increasing air traffic with the keenest interest until now there are special weekly programs from several stations where for years the Westinghouse stations performed this service exclusively.

Concerning the announcement of the advancement of television over KYW he wrote to Radio Digest as follows:

"Having originated these Arctic broadcasts something over five years ago, I could not help but visualize what your talk meant to the men in the North. The Hudson's Bay company's men usually go in for a period of three years while the mounted police usually stay in on an average of two years, and in all that time except when the annual supply ship arrives, they see no one except the two or three men associated with them, and usually the same Eskimos.

"Only once a year do the ships go in and take in the usual supply of mail and pamphlets and bring out the furs, and then, except for Radio, they are entirely cut off from the outside world for a period of twelve months. The vision which you brought before them of the possibility of some day in the future of seeing events of the outside world by Radio probably meant more to these people than any other human beings in the world.

"One of the curious things that I encountered was that the Eskimos had been taught the old square dances some centuries ago by the whalers, and accordingly all the women learned to play the accordion, some of them being very adept at this.

"In one of the posts in the Far North the Mounties told me the Eskimos were great at coming in and listening to Radio music, and after listening to some of the old time fiddlers' contests of KDKA, they were quite able to reproduce some of these tunes. Every year the supply ship carries up a fresh batch of phonograph records—the popular new songs produced since the last shipment.

"The Mounties eagerly try them out. Recent years it has been somewhat of a surprise to them to find the records are reminiscent of tunes heard from the Eskimo accordions. Of course it was obvious that the Eskimos were getting the latest first by Radio, and making the tunes familiar. Consequently phonograph records have lost some of their former zest of 'something new.'"

Mr. Wendt ridicules claims published recently that Greenland is just getting its first Radio reception. He sends copies of letters from Godhaven and other points giving details of American reception for the last three years. Experts note that signals fade for eleven-day periods in Greenland.

Point Barrow Gets Time Signals

FACING the ice-covered Arctic Ocean, Point Barrow is America's "farthest north" point of civilization. Except for a few weeks in the summer time when the ice goes off shore and it is possible for boats to come in, Point Barrow has no communication with the outside world other than by dog trail over the great barren waste that separates it from communities further south. Dog sleds are seldom used except for emergency as settlements are far apart and not easily reached overland.

Point Barrow is the center of activity of great whaling and sealing operations. The Department of the Interior maintains a school for the natives. There is also a Presbyterian Hospital and mission and a trading post at Point Barrow. Its population is approximately 508—500 Eskimos and eight whites. Occasionally the white population is augmented by those who are planning dashes to the North Pole or correspondents for newspapers awaiting the completion of flights from the other side of the world, as Point Barrow is America's "hopping-off place" for the North Pole.

In spite of its remoteness, time is important in this tiny Alaskan village. Owing to the fact that the sun sets on November 20th not to rise again until January 22nd, Point Barrow has no way of verifying its time for more than two months. It is said that the last thing a man does who is going to Point Barrow is to secure a dependable watch and have it adjusted to keep good time for years.

During this long, dark, winter night of more than two months, all activity in the village ceases with the exception of the school. The time observed by the school authorities necessarily is taken as the standard time of the village, although it has been known to have been known as much as two hours off when finally checked against the position of the sun. Complications, it can be seen, easily arise from situations such as this and there have been many heated arguments as to the correct time.

Last summer was a particularly severe one in the Arctics. The government revenue cutter got no further north than Teller (near Nome). Were it not for the fact that Point Barrow would have been without a school teacher, no attempt would have been made to reach the northern village.

Typical of the kind of men who ventured forth into America's far north is Leon S. Vincent, a young

recruit in the Alaska service of the United States department of education. He and his bride of a few months had accepted a teaching position near Nome. When the word came of the vacancy at Point Barrow, the young couple immediately volunteered to go further north, and the stalwart crew of the U. S. M. S. Boxer, a small vessel used by the Alaska School Service, determined to make the attempt to reach Point Barrow.

(Continued on page 122)



MISS LILLIAN REHBERG is the accomplished young cellist of the Westinghouse station, KYW. She has won several prizes for her artistic ability although still in her "teens." One of the distinctions conferred upon her was to serve as soloist for the Chicago Symphony orchestra. Her artistic nature does not prevent her from being a regular girl. She is the "life of the party" in the KYW studio.

Radio Continuities New Art

Skill and Special Writing Technique Required to Link Elements of Broadcast Program in Smooth Running Order

By Gerard Chatfield
Supervisor of Programs, NBC

WHAT is a Radio "continuity"? There are several answers to the question. The best, perhaps, is that the continuity is the manuscript of the broadcast program—the speeches, cues and "business" of the air production.



Gerard Chatfield

A continuity is to Radio what a scenario is to a motion picture or a libretto to a musical comedy. It links together the various episodes of the entertainment and makes the broadcast coherent and easy to understand. In other words, the continuity is the "plot" of the broadcast.

The Radio continuity is truly the infant of the literary branch of the enormous family of entertainment. The Radio continuity has come into general use in the past three years. Because it is a new thing, it is still in development and subject to many experiments and changes. In spite of its swaddling clothes, the Radio continuity has an individuality that is distinctly its own—it has created a new

technique in writing.

A careful search has failed to reveal the original Radio continuity. If it were found it probably would be a tattered program of an early Radio broadcast with some penciled notes of an announcer on the margins. Three years ago, almost all

announcers stepped up to the microphone with a faint idea of what ought to be said and then trusted to spontaneous eloquence, a necessary attribute of every announcer in those days, to carry them through. With the advent of bigger programs and more programs, spontaneous announcements became increasingly difficult to offer with any degree of satisfaction and gradually, the announcers started their evenings' work with typed notes of the proper things to be said. These typed notes rapidly were evolved into the present continuity which not only tells the announcer what to say but tells him when to say it and, quite often, how to say it.

The sponsored program—the program offered "through the courtesy of" some firm—proved a further stimulus to the development of the continuity. The continuity for a sponsored program was so written that the firm received mention in the right way at the right time and benefited from the advertising of the Radio program. Though sales arguments and direct appeals to buy are unheard of on the better class of programs, there is always some deft phrase that impresses the listener-in with the quality of the broadcast sponsor's product.

THE production of a Radio continuity is interesting. The work as it is done in the continuity department of the National Broadcasting company, may be taken as an example of the care used in preparing the script. It might be of interest to follow the growth of a script.

Three weeks before the planned program is to go on the air, copies of the musical selections are submitted to the continuity department. Assume that the program is sponsored by the manufacturers of Clicquot Club ginger ale. The con-

tinuity writers study the program and then begin to work out the announcements, cues for music and other directions. The opening announcement is carefully done, for it must be skillfully written in order to attract immediate attention. Then there must be a subtle reference to the advertised product—for instance, mention may be made of "snappy, sparkling music" and one thinks of "snappy, sparkling" in connection with the ginger ale.

Between each musical selection—if music happens to be the foundation of the entertainment—there must be speeches for the announcer. These speeches are carefully worked out and timed to the second. Then there is the closing announcement which is designed to leave the auditor with a definite impression of the program he has just heard and a desire to hear a similar program at the next opportunity.

The technique of continuity writing includes three important things. The whole thing must be pleasing to the listener; the words and phrases must be clear and easily understood and the entire continuity must be written to take up a certain period of time—no more and no less. Truly, minutes on the air are golden minutes.

Long words, words of four or more syllables are carefully avoided. Compound, complex sentences, too, are taboo. Simple words and simple phrases must be used—and the general effect is a clarity of expression that is very pleasing.

The continuity writers must be sure of their facts, too. Always there is some person in Keokuk or Kokomo who is

quick to notice the slightest error in an explanation of some musical selection. In order to make sure that all facts used are actual facts, the National Broadcasting company has established a department of Literary and Musical Research where experts prepare data on the various programs. This department is a valuable ally of the continuity department.

The sponsored program is not the only job put up to the continuity department. The writers are called upon to evolve new and novel methods of presenting Radio programs, to present unusual pro-

grams in a manner that will emphasize the individuality of the broadcast and to cut and trim and rewrite dramatic sketches in order that they may be presented in the time allotted for the program.

Each month sees the continuity department assuming a greater importance in the broadcasting industry. As broadcasts improve steadily in entertainment content and in general merit, so must the continuities improve.

The time is not far distant when the continuity department will be called upon to arrange productions that will be as complicated and as laborious as many of the mammoth theatrical entertainments now on Broadway. Big things are to be done in Radio and big things will be expected of the continuity department.

The infant Radio continuity is a lusty youngster. He has grown in a few short years from his embryonic form of the scribbled notes on a tattered program to his present development of many pages securely bound in manila cover. One may expect to see the day when he will appear in a cloth bound jacket and take his place along with the bound volumes of successful plays or motion picture stories.



MR. CHATFIELD, at left of engineer before the control board, must be familiar with the opera score and advise the technician where to modulate. Members of the Chicago Civic Opera, direct from the stage, take keen interest in "the works." Director Daniels is seen sitting before the mike, continuity in hand. The picture was taken in the opera control room located in the basement of the Auditorium. Phone and telegraph keep continuous contact with other net stations.

Hot Presidential Campaign

Convention Halls
Will Convey
to All



Regular Sunday Features Eastern Time Stations

CFCA Toronto, Can. (356.9m-840kc) 7 p. m. service; 8:15, musicale.

KDKA Pittsburgh, Pa. (315.6m-850kc) 11 a. m. service; 1 p. m., WJZ; 4, organ; 6:15, symphony orchestra; 6:30, WJZ; 8:15-11:15, N. B. C.

WABC New York, N. Y. (325.6m-820kc) 10:50 a. m. church service; 4 p. m., theater hour; 5, vespers; 7, orchestra; 8, service; 9, forum; 9:30, program.

WAIU Columbus, O. (282.2m-1060kc) 9 p. m. music.

WBAL Baltimore, Md. (285.5m-1050kc) 5:30 p. m. N. B. C.; 6:30, N. B. C.; 7, concert orchestra; 8, musicale.

WBZ Springfield, Mass. (333.1m-900kc) 11 a. m. service; 1 p. m., N. B. C.; 2 WJZ; 7:30, Hotel Statler ensemble; 8:15, N. B. C.; 9:15, music; 10:05, musicale.

WCAE Pittsburgh, Pa. (461.3m-650kc) 6 p. m. N. B. C.

WCSH Portland, Me. (214.2m-1400kc) 10:30 a. m. church; 7:30, church; 8, WEAF; 9:15, organ.

WEAF New York, N. Y. (491.5m-610kc) 1 p. m. music, WRC; 2, service; 3, Young People's Radio conference, WTIC, WJAR, WCSH, WRC, WEAR, WTAJ, KSD, WOC, WDAF, KVOO, WFAA, WHAS, WVIC; 4, Men's conference, WEEL, WTIC, WJAR, WTAG, WCSH, WGY, WCAE, WEAR, WSAJ, WHO, WOV, KVOO, WFAA, WSM, WSB; 5:30, Accustion hour, WEEL, WRC, WGY, WCAE, WVI, WEBB, WRHM, WOC, WHO, WOV, WDAF, KVOO, WHAS, WVIC, WSB; 7:20, Major Bowes' Family, WTIC, WJAR, WTAG, WRC, WCAE, WVI, KSD, WHO, WOV, WFAA, KVOO, WHAS, WSM, WVIC, WSB, WBT, KPRC, KOA; 9, Our Government, WTIC, WJAR, WTAG, WCSH, WRC, WGY, WGR, WCAE, WSAJ, WTIC, KSD, KVOO, WFAA, WVIC, WSB, WBT, KOA; 10:30, WOV, WHO; 9:15, Atwater Kent Radio hour, WEEL, WFI, WRC, WGY, WGR, WCAE, WTAM, WVI, WSAJ, WGN, KSD, WCCO, WOC, WHO, WOV, WDAF, KVOO, WFAA, WSM, WVIC, WSB, WVI; 10:15, drama.

WEEL Boston, Mass. (508.2m-590kc) 7:30 p. m. musicale; 9:15, WEAF; 10:15, cruising the air; 10:30, Keith's Radio revue.

WFAN Philadelphia, Pa. (223.7m-1340kc) 11 a. m. service; 8 p. m., orchestra; 10, organ.

WFI Philadelphia, Pa. (405.2m-740kc) 4:30 p. m. chapel; 7:30, service; 9:15, WEAF.

WCBS New York, N. Y. (349m-860kc) 9:15 p. m. program.

WGHP Detroit, Mich. (277.6m-1080kc) 3 p. m. Columbia chain; 9-11, Columbia chain; 11-11:30, Aradians; 11:30-12, organ.

WGR Buffalo, N. Y. (302.8m-990kc) 10:45 a. m. service; 7:30 p. m., service; 9, N. B. C.

WGY Schenectady, N. Y. (375.5m-790kc) 10:30 a. m. service; 8:30 p. m., orchestra; 4, X. M. C. A.; 5:30-10:45, N. B. C.

WHAM Rochester, N. Y. (280.2m-1070kc) 10:30 a. m. service; 1 p. m., N. B. C.; 5:30, N. B. C.; 6:30-10:15, musicale; 9:15-10:15, N. B. C.

WHK Cleveland, O. (265.3m-1130kc) 6:30 p. m. dinner concert; 7:30, Bible Students' association; 8:45, concert.

WHN New York, N. Y. (394.5m-760kc) 6 p. m. program; 11, organ; 11:30, club orchestra.

WIP Philadelphia, Pa. (348.6m-800kc) 9:30 p. m. WGBS, or 7:15 p. m., service.

WJAX Jacksonville, Fla. (340.7m-880kc) 6:30 p. m. dinner music; 8, service; 10, organ.

WJR-WCX Detroit, Mich. (440.9m-680kc) 10 a. m. First Baptist church; 1 p. m., N. B. C.; 2, WJZ; 5:30, twilight church; 8:15, WJZ; 10, song service. First Baptist church of Pontiac.

WJZ New York, N. Y. (545.1m-660kc) 1 p. m. Gold-Strand group, WJZ, WJAM, KDKA, WJW, WJR, WEHL, KSD, WOC, WOV, WDAF, KVOO, WFAA, WHAS, WBT; 2, Roxey, WJZ, KDKA, KYW, WOL, WJR, WRC, WIMJ, WJIO, WOV, WVD, WFAA; 3, music; 5:30, service, WJZ, WJAM, KYW, WJAL; 6:30, Cook's tour, WJZ, WBAJ, KDKA, WJR, KYW, KWK; 7, organ; 7:30, music, KWK; 8:15, Collier hour, WJZ, KDKA, KYW, WJR, WCO, WJW, KWK; 9:15, Abraham Melodius, WHAM, KDKA; 9:35, singers, KDKA, WHAM, WJZ; 10, time, WJZ, WHAM, KDKA; 10:15, Don Amazio, KDKA, KYW, WJZO, WTMJ.

WHO'S Chapter of the Barney Google's "Nanny Goat" club was organized by Mildred Sandy and Grace Alberson. They are shown here giving the club's high sign. Members are welcome, they say. Here's a new picture of smiling Ed McConnell, the genial comedian, pianist and songbird of Station WSUN, inviting the western world to his party each Thursday night between 11 and 12 o'clock.

WLW Cincinnati, Ohio (426.3m-700kc) 9:30 a. m. Sunday school; 11, services; 1 p. m., N. B. C.; 2, organ; 7:15 p. m., service; 8:15, WJZ; 9:15, orchestra.

WLWL New York, N. Y. (370.2m810kc) 5 p. m. forum; 8, service.

WMAK Buffalo, N. Y. (545.1m-550kc) 2:30 p. m. forum; 3, Columbia chain; 7:35 p. m. service; 9, Columbia chain.

WMAA New York, N. Y. (370m-810kc) 6-8 p. m. program; 9:15-11:30, musicale.

WNAO Boston, Mass. (461.3m-650kc) 7:30 p. m. service; 9, Columbia chain; 10, Columbia chain.

WOO Philadelphia, Pa. (348.6m-860kc) 2:30 p. m. exercises; 6, organ; 7:30, service.

WOR Newark, N. J. (422.3m-710kc) 3-5 p. m. Columbia chain; 7:45, Sunday evening musicale; 9, Columbia hour.

WPCH New York, N. Y. (325m-920kc) 6:30 p. m. music.

WPC Atlantic City, N. J. (272.6m-1100kc) 3:15 p. m. organ recital; 4:15 p. m., community recital; 9:10, evening program; 10, Sunday evening musicale.

WQAM Miami, Fla. (384.4m-780kc) 7 p. m. program.

WRC Washington, D. C. (468.8m-640kc) 11 a. m. service; 1 p. m., WJZ; 2, N. B. C.; 3, service; 4, Washington cathedral; 5:30-11:15, N. B. C.

WSAI Cincinnati, Ohio (361.2m-830kc) 7:45 p. m. chimes; 8:15, time; 8:15, program; 9:15, WEAF; 10:15, WEAF.

WTAG Worcester, Mass. (516.9m-580kc) 4 p. m. N. B. C.; 7:20, WJZ; 9, Our government; 9:15, time; 9:16, news.

WTAM Cleveland, Ohio (399.8m-750kc) 4 p. m. ensemble; 6, orchestra; 6:30, WEAF; 7:20, studio program; 9:15, WEAF; 10:15, orchestra.

WTIC Hartford, Conn. (535.4m-560kc) 5:30 p. m. ensemble; 6-9:15, N. B. C.

WVJ Detroit, Mich. (352.7m-850kc) 10:30 a. m. service; 7:20 p. m., N. B. C.; 9, piano recital; 9:15, N. B. C.

WWNC Asheville, N. C. (296.9m-1010kc) 7:30 p. m. service.

Central Time Stations

CNRW Winnipic, Can. (384.4m-780kc) 9 p. m. Fort Garry hotel orchestra.

KFAB Lincoln, Neb. (319m-940kc) 11 a. m. service; 1 p. m., symphony.

KFNF Shenandoah, Iowa (461.3m-650kc) 8:30 a. m. gospel service; 10:45, service; 2 p. m., sermon; 4, talk; 6, Golden Rule service.

KLDS Independence, Mo. (270.1m-1110kc) 8:30 a. m. Bible study; 11, studio service; 2 p. m., KLDS string quartet; 3, Radio church; 6:30 vespers, sermon; 9:15, services, choir.

KMA Shenandoah, Iowa (394.5m-760kc) 8 a. m. sacred; 11, service; 12:15, sacred songs; 1:30 p. m. 4, orchestra; 6, service.

KOIL Council Bluffs, Iowa (319m-940kc) 10 a. m. service; 3 p. m., Columbia chain; 7, sacred music; 11, orchestra; 12, dance program.

KPRC Houston, Texas (293.9m-1020kc) 7:30 p. m. service.

KSD St. Louis, Mo. (545.1m-550kc) 6:20 p. m. WEAF; 8:15, WEAF.

KTHS Hot Springs National Park, Ark. (384.4m-780kc) 11 a. m. services; 7:30-11 p. m., soloists.

LET the eagle scream, but watch out for blasting!

From now on until election the air of the nation will quiver with the impassioned voices of political leaders proclaiming the virtues of their respective candidates, and warning against the calamities that always threaten the American government every four years.

George R. Wood claims that Station KOIL, Council Bluffs, was the first in the field to take a straw vote. Standings of the various Presidential nominees are announced daily.

Engineers from the leading broadcast stations are surveying the convention halls at Kansas City and Houston. Those not served by the chain systems are trying to get independent hook-ups.

KVOO Tulsa, Okla. (348.6m-860kc) 8 a. m. service; 9:15, Sunday school; 11, service; 12n.12:15, N. B. C.

KYW Chicago, Ill. (526m-570kc) 1 p. m. WJZ; 7:15-8:15, WJZ; 8:17, good reading; 9:15, WJZ.

WBAP Ft. Worth, Texas (499.7m-600kc) 5 p. m. sacred concert; 6, vesper service; 9:15, Seven Aces.

WBBM Chicago, Ill. (389.4m-770kc) 12 m., Nutty club.

WCBD Zion, Ill. (344.6m-870kc) 8 p. m. trios, mixed quartet. Zion choir.

WCCO Minneapolis-St. Paul, Minn. (405.2m-740kc) 9:45 a. m. services; 10:50, services; 4:10 p. m., House of Hope Presbyterian church; 7:15-10:15, N. B. C.

WCFL Chicago, Ill. (483.6m-620kc) 11 a. m. service; 2:30 p. m., musicale; 5:15, question box; 6:30, Utah hour.

WCOA Pensacola, Fla. (249.9m-1200kc) 7:30 p. m. service.

WDAF Kansas City, Mo. (370.2m-810kc) 8:15 p. m. WEAF.

WDD Chattanooga, Tenn. (243.8m-1230kc) 11 a. m. service; 5, Bible forum; 7:30, service; 9:30 concert.

WEBB Chicago, Ill. (365.6m-820kc) 10:30 a. m. Seventh Church of Christ, Scientist; 6:30 p. m. organ; 7:30, studio program.

WEEL Boston, Mass. (508.2m-590kc) 10:50 a. m. service; 1 p. m., orchestra; 3:30, players; 4, N. B. C.; 6, N. B. C.; 7:30, orchestra; 9:15, N. B. C.; 10:15, cruising the air; 10:30, musicale.

WENR Chicago, Ill. (283.3m-1040kc) 9:30-11 p. m. classical program.

WFAA Dallas, Texas (545.1m-550kc) 2:45 p. m. Farmers' hour, musical; 6-7, Bible class; 8:15, WEAF; 9:15, musicale; 11-12, orchestra.

Makes Atmosphere Quake

Swathed in Wire Information America



"SMILIN' Through" the microphone might be the title of these two pages with smiles on every side. Jack Richards and Billy Church were formerly with A. G. Fields' minstrels. They certainly know how to make the audience of WAIU smile. No wonder Dorothy Talbot, below, is called "The Sweetheart of the N. B. C. Pacific Coast Division. Her dimples are enough to win any heart. However, her real drawing card with her invisible audience is her soprano voice. She is an old and experienced Radio singer.

Wires of the press and wires of the broadcasters will make a veritable web of tingling fibers swathing the halls that are to pick the man to guide the nation through the next four years.

Never in its history will the United States have been so well served with instantaneous news of the Presidential campaign as during the year 1928.

Women will have a great deal to say at this election. The league of women voters has made affiliations with prominent broadcasting stations in all the important centers. The Government club is on the air regularly through the National Broadcasting system. This society furnishes civic news for housewives.

Let the eagle scream. America is listening.

- WGN-WLIB Chicago, Ill. (416.4m-720kc) 12 n. comics; 1 p. m., musicale; 6, Million sing; 6:20, Punch and Judy; 6:50, Almanac; 8, Auld Sandy; 8:15, N. B. C.; 9:15, Our music room; 10, Tomorrow's Tribune; 10:10-10:20, songs; 11, Mardi Gras.
- WHAS Louisville, Ky. (322.4m-930kc) 10 a. m. services; 4:30 p. m., N. B. C.; 6:20, WEA; 8:15, orchestra.
- WHB Kansas City, Mo. (340.7m-880kc) 6:30 p. m. service; 7:15, concert; 11:15, organ.
- WHO Des Moines, Iowa (535.4m-560kc) 6 p. m. orchestra; 6:20, N. B. C.; 7:15, dinner concert; 8:15-10:15, N. B. C.
- WHT Chicago, Ill. (305.9m-980kc) 8:30 a. m. sacred concert.
- WIBO Chicago, Ill. (305.9m-980kc) 7:10 p. m. program; 10, concert.
- WJAZ Chicago, Ill. (263m-1140kc) 7-9 p. m. studio program.
- WJBT Chicago, Ill. (389.4m-770kc) 10:30 a. m.-12 mid., Paul Rader
- WJJD Chicago, Ill. (365.6m-820kc) 9 p. m. opera company.
- WLAC Nashville, Tenn. (226m-1330kc) 6:30 p. m. service; 9:15, sacred music.
- WLS Chicago, Ill. (344.6m-870kc) 1:30 p. m. chapel service; 6, WLS Little Brown church.
- WMAQ Chicago, Ill. (447.5m-670kc) 10:45 a. m. Peoples' church; 1 p. m., artists' recital; 2, Columbia chain; 4, musicale; 6:15, symphony hour; 7 p. m., Chicago Sunday Evening Club; 9:15, Columbia chain; 10, De Luxe Dreamers.
- WMBB Chicago, Ill. (252m-1190kc) 3-6 p. m. orchestra; 7:40, Fifth Church of Christ Scientist; 9, popular program.

- WMBI Chicago, Ill. (263m-1140kc) 5 p. m. gospel songs.
- WMC Memphis, Tenn. (516.9m-580kc) 11 a. m. services; 2 p. m., conference; 3, N. B. C.; 4:30, N. B. C.; 6:20-9:15, p. m., N. B. C.
- WOAI San Antonio, Texas (499.7m-600kc) 7:30 p. m. service.
- WOC Davenport, Iowa (374.8m-800kc) 10:45 a. m. service; 1 p. m., N. B. C.; 2, N. B. C.; 4:30, N. B. C.; 6, old folks' musicale; 7, service; 8:15-9:45, WEA.
- WOW Omaha, Neb. (508.2m-590kc) 9 a. m. services; 5:30 p. m. Bible hour; 8:15, WEA; 9:15, music; 9:45, sermonette.
- WSB Atlanta, Ga. (475.9m-630kc) 5 p. m. vesper; 6:20, WEA; 8:15, WEA.
- WSBC Chicago, Ill. (232.4m-1290kc) 9-11 p. m. program; 12-1 a. m., popular artists.
- WSM Nashville, Tenn. (366.9m-890kc) 11 a. m. service; 6:20 p. m., WEA; 8:15, WEA.
- WTMJ Milwaukee, Wis. (293.9m-1020kc) 6 p. m. dinner concert; 7, organ; 8:9-45, N. B. C.; 9:45, trio.
- WWNC Asheville, N. C. (286.5m-1010kc) 11 a. m. service; 4 p. m., sacred music; 7:30, service.

Mountain Time Stations

- CFAC Calgary, Can. (434.8m-690kc) 7:10 p. m. service.
- KOA Denver, Colo. (325.9m-920kc) 11 a. m. church service; 5:30, organ; 6:30, dinner concert; 8, service.

Pacific Time Stations

- KEX Portland, Ore. (239.9m-1250kc) 6 p. m. concert; 7:30, service; 8:30, studio program; 9, students' association.
- KFI Los Angeles, Calif. (468.5m-840kc) 10 a. m. service; 1 p. m., N. B. C.; 2:5-30, musicale; 3:30, artists; 6:30 p. m., N. B. C.; 8-9, classic hour; 9-10, orchestra; 10-11, Packard Six dance orchestra.
- KFOA Seattle, Wash. (447.5m-670kc) 6:30 p. m. symphony hour; 9, N. B. C.
- KFON Long Beach, Calif. (241.8m-1240kc) 9:30 a. m. organ; 11, church service; 1:30, organ; 2:30, church; 4, studio program; 4:30, orchestra; 7:45, service; 9, All Star night.
- KFRC San Francisco, Calif. (454.3m-660kc) 5 p. m. organ; 6:30, twilight recital; 8:30, orchestra; 10, orchestra.
- KGA Spokane, Wash. (280.7m-1150kc) 11 a. m. service; 1 p. m., lecture; 7:30, service.
- KFVB Hollywood, Calif. (352.7m-850kc) 6:30-7 p. m. string quartet; 8, light opera program; 9, news; 9:10, blue singers.
- KGO Oakland, Calif. (384.4m-780kc) 11 a. m. service; 1 p. m., N. B. C.; 3, N. B. C.; 6:30, symphony hour; 7:30, weather; 7:35, service.
- KGW Portland, Ore. (491.5m-610kc) 11 a. m. church; 7:30-9 p. m., church; 9:10, N. B. C.; 10-11, symphony.
- KHJ Los Angeles, Calif. (399.8m-750kc) 7-8 p. m. service, First M. E. church; 8-10, program.
- KHQ Spokane, Wash. (370.2m-810kc) 10:30 a. m. children's Sunday school; 11, services; 1 p. m., N. B. C.; 3, N. B. C.; 6:30, orchestra; 8, N. B. C.; 9, N. B. C.; 9:30, services.
- KJR Seattle, Wash. (348.6m-860kc) 10 a. m. program; 7:30, service.

- KNX Hollywood, Calif. (336.9m-890kc) 1 a. m. service; 2-4 p. m., musicale; 6:30, service; 8, orchestra; 9, artist.
 - KOIN Portland, Ore. (319m-940kc) 6 p. m. dinner concert; 7, orchestra; 8, service; 9, comedy hour.
 - KPO San Francisco, Calif. (422.3m-710kc) 6:30 p. m. symphony hour; 7:30, organ; 8:30, orchestra.
 - KYA San Francisco, Calif. (309.1m-970kc) 11 a. m. service; 7, feature writer; 7:30, service.
- For Daylight Saving add one hour.

Regular Monday Features Eastern Time Stations

- CFCA Toronto, Can. (357m-840kc) 6:30 p. m. talk; 7:15, organ.
- CNRO Ottawa, Can. (434.5m-690kc) 7:15 p. m. children's half hour; 7:45, market reports; 8, orchestra.
- KDKA Pittsburgh, Pa. (315.6m-950kc) 9:45 a. m. time; 10, WJZ; 11, Blue Monday cheer; 11:57, time; 12 n., stocks; 5 p. m. time; 6:15, symphony; 6:30, WJZ; 7, Clippers; 7:30-11, N. B. C.
- WABC New York, N. Y. (325.9m-920kc) 11:55 a. m. time; 12:55, weather; 1 p. m., orchestra; 2, forum; 6:30 p. m., program; 10, weather; 10:02, orchestra; 11, High-Ho hour.
- WAIU Columbus, Ohio (282.8m-1060kc) 10:30 a. m. service; 11:30, news; 3 p. m., shopper's hour; 6, orchestra; 6:30, trio; 7, advice; 7:15, farm talk; 8, music; 9, Columbia chain.
- WBAL Baltimore, Md. (285.5m-1050kc) 3:30 p. m. recital; 3:45, travelog; 4, salon music; 6:30 p. m. dinner concert; 7:30-9:30, N. B. C.; 9:30, recital; 10, dance program.
- WBZ Springfield, Mass. (333.1m-900kc) 10 a. m. N. B. C.; 11, Polly and her pals; 11:55, organ; 11:55, Aunt Sammy; 12:10 p. m., service; 12:40, music; 1, Polly; 1:30, time; 1:35, ensemble; 2, forum; 5:46, ensemble; 6:15, ensemble; 7, orchestra; 7:30 p. m., WJZ; 9, N. B. C.; 9:30, program; 10:05, talk; 10:35, program.
- WCAE Pittsburgh, Pa. (461.3m-650kc) 6:45 a. m. setting up exercises; 11, weather; 11:15, household; 12 n., farm; 1 p. m., Bible class; 3:45, music; 6, dinner concert; 7 p. m., program; 6:30-10:30, N. B. C.; 10:30, orchestra.
- WCAU Philadelphia, Pa. (261m-1150kc) 12:30 p. m. musicale; 3, players; 4, concert; 5, revue; 6:30 p. m. orchestra; 9, chain.
- WCSH Portland, Maine (214.2m-1400kc) 10 a. m., Home-sweet's hour; 11, charm; 11:15, N. B. C.; 11:57, time; 12 n., stocks; 12:10, news; 12:45, farm flashes; 3, music hour; 4, news; 6, stocks; 6:15, best ads; 7:30, news; 8:30-11, N. B. C.; 11:40, N. B. C.
- WEAF New York, N. Y. (491.5m-610kc) 11 p. m. studio program; 11:15, Radio institute; 12:45, orchestra; 2 p. m., health service; 4:15, trio; 5, orchestra; 6, orchestra; 7:30 p. m. chamber music; 8:30, time; 8:30, A. & P. Gossips; WEEL, WJAR, WLIT, WTC, WWSH, WYAE, WTAM, WSA, WDAF, WTIC, WWJ, WHO, KSD, WGY, WGN; 9:30, General Motors; 10:30, WFL, WFLC, WCHS, WCAE, WDAF, WWJ, WEEL, WSA, WHAS, WTMJ, WEEL, WJAR, WTAG, WGR, WTAM, KSD, WHO, WOW, WJAX, WYOO, WOC, WSN, WMC, WSB, WTTT, WGY, KYOO, WAAA; 10:30, Fish hour; 11, WTIC, WGR, WTAG, WCHS, WLIT, WRC, WGT, WGR, WCOE, WNY, WSA, WTB, WTML, KSD, WYOO, WOC, WJO, WOW, WDAF, KYOO, WFAA, KFRC, WHAS, WNC, WSB, WBT, WOA; 11, orchestra.
- WEEI Boston, Mass. (508.2m-590kc) 10:30 a. m. shopping service; 11, Friendly maids; 11:15, N. B. C.; 2:30 p. m., musicale; 4, news; 6, N. B. C.; 7:30 p. m., minstrel; 8:30-10:30, N. B. C.; 10:30, cruise on the air.
- WFLA Clearwater, Fla. (516.9m-580kc) 3 p. m. guards; 7:30, band; 8:30, studio musicale; 10, dance orchestra; 12, Bell Boy.
- WFI Philadelphia, Pa. (495.2m-740kc) 10:15 a. m. markets; 10:30, Aunt Sammy; 1 p. m., ensemble; 1:30, markets; 1:30, ensemble; 3, music; 6:30, orchestra.
- WGBS New York, N. Y. (349m-860kc) 9 a. m. shopping service; 10, home-making; 10:45, gym class; 1:30 p. m., scripture reading; 1:50, program; 2:05, interview; 2:15, songs; 9, Lode Gee Bee.

FARMERS' PROGRAM INDEX

Special Farm Features

Weather

Local Time

KDKA, 12 n., 10:30 p. m.
 KFV, 8:30 p. m.
 KFKX, 10:55 a. m., 11:55 p. m.
 KFNF, 7:30 a. m., 12:40 p. m.
 KFOA, 5:30 p. m.
 KFWI, 10:27 a. m.
 KGA, 6 p. m.
 KGO, 12:30 p. m., 7 p. m.
 KGV, 10 a. m., 7:30 p. m.
 KJR, 12 n.
 KMMJ, 9:30 a. m., 12:30 p. m.
 KMOX, 1 p. m.
 KOA, 11:45 a. m.
 KOIL, 11:45 a. m., 5:45 p. m.
 KOMO, 12:15 p. m., 8 p. m.
 KWB, 5:55 p. m., 11:30.
 WCAE, 3:40 p. m.
 WCAU, 4:25 p. m.
 WCSI, 7:10 p. m.
 WCCO, 9:45 a. m., 10 p. m.
 WDBO, 7:40 p. m.
 WEAF, 12:30 p. m.
 WEEL, 11:40 p. m.
 WENC, 8:55 a. m.
 WFAA, 10:30 a. m., 9:30 p. m.
 WGY, 12:01 p. m.
 WHAM, 11 p. m.
 WHO, 10 a. m.
 WIP, 1:30 p. m.
 WKH, 4 p. m.
 WIZ, 2 p. m.
 WLAC, 8:30 p. m.
 WLW, 11:15 p. m., 12.
 WMAQ, 10 p. m.
 WMC, 9:45 a. m., 12 n., 2:30 p. m.
 WOAL, 10 a. m.
 WOC, 11 p. m.
 WOI, 10:30 a. m.
 WOO, 11:30 a. m., 9:55 p. m.
 WSM, 11:45 a. m.
 WTAC, 12:59 p. m.
 WTIC, 11:55 a. m., 11:30 p. m.

Monday

Eastern 9 a. m.	Central 8	Mountain 7	Pacific 6
KMMJ (285.5m-1050kc), Poultry talks.	11:30	9:30	8:30
WTIC (535.4m-560kc), Farm flashes.	12	10	9
WHK (265.3m-1130kc), Farm Flashes.	12:05	11:05	9:05
WCAE (461.3m-650kc), Farm flashes.	12:30	11:30	9:30
WJAX (340.7m-880kc), Farm flashes.	12:40	11:40	9:40
WMAK (545.1m-550kc), Farm flashes.	12:45	11:45	9:45
WMAQ (447.5m-670kc), Prairie Farmer.	12:55	11:55	9:55
KTHS (384.4m-780kc), Farm features.	12:45	11:45	9:45
WDAF (370.2m-810kc), U. S. farm flashes.	12:45	11:45	9:45
WKBH (220.4m-1360kc), U. S. farm talks.	12:45	11:45	9:45
WRIH (260.7m-850kc), U. S. farm talks.	12:45	11:45	9:45
WTAW (483.6m-620kc), Farm talks.	12:45	11:45	9:45
WLAG (282.8m-1060kc), Timely hints to farmers.	1:30	10:30	9:30
WFAA (545.1m-550kc), Farmers' hour.	1:35	11:35	10:35
KSAC (333.1m-900kc), Farm talks.	1:45	11:45	10:45
WOI (265.3m-1130kc), Animal Husbandry	2	12	11
WSB (475.9m-630kc), Georgia State Agri. program.	2:05	1:05	11:05
WDAY (545.1m-550kc), U. S. Farm talks.	4	3	2
KOIN (319m-940kc), U. S. farm flashes.	6:20	5:20	4:20
WDBO (288.3m-1040kc), Farm flashes.	8:30	7:30	6:30
KSAC (333.1m-900kc), Farm courses.	8:10	7:10	6:10
WCSH (214.2m-1400kc), Farm feature.	8:20	7:20	6:20
KOIA (266.9m-1010kc), U. S. Farm school.	8:30	7:30	6:30
WOS (422.3m-710kc), U. S. Farm school.	8:30	7:30	6:30
WHF (394.7m-880kc), Poultry talk.	8:55	7:55	6:55

Tuesday

Eastern 9 a. m.	Central 8	Mountain 7	Pacific 6
KMMJ (285.5m-1050kc), Poultry talks.	11:20	9:20	8:20
WCSH (214.2m-1400kc), Farm features.	11:20	9:20	8:20
WTIC (535.4m-560kc), Farm flashes.	12	10	9
WHK (265.3m-1130kc), Farm flashes.	12:05	11:05	9:05
WCAE (461.3m-650kc), Farm flashes.	12:30	11:30	9:30
WJAX (340.7m-880kc), Farm flashes.	12:30	11:30	9:30
WMAK (545.1m-550kc), Farm flashes.	12:45	11:45	9:45
WMAQ (447.5m-670kc), Prairie Farmer.	12:45	11:45	9:45
WVJ (352.7m-850kc), U. S. farm flashes.	12:45	11:45	9:45
WSM (336.9m-980kc), Farm talk.	12:55	11:55	9:55
WMAQ (447.5m-670kc), Prairie Farmer.	12	11	10
KTHS (384.4m-780kc), Farm features.	12:45	11:45	9:45
WCCO (405.2m-740kc), Farm hour.	12:45	11:45	9:45
WDAF (370.2m-810kc), U. S. farm flashes.	12:45	11:45	9:45
WKBH (220.4m-1360kc), U. S. farm talks.	12:45	11:45	9:45
WLS (344.6m-870kc), Dinner bell program.	12:45	11:45	9:45
WFAA (545.1m-550kc), Farmers' hour.	12:45	11:45	9:45
KSAC (333.1m-900kc), Farm talks.	12:45	11:45	9:45
KFDY (545.5m-550kc), Poultry.	12:45	11:45	9:45
WOI (265.3m-1130kc), Plant pathology.	12	11	10
WSB (475.9m-630kc), Georgia State Agri. program.	3	2	1
KOMO (305.9m-980kc), Garden talk.	6:20	5:20	4:20
WDBO (288.3m-1040kc), Farm talks.	8:30	7:30	6:30
WFBG (280.2m-1070kc), U. S. Farm school.	8:30	7:30	6:30
KQW (296.9m-1010kc), U. S. Farm talks.	9:20	8:20	7:20
KOA (325.9m-920kc), Farm Question box.	10:30	9:30	8:30
KOAC (270.1m-1110kc), Farm utility program.	10:30	9:30	8:30

Wednesday

Eastern 11:30	Central 10:30	Mountain 9:30	Pacific 8:30
WTIC (535.4m-560kc), U. S. Farm flashes.	11:30	9:30	8:30
WCSH (214.2m-1400kc), Farm feature.	12	10	9
WHK (265.3m-1130kc), Farm flashes.	12:05	11:05	9:05
WMAQ (447.5m-670kc), Prairie Farmer.	12:45	11:45	9:45
WCAE (461.3m-650kc), Farm flashes.	12:30	11:30	9:30
WJAX (340.7m-880kc), Farm flashes.	12:30	11:30	9:30
WMAK (545.1m-550kc), Farm flashes.	12:45	11:45	9:45
WMAQ (447.5m-670kc), Prairie Farmer.	12:45	11:45	9:45
WVJ (352.7m-850kc), U. S. farm flashes.	12:45	11:45	9:45
WDAF (370.2m-810kc), U. S. farm flashes.	12:45	11:45	9:45
WKBH (220.4m-1360kc), U. S. farm talks.	12:45	11:45	9:45
WRIH (260.7m-850kc), U. S. farm talks.	12:45	11:45	9:45
WTAW (483.6m-620kc), Farm program.	12:45	11:45	9:45
WLAG (282.8m-1060kc), Timely hints to farmers.	1:30	10:30	9:30
WFAA (545.1m-550kc), Farmers' hour.	1:35	11:35	10:35
KSAC (333.1m-900kc), Farm talks.	1:45	11:45	10:45
WOI (265.3m-1130kc), Poultry talk.	2	1	1
WSB (475.9m-630kc), Georgia State Agri. program.	2:05	1:05	11:05
KOIN (319m-940kc), U. S. farm flashes.	6:20	5:20	4:20
WVJ (352.7m-850kc), U. S. farm flashes.	8:30	7:30	6:30
WJAX (340.7m-880kc), Farm talks.	8:30	7:30	6:30
WTAW (428.3m-700kc), Farm Federation bureau.	8:20	7:20	6:20
WOS (422.3m-710kc), Farm talk.	8:27	7:27	6:27
KOA (325.9m-920kc), Farm talk.	8:27	7:27	6:27

Thursday

Eastern 8:30	Central 7:30	Mountain 6:30	Pacific 5:30
WFBG (267.7m-1120kc), U. S. Farm school.	11:30	9:30	8:30
KGO (384.4m-780kc), Farm program.	10	9	8
KOAC (270.1m-1110kc), Farm utility program.	10:30	9:30	8:30
KWSC (394.5m-760kc), Farm flashes.	10:40	9:40	8:40

Eastern 9 a. m.	Central 8	Mountain 7	Pacific 6
WTIC (535.4m-560kc), Farm flashes.	12	10	9
WHK (265.3m-1130kc), Farm flashes.	12:05	11:05	9:05
WCAE (461.3m-650kc), Farm flashes.	12:30	11:30	9:30
WCSH (214.2m-1400kc), Farm program.	12:40	11:40	9:40
WVJ (352.7m-850kc), U. S. farm flashes.	12:45	11:45	9:45
WHK (265.3m-1130kc), U. S. farm flashes.	12:45	11:45	9:45
WSM (336.9m-980kc), Farm talks.	12:55	11:55	9:55
WMAQ (447.5m-670kc), Prairie Farmer.	12	11	10
WDAF (370.2m-810kc), U. S. Farm flashes.	12:45	11:45	9:45
KTHS (384.4m-780kc), Farm frolic.	12:45	11:45	9:45
WKBH (220.4m-1360kc), U. S. farm talks.	12:45	11:45	9:45
WLS (344.6m-870kc), Dinner bell program.	12:45	11:45	9:45
WTAW (483.6m-620kc), Farm program.	12:45	11:45	9:45
WFAA (545.1m-550kc), Farmers' hour.	12:45	11:45	9:45
KSAC (333.1m-900kc), Farm talks.	12:45	11:45	9:45
KFDY (545.5m-550kc), Cattle.	12:45	11:45	9:45
WOI (265.3m-1130kc), Farm crops.	12	11	10
WSB (475.9m-630kc), Georgia State Agri. program.	2	1	1
KOMO (305.9m-980kc), Poultry talk.	4	3	2
KOIN (319m-940kc), U. S. farm flashes.	6:10	5:10	4:10
KUGA (296.9m-1010kc), U. S. Farm school.	7:30	6:30	5:30
WFBG (267.7m-1120kc), U. S. Farm school.	8:20	7:20	6:20
KQW (296.9m-1010kc), U. S. Farm talks.	9:30	8:30	7:30
KOA (325.9m-920kc), Farm question box.	10:30	9:30	8:30
KOAC (270.1m-1110kc), Farm utility program.	10:30	9:30	8:30
KUOM (461.3m-650kc), Radio Farm school.	10:30	9:30	8:30

Friday

Eastern 11:30	Central 10:30	Mountain 9:30	Pacific 8:30
WTIC (535.4m-560kc), Farm flashes.	12	10	9
WHK (265.3m-1130kc), Farm flashes.	12:05	11:05	9:05
WCAE (461.3m-650kc), Farm flashes.	12:30	11:30	9:30
WVJ (352.7m-850kc), U. S. farm flashes.	12:40	11:40	9:40
WMAQ (447.5m-670kc), Prairie Farmer.	12:45	11:45	9:45
KTHS (384.4m-780kc), Farm talks.	12:45	11:45	9:45
WDAF (370.2m-810kc), U. S. farm flashes.	12:45	11:45	9:45
WKBH (220.4m-1360kc), U. S. farm talks.	12:45	11:45	9:45
WLS (344.6m-870kc), Dinner bell program.	12:45	11:45	9:45
WTAW (483.6m-620kc), Farm program.	12:45	11:45	9:45
WFAA (545.1m-550kc), Farmers' hour.	12:45	11:45	9:45
KSAC (333.1m-900kc), Farm talks.	12:45	11:45	9:45
WOI (265.3m-1130kc), Soils.	12	11	10
KFDY (545.5m-550kc), Questions and answers.	2	1	1
WSB (475.9m-630kc), Georgia State Agri. program.	2:05	1:05	11:05
KOIN (319m-940kc), U. S. Farm talks.	6:20	5:20	4:20
WOS (422.3m-710kc), U. S. Farm talk.	8:20	7:20	6:20
WTIC (535.4m-560kc), Agri. talks.	9:05	8:05	7:05
WFBG (267.7m-1120kc), U. S. Farm school.	9:20	8:20	7:20
KOA (325.9m-920kc), Aggie Kickoffs.	9:20	8:20	7:20
WOS (422.3m-710kc), Farm talks.	9:20	8:20	7:20
KQW (296.9m-1010kc), U. S. Farm talks.	9:20	8:20	7:20
WOS (422.3m-710kc), Missouri State Board of Agriculture.	9:30	8:30	7:30
KOAC (270.1m-1110kc), Farm utility program.	10:30	9:30	8:30
KWSC (394.5m-760kc), Farm flashes.	10:40	9:40	8:40

WGHP Detroit, Mich. (277.6m-1080kc) 1:15-2:15
 1. Columbia chain
 2. Home hour; 6 p. m., dinner music;
 3. Concert
 WGR Buffalo, N. Y. (302.8m-990kc) 8 p. m. concert
 hour; 9:30, 11 p. m., orchestra
 WCV Schenectady, N. Y. (379.5m-790kc) 11:15 a. m.
 N. B. C.; 1:15, time; 12:01, weather; 12:06,
 weather; 12:07, farm flashes; 12:45, weather; 2
 p. m., Festival; 2:30, orchestra; 6:20, U. S. Radio
 farm school; 6:30 p. m., dinner music; 9, program
 8:30-11, N. B. C.
 WHAM Rochester, N. Y. (280.2m-1070kc) 10 a. m.
 N. B. C.; 6:45 p. m., orchestra; 9, N. B. C.; 10,
 weather
 WHAZ Troy, N. Y. (305.9m-980kc) 8 p. m. program
 WHK Cleveland, Ohio (265.3m-1130kc) 11 a. m.
 morning program; 2 p. m., markets; 3:30, music;
 5:45, homecast; 8:30, 6, orchestra; 7, talk;
 7:45, music; 8 p. m., program; 11, features
 WHN New York, N. Y. (394.5m-760kc) 11 a. m. program
 11:30, woman's hour; 12:30 p. m., good
 cheer program; 3, program; 6, American period;
 6:30 p. m., program; 8, Frodoandors
 WIP Philadelphia, Pa. (348.6m-860kc) 1 p. m. lunch-
 hour music; 1:30, weather; 3, concert; 6:30, orches-
 tra; 7, Uncle Wip.

WJAX Jacksonville, Fla. (340.7m-880kc) 8 p. m.
 services; 10, organ
 WJR-WCX Detroit, Mich. (440.9m-680kc) 10 a. m.
 N. B. C.; 12 n., song review; 12:30 p. m., farm
 music; 12:45, musicale; 4, news; 5:30, children's
 hour; 6, dinner music; 6:30, ensemble; 7, mis-
 tress; 9:30, W J Z; 9, trio; 9:30, N. B. C.;
 11:30, dance music
 WJZ New York, N. Y. (454.2m-660kc) 12:30 p. m.
 luncheon music; 1:30, orchestra; 2, weather; 2:05,
 daily menu; 2:20, good housekeeping; 2:30, Den-
 nisons; 6, orchestra; 7 p. m., Shoemakers; 7:30,
 Roxy and his gang; 8:30, KJKA, KYW, WRC,
 WRAL, WJR, WFAM, WDT, WREN,
 KOA, WSM, WHO, WOW, WVK, 9, Riverside
 hour, network; 9:30, Rise and Shine; 11, slumber
 music; 11 studio program
 WLTH Philadelphia, Pa. (405.2m-740kc) 7 p. m.
 opera
 WLW Cincinnati, Ohio (428.3m-700kc) 8 a. m. ex-
 ercises; 10, woman's hour; 12:05 p. m., organ;
 3:35, program; 6:15, announcements; 6:30, N. B. C.;
 7 p. m., orchestra; 9, N. B. C.; 10, orchestra;
 11 studio program
 WLWL New York, N. Y. (370.2m-810kc) 6-7 p. m.
 music; 7-8, talk.

WMAK Buffalo, N. Y. (545.1m-550kc) 8:45 a. m.
 talk; 11, menu; 12 n., organ; 1 p. m., melody
 hour; 6, stocks; 6:15, dance orchestra; 7:15, news,
 sports, weather; 7:30 p. m., music; 9, Columbia
 chain
 WMCA New York, N. Y. (370m-810kc) 9 a. m. en-
 semble; 12 n., woman's hour; 1 p. m., program;
 2, shoe program; 4:30, Deutch early birds; 5, en-
 tertainers; 5:30, studio program; 5:50, theater re-
 view; 8, time; 9:15, Jewish hour; 10:15, orchestra;
 11, dance orchestra; 12, music
 WNAC Boston, Mass. (461.3m-650kc) 7:45 a. m.
 morning watch; 9:30, Polar Bears; 10:30, women's
 club; 7:30 p. m., program; 9, Columbia chain
 WOP Philadelphia, Pa. (348.6m-860kc) 11 a. m. or-
 gan; 12 n. luncheon music; 4:45 p. m., orga-
 n; 7:30 p. m., dinner music; 8:50, organ; 10:02,
 quartet
 WOR Newark, N. J. (422.3m-710kc) 6:45 a. m.
 Colgate hour; 11, woman's hour; 11:15, fashions;
 12:15, orchestra; 2:30, music; 6:15, children's hour;
 7:30 p. m., orchestra; 9, Columbia hour; 10:07,
 orchestra
 WPC Atlantic City, N. J. (272.6m-1100kc) 1 p. m.
 luncheon music; 6:45 p. m., organ; 9, program;
 10:30, orchestra; 11:30, dance orchestra.

WQAM Miami, Fla. (384.4m-780kc) 7 p. m. organ; 8, band.
WRC Washington, D. C. (468.5m-640kc) 6:45 a. m. N. B. C.; 11:15, N. B. C.; 12, farm flashes; 1 p. m. N. B. C.; 6, N. B. C.; 6:45, home hour; 7:30-10:30 p. m. N. B. C.; 10:30, synopsators.
WRVA Richmond, Va. (254.7m-1180kc) 12 n. Aunt Sammy; 6:30 p. m., juvenile hour; 7:15, orchestra; 8 p. m., orchestra; 9-10, musicale; 11, orchestra; 12, Back to Old Virginia.

Central Time Stations

KFAB Lincoln, Neb. (319m-940kc) 7 a. m., 9, U. of Nebraska; 11, Good Will program; 12 n., program; 2 p. m., music; 4, orchestra; 6, dinner music; 8, program; 10, request program.
KFNF Shenandoah, Iowa (461.3m-650kc) 6 a. m. concert; 7, devotional period; 11, talk; 3:30 p. m., mothers' hour; 5, music; 6:30, letter basket.
KMA Shenandoah, Iowa (394.5m-760kc) 7 p. m. music; 9-10:30 p. m., music.
KMBC Kansas City, Mo. (270.1m-1110kc) 8 p. m. Columbia chain.
KOIL Council Bluffs, Iowa (319m-940kc) 8 a. m. news, music; 10, recording; 1:30 p. m., Aunt Sammy; 3, music; 5:30, orchestra; 7, entertainers; 7:30, classical program; 9, soloists; 12, Indian Pow Wow.

WOW Omaha, Neb. (508.2m-590kc) 8:55 a. m. market talk; 9:15, Y. W. C. A.; 12:45 p. m., poultry talk; 12:50, talk; 2:15, your troubles; 6, organ; 6:30 p. m., WJZ; 8, program; 8:30-11, N. B. C.
WSB Atlanta, Ga. (475.9m-630kc) 10 a. m. home-makers' chat; 10:30, school of the air; 11:30, dinner bell; 12:30 p. m., trio; 1, agril.; 1:30, U. of Georgia program; 5:30, N. B. C.; 6, orchestra; 6:30-10:30, N. B. C.; 10:45, concert.
WSBC Chicago, Ill. (232.4m-1290kc) 5 p. m., program; 6, musicale; 9-11 p. m., program.
WSM Nashville, Tenn. (336.3m-830kc) 11:45 a. m. farm and home program; 1 p. m., concert; 6:30 p. m., WJZ; 8, music; 8:30, WEAF; 9:30, frolic.
WSMB New Orleans, La. (296.9m-1010kc) 8:30-10:30 p. m., Sunny South synopsators, theater orchestras, Billy Broussard, Louis Boyer, popular songsters.
WTMJ Milwaukee, Wis. (293.9m-1020kc) 10 a. m. music; 10:30, weather, news; 10:50, the green sheet; 11, your kitchen; 11:15, organ; 12:30, farm; 1 p. m., organ; 3, program; 3:15, screen gossip; 3:30, talk; 6, tune tinkers; 6:30, orchestra; 8:30-10, N. B. C.; 10, frolic.

Mountain Time Stations

CNRC Calgary, Can. (434.8m-690kc) 9:30 p. m. program.
KOA Denver, Colo. (325.9m-820kc) 11:15 a. m. music; 11:45, weather, stocks; 12 n., talk; 12:05 p. m., organ; 6, news, stocks; 6:30, dinner concert; 7:30, appreciation program; 8 p. m., Scheuerman's Colorado orchestra; 8:15, studio program.

Pacific Time Stations

KEX Portland, Ore. (277.6m-1080kc) 7 p. m. program; 8, studio program.
KFI Los Angeles, Calif. (468.5m-640kc) 12 n. music; 1 p. m., studio program; 2, music; 6, male quartet.

Regular Tuesday Features

Eastern Time Stations

CKCL Toronto, Can. (356.9m-840kc) 8-10:30 p. m., N. B. C.
KDKA Pittsburgh, Pa. (315.6m-950kc) 10 a. m., N. B. C.; 11, Women's club period; 6:10 p. m., calendar; 9:15, Little symphony orchestra; 7:30, Haller, Bakers; 8:30, N. B. C.; 10, Kambler's; 10:30, time, weather.
WAIU Columbus, Ohio (282.8m-1060kc) 10:30 a. m. service; 11:30, Columbus Dispatch; 12 n., markets, news; 3 p. m., Shoppers' hour; 6, orchestra; 6:30, orchestra.
WABC New York, N. Y. (309.1m-970kc) 1 p. m., orchestra; 2, afternoon program; 6:32, orchestra; 7:45, boys' program; 9:02, Mexican Good Will hour; 10:02, orchestra; 11, High-Ho hour.
WBAL Baltimore, Md. (265.5m-1050kc) 3:30 p. m., music; 3:45, talk; 4, music; 6, sandman hour; 6:30-7:30 p. m., dinner music; 7:30-9:30, N. B. C.; 9:30, program; 10, dance music.
WBZ Springfield, Mass. (333.1m-900kc) 10 a. m., N. B. C.; 11, beauty hint; 11:05, music; 11:30, Marcia Ray; 11:35, entertainment; 12:10, 1 p. m., service; 12:40, ensemble; 1 p. m., weather, time; 6:11, orchestra; 7:05, musicale; 7:15, music; 8, N. B. C.; 9, Travelers; 10:15, Bostonians.
WCAE Pittsburgh, Pa. (461.3m-650kc) 6:45 a. m. extended style; 10:30, weather; 11, style talk; 11:15, household talk; 12 n., Poultry chats; 12:05, farm period; 12:15, music; 1 p. m., B. ble class; 3:30, song hits; 5, children's period; 6, dinner concert; 8, N. B. C.; 10, bridge; 10:30, orchestra; 11, organ.
WCAU Philadelphia, Pa. (281.1m-1150kc) 12:30 p. m., luncheon music; 4:30, program; 6:30, entertainers; 7, Piccadilly orchestra; 8:01, serenaders; 9:15, entertainers; 10:15, Storylogue girl; 10:30, orchestra; 11:30, reports and announcements.
WCSH Portland, Maine (214.2m-1400kc) 10 a. m., housewives hour; 11, charm; 11:15, Household institute; 12:10 p. m., news; 12:15, farm flashes; 12:45, Lions club; 7, N. B. C.; 7:30, program; 8, WEAF; 10:30, N. B. C.
WEAF New York, N. Y. (491.5m-610kc) 11:15 a. m., Radio household institute; 12 n., program; 12:15 p. m., tenor; 12:45, music; 2, child study; 6, dinner concert; 7, voters' service; 8, Seiberling Singers and net; 9, Eveready hour, WEAF, W.A.R. WGR, WPI, WRC, WCAE, WTAM, WWJ, WSAI, WGN, KSD, WOC, WCCO, WGY, WHAS, WSM, WSB, WMC, WDAF; 10, bridge, and chain; 10:30, orchestra; 11:30, orchestra.
WEEL Boston, Mass. (508.2m-590kc) 8:15-8:45 a. m., N. B. C.; 10, program; 11:15, N. B. C.; 12, 40 markets; 2:30 p. m., hour of music; 3:30, cooking school; 6, orchestra; 6:35, news; 7:30 p. m., musicale; 8-10:30, N. B. C.; 10:30, Cruising the air; 10:40, orchestra.
WFAN Philadelphia, Pa. (224m-1340kc) 5:45 p. m., dinner music; 8, cornet solos; 10:30, Jack Myers; 11:30, organ.
WFI Philadelphia, Pa. (405.2m-740kc) 10:20 a. m., housekeepers' chat; 1 p. m., ensemble; 3, Trum-peters; 3:30, talk; 6:30, orchestra; 7, Voter's service; 8-11:30, N. B. C.
WGBS New York, N. Y. (349m-860kc) 9 a. m., shopping service; 10:30, music; 1:30 p. m., Scripture reading; 1:35, program; 6, Uncle Gee Bee; 7:30, dance orchestra; 9, feature; 9:30, quartet; 9:45, music.
WGHP Detroit, Mich. (277.6m-1080kc) 1:15 p. m., trio; 2, home hour; 6, dinner concert; 7, Lady Moon; 9-11, Columbia chain.
WGR Buffalo, N. Y. (302.8m-990kc) 6:30 p. m., orchestra; 7, N. B. C.; 7-10:30, N. B. C.; 11:30, frolics.
WGY Schenectady, N. Y. (379.5m-790kc) 6:45 a. m., exercises; 11:15, N. B. C.; 12, 40 markets; 2:30, quartet; 8-11:30, N. B. C.; 11:30, organ; 12, orchestra.
WHAM Rochester, N. Y. (280.2m-1070kc) 10 a. m., N. B. C.; 2:30, Work Basket; 6:45, orchestra; 7:30, quartet; 8, N. B. C.; 11:05, orchestra.
WHK Cleveland, O. (265.3m-1130kc) 6-10:01 p. m., music.
WHN New York, N. Y. (394.5m-760kc) 6 p. m., orchestra; 8, musicale; 11, orchestra.
WIP Philadelphia, Pa. (508.2m-590kc) 10 a. m., menu; 1 p. m., organ; 3, recital; 3:45, Bible; 4, market hints; 6:30, dinner concert; 7:30, Uncle Wip; 10, Movie broadcast; 10:30, orchestra; 11, orchestra.
WJAX Jacksonville, Fla. (340.7m-880kc) 8 p. m., dinner music; 9, recital; 10, dance music.
WJR-WCX Detroit, Mich. (440.9m-680kc) 10 a. m., N. B. C.; 12 n., song review; 12:30, farm service; 12:45, musical matinee; 4, news, weather, markets; 5:40, children's hour; 6, dinner concert; 6:30, organ; 7, orchestra; 7:15, N. B. C.; 8, Manuel girls; 9:30, N. B. C.; 10, Red Apple club.
WJZ New York, N. Y. (454.2m-660kc) 12:30 p. m., music; WBZ; 2:05, daily menu; 2:35, gardens; 3:30, band, WRC, WHO; 5, tea music, WRC; 7 p. m., dog talk; 7:15, orchestra; 8, Stromberg; 9, service hour; WBZ; 9:30, WJZ; 10, WTAM, WBAL, KWK, WREN; 9, Melody hour, KDKA, KYW, KWK, WTAM, KVOO, WFAA; 10:30, music; 11, Slumber music.
WLW Cincinnati, Ohio (428.3m-700kc) 8 a. m., exercises; 8:30, morning devotion; 10, women's hour; 12:05 p. m., organ; 3:35, program; 4, organ; 7, Banquets; 7:30, concert; 8, orchestra; 8:15, musicians; 8:15, ensemble; 9, features; 9:15, Cosacks; 10:01, studio features; 11, Vaudeons.
WLWL New York, N. Y. (370.2m-810kc) 6 p. m., Health period; 7, musicale.
WMAK Buffalo, N. Y. (545.1m-550kc) 11 a. m., menu; 6:15 p. m., ensemble; 7:30 p. m., musicale; 9, violin recital; 10:05, WILLAM; 12, symphony.



PAUL DUMONT is the new announcer who is rapidly making friends through the N. B. C. Red Network. Mr. Dumont, who has a beautiful baritone voice, has had three years of Radio work with other New York stations.

tet; 7-8 p. m., music; 8-9, N. B. C.; 9-10, program; 11, N. B. C.
KFQA Seattle, Wash. (447.5m-670kc) 10 a. m. household hints; 1:30 p. m., homemaking helps; 2, letter; 3, organ; 4:30, big brothers; 6, sightseeing hour; 7:15, news; 8, N. B. C.; 9, N. B. C.; 10:30, Cuyates' frolic.
KFON Long Beach, Calif. (241.8m-1240kc) 8:30 a. m. early musicale; 9:30, organ; 10, shopping news; 10:30, beauty hints; 11:30, news; 12 n., lost and found announcements; 12:30 p. m., musicale; 1, musicale; 2:30, organ, 3, study club; 4, sports, news; 4:30, orchestra; 6, team; 8, novelty program; 9, frolic; 12, dance music.
KFRC San Francisco, Calif. (454m-660kc) 7 p. m. Ceclians; 8, Jamboree; 10, frolic.
KFWE Hollywood, Calif. (352.7m-850kc) 9:30 a. m., program; 11, Aunt Sammy; 12:30, talks; 3, program; 6, dinner music; 7:11, evening program.
KGA Spokane, Wash. (260.7m-1150kc) 6:30 p. m. program; 10, dance music.
KGO Oakland, Calif. (384.4m-780kc) 11:30 a. m. concert; 3:30 p. m., Women's Club; 4, dance orchestra; 6-6:55 p. m., orchestra; 8-9, orange network; 9, time; 9-10, Pilgrims, 10-11, N. B. C.
KGW Portland, Ore. (491.5m-610kc) 8, National Broadcasting company; 9-10, concert.
KHJ Los Angeles, Calif. (399.8m-750kc) 8 a. m., reveille hour; 1:30 p. m., request program; 3, Melody Masters; 4:30, program; 6:15, musicale; 7, dance orchestra; 10, orchestra.
KHQ Spokane, Wash. (370.2m-810kc) 9:45 a. m., services; 10, household hints; 11, service hour; 12 n. luncheon program; 4 p. m., latest recordings; 5, service hour; 6, orchestra; 6:30, organ; 8, N. B. C.; 9, KGW; 10:30, KFQA.
KLX Oakland Calif. (508.2m-590kc) 10 a. m. household hour; 11:30, trio; 3:30 p. m., music; 4:30, organ; 8, special meeting; 9-10 p. m., Lake Merritt Ducks.



An attractive feature of WABC programs is the Atlantic Ladies Trio.

KMA Shenandoah, Iowa (394.5m-760kc) 6 a. m., farm talk; 11, music; 2 p. m., home hour; 6 p. m., program.

KMBC Kansas City, Mo. (270.1m-1110kc) 8 p. m., Columbia chain.

KOIL Council Bluffs, Iowa (319m-940kc) 1:30 p. m., Aunt Sammy; 5:30, organ; 7 p. m., program; 9, musicale; 12, dance music.

KPRC Houston, Texas (283.9m-1020kc) 7:30-8:30 p. m., N. B. C.; 8:30, concert.

KSD St. Louis, Mo. (545.1m-550kc) 7 p. m., WEAF.

KTHS Hot Springs, Ark. (384.4m-760kc) 7:30 p. m., orchestra; 8 p. m., concert; 8:30 p. m., chamber music; 9, frolic.

KVOO Tulsa, Okla. (348.6m-860kc) 6 p. m., program; 7-9:30, N. B. C.; 9:30, quartet; 10, music.

KYW Chicago, Ill. (526m-570kc) 9 a. m., N. B. C.; 1 p. m., orchestra; 6:32, orchestra; 7-9 p. m., WJZ; 9, musicale; 10-12, Serenaders.

WBAP Fort Worth, Texas (499.7m-600kc) 6 p. m., Seven Aces; 8, WEAF.

WBMM Chicago, Ill. (389.4m-770kc) 1 p. m., dance program; 7 p. m., dinner concert; 7:30-11, popular program.

WCCO Minneapolis-St. Paul, Minn. (405.2m-740kc) 10 a. m., N. B. C.; 12 n., farm hour; 6 p. m., association; 8:30 p. m., WEAF; 11:30, organ.

WCFL Chicago, Ill. (483.6m-520kc) 12 n., organ; 1 p. m., rest hour; 5, organ; 6, labor talk; 7:15-12 mid., program.

WCOA Pensacola, Fla. (249.9m-1200kc) 8 p. m., program.

WDAF Kansas City, Mo. (370.2m-810kc) 10 a. m., N. B. C.; 12, U. S. farm school; 3 p. m., string trio; 6, school of the air; 7:30 p. m., music; 8, WEAF; 9:30, Cavaliers; 11:45-1 a. m., Nighthawk frolic.

WDOD Chattanooga, Tenn. (243.8m-1230kc) 7-10 m., music.

WEBB Chicago, Ill. (365.6m-820kc) 10 a. m., N. B. C.; 10:15, N. B. C.; 10:30, organ; 11, Prudence Penny; 1:15 p. m., organ; 3, string trio; 3:30, 7 p. m., orchestra; 9-11, program; 12, revue.

WFAP Dallas, Texas (545.1m-550kc) 8:30 p. m., WEAF; 9:30, WEAF.

WGN WLIF Chicago, Ill. (416.4m-70kc) 10 a. m., homemakers' hour; 11, musicale; 12 n., health talk; 12:40 p. m., luncheon concert; 2:30, Woman's club; 3, tea time music; 5:30, League of Voters; 6:10, Punch and Judy; 6:40, ensemble; 7, music; 8-9:30, N. B. C.; 9:30, songs; 10:20, novelty program; 11, Hoodlums.

WHAS Louisville, Ky. (322.4m-930kc) 3:30 p. m., program; 7:30 p. m., program; 8, WEAF; 8:30, 9:30, N. B. C.

WHB Kansas City, Mo. (340.7m-880kc) 2 p. m., organ; 7-8, string trio.

WHO Des Moines, Iowa (534.4m-560kc) 8 a. m., Victor Record program; 9:45, Aunt Sammy; 10, markets; 10:30, Record hour; 11:30, U. S. Farm service; 12:15 p. m., talk; 12:30, luncheon music; 3, orchestra; 6, orchestra; 7, Iowa Federation Music clubs; 7:30, program; 8, N. B. C.; 10:30, N. B. C.

WHT Chicago, Ill. (305.9m-980kc) 10 a. m., Woman's hour; 10:10, story; 10:40, Maytag; 11:05, poetry; 12 n., organ; 1 p. m., news; 1:15, musicale; 2:20, service dept.; 6:15, organ; 9, Maytag Ramblers; 9:30, Your Hour league.

WIBO Chicago, Ill. (305.9m-980kc) 7:10 p. m., program; 10, musicale.

WJAZ Chicago, Ill. (263m-1140kc) 7 p. m., program; 9, studio concert.

WJBT Chicago, Ill. (389.4m-770kc) 6 p. m., dinner concert; 11, orchestra.

WJDD Chicago, Ill. (365.6m-820kc) 12 n., petite symphony; 12:30, Illinois Agri. program; 2 p. m., children's program; 8-9 p. m., children's musical hour; 11-12, Victorians.

WLAC Nashville, Tenn. (226m-1330kc) 7 p. m., classical program; 8, popular music.

WLS Chicago, Ill. (344.6m-870kc) 9:10 a. m., home question box; 12 n., dinner bell program; 2:30 p. m., homemakers' hour; 7 p. m., Tony's scrap book; 9, choral music; 11-12, popular program.

WMAQ Chicago, Ill. (447.5m-670kc) 8 a. m., U. of C. lecture 9:02, public schools program; 9:30, Davis service; 10:40, Calumet hour; 11:55, Prairie Farmer; 12:55 p. m., luncheon music; 2:30, artist recital; 3:15, bridge; 6, organ; 6:30 p. m., dinner hour; 8, Columbia chain; 10, Stevens hotel orchestra. WJZ.

WBMM Chicago, Ill. (252m-1190kc) 6 p. m., dinner music; 7-10:30, program.

WBMI Chicago, Ill. (263m-1140kc) 8 p. m., orchestra.

WMC Memphis, Tenn. (516.9m-580kc) 12 n., orchestra; 7 p. m., Fiddlin' Five; 7:45 p. m., health talk; 8, WEAF; 9:30, concert.

WOAI San Antonio, Texas (499.7m-600kc) 9-10 p. m., Utah program.

WOC Davenport, Iowa (374.8m-800kc) 10 a. m., N. B. C.; 12:30 p. m., music; 3, home management; 6, Felipe Chippers; 6:45, N. B. C.; 7:30 p. m., WEAF; 8, WEAF; 9:30, talks.

WOS Jefferson City, Mo. (422.3m-710kc) 7 p. m., Farm school; 8, program.

WOW Omaha, Neb. (508.2m-590kc) 7 p. m., WEAF; 8 p. m., WEAF.

WSB Atlanta, Ga. (475.9m-630kc) 10 a. m., homemakers' chat; 11:30, dinner bell; 1 p. m., Georgia State College of Agri.; 5, program; 6, orchestra; 7, Sears-Roebuck program; 8-10, WEAF; 10:45, concert.

WSBC Chicago, Ill. (232.4m-1290kc) 9-11 p. m., musicale.

WSM Nashville, Ten. (336.9m-890kc) 11:45 a. m., Farm and Home program; 1 p. m., luncheon concert; 7:15 p. m., dinner concert; 8, WEAF; 8:30, WEAF; 9:30, WEAF; 10:30, orchestra.

WSMB New Orleans, La. (296.9m-1010kc) 8:30-10:30 p. m., Public School of the Air program; features.

WTMJ Milwaukee, Wis. (293.9m-1020kc) 10 a. m., trio; 11, Your Kitchen; 11:15, organ; 3 p. m., Tune Tinkers; 3, studio program trio; 5, story lady; 6:30, orchestra; 7:10, talk; 7:30, program.

Mountain Time Stations

KOA Denver, Colo. (325.9m-920kc) 12:05 p. m., organ; 6:30, dinner concert; 8 p. m., Scheuerman's Colorado orchestra; 8:15, studio program; 10, dance program.

Pacific Time Stations

KFI Los Angeles, Calif. (468.5m-640kc) 10:45 a. m., Betty Crocker; 12 n., music; 1 p. m., Blues singer; 4, talk; 5, orchestra; 6:30, N. B. C.; 7, symphonette; 9, N. B. C.; 10, orchestra.

KFOA Seattle, Wash. (447.5m-670kc) 10 a. m., air news, household hints; 12:30 p. m., luncheon program; 1:30, homemaking helps; 2, program; 3, organ; 4:30, children's program; 6, program; 6:30, Musical Fruit Cocktail; 7:15, trio; 7:45, book chat; 9, N. B. C.

KFON Long Beach, Calif. (241.8m-1240kc) 9:30 a. m., organ recital; 10:15, period; 10:30, beauty talk; 12 n., musicale; 1 p. m., luncheon music; 2:30, band; 6, Happiness and Harmony; 12 mid., dance music.

KFRC San Francisco, Calif. (454.3m-660kc) 6:20 p. m., program; 8, WJZ; 10-12 mid., dance program.

KFWB Hollywood, Calif. (352.7m-850kc) 8 a. m., Breakfast club; 11, Aunt Sammy; 2:15, orchestra; 6-7 p. m., dinner hour; 7:50, news; 8-9, features; 9-10, orchestra; 10-11, Rainbo orchestra.

KGA Spokane, Wash. (260.7m-1150kc) 9 a. m., Better Homes Girl; 11, diet talk; 11:10, shopping service; 3 p. m., program; 6:02, farm school; 8, musicale; 10, dance music.

KGO Oakland, Calif. (384.4m-780kc) 11:15 a. m., household hints; 11:30, concert; 6 p. m., dinner concert; 8, vaudeville; 9, National Broadcasting company; 10, orchestra.

KGW Portland, Ore. (491.5m-610kc) 8-9 p. m., concert 9-10, National Broadcasting company.

KHJ Los Angeles, Calif. (399.8m-750kc) 12:30 p. m., dance band; 6 p. m., nightly domags; 7, male quartet; 8, concert orchestra; 10, concert.

KLX Oakland, Calif. (509m-590kc) 10 a. m., home economics hour; 11:30, trio; 8 p. m., program; 9, special program.

KOIN Portland, Ore. (319m-940kc) 10 a. m., woman's program; 12 n., luncheon program; 1, farm flashes; 4, French lesson; 6 p. m., dinner concert; 7:15, orchestra; 8, program; 9, Olsen hour; 10, dance band.

KPO San Francisco, Calif. (422.3m-710kc) 8 a. m., Happy Time; 1 p. m., orchestra; 4, string trio; 6:30 p. m., N. B. C.; 8-9, Atwater Kent artists; 9-10, orange network; 10-12, studio program.

KPSN Pasadena, Calif. (315.6m-850kc) 12 n., program; 6:15 p. m., concert.

KYA San Francisco, Calif. (309.1m-970kc) 9 a. m., Better Homes girl; 10:30, beauty talks; 11, Sunshine hour; 11:40, health talk; 12 n., news; 5:30, entertainment; 7, Women's club; 8, chamber of music; 9, popular program.

For Daylight Saving Time, add one hour.

Regular Thursday Features Eastern Time Stations

CFCA Toronto (356.9m-840kc) 11 p. m., Canadians.

KDKA Pittsburgh, Pa. (315.6m-950kc) 10 a. m., N. B. C.; 11, Cookbook; 3 p. m., musical masterpieces; 6, U. of Pittsburgh address; 6:15, Little symphony; 7 p. m., program; 8, WJZ; 8:30, WJZ; 9, WJZ.

WABC New York, N. Y. (309.1m-970kc) 12 n., program; 1 p. m., orchestra; 6:31, orchestra; 7:15, orchestra; 10:32, memorial program; 12:30, music.

WBAL Baltimore, Md. (285.5m-1050kc) 3:30 p. m., program; 6:30, dinner orchestra; 7:30, musicale; 8:30, WJZ; 9, WJZ; 10, band.

WBZ Springfield, Mass. (333.1m-900kc) 10 a. m., N. B. C.; 11:30, music; 12:10, service; 12:40, Aunt Sammy; 5:30, service; 12:40, Aunt Sammy; 5:30, Magic Box; 6, trio; 6:30, Radio Rodeo; 7, political talk; 7:10, orchestra; 9:30-10, N. B. C.; 10:01, recital.

WCAE Pittsburgh, Pa. (461.3m-650kc) 11 a. m., beauty talk; 11:15, household talk; 4 p. m., talk; 7, dinner concert; 8:30-10, N. B. C.; 10:30, orchestra.

WCAU Philadelphia, Pa. (261m-1150kc) 4:30 p. m., talks; 6:30, orchestra; 8:01, program; 9:30, Harmonians; 10, Piano duo; 11, revue.

WCSH Portland, Me. (214.2m-1400kc) 10 a. m., housewives' hour; 7:30 p. m., WEAF.

WEAF New York, N. Y. (491.5m-610kc) 11 a. m., studio program; 11:15, Radio household institute; 12:45 p. m., music; 1:45, studio program; 2, program; 4, interviews; 6, dinner music; 7:30 p. m., Coward Comfort hour, WEEL, WTIC, WJAK, WTAG, WCSH; 8, Dodge Brothers Presentation, WEEL, WTIC, WJAR, WTAG, WCSH, WJZ, WRC, WGY, WCAE, WTAL, WWI, WSAL, WEBB, WRHM, WTMI, WOC, WSO, WOW, WDAF, KVOO, WFAA, WHAS, WSM, WMC, WSB; 9, time, WEEL, WJAR, WFI, WRC, WGY, WCAE, WTAM, WWI, WSAL; 9, Chiquito club; Eskimos, WEEL, WJAR, WTAG, WFI, WRC, WGY, WCAE, WJZ, WSM, WJZ, 10, Smith Brothers, WEEL, WTAG, WRC, WGR, WCAE, WJZ, WSAL, EBH, KSD, WCCO, WOC, WDAF, 10:30, Pennsylvanians, WTIC, WFL, WGY, WGIK, WWI, WWJ; 11:30, HO, KSD.

WEEI Boston, Mass. (508.2m-590kc) 10:30 a. m., shopping service; 11:15, N. B. C.; 2:30, hour of music; 7:30-10:30 p. m., WEAF.

WFAN Philadelphia, Pa. (224m-1340kc) 5:45 p. m., dinner music; 7, Radio play; 9, program; 11, Cheer-up club.

WFI Philadelphia, Pa. (405.2m-740kc) 10:20 a. m., housekeepers' chats; 1 p. m., ensemble; 1:40, ensemble; 3, notes of interest; 6:30, orchestra.

WGBS New York, N. Y. (349m-860kc) 9 a. m., shopping service; 1:35 p. m., program; 6, Uncle Gee Bee; 10 p. m., program.

WGHP Detroit, Mich. (277.6m-1080kc) 8 p. m., program; 10:30, orchestra.

WGR Buffalo, N. Y., N. Y. (302.8m-990kc) 8-11:30 p. m., N. B. C.

WGY Schenectady, N. Y. (379.5m-790kc) 11:15 a. m., N. B. C.; 12:07 p. m., farm flashes, 2, orchestra; 6:30, dinner music; 7:30 p. m., college lecture; 8, WEAF; 9, WEAF; 10, program; 11, WEAF; 11:30, organ.

WHAM Rochester, N. Y. (280.2m-1070kc) 10 a. m., N. B. C.; 6:45 p. m., orchestra; 7:30, Union College speaker; 8-10, N. B. C.; 10, studio program; 11:05, Homesteaders.

WHK Cleveland, Ohio (265.3m-1130kc) 11 a. m., Ethel and Barry; 1 p. m., farm flashes; 6:30 dinner concert; 10, music.

WIP Philadelphia, Pa. (346.6m-860kc) 10 a. m., menu; 1 p. m., music; 3, musicale; 6:30, dinner music; 8 p. m., program; 9, Radio Forum.

WJAX Jacksonville, Fla. (340.7m-880kc) 8 p. m., recital; 9, WJZ.

WJR Detroit, Mich. (440.9m-680kc) 10 a. m., N. B. C.; 12:30 p. m., farm service bureau; 12:45, musical program; 5:30, children's hour; 6, dinner music; 6:45, recital; 7:30, orchestra; 8-10, N. B. C.; 10, recital; 10:45, orchestra; 11, Cotton Pickers.

WJZ New York, N. Y. (454.3m-660kc) 12:30 p. m., luncheon concert; 2:05, menu; 2:30, meat council; 5:30, markets; 5:45, studio program; 7, U. S. Marine band, WRC, WOW, 8, Re-Told tales; 8:30, Ampico music, WJZ, WVAL, WJAM, KDKA, WJR, WLW, KYW, KWB, WRHM, WTMJ; 9, Maxwell House hour, WJZ, WRAL, WFAM, KDKA, WJR, KYW, WTMJ, KSD, WOC, WHO, WDAF, WHAS, WSM, WMC, WSB, WBT, WJAX, KPRC, WBAP; 10, time, WBZ.



THIS young artist masks her identity under the euphonious title of "Miss Yvette." She is concert pianist and is heard regularly from KTHS, Arlington Hotel, Hot Springs, Ark.

KYW Chicago, Ill. (526m-570kc) 1 p. m., orchestra; 4, woman's hour; 6, Uncle Bob; 7-9 p. m., N. B. C.; 9:05, a little bit of everything; 9:30, program; 10:30, serenaders.

WBAP Fort Worth Texas (499.7m-600kc) 6 p. m., orchestra; 8, WEAF; 8:30, popular songs.

WBMM Chicago, Ill. (389.4m-770kc) 1-2 p. m., dance program; 7-11 p. m., musicale.

WBCN Chicago, Ill. (288.3m-1040kc) 7 p. m., popular program.

WCCO Minneapolis-St. Paul, Minn. (405.2m-740kc) 10 a. m., N. B. C.; 10:15, homemaker chats; 12 n., farm hour; 2:30 p. m., N. B. C.; 6, St. Paul hour; 7 p. m., N. B. C.; 9:30, quartet; 10, dance orchestra.

WCFL Chicago, Ill. (483.6m-620kc) 12 n., organ; 1 p. m., rest hour; 5, organ; 6-12 mid., program.

WCOA Pensacola, Fla. (249.9m-1200kc) 8 p. m., program.

WDAF Kansas City, Mo. (370.2m-810kc) 10 a. m., N. B. C.; 12 n., U. S. farm school; 3 p. m., string trio; 6, school of the air; 7-10 p. m., N. B. C.; 11:45-1 a. m., Nighthawk frolic.

WDDO Chattanooga, Tenn. (243.8m-1230kc) 7-10 p. m., music.

WEBB Chicago, Ill. (365.6m-820kc) 10 a. m., N. B. C.; 10:15, N. B. C.; 10:30, organ; 11, Prudence Penny; 1:15 p. m., organ; 3, program; 7-8 p. m., artists; 8:30, WEAF; 9-11, orchestra.

WENR Chicago, Ill. (288.3m-1040kc) 6 p. m., organ; 8, classical program; 9:30, studio program.

WFAA Dallas, Texas (545.1m-550kc) 7 p. m., music; 9, program.

WGN-WLJB Chicago, Ill. (416.4m-720kc) 10 a. m., home management period; 11, musicale; 12 n., readings; 12:40 p. m., luncheon concert; 2:30, travel talk; 3, tea time music; 6:30, ensemble; 7, almanac; 7:30, Salernos; 8, musicale; 9, N. B. C.; 10:20, novelty program; 11, Hoodlums.

WHAS Louisville, Ky. (522.4m-930kc) 3:30 p. m., program; 7:30 p. m., studio concert; 8-10, N. B. C.

WHB Kansas City, Mo. (340.7m-880kc) 2 p. m., ladies' hour; 7-8 p. m., talk.

WHO Des Moines, Iowa (535.4m-560kc) 9:45 a. m., housekeepers' chat; 10:30, music; 11:30, farm service; 12:15 p. m., talk; 2:30, N. B. C.; 3:30, music; 6:30 p. m., N. B. C.; 8:30-11, N. B. C.; 11, orchestra.

WHT Chicago, Ill. (305.9m-980kc) 10 a. m., women's home hour; 12 n., organ; 1 p. m., news; 1:15, trio; 2:20, service dept.; 6, news; 6:15 organ; 8:35, musicians; 11, your home league.

WJBO Chicago, Ill. (305.9m-980kc) 7:10 p. m., musicale; 10, popular program.

WJAZ Chicago, Ill. (263m-1140kc) 7 p. m., dinner concert; 9, studio program.

WJET Chicago, Ill. (389.4m-770kc) 6 p. m., orchestra, artists; 11-12:30, music.

WJJD Chicago, Ill. (365.6-820kc) 12 n., symphony; 12:30 p. m., Illinois agr. program; 12:45, symphony; 2, children's hour; 6, orchestra; 8-8:30 p. m., musical hour; 11-1 a. m., Victorians.

WLS Chicago, Ill. (344.6m-870kc) 9:45 a. m., home question box; 10:35, Aunt Minnie; 12 n., dinner-bell program; 2:30 p. m., homemakers' hour; 3:40, Pied Piper's time; 6:35, orchestra; 7, Tony's Scrap Book; 7:10, Jack and Jean; 7:30, quartet; 10, showboat; 11, orchestra.

WMAQ Chicago, Ill. (447.5m-670kc) 8 a. m., U. of C. lecture; 9:02, public school program; 10:40, Calumet home hour; 1 p. m., luncheon music; 2:30, artists' recital; 4:30, Ill. League of Women Voters; 6 p. m., chimes; 8, Columbia chair; 10, WQJ chamber music players; 11, WQJ.

WMBB Chicago, Ill. (262m-1190kc) 6 p. m., dinner concert; 7, ensemble; 8:30, Trianon orchestra.

WMBI Chicago, Ill. (263m-1140kc) 8-9 p. m., Sunday school lesson.

WMC Memphis, Tenn. (516.9m-580kc) 12 n., ensemble; 8-10 p. m., N. B. C.; 10, orchestra.

WOAI San Antonio, Texas (499.7m-600kc) 9 p. m., program.

WOC Davenport, Iowa (374.8m-800kc) 10 a. m., N. B. C.; 10:15, fashion talk; 12:30 p. m., music; 3, home hour; 7-10 p. m., N. B. C.

WOS Jefferson City, Mo. (422.3m-710kc) 7 p. m., U. S. Radio farm school; 8, program.

WOW Omaha, Neb. (508.2m-590kc) 12:40 p. m., music; 2:15, your troubles; 3, stocks; 3:15, news; 5, home band; 6, band; 7, orchestra; 8-11, N. B. C.

WSB Atlanta, Ga. (475.9m-830kc) 10 a. m., homemakers' chat; 10:30, public school; 11, woman's hour; 11:30, dinnerbell program; 12:30 p. m., trio; 3, agr. period; 5:30, program; 6, orchestra; 8 p. m., N. B. C.; 10:45, concert.

WSM Nashville, Tenn. (336.9m-890kc) 11:45 a. m., farm and home; 1 p. m., concert; 8-10 p. m., N. B. C.

WTMJ Milwaukee, Wis. (293.9m-1020kc) 10 a. m., trio; 11, your kitchen; 11:15, organ; 1 p. m., Tune Thinkers; 3, trio; 6, Tune Thinkers; 7 p. m., classical program; 8-11, N. B. C.; 11, organ.

Mountain Standard Time Stations

KOA Denver, Colo. (325.9m-920kc) 12:05 p. m., organ; 3:30, matinee; 7:30 p. m., S. S. lesson; 8, musicale; 9, dance orchestra.

KOB State College, N. M. (394.4m-760kc) 7:30 p. m., orchestra.

Pacific Time Stations

KFI Los Angeles, Calif. (468.5m-640kc) 10:45 a. m., N. B. C.; 1 p. m., ballads; 4, orchestra; 7 p. m., organ; 8, N. B. C.; 10, music.

KFOA Seattle, Wash. (447.5m-670kc) 10 a. m., fashion notes; 1:30 p. m., homemaking helps; 3, organ; 9-10, N. B. C.; 10:30-12, KGNV.

KFON Long Beach, Calif. (241.8m-1240kc) 9:30 a. m., organ; 10:30, beauty hints; 1 p. m., music; 2:30, band; 6-1 a. m., program.

KFRS San Francisco, Calif. (454.3m-660kc) 6:30 p. m., program; 9, studio program; 10, dance music.

KFWB Hollywood, Calif. (352.7m-850kc) 11 a. m., Aunt Sammy; 11:15, talk on psychology; 11:30, shoppers' directory; 7 p. m., orchestra; 7:50, news; 8-11, program; 11-12, orchestra.

KGA Spokane, Wash. (660.7m-1150kc) 9 a. m., Better Homes' girl; 12:20 p. m., musicale; 6:02, U. S. Radio farm school; 10, dance music.

KGO Oakland, Calif. (348.4m-780kc) 11:10 a. m., home economics; 6:35-6:50 p. m., dinner concert; 8-9, N. B. C.; 9:10, National Broadcasting company orchestra; 10, orchestra.

KGW Portland, Ore. (491.5m-610kc) 6-7 p. m., dinner concert; 8-9, concert; 9, National Broadcasting company, 10, concert; 10:30, Hoot Owls, KMO, KFOA, KHO.

KHJ Los Angeles, Calif. (399.8m-750kc) 8 a. m., music; 1:30 p. m., request program; 2, music; 7-11 p. m., program.

KJR Seattle, Wash. (348.6m-860kc) 6:30 p. m., dinner hour; 8-10, program; 10-12, dance orchestra.

KLX Oakland, Calif. (508.2m-590kc) 10 a. m., home economics; 11:30, trio; 3:30 p. m., Hawaiians; 5:30, Brother Bob; 8 p. m., special program; 9-10, Athens Athletic club orchestra.

KNX Hollywood, Calif. (336.9m-890kc) 7 p. m., feature; 8, 9, 10, features; 11, Hotel Ambassador.

KOIN Portland, Ore. (319m-940kc) 10 a. m., shoppers' guide; 12 n., concert; 4 p. m., French lesson; 7:15, orchestra; 8, orchestra; 8:40, program; 10, band.

KPO San Francisco, Calif. (422.3m-710kc) 10:45 a. m., N. B. C.; 6:30 p. m., program; 8-9:30, N. B. C.; 10, dance orchestra.

KYA San Francisco, Calif. (309.1m-970kc) 9 a. m., Better Home girl; 10:30, health talks; 5:30, news; 7, talks; 8, minstrel show.

For Daylight Saving Time, add one hour.

Regular Saturday Features

Eastern Time Stations

CFCA Toronto, Can. (357m-840kc) 8 p. m., talk.

KDKA Pittsburgh, Pa. (315.6m-950kc) 6:15 p. m., band; 7:15, Home Radio club; 7:30 p. m., concert; 8-10, N. B. C.

WABC New York, N. Y. (309.1m-970kc) 1 p. m., orchestra; 7, forum; 8, orchestra; 10, music; 12, picquet time.

WBAL Baltimore, Md. (285m-1050kc) 6:30 p. m., dinner orchestra; 7:30, jubilee singers; 8, N. B. C.; 9, N. B. C.; 10, Marylanders.

WBZ Springfield, Mass. (333.1m-900kc) 11 a. m., organ; 11:45, Aunt Sammy; 6:30 p. m., Jack Morey's singing orchestra; 8:10, musicale; 10:15, orchestra.

WCAE Pittsburgh, Pa. (461.3m-650kc) 11:15 a. m., household commodities; 12 n., farm period; 4 p. m., music; 6 p. m., dinner concert; 9-12, orchestra.

WCAU Philadelphia, Pa. (261m-1150kc) 12:30 p. m., orchestra; 5, This and That; 6:30, orchestra; 10, music.

WCSH Portland, Maine (214.2m-1400kc) 11:15 a. m., N. B. C.; 7 p. m., N. B. C.; 10, news.

WEAF New York, N. Y. (491.5m-610kc) 11:15 a. m., Radio household institute; 1:45, music; 5, orchestra; Astoria, WRC; 6 p. m., dinner music, WEEL, WRC, WCAE; 7, South Sea Islanders; WWJ, WTAG; 7:30, High Linkers, WGY, WCAE, WWJ; 9, musicale; 10, Palais D'Or orchestra, WGY, WSAL, KSD, WLD, WCAE, WJOL; 10:30, orchestra; WGY, KSD, WLD, WCAE, WWJ, WMC; 11, Park Central orchestra, WGY, KSD, WHO, WCAE, WWJ.

WEEL Boston, Mass. (508.2m-590kc) 8:15 a. m., N. B. C.; 11:15, N. B. C.; 6, N. B. C.; 7:20 p. m., orchestra; 8, WEAF; 11:05, cruising the air; 11:35, news.

WFAN Philadelphia, Pa. (224m-1340kc) 4:45 p. m., music; 11:30, organ.

WFI Philadelphia, Pa. (405.2m-740kc) 1 p. m., ensemble; 3, operetta; 6:30, orchestra; 8 p. m., program; 10, orchestra; 10:30, N. B. C.

WGBS New York, N. Y. (349m-860kc) 9 a. m., shopping service; 1:35 p. m., ensemble; 5:30, dance orchestra; 7:30, quartet; 11:30, After-Theater Party; 12, Family Act.

WGR Buffalo, N. Y. (303m-590kc) 8 p. m., N. B. C. programs.

WGY Schenectady, N. Y. (379.5m-790kc) 11:15 a. m., N. B. C.; 6:30 p. m., dinner music; 7:30, N. B. C.; 8, N. B. C.; 9-10, N. B. C.; 10, organ; 11, N. B. C.

WHK Cleveland, Ohio (265.3m-1130kc) 11 a. m., music; 6 p. m., Music Makers; 8 p. m., program.

WHAM Rochester, N. Y. (280.2m-1070kc) 6:30 p. m., music; 8-10, N. B. C.; 10, glee club.

WIP Philadelphia, Pa. (348.5m-860kc) 10 a. m., menu; 1 p. m., organ; 3, Collegians; 6:30, dinner music; 7 p. m., bedtime story; 9, concert; 9:45, quartet; 10:30, dance orchestra; 11, organ.

WJAX Jacksonville, Fla. (340.7m-850kc) 8:05 p. m., program; 9, WJZ; 10, dance music.

WJR-WCX Detroit, Mich. (440.9m-680kc) 5:30 p. m., children's hour; 6, dinner music; 7 p. m., orchestra; 8, WJZ; 10, Personality Girls; 11, orchestra.

WJZ New York, N. Y. (454.2m-660kc) 12:30 p. m., luncheon music; 2:05, Gondoliers; 7 p. m., Hotel Astor orchestra; 8, New York symphony, WEEL, WTC, WJAR, WTAG, WCSH, WHAM, KDKA, WBAL, WSB, WSM, WMC, WHAS, WLW, WTR, KYW, WCCO, KSD, WOC, WDAF, WFO, WOV; 9, Philco hour, KDKA, KYW, WHAM, WTR, WLW, KSD, WOC, WHO, WOW, WDAF, KYOD, WHAS, WSM, WSB, WMC, WBT, WJAX, WTMJ, WEEL, WTC, WTAG, WCSH, WJAX, WBAP; 10, Keystone duo; 10:30, orchestra; 11, Slumber music.

WLW Cincinnati, Ohio (428m-700kc) 10 a. m., woman's hour; 12:05 p. m., noon musicale; 3:30, program; 7 p. m., Mona Motor hour; 8, WJZ; 9, WJZ; 11, orchestra.

WLWL New York, N. Y. (370.2m-810kc) 6 p. m., program.

WMAK Buffalo, N. Y. (545.1m-550kc) 11 a. m., menu period; 6:30 p. m., orchestra; 7:30, musicale; 8:30, program; 9, musicale; 10, organ; 11, orchestra.

WMCA New York, N. Y. (370.2m-810kc) 9 a. m., ensemble; 1 p. m., synopators; 5:30, studio program; 8, musical extravaganza; 9, boxing bouts; 11, entertainers.



When those lovely lilting melodies from old Spain come floating over the ether from the Red chain of the National Broadcasting company, the Ipana Troubadours are on the air.

CHAIN BROADCASTS

Table with columns: Eastern 9:30, Central 8:30, Mountain 7:30, Pacific 6:30. Includes Standard Symphony hour and Cathedral Hour.

Table with columns: Eastern 10, Central 9, Mountain 8, Pacific 7. Includes Cathedral Hour.

Table with columns: Eastern 10:15, Central 9:15, Mountain 8:15, Pacific 7:15. Includes Don Amalzo.

Table with columns: Eastern 10:30, Central 9:30, Mountain 8:30, Pacific 7:30. Includes Bible Drama.

Table with columns: Eastern 12 mid., Central 11, Mountain 10, Pacific 9. Includes Don Amalzo.

Table with columns: Eastern 6 p.m., Central 5, Mountain 4, Pacific 3. Includes Monday.

Table with columns: Eastern 6:30, Central 5:30, Mountain 4:30, Pacific 3:30. Includes Waldorf-Astoria dinner music.

Table with columns: Eastern 7:30, Central 6:30, Mountain 5:30, Pacific 4:30. Includes Buist Gardeners.

Table with columns: Eastern 8:30, Central 7:30, Mountain 6:30, Pacific 5:30. Includes Roly and His Gang.

Table with columns: Eastern 9, Central 8, Mountain 7, Pacific 6. Includes Great Moments in History.

Table with columns: Eastern 9, Central 8, Mountain 7, Pacific 6. Includes Riverside hour.

Table with columns: Eastern 8:30, Central 7:30, Mountain 6:30, Pacific 5:30. Includes A. and P. Cypriotes.

Table with columns: Eastern 8:30, Central 7:30, Mountain 6:30, Pacific 5:30. Includes Musical Romances.

Table with columns: Eastern 9, Central 8, Mountain 7, Pacific 6. Includes General Motors Family.

Table with columns: Eastern 9:30, Central 8:30, Mountain 7:30, Pacific 6:30. Includes First Performance Hour.

Table with columns: Eastern Rise and Shine, Central Key Station-WJZ, Mountain (454.2m-660kc), Pacific Call. Includes Longhines Correct Time.

Table with columns: Eastern 10:30, Central 9:30, Mountain 8:30, Pacific 7:30. Includes Buccaneers.

Table with columns: Eastern 11, Central 10, Mountain 9, Pacific 8. Includes Rudy Seiger's Shell Symphonists.

Table with columns: Eastern 11, Central 10, Mountain 9, Pacific 8. Includes Vincent Lopez Orchestra.

Table with columns: Eastern 12 mid., Central 11, Mountain 10, Pacific 9. Includes Rounders.

Table with columns: Eastern 12:30 a.m., Central 11:30, Mountain 10:30, Pacific 9:30. Includes Fisk Time-to-Retire Boys.

Table with columns: Eastern 1 a.m., Central 12, Mountain 11, Pacific 10. Includes Broadways and Boulevards.

Table with columns: Eastern 1:30 p.m., Central 12:30, Mountain 11:30, Pacific 10:30. Includes Johnson T. avelog.

Table with columns: Eastern 3:30, Central 2:30, Mountain 1:30, Pacific 12:30. Includes United States Navy Band.

Table with columns: Eastern 5, Central 4, Mountain 3, Pacific 2. Includes Ronnie Tashoff and his orchestra.

Table with columns: Eastern 6, Central 5, Mountain 4, Pacific 3. Includes Waldorf-Astoria dinner concert.

Table with columns: Eastern 7, Central 6, Mountain 5, Pacific 4. Includes Voters' Service.

Table with columns: Eastern 8, Central 7, Mountain 6, Pacific 5. Includes Seiberling Singers.

Table with columns: Eastern 8:30, Central 7:30, Mountain 6:30, Pacific 5:30. Includes Stromberg Carlson hour.

Table with columns: Eastern Sealy Air Weavers, Central Key Station-WJZ, Mountain (491.5m-610kc), Pacific Call. Includes Sealy Air Weavers.

Table with columns: Eastern 9, Central 8, Mountain 7, Pacific 6. Includes Eveready hour.

Table with columns: Eastern 10, Central 9, Mountain 8, Pacific 7. Includes Community Chest.

Table with columns: Eastern 10:30, Central 9:30, Mountain 8:30, Pacific 7:30. Includes Bridge lesson.

Table with columns: Eastern 10:30, Central 9:30, Mountain 8:30, Pacific 7:30. Includes Rolfe's Palais D'Or Orchestra.

Table with columns: Eastern 11, Central 10, Mountain 9, Pacific 8. Includes Eveready Salon Orchestra.

Table with columns: Eastern 11:30, Central 10:30, Mountain 9:30, Pacific 8:30. Includes Auction Bridge Game.

Table with columns: Eastern 11:30, Central 10:30, Mountain 9:30, Pacific 8:30. Includes Janssens's Hofbrau Orchestra.

Table with columns: Eastern 1 a.m., Central 12, Mountain 11, Pacific 10. Includes Dance Orchestra.

Table with columns: Eastern 8:30, Central 7:30, Mountain 6:30, Pacific 5:30. Includes Soconyans.

Table with columns: Eastern 7:45, Central 6:45, Mountain 5:45, Pacific 4:45. Includes 'The Political Situation in Washington Tonight.'

Table with columns: Eastern 8:30, Central 7:30, Mountain 6:30, Pacific 5:30. Includes Champion Sparkers.

Table with columns: Eastern 8:30, Central 7:30, Mountain 6:30, Pacific 5:30. Includes Great Moments of History.

Table with columns: Eastern 8:30, Central 7:30, Mountain 6:30, Pacific 5:30. Includes Sylvia Foresters.

CHAIN BROADCASTS

Eastern 9		Central 8		Mountain 7		Pacific 6	
Ipana Troubadours. Key Station—WEAF (491.5m-610kc)							
Meters Kc.	Call	Meters Kc.	Call	Meters Kc.	Call	Meters Kc.	Call
214.2	1409 WCHS	476.4	720 WLIB	461.3	650 WCAE	483.6	620 WJAZ
232.9	1020 WTMJ	468.5	640 WRC	475.9	630 WSB	483.6	620 WJAZ
302.8	990 WGR	461.3	650 WCAE	475.9	630 WSB	483.6	620 WJAZ
322.4	930 WHAS	483.6	620 WJAZ	493.7	600 WJAP	508.2	590 WEEI
325.9	920 KOA	475.9	630 WSB	508.2	590 WEEI	516.9	580 WJAZ
336.9	890 WSM	493.7	600 WJAP	508.2	590 WEEI	516.9	580 WJAZ
348.6	860 KVOO	508.2	590 WEEI	516.9	580 WJAZ	535.4	560 WTIC
352.7	850 WWJ	516.9	580 WJAZ	535.4	560 WTIC	545.1	550 WFAA
361.2	830 WSAI	535.4	560 WTIC	545.1	550 WFAA		
370.2	810 WDAF	545.1	550 WFAA				
374.8	800 WOC						
379.2	790 WGY						
399.8	750 WTAM						
405.2	740 WCCO						
Kolster Radio Hour. Key Station—WOR (422.3m-710kc)							
Meters Kc.	Call	Meters Kc.	Call	Meters Kc.	Call	Meters Kc.	Call
228.9	1310 WOVW	275.1	1090 WEAN	277.6	1080 WGHF	282.8	1060 WMOX
238	1260 WADC	277.6	1080 WGHF	282.8	1060 WMOX	299.8	1000 KMOX
243.8	1230 WCAO	282.8	1060 WMOX	299.8	1000 KMOX	319	940 KOIL
245.8	1220 WKRC	299.8	1000 KMOX	319	940 KOIL	447.5	670 WMAO
258.5	1160 WFBH	319	940 KOIL	447.5	670 WMAO	461.3	650 WNAC
260.7	1150 WCAU	447.5	670 WMAO	461.3	650 WNAC		
270.1	1110 KMBZ						
270.1	1110 WJAS						
Variety Hour. Key Station—WJZ (454.2m-660kc)							
Meters Kc.	Call	Meters Kc.	Call	Meters Kc.	Call	Meters Kc.	Call
234.2	1280 KWK	440.9	680 WJR	440.9	680 WJR	440.9	680 WJR
285.5	1050 WJBL	526	570 KYW				
315.6	950 KDKA						
Goodrich Zipper Orchestra. Key Station—WEAF (491.5m-610kc)							
Meters Kc.	Call	Meters Kc.	Call	Meters Kc.	Call	Meters Kc.	Call
258.5	1160 WBT	416.4	720 WGN	416.4	720 WGN	416.4	720 WGN
302.8	990 WGR	461.3	650 WCAE	468.5	640 WRC	475.9	630 WSB
322.4	930 WHAS	468.5	640 WRC	475.9	630 WSB	483.6	620 WJAZ
336.9	890 WSM	475.9	630 WSB	483.6	620 WJAZ	493.7	600 WJAP
348.6	860 KVOO	483.6	620 WJAZ	493.7	600 WJAP	508.2	590 WEEI
352.7	850 WWJ	508.2	590 WEEI	516.9	580 WJAZ	516.9	580 WJAZ
361.2	830 WSAI	516.9	580 WJAZ	535.4	560 WTIC	545.1	550 WFAA
370.2	810 WDAF	535.4	560 WTIC	545.1	550 WFAA		
374.8	800 WOC	545.1	550 WFAA				
379.2	790 WGY						
399.8	750 WTAM						
405.2	740 WCCO						
Musical Fruit Cocktail. Key Station—WJZ (454.2m-660kc)							
Meters Kc.	Call	Meters Kc.	Call	Meters Kc.	Call	Meters Kc.	Call
302.8	990 WGR	447.5	670 WMAO	461.3	650 WNAC		
370.2	810 WDAF	468.5	640 WRC				
384.4	780 KGO	491.5	610 KGW				
422.3	710 KPO						
Columbia Celebrity Hour. Key Station—WOR (422.3m-710kc)							
Meters Kc.	Call	Meters Kc.	Call	Meters Kc.	Call	Meters Kc.	Call
228.9	1310 WOVW	275.1	1090 WEAN	277.6	1080 WGHF	282.8	1060 WMOX
238	1260 WADC	277.6	1080 WGHF	282.8	1060 WMOX	299.8	1000 KMOX
243.8	1230 WCAO	282.8	1060 WMOX	299.8	1000 KMOX	319	940 KOIL
245.8	1220 WKRC	299.8	1000 KMOX	319	940 KOIL	447.5	670 WMAO
258.5	1160 WFBH	319	940 KOIL	447.5	670 WMAO	461.3	650 WNAC
260.7	1150 WCAU	447.5	670 WMAO	461.3	650 WNAC		
270.1	1110 KMBZ						
270.1	1110 WJAS						
National Grand Opera. Key Station—WEAF (491.5m-610kc)							
Meters Kc.	Call	Meters Kc.	Call	Meters Kc.	Call	Meters Kc.	Call
214.2	1409 WCHS	461.3	650 WCAE	468.5	640 WRC	475.9	630 WSB
232.9	1020 WTMJ	468.5	640 WRC	475.9	630 WSB	483.6	620 WJAZ
302.8	990 WGR	461.3	650 WCAE	475.9	630 WSB	483.6	620 WJAZ
322.4	930 WHAS	483.6	620 WJAZ	493.7	600 WJAP	508.2	590 WEEI
336.9	890 WSM	493.7	600 WJAP	508.2	590 WEEI	516.9	580 WJAZ
348.6	860 KVOO	508.2	590 WEEI	516.9	580 WJAZ	535.4	560 WTIC
352.7	850 WWJ	516.9	580 WJAZ	535.4	560 WTIC	545.1	550 WFAA
361.2	830 WSAI	535.4	560 WTIC	545.1	550 WFAA		
370.2	810 WDAF	545.1	550 WFAA				
374.8	800 WOC						
379.2	790 WGY						
399.8	750 WTAM						
405.2	740 WCCO						
Jack and Ethyl. The Motor. Key Station—KFOA (491.5m-610kc)							
Meters Kc.	Call	Meters Kc.	Call	Meters Kc.	Call	Meters Kc.	Call
302.8	990 WGR	447.5	670 WMAO	461.3	650 WNAC		
370.2	810 WDAF	468.5	640 WRC				
384.4	780 KGO	491.5	610 KGW				
447.5	670 WMAO						
Hal Kemp and his orchestra. Key Station—WEAF (491.5m-610kc)							
Meters Kc.	Call	Meters Kc.	Call	Meters Kc.	Call	Meters Kc.	Call
435.4	560 WTIC	545.1	550 WFAA				
Royal Ambassadors. Key Station—KFOA (491.5m-610kc)							
Meters Kc.	Call	Meters Kc.	Call	Meters Kc.	Call	Meters Kc.	Call
370.2	810 WDAF	468.5	640 WRC	491.5	610 KGW		
384.4	780 KGO	491.5	610 KGW				
12 mid. Los Angeles Studio. Key Station—KFOA (491.5m-610kc)							
Meters Kc.	Call	Meters Kc.	Call	Meters Kc.	Call	Meters Kc.	Call
302.8	990 WGR	447.5	670 WMAO	461.3	650 WNAC		
370.2	810 WDAF	468.5	640 WRC				
384.4	780 KGO	491.5	610 KGW				
1 a. m. Dance Orchestra. Key Station—KFOA (491.5m-610kc)							
Meters Kc.	Call	Meters Kc.	Call	Meters Kc.	Call	Meters Kc.	Call
422.3	710 KPO	491.5	610 KGW				
6 p. m. Waldorf-Astoria dinner concert. Key Station—WEAF (491.5m-610kc)							
Meters Kc.	Call	Meters Kc.	Call	Meters Kc.	Call	Meters Kc.	Call
461.3	650 WNAC	516.9	580 WJAZ				
468.5	640 WRC						
6:30 Sunset Dancers. Key Station—WJZ (454.2m-660kc)							
Meters Kc.	Call	Meters Kc.	Call	Meters Kc.	Call	Meters Kc.	Call
228.9	1310 WOVW	275.1	1090 WEAN	277.6	1080 WGHF	282.8	1060 WMOX
238	1260 WADC	277.6	1080 WGHF	282.8	1060 WMOX	299.8	1000 KMOX
243.8	1230 WCAO	282.8	1060 WMOX	299.8	1000 KMOX	319	940 KOIL
245.8	1220 WKRC	299.8	1000 KMOX	319	940 KOIL	447.5	670 WMAO
258.5	1160 WFBH	319	940 KOIL	447.5	670 WMAO	461.3	650 WNAC
260.7	1150 WCAU	447.5	670 WMAO	461.3	650 WNAC		
270.1	1110 KMBZ						
270.1	1110 WJAS						
Friday							
Eastern 7:30		Central 6:30		Mountain 5:30		Pacific 4:30	
Cities Service Concert Orchestra. Key Station—WEAF (491.5m-610kc)							
Meters Kc.	Call	Meters Kc.	Call	Meters Kc.	Call	Meters Kc.	Call
302.8	990 WGR	447.5	670 WMAO	461.3	650 WNAC		
352.7	850 WWJ	516.9	580 WJAZ				
370.2	810 WDAF	468.5	640 WRC				
405.2	740 WCCO						
12 mid. Dodge Brothers' Presentation. Key Station—WJZ (454.2m-660kc)							
Meters Kc.	Call	Meters Kc.	Call	Meters Kc.	Call	Meters Kc.	Call
370.2	810 WDAF	468.5	640 WRC	491.5	610 KGW		
384.4	780 KGO	491.5	610 KGW				
422.3	710 KPO						
12:30 Moon Magic. Key Station—KFOA (491.5m-610kc)							
Meters Kc.	Call	Meters Kc.	Call	Meters Kc.	Call	Meters Kc.	Call
370.2	810 WDAF	468.5	640 WRC	491.5	610 KGW		
422.3	710 KPO						
1 Dance Music. Key Station—KFOA (491.5m-610kc)							
Meters Kc.	Call	Meters Kc.	Call	Meters Kc.	Call	Meters Kc.	Call
422.3	710 KPO	491.5	610 KGW				
468.5	640 WRC						
Saturday							
Eastern 8:30		Central 7:30		Mountain 6:30		Pacific 5:30	
White Rock. Key Station—WJZ (454.2m-660kc)							
Meters Kc.	Call	Meters Kc.	Call	Meters Kc.	Call	Meters Kc.	Call
234.2	1280 KWK	333.1	900 WBZ	428.3	700 WLW	440.9	680 WJR
254.1	1180 WREN	333.1	900 WBZ	428.3	700 WLW	440.9	680 WJR
280.7	1070 WHAM	333.1	900 WBZ	428.3	700 WLW	440.9	680 WJR
285.5	1050 WDBL	333.1	900 WBZ	428.3	700 WLW	440.9	680 WJR
315.6	950 KDKA	333.1	900 WBZ	428.3	700 WLW	440.9	680 WJR
Westward Ho, Mary and Bob. Key Station—WOR (422.3m-710kc)							
Meters Kc.	Call	Meters Kc.	Call	Meters Kc.	Call	Meters Kc.	Call
228.9	1310 WOVW	275.1	1090 WEAN	277.6	1080 WGHF	282.8	1060 WMOX
238	1260 WADC	277.6	1080 WGHF	282.8	1060 WMOX	299.8	1000 KMOX
243.8	1230 WCAO	282.8	1060 WMOX	299.8	1000 KMOX	319	940 KOIL
245.8	1220 WKRC	299.8	1000 KMOX	319	940 KOIL	447.5	670 WMAO
258.5	1160 WFBH	319	940 KOIL	447.5	670 WMAO	461.3	650 WNAC
260.7	1150 WCAU	447.5	670 WMAO	461.3	650 WNAC		
270.1	1110 KMBZ						
270.1	1110 WJAS						
Whittall Anglo Persians. Key Station—WEAF (491.5m-610kc)							
Meters Kc.	Call	Meters Kc.	Call	Meters Kc.	Call	Meters Kc.	Call
214.2	1409 WCHS	461.3	650 WCAE	468.5	640 WRC	475.9	630 WSB
293.9	1020 WTMJ	468.5	640 WRC	475.9	630 WSB	483.6	620 WJAZ
362.8	990 WGR	461.3	650 WCAE	475.9	630 WSB	483.6	620 WJAZ
322.4	930 WHAS	483.6	620 WJAZ	493.7	600 WJAP	508.2	590 WEEI
336.9	890 WSM	493.7	600 WJAP	508.2	590 WEEI	516.9	580 WJAZ
348.6	860 KVOO	508.2	590 WEEI	516.9	580 WJAZ	535.4	560 WTIC
352.7	850 WWJ	516.9	580 WJAZ	535.4	560 WTIC	545.1	550 WFAA
361.2	830 WSAI	535.4	560 WTIC	545.1	550 WFAA		

Telling Fortunes With Foods

Like the Mystic of Old Mrs. Peterson Shows Housewives
How Foods Become the Elixir of Success

WHEN Colleen Moore returned to Hollywood several years ago, she looked across at a motherly looking woman who was getting off the train also surrounded by a large following of admirers. "Who are you?" the little screen star called out merrily.

"Only a cook from Chicago," answered Anna J. Peterson with a chuckle.

Here was an older woman whose Radio audience had never seen her competing for popularity with a young motion picture actress. However, for three years, at that time, Mrs. Peterson's voice had been entering thousands of homes when she broadcast from KYW. Now she may be found at her usual hour of 11:35 a. m. behind the microphone of WENR. Her experiences as a mother, a grandmother, and a business woman have given to her voice a quality that wins at once the hearts of her invisible audience. Along with her descriptions of foods, she gives homely bits of advice on homemaking, and hints for those who must economize. Her listeners know that she understands them. And so when fellow tourists heard her voice, they recognized an old and trusted friend.

Mrs. Peterson comes to her position as adviser in thousands of homes throughout the Middle West with not only her own practical experience but with the training she received under Fannie Farmer, her sixteen years of teaching in the East and her laboratory work with a corn products company and with the gas company. Every recipe she broadcasts has been tested in her kitchen. Broadcasting is, of course, only a small though very important part of her work.

In order to show the homemaker what wonderful opportunities for health and happiness the intelligent use of food may bring, Mrs. Peterson has been giving a course of lessons called "Telling Fortunes With Foods." Here is a sample broadcast:

Hints on Food Values

By Anna J. Peterson

WHEN we think of fortune telling, we probably have before our minds some sort of mystic person or thing, perhaps a Hindu, full of very wise thoughts, with his intensive steady gaze into our faces, or perhaps a very motherly looking woman, who says she is the possessor of the mind of some Indian prince or princess and can tell us our past, present and future. Without any of this mystical thing I am talking about—with just plain everyday food, I am able to tell at least what your future will be—even if I cannot delve into the past or present. The foods you eat today tell whether you keep the elastic step of youth, whether your eyes keep clear and bright in the years to come. Gray hairs and wrinkles trace their beginning to a lack of something in the system, which might have been supplied with food.

That is why I call the onion "fruit," which I give in this menu, the very elixir of life, for I know it has in it the elements which will make the skin clear and fresh, and keep you vigorous with a zest for living.

Onion Soup

- 4 large potatoes.
- 4 medium-sized onions.
- 1 bunch soup greens.
- 1 pint water.
- 1 quart milk.
- $\frac{1}{2}$ cup butter.
- 1 teaspoon salt.
- Paprika.

Scrub potatoes very clean. Cut potatoes and onions into even sized cubes; mince soup greens; add water and cook gently 15-20 minutes until thoroughly



ANNA J. PETERSON, WENR, National dietetic authority and adviser to thousands of listening housewives.

soft. Push through strainer. Add milk, butter, salt and paprika and re-heat in double boiler.

At least once a week, it is very wholesome for us to use a vegetarian dish, such as the vegetable chop suey I am giving you, to take the place of meat and potato in the daily dinner, and makes a delightful dish, which to me is the personification of life.

Vegetable Chop Suey

- 1 Spanish onion.
- 1 green pepper.
- 1 red pepper.
- 3 cups celery.
- 1 small head cauliflower.
- 1 cup fresh or canned mushrooms.
- 1 cup fresh or canned tomato.
- 1 cup bean sprouts.
- 2 cups boiling water.
- 1 tablespoon Vegex.
- $1\frac{1}{2}$ teaspoons salt.
- $\frac{1}{2}$ cup parsley.

Peel onion; wash remaining vegetables clean and cut or shred evenly. Separate flowerets of cauliflower and cut them lengthwise. Place all vegetables except parsley in saucepan; add boiling water and salt; cook gently 15 minutes uncovered. Add Vegex and cook 5 minutes

longer. Turn into serving dish and sprinkle with chopped parsley.

In my search for salads, which bring the iron you need to make the blood red, I have developed a fresh spinach and radish salad, with a new honey and lemon dressing which is perfectly delicious. Spinach shredded with a scissors as I have directed in this recipe, is entirely different from cooked spinach, and I am sure you will like the glow it brings you of joy in the spring days.

Fresh Spinach and Radish Salad

- 1 pound spinach.
- 1 bunch radishes.
- 1 small head lettuce.
- Honey and lemon dressing.

Wash vegetables thoroughly. Shred spinach with scissors, and grate radishes on coarse grater. Toss spinach, radishes and dressing together. Serve in lettuce cups.

Honey and Lemon Dressing

- $\frac{1}{4}$ cup honey.
- $\frac{1}{2}$ cup lemon juice.
- Few grains salt.

Mix all ingredients thoroughly and marinate salad greens.

When we are forecasting your future with foods, to make your golden dreams come true, we must use whole grain products in our menu which will give to the body all the elements it needs. That is why in the dessert planned for this menu I have used whole wheat in making my apple and honey turnovers, and you will note also I have used honey for sweetening the apples. Honey, like maple sugar, is one of the easiest digested forms of sweets and it does not require much of it to give the satisfaction which we crave.

Whole Wheat Apple and Honey Turnovers

Filling:

- 6 apples.
- $\frac{1}{2}$ cup honey.
- $\frac{1}{4}$ teaspoon cinnamon.
- $\frac{1}{4}$ teaspoon salt.

Crust:

- $1\frac{1}{2}$ cups whole wheat flour.
- $\frac{3}{4}$ teaspoon salt.
- $\frac{1}{2}$ cup solid shortening.
- 5 tablespoons cold water.

Wash, core and chop apples, but do not pare them; add honey, cinnamon and salt and mix well.

Mix flour and salt; cut in shortening; add water, cutting into a soft dough. Toss onto floured board, pat and roll out. Cut with large cutter about size of a saucer; place apples on $\frac{1}{2}$ of dough; moisten edge with cold water and cover with other half, pressing edges firmly. Place on baking tin and bake 40 minutes at 350 degrees.

If I could sit with you at your family table when you serve this menu, I am sure I could promise to all of you a renewed vigor in living, and a delight in the days to come, which makes it possible for you to carry out your very dreams and desires.

What Mrs. Peterson is trying to do more than anything else is to make her Radio listeners feel that the job of taking care of the family is an important far-reaching one. Upon the intelligent selection and preparation of foods depends the future success of the children.

A Menu a la Verte

MRS. JULIAN HEATH, who has advised housewives through the microphone of WJZ for three years, has made a life work of persuading women to make a serious study of their work of homemaking. From 1912 to 1917 she was editor and part owner of the Housewives' Magazine and she has also lectured throughout the country. She is especially interested in marketing problems and devotes a great deal of her time on the air to this subject.



Mrs. Julian Heath, WJZ

Everything that pertains to the business of housekeeping is included in the scope of these chats. New kitchen utensils are described as they come out. She has spoken on interior decoration. It is even rumored that she has instructed brides on the proper way to draw up a laundry list.

Here is one of Mrs. Heath's menus with a predominating tone of green suggestive of old Erin, which might easily be used for a holiday dinner. Begin the meal with cream of lettuce soup. Serve artichokes with Hollandaise sauce, roast lamb with mint sauce, potatoes O'Brien, green peas, and beans, water cress or lettuce and tomato salad. The color scheme may be carried out in the dessert by having vanilla and pistachio ice cream, small cakes

with green icing and a sprinkling of green pistachio nuts. As extras serve pickles and green olives. The recipes for these dishes given here have been submitted by Mrs. Heath.

Cream of Lettuce Soup

- 1 qt. milk, scalded.
- 1 pt. cold water.
- Lettuce leaves.
- 2 or 3 small carrots.
- Salt and pepper.
- Handful of parsley.
- 3 white onions (cooked ones may be used).
- Flour for thickening (about 2½ table-spoons).

When using the hearts of head lettuce for salad, prepare soup from the best outside leaves. Wash lettuce leaves and parsley well, add onions and carrots, pour the water over them and cook until the vegetables are soft enough to be put through a strainer. (The pulp should be scraped from strainer and used.) Thicken this liquid with blended flour and water, let boil, then gradually add scalded milk. Shredded parsley may be added.

Artichokes With Hollandaise Sauce

The artichokes themselves are prepared by plunging them in boiling water and boiling for five minutes.

Sauce for Artichokes

- ½ cup butter.
- 6 tablespoons boiling water.
- Salt and cayenne pepper.
- 4 egg yolks.
- 1 tablespoon lemon juice or vinegar.

(Continued on page 121)

WOMAN'S PROGRAM INDEX (Daily Unless Indicated)

Household Economics, Women's Hour, Etc.

Eastern	Central	Mountain	Pacific
8:15 a. m.	7:15	6:15	5:15
WJAC (225.4m-1330kc)			
9	7	6	5
WGBS (349m-850kc), Homemaker's Hour.	8:30	7:30	6:30
WVJ (352.7m-850kc), Tonight's dinner.	8:45	7:45	6:45
9:45	8:45	7:45	6:45
WJZ (344.6m-870kc), Question Box.	9	8	7
10	9	8	7
KJBC (376.1m-1110kc), WESH (214.2m-1400kc), ex Sat.			
WEO (27.9m-1600kc), Mon, Wed, Fri.			
WHT (305.9m-880kc), Home hour.			
WII (346.6m-860kc), Tues, Thurs, Sat, Mem.			
WJW (428.3m-700kc), Woman's hour.			
WOR (122.3m-710kc), Alfred W. McCann, Food Excerpt.	9:30	8:30	7:30
10:30	9:30	8:30	7:30
KJKA (315.6m-950kc), Wed.			
W.A.T. (215.9m-1220kc).			
WFI (465.2m-740kc).			
W.N.C. (401.3m-650kc), Woman's Club.			
W.F.G. (514.5m-550kc), Wed, Thurs.			
10:45	9:45	8:45	7:45
WLS (344.6m-870kc), Wed, Fri.			
WIC (435.4m-550kc), Thurs, Fri.			
11	9	8	7
KJKA (315.6m-950kc), Thurs, Cooking School.			
W.A.M. (267.7m-1120kc), Cooking, Tues, Fri.			
W.E.A.F. (491.5m-610kc), W.E.E.I. (508.2m-590kc), WJAR (423.6m-620kc), WESH (214.2m-1400kc), WLIT (465.2m-740kc), WKG (468.5m-640kc), WGY (379.5m-720kc), WGR (332.8m-990kc), WCAE (441.8m-650kc), WTAM (399.8m-750kc), WJL (352.7m-850kc), WSAI (361.2m-830kc), WEBL (365.6m-830kc), KSD (545.1m-550kc), Wed, Fri, Betty (4.10 p. m.).			
WGA (416.4m-720kc).			
WIR (486.9m-650kc), Modern Housekeeping and Cooking School.			
WJF (295.3m-1130kc), Tue., Thurs, Homemaker's hour.			
W.S.B. (475.9m-630kc).			
WIC (515.4m-550kc), Wed.			
11:10	10:10	9:10	8:10
W.M.E. (483.6m-620kc), Fri, Frat. 4 hours.			
11:15	10:15	9:15	8:15
W.E.F. (461.5m-610kc), W.E.E.I. (508.2m-590kc), WJAR (423.6m-620kc), WESH (214.2m-1400kc), WLIT (465.2m-740kc), WKG (468.5m-640kc), WGY (379.5m-720kc), WGR (332.8m-990kc), WCAE (441.8m-650kc), WTAM (399.8m-750kc), WJL (352.7m-850kc), WSAI (361.2m-830kc), W.E.B.L. (365.6m-830kc), KSD (545.1m-550kc), Wed, Fri, Betty (4.10 p. m.).			
W.H.S. (46.5m-550kc), Modern Housekeeping and Cooking School.			
W.H.N. (394.5m-790kc), Wed, Fri.			
W.H.A. (370m-610kc), Wed, Overair.			
11:40	10:40	9:40	8:30
W.F.I. (447.6m-670kc), Calumet Hour.			
11:45	10:45	9:45	8:45
W.R.N. (274.1m-1180kc).			
12	10	9	8
W.H.U. (292.8m-1090kc), Food Talk.			
W.H.M. (389.4m-790kc), Modern Housekeeping and Cooking School.			
W.E.H. (367.6m-830kc), Providence Penny.			
W.T.H. (293.9m-1020kc), Household Hints.			
12:45	11:45	10:45	9:45
W.L.M. (325.9m-1330kc).			
W.S.M. (336.9m-890kc).			
1	11	10	9
KJGA (447.5m-670kc).			
KJW (491.5m-610kc).			
KJF (376.2m-810kc), Sara Leigh's hour.			
KLN (399m-820kc), Martha Lee.			

KOIN (319m-940kc).			
KPO (422.8m-710kc).			
KTNT (256.3m-1170kc), Cook Book.			
12:30	12:30	11:30	10:30
KNX (336.9m-890kc), Ex Fri, Sat, Kate Brew.			
ROMO (305.9m-280kc), Totem Cooking School.			
1:45	12:45	11:45	10:45
K.P.D.Y. (545.5m-550kc), Wed, Homemaker's hour.			
K.F.I. (468.5m-640kc), Betty Crocker, Wed, Fri.			
2	1	12	11
K.F.R.C. (454m-660kc), Mon, Wed, Fri.			
W.G.H.P. (277.6m-1080kc), Home hour.			
2:05	1:05	12:05	11:05
WJZ (344.6m-870kc), Daily Menus.			
2:30	1:30	12:30	11:30
C.K.L.C. (356.9m-840kc), Julia Jane, Mon, Wed, Fri.			
K.F.N.E. (461.3m-650kc), Mon.			
W.A.B.C. (309.1m-970kc), Cook Book, Mon, Wed.			
K.F.I. (472.5m-700kc), Tues.			
W.O.R. (422.3m-710kc), Tues, Thurs.			
3	2	1	12
W.J.B. (340.7m-880kc).			
5:30	4:30	3:30	2:30
W.L.S. (344.7m-870kc), Homemaker's hour.			
3:45	2:45	1:45	12:45
W.B.A. (285.5m-1050kc), Cooking lesson, Wed.			
3	2	1	12
W.O.C. (374.8m-800kc), Aunt Jane.			
4:30	3:30	2:30	1:30
K.F.O.A. (447.5m-670kc), Daily ex Sun, Mon.			
4:40	3:40	2:40	1:40
W.C.A.U. (261m-1150kc), Economics, Fri.			
2	1	12	11
C.K.L.C. (356.9m-840kc), Julia Jane, Mon, Wed, Fri.			
K.Y.W. (526m-570kc), Woman's hour; Tue, Fri.			
5:35	4:35	3:35	2:35
W.N.Y. (526m-570kc), Home Economics, Wed.			
5:50	4:50	3:50	2:50
K.O.A. (325.9m-920kc), Question box, culinary hints.			
8:20	7:20	6:20	5:20
K.U.O.A. (296.9m-1010kc).			
W.O.S. (422.3m-710kc).			
W.H.A. (333.1m-900kc), Home Economics, Mon.			
10:45	9:45	8:45	7:45
K.O.A.C. (276.1m-1110kc), Tues, Thurs.			

"Aunt Sammy"

Eastern	Central	Mountain	Pacific
10 a. m.	9	8	7
WIR (440.7m-680kc), Mon, Wed, Fri.			
10:20	9:20	8:20	7:20
W.F.I. (405.2m-740kc).			
10:30	9:30	8:30	7:30
W.S.H. (214.2m-1400kc), W.H.O. (533.4m-560kc).			
W.E.M.C. (483.6m-620kc), Ex Sat.			
W.B.X. (238m-1260kc).			
10:45	9:45	8:45	7:45
W.H.D. (288.3m-1340kc).			
11	10	9	8
W.E.O. (282.8m-1060kc).			
W.E.W. (352.7m-850kc).			
W.K.F.H. (220.4m-1360kc).			
W.O.S. (422.3m-710kc).			
W.S.B. (475.9m-630kc).			
11:10	10:10	9:10	8:10
K.U.O.A. (296.9m-1010kc).			
11:30	10:30	9:30	8:30
W.R.M.C. (483.6m-620kc).			
W.O.S. (422.3m-710kc), Mon, Tues, Wed, Thurs, Fri.			
11:45	10:45	9:45	8:45
W.H.Z. (333.1m-900kc), Mon, Fri.			
12	11	10	9
K.F.S.I. (440.9m-680kc).			
K.O.V. (270.1m-1110kc), Mon, Wed, Fri.			
W.R.V.A. (254.1m-1180kc).			
12:15 p. m.	11:15	10:15	9:15
W.A.N.D. (222.1m-1350kc).			
12	11	10	9
K.T.H.S. (384.4m-780kc).			
1:30	12:30	11:30	10:30
K.F.W.B. (361.2m-830kc).			
W.A.P.I. (340.7m-880kc), Fri.			
1:45	12:45	11:45	10:45
W.D.A.F. (370.2m-810kc).			

W.D.A.G. (263m-1140kc).			
2	1	12	11
K.F.W.B. (352.7m-850kc).			
K.U.O.M. (461.3m-650kc).			
W.A.S.H. (256.3m-1170kc).			
3:30	2:30	1:30	12:30
K.F.A.U. (285.5m-1050kc).			
K.O.I.L. (319m-940kc).			
W.H.K. (265.3m-1130kc).			
2	1	12	11
W.O.C. (374.8m-800kc).			
4:10	3:10	2:10	1:10
W.F.B.G. (267.7m-1120kc).			
4:15	3:15	2:15	1:15
W.D.A.Y. (545.1m-550kc).			
4:30	3:30	2:30	1:30
K.O.I.L. (319m-940kc).			
W.O.S. (422.3m-710kc), Thurs.			
5:30	4:30	3:30	2:30
K.M.A. (394.5m-760kc).			
9	8	7	6
K.Q.W. (296.9m-1010kc).			

Fashions and Sewing

Eastern	Central	Mountain	Pacific
11:15	10:15	9:15	8:15
W.O.R. (422.3m-710kc), Fashions, Mon.			
11:30 a. m.	10:30	9:30	8:30
W.C.A.E. (461.3m-650kc), Styles, Tues, Fri.			
11:45	10:45	9:45	8:45
W.E.A.F. (491.5m-610kc), WLIT (405.2m-740kc), W.R.C. (468.5m-640kc), Fashionable Dress.			
1:30 p. m.	12:30	11:30	10:30
K.F.W.I. (267.7m-1120kc), Fashion hints, Mon, Thurs.			
1:35	12:35	11:35	10:35
K.P.O. (422.3m-710kc), Fashion critic, Fri.			
W.G.B.S. (349m-860kc), Dressmaking Lessons, Fri.			
2:45	1:45	12:45	11:45
W.O.R. (422.3m-710kc), Wed, Fashion letter.			
5:20	4:20	3:20	2:20
W.O.S. (422.3m-710kc), Wed.			

Health and Beauty

Eastern	Central	Mountain	Pacific
9:15	8:15	7:15	6:15
W.O.W. (508.2m-590kc), Y. W. C. A. health period.			
Wed.	9:15	8:15	7:15
W.C.A.E. (461.3m-650kc), Health talk.			
11	10	9	8
W.O.R. (422.3m-710kc), Lessons on Loveliness, Mon.			
11:35	10:35	9:35	8:35
W.B.Z. (333.1m-900kc), Tues, Joyce Gilbert.			
12	11	10	9
K.M.T.R. (526m-570kc), Beauty talks, Tues.			
1:30	12:30	11:30	10:30
K.F.O.N. (241.8m-1240kc), Physiology of beauty.			
K.F.W.I. (267.7m-1120kc), Beauty hints, Tues, Fri.			
K.Y.A. (309.1m-970kc), Diet and Health, Tues.			
2:20	1:20	12:20	11:20
W.J.Z. (454.3m-660kc), Tues, Beauty talk.			
2:30	1:30	12:30	11:30
K.J.R. (348.6m-860kc), Health talk.			
3:40	2:40	1:40	12:40
K.G.A. (260.7m-1150kc), Dietetic talk, Wed.			
9:20	8:20	7:20	6:20
K.F.R. (454.3m-660kc), Thurs, Madame Marie.			
10:45	9:45	8:45	7:45
W.H.A. (333.1m-900kc), Dr. Robert T. Williams, Tues.			

Gardening

Eastern	Central	Mountain	Pacific
9:50	8:50	7:50	6:50
W.W.I. (352.7m-850kc), Wed.			
11:30	10:30	9:40	8:40
W.E.M.C. (483.6m-620kc), Thurs.			
2:45	1:45	12:45	11:45
W.O.R. (422.3m-710kc), Garden talk, Mon.			
9:45	8:45	7:45	6:45
W.I.L.A.M. (280.2m-1070kc), Woodlawn landscape service.			

WHO'S WHO IN BROADCASTING



ABAS String Quartet, Nathan Abas, Violinist; Julian Brodetsky, Violinist; Michel Penha, Cellist; Roman Joseph Verney, Violaist, KPO.

Abercrombie, Mrs. C. W., Organist, Pianist, KMA.
 Adams, Mrs. J. Homer, Contralto, WBAP.
 Ago, Edward M., Public Relations, WNAC.
 Akdar Chanters, Harry Clarkson, Director, KVOD.
 Albert, Maud, Contralto, WBAL.
 Albright, Eddie, Town Crier of the Day Watch, KNX.
 Aleshin, Viacha, Balalaika Artist, National Broadcasting Company.
 Alexander, Mrs. Robert L., Pianist, WSM.
 Allen, Bob, Piano Novelties, KPO.
 Allen Sister, KNX.
 Allen, Emily, Pianist, WSM.
 Allen, Taylor, Announcer, Daytime, KMOX.
 Alley, Shelly Lee, Tenor, WFAA.
 Allie Mae Huiitt, Pianist, Organist, KFDM.
 Allison, Mary B., Pianist, WSM.
 Alvarez, Joe, Tenor, KVOO.
 Ambler, Frena, Announcer, Associate Program Director, KMA.
 Ammerman, Muriel, Violinist, WOC.
 Anchors, Don, "Poet of the Common Folks," WEEI.
 Anderson, Gordon A., Chief Engineer, KOIL.
 Andrew Male Quartet, WCCO.
 Anthony, Earle C., Owner, KFI.
 Anthony, Ida May, Pianist, WOC.
 Apollo Club, Robert Boice Carson, Director, KVOO.
 Apollo Male Quartet, KYW.
 "Appleblossom" and "Moonshine" (Blackface), WBAP.
 Apple Sauce Twins, KMA.
 Archibald, Vernon, Baritone, Columbia Broadcasting System.
 Arledge, Mrs. Irene, Contralto, KFDM.
 Arlington Concert Ensemble, KTHS.
 Armbruster, Joe, Orchestra, WMAK.
 Arnsheim, Gus, Cocoanut Grove Orchestra, KNX.
 Arnold, Ethel, Studio Director, KMOX.
 Arnoux, G. C., Director and Announcer, KTHS.
 Arnoux, Natalie, Violinist, KTHS.
 Arnold's Seven Aces, WWNC.
 Aster, Alex, Pianist, Former Concert Pianist of the Royal Orchestra at St. Petersburg, KTHS.
 Aunt Jane, WOC.
 Avery, Ann Matheson, Contralto, KOIN.
 Avey, Mrs. Thomas, Soprano, KTHS.
 Avey, Thomas, Organist, KTHS.
 Aylesworth, Merlin Hall, President, National Broadcasting Company.

BAB'S Lady Orchestra, KJR.
 Baber, Mrs. R. E., Harpist, WSM.
 Backer, Les, Entertainer, WCCO.
 Bagwill, Gladys, Blues Singer, KTHS.
 Bailey, DeFord, Harmonica Wizard, WSM.
 Bailey, Ray, Musical Director, KFWE.
 Bailey, William J., Announcer, WCAU.
 Bair, Stewart, Baritone, KYW.
 Baker, Florence, Pianist, Children's Songs, 9 Years Old, KOIL.
 Baker, Harry, Percussion, Columbia Broadcasting System Symphony Orchestra.
 Baker, W. M., Fiddle, Barn Dance Entertainer, WSM.
 Balcomb, Carl, Conducts Poet's Corner, WOC.
 Baldwin, Birdie, Soprano, KMA.
 Baldwin, J. Gordon, Organist, WHAM.
 Baldwin, Philip, Operator, WEEI.
 Balhatchet, William, Tenor, WHT.
 Ball, Joe, Concert Director, WMAK.
 Ballardiers, KYW, Quartet, KYW.
 Ballard, Robbye, Soprano, WSM.
 Bandell, Gail, Frank Chiddix, Harmony Team, WHT.

Banjo Harmony Team, Inky Henneberg, Joe Sherman, KOIN.
 Bankey, Jack, Guitar, Banjo, Voice, WMAK.
 Barborka, J. V., Bohemian Harpist, KMA.
 Barlow, Howard, Conductor, Columbia Symphony Orchestra.
 Barn Dance Group, Tom Dandurand, Claudia Parker, R. L. Tronson, Sam Mack, Ed Goodreau.
 Barnes, Edith F., Secretary to Superintendent, WEEI.
 Barnes, Pat, Announcer of WHT, Gold Cup Winner of 1927. Mr. Barnes was interested in motion picture productions before he went to war and only studied voice accidentally. When he came back from France, he produced "A Buck on Leave," which was very popular and which toured the United States. He tried to get big producers interested in it for the motion pictures but it was too soon after the war. As director and announcer of WHT he has won a large following. In fact, Al and Pat constitute one of the most popular teams on the air. Pat has that Irish sense of humor which always adds spice to any program he may be directing. He even announces market reports in a droll way.
 Barnett, Stanley, W., Announcer, WBAL.
 Barnick, Carl, Trumpeter, Columbia Broadcasting System Symphony Orchestra.
 Barnyard Twins, Walter Stohlman, Ray Denham, KOIL.
 Barr, Helen, Soprano, Queen in Salicon Vanities, WEEI.
 Barr, Mrs. J. Victor, Pianist, WSM.
 Barry, Edward, Pianist, Conductor of Piano Lessons, WGN.
 Bartholomew, Marshall, Tenor, National Broadcasting Company.
 Bartimus, Bernice, Pianist, WMAK.
 Barton, George, Jr., Saxophonist, WCCO.
 Baskerville, Nancy, Soprano, WSM.
 Bastianelli Trio, Helen Bastianelli, Cellist; Hazel May, Violinist; Louise Woodruff, Pianist, WHAM.
 Battey, Bess Beatrice, Pianist, KOIL.
 Batton, V. S., Assistant Announcer, WDAF.
 Baum, Oscar, Violinist, Director of Capitol Orchestra, WCCO.
 Bay, Victor, Violinist, Columbia Broadcasting System Symphony Orchestra.
 Beach, Dorothy, Soprano, WHT.
 Beades, J. Robert, Studio Announcer, Accompanist, WRVA.
 Beardsley, Harry, Sport Announcer, WMAQ.
 Beattie, Dorothy, Soprano, KVOO.
 Beck, Alma, Contralto, WLWL.
 Beck, Martha Bond, Mezzo-Soprano, WOC.
 Becker, H. J., Bass, KMA.
 Beckman, Harvey, Tenor, WWJ.
 Beckman, Meredith, C., Tenor, KMOX.
 Behm, Bernice, Soprano, KMA.
 Bel Canto Quartet, Male Quartet, WFAA.
 Belding, Mrs. Violet, Contralto, KTHS.
 Bellamy, Doe, One of the Apple Sauce Twins, KMA.
 Bellinger, Fred, Saxophonist, WMAK.
 Bellows, H. A., Announcer, Manager, WCCO.
 Belsbaw, Florence, Pianist, KFAR.
 Belshaw, George, Guitarist, Director of Buick Studio Orchestra, Master Six Orchestra, KFAB.
 Benedetto, Guiseppi Di, Lyric Tenor, National Broadcasting Company.
 Bender, Myra, Soprano, WSM.
 Bennett, Oscar, Baritone, KFAB.
 Bennett, Mrs. Caldwell, WSM.
 Bennett, Mrs. R. B., WSM.
 Bentley, Stanley, Organist, KNX.
 Bercovitz, Abe, Violinist and Concert Master, KGW.
 Berentsen, Organist, WHAM.
 Berger, C. A., Announcer, KHQ.
 Berton, Vic, Drums, Tympani, Columbia Broadcasting System Dance Band.
 Berwin, Bernice, KGO Players, KGO.
 Besrodny, Gregory, Concertmaster, Columbia Broadcasting Symphony Orchestra.
 Beuder, Bert, Staff Soloist, WHB.
 Biddick, Walter, Announcer, KFWE.
 Bill, Edgar L., Announcer, WLS.
 Billy and Heleu, Harold Marshall, Helen Wilson, KOIL.
 Billy's Hawaiian Trio, KOIN.
 Biltmore Hotel Orchestra, KNX.
 Binkley Brothers Barn Dance Orchestra, WSM.
 Binns, Dr. Frazier, Tenor, WSM.
 Birder, Cecil, Tenor, WCCO.
 Birkenholz, Arcadie, Violinist, National Broadcasting Company.
 Birnbach, Meta Ashwin, Soprano, WCCO.
 Birnbaum, Emil, Orchestra Leader, Violinist, KOMO.
 Blackwood, Mrs. H. O., WSM.
 Blank, Hulda, Soprano, WHT.



Bliss, Beryl Brown, Soprano, KVOO.
 Bliven, Leona, Popular Pianist, WOC.
 Boland, D. W., Cornetist, WCCO.
 Bolek, George, Pianist, WBAL.
 Boltz, Irene, Vocalist, KVOO.
 Bonaldi, Mimmo, Baritone, WHAM.
 Bonell, Bob, Announcer, WEBH.
 Boots and His Buddies, KVOO.
 Borden Brothers, WMBE-WOK.
 Borris, Merton, Novelty Piano Programs, KPO.
 Borman, Frances, Soprano, WDAF.
 Borroff, Edward, Manager, KYW.
 Borroso, Senior, Cellist, KOMO.
 Bostwick, Dr. Arthur E., Library Talks, KMOX.
 Bourdon, Rosario, Conductor of Cities Service Concert Orchestra, National Broadcasting Company.
 Bount, Reber, Baritone, WSM.
 Bowes, Major Edward, Director of Capitol Theater Family, National Broadcasting Company.
 Boyd, Nelle, Pianist, WSM.
 Boyer, Emmeline, Soprano, WSM.
 Boyle, Gertrude Hess, Contralto, WPG.
 Brace, Celia, Violinist, of Trio, WBAL.
 Bradford, Anne, Home Service Features, WEEI.
 Brainerd, Bertha, Manager, National Broadcasting Company.
 Branch, W. E., Radio Engineer, WBAP.
 Brandborg, Gustav, Baritone, KVOO.
 Brannigan, Gertrude, Organist, WOC.
 Breen, Edwin, Baritone, WLWL.
 Breene, Elizabeth, Pianist, WSM.
 Breidenstein, Grace, Mezzo-Soprano, Program Arranger, KOMO.
 Brehm, C. M., Violinist, KVOO.
 Bridges, J. E., Operator, Announcer, WBAP.
 Bristow Lions Club Quartet, KVOO.
 Broemer, Helen, Cellist of Trio, WBAL.
 Brose, Bob and His Orchestra, WCCO.
 Brown, Gene, Publicity Representative, WBAL.
 Brown, Grace, Ukulele Lady, KTHS.
 Brown, Richard Roland, Announcer, KOA.
 Brown, Mrs. Barton, Contralto, WSM.
 Brown, Mrs. Thompson, WSM.
 Brown, W. C., Baritone, KTHS.
 Brown, Rev. R. R., Radio Pastor, WOW.
 Browne, Harry C., Senior Announcer, Columbia Broadcasting System.
 Bruhl, Martin, Pianist, WOC.
 Bryan, Clafin, Pianist, KVOO.
 Bryan, Irene, Pianist, KVOO.
 Brzinsky, Frank, Accompanist, WCCO.
 Buick Little Symphony, KFAB.
 Buick Orchestra, KFAB.
 Bugg, Eugene, Bass, WSM.
 Bunchuk, Yascha, Cellist, National Broadcasting Company.
 Burbank, Marie Keber, Contralto, WHAM.
 Burke, Lucille, Soprano, WJR.
 Burleigh, Wilbur C., Studio Accompanist of Houghton and Dutton, WEEI.



LEO FITZPATRICK, Vice-President, WJR. The Merry Old Chief, as he was always called at WDAF when he announced the Nighthawk frolics, is one of the pioneer announcers. He ranks with Bill and George Hay, Lambdin Kay and the Hired Hand.

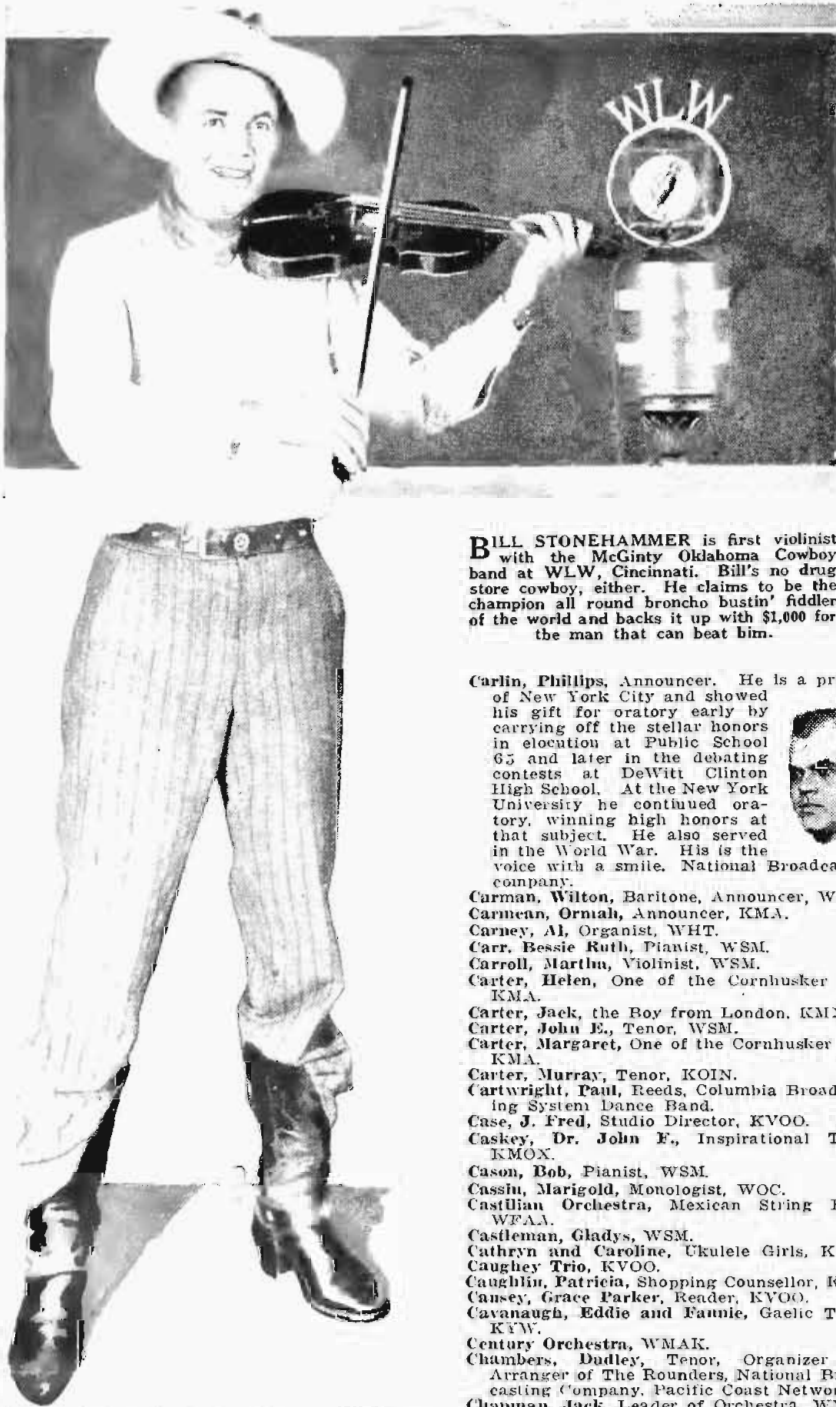

BILL STONEHAMMER is first violinist with the McGinty Oklahoma Cowboy band at WLW, Cincinnati. Bill's no drug store cowboy, either. He claims to be the champion all round broncho bustin' fiddler of the world and backs it up with \$1,000 for the man that can beat him.

Carlin, Phillips, Announcer. He is a product of New York City and showed his gift for oratory early by carrying off the stellar honors in elocution at Public School 63 and later in the debating contests at DeWitt Clinton High School. At the New York University he continued oratory, winning high honors at that subject. He also served in the World War. His is the voice with a smite. National Broadcasting company.



Carman, Wilton, Baritone, Announcer, WBAL.
Carmen, Orniah, Announcer, KMA.
Carney, Al, Organist, WHT.
Carr, Bessie Ruth, Pianist, WSM.
Carroll, Martha, Violinist, WSM.
Carter, Helen, One of the Cornhusker Trio, KMA.
Carter, Jack, the Boy from London, KMX.
Carter, John E., Tenor, WSM.
Carter, Margaret, One of the Cornhusker Trio, KMA.
Carter, Murray, Tenor, KOIN.
Cartwright, Paul, Reeds, Columbia Broadcasting System Dance Band.
Case, J. Fred, Studio Director, KVOO.
Caskey, Dr. John F., Inspirational Talks, KMOX.
Cason, Bob, Pianist, WSM.
Cassio, Marigold, Monologist, WOC.
Castilian Orchestra, Mexican String Band, WFAA.
Castleman, Gladys, WSM.
Cathryn and Caroline, Ukulele Girls, KVOO.
Caughy Trio, KVOO.
Caughlin, Patricia, Shopping Counsellor, KOIL.
Causey, Grace Parker, Reader, KVOO.
Cavanaugh, Eddie and Fannie, Gaelic Twins, KYW.
Century Orchestra, WMAK.
Chambers, Dudley, Tenor, Organizer and Arranger of The Rounders, National Broadcasting Company, Pacific Coast Network.
Chapman, Jack, Leader of Orchestra, WMAK.
Chapman, I. W., Commercial Director, KHQ.
Chappell, Ernest E., Announcer, WHAM.
Charlton, Frederick, Musical Hand Saw, WFLA.
Cheyne, Mary Alice, Children's Hour, WSAI.
Chenoweth, Wilbur, Pianist, Pipe Organist, KPAB.
Cheskin, Dave, Concert Director, WMAK.
Chicago Philharmonic Trio, Theodore Katz, Violinist; Lois Colburn Richl, Cellist; Doris Wittich, Pianist, WHT.
Christensen, Paul, Orchestra, WHO.
Christine Parsons Trio, KVOO.
Chuck and Ray, Harmony Team, WMBB-WOK.
Chlopski, Karl, Horn, Columbia Broadcasting System Symphony Orchestra.
Cimars, Jaroslav, Trombonist Ace, KYW.
Cinderella from Georgia, a "Crooner," WFAA.
Clark, Bob, Organist, WWJ.
Clark, Donald H., Announcer, WHAM.
Clark, Helen, Contralto, Royal Hour, National Broadcasting Company.
Clark, John, Announcer, Continuity Writer, WBZ.
Clark, Norman, and his South Sea Islanders, National Broadcasting Company.
Clark, Robert T., Tenor, WSM.
Clarkson, Harry Irving, Bass, KVOO.
Cleveland String Band, KVOO.
Clyburn, Mildred, Contralto, WCCO.
Clyde Spencer's Orchestra, WNNC.
Coates, Tommy, Announcer-Baritone, WGN.

Burden, Robert, Continuity Writer, Announcer, WFLA.
Burling, Lamar, Pianist, KPAB.
Burnham, Charles E., Concert Soloist, WWNC.
Burns, Jane, Soprano, KGW.
Burton, Charles W., Superintendent, WEEL.
Butler Hotel Orchestra, KIR.
Byron, Arthur, Occasional Announcer. Old Theatrical Man. Takes part in many of the delicious dialogues that are featuring the station's late evening programs as a welcome rest from our "too much mustard" but—too much mustard?
CABOT, Caroline, Shopping Reporter, WEEL.
Cantrell, Mame Helen, Dramatic Soprano, KYW.
Caffey, Rudolf, Tenor, Charles, WFAA.
Caldwell, Mrs. Charles, Contralto, KPAB.
Caldwell, Nair, Chief Announcer, WEEM.
Cameron, Jane Holbrood, Contralto, WYGO.
Campbell, Mrs. Blanche, Contralto, WSM.
Campbell, Walter N., Director Announcer, WLAZ.
Campbell's Screamers, KVOO.
Canopus Flirts, Harmony Trio, WLF.
Canova, Anna, Flautist, WJAN.
Curd, Mrs. G. W., Pianist, WSM.
Curd, Mrs. Harpur, Whistler, WSM.
Curgill, S. H., Clarinet Soloist, WCCO.

Coebel, W. A., Editor of Weekly Kansas City Star, Speaker, WDAF.
Cock a Doodle Do Orchestra, Floyd Taylor, Director, KTBS.
Coe, Wiun, Pianist, KHQ.
Colhoun, Adams, The Voice of WFAA, WFAA.
Collegians, Charles M. Riadon, Director, WSM.
Collier's June Orchestra, KVOO.
Collins, C. B., Director of "Hiram and the Hired Hands," WEEL.
Collins, Juanita, Accompanist, WDAF.
Collins, Tom, String Trio, WFAA.
Collins, Ovid, Baritone, WSM.
Colorado Theater Orchestra, KOA.
Columbia Broadcasting System's All Soloist Radio Symphony Orchestra.
Colyar, Mrs. George, Pianist, WSM.
Combs, Hance and Vance, Old Time Music, KMA.
Combs, Joe, Tenor, WSM.
Compton, Homer, Tenor, KPAB.
Condon and Rogers, Harmony Pair, WGN.
Congdon, Kenyon, Baritone, WWJ.
Connet, Paul, Announcer, KOIN.
Cook, Doc, Orchestra, WLS.
Cook, Edmund, Violist, WBAL.
Cook, I. Milton, WSM.
Cook, Mrs. I. Milton, Violinist, WSM.
Cook Painters, WDAF.
Cooke, Betty, Better Homes Girl, KGA.
Cooke, Eric Russell, Baritone, WHT.
Cooper, Peggy, Story Lady, WFAA.
Corelli, Alfonso, Director of Vienna Concert Orchestra, KMX.
Cornhusker Trio, KMA.
Corwine, Tom, Imitations, Dog Fights, Farm Animals, WLS.
Cossacks, William Stace, Director, WLW.
Cowie, Ralph, Operator, WEEL.
Cox, Joe, Farm Hands, KPH.
Coykendall, Frank, Iowa Farm Speaker, KMA.
Crandou, Fred, WCSH.
Craig, Francis and his Orchestra, WSM.
Crandell, Ervin, Operator, WCSH.
Crawford, Claire, Director, WBIS.
Crimoline Trio, WCCO.
Criterion Quartet, WCCO.
Cronshaw, Jack, Concert Director, KPWB.
Crook Brothers Barn Dance Orchestra, WSM.
Crosby, Earnest, Tenor, KOIN.
Crosley Burnt Corker, WLW.
Crosley Ensemble, Emil Heermann, Director, WLW.
Crosley, Jr., Powell, Owner, WLW.
Cross, Gladys, Hostess, Pacific Coast Network, National Broadcasting Company.
Cross, Milton J., Chief Announcer, WJZ. Completed the music supervisors course of the Damrosch Institute of Musical Art. After completing his musical education, he toured for several seasons with the Paulist Choristers covering the entire eastern portion of the United States. After this Mr. Cross devoted himself to church and concert work. As a member of the quartet of the Progressive Synagogue of Brooklyn, he was one of the pioneer broadcasters. He is, at the present time, oldest announcer in years of service with WJZ, and is considered one of the foremost announcers in the country today. When any difficult classical announcing must be done, Mr. Cross is called upon. Remember his "Good Evening, Ladies and Gentlemen?"
Croxton, Charles, Program Director, Baritone, WBAP.
Croxton, Frank, Bass-Baritone, Columbia Broadcasting System.
Croxton, Olive, Soprano, WBAP.
Cruise, Harriett, Oriole of the Air, KPAB.
Cummings, Ira, Member of Ruby Trio, KMA.
Cunningham, Roy, Baritone, KVOO.
Curtis, Virginia, Vocalist, WPG.
Cusick, Jack, and His Uke, WMBB-WOK.



DAHL, Arnold, Tenor, WCCO.
Dalton, Frank, at WGN since August, 1925. Sports Announcer at both pro football and baseball games, WGN.
Daly, John, Tenor, WWJ.
Daly, John, Irish Tenor, WJIR.
Damski, Henri, Director of Orchestra, KJR.
Danforth, Harold Potter, Announcer-Director, WDHO.
Daniel, John P., Announcer, WRC.
Dann, Arnold, Organist, WWNC.
Daugherty, Doc, Director of Hotel Traymore Dance Orchestra, WPG.
Daulton, Jack and His Orchestra, KVOO.
Dave and Evelyn, Dave Morris, Evelyn Kitts, KOIL.

Damrosch, Walter, Musical Director, National Broadcasting Company. Born in Breslau, Silesia, January 30, 1862. Long director of New York Symphony, he now directs this group in Saturday night programs. Mr. Damrosch is working on educational musical programs which will eventually be important in every school room. When the children hear his voice they will be listening to a man who remembers Liszt, Wagner, Von Bulow, Clara Schumann, Tausig, Joachim, Auer, Haenselt, Rubinstein and many moderns besides. Mr. Damrosch has composed operas, symphonies and even music for Greek plays. Probably his favorite composers



were Beethoven, Mozart and Brahms. No man in America today has done so much for the appreciation of music and he continues to do his work, using Radio as an aid.

Davenport Hotel Dance Orchestra, KHQ.
Davis, Edward A., Director-Announcer, WIP.
Davis, Bert, "The Clown of the Air," WSEB.
Davis, Clyde, Popular Singer, Violinist, KFAB.
Davis, Mildred, Cooking School, KDKA.
Day, Collett, Violinist, KVOO.
Day, Francis, Violinist, KVOO.
Dawson, Stuart, Announcer, WIBO.
Dayton, Eddie, Ukulele Soloist, WMAK.
Dawley, Walter, Organist, WTIC.
De Babary, Josica, Violinist, KYW.
DeBoer, H. O., Tenor, WOC.
De Leath, Vaughn, Soloist, National Broadcasting Company.
De Loca, Adelaide, Contralto, with Roxy and His Gang, WJZ, National Broadcasting Company.
DeLue, Willard, Director of Boston Globe Studio, WEEL.
De Moss, Lyle, Baritone, KFAB.
De Pasca, Signor, Marimba Artist, WOC.
De Sylva, Richard, Violinist, WHAM.
Detroit Symphony Orchestra, WWJ.
Dhossche, Flute, Piccolo, KFDM.
Dicker, Martin, Tenor, KMOX.
Dickerman, Carlton H., Announcer, WEEL.
Dillon, Zita, Pianist-Xylophonist, KOMO.
Dirks, Dietrich, Program Director, Baritone, KFAB.
DiRocco, Vic, Operator, KFRC.
Diskay, Joseph, Hungarian Tenor, KNX.
D'Isere, Guy, Clarinetist, Columbia Broadcasting System Symphony Orchestra.
Dixie Girls, Alta and Opal, KMA.
Dixon, Sydney, Lyric Tenor, KOMO.
Dodds, Everett, Singer of Scotch Songs, WOW.
Dodge, J. Smith, Chief Field Operator, WNAC.
Dodge, William, Leader of Pilgrims, WHEI.
Doerr, Clyde, Director of White Rock Saxophone Orchestra, National Broadcasting Company.
Donaldson, Barton, Baritone, WDAF.
Doollittle, Mabel, Contralto, WHT.
Doran, Morrell, Banjoist, KFAB.
Dowd, John, Baritone, WSM.
Downing, James, Tenor, KHQ.
Downs, Vera, Orchestra Pianist, KOMO.
Dolin, Max, Musical Director, Pacific Coast Network, National Broadcasting Company.
Dragonette, Jessica, Member of Light Opera Group, National Broadcasting Company.
Duke, Elmer, Baritone, WSM.
Dumont, Paul, Announcer, National Broadcasting Company.
Dunbar Quartet, KVOO.
Dunham, E. Lewis, Pilot Juvenile Smilers, Organist, WNAC.
Dunaway Sisters, Harmony Team, WHT.
Dunn's Orchestra, WWNC.
Dunstedter, Eddie, Organist, WCCO.
Duva, Marion Bennett, Soprano, KOIN.
Dyer, Pearl, "The Rhythm Girl," Staff Pianist, Organist, KFJF.

Elysian Symphony Orchestra, KMA.
Emerson, Ralph, Organist, WLS.
Epstein, Pauline, Continuity Writer, KMOX.
Erckenbrach, Bernice, Soprano, KVOO.

Emery, Bob, Big Brother of WEEL, is one of those early Radio stars who has made a place for himself in this ethereal world by doing what he liked best. He began his Radio work in the old days at WGI, Medford Hillside, playing the ukulele and singing a few songs. In fact, he managed the station. He began to appeal to the children through the title of Big Brother Bob. The children in this portion of Massachusetts liked him so much better as a Big Brother than they did the various uncles and aunts on the air that he became their leader. When they had Boy Scout programs he broadcast them. This last winter he made spelling bees popular through the state.



Erickson, Wallie, Orchestra Leader, WCCO.
Evans, Le Roy, Pianist of Ensemble, WBAL.
Evans, Mildred, Soprano, WMBE-WOK.
Evans, Tommy, Tenor, WJR.
Everett, Gladys, Contralto, KFOA.
Ewart, Russell, Tenor, WOC.
Ewer, Mabel Swint, Women's Club Program, WPL.

Erisman, A. J. "Al," was known for his tenor voice and his well planned Radio programs at WGR, Buffalo, for several years. Within the last two years he has become director of WMAK. He has made this station one of the best in the United States. The Columbia Chain broadcasts over this station. In the morning expert cooking chats are given by the best expert in Buffalo. Many popular features have been added and many program continuities keep listeners interested. Mr. Erisman is chiefly interested in giving the Radio public variety. The Three Musketeers is only an example of one of the popular features. George F. McGarret, and Robert



Strigl are two members of the staff who aid Mr. Erisman in making up the continuities.

FARMER, Johnny, Voice and Piano, WWNC.
Faassen, Joe, Announcer, Silver Cup Announcer of 1927, KSO.
Faerber, Joseph, Violinist, KMOX.
Fanning, John J., Sales Manager, WNAC.
Fearless Four, KVOO.
Fentress, Aline, Violinist, WSM.
Fentress, Mrs. Daisy, WSM.
Feringer, Fred C., Musical Director, KFOA.
Ferguson, Marion, Violinist, KOMO.
Fidelity Accordion Man, KMA.
Field, Henry, Official Announcer, KFNF.

Fay, William, Announcer WMAK. Mr. Fay was announcer director of the light opera company, one of harmony twins, member of the Radio Four male quartet, bass fiddler in the WGY orchestra and baritone soloist at WGY. No wonder the Buffalo station took him away from Schenectady. At the present time he is one of the three Musketeers at WMAK, announces, directs and does a little of everything.



Fifield, Dr. James W., World Traveler, WBB.
Fifield, Georgia, Director of KNX Playlets, KNX.
Fifield, Marie, Accompanist on Big Brother Club Program, WEEL.
Finsteln, Paul, Director of Orchestra, KNX.
Finzel's Dance Band, WWJ.
Fiorito and Gordy, Harmony Team, WCCO.
Fisch, Viola Jean, Soprano.
Fisk University Student Quartet, WSM.
Fitzer, H. Dean, Chief Announcer, WDAF.
Fitzgerald, E., Publicity Director, KFOA.
Fitzpatrick, Leo, Vice-President, YJR.
Fitzsimons, Mrs. W. E., Contralto, WCCO.
Fjelde, Astrid, Soprano, National Broadcasting Company.
Flagler, Robert, Assistant Announcer, KOMO.
Flake, Eileen, Hostess, WBAP.
Flanagan, Pat, Physical Director, WOC.
Flaut, Mrs. Meredith, Contralto, WSM.
Fletcher, Mrs. Vera, Soprano, KTHS.
Flick, C. Roland, Violinist, WSM.
Flynn, George "Skipper," Brunswick Artist, Tenor, WGES.
Foley, Elsa Zelinda, Coloratura Soprano, KNX.
Folger Serenaders, WDAF.
Fonteyn, J. L., Oboe, English Horn Soloist, Columbia Broadcasting System Symphony Orchestra.
Ford and Glenn, the Lullaby Boys, WLS, WFAA.
Ford, Gilbert, Tenor, who, in combination with Love, Pontius and Talbot, composes the WGN Male Quartet, WGN.
Fordham, Howard and Juanita White, Singing Serenaders, KFH.
Fordham, Louise, Ballad Girl, KGO.
Fort Worth Club Stringed Orchestra, WBAP.
Forte, Grady, One of the Apple Sauce Twins, KMA.
Fortier, Anselmo, Bass, Columbia Broadcasting System Symphony Orchestra.
Foss, William L., Manager, WCSH.
Foster, J. R., Director, CKLC.
Four Legionnaires, Male Quartet, WLS.
Four Kings of Harmony, Arthur Thomas, Clair Marshall, Renus Lytie, Ben Jordan, WHO.
Fowler, Lucile, Contralto, KOA.
Fowler, Ethel Rattay, Publicity Director, WPG.
Fox, J. Leslie, Chief Announcer, KFH.
Franham Trio, KMA.
Frank, Leon, Pianist, WSM.
Franklin, Dorothy, Assistant Shopping Reporter, WEEL.
Franklin, Leon, and his Orchestra, WSM.
Franz, Jack, Michigan Theater Organist, WJR.
Frazetto, Joseph, Silver Slipper Supper Club Dance Orchestra, Director, WPG.
Fredlund, Myrtle, Girl Baritone, KOIN.
Freeland, Carroll, Operator, KFRC.
Frenkel, John, Director, WCOA.
Frick, Leslie, Contralto, National Broadcasting Company.
Fritzland, Frances, Pianist, KPIL.
Fruit Jar Drinkers, G. W. Wilkerson, Director, WSM.
Frye, Rosalie Barker, Contralto, KNX.
Freese, Ralph, Announcer, Tenor, KOA.
Fuller, Georgia M., Program Director, Hostess, WSUN.
Fuller, R. W., Bass, KFDM.
Fulton, Sue, Contralto, KFH.

GABRIEL, Jr., Charles H., Program Director, Pacific Coast Network, National Broadcasting Company.
Gage Brewer's Hawaiians, KFH.
Gage, Franks, Announcer, Assistant Program Director, Pacific Coast Network, National Broadcasting Company.

EAST, Grace Adams, Cornetist, KGO.
Eastman, Morgan L., General Manager, WENR-WBCN.
Eclipse Clippers, Dance Orchestra, WBAP.
Edelson, Dynamo Dave, Director and Announcer of Motorist Studio, WSEB.
Edelstein, Walter, Second Violinist, Columbia Broadcasting System Symphony Orchestra.
Edes, Arthur F., Program Director, Chief Announcer, WEEL.
Edison, Harry, Vibraphone Soloist, National Broadcasting Company.
Edison String Trio, Jack Baus, Violinist; Sterra Feigen, Cellist; Sallie Menkes, Pianist and Director, WENR-WBCN.
Edward, Erle Emery, Tenor, KVOO.
Edward, Hulda Helen, Soprano, Director of Afternoon Programs, KOA.
Eken, Ann, Girl Baritone, WSEB.
Elks Municipal Band, KMA.
Elliott, Hazel, Organist, WOC.
Elliott, John, Xylophonist, WMAK.
Ellis, Roger, Operator, WEEL.



HARMONY FOUR, familiar to listeners over KPO, San Francisco. All are individually well known as concert artists. Their names are: Eva Dell Chamlee (left), contralto; Frances Minton, contralto and piano accompanist; Hortense McKee, soprano; Helen Starks, soprano.

Gainsborg, Lolita Cabera, Pianist, National Broadcasting Company.
 Gallagher, Harold, Midnight Announcer, WTAM.
 Gale, P. B., Director, KFOA.
 Gallicchio, Joe, Leader of Hotel Stevens Symphony Orchestra, WMAQ.
 Ganunous, E. H., Business Manager, WCCO.
 Ganley, Gertrude O'Neill, Impersonator, WCCO.
 Gardner, Jean, Blues Singer, KOIN.
 Gardner, Ouita Johnston, Soprano, KVOO.
 Garland, Charley, Director of Nutty Club, Tomahawk Club, Old Gray Mare Club, WBBM.
 Garland, Elbert, Pianist, KVOO.
 Garland, Mrs. E. V., Pianist, KVOO.
 Garrett, Zola, Contralto, KVOO.
 Gaylord, Stephen, Baritone, Chief Announcer, KGW.
 Gequa, Misha, Cellist, KNX.

Gaylord, Chester, Announcer of WJAG, is an accomplished musician and so can "pinch hit" when artists fail him. His saxophone selections are well known along the eastern coast. When he was leading in the Gold Cup contest in 1926, three newspapers, one mayor, a postmaster and several other civic leaders were campaigning for his victory. The only reason he lost was because there were more people in Iowa. If you like to hear Mr. Gaylord over the Radio, you can get records which he has made.

Geise, Harry, Announcer, WMAQ.
 Gerhard, Romona and Geraldine, Violin and Piano, WCCO.
 Giddings, Natalie, Publicity, Woman's Hour, WLW.
 Gill, Ernest, Violinist, KOMO.
 Gillespie, Courtney Wagoner, Pianist, WSM.
 Gillespie, William, "Feature Director." The Highest Unpaid Director in America, KFJF.
 Gilman, Don E., Manager, Pacific Coast Division, National Broadcasting Company.
 Gilmore, Iris Ruth, Dramatic Director, KOA.
 Gisharne, Edward, Announcer, WEEL.
 Giskin, Ossip, Cellist, Columbia Broadcasting System Symphony Orchestra.
 Gianta, Harry, Trumpeter, Columbia Broadcasting System Symphony Orchestra.
 Gianville, Roberta, Soprano, Former Member of the Metropolitan, WBAL.
 Glass, Margaret, Organist, KTHS.
 Gleason, Philip, Reeds, Columbia Broadcasting System Dance Band.
 Gleemen, Harry Evans, Conductor, KVOO.
 Glenn, Irma, Feature Organist, WENR-WBCN.
 Glenn, Ivo B., Tenor, WSM.
 Glorch, George, Announcer, WMBB-WOK.
 Glover, M., Banjo, WMAK.
 Gardner, Ouita Johnston, Soprano, KVOO.
 Golden Echo Quartet, WSM.
 Golden, Marie, Pianist, KNX.
 Goldenberg, H. E., Announcer, WHP.
 Goldkette, Jean, Pla-Mor Ballroom Orchestra, WDAF.
 Goldkette, Jean, Venetian Room Orchestra, Joseph Gorner, Director, WJR.
 Goldstein, Mrs. H. H., Soprano, WSM.
 Goodheart, Myrtle, Blues Singer, WBAP.
 Goodman, Lawrence, Pianist, WSM.
 Goodrich, Bill, Pianist, KOIL.
 Goodwin, Hugo Philler, Organist, WCCO.
 Goodwin, Jerry, Pianist, WMAK.
 Gordon, Mary, Air News, Household Hints, Fashions, KFOA.
 Gough, L. B., Announcer, KFDM.
 Graham, Ross, Bass, KTHS.
 Gramlich, George, Tenor, RNX.
 Grainger, Florence, Contralto, KFDM.
 Grammitt, Harry, Concert Pianist, KOIN.
 Grant, Herman, Violinist, WOC.
 Graves, Preston, Manager, Pianist, WMBB-WOK.
 Graves, Ted, Pianist, WBAP.
 Gray, G. Donald, Baritone, Drama, KOMO.
 Gray, Stanley, Croon Baritone, KOIN.
 Gray, Walter, Director of Dramatic Club, WFL.
 Great Lakes Mixed Quartet, Charlotte Cowan, Soprano; Lucile Long, Contralto; Oscar Bentner, Tenor; Martha Provensen, Bass; WENR-WBCN.
 Green, Joe and His Marimba Band, National Broadcasting Company.
 Green, Punch, Popular Songs and Piano Numbers, KGW.
 Greener, Fred, KMA Poultry Man, KMA.
 Grella, George, Director of Secret Guards Band, WFLA.
 Grenell, Lloyd, Popular Songs, KIIQ.
 Griffin, Beatrice, Violinist, WJF.
 Griffith, Bobby, Director-Announcer, WJBT.
 Grimes, Bern Meade, Pianist of "Breakfast Hour," WFAA.
 Grisev, Georges, Clarinetist, WCCO.
 Gross, Mrs. E. W., Soprano, KFDM.
 Grosse, Johanna, Organist, WLW.
 Grubb, Gayle, Director-Announcer, KFAB.
 Gull, Mary White, Soprano, WSM.
 Gullans, Florence, Mezzo-Soprano, WJAZ.
 Gully Jumpers, Paul Womack, Director, WSM.
 Gussman, Mrs. Frank, Soprano, WSM.
 Gutting, Raymond, Announces Market Report, KMOX.
 Gypsy and Martin, Harmony Team, KFO.

HADFIELD, Ben, Presentation Directors, WNAC.
 Hageman, Gertrude, Hostess, KFOA.
 Hain, William, Tenor, National Broadcasting Company.
 Hale and Derry, "Ike and Mike," WDAF.
 Hale, Theron and Daughters, Fiddle, Banjo, Piano, Barn Dance Entertainers, WSM.
 Hales Hawaiian Trio, WHP.
 Halk, John, Violinist, KMOX.
 Hall, Mrs. Gilbert, Soprano, KVOO.
 Hall, Mrs. William, Jr., Contralto, WSM.
 Haller, Richard V., Director, KGW.
 Hallroom Boys, Leroy Kullberg, Tom Breneman, KNX.
 Ham, Ray, Fred Sommer, Instrumental Duets, Banjo, Guitar, WHP.
 Hamilton, Wade, Organist, KVOO.
 Hamp, Charles W. Hamp, Saturday Night "30 Minutes of Sunshine." Comes by Airplane from San Francisco, KNX.
 Hampton, E. R., Announcer, WABC.
 Hannemann, Jacob, Pianist, WJAZ.
 Hansen, Emil, Drums, Tympani, KOMO.
 Hansen, Jack, Bass Tuba, Columbia Broadcasting System Dance Band.
 Happiness Girls, Popular Trio, WWNC.
 Hardison, Roy, Banjoist, Barn Dance Entertainer, WSM.
 Harger, Lucille Atherton, Contralto, Singer of Heart Songs and How! Has IT in her voice, KFRC.
 Harkreader, Sid, Fiddler, Barn Dance Entertainer, WSM.
 Harlow, LeRoy, Director of Salicon Vanities, Miniature Musical Comedies, WEEL.
 Harmony Girls, Grace Ingram, Edith Carpenter, WLS.
 Harmony Hounds, Stanley Gray, Stanley Bacon, KOIN.
 Harned, Mrs. Gladys, Violinist, KFDM.
 Harness Makers, Gus Swanson, Fritz Carlson, Frank Peterson, KMA.
 Harper, Clarence, Tenor, WMBB-WOK.
 Harris, Elmer, Piano, Accordion, WMAK.
 Harris, Paul, Director of Symphony Orchestra, WFAA.
 Harrison, Charles, Tenor, Columbia Broadcasting System.
 Harrison, Henriette K., Contralto, Storylogue Girl, WCAU.
 Hart, W. E., Harmonica Soloist, KVOO.
 Hartwick, George, Baritone, WWNC.
 Harvey, H. Clay, Shakespeare Lectures, WDAF.
 Hasenbald, Roy, Announcer, Studio Announcer, WMAQ.
 Hatfield, Ruth, Blues Singer, Pianist, WHP.
 Hauptmann, Liborious, Musical Director, KGW.
 Havrilla, Alois, Announcer. He was born in the foothills of a Czecho-Slovakian Mountain range and came to Bridgeport, Conn. at an early age. Graham McNamee was announcing a program from Carnegie Hall when he heard Havrilla's voice and was so impressed by it that he invited him to come to WDAF, New York, for an audition, National Broadcasting Company.
 Hawaiian Trio, Mlynan, Coral, Samuel Hallie, KMA.
 Hawkins, Frederick E., Announcer, WEEL.
 Haworth, Carl, The Singing Banjoist, KHQ.
 Hay, Bill, Chief Announcer. Started with radio at KFCK, Hastings, Neb., back in 1924. Been with WGN since December, 1926. Known as the announcer who "puts the English language in a dress suit." Announces majority of important evening programs. Born in Scotland. Married, WGN.
 Hay George, Director-Announcer WSM. "Solomon Old Judge." Gold Cup Announcer of 1924. He began his Radio career as a newspaper man. When the Memphis Commercial Appeal started WMC, it fell to George Hay to put on the programs incidental to his Radio page. His announcing was so individual and had such an appeal for the public that it soon became his real job. George Hay was the announcer who introduced the Mississippi river boat whistle. When he left WMC for WLS, Chicago, they substituted a steam whistle for the river whistle. From WLS he went to WSM where he is still presiding at the microphone. Not only has Mr. Hay won fame as an announcer, he has written a book called "Howdy Judge."
 Haynes, Tina May, Organist, WHT.
 Haynes, Zola, Pianist, Organist, KYW.
 Heath, Mrs. Julian, Home Economics Expert, National Broadcasting Company.
 Heatter, Oscar, Assistant Announcer, Publisher, WENR-WBCN.
 Hehrichs, Hilda, Cellist, WMBB-WOK.
 Heluy, Capt. J. D., Announcer, WOS.
 Hello Girls, Flo and Eda, Popular Numbers, WJR.
 Hemmeling, Robert, WHAM.
 Hemminghaus, Paula, Contralto, National Broadcasting Company.
 Hendry, Boh, Scotch Songs, WLS.
 Henion, R. W., Tenor, WFLA.
 Hennessey, Walter, Director of Orchestra, Pianist, KOMO.

Helpier, Morris, Director of Publicity, Announcer, KOA.
 Hemingway, Lee, Violin, Viola, KFAB.
 Herbert, Mrs. T. L., Pianist, WSM.
 Hewitt, Ray, Announcer, KFVB.
 Heyn, Hugo, Marimbaphonist, WOW.
 High Twelve Male Trio, W. Vance McCune, W. J. Schoenfeld, A. E. Wright, WHP.
 Ilme, Marie M., Organist, KVOO.
 Ilmer, Al, Pianist, KFHL.
 Innes, Ken, Tenor, WMAK.
 Hinton, Elizabeth Hanson, Coloratura Soprano, WHP.
 Hobart, Henry, Tenor Extra-Ordinary, WFLA.
 Hobbs, Catherine, Women Director, WCEH.
 Hoelzle, Elmer G., "The Radio Voice from Virginia," Studio Director, Program Manager, Senior Announcer, WRVA.
 Hoff, Billie Allen, Blues Singer, KTFW.
 Hoffman, Mrs. Daisy, Pianist, WSM.
 Hollinshead, Tenor, Columbia Broadcasting System.
 Hollinthead, Waldemar, Baritone, KOIN.
 Hollingsworth, Tenor, KFAB.
 Holliday, Harrison, Manager, Chief Announcer, KFRC.
 Hollowell, Frank, Pianist, WSM.
 Hollywood Sunnybrook Orchestra, WWJ.
 Homesteaders Orchestra, Joe Justana, Leader; Ben Paul, Reeds; Don La Sclala, Reeds, Violin; Larry Marsala, Banjo, Violin, Guitar; Henry Collins, Piano; Ernest Finley, Drum, Xylophone, Piano; Frank Pulsino, Bass, Guitar; Jack McWhirter, Trumpet, Melophone; Joe Justana, Trumpet, Trombone, Baritone, WHAM.
 Honeychurch, Dick, Pianist, WSM.
 Hood, Elmo C., Pianist, WSM.
 Hood, Ina Harrison, Popular Contralto, KGW.
 Hoover, Mrs. J. Webster, Program Director, KJR.
 Hopper, John, Pianist, KJR.
 Horn, Eleanor, Pianist, WSM.
 Horwitz, Edward, Horn, Columbia Broadcasting System Symphony Orchestra.
 Hotel Lowry Orchestra, Morris Jeffry, Leader, WCCO.
 Hotel President String Ensemble, WDAF.
 Houdek, Mrs. Carl, Whistler, WOC.
 Hough, Harold V., is simply another name for Hired Hand, director of help at WBAF. He is an entertaining announcer with

much original wit. His club, "Why Tell the Truth," is overflowing with members and bids fair to be the largest organization on the air; that is, if Congress does not legislate against it. When he is not announcing, the Hired Hand grows one or two little water melons which, he claims, will have the names of the recipient inside. Sometimes the wrong name appears and causes a lot of trouble. Last year his watermelons were smaller than usual, only occupying one wash tub apiece. We would like to see



what Texas could really do. The Hired Hand is also famous for his announcing of the Sunflower Girl. By the way, you can get records of her voice.
 Houle, Juliette, Studio Accompanist, WEEL.
 House, Marguerite, Cellist, KVOO.
 Houston, Stanley, Chief Announcer, Curlew Blond, KFCK.

Howdy Boys, Harry Geise, Joe Allabough, WMAQ.
 Howe, Nancy, Reporter, WBIS.
 Howell, Charlie, Golden Tenor, KMA.
 Howland, Nellie, Harp, Pianist, KFDM.
 Hoyle, Dorothy, Trio, National Broadcasting Company.
 Hudson, Harvey, Tenor, KOIN.
 Huebel, Gladys, Contralto, WCCO.
 Hughes, Bess McLennan, Contralto, KVOO.
 Hughes, James, Tenor, WLWL.
 Hugo Heyn, Vibraphone, Xylophone Artist, KMA.
 Hulbert, Ray, Saxophonist, Clarinetist, KGW.
 Hunt, Hamlin, Organist, WCCO.
 Hunter, Eva, Violinist, KVOO.
 Hunt, George W., Announcer, WRVA.
 Hurd, Robert, Program Manager, KFI.
 Hurt, Jerry, Ukulele, KVOO.
 Husing, Edward B., Junior Announcer, Columbia Broadcasting System.
 Husted, K. W., Announcer, WCCO.
 Hutchison, Burt, Guitarist, Barn Dance Entertainers, WSM.

IATONE, Leone, Pianist, KTHS.
 Illinois Four, Male Quartet, WHT.
 Ireland, Ward, Assistant Announcer, KFOA.
 Irene Buchners Trio, KVOO.
 Irwinlee, Campbell, Soprano, KNX.
 Isabel, Harold, Town Crier of the Night Watch, KNX.
 Israel, Florence, Home Service, KFVB.

JACK and Jean, Harmony Team, WLS.
Jack and Jill, WDAF.
Jack and Jill, Harmony Boys, WOC.
Jackson, Frank, Voice and Piano, WVNC.
Jackson's Society Orchestra, KVOO.
Jackson, Mrs. William Henry, Pianist, WSM.
Jarecki, Tadeusz, Special Orchestrator, National Broadcasting Company.
Jayhawker Girl, Popular Songs, KFJ.
Jellison, Otto J., Tenor, WCCO.
Jencks, E. W., Announcer, Baritone, WWJ.
Jendrek, Edward, Tenor, WBAL.
Jenkins, Dr. Burris A., Radio Preacher, WHB.
Jensen and Lettow, Harmony Boys, WHB.
Jeske, Fred, Announcer-Director, WGES, Chicago. In his short radio life, which really only constitutes two years, Mr. Jeske has done some travelling around. For a year he was with WEBM. The next thing radio fans found him at WTMJ, Milwaukee. But when he discovered that Milwaukee had lost its flavor he consented to return to WGES where he is now.



He has a fine radio personality and a nice voice and has many friends. He is planning to use many new features at WGES. He is always good as an entertainer himself and has a very pleasing voice, and doubtless will be one of the leading voices of the future.

Johnson, Clarence, Tenor, WOC.
Johnson, Connie, Accompanist, WDAF.
Johnson, Ethel, Pianist, WLAJK.
Johnson, George, Organist, WOV.
Johnson, Gladys, Cellist, Assists Musical Director, KGW.
Johnson, Gladys Lee, Second Violinist, KGW.
Johnson, Harrison Wall, Pianist, WCCO.
Johnson, J. Howard, Tenor, KNX.
Johnson, Joe, Orchestra Leader of Coronadians, KMOX.
Johnson, Mott, Announcer, KMMJ.
Johnson, Paul, Announcer, WCCO.
Johnson Sisters, Piano, Uke, Voices, WMAK.
Johnson, Stute, Announcer, KMMJ.
Johnson, Walter, Announcer, WTIC.
Johnstone, G. W., Manager Press Relations, National Broadcasting Company.
Johnston, Gertrude, Pianist, WWNC.
Johnston, Patti, Pianist, KVOO.
Jolley, Marge, Continuity Writer, KMOX.
Jones, Daniel Boone, Fiddler, WOS.
Jones, Eva, Hostess, Programs, WFLA.
Jones, Gwyneth, Tenor, Pacific Coast Network, National Broadcasting Company.
Jones, Ivan, Announcer, Bass, KYW.
Jones, Mrs. Eva Thompson, Contralto, WSM.
Jones, Mrs. Harry, KTHS.
Jordan, Corinne, Announcer, Contralto, Pianist, WCCO.
Jorgenson, Phil, Pianist, KFAB.
Jospe Wood-wind Ensemble, National Broadcasting Company.
Joung, Jessie, KMA Sewing Circle, KMA.
Judges, Fred, Spokesman for Auto Club of Washington, KPQA.
Jules, Jacquinet, Organist, KMOX.
Jules Klein's Symphonic Ensemble, WWJ.
Junkin, George, Director, Announcer, KMOX.

KALLES, Arthur, Manager, KFI.
Kalis, Henry, Director of Lido Venice Orchestra, WEEL.
Kanes Hawaiians, KPO.
Karman, Ivor, Violinist, Columbia Broadcasting System Symphony Orchestra.
Katzman, Louis, Director of Whittall Anglo Persians, National Broadcasting Company.
Kaufmann, Harry J., Violinist, WDAF.
Kaufman's Aladdin Hotel Merry-makers, WDAF.
Kay, Lambdin, Little Colonel, Announcer of WSB. No one who has ever heard Lambdin Kay say Atlanta, Georgia, has ever forgotten it. In fact these two words coming over the loudspeaker or ear phones have thrilled more than one fan seeking distant stations. Lambdin Kay belongs to the early and select group of announcers who lured the DX fan to late hours. Whenever a radio station has a birthday party, Mr. Kay is one of the guests. The rumor is that he got married this last summer, but he refuses to make any statement. At least he does not deny it.



Kean, Harold, Baritone, WJR.
Keefe, Jack, Associate Announcer, WSM.
Keele, Hester, Pianist, WSM.
Keener, Marion, Soprano, National Broadcasting Company.
Keim, Dr. A. S., Physical Director, WLAC.
Keithley, E. Clinton, Tenor, WMBB-WOK.
Kellogg, Ester, Violinist, WFLA.
Kelly, Earl, Engineer, KOIL.
Kemp, Evelyn, Pianist, KNX.
Kendrick, James, Announcer, KFRC.
Kephart, Victor and Marjorie, Harmony Team, WIT.

Kerk, Loretta, Accompanist, WFI.
Kessel, Harry, Popular Singer, WHB.
Keulander, Edith, Soprano, WMBB-WOK.
KFAB Symphony, KFAB.
Kidder, Walter, Baritone, King in Saloon Vanities, WEEL.
Kineaid, Bradley, "Mountain Boy," Sings Mountain Songs with Guitar, WLS.
King, Charles, Tenor, KNX.
King, Dr. O. H., Baritone, KTHS.
King, Gerald, Manager, KFWE.
King, Mildred, Pianist, WSM.
King, Mrs. William, Organist, WOC.
Kings of Rhythm, WWJ.
Kinman's Melody Boys, KGA.
Kirtley, Lucille, Soprano, KGW.
Klber, Bob, Zither-player. "Bob" is a monument in the cafe life of San Francisco, a tradition for 21 years. "Bob," incidentally, is also an artist at Hungarian goulash, which, unfortunately, he can't cook over the air, KFRC.

Kline, Ted, Tenor, WCCO.
KMA String Trio, Bernice Currier Birdie Baldwin, Doc Bellamy, KMA.
Kneisel, Jack and his Gypsy Barons Orchestra, WWJ.
Kneiss, Professor Henry, Violinist, Director of Lincoln Salon Orchestra and KFAB Symphony, KFAB.
Knickerbocker Quartet, WEEL.
KNX Concert Orchestra, KNX.
Knutson, Erling, Violinist, WDAF.
KOA Mixed Quartet, Bernice W. Doughty, Soprano; Lucille Fowler, Contralto; Ralph Freese, Tenor; Everett E. Foster, Baritone; Freeman H. Talbot, Director, KOA.
KOA Orchestra, KOA.
Koehne, Freida, Violinist, KYW.
KOIN Male Quartet, Emil Brahms, bass; Bud Abbot, Baritone; Denton Denman, Tenor; Lloyd Warren, Tenor.
KOIN Radio Players, KOIN.

Konecky, Eugene, Grand Champion Staller, WOW. He is well remembered for his Blah club which ceased to operate because Dizzy Izzy, none other than our hero, was too busy to blah. Mr. Konecky has been with the Oninaha station since it began as WOAW. Among his other duties he sends out all the station's publicity. In his spare time Mr. Konecky writes poetry, some of which has been published.

Kopec, Mike, Pianist, Piano-Accordianist, KFAB.
Kooker, Ethel, Book Reviews, WFI.
Kornstein, Egon, Violaist, Columbia Broadcasting System Symphony Orchestra.
Kraft, Vincent, L., President, KJR.
Kramer, L. J., Guitarist, KVOO.
Kresge, S. S., Quartet, WTR.
Krueger, Florence, Soprano, WOC.
Kuhn, Eddie, Kansas City Athletic Club Orchestra, WDAF.
Kuhn, Vincent, Baritone, WSM.
Kyle, Muriel Magerl, Soprano, WJR.
Kynett, Mrs. Xenophon, Contralto, KOIL.

LACEY, Olive June, Coloratura Soprano, WGN.
Laderoute, Joseph, Boy Soprano, WLWL.
Lady Baltimore, Sandman Circle, WBAL.
La Ferrara, Vincent, Violinist, Director of "The Trocadero," Pacific Coast Network, National Broadcasting Company.
LaGue, Charles J., Transmission Engineer, KOA.
Laidley, Isobel, Cellist, WIBO.
Lainb, Christine, Contralto, WSM.
Lamborn, Betty, Woman's Hour, WGHP.
La Mother, Gertrude, "Mrs" of Universal Radio Features, WEEL.
LaMotte, George, Bass, KVOO.
Lampe, J. B., Director, WMBB-WOK.
Lancey, Lorraine, Accompanist, WJR.
Laue, Frank, Announcer-Director of WDOD. One of the younger announcers who began his radio work at KFRJ, Bristow, and stayed with the station until the call letters were changed to KVOO. Last June he went to Chattanooga. As Frank is only twenty-two years old, he is getting along rather rapidly, and, as his is one of the favorite voices of the South, he will, no doubt, be heard from in the future. However, he is interested in a fruit and poultry farm in Oklahoma and may leave his announcing for a farmer's life.



Lang, Harry, Orchestra Leader of Arcadians, KMOX.
Lange, Verne, Tenor, KFAB.
Lantry, C. C., Announcer, KHQ.
Largent, Mrs. D. W., Soprano, KFDM.
Larkowe, Phillip, Central High School Organist, KVOO.
Larsen, Dorothy, Pianist, WSM.
Laughton Family Orchestra, KVOO.
Laux, J. Francis, Assistant Announcer, Sports, KVOO.



SAM PICKARD, one of the more recent and aggressive members of the federal Radio commission. He organized the Radio department of the bureau of Agriculture, Washington.

Lavey, Don, Assistant Director-Announcer, Pianist, "Jiggs" of "Maggie and Jiggs," WGES.
Lawrence, Harry, Uncle Harry and Clarence, WENI-WBCN.
Lawrence, Mrs. May F., Pianist, WSM.
Lawrie, Justin, Tenor, National Broadcasting Company.
Leaska, Mme. Leah, Operatic and Concert Soprano, KGW.
LeBow, Dan, Violinist, Conductor of Orchestra, KTHS.
Lederer, John, Conductor of Marylanders, WBAL.
Lee, Virginia, Soprano, WOC.
LeMon, Mel, Announcer, KFWE.
Lennox, Elizabeth, Contralto, Columbia Broadcasting System.
Leon, Frank, Orchestra Pianist, KOMO.
Leotta, Mme., Reader, KOIN.
Leviene, Mischea, Violinist, KJR.
Levine, Shepard, Tenor, WJAZ.
Levine, Walter, Baritone, WJAZ.
Leveune, Kola, Cellist, KJR.
Lewis, C. M., Spokesman for Washington Manufacturers Association, KPQA.
Lewis, Dorothy, Contralto, KGW.
Lewis, Ednyfed, Tenor, Director, WFI.
Light and Power Concert Orchestra, WDAF.
Lighthall, Mrs. Ray, Soprano, KFPM.
Lincoln Salon Orchestra, KFAB.
Lind, George, Baritone, KFDM.
Lindhe, Vin, Pianist, Reader, WFAA.
Lindsay, Art, Announcer, KPQA.
Lingeman, Caspar J., Minstrels, WJR.
Lingeman, Johann, European Cellist, WGN.
Liniak, Arthur, Dutch Comedian, Presides at Duncakes Club, KYW.
Link Bolines Cowboy Band, KVOO.
Linn, Martha, Daytime Announcer, WHT.
Luthicnuh, Walter N., Baritone, Announcer, WBAL.
Littorer, Dr. Henry, Guitarist, WSM.
Little Brown Church Quartet, Lucille Magill, Soprano; Bernice Ozmun, Contralto; Eugene Leonardson, Baritone; William O'Connor, Tenor, WLS.
Livingston, Charles, Baritone, WHT.
Locke, Mrs. Iona Towne, Soprano, KFDM.
Loder, Kenneth, Cellist, KFAB.
Lombards, Lela and Harry, Comedy and Musical Sketches, WLS.
Long, Dick, Orchestra Leader, Violinist, WCCO.
Long, Emmet, Orchestra Leader, WCCO.
Long, Fiddlin' Sam, Old Time Tunes, KVOO.
Lopez, Joseph, Presentation Directors, WNAC.
Lorinz, August, Tenor, WCCO.
Loyet, Paul, Announcer, WOC.
Love, Mark, Basso, Director of vocal group. A popular favorite with thousands of listeners, and a well known concert singer outside radio. Even his deepest bass notes have a singing quality that make them superb on the radio. He is to sing this year with the Minneapolis Symphony Orchestra, WGN.
Loveless, Wendell P., Director, WAIB.
Loving, Refuge Ray, Soprano, KFDM.
Lowry Male Quartet, WCCO.
Luboviski, Culmon, Violinist, KNX.
Lucas, Mrs. Lucian L., Pianist, WFLA.
Lucy, C. T., Announcer of Special Features, WRVA.

Ludlow, Godfrey, Violinist, National Broadcasting Company.
 Ludwig, Preston, Percussionist, KGW.
 Lugeska Trio, WMAK.
 Lohken, Mrs. Albert, Contralto, KVOO.
 Lynch, Fred, Popular Tenor, KOMO.
 Lynch, Montgomery, Baritone, General Director, KOMO.
 Lynch, William S., Junior WOR Announcer, Columbia Broadcasting System.
 Lyon, Hartzell J., Baritone, KMOX.
 Lyon, Ruth, Soprano, WMBB-WOK.
 Lyons, William, Harmonicist, WOC.

MACARTHUR, Peter, Announcer, WOC.
 MacFerran, J. D., "Radio Mac," Publicity, Assistant Announcer, WMBB-WOK.

MacDonald, Avis, Vibraphone Player, KYW.
 MacKown, Marjorie Truelove, Pianist, WHAM.
 McCart, W. J., Tenor, KVOO.
 McCampbell, Ursula, Violinist, WSM.
 McConville, Leo, Trumpeter, Columbia Broadcasting System Dance Band.
 McCormick, Peggy, Contralto, KVOO.
 McCracken, Hal, Popular Pianist, KOIN.
 McDonough, Dick, Banjo, Guitar Soloist, Columbia Broadcasting System Dance Band.
 McElwain, George, Announcer, Drafted from Technical Department for late program, KGO.

McFadden, Frances, Pianist, WSM.
 McGann, Hugh, Baritone, KOIL.
 McGinty Cowboy Band, WLW.
 McGowan, Grace, Office Director, Coloratura Soprano, KMOX.

McGlone, Louise, Organist, KMA.
 McGrath, Frank, Director Parker House Concert Orchestra, WEEL.
 McGee, Beulah, Contralto, WOC.
 McGee, Sam, Fiddler, Barn Dance Entertainer, WSM.

McIntire, Kathrynne, Violinist, Contralto, Monologues, KMOX.
 McInturf, Lucille, Organist, WWNC.
 McKee, Edna, Popular Songs, KVOO.
 McKenzie, Rev. J. A., Weekly Bible School Lesson, KMA.

McKinney's Cotton Pickers, Dance Orchestra, WJR.

McLaughlin, Frances, Secretary to Big Brother Club, WEEL.

MacLean, Alice, Lyric Soprano, KOMO.
 McMillin, Mrs. Benton, Reader, WSM.

McNamee, Graham, Announcer, Began work at WEAJ in 1923. Has described the World Series, the Presidential Inauguration, the Democratic National Convention, Football games. He is also remembered for his announcing of the Sharkey-Dempsey and the Tunney-Dempsey Fights. He is known by his "Good Evening Ladies and Gentlemen of the Radio Audience." National Broadcasting Company.

MAC, Children's Hour Entertainer; a Favorite with "Youngsters from 9 to 90"; has probably wrecked the old "97" more times than anyone else, KFRC.
 Mace, Alice, Pianist, KMOX.
 Macon, Uncle Dave, Banjoist, Singer, WSM.
 Magglo, Agie, Crystal Beach Orchestra, WMAK.

Mahon, William, Announcer, KOIN.
 Mahoney, Bill, Announcer, KOIL.
 Male Quartet, WWNC.
 Mallin, Donald F., Announcer, WLS.
 Mallory, Walter, Tenor, WCCO.
 Malone, Mary Cornelia, Soprano, WSM.
 Man, L. R., Operator, WBAP.
 Mandolin Musicians, KMA.
 Mangel Cigar Girls, Popular Numbers Singers, WJF.

Maple City Four, Male Quartet, WLS.
 Marcoux, Henri, Baritone, WLWL.
 Marlan, Edith, Soprano, National Broadcasting Company.

Marsh, Frank B., Manager Vocal Personnel, Columbia Broadcasting System.

Marshall, Rhena, Mezzo-Soprano, KOMO.
 Martin, Brown, Violinist, WSM.
 Martin, Howie, Announcer, KOIL.
 Martin, Marion, Accompanist, Hostess, WWJ.
 Martha Trio, Helen Bennett, Violinist; Marion Matthews, Cellist; Mildred Carroll, Pianist and Soprano; KMX.

Mathin, Allee G., Program Director, Pianist, Continuity Writer, Organist, KMOX.

Massengale, Clyde and Florence, WBAP.
 Massey, Mrs. Guina, Pianist, KTHS.
 Master Six Orchestra, KFAB.

Mather, Donald, Operator, WEEL.
 Mathew Sisters, WHE.

Mathewson, Ralph W., Chief Operator, WEEL.
 Matheson, E. E., Director, KFRC.
 Matthews, Alice, Pianist, WWAC.

Matthews, Blanche Moore, Pianist, WSM.
 Matthews, C. J., Commercial Representative in Chicago Office, National Broadcasting Company.

Matthew, E. B., Announcer and Director of the Farmers' Radio Chautauqua, KTHS.

Matthews Sisters, Harmony and Uke Players, KFW.

Maurio Sherman and his All Star College Inn Orchestra, WLS.

May, Earl E., Owner, Announcer, Station Director, KMA.

May, Mrs. Earl, Solist, KMA.
 May and June, Harmony Team, WMBB-WOK.
 Mays, Esmeralda Berry, Violinist, KMOX.
 Maytore Orchestra, KMA.
 Mecker, Louise, Weekly Book Reviews, WDAF.
 Meek, Sandy, Scotch Tenor, WSBC.
 Meeker, Bobby, Director Drake Hotel Dance Orchestra, WGN.

Melaney, Howard, Tenor, WLS.
 Mellonino, Claire, Pianist, KNX.
 Melodians, Laurie, Eddie, Bennie, Male Trio, WGES.

Melodians, Quartet, WSM.
 Melody Trio, Sid Lippman, Dale Imes, Sally Farnsworth, KNX.

Melody Twins, Dorothy Maddox, Vera Trueblood, WHEB.

Menkes, Sallie, Accompanist, WENR-WBCN.
 Menzer, Carl, Announcer, WSUL.

Mercer, Harry Yeazell, Tenor, WOC.
 Miles, Mrs. T. E., Contralto, WSM.

Millrood, George B., Violinist, WJR.
 Mills, Byron, Announcer. Learned to sing touring country towns with his father who was a circuit rider. It is also rumored he reads all the fan mail, KGO.

Mineo, Sam, Pianist, WMAK.
 Minneapolis Symphony Orchestra, Henri Verbruggen, Conductor, WCCO.

Missouri Ramblers, Dance Orchestra, WHE.
 Mitchell, Everett, Popular Announcer, WENR-WBCN.

Moffit, Star's Photoplay Editor, WDAF.
 Mole, Miff, Trombonist, Columbia Broadcasting System Dance Band.

Mona Motor Oil Orchestra, KOIL.
 Mona Motor Oil Twins, John Wolfe, Ned Tollinger, KOIL.

Montanus, Mrs. Agnes, and her Friendly House Dramatic Players, WOC.
 Monroe Jockers' Orchestra, KNX.

Montgomery, Angie, Contralto, WHT.
 Mooney, Tom, Baritone, WSM.

Moore, Homer, Operatic Baritone, WFLA.
 Moore, Morrill, Organist, WHE.

Merrick, Mahlon, Director of Concert Orchestra, KHQ.

Mertens, Louis, Violinist, WSM.
 Metropolitan Male Quartet, KVOO.

Meyer, Mrs. Eugene, Pianist, WSM.
 Meyer, Vic, Leader of Butler Hotel Orchestra, KJR.

Meyers, Charlotte, Member of Team with Miss Tudor, WLW.

Michael, Milton, Tenor, KFDM.
 Micklin, Harold, Violinist, Conductor of Orchestra, WFI.

Mignolet, Jeanne, Member of Roxy's Gang, National Broadcasting Company.

Mike and Herman, Comedians, Arthur Wellington and James Murray, WENR-WBCN.

Miholland, Howard L., Studio Manager, Chief Announcer, Program Director, Famous for his Radio Vaudeville. He is also a reader, impersonator and singer, KGO.

Miller, Dick, Tenor, WMAK.
 Miller, George, WSBC.

Miller, Hugh, Bass, KFDM.
 Miller, Lou, Uncle Jack, KOIL.

Miller, Mamie, Domestic Science Lady, KMA.
 Moosman, Beal, Dramatic Player, Control Operator, KOMO.

Moran, Nellie Lee, Soprano, WSM.
 Morehouse, Marguerite, Organist, KOIL.

Morgan, Arthur, Violinist, WBAL.
 Morgan, Madge, Soprano, KVOO.

Morelli, Whitfield, Pianist, WSM.
 Morrey, Grace Hamilton, Pianist, WAUI.

Morris, Margaret Messer, Soprano, KNX.
 Morrison, Clair E., Manager of KYA, Mr. Morrison received his early training as director of KFO, San Francisco. For the past year and a half he has been piloting KYA into national prominence. The reason he is not on the air now as much as formerly is because he is too busy looking after all the details which go toward making a smooth broadcast.

Morrison, Edris, Director, KOIN Players.
 Morrow, Fred, Reeds, Columbia Broadcasting System Dance Band.

Morton, Dorothy, Pianist, WSM.
 "Mose and Charlie," Harold Hughes, Jose Simonson, KOIL.

Moses, Eva, Hostess, KFON.
 Moss, Frank, Musical Director of KFRC and WFR Concert Orchestra; a concert pianist of distinction; has co-starred throughout America with Alice Gentle.

Mortory Maxwell, Tina Lerner, Louis Persinger, Lawrence Strauss and others. He is an Ampico recording artist and former director of music at the University of Hawaii, KFRC.

Moss, Nora La Mar, Contralto, WHE.
 Munn, Frank, Tenor, Former, One of Rudd Light Opera Group, National Broadcasting Company.

Murphy, Ella, Weekly Book Reviews, KMA.
 Murphy, Russell, Tenor, WCCO.

Murray, Norine, Irish Songs, WOC.
 Murray, Rachel Neil, Guitarist, WSM.

Music Masters, Twenty-Piece Concert Orchestra, WRAP.
 Musical Chops, Don Travline, Max Freedman, WCAU.

Myatt, Mrs. Herman, Soprano, WSM.
 Myers, Walter, "Mr." of Universal Radio Features, WEEL.

Mystery Three, WEBH.

NADWORNEY, Devore, Contralto, National Broadcasting Company.
 Neatrou, Harold, Announcer, WRVA.
 Nellums, Mrs. M. E., Soprano, WSM.
 Nelson, George, Chief Announcer, Bass, KOMO.

Nelson, William Warvelle, Orchestra Leader, WCCO.

Neumiller, Howard, Musical Director, WENR-WBCN.

Nevins, George, Tenor, WSM.
 Newman, John W., Chief Operator.

Nicholls, John N., Announcer, Staff Pianist, Baritone, KOIN.

Nichols, G. B., Spanish Announcer, KFDM.
 Nichols, Marvin, Tenor, WSM.

Nichols, Red, Trumpeter, Columbia Broadcasting System Dance Band.

Nichols, Robert, Associate Announcer, Baritone, KOMO.

Nicholson, James, Chief Operator, WCSH.
 Nicholson, Williams B., Tenor, WSM.

Nightingale, Helen, Soprano, KOIL.
 Noel, Harold, Announcer, Publicity, WGES.

Novak, Frank, Tenor, WCCO.

OAKLEY, Iris Martinson, Contralto, KOIN.
 Oakley, John, Bass, National Broadcasting Company.

Oakley, Victor Dale, Announcer, WFAA.
 O'Brien, George, Tenor, National Broadcasting Company.

Oehl-Alhi, Nicholas, Cellist, KNX.
 O'Connor, Stanley, Baritone, KOIN.

O'Grady, William, Tenor, WCCO.
 O'Kane, Dick, Popular Singer, WHE.

Older, Ferd, Banjoist, WCCO.
 Olds, E. L., Technical Director, KTHS.

Olds, Dorothy, Pianist, KVOO.
 O'Leary, Joseph, Leader of O'Leary's Irish Minstrels, WEEL.

Oliver, Althea, Mezzo-Soprano, KNX.
 Olsen, Al, and his Whispering Guitar, WBAP.

Olsen, Robert, Tenor, Graduated from the try-out programs six months ago and is now one of the Radio sensations of the West, KFRC.

Olson, Clarence, Orchestra Leader, Violinist, WCCO.

Olson, Mrs. Clara, Soprano, WCCO.
 Olson, Mrs. H. O., Cellist, WSM.

O'Neill, Helen, Program Director, KFRC.
 O'Neill, Lucille, Soprano, WJAZ.

O'Neill, Peggy, Studio Director, Singer, Accompanist, "Maggie" of "Maggie and Jiggs," WGES.

Optimistic Do-Nuts, KNX.
 Oriental Male Quartet, WLS.

Orowitz, Eli M., Weekly Movie Broadcasts, WPG.

Osina, Sophia, Pianist, KVOO.
 Otey, Florence Walden, Member of Trio, WBAL.

Owen, Delos, Theatrical man of long experience with many musical shows and a host of popular tunes to his credit. In charge of WGN's popular programs. Came to WGN January 1, 1928. This is his first radio work.

Owen, Robert, Chief Engineer, KOA.

PAGLIARA, Nicholas, Tenor, WHAM.
 Palmer, Harold, Announcer, WOW.

Palmer, Lester, Announcer, WOW.
 Palmer, W. G., "Bill," WCOA.

Pam, Anita, Household Advisor, WPAP.
 Parnassus Trio, National Broadcasting Company.

Patriek, Frances, Pianist, WSM.
 Patt, John F., Program Director, WJR.
 Paulist Choristers, WLWL.



OLD time Radio listeners will remember Doc Reynolds (above) way back when KLZ at Denver was just plain 9ZAF. He has been with the station through thick and thin and his saxophone is the most familiar Radio instrument in the West.



AMERICAN broadcasting stations furnish the greatest variety and the best quality of music in the world, declares Edward A. Davies, director of WIP, Philadelphia, as the result of a European tour.

Payne, George, Tenor, WHAM.
 Pedroza, Alfonso and Sophia P., Spanish Bass, Soprano, WGN.
 Peery, Harold G., Technical Director, KPERC.
 Pelletieri, Vito, and his Orchestra, WSM.
 Perfetto, John J., Trombone, Baritone, Columbia Broadcasting System Symphony Orchestra.
 Perkins, Omar, Director Playmate, Popular Orchestra, WHB.
 Perkins, Mrs., KMA Poultry Lady.
 Perkins, Rev. J. R., Station Chaplain, KOIL.
 Pernin, Father Claude J., S. J., "Twenty Minutes of Good Reading," KYW.
 Perry, Jr., William, Tenor, WSM.
 Personality Twins, Mildred McKinley, Ruth McKinley, KOIN.
 Peterman, H. J., Conductor of the U. S. Naval Academy Band, WBAL.
 Peterson, Curt, Announcer. Born in Albert Lea, Minn., February 12, 1898. He graduated from the University Oregon with the degree of Bachelor of Science in 1920, after serving in the World War as a Lieutenant of Infantry. Before entering the field of Radio he was a singer and a teacher of voice at Miss Mason's Castle School for Girls, National Broadcasting Company.
 Peterson, Walter, "Kentucky Wonderbean," Harmonica, Guitar, WLS.
 Petty, Fred, Farm Program Announcer, WLS.
 Peyer, Joe, Orchestra Leader, WCCO.
 Phelan, Charles W., Director of Co-operative Broadcasts, WNAC.
 Phelps, G. Allison, Announcer, KMTR.
 Phillips, Phil, Director of Springtime Serenaders, WFLA.
 Phillips, Pete, Tenor, KTHS.
 Phillips, Ronald, Clarinetist, KOMO.
 Piano Twins, National Broadcasting Company.
 Pickard, Obed, One-Man Orchestra, WSM.
 Pierce, Jennings, Announcer, National Broadcasting Company Pacific Network.
 Piggot, Eileen, Soprano, National Broadcasting Company, Pacific Coast Network.
 Pine, Joseph, Clarinetist, Saxophonist, KOMO.
 Pinney, Katherine, Accompanist, KOMO.
 Pironi, Ruth, Soprano, KOIN.
 Pitcher, J. Leslie, Tenor, KJR.
 Pitman, Linwood T., Announcer, WCSH.
 Pittenger, Theodore, Violinist, KVOO.
 Gerwe, John, Tenor, WOC.
 Plasencia, Flavio, Young Mexican Baritone. In eight months on WGN, where he began as an unknown, he has won himself vaudeville honors and a place on the phonograph records, WGN.
 Polk, Marshall, Tenor, WSM.
 Polokoff, Eva, Violinist, WIBO.
 Pontius, Walter, Tenor.
 Pool, R. S., Director, WFAA.
 Pop Twins, Dorothy Drakeley, Soprano; Rose Quigley, Contralto; WHAM.
 Portal Players, WCCO.
 Posselt, Marjorie, Leader of the Friendly Maids, Instrumental Quintet, WEEL.
 Powell, Verne, Saxophonist, KFAB.
 Possum Hunters, Dr. Humphrey Bate, Director, WSM.

Pratt, Russell, Originator of Topsy Turvey Time and Potpourri, WMAQ.
 Fregg, Herbert, Orchestra Leader, Violin, KOMO.
 Preston, Walter J., Director, WIBO.
 Provensen, Martin, Assistant Announcer, WENR-WBCN.
 Pulley, Guy and Katherine, Ukulele, Banjo, Guitar, WLS.

QUILLIAN, H. J., Assistant Announcer, KOMO.
 Quinby, Dan, Reader, KOIN.
 Quisenberry, T. E., Poultry Lectures, WDAF.

RADER, C. B., Market Announcer, KFH.
 Radley, Verne, Orchestra, KTHS.
 Randall, Art, Director of Royal Fontenelle Orchestra, WOW.
 Randell, Harlan, Baritone, WHT.
 Rankel, John, Baritone, WHT.
 Rapp, J. C., Announcer, Operator, KMA.
 Raul, Helen, Pianist, WIBO.
 Ray, Bill, Chief Announcer, KFWE.
 Raymond, Joseph, Violinist, Columbia Broadcasting System Dance Band.
 Reddy, Laurence, Baritone, WCCO.
 Redfern, Gene, and Barney Breene, Harmony Team, KVOO.
 Redmond, Aidan, Chief Announcer, WBZ.
 Red Peppers, Frank Silsby, Director, KVOO.
 Reedy, Dorothy Heywood, Pianist, KVOO.
 Rcep, Philip, Tenor, WHAM.
 Rehberg, Lillian, Violon-cellist, KYW.
 Rehmuth Trio, Vocalists, WCCO.
 Renard, Jacques, Director of Coconut Grove Orchestra, WEEL.
 Rendina, S. F., Pianist, Director of K. C. Artist Trio, Director of Concert Orchestra, WHB.

Renier, Tiny, Solist, WDAF.
 Resta, Francis, Director of the 17th U. S. Infantry Band, WOW.
 Reymers R. V. B. Trio, Jack Thompson, Comedian; Ed Ricks, Bass; Edgar Sprague, Tenor; KDKA.
 Reynolds, Al, Comedian, Dialect Stories, KTHS.

Reynolds, F. W., Announcer, WHAM.
 Rhies, Frank, Pianist, KVOO.
 Rhys-Herbert Male Quartet, WCCO.
 Rhythm Kings, Charles Fitz-Gerald, Director, WJR.
 Rice, Gladys, Character Singer, Roxy's Gang, National Broadcasting Company.
 Rice, Glen, Assistant Manager, KNX.
 Richardson, Mrs. Henry E., Contralto, WSM.
 Richie, George T., Announcer, Station Accompanist, KOA.
 Richison and Sons, Old Time Fiddlin' Music, KVOO.

Richter, Michael, Flutist of Ensemble, WBAL.
 Ridley and Adkins, Guitars, KVOO.
 Ridley, Bob, Steel Guitarist, KVOO.
 Rideout, E. B., Meteorologist, WEEL.
 Riesinger, Hazle, "The Sooner Girl," Staff Singer, Assistant Director, KFJF.
 Rines, Joe, and his Elks Hotel Orchestra, WEEL.

Risinger, J. L., Announcer, KFDM.
 Ritchie, Albany, Violinist, KFQA.
 Roberts, Albert, Baritone, WSM.
 Roberts, Helen Buster, Organist, WBAP.
 Robinson, C. C., Old-Time Fiddler, WOC.
 Robinson, Irving B., Technical Director, WNAC.

Robinson, Lloyd, Bass, KFAB.
 Rochester String Quartet, Allison MacKown, Cellist; Carl Van Hosen, 1st Violinist; Abram Boone, 2nd Violinist; Arthur Stillman, Violinist; WHAM.

Rock, Vincent, Solist, WDAF.
 Rodgers, Mrs. R. L., Coloratura Soprano, Soprano, WFLA.
 Roe, Thelma, Violinist, KVOO.
 Roelofsma, E., Clarinetist, Columbia Broadcasting System Symphony Orchestra.
 Roentgen, Engelbert, Cellist, WCCO.
 Rogers, Ellen, Jass Pianist, Blues Singer, KGW.

Rogers, Ralph, Universal Radio Features, Director of "Mr. and Mrs. Skits," WEEL.
 Roger Williams' Club Quartet, KVOO.
 Rogers, Naylor, Manager, KNX.
 Ronayne, Mary C., Assistant Program Director, WEEL.

Roning, Russell, Saxophonist, WCCO.
 Rose, Hazel Coate, Pianist, WSM.
 Rose, Kenneth, Violinist, WSM.
 Rose, Toney, and his Orchestra, WSM.
 Rosenthal, Frances, Bass, WCCO.

Roth, Marcella, Twilight Story Girl of WSMB. This little actress takes children's parts in the Saenger Stock companies and has also taken charge of the children of this Southern station for several years. She is a little red-haired, freckle-faced child who tries to meet her Radio audience as informally as she would her other friends. Not only does she broadcast but she also answers a large correspondence. When she grows up she wants to be an actress.

Rothermel, Charles, Banjoist, WGES.
 Rounders, Myron Neilsley, 3rd Tenor; Dick Harit, Baritone; Armond Girard, Bass; Dudley Chambers, 1st Tenor; Bill Cowles, Pianist; Ben McLaughlin, 2nd Tenor. Pacific Coast Network; National Broadcasting Company.

Rouse, Gene, Announcer, WJJD.
 Rowell, Glenn, of Ford and Glenn, WLS, WFAA.

Ruby, Bernard, Member of Ruby Trio, KMA.
 Ruby, Floyd, Member of Ruby Trio, KMA.
 Ruby Trio, KMA.

Rucker, Stanley, One of the Cornhusker Trio, KMA.

Rudolph, Joe, Member of Potpourri Time, WMAQ.

Ruff, Olga, Soprano, KOIN.
 Ruppel, Vera, Soprano, WMAK.

Rush, Ford, of the Ford and Glenn, WLS, WFAA.
 Russell, Jack, WMBB-WOK.
 Russian Native Orchestra and Art Troupe, WCCO.

Russo's String Quintet, WDAF.
 Ruth Snyder, Indigo Blues Singer, WSBG.

Ryan, Frank, Sports Announcer, WEEL.
 Ryan, Kathleen, Contralto, at WGN since early in 1925. A fixture in the WGN Mixed Quartet, WGN.

Ryan, Quin, Director of Feature Broadcasts, Feature Announcer, "Been at it" in Radio since 1923. One of original directors of WLS and heard before that in special broadcasts over WMAQ. Came to WGN in middle of 1924. Known to thousands as one of the most vividly graphic and entertaining of the country's sports announcers. Has broadcast everything from a senatorial debate and an evolution trial to a high school football game. His stories of Army vs. Navy (1926), the Dayton Evolution Trial, Chicago vs. Illinois (Red Grange), 1925, are regarded as classics in radio reporting, WGN.

Ryau, Russell, Assistant Announcer, WDAF.

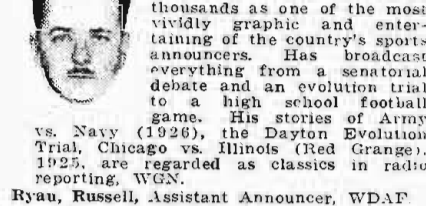

SACHSE, Alice Warren, Program Director, WPG.
 Safford, Harold A., WLS.

Sagamore Hotel Orchestra, Hughie Barrett, Leader, Mort Adams, Johnnie Wade, Freddie Menzer, Saxophones; Charles Jacobs, 1st Trumpet; Fred Wagner, 2nd Trumpet; Norman Booth, Trombone; Frank Smith, Banjo; Fred Kay, Bass; "Prep" Ward, Percussion; Frank Skultety, Piano; Bob Hemming, Piano, WHAM.

Salernos, Out of Italy by way of Madison, Wis., Lawrence, Baritone Member; Frank, Virtuoso Accordionist; WGN.

Sam and Petunia, KFQA.
 Sampson, H. P., Announcer, WABC.
 Sampson, Dewey J., Tenor, WCCO.

Samelle, Andy, Saxophonist of the Ipana Troubadours, National Broadcasting Company.

Sargent, Jean, Program Manager, WNAC.
 Sartain, Daisy, Pianist, WSM.

Satley, Mac, Impresario of Popular Shows, Singer, An Occasional Announcer, WGN.



IF you haven't heard Jim Wilt yet over KMA, Shenandoah, you've got a treat coming. Jim's vocation is government hunter and game warden in Glacier National park. His avocation is broadcasting and poetry. Audiences are thrilled with stories of capturing wild animals alive and tricks of handling them—"once you got a bear by the tail."

Sawyer Saxophone Group, WJR.
 Static Girls, Gladys, Ivah, Popular Numbers, WJR.
 Satterfield, Thelma, Story Lady.
 Saumenig, Dudley, Announcer, Studio Director, WSUN.
 Sax, Sol, Pianist, WBAL.
 Schaeftgen Trio, Instrumental, WCCO.
 Scheurer, Karl, Violinist, WCCO.
 Schilling, John T., Announcer, Director, has been with WBB since it went on the air in 1922. Kansas City fans have never tired of his voice which is a compliment in itself. This is no doubt due to the fact that he is thinking of his invisible audience rather than himself. Mr. Schilling has always stood high in any announcers' contest. He maintains the same high standard of programs.



Schindler, Willard, Baritone, National Broadcasting Company.
 Schlagle, George, Announcer, Operator, WSUN.
 Schoggen, Walter, Tenor, KVOO.
 Schroeder, Leon, Baritone, KVOO.
 Schuett, Arthur, Pianist, Columbia Broadcasting System Dance Band.
 Schoop, Dorothea, Rehearsal Accompanist, KGW.
 Schwartzler, Ethel, Violinist, WMPB-WOK.
 Scott, Ivy, Soprano, National Broadcasting Company.
 Scott, Jose, WSBC.
 Scull, Fern, Staff Accompanist, WGN.
 Seale, Walter B., Baritone, WOAN.
 Searle, Don, Announcer, Station Manager, KOIL.
 Sebel, Frances, Soprano, National Broadcasting Company.
 Seeley, Margaret Calhoun, Pianist, WSM.
 Seixus, Dr. P. M., Setting Up Exercises, KNX.
 Selinger, Henry, Program Director of Station WGN and manager-in-chief of its numerous musical activities. His Drake Concert ensemble is a pioneer radio orchestra, having broadcast over WDAP (later WGN) back in 1923. He is known as the Phantom Violin, WGN.
 Selph, Orris M., Chief Operator, Announcer on Sunday Service, WRVA.
 Semmler, Alexander, Assistant Conductor, Columbia Symphony Orchestra.
 Serafino, Bertha, Popular Pianist, KFDM.
 Seven Aces, "All Eleven of 'Em," WBAP.
 Seymour, L. J., Announcer, WCCO.
 Shadwick, E. Joseph, Violinist, WCCO.
 Shaffer, George, Saxophonist, KVOO.
 Shaffer, Rachel Watson, Soprano, KVOO.
 Shannon, John Finley, Pianist, WSM.
 Shannon, Mrs. Marguerite, Pianist, WSM.
 Shannon, Ray, Tenor, WDAF.
 Shaver's Jubilee Singers, WLS.
 Shaw, Dudley, "The Tired Hand," Director, Chief Announcer, KFJE.
 Shaw, R. M., "Father Time," Office Manager, KFJE.
 Shean, Jack, Tenor, National Broadcasting Company.
 Shea's Stage Band, Alex Hyde, Director, WMAK.
 Shea's Symphony Orchestra, WMAK.
 Sheehan, Bartholomew, Announcer, WLWL.
 Sheldon, Chet, Orchestra, KFH.
 Shell, Fred, Cellist, KOMO.
 Shepard, Jr., John, President, Treasurer, WNAC.

Shepard, John, 3rd, Executive in Charge, WNAC.
 Sheridan, Maude, Contralto, WFLA.
 Sherman, Joe, Banjoist, KGW.
 Sherman, Ransom, Member of Potpourri Time, WMAQ.
 Sherr, Norm, Pianist, WGES.
 Sherris, Marley R., Announcer. Born in Toronto, Canada, June 23, 1884. Studied piano and singing in the Toronto Conservatory of Music and in Chicago. He made appearances all through Canada and the Western States. Finally studied in London, England, and returned to New York, National Broadcasting Company.
 Shields, Louise, Pianist, WSM.
 Shields, Mrs. E. P., Contralto, KTHS.
 Shippey, Max E., Ballad Singer, WBAP.
 Shirik, Kenneth, Engineer, KOIL.
 Shoffner, Charles P., Weekly Talks, WFL.
 Shope, Henry, Tenor, National Broadcasting Company.
 Shriner, Patti Adams, Pianist, KVOO.
 Schroeder, Leon, Baritone, KVOO.
 Shumate Brothers, KMA.
 Shurtz, E. Judson, Baritone, WOC.
 Sicilians, Male Quartet, WOC.
 Silberstein, Herbert, Violinist, WOC.
 Simmons, Bertha, Popular Singer, KFDM.
 Simon, Harry, Director of the KFRC Dance Orchestra, Formerly Director at The Ambassador, Ltd., Melbourne, Australia, KFRC.
 Simonds, Harold, Baritone and Announcer, WPI.
 Simonds, Raymond, Leader of Whiting's Quintet, Male, WEEL.
 Simons, George, Announcer, WMAQ-WQJ.
 Simons, Mildred, Announcer, WCCO.
 Simpleton Fitts, Conducts the Early Bird program from 7-8 a. m. daily. When "Simp" wears his other uniform he is known as Munroe Upton, Announcer par excellence, KFRC.
 Singleton, Harold, Baritone, WHAM.
 Skulety, Frank, Pianist, WHAM.
 Skimmon, Wesley, Baritone, KFOA.
 Sloan, George R., Operator, WBAP.
 Smiley, Robert, Announcer, KFRC.
 Smith, Anna Mary, Soprano, KVOO.
 Smith, Arthur, Fiddle, Barn Dance Entertainer, WSM.
 Smith, Beasley, and his Orchestra, WSM.
 Smith, Fred, Announcer-Director, WLW. Mr. Smith has done more research work on continuity programs than any other announcer. He developed a Radio play called the Radar which was favorably received by Cincinnati fans. He was first to adapt a mystery story called "The Step on the Stairs" into a Radio play which was played from week to week. Two years ago Mr. Smith made a tour of European stations and came back with many new ideas. Before he went into Radio work Mr. Smith studied music and so comes to the microphone with a good background. He is married to Marjorie Garrigus Smith, the pianist.
 Smith, George, Announcer, Director, WJAZ.
 Smith, Harold Osbourn, Organist, WHAM.
 Smith, Lee O., Announcer, Director, KFDM.
 Smith, Madge, Hawaiian Music, WHB.
 Smith, M. G., Fiddle, Barn Dance Entertainer, WSM.
 Sni-A-Bar Gardens Orchestra, WDAF.
 Snyder, G. M., Assistant Operator, KHQ.
 Snyder, Reed, Announcer, WOC.
 Sobey, Roy, Vocalist, KYA.
 Sodero, Cesare, Maestro, Opera Presentations, National Broadcasting Company.



Two years ago Mr. Smith made a tour of European stations and came back with many new ideas. Before he went into Radio work Mr. Smith studied music and so comes to the microphone with a good background. He is married to Marjorie Garrigus Smith, the pianist.

TAGGART, Dorothy, Soprano, Office Assistant, KOMO.



Talbot, Freeman, Announcer-Director KOA. The friendly atmosphere at KOA, Denver, is for the most part due to the genial disposition of Mr. Talbot, the Director. He is, also, one of those announcers who has broadcast everything and from every place. He has broadcast from the depths of mines and from the tops of mountains. He also directs the KOA Minstrels which have been winning so many Radio laurels the last two years. The Radio Rodeo Radio, one of the biggest Radio productions in the last few years, was also directed by Mr. Talbot. He manages to infuse some of the western atmosphere into the station. All the programs have a distinct individuality.
 Talbot, Bryce, Baritone, Character Singer. Known for his Gilbert & Sullivan and musical comedy programs, WGN.
 Taylor, Bernice, Dramatic Soprano, KYW.
 Taylor, Frank, Popular Pianist, KOIN.
 Taylor, Rose, Accompanist, WDAF.
 Ted Weems, Victor Recording Orchestra, WDAF.

Teget, Leona, Flower and Domestic Science Talks, KMA.

Teel, Ikey, Dramatic Reader, WOC.

Teeter, Kenneth, Baritone, KOIN.

Temple, O. D., Tenor, WOW.

Tennyson, Juanita, Soprano, the Original "all-around musical athlete." She has had an excellent musical education, is an experienced concert and operatic singer, but is not reluctant to do a popular number now and then.

Tepley, John, Bass, KOMO.

Thaden, Zona Gale, Staff Pianist, WFLA.

Thiede, Elsie, Soprano, Columbia Broadcasting System.

Thomas, Dolph, Chief Announcer, Studio Director, Baritone, KOIN.

Thompson, Billy, Baritone, KVOO.

Thompson, C. R., Announcer, WAU.

Thompson, Mae, Soprano, KFRC.

Thorgersen, Edward, Announcer, Pianist, Engineer, National Broadcasting Company.

Thornton, Henry, Organist, WOW.

Thorwald, John, Director-Announcer, WRR.

Tison, James B., Operator.

Tison, W. Walter, Director-Announcer, WFLA; Director of Operations, WFLA-WSUN.

Todd, Rev. John, Sunday Morning Service, WMA.

Tofall, John, Accordionist, Pacific Coast Network, National Broadcasting Company.

Tom and Jerry, Bob Lee, Ethel Warner, WHB.

Tom, Joe and Jack, Minstrel Men, WSM.

Tone, William, Trombonist, Melophonist, Columbia Broadcasting System Dance Band.

Topping, John D., Publicity Director, WVNC.

Torrey, Mrs. J. D., Pianist, WSM.

Totten, Hal, Sport Announcer. When the football season or the baseball comes around, the Daily News station, WMAQ, calls upon Hal Totten to do the announcing and for the season he leaves his editorial desk. Fans think no one can announce these two sports like Hal. As most of his five years of newspaper work has been spent writing sport copy,

it is not queer that he should qualify in this capacity. He remembers football announcing when the Radio reporter faced a mike exposed to all sorts of weather and often the reception was spoiled by rain. Of course, now the announcers sit tranquilly behind glass and report each play undisturbed by the weather.

Totty, W. J., Banjoist, Barn Dance Entertainer, WSM.

Third Infantry Band, Carl Dillon, Conductor, WCCO.

Traband, Mrs. Clifford, Soprano, KVOO.

Thur, Paul H., Announcer, WCCO.

Tucker, Bobby, Juvenile Concert Pianist, WFLA.

Tudor, Mary, Formerly at WJR, WLW.

Tulley, Marie, Popular Accompanist, Singer, WENR-WBCN.

Tulsa Community Chorus, KVOO.

Tulsa Male Quartet, KVOO.

Tulsa Symphony Orchestra, KVOO.

Tulsa Symphony Male Quartet, KVOO.

Turney, Alta, Dramatic Soprano, WFLA.

Turrill, Celia, Mezzo-Soprano, National Broadcasting Company.

Twamley, Edgar, Announcer, WOC.

Tweed, Grandpa, with Uncle Bob, Guitarist, Mouth Harpist, KYW.

Tyson, E. L., "Ty," Station Manager, Chief Announcer, six years, WWJ.

Tyson, John Reed, Morning Announcer. His "entertainment for shut-ins" and readings have made him the popular announcer with thousands of unfortunate listeners, WGN.

Tyson, John Reed, Morning Announcer. His "entertainment for shut-ins" and readings have made him the popular announcer with thousands of unfortunate listeners, WGN.

Tyson, John Reed, Morning Announcer. His "entertainment for shut-ins" and readings have made him the popular announcer with thousands of unfortunate listeners, WGN.

Tyson, John Reed, Morning Announcer. His "entertainment for shut-ins" and readings have made him the popular announcer with thousands of unfortunate listeners, WGN.

Tyson, John Reed, Morning Announcer. His "entertainment for shut-ins" and readings have made him the popular announcer with thousands of unfortunate listeners, WGN.

Tyson, John Reed, Morning Announcer. His "entertainment for shut-ins" and readings have made him the popular announcer with thousands of unfortunate listeners, WGN.

Tyson, John Reed, Morning Announcer. His "entertainment for shut-ins" and readings have made him the popular announcer with thousands of unfortunate listeners, WGN.

Tyson, John Reed, Morning Announcer. His "entertainment for shut-ins" and readings have made him the popular announcer with thousands of unfortunate listeners, WGN.



GUY LOMPARDO and his orchestra are now playing over WBBM-WJBT, Chicago. For four years they were heard from WTAM, Cleveland. The orchestra with the exception of one member, was recruited from Canada.

Tyson, E. L., Announcer-Director WWJ. Mr. Tyson is one of the real pioneers of Radio. When the DX fan was searching through the ether for the sound of a distant voice, listeners East, West, North and South heard E. L. announcing. He was also on the air when stations were fewer and all the announcers knew each other. Mr. Tyson has been six years with the same station, which is remarkable. Before Radio was, he went to the Pennsylvania State College and finished his education traveling with the A. E. F. in France and Belgium. He served with the Pennsylvania National Guards (103d Trench Mortar Battery). After the war he was content to travel via the ether and return every night. He has a quiet, unaffected way of announcing which never grows tiresome.



UKULELE Larry, Popular Songster with Ukulele, WHB.
Uncle Wip, WIP.
Underwood, C. P., Studio Director and Chief Announcer, KHQ.
Underwood, Daisy Maude, Soprano, KVOO.
Underwood, Loyal, Feature Announcer, KNX.
University of Minnesota Band, Michael Jabna, Conductor, WCCO.
Upton, Monroe, Announcer, Continuity Writer, Simpleton Fittz, KFRC.
Utica Jubilee Singers, National Broadcasting Company.

VAGABOND Male Quartet, Harold Singleton, Baritone, Leader; Albert Newcomb, 1st Tenor; Philip Reep, 2nd Tenor; Benjamin Weaver, Bass; WHAM.
Vannatta, Mrs. L. L., Iowa Farm Housewife, KMA.
Vance, Margaret, Pianist, WSM.
Vandersloot, John, Bass, Announcer, WFI.
Vannini, Augusto, Director of La Touraine Coffee Concert Orchestra, WEEL.
Van Praag, Henry, Cellist, Columbia Broadcasting System Symphony Orchestra.
Van Praag, Maurice, Manager, Columbia Broadcasting System Symphony Orchestra.
Van Vaulkenburg, Lucie, Violinist, WSM.
Varnum, Girard, Safety Council Program, KMOX.
Vaughan, G. Kieffer, Tenor, WOAN.
Vaughan, James D., Owner, WOAN.
Vaughan Trio, L. E. Gilbert, 1st Tenor; Elland Scarbrough; 2nd Tenor; Z. H. Lester, Baritone, WOAN.
Vaughn, Kate Brew, Economics Department; KNX.
Vaughn Radio Quartet, Hilman Barbard, Tenor; Otis L. McCoy, Tenor; W. B. Walbert, Baritone; A. M. Pace, Bass; WOAN.
Ventre, G. W., Leader of Weymouth Post No. 79 American Legion Band, WEEL.
Vierk, Evelyn, Soprano, WHT.
Vienna Concert Orchestra, KNX.
Vincent, Margaret, Director of Women's Activities, KGW.
Vita and Zita, Harmony Sisters, WFAA.
Voorhees, Don, Conductor, Columbia Broadcasting System Dance Band.
Voris, Mrs. Clifton, Contralto, KVOO.
Voss Vagabonds, Herb Heuer, Director, WOC.
Vouville, Harold, Pianist, WSM.

WADE, Mrs. William, Soprano, WSM.
Waggoner, Aleda, Soprano, WSM.
Wagoner Hawaiian Trio, WBAP.
Waldner, Fred, Tenor, WDAF.
Waldorf-Astoria Dinner Music, National Broadcasting Company.
Wahlstedt, John, Tenor, WDAF.
Wales, William S., Announcer, WVAE.
Wallace, E. P., Assistant Announcer, WWJ.
Wallace, Eddie, Sunshine, Tenor, WMBB-WOIK.
Waller, Judith, Director of WQJ, WMAQ.
Walter, Elsie, Pianist, WHAM.
Walter, Julius, Jazz Pianist and Orchestra Manager, KGW.
Walter, Mrs. Clyde, Pianist, Program Director, WLAC.
Walther, Oscar, 2nd Violinist, Columbia Broadcasting System Symphony Orchestra.
Walton, Hugh, Tenor, Announcer, KGW.
Wanbe, Sam, Pianist, WMAK.
Ward, Cecil and Esther, Hawaiian Guitars, WLS.
Ward, Mande, Librarian, KFRC.
Warner, Ann, Domestic Economist, KPO.
Warner, Don, Popular Musical Director, KFWE.
Warner, Ted, Cellist, KVOO.
Warner Trio, KVOO.
Warren, F. H., Announcer, WHAM.
Warrington, John, Saxophonist, WPG.
Wasmer, Louis, Manager, KHQ.
Wasmer, Mrs. Louis, Program Director, KHQ.
Wathall, Alfred G., Composer, Arranger, Conductor, WGN.
Watt, Charlee, Southern Crooner (Miss) KYW.
Way, James, Ace Tenor, WYG.
Weaver, Frederick D., Organist, WBAL.
Webb, Paul, Baritone, WSM.
Webb, M., Organist, KOLL.
Webber, Blanche, Hostess, WOW.



UNCLE JOE FAASSEN of KSO, Clarinda, Iowa, is the announcer with smiling voice who won second place in the last Radio Digest gold cup contest. He lives the station slogan, "Keep serving others."

Weber, Julian P., Announcer, Operator, WSUN.
Webster, J. Oscar, Tenor, WEAP.
Weddin Brothers, Guitars, KVOO.
Weems, Ted, and his Band, KTHS.
Weiss, Adolph, Bassoon, Columbia Broadcasting System Symphony Orchestra.
Weiner, Michael, Violinist, WBAL.
Wellington, Arthur, Classical Announcer, WENR-WBCN.
Welsh, Fred, Tenor, KVOO.
Wenige, Arthur, Pianist, WUNC.
Wentworth, Ralph, Announcer. Studied music at Sorbonne and the Conservatory of Music in Paris after seeing action in France. When he returned to the United States he appeared in concerts and traveled with a well-known musical comedy. National Broadcasting Company.
Wesson, Marguerite, Soprano, WFAA.
West, Fred, Hawaiian Music, WHB.
West, Grace, Blues Singer, WFAA.
West, Wm. H., Chief Engineer, KMOX.
Westphal, Frank, Director of Studio Orchestra, WENR-WBCN.
Wetzel, Maurice, Chief Announcer of KYW. Mr. Wetzel is one of the pioneers in the Radio field. For two or three years he directed WOOD, Grand Rapids, and was known for his continuity programs. He used to take down his programs on dictaphone rolls and it is said he has a canned program for almost every occasion. Recently he has been in Chicago announcing at WCFL, but since the first of the year moved over to KYW.
WGES Little Symphony, WGES.
WHAM Studio Mixed Quartet, Lucille Brightman Davis, Soprano; Rae Potter Roberts, Contralto; Herbert Senior, Tenor; George Frank, Baritone; WHAM.
Wheatley, Walter, Tenor, Director of Opera Hour, KFAB.
Whitcomb, Lewis S., Assistant Superintendent, WEEL.
Whitt, Jim, Post of the Rockies, KMA.
White and MacDonough, Banjoists, WCCO.
White, Jimmie and **Howard Fordham**, Singing Sereaders, KEF.
White, Josephine Storey, Contralto, KVOO.
White, Major J. Andrew, President, Columbia Broadcasting System.
White, Onalese, Contralto, KYW.
Whitney, Robert, Leader of Whitney Trio, WMAQ.
Wienand, C. Marcus, Dramatic Director, Publicity, KOMO.
Wiener, Jean, Organist, WPG.
Wightman, Florence, Harpist, Roxy's Gang, National Broadcasting Company.
Wilbourn, John, Tenor, Announcer, WBAL.
Wilfabrt's Concertina Orchestra, Old Time Dance Music, WCCO.
Willett, Gertrude, Hostess, WMAK.
Williams, (Chuck, Dan Bannister), Harmony Team, KVOO.



Williams, Frank, Old Time Fiddler, WOC.
Williams, Jess, Popular Pianist, Entertainer, KFAB.
Williams, Mary, Blues and Ballad Singer, WGES.
Wilson, R. Meredith, Flutist and Piccolo soloist, Columbia Broadcasting Symphony Orchestra.
Wilson, Dr. Walter L., Morning Bible Lesson, WDAF.
Wilson, Ethel, Pianist.
Wilson, Grace, Contralto, WLS.
Wilson, Jimmie, and his Catfish String Band, KVOO.
Wilson, Lillian, English Soprano, KNX.
Wilson, Thelma, Accompanist, WCCO.
Wilson, Walter, Uncle Bob, KYW.
Wing, Henry C., Program Director, Announcer, WCSH.
Winters, Rudolph, Character Impersonator, Baritone, KYW.
Wise, Frank, Reader, KOIN.
Wise, Olive, Popular Pianist, WEAP.
Wishnow, Emmanuel, Violinist, KFAB.
Wisniewska, Soprano, KNX.
Witte, Parvin, Tenor, KFAB.
Witten, Louis A., Senior WOR Announcer, Columbia Broadcasting System.
Wittich, Doris, Pianist, Program Director, WHT.
Wittich, Wolfgang, Tenor, WHT.
WJR String Quartet, Eric Von Myhr, Director, WJR.
WLS Hired Men, Male Harmony Trio, WLS.
WLS Players, John Brown, Pianist; Theodor DuMoulin, Cellist; Herman Felber Jr., Violinist, WLS.
WMAK Male Quartet, WMAK.
Woenpner, Heiney, Orchestra Leader, WCCO.
Wolf, Irene, Soprano, WMAK.
Wolfe, Rosalie, Soprano, National Broadcasting Company.
Wonnack, Lucille, Popular Songs, KVOO.
Wood, Elsie Miller, Pianist, WSM.
Wood, George, Announcer, News Director, KOIL.
Woolwine, Sam, WSM.
Worthians, Dance Orchestra, WBMP.
Wrigley, Frank, Organist, WWJ.
Wright, Harold, Jazz Genius, WGN.
Wylie, Allister, Orchestra Leader of Pal Jido, KMOX.
Wylie, Mary E., Conductor of the Musical Appreciation Period, KTHS.
Wyllie Walcott, Associate Announcer, WFLA.

YAGEL, Merle, "Big Boy," WSBC.
Yates, Fred L., Tenor, KVOO.
Yoder, Lloyd E., Press Representative and Special Announcer, Pacific Coast Network, National Broadcasting Company.
Young, Floyd, Solist, KMA.
Younge, Ruth, Novelty Pianist, WHB.



GARO RAY (above), formerly of Robert College, Constantinople, Turkey, is now chief announcer and member of the engineering staff of WRST, Bay Shore, N. Y. He talks cold Turkey when necessary.



WINNER of the famous Lazer S. Samoiloff scholarship, Miss Miyoshi Sugimachi of Seattle will begin her studies for an operatic career at Milan. She first won recognition over KFOA, Seattle, and later over KGW, Portland, Ore. She was "discovered" by Jacques Jou-Jerville of the Boston opera company. Miss Sugimachi was given a trial in *Madame Butterfly* and her success in the leading role led to her achieving the Samoiloff scholarship. Her histrionic ability matches her voice, say critics.

Opera Popularized in Air Programs

Various Forms of the Ultra Classic Now Accepted by Many Listeners With New Appreciation

OPERA. The name opera comes from the Italian and indicates generally, a musical work. The art form of opera or "Music-drama" is of ancient origin, having reached a stage of great perfection under the Greeks, but it probably had an even earlier origin.

Opera has several distinct developments, grand opera; simple opera (in which everything is sung), and opera comique (a comic opera with spoken dialogue). An operetta, a light form of opera is generally of short duration with the song and dialogue alternated.

For a while opera was one of the early attractions of Radio broadcasting. Then it was withdrawn by the producers. But now we are not only hearing the old established opera companies but many of the leading broadcasting companies have organized their own opera groups. All of the forms of opera indicated above have been produced for the listener in his home and the community center where loud speakers bring the programs of the air. Following are short sketches of some of the better known productions heard by Radio audiences.

AFRICANA (The African). Opera in five acts. Music by Meyerbeer; text by Scribe. Produced in Paris, 1865; London, 1865; New York, 1865. Story: Vasco di Gama, an explorer, is betrothed to Inez, daughter of the King of Portugal. The king wishes his daughter to marry Don Pedro and later to gain his end, the king orders Vasco to prison. To save Vasco, Inez marries Don Pedro and they sail away to find a new land. Vasco follows, but through the treachery of Nelusko, his ship is wrecked and most of the crew massacred by Selika's people, the Queen of India. Selika, however, saves Vasco's life and they are to wed when Vasco hears the voice of Inez. Selika then generously allows the lovers to escape regardless of her own sentiments, then kills herself by inhaling the fumes of the blossoms of the poisonous Mancanillo tree.

AIDA. Opera in four acts and seven scenes. Music by Verdi; text by Ghislanzoni. First produced in Cairo, Egypt, 1871; Paris, 1876; London, 1876; New York, 1873.

Story: Aida, daughter of the King Amonasro of Ethiopia is being held captive by the Egyptians at Memphis. She and Radames, a young Egyptian soldier, are in love with each other. Radames departs to lead the Egyptian army against the Ethiopians, and Amneris, daughter of the King of Egypt, who is in love with Radames, learning of the attachments of the young lovers, becomes furious.

The victorious Radames returns in a blaze of glory, with many Ethiopian prisoners, including Aida's father, Amonasro, who is released by the king at the request of the young captain. As a reward for his victory, the king offers Amneris, his daughter, in marriage to Radames.

In the next, the Nile scene, Aida is forced by her father to persuade Radames to turn traitor. Because of his love for Aida, and his unwillingness to go through with the marriage with Amneris, Radames agrees to the plot, but is overheard by Amneris. When the young soldier, true to his love, refuses to forsake Aida, he is denounced as a traitor by Amneris, and condemned to be buried alive in a vault. When he is entombed, he finds concealed there, Aida, who has come to die with him. Here they die in each others arms, while above them the penitent Princess kneels in prayer.

ANDREA CHENIER. Opera in four parts. Music by Umberto Giordano; libretto by Luigi Illica. Presented in Milan, 1896.

Story: Gerard, a servant and revolutionist, is secretly in love with Madeline, who loves Andrea Chenier. Through a letter Madeline and Andrea Chenier arrange a meeting. Gerard interposes just as they are about to flee; Chenier and Gerard duel with swords and Gerard is

wounded. The lovers flee but are captured later. Gerard, knowing that Chenier has been captured, writes an indictment against him, despite the pleadings of Madeline. Later Gerard declares that he will save his rival, as Madeline has promised herself to him (Gerard). Gerard then tells the crowd that the charges against Chenier are false, but the mob demands the poet's death. Madeline enters Chenier's cell in the prison of Lazare with Gerard. She has bribed the jailer to allow her to substitute herself for another woman prisoner so that she may die with her lover, Chenier. Together she and Chenier go to the scaffold and to immortality as true lovers.

BARBIERE DI SIVIGLIA (The Barber of Seville). Comic opera in two acts. Music by Rossini; text by Sterbini. First presented in Rome in 1816.

Story: Count Almaviva loves Rosina, the ward of Dr. Bartolo, an old bachelor, who secretly wishes to marry her himself. Almaviva persuades the village barber, Figari, to arrange a meeting for him, and gains entrance to the house disguised as a dragon, but is arrested by the guardian. Not discouraged, he returns, pretending to be a substitute for Rosina's music teacher, who, he says, is ill. The appearance of the real music teacher, Don Basilio, spoils this plan, and the count retreats for the second time, having, however, arranged a plan for elopement. Bartolo finally arouses Rosina's jealousy by pretending that the count loves another, and she promises to forget him and marry her guardian. When the time for the elopement arrives she meets the count, intending to reproach him, but he convinces her of the base plot of Bartolo, and the lovers are wedded by a notary, just as Bartolo arrives with the officers to arrest the count. The opera, by many, is considered Rosini's masterpiece.

THE BARTERED BRIDE. Comic opera in three acts. Music by Friedrich Smetana; text by Sabina. First performed in Prague, May 30, 1866.

Story: Hans, a servant in the household of Kruschina, has won the love of that rich peasant's daughter, Marie, who is planned, at the instance of a marriage broker, Kezal, to be married by her father to the rich but half-witted Wenzel. Wenzel is the son of Kruschina's friend, Micha. Kezal, the marriage broker, offers Hans 300 crowns to renounce Marie. He agrees if the contract shall contain the words "Marie shall marry only a son of Micha." Marie refuses to believe that Hans has sold his love, but upon meeting him, she seems quite joyous over the affair. Micha and his wife arrive in time to recognize in Hans their long-lost eldest son. The contract remains valid and the marriage broker is out 300 crowns.

LA BOHEME. An opera in four acts. Music by Giacomo Puccini; text by Giuseppe Giacosa and Luigi Illica.

Story: Deals with the life and love in the students' quarters in 1830. The happiness, joys and sorrows of the four inseparable companions, Rudolph, the poet; Marcel, the painter; Colline, the philosopher and Schauand, the musician, are all vividly shown. They live together in a small garret of the quartier Latin, in a happy-go-lucky and carefree manner that is typical of Bohemians. Rudolph makes the acquaintance of Mimi, a little flower girl; Marcel meets the gay Musetta, who plays at love with him. Alternate quarrels and reconciliations fill the lives of these lovers. But the final separation comes with the sad death of Mimi, at the close of the opera.

THE BOHEMIAN GIRL. A romantic light opera in three acts. Music by Michael William Balfe. First produced at Drury Lane London, 1843.

Story: Arline, the daughter of the Count Arnheim, has been kidnapped by the great gypsy chief, Devilshoof, and is forced to live with them.

Arline, however, falls deeply in love with Thaddeus, who is a young nobleman that has been banished from his own country, and who has joined the gypsy band. Arline has angered the gypsy queen and during a moment of rage, the queen accuses Arline of stealing. Arline is then taken before Count Arnheim who discovers

that she is his daughter by a scar on her arm. Arline is restored to her home and position, but, however, continues meeting her lover, Thaddeus, secretly. In a short time Arnheim is informed of the secret courtship by the jealous gypsy queen. At first Count Arnheim is furious, but the pleadings of his daughter and the knowledge that Thaddeus is of noble birth, causes him to give them his blessing.

CARMEN. Opera in four acts. Music by Bizet. Founded on Merimee's novel. Text by Meilhac and Haevy. The story of Carmen is tragic. Don Jose, a brigadier, is betrothed to the peasant girl, Micaela. He is instructed to arrest Carmen, a reckless and beautiful girl who works in a cigarette factory nearby. She had stabbed a fellow worker. In fulfilling his duty, Jose is fascinated by the alluring Carmen, and allows her to escape. For this he is thrown into jail. He later follows her to the Pastia Inn, where he finds her accepting the attentions of Escamillo, a torreador, and Zuniga, his captain.

Unable to forget Carmen, Jose joins the band with the hopes of winning her, but Carmen soon tires of his attentions and repulses him in favor of Escamillo, the torreador. In a fit of anger, Jose attempts to kill Carmen, but is intercepted by the arrival of his former sweetheart, Micaela, who has a summons from his dying mother. He goes but swears vengeance.

In the last scene Carmen is waiting outside the bull ring for the triumphant Escamillo. She is found there by Jose, who, in a fit of crazed jealousy, kills her.

CAVALLERIA RUSTICANA. An opera in one act. Music by Mascagni. Plot adopted from Verga's short story. First shown in Rome, 1890. The scene is in a Sicilian village square.

Story: Turiddu, is in love with Lola, but returning from the army finds her married to Alfio, the carter. Turiddu then turns to the beautiful peasant girl, Santuzza, to whom he makes ardent love. He soon tires of her, however, and returns to Lola, who accepts his attentions.

Santuzza, in despair, appeals to Turiddu's mother, Lucia, who attempts to help her. Santuzza is scorned, however, and goes to Alfio revealing to him the faithlessness of his wife.

Alfio then challenges Turiddu to a duel. Turiddu bids his mother farewell, asking her to take care of Santuzza, whom he regrets having wronged. The duelists go to the field, and soon peasants rush upon the stage, telling of the death of Turiddu.

CHIMES OF NORMANDY. A comic opera in three acts. Music by Robert Planquette; text by Clairville and Gabet. First produced in Paris, 1877.

Story: Henri, Marquis de Valleroy, is romantic and adventurous. During his absence from home strange things happen. Gaspard, the warden of the estate, has turned miser, and has planned that Germaine, his supposed niece, shall wed the sheriff and ward off detection. Germaine, however, loves Grenieueux, whom she thinks saved her from drowning. Grenieueux seeks her hand, also the supposed wealth she will inherit from her miser uncle. He jilts Serpolette, a girl of unknown parentage, found as a baby in the fields by Gaspard. Villagers, at a fair, try to tease Serpolette, but fail. She claims she is a nobleman's daughter and cares nothing for Grenieueux.

Henri returns in Mexican costume, and is not recognized. It is believed that Corneville castle is "haunted" for chimes ring out mysteriously. Henri decides to investigate. Germaine and Serpolette, with Grenieueux, enter his service, and he reveals his rank. They discover, after blood curdling experiences, that Gaspard is using the castle as a treasure house and ringing the chimes to keep away the curious minded. Gaspard finally reveals that Germaine is the true Marchioness. Henri and Germaine marry, and Grenieueux and Serpolette. The chimes ring out for a double wedding.

CLEOPATRA. Opera in four acts. Music by Jules Massenet; text by Louis Payen. First produced at Monte Carlo, 1914.

Story: Marc Antony, encamped in Asia Minor, receives pledges of fidelity from his de-

feated enemies. Spakos, an Egyptian freedman, arrives to announce Cleopatra. Marc Antony is not pleased, but the queen's beauty impresses him and he falls in love. Despite orders recalling him to Rome, he decides for Egypt with her. They enter the royal barge, to the chagrin of Spakos, himself in love with the queen.

Antony wearies of his prize and returns to Rome to wed his former betrothed, Octavia. An officer from Egypt arrives at the wedding festivities in the second act, with the intelligence that Cleopatra has consoled herself with Spakos. Antony becomes jealous, leaves his bride and hurries back to Egypt.

In the midst of a riotous scene in Alexandria, Charinian arrives to tell the queen of Marc Antony's arrival. Spakos tries to detain her but she has him arrested and hastens back to the palace to welcome her lover. At a fete in the queen's garden Octavia, Antony's wife, arrives and begs him to return to Rome. He refuses and she returns alone. While he is warring in Egypt Spakos brings word of his death, whereupon Cleopatra, enraged, stabs him.

Antony returns, vanquished, and dies in the queen's arms. She then, overwhelmed by grief, applies a poisonous asp to her breast and dies.

DON CARLOS. Opera in four acts. Music by Verdi; text by Mery and Du Locle. First produced in Paris, 1867.

Story: Don Carlos, son of Philip II, King of Spain, is in love with Elizabeth de Valois, daughter of Henry II of France. Their love is mutual, but for reasons of state, Elizabeth is married, not to Don Carlos, but to Philip II and the young prince therefore finds himself in love with his own stepmother. He confides in Rodrigo, Marquis de Posa, who entreats him to leave the Spanish court.

Don Carlos has a dangerous admirer in Princess Eholi, who learns that the queen has by no means ceased to love Don Carlos, though married to his father. Moved by jealousy she informs the King of the conditions of affairs, whereupon he orders his son Don Carlos thrown into prison. While his friend Rodrigo visits him there he is shot by the king's friends.

Don Carlos is freed and goes to the monastery of St. Just to keep tryst with the queen. The king surprises them there, and his anger once more aroused he hands over Don Carlos to the officers of the Inquisition, who bear him away to death as the curtain falls.

FAUST. Opera in five acts. Music by Gounod; text founded upon Goethe's tragedy. First produced in Paris, 1859.

Story: Faust, a German philosopher, after a life of meditation, becomes disgusted with the smallness of human knowledge and his own inability to unravel the mysteries of nature. He summons to his aid the Spirit of Evil, who appears to him under the form of Mephistopheles. Through the supernatural power of Mephistopheles, Faust is restored to youth and endowed with personal beauty and luxurious garb.

Mephistopheles, in a vision, reveals to him the village maid, Margaret, with whom the Faust falls in love. Margaret, noted for her loveliness, has been left by her soldier brother, Valentine, under the care of dame Martha, a worthy but not very vigilant personage. The maiden at first rejects the stranger's advances, but Faust, aided by the influence of Mephistopheles, urges his suit, and Margaret's resistance is at length overcome.

Later, Valentine, Margaret's brother, who has learned of her betrayal, is killed in a duel with Faust. Overcome by the calamity of which she is the cause, Margaret's reason becomes affected and in a frenzy she kills her infant. She is thrown into prison, and Faust, aided by Mephistopheles, obtains access to the cell in which she is confined. They both eagerly urge her to escape, but Margaret, in whom holier feelings have obtained ascendancy, spurns their proffered aid, and expires. She is borne to heaven by ministering angels.

FRA DIAVOLO. Comic opera in three acts. Music by Daniel Auber; text by Scribe. First produced in Paris, 1830.

Story: Serafin and Lorenzo, her soldier lover, are too poor to marry. The girl's father, Matteo, has a rich suitor all ready, and plans the nuptials for the following day. There is a gay time at the inn. Lord Roeburg and his wife, Lady Pionda, arrive. They have been robbed, and Lorenzo and his men go after the bandits.

Another guest, the suave Marquis of San Marco (Fra Diavolo, the bandit), next comes in—to flirt with Lady Pamela, and to gain access to the noble Lord's money-belt. He is distressed when Lorenzo returns with the jewels and news of the slain robbers. The young man is given a reward which seems to make possible his marriage.

That night, the marquis and two followers, Beppo and Giacomo, conceal themselves in Zerlina's room to rob Roeburg in the night. Lorenzo arrives; discovered, the marquis makes both him and Roeburg believe that he has been conducting affairs with Zerlina and Lady Pamela. Both men challenge him. Next morning Zerlina discovers Beppo and Giacomo were in her room too. Lorenzo arrests them, and they are forced to betray their chief. He is led into a trap and is shot, whereupon it is found that Fra Diavolo and the marquis were one. All ends happily.

FORZA DEL DESTINO (Force of Destiny). (Fort-zah del des-tee-noh.) Opera in four acts by Verdi. First produced in Petrograd, 1862.

A brief summary of the story follows: Alvaro is in love with Leonora, and they are about to elope, when the latter's father, Marquis of Calatrava, enters. The Marquis and Alvaro engage in a conflict in which Alvaro accidentally kills the Marquis. Alvaro and Leonora then flee to an old abandoned hermitage. In the meantime Don Carlo, who is Leonora's brother, swears to avenge his father's death and through strange circumstance, he meets Alvaro and they become good friends. Later Don Carlo discovers his friend's identity and attacks him. In the fight which ensues Don Carlo is wounded. As the fight has taken place just outside Leonora's refuge, she rushes out only to receive the dagger from her brother before he dies. Alvaro's grief is so great that he suddenly becomes insane and leaps to death over a precipice.

JEWELS OF THE MADONNA. By Wolf-Ferrari. First produced in Berlin, 1911. The story is set in Naples.

Story: Maliella scorns the love of her foster brother, Gennaro, and is captivated by the bandit leader, Rafaele, during the celebration of the Madonna's feast day.

In his ardent pledge of love, Rafaele declares that for love of Maliella he will steal the jewels from the statue of the Madonna. She is overcome by his lovemaking and when Gennaro rebukes her for associating with the worst character in Naples she tells him of the Camorra chief's offer to steal the jewels.

Finally in despair Gennaro himself steals away and robs the statue of the valuable and beautiful jewels and lays them at the feet of the girl he loves. She decks herself out with the jewels and thinking only of Rafaele she is unaware that it is Gennaro who embraces her.

She flees to the bandit's lair where she is spurned by the chief. Gennaro follows, Maliella flees, leaving the jewels scattered around the floor. As the angry mob arrives in pursuit of Gennaro for stealing the jewels they find him dead at his own hand with the jewels laid at the foot of the statue where he has prayed for pardon.

LOHENGRIN. Romantic drama in three acts; words and music by Richard Wagner. First produced Weimar, August, 1850, under the direction of Liszt.

Many of Wagner's most beautiful melodies come in the story of the son of Parsifal. Lohengrin, a Knight of the Holy Graal, who is sent to earth to protect Elsa, wickedly accused of the murder of her young brother by Tetramund and his wife, Ortrud. Lohengrin overcomes Tetramund and wins Elsa as his bride. Upon her he lays the well known *verboten* that she shall ask no questions concerning his past. The unfortunate girl, under the influence of the powerful Ortrud, is filled with curiosity, and at last asks Lohengrin the fatal question. He satisfies her curiosity, but is compelled to return at once to Mont Salvat and disappears in the distance in his swan-drawn boat. The motifs in this opera are infinitely beautiful throughout.

LUCIA DI LAMMERMOOR (Loo-chee-ah). (Donizetti.) Opera in three acts. Text by Camerano. Music by Gaetano Donizetti. First produced in Naples in 1835.

The plot of the story was taken from Sir Walter Scott's novel, "The Bride of Lammermoor." A brief sketch of the story follows:

Lucia has been deeply in love with Edgar of Ravenswood, but her brother, Lord Henry Ashton, who was quite unaware of the love affair between them, has secretly arranged for her marriage to Lord Arthur Bucklaw, a wealthy nobleman. Ashton wishes this marriage as it would aid him in a financial way. Later, he learns of his sister's love for Edgar and in an underhand manner convinces Lucia that Edgar is not true to her. Due to the intense pleadings of her brother she finally, very much against her will, says that she will marry Lord Arthur. Then the wedding scene at which the famous sextette is sung. It is at this time the heart-broken Edgar arrives to denounce Lucia for her unfaithfulness. He is evicted from the castle

and Lucia, whose mind has become deranged, suddenly kills her husband and then dies. Edgar's sorrow is more than he can bear, so he stabs himself while in the churchyard at Ravenswood.

MANON LESCAUT (Man-on Les-koh). (Puccini.) Sung in Italian. Opera in four acts, the libretto, founded on Abbe Prevost's novel, being mainly the work of the composer. The Abbe Prevost romance has been treated operatically by several composers.

Manon's brother, Lescaut, is escorting his sister to the convent where she is to complete her education. While Lescaut is carousing with companions, Manon meets des Grieux, who chances to be dining at the inn, dressed as a student. School not appealing to the girl, she agrees to elope, thereby spoiling the plans of Geronte, who had planned to abduct her. Manon tires of des Grieux and his poverty, and leaves him for Geronte; but when des Grieux appears again she runs away with him. Geronte denounces Manon as an abandoned woman. She is condemned to be deported to Louisiana. Des Grieux and Lescaut try to rescue her, but the attempt fails and the former begs the commandant to permit him to accompany her. In the final scene the lovers are shown in a "desert" near New Orleans. Des Grieux leaves Manon to search for water, and returns just in time to see her die in his arms.

MARTHA (Flotow). Opera in four acts by Friedrich Von Flotow. Libretto by Wilhelm Friedrich Reese and St. George. First produced in Vienna, 1847.

The story: Lady Harriet, maid of honor to Queen Anne, has tired of the dullness of court life so she and her maid, Nancy, slip away, disguised as servants, to the fair at Richmond. Here, according to the old custom, they are bargained for by the two farmers, Lionel and Plunkett, and are taken away to a farm. They escape, however, in the morning and return to court. Life to Nancy and Lady Harriet is even duller than before, for in their adventure, Dan Cupid short four arrows true to the mark. Plunkett possesses a ring, which Lionel presents to the Queen and is restored to court as the son of the Earl of Denby. Plunkett and Nancy are reunited and they plot to bring Lady Harriet and Lionel together, whom they know love each other. At a re-enactment of the Richmond fair, Lionel hears a sweet voice singing "Last Rose of Summer." He recognizes the owner as Lady Harriet, whom he knows as Martha, and sweeps her into his arms.

MIGNON (Meen-yon). (Paris, 1866.) (Ambroise Thomas.) Opera in three acts; text by Barbier and Carre, based upon Goethe's "Wilhelm Meister;" music by Ambroise Thomas. First production, Paris, 1866; London, 1870; New York, 1872.

The first act opens in the yard of a German inn. A group of actors, including the beautiful Filina, are on their way to the Prince's castle, where they are to give a performance. A strolling band of gypsies arrives, and Mignon, who is with them, is ordered to dance for the entertainment of the guests. The girl is weary, and on her refusal to dance, Giarno, the leader, threatens her. Lothario tries to protect the young girl, and Giarno turns upon the old man.

Wilhelm, a wandering student, appears and rescues both Mignon and the harper, and to save the girl from further persecution engages her as his page. Wilhelm is invited by Filina to join the troupe in their visit to the castle. He consents, and the flirtation which follows arouses the jealousy of Mignon, who, touched by Wilhelm's kindness, has fallen in love with him. In despair she is about to throw herself into the lake when she hears the notes of Lothario's harp. She asks his protection, and rashly tells him she wishes the castle would burn to the ground. The demented old man, thinking only to please her, goes into the castle. Filina and the actors appear, and Filina sends Mignon to the castle for some flowers she has left there. Suddenly flames burst from the windows, and Wilhelm rushes to the burning building and carries out the unconscious Mignon. Wilhelm is soon cured of his infatuation for Filina and discovers Mignon's devoted attachment for him.

The third act takes place in the palace of Lothario, who has instinctively returned to his ancestral home, bringing with him Mignon. They are accompanied by Wilhelm, who now realizes that he loves his youthful ward. The young girl is soon discovered to be the long lost child of Lothario, who suddenly recovers his reason. Father and daughter are reunited, while a blessing is bestowed on the young people by the happy Lothario.

ORFEO ED EURIDICE (Or-feh-oh ayd Ay-co-ree-dee-cheh). (Orpheus and Eurydice.) (Vienna, October 5, 1762.) (Gluck.)

Book by Ramieri De Calzabigi; music by Christoph Willibald von Gluck. First production in Vienna, October 5, 1762, Gluck conducting. First Paris production, 1774, when the role of Orpheus was transposed for high tenor. First London production at Covent Garden, June 26, 1770. Other revivals were during the Winter Garden season of 1863; in 1885 (in German), by the Metropolitan Opera under Walter Damrosch; the English production in 1886 by the National Opera company; the Abbey revival in Italian in 1892; and the Metropolitan production of 1910, with Homer, Gadsli and Gluck.

The opera has had only one adequate American production previous to this Metropolitan revival, and that was during the American Opera company season of 1886—the Abbey revival of 1892 meeting with but indifferent success.

This opera, which has been called "Gluck's incomparable masterpiece," and of which the great Fetis wrote, "it is one of the most beautiful productions of genius," may be properly termed a purely classical music drama. The music is exquisite in its delicacy and grace, while the story is an interesting and affecting one. "Orpheus" may be called the grandfather of grand opera, it being the oldest work of its kind to hold its place on the stage, the first representation occurring over one hundred and fifty years ago.

The story concerns the Greek poet, Orpheus, who grieves deeply over the death of his wife, Euridice, and finally declares he will enter the realms of Pluto and search for her among the spirits of the departed. The goddess Love appears and promises to aid him, on condition that when he has found Euridice he will return to earth without once looking at her.

PAGLIACCI (The Players). (Pahl-yat-chee.) Dramatic opera in two acts by Ruggiero Leoncavallo. First produced in Milan, 1892.

It opens with the world-famous "Prologue" in which Tonio, the clown of the strolling players, parts the curtains and explains that the play is taken from real life; reminds the audience that actors are but men with passions and emotions like our own, and that the author has tried to express the real feelings and sentiments of the characters. The "Prologue" ends when Tonio orders up the curtain.

The first act shows Canio and his band of players returning from parading the village. He announces that the performance will begin at seven that evening and takes leave with Peppe (the Harlequin). Tonio remains behind and makes love to Canio's wife, Nedda, but she scorns him, striking him with her whip for which humiliation he swears to be revenged.

Silvio, a rich young villager, is also in love with Nedda, and begs her to flee with him. She refuses but vows that she loves him. This is all overheard by the spurned Tonio, who immediately tells Canio. Canio comes to kill Nedda's lover but arrives too late. He demands, however, that she tell him the name of her lover. She refuses. They then prepare for the evening performance.

In Act II the audience is assembled and the play begins. A situation is then presented which is very akin to the drama of actual life which we have just recounted. PUNCHINELLO (Canio) arrives and surprises the lovers (as the playlet demands), then he loses his head when he hears Columbine (Nedda) repeat the very words he heard her say to her lover. Columbine (Nedda) tries to save the situation by continuing the play. The audience is delighted with such "realistic acting." He again demands the lover's name until Nedda, stung by his taunts, defies him (Canio) and is stabbed by him. She falls, calling for Silvio, who rushes to the stage from the crowd, only to receive in turn the dagger of the enraged husband.

As Canio stands stupefied he drops the dagger and cries, "The comedy is ended."

PEARL FISHERS—Pescatori di Perle (Paris, 1863). (Bizet.) (All sung in Italian unless otherwise noted.)

This beautiful opera tells of the love of two Cingalese pearl fishers for Leila, a priestess, and of the generosity of the unsuccessful one, who helps his rival and his love escape at the cost of his own life. Nadir appears to Zurga, a lifelong friend, during a dance of the pearl fishermen. A mysterious veiled lady, who comes once a year to pray for the fisheries, appears and begins her invocation. Despite her veil, she is recognized by Nadir and contrives to let him know that his love is returned. She is reminded later, at

a temple, of her vow to renounce love and marriage. The high priest, who reminds her that the penalty is death, then leaves her alone, and Nadir enters. The lovers are surprised by Nourabad, the high priest, and Nadir flees. He is recaptured, and Zurga is brought to pronounce sentence upon the pair. Their funeral pyre is ready when Zurga cries that the camp is on fire; the lovers escape in the melee; Zurga later confesses and is burned to death.

MIKADO (Gilbert and Sullivan). Light Opera in two acts. Text by Gilbert. Music by Sullivan. First produced in London, 1885.

The scene is laid in Japan. Nankipoo, the son of the Japanese Mikado, flees from an undesirable marriage with Katisha. He falls in love with Yum-Yum, the ward of Ko-Ko, who secretly wishes to marry her himself. Because of his ill-luck in this affair Nankipoo starts to kill himself but is intercepted by Ko-Ko's executioners. Later Nankipoo is the hero of a fake execution but is recognized by his father and Ko-Ko is caught in his deception. The deceiving Ko-Ko is then forced to marry Katisha, and Nankipoo gets the girl of his heart.

RIGOLETTO (Ree-goh-let-toh). An opera in three acts by the great Italian composer, Verdi. First presented in Venice, 1851.

The story tells of the young profligate, the Duke of Mantua, who loves every girl whom he meets. He is aided in his conquests by the deformed jester, Rigoletto. Count Monterone, father of one of the Duke's victims, meets Rigoletto and hurls an awful father's curse upon him, which affects him (Rigoletto) because of his own daughter, Gilda. On his way home Rigoletto meets the assassin, Sparafucile, who offers to kill any enemy he may have. Rigoletto sends him on his way but tells him that he may use him later.

Later, Gilda (Rigoletto's daughter) falls in love with the Duke and is abducted to his palace, with the aid of Rigoletto, who is unaware that it is his daughter.

When Rigoletto learns of what he has done and that he is too late to save his daughter, he swears vengeance and arranges to have Sparafucile murder his master.

Sparafucile has his attractive sister Maddalena lure the Duke to an old tavern. Maddalena, however, falls in love with the Duke and induces her father to murder a substitute. Gilda, who has been taken to the Inn by her father to witness the Duke's "fickleness," overhears the plot and determines to save the Duke at a sacrifice of her own life.

SAMSON ET DALILAH (Sam-sohn-ay-Dah-lee-lah). A biblical opera in three acts. By Saint-Saens. First produced in Weimar in 1877.

Samson is the self-appointed leader of the Hebrews, and after a great battle returns a triumphant victor. His great power had won for him the Hebrews. Dalilah, a beautiful woman, came with flowers to pay homage to the warrior and Samson, unwillingly (because he had been warned of her) fell madly in love with Dalilah.

Later, in her own home, Dalilah uses all her charms to induce Samson to reveal the plans of the Hebrews and when he refuses, she calls for the Philistines, who overpower and capture him. They chain him to a heavy mill which is grinding corn for the Philistines and torture him.

Samson is taken before the High Priests, who are celebrating their victory at a banquet in the temple and is made sport of. He prays to God for strength, is answered and pulls the pillars from beneath the roof. The Temple crashes down amid shrieks and groans.

TANNHAUSER (Tabn-hoy-zer) (Wagner). One of Richard Wagner's most notable music dramas. In three acts. Words also by Wagner.

Tannhauser, a brave knight, has been under the evil wiles of Venus, living a life of passion and evil. He tires of such a sordid existence and returns to his home. He is joyously welcomed by Elizabeth, whose love for him is pure and holy.

There is to be a song tournament and the one who wins is to have the hand of Elizabeth as the prize. Tannhauser is urged to compete in the contest, which is to be on individual compositions on "The Nature of Love." Because of his recent experience with Venus, Tannhauser renders a song of such a disgusting passionate appeal that the Minstrels draw their swords to slay him. He is saved, however, by Elizabeth, who pleads for his life.

Tannhauser repents and realizes the greatness of the higher love. He joins a band of pilgrims and starts for Rome to ask forgiveness of the Pope.

Elizabeth has been watching and waiting for the return of Tannhauser, steadfast in her love,

but when she finds that he is not among the band of Pilgrims which has passed, she passes away.

Tannhauser appeals to the Pope for forgiveness but is told that it is impossible. He is heart-broken and intends to return to Venus-berg and Venus, but he meets his old friend, Wolfram, and tells him of his intentions. Then a band of Pilgrims is heard approaching. They come with the good news that the Pope's staff has blossomed and that Tannhauser was forgiven. Tannhauser kneels in prayer as the body of his beloved Elizabeth is carried by.

TOSCA, LA (Toss-kah) (Puccini). An opera in three acts based on Sardou's novel. Text by Illica and Giacosa. Music by Giacomo Puccini. First produced in Rome, 1900.

Mario Cavaradossi is in love with the beautiful Tosca. Scarpia, the head of the police, has maliciously imprisoned Mario when he is found to be hiding a friend, a state fugitive. In the absence of Mario, Scarpia makes ardent love to Tosca, and threatens to bring about the death of Mario unless she gives herself to him. Because of her great love for Mario she consents to this. Scarpia has told her there have been orders issued to the soldiers to use blank cartridges in their guns. He has, however, secretly instructed them that genuine bullets be used.

Mario has been told, in the meantime, by Tosca, who has stabbed Scarpia, of the plan and he is to feign death after the firing.

When the execution takes place, Mario falls to the ground and it is not until she calls for him to arise does Tosca discover the terrible tragedy. The body of Scarpia has been found and the officials enter to arrest Tosca, who throws herself from the Castle Wall—to death.

TRAVIATA. Opera in three acts; libretto by Piave, based upon Dumas' "Lady of the Camellias"; music by Verdi. First presented in Venice, 1853.

Verdi's opera "Traviata," and Sarah Bernhardt's playing of "Camille," are the two famous adaptations of Dumas' story. The story is simple, but appealing. Violetta is one of the beautiful and spoiled courtesans of Paris. Alfred, her lover, after a long suit has at last persuaded Violetta to give up her gay life and live with him in his humble apartment. Alfred's father, whose aims for his son are of another sort, comes to Violetta and persuades her to release his son from the marriage. Violetta unselfishly agrees, but being left alone seeks comfort in returning to her former gay life. Alfred, who has been made to believe Violetta untrue, goes to Paris and publicly insults her. The heroine gallantly remains by her promise to Alfred's father, and not until too late does the young man discover the truth. He seeks her again only to find her dying.

TROVATORE. Opera in four acts. Words by Cammanaro; music by Verdi. First produced in Rome, 1853.

Before the curtain rises on the first act, it is necessary to know that, many years before, the father of the present Count di Luna had burned the mother of Azucena, an old gypsy, who in revenge had stolen the young brother of the Count, and at the opening of the story had brought up Manrico as her own son, Manrico being quite unconscious of the plot of the gypsy. As a Troubadour he has gained the love of Leonora, also admired by the Count. In the first act Manrico and the Count meet in a duel, their paths having crossed on the way to Leonora. The Count's life is generously spared by Manrico. In the next act Manrico is seen in the gypsy camp under the care of Azucena, recovering from a wound. He hears that Leonora, whose affections are in his favor, believing him dead, is about to take the veil. Also he hears the Count intends to abduct her. He hastens to the Convent in time to rescue Leonora. One tragedy after another darkens the third act. Manrico learns that Azucena is in the power of the Count, condemned to be burned. Still believing her his mother, he flies to the rescue and is in turn captured by the Count. The gloom is even darker in the final act, where Leonora, to save Manrico, agrees to wed the Count, but on the signing of the order swallows poison. In realization the Count orders Manrico to instant death, and only learns, when too late, from Azucena that he has killed his own brother.

ZAZA (Tsah-sah.) Opera in four acts. Libretto and music by Ruggiero Leoncavallo. First produced in Milan in 1900.

Zaza, a concert singer loves Milio Dufresne but discovers that Dufresne is wedded to another. She tells him that she has discovered his deception and also that she has told his wife of their intimacy.

This is untrue, but Dufresne curses Zaza and kills her love for him.

Instruments in the Symphony

Now That You Have Heard Symphony Orchestras
Here Is Useful Information About Them

THE SYMPHONY: As applied to instrumental music, we find from the time of Peri (1600) that whenever the voices were silent for a time and the orchestra played fragments by itself, that these such portions were called "Symphonies." Thus came into vogue the "Symphonia" as we understand it, a work for Orchestra alone, in several movements (generally four), these movements or parts being a more or less stereotyped order of (a) quick, (b) slow, (c) lively, and (d) quick.—From E. M. Lee's "Story of Symphony."

Instruments of the Symphony

The String Instruments

THE VIOLIN. The violin, sometimes called the "Queen of the Orchestra," is essentially a melodic instrument, though it can be made very effective when several are employed together for the playing of sustained chords, properly divided among them.

THE VIOLA. The tone character of the Viola is sombre and withal, mysterious. It has great charm when used in the middle register, but is more or less at a disadvantage when employed as a solo instrument. It is frequently used to reinforce the 2nd Violins, especially in small orchestras, to obtain a proper balance of tone.

THE VIOLONCELLO. This instrument many times is used to carry the melody of the composition, along with the 1st Violins, and also for improving the tone-color or strength of the Violas. Possessing many different tone contrasts and qualities, having great carrying power, it makes a splendid solo-instrument.

THE CONTRA-BASS OR DOUBLE-BASS. The Double-Bass, so to speak, is the foundation or "base" of the orchestra. It is useless as a solo-instrument, since its long, heavy strings cannot be made to respond quickly to bowing. A poor bass section spoils an orchestra more than any other defect.

The Wood Wind Instruments

THE PICCOLO. Essentially a solo instrument, it is well adapted to illustrating the sounds of Nature, as whistling winds, et cetera. It can be used for bird-songs and as an interpreter of moods, as the martial spirit and jocularity. It is properly used only for these special effects in the symphony orchestra.

THE FLUTE. The lower notes of the Flute are grave and mellow, with a suggestion of the religious spirit; the middle register is soft and dreamy, while the upper one is brilliant but never shrill. The instrument bears some resemblance to the female voice and sometimes, as in "Lakme," is used to alternate with it. In the orchestra proper it is employed to reinforce the 1st Violins and for adding embellishments or imitations of a preceding phrase.

THE OBOE. This instrument has an expressive sadness and complaint, for its tone-color has a nasal quality. Its tonal quality is more penetrating than the Flute and Clarinet. It is the least affected by changes of temperature of all the wind instruments, and is, therefore, depended upon for sounding the "A," or pitch, to the orchestra.

THE ENGLISH HORN. This instrument has many of the tonal qualities peculiar to the Oboe, its lower register is very sonorous, yet has more power than the Oboe. It is very well adapted to express sad or painful feelings or dramatic situations.

THE CLARINET. The Clarinet is an excellent solo instrument, its three registers being quite unlike each other, the lower one (Cchalumeau) being able to interpret sad, dramatic or religious moods. The middle register reflects happy, joyous and tender emotions, while its higher register proclaims joy of a more boisterous character.

THE BASS-CLARINET. Anything written for the ordinary Clarinet can be played upon the Bass Clarinet (sounding an octave lower), though the nature of the instrument makes it best suited

for cantabile passages. Its lower register is of wonderful beauty.

THE BASSOON. The Bassoon is the bass of the wood-wind section. The Bassoon is capable of rendering grave or mysterious effects, or lamentation, and, also, can be easily adapted to humorous situations and can become comical in its depictions.

THE DOUBLE-BASSOON OR CONTRA-BASSOON. It is the Double-Bass of the wood wind section. It is best adapted for sustained notes, its stupendously low B-flat being the lowest tone in the orchestra.

The Brass Wind Instruments

THE FRENCH HORN. The French Horns are the principal and central support of harmony in the orchestra. They cannot be dispensed with. In the complete, modern orchestra four such instruments are employed. It can be made a beautiful and expressive solo instrument. From a distance the tones of the French Horn are always more distinct than those of any other instrument. It is a "tricky" instrument, and the least mechanical of all the wind instruments.

THE TRUMPET. The tone of this instrument blends well with the French Horn, though it has a more metallic quality than the latter. Its character is essentially martial.

THE CORNET. The Cornet is a brilliantly toned instrument, possessing an exceptionally bright, metallic timbre. It is an important solo instrument in this country. It is seldom employed in a full symphony orchestra, though it is employed in Gounod's "Faust."

THE SLIDE-TROMBONE. This is a good melodic instrument, yet handicapped by not being very flexible in its tone production. In this country, while the instrument is the bass of the brass section, it is also a valuable solo instrument.

THE BASS-TUBA. It is the Double-Bass of the brass section, is capable, with the aid of Trombones, of producing a grandiose effect, and can be imitated by the Double-Bass.

THE HARP. When used as an orchestral instrument, the Harp is best adapted for passage work, arpeggi, glissandi, and large chords. Simple accompaniments written for the Piano may be played fairly well upon the Harp. A Symphony orchestra is not complete without a Harp, and frequently several are employed.

Percussion Instruments

THE TIMPANI OR KETTLE-DRUMS. The Timpani are used to accentuate the rhythm or to give tonal as well as rhythmic emphasis to the bass. There are generally two employed in the orchestra, and modern scores have neces-

sitated the addition of one or two more in the Symphony orchestra.

THE SNARE-DRUM. This Small or Side-Drum is a military rhythmic instrument, and its proper place is in the military band. Its use in the orchestra should be restricted to the compositions of a martial character, or to dance music.

THE BASS-DRUM. Its principal use is in accentuating the force of a climax. For dance music, or in military marches, it is used for practically every "down-beat." A good imitation of a cannon shot can be obtained by its use, and the distant echo well copied (light roll and thump).

THE CYMBALS. They are usually employed together with the Bass-Drum, but certain effects can be obtained with one or more of the Cymbals alone. One Cymbal, struck with a soft Kettle-Drum stick produces the effect of a Tam-Tam. Vigorously clashed together they well depict a stroke of lightning.

THE TRIANGLE. Used for special effects, sometimes with divided Violins, sometimes with the wood winds.

THE BELLS OR GLOCKENSPIEL. Infrequently used, except for responses or answer to a foregoing figure.

THE XYLOPHONE. Many showy soli have been written for this instrument. Its use in the Symphony orchestra is restricted to certain characteristic effects.

From Gaston Borch's Practical Manual of Instrumentation.

LEADING AMERICAN SYMPHONY ORCHESTRAS AND CONDUCTORS

Boston Symphony Orch.—Serge Koussevitzky.
Chicago Symphony Orch.—Frederick Stock.
Cincinnati Symphony Orch.—Fritz Reiner.
Cleveland Orchestra—Nikolai Sokoloff.
Detroit Symphony Orch.—Ossip Gabrilowitch.
Los Angeles Philharmonic Orch.—Walter Henry Rothwell.
Minneapolis Symphony Orch.—Henri Verbrughen.
New York Philharmonic—Guest conductors.
New York Symphony Orch.—Walter Damrosch.
Omaha Symphony Orch.—Sandor Harmati.
Philadelphia Symphony Orch.—Leopold Stokowski.
St. Louis Symphony Orch.—Rudolph Ganz.
San Francisco Symphony Orch.—Alfred Hertz.
State Symphony Orch., New York—Joseph Stransky.
Syracuse Symphony Orch.—Vladimirshavitsch.
Washington Symphony Orch.—Kurt Hetzel.

EDNA LEEDOM and Norman Pierce introducing Mr. Garglesong at WMCA, New York. George Keltling harmoniconrowing.



World Celebrities Heard Over Radio

Improved Broadcasting Brings Stars to Microphone to Give Their Best—Brief Biographies

TIMES have changed. Not so long it would have been considered practically an insult to have asked one of the great opera or concert stars to broadcast over the Radio. "The idea! Radio is simply a boy's toy—an electrical plaything to amuse the youngsters of a scientific turn of mind." But all that has been changed. No artist is too rare and superior to "go on the air" in these days. The greater they are the more important it is that they should cultivate their Radio audiences. Today there are thousands familiar with the works of the great stars where there were only scores before.

Some of the most prominent celebrities to be heard over the Radio are represented in the short biographical sketches that follow.

ALDA, FRANCES, Soprano (Ah-dah). Frances Alda's amazing versatility is one of the most conspicuous of the many gifts bestowed upon her by nature in a prodigal mood. A mere list of the operas in which she has sustained leading soprano roles would fill a paragraph. Since making her debut in "Rigoletto" at the Paris Opera Comique in 1904, she has sung a great number of exacting roles. As the wife of Giulio Gatti-Casazza, general manager and impresario of the Metropolitan Opera, she has long taken a prominent place as a factor in American musical affairs, and her vocal gifts have won her countless friends at the opera and on the concert platform. Perhaps the fact that she was born in Christchurch, New Zealand, has given her a special sympathy with American musical aspirations. Her voice is singularly fresh and sweet, though capable of remarkable color-shading.

AMATO, PASQUALE, Baritone (Ah-mah-toh, Pahs-kwahl-leh). Pasquale Amato was born in Naples, and was not originally destined for a musical career. After his voice developed under the teaching of famous masters, however, it became evident that he was destined for operatic success. One of the most gifted baritones of the day, he has achieved success not only in Italy, but also in London and other European music centers, as well as South America. He made his debut with the Metropolitan Opera house in New York, 1908, in "Traviata."

BACHUS, WILHELM, Pianist (Back-hus, Vil-ehlm). Wilhelm Bachus has been touring the world, as a concert pianist, at intervals since 1900, when, as a lad of sixteen, fresh from the hands of Eugen d'Albert, he was recognized as an artist of the foremost order—one of the few who reach that goal of perfect artistry so many strive for, and strive for vainly. He was born at Leipzig, the home of so much of the world's really great music. In 1905 he began teaching in England, where he won the Rubinstein prize for piano-playing. He made a notable tour of the United States in 1912-14, and he has repeated this with the highest kind of recognition vouchsafed the artist. His playing is characterized by a brilliant, sound technic with a subtle and delicate sense of tone-color, and a feeling for the musical phrase like that of the poetic phrase in words.

BAUER, HAROLD, Pianist (Bow-urr). Harold Bauer is an artist of intellect fired with emotion. He was born in England, but, as his name indicates, of German, and of Welsh, descent. When only ten years old, he made his debut, in London, as a violinist, and he for nine years toured Great Britain in this capacity. He then met Paderewski, who strongly advised him to study further, in Paris; and while teaching the violin there, he studied and mastered the piano, which he ever since has made his chosen instrument of expression, and which he plays with an art which admits of few rivals. He made his debut as a pianist in 1893, and first appeared in the United States in 1900. He has toured everywhere, has upheld the finest and most robust ideals of music throughout the world, and now, with mature life, has come into that place in the art-life of the world which is given to but very few.

BESANZONI, GABRIELLA. Gabriella Besanzoni is one of the great mezzo-contraltos of the younger generation. She is by birth a Roman, and it was in the Imperial City that she first made her operatic debut at the Costanzi theater. Her fame spread rapidly as she appeared at one Italian opera house after another, including La Scala at Milan. She appeared then with high honors at the Reale of Madrid and the Liceo of Barcelona. Her "Santuzza" in Italy was a triumph, as was her "Carmen" in Spain, where, as a rule, this opera had formerly been received with coldness. South American and Mexican engagements led to her coming to the United States, where she was instantly engaged to sing with the Metropolitan Opera company.

Signorina Besanzoni's voice is remarkable for its range and beauty. She has mastered roles as unlike as Amneris in "Aida," and Norma in the opera of the same name.

BOHNEN, MICHAEL, Baritone, is the possessor of an unusually powerful, rich baritone voice that is capable of negotiating the most difficult operatic roles with that splendid brilliancy and ease which can be acquired only through years of experience and performance.

Bohnen was born in Cologne, and first sang in concert at the age of fifteen. From that time his appearances were one success after another.

His debut in opera was made in Dusseldorf where he rapidly gained recognition and soon became one of the leading members of the company. Then Count Von Hulsens, the intendant of the Berlin Royal opera, heard of his sensational success and obtained his services for Berlin. He has been a member of the Bayreuth Festival since 1910, and was formerly the leading baritone in all the great Wagnerian parts at Covent Garden, London.

He is now a member of the Metropolitan Opera company and of the Vienna Opera company.

BONELLI, RICHARD, Baritone, is the newest of the young American musicians to have his name written in capital letters for his successes on the operatic stage. Now, in his second year as a principal baritone of the Chicago Civic Opera, Bonelli is one of the important members of that great organization. For Bonelli has not alone a remarkable voice, he possesses all the other attributes necessary to operatic success—confidence, intelligence, personality, musicianship and dramatic fire. The quality of Bonelli's voice resembles more the Italian timbre than that of the northern voice. It is rich, full, powerful and sonorous, with warmth and range.

Bonelli comes by his musical talents naturally, as several members of his family were accomplished musicians. He was born in Port Byron, N. Y., and his younger days were spent in Syracuse, where he went to the public schools and later became a student of Syracuse university, bent on a career of mechanical engineering. Aside from his college studies, Bonelli took up the study of music, and languages, which interested him so greatly that he determined to give up engineering.

After his graduation from college, Bonelli went abroad to study with the great Jean de Reszke, who told him that he had a great gift of dramatic instinct. The young American artist later completed his studies in America and his debut was made at the Academy of Music in Brooklyn as "Valentine" in "Faust," in which opera he scored a tremendous success in his first year with the Chicago Opera. Returning to Europe, he was engaged with the Monte Carlo Opera. His success was so notable here that Bonelli's services were immediately in demand all over Europe, and he subsequently appeared in important opera houses in Italy, Munich, Hamburg, Dresden, Berlin, Paris and Havana, Cuba, in the leading baritone roles. Bonelli's first appearances with the Chicago Opera were made in 1925 and his success was instantaneous. Bonelli has recently appeared with the Los Angeles and San Francisco Opera companies and in concert.

BORI, LUCREZIA, Soprano (Boh-ree). Lucrezia Bori's real name is Lucrezia Borgia (or Borja, in Spanish), but she prefers to be known

as Bori. Though of Italian descent, she is a native of Valencia, Spain. Permitted to follow her obvious destiny as a singer, she went to Milan for study, and eventually made her debut in Rome as Micaela in "Carmen." Her first season was very successful, and she followed it up with success in South America. After another European season she was engaged for the Metropolitan Opera company in New York. The memory of her success at our leading opera house is still fresh in the minds of music-lovers, and she needs little further introduction. She is one of the youngest singers ever heard in opera in this country, and her youth and beauty, together with her lovely voice and dramatic ability, make her unique.

CASALS, PABLO, Violoncellist (Kah-sahls, Pahb-loh). Pablo Casals is such a recognized master of the violoncello, that it is common knowledge that whenever he visits a city, its orchestras are likely to be bare of cellists, as they all flock to hear him play. This great artist was born in Vendrell, near Barcelona, Spain, in 1876. He was the son of an organist, from whom he learned to play the violin, flute and piano. At twelve he took up the 'cello, began to win prizes, and in a year or two he began his concert career, which has brought him the highest honors that may come to an artist, including the profound admiration and respect of those of his own craft. His playing is almost unbelievably smooth, finished and elegant.

CHALIAPIN, FEODOR, Bass (Shal-yah-pin, Fed-or). This remarkable Russian basso is not simply a singer but an artist; not merely a personality but a man. Being such, he has had not a "career," but a life. He was born at Kazan, Russia, in 1873. At 7 he was a cobbler's apprentice; he became wood-carver, book-binder, pawn-broker's clerk, novice in a monastery of the Russian church, and longshoreman on the Volga at 17 cents a day. At 17 he was in comic opera at \$6 a week—machinist, prompter, stage manager, singer, all in one. Not long afterwards he was singing in Moscow at \$6,000 a year. He upset all stage tradition, expanding, not breaking, rules. In Boito's "Mefistofele" he appears with the upper half of his body nude and covered with luminous paint.

CHAMLEE, MARIO, tenor, is an American artist, born in Los Angeles, California. He is one of the youngest of the great artists of today and his musical career has been a rather phenomenal one, inasmuch as he leaped to fame in an amazingly short time.

While a student at the University of California, Chamlee first demonstrated his great vocal ability in a college musical show. He studied under Alberti of Los Angeles. Then his unusual career began. Each appearance seemed to push him further up the ladder of musical fame until now he is recognized as one of the world's greatest living tenors.

His operatic debut was made as "Mario Cavaradossi" in "Tosca," with the Metropolitan Opera company of New York City, and has been a member of this famous organization ever since, and his popularity is ever increasing.

Mario Chamlee's voice is alive with youth, personality and power such as is found in only a few great artists. His great number of admirers is increasing at a rapid rate through his splendid recordings on Brunswick records.

As a foremost member of the New Hall of Fame, Chamlee has achieved a most enviable position.

COATES, ALBERT, Conductor and Symphony Orchestra. Albert Coates, despite his English name, is of Russian birth, although of mixed English and Russian parentage. He has conducted and trained orchestras in almost every country, it would seem, in which the symphony orchestra is known as a type of musical organization. A student of Nikisch's, he began conducting in public at Leipzig itself; thence took charge of various operas throughout Europe. In 1911 he became chief conductor of the old Imperial Opera; later he went to England, and then came to the United States as guest conductor, later as conductor of the Rochester Philharmonic orchestra. He is a composer of pronounced ability; a musician of profound

knowledge, and a conductor of splendid masculine personality.

DALMORES, CHARLES, Tenor (Dahl-moh-ress). Mr. Dalmore has made a splendid success in America, and has proven one of the best French tenors heard in many years.

Charles Delmore was born at Nancy, France, in 1872, and made his debut at Rouen in 1899 with such success that he was engaged for the Brussels Opera, and his Brussels triumphs were repeated at Covent Garden, where he sang with Calve in "Carmen," and with Melba in "Faust." He was brought to the U. S. in 1906 by Oscar Hammerstein, and his successes at the Manhattan in Don Jose, Hoffmann and other roles are well remembered.

D'ALVAREZ, MARGUERITE, Contralto (Dahl-vahr-ayz). Marguerite d'Alvarez, contralto, comes from the ancient Inca city of Cuzco, in Peru, which even the Indians of today salute with a brief invocation whenever they come in sight of it. She made her European operatic debut as a young girl. She since has sung in the chief opera houses of the world. An artist of strong personality, who gives her own individual stamp to everything she undertakes, d'Alvarez has become something more than a favorite with American audiences. She is a writer as well as a singer; a circumstance of enormous help in considering creatively, her very numerous operatic roles.

DAL MONTE, TOTI, Soprano (Dahl Monte, Toh-tec). Toti Dal Monte is a name which is borne by one of the greatest coloratura sopranos ever sent here from Italy, the home of song. She is a Venetian, the daughter of Professor Amilcare Dal Monte, a distinguished man of letters, and, like Galli-Curci, she originally intended piano study. While yet at school, she strained a hand practicing, and thus put an end to hope in that direction. Her father took her to Barbara Marchisio, famous teacher, then living in retirement, for whom she sang, in a little-girl voice, the Jewel Song from "Faust." Marchisio became literally her guardian angel; and in 1916 she made her debut, at La Scala, in Milan. Since then she has sung in Europe, South America and Australia, recognized and acclaimed everywhere, and with justice, as one of the greatest of coloratura sopranos.

DANISE, GIUSEPPE, Baritone, is of Italian descent and studied under Colonnesi in the conservatory of Naples. He has sung in the great opera houses of Europe, South America and the United States, appearing for two years at the La Scala Opera house in Milan, Italy, where he endeared himself to all who heard him.

When he came to America he aroused the admiration of New York's critics through his first appearance with the Metropolitan Opera company. Since that time he has been an outstanding figure in the musical world.

DE LUCA, GIUSEPPE, Baritone. Giuseppe de Luca is one of the most distinguished members of the Metropolitan Opera company, and no artist has more successfully proven his right to a place of distinction than this young Italian baritone.

A Roman by birth, at the age of thirteen his talent for singing was brought to the attention of Bartolini, the famous baritone and teacher. The boy then showed indications of musical feeling in marked degree, and his voice at that time was of the distinctly baritone quality. Fearing a possible change in the voice, it was not until some two years later that de Luca entered the Conservatory of Santa Cecilia in Rome, where he studied for five years before making his debut in "Faust." He spent eight winter seasons in the famous La Scala and has appeared with most significant success in all the considerable capitals of Europe.

Mr. de Luca's American debut was made as Figaro in the "Barber of Seville" at the Metropolitan Opera house, November 25, 1915, when he won instant favor with press and public alike.

DUX, CLAIRE, Soprano, was born in Poland but her ancestry represents several nationalities. Her parents were musical and she began to sing as a child. At the age of twelve she made her first public appearance as "Gretel" in a school presentation of "Hansel and Gretel."

After a few years of study, she made her debut in Germany and since that time has been one of the leading sopranos with almost all of the great opera companies of the world. She made her debut at the Royal Opera in Berlin, and sang leading roles at La Scala in Milan.

Subsequently, Dux sang at Covent Garden, London, where she gained the sincere praise and admiration of her fellow artists as well as of the public. After singing at the Royal Opera in

Stockholm and Copenhagen, she came to America and joined the Chicago Civic Opera Association. Here she won additional fame and her subsequent tours in concert have made her one of the greatest sopranos of today.

EASTON, FLORENCE, Soprano, was born in Middleboro, England. At the age of five she moved with her family to Toronto, Canada, where she started the study of music a year later.

Miss Easton later returned to England and took up the study of voice at the London Royal Academy of Music, later going to Paris to continue her vocal work. She made her debut at Covent Garden, London, and then came to the United States to sing with the Henry W. Savage Company. Her success here gained for her an engagement with the Berlin Opera.

Following this, Easton went to London to create the leading soprano role in the Ricordi prize opera, "The Angelus." Again, she returned to the United States to sing the leading dramatic roles with the Chicago Opera Association and later joining the Metropolitan Opera Company. Since then, her career as a portrayal of leading soprano roles at the Metropolitan has been most successful.

ELMAN, MISCHA, Violinist. Though he has lived for some years in America, and has come to be regarded as one of our own, Mischa Elman was born in South Russia, and owed his musical education to the accident that the great teacher, Leopold Auer, while on tour, heard him play. Owing to racial difficulties, a special permit from the Czar had to be obtained to get Elman and his family out of Moscow and into Petrograd. Once there, however, he made astonishing progress. Overwhelming success in the Russian capital was followed by equally astounding results in London and eventually in Russia. Among violinists the "Elman tone" is spoken of almost with bated breath, as of a thing apart from ordinary experience. It has a fullness of volume, a sensuous richness of quality that make it unique, and it is used with extraordinary nicety of technique and a musicianly understanding.

FARRAR, GERALDINE, Soprano (Fay-rah). Few artists are so dear to the heart of the American public as Geraldine Farrar. Her wonderful voice, her histrionic gifts, her personal beauty, count for much, but above all her courage, her spirit and enterprise, are peculiarly appealing to the American point of view. She was born in Melrose, Mass., and began her musical studies at the age of twelve, under Miss Long, of Boston. Later she studied with Emma Thursby in New York, at the same time learning dramatic action from Capoul. In 1899 she went to Paris to study with Trahadello, but being desirous of achieving the highest development wisely went to Mme. Lilli Lehmann. Operatic successes in Europe of the most brilliant kind made her engagement by the Metropolitan inevitable. Among American music-lovers, especially opera-goers, the name of Geraldine Farrar has become a household word. The number of roles she has successfully created is astonishing, and to every one she has brought the same care, the same intelligence, the same superb artistry. More especially, perhaps, we think of her as Tosca, as Carmen, Marguerite, or Madame Butterfly, but to these may be added Mimi, (an unforgettable achievement), Zerlina, Juliet, Cherulino, Gilda, Violetta, Nedda and many others. Nor can we omit reference to the charm with which she sings the old American and other folk songs, and established favorites of the concert room.

FLETA, MIGUEL, Tenor (Flet-ah, Mig-ell). Miguel Fleta, who made his Metropolitan debut during the season of 1922-23, is of Spanish birth. Almost by accident it was discovered he could sing—when a disciple of the famous singer Manuel Azo heard him and offered instruction. He studied in Barcelona, but made his debut in Trieste, passing thence to Rome, Bologna, Milan, Vienna, Madrid, and the Colon at Buenos Aires. When he first sang in Madrid, he was recognized as one of the greatest of Spanish tenors. He has been chosen to create important roles by modern composers. Fleta's voice is a pure fresh tenor, clear and bell-like in quality, and he especially delights in music and in musical phrases which exhibit his musical power of coloring a single long note. This, however, is only one detail of many.

GABRILOWITSCH, OSSIP, Pianist (Ga-bril-ov-itch, Ohs-sip). Ossip Gabrilowitsch is one of the greatest living tone-poets of the piano. Composer, virtuoso and orchestral conductor, his is one of the most significant names in contemporary music. In listening to his several records one is impressed by the feeling that every individual tone has its own special and separate life,—and

yet how marvelously each is fused into an organic whole like a separate cell into its parent organism! Gabrilowitsch is of Russian birth, and he studied with Lidlow, Glazounov, Leschetitzky and Navratil,—all of them geniuses. Concertizing, touring, composing, working quietly but incessantly since his debut at Berlin in 1896, he several years ago was called to the conductorship of the Detroit Symphony Orchestra.

GALLI-CURCI, AMELITA, Soprano (Gal-lee Koor-chee, Ah-may-lee-tah). Galli-Curci first came to the United States unheralded. Her debut with the Chicago Opera Company in November, 1916, however, was such a triumph as has rarely been experienced in recent times. As soon as her operatic engagements permitted she visited other important music centres in America, where similar fortune awaited her. Not until January, 1918, did she make her formal debut in opera in New York. Her singing at once created the wildest enthusiasm, and her conquest of the United States was complete. Galli-Curci is an Italian by birth and training, but is something of a cosmopolitan by nature. Her voice is one that haunts the memory; wonderfully pure in quality, amazingly flexible, and of even quality throughout its entire wide compass.

GARDEN, MARY, Soprano. Mary Garden is a unique figure in music. Singer, actress, critic, manager, there is no phase of operatic art which she has not conquered and made her own. She was born in Scotland, coming to the United States as a child. When only twelve, she played the violin in public. A few years later she went to Paris to study singing; and when Charpentier's "Louise" was first put on at the Opera Comique, she substituted in the third act. Paris went wild and she was compelled to sing the role for 100 successive nights. She has created many famous operatic roles, and many an opera has been written with the image of Mary Garden in the brain of the composer.

GIANNINI, DUSOLINA, Soprano (Jahnee-nee, Doo-so-lee-nah). Dusolina Giannini is an American soprano who startled conservative London into placing her with the greatest recent names in song. She was born in Philadelphia, and as the daughter of Ferruccio Giannini, a distinguished tenor who made some records in the very early days of the Victor, she comes honestly by her fine natural powers. Though, like very perfectly trained singer, she can "sing everything," some of her loveliest achievements have been in the domain of pure lyric song—in simple legato melodies of the type where the utmost correctness of intonation is the very first demand upon the artist. A woman of gentle and winning personality, of almost Olympian simplicity and dignity of presence, she steps by natural right into the company of the great.

GIGLI, BENIAMINO, Tenor (Jeel-ye, Ben-yah-mee-noh). Beniamino Gigli is of Italian birth and training, and by right of those things is fitted to carry on the great traditions of the art of bel canto. Coming to the United States almost unknown, he was engaged practically offhand, by the Metropolitan Opera Company, for which he sang a number of important roles.

Gigli was born at Recanati in Italy, March 20, 1890. His musical studies began in childhood. His father was sexton of the largest church in his native town, and for ten years the boy sang in its choir, soon rising to be chief soloist. His voice attracted crowds, even then. He was sent to the Conservatory at Rome, where he studied under Rosati, and his operatic debut was made at Rovigo, in 1914, in La Gioconda. His success was instant. He soon became one of the most celebrated Italian tenors of the day.

GLUCK, ALMA, Soprano (Glook). Although born in Bucharest, Roumania, Mme. Gluck is essentially American, as she came to this country at the age of six, and most of her musical education was received here. The public knew very little of this fine artist until one morning, several years ago, when, after making her first appearance as Sophie in "Werther" at the New Theatre, she awoke to find herself famous. After several seasons at the Metropolitan, Alma Gluck entered the concert field, in which she has made a phenomenal success. There are few singers today who can turn so readily from the heavier operatic arias to the simple songs which find an echo in every heart, and it would be difficult to say in which province this brilliant artist is best appreciated. Her concert seasons have been among the most successful ever enjoyed by any singer.

GODOWSKY, LEOPOLD, Pianist, was born in the ancient town of Vilna, in the Lithuanian province of Russian Poland. From early childhood he showed an extraordinary aptitude for music, making his first public appearance at the age of nine at a concert in his native town. Four years later, he was enrolled at the Berlin-Hoch-

schule, and soon afterwards the young pianist left for America.

Godowsky toured in concerts for two years and later returned to Europe to study under Liszt at Weimar. This, his greatest ambition, was never realized, for Liszt had died before Godowsky reached him. He studied under Saint-Saens, the great composer, but the latter's restless nature and incessant activities made continuous work impossible, and Godowsky became practically his own teacher. That he was his best instructor, time and his great reputation today have proven.

A master pianist of singular depth, celebrated for his wondrous and perfect technique, Godowsky is a thorough musician and the composer of several fine compositions.

GORDON, JEANNE, Contralto. Jeanne Gordon, contralto, is one of the growing family of New World singers who have not found it necessary either to study, or to seek first critical approval, abroad. She was born in Canada, and took up the study of music under Dr. Albert Ham, of Toronto. Her first public appearances were in New York film theatres. She then went to the Metropolitan Opera Company, the great goal of all singers in America, singing with it for nine seasons and going thence into the still larger field of concert work. Her voice is of lovely rich quality, and she employs it with great skill and expressiveness.

GRAINGER, PERCY, Pianist-Composer, has been called "The Playboy of the Musical World" and in his playing there is certainly a buoyant, joyous virility entirely his own. Grainger is an "outdoor" man, keenly athletic and actually took muscular rhythmic exercise from Muldoon to develop the surety and strength necessary for his dynamic playing. Grainger was born in Australia, his mother was his first instructor and his first London appearance, at the age of ten, secured his fame. In 1906 Grieg heard Grainger play and so admired the young man and his art that he asked him to spend the summer with him. Just before his death Grieg had selected Grainger to play his concerto under his own conductorship at the Leeds festival. During the war Grainger became a naturalized American and entered the service of our country. In camp as on the concert stage the pianist was a favorite. Grainger's American concert seasons during the last few years and his appearances with the various Symphony Orchestras have always been sensational.

HACKETT, CHARLES, Tenor. One of the greatest achievements of all musical history is the sweeping, meteoric rise of "Charlie" Hackett through the most varied international career ever accorded an American tenor to the secured fame of a leading star of the great Metropolitan Opera.

Mr. Hackett studied music as a boy in Worcester, Mass. He went abroad at twenty, made his first sensation in Florence and established himself with incredible swiftness in Italy's foremost Opera Houses. In Buenos Aires, where musical discrimination is cultivated to the highest point, Hackett swept all before him.

Northward to the Metropolitan, in 1919, was Hackett's next step, where, in one of the most florid and faultless interpretations of the tenor role of Il Barbiere di Siviglia ever heard from the famous boards, Hackett was acclaimed by musicians and music lovers, artists, impressarios, singers and critics—"a tenor in a class by himself!"

HEIFETZ, JASCHA, Violinist (High-fetz, Yash-ah). To few it is given while still on the threshold of life to achieve the success which comes ordinarily—if it comes at all—only after maturity and experience. Yet that is what Jascha Heifetz accomplished. He commenced playing the violin at three, completed the course at the Royal Music School in Vilna, Poland, at the age of seven, and, after study with Professor Leopold Auer in Petrograd, was a mature artist at the age of ten. His tour through Russia was a triumph; the keenest critics of Europe had nothing but praise for him. And after a leisurely trip from Russia to the United States, by way of Vladivostok and California, he swiftly conquered America. Though his years can be counted, the measure of his genius knows no bounds. His technique is flawless; the intonation is perfect, the quality of tone superb and utterly individual, complete mastery over bow and violin having been vouchsafed him in childhood by a Nature bent upon a perfect model.

HOFMANN, JOSEF, Pianist, was born in Cracow, Poland, in 1877, of musical parents. His father was a professor at the Warsaw Conservatory and conductor of the Warsaw opera, and his mother was a distinguished singer. After studying the piano with his father until 1892, Josef Hofmann spent two years as a pupil of Anton Rubinstein, who predicted a brilliant career for the young boy—a prophecy which has been marvelously fulfilled. As a boy prodigy, Hofmann was

a sensation in the musical world, and when, after retirement for study, he emerged in 1894 to make his debut in Dresden, he had gained strength, maturity and a more solid musicianship. Again, he toured Europe and America, coming to the United States in 1898, and making his home in Aiken, South Carolina. Today, Hofmann is considered among the greatest pianists now before the public. He has no superior in technical mastery of his instrument, interpretative power and in musicianship. He is also a composer, inventor and an American citizen.

HOMER, LOUISE, Contralto. The popular American contralto comes from Pittsburgh, Pa., where she was Louise Delworth Beatty, daughter of a well-known clergyman. She is now the wife of Sidney Homer, American composer and one of her earlier teachers, known as the composer of many fine and original songs. Louise Homer laid the foundations of her musical education in the United States, with Alice Groff in Philadelphia, and with W. L. Whitney. Her unusual talent was recognized by George W. Chadwick and Arthur Foote, who with her husband, then in Boston, encouraged her to study and advised her to seek the operatic stage. Taking this advice she went abroad, and two years in Paris atmosphere and training accomplished wonders for her voice and her stage experience. She made her debut as Leonora in "Favorita" in 1898.

JERITZA, MARIA, Soprano (Yeh-ritzah, Mah-ree-ah). Maria Jeritza is in private life the Baroness Popper. She is of Moravian birth, having been born in the little town of Brun, Her debut was at Alnitz, and she came thence to Vienna in 1912. The Metropolitan forces had her in mind for New York as early as 1914, but the war interrupted all, and her debut here did not take place until 1921, when she sang in Erich Korngold's "Dead City," in New York, in its first American presentation. Mme. Jeritza has a fine large voice, a commanding presence, and dramatic powers of a high order, especially fitting her for the roles of the Northern opera—though indeed she sings with facility, and with splendid intelligence, in those of the Italian and French schools. She is an artist who still is young, whose sympathies are keen, vivid and inclusive, and whose work will probably grow even richer and finer as years advance.

JOURNET, MARCEL, Bass (Zhoor-nay). Journet was born at Nice, France. He studied under Seghettini and made his debut at Bezieres, Belgium, in 1891, where M. Calabresi, manager of the Brussels La Monnaie, heard him and promptly engaged him for three years. In 1897 he made his first appearance in London and has since been a prime favorite there.

Journet is possessed of a magnificent voice, full and resonant, and has a fine stage presence. He is perfectly at home in an unusually varied repertoire, speaking the languages as a native.

His records cover a great range of compositions, from the splendid rolling bass numbers of the great operas to the patriotic and popular songs of various countries.

This sterling artist is well known to opera-goers in America, as he was a member of the Metropolitan Opera Company for many years. In 1908 M. Journet was engaged by the Paris Opera, and has since been one of the important members of that great company, returning to America only at intervals.

JOHNSON, EDWARD, Tenor. Edward Johnson, the great Canadian tenor, is one of the greatest operatic artists developed within recent years. As with so many singers born in the New World, his first triumphs came to him in Italy. He was a born singer. He began as a choir boy in New York, passed thence into comic opera, then went abroad, translated his name into Italian, and, as "Eduardo di Giovanni," toured Europe for seven years. He created a number of important roles, including those in "Il Tabarro" and "Gianni Schicchi," and he first introduced Wagnerian roles into a number of Italian cities. In July, 1920, King Victor Emanuel II conferred upon him the Cross of Officer of the Order of the Crown of Italy. Mr. Johnson's reappearance in the New World, last season with the Chicago Opera Company, was one of the events of the musical year. His voice is fine, fresh, powerful and with a certain quality altogether his own.

KREISLER, FRITZ, Violinist. (Krice-ler). Kreisler was born in 1875, the son of a distinguished physician and musical amateur. He was a healthy and sane boy, full of life, who at first thought nothing of his natural powers, and who would rather be a "trolley conductor" than a violinist.

At the age of ten young Fritz won the first prize at the Vienna Conservatory; and in his twelfth year astonished the professors at the Conservatoire in Paris by winning the Prix de Rome, an unprecedented occurrence. As a boy

prodigy, he toured America with Rosenthal, returning to Austria to enter other fields. Although during these four years he abandoned violin practice entirely, on his reappearance in 1899 his bow was as true and his technique as flawless as ever. Since then he had toured and concertized, interpreting in the terms of his own experience all that has come within the range of his genial, broad, and sympathetic mind.

LASHANSKA, HULDA, Soprano (Lah-shan-skah). Hulda Lashanska possesses that rare gift, a pure lyric soprano voice, developed to the utmost fluency by coloratura training. She is an American, born in New York City, and reared among surroundings conducive to her artistic development. At eighteen she was a pianist of enviable powers. Then her voice was discovered. She studied with Frieda Ashforth and with Marcella Sembrich, and was encouraged, in moments of self-doubt, by Sophie Braslau. She has appeared with practically every symphony organization of importance in the United States since her debut in New York under Walter Damrosch. She sings with rare evenness, self-possession, and with quite extraordinary beauty of tone.

LAUDER, SIR HARRY, Comedian (Law-der). Sir Harry Lauder began life as a miner. He lightened the labors of his fellows by singing to them, at odd times, his now world-famous songs of humor and sentiment. He sought the music-halls of London; at first was received coldly, but in a short while was singing at three or four every night, being whirled from one to the other in taxicabs. It has been said of him that in national crises, he possibly did more than any single individual to raise the spirits of London; his appearance anywhere was the signal for laughter and cheers. The World War, which brought him the loss of his only son, brought also the honor of knighthood.

LAZARO, HIPOLITO, Tenor (Lah-thah-rah). This promising young tenor, who is a native of Spain, has made considerable success in Europe and South America, and recently appeared at the Metropolitan Opera House. However, it was not necessary to wait for his actual appearance here, as the Victor had already made some records of his voice. In the recording of this singer the Victor has followed its usual policy of endeavoring to exhibit the beauty of the voice rather than its extreme power, and the records are therefore doubly attractive ones.

LEWIS, MARY, Soprano. Mary Lewis was born in Arkansas. Step-child of a Methodist minister, when eight years old she sang in the local choir. Ten years later she virtually "ran away" with a theatrical troupe that stranded on the Pacific Coast. She became a "bathing beauty," then a cabaret singer in Greenwich Village, then, by virtue of her unusual voice and beautiful presence, won first place in the "Follies." Her ambitions, however, were made of sterner stuff than so often goes to the uplifting of Follies celebrity, and she went abroad to study singing. She won a place in smaller operatic companies, then came back to America for a Metropolitan debut. Applauded, recognized and accepted, she there came into her true and high place among the singers of the New World.

MACBETH, FLORENCE, Soprano. The King and Queen of England were in their box when little "Flossie" Macbeth of Mankato, Minnesota, aged nineteen, was making her debut in London. As a tribute the Queen threw her bouquet toward the stage and Florence Macbeth, who had played many a game of baseball with the boys back home, caught it and fame in a single night.

Florence Macbeth, the American coloratura soprano, is known as the "Minnesota Nightingale." Many a critic has said of her, "Another Patti, flawless in tone from lower G to E sharp in alt." Miss Macbeth has a brilliant, clear, even range through three octaves. Her professional debut was made in Holland in 1912, followed by appearances in London, Dresden, Liverpool and Manchester. In 1914 Miss Macbeth joined the Chicago Opera Company forces and since that time has appeared with that Company and in concert throughout America.

MARTINELLI, GIOVANNI, Tenor. This brilliant singer has made a notable success at the Metropolitan, and is one of the best Italian sopranos ever heard in America. He was born in Montagnana. His father, a cabinetmaker, was not able to give his son a musical education, but he managed to learn the clarinet and finally joined the regimental band, where the director discovered the young player's remarkable voice. He was sent to Professor Mandolini, and soon made his debut at the Dal Verme as Ernani. A Covent Garden engagement soon followed, and as America eventually gets the best singers, Martinelli soon came to the Metropolitan.

MASON, EDITH, Soprano. The soprano voice of Edith Mason, of the Chicago Civic Opera, has

no superior, and few equals, among the lyric voices of the day. High, brilliant, flexible, her voice has the shimmering quality which makes it seem, at times, to float. And with such a voice, combined with keen musical intelligence, Mme. Mason has gone far in the fields of concert and opera.

Edith Mason was born in St. Louis, and attended the Ogontz and the Miss White schools in Philadelphia. This training was supplemented with courses at the National Cathedral School of Washington, D. C., and with collegiate work at Bryn Mawr. During this period, every obstacle that could possibly restrain a gifted and ambitious young woman from planning and preparing for a professional career, was brought to influence the naturally susceptible "sub-deb," whose mother strenuously opposed the exploitation of her daughter's talent, while the young woman let no opportunity slip which gave her a chance to exercise the same.

Mme. Mason, who in private life, is the wife of Giorgio Polacco, the distinguished musical director of the Chicago Civic Opera, has appeared with the Metropolitan and Ravinia Park Opera Companies, at the famous La Scala in Milan and other European Opera houses. She is equally at home in concert and has appeared extensively in this field.

MATZENAUER, MARGARETE, Mezzo-Soprano (Maht-zen-our). Mme. Matzenauer made her American debut as Amneris in "Aida," soon afterward attaining other successes. She has impressed lovers of Italian opera as well as German with her splendid voice, her musical intelligence and her dramatic power. The artist was born in Hungary. She made her debut in 1901, in Strassburg, in Weber's "Oberon." After some years in continental Europe, she came to the United States, where she sang for some years with the Metropolitan Opera Company. She has sung at the Wagner festivals in Bayreuth. Her roles are very numerous, and they include all schools of opera. Her voice, generally characterized as a "mezzo-soprano," is of great range, and she has sung soprano roles with ease. She has received medals and orders from various European countries. She has made many concert tours in both the Old and the New Worlds, where she is equally well known.

MCCORMACK, JOHN, Tenor. Born in Athlone, Ireland, John McCormack early learned to sing the songs of his native land, but he had no reason to suspect that the voice he loved to use was exceptional. Induced to compete at the Dublin Musical Festival, however, he met with such success as enabled him, with the proceeds of a few other concerts, to go to Italy to study. After a successful debut, followed with numerous other operatic appearances in Italy, he was engaged for Covent Garden, London, on October 15, 1907. His succeeding triumphs in America are well within memory. He has traveled the length and breadth of the land, and is everywhere received with tumultuous enthusiasm. Now an American citizen, John McCormack has come to be something of an "institution" in America, and he undoubtedly interprets in song the heart of the American people in a way peculiarly his own. Gifted with a voice of superb beauty, he can turn lightly from the most exacting of operatic airs to simple, haunting melodies that linger in the memory with the most treasured experiences of a lifetime.

MELBA, DAME NELLIE, Soprano. No prima donna of the present day has ever been more beloved in three continents than has this Australian artist.

Melba was born at Burnley, near Melbourne, Australia. Her father was a Scotch contractor who had been in Australia some years. He was proud of his daughter's musical talent, but objected to her following it as a profession, and it was not until her marriage to Captain Charles Armstrong that she finally decided on a musical career. The singer went to Europe in 1886, and began to study under Mme. Marchesi, making such rapid progress that her debut was made in Brussels in 1887 under the name of Melba (derived, of course, from her native city), and her success was immediate.

In England, where she sang in opera in 1923, she received the title of Dame, the most recent of distinctions conferred upon women of intellect. Her formal retirement, a year or two later, was a national event.

MELIUS, LUELLA, Soprano (May-lee-us, Loo-ell-lah). Luella Melius, friend and protegee of the De Reszles, and one of the foremost singers of France, is an American, born in Chicago. She began music study as a little girl, in Chicago, and was amazed when her teachers presented her with a special diamond medal. A few years later, when she went to France, she was fortunate enough to meet Jean de Reszle, who told her she must study with him three years, and that he

would accept from her no fees for her tuition. Her debut was made in Vienna, under Felix Weingartner. Called again to America through a family illness, she was invited to sing, in Chicago, as a guest artist in "Rigoletto," and her American reputation at once was made.

MERO, YOLANDA, Pianist (Meh-ro). Yolanda Mero, pianist, is of Hungarian birth and a natural inheritor of Franz Liszt's great tradition. She was born at Budapest, where, as a little girl, she took up the study of music at the Evangelique School, under her father and Augusta Rennebaum. She made her debut in 1903, with the Dresden Philharmonic Orchestra, and six years later, she first was heard in America at Carnegie Hall, New York. She has played with almost every orchestra of note in the United States and Europe. In recognition of her work she was elected Professor at the National Conservatory in Budapest.

MURPHY, LAMBERT, Tenor. Lambert Murphy comes from New England, having been born at Springfield, Massachusetts. His career as a singer began as a choir-boy; in which occupation, as an alto, he was greatly outshone by his brother, who went to Harvard, where, under the fantastic tests of his classmates, he "made" the Glee Club. Not so long afterward, at the instance of Riccardo Martin, he was heard by, and taken into, the who had a soprano voice. He "grew up" and Metropolitan Opera Company. Since leaving there, he has sung at concerts, festivals, and with symphony and other important organizations everywhere in America.

PADEREWSKI, IGNACE JAN, Pianist (Pad-er-ehf-skee, Een-yahss Yahn). The world today knows the history of Ignace Jan Paderewski—as an artist, a patriot, an administrator in troublous times, and now, at the crown of his life, an artist again, in everything the term recognizes and implies. He is of Polish birth, and it will always be remembered that he was the first Premier of new Poland.

Paderewski, for all his superb mechanical skill, is a tonalist—an artist who can overlay the silvery and at times cool tones of the piano with coruscating iridescences of color. The key once struck, the pianist, unlike the singer, or the player of almost any other instrument, has no control whatsoever in this matter of tone—all must be done beforehand, while the finger descends.

PAPI, GENNARO, is one of the most distinguished of Italian Operatic conductors. Operatic conducting, like that of the symphony orchestra, requires a special and a most comprehensive technique. The duties of a conductor of opera are not what appears to many to be simply to beat time for the body of musicians in the orchestra pit, but it requires something far more difficult. The operatic conductor must prepare the temperamental artists and the chorus on the stage, as well as to drill the orchestra in interpreting the musical score of the composer. The successful operatic conductor thus must hold together all forces of the production—the artists, the chorus, the ballet and the orchestra—and at the same time inspire his associates to artistic performance through his own musically sensitive personality. This is no easy task, and the power to attain complete musical success is given to but few. Toscanini, the late Campanini, Polacco, Marinuzzi have risen to prominence among the hosts of operatic conductors, and to this list must necessarily be added the name of Gennaro Papi.

Born in Italy, Papi came to the United States thirteen years ago and for ten of these years, has been a leading conductor of the Metropolitan Opera House. For nearly as long, he has been the Italian conductor of the remarkable summer opera seasons of the famous Ravinia Park in Chicago. Signor Papi has the genius and the temperament of the perfect opera conductor, and has the rare quality of knowing his work so well that he conducts from memory.

PATTIERA, TINO, Tenor, was born in Ragusa-Vecchia, Dalmatia, and there he attended college, taking up the study of law with the intentions of making that his career. He possessed a naturally beautiful voice, however, and each time he sang for his friends they enthusiastically urged him to take up music, seriously. In the end, his inherent love for music compelled him to abandon the study of law and concentrate his every effort and talent in the study of music.

After a thorough study, Pattiera made his very successful operatic debut in Dresden and earned a place among the tenors of Europe. After gaining commendable praise from the critics of Europe, he came to this country and made his American debut as "Cavaradossi" in Tosca with the Chicago Civic Opera Company, earning the same complete success. He has youth, splendid physique, education and a true tenor voice of the finest lyric quality.

PINZA, EZIO, Basso (Peen-tsah, Ay-tsee-oh). This wonderful artist is a Roman. His career, begun at Spezia, in Italy, was interrupted by the World War, in which he served in the artillery. Practically all of the important bass roles in modern opera have been sung by Ezio Pinza; in "Aida," in "I Puritani" and "Mefistofele" he has been especially singled out for praise by European critics. His engagement by the Metropolitan Opera Company in New York, the best tribute America might pay to any artist's powers, soon led to the realization that Pinza was one of the great race of singers who stand hopelessly separate and apart from the common average. His voice is of noble quality, and he employs it in the grand manner of Italian operatic tradition.

PONSELLE, ROSA, Soprano (Pon-zell). Rosa Ponselle is of Italian blood but American birth, and a singer by divine right. She began life in Meriden, Conn., with an enormous handicap, but a handicap over others; for hers is a voice of such beauty and power that it is difficult to see how an artist could develop within any distance of her without a similarly great natural gift. She began as a very young girl, singing in public in all sorts of minor engagements. It was impossible, however, to keep such powers long in obscurity, and still at an age when most singers consider themselves hardly advanced students, she was singing at the Metropolitan with Caruso. Her voice is always sympathetic, and in great moments it reaches qualities of grandeur. She is an actress of such power that if she were to give up singing tomorrow, she still would rank high with her contemporaries of the spoken drama.

RETHBERG, ELISABETH, Soprano, is one of the brightest spots of the Metropolitan Opera and possesses one of the most beautiful soprano voices in the world. The witchery of her voice can reveal the most dramatic intensity as well as the most alluring tenderness, and as one famous critic wrote of it: "It is like milk and honey." There is no finer musician, no artist better equipped among the singers appearing before the American public today.

Mme. Rethberg was born in the Swartzenberg in the Erz mountains, of devotedly musical parents. At five, she started to play the piano after a fashion, and was so happy at hearing the little tunes which responded to her fingers that she soon commenced to study music. The songs which her mother used to sing when she was a girl interested her also, and she would divide her time playing the piano and singing these songs and some of those by Schubert, which especially interested her.

It was not until she heard her first performance of opera on the stage of the Dresden Opera House, however, that she decided upon a career as a singer. After long and arduous preparation, she made her debut as Agatha in "Der Freischutz," followed by her appearance as Micaela in "Carmen." Her success was so notable that Richard Strauss wanted to engage her for the Vienna Opera, and her services from then on were greatly in demand. Mme. Rethberg has concentrated in all the important musical centers of northern Europe and the United States. Her appearances in opera have been just as extensive, and in addition to the Metropolitan Opera House, she has appeared in the United States also at the famous Ravinia Park Opera during the summer seasons. She sings the lyric and dramatic roles of both the French and Italian repertoire as well as her native German operas.

ROMAINE, MARGARET, Soprano. Not so many years ago out in Utah a little seven-year-old girl was playing the 'cello and singing to herself. Dreams of being a world-renowned 'cellist floated through the youthful musician's mind. But it was her singing which discovered a voice, today one of the prides of the Metropolitan Opera House.

Miss Romaine first studied in London, then Paris, where she appeared in the opera at the Opera Comique. Returning to America her concert appearances and light opera tour brought her to the attention of Gatti-Casazza, who realized that America had produced another sensational soprano and engaged her for the Metropolitan.

ROSEN, MAX, Violinist, the son of a poor Roumanian musician, came to America with his father when less than a year old. He lived in New York's East Side. His first lessons in violin were received from his father. Later he was brought to the attention of the late Edward de Coupet. Through his interest and generosity, Max Rosen went to Europe to study under Leopold Auer. From this point on, his career was assured.

At the age of fifteen, Rosen made a phenomenal debut with the Philharmonic Orchestra in Dresden. There followed a series of European triumphs, including a concert tour of Norway and Sweden, where he was literally idolized by the

people and applauded by royalty. His first public appearance upon his return to America was made with the New York Philharmonic Orchestra at Carnegie Hall. Max Rosen's success in America, really his native country, was immediate, and his further appearances with orchestra and in recital in this country have added laurels to his fame.

SALVI, ALBERTO, Harpist (Sahl-vee). Alberto Salvi, harpist, was born at Vigiano, Italy, not far from Naples. His father was a maker of harps and pianos at Venice, who thought he might "carry on" the industry. The lad, however, exhibited extraordinary talent for playing the instruments, and it was decided to send him to the Conservatory at Naples. His studies matured just at a time when war conditions made it impossible to begin, in Italy, the career of a virtuoso, and in 1919 he came to the United States, where one of his first acts was to apply to become a citizen. Since then he has lived and concertized in America. Like every master of an instrument, he has expanded the technique of his own.

SCHIPA, TITO, Tenor (Skee-pah Tee-to). Tito Schipa was born at Lecce, in 1889, and made his debut at the Costanzi Theatre, in Rome, in "La Traviata." Ten years later, he made his first American appearance in Chicago, as the Duke in "Rigoletto." His fine voice, distinguished stage presence, and his most intelligent singing, brought him quickly into recognition, and into favor, in the new world. He is a tenor of natural gifts, accomplishing with ease what so many strive for, and so vainly, through the whole of a lifetime, without success. His voice has a wholesome, robust, manly quality for all its lyric smoothness and its ease of production. He has those attributes, as an artist, which seem to appeal most powerfully to the general American public.

SCHUMANN-HEINK, ERNESTINE, Contralto (Shoo-mahn-Hynk). Mme. Schumann-Heink has been long in America, and has been long and closely identified with American life. At the age of ten she was sent to the Convent of the Ursuline Nuns in Prague, where she sang in the choir, but entirely by ear. Her father was afterward transferred to Graz, where a teacher named Marietta von Le Clair, who had recognized the signs, offered to give the budding genius her efforts without pay. The girl's voice at that time was a deep contralto, with no high notes. The wise teacher kept her on nothing but exercises for two years before she gave her songs by Mendelssohn, Schubert and other composers. In 1878 she made her first appearance at the Dresden Opera House at Azucena in "Il Trovatore," and in the early '90s she achieved fame in Berlin. In 1896 she appeared at Bayreuth and in 1898 created a sensation in London. Her first appearance in New York was in 1898. American audiences refused to allow her to return to Europe. Since then, for almost a generation she has been a great presence among us.

SEIDEL, TOSCHA Violinist. "Small, compact, fiery, the boy fiddled like a very demon, but a frank, healthy little demon, charged with a message from the gods." So spoke the critics on that March day in 1918 when Toscha Seidel made his American reputation in one hour. Seidel is the youngest and many think the greatest pupil of Auer. Seidel was born in Odessa in 1900. His mother was a school teacher, his father a business man, his uncle a violinist and Toscha at the age of three, "chose" his uncle's profession for his own. From that day began the career of one of the paramount musical geniuses of the world—"a boy born with a fiddle in his hand." Although temperamental and by the grace of his great gift a peerless violinist, Seidel is also a literary scholar, a genius at chess and an athlete.

STOKOWSKI, LEOPOLD, Conductor (Stokoff-skee). Leopold Stokowski is one of the greatest living masters of that most gigantic, most sensitive and most difficult of all musical instruments,—the symphony orchestra with its hundred or more individual wills. The mind of the great orchestral conductor is much like that of the simultaneous blindfold chess-player; who must not only keep the functions of many separate pieces in mind, but also their hearings upon one another; and he has this added difficulty, that he does not deal with inert mathematical certainties, but with the plastic material of human emotion and the evanescent human sense of beauty. Stokowski's achievements in this peculiar sphere have become part of the true history—the inner history,—of music in America.

Stokowski is of English birth but American citizenship. In 1912 he became conductor of the Philadelphia Orchestra raising it to the front rank of the world's organizations.

STRAUSS, RICHARD, Composer-Conductor of Vienna, is undoubtedly one of the greatest musicians of today. He has been called the Dean of living composers. For many years he has been the presiding musical genius of the Vienna opera.

His phenomenal creative powers, his genius for interpretation so evident in his performance in conducting the great Strauss Symphony Orchestra, sets him apart in that order of musical geniuses which numbers only one or two in a generation. It is remarkable that one man should be endowed with so many talents, for Richard Strauss, the conductor, is equally as famous as Richard Strauss, the composer. He has composed many very beautiful songs, and contributed generously to different forms of music—symphony, symphonic poem, song literature, opera.

When Strauss last toured the United States with his great symphony orchestra he received the highest honors that the American press and public could bestow.

TALLEY, MARION, Soprano. Marion Talley is an artist by natural right. She was born at Nevada, Missouri. She sang as a mere tot, and rejoiced in it. As a child she was taken into a choir of mature singers. The purity of her voice and the truthfulness of her ear amazed everyone who heard her. By the time she was fifteen years old her fame had spread to the East, and she received a hearing at the Metropolitan Opera House. Advised to put in a couple of years at further study, she had not passed out of her teens when her debut took place as Gilda in "Rigoletto." And a sophisticated New York audience almost broke down the doors to get in and hear. She at once took place among the foremost coloratura sopranos of the day.

TIBBETT, LAWRENCE, Baritone. Lawrence Tibbett, baritone, was born at Bakersfield, California; when he was seventeen his voice was discovered by Joseph Dupuy in a school theatrical performance. He studied with Dupuy and with Basil Ruysdael, and for eight or nine years sang in church, concert and light opera. Coming to New York, he was engaged by the Metropolitan Company. He memorized Italian roles before he knew the precise meaning of the words. Cast for the role of Ford at a revival of Verdi's Falstaff, a riot of applause broke forth for him at the end of the second act. Since then he has mastered, and triumphed in, other roles. His voice is rich, powerful and marvellously expressive, and his stage presentations are splendidly vivid and human.

TOSCANINI, ARTURO, who is generally recognized as the greatest personality among the master conductors of today, was born in Parma, Italy, in 1867. While an Italian by birth and training, his career has brought him in touch with the music of every country, and himself as conductor in many parts of the world. His musical training was devoted to the study of the cello in his native town, where at his graduation he obtained first prize for his accomplishments. He played in various orchestras and the year, 1886, found him in Rio de Janeiro. While here, the incompetence of a conductor led to his chance debut as a conductor on the second night of his engagement. Subsequently, he was engaged as conductor in Turin, Treviso, Bologna, Genoa, and at the famous La Scala in Milan in 1898. The same year he came to the Metropolitan Opera House in New York as chief conductor, resigning that position in 1915, to return to Italy. During the war, he was actively engaged in the encouragement of patriotism among musicians, and also in the relief of distressed musicians. From 1916 to 1918, he produced open air opera performances through which he secured large sums to devote to worthy causes. Although Toscanini is associated more with the opera house, in Italy he has the reputation of being equally prominent as a Symphony and Opera Conductor, and Americans who heard him on his recent tour of America with the La Scala Orchestra, will realize the correctness of this statement. Owing to his near-sightedness, Toscanini has had to rely upon a marvelous musical memory, and he conducts the most complicated scores entirely without book. It is said that he is prepared to conduct, at a moment's notice, any one of 150 or more operas and a great number of symphonic compositions as well. Last year, Arturo Toscanini made a brilliant re-entry into American musical circles as Guest-Conductor of the New York Philharmonic Orchestra, with which orchestra he will again appear.

VERBRUGGHEN, HENRI, conductor of the Minneapolis Symphony Orchestra, was born in Brussels, Belgium. The only son of a well-to-do manufacturer, it was determined that young

Henri should be a professional man, preferably a doctor; but the youngster had ideas of his own. He was allowed to study the violin and his talent immediately became so apparent that the attention of Ysaye, the great Belgian violinist, was attracted to the boy, with the result that he later became a pupil of the virtuoso. After the great success of his first appearance in Brussels, Ysaye took Verbruggen to London, where at the age of fourteen, he created a sensation.

A career as a concert violinist lay ahead of Verbruggen, and for five years he followed it. Tiring of what he termed "The futility of spending my life with a violin tucked under my chin," he determined that he would some time be a conductor. He, therefore, deliberately deserted the concert stage, took a minor position in an orchestra in Wales, and step by step worked his way upward to the concert master's desk. He played in different orchestras in England and on the continent to gain experience and was offered the post of Assistant Conductor of the Symphony Orchestra of Glasgow, Scotland, serving as Guest-Conductor in Russia, France, Belgium and Germany, he rapidly achieved an immense reputation. An engagement in London as conductor of the London Symphony Orchestra in the famous Beethoven Festival in 1914—recalled the following year to conduct the Beethoven-Brahms-Bach Festival, established the name of Verbruggen as one of the great contemporary conductors. He later accepted the post of head of the State Conservatory in Sydney, Australia, where he organized successfully and conducted the State Symphony Orchestra of that city. From Australia, Verbruggen came to Minneapolis, where he succeeded Emil Oberhoffer as conductor of the Minneapolis Symphony Orchestra. He is also leader and first violinist in the String Quartet that bears his name, and is one of the prominent orchestral conductors of the day. While Verbruggen has attained pre-eminence as conductor of Beethoven-Brahms-Bach music, he is equally noted for his interpretation for the more modern orchestral works.

WERRENATH, REINALD, Baritone (Wair-ren-rahth, Ry-nald). Reinald Werrenath has been making Victor Records for some years. As a younger artist (he still is young) his contributions were made to the Black and the Blue Label classes. By sheer force of merit he won a place among the immortals of modern vocal music, and his records now are made in the Red Seal class.

He has sung with the Metropolitan Opera Company, and he has sung in concert everywhere throughout the United States. He is the son of George Werrenath, who was himself a famous singer. He was born of Danish ancestry, in Brooklyn, N. Y., and graduated from New York University. He has a splendid rich baritone voice, clear, smooth and sympathetic, and beyond that he sings with extraordinary understanding and intelligence.

WHITEHILL, CLARENCE, Baritone. Mr. Whitehill hails from the West, having been born in Marengo, Iowa. He took such a keen interest in music that at the age of 19 he went to Chicago to begin studying in earnest. He sang in several Chicago churches with some success, and four years later Mme. Melba advised him to go abroad for serious study. The young man took her advice, went to Paris and placed himself under Giraudet for dramatic action, and Sbriglia for French dramatic roles. He proved an earnest student and hard worker, and had soon mastered more than thirty bass roles.

His debut was made at Brussels in 1900 as Friar Laurence in "Romeo." He returned to Paris for a season at the Opera Comique, and was then secured by Mr. Savage for the English opera season at the Metropolitan in 1901. Returning to Europe in the spring of that year he began on the advice of Mme. Wagner, to study German opera, and in 1902 appeared in the "Ring" at Lubeck, and as Wolfram at Bayreuth in 1904.

ZIMBALIST, EFREM, Violinist (Zim-bal-ist, Eff-rem). This distinguished Russian violinist was born at Rostoff on the Don, Russia, April 9, 1889, and disclosed a musical temperament at an early age. He did not, however, commence to study the violin until seven years old, when he took lessons from his father, a distinguished orchestra director. Later he went to Leopold Auer in Petrograd, and made rapid progress. His debut in that city was a phenomenal success, which was repeated in the principal European music centres. A splendid London debut definitely established his fame in England, and an equally warm welcome awaited him in the United States. His marriage to Alma Gluck led to the making of beautiful duet records by these famous Victor artists.

Song Hits of Yesterday and Today

Can You Remember Way Back to 1910 and In Between When These Songs Were Most Popular?

NEVER has there been such a demand for new and snappy airs as today. The composers cannot grind them out fast enough. And that is because the moment a song strikes the popular fancy it is heard everywhere and everybody wants it immediately. Some of the composers claim that a popular song lives much shorter but merrier, and stands a better chance to make more money because it is broadcast. In case you may want information about the hits of yesterday here is a handy reference to keep in your library.

Aggravatin' Papa, Roy Turk and J. Rossel Robinson; Waterson, Berlin & Snyder, 1922.

After You're Gone, Creamer and Layton; Broadway Music Corp., 1918.

Ain't She Sweet? Jack Yellen and Milton Ager; Ager, Yellen & Bernstein, Inc., 1927.

Alcoholic Blues, Edw. Lasky and Al Von Tilzer; Broadway Music Corp., 1918.

Alice, I'm in Wonderland, Arthur Fields and Theo. Morse; Leo Feist, Inc., 1918.

A Little Bit of Heaven, Sure They Called It Ireland, E. R. Ball and J. K. Brennan; M. Witmark & Sons, 1914.

All Alone, Irving Berlin; Irving Berlin, Inc., 1924.

All the World Will Be Jealous of Me, Al Dubin and E. R. Ball; M. Witmark & Sons, 1917.

Alma, Geo. V. Hobart; Jerome H. Remick Co., 1910.

Along the Way to Waikiki, Gus Kahn and R. Whiting; Jerome H. Remick Co., 1917.

Always, Irving Berlin; Irving Berlin, Inc., 1927.

America, I Love You, A. Gottler and E. Leslie; Kalmat & Puek Pub. Co., 1915.

And I'm All Alone, P. G. Wodehouse and J. V. Horn; T. B. Harms & Co., 1916.

Any Old Time at All, Gene Buck and Louise Herick; M. Witmark & Sons, 1918.

Anywhere the Wind Blows, Henry Creamer and James F. Hanley; Shapiro, Bernstein & Co., 1924.

At Half Past Nine, S. Lewis and A. Gottler; Waterson, Berlin & Snyder, 1918.

At Peace With the World, Irving Berlin; Irving Berlin, Inc., 1927.

A Word That Means the World to Me, Theo. Morse and H. Johnson; Leo Feist, Inc., 1915.

Avalon, Vincent Rose and Al Jolson; Jerome H. Remick Co., 1920.

Bam Bam Bammy Shore, M. Dixon and R. Henderson; J. H. Remick & Co., 1925.

Barney Google, Con Conrad and Billy Ross; J. H. Remick & Co., 1925.

Beautiful Ohio, Mary Earl and McDonald; Shapiro, Bernstein & Co., 1918.

Beautiful Queen of the Nile, R. Hubbel and J. L. Golden; Golden, Hubbel and Burnside, 1917.

Because I Love You, Irving Berlin; Irving Berlin, Inc., 1926.

Beside a Babbling Brook, Gus Kahn and W. Donaldson; J. H. Remick & Co., 1923.

Big Show Selection, R. Hubbell; T. B. Harms & Co., 1916.

Blue Goose, B. Birch; Forster Music Pub. Co., 1916.

Blue Skies, Irving Berlin; Irving Berlin, Inc., 1927.

Bo-La-Bo, Geo. Pateman; M. Witmark & Sons, 1919.

Bye Bye Blackbird, Mort Dixon and Ray Henderson; J. H. Remick & Co., 1926.

Call Me Zack, Old Pal o' Mine, Dixon and Lane; Harold Dixon and J. Perricone, California, Here I Come, Al Jolson, Bud de Sylva and Joe Meyer; Witmark & Sons, 1925.

Cecilia, D. Bryson and H. Ruby; Irving Berlin, Inc., 1926.

Cheer Waltz, F. W. McKee; G. Ricordi & Co., 1914.

Chansonette, R. Fried; Harms, Inc., 1923.

Charleston, W. C. Brock; J. Johnson Harms, Inc., 1923.

Charley My Boy, Gus Kahn and T. Florito; Irving Berlin, Inc., 1921.

Chimes of Normandy, A. Bryson and J. Wells; T. B. Harms & Co., 1917.

China Chin, Chimmam, J. Goodwin and J. Hanley; Shapiro, Bernstein & Co., 1917.

"China", Bud de Sylva and Al Jolson; T. B. Harms, Inc., 1924.

Collectate, Lew Brown, Moe Jaffe and Nat Bronx; Shapiro, Bernstein & Co., 1925.

Come on Papa, Edgar Leslie and Harry Ruby; Waterson, Berlin & Snyder, 1918.

Cover Me Up With the Sunshine of Virginia, Lewis and Meyer; Irving Berlin, Inc., 1923.

Crazy Words, Crazy Tune, Milt Ager and Jack Yellen; Ager, Yellen & Bernstein, Inc., 1927.

Daisy Days, Gus Kahn, W. Blaufuss and Chas. L. Cooke; Jerome H. Remick Co., 1921.

Dancing Dan, Jack Stanley; Goodman and Rose, Inc., 1924.

Dear Old Pal of Mine, H. Robe and Lieutenant Getz Rice; G. Ricordi & Co., 1918.

Dear Little Baby of Mine, J. K. Brennan and E. R. Ball; M. Witmark & Son, 1918.

Dolly, Eugene West and Martin Fried; J. H. Remick & Co., 1924.

Don't Blame It All on Me, Dorothy Terriss, Leo Wood and Ted Morse; Leo Feist, 1924.

Don't Bring Lulu, Billy Rose, Lew Brown and R. Henderson; J. H. Remick & Co., 1925.

Don't Cry Little Girl Don't Cry, Maceo Pinkard; Shapiro, Bernstein & Co., 1918.

Doodle-Do-Do, Art Kassel and Mel Stitzel; Leo Feist, 1924.

Down Where the Swanee River Flows, Chas. McCarron and Al Von Tilzer; Broadway Music Corp., 1916.

Eve Wasn't Modest Till She Ate the Apple, Al Von Tilzer and Chas. McCarron; Broadway Music Corp., 1917.

Everything Is Peaches Down in Georgia, Milt Ager, Geo. Meyer and Grant Clark; Leo Feist, Inc., 1918.

Everybody Ought to Know How to Do the Tickle Toe, O. Hauerbach and L. Hirsh; M. Witmark & Sons, 1917.

Florida Moon, Wm. Haegney; M. Witmark & Sons, 1918.

Follies of 1918 Selection, L. Hirsch and D. Stamper; T. B. Harms & Co., 1918.

For Me and My Gal, E. Leslie, E. R. Goetz and G. Meyer; Waterson, Berlin & Snyder, 1917.

For Old Times Sake, C. Keithley; Maurice Abrams, Inc., 1923.

For the Two of Us, E. Leslie and H. Ruby; Waterson, Berlin & Snyder, 1918.

Freebies, Cliff Hess, H. Johnson and Milt Ager; Leo Feist, Inc., 1918.

From Here to Shanghai, Irving Berlin; Waterson, Berlin & Snyder, 1917.

Futurist Girl, Gene Buck and Dave Stamper, T. B. Harms & Co., 1914.

Garden of My Dreams, D. Stamper and G. Buck; T. B. Harms & Co., 1918.

Give Me All of You, L. O. Smith, Milt Schwarzwald and Earl Carroll; Leo Feist, Inc., 1918.

Give Me a Little Kiss Willa Huh? Irving Berlin, 1927.

Give Me the Moonlight, Al Von Tilzer and Lew Brown; Broadway Music Corp., 1917.

Going Up, O. Hauerbach; M. Witmark & Sons, 1917.

Good-bye, Alexander, Good-bye, Money Boy, Creamer and Layton; Broadway Music Corporation, 1919.

Good-bye, Broadway, Hello, France, C. Reiser, B. Davis and M. B. Baskette; Leo Feist, Inc., 1917.

Goodish Fox Trot, Victor Hyde and Jack Egan; Broadway Music Corp., 1917.

Gypsy Love Song, Victor Herbert and H. B. Smith; M. Witmark & Sons, 1898.

Hard Hearted Hannah, Jack Yellen, Bob Bigelow and Chas. Bates; Ager, Yellen & Bernstein, Inc., 1924.

Have a Smile for Everyone You Meet, J. K. Brennan and P. Cunningham; M. Witmark & Sons, 1918.

Hayonola (Have Another), Hugo Frey; G. Ricordi & Co., 1916.

Hawaiian Butterfly, Geo. Little, Billie Baskette and Joe. Santly; Leo Feist, Inc., 1917.

Hawaiian Smiles, Mary Earl; Shapiro, Bernstein & Co., 1919.

Head Over Heels, E. A. Woolf and J. Kern; T. B. Harms & Co., 1918.

Hello Central, Give Me No Man's Land, S. Lewis, J. Young and J. Schwartz; Waterson, Berlin & Snyder, 1918.

Hello, I've Been Looking For You, J. Golden and R. Hubbell; T. B. Harms & Co., 1916.

Hiavutha's Melody of Love, G. Meuer, Al Bryan and Artie Mehling; Jerome H. Remick Co., 1920.

Homeward Bound, Geo. Meyer, H. Johnson and C. Goetz; Leo Feist, Inc., 1917.

Honest and Truly, Fred Ross; Leo Feist, 1924.

Honky Tonky, Chas. McCarron and Chris Smith; Broadway Music Corp., 1916.

Honolulu Eyes, M. Violinsky and H. Johnson; Leo Feist, Inc., 1920.

The Honolulu Hickie Boola Boo, Al Von Tilzer, Chas. McCarron and Lew Brown; Broadway Music Corp., 1916.

How Can I Forget When There's So Much to Remember, Irving Berlin; Waterson, Berlin & Snyder, 1917.

How Come You Do Me Like You Do, Gene Austin; Ray Bergere, 1924.

How'd You Like to Be My Daddy, J. Young, S. Lewis and T. Snyder; Waterson, Berlin & Snyder, 1918.

How's Every Little Thing in Dixie, Albert Gamble and Jack Yellen; Jerome H. Remick Co., 1916.

How Many Times, Irving Berlin; Irving Berlin, Inc., 1926.

How You Gonna Keep 'Em Down on the Farm, S. Lewis and W. Donaldson; Waterson, Berlin & Snyder, 1919.

Huckleberry Finn, C. Hess, S. M. Lewis and J. Young; Waterson, Berlin & Snyder, 1917.

Humming Fox Trot, L. Breaux and R. Henderson; T. B. Harms & Co., 1921.

Hush-a-Bye, Ma Baby, J. P. Eppel and J. R. Shannon; Forster Music Pub. Co., 1916.

I Called You My Sweetheart, J. Monaco, Grant Clark and H. Johnson; Leo Feist, Inc., 1917.

I Can Not Bear to Say Good-bye, Anita Owen; Waterson, Berlin & Snyder, 1918.

I Can't Get the One I Want, Billy Rose and Lou Henderson; Irving Berlin, Inc., 1924.

I'd Climb the Highest Mountain, St. Claire and L. Brown; Irving Berlin, Inc., 1926.

I Don't Want to Get Well, Howard Johnson, H. Pease and H. Jentes; Leo Feist, Inc., 1917.

If He Can Fight Like He Can Love, Grant Clark, H. E. Rogers and Geo. Meyer; Leo Feist, Inc., 1918.

I Hate to Lose You, I'm So Used to You Now, Archie Gottler and Grant Clark, Waterson, Berlin & Snyder, 1918.

I Know I Got More Than My Share, Grant Clark and H. Johnson; Leo Feist, Inc., 1916.

I'll See You in My Dreams, Gus Kahn and Isham Jones; Leo Feist, 1924.

I Love My Baby (My Baby Loves Me), Bud Gren and Harry Warren; Shapiro, Bernstein & Co., 1925.

I Love You, H. Thompson and Harry Archer; Leo Feist, 1923.

I'm Always Fallin' in Love With the Other Fellow's Girl, Ceasear and Meyer; Jerome H. Remick Co., 1920.

I'm Forever Blowing Bubbles, Jean Kenbrovin and J. W. Hellette; Kendis, Brockman Music Co., 1919.

I'm Going to Follow the Boys, H. Rogers and J. V. Manaco; M. Witmark & Sons, 1917.

I'm Knee Deep in Daisies and Head Over Heels in Love, Joe Goodwin, Geo. Little and Jack Stanley; Larry Shay and Paul Ash, 1925.

I May Be Gone for a Long, Long Time, Al Von Tilzer and Lew Brown; Broadway Music Corp., 1917.

I Miss My Swiss, L. Gilbert and A. Baer; Leo Feist; 1925.

I Miss That Mississippi Miss That Misses Me, S. Lewis, J. Young and P. Wendling; Waterson, Berlin & Snyder, 1918.

I'm Proud to Be the Sweetheart of a Soldier, Mary Earl; Shapiro, Bernstein & Co., 1918.

I'm So Glad My Mamma Don't Know Where I'm At, W. Toosweet; Leo Feist, Inc., 1918.

I'm Sorry I Made You Cry, N. J. Clesi; Leo Feist, Inc., 1918.

I'm Worried About You, Gus Kahn and Vincent Rose; Leo Feist, 1924.

I Never Knew, Gus Kahn; Irving Berlin, Inc., 1925.

I Never Knew I Could Love Anybody, Tom Pitts, Ray Egan and R. K. Marsh; Leo Feist, 1920.

Indiana, B. McDonald and J. Hanley; Shapiro, Bernstein & Co., 1917.

Indiana Moon, B. Davis and I. Jones; Irving Berlin, Inc., 1923.

In the Land of Beginning Again, Grant Clark and Geo. Meyer; Leo Feist, Inc., 1918.

In the Land of Wedding Bells, H. Johnson and Geo. Meyer; Leo Feist, Inc., 1917.

Irristible Waltz, F. W. McKee; G. Ricordi & Co., 1916.

It Ain't Gonna Rain No Mo', W. W. Hall; Maurice Abrams, Inc., 1924.

It Had to Be You, Isham Jones and Gus Kahn; J. H. Remick & Co., 1924.

It's a Long Way to Berlin But We'll Get There, Leon Flatow and Artie Fields; Leo Feist, Inc., 1917.

I Used to Call You Ma Baby, H. Johnson, Murry Roth and Cliff Hess; Leo Feist, Inc., 1919.

(Continued on page 106)

Folks Know Old Masters Better Now

Daily Repetition of Names of Composers by Announcers Gives Opportunity to Learn Pronunciation

GENERAL interest in the old masters has been greatly stimulated as the result of Radio broadcasting of their works. Not only is there an awakened appreciation of the best in music that has ever been produced but there is an unusual curiosity concerning the lives of these inspired geniuses. Here are a few of them.

ARNE, DR. THOMAS AUGUSTINE (1710-1773). Born in London, designed for the law. Practiced music secretly. Became one of the most prolific of English composers. Wrote 30 operas and other works. Trained his own sister, Mrs. Colley Cibber, famous actress. Composer of "Rule, Britannia," first written for a royal masque. First introduced women's voices into oratorio.

BALFE, MICHAEL WILLIAM. Born Dublin, 1808. Violinist at Drury Lane, London, 1824. First baritone, Paris Opera, 1828. First opera was produced in Italy. Married Lina Rosa, Hungarian singer. Wrote 31 operas, including "Bohemian Girl," sung in many languages and popular the world over. Wrote many songs in addition. Died 1870, Rowney Abbey, England.

BACH, JOHANN SEBASTIAN (Bahkh). Born Eisenach, Prussia, 1685. Family very musical and was taught violin by father. Afterward studied clavichord. Chorister at Luneberg, 1700. Organist, Armstadt, 1704; appointed court organist at Weimar, 1707; then Concertmeister. Kapellmeister at Coethen 1717 to 1723, then director of several Leipsic churches. Married twice; 20 children. Was greatest master of fugue and counterpoint, and first to introduce present method of fingering for pianoforte. Works numerous, including 300 church cantatas, many organ works, suites, concertos, etc. Larger works include "Mass in B Minor," "Christmas Oratorio," "Passion of St. John and St. Matthew." Bach died in 1750, after having become almost blind.

BEETHOVEN, LUDWIG VAN (Bay-toh-ven) (1770-1827). Born Bonn, Germany, 1770. Began study of music at age 4. Played at concert at 8. Began composition at 10, writing a cantata and "nine variations." Assistant to concert organist at 11, at 12 conductor of Court Opera Orchestra (without pay). When 14 was granted a salary of 150 florins (about \$80 a year!). In 1787 made first visit to Vienna, a great event for the boy. Compositions not important until 1795, but from then to his death wrote 260 works. Only opera, "Fidelio," produced Vienna, 1805.

Beethoven's influence on art of music very great and can hardly be estimated. He died March 26, 1827; buried in Vienna.

BIZET, GEORGES (Bee-zay). One of the greatest musicians of the modern French opera school was Georges Bizet (1838-1875). His first operas were "The Pearl Fishers" and "Djamileh." In "Carmen" Bizet composed one of the most pleasing and popular operas of all time. Although not an opera the music which Bizet wrote for Alphonse Daudet's drama "L'Arlesienne" is one of the greatest compositions of a dramatic type which has been found in modern music.

BRAHMS, JOHANNES (Brahmz) (1833-1897). Rightly regarded as one of the greatest masters of the modern school of music. His works are monuments of technical skill, ranking with those of Beethoven and others of the world's foremost composers. He wrote almost entirely in symphonic forms. He wrote many beautiful songs and several symphonies, serenades, concert overtures for orchestra, and the Hungarian Dances.

CHOPIN, FREDERIC FRANCOIS (Show-Pahn) (1809-1849). Frequently called "the poet of the piano." A Pole by birth and deeply devoted to his native land, whose folk music he constantly uses in his own compositions. He is often classified as a member of the French Romantic School. His great Sonata in B minor reflects his sorrow on the downfall of his native Poland. His Mazurkas, Polonaises, Krakoviaks, reflect his love for his homeland. He was the first great composer to bring into prominence the use of national characteristics in his compositions. His works are for piano solo, with the exception of a few songs and his two concertos for piano and orchestra. Chopin is regarded as the greatest poetic musician who ever lived.

DVORAK, ANTONIN. The greatest of modern Bohemian composers, was born in 1841. Died 1904. In the early nineties he spent three years in New York City as artistic director of the National Conservatory, a result of his stay being the wonderful "Symphony, from the New World," which has for its basic motive a number of the American plantation melodies.

GOUNOD, CHARLES FRANCOIS (1818-1893) (Goo-no). Born in Paris. Father, artist, died when Gounod was five. Taught by mother. Won Conservatory Prix de Rome, 1837. Became organist San Luigi Church; contemplated priesthood. In 1850, when Mass became successful in England, asked to write a work for Paris Academie Opera "Sapho," 1851, a failure. Work unimportant until 1859, when masterpiece, "Faust," appeared, most famous of all operas—given 1,500 times in Paris alone.

GLUCK, CHRISTOPH WILLIBALD (Glook). (Weidenwang, Upper Palatinate, 1714; D. Vienna, 1787.) Studied music at Prague and later in Italy. Encouraged by Marie Antoinette in Paris, he inaugurated much needed reforms in opera against violent opposition. One of the earliest and most renowned of dramatic composers. His two greatest operas, "Orfeo" and "Armide," produced respectively in the years 1762 and 1777, are still to be found among the mainstays of the modern repertory and are given by critical opinion a high place among the greatest masterpieces of operatic writing. The simplicity and grandeur of Gluck's style have seldom been approached.

GRANADOS, ENRIQUE (1869-1916). Composer. The hopes of Spain for a great national composer were built largely upon Granados, who, with his wife, was drowned upon an ocean journey in 1916, shortly after his opera, "Goyescas," was given in New York. He wrote many brilliant works for the piano.

GRIEG, EDVARD HAGERUP (1843-1907) (Greeg). Born Bergen, Norway, 1843. At 6 began musical education under his mother. At the age of 15 was sent to Leipsic Conservatory. Returned to Norway, 1863, and began writing the original and spontaneous music which was to make him famous. Grieg really founded a new school of Scandinavian music. His short piano pieces are charming works of their class and his numerous songs full of poetic feeling. The Peer Gynt Suite, written for Ibsen's dramatic poem, "Peer Gynt," is perhaps the best known of all his compositions. Grieg died September 4, 1907.

HANDEL, GEORGE FRIEDRICH (1685-1759). Born Halle, 1685. Father a barber, afterwards valet to Prince Saxe. Intended for law, studied harpsichord secretly. Visited Court at 7. Heard playing organ by Prince, who offered to educate him. Went to Berlin in 1698, precocity astonishing all. Entered Halle University, organist at \$50 a year. Wrote two operas, 1705, at Hamburg. Visited Italy, then England, where he settled, 1718. Wrote first English opera, "Rinaldo." Director Royal English Academy Music, 1720, producing many operas. British subject, 1726. Paralysis, 1737, induced by opera worries. Turned to oratorio, 1737. "Messiah," greatest of oratorios, 1742. Almost blind, 1752, worked till death, 1759. Buried in Westminster Abbey. Wrote 40 operas; none now performed.

HAYDN, FRANZ JOSEF (High-dn). Born Rohrau, Austria, 1732. At 5 years of age was sent to school at Hainburg, where for two years he was taught rudiments of music, playing on the violin. 1740 taken to Vienna by Reutter as chorister at St. Stephen's, where he learned singing, violin, clavier and composed a great deal. Later supplanted as singer by brother Michael. Became first capellmeister to Prince Esterhazy. Composed 30 symphonies, 40 quartets and became known and admired all over Europe. 1791 visited London and received degree from Oxford. 1792 returned to Vienna, where he gave lessons to Beethoven. Died Vienna, 1809.

HERBERT, VICTOR. This famous director was born in Dublin in 1859, and at the age of seven was sent to Stuttgart as a student of the cello. After some years' study and a tour of Europe, he accepted the position of solo 'cellist in the orchestra at the Metropolitan Opera in 1886. A more brilliant career as conductor became possible and, after having been bandmaster of the Twenty-Second Regiment Band and conductor of

the Pittsburgh Symphony Orchestra, Mr. Herbert organized in 1904 the Victor Herbert Orchestra, which has had a most successful career. All this time Mr. Herbert continued to compose operas, writing more than 25, including two grand operas.

Mr. Herbert's great fame as a composer of operas has somewhat obscured the fact that he is a gifted cello virtuoso, and when but a young man held the position of first 'cellist in the Stuttgart Court Orchestra.

LEONCAVALLO, RUGGIERO. Born Naples, 1858; died Rome, August, 1919. One of the leaders of the so-called "Young Italian" school. He wrote many operas; but his fame rests almost entirely upon "I Pagliacci," which was first produced in Milan, in 1892, and has since been a favorite, especially with American audiences. In 1906 and again in 1913 he visited the United States.

LISZT, FRANZ (List) (1811-1886). The greatest piano virtuoso of his time. His technique as a pianist as well as a composer was colossal. He was the inventor of the symphonic poem. His greatest works are thirteen symphonic poems, the "Dante" and "Faust" symphonies, two piano concertos for orchestra, oratorios "Christus" and "St. Elizabeth," several Masses, many songs and last, but not least, the Hungarian Rhapsodies for piano. Liszt wrote nearly four hundred compositions for piano which form a large part of the repertoire of the modern concert pianist.

MAC DOWELL, EDWARD (MacDowel) (1861-1908). A musical genius which America has produced. Although his training in composition was obtained principally in Europe, he never lost his American expression. One of MacDowell's early teachers was the great pianist, Theresa Careno.

MacDowell was the head of the Music Department of Columbia University. After his death there was established in Peterborough the MacDowell Colony, where American musicians, writers and artists may go and quietly work. MacDowell wrote a remarkable suite for orchestra based on Indian themes.

MASSENET, JULES EMILE FREDERIC (1842-1912) (Mahss-'n-nay). Jules Massenet, whose death occurred in 1912, was one of the best known of modern French composers. He was born in Montcaux, near St. Etienne, in 1842, and numbered among his teachers Ambroise Thomas, composer of "Mignon." At the age of twenty-one he carried off the Grand Prix de Rome with his cantata "David Rizzio." He composed prolifically for the lyric stage, the orchestra, the voice and the piano. His latest work, "Theresé," was recently produced at Monte Carlo. One of his most popular operas is "Manon"; others are "Herodiade," "Werther," "Le Cid" and "La Navarraise."

MENDELSSOHN, FELIX (Men-dl-sohn). Born on February 3, 1809. His father was a Jewish banker at Berlin. He received his first music lessons from his mother—then Ludwig Berger became his tutor for the piano, and Zelter, a very learned theorist, for counterpoint. When twelve years old he began to compose—wrote a trio, some sonatas, a cantata and several organ pieces. His home life was most favorable to his musical development.

In 1824 Mendelssohn began to study under the celebrated pianist, Moscheles, and he soon became a mature musician. In 1826 he gave to the world the overture "Midsummer Night's Dream." Conducted the famous Gewandhaus Chorus in Leipsic. He later married Cecile Jeannerand, the daughter of a clergyman. Completed "Elijah," his greatest works, in Leipsic in 1846. The death of his sister, Fanny Hensel, proved such a great shock that it resulted in his death at Leipsic in 1847.

MOZART, WOLFGANG (1756-1791) (Moh-tsart). Born 1756, Salzburg. Son of musician and teacher. When 4 could play piano, at 6 wrote a concerto. Learned violin and traveled as a prodigy. At 11 wrote an opera, never given. As 12 concertmeister of Salzburg church, and wrote several Masses. When 13 went to Italy, where the young genius astonished by his musical knowledge. Was knighted by Pope. Produced and conducted his opera "Mitridate," 1770. Returned home, and in 1782 married Constance (Continued on page 118)

OFFICIAL CALL BOOK AND LOG

Corrected Every Issue

KDKA

E. Pittsburgh, Pa., 315.6m-950kc, 50,000 watts. Westinghouse Elec. & Mfg. Co. 9:45 am-11 pm. Tues, 9:45 am-10:30 pm. Wed, 9:45 am-11 pm. Thurs, 9:45 am-12 mid. Fri, 9:45 am-11:30 pm. Sat, 9:45 am-11 pm. Sun, 10:45 am-11:45 pm. Eastern.

KDLR

Devils Lake, N. Dak. 230.6m-1300kc, 15 watts. Radio Elec. Co. Announcer, George Bairey. Daily ex Sun, 7:30 am, news, music; 12-12:30 pm, weather; 4:30-5 pm, Mon, 9:30-11:30 pm. Sun, 11 am, church. Founded Jan. 25, 1925. Central.

KDYL

Salt Lake City, Utah, 234.2m-1280kc, 500 watts. Intermountain Broadcasting Corp. Announcer, Philip G. Lasky. Slogan, "On the Air—Goes Everywhere." Daily ex Sun, 10:30 am, 2-5:15 pm. Mon, Wed, Fri, 6-11 pm. Tues, Thurs, Sat, 6-12 mid. Sat, 12-3 am. Sun, 2-6 pm, 8-10. Mountain. Founded June, 1922.

KEJK

Los Angeles, Calif. 252m-1190kc, 250 watts. Freeman Lang. Daily ex Sun, 12:30-2:30 pm, 5:30-7:30, 9-12 mid. Pacific. Founded Feb. 7, 1927.

KELW

Burbank, Calif. 228.9m-1310kc, 250 watts. Earl L. White. Daily ex Sun, 10-2 pm, 6-10. Wed, 10-2 pm, 6-7 pm. 9-10. Pacific. Founded Feb. 12, 1926.

KEX

Portland, Ore. 277.6m-1080kc, 2,500 watts. Western Broadcasting Co. Announcer, Jack Barnett. Daily ex Sat, Sun, 9 am-12 mid. Sat, 9 am-2 am. Sun, 5:30-10 pm. Pacific. Opened Dec. 25, 1926.

KFAB

Lincoln, Neb. 319m-940kc, 5000 watts. Nebraska Buick Auto Co. Announcer, Gayle Grubb. Daily, 7-8 am, 9-10, 11-12:30 pm, 2-3, 4-5, 6-7, 8-9, 10-11. Founded Dec. 4, 1924. Central.

KFAD

Phoenix, Ariz. 272.6m-1100kc, 500 watts. Electrical Equip. Co. Announcer, Arthur C. Anderson. Slogan, "The Voice of Phoenix." Daily ex Sun, Mon, 12-1 pm, 2-3, 3-4 pm. Tues, Wed, Sat, 10-11 pm. Daily ex Sun, Mon, Sat, 9-11 pm. Sun, 11 am-12:30 pm, 8-9. Founded Oct. 30, 1921. Mountain.

KFAU

Boise, Idaho. 285.5m-1050kc, 4000 watts 6 am-6 pm, 2000 watts. Independent School Dist. of Boise. Announcer, Walter T. Lockwood. Mon, Tues, Wed, Thurs, Fri, 12:30-1:30 pm, weather, markets. Tues, Thurs, 7:30-10 pm. Thurs, 11:30 pm. Sun, 10 am-12:30 pm, 7:30-9. Founded Oct., 1921. Mountain.

KFBB

Hayre, Mont. 275.1m-1090kc, 50 watts. E. A. Buttrey. Announcer, E. H. Nelson. Daily ex Sun, 12:30-3 pm, music, markets, weather reports, household talk. Wed, 7:30-9 pm. Sun, 1-3 pm. 7-9:30. Founded 1921. Mountain.

KFBC

San Diego, Calif. 247.8m-1210kc, 100 watts. Balboa Theater Bldg. Daily ex Sun, 9:30-10:30 am, 12:45-1:45 pm, 5-10. Sun, 10-12 am. Bible lesson. Pacific.

KFBI

Pacific Coast. 204m-1470kc, 50 watts. Flying Broadcasters, Inc.

KFBK

Sacramento, Calif. 275.1m-1090kc, 100 watts. Sacramento Bee. Kintell-Upson Co. Announcer, R. K. Clark. Tues, Sat, 7:30-10 pm. Thurs, 7:30-10 pm. Founded 1921. Pacific.

KFBL

Everett, Wash. 223.7m-1340kc, 50 watts. Lesse Bros. Daily ex Sun, 10-11 am, 4-5 pm, 6-7. Sun, 11-12 a. Tues, 10:30-12 mid. Pacific. Founded Aug. 25, 1925.

KFBU

Laramie, Wyo. 463m-620kc, 500 watts. Bishop N. S. Thomas. Announcer, S. E. Edwards. Sunday services. Daily, 12 m, 2 pm. Mon, Wed, Fri, Thurs, Wed, Fri, 7:30 pm. Mountain. Founded Nov., 1925.

KFCB

Phoenix, Ariz. 241.8m-1290kc, 125 watts. Nielsen Radio Supply Co. Announcer, E. A. Nielsen. Slogan, "Kind Friends Come Back." Mon, Thurs, 8-9 pm. Sat, 8-9 pm. Every other Thurs, 12 mid-3 am. Sun, 9-11 pm. Mountain.

KFCR

Santa Barbara, Calif. 290.6m-1290kc, 100 watts. Santa Barbara Broadcasting Co. Announcer, Jack W. Hilley. Daily ex Sun, 12-1 pm, 6-8:57, 7-7:30, 7:30-7:50. Mon, Tues, 8:58-11:55. Thurs, 8:30 pm. 7:30-10 pm. Sat, 12-1 pm, 6:45-7:30 pm. Sun, 7:15-7:45 pm, 8:15-9:15, 9:30-10:30. Pacific. Founded Dec. 22, 1926.

KFDM

Fort Worth, Tex. 249.9m-1200kc, 500 watts. Magnolia Petroleum Co. Announcer, "Slooby" Sloggan. "Call for Dependable Magnolones." Daily ex Sun, 11 am. Tues, Fri, 12:30-1:15. Thurs, 8:30 pm. Fri, 8:30-10:30 pm. Sat, 12-3 am. Sun, 9-10 pm. 7:30-9:30 pm. Sun, 9:45-11:30 pm. Central. Founded Oct. 3, 1924.

KFDX

Shreveport, La. 286.1m-1270kc, 250 watts. First Baptist Church. Announcer, W. H. Lee. Wed, 9-10 pm. Sun, 8:50-12 m, 7-8:57. Founded 1922. Central.

KFDY

Brookings, S. D. 545.1m-550kc, 500 watts. State College of Agriculture and Mechanical Arts. Announcer, Albert Kranz. Daily ex Sun, 12:30-1:15 pm. Tues, Thurs, 7:30-9 pm. Central.

KFDZ

Minneapolis, Minn. 215-7m-1390kc, 10 watts. Harry O. Iverson. Sat, 8 pm. Central.

KFEC

Portland, Ore. 214.2m-1400kc, 50 watts. Meier & Frank Co., Inc. Announcer, R. E. Hartzog. Daily ex Sun, 12-1 pm, weather, music; 4-5 pm, music, 6-7. Pacific. Founded 1922.

KFEL

Denver, Colo. 247.8m-1210kc, 250 watts. Eugene P. O'Fallon, Inc. Announcer, J. H. Hathaway. Daily ex Sun, 7:15 am, gym; 10, 11, 2, 4, 5, 6, 7. Tues, Thurs, 8 pm. Tues, 10 pm. Fri, 11 pm. Sun, 8:30 am, 10, 2:30 pm, 4:30. Mountain.

KFEQ

St. Joseph, Mo. 230.6m-1300 kc, 1000 watts. J. L. Scroggin. Announcer, Clarence Koch. Daily ex Sun, 8:45 am, 9, 10, 11, 12, 2, markets; 5 music; 6:30, music, 8:30-10. Mon, 11-12 mid. Sun, 11-12 n. Central. Founded 1922.

KFEY

Kellogg, Idaho. 332.4m-1290kc, 10 watts. Union High School Station. Announcer, Walter C. Clark. Slogan, "Voice of the Coeur D'Alenes." Mon, Thurs, 7-8 pm. Sun, 11 am, 7:30 pm. Pacific.

KFGQ

Boone, Iowa. 209.7m-1430kc, 100 watts. Boone Biblical school. Founded April 1923.

KFH

Wichita, Kan. 245.8m-1220kc, 500 watts. Hotel Lassen. Announcer, J. L. Fox. Daily ex Sun, 8:30 am, 9, 10, 11, 1-2 pm, markets; 1:15, music, 7:30-9. Sat, 11-1:30 am. Sun, 9:30 am, 7:30 pm. Founded Dec. 1, 1925. Central.

KFHA

Gunnison, Colo. 249.9m-1200kc, 50 watts. Western State College of Colorado. Announcer, E. Russell Wightman. "Where the Sun Shines Every Day." Tues, Fri, 7-9:30 pm. Founded May 1922. Mountain.

KFHL

Oskaloosa, Iowa. 212.6m-1410kc, 10 watts. Penn College. Announcer, Donald Haworth. Tues, Fri, 7 pm. Fri, 9:45 am. Sun, 4 pm. Central.

KFI

Los Angeles, Calif. 468.5m-640kc, 5000 watts. Earle C. Anthony, Inc. Announcer, Leslie Adams. Slogan, "A National Institution." Daily ex Sun, 12:30-11 pm. Sun, 11 am, 1 pm. Sat, 11 am-2 am. Installed Spring, 1920. Pacific.

KFIF

Portland, Ore. 228.9m-1310kc, 50 watts. Benson Polytechnic School. Announcer, Albert Skel. Olga Bettner. W. Hollensted. Tues, 8:15-9:15 pm. Pacific.

KFIO

Spokane, Wash. 245.8m-1220kc, 100 watts. North Central High School.

KFIU

Juneau, Alaska. 225.4m-1330kc, 10 watts. Alaska Elec. Light & Power Co. Announcer, O. E. Schoenbeck. Mon, Wed, Fri, 6-7 pm. Alaskan time.

KFIZ

Fond du Lac, Wis. 267.7m-1120kc, 100 watts. Fond du Lac Commonwealth Reporter. Daily ex Sun, 5 pm, news, markets, weather. Central.

KFJB

Marshalltown, Iowa. 247.8m-1210kc, 100-250 watts. Marshall Electric Co. Announcer, E. L. Pickett. Slogan, "Marshalltown, the Heart of Iowa." Daily ex Sun, 10 am, 12-1:30 pm. Daily, 6 pm, 7. Tues, Fri, 8:30 pm. Sun, 11 am, 7:30 pm. Founded June 2, 1923. Central.

KFJJ

Oldahoma City, Okla. 272.6m-1100kc, 750-1000 watts. National Radio Mfg. Co. Announcer, Tired Hand. Slogan, "Radio Headquarters of Oklahoma City—The City of Opportunity." Daily ex Sun, 9 am, music; 10, sacred music; 10:30, markets; 12-1:30 pm, music; 7-10. Sun, 9 am, 1, 8, 9, A., 10. Men's class; 11, services; 8, services. Central. Founded July, 1923.

KFJI

Astoria, Ore. 249.9m-1200kc, 15 watts. E. E. Marsh and Liberty Theater. Announcer, E. E. Marsh. Daily ex Sun, 7-8 pm. Tues, Fri, 11-12 mid. Wed, Fri, 12:15-1:15 pm. Sun, 11 am-1:30 pm. Pacific.

KFJM

Grand Forks, N. D. 333.1m-900kc, 100 watts. University of North Dakota. Announcers, Howard J. Monley, Alfred R. Botten, Norman Cross. Daily, 12 m, 6 pm. Sun, 10:45 am, 12:30 pm, 4:30, 6. Founded Oct., 1923. Central.

KFJR

Portland, Ore. 239.9m-1250kc, 500 watts. Ashley C. Dixon & Son. Announcer, Ashley C. Dixon, Sr. Mon, Tues, Wed, Thurs, 5-6 pm, 7-8. Mon, 9-11 pm. Tues, 9-11:30 pm. Fri, 4-6 pm, 7-8, 12-1. Sat, 4-6 pm, 7-8, 9-10. Founded Sept. 23, 1923. Pacific.

KFJY

Fort Dodge, Iowa. 232.4m-1290kc, 100 watts. Tunwall Radio Co. Announcer, Carl Tunwall. Daily ex Sun, 10:30-11:30 am, 5:45-7 pm. Tues, 10-11:30 pm. Thurs, Fri, 8:30-9:30 pm. Wed, 3-4 pm. Sun, 11-12:30 pm. Founded Oct. 1923. Central.

KFJZ

Fort Worth, Texas. 249.9m-1200kc, 50 watts. W. E. Branch. Announcer, Jack Fralia. Daily ex Wed, Sun, 7-8 pm, 9-10, 7-8, 9-10. Sun, 1-3 pm, 6-7. Central. Founded Sept., 24, 1923.

KFKA

Greeley, Colo. 249.9m-1200kc, 200 watts. Colorado State Teachers' College. Announcer, H. E. Green.

KFKB

Milford, Kan. 241.8m-1240kc, 2500-1500 watts. J. R. Brinkley, M. D. Daily ex Sun, 10:15-10:30 am, 12-1:30 pm. Daily ex Sun, Sat, 5-11 pm. Sun, 8 am, 10, 6-12 mid. Central.

KFKU

Lawrence, Kan. 254.1m-1180kc, 500 watts. University of Kansas. Announcer, Ellsworth C. Dent. Wed, Thurs, 7-8 pm. Sun, 3-4:45 pm. Founded Dec. 15, 1924. Central.

KFKX

Chicago, Ill. 526m-570kc, 2500 watts. Westinghouse Elec. & Mfg. Co. Daily ex Sat, Sun, 10 am, 11, 12, 1:30 pm, 3, 5:15, 5:30. Sat, 10 am, 11, 12 n, 5:15, 5:30. Central.

KFKZ

Kirksville, Mo. 225.4m-1330kc, 15 watts. State Teachers College. Announcer, F. M. Henry. Mon, 8:30-9:30 pm. Thurs, 8-9 pm. Founded 1923. Central.

KFLV

Rockford, Ill. 267.7m-1120kc, 100 watts. Rev. A. J. Frykman. Announcers, Oscar Olson, Paul Bodin. Wed, 8:15 pm. Sun, 10:40 am, 9:30 pm. Founded Oct., 1923. Central.

KFLX

Galveston, Texas. 270.1m-1110kc, 100 watts. George R. Clout.

KFMR

Sioux City, Iowa. 232.4m-1290kc, 100 watts. Morningside College. Daily ex Sun, Sat, 11:40-12:30 pm. Tues, Wed, Thurs, Fri, 7:30-8:30 pm. Founded 1924. Central.

KFMX

Northfield, Minn. 236.1m-1270kc, 500 watts. Carleton College. Daily ex Sun, 10:30 am, time. Fri, 8:15 pm, lecture, 8:45, 10, Sun, 7 pm. Central.

KFNF

Shenandoah, Iowa. 461.3m-650kc, 2000 watts. 6 am-7 pm. Henry Field Seed Co. Announcer, Henry Field. Slogan, "The Friendly Farmer Station." Daily ex Sun, 6-8:30 am, 11-1 pm, 1:30-2:15, 3:30-4:30, 5-7. Tues, 7:40-7:50 am. Sun, 8:30-9:30 am, 10:45, 2 pm, sermonette; 6. Founded Feb., 1924. Central.

KFOA

Seattle, Wash. 447.5m-670kc, 1000 watts. Rhodes Dept. Store. Announcer, Arthur W. Lindsay. Mon, 10 am-10 pm. Tues, 12-10 pm. Wed, 10 am-11 pm. Thursday, 12-10 pm. Fri, 10 am-12 mid. Sat, 12 m-10 pm. Sun, 1-9:30 pm. Pacific. Founded May, 1922.

KFON

Long Beach, Calif. 241.8m-1240kc, 500 watts. Nichols & Warinner, Inc. Announcer, Hal G. Nichols. Slogan, Piggly Wiggly Station. Daily and Sun, 8:30-10 am. Founded March, 1924. Pacific.

KFOR

Lincoln, Neb. 217.3m-1380kc, 100 watts. Howard A. Shuman. Daily ex Sun, 12-1 pm, 2-3:15, 6-7, 8-10. Fri, 11-1 am. Central. Founded March, 1924.

KFOX

Omaha, Neb. 258.5m-1160kc, 100 watts. Board of Education. Technical High. Daily ex Sun, Sat, 12-1:30 pm. Tues, 7:30-9 pm. Central.

KFPL

Dublin, Texas. 275.1m-1090kc, 15 watts. C. C. Baxter, announcer. Mon, Thurs, 8 pm. Sat, 11 pm. Sun, 7:30 am, 1:30 pm. Central.

KFPM

Greenville, Texas. 230.6m-1300kc, 15 watts. The New Furniture Co.

KFPR

Los Angeles, Calif. 232.4m-1290kc, 250 watts. Los Angeles Co. Forestry Dept. Irregular schedule.

KFPW

Cartersville, Mo. 263m-1140kc, 50 watts. St. John M. E. church, S. Sloggan, "Keeping Pace with Christ Means Progress." Daily ex Sun, 8-6 am, 1:30-2:30 pm. Sun, 1-2:30 pm. Central. Founded April 17, 1924.

KFPY

Spokane, Wash. 245.8m-1220kc, 250 watts. Symons Investment Co. Announcer, E. B. Craney. Daily ex Sat, Sun, 9:45-11 am. Mon, 5-9 pm. Tues, Wed, Thurs, Fri, 3-10 pm. Mon, 3-9 pm. Sun, 7:40-10:30 pm. Pacific. Founded 1922.

KFQA

St. Louis, Mo. 234.2m-1280kc, 1000 watts. The Principia. Sun, 8 pm. Founded May 9, 1924. Central.

KFQB

Fort Worth, Tex. 333.1m-900kc. 1000 watts. W. B. Fishburn, Inc. Announcer, Alva R. Willgus. Daily ex Sun, 10:30-11:30 am, 12:30-1:30 pm, 2:15-3:30-8:30, 9:30-11. Wed, 10:30-11:30 am, 12:30-1:30 pm. Sun, 11-12 n, 2-4 pm, 7:30-11. Central.

KFQD

Anchorage, Alaska. 344.6m-870kc. 100 watts. Anchorage Radio Club. Mon, Fri, 8-10 pm. Sun, 7:30-9 pm. Alaskan time.

KFQU

Holy City, Calif. 208.2m-1440kc. 100 watts. W. E. Riker. Announcer, Arthur J. Landstrom. Daily ex Sun, 6:30-7:30 pm. Tues, Fri, 9:30-11 pm. Wed, Thurs, Sat, 9-10 pm. Sun, 11-12 n, 10-11 pm. Pacific. Founded Nov., 1924.

KFQW

Seattle, Wash. 217.3m-1380kc. 100 watts. KFQW, Inc. Pacific. Announcer, Harry R. Long. Daily ex Sun, 11 am-12 mid. Sun, 4-5 pm, 5-7, 10-12. Pacific. Founded June, 1924.

KFQZ

Hollywood, Calif. 232.4m-1290kc. 250 watts. Taft Radio Company. Announcer, Allan Fairchild. Daily ex Sun, 12-1 pm, 5-6 pm, 6-11. Sun, 7-11 pm. Pacific.

KFRC

San Francisco, Calif. 454.3m-660kc. 1000 watts. Don Lee, Inc. Announcer, Harrison Hollway. Daily ex Sat, Sun, 7-9 am, 10-12 n, 12-1 pm, 3-12 mid. Sat, 7-9 am, 10-12 n, 12-1 pm, 2-12 mid. Sun, 10 am-12 n, 12-12 mid. Pacific.

KFRU

Columbia, Mo. 249.9m-1200kc. 500 watts. Stephens Bros. Announcer, La. V. Rail. Slogan, "Where Friendliness Is Broadcast Daily." Daily ex Sun, 8:30-11:15 am, 3 pm, 6:30. Wed, 7:30-10 pm. Thurs, 7:30-11 pm. Sun, 7:30 am, 9:20, 10:45, 4 pm, 5, 7:30. Founded October 25, 1925. Central.

KFSB

San Diego, Calif. 440.9m-680kc. 500 watts. Airfan Radio Corp. Announcer, Tom Sexton. Daily ex Sun, 10-1:30 pm, 5:45-12 mid. Sun, 10-12:15 pm, 2-4, 8:30-12. Pacific. Founded Mar. 28, 1926.

KFSG

Los Angeles, Calif. 252m-1190kc. 500 watts. Daily ex Sun, 10:30-12:30 pm, 2:30-4:30. Tues, Wed, Sat, 6:30-9:30 pm. Thurs, Fri, 6:30-11 pm. Sun, 10:30-12:30 pm, 2:30-4:30, 6:30-11 pm. Pacific.

KFUL

Galveston, Texas. 258.5m-1160kc. 500 watts. Thomas Goggin & Bros.

KFUM

Colorado Springs, Colo. 483.6m-620kc. 1000 watts. Corley Mountain Highway. Announcer, Edgar Laughlin. Mon, 5-7 pm, 10-12. Tues, 8-10 pm. Thurs, 8-12 mid. Fri, 10-12 mid. Sat, 8-10 pm. Mountain.

KFUS

St. Louis, Mo. (Tr. at Clayton.) 545.1m-550kc. 1000 watts. Concordia Theological Seminary (Lutheran). Announcer, Herm. H. Hohenstein. Mon, Tues, Wed, Fri, 6 pm. Sun, 3:30 pm, 4, 9:15. Founded Dec. 14, 1924. Central.

KFUP

Denver, Colo. 227.1m-1320kc. 100 watts. Fitzsimons General Hospital, Educational and Recreational Dept. Announcer, Major Transue. Daily ex Sat and Sun, 10-11 am. Tues, Thurs, Fri, 7:30 pm. Mountain.

KFUR

Farmington, Utah. 225.4m-1330kc. 50 watts. Peery Building Co. Tues, Thurs, Sat, 9:50-11:50 pm, dance music. Mountain.

KFUS

Oakland, Calif. 208.2m-1440kc. 50 watts. The Gospel Radio.

KFUT

Salt Lake City, Utah. 249.9m-1200kc. 50 watts. University of Utah.

KFVD

Venice, Calif. 215.7m-1390kc. 250 watts. W. J. & C. McWhinnie. Announcer, Mrs. G. Webb. Daily ex Sun, 9:30-12 n, 4:30-6 pm, 9-12 mid. Wed, 12-2 am. Founded April, 1925. Pacific.

KFVG

Independence, Kan. 225.4m-1330kc. 50 watts. First Methodist Episcopal church. Announcer, R. W. Elliott. Slogan, "The Voice of Southeastern Kansas from Independence, the Buckle on the Oil Belt." Tues, 8 pm. Sun, 10:55 am, 7:30 pm. Founded Mar. 1925. Central.

KFVI

Houston, Texas. 238m-1260kc. 50 watts. KFVI Broadcasting Company. Announcer, Harry Waters. Daily ex Sun, 1-2 pm. Mon, Wed, Sat, 8-9:30 pm. Founded 1925. Central.

KFVS

Cape Girardeau, Mo. 223.7m-1340kc. 50 watts. Hirsch Battery & Radio Co. Announcer, W. W. Watkins. Slogan, "The City of Opportunity." Daily ex Sun, 12-15 pm, news, markets, 6:45; music. Sun, 11 am. Founded May 27, 1925.

KFWB

Hollywood, Calif. 352.7m-850kc. 1000 watts. Warner Brothers. Announcer, William "Bill" Ray. Daily ex Sun, 9:15 am-11 pm. Sun, 11 am, novelty program; 1 pm, music; 6:30-10. Pacific.

KFWC

Ontario, Calif. 247.8m-1210 kc. 100 watts. L. E. Wall. Announcer, Bert Elise Wall. Daily ex Sun, 4-6 pm, 7-11. Pacific.

KFWF

St. Louis, Mo. 214.2m-1400kc. 250 watts. St. Louis Truth Center. Slogan, "The Voice of Truth." Announcer, Rev. Charles H. Hartmann. Thurs, 10:45 am, 7:45 pm. Sun, 9 am, 10:45, 7:45 pm. Founded 1925. Central.

KFWI

San Francisco, Calif. 267-7m-1120kc. 500 watts. Radio Entertainments, Inc. Announcer, Glenhail Taylor. Mon, 8 am-11 pm. Tues, Wed, Thurs, Fri, 7 am-11 pm. Sat, 7 am-12:30 am. Sun, 7:50-11 pm. Pacific.

KFWM

Oakland, Calif. 236.1m-1270kc. 500 watts. 1000 6 am-6 pm. Oakland Educational Society. Announcer, G. R. Pollock. Mon, Tues, Thurs, Fri, Sat, 8-10 pm. Thurs, 12:30-1:15 pm, 2-4. Tues, Wed, Fri, 2-3 pm. Tues, 12:30-1:15 pm, 2-3. Sun, 9:30-11 am, 12:30-2:30 pm, 7:30-9, 10-11. Pacific.

KFWO

Avalon, Calif. 299.8m-1000kc. 250 watts. 53.07m-5650m. 100 watts. Major Lawrence Mott-Signol Corn. Slogan, Katalina for Wonderful Outings. Daily, 12:30-1:30 pm, 7:30-9. Tues, Fri, Sun, 5-6 pm. Pacific. Founded April, 1925.

KFXD

Jerome, Idaho. 204m-1470kc. 15 watts. KFXD Inc. Daily ex Sun, 12 n, Wed, Sat, 8-10 pm, Sun, 11:20-12:20 pm. Mountain.

KFXF

Denver, Colo. 282.8m-1060kc. 250 watts. Colorado Radio Corp. Announcer, W. D. Pyle. Slogan, "The Voice of Denver." Tues, Sat, Sun, 7-8 pm, 10-11 am. Thurs, 7-8 pm. Mountain.

KFXJ

Edgewater, Colo. 209.7m-1430kc. 50 watts. R. G. Howell. Slogan, "America's Scenic Center." Daily, 11-2 pm, 6-8. Sun, 12-1 pm. Mountain.

KFXR

Oklahoma City, Okla. 223.7m-1340kc. 50 watts. Exchange Ave. Baptist church. Mon, Wed, Fri, 8 pm. Sun, services. Central.

KFXY

Flagstaff, Ariz. 205.4m-1460kc. 25 watts. Mary M. Costigan. Announcer, Cecil J. Walters. Daily, 11 am, 3 pm, 6. Sun, 12-1 pm. Mountain.

KFYO

Breckenridge, Tex. 211.1m-1420kc. 15 watts. Kirksey Brothers Battery & Elec. Co. Daily ex Sun, 10:30-11:30 am, 12-1 pm, 8-10. Sun, 8-10 pm Central. Founded Feb. 19, 1927

KFYR

Bismarck, N. D. 249.9m-1200kc. 250 watts. 500 6 am-6 pm. Hoskins-Meyer, Inc. Announcer, E. Dirlam. Daily ex Sun, 9:30-10:30 pm, 6:30-8:30 pm. Tues, Thurs, 10-11 pm. Sun, 10:30-12 n, 1-3 pm. Founded Dec. 1925.

KGA

Spokane, Wash. 260.7m-1150kc. 2,000 watts. Northwest Radio Service Co. Announcer, Albert Ely. Daily ex Sun, 9, 11 am; 12, news; 12:15 pm, 5-15, kiddies program; 6 time; 6:15-10 pm, 10-12. Sun, 11 am, 7:30. Pacific.

KGAR

Tucson, Ariz. 234.2m-1280kc. 100 watts. Tucson Citizen. Announcer, Harold S. Sykes. Tues, Fri, 8-9 pm. Sun, 11 am, 7:30-9 pm. Installed June, 1925. Mountain.

KGBU

Ketchikan, Alaska. 399.8m-750kc. 500 watts. Alaska Radio & Service Co. Announcer, Jack Ryno. Slogan, "The Voice of Alaska." Daily ex Wed, 11-1 pm, 7-8:30. Tues, Thurs, 8:30-10 pm. Sat, 10-12 mid. Alaskan time.

KGBX

St. Joseph, Mo. 288.3m-1040kc. 100 watts. Foster-Hall, Inc. Announcers, R. D. Foster, R. L. Hill. Daily ex Sun, 7-8 am, 12-1 pm. Mon, 5-6 pm. Wed, 5-7 pm. Tues, Thurs, Fri, 6-10 pm. Sun, 7:30 pm. Founded August 11, 1926. Central.

KGBY

Columbus, Neb. 222.1m-1350kc. 50 watts. Ervin Taddiken. Mon, 12-1 pm, 6. Tues, 12 n, 8 pm. Wed, 12 n, 8 pm. Thurs, 12 n, 6 pm. Fri, 12 n, 8 pm. Sat, 12. Sun, 2:30 pm. Central. Founded Aug. 1926.

KGBZ

York, Neb. 212.6m-1410kc. 250 watts. Announcer, Dr. George R. Miller. Slogan, "Keep Your Hogs and Poultry Healthy." Mon, Tues, Wed, Thurs, Fri, Sat, 5:30 am, 9. music, 12:30, 2:30, 7:30. Thurs, Sat, 10:30-11:30 pm, music. Alternate Sun, 11 am, 7:30 pm, service. Opened Aug., 1926. Central.

KGCA

Decorah, Ia. 247.8m-1210kc. 10 watts. Ben Bear Clothing Company.

KGCB

Oklahoma City, Okla. 215.7m-1390kc. 50 watts. Wallace Radio Institute. Daily ex Sun, 10 am, 5 pm, 9-12. Central.

KGCH

Wayne, Nebr. 293.9m-1020kc. 250 watts. Wayne Hospital. Announcer, M. Shum. Slogan, "Remember Us When It's R. H." Daily ex Sat, Mon, 6:30 pm. Tues, Thurs, 4-5 pm. Sun, 2:30 pm. Founded Aug., 1926. Central.

KGCI

San Antonio, Texas. 220.4m-1360kc. 100 watts. Liberty Radio Sales.

KGCL

Seattle, Wash. 230.6m-1300kc. 100 watts. Louis Wasmer, Archie Taft. Announcer, Heriman Rice. Mon, Wed, Thurs, 6:30-7:30 pm, 8:30-11. Tues, Fri, Sat, 3-7:30 pm. Pacific.

KGCN

Concordia, Kan. 208.2m-1440kc. 50 watts. Concordia Broadcasting Co. Daily ex Sun, 12:30-1:30 pm, 7-9. Founded Aug. 1926. Central.

KGCR

Brookings, S. D. 208.2m-1440kc. 15 watts. Cutler's Radio Broadcasting Service, Inc.

KGCU

Mandan, N. D. 239.9m-1250kc. 100 watts. Mandan Radio Assn. Announcers, H. L. Dahmgers, C. E. Basley. Daily ex Sun, 7-8:30 am, 10-11, 12-1:30 pm, 6:30-8. Mon, 11 pm-1:30 am. Sun, 11-12 n, 4:30-6:30 pm. Mountain. Founded 1925.

KGCX

Vida, Mont. 243.8m-1230kc. 10 watts. First State Bank of Vida. Announcer, E. E. Krebsbach. Daily ex Sun, 12:30-1:30 pm. Sun, 2-4 pm. Mountain. Founded Oct. 1, 1926.

KGDA

Dell Rapids, S. D. 254.1m-1180kc. 6 am-6 pm, 15 watts. Home Auto Co. Sun, 10-11 am, 1:30-3 pm. Central.

KGDE

Barrett, Minn. 205.4m-1460kc. 50 watts. Jaren Drug company. Daily ex Sun, 12:30 pm, musicale; 1. news, weather, markets; 4:30-7, musicale. Sun, 10:30-3 pm, 6-8. Licensed Sept. 15, 1926. Central.

KGDM

Stockton, Calif. 217.3m-1380kc. 10 watts. Peffer Music Co. Daily ex Sun, 10-11:30 am, 2-3 pm. Thurs, Sat, 8-10 pm. Pacific. Founded Jan. 1, 1927.

KGDP

Pueblo, Colo. 223.7m-1340kc. 10 watts. Boy Scouts of America. Tues, 8 pm. Thurs, 9 pm. Mountain.

KGDR

San Antonio, Texas. 206.8m-1450kc. 15 watts. Joe E. McShane.

KGDW

Humboldt, Nebr. 293.9m-1020kc. 100 watts. Frank J. Rist. Announcer, C. M. Hecht. Mon, Sat, 7:30 pm. Tues, Wed, Fri, 11:30 am. Thurs, 8:30 pm. Central. Founded Nov., 1926.

KGDY

Oldham, S. D. 206.8m-1450kc. 15 watts. J. Albert Loesch. Thurs, 7:45-11 pm. Central. Founded Dec. 26, 1926.

KGEF

Los Angeles, Calif. 263m-1140kc. 500 watts. Trinity Methodist church. Announcer, E. C. Huckabee. Daily ex Sat, 6-10 pm. Sun, 10:45-12:30 pm, 5-6, 7-10:30. Pacific. Founded Dec. 26, 1926.

KGEK

Yuma, Colo. 263m-1140kc. 10 watts. 7 am-7 pm. Beehler Electrical Equipment Co.

KGEM

El Centro, Calif. 225.4m-1330kc. 15 watts. E. R. Irey and F. M. Bowles. Daily ex Thurs, Sun, 12:15-1:15 pm. Mon, Wed, Fri, 5:30-6:30 pm. Tues, Sat, 8-9 pm. Thurs, 9-11 pm. Pacific.

KGEO

Grand Island, Nebr. 205.4m-1460kc. 100 watts. Hotel Yancey. Mon, Wed, Sat, 8-9 pm. Tues, Fri, 12:25-12:55 pm. Sun, 2-4 pm. Central.

KGEG

Minneapolis, Minn. 204m-1470kc. 50 watts. Fred W. Herrmann.

KGER

Long Beach, Calif. 215.7m-1390kc. 100 watts. C. Merwin Dobyns. Daily, 9-12 mid. Pacific. Founded Dec. 19, 1926.

KGES

Central City, Neb. 204m-1470kc. 10 watts. Central Radio Elec. Co.

KGEW

Fort Morgan, Colo. 218.8m-1370kc. 100-200 watts. City of Fort Morgan. Announcer, Glenn S. White. Daily ex Sat, Sun, 5:15-5:45 pm, markets. Tues, Thurs, 8-10 pm. Sat, 12-1 pm, 8-10. Sun, 11-12n, 2-4 pm. Mountain. Founded Jan. 15, 1927.

KGEZ

Kalispell, Mont. 293.9m-1020kc. 100 watts. Flair-head Broadcasting Assn. Announcer, John E. Parker. Daily ex Sun, 12-1 pm. Thurs, 7:30-9 pm. Sun, am, 7:30 pm, services. Mountain. Founded Feb. 20, 1927.

KGFB

Iowa City, Iowa. 223.7m-1340kc. 10 watts. A. G. Dunkel.

KGFF

Alva, Okla. 205.4m-1460kc. 25 watts. Earl E. Hampshire. Irregular schedule.

KGFG

Oklahoma City, Okla. 215.7m-1390kc. 50 watts. Full Gospel Church.

KGFH

La Crescenta, Calif. 263m-1140kc. 250 watts. Frederick Robinson. Announcer, Formosa H. Robinson. Slogan, "Voice of the Sierras." Mon, Tues, Wed, Fri, 8-10 pm. Pacific. Founded Feb. 7, 1927.

KGFI

San Angelo, Tex. 220.4m-1360 kc. 15 watts. Ragsdale Auto Co. Daily ex Sun, 12 n, 3 pm, 8-10 pm. Sun, 10:45 am, 7:45 pm, sermons. Central.

KGFJ

Los Angeles, Calif. 212.6m-1410kc. 100 watts. Ben S., McClashan. Slogan, "Keeping Good Folks Joyful." Daily ex Sun, 6:30-9:30 am, 12-4:30 pm, 6-9. Daily ex Sat, 12-6:30 pm. Sun, 12:01 am-6 pm, Pacific. Founded Jan. 18, 1927.

KGFK

Hallock, Minn. 223.7m-1340kc. 50 watts. Kittson County Enterprise.

KGFL

Raton, N. M. 222.1m-1350kc. 50 watts. Radio Trust Co.

KGFN

Aneta, N. D. 199.5m-1360kc. 15 watts. Haraldson & Thinsstad.

KGFO

Terre Haute, Ind. 204m-1470kc. 100 watts. KGFO, Inc.

KGFW

Ravenna, Nebr. 296.9m-1010kc. 10 watts. Otto E. Sotherman, Announcer R. H. McConnell. Slogan, "Greeting to the Home Folks." Daily ex Sun, 8-9 am, 11:45-12:15 pm, 3:15-4:15. Central.

KGFX

Pierre, S. D. 254.1m-1180kc. 200 watts. 6 am-6 pm. Dana McNeil. Daily ex Sun, 12-15 pm, news, weather. Central.

KGGF

Picher, Okla. 206.8m-1450kc. 100 watts. Dr. D. L. Connell. Daily ex Sun, 7:30-8:30 pm, 8:30-9:30. Central. On air Sept. 1, 1927.

KGGH

Cedar Grove, La. 212.6m-1410kc. 50 watts. Bates Radio & Elec. Co. Announcer, A. J. Bates. Mon, Wed, Fri, 7-9 pm. Central. Founded Sept. 15, 1927.

KGGM

Inglewood, Calif. 204m-1470kc. 100 watts. Jay Peters, Portable. Founded Nov. 1, 1925.

KGHA

Pueblo, Colo. 209.7m-1430kc. George H. Sweeney and N. S. Walpole.

KGHB

Honolulu, H. I. 227.1m-1320kc. 250 watts. Radio Sales Co. Announcer, Gaylord Byron. Mon, Tues, Wed, Fri, 9-10 am, 11:50-12 pm, 3:30-5, 6-10. Thurs, 9-10 am, 11:30-1 pm, 3:30-5, 6-7. Sat, 9-10 am, 11:30-1 pm, 3:30-5, 8-12 mid. Sun, 10-12 n, 6-10 pm. 157 1/2 meridian, 2 1/2 hours earlier than Pacific. Founded Sept. 28, 1927.

KGHC

Shayton, Minn. 209.7m-1430kc. 15 watts. Hegstad Radio Co.

KGHF

Pueblo, Colo. 209.7m-1430kc. 250 watts. Philip G. Lasky & J. H. Albert. Announcer, M. E. Gorman. Slogan, "Voice of the Rockies." Daily ex Sun, 9:30-10 am, weather, road reports; 12 n, markets; 2-6 pm, music; 7, police report; 7:30-11, Sun, 11 am, service. Mountain.

KGHP

Hardin, Mont. 263m-1140kc. 50 watts. American Legion, Hardin Post, No. 8.

KGO

Oakland, Calif. 384.4m-780kc. 5000 watts. Gen. Elec. Co. Announcer, Howard I. Milholland. Daily ex Sun, 11:30 am, 1 pm, weather, stocks; 6:55-8:55, dinner concert; 9:55, reports. Mon, 4-5 pm. Mon, 9 am, book review; 5:30, kiddies club; 8:9, grand opera, 9, time; Tues, 8-9 pm, Pilgrims; 9-10, Ever-ready hour; 10-11, Hits and Bits; Wed, 6:35 pm, farm; 8:9, vaudeville; 9-10, drama; 10-12, dance music; Thurs, 8-6 pm, Boy's hour; 8-9, 9-10, 10-11, Fri, 5:30-6 pm, 8-9, 9-10, 10-11, 11-12. Sat, 8-9 pm, 9-10, 10-11, 11-12. Sun, 11 am, 7:30 pm, services; 4, vester, 5:30-6:30, 6:30-7:30, 9, 9-10. Pacific.

KGRC

San Antonio, Texas. 220.4m-1360kc. 100 watts. Paramount Radio Co. Announcer, L. G. Weber. Daily ex Sun, 8:30-9:30 am, 2-3 pm. Mon, Sat, 2:30-9:30 pm, Wed, 9:30-10:30 pm, Fri, 7:30-8:30 pm, Sun, 1-2 pm. Central. Opened Jan. 31, 1927.

KGRS

Amarillo, Texas. 243.8m-1230kc. 250 watts. Gish Radio Service. Announcer, L. B. Cornelius. Daily ex Sun, 6:30 am, 10, 11:45, 6:30. Mon, Wed, Fri, 9 am, Sun, 11 am, 7:30 pm. Central.

KGTT

San Francisco, Calif. 220.4m-1360kc. 50 watts. Glad Tidings, Temple and Bible Institute. Daily ex Sun, 12:30 pm, scripture reading, Tues, Wed, Fri, 8-10 pm, Wed, 2:30-4 pm, Divine healing service, Sun, 2:30-3 pm, Sunday school, 3-5, service; 7:30-10, service. Pacific. Founded Nov. 1925.

KGU

Honolulu, Hawaii. 270.1m-1110kc. 600 watts. Marion A. Mahoney, Announcer, Homer Tyson. Daily, 12-1 pm. Daily ex Sun and Sun, 5-6 pm, Mon, Tues, Thurs, 7:30-9:30 pm, Fri, 8-9:30 pm. Sat, 2-4:30 pm, sports, 5:15, meridian, 2 1/2 hours earlier than Pacific. Founded May 11, 1922.

KGW

The Wood, Ore. 490 m-610kc. 1600 watts. Oregonian Publishing Co. Announcer, Dick Haller. Slogan, "Kegs, Kegs, Kegs." Daily ex Sun, 12:30-1:30 am, noon prayer, hot chili help; 6-7, concert; 7-8, Mon, 9-11 pm, news; 9:55-10 am, exercises; 2-9 pm, 3-11 pm, Wed, 9-10 pm, 10-12, Thurs, 7:30-9:45 pm, amusement guide; 7:45-8, lecture, 9-10, Fri, 9:45-10 am, exercise; 7-9, 9-12 pm, Sun, 10-12 mid. Pacific.

KGY

Bozoy, Wash. 247.1m-1230kc. 50 watts. St. Martin's College. Announcer, Sebastian Ruth. Slogan, "Out Where the Cedars Meet the Sea." Sun, Tues, Thurs, 8:30-9:30 pm. Pacific. Opened April 5, 1922.

KHJ

Los Angeles, Calif. 329.9m-590kc. 1000 watts. Don Lee. Daily ex Sun, 8 am, 9, time; 9:30, stories; 12:30, news; 1:30-1:45 am, Sun, 7:30 am, concert; 10:30, service; 1-10. Pacific.

KHMC

Hartington, Tex. 236.1m-1240kc. 120 watts. Har-Announcer, N. R. Burns, M. S. Niles. Slogan, "Down in the Valley." Daily ex Sun, 1 pm, weather; 2:30-4, Mon, Wed, Fri, 7-9 pm, Sat, 8-10 pm, Central. Founded Feb., 1927.

KHQ

Spokane, Wash. 370.2m-810kc. 1000 watts. Louis Wasmer, Inc. Announcer, C. P. Underwood. Slogan, "Tells the World." Daily ex Sun, Wed, 12:30-1:30 pm, 3-4, 6-12 mid, Wed, 7-10 pm. Sun, 10:30 am, 11, 2-10 pm. Pacific.

KIAF

Sihitpor, Minn. 422.3m-710kc. 500 watts. Steele Co. Slogan, "Far from the Madding Crowd." Nov, Wed, Fri, 7-8 pm, Sun, 2-3 pm. Central.

KICK

Red Oak, Iowa. 322.4m-930kc. 100 watts. Atlantic Automobile Co. Operated by Walnut Grove Products Co. Announcer, H. A. Marshall. Daily ex Sun, 10 am-1 pm, 4-6, Founded 1923. Central.

KIOS

Fogene, Ore. 201.2m-1490kc. 50 watts. Eugene Broadcast Station. Announcer, Curtis Phillips. Daily ex Sun, 7-10 am, 12:15-1 pm, 3-4, 6-8, Sun, 11-12:30 pm, 2-4, 7:30-9:30. Pacific. Founded Jan. 1, 1927.

KJBS

San Francisco, Calif. 220.4m-1360kc. 100 watts. Julius Brunton & Sons Co. Announcer, Carl Christiansen. Daily ex Sun, 9-12 n, 1:30-7:30 pm. Mon, Wed, Thurs, 8-10 pm. Tues, Fri, 8-11 pm, Sun, 1:30-6 pm. Pacific. Founded Jan., 1925.

KJR

Seattle, Wash. 348.6m-860kc. 2500 watts. Northwest Radio Service Co. Daily ex Sun, 9 am-12 mid. Sun, 9 am, 10, 11, 2:30 pm. 6:15-7:15, 7:15, 7:30, 9. Pacific. Opened July 2, 1920.

KKP

Seattle, Wash. 202.6m-1480kc. 15 watts. City of Seattle. Daily, 10 pm. Pacific. Opened Dec., 1926.

KLCN

Blytheville, Ark. 285.5m-1050kc. 6 am-6 pm. 50 watts. Edgar G. Harris.

KLDS

Independence, Mo. 270.1m-1110kc. 1500 watts. Reorganized Church of Jesus Christ of Latter Day Saints. Midland Broadcasting Co. Announcer, Dr. F. H. Criley. Tues, 6:30 am, 7, 7:30 pm. Fri, 6:30 am, 7, Sat, 8:30 pm, Sun, 8:30 am, 9, 10, 6 pm, 7:15, 10. Central. Founded 1921.

KLIT

Portland, Ore. 199.9m-1500 kc. 10 watts. Lewis I. Thompson.

KLS

Oakland, Calif. 245.8m-1220kc. 250 watts. Warner Bros. Radio Supplies.

KLX

Oakland, Calif. 508.2m-590kc. 500 watts. Oakland Tribune. Announcer, Charles Lloyd. Slogan, "Where Rail and Water Meet." Daily ex Sun, 10 am, woman hour, 11:30, luncheon concert; 3:30, 4:30, 5:30, 6:30, dinner concert; 7, news. Daily ex Sun, Sat, 8, program, Sun, 4-6 pm. Pacific. Founded Nov. 20, 1922.

KLZ

Denver, Colo. 352.7m-850kc. 750-1000 watts. Reynolds Radio Co. Announcer, Julian C. Riley. Slogan, "Pioneer Broadcasting Station of the West." Daily ex Sun, 9 am-6 pm. Mon, 7:30-9:30 pm, Tues, Wed, 7:30-10 pm, Fri, 7:30-11:30 pm, Sat, 7:30-12 mid, Sun, 7-11 pm. Mountain. Founded 1919 as 9ZAF.

KMA

Shenandoah, Iowa. 394.5m-760kc. 1000 watts. May Seed & Nursery Co. Announcer, Earl E. May. Daily ex Sun, 6-7 am, 9-10, 11-1 pm, 2-4 pm. Daily ex Sun, Mon, 5-8:30 pm. Mon, 5-10:30 pm. Sun, 8-9 am, 11, 12:15-2:30 pm, 4-6, 6-7. Central. Founded Jan., 1925.

KMBC

Kansas City, Mo. 270.1m-1110kc. 1500 watts. Midland Broadcast Central. Announcer, Arthur B. Church. Daily ex Sun, 9 am, homemakers' hour; 9:30, music; 10, markets; 10:30, organ; 11, markets; 12 n, news, weather, markets; 12:15 pm, music; 4:10, news; 7, news and talks; 7:30, musicale; 8-10, Sun, Mon, Wed, Fri, 8-10 pm, Columbia chain, Tues, Thurs, Sat, 10 pm, entertainment; 10:30, features; 11:30, dance music, Tues, Sat, night club, Sun, 11 am, 2-4 pm, Columbia chain, 5, 8. Founded April, 1922. Central.

KMED

Medford, Ore. 270.1m-1110kc. 50 watts. W. J. Virgin. Daily ex Sun, 10-11 am, 12:15-1:15 pm, 6:15, Mon, Tues, Wed, Fri, 10 pm, entertainment; 11-11:30 pm, Sun, 11-12 n, 8:9:15 pm. Pacific. Founded Dec. 22, 1926.

KMIC

Inglewood, Calif. 223.7m-1340kc. 250 watts. J. R. Pooch. Mon, Tues, Wed, Fri, 7 am-8 pm, 10-12. Thurs, Sat, 7 am-12 mid. Sun, 11-12:15 pm, 8:30-10. Pacific. Founded Jan. 10, 1927.

KMJ

Fresno, Calif. 365.6m-820kc. 50 watts. Fresno Post. Announcer, W. F. Bragg. Mon, Wed, Fri, 7:15-10 pm. Tues, Thurs, 9-10 pm. Sat, 9:15-12 mid. Pacific. Founded Oct. 1, 1922.

KMMJ

Clay Center, Neb. 285.5m-1050kc. 250-500 watts. M. M. Johnson Co. Daily ex Sun, 7:30 am, 10, 11, 12:30, L. S. livestock market; 1:30 pm, 7, 8, Sun, 9 pm. Tues, silent. Founded 1925. Central.

KMO

Tacoma, Wash. 254.1m-1180kc. 500 watts. KMO, Inc. Announcer, Carl E. Raymond. Mon, Tues, Wed, Thurs, 10-11 am, 2-3 pm, Mon, 7-9:30 pm. Tues, 9-12:30 am, Wed, Thurs, Fri, 8-10 pm. Sat, 10-11 am, 2-3 pm, 6-7, 9-11, Fri, 10-11 am, 2-3 pm. Sun, 10:30-12 mid., 6-7, 7:30-9. Pacific. Founded Aug. 25, 1926.

KMOX

St. Louis, Mo. 299.8m-1000kc. 5000 watts. The Voice of St. Louis. Announcer, George Junkin. Daily ex Sun, 9:40 am, markets; 9:55, safety program; 10:45 pm, talks; 11:15, music; 12 n, farm. Hash; 1 pm, orchestra; 2, lecture; 2:30, studio program; 5, markets; 6, children's club; 6:30, program. Mon, Wed, Fri, 8 pm, Columbia chain; 10-11 am, dance music. Tues, Thurs, 8 pm, 10-11 am. Sun, 2 pm, 4 pm, S. Central. Founded Dec. 18, 1925.

KMTR

Los Angeles, Calif. 526m-570kc. 500 watts. KMTR Radio Corp. Announcer, G. Allison Phelps. Daily ex Sun, 7:30 am, exercises; 7:30-8:30, 8:45-9, time; 11, 1:30-2:30 pm, 5:30-11. Pacific. Installed June, 1925.

KNRC

Santa Monica, Calif. 374.8m-800kc. 500 watts. Keiruff & Ravenscroft Co. Announcers, R. L. Rust, Margaret M. Shontz. Daily ex Sun, 1:30-4:30. Tues, 4:30-6 pm. Sun, 10:45 am, 2:30-4 pm, 5-9. Installed 1921. Pacific.

KNX

Los Angeles, Calif. 336.9m-890kc. 500 watts. West-crn Broadcast Co. Announcer, "Town Crier." Daily ex Sun, 6:45 am, exercises; prayer; 8:55, time; 9, news; 10, Town Crier; 10:30, economies; 1:30 pm, look talk; 2-4, 4:55, markets; 5, 5:30, music; 5:45, Town Crier; 6:30, dinner music. Mon, Tues, Wed, Thurs, Fri, 7-12 midnight. Sat, 7-2 am. Sun, 10-12:30 pm, church service; 12:45-1:45, 2-4, 6:30-9, 9-10:30. Installed Oct. 11, 1924. Pacific.

KOA

Denver, Colo. 325.9m-920kc. 2500 watts. 6 am, 7 pm. 5000 watts. General Elec. Co. Announcer, Freeman Talbot. Daily ex Sun, 11:45 am, weather, markets; 12:05 pm. Daily ex Sat, Sun, produce. Daily ex Sun, 12:05 pm, organ. Tues, 8 pm, bridge; 8:30, dance. Tues, Thurs, Fri, 3:30, housewives matinee. Thurs, 4 pm. Daily ex Sat, Sun, 6 pm, stocks, markets, produce, news, bulletins. Mon, 7:30 pm, Appreciation hour. Tues, farm question box; 7:30 pm, Wed, 7:30 pm, Tiny Town tales. Fri, 7:30 pm, S. S. lesson. Mon, Wed, Fri, 8 pm, orchestra; 8:15 pm, regular program. Wed, Fri, 10-11 pm, dance program. Sat, 9 pm, dance. Sun, 11 am, 4-7:30 pm, service; 5:30 pm, music. Founded Dec. 15, 1924. Mountain.

KOAC

Corvallis, Ore. 270.1m-1110kc. 500 watts. Oregon Agricultural College. Announcer, W. L. Kaddyly. Mon, Tues, Wed, Thurs, Fri, 7 pm. Pacific. Founded Dec., 1922.

KOB

State College, N. M. 394.5m-760kc. 7500 watts. 6 am-10 pm. 5000 watts. N. M. College of Agr. & Mech. Arts. Announcer, Robert Stewart. Slogan, "The Sunshine State of America." Daily 11:55-1 pm, time, weather, markets, road reports, news; music; 9:55-10:10, time, weather, road reports. Mon, 7:30-8:30 pm, farm program. Wed, Fri, 7:30-8:30 pm, music. Founded 1920. Mountain.

KOCH

Omaha, Neb. 258.5m-1160kc. 250 watts. Central High School. Announcer, Wilbur Cramer. Tues, Wed, Thurs, Fri, Sat, 6-10 pm. Sun, 10-12 n, 7-9 pm. Founded 1923. Central.

KOCW

Chickasha, Okla. 252m-1190kc. 250 watts. Okla. Chickasha Broadcasting Co. Slogan, "The Friendly Station in a Friendly Town." Daily ex Sun, 9-10 am, 12-1 pm, 12-12 mid. Sun, 10-10:50, 7:30-8:30, service. Central. Founded Nov., 1922.

KOIL

Council Bluffs, Ia. 319m-940kc. 5000 watts. Mona Motor Oil Co. Daily ex Sun, 8-9 am, musicale; 10-11, Aunt Sammy; 12:30-2 pm, musicale; 3-4, 5:30, 5:30-6, 7-8, 9-10, 11-12, 12-1. Central. Founded July 10, 1925.

KOIN

Portland, Ore. 319m-940kc. 1000 watts. KOIN, Inc. Announcer, Paul H. Connet. Daily ex Sun, 10 am, 11 am, 12 n, 3, 5:15, 6, 7, 7:15, 8-9, 9-10, Sat, 11-1 am, Tues, Thurs, 10-11 pm. Mon, Wed, Fri, 10-11:30 pm. Sun, 3-4:30 pm, 6-7 pm, 7:50, 9. Pacific. Founded April, 1926.

KOMO

Seattle, Wash. 309.1m-790kc. 1000 watts. Fisher's Blessing Station, Inc. Announcer, Robert Nichols. George Nelson. Daily ex Sun, 10 am-12:30 am, 10, inspirational; 10:15, health exercises; 10:30, home economics; 11, vocalists; 12 n, farm talks; 12:15, organ; 1:15, orchestra; 5:15, children's program; 5:45, stocks and bonds; 6, news; 6:15, orchestra; 9, Nat. B. C.; 10, program; 10:30, news; 10:45, dance orchestra. Sun, 10 am-11 pm. Pacific. Founded Dec. 31, 1926.

KOW

Denver, Colo. 218.8m-1370kc. 250 watts. The Associated Industries Broadcasting. Daily ex Thurs, 7-9 pm. Sun, 11-12 n, 6-7 pm, 7:30-9. Mountain.

KPCB

Seattle, Wash. 330.6m-1300kc. 100 watts. Pacific Coast Biscuit Co. Announcer, L. D. Greenway. Daily ex Sun, 9:30-9:50 am, recipe; 7:30-8:30 pm. Mon, Wed, 5:30-6 pm, 6, sports. Tues, 8:30-10 pm. Fri, 8:30-9:30 pm. Sat, 8:30-9:30 pm. Pacific. Founded April 1, 1927.

KPJM

Prescott, Ariz. 214.2m-1400kc. 15 watts. Frank Wilburn. Irregular hours, news, sports.

KPLA

Los Angeles, Calif. 288.3m-1040kc. 500 watts. Pacific Development Radio Co. Announcer, Winton Cotton. Daily, 11 am-11 pm. Sun, 7-10 pm. Pacific. Founded March, 1927.

KPNP

Muscataine, Iowa. 211.1m-1420kc. 100 watts. Central Radio Co. Wed, 9:20-10:20 pm. Central.

KPO

San Francisco, Calif. 422.3m-710kc. 1000 watts. Hiale Bros. and the Chronicle. Announcer, Curtis Peck. Slogan, "The Voice of San Francisco. The City by the Golden Gate." Daily ex Sun, 6:45-8 am, exercises; 8, music; 10:30, utility features; 12 n, time, weather. Daily ex Sun, 1:7-30 pm, concert, talks. Mon, Tues, Wed, Thurs, Fri, 8-12 mid. Fri, 12:45 pm, luncheon talks. Sun, 9:45-10:45 am, service; 1-5 pm, N. B. C.; 5:30-6:30, music; 6:30-7:30, N. B. C.; 7:30, organ; 8:30-10, orchestra. Pacific.

KPOF

Denver, Colo. 201.6m-1490kc. 500 watts. Pillar of Fire, Inc.

KPPC

Pasadena, Calif. 315.6m-950kc. 500 watts. Pasadena Presbyterian church. Announcer, Wm G. Anton Pohlman. Wed, 6:45-9 pm. Sun, 9:45 am, 12:30 pm, 6:45-9 pm. Founded Dec. 25, 1924. Pacific.

KPRC

Houston, Texas. 293.9m-1020kc. 500 watts. Houston Post-Dispatch. Slogan, "Kotton Port Rail Center." Announcers, Alfred P. Daniel, Ted Hills. Daily ex Sun, 10:55 am, time; 11, weather, markets; 12 n, entertainment, 3-4 pm, 6:10-10:45. Sun, 11 am, 8 pm, services. Founded May 8, 1925. Central.

KPSN

Pasadena, Calif. 315.6m-950kc. 1000 watts. Pasadena Star-News. Announcers, George Frenger, P. C. Fryor. Daily ex Sun, 12:15 pm, 6 pm, news. Tues, Thurs, Sat, 8-9 pm. Sun, 10:30-12:30 am. Installed Nov. 23, 1925. Pacific.

KQV

Pittsburgh, Pa. 270.1m-1110kc. 500 watts. Doubleday-Hill Elec. Co. Announcer, Howard E. Clark. Mon, Wed, Fri, 4-5 pm, 6-9. Tues, Thurs, 4-5 pm, 6-7. Sun, 1-2 pm. Eastern.

KQW

San Jose, Calif. 296.9m-1010kc. 500 watts. First Baptist church. Daily ex Sun, 1-3 pm, music; 5-5:30, children's hour; 5:30-6, studio program; 6, Aunt Sammy; 6:20-6:30, U. S. A.; 6:40, U. S. Farm Radio school; 6:50, Farmers exchange; 7, news, weather, markets; 7:20, farm topics; 7:30, mail bag; 7:40, talk; 7:55, riddles; 8, program. Sun, 10 am, 7:30 pm. Pacific.

KRAC

Shreveport, La. 220.4m-1360kc. 500 watts. Caddo Radio Club. Announcer, R. M. Dean. Irregular schedule.

KRE

Berkeley, Calif. 245.8m-1220kc. 100 watts. First Congregational Church of Berkeley. Pacific School of Religion. Daily ex Sat, Sun, 12:30-1 pm. Sun, 1-4 am. Pacific.

KRLD

Dallas, Texas. 461.3m-650kc. 500 watts. KRLD, Inc. Announcer, Arthur W. Stowe. Slogan, "Where the Bluebonnets Grow." Daily ex Sun, 11-11:30 am; 12:30-2 pm, 3:30-4, 5-6, 7-8, 9-10, 11-12. Sun, 9:30-10:30 am, 11-12, 1-4 pm, 5-7:30, 9:30-10:30, 11-13:30. Sat, 12 m-3 am. Central. Founded Oct 30, 1926.

KRSC

Seattle, Wash. 202.6m-1480kc. 500 watts. Radio Sales Corp. Announcer, William J. Calsamalia. Daily ex Sun, 9:10 am, 6-7:30 pm, 9-10:30 pm. Mon, Wed, Fri, 3:30-5 pm. Pacific.

KSAC

Manhattan, Kan. 333.1m-900kc. 500 watts. Kansas State Agricultural College. Announcer, Lisle L. Longsdorf. Daily ex Sat, Sun, 9:55 am, 9:55-10:30, 12:35 pm, 4:30, 6:30-8, 9-9:30, 12:30-1:30, 3:30-8:30. Central. Founded Dec. 1, 1924.

KSBA

Shreveport, La. 267.7m-1120kc. 1000 watts. Shreveport Broadcasting Assn. Announcer, W. G. Patterson. Daily ex Sun, 10:15 am, 12:15 pm, 3:15, markets, weather, news. Tues, Wed, Thurs, Fri, 6:30 pm, 8, Mon, 11 pm, Sat, 9 pm. Sun, 11 am, 7:30 pm. Central. Founded March 14, 1922.

KSCJ

Sioux City, Iowa. 243.8m-1230kc. 500 watts. 1000 6 am-6 pm. Perkins Brothers Co. Announcer, C. W. Corkhill. Daily ex Sun, 9:45 am, 10:12:15, stock, markets, weather; 11:30-12:30 pm, news, music; 1:45-3:45 pm, Mon, Tues, Wed, Fri, 6 pm. Mon, Fri, 11 pm, organ. Mon, 10:30 pm. Wed, 9 pm. Sun, 10:30 am, 2 pm, 7:10. Central. Opened April 4, 1927.

KSD

St. Louis, Mo. 545.1m-550kc. 500 watts. Pulitzer Pub. Co. Announcer, W. P. Corwin. Daily ex Sun, 9:40 am, 10:40, 11:40, 12:40, 1:40, 3:40. Mon, Tues, Thurs, Fri, 7-11 pm, Wed, 6:30-11 pm, Sat, 7-11 pm. Sun, 2-9:15 pm. Central. Founded June 24, 1922.

KSEI

Pocatello, Idaho. 333.1m-900kc. 250 watts. KSEI Broadcasting Assn. Announcer, W. J. O'Connor. Daily ex Sun, 3-4 pm, 6-8, 9-11. Sun, 9-11 pm. Mountain. Opened Jan., 1925.

KSL

Salt Lake City, Utah. 302.8m-990kc. 1000 watts. Radio Service Corp. of Utah. Announcers, Roscoe Grover, Lewis Lacey, Preston Iverson. Daily ex Sun, 7-8 am, 10-11 am, 12 n-1 pm, 4-5:30. Mon, Tues, Wed, 6-11:30 pm, Thurs, 6:30-11 pm, Fri, 5:30-11:30 pm, Sat, 6:30-12 mid. Sun, 11-1 pm, 1:55-3, 5-11:30. Mountain.

KSMR

Santa Maria, Calif. 272.6m-1100kc. 100 watts. Santa Maria Valley Railroad Company. Announcer, Sydney C. Peck. Daily ex Sat, Sun, 10:30-11 pm, 6-9:30 pm. Sat, 7:30 pm, markets. Pacific. Founded Dec. 3, 1925.

KSO

Clarinda, Iowa. 227.1m-1320kc. 500 watts. Berry Seed Co. Announcer, Joe Petersen. Slogan, "Serving Others." Daily ex Sun, 6:30-8 am, 12-1 pm, music talks. Daily ex Sun, 6:30-9 pm, Sun, 11-12 n; 5-6 pm. Founded Nov. 2, 1925. Central.

KSOO

Sioux Falls, S. D. 209.7m-1430kc. 250, 500 watts. Sioux Falls Broadcast Assn. Announcer, L. M. Austin. Daily ex Sun, 7-8 am, 12-1 pm, 5-6. Central. Founded 1922.

KSTP

St. Paul-Minneapolis, Minn. (tr. Wescott, Minn.). 220.4m-1360kc. 2000 watts. The National Battery Station. Slogan, "The Call of the North." Daily ex Sun, 10:30 am; 10:45, shopping news; 12, weather; 12-01, organ; 5, 5:30, 6:50, 6:55, farm flashes; 7, weather; 7:01, music; 7:30, 8, 8:30, 9, 10. Sun, 3 pm, 4, 9:30. Central. Founded May, 1924.

KTAB

Oakland, Calif. 280.2m-1070kc. 500 watts. The Associated Broadcasters. Announcers, Lytton Spaulding, R. M. Bitzer. Slogan, "Knowledge, Truth and Beauty." Daily ex Sun, 6:45-1:30 pm, 4-7:30, 8-11. Sun, 9:45-12:30 pm, 1:30-2:30, 7-8, 8-9:15. Pacific. Opened Aug. 1, 1925.

KTAP

San Antonio, Tex. 228.9m-1310kc. 20 watts. Robert B. Bridge, Alamo Broadcasting Co. Slogan, "Kum to America's Playground." Daily ex Sun, 6:30-8:30 am, 10:30-11:30, 12:30-2 pm, 6:30-8, 9:30-10:30. Mon, silent. Sun, 4-6 pm, 9:30-10:30. Central. Founded Sept. 15, 1927.

KTBI

Los Angeles, Calif. 275.1m-1090kc. 1000 watts. Herb Inst. of Los Angeles. Announcer, H. P. Bierman. Daily ex Sun, 8:45 am, 2 pm. Daily ex Sat, Sun, 7:15-9. Sun, 10:45 am, 3, 6 pm, 7:15-9:30. Pacific. Founded Sept., 1922.

KTBR

Portland, Ore. 228.9m-1310kc. 500 watts. M. E. Brown. Announcers, M. E. Brown, Sid Goodwin. Daily ex Sun, 6-7 pm, dinner program, markets. Mon, Tues, Thurs, Sat, 8-9 pm. Mon, 9-12 mid. Wed, 8-9:30 pm, 9:30-12. Fri, 8-10 pm, 10-12. Sun, 10:30 am, 2-4 pm, 7:30-9. Pacific. Opened Sept. 23, 1925.

KTHS

Hot Springs National Park, Ark. 384.4m-780kc. 1000 watts. The Arlington hotel. Announcer, G. C. Arnoux. Slogan, "Kum to Hot Springs." Mon, Tues, Thurs, Fri, 12-1 pm, 7:30-11. Wed, 7:30-11 pm, Sat, 12-1 pm, 7-10:30. Sun, 11-12:30 pm, 7:30-11. Installed Dec. 20, 1924. Central.

KTNT

Muscatine, Iowa. 256.3m-1170kc. 2000 watts. Norman Baker. Slogan, "The Home of the Calliophone and Voice of the Iowa Farm Union." Announcer, Norman Baker. LeRoy De Turk, Mable Albers, Charles Salisbury, Rene Bellows. Daily ex Sun, 6-7:30 am, 9-11, 12-1 pm, 2:30-5:30, 6:30-9. Sun, 12-1 pm, 2:30-4. Central. Founded 1924.

KTSA

San Antonio, Tex. 265.3m-1130kc. 2000 watts. Alamo Broadcasting Co.

KTUE

Houston, Tex. 212.6m-1410kc. 500 watts. Uhalt Electric. Announcer, Carlos Worley. Daily ex Sun, 2-3 pm. Sat, 8-9:30 pm. Central.

KTW

Seattle, Wash. 394.5m-760kc. 1000 watts. First Presbyterian church. Announcer, J. D. Ross. Slogan, "Hear Ye, Hear Ye, the Gospel." Sun, 11-12:30 pm, 3-4:30, 7-9:30, church service. Pacific.

KUJ

Seattle, Wash. 199.9m-1500kc. 100 watts. Puget Sound Radio Broadcasting Co. Mon, Wed, Fri, 8-9 pm. Sat, 6-12 mid. Pacific.

KUOA

Fayetteville, Ark. 296.9m-1010kc. 500 watts. University of Arkansas. W. S. Gregson. Daily ex Sun, 12-1 pm. Sun, Mon, 7-9 pm. Thurs, 7-9 pm. Central. Founded 1923.

KUOM

Missoula, Mont. 461.3m-650kc. 500 watts. University of Montana. Mon, Thurs, 8-9:30 pm. Sun, 9:15-10:30 pm, Mountain. Founded 1924.

KUSD

Vermillion, S. D. 483.6m-620kc. 250 watts. University of South Dakota. Announcer, Lyman Judson. Slogan, "South Dakota University for South Dakotans." Mon, Fri, 6:45-7:45 pm. Wed, 9-10 pm. Sat, 11 pm-1 am. Central.

KUT

Austin, Tex. 232.4m-1290kc. 500 watts. University of Texas. Announcer, J. G. Adams. Mon, Wed, 8 pm. Fri, 8 pm. Founded 1925. Central.

KVI

Tacoma, Wash. 282.8m-1060kc. 250 watts. Puget Sound Radio Broadcasting Co. Daily ex Sun, 8-10 am. Mon, Thurs, 3-9 pm. Wed, Sat, 3-10 pm. Sun, 11-12:30, 7:30-9. Pacific.

KVL

Seattle, Wash. 202.6m-1480kc. 100 watts. Arthur C. Dailley, Moore Hotel. Mon, Tues, Wed, Thurs, Fri, 6-10 pm. Pacific. Founded July 13, 1926.

KVOO

Tulsa, Okla. 348.6m-860kc. 1000 watts. Southwestern Sales Corp. Announcer, Billy Thompson. Daily ex Sun, 11 am, markets, 12-1 pm, 2-45 pm, 3-4, 6-12:30 am. Sun, 8 am-12 n, 12:45-1. N. B. C. Central. Opened Jan., 1925.

KVOS

Bellingham, Wash. 209.7m-1430kc. 250 watts. Mt. Baker Station.

KWBS

Portland, Ore. 199.9m-1500kc. 15 watts. Schaeffer Radio Co.

KWCR

Cedar Rapids, Iowa. 239.9m-1250kc. 250 watts. H. F. Pass. Slogan, "The Voice of Cedar Rapids." Daily ex Sun, 6:30 am, 11:30, 3:45 pm, 4, 4:30, 5, 6, 9, 10. Sun, 4 pm, 9:30. Central. Founded July 29, 1922.

KWEA

Shreveport, La. 212.6m-1410kc. 250 watts. William Erwin Anthony.

KWJ

Stockton, Calif. 344.6m-870kc. 500 watts. Portable Wireless Telephone Co. Announcer, George J. Turner. Slogan, "Voice of the San Joaquin Valley." Daily ex Sun, 4-5 pm, news, concert, markets, 6-6 pm, 6:30, 8-10, concert. Wed, Thurs, Sat, 10-11 am, dance music. Sun, 7:30-9:30 pm, service; 9:30-10:30, organ. Pacific.

KWJJ

Portland, Ore. 249.9m-1200kc. 500 watts. Wilbur Jernan. Slogan, "The Voice From Broadway." Daily ex Sun, 1-6 pm, 8-8, 8-10:30. Wed, 10:30-12 mid, 12-1. Sun, 12-1 pm. Pacific. Founded July 25, 1925.

KWK

St. Louis, Mo. 234.2m-1280kc. 2000 6 am-6 pm. 1000 watts. Greater St. Louis Broadcasting Corp. Announcer, Thomas Patrick Convey. Daily ex Sun, 9:30 am-11, shoppers' club; baseball, studio concert, 12 n-8 pm. Central.

KWKC

Kansas City, Mo. 222.1m-1350kc. 100 watts. W. G. Duane Studios. Announcer, Elmer C. Hode. Slogan, "Keep Watching Kansas City." Tues, Wed, Thurs, Fri, 7 pm, 9. Central. Founded 1925.

KWKH

Shreveport, La. 394.5m-760kc. 1000 watts. Henderson Iron Works & Supply Co. Daily ex Sun, Mon, 8-10-12 mid. Sun, 7:30-12 mid. Central. Founded Jan. 8, 1925.

KWLC

Decorah, Iowa. 247.8m-1210kc. 500 watts. Luther College.

KWSC

Fullman, Wash. 394.5m-760kc. 500 watts. State College of Washington. Announcer, Harvey Wixson. Mon, Wed, Fri, 7:30-9 pm, music, lectures. Pacific. Founded 1922.

KWTC

Santa Ana, Calif. 272.6m-1100kc. 100 watts. Dr. John Wesley Hancock. Mon, Wed, 5:30-7 pm. Tues, 8-10, 7-9. Thurs, 7:30-9. Sat, Fri, 5:30-9 pm. Sat, 5:30-9 pm. Pacific. Founded Nov. 15, 1926.

KWUC

Le Mars, Iowa. 243.8m-1230kc. 1500 watts. Western Union College. Announcer, Rex Frolkey. Daily ex Sun, 12:15 am, 12:15 am, 4, 5, 7. Wed, Sat, 10 pm. Central. Founded 1922.

KWWG

Brownsville, Texas. 277.6m-1080kc. 500 watts. Lone Star Broadcast Co. Inc. Slogan, "Good Night, World." Daily ex Sun, 9:30 am, 12 n, weather, markets, news; 4 pm, markets. Mon, Tues, Thurs, Fri, 7:30 pm. Wed, 12 mid. Central.

KXA

Seattle, Wash. 348.6m-860kc. 500 watts. American Radio Tel. Co.

KXL

Portland, Ore. 220.4m-1360kc. 100 watts. KXL Broadcasters. Announcer, A. R. Tritt. Slogan, "The Voice of Portland." Daily, 8 am-11 pm. Sat, 6 pm. Sun, 11 pm. Pacific. Founded Dec. 13, 1926.

KXRO

Aberdeen, Wash. 223.7m-1340kc. 500 watts. KXRO, Inc.

KYA

San Francisco, Calif. 361.2m-830kc. 1000 watts. Pacific Broadcasting Corp. Announcer, Chester E. Boone. Daily ex Sun, 8-12 n, 12, time, news; 5:30-10, Tues, Thurs, 10-11 pm. Sat, 10-11 am. Sun, 11 am, 7:30 pm, service. Pacific. Founded Dec. 18, 1926.

KYW

Chicago, Ill. 526m-570kc. 2500 watts. 5000 after 10 pm. Westinghouse Elec. & Mfg. Co. Announcer, Maurice Wetzel. Daily ex Sun, 6, bedtime story; 6:30, dinner concert; 7-9, WJZ; 9-10:30, program; 10:30, weather; 10:32, orchestra, Congress Carnival. Tues, Fri, 4-5 pm. Sun, 10:50 am, time; 11, service; 1 pm, WJZ; 2, 4:30, 7:15-8:35, Twenty Minutes of Good Reading; 8:35-9:15, Home Folks hour; 9:15, WJZ. Central.

KZIB

Manila, P. I. 249.9m-1200kc. 200 watts. I. Beck, Inc. Daily, 6:30-8 pm. Wed, 7:30-10:30 pm.

KZM

Oakland, Calif. 208.2m-1440kc. 100 watts. Western Radio Institute (Hotel Oakland). Announcer, Elbert Cowan. Daily ex Sun, 6:30-7:30 pm. Sun, 8-10 pm. Pacific. Founded June 29, 1921.

KZRM

Manila, P. I. 413m-726.1kc. 1000 watts. Radio Corp. of Philippines.

NAA

Washington, D. C. 434.5m-690kc. 1000 watts. United States Navy Dept. Daily and Sun, 10:05 am, 10:05 pm, weather; 10 am, 10 pm, time. Daily ex Sun, 3:45 pm, weather. Fri, 7:45-8 pm. Eastern.

WAAD

Cincinnati, Ohio. 230.6m-1300kc. 25 watts. Ohio Mechanics' Institute. Sat, 9:45 pm. Eastern.

WAAF

Chicago, Ill. 389.4m-770kc. 500 watts. Chicago Daily Provers Journal. Announcer, Carl Ulrich. Daily ex Sun, 8:45 am, 10:50, 11, 12:50 pm. Daily ex Sun, Sat, 4:30, live stock and weather reports. Central. Founded May 22, 1922.

WAAM

Feb. 1922.
Newark, N. J. 367.7m-1120kc. 250 watts. I. R. Nelson Company. Announcer, Jack Van Ripper. Daily ex Sun, 7-8 am, 11-1:30 pm, Tues, Wed, 6-8 pm. Fri, Sat, 8-10 pm. Mon, Thurs, 10-12 mid. Sat, 12-30 am-2:30 pm. Sun, 11 am-12:30 pm, 3:30-6:30. Eastern. Experimental call 2NBA 65.18m. Founded

WAAT

Jersey City, N. J. 245.8m-1220kc. 300 watts. Bremer Broadcasting Corp. Announcer, Joseph Goustin. Slogan, "The Voice at the Gate of the Garden State." Daily ex Sun, 10:30 am, housewives' hour; 6 pm, markets; 6:05, dinner music; 6:40, weather; 6:45, sports; 7, time. Mon, 8-2 am. Tues, 8-3 pm. Sat, 9 pm. Sun, 9-10:30 am, 12:30-4 pm, 8-11 pm. Eastern. Founded 1921.

WAAW

Omaha, Neb. 440.9m-680kc. 500 watts. Omaha Grain Exchange. Announcer, James Thompson. Slogan, "Pioneer Market Station of the West." Daily ex Sun, 6 am, 8, 9:30, 9:45, 10:15, 10:45, 11:15, 11:45, 12:15, 1:15, 1:35, 1:40, 2-6 pm. Founded 1921. Central.

WABC

Richmond Hill, N. Y. 309.1m-970kc. 5000-2500 watts. Atlantic Broadcasting Corp. Daily ex Sun, 1-3 pm, 4-11:30 or 12:30 am, Sun, 10:50-12 n, 4-10:30 pm. Eastern.

WABF

Kingston, Pa. 205.4m-1460kc. 250 watts. Markle Broadcasting Corp. Announcer, E. L. Jones. Slogan, "The Voice of the Station with a Message." Daily ex Sun, 12-1 pm, 6-7, Sun, 10:30-12, 7:30-9, 9-10:30. Eastern.

WABI

Bangor, Me. 389.4m-770kc. 100 watts. First Universalist church. Announcer, Prof. W. J. Cremer. Fri, Sun, 10:30 am, 7:30-9 pm. Eastern. Founded 1923.

WABW

Wooster, Ohio. 247.8m-1210kc. 50 watts. The College of Wooster, Dept. of Physics. Announcer, A. W. Coven.

WABY

Philadelphia, Pa. 247.8m-1210kc. 50 watts. John Magaldi, Jr.

WABZ

New Orleans, La. 238m-1260kc. 50 watts. The Coliseum Place Baptist church. Announcer, Charles E. Page. Slogan, "The Station with a Message." Sun, 11-12:15 pm, 7:30-9, church service. Central. Founded January, 1924.

WADC

Akron, Ohio. 238m-1260kc. 1000 watts. Allen Theater Broadcasting Station. Announcer, George F. Houston. Daily ex Sun, 11-12 noon, 5:30-6 pm. Daily ex Sun, Sat, 8-11 pm. Sun, 10:30-11:45 am, 12:30-1:30 pm, 3-5, 8-11 pm. Eastern. Founded Mar., 1925.

WADF

Detroit, Mich. 230.6m-1300kc. 100 watts. Albert B. Parflet Co. Announcer, Owen F. Uridge. Daily ex Sat, 6:45 pm, dinner music, 7:15, 7:30, 8. Eastern. Founded Jan. 1925.

WAGM

Royal Oak, Mich. 225.4m-1330kc. 50 watts. Robert L. Miller. Announcer, R. L. Miller. Slogan, "The Little Station With the Big Reputation." Mon, 8-12:30 am. Wed, Fri, 8-12 mid. Founded Oct. 3, 1925. Central.

WAIT

Taunton, Mass. 214.2m-1400kc. 10 watts. A. H. Waite & Co., Inc.

WAIU

Columbus, Ohio. 282.8m-1060kc. 5000 watts. American Insurance Union. Announcer, Don Bernard. Daily ex Sun, 10:30-11 am, services 11:30-12:30 pm. Daily ex Sat, Sun, 3-4 pm, 6-7. Mon, Fri, 7-11 pm. Wed, 9-11 pm. Sun, 2:30-5, 8:30-11. Eastern. Founded June, 1922.

WAIZ

Appleton, Wis. 227.1m-1320kc. 100 watts. Irving Zuelke, Inc. Daily ex Sun, 10-1:30 pm. Mon, 8-8:45 pm, band. Daily, 5-6:30 pm, dinner concert. Central.

WALK

Willow Grove, Pa. 201.2m-1490kc. 50 watts. Albert A. Walker, portable.

WAMD

St. Paul, Minn. 222.1m-1350kc. 500 watts. National Battery Co.

WAPI

Northham, Ala. 340.7m-880kc. 1000 watts. Alabama Polytechnic Institute. Announcer, W. A. Young. Daily ex Sun, 12-1. Tues, Thurs, Fri, 9-10 pm. Founded 1922. Central.

WASH

Grand Rapids, Mich. 236.3m-1170kc. 250 watts. Henry Landrieu, Inc. Announcers, Hubert Hart, Richard Smith. Daily ex Sat, Sun, 12:30-1:30 am, 5-6, 8-9, 10-11 pm. Daily ex Thurs, Sun, 7-8 pm. Sun, 10-11:30 am, 4-5 pm, 7-8:30. Central. Founded March 13, 1925.

WATT

Brown, Mass. 280.2m-1490kc. 100 watts. Edison Elec. Filamenting Co.

WBAA

N. Lakesette, Ind. 222.6m-1100kc. 500 watts. Purdue University. Announcer, J. W. Stafford. Daily ex Sun, 11:15 am, 8-9:45, markets, weather. Mon, Fri, 7 pm, special program. Central. Founded 1920.

WBAK

Harrisburg, Pa. 238.5m-1060kc. 500 watts. Pennsylvania State Police. Announcer, A. E. Peerman. Daily ex Sun, 10:30 am, 11:30 pm, 4-5, police report, fire protection, farm news. Eastern. Founded 1919.

WBAL

Baltimore, Md. 285.5m-1050kc. 5000 watts. Consolidated Gas, Elec. Light & Power Co. Announcer, Stanley W. Barnett. Slogan, "The Station of Good Music." Daily ex Sun, Sat, 3:30-5:30 pm, 6-11 pm. Sun, 6:30-11 pm, 6:30-9 pm, Eastern. Founded Nov. 1, 1925.

WBAO

Decatur, Ill. 267.7m-1120kc. 100 watts. James Millikin University. University activities. Mon, Wed, 7-8 pm. Central. Founded 1922.

WBAP

Fort Worth, Tex. 499.7m-600kc. 5000 watts. Fort Worth Star-Telegram. Announcer, "The Hired Hand." Daily ex Sun, 8, 9, 10, 11, 12 m, 1 pm, 2, 3, "Port of Missing Men." Mon, Tues, Wed, Thurs, Fri, Sat, 6-7 pm, 8-9, Mon, Thurs, Sat, 10-12 mid. Sun, 1-7 pm, 9:15-12. Sun, 6-7 pm, vesper. Central. Founded April, 1922.

WBAR

Sisist, Wis. 270.1m-1110kc. 500 watts. Kopp Radio Co. Slogan, "The Station of Northern Wisconsin." Mon, 9-10 pm. Wed, 8-9 pm. Thurs, 7:30-8:30. Sun, 10-11 pm. Central.

WBAW

Nashville, Tenn. 239.9m-1250kc. 500 watts. WBAW Broadcasters. Announcer, Harry Stone. Daily ex Sun, 10-11:15 am, 2:30-3:30 pm, 5-8, 9-10. Tues, 11-12 mid. Sun, 9:30-10:50 am; 11-12:30 n. 7-9. Founded Feb. 24, 1924. Central.

WBAX

Wilkes-Barre, Pa. 249.9m-1200kc. 100 watts. John H. Stenger, Jr. Slogan, "In Wyoming Valley, Home of the Anthracite." Tues, 6:30-11 pm. Thurs, 9-2 am. Sun, 5-9 pm. Eastern. Founded May, 1922.

WBCC

Brooklyn, N. Y. 227.1m-1320kc. 500 watts. Brooklyn Broadcasting Corp. Announcer, John M. Hurley. Mon, 10-3 pm, 7-8, 10-12. Tues, 9:30-12 n, 3-7:30. 10:30-12. Wed, 10-3 pm, 6-7, 10-12. Thurs, 10-12 n, 4-6, 7-10. Fri, 10-3, 6-8, 10-12. Sat, 9-10:45 am, 3:30-9 pm. Sun, 9-10 am, 3-8 pm, 10:30-12. Eastern. Founded Aug., 1926.

WBBL

Richmond, Va. 234.2m-1280kc. 100 watts. Grace Covenant Presbyterian church. Founded Feb. 1924.

WBMM

Chicago, Ill. (Tr. at Glenview.) 389.4m-770kc. 5000 watts. Atlas Investment Co. Daily ex Sun, Mon, 1-2 pm, 7-11. Mon, 1 pm, 6-7 pm, 7-10. Thurs, 11-12 mid. Sat, 1-2 am. Sun, 12-3 am. Nutty Club. Founded 1922. Central.

WBPP

Petoskey, Mich. 239.9m-1250kc. 100 watts. Petoskey High School. Announcer, Carl Bowman. Daily ex Sun, 12-12:15 pm, weather stocks, news. Wed, 6-7 pm, popular program. Sun, 3-4 pm. Central. Founded Jan. 31, 1924.

WBBR

Rossville, N. Y. 256.3m-1170kc. 1000 watts. International Bible Students' Association. Announcer, Viktor F. Schmidt. Mon, Tues, Thurs, Fri, 2-4 pm, 7-9. Wed, 2-4 pm. Sun, 10-12 n, 2-4 pm, 7-9. Founded Feb., 1924. Eastern.

WBBW

Norfolk, Va. 236.1m-1270kc. 100 watts. Ruffner Junior High School. Announcer, Lee M. Klinefelter. Slogan, "The School You'd Like to Go To." Mon, 8 pm. Fri, 8-9:30 pm. Eastern. Founded Feb. 26, 1924.

WBBY

Charleston, S. C. 249.9m-1200kc. 75 watts. Washington Light Industry. Slogan, "Seaport of the Southeast." Sun, 10-11 pm. Eastern.

WBBZ

Chicago, Ill. 204m-1470kc. 100 watts. C. L. Carrell.

WBCN

Chicago, Ill. 288.3m-1040kc. 250 watts. Great Lakes Broadcasting Co. Daily ex Sun, Mon, 11 am, Mrs. Peterson; 1-2 pm, 5-6, 7-8. Mon, 1-2 pm, 5-6, 7-8. Sun, 10:30 am, church; 4-6 pm, 7:30-9:30. Central.

WBES

Takoma Park, Md. 265.3m-1130kc. 100 watts. Bliss Elec. School. Announcer, Wm. M. Johnson, Jr. Fri, 6-7 pm. Eastern. Opened Jan., 1923.

WBET

Medford, Mass. 288.3m-1040kc. 500 watts. Boston Transcript Co. Announcers, Gerard H. Slattery, Wayne H. Latham, Richard D. Grant. Slogan, "The Boston Evening Transcript—New England's Leading Family Daily." Daily 6:30-11 pm. Eastern. Opened Feb. 28, 1927.

WBIS

Boston, Mass. 461.3m-650kc. 500 watts. Boston Information Service. Announcer, Nancy Howe. Daily ex Sun, 8-9:30 am, 2-4 pm. Eastern. Founded Jan. 29, 1927.

WBKN

Brooklyn, N. Y. 199.9m-1500kc. 100 watts. Arthur Faske. Announcer, L. W. Berne. Daily Sun, 12-2 pm, 3-5. Mon, Fri, 8-10 pm. Tues, 10-12 mid. Wed, 12-1 pm. Thurs, 6-8 pm. Sat, 6-8. Eastern. Founded Nov. 22, 1926.

WBMH

Detroit, Mich. 211.1m-1420kc. 100 watts. Braun's Music House. Announcers, Larry Dean, W. S. Burnett, O. F. Gaffert, Jr. Mon, Wed, Thurs, 8-12 mid. Tues, 9-11:30 pm. Fri, 8:30-11:30 pm. Sat, 9-12 mid. Eastern. Founded Jan. 11, 1927.

WBMS

Union City, N. J. 199.9m-1500kc. 100 watts. WBMS Broadcasting Corp. Slogan, "The Voice of Union City." Daily ex Sun, 12-1 pm, 5-6:30, 8-12 mid. Sun, 3-6 pm, 8-12 mid. Daily ex Sun, 8:30-12 mid. Sun, 1-3 pm, 7:30-11. Eastern.

WBNY

New York, N. Y. 236.1m-1270kc. 500 watts. Baruchrome Corp. Daily ex Sun, Mon, 6-12 mid. Sun, 2:30 pm, 6. Founded 1925. Eastern.

WBOQ

Richmond Hill, N. Y. 309.1m-970kc. 500 watts. Atlantic Broadcasting Co.

WBRC

Birmingham, Ala. 241.8m-1240kc. 250 watts. Birmingham Broadcasting Co. Announcer, Dud Counolly. Slogan, "The Biggest Little Station in the World." Daily ex Sat, Sun, 1-2 pm. Mon, Tues, Wed, Fri, 8-10 pm. Sun, 10:45 am, service; 7:30, service. Central. Founded May 18, 1925.

WBRE

Wilkes-Barre, Pa. 249.9m-1200kc. 100 watts. Liberty State Bank and Trust Co. Announcer, Louis G. Baltimore. Mon, Fri, 12:30-1:15 pm, 6:30-12. Wed, 12:30-1:15 pm, 6:30-11:30. Sun, 9-12 mid. Eastern.

WBRL

Tilton, N. H. 232.4m-1290kc. 500 watts. Booth Radio Laboratories.

WBRS

New York, 211.1m-1420kc. 100 watts. North American Broadcasting Corp. Announcer, M. E. Krieger. Daily ex Sun, 1-2 pm. Mon, Wed, 10-11 pm. Fri, 8-9. Eastern.

WBSO

Babson Park, Mass. 384.4m-780kc. 100 watts. Babson's Statistical organization. Announcer, Marshall McCarrroll. Daily ex Sun, 4-5 pm, 12-1 am. Eastern. Founded Jan., 1927.

WBT

Charlotte, N. C. 258.5m-1160kc. 750 1000 watts. 7 am-7 pm. C. C. Coddington, Inc. Announcer, H. W. Burwell. Daily ex Sun, 12:30 pm, 3 pm, 6-11 mid. Tues, 7-11:30 pm. Wed, 7-11:30 pm. Thurs, 7-11 pm, Fri, 7-12:30 am. Sat, 6-12:30 am. Eastern.

WBZ

Springfield, Mass. 333.1m-900kc. 15000 watts. Westinghouse Elec. & Mfg. Co. Radio Station of New England. Announcer, Aidan Redmond. Mon, 10 am-11:30 pm. Tues, 10 am-11 pm. Wed, 10 am-11:30 pm. Thurs, 10 am-11:30 pm. Fri, 10-11:30 pm. Sat, 11 am-10:45 pm. Sun, 11 am-11:30 pm. Installed Sept. 19, 1921. Eastern.

WBZA

Boston, Mass. 333.1m-900kc. 500 watts. Westinghouse Elec. & Mfg. Co. Same programs as WBZ.

WCAC

Mansfield, Conn. 535.4m-560kc. 500 watts. Connecticut Agricultural College. Announcer, Daniel E. Noble. Slogan, "From the Nutmeg State." Mon, Wed, 7-7:30 pm. Sat, 7-8 pm. Eastern. Founded June, 1923.

WCAD

Canton, N. Y. 243.8m-1230kc. 500-1000 watts. St. Lawrence University. Announcer, Ward C. Priest. Slogan, "The Voice of the North Country." Daily, 12-30 pm, weather reports, talks, music, time. Wed, 4:30-6 pm. Eastern. Founded Dec. 7, 1922.

WCAE

Pittsburgh, Pa. 461.3m-650kc. 500 watts. Gimbel Brothers. Daily ex Sun, 6:45-8 am, exercises; 8:15, 9:15, 10:15, 12:15, 2:15 pm, 5:15; 1:30, 3:40 pm, news; 2:30 pm, organ; 6, dinner music; 7, popular music; 5:30, 7:30, Uncle Kay Bee; 8-10. Sun, 6 pm, 7:15-10, WEAJ. Eastern.

WCAH

Columbus, Ohio. 234.2m-1280kc. 250 watts. Entekin Electric Co. Daily ex Sun, 12-1 pm, Mon, Wed, 6-7. Daily ex Sun, Sat, 6:10-30 pm. Sat, 6-12 mid. Eastern. Founded April, 1921.

WCAJ

University Place, Nebr. 379.5m-790kc. 500 watts. Nebraska Wesleyan University. Announcer, J. C. Jensen. Daily, 10 am, convocation exercises; 4:30 pm, weather, news. Tues, Fri, 12 n. organ. Sun, 11 am, services; 4 pm, vesper. Founded Oct., 1921. Central.

WCAL

Northfield, Minn. 285.5m-1050kc. 500 watts. Dept. of Physics, St. Olaf College. Announcer, Hector Skifter. Slogan, "The College on the Hill." Daily ex Sun, Thurs, 9:45 am, Mon, 7 pm; 8:15. Sun, 8:30-9:30 am; 3-4 pm. Central. Founded, 1922.

WCAM

Camden, N. J. 223.7m-1340kc. 500 watts. City of Camden. Announcer, Harry E. Ehrhart. Mon, Wed, Fri, 7:30-10:30 pm. Eastern. Founded Oct. 26, 1926.

WCAO

Baltimore, Md. 243.8m-1230kc. 250 watts. Monumental Radio, Inc. Announcer, Wan L. Atkinson. Mon, Wed, Fri, 6-11 pm. Sun, 11 am, service; 3-5, 7-4:45 pm, service; 9-11. Columbia chain. Eastern. Founded May 17, 1922.

WCAP

Asbury Park, N. J. 239.9m-1250kc. 500 watts. Chamber of Commerce. Announcer, Thomas F. Hurley, Jr. Mon, Tues, Thurs, Sat, Sun, 10 am-12 pm. Eastern. Founded July 1, 1927.

WCAT

Rapid City, S. D. 247.8m-1210kc. 100 watts. South Dakota State School of Mines. Announcer, J. O. Kammerman. Daily ex Sun, 9:30 am, 12:30 pm, weather reports, Thurs, 7:30 pm, concert. Mountain. Founded 1920.

WCAU

Philadelphia, Pa. 260.7m-1150kc. 500 watts. Universal Broadcasting Co. Announcer, Stan Lee Broza. Slogan, "Where Cheer Awaits U." Mon, 5:30-11:30 pm. Tues, 5-11:30 pm. Wed, 5:30-12 mid. Thurs, 5:30-12 mid. Fri, 5:30-11 pm. Sat, 6:30-11. Sun, 2-11 pm. Eastern. Founded May, 1922.

WCAX

Burlington, Vt. 254.1m-1180kc. 100 watts. University of Vermont. Slogan, "The Voice of the Green Mountains." Fri, 7-8 pm. Eastern.

WCAZ

Carthage, Ill. 249.9m-1200kc. 50 watts. Carthage College. Announcer, Raymond Derks. Daily ex Sat. Sun, 11:40-12:15 pm. Mon, 7-8 pm. Central.

WCBA

Allentown, Pa. 222.1m-1350kc. 100 watts. Queen City Radio station. Wed, 8:15-11 pm. Fri, 7:30-10:30 pm. Sat, 10-11 pm. dance music. Sun, 10 am, 5:30 pm. 7, church service. Eastern.

WCBD

Zion, Ill. 344.6m-870kc. 5000 watts. Wilbur Glenn Voliva. Announcer, J. H. DePew. Slogan, "Where God Rules, Man Prospers." Tues, Thurs, 8-10:30 pm. concert. Wed, 12:30-1 pm. organ. Thurs, 2:30-3:45 pm. service. Sun, 9-10:45 am. Bible school; 2:30-6 pm. church services; 8-10:30 pm. Founded Nov. 15, 1920. Central.

WCBE

New Orleans, La. 227.1m-1320kc. 5 watts. Uhalt Brothers Radio Co.

WCBM

Baltimore, Md. 225.4m-1330kc. 100 watts. Charles Schwarz. Announcer, Harry J. Dobe. Mon, Wed, Fri, 12-1:30 pm, 6-10. Tues, Thurs, Sat, 6-11:30 pm. Sun, 6-8 pm. Eastern. Founded March 25, 1923.

WCBR

Providence, R. I. 201.2m-1490kc. 100 watts. Charles H. Messter. (Portable.)

WCBS

Springfield, Ill. 209.7m-1430kc. 250 watts. Harold L. Dewing. Charles H. Messter. Slogan, "Home of Abraham Lincoln." Mon, 9-11 pm. Tues, Wed, Thurs, Fri, 8:30-10:30 pm. Sun, 10:45-12 n, 12:30-2 pm, 6-7, 7:30-8. Central. Founded April 8, 1923.

WCCT

Minneapolis-St. Paul, Minn. (Tr. at Anoka.) 405.2m-740kc. 7500, 6 am-6 pm. 5000 watts. Washburn-Crosby Co. Announcer, L. Seymour. Slogan, "Service to the Northwest." Daily ex Sun, 7 am. music; 9:30 am, program for day; 9:35, news; 9:45, weather, markets; 10:30, markets; 11:30, markets; 12, music; 1:30, weather, markets; 3, markets, 4:45, readers' club; 5:15, children's hour; 5:45, livestock. Mon, 6:30 pm, dinner music; 7:30, orchestra; 8:30, WEA; 9:30, program; 10, weather. Tues, 6-7, 8 pm. New York; 9:30, musicale; 10:30, weather. Wed, 6 pm; 7:30, WEA; 10, weather; 10:30, dance; 11:30, organ. Thurs, 7 pm. WEA; 10, weather, markets. Fri, 7, WEA; 8, WEA; 9:30, music; 10, weather; 10:05, music. Sat, 6:15 pm, music; 7, WEA; 10, weather, dance program. Sun, 7:15-10:15 pm. Founded Oct. 1, 1924. Central.

WCDA

New York, N. Y. (tr. at Cliffside Park, N. J.). 211.1m-1420kc. 250 watts. Italian Educational Broadcasting Co.

WCFL

Chicago, Ill. 483.6m-620kc. 1500 watts. Chicago Federation of Labor. Announcer, Harold O'Halloran. Slogan, "The Voice of Labor." Daily ex Sun, 10-2 pm, 4-12 mid. Sun, 11-1 pm, 2:30-6:30, 7:30-9:30. Central.

WCGU

Coney Island, N. Y. 218.8m-1370kc. 500 watts. Charles G. Unger. Daily ex Sun, 1 pm, Wed, Fri, 8 pm. Sun, 11 am. Eastern.

WCLO

Kenosha, Wis. 227.1m-1320kc. 100 watts. C. E. Whitmore. Announcer, Glenn G. Balcom. Daily ex Tues, Thurs, 11:30 am, 2:30-5:30, 7-12 mid. Founded Aug. 4, 1925. Central.

WCLS

Joliet, Ill. 215.7m-1390kc. 150 watts. M. A. Felman Co. Slogan, "Will County's Largest Store." Wed, Fri, 7-11 pm. Tues, 8-11 pm. Sat, Sun, 9-11:30 pm. Sun, 9:30-12:30 pm. Wed, Sat, 11-11:30 am. Central. Founded June 1925.

WCMA

Culver, Ind. 260.7m-1150kc. 500 watts. Culver Military Academy. Announcer, C. E. McKinney. Daily ex Sun, 3-4 pm. public service hour. Mon, 8-10:30 pm. Wed, 8-10:30 pm. Fri, 8-10:30 pm. Sun, 11-12:30 pm. chapel service. Founded 1925. Central.

WCOA

Pensacola, Fla. 249.9m-1200kc. 500 watts. Municipal Broadcasting Station. Announcer, John E. Frenkel. Slogan, "Wonderful City of Advantages." Daily ex Sun, 10:30 am, 12:30 pm. Mon, Wed, Fri, 8 pm. Sun, 12:30 pm, 7:25. Central. Founded Feb. 2, 1926.

WCOC

Columbus, Miss. 230.6m-1300kc. 250 watts. Crystal Oil Co. Announcer, T. C. Billups. Daily, 5-6 pm. Tues, Fri, 8-10 pm. Central. Founded Feb. 26, 1927.

WCOT

Olneyville, R. I. 225.4m-1330kc. 100 watts. Jacob Conn. Announcer, Lewis S. Bellem, Jr. Daily and Sun, 2:30-4 pm. Daily ex Sun, 8-10 pm. Eastern.

WCRW

Chicago, Ill. 223.7m-1340kc. 500 watts. Clinton E. White, Announcers, C. R. White, Charles F. Bush, Josephine. Slogan, "For Your Entertainment." Daily ex Sun, 11:30-1 pm. Daily ex Mon, 5-7:30 pm, 9:30-10:30. Central. Founded May, 1926.

WCSE

Portland, Me. (tr. Cumberland.) 214.2m-1400kc. 500 watts. Congress Square Hotel. Slogan, "Sun-Day Gateway of America." Announcers, L. T. Friedman, H. C. Wieg. Daily ex Sun, 10 am, housewives hour; 11, WEA; 12 n, stocks, weather; 12:10, news; 3, music hour; 4, news; 6, stocks; 7:45, news. Mon, 8:30 pm, 9:30, 10:30, 11. Tues, 7 pm, 8, 10, 10:30. Wed, 7:30 pm, 9, 10:30, 11. Thurs, 7:30 pm, 8, 8:30. Fri, 9 pm, 10. Sat, 7 pm, 8, 9, 10. Sun, 10:30 am, 1:30 pm, 4, 7:30, 9-9:45. Eastern. Founded June, 1925.

WCSS

Springfield, Ohio. 256.3m-1170kc. 500 watts. Wittenberg College. Announcer, C. Parker Libby. Mon, Wed, Fri, 7-9 pm. Tues, 11-12 n. 6:30-7:30 pm. Thurs, 8-8 pm. Fri, 4 pm. Sat, 2:30 pm. A. G. left activities also broadcast. Eastern. Founded Dec., 1921.

WCWK

Fort Wayne, Ind. 214.2m-1400kc. 250 watts. Chester W. Keen. Slogan, "The Home Sweet Home Station." Fri, 7-8 pm. Sat, 8-10 pm. Sun, 11-12 n. 5-5:30 pm, 5:30-6:30, 6:30-7:30 pm. Founded, 1924. Central.

WCWS

Danbury, Conn. 265.3m-1130kc. 100 watts. Danbury Broadcasting Station. Founded Aug. 2, 1926.

WCX

Detroit, Mich. 440.9m-680kc. 5000 watts. The Detroit Free Press. Announcer, C. D. Tomy. Club, "Red Apple Club." See WJR schedule. Eastern. Founded May, 1922.

WDAA

Tampa, Fla. 267.7m-1120kc. 500 watts. Tampa Daily Times. Announcer, Bruce Lum. Daily ex Sun, 11:55 am-2:30 pm, 3-4, 7:30-11:30. Tues, 1:30-4:30 am, Tom Cat Club. Sun, 10:30-12:15 pm, 7:30-9:15. Eastern. Founded 1921.

WDAF

Kansas City, Mo. 370.2m-810kc. 1000 watts. Kansas City Star. Announcer, H. Dean Fitzner. Club, "Nighthawks." Daily ex Sun, 9:30 am, 10:30, 11:30, 12:30, 1:15 pm. grain quotations. Wed, Fri, 10 am, Betty Crocker. Daily ex Sun, 8 am, Bible lesson; 12-1 pm, Aunt Sammy, farm school; 3-4, magazine; 7-7:15, school of the air; 7-10, musicale; 11:45-1, Nighthawk frolic. Sun, 12-1 pm, 2-3, 4:30-5, 8:15-9:45. Founded June 5, 1922. Central.

WDAG

Amarillo, Tex. 263m-1140kc. 250 watts. J. Lawrence Martin. Daily ex Sun, Fri, 6:30 am, 12:45-1:45 pm, weather, markets, farm; 9-10:30 pm, music. Mon, 8-10 pm. Sun, 9:45-10:45 am, 7:30-9:30 pm. Central. Founded May 16, 1922.

WDAH

EJ Paso, Tex. 234.2m-1280kc. 100 watts. Trinity Methodist church. Announcer, Louis Gemoets. Mon, 8-10 pm. Wed, 7:30-8:30 pm. Sun, 9:30-12 n, 7:30-9 pm. Founded Spring 1924. Mountain.

WDAY

Fargo, N. D. 545.1m-550kc. 250 watts. 500 watts 6 am-6 pm. Radio Equipment Corporation. Announcer, Kenneth M. Hance. Daily ex Sun, 7-9 am, music; 7:30-9, news; 10, weather; markets; 11, magazine; 11:45, market music; 2-3, markets; 3-4, music; 5:45, news; 6-7:30, entertainment. Mon, Wed, Fri, 7:30-8:15 pm, N. D. Agri. college. Daily ex Sat, Sun, 10:15 am. chapel. Sun, 10:30 am, service; 1-3 pm, service; 4:15-6:15, entertainment. Central. Founded May, 1922.

WDBJ

Roanoke, Va. 230.6m-1300kc. 250 watts. Richardson Wayland Elec. Corp. Announcers, J. W. Johnson, Harold Gray. Slogan, "Roanoke Down in Old Virginia." Daily ex Sun, 12-1 pm, music; 5:30-6:45, music, news, weather. Mon, 8-9 pm. Wed, Sat, 9 pm. concert. Sun, 7:45 pm, church. Eastern. Founded May, 1924.

WDBO

Orlando, Fla. 288.3m-1040kc. 500-1000 watts 6 am-6 pm. 500 watts. Orlando Broadcasting Co. Announcer, Harold Dantforth. Slogan, "Down Where the Oranges Grow." Mon, 7:15-9 pm, 2-4 pm. Tues, 8:30-11 pm. Thurs, 9:15-11:30 pm. Fri, 7:30-9 pm. Sat, 9-11 pm. Sun, 10:45 am, 2:30 pm, 4, 7:30. Founded 1921. Eastern.

WDEL

Wilmington, Del. 296.9m-1010kc. 100 watts. Wilmington Elec. Spec. Co. Announcer, Willard S. Wilson. Slogan, "The First Broadcasting Station of the First City of the First State." Tues, Thurs, Sat, 8-11 pm. Sun, 10-12 mid. Eastern. Founded 1922.

WDGY

Minneapolis, Minn. 285.5m-1050kc. 500 watts. Dr. George Young. Daily 3-5 pm. Mon, Wed, Fri, 7-8 pm, 10-12 mid. Tues, Thurs, 7-12 mid. Sat, 12-2 am. Sun, 10:30-12 n, 2-3 pm. Central. Founded 1923.

WDOD

Chattanooga, Tenn. 243.8m-1230kc. 500 watts. Chattanooga Radio Co., Inc. Announcer, Frank S. Lane. Daily ex Sun, 12-1:15 pm. Tues, Wed, Fri, 6:45-10 pm. Mon, 6-10 pm. Sat, 6:45-8:30 pm. Sun, 11 am, 6:30 pm, 7:30-9, Sat, 9-10 pm. Founded 1925. Central.

WDRG

New Haven, Conn. 282.8m-1060kc. 500 watts. Doolittle Radio Corp. Announcer, F. M. Doolittle. Daily ex Sat, Sun, 9:30-12 n, 5-10 pm. Sun, 11 am, 3:30-5 pm, 7-8. Eastern. Founded Dec., 1922.

WDFW

Cranston, R. I. 247.8m-1210kc. 250 watts. Dutee W. Flint, Inc. Slogan, "Quality First." Eastern.

WDZ

Tuscola, Ill. 277.6m-1080kc. 100 watts. James L. Bush. Announcer, G. R. Muir. Daily ex Sun, 9 am, 9:30, 10, 10:30, 11, 11:30, 12 n, 12:30, 1, 1:15, 1:30, 2:45, grain, markets, livestock, markets. Central. Founded Mar. 1921.

WEAF

New York, N. Y. (tr. at Baltimore), 491.5m-610kc. 50,000 watts. National Broadcasting Co., Inc. Slogan, "The Voice of the Millions." Daily ex Sun, 6:45-8 am, 8-8:45, am-12 mid. Sun, 12n-10:30 pm. Eastern. Founded July 25, 1922.

WEAM

North Plainfield, N. J. 263m-1140kc. 250 watts. Borough of North Plainfield, Announcer, H. W. Blackford. Slogan, "America's Pioneer Municipal Broadcasting Station." Thurs, 8-12 pm, concert, talks. Sun, 11-12 noon. Eastern.

WEAN

Providence, R. I. 275.1m-1090kc. 500 watts. The Shepard Stores. Announcer, Chester H. Miller. Slogan, "We Entertain a Nation." Daily ex Sun, 9:45 am-1 pm, women's institute; 4-5 pm, music; 11:30 am, 3-5 pm, 6:30-11 pm. church service. Eastern. Founded 1922.

WEO

Columbus, Ohio. 282.8-1060kc. 750 watts. Ohio State University. Announcer, Robert Coleman. Daily ex Sun, 9:45 am, 11, 12:30 pm, 4. Mon, Wed, Fri, 10 am. Tues, 7 pm. Wed, 7-8:30 pm. Thurs, 7-10:30 pm. Eastern. Founded 1912.

WEAR

Cleveland, Ohio. 399.8m-750kc. 1000 watts. Willard Storage Battery Co. Daily ex Sat, Sun, 11:35 am-4 pm. Sat, 11:35-1:30 pm. Sun, 10:45 am-5:30 pm. Eastern. Opened Jan. 15, 1926.

WECB

Superior, Wis., Duluth, Minn. 241.8m-1240kc. 250 watts. Head-of-the-Lakes Radio Station. Daily ex Sun, 1:15 pm, 5, markets; 6, orchestra. Mon, 8 pm, music. Wed, 8:30 pm. Fri, 9 pm. Sun, 10:40 am, services. Central.

WEBE

Cambridge, Ohio. 247.8m-1210kc. 10 watts. Roy W. Waller. Fri, 7:45-9:45 pm. Sun, 10:30-11:45 am, 7-8:30 pm. 1st and 3rd Sun, 2:30-3:30 pm. Eastern.

WEBH

Chicago, Ill. 365.6m-820 kc. 500 watts. Edgewater Beach Hotel-Herald-Examiner. Announcer, Robert Boniel. Slogan, "The Voice of the Great Lakes." Daily ex Sun, 10-12 n, 1:15-2 pm, 3-4 pm, music; 5-5:45, children's club. Daily ex Sun, 7-9 pm, dinner concert. Daily ex Sun, Sat, 9-11 pm. Wed, 12 am. Sat, 11-2 am, Sun, 10:30 am, service; 12 pm, music; 4:30-6:30, 7:30-9. Central. Founded M. 4, 1923.

WEBJ

New York, N. Y. 256.3m-1170kc. 500 watts. Third Avenue Railway Co. Announcer, H. A. Bruno. Slogan, "The Red Trolley Station." Wed, 7-11 pm. Fri, 9-11 pm. Eastern.

WEBQ

Harrisburg, Ill. 223.7m-1340kc. 15 watts. Tate Radio Co. Announcer, Dr. H. J. Raley. Slogan, "The Voice from Egypt." Daily ex Sun, 7:15-7:45 pm. Mon, Thurs, 7:30-10:30 pm. Sun, 11-12 n, 2-4 pm, 7-8. Central. Founded Sept. 1, 1923.

WEBR

Buffalo, N. Y. 241.8m-1240kc. 200 watts. H. H. Howell. Announcer, Francis H. Striker. Slogan, "We Extend Buffalo's Regards." Daily ex Sun, 7:45-8:30 pm. Mon, Wed, Fri, 8:30-11:30 pm. Sat, 9-11 pm. Sun, 12 in. concert; 8-9 pm, church; 10:15-12 mid, organ. Eastern. Founded Oct. 8, 1924.

WEBW

Beloit, Wis. 258.5m-1160kc. 500 watts. Beloit College. Announcer, Arthur Weimer. Sun, 4:30 pm. Central. Founded Oct. 26, 1924.

WEDC

Chicago, Ill. 241.8m-1240kc. 500 watts. Emil Dene-mark, Broad. Station. Daily, 6-7:30, 9:30-11:30. Daily ex Sun, 6:30-7:30 pm. In. hour. Fri, 6:30-7:30 pm. Bohemian hour. Central.

WEEL

Boston, Mass. 508.2m-590kc. 500 watts. Edison Electric Illuminating Company. Announcers, Robert Burden, Carlton H. Dickerman, Edward Gisburne, Frederick Hawkins. Slogan, "The Friendly Voice." Daily ex Sun, 6:45-8 am, exercises; 8-8:45, musicale; 10-11:15, home service features; 11-12:15, Friendly Maids; 12-12:15, news; 12:15-12:45 pm, Friendly Maids; 1:34-1, market and garden reports; 2-5, varied music; 5:30-6:45, service features and music; 6:45-7:30, Big Brother Club; 7:30-11, local and New York features from Red Network NBC. Sun, 10:55-12:15, church; 12:15, symphony; 1-4, concert; 4-5:30, Dr. Cadman; 5:30, musical; 6:30, band; 7:20, news; 7:30, symphony concert; 9:15, Atwater-Kent. Eastern. Founded Sept. 29, 1924, succeeding WTAT.

WEHS

Evanston, Ill. 215.7m-1390kc. 100 watts. Victor C. Carlson. Daily ex Mon, 4:45 pm, 5:45, 6:15, 6:30, 7:30. Central. Founded Feb., 1924.

WEMC

Berrien Springs, Mich. 483.6m-620kc. 1000 watts. Emanuel Missionary College. Announcer, Wm. A. Wentworth. Slogan, "The Radio Lighthouse." Daily ex Sat, Sun, 7:30-9 am, 10:10-11. Mon, 10-11 pm. Tues, Thurs, 3-4 pm. Sun, 9 am, 7:30-10 pm. Central. Founded April 1, 1923.

WENR

Chicago, Ill. 288.3m-1040kc. 500 watts. Great Lakes Radio Broadcasting Co. Slogan, "The Voice of Service." Daily ex Sun, Mon, 11:30 am, Mrs. Peterson, 12-1 pm, concert; 2-5, popular requests; 6-7, dinner concert; 8-9:30, classical; 9:30-12 mid. Mon, 12-1 pm, 2-5, 6-7, 8-9:30 pm, 9:30-12 mid. Sun, 2-4 pm, 6-7, 9:30-11. Central.

WEPS

Glooucester, Mass. 296.9m-1010kc. 100 watts. Matheson Radio Co., Inc.

WEVD

Woodhaven, N. Y. 245.8m-1220kc. 500 watts. Feels Memorial Radio Fund. Daily ex Sun, Sat, 1-6 pm. Tues, Thurs, 9-12 mid. Sat, 7-9:30 pm. Sun, 12-30-4 pm. Eastern. Founded Oct. 1, 1927.

WEW

St. Louis, Mo. 352.7m-850kc. 1000 watts. St. Louis University. Announcer, C. G. Dahm. Daily ex Sun, 9 am, 10, 2 reports, Tues, Thurs, 5 pm, lectures, music. Mon, Wed, Fri, 5, U. S. farm school, Sun, 9:35 am, 11, 2 pm, 5. Founded April 26, 1921. Central.

WFAA

Dallas, Tex. 545.1m-550kc. 500 watts. Dallas News and Dallas Journal. Adams Colihoun. Slogan, "Working for All Alike." Daily, 6:30-7:30 am, exercises; 7:30, 9:30, 10:30, 11:30, reports, music; 12:30, 1:30, 2:30, 3:30, 4:30, 5:30, reports, news; 6-10, music. Tues, Sat, 10-12 mid. Sun, 12 n-12 mid. Founded June 26, 1922. Central.

WFAM

St. Cloud, Minn. 252m-1190kc. 10 watts. St. Cloud Daily Times. Off the air temporarily.

WFAN

Philadelphia, Pa. 223.7m-1340kc. 500 watts. Keystone Broadcasting Co. Hotel Lorraine. Mon, 5-6 pm. Tues, Thurs, 5:30-1 am. Wed, 5-6 pm. Fri, 5-6 pm. Sat, 6-12 mid. Sun, 11 am-4:30 pm, 8-11. Eastern.

WFBC

Knoxville, Tenn. 234.2m-1280kc. 50 watts. First Baptist church. Announcer, St. John Reynolds. Sun, 10:45 am; 7:30 pm, services; 4 pm, sacred music. Central. Founded 1925.

WFBE

Cincinnati, O. 245.8m-1220kc. 250 watts. Hotel Park View. Announcer, Clark Waskom. Daily ex Sun, 12-1 pm. Mon, 5:30 pm, 9, 11, 12:30. Tues, 5:30 pm, 8:30, 9, 12:30. Wed, 6-8:30 pm, 9, 10, 11, 12:30. Thurs, 6 pm, 8, 10, 10:30, 11, 12:30. Fri, 5:30 pm, 6:30. Sat, 3-4 pm, 6-8, 9-10, 11, 2:30. Sun, 1-2 pm, 6:30-7:30 pm, 11, 12:30. Central.

WFBG

Altoona, Pa. 267.7m-1120kc. 100 watts. The Wm. F. Gable Co. Announcer, Roy F. Thompson. Slogan, "The Original Gateway to the West." Daily ex Sun, Mon, 11:45 am; 12 n, 3 pm, 6:30, 7:30, 8, 8:30, 10. Sun, 10:45 am, 3:30 pm, 7:30. Eastern. Founded Aug. 28, 1924.

WFBJ

Collegeville, Minn. 272.6m-1100kc. 100 watts. St. John's university. Announcer, Hilary Doerfler. Slogan, "In the Heart of the Landscape Paradise." Thurs, 8-9:30 pm. Fri, 4-5 pm. Central. Founded Oct. 1, 1924.

WFBM

Syracuse, N. Y. 258.5m-1160kc. 750 watts. Onondaga company. Announcer, Charles F. Phillips. Daily ex Sun, 3-4 pm, 6-8, 10-12 mid. Sun, 2-12 mid. Eastern. Opened Nov. 19, 1924.

WFBM

Indianapolis, Ind. (Tr. at Perry Township.) 275.1m-1050 kc. 1000 watts. Indianapolis Power and Light Company. Announcer, John Tribby. Slogan, "The Crossroads of America." Mon, Tues, Wed, Thurs, Fri, 12 n-12 mid. Sun, 9:30 am, 8 pm. Central.

WFBR

Baltimore, Md. 243.8m-1230kc. 250-500 watts. Baltimore Radio Show, Inc. Founded Oct. 1, 1924.

WFBZ

Galesburg, Ill. 247.8m-1210kc. 50 watts. Knox college. Announcer, George R. Strain. Slogan, "At Old Siwash." Wed, 8-10 pm. Central.

WFCL

Lawtucket, R. I. 241.8m-1240kc. 100 watts. Frank Crockett, Inc. Announcer, H. E. Stafford NYZ. Slogan, "The City of Diversified Industries." Daily, 2-3 pm. Mon, Wed, Fri, 8-11 pm. Eastern. Opened Jan., 1924. Reopened Aug., 1926.

WFDF

Elletts, Mich. 272.6m-1100kc. 100 watts. Frank D. Fallain. Slogan, "The Motor City." Mon, Wed, Fri, 8-11 pm. Eastern. Founded May 25, 1922.

WFI

Philadelphia, Pa. 405.2m-740kc. 500 watts. Strawbridge & Clothier. Announcer, John Vandersloot. Daily ex Sun, 10:15 am, 1 pm, 3, 6:20, 7:30 pm. Thurs, 8-11 pm. Sun, 10:20 am, 7:30, 4:30 pm. Eastern. Founded March 18, 1922.

WFIW

Windsorville, Ky. 267.7m-1140kc. 750-1000 watts. Deane Radio, Inc. Announcer, Clyde Smith. Daily ex Sun, 10:15 am, 1 pm, 3, 6:20, 7:30 pm. Thurs, 12 mid-4 am. Sun, 10:30-12 n, 12-1 pm. Central. Founded Feb. 12, 1927.

WFJC

Steubenville, Ohio. 227.7m-1200kc. 100 watts. W. F. Jones Broadcasting, Inc. Ann. Mon, Wed, Fri, 7-9:30 pm. Thurs, Sat, 10:30-11:30 pm. Sun, 9:30-10:30 pm. Eastern.

WFKB

Chicago, Ill. 223.7m-1360kc. 500 watts. Francis K. Hoffmann. Founded April 23, 1925.

WFKD

Philadelphia, Pa. 247.8m-1210kc. 50 watts. Foulker Radio Eng. Co. Tues, Thurs, 8-11 pm. Sun, 2-7:30 pm. Eastern.

WFLA

Clearwater, Fla. 516.9m-590kc. 750 watts. Chamber of Commerce. Announcer, Walter Tison. Daily ex Sun, 7-8:12 mid. Founded Dec. 25, 1925. Eastern.

WLAN

Lancaster, Pa. 252m-1190kc. 15 watts. Lancaster Lace Supply & Construction Co. Announcers, J. E. Nathiot, Luther J. Mathiot. Slogan, "World's Gardens at Lancaster." Daily ex Sun, 9-9:15 am, 12-12:15 pm, 5:30-5:45. Tues, Thurs, Sat, 7-10:30 pm. Sun, 11 am. Eastern.

WGGB

Freeport, N. Y. 245.8m-1220kc. 400 watts. Harry H. Carman. Mon, 7-8 pm. Wed, Fri, 7-11 pm. Sun, 10:40-12:30 pm, 4-5:30. Eastern. Founded Dec. 13, 1924.

WGBC

Memphis, Tenn. 228.9m-1310kc. 15 watts. First Baptist church. Announcer, A. L. Cowles. Sun, 9:30 am, 7:30 pm. Central. Opened 1925.

WGBF

Evansville, Ind. 236.1m-1270kc. 250 watts. The Finke Furniture Co. Announcers, Harold Finke, H. Thompson. Slogan, "The Gateway to the South." Daily ex Sun, 7:15 am, 12:10 pm, markets; 12:15, weather; 12:20, farm talk; 12:30, music; news. Mon, 7-11:15. Tues, 1:15 pm, 7, 8, 12 mid. Wed, 2:30 pm, 4:30. Fri, 1:15 pm, 7. Sun, 9 am. Central. Founded Oct. 1923.

WGBI

Scranton, Pa. 230.6m-1300kc. 250 watts. Scranton Broadcasters, Inc. Daily ex Sun, 10-12:30 pm, 6 pm. Sun, 3 pm, 8. Eastern.

WGBO

New York, N. Y. (tr. at Astoria). 348.6m-860kc. 500 watts. Gimbel Brothers. Announcer, Dailey Paskman. Daily ex Sun, 9 am, 1:30-3 pm, 5:30-6:30. Tues, 7:30-10 pm. Wed, 9 pm. Thurs, 10 pm. Fri, 10 am. Sat, 7:30-9 pm, 11:30. Sun, 9:15 pm. Eastern. Founded Oct. 26, 1924.

WGCP

Newark, N. J. 267.7m-1120kc. 500 watts. Paramount Broadcasting & Artists Service, Inc. Announcers, Bradford Browne, Irving Porter. Daily ex Sun, 3:30-6 pm. Mon thru Fri, 6-8 pm. Tues, Sat, 10-12 mid. Wed, Thurs, 8-10 pm. Sun, 12 n-3:30 pm. Eastern. Founded Mar., 1922.

WGES

Chicago, Ill. 241.8m-1240kc. 500 watts. Guyons Paradise Ballroom. Announcer, Fred L. Jeske. Mon, 7:30-9:30 pm. Tues, 8:30-11 pm. Wed, Thurs, 7:30-9:30 pm, 11:30-12:30. Fri, 7:30-9:30 pm, 11 am. Sat, 7:30-9:30 pm, 11:30-1 am. Sun, 10:15-11:30 am, 11:40-1 pm, 2:30-4, 7:30-9:30, 11:30-1. Founded Aug., 1920. Central.

WGHP

Mt. Clemens, Mich. 277.6m-1080kc. 750 watts. George Harrison Phelps, Inc. Announcer, Corley W. Kirby. Daily ex Sun, Sat, 1:15-3 pm, 6-7:15. Mon, Wed, 9-11 pm. Tues, Thurs, 8-10 pm. Fri, 8-11:30 pm. Sun, 10:30-12:15 pm, 3-5, 9-12. Eastern. Founded Oct. 10, 1925.

WGL

New York, N. Y. 293.9m-1020kc. 500 watts. 1000 watts, 7 am-1 pm. International Broadcasting Corp. Daily ex Sun, 10:12 n, 2-4 pm, 6. Mon, Wed, Fri, 9-12 mid. Tues, Thurs, Sat, 6-9 pm. Sun, 7-12 mid. Eastern. Founded Jan. 30, 1927.

WGMT

Jeanette, Pa. 208.2m-1440kc. 50 watts. Verue & Elton Spencer. Announcer, Verne Spencer. Slogan, "Voice from Glass City." Mon, Tues, Thurs, Fri, 7:30-9 pm. Sun, 1:30-4 pm. Eastern. Founded Jan. 1, 1925.

WGMS

Minneapolis, Minn. 245.8m-1220kc. 500 watts. University of Minnesota.

WGJU

New York, N. Y. 201.2m-1490kc. 100 watts. Atlantic Broadcasting Co.

WGN

Chicago, Ill. (tr. at Elgin). 416.4m-720kc. 500 watts. Chicago Tribune. Announcers, Bill Hay, Quin Ryan, Frank Dahm, J. R. Tyson, Tommy Coates. Daily ex Sun, 9-12 n, women's programs; 12:20 pm, children's story period; 12:40, luncheon program; 2:30, women's club; 3, tea time music; 5, readings; 6, stocks; 6:10, Punch and Judy; 6:35, ensemble; 6:50, Almanac; 7-12, music. Sun, 12 n, comics; 1-6:50 pm, afternoon program; 6:50-12 mid, midnight program. Central.

WGOP

Port Washington, N. Y. 199.9m-1500kc. 100 watts. Frederick B. Zittel, Jr. Founded Sept. 15, 1925.

WGR

Buffalo, N. Y. 302.8m-990kc. 750 watts. Federal Radio Corp. Senior announcer, Kenneth Fickett. Daily ex Sun, 6:45-8 am. Daily ex Sun, Sat, 12 n, stocks; 1 pm, 2:30-4:30. Tues, Thurs, 8-11 pm. Mon, Wed, Fri, 8-12 mid. Sun, 10:45-12 n, 7:45-9 pm, 9:15-10. Eastern. Founded May 21, 1922.

WGST

Atlanta, Ga. 270.1m-1110kc. 500 watts. Georgia School of Technology. Announcer, Walter W. Merkle. Slogan, "The Southern Technical School with a National Reputation." Mon, 9:30-10:30 pm. Thurs, 7-8 pm. Central. Founded Jan., 1924.

WGWB

Milwaukee, Wis. 270.1m-1110kc. 500 watts. Radiocast Corp. of Wisconsin. Announcer, John Sullivan. Slogan, "Make Milwaukee Michtier." Daily ex Sun, Sat, 10:30-12:30 pm. Mon, 8-10:30 pm. Wed, 8-9 pm. Fri, 9-10:30 pm. Sun, 10-11 am, 6-7 pm. Central.

WGY

Schenectady, N. Y. 379.5m-790kc. 50,000 watts. General Electric Company. Announcer, Kolin Hager. Slogan, "Good Evening to You All." Daily ex Sun, 6:45-8 am, exercises; 8:30, talk; 11:15, talk; 11:58, time; 12:01 pm, weather; 12:02, produce; 12:06, weather; 2 pm, music; 2:30, orchestra; 6, stocks; 6:30, orchestra. Mon, 6:30-11 pm. Tues, 6:30-11 pm. Wed, 6:30-11 pm. Thurs, 6:30-12:30 pm. Fri, 6:30-11 pm. Sat, 6:30-12 mid. Sun, 10:30-12n, 3:30-10:45 pm. Short wave. Mon, Tues, Thurs, Sat, 2XAM, 31.0m. Wed, Fri, Sun, 2XAM, 21.06. Founded 1922.

WHA

Madison, Wis. 333.1m-900kc. 750 watts. Univ. of Wis. Announcer, George Curran. Mon, Wed, Sat, 7:30-9:30 pm. Central. Founded 1920.

WHAD

Milwaukee, Wis. 270.1m-1110kc. 500 watts. Marquette University. Cy Foster, Harry Friedman. Mon, Tues, Wed, Thurs, Fri, 3:30-4 pm, 7:30-8. Fri, 4:30-5 pm, 8-9:30. Sun, 4:30-5 pm. Central. Founded Oct., 1921.

WHAM

Rochester, N. Y. 280.2m-1070kc. 5000 watts. Stromberg-Carlson. Tel., Mig. Co. Announcer, P. H. Warren. Slogan, "This is Rochester—Where Quality Dominates." Daily ex Sun, 6:30-11 pm. Tues, 2:30-4 pm. Sun, 10:30-12 n, 3:30-5, 6:30-11. Eastern. Founded July 11, 1922.

WHAP

Carlstadt, N. J. 236.1m-1270kc. 1000 watts. Defenders of Truth Society, Inc. Announcer, Franklin Ford. Mon, Thurs, 6-9 pm. Wed, 9-11:30 pm. Sat, 7-11:30 pm. Sun, 7:30-9:30 pm. Eastern. Founded May, 1925.

WHAS

Louisville, Ky. 322.4m-930kc. 500 watts. Courier-Journal and Louisville Times Co. Daily ex Sun, 3-5 pm, 7-9:30. Sun, 10 am, service; 2-3, 4:30-5:30, 6:20-8:15, 8:15-9:15. Founded July, 1922. Central.

WHAZ

Troy, N. Y. 305.9m-980kc. 500 watts. Reppselaer Polytechnic Inst. Announcer, Rutherford Hayner. Slogan, "Transcontinental and International Broadcasting Station Located at the Oldest College of Science and Engineering in America." Club, R. P. I. students. Mon, 8-12 midnight, concert, educational talks, orchestra, features. Founded June 22, Eastern.

WHBA

Kansas City, Mo. 340.7m-880kc. 500 watts. Swinney Auto & Electrical School. Announcer, John T. Schilling. Slogan, "Heart of America." Daily ex Sun, 8:25 am, 9:25, 10:25, 10:30, 11:20, 11:30, 11:56, market reports; 2-3, ladies' hour. Daily ex Sun, Sat, 12:15 pm, 12:30, 1:25, 1:40, stocks. Daily, 7-8 pm. Mon, 8-10 pm. Tues, Thurs, 8-10 pm. Sat, 12:05 pm, 12:30, 1:25, markets, 8-10 pm. Sun, 9:45-10:45 am, service 6:30, 7:15, 7:45; 11:15-1 am, organ. Central. Founded April, 1922.

WHBB

Oil City, Pa. 260.7m-1150kc. 10 watts. Shaffer Music House. Tues, 9-10 pm. Eastern. Founded Nov., 1924.

WHBC

Canton, Ohio. 236.1m-1270kc. 10 watts. Rev. E. P. Graham. Slogan, "Ignorance is Our Greatest Foe." Sun, 1:30-2 pm. Central. Founded Feb., 1925.

WHBD

Bellefontaine, Ohio. 222.1m-1350kc. 100 watts. First Presbyterian church. Sun, 11 am, 7:30 pm. Eastern. Founded Feb., 1925.

WHBF

Rock Island, Ill. 222.1m-1350kc. 100 watts. Beardsley Specialty company. Announcer, C. L. Beardsley. Slogan, "Where Historic Blackhawk Fought." Daily ex Sun, 12-2 pm. Mon, Wed, 9-11 pm. Sat, 2-4 pm, 7-9. Central. Founded Feb., 1925.

WHBL

Chicago, Ill. 204m-1470kc. 100 watts. C. L. Carroll. (Portable.) Founded 1925.

WHBM

Chicago, Ill. 201.2m-1490kc. 100 watts. C. L. Carroll. (Portable.)

WHBP

Johnstown, Pa. 228.9m-1310kc. 250-500 watts. Johnstown Automobile Co. Announcer, J. C. Tully. Slogan, "The Voice of the Friendly City." Daily ex Sun, 1:15 pm. Mon, 11 pm. Thurs, 10 pm. Sat, 10 pm. Sun, 8:15 pm. Eastern.

WHBQ

Memphis, Tenn. 232.4m-1290kc. 100 watts. Broadcasting Station WHBQ, Inc. Founded March, 1925.

WHBU

Anderson, Ind. 220.4m-1360kc. 15 watts. Citizen's Bank. Announcer, A. L. McKee. Slogan, "Radio Voice of Anderson."

WHBV

Philadelphia, Pa. 220.4m-1360kc. 100 watts. D. R. Kienzie. Tues, Fri, 7 pm-12:15 am. Sun, 7:30-10:30 pm. Eastern.

WHBY

West De Pere, Wis. 249.9m-1200kc. 50 watts. St. Norbert's College. Green Bay-De Pere Broadcasting Station. Daily, 6:30 pm. weather, markets. Wed, Fri, Sat, Sun, 5-6 pm. Fri, 7-8 pm. Sun, 10-11 am, service. Central. Founded Jan., 1925.

WHDI

Minneapolis, Minn. 245.8m-1220kc. 500 watts. Wm. Hood Dunwoody Industrial Institute. Announcers, M. R. Bass, A. P. Union. Slogan, "Northwest Leading Trade School." Mon, 8-9 pm. Wed, 8:30 pm. Fri, 9-10 pm. Daily ex Sun, 6:57-9:30 am, time. Central. Founded May 22, 1922.

WHEC

Rochester, N. Y. 254.1m-1180kc. 500 watts. Hickson Electric company, Inc. Slogan, "The Magazine of the Air." Announcer, George Tolley. Daily ex Sun, 10 am, 8 pm. Sun, 10:30-12 n, 4:30-5:30 pm, 7:30-10 pm. Eastern. Founded Jan., 1924.

WHFC

Chicago, Ill. 215.7m-1390kc. 200 watts. Triangle Broadcasters. Daily ex Mon, 8-12 mid. Central.

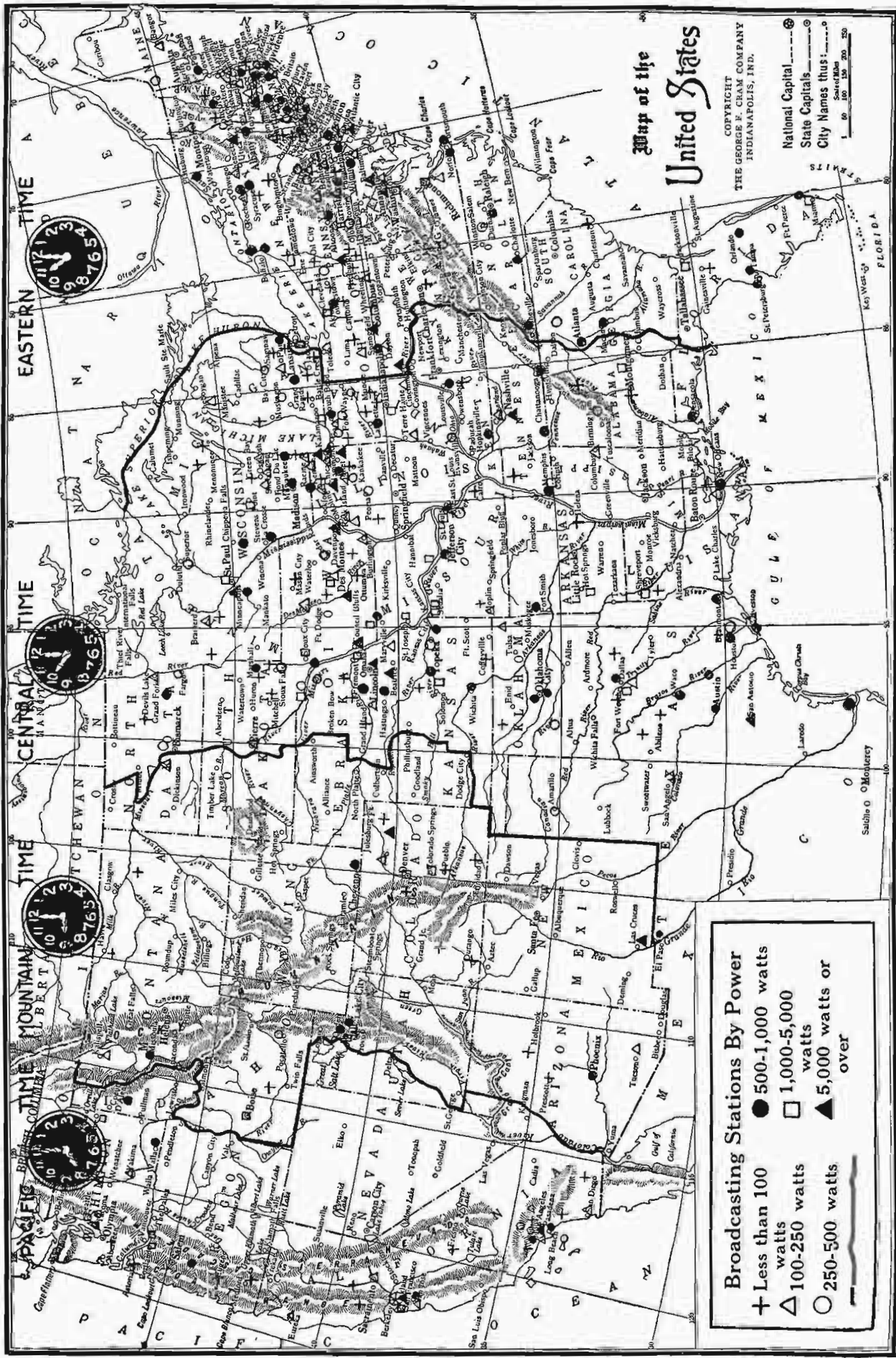

Broadcasting Stations By Power

- + Less than 100 watts
- △ 100-250 watts
- 250-500 watts
- 500-1,000 watts
- 1,000-5,000 watts
- ▲ 5,000 watts or over

Map of the United States

COPYRIGHT
THE GEORGE F. CHAS. COMPANY
INDIANAPOLIS, IND.

National Capital
State Capitals
City Names thus:
Saratoga

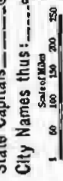



WHK

Cleveland, Ohio. 265.3m-1130kc. 500 watts. 1,000 watts 6 am-6 pm. Radio Air Service Corp. Slogan, "Cleveland's Pioneer Broadcasting Station." Daily, 11 am-1 pm, music; 3:30, music; 3:40, housekeepers' chat. Daily ex Sun, 6 pm, Thurs, 6-12 mid. Sun, 10 am, 2-3 pm, 4:30-9:30, Eastern. Founded 1921.

WHN

New York, N. Y. 394.5m-760kc. 500 watts. Loew's State Broadcasting Station, Announcers, N. T. G. Perry, Charles S. Slogan, "The Voice of the Great White Way." Daily ex Sun, 1-2 pm, 6-12:30 am. Sat, 12-11 pm. Sun, 9-11 am, 12:30-3 pm, 5-7:30, 9:45-12 mid. Eastern. Founded March, 1922.

WHO

Des Moines, Ia. 535.4m-560kc. 5000 watts. Bankers Life Co. Announcer, N. Dean Cole. Daily ex Sun, 8-9 am, 9:45, Aunt Sammy; 10, 10:30-12 n, 12:15-1:15, 2:15-4:30, 6:30-12. Sun, 11 am, 2-5 pm, 6:30-9:30. Central. Founded 1924.

WHPP

Englewood, N. J. 206.8m-1450kc. 10 watts. Bronx Broadcasting Co.

WHT

Chicago, Ill. (tr. at Deerfield). 305.9m-980kc. 5000 watts. Radiophone Broadcasting Corp. Announcer, Pat Barnes. Slogan, "Write Home Tonight." Daily and Sun, 10 am-2:30 pm. Daily ex Mon, 6-7 pm. Tues, Wed, 8:30-10 pm, Thurs, Fri, Sat, 8:30-10 pm, 11-12. Sun, 10-2 pm, 6-7, 8:30-10 pm. Central. Founded April 25, 1925.

WIAD

Philadelphia, Pa. 288.3m-1040kc. 100 watts. Howard R. Miller. Slogan, "The Voice from the Birthplace of Liberty." Tues, Thurs, Fri, 6-12 mid. Eastern. Founded June, 1922.

WIAS

Ottumwa, Ia. 322.4m-930kc. 100 watts. Poling Electric Co. Announcer, J. Ernest Gray. Daily ex Sun, Tues, 12-1 pm, 2:30-3:30, 5-6. Central. Founded June 12, 1922.

WIBA

Madison, Wis. 239.9m-1250kc. 100 watts. The Capital Times Strand theater. Announcer, Kenneth F. Schmitt. Slogan, "Four Lakes City." Mon, 8-11 pm. Wed, 7-9 pm. Fri, 6:15-7 pm. Sun, 12-1 pm. Central. Founded June, 1924.

WIBG

Elkins Park, Pa. 440.9m-680kc. 50 watts. St. Paul's Protestant Episcopal church. Announcer, W. Le Roy Ansack. Sun, 10:55 am, 3:55 pm. Eastern. Founded 1925.

WIBJ

Chicago, Ill. 201.2m-1490kc. 100 watts. C. L. Carroll. (Portable.)

WIBM

Chicago, Ill. 201.2m-1490kc. 100 watts. C. L. Carroll. (Portable.)

WIBO

Chicago, Ill. (tr. at Des Plaines). 305.9m-980kc. 5000 watts. Nelson Brothers, Bone and Mtx. Co. Announcers, Walter Preston, Stu Dawson. Daily, 2:30-6 pm. Daily ex Mon, 7-8:30, 10-11 pm. Sun, 8:45-10 am. Sun, Tues, Wed, 11-1 am. Central. Founded May 20, 1925.

WIBR

Steubenville, Ohio. 249.9m-1200kc. 50 watts. Thurman A. Owings. Announcer, Robert Merry; man. Slogan, "Where Investments Bring Results." Founded Jan., 1925. Eastern.

WIBS

Elizabeth, N. J. 204m-1470kc. 250 watts. New Jersey Broadcasting Corp. Announcer, Capt. H. J. Lepper. Mon, Wed, Fri, 3-5 pm, 6-8, 10:30-12:30. Tues, Thurs, 3-5 pm, 6-7:30. Sat, 6-11 pm. Sun, 10:30-12 n, 5:30-7:30 pm. Eastern. Founded June, 1925.

WIBU

Poynette, Wis. 217.3m-1380kc. 20 watts. The Electric Farm. Daily ex Sun, 12-1 pm. Mon, 8-12 mid. Wed, 2-3 pm. Sun, 2-4 pm. Central. Founded July 10, 1925.

WIBW

Topeka, Kan. 204m-1470kc. 250 watts. C. L. Carroll. Founded 1926. Announcer, M. W. Macy. Daily ex Sun, 10:30 am, 5:30 pm, 8:30. Sun, 12:15 am, 4, 6:15 pm. Central.

WIBX

Utica, N. Y. 238m-1260kc. 300-150 watts. WIBX Inc. Daily ex Sun, 9:30-11 am, shopping tour, 12-1, news, stocks, markets, music, farm news, 3-4, music, 6-11. Wed, silent night, Sat, 6-1 am. Sun, 10:30-1 pm, 6-11. Eastern. Founded 1923.

WIBZ

Montgomery, Ala. 230.6m-1300kc. 15 watts. A. D. Trum.

WICC

Easton, Conn. 265.3m-1130kc. 500 watts. The Bridgeport Broadcasting Station, Inc. Announcers, Charles W. Selen, Harold Campbell. Slogan, "The Industrial Capital of Connecticut." Daily ex Sun, 9-11 am, 12-1 pm, 5-11. Sun, 10:50 am-12:30 pm, 2-5, 7:30-9:30. Eastern. Founded Aug. 2, 1926.

WIL

St. Louis, Mo. 258.5m-1160kc. 250 watts. Benson Broadcasting Co. Announcers, "Bill" Ellsworth, L. A. Benson. Daily and Sun, 9:30-11:30 am, 2:45-5 pm. Daily ex Wed, 8-11 pm. Central. Founded Sept., 1922.

WIOD

Miami Beach, Fla. 247.8m-1210kc. 1000 watts. Carl G. Fisher. Announcer, Jesse H. Jay. Slogan, "Wonderful Isle of Dreams."

WIP

Philadelphia, Pa. 348.6m-860kc. 500 watts. Gimbel Bros. Announcer, E. A. Davies. Slogan, "Watch Its Progress." Daily ex Sun, 1-1:30 pm, 3-4:30, 6:30-7:30. Tues, Thurs, Sat, 10-10:30 am. Tues, 10 pm, Wed, 8-9 pm. Thurs, 8-10 pm. Sat, 9-11:30 pm. Sun, 10:45-12 n, alternate Sun, 9 pm and 7:45 pm. Eastern. Founded Nov. 1921.

WISN

Milwaukee, Wis. 270.1m-1110kc. 250 watts. School of Engineering of Milwaukee. Managed by Wisconsin News. Slogan, "In the Land of the Sky-blue Waters." Daily ex Sun, Sat, 1:30 pm, request number; 2:15, newspaper features; 2:30, orchestra; 5:15, Peter Rabbit; 6:15, organ; 8, dance music; Mon, Fri, 10 pm. Sun, 3:30 pm, Bible class; 7:30, service. Central. Founded Sept. 21, 1922.

WIVA

Charlottesville, Va. 209.7m-1430kc. 100 watts. Radio Corporation of Virginia. Slogan, "The Voice of the Business District." Mon, Tues, Thurs, Fri, 7-8 pm. Sun, 10:30-12:15 pm, 7:15-8:45. Eastern.

WJAD

Waco, Tex. 333.1m-900kc. 500 watts. Hotel Raleigh. Daily ex Sun, 9:30-10:30 am, 11:30-12:30 pm, 6-7:30. Sun, 1-2 pm, 8, 6:30-7:30. Central. Founded July 22, 1922.

WJAG

Norfolk, Nebr. 285.5m-1050kc. 250-500 watts. Norfolk Daily News. Announcer, Karl Stefan. Slogan, "The World's Greatest Country Daily, and Home of Printer's Devil." Daily ex Sun, 12:15 pm; 4 pm; 6:30-7:30 pm, orchestra. Sun, 3 pm. Central. Founded 1922.

WJAK

Kokomo, Ind. 234.2m-1280kc. 50 watts. Kokomo Tribune. Daily ex Sun, 11:45 am. chapel. Mon, 7:30 pm, music. Wed, Thurs, 5:30 pm. concert. Fri, 7:30 pm. Founded Sept., 1921. Central.

WJAM

Cedar Rapids, Iowa. 239.9m-1250kc. 250 watts. D. M. Berham. Daily ex Sun, 9 am, 9:40, 12:30, 1:20, markets. Mon, Wed, Fri, 7-9 pm. Tues, Thurs, Sat, 9-11 pm. Central. Founded July 29, 1922.

WJAR

Providence, R. I. 483.6m-620kc. 500 watts. "The Outlet Co. Announcer, J. A. Reilly. Slogan, "The Southern Gateway of New England." Daily ex Sun, 1:05-2 pm, weather, reports, music. Wed, Thurs, Fri, 10 am. household hints, Mon, Wed, 7:30-10:30 pm. Tues, 7-10:30 pm. Thurs, 7:30-10 pm. Fri, 8-11 pm. Sat, 7:45-10 pm. Sun, 6:30-10:15 pm. Eastern. Founded Sept. 6, 1922.

WJAS

Pittsburgh, Pa. 270.1m-1110kc. 500 watts. Pittsburgh Radio Supply House, Pickering's Studio. Announcer, Howdy Clark. Slogan, "World's Jolliest Aerial Station." Daily ex Sun, 10:30 am-2 pm, 9-11. Tues, Thurs, Sat, 10:30 am-2 pm, 8-11. Sun, 11 am-2 pm, 3-4, 9-10. Eastern. Founded Aug. 4, 1922.

WJAX

Jacksonville, Fla. 340.7m-880kc. 1000 watts. City of Jacksonville. Daily ex Sun, 11:55-12:05 pm. Daily ex Sun, Wed, 7:30-11 pm. Sun, 11 am, 6:30-7:30 pm, 8-9, 10-11. Eastern. Founded Nov. 26, 1925.

WJAY

Cleveland, Ohio. 227.1m-1320kc. 500 watts. Cleveland Radio Broadcasting Corp. Announcer, Johnny Mack. Slogan, "On The Hollenden." Daily ex Sun, 10 am, 12 n, time; 6-12 mid. Sun, 10:30 am, service; 6:30 pm, 11 pm, 11, time. Eastern. Founded Jan. 7, 1927.

WJAZ

Mt. Prospect, Ill. 263m-1140kc. 5000 watts. Zenith Radio Corp. Announcer, George G. Smith. Daily ex Sun, Mon, Thurs, 7-8 pm, 9-11. Thurs, 9-12 mid. Sun, 7:30-9:30 pm. Founded 1922. Central.

WJBA

Joliet, Ill. 247.8m-1210kc. 50 watts. D. H. Lentz, Jr. Tues, Thurs, Fri, Sat, 7-12 mid. Central.

WJBB

Sarasota, Fla. 238m-1260kc. 250 watts. Financial Journal. Announcer, Jack Daisevell. Daily ex Sun, 11:30-2 pm, 4:30-6, 6-7, 9-12. Eastern. Founded 1920.

WJBC

La Salle, Ill. 227.1m-1320kc. 100 watts. Hummer Furniture Co. Announcer, LeRoy Stremlau. Slogan, "Better Home Station." Daily ex Sun, 7:30-8 am, 9-9:30, 12:30-1:30 pm, 6-7, 7-8, Wed, 8-9. Sun, 10-11:30 am. Founded May 4, 1925. Central.

WJBI

Red Bank, N. J. 263m-1140kc. 250 watts. Robert S. Johnson. Founded Sept. 15, 1925.

WJBK

Ypsilanti, Mich. 220.4m-1360kc. 15 watts. Ernest Goodwin. Announcer, H. T. Augustus. Mon, 9-11 pm. Thurs, 10-12 mid. Sun, 10-11:20 am, 7:30-8:30 pm. Eastern. Founded Oct. 7, 1925.

WJBL

Decatur, Ill. 212.6m-1410kc. 250 watts. William Gushard Dry Goods Co. Announcer, W. H. Wiley. Mon, 9-10:30 pm. Wed, 9-11 pm. Sat, 9-11:30 pm. Sun, 10:45-12:15 pm. Central. Founded Sept. 24, 1925.

WJBO

New Orleans, La. 263m-1140kc. 100 watts. Valdemar Jensen. Founded 1922.

WJBT

Chicago, Ill. 389.4m-770kc. 500-5000 watts. J. S. Boyd, Inc. Announcer, Bobby Griffin. Daily ex Sun, 11:05 am, 1:30 pm, 5, Mon, 10-11 pm. Tues, 11 pm-12 am. Wed, Fri, Sat, 11 pm. Thurs, 11-12 mid. Sun, 10:30-12 n, 2:30-12 mid. Central. Founded 1926.

WJBU

Lewisburg, Pa. 214.2m-1400kc. 100 watts. Bucknell University. Announcer, A. B. Lauderdale. Slogan, "In the Heart of the Keystone State." Thurs, 8 pm. Eastern. Founded 1925.

WJBW

New Orleans, La. 238m-1260kc. 30 watts. C. Carlson, Jr.

WJBY

Gadsden, Ala. 234.2m-1280kc. 50 watts. Electric Construction Co. Mon, Wed, Fri, 3-9 pm. Central. Founded Aug. 11, 1926.

WJBZ

Chicago Heights, Ill. 208.2m-1440kc. 100 watts. Roland G. Palmer. Anthony Coppotelli. Mon, Wed, Fri, 7-12 mid. Central. Founded Jan. 10, 1926.

WJJD

Chicago, Ill. (tr. at Mooseheart). 356.6m-620kc. 1000 watts. Loyal Order of Moose station, Palmer House. Herald Examiner. Announcer, Gene Rouse. Slogan, "The Call of the Moose." Daily ex Sun, 12 n, 2 pm, 4, 5:45, 8-9. Mon, Tues, Wed, 11-12 mid. Thurs, Fri, 11-1 am. Sat, 8-11 pm. Sun, 7:30-10:30 am, 1 pm, 2, 6:30, 9-10:15. Central.

WJKS

Gary, Ind. 232.4m-1290kc. 500 watts. Thomas J. Johnson and Frances Kennedy Radio Corp. Mon, 7-11 am. Tues, 3:30-5 pm, 7-9, 11-12. Wed, 7-9 pm, 11-1 am. Thurs, 3:30-5 pm, 7-9, 11-12. Fri, 3:30-5 pm, book review, 7-9, 11-12. Sat, 3:30-5 pm, 7-9, 11-1 am. Sun, 11-1:30 pm, 3:30-5, 7-9, 11-12. Central. Founded Aug. 16, 1927.

WJPW

Ashtabula, Ohio. 208.2m-1440kc. 30 watts. J. P. Wilson. Central.

WJR

Detroit, Mich. (tr. at Pontiac). 440.9m-680kc. 5000 watts. 8x A. O. 32 m. The Richards-Oakland Co. Slogan, "The Good 'Will Station." Announcers, Leo Fitzpatrick, John F. Patt. Daily ex Sun, 12:45-2 pm, 6-12 mid. Daily ex Sat, Sun, 10-11:30 pm. Sun, 10 am, service; 2-4 pm, service; 6-10:30 pm. Eastern. Founded August, 1925.

WJZ

New York, N. J. (tr. at Bound Brook). 454.3m-660kc. 40,000 watts. R. C. A. Managed by National Broadcasting Co. Announcers, Milton J. Cross, Marley Sherris, Norman Sweetser, Curt Peterson. Daily ex Sun, 10-11 am, 12:30-12 mid. Sun, 9-10 am, 1-10:45 pm. Founded 1921. Eastern.

WKAQ

San Juan, Porto Rico. 322.4m-930kc. 500 watts. Radio Corporation of Porto Rico. Announcer, Joaquin Agusty. Slogan, "The Island of Enchantment. Where the World's Best Coffee Grows." Wed, 7-9 pm. Fri, 8:30-9:30 pm. Eastern. Founded Dec. 3, 1922.

WKAR

East Lansing, Mich. 277.6m-1080kc. 500-1000 watts. Michigan State College. Announcer, Keith Himebaugh. Daily ex Sun, 12-12:30 pm, weather, markets, agricultural topics, 7:15-8, farm school; Mon, 8-9 pm. Music. Eastern. Founded 1922.

WKAJ

Laconia, N. H. 223.7m-1340kc. 50 watts. Laconia Radio club. Fri, 7:30 pm. Sun, 11 am, 5 pm. Eastern. Founded Oct. 1, 1922.

WKBB

Joliet, Ill. 215.7m-1390kc. 150 watts. Sanders Brothers. Mon, 7-9 pm. Tues, Thurs, 8-12 mid. Moo, 8-10 pm. Sun, 3-5 pm. Central.

WKBC

Birmingham, Ala. 218.8m-1370kc. 10 watts. H. L. Ansley. Tues, Thurs, 5-6:30 pm, Sat, 9-10 pm. Central. Founded June, 1926.

WKBE

Webster, Mass. 228.9m-1310kc. 100 watts. K. & B. Electric Co. Tues, Wed, 8-10 pm. Sat, 8-10:30 pm. Eastern. Founded Feb. 27, 1925.

WKBF

Indianapolis, Ind. 252m-1190kc. 250 watts. Noble B. Watson. Announcers, Carl Fohl, Carl Watson. Daily ex Sun, 10 am, 10:30, 10:40, 5 pm, 7, 7:10. Daily ex Sun, 12 n. Mon, 7:30 pm, 8:30-9, Tues, 8:30-10:30 pm, Thurs, 7:30-10 pm. Fri, 7:30, 8-9:30 pm. Sun, 10:45 am, 3 pm, 7:30. Founded Oct., 1925. Central.

WKBG

Chicago, Ill. 201.2m;1490kc. 100 watts. C. L. Carroll. (Portable.)

WKBH

LaCrosse, Wis. 220.4m-1360kc. 500 watts. Callaway Music Co. Announcer, Arthur J. Hecht. Daily ex Sun, 10 am, Aunt Sammy; 12 n, weather, U. S. Farm talks. Mon, 8-9 pm, Wed, 8:30 pm. Fri, 7:30 pm, 8, 8:30, Sat, 9 pm. Sun, 10:30 am, 6:30 pm. Central. Founded 1924.

WKBI

Chicago, Ill. 215.7m-1390kc. 50 watts. Fred J. Schoenwolf. C. W. Vermich. Daily, 2-4 pm. Daily ex Sun, 7:30-9:30 pm. Central. Founded Aug., 1926.

WKBL

Monroe, Mich. 205.4m-1460kc. 15 watts. Monrovia Radio Mfg. Co.

WKBN

Youngstown, Ohio. 214.2m-1400kc. 50 watts. Radio Electric Service Co. Announcers, Arthur Brock, Warren E. Williamson, Jr. Daily ex Sun, 7:30 am, exercises, Tues, 5:45 pm, Thurs, Sat, 6 pm. Eastern. Founded Sept., 1926.

WKBO

Jersey City, N. Y. 218.8m-1370kc. 500 watts. Smith Co. Announcers, H. E. Bidwell, Donald Fischer. Mon, 12-1 pm, 6-9. Tues, 12-1 pm, 6-8. Wed, 12-6 pm. Thurs, 10-1 pm, 6-8. Fri, 10-1 pm, 9-12 mid. Sat, 12 n-3 pm. Sun, 2-6 pm. Eastern. Founded Sept. 11, 1926.

WKBP

Battle Creek, Mich. 212.6m-1410kc. 50 watts. Battle Creek Enquirer and News.

WKBQ

New York, N. Y. 218.8m-1370kc. 500 watts. Standard Cabill Co., Inc. Announcer, Allan Cabill. Mon, 9-12 pm, 1-5 pm, 9-12. Wed, 9-12 mid. Thurs, 1-3 pm, 8-12. Fri, 3-6 pm. Sat, 3-8 pm. Sun, 8-12 mid. Eastern. Founded Sept. 1926.

WKBS

Galesburg, Ill. 217.3m-1380kc. 100 watts. Permlil N. Nelson. Announcer, Paul W. Palmquist. Slogan, "The Mayflower Station in the Renowned City of Colleges." Daily ex Sun, Sat, 1-1:30 pm, 3:30 pm, Mon, Wed, Fri, 2:30-3:30 pm, 7-11. Wed, 6:30-7 pm. Tues, Thurs, 2:30-3:30 pm, 7-9, 10-11. Sat, 7-9 pm, 10-11, 11-12. Sun, 1:30-3 pm. Central. Founded Oct., 1926.

WKBT

New Orleans, La. 252m-1190kc. 50 watts. First Baptist church. Announcer, W. H. Green. Slogan, "We Kest Bible Truth." Sun, 10:45 am, 7:20 pm. service. Central. Founded Feb. 1924.

WKBV

Brookville, Ind. 217.3m-1380kc. 100 watts. Knox Battery & Electric Co., Fri, 7-9 pm. Sun, 7-9 pm. Central.

WKBW

Buffalo, N. Y. 217.3m-1380kc. 500-750 watts. Churchill Evangelistic Assn., Inc. Daily ex Sun, 3-4 pm, 6:30-10. Sun, 9:30 am, 10:30, 3 pm, 7-9, 10:15-12 mid. Eastern. Founded 1926.

WKBZ

Ludington, Mich. 199.9m-1500kc. 15 watts. The Tokery. Mon, 8-10 pm. Sun, 10:30-12 n, 7-8:30 pm. Central. Founded Nov. 23, 1926.

WKDR

Kenosha, Wis. 247.8m-1210kc. 15 watts. Edward A. Dato.

WKEN

Amherst, N. Y. 204m-1470kc. 750 watts. WKEN, Inc. Announcers, Walter L. Amidon, Carl E. Welsler. Daily ex Sun, 11:45 am, Mon, Thurs, 6-12:30 am. Tues, 8-12 mid. Sat, 6:30 pm. Sun, 9:30 am, 11, 2:30-3:30 pm, 7:30. Eastern. Founded Fall 1925.

WKJC

Lancaster, Pa. 252m-1190kc. 50 watts. Kirk Johnson & Co. Announcer, R. M. Harnish. Mon, Wed, Fri, 6-10 pm. Fri, 11-12 mid. Sun, 10:45-12 n, 7:30-8:30. Eastern. Founded Nov., 1921.

WKRC

Cincinnati, Ohio. 245.8m-1220kc. 500 watts. Kodel Radio Corp. Mon, Wed, 6-8 pm, 9-11, 12-2. Tues, 6-7 pm, 9-12 mid. Thurs, 8-10 pm. Fri, 9-11 pm, Sat, 6-7 pm, 9-12. Sun, 11-12, 3-5 pm, 7-8, 9-11, 11:30-1. Eastern. Founded May, 1924.

WKY

Oklahoma City, Okla. 288.3m-1040kc. 150 watts. WKY Radiophone Co. Daily 10-11 am, 6-7:30 pm. Mon, Wed, Fri, 9-11 pm. Central.

WLAC

Nashville, Tenn. 225.4m-1330kc. 1000 watts. Life and Casualty. Announcer, Walter N. Campbell. Daily 6:45-7:45 am. Daily ex Sun, 12:25-12:55 pm. Mon, Wed, 6-9 pm. Tues, Thurs, 6-7 pm, 9-11. Sat, 6-9 pm. Sun, 6-7 pm, 9:15-10:15. Central. Opened Nov. 24, 1926.

WLAP

Louisville, Ky. 267.7m-1120kc. 30 watts. 100 watts 6 am-6 pm, Virginia av. Baptist Church. Sun, 11 am, 7:30-8:45 pm. Central. Founded 1922.

WLB

Minneapolis, Minn. 245.8m-1220kc. 500 watts. U. of Minnesota. Announcer, Gordon C. Harris. Mon, 12:30-1 pm. Tues, 6-7 pm, 8-9. Wed, 6:15-7 pm, 7-8. Fri, 12:30-1 pm, 4-5. Central. Opened Oct. 3, 1927.

WLBC

Muncie, Ind. 209.7m-1430kc. 50 watts. D. A. Burton. Slogan, "Muncie, Ind. The Ideal American City." Daily ex Sun, 10 am, 12 u, 3 pm, 7. Sun, 10 am, 2 pm. Central.

WLBF

Kansas City, Mo. 209.7m-1430kc. 50 watts. Everett L. Dillard. Slogan, "Where Listeners Become Friends." Daily ex Sun, 9-12 n, 2-4 pm, 7-10:30. Central. Founded Nov. 13, 1926.

WLBG

Petersburg, Va. 214.2m-1400kc. 100 watts. R. A. Gault.

WLBH

Farmingdale, N. Y. 232.4m-1290kc. 30 watts. Jos. J. Lombardi. Announcer, D. J. Martin. Daily, 11-11 am. Mon, Wed, Fri, 7:30-11 pm. Eastern.

WLBI

Wenona, Ill. 239m-1260kc. 250 watts. Wenona Legion Broadcasters, Inc. Daily ex Sun, 10 am, 2 pm. Wed, 7-9 pm. Mon, Thurs, Fri, 7 pm. Central. Opened Nov 1926.

WLBL

Stevens Point, Wis. 333.1m-900kc. 1000 watts. 2000 watts. 6 am-6 pm, Wisconsin Dept. of Markets. Slogan, "Wisconsin Land of Beautiful Lakes." Daily ex Sun, 7 am, 9, 10-11, 12 n, weather, markets, 1 pm, news, Thurs, Sat, 8-10 pm. Central.

WLBM

Cambridge, Mass. 236.6m-1300kc. 50 watts. Brown-ning Drake Corporation.

WLBN

Chicago, Ill. 204m-1470kc. 100 watts. William H. Hiler. (Portable). Daily ex Sun, 12-1 pm, 5-7, 9-11. Central.

WLBO

Galesburg, Ill. 217.3m-1380kc. 100 watts. Frederick A. Trebbe, Jr. Tues, Thurs, Sat, 9-10 pm. Central. Founded Jan. 16, 1927.

WLBO

Atwood, Ill. 218.8m-1370kc. 25 watts. E. Dale Trout.

WLBR

Rockford, Ill. 247.8m-1210kc. 15 watts. Rockford Broadcasting Corp.

WLBT

Crown Point, Ind. 247.8m-1210kc. 50 watts. Harold Wendell.

WLBV

Mansfield, Ohio. 206.8m-1450kc. 50 watts. Mansfield Broadcasting Association. Announcers, Ray Davis, John F. Weimer. Daily ex Sun, 6-7 pm. Mon, 9-11 pm. Wed, 9-11 pm. Sat, 9-12 mid Sun, 10:30-12 n. Central. Founded Jan. 1, 1927.

WLBW

Oil City, Pa. 293.9m-1020kc. 500 watts. Petroleum Telephone Co., Announcer, Deane Moore. Daily ex Sun, 12:15-1:15 pm, 5:15 pm. Mon, 12-1:30 am. Mon, 9:30-11 pm. Thurs, 10-11:30 pm. Sun, 3:30-5 pm. Eastern. Founded 1926.

WLBX

Long Island, N. Y. 204m-1470kc. 250 watts. John N. Brady.

WLBY

Iron Mountain, Mich. 209.7m-1430kc. 50 watts. Aimone Electric. Daily and Sun, 12-1 pm. Central.

WLBY

Foxcroft, Me. 208.2m-1440kc. 250 watts. Thompson L. Guernsey.

WLBI

Ithaca, N. Y. 247.8m-1210kc. 50 watts. Lutheran Assn. of Ithaca. Announcer, Robert F. Schuetz. Slogan, "The Church at the Gate of the Campus." Sun, 10:45 am, 7:45 pm. Eastern. Founded 1926.

WLBY

Lexington, Mass. 215.7m-1390kc. 50 watts. Lexington Air Station. Announcers, Gerald Harrison, Carl S. Wheeler, Paul Morgan. Daily ex Sat, 8:30-10:30 pm. Sat, 11 pm. Eastern. Founded Oct., 1926.

WLBI

Chicago, Ill. (Tr. at Elgin.) 416.4m-720kc. 1500 watts. Liberty Magazine. Announcers, Bill Hay, Art Smith. See WGN. Central. Founded 1925.

WLIT

Philadelphia, Pa. 405.2m-740kc. 500 watts. Lit Bros. Mon, Wed, Fri, 12-2 pm, music, 2-3, 4:30, music; 5:30, stories; 7:30-mid. Tues, Thurs, 11 am, 5:30, Thurs, Sat, 12n, 2 pm, 4:30, 5:30, 7:30. Eastern. Founded Mar. 18, 1923.

WLOE

Chelsea, Mass. 211.1m-1420kc. 100 watts. William S. Fote.

WLS

Chicago, Ill. (tr. at Crete). 344.6m-870kc. 500 watts. Sears, Roebuck & Co. Slogan, "World's Largest Store." Daily ex Sun, 9-1:30 pm, half hour markets; 12-1 pm, farm program; 2:30-3:30, homemakers hour. Mon, 4:30-10 pm. Wed, Fri, 4:30-12 mid. Sat, 4:30-11 pm. Tues, Thurs, 4:30-8 pm. Sun, 10:45-12:15 pm. U. of C. services; 12:15-1:30 pm, concert; 1:30-2:30, S. C. school; 6-8, Little Brown church. Central. Founded April 6, 1924.

WLSI

Providence, R. I. 247.8m-1210kc. 250 watts. Lincoln Studios Inc. Announcer, Armand J. Lopez. Mon, 6:45 pm. Tues, 6:30 pm. Wed, 7 pm, 9. Thurs, 6:30. Fri, 7 pm. Sat, 6:30 pm. Sun, 6:30 pm. Eastern. Founded Jan. 1925.

WLTH

Brooklyn, N. Y. 256.3m-1170kc. 250 watts. Voice of Brooklyn, Inc. Mon, 10 am, 5-6 pm, 9-11. Tues, Wed, Thurs, 4-7 pm, 9-12. Fri, 5-7 pm, 11-11 am. Sat, 4-6 pm, 9-12 mid. Sun, 1-2 pm, 5-6, 9-11. Eastern.

WLTS

Chicago, Ill. 483.6m-620kc. 100 watts. Lane Technical High School. Mon, 9-10 am, 2-4 pm, 6-7. Tues, Wed, Thurs, Fri, 9-10 am, 2-4 pm. Central. Founded May 1924.

WLW

Cincinnati, Ohio. (tr. at Harrison). 428.3m-700kc. 5000 watts. 52m-576kc. 250 watts. The Crosley Radio Corp. Announcer, Fred Smith. Daily ex Sat, Sun, 8 am, exercises; 10, woman's hour; 11:15, markets; 11:55, time; 12 n, weather, musicale; 1:30, 3:30, markets; 4, program; 6:45, markets; 6:45-12, Sat, 10 am, woman's hour; 11:15, markets; 11:55, time; 12 n, weather; 12:45, markets; 2:30-4:30, musicale; 6:45, markets, 6-12. Sun, 9:30 am, 11:30, 7:15-11. Eastern. Founded 1919.

WLWL

New York, N. Y. (tr. at Kearney). 370.2m-810kc. 1000 watts. The Paulist League. Announcer, Bar. tholomey Sheehan. Slogan, "For God and Country." Tues, Thurs, 8-11 pm. Sat, 7-9 pm. Sun, 8-9:15 pm. Eastern.

WMAC

Cazenovia, N. Y. (tr. at Cazenovia). 225.4m-1330kc. 500 watts. C. B. Meredith. Announcer, C. R. Jones. Thurs, 12 n, farm program; 8 pm, popular studio. Founded 1922. Eastern.

WMAF

South Dartmouth, Mass. 428.3m-700kc. 500 watts. Round Hills Radio Corp. Not operating.

WMAK

Buffalo, N. Y. (tr. at Lockport). 545.1m-550kc. 750 watts (tr. Tonawanda). WMAK Studios, Inc. Announcer, William Fay. Daily ex Sun, 11 am, 12 mid. Sat, 6-12 mid. Sun, 3-11 pm. Eastern. Founded Sept. 22, 1922.

WMAL

Washington, D. C. 241.8m-1240kc. 500 watts. M. A. Leese Radio Co. Daily 6:30 pm. Eastern.

WMAN

Columbus, Ohio. 234.2m-1280kc. 50 watts. First Baptist church. Announcer, John Bobannan. Sun, 10:30-11:45 am, 7:30-8:45 pm. Eastern. Founded Sept., 1922.

WMAQ

Chicago, Ill. 447.5m-670kc. 5000-2500. The Chicago Daily News. Announcer, Harry Geise. Daily ex Sun, 6:30 am-1 am. Sun, 10:45 am, service. 1-11 pm. Central. Founded April 13, 1922.

WMAY

St. Louis, Mo. 234.2m-1280kc. 100 watts. Kings-highway Presbyterian churches. Announcer, Don O'Neil. Slogan, "May Every By-Way Hear Kings-highway." Sun, 11 am, 8 pm. Central.

WMAZ

Macon, Ga. 270.1m-1110kc. 500 watts. Mercer University. Announcer, E. K. Cargill. Tues, Wed, Thurs, 8-9:15 pm. Fri, 11-12:15 am. Eastern. Founded 1925.

WMBA

Newport, R. I. 204m-1470kc. 100 watts. LeRoy Joseph Beebe. Daily ex Sun, 3-4 pm, 8-10.

WMBB

Homewood, Ill. 252m-1190kc. 5000 watts. American Bond & Mortgage Co. Tri-agon. Announcer, George Gjorch. Slogan, "World's Most Beautiful Ballroom." Daily ex Sun, 7:10-10:30 pm, 4-6 pm, 7:40-10:30. Central. Founded 1925.

WMBC

Detroit, Mich. 243.8m-1230kc. 100 watts. Michigan Broadcasting Co. Announcer, Gordon Higham. Daily, 6-10 pm. Eastern. Founded 1925.

WMBD

Peoria Heights, Ill. 205.4m-1460kc. 250 watts. Peoria Heights Radio Laboratory. Daily ex Thurs, musicale. Sun, service.

WMBE

St. Paul, Minn. 208.2m-1440kc. 10 watts. Dr. C. S. Stevens.

WMBF

Miami Beach, Fla. 384.4m-780kc. 500 watts. Fleetwood Hotel. Announcer, Paul Whitehurst. Daily 6:30-7:30 am, 9:30-11 pm. Eastern. Founded 1924.

WMBG

Richmond, Va. 220.4m-1360kc. 15 watts. Havens and Martin. Slogan, "The Public Be Pleased." Announcer, Wm. K. Sealey, Jr. Daily ex Sun, 2-3 pm, 6-10. Eastern.

WMBH

Joplin, Mo. 204m-1470kc. 100 watts. Edwin Dudley Aber. Announcers, M. E. Jones, E. D. Aber. Slogan, "Where Memories Bring Happiness." Mon, Tues, Wed, Thurs, 12:15-1 pm, 5:30-7:30, 8:30-10:30. Fri, 12:30-1:15 pm, 5:30-7:30. Sat, 12:30-1:15 pm, 5:30-7:30, 8:30-10:30. Sun, 10:50-12 n., 6, 7:30. Central.

WMBI

Chicago, Ill. 263m-1140kc. 2500 watts. Moody Bible Instan. Slogan, "Wage West Point of Christian Service." Announcer, Wendell P. Loveless. Daily ex Sun, 7-7:40 am, 10:30-11:30, 12:30-1:30 pm, 3:30-4:30, Tues, Thurs, Sat, 4:30-5 pm. Tues, Wed, Fri, Sat, 8-9 pm. Thurs, 7-9 pm. Sun, 3:30-7 pm. Central. Founded July 28, 1926.

WMBJ

Monessen, Pa. 232.4m-1290kc. 50 watts. Star theater.

WMBL

Lakeland, Fla. 228.9m-1310kc. 100 watts. Denford's Radio studios. Daily ex Sun, 10:30-1:30 pm, 7:30-9, 9-10, 10-11, Sun, 11-12 n., 7:30-8:30. Eastern.

WMBM

Memphis, Tenn. 209.7m-1430kc. 10 watts. Seventh Day Adventist Church.

WMBO

Auburn, N. Y. 220.4m-1360kc. 100 watts. Radio Service Laboratories.

WMBQ

Brooklyn, N. Y. 204m-1470kc. 100 watts. Paul J. Golhofer.

WMBR

Tampa, Fla. 252m-1190kc. 100 watts. F. J. Reynolds. Daily ex Sun, 1-2 pm, 2-3, 7-8, 8-9, 10-11. Eastern.

WMBT

Leimoyne, Pa. 234.2m-1280kc. 250 watts. Mack's Battery Co. Announcer, W. S. McCaehren. Slogan, "The Voice of the Susquehanna." Daily ex Sun, 11:30 am, musicale, 12 n, organ; 6, time, 6-11:30 pm, music. Sat, 11:30-3 am. Knut Kracker. Klub frolic. Sun, 8:30 am-9 pm. Eastern. Founded March 1, 1924.

WMBW

Youngstown, Ohio. 214.2m-1400kc. 50 watts. Youngstown Broadcasting Co., Inc. Mon, Wed, Fri, 2:30-3:30 pm, 6-12. Sat, 10:30-12:30 am. Founded Jan., 1927.

WMC

Memphis, Tenn. 516.9m-580kc. 500 watts. The Commercial Appeal. Announcer, Francis S. Chamberlin. Slogan, "Station WMC, Memphis." "Down in Dixie." Daily ex Sun, 12 n, Mon, 8-11:30 pm. N.B.C.; Tues, 9:50 am, 7 pm, N.B.C.; 7:30 music; Sun, 11 am, services; 2 pm, N.B.C.; 4:30 concert; 6:30, N.B.C.; 8, N.B.C.; 9:15 N. B. C. Founded Jan. 20, 1923. Central.

WMCA

New York, N. J. (tr. at Hoboken). 370.2m-810kc. 500 watts. **Hotel McAlpin**, **Announcer**, **Snedden Weir**, Slogan, "Where the Searchlight Flashes and the White Way Begins." Daily ex Sun, 9 am, 9 am, 10:45, 12 n, 1-6 pm, 8-12 mid. Thurs, Sat, 12-1 am, Sun, 10:30 am, 11, 12:15, 1 pm, 2, 3, 3:30, 6-8, 9:15-1:30. Eastern.

WMES

Boston, Mass. 211.1m-1420kc. 50 watts. **Mass. Educational Society**. Mon, 7:30-10 pm. Sun, 10:45-12:15. 1:55-2:30 pm, 7:45-9. Eastern. Founded Aug. 1, 1927.

WMPC

Lapeer, Mich. 234.2m-1280kc. 30 watts. **First Methodist Protestant Church**. Daily ex Sat, 12-1 pm. Daily ex Sat, Thurs, 7:30-10 pm. Moo, 12-12:30 am. Daily ex Sat, 4-5 pm. Sun, 10:30-12 n, 12-1 pm, 4-5:30, 7:30-12. Central. Founded Dec. 6, 1926.

WMRJ

Jamaica, N. Y. 206.8m-1450kc. 10 watts. **Peter J. Prinz**, Tues, Thurs, 8-11:30 pm, Sat, 12:23-30 am. Sun, 12-2:30 pm, 9-11:30. Eastern. Opened July 9, 1926.

WMSC

New York, N. Y. 236.1m-1270kc. 500 watts. **Madison Square Garden**. **Announcer**, **Horace E. Beaver**, Mon, 9:45-12 mid, Tues, 6-11 pm. Wed, Sat, 3-6 pm. Thurs, 8:30-11. Eastern.

WNAC

Boston, Mass. 461.3m-650kc. 500 watts. **The Shepard Stores**. **Announcers**, **Ben Hadfield**, **E. Lewis Dunham**, **Joseph Lopez**, **Jean Sargent**. Daily ex Sun, 7:45 am-12 mid. Sun, 10:45 am-5:30 pm; 6:30-11. Eastern. Founded July 31, 1922.

WNAD

Norman, Okla. 239.9m-1250kc. 500 watts. **University of Oklahoma**. **Announcer**, **Fred Humphrey**, Mon, Wed, Thurs, 7:15-9:45 pm. Tues, Fri, 12:15-1 pm. Sat, 2-5 pm. Central. Founded Jan. 5, 1925.

WNAL

Omaha, Nebr. 258.5m-1160kc. 250 watts. **R. J. Rockwell**. **Announcer**, **Ronald J. Rockwell**, Slogan, "Pioneer Station of Omaha." Fri, Sat, 7-9 pm, 9-11 pm. Central. Founded 1921.

WNAT

Philadelphia, Pa. 288.3m-1040kc. 100 watts. **Lening Bros. Co.** Slogan, "We Never Are Tired." Wed, 7:30 pm. Sat, 8 pm. Eastern. Founded 1921.

WNAX

Yankton, S. D. 302.8m-990kc. 1000 watts. 6 am-6 pm. 250 watts after 6 pm. **Gurney Seed & Nursery Co.** Daily ex Sun, 6 am-6 pm. Sun, 9:30-12 n, 1:30-6 pm. Central. Founded 1921.

WNBA

Forest Park, Ill. 208.2m-1440kc. 200 watts. **Michael T. Pafferty**. Irregular hours.

WNBK

Endicott, N. Y. 206.8m-1450kc. 50 watts. **Hovitt-Wood Radio Co.** Thurs, 7-10 pm. Sun, 1-3 pm, 7:30-10. Eastern.

WNBH

New Bedford, Mass. 260.7m-1150kc. 250 watts. **New Bedford Hotel**. **Announcer**, **I. Vermilya**, Mon, 6-10:30 pm. Tues, Thurs, 7-8 pm. Wed, 6-10 pm. Fri, 6-10:30 pm. Sun, 11-12:15 pm, 7:30-9 pm. Eastern. Founded 1923.

WNBKJ

Knoxville, Tenn. 206.8m-1450kc. 50 watts. **Lonsdale Baptist Church**. Sun, 9:45 am, 10:45, 5-6 pm, 7, 9-10. Central.

WNBO

Washington, Pa. 211.1m-1420kc. 15 watts. **John Brownlee Springs**. Slogan, "Where the Hills of Penn. Greet the Western Lea." Daily ex Sun, 2-4 pm, 9-11 pm. Sun, 11 am, 7 pm. services. Eastern.

WNBQ

Rochester, N. Y. 205.4m-1460kc. 15 watts. **Gordon P. Brown**.

WNBZ

Memphis, Tenn. 228.9m-1310kc. 100 watts. **Popular Radio Shop**. **Announcer**, **Mrs. John Ulrich**. Daily ex Sun, 6:30 pm. Sun, 2:30 pm. Central. Opened Feb. 28, 1927.

WNBW

Carbondale, Pa. 199.9m-1500kc. 5 watts. **Home Cut Glass and China Co.**

WNBX

Springfield, Vt. 241.8m-1240kc. 10 watts. **WNBX Broadcasters**.

WNBZ

Saranac Lake, N. Y. 232.4m-1290kc. 10 watts. **WNBZ Broadcasters**. Daily 10 am-12 n. Eastern.

WNJ

Newark, N. J. 267.7m-1120kc. 250 watts. **Herman Lubinsky**. **Announcer**, **Snedden Weir**. Daily ex Sat, Sun, 10 am, 1:30-3:30 pm. Mon, Tues, 6-8 pm. Wed, Fri, 10-12 mid. Thurs, 6-8 pm. Sun, 6:30-12 mid. Eastern.

WNOX

Knoxville, Tenn. 265.3m-1130kc. 1,000 watts. **Peoples Telephone & Telegraph Co.** Mon, Wed, 7-10 pm. Fri, 7-11 pm. Tues, 9-9:30 pm. Sat, 12:30 am. Central. Founded 1921.

WNRC

Greensboro, N. C. 223.7m-1340kc. 250 watts. **Wayne A. Nelson**. Mon, Wed, Fri, 12:30-1:30 pm, 6:45-9 pm, Tues, 7-10 pm. Thurs, 7-11 pm. Sun, 11:15 am, 8 pm. services, 9, spirituals. Eastern. Founded Mar. 24, 1926.

WNYC

New York, N. Y. 526m-570kc. 500 watts. **New York Municipal Radio station**. **Announcer**, **Christie R. Bohmsack**. Slogan, "Municipal Broadcasting Station of the City of New York." Mon, 5:45-10:30 pm, Tues, 6-10:30 pm, Wed, 5:10-30 pm, Thurs, 6:50-10 pm. Fri, 6-10:45 pm. Sat, 6:50-10:30 pm. Eastern. Founded July 8, 1924.

WOAI

San Antonio, Texas. 499.7m-600kc. 5000 watts. **Southern Equip. Co.** (Evening News-Express). **Announcer**, **J. G. Cummings**. Slogan, "The Winter Playground of America, Where the Sunshine Spends the Winter." Daily ex Sun, 9:30 am. weather, markets, news, 12:30 pm, 2:30, 3:30, music; 4:30: 5:45, markets, news, sports. Mon, 7-8 pm. Tues, Wed, Thurs, Fri, 9-10 pm. Sun, 11 am, 7:30 pm. Central. Founded summer 1922.

WOAN

Lawrenceburg, Tenn. 239.9m-1250kc. 500 watts. **James D. Vaughan**. **Announcer**, **James D. Vaughan**, Sun, 11-12 n, 7:30-8:30 pm. Central.

WOAX

Trenton, N. J. 239.9m-1250kc. 500 watts. **F. J. Wolff**. Slogan, "Trenton Makes; the World Takes." Daily ex Sun, 12:15-1:15 pm. Mon, 7:30-8:30 pm. Tues, Wed, Thurs, 7:30-8:30 pm. Fri, 7:30-8:30 pm. Sat, 7:30-9 pm. Eastern. Founded March 2, 1923.

WOBR

Ohio. 204m-1470kc. 10 watts. **Karl Smith**. (Portable.)

WOBT

Union City, Tenn. 205.4m-1460kc. 15 watts. **Tittsworth Radio Music Shop**. Daily ex Sun, 9:30-10:30 am, 4-5 pm, 8-10, Sun, 4-5 pm. Eastern.

WOBU

Charleston, W. Va. 267.7m-1120kc. 50 watts. **Charleston Radio Broadcasting Corp.** **Announcers**, **Wally Fredericks**, **Tom Mays**. Slogan, "You're There With a Crosley." Daily 7-9 pm. Eastern.

WOC

Davenport, Iowa. 374.8m-800kc. 500 watts. **The Palmer School of Chiropractic**. **Announcers**, **Peter Mac Arthur**, **Edgar Twambley**, **Pat Flanagan**. Slogan, "Where the West Begins and in the State Where the Tall Corn Grows." Daily ex Sun, 6:45 am. Hanpy hour; 9:45, markets, 11-11:15, 1:57 pm, time; 2 markets; 3. Aunt Jane; 5:45, chimes. Mon, 6-11 pm. Tues, Wed, Thurs, Fri, 6-10 pm. Sat, 6-9 pm. Sun, 10:45 am. service; 12 n. N. B. C., 1-5 pm, 6-9:45. Founded May, 1922.

WOCL

Jamestown, N. Y. 223.7m-1340kc. 25 watts. **A. E. Neroton**. **Announcer**, **Bob Page**. Tues, Fri, 6:30-7 pm. Sun, 10:30 am, 7-9 pm. Eastern.

WODA

Paterson, N. J. 293.9m-1020kc. 1000 watts. **O'Dea Temple of Music**. Slogan, "A Voice from the Silk City." Daily ex Sun, 9-10 am, 12-2 pm; Mon, 5:30-9 pm. Tues, 4:30-6 pm, 9-11. Wed, 5:30-9 pm, 11-12. Thurs, 4:30-6 pm, 9-12. Fri, 5:30-9 pm, 11-12. Sat, 4:30-6 pm, 9-12. Sun, 9 am, 7 pm. Eastern. Founded April 13, 1925.

WOI

Ames, Iowa. 265.3m-1130kc. 2500-5000 watts. **Iowa State College**. **Announcer**, **A. G. Woolfries**. Daily ex Sun, 7 am, 8:45, 9:30, 10, 10:30, 12:30, 12:15 pm, 1:30, 12:40, 12:45, 1 pm, 1:30, 9:30. Mon, 7, 7:30 pm, 7:45, 8. Thurs, 7:30, 7:45, 8. Sat, 4:15 pm, Boy Scouts. Sun, 10:45 am, 3:15 pm. Founded April, 1922. Central.

WOK

Chicago, Ill. (tr. at Homewood). 252m-1190kc. 5000 watts. **Karzas**. **Announcer**, **George Giorch**. Daily, 9:30-12:30 am. Sun, 10:30-12:30 am. Founded July 20, 1925. Central.

WOKO

Mt. Beacon, N. Y. 215.7m-1390kc. 500 watts. **Hudson Valley Broadcasting Co.** Daily, 10:11 am, 6-8 pm. Sat, 9-11 pm. Sun, 11 am, 12:30 pm, 3:30 pm. Eastern. Founded March, 1924.

WOKT

Binghamton, N. Y. 209.7m-1430kc. 500 watts. **Titus-Ers Corp.** **Announcers**, **P. M. Titus**, **E. F. Kinsman**, **Herbert Kroep-Baker**. Daily ex Sun, 12-1 pm, 5-6, 7-12. Eastern.

WOMT

Manitowoc, Wis. 222.1m-1350kc. 150 watts. **The Mikadov theater**. **Announcer**, **F. M. Kadon**. Daily ex Sun, 11:50 am-1:10 pm, 5:45-7. Mon, 10:30-1:30 am. Central. Founded July 1926.

WOO

Philadelphia, Pa. 348.6m-860kc. 500 watts. **Iohn Wananaker**. Daily ex Sun, 11 am. organ; 11:30. weather; 11:55 am. time. weather; 12 n. organ; 4:40. weather; 4:45. organ recital; 5. music. Mon, Fri, 7:30 pm. ditto; music; 7:55 talk; 10:02. music; 10:30. musicale. Wed, Thurs, 7:30 pm. Sun, 2:30 pm, 6, 7:30. Eastern. Founded Aug. 1922.

WOOD

Grand Rapids, Mich. 260.7m-1150kc. 500 watts. **Walte B. Stiles, Inc.** Mon, Tues, Wed, Thurs, Fri, 9-11 pm. Sun, 9-10 pm. Central.

WOQ

Kansas City, Mo. 340.7m-880kc. 500 watts. **Unity School of Christianity**. **Announcer**, **Rex G. Bettis**. Daily ex Sun, 11-11:30 am. Daily ex Sun, 6-7 pm. Mon, 9-10 pm. Tues, 5 pm. Wed, Fri, 8-10 pm. Sat, 10-11 pm. Sun, 11-12:30 am, 2:30-3 pm, 5-6, 7:45-9. Central. Founded 1921.

WOR

Newark, N. J. (tr. at Kearney). 422.3m-710kc. 5000 watts. **L. Bamberger & Co.** **Announcers**, **Louis A. Witten**, **Merred Page**, **C. M. Bosworth**, **William S. Lynch**. Daily ex Sun, 6:45-8 am, 10-11:30, 2:30-5 pm. Daily ex Sun, 6:15-12 mid. Sun, 3-5 pm, 7:45-11 pm. Founded 1922. Eastern.

WORD

Baravia, Ill. 252m-1190kc. 5000 watts. **Peoples Pulpit Association**. **Announcer**, **J. P. Holmes**. Slogan, "Watchtower Station WORD." Daily 6-7 pm. Sun, 10-12 n, 2-4 pm, 6:30. Founded Dec., 1924.

WOS

Jefferson City, Mo. 422.3m-710kc. 500 watts. **Missouri State Marketing Bureau**. **Announcer**, **Jack H. Slogan**. Slogan, "Watch Our State." Daily ex Sun, 9 am, 10, 10:30, 11, 12 n, 1 pm, 2. markets; stocks; weather. Mon, Tues, Wed, Thurs, Fri, 7 pm, markets, baseball; 7:15, news. Fri, 4 pm, children's hour. Mon, Wed, 8 pm. Fri, 8:15 pm. Central. Founded 1922.

WOW

Omaha, Neb. 508.2m-590kc. 1000 watts. **Woodmen of the World**. **Announcer**, **Lester Palmer**. Slogan, "Where the West is at Its Best." Daily ex Sun, 8:35 am, 8:55, 10:30, 12:30 pm, 1:45, 3:15, 5, markets, 6-11. Daily ex Sun, Sat, 12:45 pm. Sun, 9-10:45 am, 1-4:30 pm. 6-8:13, 9:15. Founded April 2, 1923. Central.

WOWO

Fort Wayne, Ind. 228.9m-1310kc. 5000 watts. 6-6 pm. 2500 watts after 6 pm. **Main Auto Supply Co.** **Announcers**, **Al Becker**, **Don Cruise**. Daily ex Sat, Sun, 10:30-12 n. home news, farm flashes. Daily ex Sun, 12-1:30 pm. music. Mon, 6:15-11:30 pm. Wed, 7-11 pm. Thurs, Fri, 7-11 pm. Fri, 4-5 pm. Sat, 6 pm. Sun, 4-5 pm. service; 8-10. Central. Founded Apr. 1925.

WPAP

Palisade, N. J. 394.5m-760kc. 500 watts. **Palisade Amusement Park**. **Announcer**, **Perry Charles**. Mon, Wed, Sat, 8 pm. Tues, Fri, 8:30 pm. Thurs, 9 pm. Eastern.

WPCC

Chicago, Ill. 223.7m-1340kc. 500 watts. **North Shore Congregational church**. **Announcer**, **Ralph E. Briggs**. Tues, Thurs, 7:30-8:30 pm. Wed, 7:30-8:30 pm. Fri, 7:30-9:30 pm. Sun, 11-12:30 pm, 3:30-5:30, 8-9:30. Central. Founded July, 1924.

WPCH

Hohoken, N. J. 325.6m-920kc. 500 watts. **Concourse Radio Corp.** Mon, 7-12 mid, Tues, 4-7 pm, Wed, 6-9 pm. Thurs, 4-12 mid. Sat, 4-7 pm, 9-2 am. Sun, 6:30-12 mid. Eastern.

WPEN

Waukegan, Ill. 215.7m-1390kc. 250 watts. **Announcer**, **Maurice Mayer**. Slogan, "Waukegan Pep Station." Daily, 3-5 pm, 6:30-9, 9:30-12. Central. Founded Dec. 1, 1926.

WPG

Atlantic City, N. J. 272.6m-1100kc. 5000 watts. **Municipality of Atlantic City**. Slogan, "World's Playgrounds." Daily ex Sun, 1 pm; 6:45-12:30 am. Sun, 3:15 pm, 4:15 pm, 5:15, 9:15, 10:30. Eastern. Founded Jan. 3, 1924.

WPRC

Harrisburg, Pa. 209.7m-1430kc. 100 watts. **Wilson Printing & Radio Co.** Mon, Wed, Fri, 6-7 pm. Sun, 7:30-10:30 pm. Eastern. Opened Sept. 30, 1925.

WPSC

State College, Pa. 299.8m-1000kc. 500 watts. **Pa. State College**. **Announcers**, **D. M. Cresswell**, **D. J. Henry**. Slogan, "The Voice of the Nittany Lion." Tues, Wed, 6:30-7:30 pm. Sat, 2 pm, Sun, 11 am. Eastern. Founded Nov., 1921.

WPSW

Philadelphia, Pa. 206.8m-1450kc. 50 watts. **Philadelphia School of Wireless Telegraphy**. Slogan, "First Wireless School in America." Wed, Fri, 7 pm. Eastern. Founded 1908.

WPTF

Raleigh, N. C. 345.1m-550kc. 500 watts. **Durlam Life Ins. Co.** Slogan, "We Protect the Family." Mon, Wed, Fri, 6-8 pm. Sun, 11 am, 7:30 pm. Eastern. Founded Oct. 1, 1927.

WQAM

Miami, Fla. 384.4m-780kc. 750 watts. **Electrical Equip. Co.** **Announcer**, **Frederick W. Mizer**. Slogan, "Florida's Pioneer Radio Station." Daily ex Sun, 11:50-12:30 pm, 6:30-9. Mon, Fri, 10-12 mid. Sun, 9-12 pm. Eastern. Founded Feb. 1, 1922.

WQAN

Scranton, Pa. 230.6m-1300kc. 250 watts. **Scranton Times**. **Announcer**, **T. V. Nealon**. Slogan, "The Voice of the Anthracite." Daily ex Sun, 12:30-1 pm, 4:30-5, news, reports, sports, music. Tues, Fri, 8 pm. entertainment. Sat, 6:30-7:15 pm, dance music. Sun, 4-5 pm. Eastern. Opened Jan. 8, 1923.

WQAO

Palisade, N. J. 394.5m-760kc. 500 watts. **Calvary Baptist church**. **Announcer**, **G. R. Windham**. Slogan, "The First Church Owned and Operated Broadcasting Station in the World." Wed, 7:30 pm. church service. Sun, 11:15 am, 3 pm, 7:30. church service. Founded 1922. Eastern.

WQBA

Tampa, Fla. 238m-1260kc. 250 watts. **WQBA Inc.**

WQBC

Utica, Miss. 215.7m-1300kc. 100 watts. **I. R. Jones**. Daily, 7 am-7 pm. Central.

WQBJ

Clarksburg, W. Va. 239.9m-1290kc. 65 watts. **John Raikes**.

WQBO

Gulphport, Miss. 222.1m-1350kc. 85 watts. **Gulf Coast Radio Co.**

WQBZ

Weirton, W. Va. 245.5m-1200kc. 20 watts. **J. H. Thompson**.

WQJ

Chicago, Ill. 447.5m-670kc. 500 watts. **Calumet Baking Powder company**. **Chicago Daily News**. Daily ex Sun, 11-12 n, 3-8 pm, 6-7. Daily ex Sun, 7-8 pm, 10-1 am. Sun, 10:45-12:30 pm, 2-4, 6-7. Founded May 22, 1924. Central.

WRAF

La Porte, Ind. 208.2m-1440kc. 100 watts. **Radio Club**. **Announcer**, **Clarence Middleton**. Slogan, "The Voice of the Maple City." Daily ex Sun, 12-1 pm, 2 pm. Sun, 9:45-11:15 pm. Founded April, 1923. Central.

WRAH

Providence, R. I. 199.9m-1500kc. 250 watts. Stanley N. Read.

WRBK

Escanaba, Mich. 282.8m-1060kc. 50 watts. Economy Light Company. Announcer, H. E. Flath. Slogan, "The Gateway to Cloverland." Mon, Fri, 8:30 pm. Eastern. Founded 1924.

WRAM

Galesburg, Ill. 247.8m-1210kc. 50 watts. Lombard College. Mon, 7-11 pm. Founded 1922. Central.

WRAW

Reading, Pa. 238m-1260kc. 100 watts. Avenue Radio & Elec. Shop. Slogan, "The Schuylkill Valley Echo." Announcer, C. M. Chafey. Tues, 9-11 pm. Thurs, 8-12 mid. Sun, 11 am, 3-4, 7-30. Eastern. Founded June 5, 1923.

WRAX

Philadelphia, Pa. 212.6m-1410kc. 250 watts. Bereah Church, Inc. Announcers, Walter S. Smalley, Herbert Hogg. Tues, Thurs, 7:30-9:30 pm. Sun, 11:15-12:15 pm, 4-5, 9-10. Eastern. Founded 1923.

WRBC

Valparaiso, Ind. 238m-1260kc. 250 watts. Immanuel Lutheran church. Announcer, Gerhard Schutes. Slogan, "World Redeemed by Christ." Mon, 7:30 pm. Sun, 7:30 pm. church service. Central. Founded March, 1924.

WRC

Washington, D. C. 468.5m-640kc. 500 watts. Radio Corp. of America. Announcer, John B. Daniel. Slogan, "The Voice of the Capitol." Daily ex Sun, 6:45 am-1 pm, 1-2, 6-11. Sun, 11 am-9:30 pm. Eastern.

WREC

Memphis, Tenn. 249.9m-1200kc. 100 watts. WREC Inc. Announcer, Hoyt B. Wooten. Daily ex Sun, 7-8 pm. Sun, 3:5-3:30 pm. Central. Founded Sept. 1923.

WREN

Lawrence, Kan. 254.1m-1180kc. 750 watts. Jenny Wren. Daily ex Sun, 6:30-8 am, 10:45, cooking school; 5-6 pm; 9-10:30. Sun, 8-9:30 pm. Central. Founded Feb. 1927.

WRER

Quincy, Mass. 217.3m-1380kc. 50 watts. Harry Leonard Sawyer. Founded Nov., 1926.

WRHF

Washington, D. C. 322.4m-930kc. 150 watts. American Broadcasting Company. Daily ex Sun, 10-12 n., 6-7. Sun, 5:30-7 pm. Founded 1924. Eastern.

WRHM

Minneapolis, Minn. 260.7m-1150kc. 1000 watts. Roseale Hospital, Inc. Announcer, Troy S. Miller. Daily ex Sun, 9-10:30 am, 12-1 pm, 5-6, 6-7. Mon, Wed, Fri, 8-10 pm. Thurs, 10-12 mid. Sat, 6-11 pm. Sun, 9:15 am, 11, 7:45 pm. Central.

WRK

Hamilton, Ohio. 205.4m-1460kc. 100 watts. John C. Slade, S. W. Doran. Mon, Wed, Fri, 1-2 pm, 6:45-10. Tues, Thurs, 1-2 pm, 6:45-2 am. Sat, 1-2 pm, 2:30-5, 6:45-2:50 am, 10:30. Eastern. Founded 1919.

WRM

Urbana, Ill. 272.6m-1100kc. 500-1000 watts. Univ. of Ill. Announcer, J. C. Bayles. Daily ex Sun, 5-6 pm, 7-8 pm, musical. Sun, 3:45-5 pm. Central. Founded 1922.

WRMU

New York, N. Y. 201.2m-1490kc. 100 watts. Atlantic Broadcasting Corp.

WRNY

New York, N. Y. (tr. at Coytesville, N. J.). 325.9m-920kc. 500 watts. Short wave 2XAL (30.9m-9700kc). Experimenter Pub Co. Announcers, Ralph Christman, Harold Thompson. Robert Fairchild, Paul Hagen. Daily ex Sun, 11-1 pm, 2:30-4, 7-11 pm. Sun, 11 am, 1-6:30 pm. Eastern. Founded June 12, 1925.

WRPI

Terre Haute, Ind. 208.2m-1440kc. 100 watts. Rose Polytechnic Institute Broadcasting Assn.

WRR

Dallas, Tex. 461.3m-650kc. 500 watts. City of Dallas. Announcer, John Thorwald. Slogan, "City of Achievements." Daily ex Wed, 11:30-12:30 pm, 6-7, 8-9, 10-11. Sun, 11-12 n., 7:30-9 pm, 9:30-10:30. Central.

WRRS

Racine, Wis. 247.8m-1210kc. 50 watts. Racine Broadcasting Corp. Announcer, F. G. Leavenworth. Daily ex Sun, Sat, 6-7 pm, news. Mon, Wed, Fri, 13-1 pm, organ; 8-10. Central. Founded Dec. 1, 1926.

WRST

Bay Shore, N. Y. 211.1m-1420kc. 150 watts. Radiotel Mfg. Co., Inc. Slogan, "Bay Shore, the Garden Spot of Long Island." Daily ex Sun, 12-1 pm, 4-5, 6-8. Daily ex Sun, Thurs, 12-1 pm, 4-5. Daily ex Sun, Tues, 12-1 pm, 4-5, 8-12. Eastern. Founded 1925.

WRUF

Gainesville, Fla. 202.6m-1480kc. 5000 watts. U. of Florida. Not on air.

WRVA

Richmond, Va. 254.1m-1180kc. 1000 watts. Larus & Bys. Co., Inc. Slogan, "Down Where the South Begins." Announcer, J. Robert Beades. Daily ex Sat, Sun, 12:1-3:30 pm. Mon, Wed, Thurs, Fri, 7-12 mid. Sun, 11-12 n., 8-9. Eastern. Opener March 2, 1925.

WSAI

Cincinnati, Ohio. (tr. at Mason). 361.2m-830kc. 5000 watts. United States Plating Card Co. Daily and Sun, 7-12 mid. Fri, 3-9 pm. Eastern.

WSAJ

Grove City, Pa. 223.7m-1340kc. 250 watts. Grove City College. William L. Harman, activities. Irregular schedule. Founded April 1920.

WSAN

Allentown, Pa. 222.1m-1350kc. 100 watts. Allentown Call Pub. Co. Announcer, Charles Walp. Tues, Thurs, 8:15 pm. Eastern.

WSAR

Fall River, Mass. 212.6m-1410kc. 250 watts. Doughty & Welch Elec. Co., Inc. Announcer, Barton G. Albert. Daily 12-1 pm, 5:30-6:30. Founded Jan., 1923. Eastern.

WSAX

Chicago, Ill. 204m-1470kc. 100 watts. Zenith Radio Corp.

WSAZ

Huntington, W. Va. 249.9m-1200kc. 100 watts. McKellar Elec. Co. Announcer, F. B. Smith. Daily ex Sun, 12-4 pm, 6-10. Sun, 10-12:30 pm, 3-4, 6-10. Eastern. Founded Jan., 1927.

WSB

Atlanta, Ga. 475.9m-630kc. 1000 watts. Atlanta Journal. Announcer, Lumbdin Kay. Slogan, "The Voice of the South." Daily ex Sun, 10 am, home-makers half hour; 12-1 pm, music, weather; 1, farm service; 2:30, reports; 8-9, concert; 10:45-12, concert. Mon, 5:30 pm, WJZ. Tues, 7 pm, WEA-F. Wed, 6:15 pm, health talk; 7, WJZ. Sat, 6 pm, S. lesson. Sun, 9:30 am, 10:54, 5 pm, 6:15. WEA-F; 8:15, music. Central.

WSBC

Chicago, Ill. 232.4m-1290kc. 500 watts. World Battery Co. Daily ex Sun, Mon, Thurs, 6:30-8 pm. Daily, 9-1 am. Sat, 2-4 am. Sun, 5-7 pm. Thurs, 6-7 pm. Central.

WSBF

St. Louis, Mo. 258.5m-1160kc. 250 watts. WSBF Broadcasters.

WSBT

South Bend, Ind. 399.8m-750kc. 500 watts. South Bend Tribune. Announcer, C. G. Livengood. Daily ex Sun, 6-7 pm. Mon, 9:30-11:30 pm. Thurs, 9-11:30 pm. Fri, 10-12 mid. Founded April, 1922. Central.

WSDA

New York, N. Y. 227.1m-1320kc. 500 watts. City Temple. Sun, 8-10 pm. Eastern.

WSEA

Virginia Beach, Va. 263m-1140kc. 500 watts. Virginia Beach Broadcasting Co. Founded Jan. 7, 1927.

WSGH

Brooklyn, N. Y. 227.1m-1320kc. 500 watts. Amateur Radio Specialty Co. Announcer, Irwin R. Wolfe. Daily ex Sun, 4 pm, 12 mid. Sun, 12:30-3 pm. Eastern. Opened Nov. 3, 1926.

WSIX

Springfield, Tenn. 249.9m-1200kc. 150 watts. 638 Tire and Vulc. Co. Announcer, George H. Lawrence. Daily ex Sun, 12:30-1:30 pm, 6-7. Sun, 11 am. Central. Founded Jan. 7, 1927.

WSKC

Bay City, Mich. 272.6m-1100kc. 250 watts. World's Star Knitting Co. Announcer, S. F. Northcott. Slogan, "Where the Summer Trails Begin." Daily ex Sun, 12-1 pm, Hardy hour of music. Tues, Thurs, Sat, 7-8 pm. Sat, 12-2 am. Sun, 11 am. Eastern. Founded June 13, 1925.

WSM

Nashville, Tenn. 336.9m-890kc. 5000 watts. National Life and Accident Insurance Company. Announcer, George Hay, Jack Keefer, Harry Stone. Daily ex Sun, Sat, 11:45 am, 12:30 pm, 1:1-3:0, 5:30 pm. Mon, 8-11 pm, Tues, Wed, 6-11 pm. Thurs, 6:15-11 pm. Fri, 8-10 pm. Sat, 6-11 pm. Sun, alt. 11 am, 7:15 pm, services, 3:4-3:30, 6:20-7:15 pm, 8:15-9:15. Founded Oct. 5, 1925. Central.

WSMB

New Orleans, La. 296.9m-1010kc. 500 watts. Saenger Theatre, Inc. and The Maison Blanche Co. Daily ex Sun, 12:30-1:30 pm, 6-7 pm. Mon, Wed, Thurs, Sat, 8:30-10:30 pm. Founded April 21, 1925. Central.

WSMK

Dayton, Ohio. 296.9m-1010kc. 500 watts. S. M. Krohn, Jr. Slogan, "The Home of Aviation." Daily ex Sun, Thurs, 9-10 am, woman's hour; 12-1 pm, 6-11. Thurs, 9 am, 12 pm, 6, 11-3 am. Sun, 10:30-12 n., 7-9 pm. Central.

WSPD

Toledo, Ohio. 239.9m-1250kc. 250 watts. The Toledo Broadcasting Co. Announcer, Karl Benke. Slogan, "The Gateway to the Sea." Daily, 9:30 am-10:30 pm. Wed, Sat, 10:30-12 mid. Sun, 9 pm. Eastern.

WSRO

Middletown, Ohio. 236m-1270kc. 100 watts. Middletown Broadcasting Co. Announcer, Harry W. Fahrlander. Tues, Fri, 10:30-11 am, 8-10 pm. Sun, 2-4 pm. Central. Founded 1923.

WSSH

Boston, Mass. 288.3m-1040kc. 100 watts. Tremont Temple Baptist church. Announcer, Raymond B. Meader. Fri, 7:30-9 pm. Sun, 10 am, 6:30 pm. Eastern. Founded June 8, 1924.

WSUI

Iowa City, Iowa. 475.9m-630kc. 500 watts. Univ. of Iowa. Announcer, Carl Menzer. Daily ex Sun, 9 am, 10:30. Daily ex Sat, Sun, 12:25 pm, 5 pm, 6 pm, 7 pm, 9, 11. Wed, 7 pm. Mon, 4 pm, 12 mid. Sat, 7:30 pm. Sun, 9:30 pm. Founded Feb. 12, 1924. Central.

WSUN

St. Petersburg, Fla. 516.9m-580kc. 750 watts. City of St. Petersburg. Announcer, J. Dudley Saunier. Slogan, "The Sunshine City." Tues, Thurs, Sat, 5-5 pm, 7-12. Eastern. Founded Nov. 1, 1927.

WSVS

Buffalo, N. Y. 204m-1470kc. 50 watts. Seneca Vocational School. David Warnhoff, announcer. Slogan, "Watch Seneca Vocational School." Mon, 9:30-10 am. Tues, 9:30-10 am. Wed, 9:30-10 am, 8-9:30 pm. Thurs, 9:30-10 am. Fri, 9:30-10 am, 8-9:30 pm. Eastern. Founded Nov. 9, 1925.

WSYR

Syracuse, N. Y. 293.9m-1020kc. 500 watts. Clive B. Meredith. Slogan, "Voice of Central New York." Daily ex Sun, Thurs, 6:20-9:30 pm. Sun, 6:20-9:15 pm. Eastern. Founded 1922.

WTAD

Quincy, Ill. 236.1m-1270kc. 250 watts. 500 watts. 6 am-7 pm. Illinois Stock Medicine Broadcasting Corporation. Slogan, "The Voice of Agriculture." Daily ex Sun, 11:30-12:30 pm. Central. Founded Dec. 29, 1926.

WTAG

Worcester, Mass. 516.9m-580kc. 250 watts. Worcester Telegram Gazette. Announcer, Chester Gayard. Slogan, "The Voice from the Heart of the Commonwealth." Daily ex Sun, Sat, 10:30 am, 11:15, 12 n, 12:30, 12:35, 1 pm, 6:30, 7, 7:30, 8, 8:30, 9, 10, 11. Sat, 12:30, 1 pm, 7. Sun, 3, 4, 5:30, 7:20-9:16 pm. Eastern. Founded May 12, 1924.

WTAM

Cleveland, Ohio. 399.8m-750kc. 3500 watts. 5000 watts 6 am-6 pm. Willard Storage Battery Co. Announcer, J. E. Richards. Slogan, "The Voice From the Storage Battery." Mon, Tues, 11:15 am, 5-7 pm, 8-12. Wed, 11 am, 6-7 pm, 8-12. Thurs, 6-7 pm, 8-10 pm. Fri, 11 am, 6-7:30 pm, 8-11. Sat, 11:15 am, 6-11 pm. Sun, 1:55 pm, 6-12 mid. Founded Sept. 26, 1923. Eastern.

WTAQ

Eau Claire, Wis. 254.1m-1180kc. 500 watts. Gillette Ruben Co. Announcer, C. S. Van Gorden. Slogan, "The Voice of the Wilderness."

WTR

WPOR Norfolk, Va. 236.1m-1270kc. 500 watts. Reliance Electric Co. Announcer, Ray Winters. Slogan, "Down in Old Virginia." Daily ex Sun, 12:30-1:30 pm, organ, 4:30, popular program; 4:30-5:30, 6-6:30; 6:30-10, 10-11. Sun, 2-3 pm, 4:15-5:45; 5:45, 7-9. Eastern. Founded Sept. 21, 1923.

WTAS

Chicago, Ill. 275.1m-1090kc. 3500 watts. Illinois Broadcasting Corp.

WTAW

College Station, Tex. 483.6m-620kc. 500 watts. Agricultural and Mechanical College of Texas. Daily ex Sun, Sat, 12:10 pm. Wed, Fri, 7 pm. Founded 1922. Central.

WTAX

Streator, Ill. 247.8m-1210kc. 50 watts. Williams Hardware Co., Radio Division.

WTAZ

Richmond, Va. 220.4m-1360kc. 15 watts. W. Reynolds, Jr., and T. J. McGuire.

WTFI

Washington, D. C. 202.6m-1480kc. 10,000 watts. The Fellowship Town. Mon, Wed, Fri, 7:30-11 pm. Sun, 7-11 pm. Eastern.

WTFI

Toccoa, Ga. 209.7m-1430kc. 250 watts. Toccoa Falls Institute. Announcer, Kelly Barnes. Tues, Thurs, 7-8 pm. Sun, 9-10 pm. Eastern. Founded Oct. 4, 1927.

WTRC

Hartford, Conn. 535.4m-560kc. 500 watts. The Travelers Insurance Company. Slogan, "The Insurance City." Daily, 6:30-11 pm. Sun, 3-9:15 pm. Founded Feb. 10, 1925. Eastern.

WTMJ

Milwaukee, Wis. (Tr. at Brookfield.) 293.9m-1020kc. 1000 watts. Milwaukee Journal. Announcers, Neale Bakke, Pat O'Dare, Larry Teich. Slogan, "Voice of Wisconsin. Land of Lakes." Mon, Tues, Wed, Thurs, Fri, 10-2 pm, 3-12 mid. Sat, 10-2 pm, 3-11. Sun, 8:30-10:45 pm. Central. Founded July 25, 1927.

WTRL

Midland Park, N. J. 206.8m-1450kc. 15 watts. Technical Radio Laboratory.

WWAE

Chicago, Ill. 227.1m-1320kc. 500 watts. Dr. George F. Courier. Daily 3 pm, 7-12 mid. Central.

WWJ

Detroit, Mich. 352.7m-850kc. 1000 watts. The Detroit News. Announcers, E. L. Tyson, F. P. Wallace. Slogan, "Leaning Tower of Detroit." Daily, 9:30 am, tonights dinner; 9:50, woman's hour; 10:30, weather; 11:15, N. B. C.; 11:55, time; 12 n., orchestra; 12:40, faru flashes; 1, organ; 1:30, program; 3, program; 4, weather; 5, dance music; 5:45, markets; 6, organ; 6:30, dinner music; 7, news; 7:15, evening program. Sun, 10:30 am, services; 2 pm, program; 7:20-10:15, N. B. C. Eastern. Founded, Aug., 1920.

WWL

New Orleans, La. 245.8m-1220kc. 500 watts. Loyola Univ. Announcer, O. L. Abell. Sat, 7:30-8:30 pm. Central. Founded March 31, 1922.

WWNC

Asheville, N. C. 296.9m-1010kc. 1000 watts. Asheville Chamber of Commerce. Announcer, J. Dale Stentz. Daily ex Sun, 1 pm, 2, 7-8. Tues, 7-10:30 pm. Thurs, 6:30-12 mid. Sun, 11 am-4 pm, 7:30 pm. Eastern. Founded Feb. 21, 1927.

WWRL

Woodside, N. Y. 199.9m-1500kc. 100 watts. W. H. Reuman. Founded Aug. 15, 1926.

WWVA

Wheeling, W. Va. 516.9m-580kc. 250 watts. John C. Stroebel, Jr. Daily ex Sun, 7 am, 8, 11, 12, 2, 6-5 pm, Mon, 7-11 pm. Sat, 11 am. Sun, 10:30 am, 1 pm, 3, 7:30. Eastern. Founded Dec. 6, 1926.

CANADA, CUBA, MEXICO

Canada

CFAC

Calgary, Alta., Can. 434.5m-690kc. 500 watts. Calgary Herald. Announcer, Fred Carleton. Daily ex Sun, 11:30-12:15 pm, 1:15 pm, weather, markets. Mon, 3:30-4:30 pm, 9:30-10:30. Tues, 6-7 pm, Wed, 3:30-4:30 pm, 7:45-8:45. Thurs, 9 pm, 9:30-10:30, 12. Fri, 3:30-4:30 pm, 8:30. Sun, 11 am, 7 pm. service.

CFCA

Toronto, Ont., Can. 356.9m-840kc. 500 watts. Toronto Star. Announcer, Gordon W. McClain. Daily ex Sun, 12 n, 8:45, 6:20, weather, stocks. Mon, 6:30-8 pm, Wed, 6:30-12 mid. Thurs, 6:30-9 pm, 10:30-12 mid. Sat, 6:30-10 pm. Sun, 11 am, 7 pm, 8:15. Eastern. Founded March, 1922.

CFCF

Montreal, P. Q., Can. 410.7m-730kc. 1650 watts. Canadian Marconi Co. Announcer, C. Walter Darling. Daily ex Sun, 12:45-1:40 pm, stocks, music. Mon, Fri, 7-7:30 pm, bedtime stories; 7:30-8:30, music, 9-10, 10:30-11:30, orchestra. Wed, 7-8 pm, orchestra. Eastern.

CFCH

Iroquois Falls, Ont. 499.7m-600kc. 250 watts. Abitibi Power and Paper Co., Ltd.

CFCN

Calgary, Alta., Can. 434.5m-690kc. 1800 watts. V. W. Grant, Ltd. Slogan, "Voice of the Prairies." Tues, 9-10 pm, Wed, 9-10 pm, 11-12. Thurs, 7:45-8:45 pm. Fri, 9-10 pm. Sun, 11 am, 7:15 pm, services, 3 pm. Mountain.

CFCQ

Vancouver, B. C. 410.7m-730kc. 10 watts. Sprout-Shaw Radio Co.

CFCT

Victoria, B. C., Can. 329.5m-910kc. (Temporarily using 475.9m-630kc. 500 watts. The Victoria Broadcasting Assn. Daily ex Sun, 11-12:15 am, 7:30-9:15 pm. Daily, 8-8:30 am. Mon, 11-12 mid. Fri, 7:30-9:30. Thurs, 10:30-12 mid. Pacific. On air March, 1924.

CFCY

Charlottetown, P. E. I. 312.3m-960kc. 100 watts. Island Radio Co. Daily, 12-1 pm, 4-6. Wed, Thurs, 7-8 pm. Sun, 11 am, 7 pm.

CFGC

Brantford, Ont., Can. 296.9m-1010kc. 50 watts. The Brant Radio Supply Co., Ltd.

CFJC

Damloops, B. C. 267.7m-1120kc. 15 watts. N. S. Dalgleish and Sons, Weller and Weller. Mon, Fri, 5:30-6:30 pm. Wed, 8 pm. Pacific.

CFLC

Prescott, Ont. 296.9m-1010kc. 50 watts. Radio Association of Prescott. Fri, 8-10:30 pm. Sun, 3-4:30 pm, 7-8.

CFMC

Kingston, Ont., Can. 267.7m-1120kc. 20 watts. Monarch Battery Mfg. Co., Ltd.

CFNB

Fredericton, N. B. 247.8m-1210kc. 25 watts. James S. Neill & Sons, Ltd. Daily 9 am, news, weather, 7 pm, stock markets. Sun, 11 am, 7 pm, services; 2:30-3:30 pm, musicale. Atlantic.

CFQC

Saskatoon, Sask., Can. 329.5m-910kc. 500 watts. The Electric Shop, Ltd. Announcer, Grant Stevenson. Slogan, "The Hub City of the West Where No. 1 Northern Hard Wheat Grows." Daily ex Sun, 9-10 am, 1:15-2 pm, markets, reports, music. Mon, 6 pm, Wed, 7:30-10 pm, Thurs, Fri, 7:30-8:30 pm. Sun, 11 am, 7 pm, church service. Mountain.

CFRB

Toronto, Ont. 516.9m-580kc. 1000 watts. Rogers-Batterless Station. Announcer, Charles Shearer. Slogan, "Just Plug In, Then Tune In." Daily ex Sat, Sun, 12 n, 1 pm, 6, stocks; 5:45. Tues, Fri, 6-8 pm, Wed, Thurs, 8-12 mid. Sun, 11 am, 3 pm, 7. Eastern.

CFRC

Kingston, Ont., Can. 267.7m-1120kc. 500 watts. Queen's University. Announcer, H. J. D. Minter. Inc. Oct., 1923.

CFYC

Vancouver, B. C. 410.7m-730kc. 500 watts. International Bible Students' Assn.

CHCA

Calgary, Alta. 434.5m-690kc. 250 watts. The Alberta Pub. Co. Ltd.

CHCS

Hamilton, Ont., Can. 340.7m-880kc. 10 watts. Hamilton Spectator.

CHCT

Red Deer, Alta. 356.9m-840kc. 1000 watts. Messrs. G. F. Tull and Ardern Ltd.

CHCY

King Edward Park, Edmonton, Alta. 516.9m-580kc. 250 watts. International Bible Students' Association. Tues, Sat, 8:30-10 pm, Thurs, 8-8:30 pm. Sun, 10-11 am, 3-4:30 pm, 9:15-10:30. Mountain. Founded May 11, 1926.

CHGS

Summerside, P. E. I. 267.7m-1120kc. 25 watts. R. T. Holman, Ltd. Daily ex Sun, 12 n. Sun, 11 am, 7 pm. Atlantic.

CHIC

Toronto, Can. 356.9m-840kc. 500 watts. Northern Electric Company, Ltd. Announcer, R. W. Lowman. Mon, 8-9 pm, 11-1 am. Sat, 10-11 am, 10-12 pm. Sun, 5-6 pm. Eastern.

CHMA

Edmonton, Alta. 516.9m-580kc. 250 watts. Christian & Missionary Alliance. Sun, 11 am, 1:15 pm, 2:15, 2:30, 5, 5:30, 5:45, 10:30. Tues, Thurs, 6:15-6:45 pm. Sat, 6 pm. Mountain.

CHML

Mount Hamilton, Ont., Can. 340.7m-880kc. 50 watts. Maple Leaf Radio Co., Ltd. Mon, Wed, Fri, 6-8 pm. Tues, Thurs, 12-1 pm. Sat, 8-9 pm. Eastern.

CHNC

Toronto, Can. 356.9m-840kc. 500 watts. Toronto Radio Research society.

CHNS

Halifax, N. S. 322.4m-930kc. 100 watts. Northern Elec. Co., Ltd. Sun, Mon, Wed, evening program. Atlantic. Founded May 12, 1926.

CHPC

Vancouver, B. C. 410.7m-730kc. 1000 watts. Central Presbyterian Church. Sun, 11 am, 7:30 pm. Pacific.

CHRC

Quebec, Que. 340.7m-880kc. 5 watts. E. Fontaine.

CHSC

Unity, Sask. 267.7m-1120kc. 50 watts. H. N. Slavin, Radio Sales. Mon, Tues, Wed, Thurs, Fri, 4-5 pm. Tues, 7:30-9 pm. Thurs, 10:30-11:30 pm. Sat, 12 mid-1:30 pm. Sun, Sun, 7:30-8:45 pm.

CHUC

Saskatoon, Sask., Can. 329.5m-910kc. 250 watts. International Bible Students' association. Announcer, C. Roberts. Tues, 7:30-10 pm, Thurs, 8:30-10 pm. Fri, 9-10 pm. Sun, 12:45-2:15 pm, 8:30-10 pm.

CHWC

Regina, Sask., Can. 312.3m-960kc. 500 watts. R. H. Williams & Sons, Ltd. Daily ex Sun, 12-1 pm, 5-6. Wed, Sat, 8-10 pm. Mountain.

CHWK

Chilliwack, B. C. Can. 247.8m-1210kc. 5 watts. Chilliwack Broadcasting Co., Ltd.

CHYC

Montreal, Que., Can. 410.7m-730kc. 750 watts. Northern Elec. Co., Ltd. Announcer, N. S. Richards. Wed, 6-12:30 am. Thurs, 8-8:30 pm. Sun, 11 am, 7 pm. Eastern.

CJBC

Toronto, Ont. 356.9m-840kc. 500 watts. Baptist Church.

CJBR

Regina, Sask. 312.3m-960kc. 500 watts. Saskatchewan Co-operative Wheat Producers, Ltd. Thurs, 7:30-9 pm.

CJCA

Edmonton, Alta., Can. 516.9m-580kc. 500 watts. Edmonton Journal, Ltd. Announcer, R. A. Rice. Slogan: "The Sunniest Spot in Sunny Alberta." Daily ex Sun, 12:30 am, markets, news; 7:15 pm, children's program; Wed, Sat, 12:30 pm, 12 mid, Messages to North. Daily ex Sun, 11 am, music, Tues, 3-4 pm, Wed, 8-8:30 pm, bridge; 9-11, 11-12. Fri, 8-10:30 pm. Sat, 10-12 mid. Sun, 11 am, 7:15 pm, Mountain.

CJ CJ

Calgary, Alta. 434.5m-690kc. 250 watts. Radio Service & Repair Shop.

CJCR

Red Deer, Alta., Can. 356.9m-840kc. 1000 watts. The North American Collieries, Ltd.

CJGC

London, Ont., Can. 329.5m-910kc. 500 watts. London Free Press. Daily ex Sun, 1-2 pm, stocks, music. Mon, Tues, Wed, Thurs, Fri, 7-9 pm. Fri, 11-12 midnight. Sun, 11 am, 2-3 pm, 7, church services. Eastern.

CJGX

Yorkton, Sask. 475.9m-630kc. 500 watts. The Winnipeg Grain Exchange. Daily ex Sun, 9:30 am, 11:30, grain; 1:45 pm, 7:15. Tues, Thurs, Fri, 8:30-10 pm. Central.

CJOC

South Lethbridge, Alta. 267.7m-1120kc. 50 watts. J. E. Palmer.

CJOR

Sea Island, B. C. 291.1m-1030kc. 50 watts. G. C. Chaudler.

CJRM

Moose Jaw, Sask. 296.9m-1010kc. 500 watts. James Richardson & Sons, Ltd. Daily ex Sun, 8:30-10:35 am, 11:55-2:30 pm, weather, markets. Mon, Wed, Fri, 6:30 pm. Sat, 10-12 mid. Sun, 9:30 am, 1:30 pm. Mountain.

CJSC

Toronto, Can. 356.9m-840kc. 500 watts. The Evening Telegram.

CJWC

Saskatoon, Sask., Can. 329.5m-910kc. 250 watts. Wheaton Elec. Co. Announcer, Martha Bowes. Daily ex Sun, 11:45-1 pm. Mon, 7 pm. Tues, Wed, Thurs, Sat, 6-7 pm. Sun, 3:45-5 pm. Founded Sept. 28, 1925.

CJYC

Toronto, Can. 516.9m-580kc. 500 watts. Universal Radio of Canada, Ltd. Mon, 6-12 mid. Tues, 10-13 pm. Wed, 6-8 pm. Eastern.

CKAC

Montreal, Que., Can. 410.7m-730kc. 1200 watts. La Presse. Announcer, Arthur Dupont. Mon, Fri, 1:45 pm, 4:15, weather, stocks; Tues, 11 am, music, stocks; 11:15, cooking school; 11:45, news, time; 12 n, music; 4:15 pm, weather; 7, markets. Tues, Thurs, Sat, 7:15-11:30 pm. Thurs, 11 am, 11:15, 12 n, 4-45. Eastern.

CKCD

Vancouver, B. C., Can. 410.7m-730kc. 1000 watts. Vancouver Daily Province. Announcer, W. G. Haswell. Slogan, "Canada's Western Gateway." Mon, Sat, 8:30-10:30 pm. Tues, Wed, 8:30-9:30 pm. Thurs, 8:30-9 pm. Fri, 8:30-8:50 pm. Sat, 8:30-10:30 pm. Wed, 2:30-3:30 pm. Pacific.

CKCI

Quebec, Que. 340.7m-880kc. 22½ wts. Le Soleil, Ltd.

CKCK

Regina, Sask., Can. 312.3m-960kc. 500 watts. Leader Pub. Co. Announcer, A. W. Hooper. "The Queen City of the West." Mon, Tues, Thurs, Fri, 8:45-10:30 am, 11:45 pm, 8-10. Wed, Sat, 9:45-10:30 am, 1-1:45 pm. Sun, 9-10 pm. Mountain.

CKCL

Toronto, Can. 356.9m-840kc. 500 watts. The Dominion Battery Co., Ltd. Daily ex Sun, 12:45-1:45 pm. Daily ex Sat, Sun, 10:30 am, 10:58, time; 7 am, 7:20, 7:40, exercises. Mon, 12:30 pm, markets; 3-4:30 pm. Tues, 3-4:30 pm, 6:40-1. Wed, 12:30 pm, 3-4:30 pm. Thurs, 2:30-4:30 pm. Alternate, 7-8 pm. Fri, 11 am, 12:30 pm, markets; 3-4:30 pm. Sat, 7-8 pm. Sun, 3-5 pm. Eastern. Founded May 5, 1925.

CKCO

Ottawa, Ont., Can. 434.5m-690kc. 100 watts. Dr. G. M. Geldert (Ottawa Radio Assn.). Announcer, Dr. G. K. Gilson. Slogans, "Ottawa's Radio Voice." "The Community Voice of Canada's Capital." Tues, 8-10 pm. Sun, 7 pm, services; 9, sacred concert. Eastern. Founded March, 1924.

CKCR

St. George, Ont., Can. 267.7m-1120kc. 25 watts. John Patterson.

CKCV

Quebec, P. Q. 340.7m-880kc. 50 watts. G. A. Vandy.

CKCX

Toronto, Ont. 516.9m-580kc. 1000 watts. International Bible Students' Assn. Tues, Fri, 8-10 pm. Sun, 9:30-11 am, 1:30-3 pm, 8:15-10:15. Eastern.

CKFC

Vancouver, B. C., Can. 410.7m-730kc. 50 watts. St. Andrews United Church.

CKGW

Bowmanville, Ont., Can. 312.3m-960kc. 5000 watts. Gooderman & Worts, Ltd.

CKLC

Fed Deer, Alta. 365.9m-840kc. 2000 watts. Alberta Pacific Grain Co., Ltd. Daily ex Sun, 12 n, music, news, weather, markets. Daily ex Sat, Sun, 7-8 pm, news, markets; 8, studio program. Mon, Wed, Fri, 9:30 pm. Sun, 11 am, 7:30 pm, service. Mountain.

CKMC

Cobalt, Ont. 247.8m-1210kc. 5 watts. R. L. MacAdam.

CKNC

Toronto, Ont., Can. 356.9m-840kc. 500 watts. Canadian National Carbon Co., Ltd. Announcer, E. J. Stafford. Daily ex Sat, Sun, 2 pm. Mon, Thurs, 9 pm, 10. Eastern. Founded May 2, 1924.

CKOC

Hamilton, Ont., Can. 340.7m-880kc. 180 watts. Wentworth, Radio Supply Co., Ltd. Announcer, L. M. N. Slogan, "The Voice of Hamilton." Mon, Wed, Fri, 11 am, 12:15 pm. Thurs, 6-8 pm, 10:30-12. Sat, 12-2 pm, 5-7, 11-12. Tues, Thurs, 4-30 pm, stocks. Mon, Wed, Fri, Sat, 1 pm. Eastern.

CKOW

Starbuck Station, Ont. 291.1m-1030kc. 500 watts. Nestlé's Food Co. of Canada.

CKPC

Preston, Ont. 247.8m-1210kc. 7½ watts. Wallace Ross. Announcer, Jas. Newell. Mon, Fri, 8-11 pm. Sun, 8-12:30 pm, 3-4:30. Eastern.

CKPR

Midland, Ont. 267.7m-1120kc. 50 watts. Pioneer Broadcasting Station. E. O. Swan. Slogan, "Voice of Georgian Bay." Daily ex Sun, 12:25 am, 6-8 pm, stocks, news, weather. Mon, Tues, Thurs, 6-8 pm, 8, 8:15. Sat, 10:45 am, 11, 11:15. Sun, 10:45 am, 6-8 pm, service. Eastern.

(Continued on page 98)

Official Wave Lengths Table

Wave length	Frequency (kilocycles)	Power (watts)	Call signal	Location	Wave length	Frequency (kilocycles)	Power (watts)	Call signal	Location	Wave length	Frequency (kilocycles)	Power (watts)	Call signal	Location						
199.9	1,500	15	KCFN	Aneta, N. D.	215.7	1,390	10	KFBN	Youngstown, Ohio.	232.4	1,290	10	KFEY	Kellogg, Idaho.						
		10	KLIT	Portland, Ore.			100	WLBG	Petersburg, Va.			100	KFIY	Fort Dodge, Iowa.						
		10	KUJ	Seattle, Wash.			50	WMBW	Youngstown, Ohio.			100	KFMR	Sioux City, Iowa.						
		15	KWBS	Portland, Ore.			10	KFDZ	Minneapolis, Minn.			250	KFPR	Los Angeles, Calif.						
		100	WBKN	New York, N. Y.			250	KFVD	Venice, Calif.			100	KFOZ	Hollywood, Calif.						
		100	WBMS	New York, N. Y.			50	KGCB	Oklahoma City, Okla.			500	KUT	Austin, Tex.						
		100	WGP	New York, N. Y.			100	KGER	Long Beach, Calif.			500	WBR	Mon, N. H.						
		15	WKBY	Ludington, Mich.			50	KGFC	Oklahoma City, Okla.			100	WHBO	Memphis, Tenn.						
		5	WNBW	Carbondale, Pa.			150	WCLS	Joliet, Ill.			500	WJKS	Gary, Ind.						
		250	WRAH	Providence, R. I.			100	WEHS	Evanston, Ill.			30	WLBH	Farmdale, N. Y.						
100	WWRL	Woodside, N. Y.	200	WHFC	Chicago, Ill.	10	WMBJ	Monessen, Pa.												
201.2	1,490	50	KIOS	Eugene, Ore.	217.3	1,380	150	WKBB	Joliet, Ill.	234.2	1,280	500	WBCB	Sarasac Lake, N. Y.						
		500	KPOF	Denver, Colo.			50	WKBI	Chicago, Ill.			500	WSBC	Chicago, Ill.						
		50	WALK	Wilmington Gardens, Pa.			50	WLEX	Lexington, Mass.			500	KDYL	Salt Lake City, Utah.						
		100	WATT	Boston, Mass.			250	WOKO	Mt. Beacon, N. Y.			1,000	KFGA	St. Louis, Mo.						
		100	WCBR	Providence, R. I.			250	WPEP	Waukegan, Ill.			1,000	KGAR	Fucson, Ariz.						
		100	WGMU	New York, N. Y.			100	WQBC	Utica, Miss.			1,000	KWST	St. Louis, Mo.						
		100	WHBM	Chicago, Ill.			100	KFOR	Lincoln, Neb.			100	WBBL	Richmond, Va.						
		100	WIBJ	Chicago, Ill.			100	KFQW	Seattle, Wash.			250	WCAH	Columbus, Ohio.						
		100	WIBM	Chicago, Ill.			10	KGDM	Stockton, Calif.			100	WDAH	El Paso, Tex.						
		100	WKBC	Chicago, Ill.			20	WIBU	Poyette, Wis.			50	WFBC	Knoxville, Tenn.						
100	WRMU	New York, N. Y.	100	WKBS	Galesburg, Ill.	50	WJAK	Cokomo, Ind.												
202.6	1,480	15	KKP	Seattle, Wash.	218.8	1,370	100	WKBV	Brookville, Ind.	236.1	1,270	250	WMAN	Columbus, Ohio.						
		50	KRSC	Seattle, Wash.			500	WKBS	Buffalo, N. Y.			100	WMAY	St. Louis, Mo.						
		100	KYL	Seattle, Wash.			100	WLBG	Galesburg, Ill.			250	WMB5	Lemoyne, Pa.						
		5,000	WRUF	Gainesville, Fla.			50	WRBS	Quincy, Mass.			30	WMPC	Lapeer, Mich.						
		10,000	WTFF	Washington, D. C.			100	KGEW	Fort Morgan, Colo.			500	KFDX	Shreveport, La.						
		204	1,470	15			KFXD	Jerome, Idaho.	220.4			1,360	100	KOW	Denver, Colo.	238	1,260	50	KFMX	Northfield, Minn.
				50			KCEQ	Minneapolis, Minn.					500	WCGU	Coney Island, N. Y.			500	KFMW	Oakland, Calif.
				10			KCES	Central City, Neb.					100	WKBU	Birmingham, Ala.			100	KLING	Klinton, Tex.
				100			KGFO	Terre Haute, Ind.					500	WKBO	Jersey City, N. J.			100	WBBW	Norfolk, Va.
				100			KGGM	Inglewood, Calif.					500	WKBO	New York, N. Y.			500	WBNY	New York, N. Y.
50	KHAC			Portland on Plane.	25	WLQB	Atwood, Ill.	2,000		WGBF	Evansville, Ind.									
100	WBBZ			Chicago, Ill.	100	KGCI	San Antonio, Tex.	1,000		WHAF	Carlsstadt, N. J.									
100	WHBL			Chicago, Ill.	15	KCFI	San Angelo, Tex.	10		WHBC	Canton, Ohio.									
250	WIBS			Elizabeth, N. J.	100	KGRC	San Antonio, Tex.	500		WMSC	New York, N. Y.									
250	WIBW			Topeka, Kan.	50	KGTT	San Francisco, Calif.	100		WSRO	Middleton, Ohio.									
750	WKEN	Amherst, N. Y.	400	KJBS	San Francisco, Calif.	250	WTAD	Quincy, Ill.												
100	WLBK	Chicago, Ill.	2,000	KSTP	St. Paul, Minn.	500	WTAR	Norfolk, Va.												
250	WLBX	Long Island, N. Y.	100	KXLL	Portland, Ore.	50	KFVI	Houston, Tex.												
100	WMB	Newport, R. I.	15	WHBU	Anderson, Ind.	50	WABZ	New Orleans, La.												
100	WMBH	Joplin, Mo.	100	WHBW	Philadelphia, Pa.	1,000	WADC	Akron, Ohio.												
100	WMBQ	Brooklyn, N. Y.	15	WJBK	Ypsilanti, Mich.	150	WBX	Utica, N. Y.												
10	WOBR	Ohio (Portable)	500	WKBI	La Crosse, Wis.	250	WBZ	Sarasota, Fla.												
100	WSAX	Chicago, Ill.	30	WMBG	Richmond, Va.	30	WBW	New Orleans, La.												
50	WSVS	Buffalo, N. Y.	100	WMBO	Auburn, N. Y.	250	WLB	East Wenona, Ill.												
205.4	1,460	25	KFXV	Flagstaff, Ariz.	222.1	1,350	50	KGBV	Columbus, Neb.	239.9	1,250	250	KFJR	Portland, Ore.						
		50	KGDE	Barrett, Minn.			50	KGFL	Raton, N. M.			100	KCCU	Mandan, N. D.						
		100	KGEO	Grand Island, Ne.			100	WKFC	Kansas City, Mo.			250	WCCR	Cedar Rapids, Iowa.						
		25	KGFA	Alva, Okla.			500	WAMD	St. Paul, Minn.			500	WBAN	Nashville, Tenn.						
		250	WABF	Kingston, Pa.			100	WBCA	Allentown, Pa.			100	WBOT	Petoskey, Mich.						
		15	WKBL	Monroe, Mich.			100	WBBC	Belleville, Ohio.			500	WCAP	Asbury Park, N. J.						
		250	WMBD	Peoria Heights, Ill.			100	WHBF	Rock Island, Ill.			100	WIBA	Madison, Wis.						
		15	WNBO	Rochester, N. Y.			100	WOMT	Manitowoc, Wis.			250	WJAM	Cedar Rapids, Iowa.						
		15	WOBT	Union City, Tenn.			15	WQBO	Gulfport, Miss.			500	WNAD	Norman, Okla.						
		100	WRK	Hamilton, O.			100	WSAN	Allentown, Pa.			500	WOAN	Lawrenceburg, Tenn.						
206.8	1,450	15	KDDR	San Antonio, Tex.	223.7	1,340	50	KFBL	Everett, Wash.	241.8	1,240	1,500	KFKB	Millford, Kan.						
		15	KCDY	Oldham, S. D.			50	KFVS	Cape Girardeau, Mo.			500	KFON	Long Beach, Calif.						
		100	KGGP	Picher, Okla.			50	KFXR	Oklahoma City, Okla.			250	WBRC	Birmingham, Ala.						
		10	WHYP	New York, N. Y.			10	KGDP	Pueblo, Colo.			250	WBCS	Superior, Wis.						
		50	WLBV	Mansfield, Ohio.			10	KCEB	Iowa City, Iowa.			200	WEBR	Buffalo, N. Y.						
		10	WMRJ	Jamaica, N. Y.			50	KGPK	Halleck, Mich.			500	WEP	Chicago, Ill.						
		50	WNBZ	Endicott, N. Y.			250	KMCB	Inglewood, Calif.			100	WFCP	Pawtucket, R. I.						
		50	WNBK	Knoxville, Tenn.			50	KXRO	Aberdeen, Wash.			500	WGES	Chicago, Ill.						
		50	WPSW	Philadelphia, Pa.			500	WCAM	Camden, N. J.			500	WMAL	Washington, D. C.						
		15	WTRL	Midland Park, N. J.			500	WCWV	Chicago, Ill.			10	WNBS	Springfield, Vt.						
208.2	1,440	100	KFQU	Holy City, Calif.	225.4	1,330	10	KFII	Juneau, Alaska.	243.8	1,230	125	KFCB	Phoenix, Ariz.						
		50	KFUS	Oakland, Calif.			15	KFKZ	Kirkville, Mo.			100	KCCX	Vida, Mont.						
		50	KGCN	Concordia, Kan.			50	KFUR	Farmington, Utah.			250	KGRS	Amarillo, Tex.						
		15	KGCR	Brookings, S. D.			50	KFGV	Independence, Kan.			500	KSCJ	Sioux City, Iowa.						
		100	KZM	Oakland, Calif.			15	KGEN	El Centro, Calif.			500	KWUC	Lamar, Iowa.						
		50	WGM	Jeannette, Pa.			100	WCOM	Baltimore, Md.			500	WCAD	Canton, N. Y.						
		100	WJZ	Chicago Heights, Ill.			100	WCOT	Oneyville, R. I.			250	WCAO	Baltimore, Md.						
		30	WJWV	Ashabula, Ohio.			100	WCAT	Royal Oak, Mich.			500	WDDO	Chattanooga, Tenn.						
		250	WLBZ	Dover-Essex, Maine.			100	WCBM	Baltimore, Md.			100	WFRB	Baltimore, Md.						
		10	WMBE	St. Paul, Minn.			1,000	WLAC	Nashville, Tenn.			100	WMBG	Detroit, Mich.						
200	WNSA	Forest Park, Ill.	500	WMAC	Cazenovia, N. Y.	245.8	1,220	500	KFH	Wichita, Kan.										
100	WRPI	Terre Haute, Ind.	100	KFUP	Denver, Colo.			100	KFIO	Spokane, Wash.										
209.7	1,430	10	KFGQ	Boone, Ia.	227.1			1,320	250	KGHB	Honolulu	247.8	1,210	500	KPPY	Spokane, Wash.				
		50	KFXJ	Edgewater, Colo.					500	KSO	Clarinda, Iowa.			250	KLS	Oakland, Calif.				
		50	KGHC	Slayton, Minn.					100	WAIZ	Appleton, Wis.			100	KRE	Berkeley, Calif.				
		250	KGHF	Pueblo, Colo.					500	WBBC	Brooklyn, N. Y.			300	WAAT	Jersey City, N. J.				
		250	KSOO	Sioux Falls, S. D.					5	WCBE	New Orleans, La.			500	WEVD	Woodhaven, N. Y.				
		250	KVOS	Bellingham, Wash.					100	WCD	Kenosha, Wis.			250	WFBE	Cincinnati, Ohio.				
		250	WCBS	Springfield, Ill.					500	WFJC	Akron, Ohio.			400	WGB	Freeport, N. Y.				
		100	WIVA	Charlottesville, Va.					500	WGST	Atlanta, Ga.			500	WCMS	Minneapolis, Minn.				
		50	WLBC	Muncie, Ind.		500	WJAY		Cleveland, Ohio.	500	WHD			Minneapolis, Minn.						
		50	WLBK	Kansas City, Mo.		100	WJBC		LaSalle, Ill.	500	WKRC			Cincinnati, Ohio.						
50	WLBY	Iron Mountain, Mich.	250	WSDA	New York, N. Y.	500	WLB	Minneapolis, Minn.												
10	WMBM	Memphis, Tenn.	500	WSCH	Brooklyn, N. Y.	50	WWL	New Orleans, La.												
500	WOKT	Binghamton, N. Y.	500	WWAE	Chicago, Ill.	248.9	1,310	250	KELW	Burbank, Calif.										
100	WPRC	Harrisburg, Pa.	100	WGBE	Webster, Mass.			50	KFIF	Portland, Ore.										
250	WTFI	Topeca, Ga.	100	WMBL	Lakeland, Fla.			20	KTAP	San Antonio, Tex.										
211.1	1,420	100	KFCR	Santa Barbara, Calif.	230.6			1,300	15	WGBE	Memphis, Tenn.	249.8	1,200	5	CKMC	Cobalt, Can.				
		15	KFYD	Breckenridge, Tex.					250	WBBP	Johnstown, Pa.			7/2	CKPC	Preston, Can.				
		100	WBHM	Detroit, Mich.					100	WKBE	Webster, Mass.			5	CKWC	Chilliwack, Can.				
		100	WBRS	Brooklyn, N. Y.					100	WMOU	Fort Wayne, Ind.			100	KFCB	San Diego, Calif.				
		250	WCDA	New York, N. Y.					2,500	WOWO	Fort Wayne, Ind.			100	KFJB	Marshalltown, Iowa.				
		100	WLOE	Chelsea, Mass.					100	KDLR	Devils Lake, N. D.			100	KFCW	Ontario, Calif.				
		50	WME5	Boston, Mass.					1,000	KFEQ	St. Joseph, Mo.			100	KCCA	Decorah, Iowa.				
		15	WNBO	Washington, Pa.		15	KFFM		Greenville, Tex.	50	WGLC			Decorah, Iowa.						
		150	WRST	Bay Shore, N. Y.		50	KGLL		Seattle, Wash.	50	WABW			Weaver, Ohio.						
		212.6	1,410	10		KFHL	Oskaloosa, Iowa.		236.6	1,300	100			KPCB	Seattle, Wash.	250	1,200	50	WABY	Philadelphia, Pa.
250	KGBZ			York, N. Y.	100	WAAD	Cincinnati, Ohio.	100			WCAT	Rapid City, S. D.								
100	KGFJ			Los Angeles, Calif.	25	WAFD	Detroit, Mich.	250			WDWF	Cranston, R. I.								
5	KGCH			Cotton Grove, La.	100	WAGB	Buffalo, N. Y.	10			WBE	Cambridge, Ohio.								
5	KTUE			Houston, Tex.	50	WCCO	Columbus, Miss.	50			WFZ	Galesburg, Ill.								
250	KWEA			Shreveport, La.	250	WDBJ	Roanoke, Va.	50			WFKD	Philadelphia, Pa.								
250	WJBL			Decatur, Ill.	250	WGBJ	Scranton, Pa.	1,000			WIOD	Miami Beach, Fla.								
50	WKBP			Battle Creek, Mich.	100	WDFD	Detroit, Mich.	50			WJBA	Joliet, Ill.								
250	WRAX			Philadelphia, Pa.	15	WDFW	Fort Wayne, Ind.	15			WKB	Kenosha, Wis.								
250	WSAR			Fall River, Mass.	50	WDMB	Montgomery, Ala.	15			WLBR	Rockford, Ill.								
214.2	1,400	50	KFEF	Portland, Ore.	249.8	1,200	250	WDBJ	Roanoke, Va.	250	1,200	50	WLCI	Ithaca, N. Y.						
		250	KFWF	St. Louis, Mo.			250	WGBJ	Scranton, Pa.			250	WLSI	Cranston, R. I.						
		15	KPJM	Prescott, Ariz.			15	WIBM	Montgomery, Ala.			50	WRAN	Galesburg, Ill.						
		10	WAIT	Taunton, Mass.			50	WLBG	Galesburg, Ill.			50	WRS	Racine, Wis.						
		500	WCSH	Portland, Ore.			250	WLBW	Wayne, Mich.			50	WTAX	Streator, Ill.						
		250	WCWK	Fort Wayne, Ind.			50	WQAN	Scranton, Pa.			50								
		100	WJBU	Lewisburg, Pa.			50					50								

Wave length	Frequency (kilocycles)	Power (watts)	Call signal	Location	Wave length	Frequency (kilocycles)	Power (watts)	Call signal	Location	Wave length	Frequency (kilocycles)	Power (watts)	Call signal	Location		
249.9	1,200	50	KFHA	Gunnison, Colo.	275.1	1,080	50	KFBB	Havre, Mont.	344.6	870	100	KFOD	Anchorage, Alas.		
		15	KFJJ	Astoria, Ore.			100	KFBK	Sacramento, Calif.			500	KWJ	Stockton, Calif.		
		50	KFJZ	Fort Worth, Tex.			15	KFPL	Dallas, Tex.			5,000	WCBZ	Zion, Ill.		
		200	KFFA	Greeley, Colo.			1,000	KTBI	Los Angeles, Calif.			50	WLS	Chicago, Ill.		
		500	KFRU	Columbia, Mo.			500	WEAN	Providence, R. I.			100	KWJ	Chicago, Ill.		
		50	KFTU	Salt Lake City, Utah.			1,000	WFBN	Indianapolis, Ind.			500	WIP	Philadelphia, Pa.		
		250	KFYR	Bismarck, N. D.			3,500	WTAS	Chicago, Ill.			5,000	WOO	Philadelphia, Pa.		
		50	KWJL	Portland, Ore.			2,500	KEX	Portland, Ore.			1,000	KVOO	Tulsa, Okla.		
		20	KZIB	Manila, P. I.			100	KWWG	Bayville, Tex.			500	KXA	Seattle, Wash.		
		100	WBAX	Wilkes-Barre, Pa.			100	WDZ	Tuscola, Ill.			500	WGBS	New York, N. Y.		
		75	WBBY	Charleston, S. C.			750	WCFP	Detroit, Mich.			500	WIP	Philadelphia, Pa.		
		100	WBRE	Wilkes-Barre, Pa.			500	WKAR	East Lansing, Mich.			500	WOW	Philadelphia, Pa.		
		50	WCAZ	Carthage, Ill.			500	KTAB	Oakland, Calif.			1,000	KFWB	Hollywood, Calif.		
		500	WCOA	Pensacola, Fla.			5,000	WHAM	Rochester, N. Y.			1,000	KLZ	Denver, Colo.		
		50	WHBY	West De Pere, Wis.			250	KVI	Tacoma, Wash.			1,000	WEW	St. Louis, Mo.		
		50	WIBR	Steubenville, Ohio.			250	KXFX	Denver, Colo.			1,000	WWJ	Detroit, Mich.		
		60	WBQZ	Weylton, W. Va.			5,000	WAIU	Columbus, Ohio			1,000				
		100	WREC	Memphis, Tenn.			500	WDRG	New Haven, Conn.			1,000				
		100	WSAZ	Huntington, W. Va.			750	WEAO	Columbus, Ohio			500	CFCA	Toronto, Can.		
		150	WSIX	Springfield, Tenn.			50	WRAK	Escanaba, Mich.			1,000	CHCT	Red Deer, Can.		
252	1,190	250	KOCW	Chickasha, Okla.	285.5	1,050	2,000	KFAU	Boise, Idaho	365.6	820	500	CHIC	Toronto, Can.		
		500	KFSG	Los Angeles, Calif.			500	KLCN	Blytheville, Ark.			500	CJBC	Toronto, Can.		
		250	KEJK	Los Angeles, Calif.			250	KMMJ	Way Center, Neb.			1,000	CJCR	Red Deer, Can.		
		10	WFAM	St. Cloud, Minn.			5,000	WBAL	Baltimore, Md.			500	CJSC	Toronto, Can.		
		15	WGLA	Lancaster, Pa.			500	WCAL	Northfield, Minn.			500	CKCL	Toronto, Can.		
		250	WKBZ	Indianapolis, Ind.			500	WJAG	Norfolk, Neb.			2,000	CKLC	Red Deer, Can.		
		50	WKBW	New Orleans, La.			250	WJAG	Norfolk, Neb.			500	CKLC	Toronto, Can.		
		50	WKJC	Lancaster, Pa.			100	KGBX	St. Joseph, Mo.			500	CNRT	Toronto, Can.		
		5,000	WMBB	Homewood, Ill.			500	KPLA	Los Angeles, Calif.			1,000	KYA	San Francisco, Calif.		
		100	WMBR	Tampa, Fla.			250	WBNC	Chicago, Ill.			5,000	WSAI	Cincinnati, Ohio		
		5,000	WOK	Chicago, Ill.			500	WBET	Medford, Mass.			50	KMJ	Fresno, Calif.		
		5,000	WORD	Batavia, Ill.			500	WDBO	Orlando, Fla.			1,000	WBEH	Chicago, Ill.		
254.1	1,180	500	KFKU	Lawrence, Kan.	288.3	1,040	100	WENR	Chicago, Ill.	370.2	810	1,000	WJJD	Moosebeart, Ill.		
		15	KGDA	Dell Gap, S. D.			250	WIAD	Philadelphia, Pa.			1,000	KHQ	Spokane, Wash.		
		200	KGFX	Pierre, S. D.			100	WKY	Oklahoma City, Okla.			1,000	WDAF	Kansas City, Mo.		
		500	KMO	Tacoma, Wash.			150	WNAI	Philadelphia, Pa.			1,000	WDLW	New York, N. Y.		
		250	WABO	Rochester, N. Y.			100	WSSH	Boston, Mass.			500	WMCA	Hoboken, N. J.		
		100	WCAX	Burlington, Va.			50	CJOR	Sea Island, Can.			500	KNRC	Santa Monica, Calif.		
		500	WHCC	Rochester, N. Y.			1,000	CKOW	Scarboro, Can.			5,000	WOC	Davenport, Iowa		
		750	WREN	Lawrence, Kan.			250	CKSM	Toronto, Can.			790	WCAJ	Lincoln, Neb.		
		1,000	WRVA	Richmond, Va.			500	CNRV	Vancouver, B. C.			50,000	WGY	Schenectady, N. Y.		
		500	WTAQ	Eau Claire, Wis.			100	KGCH	Wayne, Neb.			780	CKY	Winnipeg, Can.		
256.3	1,170	2,000	KTNT	Muscatine, Iowa.	293.9	1,020	250	KGDW	Humboldt, Neb.	384.4	780	500	CNRW	Winnipeg, Can.		
		250	WASH	Grand Rapids, Mich.			100	KGEZ	Kalispell, Mont.			5,000	KGO	Oakland, Calif.		
		1,000	WBBR	Ryeville, N. Y.			500	KPRC	Houston, Tex.			1,000	KTHS	Hot Springs, Ark.		
		500	WCSO	Springfield, Ohio.			1,000	WGL	New York, N. Y.			100	WBSS	Hobson Park, Mass.		
		500	WEBJ	New York, N. Y.			500	WLBW	Oil City, Pa.			500	WWSB	Miami Beach, Fla.		
		250	WLTH	Brooklyn, N. Y.			1,000	WODA	Paterson, N. J.			750	WQAM	Miami, Fla.		
258.5	1,160	100	KFOX	Omaha, Neb.	296.9	1,010	50	CFGC	Brantford, Can.	359.4	770	500	WAAF	Chicago, Ill.		
		500	KFUL	Galveston, Tex.			50	CFLC	Prescott, Can.			100	WABI	Bangor, Maine		
		250	KOCH	Omaha, Neb.			500	CJRM	Moose Jaw, Can.			5,000	WBBM	Chicago, Ill.		
		1,000	WBT	Charlotte, N. C.			10	KGFW	Ravenna, Neb.			500	WJBT	Chicago, Ill.		
		500	WEBW	Beloit, Wis.			500	KOW	San Jose, Calif.			1,000	KMA	Shenandoah, Iowa		
		750	WFBF	Syracuse, N. Y.			500	KUOA	Fayetteville, Ark.			5,000	KOB	State College, N. M.		
		250	WIL	St. Louis, Mo.			100	WDEL	Mililmington, Del.			1,000	KTW	Seattle, Wash.		
		250	WNAL	Omaha, Neb.			500	WEPS	Gloucester, Mass.			1,000	KWKH	Shreveport, La.		
		250	WSBF	St. Louis, Mo.			750	WSMB	New Orleans, La.			500	WSCM	Pullman, Washington		
260.7	1,150	2,000	KGA	Spokane, Wash.	299.8	1,000	250	KFWO	Avalon, Calif.	394.5	760	1,000	WBN	New York, N. Y.		
		500	WCAU	Philadelphia, Pa.			5,000	KMOX	St. Louis, Mo.			500	WPAF	Palisade, N. J.		
		500	WCMA	Culver, Ind.			500	WBA	Harrisburg, Pa.			500	WQAO	Palisade, N. J.		
		750	WFIV	Hopkinsville, Ky.			500	WPSC	State College, Pa.			500	KGBU	Ketchikan, Alas.		
		500	WBFA	Oil City, Pa.			1,000	WQSL	Salt Lake City, Utah			1,000	KHJ	Los Angeles, Calif.		
		250	WNBH	New Bedford, Mass.			1,000	WGR	Buffalo, N. Y.			500	PWX	Cuba		
		500	WOOD	Grand Rapids, Mich.			500	WNAX	Yankton, S. D.			1,000	WEAR	Cleveland, Ohio		
		1,000	WRHM	Minneapolis, Minn.			500	WHAZ	Troy, N. Y.			500	WBBT	South Bend, Ind.		
263	1,140	50	KCFW	Carlinville, Mo.	302.8	990	1,000	WHY	Chicago, Ill.	405.2	740	5,000	WTAM	Cleveland, Ohio		
		10	KCEB	Los Angeles, Calif.			750	WBO	Chicago, Ill.			500	WCCO	Minneapolis-St. Paul, Minn.		
		250	KCFH	La Cres, Calif.			1,000	WBOQ	New York, N. Y.			500	WFI	Philadelphia, Pa.		
		50	KGHP	Hardin, Mont.			500	WBOQ	New York, N. Y.			1,650	CFCE	Montreal, Can.		
		250	WDAG	Amarillo, Tex.			500	CFCY	Charleston, Can.			1,000	CFYC	Vancouver, Can.		
		250	WEAM	North Plainfield, N. J.			500	CHWC	Regina, Can.			1,000	CHPC	Vancouver, Can.		
		5,000	WJAZ	Mt. Prospect, Ill.			500	CKRG	Regina, Can.			750	CHYC	Montreal, Can.		
		250	WJBI	Red Bank, N. J.			5,000	CKCK	Regina, Can.			1,200	CKAC	Montreal, Can.		
		100	WJBO	New Orleans, La.			500	CKRW	Brwn'ville, Can.			1,000	CKCD	Vancouver, Can.		
		2,500	WMBI	Chicago, Ill.			50	CKSH	St. Hyacinthe, Can.			50	CKFC	Vancouver, Can.		
		500	WSEA	Virginia Beach, Va.			500	CNRR	Regina, Can.			1,000	CKWX	Vancouver, Can.		
265.3	1,130	2,000	KTSA	San Antonio, Tex.	312.3	960	100	CFCY	Charleston, Can.	413	726	1,000	KZRM	Manila, P. I.		
		100	WBES	Tacoma Park, Md.			500	CHWC	Regina, Can.			1,000	WGN	Chicago, Ill.		
		100	WCWS	Bridgeport, Conn.			500	CKRG	Regina, Can.			1,500	WLIB	Chicago, Ill.		
		500	WHK	Cleveland, Ohio			500	CKCK	Regina, Can.			422.3	710	1,000	KPO	San Francisco, Calif.
		500	WICC	Easton, Conn.			500	CKRW	Brwn'ville, Can.			5,000	WOR	Newark, N. J.		
		1,000	WNOX	Knoxville, Tenn.			1,000	CNRR	Regina, Can.			500	WOS	Jefferson City, Mo.		
		2,500	WOI	Ames, Iowa			500	CKSH	St. Hyacinthe, Can.			5,000	WLV	Harrison, Ohio		
267.7	1,120	15	CFJC	Kamloops, B. C.	315.6	950	50,000	KDKA	Pittsburgh, Pa.	417.7	730	1,650	CFCE	Montreal, Can.		
		20	CFMC	Kingston, Can.			50	KPPC	Pasadena, Calif.			500	CFYC	Vancouver, Can.		
		500	CFRC	Kingston, Can.			1,000	KPSN	Pasadena, Calif.			1,000	CHPC	Vancouver, Can.		
		25	CHSC	Summerside, Can.			940	KFAB	Lincoln, Neb.			1,200	CKAC	Montreal, Can.		
		50	CHGS	Unity, Can.			5,000	KFBN	Council Bluffs, Iowa			1,000	CKCD	Vancouver, Can.		
		50	CJOC	South Athbridge, Can.			1,000	KOIN	Portland, Ore.			50	CKFC	Vancouver, Can.		
		25	CKCR	St. George, Can.			930	CHNS	Halifax, Can.			1,000	CKWX	Vancouver, Can.		
		50	CKPR	Midland, Can.			100	CNRA	Moncton, Can.			500	CNRM	Montreal, Can.		
		100	KFIZ	Fond du Lac, Wis.			100	KICR	Red Oak, Iowa			500	NAA	Radio, Va.		
		100	KFLV	Rockford, Ill.			500	WHAS	Louisville, Ky.			1,800	CFAC	Calgary, Can.		
		500	KFWI	San Francisco, Calif.			500	WIAS	Ottumwa, Iowa			250	CFCA	Calgary, Can.		
		1,000	KSBA	Shreveport, La.			500	WKAQ	San Juan, P. R.			250	CJCA	Calgary, Can.		
		250	WAAM	Newark, N. J.			150	WRHF	Washington, D. C.			100	CKCO	Ottawa, Can.		
		100	WBAG	Decatur, Ill.			2,500	KOA	Denver, Colo.			500	CNRC	Calgary, Can.		
		50	WDAE	Tampa, Fla.			500	WPCH	Hoboken, N. J.			1,000	CNRO	Ottawa, Can.		

STATE AND CITY INDEX

Alabama					Illinois (Continued)					Maine						
City	Call	Meters	Kc.	Watts	City	Call	Meters	Kc.	Watts	City	Call	Meters	Kc.	Watts		
Auburn	WAPI	340.7	880	1,000	Chicago	WABC	241.8	1,500	500	Bangor	WABI	770	770	100		
Birmingham	WBBC	218.8	370	10	Springfield	WBBZ	204	1,470	100	Foxcroft	WBZ	208.2	1,440	250		
Gadsden	WJBY	234.2	1,280	50	Decatur	WBCN	288.3	1,040	250	Portland	KCSH	214.2	1,400	500		
Montgomery	WIBZ	230.6	1,300	15	Evanston	WCFL	483.6	620	1,500	Maryland						
Arizona					Forest Park	WWEB	358.6	1,340	500	Baltimore	WBAL	285.5	1,050	5,000		
Flagstaff	KFYX	205.4	1,460	25	Galesburg	WEDC	241.8	1,240	500	Baltimore	WCAO	243.8	1,230	250		
Phoenix	KFAD	272.6	1,100	500	Harrisburg	WENR	288.3	1,040	500	Baltimore	WCMB	225	1,330	100		
Prescott	KFCB	243.8	1,230	125	Joliet	WFKB	223.7	1,340	500	Baltimore	WFBR	243.8	1,230	100		
Tucson	KPJM	214.2	1,400	15	La Salle	WGCS	221.8	1,240	500	Takoma Park	WBES	265.3	1,130	100		
Tucson	KGAR	234.2	1,280	100	Peoria	WGN	416.4	720	500	Massachusetts						
Arkansas					Rock Island	WHBL	204	1,470	100	Babson Park	WBSO	384.4	780	100		
Blytheville	KLCN	285.5	1,050	50	Springfield	WHBM	201.2	1,490	100	Boston	WATL	201.2	1,480	100		
Fayetteville	KUQA	296.9	1,010	500	Streator	WHFC	215.7	1,390	200	Boston	WBEA	461.3	650	500		
Hot Springs	KTHS	384.4	780	1,000	Tulsa	WHT	305.9	980	5,000	Boston	WEEI	508.2	590	500		
California					Waukegan	WIBJ	261.2	1,490	100	Boston	WMES	211.1	1,420	50		
Avalon	KFWO	239.8	1,000	250	Wenona	WIBM	201.2	1,490	100	Boston	WNAO	333.1	900	500		
Berkeley	KRE	245.8	1,220	100	Ypsilanti	WIBO	305.9	980	5,000	Cambridge	WWSH	461.3	650	500		
Burbank	KELO	228.9	1,310	250	Waukegan	WJAZ	263	1,140	5,000	Cambridge	WWSH	288.3	1,040	100		
El Centro	KEEN	224.4	1,320	15	Waukegan	WJBT	389.4	770	500	Cambridge	WLOE	210.1	1,420	100		
Fresno	KMJ	365.6	820	50	Waukegan	WKBC	365.6	820	1,000	Fall River	WSAR	212.6	1,410	250		
Holy City	KFQU	208.2	1,440	100	Waukegan	WKBI	215.7	1,390	50	Gloucester	WEPS	296.9	1,010	100		
Hollywood	KFOZ	232.4	1,290	250	Waukegan	WLBW	204	1,470	100	Lexington	WBET	288.3	1,040	500		
Inglewood	KFWB	352.7	850	1,000	Waukegan	WLIB	416.4	720	1,500	New Bedford	WNBH	260.7	1,150	250		
La Crescenta	KFGH	263	1,140	250	Waukegan	WLJ	344.6	870	5,000	Quincy	WRFS	217.3	1,380	50		
Long Beach	KFON	241.8	1,240	500	Waukegan	WLS	344.6	870	1,000	South Dartmouth	WMAF	428.3	700	500		
Los Angeles	KGER	215.7	1,390	100	Waukegan	WMAQ	447.5	670	2,500	Springfield	WVBT	333.1	900	15,000		
Los Angeles	KFI	465.5	5,000	5,000	Waukegan	WMBB	252	1,190	5,000	Springfield	WBAT	23.2	1,400	10		
Los Angeles	KFPR	232.4	1,290	250	Waukegan	WMB	263	1,140	2,500	Webster	WKBE	228.9	1,310	100		
Los Angeles	KFSC	252	1,190	500	Waukegan	WMC	252	1,190	5,000	Worcester	WTAG	516.9	590	250		
Los Angeles	KGEF	263	1,140	500	Waukegan	WQJ	447.5	670	500	Michigan						
Los Angeles	KGTF	208.2	1,440	100	Waukegan	WSAX	204	1,470	100	Battle Creek	WKBP	212.6	1,410	50		
Los Angeles	KHJ	399.8	750	1,000	Waukegan	WSBC	234	1,290	500	Bay City	WSKC	272.6	1,100	250		
Los Angeles	KMTR	528	570	500	Waukegan	WTAS	275.1	1,090	3,500	Berrien Springs	WEMC	483.6	620	1,000		
Los Angeles	KNX	336.9	890	500	Waukegan	WVAD	226.1	1,270	250	Detroit	WAFD	230.6	1,300	100		
Los Angeles	KPLA	288.3	1,040	500	Waukegan	WVBJ	282.4	1,040	100	Detroit	WDFW	211.1	1,420	100		
Los Angeles	KEJK	252	1,190	250	Waukegan	WVBR	267.7	1,120	100	Detroit	WJW	440.9	680	5,000		
Los Angeles	KTLB	245.8	1,090	500	Waukegan	WVCS	215.7	1,390	200	Detroit	WJW	440.9	680	5,000		
Los Angeles	KCEU	227.1	1,320	50	Waukegan	WVLD	217.3	1,380	100	Detroit	WJW	440.9	680	5,000		
Los Angeles	KFUS	208.2	1,440	50	Waukegan	WRAM	247.8	1,210	50	Detroit	WJW	440.9	680	5,000		
Los Angeles	KFWM	236.1	1,270	500	Waukegan	WVBO	217.3	1,380	100	Detroit	WJW	440.9	680	5,000		
Los Angeles	KGO	384.4	780	5,000	Waukegan	WVBR	267.7	1,120	100	Detroit	WJW	440.9	680	5,000		
Los Angeles	KLS	245.8	1,220	250	Waukegan	WVCS	215.7	1,390	200	Detroit	WJW	440.9	680	5,000		
Los Angeles	KLX	588.2	500	500	Waukegan	WVLD	217.3	1,380	100	Detroit	WJW	440.9	680	5,000		
Los Angeles	KTAB	280.2	1,070	500	Waukegan	WVBR	267.7	1,120	100	Detroit	WJW	440.9	680	5,000		
Los Angeles	KZM	208.2	1,440	100	Waukegan	WVCS	215.7	1,390	200	Detroit	WJW	440.9	680	5,000		
Ontario	KFWF	247.8	1,210	100	Waukegan	WVLD	217.3	1,380	100	Detroit	WJW	440.9	680	5,000		
Pasadena	KPFC	315.6	850	50	Waukegan	WVBR	267.7	1,120	100	Detroit	WJW	440.9	680	5,000		
Pasadena	KPSN	315.6	850	1,000	Waukegan	WVCS	215.7	1,390	200	Detroit	WJW	440.9	680	5,000		
Sacramento	KFBC	275.1	1,090	100	Waukegan	WVLD	217.3	1,380	100	Detroit	WJW	440.9	680	5,000		
Sacramento	KFBC	247.8	1,210	100	Waukegan	WVBR	267.7	1,120	100	Detroit	WJW	440.9	680	5,000		
Sacramento	KFS	440.9	680	500	Waukegan	WVCS	215.7	1,390	200	Detroit	WJW	440.9	680	5,000		
San Francisco	KFRC	454.3	860	1,000	Waukegan	WVLD	217.3	1,380	100	Detroit	WJW	440.9	680	5,000		
San Francisco	KFRC	257.7	1,120	500	Waukegan	WVBR	267.7	1,120	100	Detroit	WJW	440.9	680	5,000		
San Francisco	KGTT	220.4	1,360	50	Waukegan	WVCS	215.7	1,390	200	Detroit	WJW	440.9	680	5,000		
San Francisco	KJBS	220.4	1,360	100	Waukegan	WVLD	217.3	1,380	100	Detroit	WJW	440.9	680	5,000		
San Francisco	KPO	422.3	710	1,000	Waukegan	WVBR	267.7	1,120	100	Detroit	WJW	440.9	680	5,000		
San Jose	KYA	361.2	830	1,000	Waukegan	WVCS	215.7	1,390	200	Detroit	WJW	440.9	680	5,000		
Santa Ana	KWTC	272.6	1,100	100	Waukegan	WVLD	217.3	1,380	100	Detroit	WJW	440.9	680	5,000		
Santa Barbara	KFCR	211.1	1,420	100	Waukegan	WVBR	267.7	1,120	100	Detroit	WJW	440.9	680	5,000		
Santa Maria	KSMR	272.6	1,100	100	Waukegan	WVCS	215.7	1,390	200	Detroit	WJW	440.9	680	5,000		
Santa Monica	KNRC	374.8	800	100	Waukegan	WVLD	217.3	1,380	100	Detroit	WJW	440.9	680	5,000		
Stockton	KMBC	217.3	1,380	10	Waukegan	WVBR	267.7	1,120	100	Detroit	WJW	440.9	680	5,000		
Stockton	KWG	344.6	870	50	Waukegan	WVCS	215.7	1,390	200	Detroit	WJW	440.9	680	5,000		
Venice	KFVD	215.7	1,390	250	Waukegan	WVLD	217.3	1,380	100	Detroit	WJW	440.9	680	5,000		
Colorado					Waukegan	WVBR	267.7	1,120	100	Detroit	WJW	440.9	680	5,000		
Colorado Springs	KFUM	483.6	620	1,000	Waukegan	WVCS	215.7	1,390	200	Detroit	WJW	440.9	680	5,000		
Denver	KFEL	247.8	1,210	250	Waukegan	WVLD	217.3	1,380	100	Detroit	WJW	440.9	680	5,000		
Denver	KFUP	227.1	1,320	100	Waukegan	WVBR	267.7	1,120	100	Detroit	WJW	440.9	680	5,000		
Denver	KFXF	282.8	1,060	250	Waukegan	WVCS	215.7	1,390	200	Detroit	WJW	440.9	680	5,000		
Denver	KPOF	201.2	1,490	250	Waukegan	WVLD	217.3	1,380	100	Detroit	WJW	440.9	680	5,000		
Denver	KPFB	352.7	850	1,000	Waukegan	WVBR	267.7	1,120	100	Detroit	WJW	440.9	680	5,000		
Denver	KOD	325.9	820	2,500	Waukegan	WVCS	215.7	1,390	200	Detroit	WJW	440.9	680	5,000		
Edgewater	KOW	218.8	1,370	250	Waukegan	WVLD	217.3	1,380	100	Detroit	WJW	440.9	680	5,000		
Edgewater	KFKJ	209.7	1,430	50	Waukegan	WVBR	267.7	1,120	100	Detroit	WJW	440.9	680	5,000		
Fort Morgan	KGEV	218.8	1,370	200	Waukegan	WVCS	215.7	1,390	200	Detroit	WJW	440.9	680	5,000		
Greeley	KKA	249.9	1,200	200	Waukegan	WVLD	217.3	1,380	100	Detroit	WJW	440.9	680	5,000		
Gunnison	KFHA	249.9	1,200	50	Waukegan	WVBR	267.7	1,120	100	Detroit	WJW	440.9	680	5,000		
Pueblo	KGDP	223.7	1,340	50	Waukegan	WVCS	215.7	1,390	200							

New Jersey

Table listing radio stations in New Jersey with columns for City, Call, Meters, Kc., and Watts.

New Mexico

Table listing radio stations in New Mexico with columns for City, Call, Meters, Kc., and Watts.

New York

Table listing radio stations in New York with columns for City, Call, Meters, Kc., and Watts.

North Carolina

Table listing radio stations in North Carolina with columns for City, Call, Meters, Kc., and Watts.

North Dakota

Table listing radio stations in North Dakota with columns for City, Call, Meters, Kc., and Watts.

Ohio

Table listing radio stations in Ohio with columns for City, Call, Meters, Kc., and Watts.

Oklahoma

Table listing radio stations in Oklahoma with columns for City, Call, Meters, Kc., and Watts.

Oregon

Table listing radio stations in Oregon with columns for City, Call, Meters, Kc., and Watts.

Pennsylvania

Table listing radio stations in Pennsylvania with columns for City, Call, Meters, Kc., and Watts.

Rhode Island

Table listing radio stations in Rhode Island with columns for City, Call, Meters, Kc., and Watts.

South Carolina

Table listing radio stations in South Carolina with columns for City, Call, Meters, Kc., and Watts.

Tennessee

Table listing radio stations in Tennessee with columns for City, Call, Meters, Kc., and Watts.

Texas

Table listing radio stations in Texas with columns for City, Call, Meters, Kc., and Watts.

Utah

Table listing radio stations in Utah with columns for City, Call, Meters, Kc., and Watts.

Vermont

Table listing radio stations in Vermont with columns for City, Call, Meters, Kc., and Watts.

Virginia

Table listing radio stations in Virginia with columns for City, Call, Meters, Kc., and Watts.

Washington

Table listing radio stations in Washington with columns for City, Call, Meters, Kc., and Watts.

West Virginia

Table listing radio stations in West Virginia with columns for City, Call, Meters, Kc., and Watts.

Wisconsin

Table listing radio stations in Wisconsin with columns for City, Call, Meters, Kc., and Watts.

Wyoming

Table listing radio stations in Wyoming with columns for City, Call, Meters, Kc., and Watts.

Alaska

Table listing radio stations in Alaska with columns for City, Call, Meters, Kc., and Watts.

Hawaii

Table listing radio stations in Hawaii with columns for City, Call, Meters, Kc., and Watts.

Philippines

Table listing radio stations in the Philippines with columns for City, Call, Meters, Kc., and Watts.

Porto Rico

Table listing radio stations in Porto Rico with columns for City, Call, Meters, Kc., and Watts.

Canada

Table listing radio stations in Canada with columns for City, Call, Meters, Kc., and Watts.

(Continued on page 100)

Simple Explanation of Broadcasting

Part IV—The Voice and Music Are Separated from the Radio Wave to Be Reproduced by the Speaker

By Marvin W. Thompson

FOR those who have not been following this series of articles, it should be explained that, in the previous three, we have looked into the creation of sound waves in a singer's throat, then followed them as they became Radio impulses in the huge transmitter of a broadcasting transmitter and, finally, discussed interesting features connected with their travels through space. This fourth and concluding article takes up their reception in a broadcast receiver—and some of the whys connected with a receiving set.

In order to understand what is necessary in a set, and what

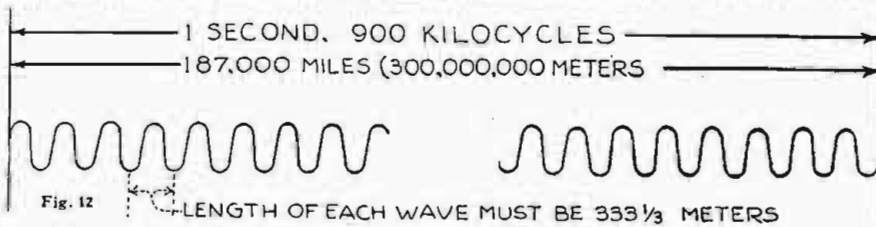

goes on within it, we must first analyze Radio broadcast waves to some extent to know what the problem is for their reception. Obviously, since these programs are tearing through space in all directions they must pass through us by the hundred yet we do not respond to them, nor are we conscious of them.

Taking now, the waves from only one station, they must be considered as a series of ripples, occurring at a certain definite number per second and spreading out from their source, getting weaker as they go, since the diameter of the circle gets greater. Each ripple contains energy in the form of a slight disturbance of the particles that make up what we call the atmosphere. This disturbance is passed on without the particles themselves moving the least bit from their individual places. Each sort of nudges the next and settles back until nudged again by its neighbor toward the broadcasting station, when it once more jostles that particle on its opposite side. That is energy, in the form of radio waves, traveling at 187,000 miles each second.

WHEN a station announces "we are broadcasting on a frequency of 900 kilocycles by the authority of, etc." it means that the ripples of energy in the air occur at the rate of 900,000 per second (See Figure 12). Since that many are created in one second, and the first one has gone 187,000 miles when the last one leaves the aerials, we can readily determine the length of each wave by dividing 187,000 miles by the announced frequency. This is most easily done by changing miles into meters and 187,000 miles is approximately 300,000,000 meters or 300,000 kilometers. If we now divide 300,000,000 we find that the station's wave is 333 1/3 meters. That is what is called converting frequency into wavelength. If you have the wavelength of a broadcaster, you have merely to divide its wavelength into 300,000 to know its frequency. Remember that as it may come in handy some night when you have a station identifying its channel in kilocycles and some neighbor wishes to get it but his log is by wavelength.

On this stream of impulses, it should be remembered, there have been impressed impulses occurring at the audible number per second of 30 to several thousand. This was done in the transmitter as explained in article two. Our problem now is first, to pick up and strengthen the radio and audio energy, second, to sort out the music and voice part, and third, to further strengthen the electrical

impulses which we will then have at the audible frequencies just mentioned. Since about 85 per-cent of the receivers in use are of the type known as "tuned radio frequency," we will consider reception by such an outfit.

We must, first of all, have an aerial and ground. The aerial can be either an outside wire running up the side of the building and over part of the roof, or an inside wire running around the picture moulding or baseboard or in the attic. The ground can be a wire attached to the water pipe, one running down to the water in a well, or a wire connected to a long metal spike driven into the earth. What we are trying to do is create a length of wire above the ground possessing what we call "inductance" and a space between two conductors (antenna and ground) possessing a characteristic which we call "capacity." As a stream of energy, radio impulses, passes through this space and cuts across our wire having inductance value, part of the energy in each ripple changes its form and becomes electricity in the wire.

It is in the circuit composed of aerial and ground wires as "oscillating electrical currents" which go one way, reverse, and go the opposite way the same number of times per second that our ripples of energy occurred in the air. It is said to be at radio frequencies, though no longer in the form of radio waves. This energy, still carrying the voice and music, is to be amplified by one or more of the glass bulbs which we call "tubes."

Each tube has associated with it, some other parts which are necessary to getting our energy into and out of the tube

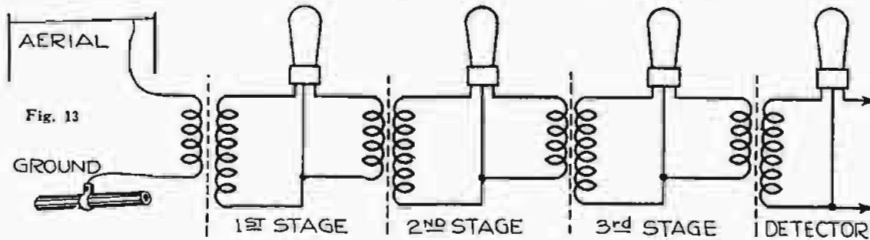

properly so we speak of each tube and these parts as a "stage"—a stage of amplification. Amplification means to add to and, in this case, we mean to add energy in the form of electrical power to each swing of the current in our circuits. When you consider

that these swings occur at from 550,000 to 1,500,000 times per second, it is evident that this adding of strength is a very delicate operation. To date, nothing has been discovered that will do this, other than a tube, the invention of Dr. Lee DeForest, who called it the "audion" when he first brought it out.

It is possible to have from one to four of these stages or tubes amplifying these very high frequency currents in a set that can be made and sold commercially. (See Figure 13). More stages are possible in the laboratory, but not over the counter. Our first stage builds up the signal to, let us say, nine times its original strength. The signal is then fed to the second stage, which amplifies it nine times more. It is now eighty-one times more powerful than when it came in on our aerial and ground. A third stage will multiply its energy nine times further so that it is 729 times its original value.

Supposedly, this could go on indefinitely, but when more (Continued on page 116)

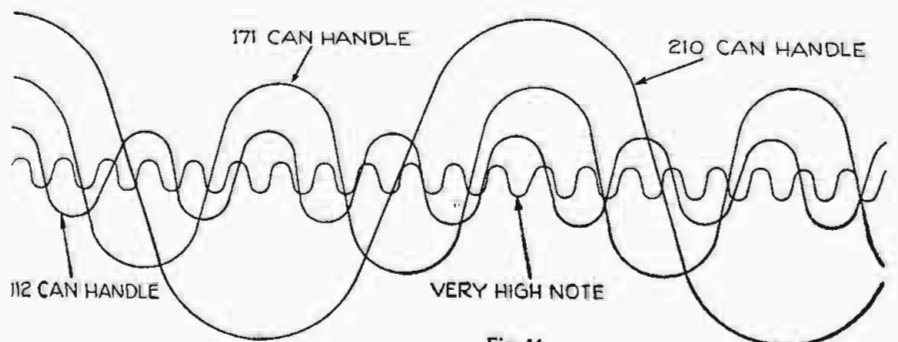

Fig. 14

Hot Spot 14 With Shielded Grid Tube

With Push Pull Power Amplifier the Very Finest Set That Can Be Built Today

By WILLIAM P. LEAR*

THE receiver "that couldn't be" has come into actual existence. The set that will really slice off stations in ten kilocycle bands, regardless of whether they are local or long distance, can now be built—and very easily. Upsetting all of last season's ideas of amplification and how to get it, the Hot Spot Fourteen is indeed the wonder set of the year. Each Radio season winds up with some one outstanding development as a standard of selectivity and distance for the super-heterodyne enthusiasts to shoot at—and try to better for the next season. Last spring the season ended with an excellent edition of the "Nine-in-Line," which seemed to give almost everything desired. We approach the spring months this time with the Hot Spot Fourteen—with variations.

Hot Spot Fourteen, as brought out by its original designers, is a "super" with fourteen tubes, all coupled with transformers. Without changes in panel drilling or general design, we have added the new high amplification tube UX-222, resistance coupling after the detector, and this magnificent assemblage is adequately ended with a push-pull power amplifier employing UX-210 tubes. Counting the rectifiers, it has become the "Very Hot Spot Seventeen." It seemed incongruous to us to build such a marvelous outfit, from the standpoint of selectivity and range, and wind it up with either a 112 or 171. Only 210's in a push-pull arrangement seemed enough. And what tone quality they give—with a Jensen Dynamic Speaker!

Some idea of the truly remarkable selectivity of this set may be gained from the following excerpts from the log sheet. Most of these stations are available nightly—clear, sharp, enjoyable. This on the north side of Chicago not far from the Edgewater Beach hotel.

KDKA	40 -56½	WGN	68 -77½
KOIL	41 -58	KPO	69 -78½
WHAS	42 -59	WLW	71 -80
KOA	43 -60	WMAQ	73 -82
WBZ	45 -61		
WSM	46½-62	KRLD	78 -85
WLS	49 -64	KFI	79 -86½
KVVO	50½-65	WSB	80½-87½
WWJ	52½-66½	WCFL	81½-88½
WSAI	54 -67	WEAF	83½-89½
WEBH	55½-68	CFRB	88 -92½

There are those who, without the following explanation, would scoff at the idea of using fifteen active tubes in any receiver. It has been the general experience that, when one reached a certain number of stages of amplification, the sensitivity per stage had to be pulled down to add any, and nothing was gained by the addition of any more. It is this experience that has been changed by Robertson-Davis Company, chief backers of the Hot Spot. If we take one stage with an amplification of 10, and add to it another stage with an am-

*Chief Engineer, King Lear Laboratories, 804 East 81st Street, Chicago, Ill.

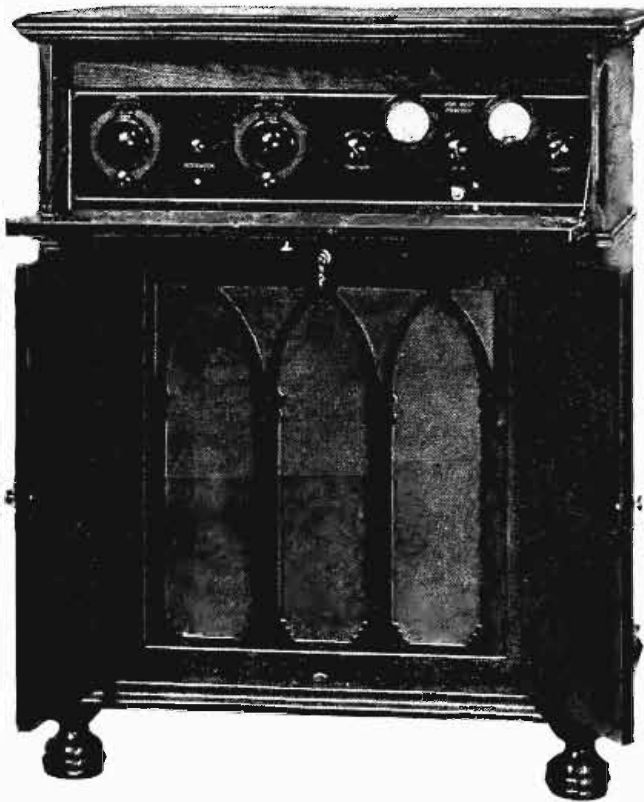

HOT SPOT 14 in Excello Console R-31. The Jensen Speaker and Push Pull Amplifier go in lower compartment.

plification of 10, the total is a strengthening of the signal of 100. A third stage with a gain of 10, gives us a grand total of 1,000. Beyond that you cannot go, since feedbacks and tendency to oscillation necessitate cutting down the gain per stage so that the resultant overall gain is not even 1,000.

IF, on the other hand, one will accept a gain of but 6 per stage, and use four stages, it is possible to have and control, a gain of 1,296 from input to detector. Going yet further and cutting the gain per stage to 3, it is feasible to use eight stages for a total gain of 6,560 without losing control. Using eight stages it is possible also, to create an intermediate frequency channel so narrow that it is strictly 10 kilocycles wide. There you have the basic theory of the Hot Spot. The amplification per stage is low enough so that the feedback from plate to grid in each tube does not get away from one, and that from following stages will not be great enough to start the system into oscillation. The tremendous gain of eight stages, with a gain of 3 each, is actually achieved.

Due to the fact that all tubes are worked well below their limit, and regeneration does not have to be brought up to instability, the music comes through with exceptional purity. Due to the sharpness of tuning, the static component of what one hears is very low. On receivers not so sharp, one gets the static of not only the ten kilocycle band to which he is tuned, but that of one or two bands on either side, which

forces its way in, due to inherent broadness. On the Hot Spot, you get only the static which is strong on the frequency channel of the station to which you are listening—comparatively little.

A further advantage of the Hot Spot is that stations come in at only one point on the oscillator dial, giving "one spot" tuning. This result is gained by using an intermediate amplifier frequency of 465 kilocycles (645 meters) and an oscillator which covers a frequency range of approximately 1,000 to 2,000 kilocycles. If you subtract 465 from 1,000 you get 535, which is a shade lower in kilocycles than any broadcast station goes, while if you subtract 465 from 2,000 you get 1,535, which is a few kilocycles higher than stations go. Hence, you completely cover the broadcast range, and to get a second "spot" on the oscillator dial its range would have to go far below broadcasting.

YOU can construct the Hot Spot exactly as described here, to feed into the Power Amplifier and "B" Supply which is also described—or any of these Amplifier and Supply units which are on the market—or, you can put the fourteenth tube in the set as originally intended and for which the makers of the Celeron drilled and engraved panels have provided a socket hole. If the latter, you use the Brown wire in the cable for the 180-volt supply and put a binding post on the rear edge of the sub-base for 40.5 volts "C" battery. You can build the outfit complete as described and use some other type of speaker by merely shunting the "field" binding posts on the power unit with a 2,200-ohm resistance. However, some care in the choice of speakers must be used, in this last named case, since few on the market can handle the output of two 210 tubes and give you those heavy low notes that make the reproduction of this set so awe inspiring.

The sub-base of this set is assembled completely first, then the front panel and, finally, the two are bolted to the brackets and connected with 19 wires to complete the job. The system of inserting machine screws and soldering lugs along the front edge to take wiring across to the front panel, makes this set considerably easier to build, and the holes for all these screws have been provided by the panel makers. The only holes you need drill for this adaptation of Hot Spot are for brackets and the Power Switch on the panel. The original method of assembly included a huge wooden baseboard and a number of pillars up to the sub-base, but since Benjamin brackets are available everywhere and the pillars would have to be made to order, this assembly was considered better.

The sub-base, as supplied, measures 28½ inches long. Measuring in from the left end 7¼ inches, a hole is drilled

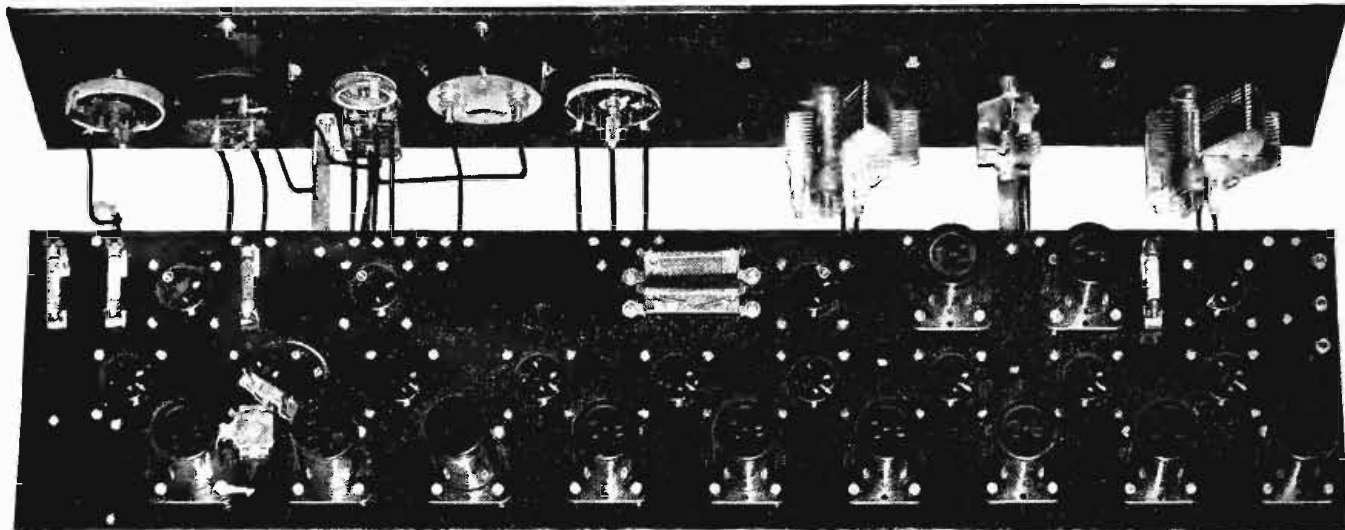

NOTE the total absence of wiring above sub-base and that resistance coupling has replaced transformer coupling at the left. The clip for the cap on the 222 tube can be seen near lower left corner.

$\frac{1}{2}$ inch from the front edge of sub-base, and another $3\frac{3}{8}$ inches from front edge. These mount one Benjamin bracket. Measuring in $6\frac{1}{2}$ inches from the right end of sub-base, another hole is drilled $\frac{1}{2}$ inch back from front edge, and one $3\frac{3}{8}$ inches back. These take the second bracket. The positions for holes in the front panel are determined by moving the sub-base and brackets up against the back of the front panel, making sure it is centered, and marking the drilling spots right through the bracket holes and on the back surface of the front panel. All holes so far mentioned are for 6-32 screws, as provided by Benjamin with the brackets. The holes in the front panel are to be countersunk. The hole for the 1mp Power Switch is drilled squarely below the hole already in the front panel intended for the 200,000-ohm volume control, and its center is to $1\frac{1}{16}$ inches from the bottom edge.

The Exeello Console R-31 was chosen for the reason that it is one of the few such cabinets on the market that is a truly attractive piece of furniture. It is of unusually heavy construction with door panels of carefully selected and matched butt walnuts that are the admiration of all the women who have seen this outfit. The entire console has been given a two-tone full piano finish, and behind the lower doors there is a

large 29x24x14 $\frac{1}{2}$ -inch compartment with removable grille.

IF you are going to place this set in the Exeello Console R-31, which is made for a 29-inch panel, it will be necessary to cut $\frac{1}{2}$ inch from each end of the Hot Spot front panel which is 30 inches long as it comes to you. This we did quite easily with a small hack saw and followed the outside of the gold line that runs down each end of the panel. This in no way affects the appearance after the set is in place. It is also a good idea to slightly file out the notch in the bottom of the hole provided for the double range voltmeter. There is a switch which runs from the front flange of the meter back to the rear face and this must have freedom to turn. The notch was not quite deep enough in our case.

When assembling the sub-panel equipment, first countersink the two holes provided for the Yaxley terminal bracket as they come below two of the Melocouplers which are flat-bottomed. Once this is done, flat head screws can be dropped into the holes and Melocouplers can be placed directly over them. Melocoupler 420 is mounted on the front left corner of sub-base with its G and P posts toward the front, while 460 is the one to its right in the front row and has its G and P posts to the rear. Melo-

couplers 461 to 469 inclusive are mounted in that order from left to right across the rear edge, with their G and P posts to the front.

Coming to the tube sockets, we find the socket for the first detector in the left front corner of sub-base with G and P to the right, while the socket which is 9 inches to its right and beside the 460 coupler is the oscillator with G and P to the left. The row of sockets extending clear across the sub-base and midway front to back are all placed with G and P to the rear. Near the right end of the sub-base, and in the front row, are the sockets for the first and second stages of audio frequency amplification and here we place them with G and P to the front. The mounting of the smaller parts such as the Melochoke, the Samson Choke, bypass condensers and Sangamo fixed condensers should be clear from a little study of the photographs. In mounting the bypass condensers, about 20 inches of brass strip $\frac{1}{16}$ x $\frac{1}{16}$ inch are used. That at the left end is held away from the under side of the sub-base by mounting the brass strip on $\frac{3}{4}$ -inch pillars which can be easily built up on a machine screw with battery nuts or hex nuts.

(Continued on page 94)

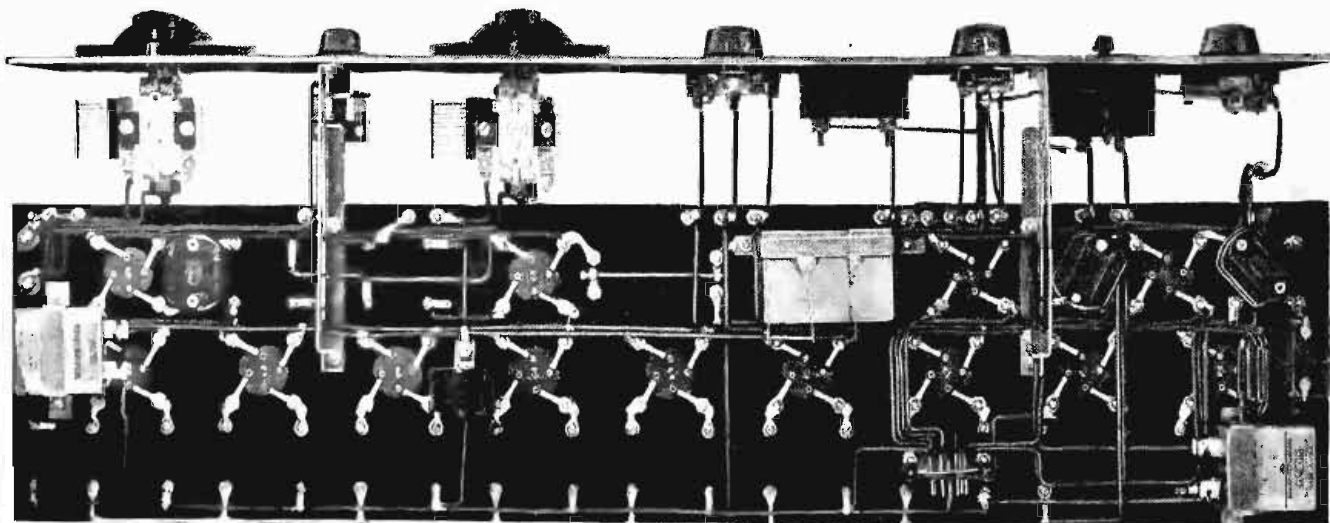

NOT so difficult to wire, due to careful layout of parts. Flexible cotton covered wire is easily handled and prevents "shorts." Note how terminals along front edge of sub-base facilitate getting to front panel.

As He Chose *his* Lady

So he Chooses
—her Gift—



AS in a mirror, the gift reflects the giver. As he chooses his lady for beauty—character—purity—so he chooses her gift—the famous Mi Choice package. A frivolously dainty package. An alluring, tasteful thing. Quiet, with an air of aristocratic reserve. Mi Choice is *the perfection of all box chocolates.*

Each filling is an intriguing surprise—a crispy nut or pure creamy filling, flavored with the true fruit. Each smooth coating proves the big difference between a cursory milling and the fourteen day Bunte process.

Give the gift of gifts and thus again prove that "*as you choose your lady*" so you have chosen her gift.

Your dealer can supply you. Or send us \$1.50 and we will mail the 1 pound Mi Choice package prepaid. Also two, three and five pound sizes.

BUNTE BROTHERS
Est. 1876 ; CHICAGO
Makers of Diana "Stuft" Confections

Bunte
WORLD FAMOUS

CANDIES

1200 Kinds from Which to Choose

Candy—The Universal Gift—appropriate and appreciated always. Vary your gifts of candy with these three packages of distinction—"Home Made Sweets," "Tri Assortment" and Bunte Milk Chocolates. Bunte quality in both candy and package.

THIS bypass condenser at the left end is C5 in the wiring diagram, while the two in the rear right corner are C8 and C10. The three that are mounted together near the front edge and just to right of center are those identified as C4, C6 and C7 in the diagram. Taking up the mica fixed condensers, that beside the Samson choke, is C9, that in the front right corner is C11, that behind the voltmeter is C12 while that near the front left corner is C13. In wiring, the placing of the Melcouplers and intermediate tube sockets is quickly appreciated, as it is only necessary to tighten down the coupler mounting screws with the soldering tugs swung to the correct positions and a drop of solder will make each connection.

On the front panel, the variable condenser at the left end is C2, the little one next to it is C3 while the second large variable condenser is C1. Next to it, from left to right, is the Yaxley 400-ohm potentiometer, then the Carter 200,000-ohm volume control and, finally, the 3-ohm rheostat. The Kurz-Kasch dials are a little difficult to understand but are well worth the slight difficulty in putting them on. If a good size end wrench that will fit the lock screw in them is available, so much the better, but a pretty good job can be done with large pliers. Turn the condenser plates clear in, slip on the dial disc and tighten the lock nut with the dial disc reading 100 at the top. Keep the dial disc out from the panel about 1/16 inch. The cover, with spring and small friction pinion in place, is now brought up against the condenser shaft with the small pinion just below the large disc. If you lift carefully, and press in, the small pinion will fit against the disc and the cover will slip over the shaft. The screws embedded in the cover near the top, then hit the holes provided for them in the front panel, and it is but a minute's work to slip the nuts on them.

THE Power Amplifier and "B" Supply is mounted on a wooden baseboard but if this is not convenient, a single piece of board, not laminated, will do



THE Jensen Dynamic Speaker is hung from ceiling of the lower compartment opposite the hole near top of baffle plate.

very well. The bakelite strip for the binding posts measures 10 7/8 inches by 3/4 inch, but this can be a little more or less just so you can get 9 binding posts on it. The placing of parts for this unit is clear from the photograph, but it might be well to explain that of the push pull transformers, that which is close to the end of the board is type B while that which is close to the Thordarson Double Choke unit is the output D210 transformer.

The Aerovox Filter Block is so assembled that the leads coming from the front are (1) B minus, (2) 2 mfd. test 1,000 volts, (3) 2 mfd. test 600 volts, (4) 2 mfd. test 600 volts, (5) 4 mfd. test 400 volts and (6) 1 mfd. test 200 volts. This arrangement is due to the fact that the first condenser takes the full voltage as it comes from the

rectifiers, while it has been reduced by the first choke when it hits the second condenser, and still further by the second choke when it reaches the third. The 4 mfd. unit only takes 90 volts while the 1 mfd. is across "C" bias. One connection may not be quite clear from the photo. There is a wire which connects to the center terminal at the "back" of the Thordarson transformer, comes through between condenser block and choke unit and connects to the right end of the 750-ohm "C" bias strip.

It should be mentioned that, since this Power Unit was constructed, the Aerovox Filter Block T H 662 shown in the illustration has been replaced by the more developed model T H 682, specified in the list of parts. On this new unit, the three capacities of 2 mfd. have their high potential terminals at the top, No. 1 being the 1,000-volt unit, No. 2 the first of the 600-volt type and No. 3 the second 600-volt. This block is to be placed with terminals 6, 7 and 8 to the front and 4 and 5 at the rear. Connect 4 and 5 together and use jointly as minus B lead. Terminal 7 is the 4 mfd. unit while 6 and 8 are 1 mfd. each; use 6 across the 45-volt section of Truvolt and 8 across the 4 1/2-volt "C" bias section.

You will note that several pairs of leads in this unit have been twisted; be sure and do this to yours, as it keeps out "hum." You will see, also, that each of the cases on apparatus has been connected to the wire of lowest potential, which is "lower" end of the resistance and becomes the minus 4 1/2 "C" bias for the set. It is very likely that you will (Continued on page 114)

LIST OF PARTS FOR HOT SPOT RECEIVER

Robertson-Davis Co., 412 Orleans St., Chicago:	1 "Imp" Power Switch, type 110	75
	3 Tip Jacks, Code No. 10 @ \$0.10	30
Jewell Electrical Inat. Co., 1650 Walnut St., Chicago:	1 Type 55 Voltmeter, 0-7.5-150, case 2 1/2"	10.00
	1 Type 53 Milliammeter, 0-100, case 2 1/2"	7.50
Diamond State Fibre Co.:	1 Ceteron Front Panel, "Hot Spot 14"	7.20
	1 Ceteron Sub Base Panel, "Hot Spot 14"	6.05
The Kurz-Kasch Co., Dayton, Ohio:	2 Vernier Walnut Dials, No. 592, 0-100 @ \$2.00	4.00
Sangamo Electric Co., Springfield, Ill.:	1 Mica Condenser, capacity .015 mfd.	1.50
	1 Mica Condenser, capacity .01 mfd.	1.15
	1 Mica Condenser, capacity .001 mfd.	.50
	1 Mica Condenser, capacity .00025 mfd.	.40
	4 pairs resistor clips @ \$0.10	.40
Arthur H. Lynch, Inc., Fisk Bldg., New York City:	2 Metallized Resistors, 3/4 meg. @ \$0.75	1.50
	1 Metallized Resistor, 1/2 meg.	.50
	1 Metallized Resistor, 3 meg.	.50
Samson Electric Co., Canton, Mass.:	1 Choke No. 85	2.00
Acme Wire Co., New Haven, Conn.:	6 Parvott Bypass Condensers, 1.0 mfd. @ \$1.25	7.50
		\$148.50

LIST OF PARTS FOR POWER SUPPLY

Thordarson Electric Mfg. Co., 500 W. Huron St., Chicago:	1 Transformer, type T-2098	\$20.00
	1 Double Choke, type T-2099	14.00
Aerovox Wireless Corp., 70 Washington St., Brooklyn, N. Y.:	1 Filter Condenser Block, 2-2-2-4-1 mfd., type T H-682	18.00
Sangamo Electric Co., Springfield, Ill.:	1 Type B Push Pull Transformer	12.00
	1 Type D-210 Push Pull Transformer	12.00
	1 Mica Fixed Condenser, .00025 mfd.	.40
Electrad, Inc., 173 Varick Street, New York City:	1 Truvolt, type D Resistance, D-150	2.50
	3 Taps for Truvolt @ \$0.10	.30
Acme Wire Co., New Haven, Conn.:	1 Bypass Condenser, 1.0 mfd.	1.25
Benjamin Electric Co., 120 S. Sangamon St., Chicago:	4 Sockets, type 9040 @ \$0.75	3.00
Carter Radio Co., 300 S. Racine, Chicago:	1 Resistor Strip, type P-750-60	.50

ACCESSORIES USED IN ORIGINAL MODEL

Jensen Radio Mfg. Co., 212 Ninth Street, Oakland, Cal.:	1 Dynamic Speaker, type D5	50.00
Exello Products Corp., 4820 W. 16th St., Cicero, Ill.:	1 Console Cabinet, without horn, type R-31	90.00
The Abox Company, 215 No. Michigan Ave., Chicago:	1 Abox "A" Eliminator	32.50
Tubes Required in Set:		
	5 type 201A @ \$1.50	7.50
	7 type 199 @ \$2.25	15.75
	1 type 222 @ \$6.50	6.50
Tubes Required in Power Unit:		
	2 type 210 @ \$9.00	18.00
	2 type 281 @ \$7.50	15.00

GULBRANSEN PIANOS



Trade Mark Reg.



*In the
Eyes of Your
Visitor*

**IS YOUR HOME
COMPLETE ?**

To a beauty conscious world, the Piano now becomes more than a cultural influence in the home. Interpreted in authentic period designs, it is the artistic center around which the modern living room so effectively groups itself. In presenting our new models we pledge that now as always every Gulbransen Piano will be made and sold under the Golden Rule principle.

A. G. Gulbransen

WITH the right Piano as the focal point, harmony and good taste form the leitmotif of the modern interior.

A. G. Gulbransen has designed twenty-three charming new models; grands and uprights, Registering, reproducing and hand played, in modern and period designs, to harmonize with every interior from the early American to the Spanish.

The right Piano! How much it means. Yet equally important is the way it is placed. When should the Piano be opened? When closed? The scarf, is it always appropriate?

Mr. Gulbransen has prepared an authentic booklet, "Artistic Interiors." Profusely illustrated with interiors in every period, it portrays the Gulbransen in

its modern setting. He chooses the petite Minuet model, nationally priced at \$295, for one type of room and the stately roll-played grand at \$2400 for another. Whether you own a Piano or not send for your copy now. As in design—so in tonal quality the Gulbransen is the most advanced step in Piano making. Irrespective of price it is the finest money will buy—an art product at a moderate price. See the new Gulbransen models.

GULBRANSEN COMPANY
Dept. 1, 3230 W. Chicago Ave., Chicago, Ill.

Please send me Mr. Gulbransen's brochure "Artistic Interiors," also the new 1928 Gulbransen calendar. I admit no obligation.

Name

Address

The National Association of Piano Tuners recommends tuning two to four times a year. Keep the fine tone of your Gulbransen with this care.

© 1928, G. Co.

THE INSTRUMENT OF TODAY · A STYLE FOR EVERY HOME

Voice of the Reader

Radio Makes Invalid Happy

WHILE nine out of every ten letters received by Reader's View of Radio Digest are complaints about the way programs are broadcast and received, once in a while a letter comes that glows with optimism and good cheer.

Outstanding of all the mail received for some time is the letter from Miss Jennie R. Miller, 139 W. Seneca street, Oswego, N. Y., who has been an invalid for twenty years. To her the pleasures of Radio are growing greater and greater all the time. With her one-tube set she has logged 412 stations located from one side of the globe to the other.

It is the bright spot in her life. It has expanded her world from the four walls of her room to the sky and the ends of the earth. She takes great pride in the trophies that have been awarded her by the big Radio shows in New York and Chicago for the remarkable DX log made with so simple a receiver.

How does Miss Miller manage to keep such a fine disposition? It is the old answer. She keeps busy. She says:

"I AM an artist and spend most of the daylight hours painting pictures, being gifted with this lovely faculty since I was old enough to hold a pencil. Some will remember the painting I made of Miss Radio for the Radio World's Fair, 1925-26. I love this work and I suppose you wonder how I can paint pictures lying in bed—but where there's a will there's a way.

"I have been taking the Radio Digest for over four years now and think it is the best Radio magazine there is. I would not like to miss a single copy of it, and let me tell you that it is by the help of the Radio Digest directory that I have been able to find these very long distance stations on my one-tube set."

Miss Miller then heaps the bouquets on our modest little book and makes a suggestion, "that you put a list of the European and South American and Australian and all far distant stations in the log, giving their wave lengths in meters and kilocycles. This would be a great help to find out where to locate some of the very far stations not yet discovered." The wish is granted.

Concerning some of her DX experiences Miss Miller says:

"The longest distance I have had is 3LO, Melbourne, Australia. But I have also had LOW, Buenos Aires, Argentine, and 5NO, New Castle, England. It is no trick at all to pick up KFI, Los Angeles, or PWN, Havana."

It was last summer that she first picked up the Australian station. She was keyed to tune in bulletins of the flight of the Bellanca to Berlin.

"AT 3:15 a.m. I picked up a very weak signal," she said, "and after a few seconds I heard a man talking. But the static was noisy, so I just marked the dial setting and decided to try it again on a better night at the same place. The next cool evening that came along I began listening at 3 o'clock. At 3:05 I heard the call 3LO, Melbourne. It was clear and distinct. I heard very clearly a piano solo. As long as I live I never will forget the thrill of those few precious moments."



JENNIE R. MILLER, Who Wins DX Prizes With One-Tube Set

Throughout the entire six-page letter Miss Miller did not make one complaint, and the only reference to her ailment explained the picture she enclosed. It stated, "this little picture will tell you how happy Radio has made me after being shut away from the world for twenty years, for I have been confined to my bed with spine trouble all these long years. I am holding the silver cup, as you see in the picture, that the Chicago Radio show awarded me for making a world's record in 1926 with my one-tube set."

Letter from JODK, Seoul

We beg you will excuse for our long negligence in writing you. This station was opened up on the fifteenth of February last, equipped with Marconi's standard type transmitter 1 kw output. We have received many letters from the U. S. fans in California and Arizona regarding reception of the station on 345 meters.

Our program contains both Korean and Japanese music and others also in both languages on the announcement. We broadcast market, lecture, news and weather, etc., in the daytime; music and other amusements in the night until 10 p. m.

There were about 3,000 listeners when the fee was two yen (\$1) a month, but on and from first of October the fee is reduced to one yen a month. Thereafter the listener are increasing steadily. We expect 5,000 by the end of the year.

Broadcasting Station JODK, Seoul
per T. P. Hahn

Cuss and Go to Bed

After reading the silly replies to Mr. Cranse I have decided to write as the people in these parts see the situation. Radio conditions are 100 per cent worse than they were last winter. We don't object to a chain but we do object to them being scattered about two degrees apart all over the dial, and being forced to listen to them or go to bed. Some chain programs are good but the majority are not appreciated by the general public. People of real culture and refinement in the country homes love to hear and understand the words of the artist. They appreciate the artist's ability but would much rather the artist would sing to the birds in the woods. When a man comes in from his work, tunes in his favorite station and then the station is crowded out by some artist with a long handle to his name it's too much. You can only cuss and go to bed.

V. C. Shive, Giber, Tex.

Why Razz Commission?

While so many are complaining I want to express a word of appreciation for benefits I have received from listening to Radio. I have no income, am a dependent and all for very good reasons. I love music of all kinds. I hear all kinds on the

air—by that I mean classical music, jazz and so called popular music. I hear some disturbance, too, but I am much more interested in what I hear than what I do not hear. For that I am thankful. Let the commission alone. They are honest men and dealing with problems that no human being ever before was called upon to solve. Two of the original five are dead in less than a year after tackling the problem and a third was hounded out of office.

Justice, St. Louis, Mo.

Thinks Broadcasters Selfish

Your editorial in the February issue, "Get Ready Another Doorn" is all right. We may not agree on everything, like that month's editorial demanding that chain programs be put on one wave, but we sure do agree on this one. I have been lying here on the flat of my back for nearly fifteen months, and the more I use my Radio the more I think. It seems to me the broadcasters are a very selfish lot. It isn't the listener they are thinking of but how far out are they getting, regardless of what they are putting on the air. "Write us and let us know how we are coming in," they ask. I haven't found so many stations off their wave but they are blanketing everything around them. The worst offenders are KMOX, then KOIL, KOA, WBBM-WJBT, KMA-KVKH, WGN-WLIB. It is pure selfishness that causes blanketing.

Oscar Duncan,

311 W. Woodward St., Denison, Tex.

Almost a Threat

Bridge is an abomination on the air. I think only a very small minority is interested and the chain stations are arranged geographically so that it is almost impossible to tune them out. The big companies with so much power within their grasp should consider well how they use it and not abuse it or they will lose it. Indignation might reach such a point that a concerted move would be made to boycott all concerns that advertise with the chains. The Radio clubs across the country might bring considerable pressure in this way.

Ben F. Redmann,

602 Fifth St., Rock Island, Ill.

Guarding the Frontiers

I have been keeping tab on the federal Radio commission since it began juggling wave lengths, and clearing channels for the National Broadcasting company, and the only improvement I have noted is the rescue of WOAI, which had been buried at 1010kc, but at the same time the commission interred WSMB, another good station, in the same grave.

Several years ago, Canadian and Mexican broadcasters could invade the U. S. with impunity, but the commission, sensing the danger and with the slogan "U. S. air for U. S. stuff," impelled by patriotic fervor, apparently put into effect strategic measures that would repel the invaders. WENR, KPRC and others were charged with keeping out 7 Canucks at 1030 kc; WABC and KDKA blocked seven others at 960kc; WSM and WJAX defended the frontier against another seven at 830kc and to WWJ and WSAI fell the task of protecting us against ten Canadian stations at 840kc, besides CZE, formerly a regular visitor from Mexico. WCCO and WGN can be depended on to keep out nine stations at 730kc, besides CYJ of Mexico. A new Toronto station, CFYB on 517 meters, sneaked through the lines several nights lately, but as you have not got it listed as yet, the Commission has evidently not heard of this new menace to our peace of mind, but you can rest assured that as soon as official notice is received, WOW, WMC and WSUN will be ordered to work overtime in order to stop the gap. KWKH, "Shreveport everywhere" will keep out Havana or die trying.

Irwin Matheny,

3968 Utah Place, St. Louis, Mo.

How dare you say, "I have no opportunity"

—when men and women, thru home-study training, are making records such as these?



Harry J. Williams, Accounting Engineer, Lehigh Valley R. R., Wilkes Barre, Pa. Mr. Williams chose the Accountancy route to lead him out of a "blind-alley" job, and within comparatively few months won a 80 per cent "raise" and promotion to a position that spells—opportunity.



Charles W. Sheldon, Sheridan, Wyoming. At forty, Mr. Sheldon, then telegrapher and station agent on the C. B. & Q., left railroad work and took up selling. He increased his income 500 per cent.



J.L. Aldrich, District Manager at Fargo, N. Dak., for the Monroe Calculating Machine Co., Inc. "At the end of six months my income was 158% per cent greater than during any six months before I enrolled with LaSalle."



Ralph H. Berndt, Treasurer and General Manager, W. C. DuComb Co., Inc., Detroit. "LaSalle has been the instrument to my success."

YOU seek a better opportunity to get ahead in business—and you don't want "promises;" you want a definite program for advancement, backed by positive proof that that program works!

Listen, then, to these actual experiences—and when you have heard them, tell us, if you can, how you dare to say, "I have no opportunity!"

Mill Man Becomes Auditor—then Treasurer and General Manager

At sixteen, Ralph H. Berndt—his schooling ended with the eighth grade—entered the Carnegie Union Steel Mills, at Youngstown, Ohio. His wage was \$2.15 a day, and his working day was twelve hours long.

Six years later he was assistant roller—drawing good wages and with prospect of promotion.

Looking ahead, however, he saw himself "an old man at fifty—and with nothing then to look forward to but retirement and probable poverty."

"Realizing that hands and feet would do for me no longer," he writes, "I decided to give my brain a business training. Accordingly, I enrolled with LaSalle for home-study training, gave up the mills forever, and made a humble start in my new profession."

His apprenticeship was short. Almost before he knew it, an opening came with W. C. DuComb Co., Inc., Detroit, and he got the place—as Accountant, then Auditor! Raise followed raise.

Late in 1925 he was made Treasurer and General Manager of this company; and so highly does he value his LaSalle training that he is now on his second course—in Business Management.

Clerk Becomes Accounting Engineer Wins 60% Raise

"You've picked a blind alley." That was what many good friends of Harry J. Williams thought when he took a job as clerk with the Lehigh Valley Railroad.

"Blind for some, perhaps," said Harry Williams, "but not for the man with specialized training!"

Acting on his conviction, he enrolled with LaSalle for Higher Accountancy training—and soon won advancement to the position of Accounting Engineer, with an increase in salary of better than 60 per cent.

"Mr. Williams proves exceptionally competent in his new capacity," writes Francis N. Loughnane, Division Engineer. "He shows marked ability and is a very creditable product of your great university."

Send for These Free Books

You are eager to get ahead? Then you will find it of vital importance to learn more of the success-methods which Berndt and Williams and thousands of others have employed so profitably.

We have therefore prepared a special 64-page book which outlines these methods in detail. It also points out the big opportunities in the field you are in or wish to enter—shows you how you can fit yourself to grasp them.

The coupon brings this book to you without cost or obligation—also a copy of "Ten Years' Promotion in One," the inspiring story of how one man, after many wanderings, found the path to responsibility and power.

Measure your will to succeed by what you do with this coupon—NOW!



Annetta L. Koch, Assistant Manager, Hotel Secor, Toledo, Ohio. "When I enrolled with LaSalle, I was a bookkeeper of average ability. The results of my training soon became apparent. I was promoted to Auditor and then to Assistant Manager. My salary was increased substantially—which increase in several months completely paid the entire cost of the training."

LaSalle Extension University

THE WORLD'S LARGEST BUSINESS TRAINING INSTITUTION

Find Yourself Through LaSalle

LASALLE EXTENSION UNIVERSITY, Dept. 3484-R CHICAGO

I would welcome an outline of the LaSalle plan, together with a copy of "Ten Years' Promotion in One," all without obligation.

- | | |
|---|--|
| <input type="checkbox"/> Business Management: Managerial, Sales and Executive positions. | <input type="checkbox"/> Stenography: Training in the new superior shorthand, stenotypy. |
| <input type="checkbox"/> Higher Accountancy: Auditor, Comptroller, Certified Public Accountant, Cost Accountant, etc. | <input type="checkbox"/> Modern Foremanship |
| <input type="checkbox"/> Expert Bookkeeping | <input type="checkbox"/> Personnel Management |
| <input type="checkbox"/> C. P. A. Coaching | <input type="checkbox"/> Banking and Finance |
| <input type="checkbox"/> Modern Salesmanship | <input type="checkbox"/> Stenotypy: Training in the fast, accurate machine shorthand. |
| <input type="checkbox"/> Traffic Management—Foreign and Domestic | <input type="checkbox"/> Telegraphy—Railway and Commercial |
| <input type="checkbox"/> Railway Station Management | <input type="checkbox"/> Credit and Collection Correspondence |
| <input type="checkbox"/> Law: LL.B. Degree. | <input type="checkbox"/> Business English |
| <input type="checkbox"/> Modern Business Correspondence | <input type="checkbox"/> Commercial Law |
| <input type="checkbox"/> Industrial Management | <input type="checkbox"/> Effective Speaking |
| | <input type="checkbox"/> Commercial Spanish |



free!
mail coupon now

Announcement

to Executives

Introducing Ref-Ex

a scientifically-planned card-indexed, self-check reading, reference and consultation service for executives

LaSalle now offers to executives a new, unique and invaluable service known as Ref-Ex.

Ref-Ex is card-indexed, "brass tacks" business information built especially for the convenient use of the busy executive. It affords instant access to fundamental facts, analyses and principles that underlie all successful executive work. It is supplemented by current business surveys and carries the privilege of confidential consultation on specific business problems. Write on your business letterhead for full particulars.

Name

Present Position

Address

Canada—Continued

(Continued from page 25)

CKSH

St. Hyacinthe, P. Q. 312.3m-960kc. Temporarily using 296.9m-1010kc. 50 watts. City of St. Hyacinthe.

CKSM

Toronto, Ont. 516.9m-580kc. 1000 watts. St. Michael's Cathedral.

CKUA

Edmonton, Alta. 516.9m-580kc. 500 watts. U. of Alberta. Announcer, Harold P. Brown. Mon. 4:45 pm. organ; 5:45, dinner music; 6:30, children; 8, program; 8:20, colleges; 8:45, lecture; 9, feature. Thurs, 3 pm, homemakers' hour; 8:30, farmers. Mountain.

CKWX

Vancouver, B. C. 410.7m-730kc. 50 watts. Sparks Company. Announcer, H. W. Paulson. Daily ex Sun, 11-12 n, 4:30-5:30 pm, 6-7:30. Wed, 9:30-12 mid. Thurs, 11-12 mid. Fri, 9-10:30 pm. Sat, 11:30-1 am. Pacific.

CKY

Winnipeg, Man., Can. 384.4m-780kc. 500 watts. Manitoba Tel System. Announcer, F. E. Rutland. Slogan, "Manitoba's Own Station." Daily ex Sun, 9:30-9:45 am, 10:50-11, 11:30-11:45, 12-2 pm. Daily ex Sat, Sun, 3-4:30 pm. Mon, Wed, Thurs, Sat, 8-11 pm. Sun, 11-12:30 pm, 6-8:30. Central.

CNRA

Moncton, N. B., Can. 322.4m-930kc. (Temporarily using 475.9m-630kc.) 500 watts. Canadian National Railways. Announcer, W. V. George. Slogan, "Voice of the Maritimes." Daily ex Sun, 2:30-4 pm. Tues, Fri, 9 pm. Atlantic. Started Nov. 8, 1924.

CNRC

Calgary, Alta., Can. 434.5m-690kc. 500 watts. Canadian National Railways. Mon, Thurs, 9:30-10:30 pm. Mountain.

CNRE

Edmonton, Alta., Can. 516.9m-580kc. 500 watts. Canadian National Railways. Mon, 10:30-12 mid. Fri, 10:30-12 mid. Mountain.

CNRM

Montreal, Que., Can. 410.7m-730kc. 1,000-1,650 watts. Canadian National Railways. Announcers, J. S. McArthur, J. T. Carlyle, T. A. Marion. Thurs, 8:30 pm. Eastern.

CNRO

Ottawa, Can. 434.5m-690kc. 500 watts. Canadian National Railways. Announcer, A. W. Ryan. Daily ex Sun, 2:57-3 pm, time; 3-4:30, music. Mon, Thurs, 7:15-11 pm. Eastern. On the air Feb. 27, 1924.

CNRQ

Quebec City, Can. 340.7m-880kc. 50 watts. C. N. R. Thurs, 7:15-12 mid. Eastern.

CNRR

Regina, Sask., Can. 312.3m-960kc. 500 watts. Canadian National Railways. Tues, 8-10 pm. Mountain.

CNRS

Saskatoon, Sask., Can. 329.5m-910kc. 500 watts. Canadian National Railways. Daily, 2:30-3:30 pm. Mountain.

CNRT

Toronto, Ont., Can. 356.9m-840kc. 500 watts. Canadian National Railways. Announcer, E. W. Jackson. Fri, 7-8 pm, 9-11. Eastern. First broadcast May 16, 1924.

CNRV

Vancouver, Can. 291.1m-1030kc. 500 watts. Canadian National Railways. Announcer, G. A. Wright. Daily ex Sat, Sun, 10-11 am. Mon, Wed, 10-11 pm. Tues, 9-12:45 am. Thurs, 10-11 pm. Fri, 9-11 pm. Pacific.

CNRW

Winnipeg, Man., Can. 384.4m-780kc. 500 watts. Canadian National Railways. Announcer, R. H. Roberts. Mon, Tues, 6:30 pm. Wed, 10 pm. Thurs, Fri, 6:30 pm. Sun, 9 pm. Central.

Cuba

PWX

Havana, Cuba. 400m-750kc. 500 watts. Cuban Telephone Co. International Tel. and Teleg. Corp. Wed, Sun, 8:30 pm. music. Eastern.

2CT

Havana, Cuba. 350m-855kc. 50 watts. Casimiro Puadas.

2FG

Hershey, Cuba. 200m-999.4kc. 20 watts. Alberto A. Ferrera.

2GF

Havana, Cuba. 192m-1540kc. 5 watts. Francisco Williams.

2HP

Havana, Cuba. 205m-1460kc. 200 watts. Cristina W. Vda. Cruet.

2JF

2JT

Havana, Cuba. 46m-650kc. 5 watts. Jose A. Terry.

2JL

Havana, Cuba. 294m-1020kc. 5 watts. Jose Leiro.

2MA

Havana, Cuba. 305m-980kc. 50 watts. Modesto Alvarez.

2MF

Madruga, Cuba. 100m-299kc. Moises Fernandez.

2MG

Havana, Cuba. 284m-1055kc. 20 watts. Manuel y Guillermo Salas Music Store. Announcer, Roger Morales. Daily 3-4 pm, music. One day each week, 8-11 pm. Eastern.

2MK

Havana, Cuba. 85m-349kc. 100 watts. R. V. Waters.

2MU

Havana, Cuba. 265m-1330kc. 10 watts. Ulpiano Muniz.

2OK

Havana, Cuba. 360m-833kc. 100 watts. Mario Garcia Velez.

2OL

Havana, Cuba. 257m-1170kc. 100 watts. Oscar Collado.

2RK

Havana, Cuba. 315m-950kc. 100 watts. Raoul Karman. Casa De La Porte.

2TW

Havana, Cuba. 270m-1110kc. 20 watts. Roberto E. Ramirez.

2UF

Havana, Cuba. 355m-844kc. 20 watts. Roberto E. Ramirez.

2XA

Havana, Cuba. 230m-1300kc. Lecuona Music Co.

2XX

Havana, Cuba. 225m-1333kc. 5 watts. Antonio A. Ginard.

5DW

Matanzas, Cuba. 270m-1110kc. 100 watts. Ramon Sarría Calderon.

5EV

Colon, Cuba. 360m-833kc. 5 watts. Leopoldo V. Figueroa. Sun, 9-11 pm. Eastern.

6BY

Cienfuegos, Cuba. 260m-1153kc. 200 watts. Jose Ganduxa.

6EV

Caibarien, Cuba. 250m-1200kc. 50 watts. Maria Josefa Alvarez. Daily, 10:30 pm.

6HS

S. La Grande, Cuba. 200m-1500kc. 10 watts. Santiago Ventura.

6KC

Cienfuegos, Cuba. 240m-1250kc. 10 watts. Carlos Hernandez.

6KP

Sancti Spiritus, Cuba. 195m-1540kc. 20 watts. Antonio Galguera.

6KW

Tuinucu, Cuba. 340m-880kc. 100 watts. Frank H. Jones. Slogan, "If You Hear the Koo of the Cuckoo You Are in Tune With Tuinucu." Daily 11:30-12:15 am. Eastern.

6LO

Caibarien, Cuba. 325m-920kc. 250 watts. Manuel A. Alvarez.

6RG

Santa Clara, Cuba. 200m-1500kc. 20 watts. Rafael Garcia Perez.

6XJ

Tuinucu, Cuba. 278m-1080kc. 100 watts. Frank H. Jones.

6YR

Camaguey, Cuba. 200m-1500kc. 20 watts. Diego Iborra.

7AZ

Camaguey, Cuba. 225m-1333kc. 10 watts. Pedro Nogueras.

Mexico

CYA

Mexico City, Mex. 265m-1130kc. 500 watts. Mon, Fri, 6:45-8 pm. Sun, 4-6 pm. Partido Liberal Avanzado. Mexican.

CYB

Mexico City, Mex. 270m-1110kc. 500 watts. El Buen Tono. Tues, Thurs, Sat, 7:30-9 pm, concert. Mexican.

CYF

Oaxaca, Oax., Mex. 270m-1110kc. Federico Zorrilla. "The Voice from South of Mexico." Tues, Thurs, 7-8 pm. Sun, 8:30-10 pm. Mexican.

CYG

Mexico City, Mex. 300m-1000kc. 1000 watts. Secretaría de Guerra y Marina.

CYH

Monterrey, Mexico. 311m-964kc. 1000 watts. Tarzava & Cia. Slogan, "The Industrial Center of the Mexican Republic." Daily ex Sun, 7:55-8:10 pm. Wed, Sun, 8:30-10 pm. Thurs, Sat, 8:30-9:30 pm.

CYJ

Mexico City, Mex. 410m-730kc. 1000 watts. General Electric Co. Daily ex Sun, 8 pm. Mountain.

CYL

Mexico City, Mex. 480m-625kc. 500 watts. La Casa del Radio. Announcer, George Marron. Slogan, "The Land of Eternal Summer." Daily ex Sun, 1:30-2 pm, weather, financial reports, music. Tues, Fri, 8-9:30 pm. Sun, 8-9:30 pm, church. Mexican.

CYR

Mazatlan, Sin., Mex. Rosseter y Cia.

CYX

Mexico City, Mex. 333m-900kc. 500 watts. Excelsior & Revista de Revistas. Announcer, Rafael Hernandez de Dominguez. Slogan, "Land of the Aztecs." Mon, 8-9:30 pm. Mexican.

CYZ

Mexico City, Mex. 400m-750kc. Liga Central Mexicana de Radio. Mexican.

CZA

Mexico City, Mex. 70-500-1070 meters. Aviation Dept., War Ministry. Announcer, Ricardo S. Bravo. Daily, 12:30-1 pm, time, weather, news; 6:30-7:30, time, markets, music. Mexican.

CHAIN BROADCASTS

(Continued from page 50)

Eastern 7:30				Central 6:30				Mountain 5:30				Pacific 4:30					
Stattler's Pennsylvanians.																	
Key Station—WEAF (491.5m-610kc)				Meters Kc. Call				Meters Kc. Call				Meters Kc. Call					
325.9	930	WJZ	461.3	650	WCAE	325.9	930	WJZ	461.3	650	WCAE	325.9	930	WJZ	461.3	650	WCAE
New York Symphony Orchestra.																	
Key Station—WJZ (491.5m-610kc)				Meters Kc. Call				Meters Kc. Call				Meters Kc. Call					
325.9	930	WJZ	461.3	650	WCAE	325.9	930	WJZ	461.3	650	WCAE	325.9	930	WJZ	461.3	650	WCAE
Arnold Johnson's Park Central Orchestra.																	
Key Station—WEAF (491.5m-610kc)				Meters Kc. Call				Meters Kc. Call				Meters Kc. Call					
325.9	930	WJZ	461.3	650	WCAE	325.9	930	WJZ	461.3	650	WCAE	325.9	930	WJZ	461.3	650	WCAE

Philco Hour. 9				8				7				6				11				10			
Key Station—WJZ (454.2m-660kc)																							
Meters Kc. Call				Meters Kc. Call				Meters Kc. Call				Meters Kc. Call				Meters Kc. Call							
214.2	1400	WCSH	461.3	650	WCAE	214.2	1400	WCSH	461.3	650	WCAE	214.2	1400	WCSH	461.3	650	WCAE	214.2	1400	WCSH	461.3	650	WCAE
12 mid. 11																							
Key Station—WJZ (454.2m-660kc)																							
Meters Kc. Call				Meters Kc. Call				Meters Kc. Call				Meters Kc. Call				Meters Kc. Call							
305.9	980	KOMO	461.3	650	WCAE	305.9	980	KOMO	461.3	650	WCAE	305.9	980	KOMO	461.3	650	WCAE	305.9	980	KOMO	461.3	650	WCAE
1 a.m. 12																							
Key Station—WJZ (491.5m-610kc)																							
Meters Kc. Call				Meters Kc. Call				Meters Kc. Call				Meters Kc. Call				Meters Kc. Call							
422.3	710	KFO	461.3	650	WCAE	422.3	710	KFO	461.3	650	WCAE	422.3	710	KFO	461.3	650	WCAE	422.3	710	KFO	461.3	650	WCAE



“Six Months Ago All I Got Was Sympathy”

The personal story of a woman who was never really sick, yet always ailing, always too tired to enjoy life and how she made herself into a virile, vital being of super-health and strength.

“WHY Ruth, what in the world has happened to you?”

I knew what Frances Knight meant. She hadn't seen me for over a year. We were chums until she married and moved away. The last time she saw me I was on the verge of a breakdown. Now she found me the picture of health.

A year ago, yes, even six months ago, I was an object of pity. All my friends felt sorry for me. I was always tired, always weary, always despondent. My nerves were worn to a ragged edge. My head ached, my back ached, every bone in my body seemed to ache. All I got was sympathy—and advice.

Naturally I tried everything that sounded reasonable. I took tonics, pills and powders until I was a walking drug store. Still I had every ache and pain one could suffer with. I kept on growing weaker. I had no energy to dance, or join in the sports of my friends. My entire physical condition became that of an aging woman. Though I was seldom really sick enough to call a physician, yet I was always so tired, so worn out. I had to give up nearly all my social activities, because I was too weary to exert myself.

My poor physical condition was reflected in my appearance. My face was drawn and haggard. My eyes became dull and sickly-looking. My complexion was “pasty” and colorless.

Then one day I heard someone refer to me as having “one foot in the grave!”

What a shock it was to hear that! How angry I felt! But my anger soon gave place to a feeling of shame that I should become an object of pity.

I decided then and there to find “the way out.” How well I did can be seen by just looking at me.

My secret is simple that of Annette Kellermann's methods! I read, in a magazine, of Annette Kellermann's life—how she, who is called the world's most perfectly formed woman, was once practically a cripple; puny, ailing, always sickly.

The story of how she dragged herself out of misery and actually made of herself the lovely, healthy, beautiful woman she is, gave me new hope and new faith. I wrote to her for her book, “The Body Beautiful” which describes her methods.

To that little book, I can truthfully say, I owe the wonderful health and exuberance of spirit that is mine today. It opened my eyes to the fact that it is totally unnecessary for women to suffer as they do. I learned that every woman—unless she has a serious organic derangement—can live a life as vigorous and strong and free from pain as a man's.

Today I am practically never tired. I am never nervous or irritable. I never have any of the petty ailments from which so many women suffer. My step is springy, my eyes are bright, my skin is firm and clear, my body is slender and graceful. I dance again as I used to. I play tennis

again as I used to. I am gloriously happy as I used to be.

And because I know that there are thousands of women who are now living as I did, because I know every one of them can actually be a new woman, with health and beauty such as they never knew existed, I am glad to tell them about this simple way out of their troubles.

Miss Kellermann is now anxious to give every woman the benefit of her simple, 15-minute-a-day system and invites you to write a letter or mail the coupon below for her new book, “The Body Beautiful.” There is no charge or obligation. No salesman will bother you. The book will be sent free, if you will only write for it. And you can judge at your leisure whether or not you can afford to miss this opportunity to make a “new woman” of yourself, as over thirty thousand women have done.

Send for Miss Kellermann's book at once—now, while your determination to do something about yourself is strong. Just address Annette Kellermann, Inc., Suite 773, 225 West 39th St., New York City.

ANNETTE KELLERMANN, Inc., Suite 773
225 West 39th St., New York City
Dear Miss Kellermann:

Kindly send me, entirely without cost, your new book, “The Body Beautiful.” I am particularly interested in
 Body Building Weight Reducing
 Name
 Address
 City..... State.....

Foreign Wave Lengths Table

Frequency Wave (Kilo-Lgth. cycles)	Power (Watts)	Location	Call Signals	Frequency Wave (Kilo-Lgth. cycles)	Power (Watts)	Location	Call Signals	Frequency Wave (Kilo-Lgth. cycles)	Power (Watts)	Location	Call Signals
Europe											
158	1,899	500		384.6	780	1,500	Manchester, Great Britain	391	767	3,000	Toulouse, France
187.5	1,600	250		396	757	4,000	Hamburg, Germany	400	750	500	Madrid, Spain
186	1,530	250									
200	1,500	250									
201.3	1,490	500									
214.3	1,400	700									
215.8	1,390	250									
217.4	1,380	250									
220.4	1,300	250									
222.2	1,350	100									
225.6	1,300	2,000									
229	1,310	250									
	1,310	250									
230.2	1,303	1,000									
236.2	1,270	750									
237	1,265	1,500									
241.9	1,240	1,500									
243.9	1,230	700									
250	1,200	200									
252.1	1,190	750									
254.1	1,190	200									
256	1,172	700									
259	1,160	500									
260.9	1,150	1,000									
263.2	1,140	500									
272.7	1,100	1,500									
273	1,098	500									
275.2	1,090	1,000									
278	1,079	1,000									
283	1,060	4,000									
287.9	1,042	500									
288.5	1,040	200									
291.3	1,030	1,500									
294.1	1,020	500									
302	993	1,000									
303	990	4,000									
304	986	1,000									
306.1	980	1,500									
309	970	500									
310	967	350									
312.5	960	1,500									
317	946	1,500									
318	943	1,000									
319.1	940	1,500									
322.6	930	4,000									
326	920	1,000									
328.1	920	1,500									
330.3	908	1,000									
333.1	900	1,000									
335	895	1,000									
337	890	1,000									
340.9	880	500									
344.8	870	1,500									
348.9	860	5,000									
353	850	1,500									
357	840	2,000									
361.4	830	3,000									
365.3	819	4,000									
370	811	500									
370.4	810	1,500									
375	800	1,500									
375.9	798	1,200									
380.7	788	4,000									
South Africa											
								375	800	1,500	Cape Town
								400	760	1,500	Durban
								443.5	676	500	Johannesburg
Australia-Tasmania											
								249.9	1,200	1,000	Prospect, S. Australia
								255	1,176	500	Melbourne, Victoria
								267.7	1,120	500	Sydney, N. So. Wales
								275.1	1,090	250	Bathurst, N. So. Wales
								280.2	1,070	1,500	Sydney, N. So. Wales
								288.3	1,040	100	Newcastle, N. So. Wales
								293.9	1,020	250	Sydney, N. So. Wales
								293.9	1,020	100	Toowoomba, Queensland
								313	958	500	Parkside, So. Australia
								315.6	950	100	Sydney, N. So. Wales
								319	940	100	Melbourne, Victoria
								352.7	850	5,000	Sydney, N. So. Wales
								370.2	810	5,000	Melbourne, Victoria
								384.4	770	5,000	Brisbane, Queensland
								394.5	760	5,000	Adelaide, S. Australia
								442	678	5,000	Sydney, N. So. Wales
								483.6	620	5,000	Melbourne, Victoria
								516.9	590	3,000	Hobart, Tasmania
								1,250	239	5,000	Perth, Western Australia
Argentina											
								252	1,190	1,000	Buenos Aires
								260.7	1,150	500	Buenos Aires
								285.7	1,050	5,000	Buenos Aires
								302.8	990	1,000	Buenos Aires
								315.8	949	1,000	Buenos Aires
								319.5	919	1,000	Buenos Aires
								344.8	870	1,000	Buenos Aires
								365.5	820	1,000	Buenos Aires
								379.5	790	500	Buenos Aires
								399.8	750	1,000	Buenos Aires
								425	705	1,000	Buenos Aires
Brazil											
								399.8	750	1,000	Rio De Janeiro
								320	937	500	Rio De Janeiro
								350	856	1,000	Sao Paulo
Ceylon											
								800	375	1,750	Colombo
Chile											
								239.9	1,250	100	Temuco
								285.5	1,050	100	Santiago
								308	973	100	Santiago
								340	881	100	Tacna
								360	832	1,000	Santiago
								480	624	1,000	Santiago
China											
								338	885	500	Shanghai
Chosen											
								344.6	870	1,000	Keipo
Haiti											
								361.2	830	1,000	Port au Prince
India											
								305	857	350	Rangoon, Burma
								357.1	840	3,000	Bombay
								370.4	810	3,000	Calcutta
Japan											
								360	831	1,000	Nagoya
								385	778	1,000	Osaka
								375	800	1,000	Tokyo
New Zealand											
								305.9	980	500	Christchurch
								333	901	500	Auckland
								420	714	5,000	Wellington
								463	647	250	Dunedin
Peru											
								360	831	1,500	Lima
Venezuela											
								375	800	1,000	Caracas

State and City Index

(Continued from page 89)

Summerville	CHCS	267.7	1,120	25
Toronto	CFCA	356.9	840	500
	CFRB	516.9	580	1,000
	CHIC	356.9	840	500
	CJNC	356.9	840	500
	CJBC	356.9	840	500
	CJSC	356.9	840	500
	CJYJ	516.9	580	500
	CKCI	356.9	840	500
	CKYJ	291.1	1,030	1,000
	CKNC	356.9	840	500
	CKSM	516.9	580	1,000
	CNRT	356.9	840	500
Unity	CHSC	267.7	1,120	50
Vancouver	CFQ	410.7	730	10
	CFYC	410.7	730	500
	CHPC	410.7	730	1,000
	CFKC	410.7	730	1,000
	CFKC	410.7	730	50
	CKWX	410.7	730	50
	CNRV	291.1	1,030	500
Victoria	CFCT	475.9	630	500
Winnipeg	CKY	384.4	780	500
	CNRW	384.4	780	500
Yorkton	CJGJ	475.9	630	500

Official Wave Lengths

(Continued from page 87)

I Was Afraid of This New Way to Learn Music

— Until I Found It Was Easy As A-B-C

Then I Gave My Husband the Surprise of His Life

DON'T be silly, Mary. You're perfectly foolish to believe you can learn to play music by that method. You can never learn to play the piano that way . . . it's crazy! You are silly to even think about it."

"But Jack, it's . . ."

"Mary, how can you believe in that crazy music course. Why, it claims to teach music in half the usual time and *without a teacher*. It's impossible!"

That is how my husband felt when I showed him an ad telling about a new way to learn music. He just laughed. His unbelieving laughter made me wonder. I began to feel doubtful. Perhaps I had been too optimistic—perhaps enthusiasm and the dream of realizing my musical ambitions had carried me away. The course, after all, might prove too difficult. I knew that I had no special musical talent. I couldn't even tell one note from another—a page of music looked just like Chinese to me.

But how I *hated* to give up my new hope of learning to play the piano. Music had *always* been for me one of those dreams that never-come-true. I had longed to sit down at the piano and play some old sweet song . . . or perhaps a beautiful classic, a bit from an opera, or even the latest jazz hit. When I heard others playing, I envied them so that it almost spoiled the pleasure of the music for me. For *they* could entertain their friends and family . . . *they* were musicians. And I, I was a mere listener. I had to be satisfied with only *hearing* music.

I was so disappointed at Jack. I felt very bitter as I put away the magazine containing the advertisement. For a week I resisted the temptation to look at it again, but finally I couldn't keep from "peeking" at it. It fascinated me. It told of a woman who had learned to play the piano by herself, in her spare time, and at home, without a teacher. And the wonderful method she used required no tedious scales—no heartless exercises—no tiresome practicing. Perhaps I might do the same thing!

So finally, half-frightened, half-enthusiastic, I wrote to the U. S. School of Music—without letting



Jack know. Almost as soon as I mailed the letter I felt frightened. Suppose the course proved to be horribly difficult . . . suppose Jack were right after all.

Imagine my joy when the lessons started and I found that they were as easy as A, B, C. Why, a mere child could master them.

While Jack was at work, I started learning. I quickly saw how to blend notes into beautiful melodies. My progress was wonderfully rapid, and before I realized it, I was rendering selections which many pupils who study with private teachers can't play. For through this short-cut method, all the difficult, tiresome parts of music have been eliminated and the playing of melodies has been reduced to a simplicity which *anyone* can follow with ease.

Finally I decided to play for Jack, and show him what a "crazy course" had taught me. So one night, when he was sitting reading, I went casually over to the piano and started playing a lovely song. Words can't describe his astonishment.

"Why . . . why . . ." he floundered. I simply smiled and went on playing. But soon, of course, Jack insisted that I tell him all about it. Where I had learned . . . when I learned . . . how. So I told of my secret . . . and how the course he had laughed at had made me an accomplished musician.

One day not long after, Jack came to me and said, "Mary, don't laugh, but I want to try learning to play the violin by that wonderful method. You certainly proved to me that it is a good way to learn music."

So only a few months later Jack and I were playing together. Now our musical evenings are a marvelous success. Everyone compliments us, and we are flooded with invitations. Music has simply meant everything to us. It has given us Popularity! Fun! Happiness!

If you, too, like music . . . then write to the U. S. School of Music for a copy of the booklet, "Music Lessons in Your Own Home," together with a Demonstration Lesson, explaining this wonderful new easy method.

Don't hesitate because you think you have no talent. Thousands of successful students never dreamed they possessed musical ability until it was revealed to them by a wonderful "Musical Ability Test." You, too, can learn to play your favorite instrument through this short-cut method. Send the coupon. The Demonstration Lesson showing how they teach will come AT ONCE. Address the U. S. School of Music, 1833 Brunswick Building, New York. Instruments supplied when needed, cash or credit.

U. S. SCHOOL OF MUSIC
1833 Brunswick Bldg., New York City.

Please send me your free book, "Music Lessons in Your Own Home," with introduction by Dr. Frank Crane, Demonstration Lesson and particulars of your offer. I am interested in the following course:

PICK YOUR COURSE	
Mandolin	Saxophone
Drums and Traps	Piano
Harmony and Composition	Organ
Sight Singing	Violin
Ukulele	Clarinet
Piccolo	Flute
Trombone	Harp
	Cornet
	Cello
	Guitar
	Hawaiian Steel Guitar
	Voice and Speech Culture
	Automatic Finger Control
	Piano Accordion
	Banjo (Plectrum, 5-String or Tenor)

Have you above instrument?

Name..... Please Write Plainly

Address.....

City..... State.....

Listener's Evening at Home

IN EASTERN TIME

Call	Location	Meters	Kilo.	Watts	Saturday	Sunday	Monday	Tuesday	Wednesday	Thursday	Friday
CFAC	Calgary, Can.	434.5	690	500	Silent	9:00-10:00	11:30-12:30	8:00-9:00	9:45-10:45	11:00-12:30	10:30-11:30
CFCA	Toronto, Can.	356.9	840	500	9:00-10:00	7:00-8:00	7:15-9:15	Silent	7:00-11:00	8:00-12:00	Silent
CFCF	Montreal, Can.	410.7	730	1650	Silent	Silent	7:30-8:30	Silent	7:00-8:00	Silent	7:30-8:30
CFCN	Calgary, Can.	434.5	690	1800	Silent	9:15-10:15	Silent	11:00-12:00	11:00-12:00	9:45-10:45	11:00-12:00
CFCT	Victoria, Can.	329.5	910	500	10:30-12:15	Silent	2:00-3:00	10:30-12:15	9:30-12:15	1:30-3:00	10:30-11:30
CFQO	Saskatoon, Can.	329.5	910	500	Silent	9:00-10:00	8:00-9:00	Silent	8:00-12:00	8:00-12:00	6:00-8:00
CFRB	Toronto, Can.	516.9	580	1000	Silent	7:00-8:00	Silent	6:00-8:00	Silent	Silent	Silent
CHIC	Toronto, Can.	356.9	840	500	10:00-12:00	5:00-6:00	7:00-8:00	7:00-8:00	7:00-8:00	7:00-8:00	7:00-8:00
CHWC	Regina, Can.	312.3	960	500	10:00-12:00	Silent	7:00-8:00	Silent	Silent	8:00-8:30	Silent
CHYC	Montreal, Can.	410.7	730	750	Silent	7:00-8:00	Silent	Silent	Silent	Silent	10:00-12:30
CJCA	Edmonton, Can.	516.9	580	500	12:00-2:00	9:15-10:15	Silent	Silent	10:00-2:00	Silent	Silent
CJGC	London, Can.	329.5	910	500	Silent	7:00-8:00	7:00-9:00	7:00-9:00	7:00-9:00	7:00-9:00	7:00-9:00
CJGX	Yorkton, Can.	475.9	630	500	Silent	Silent	Silent	9:30-11:00	Silent	9:30-11:00	9:30-11:00
CJRM	Moose Jaw, Can.	296.9	1010	500	10:00-12:00	Silent	6:30-8:30	Silent	6:30-8:30	Silent	6:30-8:30
CJYC	Toronto, Can.	516.9	580	500	Silent	Silent	6:00-12:00	10:00-12:00	6:00-8:00	Silent	Silent
CKAC	Montreal, Can.	410.7	730	1200	8:15-12:00	Silent	Silent	7:15-12:30	Silent	7:15-9:00	Silent
CKCD	Vancouver, Can.	410.7	730	1000	11:30-1:30	Silent	11:30-1:30	11:30-12:30	11:30-12:30	11:30-12:30	11:30-11:50
CKCK	Regina, Can.	312.3	960	500	Silent	11:00-12:00	10:00-12:00	10:00-12:00	Silent	10:00-12:00	10:00-12:00
CKCL	Toronto, Can.	356.9	840	500	7:00-8:00	3:00-4:00	Silent	6:40-1:00	Silent	Silent	Silent
CKCX	Toronto, Can.	516.9	580	1000	Silent	8:15-10:15	Silent	8:00-10:00	Silent	Silent	8:00-10:00
CKNC	Toronto, Can.	356.9	840	500	Silent	Silent	9:00-10:00	Silent	Silent	9:00-10:00	Silent
CKY	Winnipeg, Can.	384.4	780	500	8:30-11:30	7:00-10:00	8:30-12:00	Silent	9:00-1:00	8:30-10:00	Silent
CNRA	Moncton, Can.	322.4	930	500	Silent	Silent	Silent	8:00-9:00	Silent	Silent	8:00-9:00
CNRC	Calgary, Can.	434.5	690	500	Silent	Silent	11:30-12:30	Silent	Silent	11:30-12:30	Silent
CNRE	Edmonton, Can.	516.9	580	500	Silent	Silent	12:30-2:00	Silent	Silent	Silent	12:30-2:00
CNRM	Montreal, Can.	410.7	730	1000	Silent	Silent	Silent	Silent	Silent	8:30-9:30	Silent
CNRO	Ottawa, Can.	434.5	690	500	Silent	Silent	7:15-10:00	Silent	Silent	7:15-12:00	Silent
CNRR	Regina, Can.	312.3	960	500	Silent	Silent	Silent	10:00-12:00	Silent	Silent	Silent
CNRT	Toronto, Can.	356.9	840	500	Silent	Silent	Silent	Silent	Silent	Silent	9:00-11:00
CNRV	Vancouver, Can.	291.1	1030	500	Silent	Silent	1:00-2:00	Silent	1:00-2:00	1:00-2:00	12:00-2:00
CNRW	Winnipeg, Can.	384.4	780	500	Silent	10:00-11:00	7:30-8:30	7:30-8:30	11:00-12:00	7:30-8:30	7:30-8:30
CYH	Monterey, Can.	311	964	1000	10:30-11:30	10:30-12:00	Silent	Silent	10:30-12:00	10:30-11:30	Silent
YYJ	Mexico City, Mex.	470	730	1000	10:00-11:00	Silent	10:00-11:00	10:00-11:00	10:00-11:00	10:00-11:00	10:00-11:00
KDKA	E. Pittsburgh, Pa.	315.6	950	50,000	6:15-11:00	6:15-11:45	6:15-11:00	6:15-10:30	6:15-11:00	6:15-11:00	6:15-11:30
KDYL	Salt Lake City, Utah	234.2	1280	500	8:00-2:00	8:00-2:00	8:00-1:00	8:00-2:00	8:00-1:00	8:00-2:00	8:00-1:00
KEX	Portland, Ore.	277.6	1080	2500	9:00-5:00	8:30-1:00	9:00-3:00	9:00-3:00	9:00-3:00	9:00-3:00	9:00-3:00
KFAB	Lincoln, Nebr.	319	940	5000	7:00-12:00	7:00-12:00	7:00-12:00	7:00-12:00	7:00-12:00	7:00-12:00	7:00-12:00
KFAD	Phoenix, Ariz.	272.6	1000	500	12:00-1:00	10:00-11:00	Silent	12:00-1:00	12:00-1:00	Silent	Silent
KFAU	Boise, Idaho	285.5	1050	2000	Silent	9:30-11:00	Silent	9:30-12:00	Silent	9:30-12:00	Silent
KFBU	Laramie, Wyo.	483	620	500	Silent	Silent	Silent	Silent	9:30-10:30	9:30-10:30	9:30-10:30
KFDM	Beaumont, Tex.	483	620	500	Silent	7:45-10:00	Silent	Silent	9:00-11:00	Silent	9:30-11:30
KFEQ	St. Joseph, Mo.	230.6	1300	1000	7:30-11:00	Silent	7:30-1:00	7:30-11:00	7:30-11:00	7:30-11:00	7:30-11:00
KFH	Wichita, Kans.	245.8	1220	500	8:30-2:30	8:30-9:30	8:30-10:00	8:30-10:00	8:30-10:00	8:30-10:00	8:30-10:00
KFI	Los Angeles, Calif.	468.5	640	5000	9:00-5:00	Silent	9:00-2:00	9:00-2:00	9:00-2:00	9:00-2:00	9:00-2:00
KFJF	Oklahoma City, Okla.	272.6	1100	1000	8:00-11:00	9:00-10:00	8:00-11:00	8:00-11:00	8:00-11:00	8:00-11:00	8:00-11:00
KFKB	Milford, Kans.	241.8	1240	1500	Silent	7:00-1:00	7:00-12:00	7:00-12:00	7:00-12:00	7:00-12:00	7:00-12:00
KFKU	Lawrence, Kans.	251.1	1180	500	Silent	Silent	Silent	Silent	8:00-9:00	8:00-9:00	Silent
KFNF	Shenandoah, Iowa	461.3	650	2000	6:00-8:00	7:00-8:00	6:00-8:00	6:00-8:00	6:00-8:00	6:00-8:00	6:00-8:00
KFOA	Seattle, Wash.	447.5	670	1000	9:00-1:00	9:00-12:30	9:00-1:00	9:00-1:00	9:00-2:00	9:00-1:00	9:00-3:00
KFON	Long Beach, Calif.	241.8	1240	500	11:30-4:00	11:30-4:00	11:30-4:00	11:30-4:00	11:30-4:00	11:30-4:00	11:30-4:00
KFQB	Fort Worth, Tex.	333.1	900	1000	8:00-12:00	8:30-12:00	8:30-12:00	8:30-12:00	8:30-12:00	8:30-12:00	8:30-12:00
KFRC	San Francisco, Calif.	454.3	660	1000	9:00-3:00	9:00-3:00	9:00-3:00	9:00-3:00	9:00-3:00	9:00-3:00	9:00-3:00
KFRU	Columbia, Mo.	249.9	1200	500	7:30-8:30	8:30-9:30	7:30-8:30	7:30-8:30	8:30-11:00	8:30-12:00	7:30-8:30
KFSD	San Diego, Calif.	440.9	680	500	8:45-3:00	11:30-1:00	8:45-3:00	8:45-3:00	8:45-3:00	8:45-3:00	8:45-3:00
KFSG	Los Angeles, Calif.	275.1	1090	500	9:30-12:30	9:30-2:00	Silent	9:30-12:30	9:30-12:30	9:30-2:00	9:30-2:00
KFUM	Colorado Springs, Colo.	282.8	1060	1000	10:00-12:00	Silent	7:00-9:00	10:00-12:00	Silent	10:00-2:00	12:00-2:00
KFUO	St. Louis, Mo.	545.1	550	1000	Silent	10:15-11:15	7:00-9:00	7:00-9:00	7:00-9:00	7:00-9:00	7:00-9:00
KFWB	Hollywood, Calif.	352.7	850	1000	7:00-2:00	7:00-1:00	7:00-2:00	7:00-2:00	7:00-2:00	7:00-2:00	7:00-2:00
KFWI	San Francisco, Calif.	267.7	1120	500	7:00-3:30	10:50-2:00	7:00-2:00	7:00-2:00	7:00-2:00	7:00-2:00	7:00-2:00
KFWM	Oakland, Calif.	236.1	1270	500	11:00-1:00	10:30-2:00	11:00-1:00	11:00-1:00	11:00-1:00	11:00-1:00	11:00-1:00
KGA	Spokane, Wash.	260.7	1150	2000	9:15-3:00	10:30-11:00	9:15-3:00	9:15-3:00	9:15-3:00	9:15-3:00	9:15-3:00
KGEF	Los Angeles, Calif.	263	1140	500	9:00-1:00	10:00-1:30	9:00-1:00	9:00-1:00	9:00-1:00	9:00-1:00	9:00-1:00
KGO	Oakland, Calif.	384.4	780	5000	11:00-3:00	8:30-1:00	11:00-12:00	11:00-2:00	11:00-3:00	11:00-2:00	11:00-3:00
KGW	Portland, Ore.	491.5	610	1000	9:00-3:00	10:00-2:00	9:00-2:00	10:00-2:00	9:00-3:00	9:00-3:00	9:00-3:00
KHJ	Los Angeles, Calif.	399.8	750	1000	7:00-2:00	7:00-1:00	7:00-2:00	7:00-2:00	7:00-2:00	7:00-2:00	7:00-2:00
KHQ	Spokane, Wash.	370.2	810	1000	9:00-1:00	5:00-1:00	9:00-1:00	9:00-1:00	9:00-1:00	9:00-1:00	9:00-1:00
KJR	Seattle, Wash.	348.6	860	2500	7:00-2:00	9:15-1:00	7:00-3:00	7:00-3:00	7:00-3:00	7:00-3:00	7:00-3:00
KLDS	Independence, Mo.	270.1	1110	1500	9:30-10:30	7:00-12:00	Silent	8:00-9:30	Silent	Silent	Silent
KLX	Oakland, Calif.	508.2	590	500	10:00-11:00	7:00-9:00	9:30-12:00	9:30-12:30	9:30-12:30	9:30-12:30	9:30-12:30
KLZ	Denver, Colo.	352.7	850	1000	9:30-2:00	9:00-1:00	10:30-12:30	10:30-1:00	10:30-1:00	Silent	9:30-1:30
KMA	Shenandoah, Ia.	394.5	760	1000	6:00-9:30	5:00-8:00	6:00-11:30	6:00-9:30	6:00-9:30	6:00-9:30	6:00-9:30
KMBC	Kansas City, Mo.	270.1	1110	1500	8:30-1:30	6:00-10:00	8:30-11:00	8:30-1:30	8:30-11:00	8:30-11:00	8:30-11:00
KMOX	St. Louis, Mo.	299.8	1000	5000	7:30-11:00	9:00-11:00	9:00-2:00	9:00-2:00	9:00-2:00	9:00-2:00	9:00-2:00
KMTR	Los Angeles, Calif.	526	570	500	8:30-2:00	8:30-9:30	8:30-2:00	8:30-2:00	8:30-2:00	8:30-2:00	8:30-2:00
KNX	Los Angeles, Calif.	336.9	890	500	10:00-5:00	9:30-1:30	10:00-3:00	10:00-3:00	10:00-3:00	10:00-3:00	10:00-3:00
KOA	Denver, Colo.	325.9	920	2500	11:00-1:00	9:30-10:30	9:30-12:00	9:30-12:00	9:30-12:00	9:30-12:00	9:30-12:00
KOIL	Council Bluffs, Ia.	319	940	5000	8:00-2:00	8:00-2:00	8:00-2:00	8:00-2:00	8:00-2:00	8:00-2:00	8:00-2:00
KOIN	Portland, Ore.	319	940	1000	9:00-4:00	9:00-1:00	9:00-1:00	9:00-1:00	9:00-1:00	9:00-1:00	9:00-1:00
KOMO	Seattle, Wash.	305.9	980	1000	9:00-2:00	9:00-2:45	9:00-2:45	9:00-2:00	9:00-2:00	9:00-2:00	9:00-2:00
KPLA	Los Angeles, Calif.	288.3	1040	500	9:00-2:00	10:00-1:00	9:00-2:00	9:00-2:00	9:00-2:00	9:00-2:00	9:00-2:00
KPO	San Francisco, Calif.	422.3	710	1000	9:30-1:00	8:30-1:00	9:30-1:30	9:30-1:30	9:30-1:30	9:30-1:30	9:30-1:30
KPRC	Houston, Tex.	293.9	1020	500	7:10						

You can now own a Typewriter!

only
\$ **300**
down
and it's
yours

Be up-to-date—know the pleasure and convenience of having one in your own home. You'll be amazed at the uses every one in your household will find for this real Underwood typewriter. Every member of the family will use and enjoy it! Don't send a cent—but do get our big special offer—our valuable book on typewriters and typewriting—FREE.

Any One Can Learn to Operate a Typewriter

You can learn to write on this standard-keyboard machine in one day; it's so simple that even a child can use it. A week after the expressman has brought it, you'd feel LOST without it. A trial will PROVE it—and doesn't cost you a penny!

SPECIAL FREE TRIAL OFFER

We don't want a penny now. Nor any money at all unless this proves the typewriter bargain of your life. The trial is FREE. If you buy, our easy terms make it a pleasure to pay. There's no excuse now, for not owning a typewriter—and the finest make! We include all tools, a cover, etc., all complete, all ready to write. Write us now. Deal direct; we are the largest factory of the kind.

Our plan gives you the opportunity of a thorough trial before you buy. You run no risk whatever. You start to pay for your typewriter AFTER you have found it the only machine for you! But get the facts before this lot of machines is all in use. Clip the information coupon before you turn the page. It will pay you! Note the very useful book you will receive free! Write for full particulars at once.

The Greatest Typewriter Offer Ever Made

If you know typewriters, you know the perfect work and the ease and speed of a Shipman Ward rebuilt Underwood typewriter. New machines are guaranteed for only one year; WE GUARANTEE EVERY ONE OF OUR MACHINES FOR FIVE YEARS! If you have never owned a typewriter, start with the finest! You can try this one at our risk. But, the time to act is NOW. Don't miss out on this present bargain offer whereby you can get this genuine Underwood at a big savings. Don't do longer without the convenience of a typewriter.

FREE! Get our catalogue free; lowest prices and terms. A manual free, too; valuable instruction for learning rapid typing, useful pointers for all who use a typewriter, business forms, social correspondence, work for others, etc.

Clip Coupon NOW!



MAIL TODAY!

Shipman Ward Manufacturing Company,
4103 Shipman Building, Chicago, Illinois.
Please send me your big Free Trial Plan and Typewriter Book,
together with your special offer on prices, terms, free course in Touch
Typewriting and also how I can make money with this typewriter, without obliga-
tion. This is not an order.

Name.....
Street or R. F. D..... City..... State.....

Call	Location	Meters	Kilo.	Watts	Saturday	Sunday	Monday	Tuesday	Wednesday	Thursday	Friday
KYW	Chicago, Ill.	526	570	2500	7:00-12:00	8:15-12:00	7:00-12:00	7:00-12:00	7:00-12:00	7:00-12:00	7:00-12:00
WAAM	Newark, N. J.	267.7	1120	250	8:00-10:00	Silent	10:00-12:00	6:00-8:00	6:00-8:00	10:00-12:00	6:00-8:00
WABC	Richmond Hill, N. Y.	309.1	970	2500	4:00-12:30	4:00-10:30	4:30-12:30	4:00-12:30	4:00-12:30	4:00-12:30	4:00-12:30
WADC	Akron, Ohio	238	1260	1000	8:00-11:00	8:00-11:00	8:00-11:00	8:00-11:00	8:00-11:00	Silent	Silent
WAIU	Columbus, Ohio	282.8	1060	5000	Silent	8:30-11:00	7:00-11:00	6:00-7:00	9:00-11:00	6:00-7:00	7:00-11:00
WBAL	Baltimore, Md.	285.5	1050	500	6:30-11:00	6:30-9:00	6:00-11:00	6:00-11:00	6:00-11:00	6:00-11:00	6:00-11:00
WBAP	Fort Worth, Texas	499.7	600	5000	7:00-1:00	7:00-1:00	7:00-1:00	7:00-10:00	7:00-10:00	7:00-1:00	7:00-10:00
WBAW	Nashville, Tenn.	239.9	1250	500	6:00-11:00	8:00-10:00	6:00-1:00	6:00-10:00	6:00-10:00	6:00-10:00	6:00-10:00
WBBC	Brooklyn, N. Y.	227.1	1320	500	9:00-10:45	3:00-12:00	7:00-12:00	10:30-12:00	6:00-12:00	7:00-10:00	6:00-12:00
WBMM	Chicago, Ill.	389.4	770	5000	8:00-3:00	1:00-4:00	7:00-12:00	8:00-12:00	8:00-12:00	8:00-12:00	8:00-12:00
WBRR	Rossville, N. Y.	256.3	1170	1000	Silent	7:00-9:00	7:00-9:00	7:00-9:00	Silent	7:00-9:00	7:00-9:00
WBET	Medford, Mass.	288.3	1040	500	6:30-11:00	6:30-11:00	6:30-11:00	6:30-11:00	6:30-11:00	6:30-11:00	6:30-11:00
WBNY	New York, N. Y.	236.1	1270	500	6:00-12:00	6:00-7:00	Silent	6:00-12:00	6:00-12:00	6:00-12:00	6:00-12:00
WBT	Charlotte, N. C.	258.5	1160	750	6:00-12:30	Silent	6:00-12:00	7:00-12:30	7:00-11:30	7:00-11:30	7:00-12:30
WBZ	Springfield, Mass.	333.1	900	15000	6:00-11:30	6:00-11:30	6:00-11:00	6:00-11:30	6:00-11:30	6:00-11:30	6:00-11:30
WCAC	Mansfield, Conn.	535.4	560	500	7:00-8:00	Silent	7:00-7:30	Silent	7:00-7:30	Silent	Silent
WCAE	Pittsburgh, Pa.	461.3	650	500	6:00-10:00	7:15-10:00	6:00-10:00	6:00-10:00	6:00-10:00	6:00-10:00	6:00-10:00
WCAM	Camden, N. J.	223.7	1340	500	Silent	Silent	7:30-10:30	Silent	7:30-10:30	Silent	7:30-10:30
WCAU	Philadelphia, Pa.	260.7	1150	500	6:30-11:00	12:30-11:00	5:30-11:30	5:00-11:30	5:30-12:00	5:30-12:00	5:30-11:30
WCBD	Zion, Ill.	344.6	870	5000	Silent	9:00-11:30	Silent	9:00-11:30	Silent	9:00-11:30	Silent
WCCO	Minneapolis, Minn.	405.2	740	5000	7:15-12:00	8:15-11:15	7:30-12:00	7:00-12:30	7:00-1:30	7:00-1:10	8:00-12:00
WCFL	Chicago, Ill.	483.6	620	1500	5:00-1:00	8:30-10:30	5:00-1:00	5:00-1:00	5:00-1:00	5:00-1:00	5:00-1:00
WCGU	Coney Island, N. Y.	218.8	1370	500	Silent	Silent	Silent	Silent	8:00-10:00	Silent	8:00-10:00
WCOA	Pensacola, Fla.	249.9	1200	500	Silent	8:23-9:25	9:00-12:00	Silent	9:00-12:00	Silent	9:00-12:00
WCRW	Chicago, Ill.	223.7	1340	500	10:30-11:30	Silent	Silent	10:30-11:30	10:30-11:30	10:30-11:30	10:30-11:30
WCSS	Portland, Me.	214.2	1400	500	7:00-11:00	7:30-9:45	8:30-12:00	7:00-11:30	7:30-12:00	7:30-9:30	9:00-11:00
WDAE	Tampa, Fla.	267.7	1120	500	7:30-11:30	7:30-9:15	7:30-11:30	7:30-4:30	7:30-11:30	7:30-9:15	7:30-11:30
WDAF	Kansas City, Mo.	370.2	810	1000	7:00-2:00	9:15-10:45	7:00-2:00	7:00-2:00	7:00-2:00	7:00-2:00	7:00-2:00
WDBO	Orlando, Fla.	288.3	1040	500	9:00-11:00	7:30-9:30	7:15-2:00	8:30-11:00	Silent	9:15-11:30	7:30-9:00
WDOD	Chattanooga, Tenn.	243.8	1230	500	10:00-11:00	7:30-10:00	7:00-11:00	7:45-11:00	7:45-11:00	Silent	7:45-11:00
WDRC	New Haven, Conn.	282.8	1060	500	Silent	7:00-8:00	5:00-10:00	5:00-10:00	5:00-10:00	5:00-10:00	5:00-10:00
WEAF	New York, N. Y.	491.5	610	50000	6:00-12:00	3:00-11:15	6:00-12:00	6:00-12:00	6:00-12:00	6:00-12:00	6:00-12:00
WEAN	Providence, R. I.	275.1	1090	500	6:30-11:30	6:30-11:00	6:30-11:30	6:30-11:30	6:30-11:30	6:30-11:30	6:30-11:30
WEBH	Chicago, Ill.	365.6	820	500	8:00-3:00	8:00-10:00	8:00-12:00	8:00-12:00	8:00-12:00	8:00-12:00	8:00-12:00
WEBJ	New York, N. Y.	256.3	1170	500	Silent	Silent	Silent	Silent	7:00-12:00	Silent	9:00-11:00
WEEI	Boston, Mass.	508.2	590	500	5:30-11:00	6:30-10:15	5:30-11:00	5:30-11:00	5:30-11:00	5:30-11:00	5:30-11:00
WENR	Chicago, Ill.	288.3	1040	500	7:00-1:00	7:00-12:00	7:00-1:00	7:00-1:00	7:00-1:00	7:00-1:00	7:00-1:00
WEVD	Woodhaven, N. Y.	245.8	1220	500	7:00-9:30	Silent	Silent	9:00-12:00	Silent	9:00-12:00	Silent
WFAA	Dallas, Texas	545.1	550	500	7:00-1:00	7:00-1:00	7:00-11:00	7:00-1:00	7:00-11:00	7:00-11:00	7:00-11:00
WFFN	Philadelphia, Pa.	223.7	1340	500	6:00-12:00	8:00-11:00	Silent	5:30-1:00	Silent	5:30-1:00	Silent
WFBL	Syracuse, N. Y.	258.5	1160	750	6:20-12:00	6:00-12:00	6:20-12:00	6:20-12:00	6:20-12:00	6:20-12:00	6:20-12:00
WFBM	Indianapolis, Ind.	475.1	1090	1000	Silent	9:00-10:00	6:00-12:00	6:00-12:00	6:00-12:00	6:00-12:00	6:00-12:00
WFI	Philadelphia, Pa.	205.2	740	500	8:00-11:00	Silent	Silent	8:00-11:30	Silent	9:00-11:00	Silent
WFIW	Hopkinsville, Ky.	227.1	1320	500	9:00-12:00	Silent	9:00-12:00	Silent	9:00-12:00	9:00-5:00	9:00-12:00
WFLA	Clearwater, Fla.	516.9	585	750	7:45-12:00	Silent	7:45-12:00	7:45-12:00	7:45-12:00	7:45-12:00	7:45-12:00
WFLB	New York, N. Y.	348.6	860	500	7:30-9:00	Silent	7:30-10:00	6:00-10:00	6:00-10:00	10:00-11:00	8:00-8:00
WGLB	Newark, N. J.	267.7	1120	500	10:00-12:00	Silent	6:00-8:00	6:00-10:00	6:00-10:00	6:00-10:00	6:00-8:00
WGES	Chicago, Ill.	241.8	1240	500	8:30-2:00	8:30-2:00	9:30-12:00	9:30-12:00	8:30-1:30	8:30-1:30	8:30-1:30
WGHP	Mt. Clemens, Mich.	277.6	1080	750	Silent	9:00-12:00	9:00-11:00	8:00-10:00	9:00-11:00	8:00-10:00	9:00-11:00
WGL	New York, N. Y.	293.9	1020	500	6:00-9:00	7:00-1:00	9:00-12:00	6:00-9:00	9:00-12:00	6:00-9:00	9:00-12:00
WGN	Chicago, Ill.	416.4	720	500	7:00-1:00	7:50-1:00	7:00-1:00	7:00-1:00	7:00-1:00	7:00-1:00	7:00-1:00
WGR	Buffalo, N. Y.	302.8	990	750	8:00-9:00	7:45-10:00	6:15-12:00	8:00-11:00	8:00-12:00	8:00-11:00	8:00-12:00
WGW	Milwaukee, Wis.	218.8	1370	500	Silent	7:00-8:00	9:00-11:30	Silent	9:00-10:00	Silent	10:00-11:30
WGY	Schenectady, N. Y.	379.5	790	50000	6:30-12:00	3:30-10:45	6:30-11:00	6:30-1:00	6:30-11:00	6:30-12:30	6:30-11:00
WHAD	Milwaukee, Wis.	270.1	1110	500	Silent	Silent	8:30-9:00	8:30-9:00	8:30-9:00	8:30-9:00	8:30
WHAM	Rochester, N. Y.	280.2	1070	5000	6:30-11:30	6:30-11:00	6:30-11:00	6:30-11:00	6:30-11:00	6:30-11:00	6:30-11:00
WHAP	Carlstadt, N. J.	236.1	1270	1000	7:00-11:30	7:30-9:30	6:00-9:00	Silent	9:00-11:30	6:00-9:00	Silent
WHAS	Louisville, Ky.	322.4	930	500	8:00-10:30	7:20-10:15	8:00-10:30	8:00-10:30	8:00-10:30	8:00-10:30	8:00-10:30
WHAZ	Troy, N. Y.	305.9	980	500	Silent	Silent	8:00-12:00	Silent	Silent	Silent	Silent
WHB	Kansas City, Mo.	340.7	880	500	9:00-11:00	7:30-2:00	8:00-11:00	8:00-11:00	8:00-9:00	8:00-11:00	8:00-9:00
WHCK	Rochester, N. Y.	254.1	1180	500	8:00-9:00	7:30-10:00	8:00-9:00	8:00-9:00	8:00-9:00	8:00-9:00	8:00-9:00
WHK	Cleveland, Ohio	265.3	1130	500	6:00-10:00	4:30-9:30	6:00-10:00	6:00-10:00	6:00-10:00	6:00-10:00	6:00-10:00
WHN	New York, N. Y.	394.5	760	500	6:00-12:30	5:00-12:00	6:00-12:30	6:00-12:30	6:00-12:30	6:00-12:30	6:00-12:30
WHO	Des Moines, Iowa	535.4	560	5000	6:30-12:00	6:30-9:30	6:30-12:00	6:30-12:00	6:30-12:00	6:30-12:00	6:30-12:00
WHT	Chicago, Ill.	305.9	980	5000	7:00-1:00	7:00-11:00	Silent	7:00-11:00	7:00-1:00	7:00-1:00	7:00-1:00
WIBO	Chicago, Ill.	305.9	980	5000	8:00-12:00	8:00-2:00	Silent	8:00-12:00	8:00-12:00	8:00-12:00	8:00-12:00
WICC	Easton, Conn.	265.3	1130	500	7:00-11:00	7:30-9:30	7:00-11:00	7:00-11:00	7:00-11:00	7:00-11:00	7:00-11:00
WIP	Philadelphia, Pa.	348.6	860	500	9:00-11:30	7:45-8:45	6:30-7:30	7:00-11:00	8:00-9:00	8:00-10:00	6:30-7:30
WJAD	Waco, Texas	333.1	900	500	7:00-8:30	7:30-8:30	7:00-8:30	7:00-8:30	7:00-8:30	7:00-8:30	7:00-8:30
WJAR	Providence, R. I.	483.6	620	500	7:45-10:00	6:30-10:15	7:30-10:30	7:00-10:30	7:30-10:30	7:30-10:30	8:00-11:00
WJAS	Pittsburgh, Pa.	270.1	1110	500	8:00-11:00	9:00-10:00	9:00-11:00	8:00-11:00	9:00-11:00	8:00-11:00	8:00-11:00
WJAX	Jacksonville, Fla.	340.7	880	1000	7:30-11:00	6:30-11:00	7:30-11:00	7:30-11:30	Silent	7:30-11:30	7:30-11:30
WJAY	Cleveland, Ohio	227.1	1320	500	6:00-12:00	6:30-11:00	6:00-12:00	6:00-12:00	6:00-12:00	6:00-12:00	6:00-12:00
WJAZ	Mt. Prospect, Ill.	263	1320	500	8:00-12:00	8:30-10:30	Silent	8:00-12:00	8:00-12:00	10:00-1:00	8:00-12:00
WJBT	Chicago, Ill.	389.4	770	500	12:00-1:00	3:30-1:00	11:00-12:00	12:00-1:00	12:00-1:00	12:00-1:00	12:00-1:00
WJDD	Chicago, Ill.	356.6	820	1000	9:00-12:00	10:00-11:15	9:00-1:00	9:00-1:00	9:00-1:00	9:00-2:00	9:00-2:00
WJKS	Gary, Ind.	232.4	1290	500	8:00-2:00	8:00-1:00	8:00-2:00	8:00-1:00	8:00-2:00	8:00-1:00	8:00-2:00
WJR	Detroit, Mich.	440.9	680	5000							

“Every 3,000 Miles This Amazing Little Device Buys Me a New Tire...FREE”

“THE money I save on gasoline more than keeps me in new tires. Figure it out . . . I was getting 13 miles per gallon on my Nash. With gas at 18c plus 2c tax it cost me \$46 to drive 3,000 miles. Now I’m getting better than 26 miles per gallon. It takes just half the gas and I save \$23 to \$25 every 3,000 miles—more than the price of a new tire.”



Proved by Two Million Owners

Records like these are reported in every mail for every make and model car * * * from 72 different countries * * * the world over. More than two million Stransky Vaporizers have been installed.

Easily Installed

No bigger than a dollar coin—no more expensive than a good wrench—no more trouble to attach than a fan belt! Attaches to the intake manifold of any car in five minutes. Anyone can do it.

Less Gasoline—More Power

The Vaporizer supercharges your gasoline after it leaves the carburetor. Completely vaporizes the gasoline. Under this ideal condition you get more compression out of less gasoline and a more complete explosion. Both power, pickup and speed are noticeably increased. Starting is not interfered with as the Vaporizer automatically shuts itself off when the motor is idle.

Make This Test

Test the Stransky Vaporizer on your car—and expect results that will amaze you! Double your mileage—get flashing pickup and power—forget carbon trouble, sluggish motor and fouled spark plugs from over-rich mixture—and save enough on your gasoline to more than keep you in tires. These results are guaranteed or the test costs you nothing.

Mail the coupon below for full details, guarantee, and amazing trial offer, which is even more remarkable than we can tell you here. There is no obligation whatever.

43.8 Miles Per Gallon
 Mr. M. E. Miller, Kansas City, writes: “You people claim a saving of 25 to 50% of Gasoline. I have subjected the Vaporizer to a severe and thorough test. After installing one on a Chevrolet, I found I was obtaining 43.8 miles to a gallon whereas formerly I had been getting only 19.5. That is not a saving of 25 to 50% but 124%, so you see that the actual test surpasses your claim.”

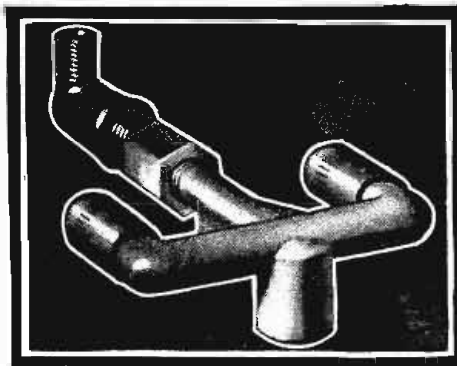

FITS ANY CAR IN 5 MINUTES

Any one can install this device in 5 minutes. Simply loosen one connection to the intake manifold with a wrench. You can do the rest with your fingers.

No matter what make of car you drive, the Stransky Vaporizer is unconditionally guaranteed to give you 50 per cent to 100 per cent more miles per gallon or it costs you nothing. As a matter of fact, it is not uncommon for the Stransky Vaporizer to more than double gasoline mileage!

Note These Records

Forty-three miles per gallon from a Chevrolet, reported by F. S. Carroll. Fifty-seven miles on one gallon in a Ford reported by J. T. Jackson, Michigan. Forty miles per gallon in a Dodge from Brownsville, Tex., to Tampico, Mex., reported by T. L. Brown.

\$4 an Hour for Salesmen, Agents and Spare Time Workers

Men are making wonderful earnings showing the Stransky Vaporizer to car owners in spare time and full time. Sells fast under our guarantee. Foster made \$357 in two weeks. G. F. Fuller earned \$114 in 5 days. Eberlein sold 23 Vaporizers in 35 minutes! J. W. Cronk actually earned \$51 in an hour. You should be able to earn at least \$3 every hour you put in. We offer demonstrators one Vaporizer FREE, under our unusual offer. Get full details. Simply mail coupon at once.

J. A. Stransky Mfg. Co.

C-1880 Stransky Block, Pukwana, So. Dakota

J. A. Stransky Mfg. Co., C-1880, Stransky Block Pukwana, So. Dakota
 Without obligation send me full details of your free trial offer.

Name

Address

City State.....

() Check here for Distributor's Sample Offer and the selling plan.

Call	Location	Meters	Kilo.	Watts	Saturday	Sunday	Monday	Tuesday	Wednesday	Thursday	Friday
WOQ	Kansas City, Mo.	340.7	880	500	11:00-12:00	8:45-10:00	10:00-11:00	6:00-7:00	9:00-11:00	Silent	9:00-11:00
WOR	Newark, N. J.	422.3	710	5000	6:15-12:00	7:45-11:00	6:15-12:00	6:15-12:00	6:15-12:00	6:15-12:00	6:15-12:00
WORD	Batavia, Ill.	252	1190	5000	7:00-8:00	7:00-8:30	7:00-8:00	7:00-8:00	7:00-8:00	7:00-8:00	7:00-8:00
WOS	Jefferson City, Mo.	422.3	710	500	Silent	Silent	9:00-11:00	Silent	9:00-11:00	Silent	9:15-10:15
WOW	Omaha, Nebr.	508.2	590	1000	7:00-12:00	7:00-11:15	7:00-12:00	7:00-12:00	7:00-12:00	7:00-12:00	7:00-12:00
WOWO	Fort Wayne, Ind.	228.9	1310	5000	7:00-8:00	9:00-11:00	7:15-12:30	Silent	8:00-12:00	8:00-12:00	8:00-12:00
WPAP	Palisade, N. J.	394.5	760	500	8:00-9:00	Silent	8:00-9:00	8:30-9:30	8:00-9:00	8:00-9:00	8:30-9:30
WPCB	Hoboken, N. J.	325.9	920	500	9:00-2:00	6:30-12:00	7:00-12:00	4:00-7:00	6:00-9:00	4:00-12:00	Silent
WPG	Atlantic City, N. J.	272.6	1100	5000	6:45-12:30	9:15-11:30	6:45-12:30	6:45-12:30	6:45-12:30	6:45-12:30	6:45-12:30
WPTF	Raleigh, N. C.	545.1	550	500	Silent	7:30-8:30	6:00-8:00	Silent	6:00-8:00	Silent	6:00-8:00
WQAM	Miami, Fla.	384.4	780	750	7:00-9:30	7:00-9:00	7:00-9:30	7:00-12:00	7:00-9:30	7:00-9:30	7:00-12:00
WRC	Washington, D. C.	468.5	640	500	6:00-11:00	6:00-9:30	6:00-11:00	6:00-11:00	6:00-11:00	6:00-11:00	6:00-11:00
WREN	Lawrence, Kans.	254.1	1180	750	9:00-10:30	8:00-9:30	9:00-10:30	9:00-10:30	9:00-10:30	9:00-10:30	9:00-10:30
WRHM	Minneapolis, Minn.	260.7	1150	1000	7:00-11:00	8:45-9:45	9:00-11:00	Silent	9:00-11:00	Silent	9:00-11:00
WRNY	New York, N. Y.	325.9	920	500	7:00-11:00	Silent	7:00-11:00	7:00-11:00	7:00-11:00	7:00-11:00	7:00-11:00
WRR	Dallas, Texas	461.3	650	500	7:00-12:00	8:30-11:30	7:00-12:00	7:00-12:00	Silent	7:00-12:00	7:00-12:00
WRVA	Richmond, Va.	254.1	1180	1000	Silent	8:00-9:00	7:00-12:00	Silent	7:00-12:00	7:00-12:00	7:00-12:00
WSB	Atlanta, Ga.	475.9	630	1000	9:00-1:00	7:15-10:15	9:00-1:00	9:00-1:00	9:00-1:00	9:00-1:00	9:00-1:00
WSBC	Chicago, Ill.	232.4	1290	500	7:30-12:00	6:00-8:00	10:00-2:00	7:30-2:00	7:30-2:00	10:00-2:00	7:30-2:00
WSBT	South Bend, Ind.	399.8	750	500	7:00-8:00	Silent	10:30-11:30	Silent	Silent	10:00-12:30	11:00-1:00
WSM	Nashville, Tenn.	336.9	890	5000	7:00-12:00	7:20-10:15	7:00-12:00	7:00-12:00	7:00-12:00	7:15-12:00	9:00-11:00
WSMB	New Orleans, La.	296.9	1010	500	9:30-11:30	Silent	9:30-11:30	Silent	9:30-11:30	9:30-11:30	9:30-11:30
WSUN	St. Petersburg, Fla.	516.9	580	750	7:00-12:00	Silent	Silent	7:00-12:00	Silent	7:00-12:00	Silent
WTAC	Worcester, Mass.	516.9	580	250	7:00-10:00	7:20-9:16	7:00-12:00	7:00-12:00	7:00-12:00	7:00-12:00	7:00-12:00
WTAM	Cleveland, Ohio	399.8	750	3500	6:00-12:00	6:00-12:00	6:00-12:00	6:00-12:00	6:00-12:00	6:00-12:00	6:00-12:00
WTAR	Norfolk, Va.	236.1	1270	500	6:00-11:00	7:00-9:00	6:00-11:00	6:00-11:00	6:00-11:00	6:00-11:00	6:00-11:00
WTIC	Hartford, Conn.	535.4	560	500	6:30-11:00	3:00-9:15	6:30-11:00	6:30-11:00	6:30-11:00	6:30-11:00	6:30-11:00
WTMJ	Milwaukee, Wis.	293.9	1020	1000	7:00-1:00	9:30-11:45	7:00-1:00	7:00-1:00	7:00-1:00	7:00-1:00	7:00-1:00
WWAE	Chicago, Ill.	227.1	1320	500	8:00-1:00	8:00-1:00	8:00-1:00	8:00-1:00	8:00-1:00	8:00-1:00	8:00-1:00
WWJ	Detroit, Mich.	352.7	850	1000	6:00-11:00	7:20-10:15	6:00-11:00	6:00-11:00	6:00-11:00	6:00-11:00	6:00-11:00
WWNC	Asheville, N. C.	296.9	1010	1000	7:00-8:00	7:30-8:30	7:00-8:00	7:00-10:30	7:00-8:00	6:30-12:00	7:00-8:00

Popular Song Hits

(Continued from page 72)

- I Wanna Go Where You Go, St. Claire and L. Brown; Irving Berlin, Inc., 1925.
- I Want a Daddy, Who Will Rock Me to Sleep, P. Bartholomae and J. M. Anderson; M. Witmark & Sons, 1919.
- I Want to Be Happy, Irving Caesar and Vincent Youmans; Harms, Inc., 1924.
- I Wish I was in Peoria, B. Rose Dixon; Irving Berlin, Inc., 1926.
- I Wonder What's Become of Sally, Jack Yellen and Mill Ager; Harms, Inc., 1924.
- I Wonder Where My Baby Is Tonight, W. Donaldson and G. Kahn; Irving Berlin, Inc., 1927.
- I Wonder Who's Dancing With You Tonight, M. Dixon, Billy Rose and R. Henderson; J. H. Remick & Co., 1924.
- Ja Da, Bob Carlton; Leo Feist, Inc., 1918.
- Jazzin' Around, Carl Fuller; Leo Feist, Inc., 1917.
- Jerry, Danny O'Neill and Billy Baskette; Leo Feist, Inc., 1919.
- Joan of Arc, Willie Weston, Jack Wells and Alfred Bryan; Waterson, Berlin & Snyder, 1917.
- Just a Baby's Prayer at Twilight, S. Lewis, J. Young and M. K. Jerome; Waterson, Berlin & Snyder, 1918.
- Just Give Me a Night in June, Cliff Friend and Abel Baer; Leo Feist, 1924.
- Just Like a Butterfly That's Caught in the Rain, M. Dixon and Harry Wells; J. H. Remick & Co., 1927.
- Just Like a Gypsy, Seymour B. Simons and Nora Bayes; Jerome H. Remick Co., 1919.
- Just Like Washington Crossed the Delaware, We'll Cross the Rhine, Geo. Meyer and H. Johnson; Leo Feist, Inc., 1918.
- Just One Rose, Cado and Sanders; J. H. Remick & Co., 1924.
- Keep Your Head Down Fritzie Boy, Lieut. G. Ide; Leo Feist, Inc., 1918.
- Kiss Me Again, Henry Glosson and Victor Herbert; M. Witmark & Sons, 1915.
- K-K-K-Kats, Geoffrey O'Hara; Leo Feist, Inc., 1918.
- Last Night on the Back Porch, Lew Brown; Carl Schaubstader, 1923.
- Lazy, Irving Berlin; Irving Berlin, Inc., 1924.
- Leave It to Jane, P. G. Wodehouse and Jerome Kern; T. B. Harms & Co., 1917.
- Let's All Be American Now, Irving Berlin, E. Leslie and G. Meyer; Waterson, Berlin & Snyder, 1917.
- Let It Rain, Let It Pour, I'll Be in Virginia in the Morning, Cliff Friend and Walt Donaldson; Leo Feist, 1925.
- Let the Rest of the World Go By, J. K. Freeman and E. R. Ball; M. Witmark & Sons, 1919.
- Liberty Bell, It's Time to Ring Again, J. Goodwin and Hubey K. Mohr; Shapiro, Bernstein & Co., 1917.
- Linger A-while, Harry Owen and Vincent Rose; Leo Feist, 1923.
- Little Bit of Sunshine, McDonald, Joe Goodwin and James Hanley; Shapiro, Bernstein & Co., 1918.
- Lucky Kentucky, M. Dixon, Billy Rose and R. Henderson; J. H. Remick & Co., 1925.
- Madame Sherry, Karl Hoschna and J. Andino; M. Witmark & Sons, 1919.
- Maudie, Harry Cost, Geo. Stoddard and J. J. Schell; Shapiro, Bernstein & Co., 1919.
- Mammy's Chocolate Soldier, S. Mitchell and A. Guttler; Waterson, Berlin & Snyder, 1918.

- Mamma Loves Papa, Cliff Friend and Abel Baer; Leo Feist, 1923.
- Mammy o' Mine, Wm. Tracey and Maceo Pinkard; Shapiro, Bernstein & Co., 1919.
- Mandalay, C. Burnett, A. Lyman and G. Arnheim; J. H. Remick & Co., 1924.
- Mary, Geo. E. Stoddard and Hugo Frey; G. Ricordi & Co., 1918.
- Melody Land, R. Hubbel and J. L. Golden; Golden, Hubbel and Burnside, 1917.
- Memory Lane, Mrs. Larry Speer and Con Conrad; Harms, Inc., 1924.
- Mickey, H. Williams and Neil Moret; Waterson, Berlin & Snyder, 1918.
- M-i-s-s-i-s-s-i-p-p-i, Bert Hanlan and Benny Ryan; Wm. Jerome Pub. Co., 1916.
- Mister Gallagher and Mister Shean, E. Gallagher and A. Shean; Harms, Inc., 1922.
- Mother Dixie and You, H. Young and Joe Santly; Leo Feist, Inc., 1917.
- Mother Macchree, Rida J. Young, Chauncey Alcott and Ernest Ball; M. Witmark & Sons, 1910.
- Mr. Radioman (Tell My Mammy to Come Back Home), Ira Schuster, J. White and Cliff Friend; Leo Feist, 1924.
- My Baby's Arms, M. H. Tierney and Lee Olean Smith; Leo Feist, Inc., 1919.
- May Baby Knows How, H. Davis and H. Richmond; Irving Berlin, Inc., 1926.
- My Belgian Rose, R. Leveson, F. Garton and G. Benoit; Garton Bros., 1918.
- My Best Girl, W. Donaldson; J. H. Remick & Co., 1924.
- My Isle of Golden Dreams, Gus Kahn and W. Blaufuss; Jerome H. Remick Co., 1919.
- My Little Gypsy Wanda, Robt. Levenson and Ted Garton; Shapiro, Bernstein & Co., 1918.
- My Rain Bow Girl, L. A. Hirsch and Renold Wolf; M. Witmark & Sons, 1917.
- My Sunday Girl, H. Ruby and B. Cooper; Irving Berlin, Inc., 1927.
- My Sweetie, Irving Berlin; Waterson, Berlin & Snyder, 1917.
- My Wild Irish Rose, Chauncey Alcott; Wetmark & Sons, 1899.
- Naughty, Naughty, Naughty, Nat. Vincent, J. Goodwin and Wm. Tracey; Shapiro, Bernstein & Co., 1916.
- Nighthale, R. Coburn and V. Rose; J. H. Remick and Co., 1920.
- No One Knows What It's All About, H. Wood and Billy Rose; Irving Berlin, Inc., 1924.
- Nothing Seems the Same, Benny Davis and Jesse Greer; E. B. Bucke Music Pub. Co., 1926.
- No Wonder, Benny Davis and Joe Rushe; Leo Feist, 1924.
- "O," by B. Gay and A. Johnson; Leo Feist, Inc., 1919.
- Oh, Baby, B. De Sylva and W. Donaldson; Irving Berlin, Inc., 1924.
- Oh, Boy, J. Kern; T. B. Harms & Co., 1917.
- O'Brien Is Trying to Learn to Talk Hawaiian, M. Dubin and R. Cornack; M. Witmark & Sons, 1916.
- Oh, Frenchy, Sam Ullrich and Con Conrad; Broadway Music Corp., 1918.
- Oh, How I Hate to Get up in the Morning, Irving Berlin; Waterson, Berlin & Snyder, 1918.
- Oh, How I Miss You Tonight, Benny Davis and J. Burke; Irving Berlin, Inc., 1925.
- Oh, I Wish I Could Sleep Till My Daddy Comes Home, S. Lewis, Joe Young and Pete Wendling; Waterson, Berlin & Snyder, 1918.
- Oh, Mabel, Gus Kahn and T. Fiorito; Irving Berlin, Inc., 1924.

- Oh, Mother, I'm Wild, Howard Johnson, H. Please and E. Nelson; Leo Feist, Inc., 1920.
- Oh, Sister, Ain't That Hot, Harry White and Will Donaldson; Stark & Cowan, Inc., 1923.
- Old Man Jazz, Gene Onaw; Jos. W. Stern & Co., 1919.
- One Day in June, Joe Goodman and J. J. Hanley; Shapiro, Bernstein & Co., 1917.
- On the Level You're a Devil, Joe Young and Jean Schwartz; Waterson, Berlin & Snyder, 1918.
- Over There, George M. Cohen; W. Jerome Pub. Co., 1917.
- Patsy, Dick Coburn, Earl Burnett and Dick Winfree; Harms, Inc., 1924.
- Peggy, Nell Moret and Harry Williams; Leo Feist, Inc., 1919.
- Persian Pearl, Mort. Nathan and J. Coper; M. Witmark & Sons, 1918.
- Poor Butterfly, J. L. Golden and Ray Hubbell; T. B. Harms & Co., 1916.
- Poor Papa, Billy Rose and H. Woods; Irving Berlin, Inc., 1925.
- Pretty Cinderella, Will Harris; Irving Berlin, Inc., 1926.
- Princess Pat, Victor Herbert and Harold Sanford; M. Witmark & Sons, 1915.
- Put You're Arms Where They Belong, H. Santly and H. Ackerman; Irving Berlin, Inc., 1927.
- Rambler Rose, V. Jacobi and H. P. Smith; T. B. Harms & Co., 1917.
- Razze Daxze, Julius Lenzberg; Jerome H. Remick Co., 1919.
- Remember, Irving Berlin; Irving Berlin, Inc., 1927.
- He's the Hottest Man in Town, Owen Murphy and Jay Gornly; Robbins, Engel, Inc., 1924.
- Rock-a-Bye My Baby Blues, Larry Yoell and Billy Hill; Maurice Abrams, Inc., 1923.
- Rock a Bye Your Baby With a Dixie Melody, J. Young, S. Lewis and J. Schwartz; Waterson, Berlin & Snyder, 1918.
- Rose Marie, Otto Harbach and Oscar Hammerstein; Harms, Inc., 1925.
- Russian Lullaby, Irving Berlin; Irving Berlin, Inc., 1927.
- Russian Rag, Will Rossiter; Geo. L. Cobb, 1918.
- Sally Lou, Holly Field, Jack Meskill and A. Hugo Fry; Richmond-Robbins, Inc., 1924.
- Say It Again, R. Richmond and A. Silver; Irving Berlin, Inc., 1926.
- Save Your Sorrow (For Tomorrow), E. G. Sylva and Al. Sherman; Shapiro, Bernstein & Co., 1925.
- Shades of Night, A. Friedland and M. Franklin; Jos. W. Stern & Co., 1916.
- Shadowland, Lawrence Gilbert; Leo Feist, 1915.
- Shine, Cecil Mack, L. Brown and Mrs. Ford Dabney; Shapiro, Bernstein & Co., 1924.
- Siubad Was in Bad All the Time, Stanty Murphy and H. Carroll; Jerome H. Remick Co., 1917.
- Sing Me Love's Lullaby, Dorothy Terris and Theo. Morse; Leo Feist, Inc., 1917.
- Sittin' in a Corner, G. Kahn and G. W. Meyer; Irving Berlin, Inc., 1923.
- Some Night, W. J. Norris, Joe Goodwin and Nat. Vincent; Shapiro, Bernstein & Co., 1917.
- Sometime You'll Remember, R. Wallace and M. L. Head; Francis, Day and Hunter, 1915.
- Sony, Bob Schaefer and Mack Fisher; Irving Berlin, Inc., 1925.
- Some One Else May Be There While I'm Gone, Irving Berlin; Waterson, Berlin & Snyder, 1917.

(Continued on page 112)

Shaves 5 YEARS with One Razor Blade!

AGENTS!

\$50 to \$200 a Week

KRISS KROSS is so astonishingly effective in rejuvenating all makes of razor blades that any number of men are earning surprising sums by representing us in their territories. Even spare-time men, office and factory workers make as much as \$6-\$12 a day extra, just showing KRISS-KROSS to friends and fellow-employees. Jas. Tillotson paid entire expenses of a 30-day vacation trip with KRISS-KROSS profits. One day he made \$114! H. King made \$66 in a day—R. Vanderhof sold 27 in 8½ hours—cleared over \$50! Emil Ham made \$200 his first four days, while S. Kantala made \$154 in 3 weeks, working just an hour or two each evening! Why not get your share of these easy profits? We furnish everything and back you to the limit. Check bottom line of coupon and get our big-profit plan at once!



“WHO says it costs a lot of money to operate a safety razor?” demands Mr. M. T. Main of Kenosha, Wisconsin. “Using KRISS-KROSS stropper, I have been getting slick shaves out of one blade for five years, and from the looks of things, the blade will outlast me!” You men who think you are lucky if you get a week’s service out of a blade—think that over! But don’t waste time envying the man who is banking the money he used to throw away on razor blades! Join

the army of KRISS-KROSS shavers right now! You’ll never know real shaving comfort and economy until you do. For KRISS-KROSS actually rejuvenates all makes of razor blades (except Durham). It makes them keener than new! Eleven seconds in a KRISS-KROSS Stropper will actually make the oldest blade you own deliver a shave so cool and velvet-smooth that you won’t believe your own eyes! That’s because KRISS-KROSS actually duplicates the diagonal stropping stroke of a master barber! No wonder more than a million men say KRISS-KROSS has solved their shaving problem forever!

Amazing Offer Means—No More Razor Blades to Buy!

You can’t possibly realize how KRISS-KROSS will brighten your mornings and save your money until you have seen and tried it yourself. So don’t fail to take advantage of our liberal trial offer which is now in effect. This offer includes an amazing new kind of razor, now given

Free to KRISS-KROSS enthusiasts. Absolutely unique and different. Adjusts three ways in a jiffy. Requires no cleaning or assembling. Gives a sliding stroke that decreases beard resistance 45%! Comes with five new-process blades—probably the last you’ll ever need to get!

Do no delay, for this unusual offer is limited and may be withdrawn at any time. Mail the coupon. It will bring full details without obligating you in any way.

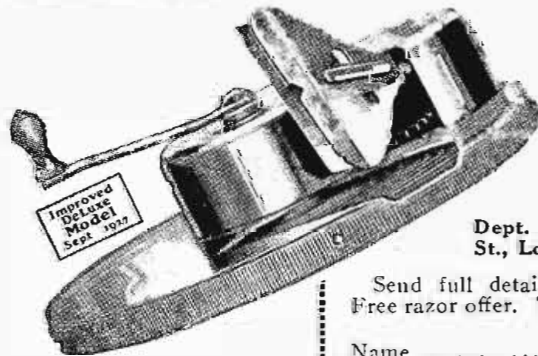

Rhodes KRIS-KROSS Corp.,
Dept. C-3212, 1418 Pendleton Ave.,
St., Louis, Mo.

Send full details of KRIS-KROSS and your Free razor offer. This request does not obligate me.

Name

Address

City State.....

Check if interested in making money as a KRIS-KROSS Representative

Rhodes KRIS KROSS CORPORATION
Dept., C-3212, 1418 Pendleton Ave., St., Louis, Mo.
World’s Largest Manufacturers of Mechanical Stropers

Listener's Evening at Home

IN CENTRAL TIME

Call	Location	Meters	Kc.	Watts	Saturday	Sunday	Monday	Tuesday	Wednesday	Thursday	Friday
CFAC	Calgary, Can.	434.5	690	500	Silent	8:00-9:00	10:30-11:30	7:00-8:00	8:45-9:45	10:00-11:30	9:30-10:30
CFC	Toronto, Can.	356.9	840	500	8:00-9:00	6:00-7:00	6:15-8:15	Silent	6:00-10:00	7:00-11:00	Silent
CFCF	Montreal, Can.	410.7	730	1650	Silent	Silent	6:30-7:30	Silent	6:00-7:00	Silent	6:30-7:30
CFCN	Calgary, Can.	434.5	690	1800	Silent	8:15-9:15	Silent	10:00-11:00	10:00-11:00	8:45-9:45	10:00-11:00
CFOC	Victoria, Can.	329.5	910	500	9:30-11:15	Silent	1:00-2:00	9:30-11:15	9:30-11:15	12:30-2:00	9:30-10:30
CFRB	Saskatoon, Can.	329.5	910	500	Silent	8:00-9:00	7:00-8:00	Silent	8:30-11:00	8:30-9:30	8:30-9:30
CHIC	Toronto, Can.	356.9	840	500	9:00-11:00	4:00-5:00	7:00-8:00	5:00-7:00	7:00-11:00	7:00-11:00	5:00-7:00
CHWC	Regina, Can.	312.3	960	500	9:00-11:00	Silent	6:00-7:00	6:00-7:00	6:00-7:00	6:00-7:00	6:00-7:00
CHYC	Montreal, Can.	410.7	730	750	Silent	6:00-7:00	Silent	Silent	Silent	7:00-7:00	6:00-7:00
CJCA	Edmonton, Can.	516.9	580	500	11:00-1:00	8:15-9:15	Silent	Silent	9:00-1:00	Silent	9:00-11:30
CJGC	London, Can.	329.5	910	500	Silent	6:00-7:00	6:00-8:00	6:00-8:00	6:00-8:00	6:00-8:00	6:00-8:00
CJGX	Yorkton, Can.	475.9	630	500	Silent	Silent	Silent	8:30-10:00	Silent	8:30-10:00	9:30-10:00
CJRM	Moose Jaw, Can.	296.9	1010	500	9:00-11:00	Silent	5:30-7:30	Silent	5:30-7:30	Silent	5:30-7:30
CJYC	Toronto, Can.	516.9	580	500	Silent	Silent	5:00-11:00	9:00-11:00	5:00-7:00	Silent	Silent
CKAC	Montreal, Can.	410.7	730	1200	6:15-11:00	Silent	Silent	6:15-11:30	Silent	6:15-8:00	Silent
CKCD	Vancouver, Can.	410.7	730	1000	10:30-12:30	Silent	10:30-12:30	10:30-11:30	10:30-11:30	10:30-11:00	10:30-10:50
CKCK	Regina, Can.	312.3	960	500	Silent	10:00-11:00	9:00-11:00	9:00-11:00	Silent	9:00-11:00	9:00-11:00
CKCL	Toronto, Can.	356.9	840	500	6:00-7:00	2:00-3:00	Silent	5:40-12:00	Silent	Silent	Silent
CKXC	Toronto, Can.	516.9	580	1000	Silent	7:15-9:15	Silent	7:00-9:00	Silent	Silent	7:00-9:00
CKXC	Toronto, Can.	356.9	840	500	Silent	Silent	8:00-9:00	Silent	Silent	8:00-9:00	Silent
CKY	Winnipeg, Can.	384.4	780	500	7:30-10:30	6:00-9:00	7:30-11:00	Silent	8:00-12:00	7:30-9:00	Silent
CNRA	Moncton, Can.	322.4	930	500	Silent	Silent	Silent	7:00-8:00	Silent	Silent	7:00-8:00
CNRC	Calgary, Can.	434.5	690	500	Silent	Silent	10:30-11:30	Silent	Silent	10:30-11:30	Silent
CNRE	Edmonton, Can.	516.9	580	500	Silent	Silent	11:30-1:00	Silent	Silent	Silent	11:30-1:00
CNRM	Montreal, Can.	410.7	730	1000	Silent	Silent	Silent	Silent	Silent	7:30-8:30	Silent
CNRO	Ottawa, Can.	434.5	690	500	Silent	Silent	6:15-9:00	Silent	Silent	6:15-11:00	Silent
CNRR	Regina, Can.	312.3	960	500	Silent	Silent	Silent	9:00-11:00	Silent	Silent	Silent
CNRT	Toronto, Can.	356.9	840	500	Silent	Silent	Silent	Silent	Silent	Silent	8:00-10:00
CNRV	Vancouver, Can.	291.1	1030	500	Silent	Silent	12:00-1:00	Silent	12:00-1:00	12:00-1:00	11:00-1:00
CNRW	Winnipeg, Can.	384.4	780	500	Silent	9:00-10:00	6:30-7:30	6:30-7:30	10:00-11:00	6:30-7:30	6:30-7:30
CYH	Monterey, Mex.	311	964	1000	9:30-10:30	9:30-11:00	Silent	Silent	9:30-11:00	9:30-10:30	Silent
CYJ	Mexico City, Mex.	410	730	1000	9:00-10:00	Silent	9:00-10:00	9:00-10:00	9:00-10:00	9:00-10:00	9:00-10:00
KDKA	E. Pittsburgh, Pa.	315.6	950	5000	5:15-10:00	5:15-10:45	5:15-10:00	5:15-9:30	5:15-10:00	5:15-11:00	5:15-10:30
KDYL	Salt Lake City, Utah.	234.2	1280	500	7:00-1:00	9:00-11:00	7:00-12:00	7:00-12:00	7:00-12:00	7:00-12:00	7:00-12:00
KEX	Portland, Ore.	277.6	1080	2500	8:00-4:00	7:30-12:00	8:00-2:00	8:00-2:00	8:00-2:00	8:00-2:00	8:00-2:00
KFAB	Lincoln, Nebr.	319	940	5000	6:00-11:00	6:00-11:00	6:00-11:00	6:00-11:00	6:00-11:00	6:00-11:00	6:00-11:00
KFAD	Phoenix, Ariz.	272.6	1100	500	11:00-12:00	9:00-10:00	Silent	11:00-12:00	11:00-12:00	6:00-11:00	6:00-11:00
KFAU	Boise, Idaho.	285.5	1050	2000	Silent	8:30-10:00	Silent	8:30-11:00	Silent	8:30-11:00	Silent
KFBU	Laramie, Wyo.	483	620	500	Silent	Silent	Silent	Silent	8:30-9:30	8:30-9:30	8:30-9:30
KFDM	Beaumont, Tex.	483	620	500	Silent	6:45-9:00	Silent	8:00-10:00	Silent	9:00-10:00	8:30-10:30
KFEQ	St. Joseph, Mo.	230.6	1300	1000	6:30-10:00	Silent	6:30-12:00	6:30-10:00	6:30-10:00	6:30-10:00	6:30-10:00
KFH	Wichita, Kans.	245.8	1220	500	7:30-1:30	7:30-8:30	7:30-9:00	7:30-9:00	7:30-9:00	7:30-9:00	7:30-9:00
KFI	Los Angeles, Calif.	468.5	640	5000	8:00-4:00	Silent	8:00-1:00	8:00-1:00	8:00-1:00	8:00-1:00	8:00-1:00
KJFJ	Oklahoma City, Okla.	272.6	1100	1000	7:00-10:00	8:00-9:00	7:00-10:00	7:00-10:00	7:00-10:00	7:00-10:00	7:00-10:00
KFKB	Milford, Kans.	241.8	1240	1500	Silent	6:00-12:00	6:00-11:00	6:00-11:00	6:00-11:00	6:00-11:00	6:00-11:00
KFKU	Lawrence, Kans.	254.1	1180	500	Silent	Silent	Silent	7:00-8:00	7:00-8:00	7:00-8:00	Silent
KFNF	Shenandoah, Iowa.	461.3	650	2000	5:00-7:00	6:00-7:00	5:00-7:00	5:00-7:00	5:00-7:00	5:00-7:00	5:00-7:00
KFOA	Seattle, Wash.	447.5	670	1000	8:00-12:00	8:00-11:30	8:00-12:00	8:00-1:00	8:00-1:00	8:00-12:00	8:00-12:00
KFOB	Long Beach, Calif.	241.8	1240	500	10:30-3:00	10:30-3:00	12:30-3:00	10:30-3:00	10:30-3:00	10:30-3:00	10:30-3:00
KFOB	Ft. Worth, Tex.	333.1	900	1000	7:00-11:00	7:30-11:00	7:30-11:00	7:30-11:00	7:30-11:00	7:30-11:00	7:30-11:00
KFRC	San Francisco, Calif.	454.3	660	1000	8:00-2:00	8:00-2:00	8:00-2:00	8:00-2:00	8:00-2:00	8:00-2:00	8:00-2:00
KFRU	Columbia, Mo.	249.9	1200	500	6:30-7:30	7:30-8:30	6:30-7:30	6:30-7:30	7:30-10:00	7:30-11:00	7:30-7:30
KFSF	San Diego, Calif.	440.9	680	500	7:45-2:00	10:30-12:00	7:45-2:00	7:45-2:00	7:45-2:00	7:45-2:00	7:45-2:00
KFSG	Los Angeles, Calif.	275.1	1090	500	8:30-11:30	8:30-1:00	Silent	8:30-11:30	8:30-11:30	8:30-1:00	8:30-1:00
KFUM	Colorado Springs, Colo.	282.8	1060	1000	9:00-11:00	Silent	6:00-8:00	9:00-11:00	Silent	9:00-1:00	11:00-1:00
KFUO	St. Louis, Mo.	545.1	550	1000	Silent	9:15-10:15	6:00-8:00	6:00-8:00	6:00-8:00	6:00-8:00	6:00-8:00
KFVB	Hollywood, Calif.	352.7	850	1000	6:00-1:00	8:30-12:00	6:00-1:00	6:00-1:00	6:00-1:00	6:00-1:00	6:00-1:00
KFWI	San Francisco, Calif.	267.7	1120	500	6:00-2:30	9:50-1:00	6:00-1:00	6:00-1:00	6:00-1:00	6:00-1:00	6:00-1:00
KFWM	Oakland, Calif.	236.1	1270	500	10:00-12:00	9:30-1:00	10:00-12:00	10:00-12:00	10:00-12:00	10:00-12:00	10:00-12:00
KGA	Spokane, Wash.	260.7	1150	2000	8:15-2:00	9:30-10:00	8:15-2:00	8:15-2:00	8:15-2:00	8:15-2:00	8:15-2:00
KGEF	Los Angeles, Calif.	263	1140	500	8:00-12:00	8:00-12:30	8:00-12:00	8:00-12:00	8:00-12:00	8:00-12:00	8:00-12:00
KGO	Oakland, Calif.	384.4	780	5000	10:00-2:00	7:30-12:00	10:00-11:00	10:00-1:00	10:00-2:00	10:00-1:00	10:00-2:00
KGW	Portland, Ore.	491.5	610	1090	8:00-2:00	9:00-1:00	8:00-1:00	9:00-1:00	8:00-2:00	8:00-2:00	8:00-2:00
KHJ	Los Angeles, Calif.	399.8	750	1000	6:00-1:00	6:00-12:00	6:00-1:00	6:00-1:00	6:00-1:00	6:00-1:00	6:00-1:00
KHQ	Spokane, Wash.	370.2	810	1000	8:00-12:00	4:00-12:00	8:00-12:00	8:00-12:00	8:00-12:00	8:00-12:00	8:00-12:00
KJR	Seattle, Wash.	348.6	860	2500	6:00-2:00	8:15-12:00	6:00-2:00	6:00-2:00	6:00-2:00	6:00-2:00	6:00-2:00
KLDS	Independence, Mo.	270.1	1110	1500	8:30-9:30	6:00-11:00	Silent	7:00-8:30	Silent	Silent	Silent
KLX	Oakland, Calif.	508.2	590	500	9:00-10:00	6:00-8:00	8:30-11:00	8:30-11:30	8:30-11:30	8:30-11:30	8:30-11:30
KLZ	Denver, Colo.	352.7	850	1000	8:30-1:00	8:00-12:00	9:30-11:30	9:30-12:00	9:30-12:00	Silent	8:30-12:30
KMA	Shenandoah, Ia.	394.5	760	1000	5:00-8:30	4:00-7:00	5:00-10:30	5:00-8:30	5:00-8:30	5:00-8:30	5:00-8:30
KMBC	Kansas City, Mo.	270.1	1110	1500	7:30-12:30	5:00-9:00	7:30-10:00	7:30-12:30	7:30-10:00	7:30-12:30	7:30-10:00
KMOX	St. Louis, Mo.	299.8	1000	5000	6:30-10:00	8:00-10:00	8:00-1:00	8:00-1:00	8:00-1:00	8:00-1:00	8:00-1:00
KMTR	Los Angeles, Calif.	526	370	500	7:30-1:00	7:30-8:30	7:30-1:00	7:30-1:00	7:30-1:00	7:30-1:00	7:30-1:00
KOA	Los Angeles, Calif.	336.9	890	500	9:00-4:00	8:30-12:30	9:00-2:00	9:00-2:00	9:00-2:00	9:00-2:00	9:00-2:00
KOIL	Denver, Colo.	325.9	920	2500	10:00-12:00	8:30-9:30	8:30-11:00	8:30-11:00	8:30-11:00	8:30-11:00	8:30-11:00
KOIN	Council Bluffs, Ia.	319	940	5000	7:00-1:00	7:00-1:00	7:00-1:00	7:00-1:00	7:00-1:00	7:00-1:00	7:00-1:00
KOMO	Portland, Ore.	319	940	1000	8:00-3:00	8:00-12:00	8:00-12:00	8:00-1:00	8:00-12:00	8:00-1:00	8:00-12:00
KPLA	Seattle, Wash.	305.9	980	1000	8:00-1:00	8:00-1:45	8:00-1:45	8:00-1:00	8:00-1:00	8:00-1:00	8:00-1:00
KPO	Los Angeles, Calif.	288.3	1040	500	8:00-1:00	9:00-12:00	8:00-1:00	8:00-1:00	8:00-1:00	8:00-1:00	8:00-1:00
KPO	San Francisco, Calif.	422.3	710	1000	8:30-12:00	7:30-12:00	8:30-12:30	8:30-12:30	8:30-12:30	8:30-12:30	8:30-12:30
KPRC	Houston, Texas.	293.9	1020	500	6:10-10:45	8:00-9:00	6:10-10:45				

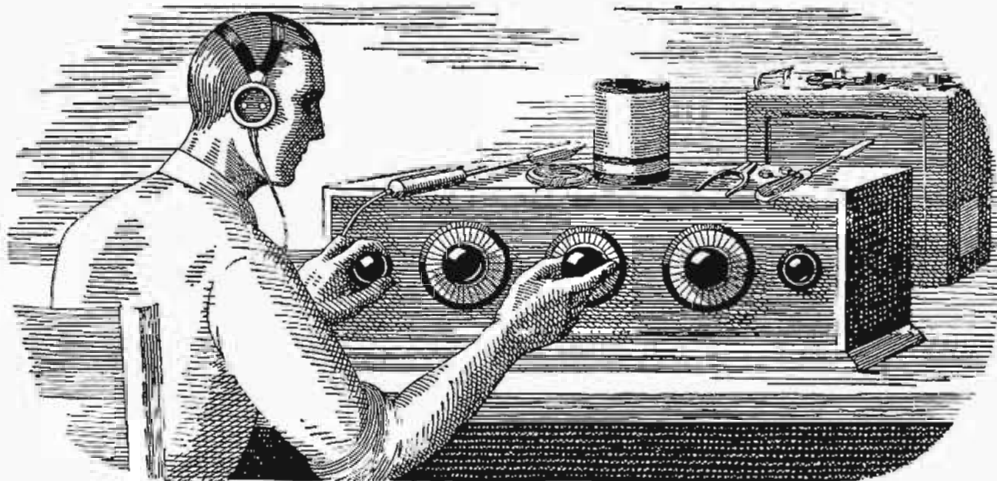

If all the Radio sets I've "fooled" with in my time were piled on top of each other, they'd reach about halfway to Mars. The trouble with me was that I thought I knew so much about Radio that I really didn't know the first thing. I thought Radio was a plaything—that was all I could see in it for me.

I Thought Radio Was a Plaything

But Now My Eyes Are Opened, And I'm Making Over \$100 a Week!

\$50 a week! Man alive, just one year ago a salary that big would have been the height of my ambition.

Twelve months ago I was scrimping along on starvation wages, just barely making both ends meet. It was the same old story—a little job, a salary just as small as the job—while I myself had been dragging along in the rut so long I couldn't see over the sides.

If you'd told me a year ago that in twelve months' time I would be making \$100 and more every week in the Radio business—whew! I know I'd have thought you were crazy. But that's the sort of money I'm pulling down right now—and in the future I expect even more. Why, only today—

But I'm getting ahead of my story. I was hard up a year ago because I was kidding myself, that's all—not because I had to be. I could have been holding then the same sort of a job I'm holding now, if I'd only been wise to myself. If you've fooled around with Radio, but never thought of it as a serious business, maybe you're just in the same boat I was. If so, you'll want to read how my eyes were opened for me.

When broadcasting first became the rage, several years ago, I first began my dabbling with the new art of Radio. I was "nuts" about the subject, like many thousands of other fellows all over the country. And no wonder! There's a fascination—something that grabs hold of a fellow—about twirling a little knob and suddenly listening to a voice speaking a thousand miles away! Twirling it a little more and listening to the mysterious dots and dashes of steamers far at sea. Even today I get a thrill from this strange force. In those days, many times I stayed up almost the whole night trying for DX. Many times I missed supper because I couldn't be dragged away from the latest circuit I was trying out.

I never seemed to get very far with it, though. I used to read the Radio magazines and occasionally a Radio book, but I never understood the subject very clearly, and lots of things I didn't see through at all.

So, up to a year ago, I was just a dabbler—I thought Radio was a plaything. I never realized what an enormous, fast-growing industry Radio had come to be—employing thousands and

thousands of trained men. I usually stayed home in the evenings after work, because I didn't make enough money to go out very much. And generally during the evening I'd tinker a little with Radio—a set of my own or some friend's. I even made a little spare change this way, which helped a lot, but I didn't know enough to go very far with such work.

And as for the idea that a splendid Radio job might be mine, if I made a little effort to prepare for it—such an idea never entered my mind. When a friend suggested it to me one year ago I laughed at him.

"You're kidding me," I said.
"I'm not," he replied. "Take a look at this ad."

He pointed to a page ad in a magazine, an advertisement I'd seen many times but just passed up without thinking, never dreaming it applied to me. This time I read the ad carefully. It told of many big opportunities for trained men to succeed in the great new Radio field. With the advertisement was a coupon offering a big free book full of information. I sent the coupon in, and in a few days received a handsome 64-page book, printed in two colors, telling all about the opportunities in the Radio field and how a man can prepare quickly and easily at home to take advantage of these opportunities. Well, it was a revelation to me. I read the book carefully, and when I finished it I made my decision.

What's happened in the twelve months since that day, as I've already told you, seems almost like a dream to me now. For ten of those twelve months, I've had a Radio business of my own. At first, of course, I started it as a little proposition on the side, under the guidance of the National Radio Institute, the outfit that gave me my Radio training. It wasn't long before I was getting so much to do in the Radio line that I quit my measly little clerical job, and devoted my full time to my Radio business.

Since that time I've gone right on up, always under the watchful guidance of my friends at the National Radio Institute. They would have given me just as much help, too, if I had wanted to follow some other line of Radio besides building my own retail business—such as broadcasting, manufacturing, experimenting, sea operating, or any one of the score of lines they prepare you for. And to think

that until that day I sent for their eye-opening book, I'd been wailing "I never had a chance!"

Now I'm making, as I told you before, over \$100 a week. And I know the future holds even more, for Radio is one of the most progressive, fastest-growing businesses in the world today. And it's work that I like—work a man can get interested in.

Here's a real tip. You may not be as bad off as I was. But think it over—are you satisfied? Are you making enough money, at work that you like? Would you sign a contract to stay where you are now for the next ten years—making the same money? If not, you'd better be doing something about it instead of drifting.

This new Radio game is a live-wire field of golden rewards. The work, in any of the 20 different lines of Radio, is fascinating, absorbing, well paid. The National Radio Institute—oldest and largest Radio home-study school in the world—will train you inexpensively in your own home to know Radio from A to Z and to increase your earnings in the Radio field.

Take another tip—No matter what your plans are, no matter how much or how little you know about Radio—clip the coupon below and look their free book over. It is filled with interesting facts, figures, and photos, and the information it will give you is worth a few minutes of anybody's time. You will place yourself under no obligation—the book is free, and is gladly sent to anyone who wants to know about Radio. Just address J. E. Smith, President National Radio Institute, Dept. 3PP, Washington, D. C.

J. E. SMITH, President,
National Radio Institute,
Dept. 3PP, Washington, D. C.

Dear Mr. Smith:

Please send me your 64-page free book, printed in two colors, giving all information about the opportunities in Radio and how I can learn quickly and easily at home to take advantage of them. I understand this request places me under no obligation, and that no salesman will call on me.

Name.....

Address.....

Town.....State.....

Occupation.....

Call	Location	Meters	Kilo.	Watts	Saturday	Sunday	Monday	Tuesday	Wednesday	Thursday	Friday
KYA	San Francisco, Calif.	361.2	830	1000	7:30-3:00	9:30-10:30	7:30-12:00	7:30-1:00	7:30-12:00*	7:30-1:00	7:30-12:00
KYW	Chicago, Ill.	526	570	2500	6:00-11:00	7:15-11:00	6:00-11:00	6:00-11:00	6:00-11:00	6:00-11:00	6:00-11:00
WAAM	Newark, N. J.	267.7	1120	250	7:00-9:00	Silent	9:00-11:00	5:00-7:00	5:00-7:00	5:00-7:00	5:00-7:00
WABC	Richmond Hill, N. Y.	309.1	970	2500	3:00-11:30	3:00-9:30	3:00-11:30	3:00-11:30	3:00-11:30	3:00-11:30	3:00-11:30
WADC	Akron, Ohio	238	1260	1000	7:00-10:00	7:00-10:00	7:00-10:00	7:00-10:00	7:00-10:00	7:00-10:00	7:00-10:00
WAIU	Columbus, Ohio	282.8	1060	5000	Silent	7:30-10:00	6:00-10:00	5:00-6:00	8:00-10:00	5:00-6:00	6:00-10:00
WBAL	Baltimore, Md.	285.5	1050	500	5:30-10:00	5:30-8:00	5:00-10:00	5:00-10:00	5:00-10:00	5:00-10:00	5:00-10:00
WBAP	Ft. Worth, Texas	499.7	600	5000	6:00-12:00	6:00-12:00	6:00-12:00	6:00-9:00	6:00-9:00	6:00-12:00	6:00-9:00
WBWA	Nashville, Tenn.	239.9	1250	500	5:00-10:00	7:00-9:00	5:00-12:00	5:00-9:00	5:00-9:00	5:00-9:00	5:00-9:00
WBBC	Brooklyn, N. Y.	227.1	1320	500	8:00-9:45	2:00-11:00	6:00-11:00	9:30-11:00	5:00-11:00	6:00-9:00	5:00-11:00
WBMM	Chicago, Ill.	389.4	770	5000	7:00-2:00	12:00-3:00	6:00-10:00	7:00-11:00	7:00-11:00	7:00-11:00	7:00-11:00
WBRR	Rossville, N. Y.	256.3	1170	1000	Silent	6:00-8:00	6:00-8:00	6:00-8:00	Silent	6:00-8:00	6:00-8:00
WBET	Medford, Mass.	288.3	1040	500	5:30-10:00	5:30-10:00	5:30-10:00	5:30-10:00	5:30-10:00	5:30-10:00	5:30-10:00
WBNY	New York, N. Y.	236.1	1270	500	5:00-11:00	5:00-6:00	Silent	5:00-11:00	5:00-11:00	5:00-11:00	5:00-11:00
WBT	Charlotte, N. C.	258.5	1160	750	5:00-11:30	Silent	5:00-11:00	6:00-11:30	6:00-10:00	6:00-11:00	6:00-11:30
WBZ	Springfield, Mass.	333.1	900	15000	5:00-10:30	5:00-10:30	5:00-10:00	5:00-10:30	5:00-10:30	5:00-10:30	5:00-10:30
WCAC	Mansfield, Conn.	535.4	560	500	6:00-7:00	Silent	6:00-6:30	Silent	6:00-6:30	Silent	Silent
WCAE	Pittsburgh, Pa.	461.3	650	500	5:00-9:00	6:15-9:00	5:00-9:00	5:00-9:00	5:00-9:00	5:00-9:00	5:00-9:00
WCAM	Camden, N. J.	223.7	1340	500	Silent	Silent	6:30-9:30	Silent	6:30-9:30	Silent	6:30-9:30
WCAU	Philadelphia, Pa.	260.7	1150	500	5:30-10:00	1:00-10:00	4:30-10:30	4:00-10:30	4:30-11:00	4:30-11:00	4:30-10:00
WCBD	Zion, Ill.	344.6	870	5000	Silent	8:00-10:30	Silent	8:00-10:30	Silent	8:00-10:30	Silent
WCCO	Minneapolis, Minn.	402.5	740	5000	6:15-11:00	7:15-10:15	6:30-11:00	6:00-11:00	6:00-12:30	6:00-10:00	7:00-11:00
WCFL	Chicago, Ill.	483.6	620	1500	4:00-12:00	7:30-9:30	4:00-12:00	4:00-12:00	4:00-12:00	4:00-12:00	4:00-12:00
WCGU	Coney Island, N. Y.	218.8	1370	500	Silent	Silent	Silent	Silent	7:00-9:00	Silent	7:00-9:00
WCOA	Pensacola, Fla.	249.9	1200	500	Silent	7:25-8:25	8:00-11:00	Silent	8:00-11:00	Silent	8:00-11:00
WCRC	Chicago, Ill.	223.7	1340	500	9:30-10:30	Silent	Silent	9:30-10:30	9:30-10:30	9:30-10:30	9:30-10:30
WCSS	Portland, Me.	214.2	1400	500	6:00-10:00	6:30-8:45	7:30-11:00	6:00-10:30	6:30-11:00	6:30-8:30	8:00-10:00
WDAE	Tampa, Fla.	267.7	1120	500	6:30-10:30	6:30-8:15	6:30-10:30	6:30-3:30	6:30-10:30	6:30-3:30	6:30-10:30
WDAF	Kansas City, Mo.	370.2	810	1000	6:00-1:00	8:15-9:45	6:00-1:00	6:00-1:00	6:00-1:00	6:00-1:00	6:00-1:00
WDBO	Orlando, Fla.	288.3	1040	500	8:00-10:00	6:30-8:30	6:15-1:00	7:30-10:00	Silent	8:15-10:30	6:30-8:00
WDOD	Chattanooga, Tenn.	243.8	1230	500	9:00-10:00	6:30-9:00	6:00-10:00	6:45-10:00	6:45-10:00	Silent	6:45-10:00
WDRC	New Haven, Conn.	282.8	1060	500	Silent	6:00-7:00	4:00-9:00	4:00-9:00	4:00-9:00	4:00-9:00	4:00-9:00
WEAF	New York, N. Y.	491.5	610	50000	5:00-11:00	2:00-10:15	5:00-11:00	5:00-11:00	5:00-11:00	5:00-11:00	5:00-11:00
WEAN	Providence, R. I.	275.1	1090	500	5:30-10:30	4:30-10:00	5:30-10:30	5:30-10:30	5:30-10:30	5:30-10:30	5:30-10:30
WEBS	Chicago, Ill.	365.6	820	500	7:00-2:00	7:30-9:00	7:00-11:00	7:00-11:00	7:00-11:00	7:00-11:00	7:00-11:00
WEI	New York, N. Y.	256.3	1170	500	Silent	Silent	Silent	Silent	Silent	Silent	Silent
WENR	Boston, Mass.	508.2	590	500	4:30-10:00	5:30-9:15	4:30-10:00	4:30-10:00	4:30-10:00	4:30-10:00	4:30-10:00
WENR	Chicago, Ill.	288.3	1040	500	6:00-12:00	6:00-11:00	6:00-12:00	6:00-12:00	6:00-12:00	6:00-12:00	6:00-12:00
WEVD	Woodhaven, N. Y.	245.8	1220	500	6:00-8:30	Silent	Silent	8:00-11:00	Silent	8:00-11:00	Silent
WFAA	Dallas, Tex.	545.1	550	500	6:00-12:00	6:00-12:00	6:00-10:00	6:00-12:00	6:00-10:00	6:00-10:00	6:00-10:00
WFAN	Philadelphia, Pa.	223.7	1340	500	5:00-11:00	7:00-10:00	Silent	4:30-12:00	Silent	4:30-12:00	Silent
WFBL	Syracuse, N. Y.	258.5	1160	750	5:20-11:00	5:00-11:00	5:20-11:00	5:20-11:00	5:20-11:00	5:20-11:00	5:20-11:00
WFBM	Indianapolis, Ind.	275.1	1090	1000	Silent	8:00-9:00	5:00-11:00	5:00-11:00	5:00-11:00	5:00-11:00	5:00-11:00
WFI	Philadelphia, Pa.	405.2	740	500	7:00-10:00	Silent	Silent	7:00-10:30	Silent	7:00-10:00	Silent
WFIW	Hopkinsville, Ky.	227.1	1320	500	8:00-11:00	Silent	8:00-11:00	Silent	8:00-11:00	8:00-4:00	8:00-11:00
WFLA	Clearwater, Fla.	516.9	580	750	6:45-11:00	Silent	6:45-11:00	6:45-11:00	6:45-11:00	6:45-11:00	6:45-11:00
WGBS	New York, N. Y.	348.6	860	500	6:30-8:00	8:15-9:15	Silent	6:30-9:00	8:00-9:00	9:00-10:00	Silent
WGCP	Newark, N. J.	267.7	1120	500	9:00-11:00	Silent	5:00-7:00	5:00-11:00	5:00-9:00	5:00-9:00	5:00-7:00
WGES	Chicago, Ill.	241.8	1240	500	7:30-1:00	7:30-1:00	7:30-9:30	8:30-11:00	7:30-12:30	7:30-12:30	7:30-2:00
WGHP	Mt. Clemens, Mich.	277.6	1080	750	Silent	8:00-11:00	8:00-10:00	7:00-9:00	8:00-10:00	7:00-9:00	8:00-10:00
WGL	New York, N. Y.	293.9	1020	500	5:00-8:00	6:00-11:00	8:00-11:00	5:00-8:00	8:00-11:00	5:00-8:00	8:00-11:00
WGN	Chicago, Ill.	416.4	720	500	6:00-12:00	6:50-12:00	6:00-12:00	6:00-12:00	6:00-12:00	6:00-12:00	6:00-12:00
WGR	Buffalo, N. Y.	302.8	990	750	7:00-8:00	6:45-9:00	5:15-11:00	7:00-10:00	7:00-11:00	7:00-11:00	7:00-11:00
WGWB	Milwaukee, Wis.	218.8	1370	500	Silent	6:00-7:00	8:00-10:30	Silent	8:00-9:00	Silent	9:00-10:30
WGY	Schenectady, N. Y.	379.5	790	50000	5:30-11:00	2:30-9:45	5:30-10:00	5:30-12:00	5:30-10:00	5:30-11:30	5:30-10:00
WHAD	Milwaukee, Wis.	270.1	1110	500	Silent	Silent	7:30-8:00	7:30-8:00	7:30-8:00	7:30-8:00	7:30-9:30
WHAM	Rochester, N. Y.	280.2	1070	5000	5:30-10:30	5:30-10:00	5:30-10:00	5:30-10:00	5:30-10:00	5:30-10:00	5:30-10:00
WHAP	Carlstadt, N. J.	236.1	1270	1000	6:00-10:30	6:30-8:30	5:00-8:00	Silent	8:00-10:30	5:00-8:00	Silent
WHAS	Louisville, Ky.	322.4	930	500	7:00-9:30	6:20-9:15	7:00-9:30	7:00-9:30	7:00-9:30	7:00-9:30	7:00-9:30
WHAZ	Troy, N. Y.	305.9	980	500	Silent	Silent	7:00-11:00	Silent	Silent	Silent	Silent
WHB	Kansas City, Mo.	340.7	880	500	8:00-10:00	6:30-1:00	7:00-10:00	7:00-10:00	7:00-8:00	7:00-10:00	7:00-8:00
WHBC	Rochester, N. Y.	254.1	1180	500	7:00-8:00	6:30-9:00	7:00-8:00	7:00-8:00	7:00-8:00	7:00-8:00	7:00-8:00
WHK	Cleveland, Ohio	265.3	1130	500	5:00-9:00	4:30-8:30	5:00-9:00	5:00-9:00	5:00-9:00	5:00-11:00	5:00-9:00
WHN	New York, N. Y.	394.5	760	500	5:00-11:30	4:00-10:00	5:00-11:30	5:00-11:30	5:00-11:30	5:00-11:30	5:00-11:30
WHO	Des Moines, Ia.	535.4	560	5000	5:30-11:00	5:30-8:30	5:30-11:00	5:30-11:00	5:30-11:00	5:30-11:00	5:30-11:00
WHT	Chicago, Ill.	305.9	980	5000	6:00-12:00	6:00-10:00	Silent	6:00-10:00	6:00-10:00	6:00-12:00	6:00-12:00
WIBO	Chicago, Ill.	305.9	980	5000	7:00-11:00	7:00-1:00	Silent	7:00-11:00	7:00-11:00	7:00-11:00	7:00-11:00
WICC	Eaton, Conn.	265.3	1130	500	6:00-10:00	6:30-8:30	6:00-10:00	6:00-10:00	6:00-10:00	6:00-10:00	6:00-10:00
WIP	Philadelphia, Pa.	348.6	860	500	8:00-10:30	6:45-7:45	5:30-6:30	6:00-10:00	7:00-8:00	7:00-9:00	5:30-6:30
WJAD	Waco, Texas	333.1	900	500	6:00-7:30	6:30-7:30	6:00-7:30	6:00-7:30	6:00-7:30	6:00-7:30	6:00-7:30
WJAR	Providence, R. I.	483.6	620	500	6:45-9:00	5:30-9:15	6:30-9:30	6:00-9:30	6:30-9:00	6:30-9:00	7:00-10:00
WJAS	Pittsburgh, Pa.	270.1	1110	500	7:00-10:00	8:00-9:00	8:00-10:00	7:00-10:00	8:00-10:00	7:00-10:00	8:00-10:00
WJAX	Jacksonville, Fla.	340.7	880	1000	6:30-10:00	5:30-10:00	6:30-10:00	6:30-10:30	Silent	6:30-10:00	6:30-10:30
WJAY	Cleveland, Ohio	227.1	1320	500	5:00-11:00	5:30-10:00	5:00-11:00	5:00-11:00	5:00-11:00	5:00-11:00	5:00-11:00
WJAZ	Mt. Prospect, Ill.	263	1320	500	7:00-11:00	7:30-9:30	Silent	7:00-11:00	7:00-11:00	9:00-12:00	7:00-11:00
WJBT	Chicago, Ill.	389.4	770	500	11:00-12:00	2:30-12:00	10:00-11:00	11:00-12:00	11:00-12:00	11:00-12:00	11:00-12:00
WJDD	Chicago, Ill.	356.6	820	1000	8:00-11:00	9:00-10:15	8:00-12:00	8:00-12:00	8:00-12:00	8:00-1:00	8:00-1:00
WJKS	Gary, Ind.	232.4	1290	500	7:00-1:00	7:00-12:00	7:00-1				

The Day-Dreamer

Will he ever wake up?

HIS life is made up of rosy visions. He sees himself in a manager's office—as the president of a firm—with a \$20,000 salary—perhaps even as a millionaire with a Rolls Royce, a rakish yacht and a swell country estate.

But all this grandeur is in his day dreams. He lives in the golden PARADISE OF TOMORROW—and it never comes.

He does nothing with the opportunities that surround him TODAY.

He feels above his present job. He is always “going to find a place where his abilities will be appreciated.” But he NEVER DOES.

He is the despair of his employers, for they know that he REALLY HAS ABILITY. He can plan with intelligence, he has original ideas, imagination. If he could only concentrate on today, instead of TOMORROW, he might have all the prosperity he craves!

What he needs is a STICK OF DYNAMITE—anything to wake him up and teach him to get results from his abilities NOW.

If he doesn't give himself a rousing jolt, he will complain more and more of not being “appreciated”—and gradually “peter out” into a failure—A JOB COWARD—a cog in a business machine.

He will always be somebody else's servant, instead of master of his own destiny.

How does he get into such a mental state? Because he uses only about ONE-TENTH of his mental energies in doing the vital things that count. Psychologists have proved that most of us use NINE-TENTHS of our brain power in day-dreaming, fortune-wishing, aimless time-killing. We are nearly all victims of the vicious habit of living far below our God-given endowments!

It doesn't help to learn that certain of your mental abilities have become WEAK THROUGH DISUSE, just as unused muscles do. Nobody knows better than you (if you are honest with yourself) that there must be a “screw loose somewhere.” The proof of it is that you have failed to reach the high mark you ONCE set for yourself.

You admit it. What you want to know is, WHAT CAN BE DONE ABOUT IT?

There is one very simple thing that you CAN do—now. You can find out what Pelmanism has done for 650,000 men and women, some of whom were facing THE VERY SAME DISSATISFACTION with their attainments that you are feeling. Pelmanism developed the mental powers they lacked—it replaced procrastination with “do it now” efficiency; it put concentration in the place of mind-wandering; it substituted self-confidence for self-distrust. You will learn how Pelmanism has often awakened abilities which the individuals did not DREAM they possessed!

Since Pelmanism is the science of applied psychology, it brings SELF-REALIZATION to all classes and conditions of men and women—prominent and famous as well as obscure and unknown. And among the better known persons who use and advocate it are:

- T. P. O'Connor, “The Father of the House of Commons”
- General Sir Robert Baden Powell, Founder of the Boy Scout Movement
- Judge Ben B. Lindsey, Founder of the Juvenile Court, Denver
- Frank P. Walsh, Former Chairman of the National War Labor Board
- Jerome K. Jerome, Novelist

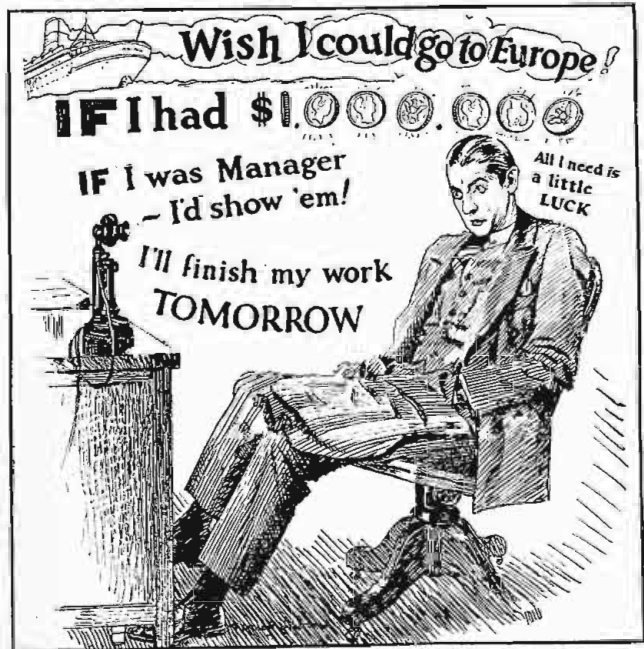

- General Sir Frederick Maurice, Director of Military Operations, Imperial General Staff
- Admiral Lord Beresford, G.C.B., G.C.V.O.
- Sir Harry Lauder, Comedian
- W. L. George, Author
- Baroness Orczy, Author
- Prince Charles of Sweden
- and hundreds of others of equal prominence.

A remarkable book called “Scientific Mind-Training” has been written about Pelmanism. IT CAN BE OBTAINED FREE. Yet thousands of people who read this announcement and who NEED this book will not send for it. “It's no use,” they will say. “It will do me no good,” they will tell themselves. “It's all tommyrot,” others will say.

But if they will use their HEADS, they will realize that people cannot be HELPED by tommyrot and that there MUST be something in Pelmanism, when it has such a record with 650,000 different individuals, and when it is endorsed by the kind of people listed above.

If you are made of the stuff that isn't content to keep on “putting off” all the good things of life—if you have a spark of INDEPENDENCE left in your soul, write for this free book. It tells you what Pelmanism is, WHAT IT HAS DONE FOR OTHERS, and what it can do for you.

The first principle of YOUR success is to do something radical in your life. You cannot make just an ordinary move, for you will soon again sink into the mire of discouragement. Let Pelmanism help you FIND YOURSELF. Don't put it off. Mail the coupon below now—now, while your resolve to DO SOMETHING ABOUT YOURSELF is strong.

THE PELMAN INSTITUTE OF AMERICA
Approved as a Correspondence School under the laws of the State of New York

71 West 45th Street Dept. 1433 New York City

The Pelman Institute of America
71 West 45th Street, Dept. 1433
New York City

I want you to show me what Pelmanism has actually done for over 650,000 people. Please send me your free book, “Scientific Mind Training.” This places me under no obligation whatever.

Name

Address

City..... State.....

Call	Location	Meters	Kilo.	Watts	Saturday	Sunday	Monday	Tuesday	Wednesday	Thursday	Friday
WOO	Philadelphia, Pa.	348.6	860	500	6:30-7:30	6:30-7:30	6:30-10:30	6:30-7:30	6:30-7:30	6:30-7:30	6:30-10:30
WOOD	Grand Rapids, Mich.	260.7	1150	500	Silent	9:00-10:00	9:00-11:00	9:00-11:00	9:00-11:00	9:00-11:00	9:00-11:00
WOQ	Kansas City, Mo.	340.7	880	500	10:00-11:00	7:45-9:00	9:00-10:00	5:00-6:00	8:00-10:00	Silent	8:00-10:00
WOR	Newark, N. J.	422.3	710	5000	5:15-11:00	6:45-10:00	5:15-11:00	5:15-11:00	5:15-11:00	5:15-11:00	5:15-11:00
WORD	Batavia, Ill.	252	1190	5000	6:00-7:00	6:00-7:30	6:00-7:00	6:00-7:00	6:00-7:00	6:00-7:00	6:00-7:00
WOS	Jefferson City, Mo.	422.3	710	500	Silent	Silent	8:00-10:00	Silent	8:00-10:00	Silent	8:15-9:15
WOW	Omaha, Neb.	508.2	590	1000	6:00-11:00	6:00-10:15	6:00-11:00	6:00-11:00	6:00-11:00	6:00-11:00	6:00-11:00
WOWO	Ft. Wayne, Ind.	228.9	1310	5000	6:00-7:00	8:00-10:00	6:15-11:30	Silent	7:00-11:00	7:00-11:00	7:00-11:00
WPAP	Palisade, N. J.	394.5	760	500	7:00-8:00	Silent	7:00-8:00	7:30-8:30	7:00-8:00	7:00-8:00	7:30-8:30
WPCB	Hoboken, N. J.	325.9	920	500	8:00-1:00	5:30-11:00	6:00-11:00	3:00-6:00	5:00-8:00	3:00-11:00	Silent
WPC	Atlantic City, N. J.	272.6	1100	5000	5:45-11:30	8:15-10:30	5:45-11:30	5:45-11:30	5:45-11:30	5:45-11:30	5:45-11:30
WPTF	Raleigh, N. C.	545.1	550	500	Silent	6:30-7:30	5:00-7:00	Silent	5:00-7:00	Silent	5:00-7:00
WQAM	Miami, Fla.	384.4	780	750	6:00-8:30	6:00-8:00	6:00-8:30	6:00-11:00	6:00-8:30	6:00-8:30	6:00-11:00
WRC	Washington, D. C.	468.5	640	500	5:00-10:00	5:00-8:30	5:00-10:00	5:00-10:00	5:00-10:00	5:00-10:00	5:00-10:00
WREN	Lawrence, Kans.	254.1	1180	750	8:00-9:30	7:00-8:30	8:00-9:30	8:00-9:30	8:00-9:30	8:00-9:30	8:00-9:30
WRHM	Minneapolis, Minn.	260.7	1150	1000	6:00-10:00	7:45-8:45	8:00-10:00	Silent	8:00-10:00	Silent	8:00-10:00
WRNY	New York, N. Y.	325.9	920	500	6:00-10:00	7:30-10:30	6:00-11:00	6:00-10:00	6:00-10:00	6:00-10:00	6:00-10:00
WRR	Dallas, Texas	461.3	650	500	6:00-11:00	7:00-8:00	6:00-11:00	6:00-11:00	6:00-11:00	6:00-11:00	6:00-11:00
WRVA	Richmond, Va.	254.1	1180	1000	Silent	7:00-8:00	6:00-11:00	6:00-11:00	6:00-11:00	6:00-11:00	6:00-11:00
WSB	Atlanta, Ga.	475.9	630	1000	8:00-12:00	6:15-9:15	8:00-12:00	8:00-12:00	8:00-12:00	8:00-12:00	8:00-12:00
WSBC	Chicago, Ill.	232.4	1290	500	6:30-1:00	5:00-7:00	9:00-1:00	6:30-1:00	6:30-1:00	9:00-1:00	6:30-1:00
WSBT	South Bend, Ind.	399.8	750	500	6:00-7:00	Silent	9:30-11:30	Silent	Silent	9:00-11:30	10:00-12:00
WSM	Nashville, Tenn.	336.9	890	5000	6:00-11:00	6:20-9:15	6:00-11:00	6:00-11:00	6:00-11:00	6:15-11:00	8:00-10:00
WSMB	New Orleans, La.	296.9	1010	500	8:30-10:30	Silent	8:30-10:30	Silent	8:30-10:30	8:30-10:30	6:00-11:00
WSUN	St. Petersburg, Fla.	516.9	580	750	6:00-11:00	Silent	Silent	6:00-11:00	Silent	6:00-11:00	Silent
WTAG	Worcester, Mass.	516.9	580	250	6:00-9:00	6:20-8:16	6:00-11:00	6:00-11:00	6:00-11:00	6:00-11:00	6:00-11:00
WTAM	Cleveland, Ohio	399.8	750	3500	5:00-11:00	5:00-11:00	5:00-11:00	5:00-11:00	5:00-11:00	5:00-11:00	5:00-11:00
WTAR	Norfolk, Va.	236.1	1270	500	5:00-10:00	6:00-8:00	5:00-10:00	5:00-10:00	5:00-10:00	5:00-10:00	5:00-10:00
WTIC	Hartford, Conn.	535.4	560	500	5:30-10:00	2:00-8:15	5:30-10:00	5:30-10:00	5:30-10:00	5:30-10:00	5:30-10:00
WTMJ	Milwaukee, Wis.	293.9	1020	1000	6:00-12:00	8:30-10:45	6:00-12:00	6:00-12:00	6:00-12:00	6:00-12:00	6:00-12:00
WWAE	Chicago, Ill.	227.1	1320	500	7:00-12:00	7:00-12:00	7:00-12:00	7:00-12:00	7:00-12:00	7:00-12:00	7:00-12:00
WWJ	Detroit, Mich.	352.7	850	1000	5:00-10:00	6:20-9:15	5:00-10:00	5:00-10:00	5:00-10:00	5:00-10:00	5:00-10:00
WWNC	Asheville, N. C.	296.9	1010	1000	6:00-7:00	6:30-7:30	6:00-7:00	6:00-9:30	6:00-7:00	5:30-11:00	6:00-7:00

Popular Songs Hits

(Continued from page 106)

- Some Sunday Morning, Gus Kahn, R. Egan and R. Whiting; Jerome H. Remick Co., 1917.
- Sometime, Ted Florito and Gus Kahn; J. H. Remick & Co., 1925.
- Somewhere in France Is a Lily, P. Johnson and J. E. Howard; M. Witmark & Sons, 1917.
- Somewhere in Ireland, J. K. Brennan and E. R. Ball; M. Witmark & Sons, 1917.
- Somewhere on Broadway, Stenly Murphy and H. Carroll; Jerome H. Remick Co., 1917.
- Spain, Isham Jones and Gus Kahn; Milton Weil, 1924.
- Starlight, D. Stamper and G. Buck; T. B. Harms & Co., 1918.
- Starlight Love, Geo. Tinhaus and L. Denni; M. Witmark & Sons, 1919.
- Steppin' Out, J. S. Howard and Con Conrad; J. H. Remick & Co., 1925.
- Suki San, J. K. Brennan and W. Donaldson; M. Witmark & Sons, 1917.
- Sunshine of Your Smile, L. Cook and Lillian Hay; Francis Day & Hunter, 1915.
- Sweet Emilia My Gal, Creamer and Layton; Broadway Music Corp., 1917.
- Sweet Georgia Brown, Ben Bernice and J. Casey and Marco; J. H. Remick & Co., 1925.
- Sweet Little You, I. M. Bibb; Maurice Abrams, Inc., 1924.
- Sweet Peaches, C. Gaskill and W. Donaldson; M. Witmark & Sons, 1918.
- Sweet Siamese, Ed Madden and Mary Earl; Shapiro, Bernstein & Co., 1919.
- Sweet Southern Breeze, Ted Florito and Gus Kahn; J. H. Remick & Co., 1926.
- Take This Rose, G. Kahn; Irving Berlin, Inc., 1925.
- Tea for Two, Irving Caesar and Vincent Youmans; Harms, Inc., 1924.
- Tell Me, Max Kortlander; Jerome H. Remick Co., 1919.
- Till I'm Cuddled by the Master Above, J. Donahue and E. R. Ball; M. Witmark & Sons, 1918.
- Till the Clouds Roll By, P. G. Wodehouse and Jerome Kern; T. B. Harms & Co., 1917.
- Till We Meet Again, R. Egan and R. Whiting; Jerome H. Remick Co., 1918.
- Thanks for the Buggy Ride, Jules Buffano; Ager, Yellen & Bernstein, Inc., 1925.
- That Certain Party, Walter Donaldson, Irving Berlin, Inc., 1925.
- That's the Kind of a Baby for Me, H. J. C. Egan, Art Music Co., 1917.
- That Naughty Waltz, Sol P. Levy and Edwin Stauder; Frontier Music Pub. Co., 1920.
- That Old Gang of Mine, Billy Rose, Ray Henderson and M. Dixon; Irving Berlin, Inc., 1923.
- That Red Headed Gal, W. Von and Schenck; Teddy Lodge, Rudolph Prinkl; Fred Fisher, Inc., 1923.
- That Soothing Serenade, Harry De Costa; M. Witmark & Sons, 1918.
- The Dark Town Strutter's Ball, Shelton Brooks; Will Rosenthal, 1917.
- The Daughter of Ross O'Grady, M. C. Price and Donaldson; M. Witmark & Sons, 1918.
- The Dixie Voluptues, E. Leslie and H. Ruby; Waterson, Berlin & Snyder, 1917.
- The Doo Doo Man, Marco Brown; Sherman Clay & Co., 1924.
- The Midnight Waltz, W. Donaldson and Gus Kahn; Leo Feist, 1925.

- The Missouri Waltz, J. V. Eppel; F. K. Logan, 1914.
- The Navy Took Them Over and Will Bring them Back, Ira Schuster and H. Johnson; Leo Feist, Inc., 1918.
- The Ragtime Volunteers Are Off to War, B. McDonald and J. Hanley; Shapiro, Bernstein & Co., 1917.
- The Rose That Will Never Die, Ted Snyder; Waterson, Berlin & Snyder, 1914.
- The Siren's Song, P. G. Wodehouse and J. Kern; T. L. Harms & Co., 1917.
- The Stormy Sea of Love, McDonald and Carroll; Shapiro, Bernstein & Co., 1916.
- The Vamp, Bryon Gay; Leo Feist, Inc., 1919.
- There's a Long, Long Trail, Stoddard King and Zo Elliott; West & Co., 1914.
- They're Wearing 'Em Higher in Hawaii, Joe Goodwin and H. Mohr; Shapiro, Bernstein & Co., 1916.
- There's Yes, Yes in Your Eyes, Cliff Friend and Joe Santly; J. H. Remick & Co., 1924.
- Tonight's My Night With Baby, Irving Ceasear and G. Meyer; Irving Berlin, Inc., 1926.
- Too Tired, Geo. A. Little and Arthur Seymour; Broadway Music Corp., 1924.
- Three Wonderful Letters From Home, Joe Goodwin and J. Hanley; Shapiro, Bernstein & Co., 1918.
- Turn Back the Universe and Give Me Yesterday, J. K. Brennan and E. R. Ball; M. Witmark & Sons, 1916.
- Ukulele Lady, Gus Kahn and R. Whiting; Irving Berlin, Inc., 1925.
- Uncle Tom, Hugo Frey; G. Ricordi & Co., 1916.
- Venetian Moon, Gus Kahn, P. Goldberg and F. Magine; Jerome H. Remick Co., 1920.
- Waiting, Harry L. Cort, Geo. Stoddard and H. Orlob; Shapiro, Bernstein & Co., 1918.
- Wait'll You See My Gal, Jerry Sullivan and Lucky Wilbur; Leo Feist, 1924.
- Wait Till the Cows Come Home, Anne Caldwell and Ivan Caryll; Chappel & Co., Ltd., 1917.
- Waltz With Me Waitzes, L. V. Gustin; Jerome H. Remick Co., 1915.
- What Does It Matter, Irving Berlin; Irving Berlin, Inc., 1927.
- What Do You Want to Make Those Eyes at Me For, Joe McCarthy, H. Johnson and J. Monaco; Leo Feist, Inc., 1916.
- What'll I Do, Irving Berlin; Irving Berlin, Inc., 1924.
- What'll We Do on a Saturday Night, Harry Ruby; Waterson, Berlin & Snyder, 1919.
- When Alexander Takes His Ragtime Band to France, E. Leslie, Alfred Bryon and Cliff Hess; Waterson, Berlin & Snyder, 1918.
- When Dreams Come True, S. Hein, Ray Webb and C. Bartholomae; T. B. Harms & Co., 1913.
- When He's All Dotted up He's the Best Dressed Babe in Town; M. Witmark & Sons, 1917.
- When I Hear a Synecgated Tune, Gene Buck and L. Hirsch; M. Witmark & Sons, 1918.
- When I Leave the World Behind, Irving Berlin; Waterson, Berlin & Snyder, 1915.
- When I See You, I See Red, White and Blue, Grant Clark and A. Gottler; Kalmar and Puck Pub. Co., 1917.
- When I Walk Out With You, F. Stammer and H. Orlob; T. B. Harms & Co., 1919.
- When It's Apple Blossom Time in Normandy, Mellor, Gefford and Trevor; Francis, Day and Hunter, 1912.

- When It's Circus Day Come Back Home, Jack Yellen and Jack Glogan; M. Witmark & Sons, 1917.
- When the Sun Goes Down in Dixieland, Chas. McCarron and Al Von Tilzer; Broadway Music Corp., 1917.
- When the Robert E. Lee Arrives in Old Tennessee All the Way From Gay Paree, Paul Cunningham and J. K. Brennan; M. Witmark & Sons, 1918.
- When You and I Were Seventeen, Chas. Rosoff and Gus Kahn; Irving Berlin, Inc., 1924.
- When You Come Back and You Will Come Back, Geo. M. Cohan; M. Witmark & Sons, 1918.
- When You Come Back, Hugo Frey; G. Ricordi & Co., 1917.
- When You're Away From the Only Girl, H. Blossom and V. Herbert; M. Witmark & Sons, 1914.
- Where Is That Old Girl of Mine, P. Jones; Irving Berlin, Inc., 1924.
- Where the Lazy Daisies Grow, Cliff Friend; J. H. Remick & Co., 1924.
- Why Did I Kiss That Girl, G. Brown, Robert King and R. Henderson; Shapiro, Bernstein & Co., 1924.
- Wild Flower, Geo. Briegel, Geo. Martens and Mary Earl; Shapiro, Bernstein & Co., 1920.
- Wonderful Pal, Maceo Pinkard; Shapiro, Bernstein & Co., 1920.
- Would You Take Back the Love You Gave Me, Al Dubin and E. R. Ball; M. Witmark & Sons, 1917.
- Yaaka, Hula, Hickey Dula, E. R. Goetz, Joe Young and Pete Wendling; Waterson, Berlin & Snyder, 1917.
- Yearning, Benny Davis; Irving Berlin, Inc., 1925.
- Yes, We Have No Bananas, F. Silver and Irving Cohen; Skidmore Music Co., 1923.
- Yes Sir That's My Baby, Gus Kahn and W. Donaldson; Irving Berlin, Inc., 1925.
- You Don't Have to Come From Ireland to Be Irish, Geo. Groff and Bert Grant; Waterson, Berlin & Snyder, 1917.
- You Leave Me Alone, W. E. West and J. Monaco; Irving Berlin, Inc., 1923.
- You'll Find Old Dixie Land in France, Geo. Meyer and Grant Clark; Leo Feist, Inc., 1918.
- You Never Knew About Me, P. G. Wodehouse and Jerome Kern; T. B. Harms & Co., 1917.
- You're Some Pretty Girl, Clarence Williams; Wm. Piron Music Pub. Co., 1917.
- You Said Something, P. G. Wodehouse and J. Kern; T. B. Harms & Co., 1916.
- Xvette, Jesse Winne; G. Ricordi & Co., 1916.

A COMPOSER'S fame is not affirmed by professional musicians but by the general public whose judgment in the end is infallible. A great masterpiece that is not destroyed will always eventually be recognized as such whether, like the Venus de Milo, it has lain hidden for centuries beneath the earth or, like the Matthew Passion of Bach, equally hidden in the dusty shelves of the Royal Library of Berlin, to be rediscovered by Mendelssohn and pronounced the greatest religious choral work ever written. —Walter Damrosch.

Know Old Masters

(Continued from page 73)

Weber. Period of poverty followed, ended by production in 1786 of "Marriage of Figaro." This success followed by greatest work, "Don Giovanni," in 1787. Other operas were "Cosi" and "Titus," not successful. In spite of failing health from overwork wrote "Magic Flute," produced 1791, and died some months later. Besides operas wrote much sacred and chamber music, many orchestral works, etc.

NEVIN, ETHELBERG (1862-1901). A popular American composer. Was born in Pennsylvania in 1862. Studied piano and composition in Boston. Then directed his attention to composing. Nearly all his compositions are lyrical—both for voice and the piano. His most famous composition is "The Rosary," although he wrote a great number of songs that are now well known. His lamentable early death occurred in 1901.

OFFENBACH, JACQUES (1819-1880). Known as the originator of French burlesque opera, was born in Cologne, the son of a Jewish cantor. In 1849 he became the director of the Theatre Francais, where many of his most popular operettas were later produced. The exceeding cleverness and animation of his music is everywhere recognized. His last and only really ambitious work, "The Tales of Hoffmann," has been produced many times of late in this country, and has countless admirers.

PUCCINI, GIACOMO (Poo-chee-nee). One of the most famous Italian composers of the Opera. He was born in 1858. His operas are among the most popular of the Italian repertoire at the present time. Puccini died in 1924.

PONCHIELLI, AMILCARE (Pohn-kee-el-ee) (1834-1886). Born in Cremona, Italy in 1834. He was the composer of many works, the most widely known being "La Gioconda," which he composed in 1876. His death occurred in 1886.

RIMSKY-KORSAKOW, NICHOLAS (1844-1908). Was one of the greatest masters of the Russian School. In 1861 he became interested seriously in his music. After a year's serious theoretical study he was ordered on a trip around the world in the Russian navy. He composed during this period a symphony which was the first work in this form ever written by a Russian. Later, he accepted the post of Director of the St. Petersburg Conservatory, a position he held until his death. He resigned from the navy in 1873, but still held the post of Inspector of Bands. The greatest of his thirteen operas are "Sadko," "The Snow Maiden" and "The Tsar's Bride."

ROSSINI, GIOACCHINO (Ros-see-nee). One of the greatest of Italian opera composers. Born Pesaro, Italy, 1792. Mother opera singer and father musician. Studied piano from 7. At 15 went to Bologna Conservatory. When 16 wrote cantata, and in 1810 an opera. During 1812 produced five light operas, and in 1813 first grand opera, "Tancredi," a success; then "Italian in Algiers." In 1816 produced his finest of comic operas, "Barber of Seville." In next eight years wrote twenty operas. Went to London, 1823, and produced his works with success. Went to Paris, managed Theatre Italien, producing his masterpiece, "William Tell." In 1832 wrote famous "Stabat Mater." Last years spent quietly and happily among devoted friends. Died in Paris, 1868.

RUBINSTEIN, ANTON GREGOR (Roo-bin-stine) (1830-1894). Was one of the greatest pianists the world has ever known. Rubinstein wrote many operas, for his chief wish was to be remembered as a composer and he placed great hope in the creation of what he called "Sacred Opera" (oratorio to be enacted with costume and scenery). In addition to this he produced many symphonies, piano concertos, chamber music compositions and over one hundred songs, yet he will live as a composer principally because of his piano compositions. His piano works are always melodious and of a simple, sincere beauty that makes an immediate appeal.

SAINT-SAENS, CAMILLE (San Sah(h) (1835-1921). A most important composer and dean of the modern French School. Saint-Saens was equally prominent as a pianist, organist, conductor and composer.

His works include symphonies, piano, violin compositions and a number of exquisite songs. "Samson and Delilah" is considered his greatest work. Saint-Saens possessed a rare gift of melody and, although he rarely departed from the strict classic forms in his instrumental works, they are always modern in spirit.

SCHUBERT, FRANZ PETER (1797-1828). Born near Vienna, 1797. Son of peasant schoolmaster. Boy taught violin and voice by local choirmaster. At 16 wrote 1st Symphony. At 17 began writing

(Continued on page 115)

**NOW
OPEN
HOTEL
PRESIDENT**

48th Street West of Broadway
NEW YORK

offers you a
Room with Private Bath
for \$2.50

A room with both Bath and Shower \$3
Rooms for Two at \$3.50 and \$4.00

SPECIAL WEEKLY RATES

LOCATION
"Just around the corner from Everything!"

THE PRESIDENT
awaits your visit

R. M^cCRIMMON
Resident Manager
PHONE: CHICKERING 7904

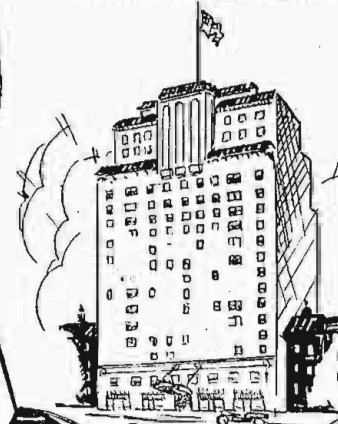

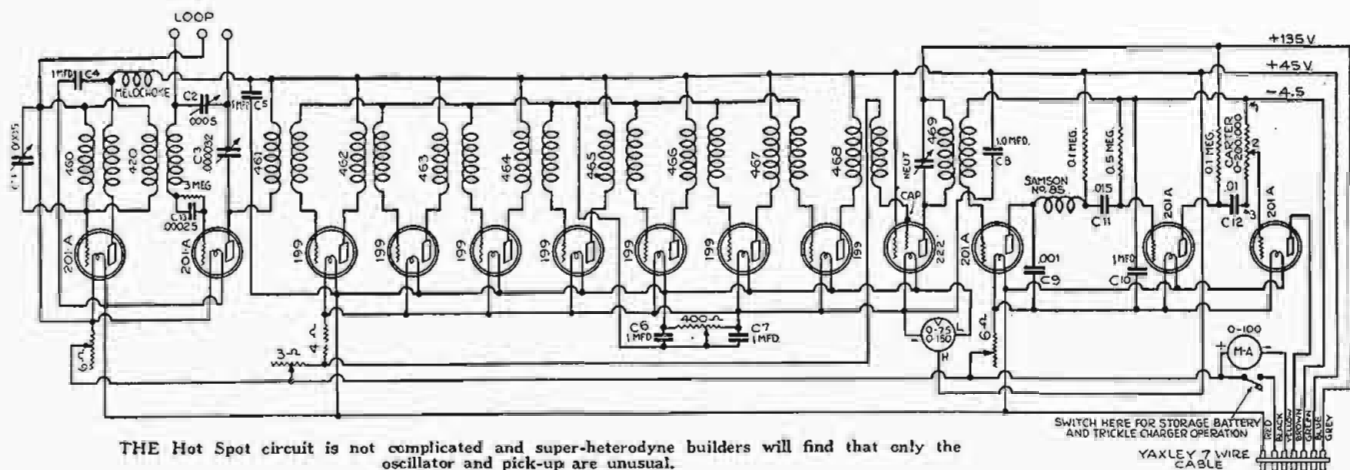

THE Hot Spot circuit is not complicated and super-heterodyne builders will find that only the oscillator and pick-up are unusual.

HOT SPOT FOURTEEN

(Continued from page 94)

need the .00025 mfd. mica condenser across one half of the input transformer due to a very high pitched whistle which will be noticeable. Occasionally this is not needed but we have found it needed 9 out of 10 times. This is no fault of the transformer but a condition seemingly a part of push pull assemblies with any units. As to just which half should be bridged with this condenser one cannot say in advance. Try it on one side, then the other. In one of these two positions, it eliminates the very faint high whistle.

PRESUMING you have 110 volts in your locality, not 105 or 120, you can set your sliders on the Electrad strip pretty closely from the pictures. These SHOULD be set, however, with a high resistance voltmeter. The slider to the left should be juggled until you get 4½ to 5 volts between the minus "C" winding post and the minus "B" post. The "B" post will be plus in relation to the "C" post. The "45" post is to be 45 volts plus to the minus "B" terminal, while the next one is to be 135 volts plus to the minus "B" post.

Now for mounting the Jensen speaker. First get a piece of ¼ inch plywood measuring 24 inches high and 25¼ inches wide. An 8½-inch circle is cut in this with the upper point of its circumference 1¼ inches from the upper edge of the board. This circle is midway between the two side edges. Looking into the Excello R-31 console from the rear, you will see a strip fastened horizontally back of the grill work and a few inches from the top. This is removed and not used, as it is only necessary when console is supplied with inbuilt speaker. The plywood baffle-plate now is set in and you will find that its edges just match the outer sides of the upright pieces each side of the grill. Four screws are put

through on each edge to hold it tightly in place.

Now cut a block of wood 1½ inch thick and just the size of the mounting base of the speaker unit. Drill holes through it to line up with the mounting holes of the base of the speaker unit. This speaker is mounted, seemingly, upside down and hung from the ceiling of the lower compartment of the console. Place the speaker in position with its base and the wood block against the ceiling of compartment and the circumference of the cone matching the 8½-in. circle cut in the baffle plate. It should press firmly against the baffle. Now have someone who is helping you push a drill up through the four holes that extend up through the wood block and the base of speaker unit, so a mark is made in the wood of the ceiling. Then drill holes through into the upper compartment, that will take 8-32 machine screws. One of these screws is now dropped through each hole from upper compartment, the block is slipped over them, then the base of the unit, and nuts turned up tightly to hold all in place. Speaker is NOT fastened to baffle-plate.

IF you are using battery, trickle charger and relay combination as "A" supply, plug the twisted light cord of the Thordarson transformer in the Power Amplifier into this "A" unit and drill a hole in bottom of cabinet for the twisted light cord of the "A" unit to go

to the wall socket. Make all connections as shown in the complete wiring diagram, insert tubes as shown, connect to the top of the 222 tube with a small clip of some kind. Connect the loop via the tip jacks on sub-base. When you turn on set switch, all tubes should light up in both units. Adjust the 3-ohm rheostat so that an "A" reading on the voltmeter (switch to left) shows 3 volts. If voltage will not come up to this, short circuit part of the fixed 4-ohm strip be-

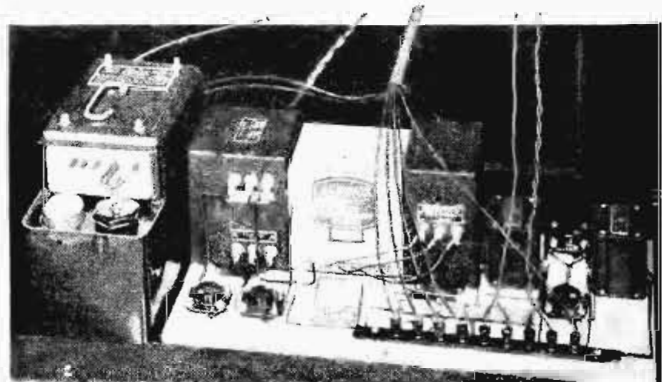

HERE we have the Power Unit and Abox "A" supply in lower compartment, connected to cable and Jensen speaker.

hind rheostat with a paper clip. Put the tips of a 0-7 or 0-10 voltmeter across the filament terminals of one of the sockets holding a 201A tube to the left, and adjust the front semi-fixed resistance on the sub-base so tube gets 5 volts. Do the same with one of the 201A tubes to the right and the 0-ohm semi-fixed resistance to the rear.

You are now ready to tune in some stations. Fuss around a bit for a few minutes, varying the potentiometer setting meanwhile, until you run into a

(Continued on page 115)

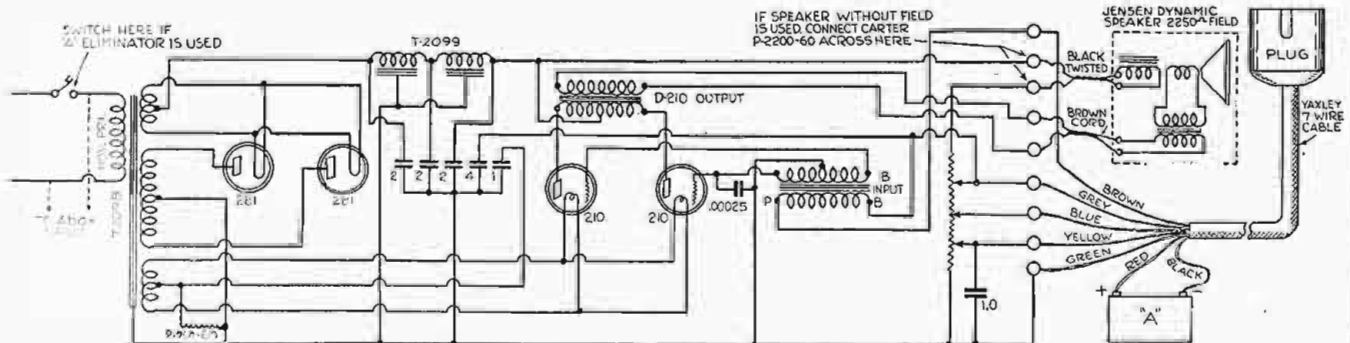

THIS circuit provides two 210 tubes as a push-pull last stage and complete "B" and "C" power to the receiver.

Know Old Masters

(Continued from page 113)

songs with remarkable facility—between 17 and 18 wrote 144 songs, including masterpiece, "Erlking."

Schubert led a somewhat Bohemian life, never married and was frequently out of funds. Was much underpaid, some of his best songs bringing only 20c each! Works numerous, including 600 songs, 10 symphonies, several overtures, much piano and chamber music, operas, etc. Schubert was the greatest of all song composers, and really creator of art of song. Also most remarkable of youthful writers. Died 1828, leaving many MSS. valued by Officials at \$12.50 (!), but which afterward made the fortune of several publishers.

SCHUMANN, ROBERT (1810-1856). Born Zwickau, Saxony. Son of bookseller. Learned piano at 6. Began composition at 7. When 16 father died; boy went Heidelberg University. Studied piano at Leipsic; injured finger and turned to composition, first piano, and, after marriage to Clara Wieck, famous pianist, other forms of composition. Toured Russia, 1844; lived Dresden, 1845; Director of Musical Society Dusseldorf, 1850. Wrote symphonies, one opera, "Genoveva," and many other works, including his great series of songs, composing 130 of these in one year.

SOUSA, JOHN PHILIP. Born Washington, D. C., 1856. Violinist in Offenbach's Company, 1877. Leader of U. S. Marine Band, 1880-1892. Founded band of his own (see below). U. S. N. R. F. and conductor Great Lakes Naval Band during war. Composer of comic operas and marches.

STRAUSS RICHARD, of Vienna, is undoubtedly one of the greatest musicians of today. He has been called the dean of living composers. For many years he has been the presiding musical genius of the Vienna opera.

His phenomenal creative powers, his genius for interpretation so evident in his performance in conducting the great Strauss Symphony Orchestra, sets him apart in that order of musical geniuses which numbers only one or two in a generation. It is remarkable that one man should be endowed with so many talents, for Richard Strauss, the conductor, is equally as famous as Richard Strauss, the composer. He has composed many very beautiful songs, and contributed generously to different forms of music—symphony, symphonic poem, song literature, opera.

When Strauss last toured the United States with his great symphony orchestra he received the highest honors that the American press and public could bestow.

SULLIVAN, SIR ARTHUR SEYMOUR (1842-1900). Celebrated British composer, of Irish parentage, best known to the world through his inimitably clever and witty comic operas, written in collaboration with W. S. Gilbert. The success of practically all of these works has been unexampled in America and Great Britain. Many of Sullivan's songs are also great favorites, notably his "Lost Chord."

TCHAIKOVSKY, PETER ILYITCH (1840-1893). The most distinguished of Russian composers and the greatest representative of what is known as the modern Russian school was trained mostly, under Rubinstein in Petrograd; from 1856 to 1877 instructor of harmony in Conservatory of Petrograd. Visited New York in 1891 at the dedication of Carnegie Hall. Is known as one of the greatest and most powerful of orchestral composers; also wrote numerous operas, few of which have been produced outside of his native land.

THOMAS, AMBROISE (1811-1896). Famous French dramatic composer; gave to the world numerous dramatic works, of which "Mignon" has done most to perpetuate his name. "Hamlet," "Le Caid" and "Raymond" have also had their share of popularity.

VERDI, FORTUNIO GIUSEPPE FRANCESCO (Vair-dee). Born 1813, near Roncole, Italy. Parents, though poor inn-keepers, gave him spinet lessons from parish organist. At 10 succeeded his teacher at church organ. Boy became so popular that village sent him to Milan for further study, where director of Conservatory refused scholarship because of lack of talent! (Many years after, this same institution was renamed Cons. di Giuseppe Verdi in Verdi's honor.) Then studied with Lavigna, returning to Roncole to marry Sirta Barezzi. Settled permanently in Milan, 1836. Died in 1901.

WAGNER, RICHARD (Vahg-ner). Born Leipsic, 1813, son of city official. Father died, mother married Geyer, actor, when Wagner was 6.

(Continued on page 117)

Hotel Century

111 West 46th Street

Just East of Broadway



Just Completed, 350 Rooms—350 Baths, this New Hotel contains every modern appointment. Every room has Private Bath—\$3.00, \$4.00 and \$5.00 per day.

SPECIAL WEEKLY RATES



Harry J. Veitch, Resident Manager

SITUATED in the heart of the city; near Railway Terminals. All Leading Shops and Theatres within a stone's throw.

HOT SPOT RECEIVER

(Continued from page 114)

station of moderate strength. Now, using a piece of wood whittled at one end like a screwdriver, adjust the small Hammarlund balancing condenser in the plate circuit of the 222 tube for maximum strength, then leave it alone. It does not take long to get used to tuning this outfit. You soon learn how far up you can bring the potentiometer and small midget condenser before going into oscillation and that volume control should be turned clear up when looking for distance.

The Abox Eliminator is highly recommended for this set because it contains no battery and is never charged or discharged. The tubes in the upper compartment, which it supplies, draw a total of 1¼ amperes which, in our case, is easily taken care of by the lowest intermediate plug on the Abox. Since there are three plugs above this, it is plain that Abox is working well below its limit. There is absolutely no hum and its regulation characteristics are such that fluctua-

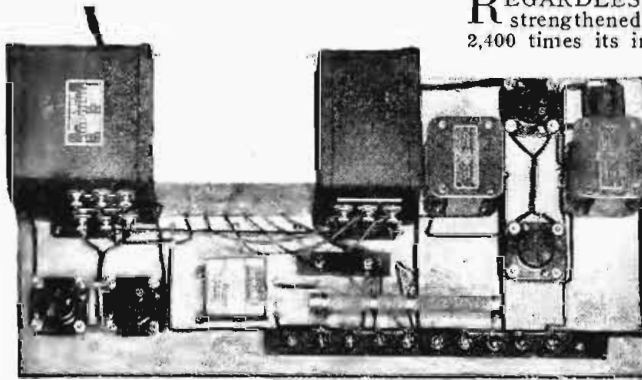

THE Thordarson Push-Pull Amplifier and "B-C" Supply as adapted for this set is very easily assembled and wired.

tations in line voltage have no effect on the operation of the set. It seems to be the solution of Radio's most annoying problem—the A current supply.

If you install this receiver with an Abox "A" supply as did the writer, do not connect the power switch on panel into the "A" circuit. Instead, remove the insulation for about ½ inch on both of the wires of the twisted pair light cord close to the Thordarson transformer, remove the socket plug from the Abox cord and connect (and solder) the Abox leads across the leads to Thordarson unit of Power unit where you have just scraped them. Then tape both joints carefully. The twisted cord from the Power unit is then brought up through a hole in the ceiling of lower compartment to the power switch on panel and one of the twisted wires is cut. One of the cut ends is then connected to each side of the switch. The second wire of the twisted pair is NOT cut. This twisted pair is then brought back through the hole to lower compartment and out the back through a notch cut in upper edge of the silk covered back frame. Switch now turns off the 110 volt supply to both units when you are through with set.

BROADCASTS EXPLAINED

(Continued from page 90)

stages are added for amplifying at radio frequencies, the whole complicated system is apt to get beyond control. If four of these stages are to be used it is better practice to cut the amplification per stage to seven which, after going through four tubes, would show a resultant gain of 2,401.

What makes all this confusing to the

beginner is the fact that one may find a single dial on a seven tube outfit and three dials on a five tube outfit. It must be explained that each of these stages of amplification at radio frequencies, and the tube used to separate the music from the radio wave, must have a device that is turned or "tuned" to adjust that tube to the desired program. Each stage can have an individual dial or they can all be moved simultaneously by one. Yet again, the first can have one dial and the following two can have a dial, or the following three, depending on the design of the set.

From the standpoint of efficiency, it is better to have separate dials for each of the tubes mentioned above, but from the viewpoint of convenience, simplicity and ease of handling, one dial for all is to be preferred. Radio sets can now be manufactured with such precision that it is feasible to put all of these devices on a mechanism to be turned by one dial and get very nearly, although not quite, 100 per cent possible results.

REGARDLESS of whether we strengthened the signal to 81, 729 or 2,400 times its incoming strength, it is then fed to a tube which, because of the duty it performs, we call the detector. It can be just the same type as its predecessors and interchangeable with them, or it may be a special tube that performs this duty better, but a detector is expected to separate the music and voices from the radio frequency currents which brought them to us. As stated, its input apparatus must have a device for tuning it to the preferred program.

To attempt to explain the exact manner by which a detector performs this delicate job is outside the scope of this series of articles, but the net result is that the radio frequencies disappear and the program appears in the output circuits of this tube as impulses of electrical energy. These all travel in the same direction, that is, they do not alternate their direction of travel as the radio currents did. For that reason they are now in a form which we call "direct current." It has been stated several times throughout this series that audible frequencies are those occurring or vibrating at from about 30 to several thousand each second. Our direct current impulses follow each other through the circuits which we now add, at these rates. A very low note is in the form of say 40 or 50 impulses each second, while a high note may be 4,000 or 5,000.

The stages which follow the detector are called audio frequency stages or tubes because they handle energy only at these frequencies. There may be either two or three of these tubes and here we can amplify the energy considerably more per stage than we could before, 12 or 15 being not uncommon. Thus with two well designed stages at a gain of 15 per stage we can get a further amplification of 225, or a total gain from the aerial circuit of 164,000. Some manufacturers claim yet more and it is possible they get it in a 6 tube tuned radio frequency set. This writer would hardly care to deny such an assertion since it is theoretically possible by good design and construction to obtain more.

THE point is bound to come up in the reader's mind as to where the energy comes from that is added. One cannot

create energy from nothing. The owner of a radio set has by now found out that he must have "A," "B" and "C" batteries, and that it is the purpose of the "A" battery or "A" eliminator to light the tubes. The "B" battery is applied to a radio set to furnish the energy which amplifies the program to pleasant loud speaker proportions. From it, each of the amplifier tubes draws a minute quantity of energy which it adds to the vibrations passing through and in exact rhythm or swing with those vibrations. The result in the loud speaker is impulses of electrical energy of considerable strength.

One may wonder why such strength is necessary or desirable. Sound is the result of vibrations of the air striking our ear drums, the pitch of the note being determined by the number of these vibrations per second. This is actual movement of the air, in the case of sound, and not just "nudgings" of infinitesimal particles, as was the case with radio waves. To move air to create a volume of sound such as that created by an orchestra or grand piano, requires considerable energy. The transition of energy from direct current impulses, as they occur in the last tube of our radio set, to sound waves as they come from a speaker, is accomplished by either a thin flat plate called a diaphragm or a large flat surface such as is used in cone speakers.

The diaphragm of a horn type speaker moves or flexes each side of normal position quite a good deal to give volume. The cone speaker, having more area, does not have to move so far to move the same quantity of air. The free-floating cone, or electrodynamic speaker, which can handle the greatest volume of all, moves a small cone through a distance of ⅛ to ½ an inch, which is a big distance as such movement goes. You cannot see a large cone speaker move, and can scarcely even feel it. The diaphragm or cone, whichever type you may be using, flexes or moves the exact number of times per second of the impulses in the last tube and moves air at that frequency. Thus the voices and music are brought out of the realm of electricity back to the sound waves to which we are accustomed.

THIS article would hardly be complete without touching on the subject of power tubes. It is not the purpose of a power tube, which is the name under which 112, 171 and 210 tubes are classified, to provide any more volume than a 201-A tube. Rather, it is their work to handle more energy without distortion. To get realism in reproduction, the amplifying apparatus and speaker should be able to handle notes in the musical scale which have a vibration frequency as low as 30 per second. Now the energy contained in such a note, when reproduced in correct relationship to a very high note of about 5,000 frequency, is over 100,000,000 times the energy to be found in the high note.

It must be made clear that there is a distinct difference between amplifying ability and handling capacity. A tube may be able to strengthen a weak signal about seven times, when we say its amplifying ability is seven, yet not be able to handle the comparatively great energy in the low notes of a moderately strong program. With 135 volts on the plate of a 201-A tube in the last stage of a receiver, it is possible to get 60-1000ths of a watt power in undistorted output. The 112 tube can handle 120-1000th of a watt and the 171 can pass 750-1000ths watt. Now consider a

(Continued on page 117)

SHORT WAVES

By Marcella

Stepping Out With Bobby; Carl Menzer, High Flier; John Clark's Romance; Suzanne Barnes' First Appearance; Sam 'n' Henry Now Amos and Andy; Mona Motor Oil Twin Talks About Birds!

Um, who do you think took Marcella out? I just knew you couldn't guess. Bobby Griffin of WJBT. Now I know you will all be suspicious but you see Bobby is also a blond and two blonds(!) of course not. But all the same I think he is a dear. He has that indefinable something that we girls like. And he certainly is popular, because lots of girls called him up at the station. But this is getting ahead of my story. Well anyway Bobby was always bragging about these Royal Canadians of Guy Lombardo. And he thought the only thing to do was to take me out there and let me meet the boys and see them in action. So he called a taxi and out we went, and I want to tell you that Guy Lombardo is the handsomest thing you ever saw. He has stunning brown eyes, such black hair and a kind of slow Italian smile. In fact, all the boys are good-looking and they are all Canadians from London, Ontario, Canada, with the exception of one. They started their band way back in 1921 when they were mere kids and in 1923 came to the United States in



(Continued on page 123)

Know Old Masters

(Continued from page 115)

Family moved to Dresden, boy studied piano. Profoundly affected hearing Weber's "Frieschutz." Composed string quartets, overture, a symphony. Began opera "The Wedding," 1832, unfinished. Directed Magdeburg Opera, 1834. Married Miina Planer, actress. (Separated 1862, marrying divorced wife of Hans Von Bulow.) Conductor Riga, Russia, 1837, began "Rienzi." Failed. Went England in small vessel, conceiving idea "Tristan" and "Flying Dutchman" during storms. Failed London, lived poor, obscure in Paris. Wrote dance music. "Rienzi" produced Dresden, 1842, through Meyerbeer. "Flying Dutchman" followed. "Tannhauser," 1845. Fled to Switzerland in revolution, 1849. Began "Niebelungen Ring." Returned Germany, 1861. "Tristan" dropped as "unsingable" after 57 rehearsals. Vienna. Helped by King Ludwig of Bavaria. Built Festival Theatre, Bayreuth, 1876. Last opera, "Parsifal," produced there 1882. Went to Italy for health, died there 1883.

WEBER, CARL MARIA (Vay-ber). Born Eutin, Germany, 1786, musical family. Choir boy Salsburg 10. Wrote an opera at 12, and at 13 opera "Waldmadchen" sung. Conductor Breslau Theatre, Musik-Intendant to Duke of Wurtemberg at 18. Banished for selling Court appointment. Went to Darmstadt, after concert tour reorganized Prague opera. "Frieschutz," greatest opera, 1821, immediate success. Went to England 1825 to superintend productions, though warned against climate. Died there following year. Married Caroline Brandt, actress. First influenced Wagner. Early life wild, became model husband and father.

Broadcasts Explained

(Continued from page 116)

210 tube with 425 volts on its plate and the power output is around 1½ full watts, which is ninety times better than the 201-A tube. The amplifying ability of the two tubes is the same and on very weak signals the volume would be about equal. On a stronger program, however, where the low notes would require energy handling capacity of 400 to 700 thousandths of a watt (see Figure 14), the volume from the 201-A would be much less as the energy-carrying low notes just wouldn't be there.

The

BELVEDERE

NEW YORK



Large room, private bath for one, ---- Four Dollars for two, ---- Five Dollars (serving pantry optional) Restaurant

THE newest, most luxuriously furnished and conveniently situated hotel in the metropolis. ¶ The town home of many distinguished authors, producers and stars of the stage and screen.

Booklet Free

48th Street — West of Broadway

(Near Times Square)

CURTIS A. HALE, Managing Director

A New and Improved Volume Control for "AC" Circuits

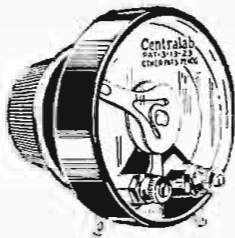

Centralab
Radiohms
RX-100 and
RX-025
have been
built with
exact taper
of resistance
to give ef-
fectual con-
trol of vol-
ume smoothly,

without jumps
and sudden blasts.

When the RX-100 is placed
across the secondary of one of
the R. F. stages it surely and
positively controls the volume
from a whisper to maximum on
all signals—powerful locals not-
withstanding. This Radiohm will
also control oscillation very ef-
fectively.

The RX-025 has the exact taper
of resistance for a volume con-
trol when placed in the antenna
circuit, or across the primary of
a R. F. transformer.

One of these two Radiohms and
the Centralab Power Rheostat
are essential resistances for all
"AC" circuits. They help to
maintain the delicate balance of
voltages throughout the circuit
and in no way affect the balance
between plate and filament cur-
rent, so necessary to maximum
efficiency.

Write for new folder
showing applications

Central Radio Laboratories
12 Keefe Avenue Milwaukee, Wis.

Centralab

NO
MORE
TIN-PAN
RECEPTION!

Townsend Clarifier

Only
\$1.00
postpaid
Cuts Out Hum
and Power Noises

NOW you can eliminate all
hum and power or line noises
in A. C. Sets and "B" Power
Units with this wonderful self-
heating electrolytic condenser
of over 20 mfd. capacity.

Two or more of these can be
used in place of high priced,
easily blown out, paper sound condensers when build-
ing your own "A" or "B" Eliminator.

Attached in One Minute

No changes in set necessary. You can now enjoy clear,
uninterrupted reception for the small cost of only
\$1.00 COMPLETE. Just slip a dollar bill in this ad
with your name and address and mail TODAY.

TOWNSEND LABORATORIES
763 Townsend St., Dept. 17, Chicago

ROGERS PLAYS "PRESIDENT"

(Continued from page 7)

but I think we'll get it all buried.

"Prohibition. Prohibition is going
down about as well as usual.

"Now, Radio audiences, I thank you."

WELL, that's certainly nice, Mr.
Coolidge. We certainly—and I
want to thank you in behalf of Dodge
Brothers and I know they will appre-
ciate your stating the condition of the
country due to the Dodge Brothers car.
And now—a—Henry Ford and Dodge
Brothers moved Americans away from
home, but it took Paul Whiteman to
provide something for 'em to do when
they got away. In the old days it was
the fashion when a man got old—all
there was for him to do was to get the
gout and make their life miserable for
everybody around him and then die.
Now, the old sucker unwraps his foot to
the interduction to the Rhapsody in
Blues and his relatives have to shoot him
to get him to quit dancing.

Paul Whiteman is the first man to find
out what to do with a band orchestration
of a piece of music. He tore it up. He
whistled the tune he wanted his men to
play and told each one to "show me at
the same time how you'd play this tune."
And what they all did turned out to be
music. There's no man in his profession
in America that stands as far ahead of
his competitors as Whiteman.

Paul took grand opera and raised it
up, and he took jazz and brought it
down, till the two met, and he originated
somethin' that if it wasn't so darned
popular that'd be called Art.

Paul, I haven't danced in twenty
years, but when you start up your music
tonight I'm goin' to grab the balance
wheel, Mrs. Rogers, and go into a huddle.

Mr. Paul Whiteman of New York.

WHITEMAN SPEAKING. "For
our first number we will play excerpts
from the Rhapsody in Blue, by George
Gershwin, written especially for this or-
chestra four or five years ago."

(Rhapsody)

ROGERS SPEAKING: Dodge
Brothers didn't know it, but I'd a
worked for nothing tonight, just to git
to tell about the good qualities of the
other performers, who are great friends
of mine. They are the three outstanding
men in their lines in the world. Fred
Stone, the most versatile performer. To
have considered him and his family my
closest personal friends has been a treat.
In addition to his marvelous daughter,
Dorothy, who you have all seen, or
heard about, anyway, he has two more
girls in preparation for a stage career.
If he'd a raised boys they'd a turned out
to be football coaches, or gone to Har-
vard and become bond salesmen. Now
he's got—he gets older and shows need
of something new. All he has to do is
to sit on the stage and reach under his
whiskers and pull out another clever
daughter. If he had raised boys he'd a
had to gone to the jail to get 'em out.
His career teaches a great moral—raise
girls and teach 'em to do som'thin', stead
of raisin' boys and tryin' to teach 'em
to do som'thin'. So I leave you in the
hands of the most beloved actor on the
American stage, the finest character of a
man out, or any profession, has to offer.
Good luck, Fred. Hello, Dorothy.
(Hatter and greetings from members of
the Rogers family.) Mary sends her

love. She is here practisin' her dance,
now—are listen'n' to you. Better be
good. Hello.

Mr. Fred Stone and daughter, Dorothy,
from Chicago.

FRED STONE SPEAKING: "Hello,
everybody. Ha-ha, Dorothy and I just
came off the stage. The first act of
Criss Cross is over. We are in my
dressing room, way out here at the
Erlanger theater by the big lake. The
Radios are all set up for us to dance
fifteen minutes, but we're not goin' to
dance. We're goin' to sing, and I hope
you all will have just as good a time
as we are. First I want Dorothy to
sing a little number of her own. She
wrote it herself. That is, she wrote the
words and Miss Margaret Hart com-
posed the music. She is Miss Mary
Cook at the piano and the Criss Cross
quartette to help out. Here, Dorothy,
dear."

DOROTHY STONE SPEAKING:
"Good evening, everybody."

(Goes into song.)

STONE SPEAKING: "Well, I'm
sure glad you liked that song. I can't
tell by the applause that you did. I think
that's pretty good for a girl just twenty
years old in her stocking feet. Now I'll
send one over the ether for you from
my old show, "Chin Chin." It's a Chi-
nese song. The reason I pick a Chinese
song is, if I make any mistakes you
won't know the difference. If you like
this song, send me your laundry and
I'll promise to get it back by Saturday."

(Goes into song.)

STONE SPEAKING: "Well, here's
Dorothy, all ready for the second act,
and we just have time to put over one
more little ditty before we go back to
the footlights. I'm sorry Mrs. Stone
isn't here, but she's home taking care of
the other two little pebbles, and they are
working hard with their vocal and danc-
ing lessons. The stage is their ambition
and I'll leave no stone unturned to make
their dreams come true. Maybe you
wonder why I let my girls go on the
stage. It's because I love and respect
my profession and the stage needs just
such girls as mine. I love my profession
and if everybody held their profession
in as great a reverence as I do there
would be no wonder why I am so
anxious to have my daughters with me
and by my side. Everybody has a mis-
sion to perform in this world, and I
believe our mission is to help make the
public forget their cares and worries.
The stage is progressing side by side
with the improvements of every other
line of endeavor. Now I believe in danc-
ing in the right spirit, we are on the
right road not too early or too late, born
to amuse the world. Good, clean, whole-
some amusement is and always will be
considered a necessity. There's an old
adage—"A rolling stone gathers no
moss," but if you find a stone that's
rolled any further than this one, I lose.
I have rolled through every city, town,
village, burg and water tank in this
country, and I'm still rolling . . . a
thousand dollars a minute. Well, I'm
going to waste five hundred dollars of it
right now, talking to Will Rogers, 'cause
I know he's listening in. Hello, Bill.
Say, Bill, what were you doing in Mex-
ico? I'll bet you were the advance agent
for Colonel Lindbergh. You old rascal.
You're some diplomat yourself. Well, if
ever you run for President again, Bill,
there's three of the Stone family old
enough to vote for you. Well, folks,
here's that last song I was talkin' about.

FREE 10 DAYS TRIAL
THE NEW IMPROVED
INKOGRAPH
 "PENCIL POINTED PEN"
The Perfect Writing Instrument
GREATEST VALUE EVER OFFERED

Writes with ink, free and easy as a lead pencil, without a miss, skip or blur. Its steady, uniform flow of ink actually improves your handwriting. Won't blot, scratch, leak or soil hands.

Makes 3 or 4 Carbon Copies with Original in Ink

Anyone can write with your Inko-graph, no style of writing or pressure can bend, spread, injure or distort its 14-kt. gold point.

SAME SIZE as \$7 and \$8.75 Fountain Pens

Patent Automatic 14-Kt. Gold Feed
 prevents clogging. Made of best grade, highly polished hard rubber, highest class workmanship. Comes with pocket clip attached, or, if desired, in a smaller size with ring on cap for attaching to watch chain or ladies' sautoir.

AN INSTRUMENT OF REFINEMENT
 In appearance, quality, workmanship and material it is the equal of writing instruments which sell for a great deal more. We know you will prefer an Inko-graph to any writing instrument once you try it.

SEND NO MONEY
 Pay postman \$1.50 plus postage. Year's guarantee certificate assures absolute satisfaction. When remittance accompanies order, Inko-graph will be sent postage prepaid. Write name and address plainly.

INKOGRAPH CO., Inc.
 199-309 Centre St., New York

AGENTS Sell Inko-graphs. Make bigger profits, more sales, without investment. Quicker commissions, popular prices, no collecting, no competition. Send for an Inko-graph or write for special sales plan booklet.

position in Plainfield, N. J. Later she left home to reside in Plainfield near the church where she sang as soloist.

In 1909, she met Governor Stokes of New Jersey at a military encampment in that state. The executive interested himself in the career of this Jersey girl and procured her an engagement at the afternoon musicales at the Hotel Bellevue-Stratford in Philadelphia. Andreas Dippel, director of the Metropolitan opera company, strolling into the Bellevue-Stratford, heard her sing and engaged her on the spot. The following week she sang an audition from the stage of the Metropolitan opera house. Her debut followed shortly in Gluck's Orfeo, just a year and six months after her first music lesson. Since then she has sung in every state in the Union and throughout many of the important centers of Europe.

ELSIE THIEDE CHARMS

(Continued from page 17)

remember the ovation she received as soloist with the Detroit Symphony orchestra, Mr. Ossip Gabrilowitch, conducting.

Unlike many vocalists Miss Thiede has no operatic aspirations. True, she has appeared as guest artist with the St. Louis Municipal Opera but concert work is her great love, and it was most natural that when Radio came along it should lure her to its fold.

A voice of great range and brilliance, she uses it with the skill that marks a real artist. Her musicianship is thorough, and she is capable of masterly executing all types of songs—a requisite when one has to appear before the microphone as often as Miss Thiede.

In private life the young soprano is Mrs. Frank Moulan, wife of the famous comedian.

RADIO SAVES LIVES

(Continued from page 25)

October and the first half of November 23 children were killed on the streets of St. Louis in accidents. During the same period in 1927—after the Careful Children's Club had got under way fully—two children were accidentally killed. Approximately the same proportion of decrease holds true throughout the year. If the lives of children are valued, it is evident that Safety Sam, Ready Eddie, Handy Andy and "KMOX" have done something worth while.

How the trio of promoters of the club are able to hold the attention of so many children and their parents is a marvelous study in simplicity. They announce their arrival daily with the buzz (apparently) of an airplane. Safety Sam always arrives by 'plane, he insinuates through the microphone, and children long ago began listening forward to hearing the whiz of Sam's 'plane, which is actually an electric fan on a table near the "mike."

Thereafter the speaker, whether it be Safety Sam or one of the Twins, gives a straight-forward talk on how children can protect themselves from accident in crossing the street, in school, around home—everywhere. The talk is interspersed with incidents which carry safety morals.

Handy Andy spends the greater part of his time going through the club's daily mail and telling his listeners what he finds and reading some of the communications. The postoffice delivers the Careful Children's Club's mail by the pouch-full, usually about five full sacks arriving daily. The speaker talks fre-

CONVERT any set to AC!

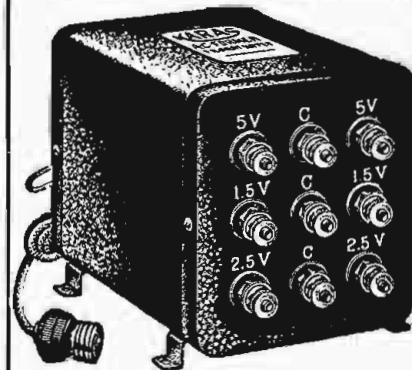

The KARAS A-C-FORMER

\$8.75

List Price Type 12 Supplies up to 8-226, 2-227 and 2-171 Tubes.

End battery troubles and bring your set up-to-date with this new Karas Achievement! Delivers correct voltage to the new AC tubes 226 and 227. Does not transmit excessive voltage fluctuations, insuring long life to your AC tubes. No rewiring necessary. Operates with Carter, Eby or other cable harness.

At Your Dealer's or Write for Details to

Karas Electric Co.

4034-6 N. Rockwell St., CHICAGO

Save 1/4

Satisfy your-self!

30 days FREE TRIAL

CONRAD 6

SINGLE DIAL CONTROL

COMPLETELY SHIELDED GENUINE LICENSED CIRCUITS

Manufactured under license of RADIO CORPORATION OF AMERICA and affiliated companies

The set that is the talk of the radio trade. Manufacture under license grants insures highest quality; classic incorporates all features found in finest sets. Latest thing in radio receivers, illuminated dial. Very selective and sensitive. Gets long distance stations with wonderful tone and volume. Table and console models in newest styles and designs.

Prove it Yourself - 30 Day Free Trial

Conrad receivers will pay you test-you demand. Try it in your home on our 30 day Free Trial Offer and be satisfied. If you are not, return the receiver to us and the money will be refunded. Write today for complete catalog and details of the Conrad Line of 1928 and other famous 30 Day Free Trial Offer.

CONSUMERS' RADIO CO.
 Dept. 182 4721 Lincoln Ave. CHICAGO

FERBEND LEADS AGAIN!

Now—Lowest Priced Quality Tube "B" Eliminator

\$18.50

Since 1921 Ferbend Products have been famous for outstanding quality and long-life efficiency at lowest prices—prices "Within Reach of All."

The new HEAVY DUTY "B" Power unit is no exception. In workmanship, performance, materials and appearance it is the equal of any. We INVITE comparison.

See Your Dealer, or Send Direct

Shipment will be made upon receipt of price or C. O. D. Use for ten days to convince yourself—then, if not satisfied write us within that time and purchase price will be refunded. Order today.

Complete Including LONG LIFE PERFECTED 85 MIL. TUBE.

Delivers up to 180 volts on any set.

DRY NO LIQUIDS OR ACIDS

10 Days Trial.

FERBEND ELECTRIC CO.,
 417 W. Superior St. Chicago, Ill.

FREE RADIO CATALOG

WHOLESALE

The Harco Catalog is chock full of unusual bargains in all the latest kits, standard sets, complete sets, furniture and accessories.

Prices That Save You Money

Harco merchandise and service form the best combination for the net builder and performer. Don't delay. Write now for your copy and see for yourself the wonderful values we offer.

The HARCO CO. 1255 S WABASH AVE CHICAGO ILL.

quently of the pledge and the card, reminding the children to keep the card hanging up where they can read it at all times.

At the bottom of the card is printed the Safety Song. Every daily program is closed with the singing of this song. Members and their parents everywhere are asked to join in and sing the song with Safety Sam and his crowd. Hundreds of the letters and cards that constitute those five bags of daily mail are from children and parents, to tell Sam that they have enjoyed singing the Safety Song with him every evening.

An occasional contest helps to intensify interest in the programs. Recently the club offered cash prizes for the two best safety slogans for the use of the club. The offer brought thousands of replies. "Be a Safety First Talker—Not a Jaywalker" won one of the prizes.

Menu a la Verte

(Continued from page 52)

Cream the butter, add egg yolks, and stir vigorously. Then add lemon juice, seasoning and water. Beat five minutes with Dover egg beater. Cook over hot water and continue to stir until thickened.

Potatoes O'Brien

Each housewife has her own favorite recipe for potatoes O'Brien (fried potatoes). Any one of these may be used.

Water Cress Salad

Procure fresh water cress, which should be kept cool to preserve the crispness, and pour over it a dash of French dressing, made in the ordinary fashion from oil, vinegar and seasoning.

Pistachio Ice Cream

Add pistachio flavoring and coloring to any good ice cream recipe. The following is suggested:

- 1 egg.
- ½ cup milk.
- 1 r. teaspoon flour.
- 2/3 cup sugar.
- ¾ pint cream.

Scald milk in double boiler. Beat egg and add dry ingredients; add to milk. Cook, stirring constantly until it thickens. Scald cream and add, then let it cool. Add flavor and color. If solids, such as nuts, are to be used, freeze partly before adding them. If vanilla cream, use one-half cup sugar. Serves five persons.

Cakes

- ½ cup butter.
- 1 cup sugar.
- 2 egg yolks.
- 2 cups flour.
- 1 cup sweet milk.
- 1½ teaspoons vanilla.
- 3 teaspoons baking powder.
- 2 teaspoons flavoring.

Mix in order given and bake in hot oven. This makes two layers, or can be used for small cakes. For layer cake, spread icing between layers and on top layer. Green coloring may be added to plain white icing, or white icing, decorated with candy shamrocks, obtainable at many candy stores, may be used.

Spanish Patio Studio

Studios of the National Broadcasting company at 111 Sutter street, San Francisco are designed after the style of a Spanish patio.

The walls around the garden resemble the exteriors of adobe dwellings. Wrought iron lanterns hang from stanchions on the walls and arched doors and windows heighten the interior court effect. Potted plants and flowers create a natural illusion. Diffused light effects from the windows and an artificial night sky overhead complete the picture. The clay-red tile floor is covered here and there with green rugs to supply the grass and earth effect.

A mezzanine floor for guests and visitors overlooks the patio, from which they may also look down upon artists performing in the two studios.

WANTED! 3,000 Men in 3,000 Towns

As a R. A. A. member in your town, you can earn \$3.00 an hour, full time or spare time, serving as "radio doctor," installing and servicing sets for dealers, building sets to sell at less-than-retail prices.

\$3.00
an hour
In Your Spare Time



BECOME a member of the Radio Association of America. We will train you to install, repair, build all kind of sets—help you secure a better paying position—train you for the \$3,000 to \$10,000 opportunities open in Radio—start you in business even though you now have no capital.

Never Before Such an Opportunity

Joining the Radio Association (which need not—should not—cost you a cent) will enable you to cash in on Radio now and later. From the moment you join, you can start making money. Look at what our members are doing! Lyle Follick, Michigan, makes \$500 in her spare hours. Werner Eschler, New York, earns \$50 a week extra. W. E. Thon, Chicago,

becomes manager Radio Department of big store at 220% greater salary. With our help O. K. Benzing, Iowa, starts store. Claude De Grave, who a year ago knew nothing about Radio, becomes Radio Engineer for great manufacturer. Hundreds of other examples.

Investigate what we can do for you.

Mail Coupon Now for Special Membership

Write today for details and for our booklet "Your Opportunity in the Radio Industry," that shows you the easiest, quickest, and best way to get into Radio. Don't wait. Don't delay! Be the R. A. A. member in your vicinity. Mail coupon below today.

Radio Association of America
4513 Ravenswood Ave.,
Chicago, Illinois

Gentlemen: Dept. RD-3
Please send me by return mail full details of your Special Membership Plan, and also copy of your book "Your Opportunity in the Radio Industry."

Name
Address
City..... State.....

DOUBLE DISTANCE DOUBLE VOLUME NEW TUBE



We guarantee this tube to double your range and distance or your money refunded. This tube has proven to be 6 times as sensitive as an ordinary 201A tube. The Prexto tube is setting records for distant reception. Increases selectivity 50%. Tested by Radio World, Radio Digest and other leading laboratories. Insert tube in detector socket, and set is ready for operation. One year of use guaranteed. Try at our risk. 50,000 users today. You to be the judge. Money refunded if not satisfied. The latest in tubes. Order Today. Price, \$3.00 Postpaid.

Verified Statements of Users.

"You are right, the Prexto tube does bring the distant stations closer. I am particularly pleased. Would like to have your agency." George A. Scott, Dealer, Pittsburgh.
"I use about half as much current, as I did before. Get distant stations from everywhere, even through static on bad nights. Would not take \$10.00 for Prexto tube, if I could not get another." D. G. Feider, Asheville, N. C.
"Have added station on my log 1500 miles further than before, since using your tube." J. P. Henderson, Detroit.

PREXTO MFG. & SALES CO.
Dept. 2—Beaumont, Texas

NEW Spring! Edition! RADIO RED BOOK

Just out with all the latest changes direct from Radio Trade Commission. New and exclusive (copyrighted) arrangement for quick and accurate tuning by kilocycles, wave lengths or call letters, also cross indexed by cities giving names of owners. Most recent and authentic information on

Chain Broadcasting

The Red Book is the greatest help to tune in programs easily and obtain the utmost enjoyment from your set. Simple, convenient, complete and reliable. Includes clear-print map of broadcasting stations. Also "Radio Doctor" section. Biggest seller in the field. Don't be misled by cheap imitations. Get the genuine. If your dealer cannot supply you, send 25c in coin or stamps to

THE WAYNE ANDREWS CO.
301 Central Bldg. Fort Wayne, Ind.

Renew OLD RADIO TUBES Instantly!

If your tubes are three months old, they need rejuvenating. And you'll be amazed at how much better they'll work. Particularly in summer time when you need every bit of tube power you can get. One at a time, plug your tubes into the Master Craft Tube Renewer, then back into your set. They'll give you bigger volume, greater distance, finer tone. The Master Craft Tube Renewer makes most any old tube as good as new—and keeps it new, indefinitely. Practically triples the useful life of all tubes.

Operates Off Your "B" BATTERY or ELIMINATOR

Requires no electric light current. Simply connect to 22½ volt "B" battery tap, insert the tube and the job is done. Anyone can rejuvenate tubes with the Master Craft Tube Renewer. Small, compact, simple to use. Nothing to get out of order. Perfect results guaranteed. Thousands of satisfied users. Approved by Popular Radio, Popular Science Monthly, etc.

FREE TRIAL OFFER

Order a Master Craft Tube Renewer NOW! Test it on your old tubes. Decide, after you have seen it do its wonder work, whether you want to keep it. Slip the coupon right away. Put it to a dollar bill and mail at once. Send the Master Craft back if you're not satisfied. We'll refund your dollar if you want it.

MASTER CRAFT PRODUCTS CO.
623 Briar Place Dept. B. Chicago, Ill.



GUARANTEE COUPON
Master Craft Products Co., Dept. B.
623 Briar Place, Chicago.

I enclose \$1. Send me one Master Craft Tube Renewer and full instructions. I understand that I can have my money back if not satisfied.

Name.....
Street.....
Town..... State.....

6 TUBE SUPERPHONIC
Radio ALL PARTS MOUNTED
Only **\$16.95**
Can be wired in a few minutes

FREE! 6 TUBES
ux 101-177E
Tested and Matched

All Metal Chassis Shielded Ready to wire

An amazing value that can't be beat! Latest six-tube tuned radio frequency circuit. Extremely selective. Marvellous sensitivity. Three stages of radio frequency, detector, and two stages of low ratio audio frequency for improved tone quality. Two-dial control. Straight-line frequency condensers. All metal chassis. Shielded. Clear and realistic reception guaranteed. Beautiful black front panel (7 in. x 18 in.); ornamental design, degree and kilocycle markings in gold. Metal panel and sub-panel. Complete chassis. No extra parts to buy. All parts mounted. Simply connect a few wires. No special tools needed. Kurz-Kasch indicator knobs. New type CX sockets. All hook-up wire and colored battery cable included. Value \$60.00; our price, \$16.95.

TESTED AND APPROVED

Severe laboratory tests have proved the remarkable efficiency of this set. Owners everywhere are sending us letters praising its wonderful receptive qualities. "Wired set in short order. Getting stations all over the country. Plenty of volume. The set sure is a dandy." B. J. Gillis, Denver, Colo. Telegram from M. A., Syracuse, N. Y.: "Ship at once two more Superphonics."

SIMPLE WIRING DIRECTIONS

Very easy to wire this set with the instructions we furnish. Just connect a few wires. All you have to do is

to follow numbers. That is all. Can be wired in a few minutes by anyone. No radio knowledge needed. Make money by wiring these sets in your spare time and selling them to your friends.



SEND NO MONEY

Just write your name and address on a post card and ask us to send you this great outfit with six tubes. We ship right away. Upon arrival pay only \$16.95, plus a small delivery charge. (Foreign countries send \$18.50 with order. We pay shipping charges.) Radio Equipment Co., Dep. 14-C, 549 S. Wells St., Chicago

SANGAMO AUDIO APPARATUS

Fixed Condensers

SANGAMO ELECTRIC COMPANY
SPRINGFIELD, ILL.

Listen Man



600 stations from 36 nations is the DX record of one FAX, and he says good ground connections are necessary and greatly enhance reception. IS YOURS A GOOD ONE? To get best results your ground wire should lead DIRECTLY to moist earth. A Ross copper composition ground point leads the ground wire directly from the set to moist earth. Users report 100% better reception. Easily installed. Cost you but \$1.25 postpaid. Can be returned in 90 days. Remit in the usual way or send your name and pay the postman on delivery.

REEVES SPECIALTY CO.
Hamilton, Ohio

BENJAMIN

Cle-Ra-Tone Sockets and Brackets for the Hot Spot Fourteen

- No. 9044—Cle-Ra-Tone Spring Supported, Shock Absorbing Socket, for mounting to 3-16-inch panel Each, 50c
 - No. 9049—For mounting to 1/8-inch panel Each, 50c
 - No. 9040—With mounting base..... Each, 75c
- Benjamin Brackets
- No. 8629—Rigid Per Pair, \$0.70
 - No. 9029—Adjustable Per Pair, 1.25

At Your Radio Dealers

Benjamin Electric Mfg. Co.
New York Chicago San Francisco

Radio at Point Barrow

(Continued from page 38)

SUCCESS rewarded these hardy mariners of the North and a few weeks later as the ice went off-shore at Point Barrow they anchored in the channel. Old timers who have spent many years in the Arctic Circle gasped with astonishment as the young school teacher stepped ashore. Under his arm was a Radio receiving set, the first to arrive on the Arctic shores of Alaska. The entire village, at least all of the whites, were on hand the following evening when the aerial was completed and the set hooked up. A twist of the dial brought in the first station and music. Astonishment appeared on the faces of the old settlers. Leon Vincent smiled. Then the call letters, "KOMO, Seattle," followed by an announcement: "You will now hear Longine's Time Signals broadcast by the Pacific Coast network, of which KOMO is a member." As the announcer pealed off his "one-two-three," every watch was out, and when the "hong" for 9:00 o'clock, Pacific Standard Time, sounded, Point Barrow for the first time in many weeks had the correct time and furthermore the assurance that no more would they be entirely dependent upon the sun that was hidden so much of the time.

The outstanding social event of the year is the annual visit of the revenue cutter and U. S. M. S. Boxer. Incidentally, it is Point Barrow's only opportunity to find out what has transpired in the previous year in the great civilized world "outside." What political scandal the U. S. Senate is investigating, whether there has been a new war in the Balkans or Central America, latest developments in science and invention—all are topics of great interest to the citizens of this northern post who have been shut off from their fellow-men for an entire year. Last summer, however, between trying to assimilate as much of the year's history as possible during the visit of the Boxer and listening to the music on Leon Vincent's Radio set, the Point Barrowans had a busy time.

Late one evening as a group was listening to KOMO came the announcement that next would be the summary of news for the day broadcast by the Seattle Post-Intelligencer. Again the possibilities of Radio were demonstrated, as the listeners heard news that not even the boat's crew had heard—the story of the capture of a noted criminal in Louisiana; the burning of a \$100,000 building in New York; the latest gang war sensation in Chicago, Cincinnati's prospects for a pennant-winning team, and other items.

A second great problem in Point Barrow's life had been solved and ever since that day last summer, according to a letter received by KOMO, Point Barrow has enjoyed a daily newspaper of its own—the North Pole edition of the Seattle Post-Intelligencer. An old hand-driven mimeograph machine was resurrected for the purpose of publishing this bulletin which contains Associated Press, International News and other news service items assimilated by the Seattle Post-Intelligencer for its daily broadcast over KOMO.

Judging from the letter it is hard to tell which is regarded with the greatest importance by the citizens of Point Barrow—the standard time signals, the music and entertainment or the daily summary of news, all of which have been received from KOMO since Leon Vincent arrived to take up his work as a government school teacher, bringing with him a Radio set.

MARCELLA

(Continued from page 117)

vaudeville. Then they settled down in Cleveland and were so well liked they were there about four years. Did you ever hear them play Rose Marie? Well, when Carmen and Guy heard that a little sister was born they decided to name her over the Radio, and they told their parents to listen in and they would give her a name. They played Rose Marie. Every year they play Rose Marie for their little sister on her birthday. I couldn't find out whether they were married or not. Carmen and Guy just smiled those baffling smiles that annoy us girls so, and there you are. Then I went back to the studio with Bobby and stayed up till he signed off. It was certainly a big night.

* *

While I was up at WBBM I met Nate Caldwell and Mrs. Caldwell. Now there is surely a contrast. Nate is a blond with blue eyes and an engaging smile and Mrs. Caldwell is a slim young thing with the loveliest black eyes and naturally brown curly hair and, my dear, they are still crazy about each other although they have been married about two years.

* *

What with Sam 'n' Henry leaving WGN and going to WMAQ, this office has just literally been swamped with telegrams and letters. It just kept me busy calling up WGN to find out where they were going and had gone. And now Sam 'n' Henry are going to change their names to Amos 'n' Andy. For heavens sakes how can I keep track of them. Well, here's how they look when not Sam 'n' Henry. Freeman Gosden is a tall slender young man with blue eyes and very light hair. He isn't married. Charles Correll is six inches shorter and a little stouter and has dark hair. Mr. Correll came from Hatteras, North Carolina, and that explains everything. He's married, girls, so that's that. They really are a nice looking pair.

* *

The cutest card came in here the other day from Mr. and Mrs. Pat Barnes and on it was a little drawing of a baby on (Continued on page 124)

Hu-Chin Plays Jazz

(Continued from page 36)

the rest of the world, the demand for more hu-chins increased. It is now heard everywhere—although the more fashionable would not dare to be seen playing one in public. It would be much the same as to expect one of your temperamental American artists going on the stage with a beggar's hand organ and monkey—too humiliating," declared Mr. Hsiang.

The younger element learns to play without the parent's knowledge, and takes secret pride in being able to perfect the use of the instrument. The young Chinese frequently organize hu-chin jazz bands for parties and larks by themselves.

The hu-chin is about three feet long, and consists chiefly of the neck or handle with an octagonal sound chamber at the end. Over the top of this sound chamber a snake skin is stretched tightly. The pitch of the tone is dependent upon the size of this sound chamber. It may be tuned by twisting large wooden plugs at the end of the neck to which the strings are attached. The bow is made of bamboo and horse hairs. The strings of the bow pass between the two strings of the hu-chin, and the notes are produced by either bearing down on one string or lifting it up so it strikes the other.

**Volume
Distance
Sharp Tuning**

WITH THE AMAZING
REESONATOR

TRADE MARK

The Reesonator is an instrument designed to balance the antenna to the receiving set and increases the volume and selectivity of your machine. It will enable you to play with dance volume stations which are barely audible or sometimes entirely inaudible without it. It will also decrease battery consumption 30 per cent, as you do not have to apply as much power to obtain the desired results. It does not require tuning for every station you receive, only when additional selectivity or distance is required. It is attached externally to the machine and can be attached by any one in a minute. Reesonator as illustrated is especially designed for Atwater Kent Models 30-32-35-37, Radiola Models 16-17 and Crosley Bandbox, Apex and Day-Fan machines. On the above machines, the REESONATOR is connected in parallel between the antenna and ground posts. When ordering, state type of machine on which Reesonator is to be used. Equivalent to two extra tubes in your machine.



**\$4.75
COMPLETE**

Not a wave trap but a wave booster (Pat. Pend.)

What Some of Our Users Say

TESTIMONIALS

Gentlemen: We wish to inform you that the REESONATOR, we purchased from you some time ago, is meeting with our highest expectations. We have found it of much value in aiding reception, increasing volume, clearness of tone, and enabling us to get stations which we otherwise could not hear. We have found it to be well worth the price.

Yours truly,
N. N. Fisher
Janesville, Wis.

Gentlemen: Last month, I bought one of your REESONATORS and I find it to be just as you said. Now, I have no trouble in bringing in far stations, and it cuts through interference good. It makes a big improvement to my set.

Signed,
Charles Morgau
Albany, N. Y.

Dear Sirs: A friend of ours let us use a REESONATOR put out by your firm, and we like it very much. We did not know where to buy this, so wish you would send us one C. O. D.

Yours truly, W. J. Simcock,
Eveleth, Minn.

Gentlemen: Enclosed find check for \$4.75. Please mail one REESONATOR at your earliest convenience. A friend of mine received one a few days ago, and it seems to be the "Cat's Whiskers." Yours truly, F. H. Lander, Lakeland, Fla.

Above Testimonials Unsolicited

We Guarantee Satisfaction
Try one for three days at our risk. If not thoroughly satisfied your money will be cheerfully refunded.

F & H Radio Laboratories
Dept. 105 Fargo, North Dakota
First National Bank, Fargo National Bank, Dun's or Bradstreet's

SEND COUPON NOW

F. & H. RADIO LABORATORIES
Dept. 105 Fargo, North Dakota

I enclose check or money order for \$4.75 for which send me a Reesonator postpaid.

Send Reesonator C. O. D.

Send Dealers' Proposition.

Please send Literature.

Send Name of Jobber.

Name

Address State

FROST-RADIO
Ask Your Neighbor
DE LUXE APPARATUS

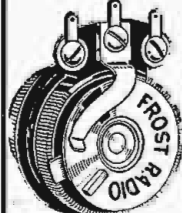

**FROST-RADIO
GEM RHEOSTATS**
75c and \$1

Frost De Luxe Gem Rheostats
The first really good small rheostats. Are but 1 1/2 in. in diameter yet operate as smoothly and efficiently as our larger types. Precision built throughout. Have Bakelite pointer knob, hand buffed nickel plated exposed metal parts, and finest quality resistance wire wound on new flexible Bakelite strip. We make them with or without filament switch, and also supply them wound as potentiometers. Plain Gem Rheostats, 3 to 30 ohms, 75c. With switch, \$1.00. Potentiometers, \$1.00. Demand from your dealer by name.

Mail the Coupon below for your FREE copy of the new Frost booklets, "What Set Shall I Build?" and "For Better Reception," two valuable books you will enjoy reading. Fill out and mail coupon now.

HERBERT H. FROST, Inc.
Main Offices and Factory, Elkhart, Ind.
Herbert H. Frost, Inc.,
160 North La Salle Street, Chicago.
Please send me your free books "What Set Shall I Build," and "For Better Reception," as offered in Radio Digest for March.

Name

Address

City State

LOOP SET OWNERS

ON RECEIPT of your order we will ship you by return mail one of our famous JENKINS INDUCTANCE-COUPPLERS, which we unconditionally guarantee to INCREASE VOLUME 400%—MORE THAN DOUBLE DISTANCE and TRIPLE THE NUMBER OF STATIONS you are now receiving.

ANY OWNER CAN INSTALL IN FIVE MINUTES. TRANS-OCEANIC RECEPTION AND OTHER STARTLING DISTANCE RECORDS FREQUENTLY REPORTED BY PURCHASERS.

Especially adapted for all Loop Sets.

ORDER ONE TODAY

\$5.00

CASH—CHECK—MONEY ORDER
Your money cheerfully refunded IMMEDIATELY without question so any purchaser NOT ENTIRELY SATISFIED.

JENKINS RADIO CO.
Box 41 Bettendorf, Iowa

Amazing NEW Ground Antenna

Gets Everything But Static!

Brings in Far Away Stations Loud and Clear Regardless of Static Conditions

Fans everywhere are replacing their troublesome and static gathering up-in-the-air aerials with the marvelous new **GROUND ANTENNA—Aer-O-Liminator**. Radio engineers and hundreds of users testify that Aer-O-Liminator gets better long distance reception, almost unbelievable freedom from outside noises, far greater selectivity and marvelously true, clear sweet tone quality.

John E. Christenson, Radio Engineer, Chicago, writes: "I have tested and thoroughly approve the Aer-O-Liminator. I find it increases selectivity and volume without distortion, practically eliminates static, gives good clear tones, both on local and distant stations. I would recommend the use of the Aer-O-Liminator to every radio owner to get the best reception from his set."

FREE TRIAL

Make this thrilling test at our risk!

Install an Aer-O-Liminator (Ground Antenna). Leave your old overhead aerial up. Try out on a night when static is bad. If you do not get a wonderful improvement in freedom from static, greater selectivity and clear sweet tone without interfering noises, if you can't get good reception on stations that are drowned out by static on your old aerial, you need not pay us a red cent for this test. Send coupon at once for scientific explanation of Aer-O-Liminator (Ground Antenna), proof of performance and our conclusive offer—Mail Coupon TODAY!

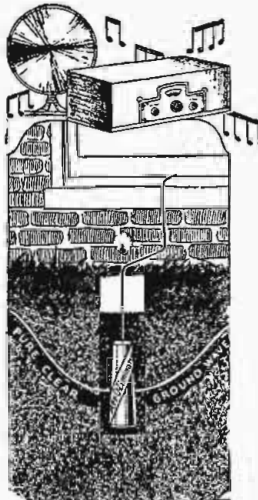

EASY TO INSTALL
Just dig a small hole about 6 inches in diameter and drop Aer-O-Liminator into it.

Aer-O-Liminator (Ground Antenna)

Endorsed by Foremost Engineers and Dealers

Rush This Important Coupon

CURTAN MFG. CO.,
154 E. Erie St., Dept. 823-C,
Chicago, Ill.

Please send me at once complete description of Aer-O-Liminator, with details of guarantee, Scientific Proof, and FREE TRIAL OFFER.

Name

Address

City

State

CURTAN MFG. CO.
Dept. 823-C Chicago, Ill.
154 East Erie Street

FOOL-YOUR-FRIENDS

Make Your Radio "SAY" anything you want!

THE SKY IS THE LIMIT
Brand New Idea for a Radio Party
The Magic Home Broadcast is ready to be used in only a minute to insert. No skill required. Hide in another room or closet, and joke, play into the microphone. Then the fun begins. Sup. Home Broadcaster in your pocket. Try it at the next home party. Send no money, \$49 position \$4.95 plus postage for microphones, special extension cord, adaptor plug. Money BACK GUARANTEE. **ELGA PRODUCTS Mfg. Co.** 726 Atlantic Ave., Bklyn., N.Y., Dept. 231

Be Your Own Broadcaster

RAISE BELGIAN HARES

New Zealand Reds - Chinchillas - Flemish Giants

MAKE BIG MONEY—No Supply Stock and pay you following prices for all your rabbits

Belgian Hares \$2 each—New Zealand \$3 each—Chinchillas \$4 each—Flemish Giants \$5 each.

82 page illustrated book, catalog and contract, also copy of Fur Farming magazine, tells how to raise about, milk, fox, etc.—for big profits, all for 10c. Address **OUTDOOR ENTERPRISE CO., Box 67, Haines Park, Missouri**

PSORIASIS

CAN BE CURED. I SUFFERED MANY YEARS WITH THIS DREADFUL SKIN DISEASE. WRITE R. S. PAYNE, 234 E. SECOND ST., COVINGTON, KY.

600 Mile Radio only \$2.95

Works without any batteries
300,000 people already use them

Write for full description and copies of letters giving lists of stations heard by users **LAMBERT CO., 227-J, Wichita, Kansas**

MARCELLA

(Continued from page 123)

top of a Radio set and underneath it said, "Barbara Ann, first appearance January 27, 8 lbs. 3/4 oz." And Pat is just too pleased for words. He says she is absolutely the most beautiful baby in the world. That's his story and he sticks to it.

* *

I liked Harold myself, Mrs. J. P., and was glad to tell you about him. Now as to Jack and Gene. They are so mischievous that it is awfully hard to get any real information out of them. Every really serious question they met with such frivolous remarks that Marcella was more than a little downcast. For instance, when asked if they were married they seemed to take it as a perfect joke. Of course, they are terribly young. They both have medium brown hair and blue eyes. Gene Carroll is tall and slim and Jack Grady is shorter and heavier. Don't they look as if they had awfully nice personalities and dispositions? They used to sing in vaudeville and met four years ago and decided they would like to team and so they have ever since. Jack plays the piano and Gene plays the harmonica and guitar.



While Miss Alexander of WLS was sending me all this material on Jack and Gene she mentioned the fact that June of May and June was married on Valentine Day to John Brown of WLS. Wasn't that romantic?

* *

Miss Inquisitive, you ask me where Jack Nelson is. When I wrote and asked him his present whereabouts, he sent back a clipping from last month's Digest speaking about a little Miss Nelson. This is what he says. "I had to cut the enclosed clipping from the Digest out so that my twenty months old son wouldn't see that part about "little Miss Nelson." He'd be after you for that. Such a husky brute—little Miss Nelson—he'd be insulted! Thought you knew he was Jack, Jr., and he's not so little either." My goodness, what do you think of that? Anyway, Jack has deserted the Mike for the present. He is the Radio advisory department of an advertising agency.

* *

Really I begin to feel like a matrimonial bureau. You remember that KFRC brag about an entirely unhooked staff?

After that appeared they all began to get attached. Now here's the latest, Harold Peery has gone and got married. That pretty Helen O'Neil is still single and so just to get even with all these big husky men who go searching outside of their station for brides when she's there, I'll use her picture. Really now, isn't she a dear?

* *

Somebody asked me about John Patt and Leo Fitzpatrick. Now there just isn't the slightest use in thinking too much about either one of these attractive men. They are married. John was that young announcer at KFBU. He also worked with Leo at WDAF. When he was in the University of Kansas, he fell in love, and was married last June in Pueblo, Colorado. John is certainly good looking. He is tall and slim and has a pair of wicked blue eyes.

(Continued on page 125)

KYW, has a lot of new voices since John Clark left. Maurrie Wetzel, the chief announcer, moved over there from WCFL. My, there is a man with ideas. He says he married a blonde although he preferred brunettes. Isn't that a cute way of saying it. But he really is a perfect gentleman. You should see him running around when he is conducting a program. That handsome Ivan Jones presides at the microphone. He has pretty curly brown hair and brown eyes and is really too attractive. He came here from KOMO Seattle. Then there's that Stanley Houston, who just tried to vanp Marcella right off the bat when he turned his blue eyes on her. Gee I wish I had that picture of Stanley made up so you could see it. He has an impish look, curly hair and is not married. Matty says a room full of stenographers just stop work when he arrives.

Elizabeth Ann, do you know I still haven't that information on Bobby Warner and Harold Pratt. Isn't that terrible?



Will you forgive me? You see you forgot to tell me where they are and I just can't guess at it. But Harry Lucke who used to be at KTNT came in the office the other day and he knows Carl Menzer.

He says he is very good looking and that he flies up to Chicago. In fact, flying is his hobby. Isn't that interesting. Perhaps, Clare, who wrote me that lovely letter about him will think this is the third reason he is not married. I just can't see why he doesn't come to see Marcella.

I want to thank everybody who sent in information about Harry Snodgrass. The last heard of he was playing in Columbia, S. C. about February 21. He is only about five feet four inches tall and has a shock of black hair. He has settled down in Johnson City, Pennsylvania, and his child is in school there.

The cutest letter came in here last week. Here it is as is: "Dearest Marcella; Note in your column of the February issue of the Radio Digest that you
Continued on page 126

A Sensational Success!

Tested--Proved--
Over 35,000 Times

We defy anyone, anywhere, to match the quality and performance of the Townsend "B" Socket Power—performance that is your privilege to obtain for only \$6.85. Thousands of reports show astounding results beyond the capabilities of many of the highest-priced "B" Eliminators. Convince yourself without delay at our risk.

A.C.--D.C.--Any Cycle

Delivers up to 100 volts on any set. Full tone, clarity, and volume. Sold on REAL GUARANTEE OF MONEY BACK IF NOT SATISFIED.

SEND ONLY \$1.00

Simply fill out the coupon and slip it into an envelope with only \$1.00, and mail at once. Your Townsend "B" Socket Power Unit will be sent promptly. Deposit only \$5.85 plus postage with the postman. Try out for 10 days—then if it does not do everything we say, return it to us and purchase price will be refunded.

TOWNSEND LABORATORIES

713 Townsend Street Dept. 17 Chicago, Ill.
MONEY BACK GUARANTEE

Townsend "B" Socket Power

Approved and passed by the rigid laboratory tests of Popular Radio and Radio News

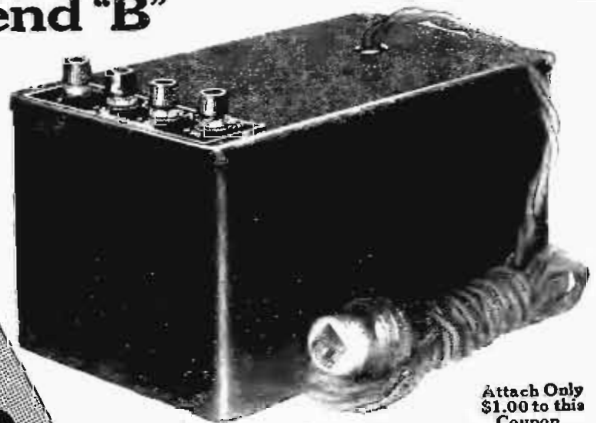

10 Days FREE TRIAL
You are the Judge!

Complete \$6.85
Step Down Balance C.O.D.

Attach Only \$1.00 to this Coupon

TOWNSEND LABORATORIES
713 Townsend St., Dept. 17 Chicago, Ill.
Gentlemen: Attached find \$1.00. Kindly send at once Townsend "B" Socket Power Unit, C.O.D. for \$5.85, plus postage, on guaranteed 10-day free trial.

Name
Address
City..... State.....

Send for Literature

JEWELL

Pattern No. 190
A. C. Voltmeter for Controlling A. C. Filament Voltage

Jewell Radio Instruments

Jewell radio instruments are sturdy and accurate, and will give years of satisfaction. They are available in many different styles and types to best suit the various requirements of the new A. C. and D. C. sets. Most of the popular radio circuits recognize the value of instruments and many specify Jewell instruments exclusively.

Our radio instruments are described and listed in our radio instrument catalog No. 15-C, which is available on request. Write for a copy.

Jewell Electrical Instrument Co.
1650 Walnut St., Chicago
"28 Years Making Good Instruments"

YAXLEY
APPROVED RADIO PRODUCTS

for the Hot Spot Fourteen

No. 660—Cable Connector\$3.50
No. 103K—3 Ohm Rheostat, with Knob 1.35
No. 400—400 Ohm Potentiometer 1.75
No. 804—4 Ohm Resistance Unit15
2—No. 506DA—6 Ohm, Double Arm, Semi-Fixed Resistance Each, .50

At Your Radio Dealers
Write for New Illustrated Catalog
YAXLEY MFG. CO.
Dept. L-9 So. Clinton St., Chicago

\$1.00 WILL SAVE YOUR SPEAKER

The Craftsman Dollar Speaker Filter is Guaranteed to relieve your speaker of the DC plate current (up to 250 volts). It gives speaker a chance to operate at its best. Attached in a second. Send dollar bill NOW!

CRAFTSMAN RADIO PRODUCTS
9 Orchard St., Newark, N. J.

MAKES A COMPLETE MACHINESHOP

EVERY-USE Electric MOTOR ATTACHMENT
Fastens on shaft of small motor in a flash. Holds attachments for Grinding, Polishing, Sawing, Drilling, etc. MADE TO FIT 1/2 inch, 3/4 inch and 1 inch shafts.

STATE SIZE. Electric Motors at Greatly Reduced Prices.

Write Us YOUR Requirements.
UNITED ELECTRIC MOTOR CO.
178-M Centre Street, New York

ONLY \$3.95

DEALERS BIG DISCOUNTS

SET BUILDERS, AGENTS!
Big New 1928 Catalog—4000 Items Shows the latest circuits, the newest developments in radio at startlingly low prices. Get the parts you want here and save money. The best in parts, kits, complete factory-built sets and supplies. Orders filled same day received. Write for free copy NOW. Standard discounts to dealers, set builders, norms.

BARAWIK CO. Dept. 873. Chicago, U. S. A.

ask me who Ione is. Yes, sir. She is 'it.' Still wondering how you found me out. (Here he draws the cutest picture of a villain saying curses I am foiled.) We are heading south from here on this trip, ending up at Nashville, Hot Springs, St. Louis, Kansas City and back home to KOIL in the spring—then look out. (Then he shows the cunningest picture of two little birds on a branch with a nest over head.) Of course, it might be a rainy season! Well we must get busy and prepare some new songs. What a life! As Oilways, Ned Tollinger Mona Motor Twin."

* *

I just heard about the sweetest romance. You remember John Clark and Matty of KYW and how we kidded along last summer? Here is the real low down on the matter. That pretty and attractive Polly Willis met Matty on the street, you remember Polly, she was at KYW in the early days, and Matty, of course, said



come up and meet the old gang. Which she did and Matty said that as soon as John Clark met Polly his heart must have done a few handspings because the next night he met them going somewhere for dinner. Well, John admitted it himself and he says she is the loveliest girl in the world and my dears, in fact, he hardly had time to speak to us the last time we saw him at KYW, because he was taking the train for Freeport, that's where Polly is teaching school. Well anyway John says it will happen sometime in June. Now here is the funny part of it. Polly is an old Radio star and John is an old Radio announcer and yet they never happened to meet until Matty introduced them. Matty says he's going to buy himself a bow and arrow and pinch hit for Cupid. There's something about these announcers that surely gets we girls. Now Polly will have to live in Springfield because John Clark is director of WBZ.

* *

Even if the Windjammer is not located his running mate the Bell Boy, Ted Hediger, has been. Ted is appearing before the microphone of KWK, incognito as Fred Hermen, his two first names. Glad to hear from you Mr. Hermen. Drop us a line again when anything exciting or thrilling happens.

Radio Finds Gold Treasure

(Continued from page 10)

with large emeralds and a large pearl drop.

"One of the finds was that of a very large cross worn by priests three hundred years ago. Another was a long gold ball chain, each ball being an inch in diameter. There were a number of crosses set with diamonds and other stones. Numerous articles were encrusted with rubies, emeralds, turquoise, pearls and diamonds. One piece resembling a tower is believed to be a part of the headgear worn in ceremonials by the old priests."

Subterranean passages were hewn from the rock by slaves in the old days and there are many legends of how the people brought their private treasure to the priests to be secreted from the threatened onslaught of pirates. It was in these passages the treasure was hidden. When Morgan arrived and began his pillage the tunnels where the treasures had been concealed were flooded.

Make this Underground DX Test FREE

Spring and static are here. From now on radio reception taken out of the air will contain more static and noise than music. Why put up with this nuisance—why, when

Try This Amazing Device Entirely at Our Risk.

SUBANTENNA Will Bring You Loud, Clear DX Right Thru Raging Summer Static

Ground waves are clear, strong and static free when air waves are noisy. Subantenna, the tried, tested and proved underground antenna, picks up these ground waves and brings them to your set. You get the same sweet clear reception you get on a crisp, cold, winter night. Prove this FREE. Mail coupon.

Recommended By Leading Authorities and Thousands of Fans

The laboratories of Citizens Radio Call Book, Popular Radio, Radio News, Radio Age, Radio Digest and others approve Subantenna.

John White of Brooklyn, N. Y., received Perth, Australia (9,400 miles away), with an ordinary 6-tube set and a Subantenna.

W. C. Freymuth of Chicago got Havana, Cuba and Buenos Aires, S. A., with a Subantenna.

Hundreds of other fans have written us reporting greater distance since installing Subantenna and all are amazed at the clarity of ground waves.

CLOVERLEAF MFG. CO. 2714-A Canal Street Chicago, Ill.

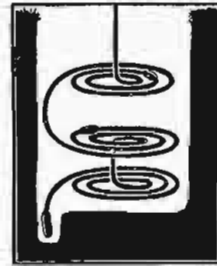

Install Subantenna. Leave your old aerial up. Select a had night when DX is almost impossible with the ordinary aerial. Make a comparison, station for station, connecting first your aerial, then Subantenna. If, from stations that are just a mess of jumbled noise with the old aerial, you don't get reception that rivals local in sweetness and clarity the instant you switch to Subantenna, this test is FREE. Send coupon at once for scientific explanation of Subantenna and for particulars of GUARANTEE and FREE TRIAL OFFER. SEND COUPON NOW!

Clip and Mail Now—

Cloverleaf Mfg. Co., 2714-A Canal St., Chicago, Ill.

Tell me all about SUBANTENNA; your unqualified, unconditional guarantee and your FREE TRIAL OFFER.

Name
Street
Town State

Guaranteed Socket Power Unit \$13.75

90-Day Guarantee

An absolutely unequalled value! We want you to test the World "A" Socket Power Unit and compare it with any other of two or three times the price. Try for ten days at our risk. Then if you are not convinced that it is unsurpassed as to quality and wonderful results, purchase price will be refunded in full. Operates on 50 or 60 cycles at 110 volts A. C. Highest quality Westinghouse electrical equipment. No hum or noise. Approved by Radio News Laboratories and other leading Authorities.

Send Order Today Just write address on a slip of paper—pin a one dollar bill to it and mail today. We will ship same day order is received for \$12.75 C. O. D. 5% discount for cash with order. Remember you are the Judge and are fully protected—so send order NOW.

only \$1.00 Down Balance C.O.D.

WORLD BATTERY COMPANY
1219 South Wabash Avenue
Dept. 62 Chicago, Illinois

Station W. S. B. Co., owned and operated by World Battery Company

\$75 to \$125 Weekly Charging Batteries Starts You

Let me show you how to make big money right from the start. I've prepared a FREE book explaining all details. First week's profit pays for all equipment. You can get all the battery charging business in your community with my Service Station Charger—it's years ahead of ordinary chargers—handles 50% to 70% more batteries. I explain everything—start you in a business of your own and put you on the way to big money. Write for FREE BOOK.

C. F. HOLMES, Chief Engineer, Dept. R. D. Independent Electric Works 5116 Ravenswood Ave. Chicago, Ill.

FREE BOOK—Just Out

Big Profits

Stop Using a Truss Free—Trial Plapao—Free

STUART'S ADHESIF PLAPAO-PADS are surprisingly different from the truss—being mechano-chemico applicators—made self-adhesive purposely to keep the muscle-tonic "PLAPAO" applied continuously to the affected parts, and to minimize painful friction and dangerous slipping. No straps, buckles or spring attached. Soft as velvet—easy to apply—inexpensive. For almost a quarter of a century satisfied thousands report success without delay.

FREE

PLAPAO CO., 176 Stuart Bldg., St. Louis, Mo.

Name.....
Address.....

Return mail will bring Free Trial PLAPAO.

CLASSIFIED ADVERTISEMENTS

HOW about that new set you want to buy? What are you going to do with the old one? A Radio Digest classified advertisement will sell it for you.

Rates are twenty cents a word for each insertion. Five per cent discount for four insertions. Name and address are counted. Two initials count one word. Cash must accompany order. Minimum of ten words. Objectionable and misleading advertisements not accepted.

Employment

Agents

We pay \$48.00 a week, furnish auto and expenses to introduce our soap and washing powder. Buss-Beach Company, Department A186, Chippewa Falls, Wisconsin.

Instructions

Earn \$25 weekly spare time, writing for newspapers and magazines. Experience unnecessary. Copyright book, "How to write for Pay." Free. Press Reporting Institute, 1269 St. Louis, Missouri.

DO YOU DRIVE A CAR? U. S. Government Chauffeur-Carrier jobs will pay you \$141 to \$175 a month. "How to Qualify," mailed Free. Write, Instruction Bureau, 206 Arcade, St. Louis, Mo.

Men qualify for forest ranger position; start \$125 month; cabin and vacation; patrol the forests; protect the game. Write Mokane Institute, M-50, Denver, Colorado.

Patent Attorneys

Inventors who derive largest profits know and heed certain simple but vital facts before applying for patents. Our book Patent-Sense gives those facts; free. Lacey & Lacey, 721 F Street, Washington, D. C. Established 1869.

PATENTS. Booklet free. Highest references. Best results. WATSON E. COLEMAN, Patent Lawyer, 724 Ninth St., N. W., Washington, D. C.

Patents

INVENTIONS COMMERCIALIZED. Patented or unpatented. Write Adam Fisher Manufacturing Company, 555 Enright, St. Louis, Missouri.

Radio

Amazing Value at Bargain Prices. A. B. Socket Power Units for any five to seven tube set. Latest model. Exceptional power. Two rate bulb type charger and bulb type four tap eliminator with automatic control switch and six volt storage battery. Every one a genuine bargain. Write today for folder and prices. The Acme Electric & Mfg. Co., 1652 Rockwell Ave., Cleveland, O.

UTAH LOUD SPEAKERS: Large \$22.50 Speaker for \$8.95; new stock in sealed cartons; \$25.00 Saal Speakers for \$7.95 while they last. Write for bargain sheet. Dealers write for quotations on above speakers. Radio Supply Co., 119 W. Main St., Springfield, Ohio.

For better coast to coast summer reception use Staal's Underground Antenna. It will cut static fifty to ninety per cent. Plan and instructions sent postpaid for \$1.00. J. T. Staal, 4005 Woodland Avenue, Kansas City, Missouri.

EDISON "A" BATTERIES—3 cell, 20 ampere hour, in neat metal cases. Price \$3.50 each, ten or more \$3.00 each. Cash with order. Department B, 25 East South Street, Indianapolis, Indiana.

COMPLETE EQUIPMENT for 15 Watt broadcasting station. Cheap. Address Pillar of Fire, 1845 Champa Street, Denver, Colorado.

Indoor Radio Aerial, costs little to build. Material obtainable anywhere. Send 25c for sample material and instructions. H. M. Sutterfield, Iowa Park, Texas.

Radio

Are you making money in Radio? If not, send for booklet. Co-operative Radio Doctors, Dept. D, 131 Essex Street, Salem, Massachusetts.

Stamps

RADIO STATION stamps bought, sold and exchanged. Chas. A. Phildius, 510 East 120th St., New York, N. Y.

Bring Back Original Color to GRAY HAIR!

New, Harmless, Quick Acting "YOUTHRAY"
• For MEN and WOMEN

Not a dye or henna. Not just a darkener that colors hair down to the scalp then leaves it gray again as it grows out. Not something you have to keep on using. Entirely different. Perfectly harmless. No Streaks, No After-Graying at Roots

Apply YOUTHRAY to scalp. Restores original youthful color by replenishing natural color pigment thru hair root. Quick results will absolutely amaze and satisfy you. **FREE TRIAL** restorer. So certain, so positive are we that YOUTHRAY will please you that we back it with an unconditional GUARANTEE. Write now for amazing explanation of YOUTHRAY and full particulars of our FREE TRIAL OFFER. No obligation. Send today. Ray Laboratories, 646 N. Michigan Av., Dept. 743, Chicago



When in New York ~
Reside where the New Yorkers reside—at Beautiful Standish Hall

THIS magnificent Apartment Hotel overlooks Central Park, faces the Museum of Natural History and is only a few minutes from Broadway—Fifth Ave. and the Shopping and theatre centers. The rooms are uniquely large and furnished with luxurious refinement. An ideal summer residence for families.

During the Spring and Summer months a Special Discount is offered to transient and permanent guests.

Send for Illustrated Booklet and Rates

Standish Hall
45 W. 81st St. New York

Turn Your Phonograph

into a

Loud Speaker

with a

Fultone

LOUD SPEAKER UNIT

Big Price Reduction Now Only

\$2⁰⁰

By Mail Supply Limited Order Today



FITS ANY MAKE

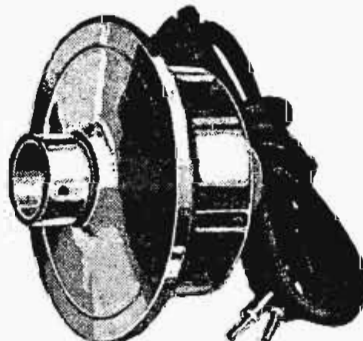

Use on Your Phonograph

- Edison Adapter.....25c
- Columbia or Pathe.....20c
- Brunswick30c

Fultone Speaker System

4600 Lincoln Ave.
Chicago, Ill.

Fultone Speaker System,
4600 Lincoln Ave.,
Chicago, Illinois.
Please send me Fultone Loud speaker unit
for which I enclose Two Dollars and.....
cent's for.....adapter.
Name
Address
CityState



If You are Making a Penny Less Than \$50 a Week, Send for This FREE BOOK



Get a copy of this 64-page book. Hundreds of other fellows have found the way to success through this book. Mail the coupon for a copy today. See what Radio offers you. Don't envy the man who is pulling down big money. You can learn to be a Radio Expert at home in spare time. Why go along at \$25, \$30 or \$40 a week when the good jobs in Radio pay \$50 to \$250 a week?

Here's Big Pay Work That's Almost Romance

Today's big-pay field is Radio. It's rapid growth from a two million dollar industry to over five hundred million dollars in a few years has amazed the world. Many fortunes have been made by this rapid growth—many more will be made in the future. Trained men are needed to carry on the tremendous Radio business that has been created. The work is easy, fascinating, interesting. Salaries range from \$50 to \$250 a week in the best jobs. Here is a most remarkable opportunity for quick financial independence. "Rich Rewards in Radio" gives you facts and proof.

Learn at Home to Be a Radio Expert

My practical method makes learning easy and interesting. With six big outfits of Radio parts, given without extra charge, you build and experiment with practically every type of receiving set known today—also learn how to locate and remedy common set troubles. In a short time you can be ready for a new job—you'll know the "how" and "why"—you'll have confidence in yourself because you will have worked out just the kind of problems that come up—not with toys, but real Radio parts and sets. This kind of training gives you experience while learning. It shows up too in your pay envelope.

Pay Your Tuition Out of Spare Time Earnings

Almost the day you enroll I begin showing you how to make money on the side. Many students earn \$15, \$20 and even \$30 a week in spare time. I'll show you how to get jobs, what to charge, tell you what methods made money for other students—give you tested ideas, hints, tips, pointers. Earle Cummings, 13 Webster Street, Haverhill, Mass., \$375 in one month; George Page, 1807 21st Ave. S., Nashville, Tenn., picked up \$935 in his spare time while studying.

You Must Be Satisfied

I'll give you a written agreement the day you enroll to refund your money if after completion you are not satisfied with the course I give you. You are the only judge. The resources of the N. R. T.—the Oldest and Largest Home Study Radio Training Organization in the world, stand back of this agreement.

Complete Information Sent FREE

I want to help you become successful. My 64-page book "Rich Rewards in Radio" gives full information on the Radio industry, what it offers you, what salaries are paid, what other men are making, and how my Employment Department helps you get into Radio after you graduate. Send for a copy. I won't charge you a cent. Simply clip or tear out the coupon and mail it. You don't obligate yourself in any way by mailing the coupon.

J. E. Smith, President,
Dept. 3P
National Radio Institute,
Washington, D. C.

Read What N.R.T. Training Has done for These Men



High As \$78 A Week

"I have made as high as \$78 in one week in a retail Radio store. I estimate my total income, as the result of my knowledge of Radio around \$3,000. I know I could not have picked a better course." Frank Reese, 304 Walnut Street, Coatesville, Penna.



Twenty Times Price of Course

"In the last ten months I have earned enough money to pay for my course twenty times. To date I haven't had a complaint on any of my work. A short time ago I was in Plattsburg and called on Mr. Stauffer, who is an Institute man. He is doing fine and making lots of money. "I want you to use this letter and my picture in any way that it will help you." William E. Riddle, 9 Stevenson Lane, Saranac Lake, New York.

You can build 100 circuits with the six big outfits of Radio parts I give you

3 of the 100 you can build

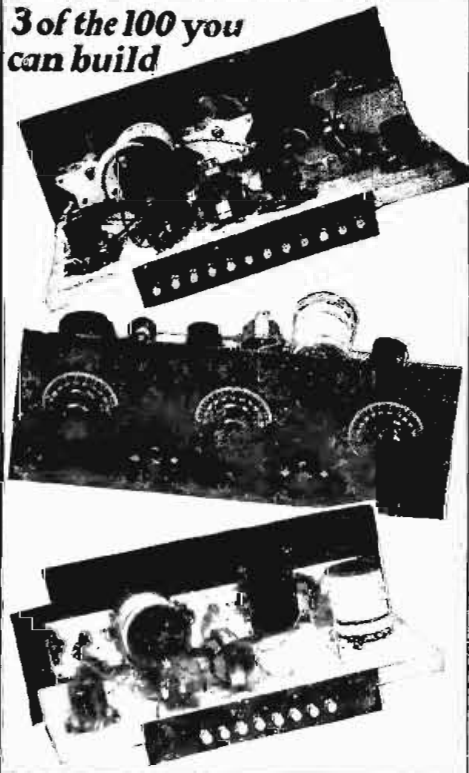

FREE BOOK COUPON

J. E. Smith, President,
Dept. 3P, National Radio Institute,
Washington, D. C.

Dear Mr. Smith: Without any obligation on my part, send me "Rich Rewards in Radio" also full facts and information on your practical Home Study Courses.

Name _____ Age _____
Address _____
City _____ State _____

Employment Service to all Graduates

Announcing A GREAT, NEW RECEIVER SCOTT CHALLENGES THE WHOLE WORLD OF RADIO TO ANY KIND OF COMPETITIVE TEST



The New Scott Shield Grid 9 was designed by E. H. Scott, designer of the World's Record Super 10, which prior to the advent of this new model held all records for Radio Set performance.

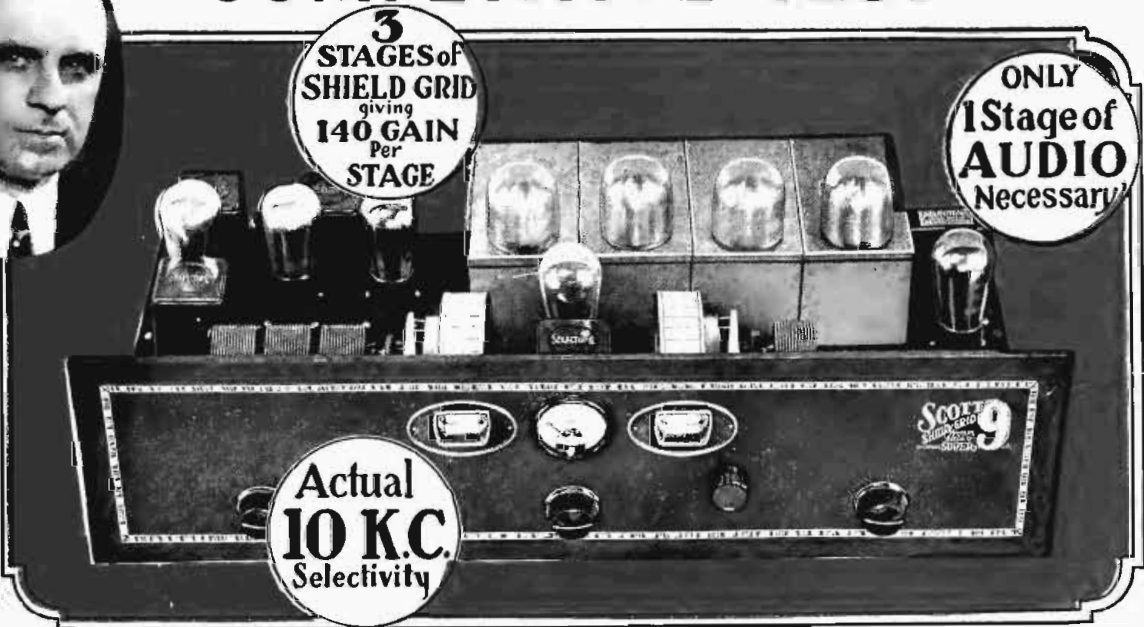

More Actual Amplification • More Distance and Volume than Any Other Existing Receiver Known to Us

This—we believe, is the most powerful, the most selective and the finest toned receiver in existence today. We draw this conclusion from having tested and scientifically measured every other receiver which might claim itself the equal of the SCOTT World's Record Shielded Grid NINE. And there is no question but that this radically new type of receiver will maintain its position of obvious superiority for years to come, for the features of circuit engineering responsible for its amazingly better performance are far ahead of any circuit developed to date.

UNLIMITED RANGE! Without aerial, ground or loop, the SCOTT Shielded Grid NINE brings Pacific Coast Stations to Chicago with loud speaker volume. And so tremendous is the amplification of the shielded grid long wave amplifier employed, that it is impossible to determine a range limit for this receiver when used with a short antenna and a connection to ground.

Shielded Grid Tubes Used in an Entirely New Way

Standard circuits commonly in use with the new shielded-grid tubes, provide actual amplification of approximately 40 per stage. The revolutionary new circuit used exclusively in the SCOTT Shielded Grid NINE, gives a practical amplification of 140 per stage, thereby making this receiver

many times more powerful than receivers using shielded-grid tubes in a conventional manner. It is this new circuit arrangement developed and used exclusively by us which enables us to challenge the whole world of radio to any kind of competitive test with assurance that the SCOTT Shielded Grid NINE will win.

Only One Stage of Audio Required!

The second detector output of this receiver is so heavy that concert volume and clear, undistorted cathedral tone, even on the most distant stations, is obtained with but a single stage of 2 to 1 audio frequency amplification.

Easy to Build — Results Guaranteed

Despite the fact that the Scott Shielded Grid NINE is one of the most elaborate receiving systems ever devised — and despite the fact that it embodies many features of circuit arrangement not known to common practice, it is a very easy set to build, and when you buy the kit of parts we positively guarantee that you will get the same results we get from our laboratory model. Both panel and sub-panel are drilled to receive each part and the shield-grid amplifier units come to you fully wired and tested — ready to be connected into the circuit just as though they were a transformer.

Why Pay More for Less?

Why pay more than the small cost of the Scott Shielded Grid NINE when no other receiver offers you so much? Why not have a receiver which provides actual 10 Kilocycle selectivity regardless of where located? Why not have a receiver with which you can listen in on all the world — no limit to its distance range. The Scott Shielded Grid NINE is, unquestionably the finest, most powerful, most advanced receiver of the day, and is, beyond all doubt, destined to hold its position of leadership, throughout the coming years. It is the ultimate. Build it — enjoy it NOW.

FREE

Circuit Diagram and Particulars

Find out all particulars of the Scott Shielded Grid NINE. Examine its circuit. See for yourself why it has unlimited range — unlimited power — perfect tone. Proof of the superiority of this great new receiver is FREE to you. Also copies of 6000 and 9000 mile reception verifications and other records made by the Scott World's Record Super 9 and the Super 10, the less powerful predecessors of the new Scott Shielded Grid NINE. Get this information now. Simply clip and mail the coupon. Mail it TODAY!

SCOTT TRANSFORMER CO.
7626 Eastlake Terrace - Dept. A.
CHICAGO, ILL.

Mail this
Coupon!

SCOTT
TRANSFORMER CO.
7626 Eastlake Terrace,
Dept. A, Chicago, Ill.

Send me full particulars of the new Scott
Shielded Grid NINE.

SCOTT SHIELD-GRID WORLD'S RECORD SUPER 9

Name.....
Street.....
Town..... State.....

*The Perfected
Invention of
Dr. J. Harris Rogers
Celebrated War Time
Naval Radio Consultant*

The eminent scientist, Dr. J. Harris Rogers is known the world over for his research work and successful accomplishments in the line of underground and underwater radio transmission and reception. His invention, the Rogers *Underground Antenna* for reception of waves within the B.C.L. band is, unquestionably, one of the most important radio advancements of the year.



This photo shows Dr. Rogers charting the country wide success of one of his numerous underground radio tests

First news of the **ROGERS** *Underground* **ANTENNA**

Made under exclusive license in accordance with patents of Dr. J. Harris Rogers Nos. 1303730, 1349103, 1349104 and pat. pend.

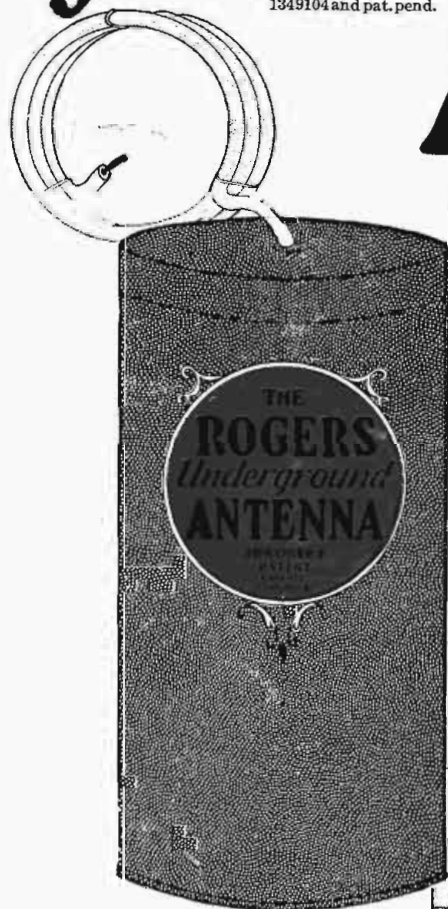

**Provides Clear, Loud Reception
Regardless of Weather
Increases Distance and Volume with Any Set**

That radio waves, unspoiled by static and less affected by weather conditions, travelled thru the ground was the belief of Dr. J. Harris Rogers. Test after test proved his contention. On nights when weather made reception from distant points impossible with an antenna suspended in the air, reception was clear, steady and loud when taken out of the ground. Static has little effect upon ground-wave reception, and it was found that ground waves usually exceeded the strength of air waves even when the latter were at their best. It then remained for someone to develop a device with which these clear, strong ground waves could be intercepted and brought to the receiving set. Followed more years of research, more experimenting, more practical tests—all resulting in the Rogers Underground Antenna—developed and perfected by Dr. Rogers, himself—the product of a lifetime of study—a proved device, successful wherever used and offered to you with a positive guaranty of money back if you are not satisfied.

Yours to Test FREE

It costs you nothing to test the Rogers Underground Antenna. We will send it to you to try on your own set, and we don't ask you to pay a cent for this great radio improvement if you don't find it all that *Dr. Rogers claims* in his patents. Send the coupon now. Let us send you the startling facts of the Rogers Underground Antenna and full particulars of the **FREE** comparative test we want you to make. Clip the coupon. Send it today.

EASILY INSTALLED IN 5 MINUTES!

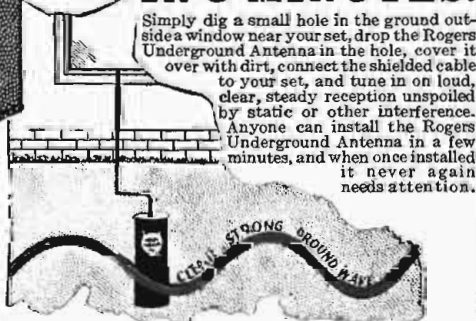

Simply dig a small hole in the ground outside a window near your set, drop the Rogers Underground Antenna in the hole, cover it over with dirt, connect the shielded cable to your set, and tune in on loud, clear, steady reception unspoiled by static or other interference. Anyone can install the Rogers Underground Antenna in a few minutes, and when once installed it never again needs attention.

THE ILLUSTRATION at the right shows a typical installation of the Rogers Underground Antenna. As there is but little static in the ground, this Rogers unit delivers clear, strong, radio impulses to the receiver, thru the shielded connecting cable. And think! How much easier it is to install the Rogers Underground Antenna than it is to climb around on a slippery roof hanging up a wire which collects as much static as it does radio waves.

MAIL THIS NOW

The Underground Antenna Co.
4207 L Cottage Grove Ave.
Chicago, Ill.

Send me all the facts on the Rogers Underground Antenna. Also full particulars of FREE Test Offer and GUARANTEE.

Name.....

Street.....

Town..... State.....

The Underground Antenna Co.
4207L COTTAGE GROVE AVENUE CHICAGO, ILL.