

Easy Methods of Making Receivers Selective; CHNC, Toronto, in Photos; Preventing Troubles in Radio Reception; DX English Circuit Hears U. S.

# Radio Digest

EVERY WEEK **Illustrated** PROGRAMS **TEN CENTS**

REG. U. S. PAT. OFF. & DOM. OF CANADA

Vol. XIV

Copyright 1925  
By Radio Digest Publishing Co.

SATURDAY, AUGUST 29, 1925

No. 8

## REDS BUILD BIG STATION

### SUPERPOWER TEST AROUSES INTEREST

FANS DIFFER ON RESULTS,  
EXPECTING A MIRACLE

Wave Length Very Sharp; Loud  
Speaker Volume on Coast;  
Other Features

in SCHENECTADY.—Tests by WGY of Schenectady, on superpower up to 50 kilowatts brought thousands of letters from interested fans in every part of the country and engineers are now engaged in a thorough analysis of these reports in the hope of arriving at some constructive conclusions.

The tests were conducted on three nights, Saturday, Tuesday and Thursday, July 25, 28 and 30. Special programs from the studio of WGY were transmitted on the experimental license 2XAG, on the 50 kilowatts transmitter at the developmental transmitter laboratory of the General Electric company and listeners were asked to report on quality and volume of signal.

Reports were received from as far west as California, but the great mass of letters came from listeners in the New England and southern states.

#### Goes Through Static

Dr. S. G. Berry of Tyndall, South Dakota, reported successful reception through static, stating that WGY was the first station he had heard east of Chicago for over five weeks.

From Berwyn, Md., came word that the station had been received on a crystal set. J. H. Bilinn of San Francisco, picked up the Saturday night signals clearly. From John M. Erdis of San Anselmo, California, came word that he had received 2XAG with loud speaker, volume equal to that of local reception.

These are a few of the correspondents who reported successful reception. It does not follow that all were favorable. Some, but they were in the minority, could find no improvement in signal, in fact a few thought the power seemed less.

None of the letters reported that any difficulty was experienced in tuning out WGY's high-powered wave and this, from a superficial review of the letters, is one of the most outstanding features of the reports. Even in Schenectady, within four miles of the transmitter owners of

(Continued on page 2)

The haughty, beautiful lady wearing the Spanish shawl is Evelyn Herbert, appearing in the "Love Song" in New York and broadcasting from WEAJ Monday evenings. In the corner is Helen Banta, a brilliant pianist heard from Station WDAF.



### EUROPE FEARS COMMUNISTIC MISUSE OF AIR

#### Prepares Counterattack

Should Bolsheviks Attempt Propaganda Broadcast, Germany Plans to Jam Ether

LONDON.—Enormous interest has been created here and all over Europe by the proposal of the Radio experts of Soviet Russia to erect a broadcasting station that will be the most powerful in the world.

It is feared that it will be used for carefully veiled Communist propaganda in the form of a "news" service. The service could be picked up by crystal set owners in most parts of western Europe, but the danger is that millions of listeners in Britain would be unable to hear anything else, as the Russian station could jam out the British Broadcasting company's stations. In fact, most of the stations in Europe could be made ineffective.

#### Germany Plans Jamming Plant

Bolshevist propaganda can be suppressed when it comes through the post, but how can it be dealt with when it comes through the air? This is the problem the possibilities of the new station suggest.

Where would an attempt to jam out the Soviet station lead? The Herzstrand station (Bavaria), originally erected for Morse transmissions, is being converted

(Continued on page 2)

# WEAF CHIEF NEARS 100,000 VOTE MARK

## G. D. HAY REGAINS SECOND IN GOLD CUP AWARD

Final Votes Pour in; August 29, Midnight, Is Closing Date; Hurry, Hurry, Hurry!

Although the last ballot has been printed in the 1925 Gold Cup Best Announcer Award and the contest is rapidly drawing to a close, it is still impossible to even guess at the name of the winner the way the votes are pouring in for every one of the sixteen present leaders. Although Graham McNamee of WEAF is still in the lead and seems to have a goodly number of votes between him and the second man, George D. Hay of WLS, it is possible for any one of several contestants to replace the top man by the reception in this office of a large enough bag of mail.

Last week George Hay, who held down the first place in the early days of the race and who was voted the best announcer in 1924, was displaced by Henry Field of KFNF, who broke the records for votes received in any one week. Now we find George back in the runner-up billet with exactly 2,000 more votes than Henry has to his credit. "The Solemn Old Judge's" friends are fighting hard to keep him above Field, and their fight is apt to develop enough force to shove him over the top. At the same time the mail from the corn belt continues to add to the total of the Shenandoah seed king. While Hay's votes have mounted up in a steady manner throughout the contest, Field's supporters have been holding them and taking every advantage of the bonus system. This leads us to believe that we might expect an eleventh hour avalanche that will help Henry considerably.

### And McNamee Still Leads

Chain station fans in the East are right behind McNamee of the chief station, and if they continue their backing Mac should be very prominent among those present when the final list is published in the September 12 issue.

Other than the Hay-Field shift, the standings of the upper half of the list of leaders remains the same this week. Rouse, Lane, Hired Hand, Arlin and Fitzpatrick all gained in their vote totals and held their places. Down in ninth place Lambdin Kay only added fourteen to his list, but managed to stay in the second division lead due to the slow headway made by those beneath him.

### Barnett Comes Back

The other boys in the second half of the leaders' list had a merry time swapping positions during the week. Bill Hay dropped two notches, as did N. D. Cole and O. E. Becker, who toppled off into the great open spaces below the superior sixteen. Stanley Barnett came up from the depths to again take position with the leaders. Many fans who realize that their favorite's chances of winning the cup are very slim are determined that they will at least receive the certificate of popularity awarded to the fifteen runners-up.

Charles Erbstein, the boss of WTAS, is once more in the thirteenth chair, the spot he held for several weeks previous to his one notch drop of last week.

### August 29 Is Deadline

And now, remember, the last chance you have to get your votes in on this contest will be at midnight of August 29, the day indicated by the date line at the top of this page. Don't forget to mail them early enough to have them reach the Radio Digest office by midnight. The Gold Cup editor and his assistants will be on hand during the closing hours to count the votes as the mail man delivers them, so that it will be possible to announce the final result in the September 12 issue. In the meantime, we will prepare a list of standings for the September 5 edition and you will thus be enabled to look over our shoulder as we count and see how things are coming. Do not fail to read the "How to Vote" paragraph published below the list of standings so that there will be no possibility of your votes failing to give your favorite the utmost help.

The below standings are NOT FINAL. They show the positions of the sixteen leaders at the present writing.

Position	Name and Station	Votes
1.	Graham McNamee, WEAF	91,122
2.	George D. Hay, WLS	57,603
3.	Henry Field, KFNF	55,603
4.	Gene Rouse, WOAW	45,453
5.	Frank S. Lane, KFRL	23,204
6.	Hired Hand, WBAP	21,689
7.	H. W. Arlin, KDKA	15,827
8.	Leo Fitzpatrick, WDAF	10,216
9.	Lambdin Kay, WSB	6,638
10.	Robert Emery, WEEI	6,546
11.	Jerry Sullivan, WQJ	6,465
12.	W. G. (Bill) Hay, KFEX	6,394
13.	Charles Erbstein, WTAS	5,932
14.	N. Dean Cole, WHO	5,724
15.	John Daggett, KHJ	5,436
16.	Stanley Barnett, WOC	5,070

### How to Vote and Get Bonus

Don't miss a single ballot, for when these are turned into Radio Digest in a group of CONSECUTIVE numbers, extra

bonus votes are allowed the announcer for whom you are voting.

The ballots, numbered consecutively, appeared in each issue of the Radio Digest until the close of the Contest, with the August 22 number.

Each of these ballots will count for one vote when sent in separately. You can hold these ballots until you have 4 that are consecutively numbered, and when they are sent in a bonus of 8 votes will be allowed for your favorite announcer.

For each 8 consecutively numbered ballots your candidates will receive a bonus of 20 votes. For each 12 consecutively numbered ballots, 30 votes. For each 16 consecutively numbered ballots, 40 votes. For each 20 consecutively numbered ballots, 50 votes, and for each 22 consecutively numbered ballots, 60 votes bonus will be allowed.

Send ballots to the GOLD CUP AWARD EDITOR, Radio Digest, 510 N. Dearborn street, Chicago.

## TRY SUPERPOWER USE

(Continued from page 1)

selective sets reported WGY's wave so sharp that it could be tuned-out at will in favor of middle western stations then on the air.

### Some Are Disappointed

One facetious listener reported that he had connected the superpower to the family washing machine and had done the wash for the week.

From many of the letters it was apparent that the observers had expected to be literally knocked from their chairs by the high power and were somewhat disappointed that something of that sort did not occur.

Practically all, however, requested that further tests be made that more observations might be recorded. These requests came, especially, from eastern listeners who are anxious that the tests be put

## REDS BUILD BIG PLANT

(Continued from page 1)

to telephony and the power increased to 100 kilowatts—the same as the Russian station. Germany does not mean to be caught napping. The slightest attempt on the part of Moscow to broadcast propaganda will see Herzostrand at full power. These stations will then jam the ether for thousands of miles.

France and Spain, for their own protection, would have to jam, too, and in the end British stations would be smothered unless their power were enormously multiplied to meet the situation. Daventry, the new B. B. C. high-power station, could be used for jamming purposes, but such a process would not only blanket S. O. S. signals from ships, but would bring all the commercial telegraph services to a standstill.

### Geneva Bureau Powerless

The International bureau at Geneva in control of the allocation of wave lengths is powerless to deal with the menace from Moscow. Germany is increasing the strength of the station at Munich, and thousands of crystal set owners in south-east England may find themselves cut off from the B. B. C.

Captain P. P. Eckersley, chief engineer of the B. B. C., says it would have to be a deliberate attempt for the Russian station to interfere with broadcasting in England. If and when constructed the International bureau will allocate it a wave length that will not interfere with other stations. The bureau, however, is powerless to enforce acceptance of such wave length.

on at an earlier hour when it will be possible to draw comparisons of reception with other nearby stations. To avoid any possible air "jumping" the General Electric engineers selected the late hour but at midnight practically the only stations on the air are those of the middle west.

# TOM McNAMARA TO TEACH GAME BY AIR

## FAMOUS FOOTBALL COACH WILL GIVE BOYS HINTS

KOA Series to Cover Entire Field of Gridiron Sports Starting August 31

DENVER.—Eyes of the sporting world will be focused on Denver next Monday evening, August 31, when Tom McNamara, nationally famous gridiron star, coach and sport writer, is presented to KOA's international audience as the first nationally-known Radio football coach to appear before the microphone of a superpower broadcasting station.



Tom McNamara

His introduction will be the opening signal for a tri-weekly series of football instructions which are to be continued by the Rocky Mountain broadcasting station of the General Electric company throughout the season.

These discussions, which are prepared for college and high school players together with parents and athletic instructors, will be heard every Monday, Wednesday and Friday evening at 8 o'clock. They will require less than ten minutes each.

### McNamara's Record

McNamara, who is head coach of Regis college at Denver, was a star backfield player at Fordham university; was a member of the coaching and scouting staff at the University of Pennsylvania four years and in 1924 gained wide prominence when Pennsylvania's defense built upon his scouting reports, turned back Coach Moran's famous Centre college team. Outstanding of the big eastern teams which McNamara has scouted, include Nav Pittsburgh, Lafayette, Penn State a. Cornell.

Also, he has won a national following as the author of a series of articles on football and basket ball which have been featured by the Public Ledger syndicate.

"To help listeners understand the basic principles of football—the offense and defense—is my aim as Radio coach for KOA," McNamara declared. "In addition, I hope to explain in simple language, the fundamental physical movements which are necessary if one is to play the game scientifically."

### Series Embraces Many Subjects

Features of the McNamara Radio series include dieting, physical fitness, mental attitude, confidence, fundamentals, offense and defense, drills, line play, suggestions for guards and centers, backfield plays, how to tackle, signals, forward passes and the like.

"It is my intention," McNamara continued, "to outline briefly some points which have proven beneficial in obtaining the utmost from players."

Next Monday's discussion will be addressed to parents and is designed to week encouragement for boys who enter the game.

"Because of many rest periods, football cannot be called a game of endurance," Coach McNamara said. "Seldom do boys play until they are exhausted. Above all, football aims at the highest goal of all sports for American youth—the development of health, character and the spirit of fair play."

## Broadcast Receptor Service Is Latest Radio Business

INDIANAPOLIS.—The Broadcast Receptor Entertainment Service has been formed here to provide special service for party dances, dinners, conventions, luncheon and social clubs, civic, fraternal and political organizations, etc., desiring to receive Radio broadcast program for either information or entertainment, where it is necessary that many persons should be able to "listen in" on a large scale to a given program through a loud speaker, with sufficient volume to fill a large size hall or auditorium. Radio programs received over a twelve tube super-heterodyne, will be greatly amplified over special power and loud speaker equipment using high tube and plate voltage, and will be temporarily installed in any hall for every occasion.

The service was formed and is operated by a father and two sons, A. Jarvis Allen and Morrow J. Allen. A. J. Allen, Sr., the consulting engineer of the trio, is publicity chairman and charter member of the Broadcast Listeners' association of Indianapolis which he helped organize last January. The organization today has 1,025 members and expects to add 5,000 more members by next winter and 20,000 by next year.

# CONTENTS

Radio Digest, Illustrated, Volume XIV, Number 8, published Chicago, Illinois, August 29, 1925. Published weekly by Radio Digest Publishing Company, 510 N. Dearborn Street, Chicago, Illinois. Subscription rates, yearly, Five Dollars; Foreign Postage One Dollar additional; single copies Ten Cents. Entered as second class matter at the post office at Chicago, Illinois, under the Act of March 3, 1879.

- All the Live News of Radio.....1 to 11
- CHNC, Toronto Radio Research Society..... 5
- Advance Programs for the Week.....12 to 17
- An Evening at Home with the Listener In, a chart in Eastern and Central time, showing when to listen in for your favorite stations.....18 and 19
- Editorials, Indi-Gest and Condensed by Dielectric..... 20
- Preventing Trouble in Radio Reception, Part I—Battery Care and Information, by James McDonald..... 21
- Easy Methods of Making Receivers Selective, Part I—Single Circuit Regenerative Types, by John G. Ryan..... 23
- A. B. C. Course in Radio Fundamentals, Chapter XXIII—The Electron Tube as an Amplifier, by David Penn Moreton..... 25
- Reader's View ..... 26
- DX English Circuit Hears America: Other Kinks..... 27
- Questions and Answers..... 29
- Directory of Radiophone Broadcasting Stations, Part I..... 31

## Looking Ahead

The Station Feature Page this week tells of a station up in Canada, so next week we are going to jump way down South to tell you all about WSMB, New Orleans, in word and picture.

The Last List of the Preliminary Standing of the sixteen most popular announcers in the 1925 Gold Cup Award to be published before the final and winner designating list, will appear next week. Look to see if your favorite is running well in the last hours of the race.

Improvements on Your Five Tube Set and suggestions to set builders contemplating building new five tube sets, will be outlined by John G. Ryan in his next article telling how to gain selectivity and efficiency. Don't miss this! You'll need the information this winter when the congestion sets in.

There Is More to a B Battery Than Merely the Name.—Too many uninitiated fans blame their sets for poor performance when the trouble is only that their B batteries need a little attention. Read next week, in the simple and easily understood terms of James McDonald, about storage B batteries, and also, minor mechanical defects in set parts.

"Cascade" Amplification May Be a New Word to many of you, but this type of amplification is in use in every radio frequency and audio frequency set. How tubes amplify in "cascade" will be the next A-B-C article by Professor Moreton.

## Newsstands Don't Always Have One Left

WHEN YOU WANT

# Radio Digest

YOU WANT IT!

BE SURE OF YOUR WEEKLY COPY BY SUBSCRIBING NOW

## SEND IN THE BLANK TODAY

Publisher Radio Digest,  
510 N. Dearborn St.,  
Chicago, Illinois.

Please find enclosed check M. O. for Five Dollars (Six, Foreign) for One Year's Subscription to Radio Digest, Illustrated.

Name .....

Address .....

City ..... State .....

## RUGBY PLANT BEST, SAYS WM. DUBILIER

**BELIEVES ORDINARY TALK OVERSEAS COMING SOON**

**New York City Conditions Worse Than Those in London Radio, He Says**

LONDON.—A short man with wide-set eyes, high forehead, dark frizzy hair and a soft, musical voice has just arrived here from America.—William Dubilier, the famous inventor of the mica condenser which displaced the Leyden jar. He is little less responsible for the miracle of Radio progress than Marconi himself.

Just before the war he offered his invention to America, to Germany, to Russia. They refused it. But Sir Henry Norman and the British Imperial Radio telegraph committee took up Dubilier. Now at the huge station being constructed by the general post office at Rugby, England, the world's largest bank of condensers has been installed.

"The Rugby transmitting station," declared Mr. Dubilier in an interview, "will be the most powerful, most perfect station in the world. In two years time I expect to be able to pick up an ordinary telephone and speak to New York, Capetown or Australia with Rugby's aid. These telephonic conversations will be secret because of a variation of wave lengths which we call 'scrambled' waves."

### English Conditions Best

Questioned as to his opinion on English Radio conditions as compared with those existing in America, he said:

"Conditions in New York city are intolerably worse than those of London. More broadcasting stations are being called for in London. That was the cry in New York also at one time. Now those who were so anxious for more stations and more variety of program are suffering from their own demands. The multiplicity of stations jammed so close make it practically impossible for the amateur to tune in to any one and listen without being subject to interference from others.

"I should not like to see this happen in Great Britain. I am certain that good broadcasting is the key not only to international amity, but world peace."

## Frisco Gets Initial High-Powered Plant

**KPO Has Novel Arrangement for New Studios**

SAN FRANCISCO.—San Francisco's first high-power broadcasting station went on the air this month when Station KPO, Hale brothers and The Chronicle, dedicated its new 4,000-watt transmitter which replaced the old 500-watt equipment.

Of special interest to listeners are the studios, one housing the great KPO organ with sufficient room to accommodate a ninety-piece band or symphony orchestra and a secondary studio for solo and smaller ensemble broadcasting. A novel feature of the arrangement is the placing of the announcer at a permanent post between the two studios and with a personal microphone. This enables him to announce the programs of either studio without leaving his post to speak before the microphones of either room. Both studios are equipped with numerous microphone leads and each have several microphones insuring perfect "pickup" of all the various instruments or voices of a group of artists.

## Cosmo Hamilton Believes in Drama Broadcasting

SCHENECTADY, N. Y.—Several weeks ago, before his return to England to direct the production of his play, "The Silver Fox," Cosmo Hamilton gave the WGY players permission to produce four of his plays. Two of these, "The Silver Fox" and "Scandal," have been put on the air already by WGY.

No playwright has taken a greater interest in the Radio drama and its possibilities than Mr. Hamilton, the Englishman whose productions are so well known on the American stage. He has given a series of talks on "Unwritten History" from a New York station and the response which he received from these efforts partly accounts for his early interest in Radio.

## Thousand Hours on Air Is Nearly Record for WSAI

CINCINNATI.—Nearly one thousand hours of music, entertainment, education and diversion in a year, is the record of the United States Playing Card company's station, WSAI, here. During the summer period WSAI is maintaining a fifteen-hour-a-week schedule.

## BIRD OUT "TWEETS" WHISTLER—WINS!

B RISTOL, Conn.—"Tweet-Tweet," came the whistle solo of Althea Tibbetts over the Radio from WBZ to the home of Wallace Miller here. "Tweet-Tweet-Tweet," answered Mr. Miller's canary awakening from a sound snooze on his perch. "Tweet-tweet-tweet," continued Miss Tibbetts. "Tweet-tweet-tweet and a lot of more tweets," the bird returned in a challenging spirit, and Miss Tibbetts continued until the end of the solo and the bird continued far into the night, thus gaining the decision of the judges in this unique tweeting contest.

## RADIO DRINKS STYLE AT DENVER FOUNTS

G ROWING popularity for Radio during hot weather is further attested by the introduction of new thirst quenchers on the soft drink market which are identified solely by Radio terms. If you're an experimenter with beverages you'll be asked to sample "static punch," "ether shorts," or "antenna sundaes," at one counter. The manager at a second counter reports a land office business in "Radio specials," while a third advises that "KOA delights" are the biggest sellers. These drinks consist of a little bit of everything.

## CHICAGO LOVES THESE THREE



When Grace Wilson, top, sings "Bringin' Home the Bacon" in her manlike voice from WLS, the Sears-Roebuck station at Chicago, fans gather a little closer to the loud speaker and shout "Hello, Grace!" She is a regular favorite of the WLS family. The Lucas Sisters, lower, make up Chicago's youngest harmony duo and they are heard each week on the WIBO Thursday midnight jamboree from the Nelson Brothers, Russo-Fiorito orchestras studio.

## New Stations

Two stations are increasing their power this week. KFOA, Rhodes department store, Seattle, Wash., which has been operating on 500 watts, opens with 1,000 watts Saturday night, September 5. WENR, All-American Radio corporation, which has been getting out unusually well on 100 watts, goes on the air August 29 with a new 1,000-watt equipment.

WGBU was dividing time with WMBF, but now has an independent wave of 273.

Two new commercial class A stations were licensed this week, KFWU, Pineville, La., 100 watts, 238 meters, and KFWV, Portland, Ore., 5 watts, 212.6 meters.

KMA are the call letters of the new

Shenandoah, Ia., station owned by the May Seed & Nursery company. This is a 500-watt set using 252 meters.

## Shut-Ins Have Program to Banish Weary Afternoons

CHICAGO.—One of the features of Radio entertainment here is the daily afternoon popular program for shut-ins from WIBO, the Nelson Brothers Bond and Mortgage company, and the Russo and Florito orchestras plant. From 2 to 4 p. m. each afternoon Chicago's Uptown Radio station broadcasts a special program for the unfortunates, the shut-ins, who cannot get out on the beautiful afternoons, but spend all of their time at the Radio. Upon the opening of WIBO, Harry Geise, director and announcer, conceived the idea of filling up the vacant space on the air here on the dead hours of the afternoon.

## MARCONI BELIEVES CODE BEST ON SHIPS

**RADIO TELEPHONY AID TO TELEGRAPH AT SEA**

**Tube Receivers Being Installed on All Vessels for Use as Their Need Arises**

LONDON.—How far is Radio telephony desirable and practicable for adoption by ships at sea? For two years past Senatore Guglielmo Marconi has been investigating this question. At the recent meeting here of the Marconi International Marine Communication company, he gave some account of the progress made.

"Trials," said Senatore Marconi, "have been made in trawlers as well as in liners, and between ship and shore, and the results obtained clearly demonstrate that technically there is no difficulty in the way of accomplishing a satisfactory service of duplex Radio telephony, especially between ships on the high seas, away from the areas of congested Radio-telegraphic work.

"In at least one instance a range of nearly 400 miles was covered. We are quite prepared to exploit this avenue of Radio development as soon as ship owners demand a means of communication between ship's commander and passengers."

### Telegraph Is Permanent

"But," he continued, "I am of the opinion that there is no likelihood of Radio telephony superseding Radio telegraphy at sea. If, however, the demand does come, telephony will be an adjunct to telegraphy serving its own particular purpose.

"Since 1920 we have expended \$500,000, in keeping up-to-date stations on hire to ship owners. With the more extensive use of Radio at sea the need has arisen for the rapid handling of this traffic, and for this reason tube receivers are being adopted on every vessel. For years to come it may be necessary to spend \$100,000 annually in modernization. This is one of the penalties of exploitation of a new and progressive science."

## NEW SERVICE ON AIR FOR THE BLIND

**WJZ Announcer Will Read from Classic for Those Who Cannot See**

SCHENECTADY.—The Radio telephone in general and broadcasting in particular have probably been a greater delight to the large number of invalids and those afflicted with blindness than to any other class of individuals known. The Radio stations receive more mail from persons in the above two classes than from any other.

It requires little or no imagination to be able to understand how great a place the Radio receiver has taken in their lives. Up to very recently a very important factor has been omitted from the Radio broadcasts—that of reading good novels, works of history and the classics to those of the Radio audience who are not able to read themselves. To take care of this matter, Station WJZ has introduced the reading of such matter into their programs and at 4:10 on Monday, Wednesday and Friday afternoons, J. B. Daniel, the staff announcer of WJZ, can be heard reading short stories, novels, works of history and other good literature from the studio of that station.

Mr. Daniel has a most pleasing voice and "air personality" and is indeed tasteful in selecting his readings. In the short space of time that the service has been in use, countless messages have been received thanking him for his trouble in broadcasting this feature.

## Wife in London Hears Band Husband Directs in U. S. A.

NEW YORK.—A cablegram from London states that on Sunday evening a large number of American music lovers in London were the guests of Mrs. Edwin Franko Goldman, wife of the American bandmaster whose concerts from the campus, New York university here are broadcast over WEAF and its associated stations. Mrs. Goldman sailed a few weeks ago to attend the Wagner festival at Beiruth, and, after arriving at London, sought to tune in for the regular Sunday night concert. They were successful, and the entire program was listened to by the music lovers present. This attempt will be repeated by Mrs. Goldman from the other continental cities she is to visit. Her husband's music was also heard aboard the steamship during her voyage to Europe.

The Birmingham station of the British Broadcasting company is to be removed soon from its present premises to a building now under construction.

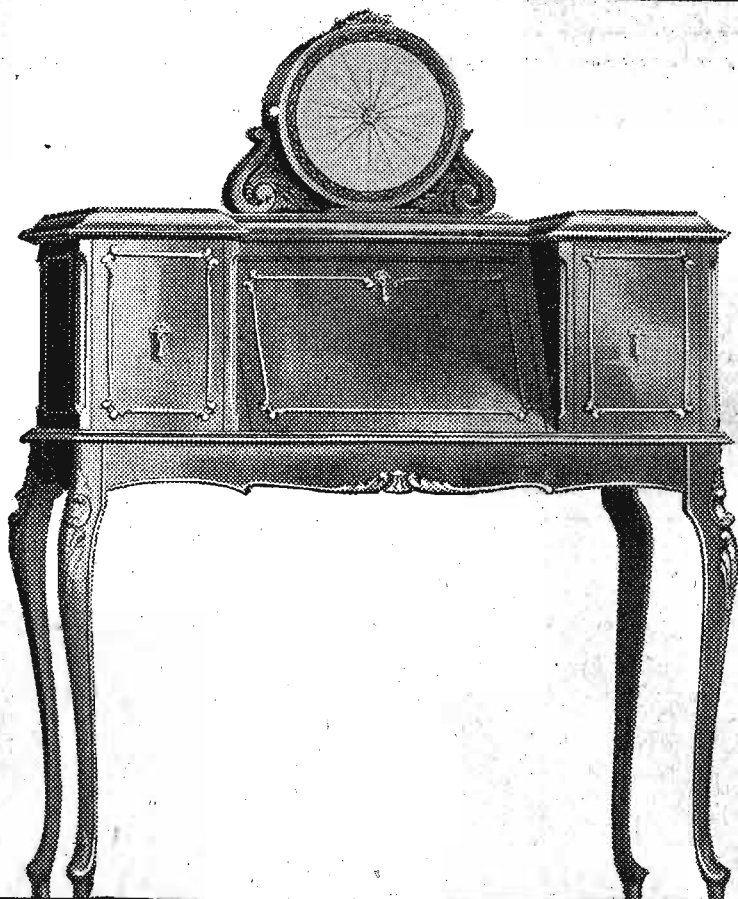

Ten Models  
\$50 to \$460  
Guaranteed  
Unconditionally

Canadian Prices Slightly Higher

TYPE 400

Five Tubes. Special super-selective circuit. No antenna or ground required. No Batteries: operated entirely on AC house current. A and B battery eliminators housed in steel-clad box within cabinet. Connect with standard bell or cabinet type Music Master Reproducer, or with specially designed art model reproducer illustrated. French Spinet Desk cabinet of solid mahogany, beautifully ornamented, in brown mahogany art satin finish. Price \$400

Music Master Reproducer Model XIII. Drum Type. Specially designed art model illustrated. Price \$40

*Its Beauty Satisfies—Its Tone Delights  
—and a Style for Every Home*

A TRULY beautiful example of the cabinetmaker's art in every detail of design and workmanship, MUSIC MASTER brings an added sense of beauty and harmony into any environment.

Designed as the supreme medium for the interpretation of Radio's infinite variety of Music, Song and Speech, MUSIC MASTER Receiver combines in one artistic unit the supreme in reception with the superbly realistic re-creative powers of MUSIC MASTER Reproducer.

One of the exquisite MUSIC MASTER models may well become one of your most prized possessions, bringing into your home a decorative beauty and a charm that is all its own, for there is a MUSIC MASTER model to harmonize in perfect unity with every interior.

Ask any authorized MUSIC MASTER dealer to demonstrate MUSIC MASTER. See MUSIC MASTER—hear—compare—before you buy any radio set.

**Music Master Corporation**

Makers and Distributors of High-Grade Radio Apparatus  
128-130 N. Tenth Street  
PHILADELPHIA

CHICAGO

NEW YORK

Canadian Factory: Kitchener, Ontario

PITTSBURGH

MONTREAL

**Music Master**  
RADIO PRODUCTS

# CHNC, Toronto Radio Research Society



Left, studio of CHNC with its battery of three pianos. Right, Frank Blachford, concert violinist and director of the Toronto Conservatory Trio, which appears regularly on the station's winter programs and is known from coast to coast in Canada as the CHNC trio.

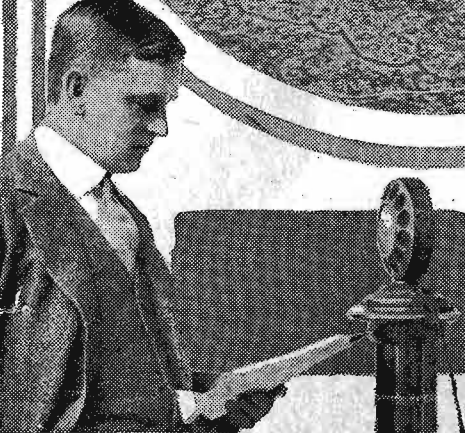
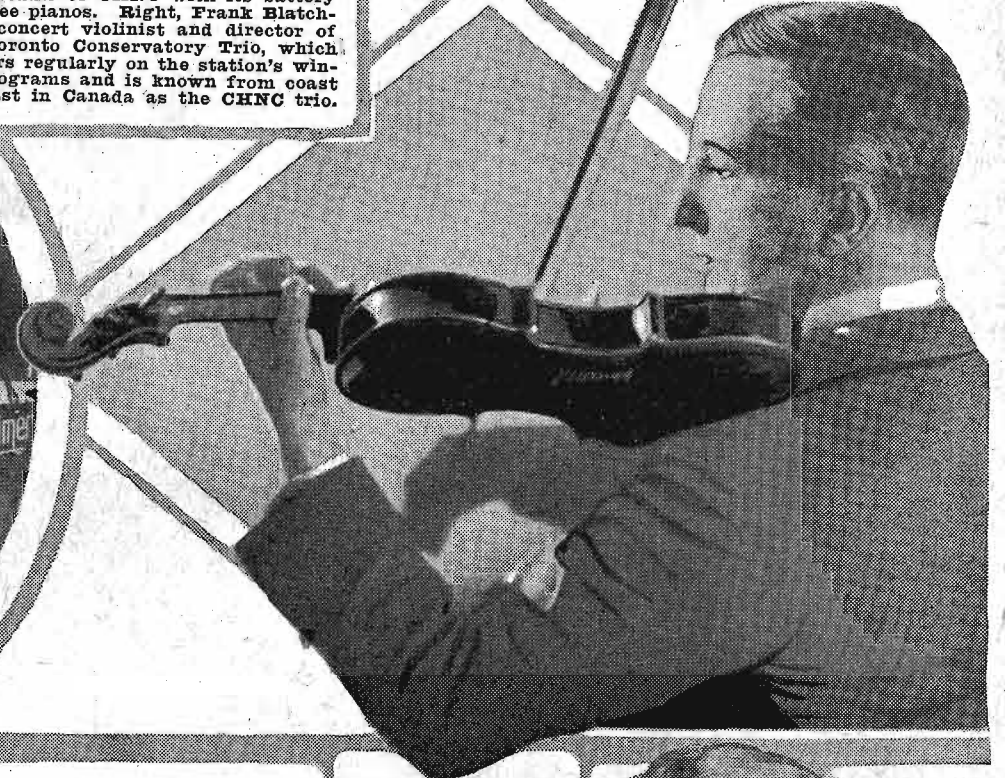

R. H. Combs, general manager, Canadian National Carbon and Presto-O-Lite companies, director and chief announcer of the station.

OVER in Toronto, Canada, the Mecca of thousands of summer tourists from the United States, is located Station CHNC, the broadcasting station of the Toronto Radio Research society, in the Canadian National Carbon plant.

This station is unique among Radio stations of North America in that it is operated by a purely amateur society of twenty members, who are electrical, mechanical or chemical engineers. It is a rather exclusive society in that the membership is limited to twenty and the men holding memberships are apparently in very good health and all are of middle age or under.

Further, one of the tenets of the society imposes a strictly non-commercial attitude to all the activities of the society. The society makes nothing, sells nothing and, according to its claim, not wishing to buy anything, is a strictly non-commercial organization and therefore the broadcasting, which is done on a regular schedule by this station, is of a strictly non-commercial nature and during the eighteen months the station has been operating, commercialism has not been allowed to enter into the broadcasts. The names of business organizations or articles of commerce have never been mentioned over its microphone.

The regular programs from station CHNC have been of the highest order—the regular Monday night programs are known wherever CHNC is heard, as being among the finest received from any station, and classical and operatic music constitutes 90 per cent of the programs from this station. Toronto will be remembered as the home of the famous Mendelssohn

choir and the seat of the great Toronto university with which are affiliated the Toronto Conservatory of Music and the Canadian Academy of Music and in Toronto's musical circles are many high class artists, all of whom from time to time appear on CHNC's programs.

In addition to the individual members of the Mendelssohn choir and the faculty of the best music schools, CHNC has for its exclusive use three distinct orchestral organizations, i. e., CHNC orchestra, composed of eight pieces; CHNC Little Symphony orchestra of fifteen pieces—both of the orchestras being under the personal direction of Chas. E. Bodley, the congenial and versatile concert master of CHNC. Then there is the dance orchestra, which appears every second Thursday evening and which is composed of twelve pieces, which is accredited by the Radio audience as being second to none on the air. Then, too, during the winter season there appear on CHNC's regular programs the Toronto Conservatory Trio in the persons of Frank Blachford, violinist; Leo Smith, cellist, and Dr. Harvey Robb, pianist and organist, each of whom is known from coast to coast in Canada for solo and ensemble work.

CHNC's broadcasting plant, including its two transmitters and equipment, as well as its permanent home, was donated to the society for its work by leading Canadian manufacturers in the Radio field. The studio and transmitters are located at Hillcrest park, Toronto, in the large plant of the Canadian National Carbon company, who have provided spacious quarters, studio, operating rooms, office, and waiting room and a first class antenna system for the society. The transmitters, 100 and 500 watts, were installed for use of the society by the Northern Electric company, who also use the equipment at intervals for broadcasting their own programs under the call letters CHIC.

While the facilities of the station are open to the Canadian National Carbon company, this company has not taken advantage of them, presumably out of respect to the well-known and Eveready hour which is broadcast weekly by the parent company through Station WEAF and others in the hook-up.

The Toronto Radio Research society, through its individual

members, also operates as a Radio research society and among its members some very interesting circuits have been developed, as well as important improvements which are applicable to other well-known circuits. One of these improvements will be remembered as having been awarded a prize in the Radio Digest international contest held early this year, and Dame Rumor has it that another, and this time a somewhat sensational development may be announced as the work of members of the society in the near future. The men who are most active in the operation of CHNC and who are in control of the broadcasting activities are:

R. H. Combs, general manager of the Canadian National Carbon and Presto-O-Lite companies, located at Toronto, who acts as director and chief announcer of the station; J. B. Parsons, electro-chemist of the Presto-O-Lite company, is the engineer of the station; J. A. Thatcher, architectural and mechanical engineer, is the

(Turn to page 24)

Lorena Combs, hostess at CHNC, who is an accomplished pianist.



Right, Arthur Blight, Canada's premier baritone and station musical director. Below, CHNC operating room, with J. B. Parsons, chief engineer of the station, at the control panel.

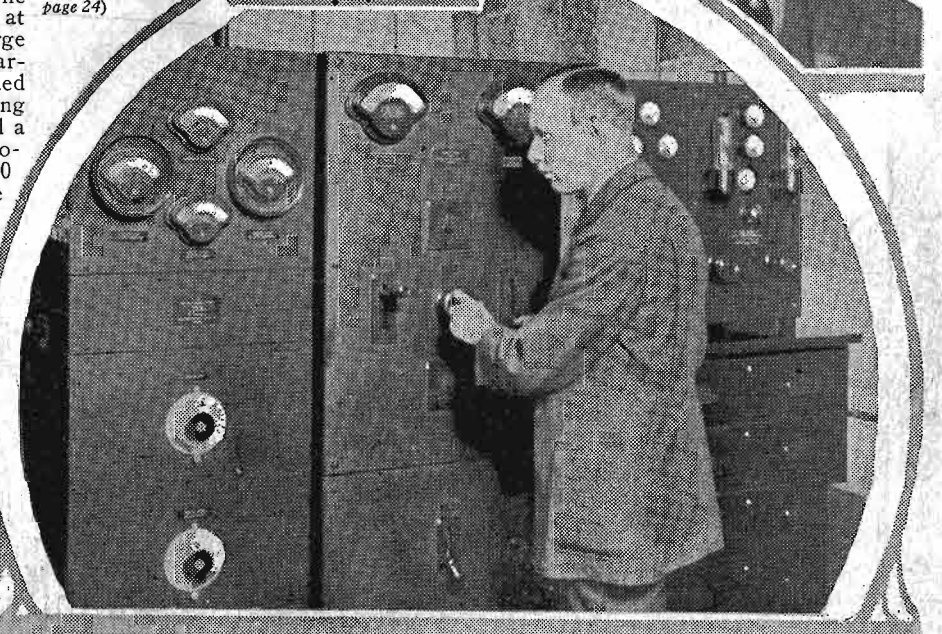

# THE GREBE SYNCHROPHASE

TRADE MARK REG. U.S. PAT. OFF.

THE crowding of low-wave stations onto the lower numbers of condenser dials increases greatly the difficulty of accurate tuning.

In the Synchronphase this trouble has been overcome by shaping the plates of the Grebe S-L-F (straight line frequency) Condensers so that station locations are spread out evenly over the dials. This makes tuning quick, easy, certain.

*Ask your dealer to demonstrate this and other exclusive Grebe advantages*

**A. H. Grebe & Co., Inc.**

Steinway Hall, 109 West 57th Street, N. Y.

Factory: Van Wyck Blvd., Richmond Hill, N. Y.

Western Branch: 443 So. San Pedro Street, Los Angeles, Cal.

*This company owns and operates stations WAHQ and WBOQ; also low-wave rebroadcasting stations, mobile WGMU, and marine WRMU.*

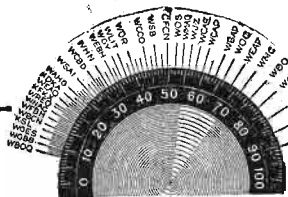

Usual Dial

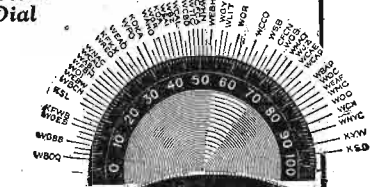

Grebe Dial

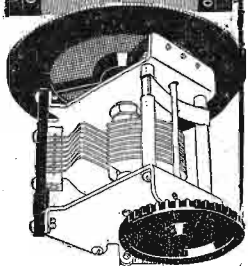

**S-L-F Condenser**

By having the plates follow a special type of hyperbolic series of curves, we have located the stations at equal intervals around the dials. This breaks up the usual crowding of low-wave stations onto the lower dial numbers and makes accurate tuning quick and easy.

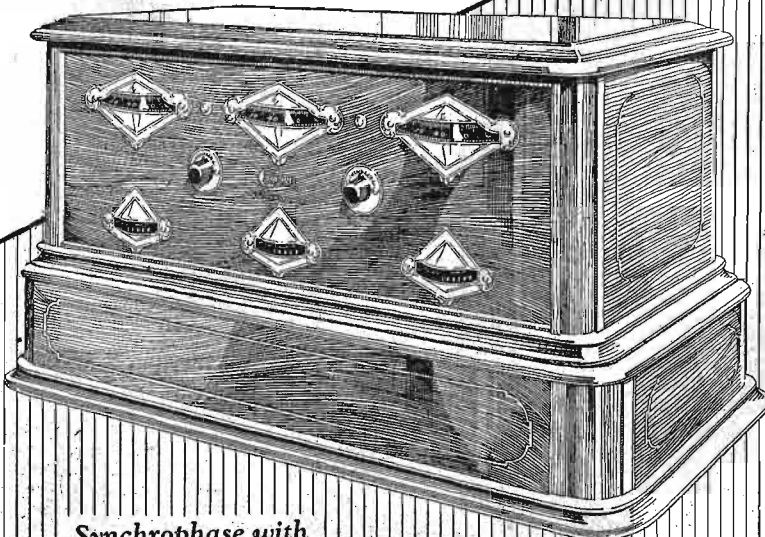

Synchronphase with Battery base



*It is written:*

*"Talking about virtue is not so good as practising it."*

The Synchronphase has never been praised as highly as its inherent virtues warrant.

*Doctor Myer*



All Grebe apparatus is covered by patents granted and pending.

# FRED SMITH TAKES IN GERMAN STUDIOS

## FINDS TEUTONS TOOTING LOUD AUTO KLAXONS

### Nearly One Million Licensees Pay \$6 a Year Fees to Support Nine Broadcasting Companies

Article III by Fred Smith, Director of WLW  
**O**F THE great cities we have seen so far—New York, Paris, London—Berlin is the most terribly fascinating. It wears a nervous, desperate air. There is a constant cry of "No money!" yet the cafes are jammed and the motion picture houses are crowded. The loud Bosch klaxons of the automobiles, which the drivers pump unceasingly, resound through the wide streets for blocks. The masses seek gaiety greedily, but there is a bitterness at the bottom.

The minister in Germany, corresponding to our postmaster general, has four important phases of communication under his supervision. One of these is Radio. The boss of all Radio in Germany is Herr Hans Bredow. The best-known name connected with private Radio interests in Germany is that of Count Arco. I had obtained an appointment with the latter, a little man of fifty, with an immense forehead, a childish smile and a charming manner. He calls Radio "A school for grown-ups."

#### Arco Has Passion for Machinery

Machinery is a passion with the count. He has five automobiles. He had the first car in Berlin. That was twenty-five years ago. He runs about in a little red French car, blowing his horn and scaring everybody off the street. He has the enthusiasm of a boy of eighteen, and got a lot of fun out of sending the shivers up my spine as we shot through the traffic on our way to the ministry; for he had only talked with me five minutes when he offered to take me to see Herr Bredow, and made the appointment by telephone forthwith. Our return to his office was an experience in dizzy dodging. When we were all safe and sound once more he laughed and gave me his photograph with the inscription: "In remembrance of our auto trip."

He and Secretary Bredow believe that Radio will do much for the broadening of the culture of humanity at large. Their ambition is to have an interchange of programs with America, and to that end are constructing both high-power receiving sets to pick up stations in the United States and superpower broadcasting stations to send to America. The first of these broadcasting stations should be ready by fall, a 25-kilowatt affair. In reply to my question: "What is the finest influence of Radio?" Herr Bredow replied: "I think Radio will become the best member of the family."

#### Broadcasting Companies

There are nine principal broadcasting companies in Germany, with the probability of another entering to make ten. Each of these operates in a principal city with secondary stations at adjoining cities, and still a third town with only studio. For example, Leipzig has as a secondary city, Dresden. Dresden has Chemnitz. But

## FIRST BROADCASTER IS GERMAN'S CLAIM



Herr Gerlach, above, of the Konigswusterhausen (Germany) station claims honors as the world's first broadcaster of a regular program. His station started this early in 1920. On June 19, 1920, a complete opera from Berlin was broadcast by remote pick-up.

Chemnitz has only a studio. Whenever this last has programs they are sent by telephone line to Dresden to be broadcast, as well as to Leipzig. Naturally, in such a group, only one city can be sending at a time, since they have a mutual wave length.

The next step will be to bind all the principal cities together by means of tele-

# General Electric Company Builds Big Laboratory for Transmission Study

## Experts Plan to Make Systematic Study of Broadcasting Phenomenon to Find Best Remedy to Cure Existing Defects; Many Antennas and Low and High Power Are Used

**A**RADIO development laboratory for research on wave lengths from 5 meters to 3,000 meters with power from 5 watts to 100 kilowatts (100,000 watts), has been constructed on a 54-acre plot, two miles southwest of Schenectady, by the General Electric company. This work of Radio development is undertaken for the purpose of making a systematic study of transmission phenomenon. Because of meager data there is one group of scientists advocating superpower as the remedy for existing broadcasting defects; another, low-power, short-wave transmission to accomplish

housed transmitters. There are three steel towers, each 300 feet high, arranged in the form of a triangle. This arrangement permits the construction of many different types of antenna.

The largest building houses the power equipment, high-voltage rectifiers, amplifiers and modulating equipment for the station. There are three rectifiers each having a capacity of 150 kilowatts at 15,000 volts. These rectifiers convert the alternating current supplied to the station into direct current which is used for plate supply on the various transmitters. The modulating equipment may be con-

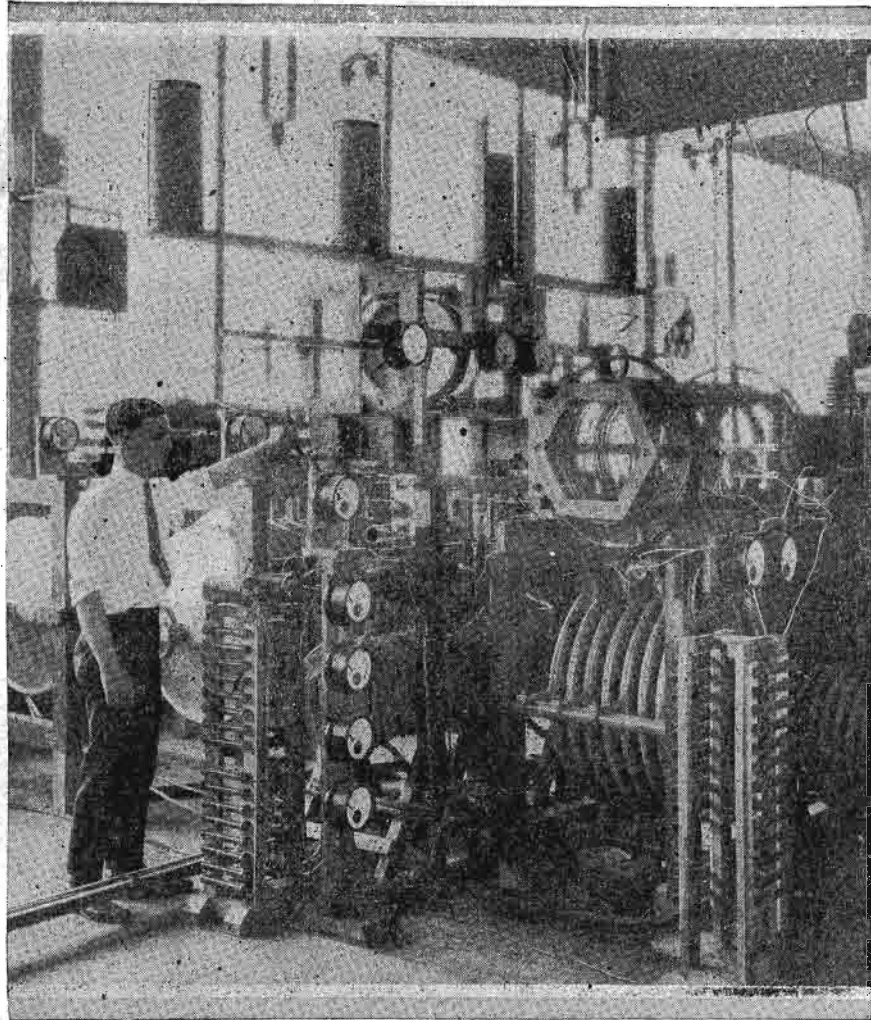

Radio history was made recently when this General Electric transmitter, broadcasting after midnight on an experimental license, used 50 kilowatts of power. This is 100 times more power than is used by the average broadcasting station and is more power than has ever been used anywhere for broadcasting. In the transmitter and modulator units of this set a group of water-cooled tubes rated at 20 kilowatts each is used. At the center foreground is the master oscillator tube.

the same results; another medium-power, long-wave transmission. As many different types of antenna systems are recommended, including the reflector, vertical, horizontal and angular.

On the plot near Schenectady are one brick building, 60 x 100 feet, and four smaller frame buildings in which are

phone lines. And now comes the greatest difficulty in German broadcasting: long distance line transmission. The government had a war recently and has an empty pocketbook at present. It will cost a great deal to put the lines in first class modern condition.

#### Konigswusterhausen, the World's First Broadcasting Station

The one station in Germany which is operated privately is Konigswusterhausen. One Sunday morning a friend took us in his car to this little town some twenty miles from Berlin. Konigswusterhausen is the grand Radio center for German sending to European news bureaus. Fourteen towers support the multiplicity of aeriels in the fields about the three main buildings wherein are operated the several stations ranging in power from two to 50 kilowatts.

The only concert given during the week was going on as we entered the main building—an orchestra was playing French music—Samson and Delilah. The director and his assistant, both young men, met us and the former showed us around, while the latter managed the program. To these two gentlemen, Herr Gerlach and Herr Schwartzkopf, belongs the honor, so far as I have been able to discover, of being the world's first regular broadcasters of music.

Early in 1920 they made a small transmitter from spare parts and broadcast (Continued on page 24)

# NEWS BRIEFS FROM THE BROADCASTERS

## ROCKY MOUNTAIN STATION OPENS QUESTION BOX

### WSAI Manager Tours Stations; Lyric Quartet at WLW one Year; Other News Items

KOA, Rocky Mountain broadcasting station of the General Electric company, has introduced a popular question box for rural listeners which is being featured over the Denver microphone every Thursday evening. During these programs, which last from 7:30 to 8 o'clock, Mountain time, questions from listeners are read aloud by a member of KOA's announcing staff and are then answered extemporaneously by an authority on agricultural problems.

Paul A. Greene, manager of Superstation WSAI, Cincinnati, has left Cincinnati for an extended tour of the leading stations in this country in order to get new ideas and perfect plans for the fall and winter programs of WSAI. The stations that will be visited are WSB, WSMB, KPRC, WFAA, WMC, WDAF, KOA, KSD, WOAW, WHO, WOC, WLS, KFI, KGO, KGW and KJR.

The Lyric male quartet recently celebrated their fifty-second consecutive week as a regular Monday evening feature of the Crosley WLW broadcasting program. This quartet is composed of Howard Hartford lyric tenor; Edwin Meyer, second tenor; Edwin Weidinger, baritone, and John Dodd, bass. Howard Evans is piano accompanist.

Charles H. Gabriel, Jr., formerly musical director of WGN, the Chicago Tribune station, and studio manager of WCEE and WTAS, Elgin, Ill., and Chicago, has been appointed director and chief announcer of KLX, the Oakland Tribune station, Oakland, Calif.

The complete opera of "Lucia de Lammermor" was given by the Civic Opera league during the Hardman hour of music on Friday evening, Aug. 21, from Station WMCA, Hotel McAlpin, New York. The music was supplied by a symphony orchestra directed by Maestro Roxas.

A Chicago Radio artist, Anne Mills Keim, appearing before the microphone of KTHS, the New Arlington hotel station, Hot Springs National Park, gave southern fans a real treat recently with a program of vocal solo numbers that are general favorites. Mrs. Keim has frequently appeared before the microphone of Station WQJ, Rainbo Garden, Chicago.

Scorning trains with their accompanying dust and smoke, Eugenie Whitmore, WOAW pianiste, who has arranged many programs from the Woodmen of the World station, rolled out of Omaha in her blue sport roadster with her father, H. P. Whitmore, art dealer of this city, bound for a month's stay at Atlantic City. She plans an Egyptian trip of several months' duration upon her return to Omaha.

## 4,000,000 WATTS TO BE SENT FROM HERE

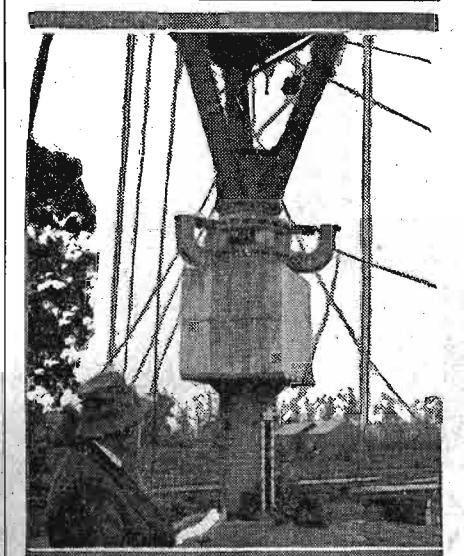

The largest Radio masts in the world are being erected at Rugby, England, for a 4,000,000-watt Radiotelephone station, which will be used to link American and English long distance telephone lines. Each tower is to be 820 feet high. There are sixteen, of which two are completed. Elevators will run up their centers. Photo shows the great insulating block and pivoted base of one tower.

**Again** They said  
it couldn't be done!

**Here it is**

New and Improved  
**FRESHMAN  
MASTERPIECE**

**But now . . .**

Complete with built-in loud speaker of great volume and superb tone quality.

**Encased in . . .**

As fine a heavy genuine solid mahogany cabinet as ever graced any radio set.

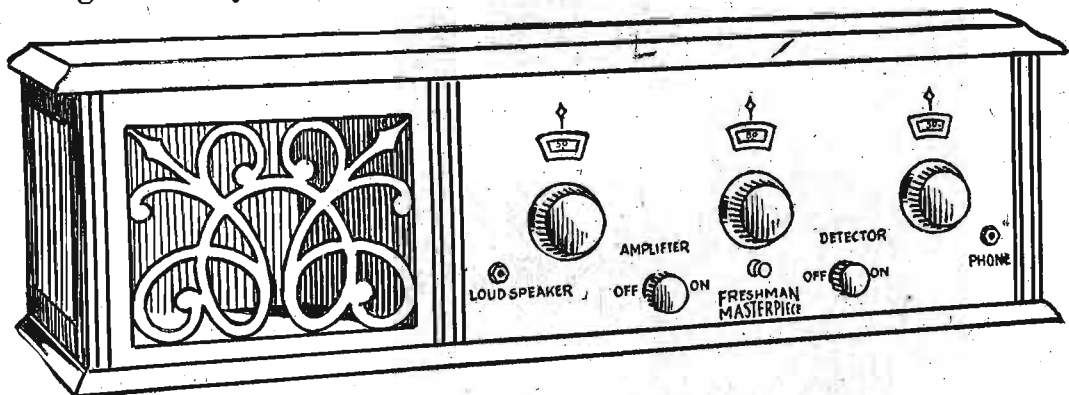

Model  
5-F-5

**\$60**

*and now!*

**At sixty dollars . . .**

Not only complete with built-in loud speaker and massive mahogany cabinet, but this wonder circuit has been scientifically perfected and each and every single part strengthened and co-ordinated.

**For example . . .**

The new Freshman Masterpiece straightline wave length condenser with vernier attachment which assures hair-line selectivity—permitting you to tune in the station you want without interference over the entire wave length range. This is merely one exclusive feature of the

**World's Greatest Radio Receiver**

For Sale at **AUTHORIZED FRESHMAN** dealers only

**Chas. Freshman Co. Inc.**  
*Radio Receivers and Parts*  
**FRESHMAN BUILDING**  
240-248 WEST 40TH ST.—NEW YORK, N.Y.  
CHICAGO OFFICE — 327 S. LA SALLE ST.

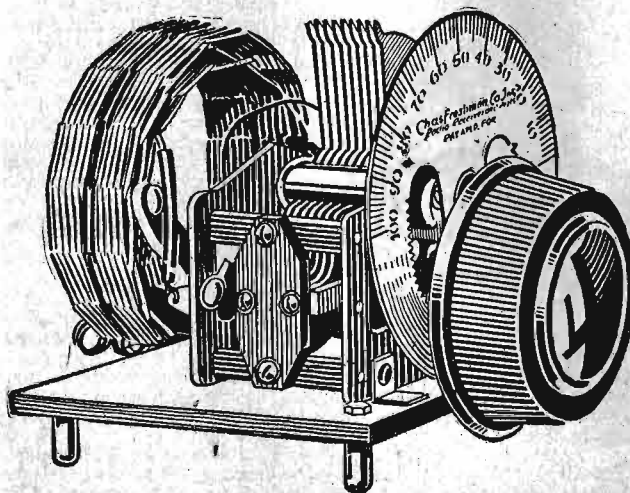



# 9XN + WJAZ PUT ON ESKIMO BROADCAST

## WAP ON BOARD S.S. PEARY IS HEARD FROM ETAH

### Zenith Experimental Station Puts Far North Voices on 322 Meters Without Notice

CHICAGO.—When the MacMillan Arctic expedition started to the far North and announced that they would send the voices of the Eskimo back to civilization via Radio, there were many skeptics who sneered and murmured something that sounded like "Blah," but now that the explorers have made good on their statement through experiment and the public is to be let in on it by means of rebroadcasting, the "Blah" will have to be changed to "Rah."

The log of the Zenith Arctic experimental station, 9XN, tells the story of the first successful rebroadcasting of voices put into a microphone located within twelve degrees of the north pole. This history-making event is recorded by the station officials as follows:

"ARLINGTON HEIGHTS, Ill., Aug. 12.—9:50 p. m. Commander E. F. McDonald, Jr., announces, 'We will broadcast Eskimo singing, the following songs, in their native tongue—"The Song of the Snow Bunting," "The Song of the Raven," and "The Song of the Fox." The Eskimos participating are In-You-Gee-Took, Kaneak, Nuk-Aping-Wa and Ak-Kom-O-Ing-Wa.'

"10:05 p. m. The first song is coming through 9XN on headphones sufficiently loud enough to be heard several feet from the operator's position.

"10:10 p. m. 9XN engineers are now working on apparatus to produce greater volume.

"10:25 p. m. WAP, transmitting station on board SS Peary, is filling in with phonograph music. They are playing 'Marchita.' Amplification has been accomplished. Music can be heard throughout the entire station, 9XN, from headphones laying on the table. Zenith officials and engineers at 9XN are now attempting to locate J. Elliott Jenkins, consulting engineer to arrange an attempt to amplify the volume of 9XN's 40-meter receiving set and rebroadcast over the new Zenith power station, WJAZ, on 322 meters, thereby making reception possible to all receivers throughout the country capable of picking up Chicago.

#### Broadcasts Phonograph Music

"10:42 p. m. WAP now playing on phonograph, 'What'll I Do.'

"11:20 p. m. We have just located J. Elliott Jenkins and he is now on his way to WJAZ at Mount Prospect, 35 miles northwest of Chicago. Commander McDonald on board the SS Peary at Etah, Greenland, has been notified of 9XN's intention to rebroadcast on the higher wave length of WJAZ and replies that he will continue the program and will again come on the air with Eskimos at 2:00 o'clock in the morning.

"11:37 p. m. Eskimos are singing songs quite similar to the intonations of a mixture of American Indian and Chinese. McDonald announces 14 Eskimos are now standing before the microphone on the Peary.

"11:45 p. m. H. E. Gray, ensign in the U. S. N. R. F. and Zenith engineer on board the SS Peary, is now on the air. Gray states, 'MacMillan and Lieutenant Schur are making test flights to locate a landing place for advance aeroplane base.' The engineers at 9XN have disconnected apparatus and installing amplifying units.

"12:40 a. m. WAP announces that E-Took-A-Shoo will sing. E-Took-A-Shoo has been MacMillan's personal guide on his several previous expeditions to the Arctic. This is evidently special, as E-Took-A-Shoo's name was not introduced at the opening of tonight's broadcast.

#### Goes on 322 Meters

"12:55 a. m. WJAZ reports ready and standing by to receive on 40 meters and to keep the signal up to 322 meters to relay the concert to the present standard broadcast receiving sets capable of reaching Chicago. 9XN is hooking up headphones with telephone transmitter connected to WJAZ and the rebroadcast of the concert is on. Jenkins reports, 'Coming through good.' Local electrical storm is now interfering to such an extent that local apparatus through the rebroadcast is reproducing considerable static and drowning out the concert.

"The experimental test of relaying the broadcast was not contemplated and was attempted as an eleventh hour conclusion with makeshift emergency connections. The success of the tests now assures officials and engineers present that the relaying is practical. Further attempts will be made while the expedition is still in the Arctic and in the meantime apparatus will be perfected so that notice can be given to all Radio listeners in advance."

## TOO MUCH RADIO SO SCHOOL HEAD WARNS

TOKIO.—The Japanese minister of public instruction has notified all schools under his control, stating that he has noticed that "school boys are inclined to pay so much attention to Radio that they are neglecting their school work. Teachers are instructed to inform the boys and their parents to the fact that listening in the Radio programs, however useful it may be, is not a proper substitute for performing home lessons."

## More Paris Hospitals Get Radio

PARIS.—Two more Paris hospitals have installed Radio for the benefit of the patients, Lariboisiere and Saint-Antoine.

A plan is being considered to open a school for the training of Radio program announcers in Berlin.

## And Now We Have the Radio and Fish Stories in One Big Whopper

LEWISTON, Me.—The Rangeley chain of lakes, reputed to produce more fish stories per square mile than most any other in western Maine, now has a new story about a fishing line that doubled in brass when it caught "the biggest fish" in Mooselookmeguntic lake by day and brought in the Radio stations by night.

Eight sportsmen from Pittsburgh brought a portable Radio receiving set and 150 feet of insulated antenna when they came to a camp on the lake, near Rangeley, Me. After a try of luck with rod and line, they set to work rigging up their aerial. It failed to bring in a single station, and after the campers had spent several hours experimenting, trying different grounds and locations, and even rigging up counterpoises, one of them said:

"Let's run Calderwood's new fishing

line down to the lake, tie a stone to one end and throw it in."

No sooner said than done. The dials were given a couple of twists, and a familiar voice sang out:

"The number to which you have been listening is the stirring Welsh melody, 'Men of Harlach,' broadcast from the Pittsburgh Post studio of KDKA."

The fishing line thereafter caught fish—big ones, too—during the day and during the night brought in the Radio stations as far away as Virginia and Chicago. The line was several rods of number 22 bare copper wire, the kind of line commonly used in the Rangeley lakes for salmon and lake trout. It was the property of H. A. Calderwood, who vouched for the story today as the party was making the first leg of the trip back to Pittsburgh by automobile.

The World Expected a Supreme Radio Set from **KELLOGG** and here it is!

**ZONE-8** WCX to WOC

**ZONE-7** WFAA to WOS

**ZONE-6** WSB to WHAS

**ZONE-5** WFI to KGO

**ZONE-4** WWJ to KDKA

**ZONE-3** WJAR to WNAC

**ZONE-2** WORD to KFBG

**ZONE-1** KFOT to 200 meters

**ZONE-9** KSD to WNYC

**WAVE-MASTER**  
Standard Model  
\$125.00

**WAVE-MASTER**  
Brown Walnut Console  
with inbuilt horn  
\$275.00

## A Separate Circuit for Each 40 Meter Wavelength Band!

Kellogg — for 28 years makers of precision telephone instruments and equipment — producers of quality parts since radio began — Kellogg has perfected a radio receiver worthy to bear the Kellogg name.

In the illustration we visualize this wonderful engineering achievement.

In the new WAVE-MASTER there are nine separate circuits—one for each 40 meter wavelength band. Each circuit gives that maximum efficiency heretofore found only in one short section of the dials of ordinary radio frequency sets. Each circuit brings within the range of the tuning dial a different group of stations.

How wonderfully simple tuning becomes! Merely set the pointer to the wave zone in which you are interested and bring in the desired station with the single Selector dial.

This remarkable tuning dial actu-

ally has a tuning range of 540 degrees—equal to 1½ times around a complete circle — over three times the station finding range of any other set.

All other radio frequency sets have variable capacity which must be tuned, usually with three different dials, to balance with their inductance coils.

The WAVE-MASTER'S inductance is not fixed but variable and is easily and quickly tuned, with the one Station Selector dial, to balance the fixed capacities.

Write for full description and complete technical explanation of the Wave Master circuit. Please mention your radio dealer's name.

Kellogg Switchboard & Supply Company  
1069 W. Adams St., Dept. H, Chicago, Ill.

# KELLOGG WAVE MASTER SWITCHBOARD & SUPPLY CO.

### Radio Dealers and Jobbers

The WAVE-MASTER franchise, backed by Kellogg resources and our powerful advertising campaign, is most valuable. Open territory is being closed rapidly. Wire us, or get into Chicago, quick, and see us.



# PROGRAM FOR GOLF BUGS AT KHJ

## Sunday, August 30

(Continued from page 12)

tra, Edward Fitzpatrick, director; 7-7:30, organ recital, First Methodist Episcopal church, Arthur Blakely, organist; 8-10, program, Martin Music company, arranged by J. Howard Johnson.

KJR, Seattle, Wash. (384.4), 11 a. m., First Methodist Episcopal church; 3:30 p. m., municipal band, Woodlawn Park; 7, First Methodist Episcopal church; Mrs. Montgomery Lynch, organist.

KNX, Hollywood, Calif. (336.9), 7-8 p. m., First Presbyterian Church of Hollywood, Rev. Stewart P. MacLennan, pastor; 8-9, Ambassador hotel concert orchestra, Josef Rosenfeld, director; 9-10:30, program, Beverly Hills Nurseries presenting the Russian stringed quartet, Calmon Luboviski, leader.

KTAB, Oakland, Calif. (215), 7:45 p. m., evening church services.

KTCL, Seattle, Wash. (305.9), 7:50-9:10 p. m., First Church of Christ Scientist; 9:10-10:10, International Bible Students' association.

## Monday, August 31

Monday, silent night for: CKAC, CNRT, KFDM, KFMO, KGW, KHJ, KLDS, KYW, PWX, WBAV, WBBM, WCAU, WCTS, WEBH, WEBJ, WFI, WGN, WGES, WHAS, WHAZ, WLS, WTTG, WMAQ, WMBB, WOC, WOAI, WQJ, WRC, WREO.

### Atlantic or Eastern Daylight Saving Time Stations

CHNC, Toronto, Can. (356.7), 10 p. m., CHNC orchestra.

WAHG, Richmond Hill, N. Y. (315.6), 12:30-12:55 p. m., dulcimer and piano, Green and Perry; 1:05-1:30, dulcimer and piano; 7:30-7:45, sports talk, Thornton Fisher; 7:45-9, John A. Salvatore, pianist; 8-8:15, Mildred Nash Carrington, soprano; 8:15-8:30, Horace J. Taylor, reader; 8:30-9, Synchronphase trio; 9-9:15, Mildred Nash Carrington; 9:15-9:30, John A. Salvatore; 9:30-10, Synchronphase trio; 10-10:15, Horace



WCCO, Minneapolis-St. Paul, Minn. (416.4), 6:45 p. m., F. & R. family; 9:05, talk, Northwest Dairy exposition.

WDAF, Kansas City, Mo. (365.6), 6-7 p. m., piano tuning-in, number on the Duo-Art; Cecile Burton, reader; Tell-Me-a-Story lady; Plantation players; 8-9, around the town with WDAF; 11:45-1 a. m., Merry Old Chief and the Plantation players; Ted Meyn, organist; Earl Coleman's orchestra.

WFAA, Dallas, Tex. (475.9), 6:30-7:30 p. m., Arlie Collins and his orchestra; 8:30-9:30, Sears-Roebuck Agricultural Foundation program.

WHAD, Milwaukee, Wis. (275), 6-7 p. m., Arthur Richter, organist; 8-10, Marquette university studio program.

WHO, Des Moines, Iowa (526), 7:30-9 p. m., program, Dean Holmes Cowper, director; 11-12, dance program.

WOAI, San Antonio, Tex. (394.5), 8:30 p. m., Menger hotel trio.

WOAN, Lawrenceburg, Tenn. (282.8), 9-10 p. m., Vaughan Radio orchestra; saxophone quartet.

WOAW, Omaha, Nebr. (526), 6 p. m., Phyllis Griswold, organist; 6:30, McCrory's popular period, Lillian Madson, director; 6:45, Ray Muzzy's Carter Lake club orchestra; 9, de luxe program.

WOS, Jefferson City, Mo. (440.9), 8 p. m., address, B. H. Piepmeyer.

### Mountain Standard Time Stations

KFWA, Ogden, Utah (216), 9-10 p. m., Ensign Drug company.

KOA, Denver, Colo. (322.4), 6:30 p. m., Herbert White and his Silver State orchestra; 7:30, Sandman's hour; 8, scientific football, Tom McNamara; 8:10, Barnes Commercial school, Barnes Ladies' chorus; Denver concert quartet; "Trees and Shrubs of the Rockies," Colorado Mountain Club; "Character in Speech," Erna Palat, Gripplett; "The Qualities Desired in Young People by Business Men," H. E. Barnes.

### Pacific Standard Time Stations

KFOA, Seattle, Wash. (454.3), 6-8:45 p. m., Hoffman orchestra, baseball scores; 6:45-8:15, Sherman, Clay

Les Roscoe is the Ragman of KHJ whose twinkling fingers make new melodies out of our popular songs. He is one of the Lost Angels heard Saturday nights. Edythe England, violinist, plays this Wednesday at WGN, Chicago. Ted Meyn, organist and creative humorist of the Fantages theater in Kansas City; plays request numbers on the organ for listeners during the Nighthawk frolics at WDAF.

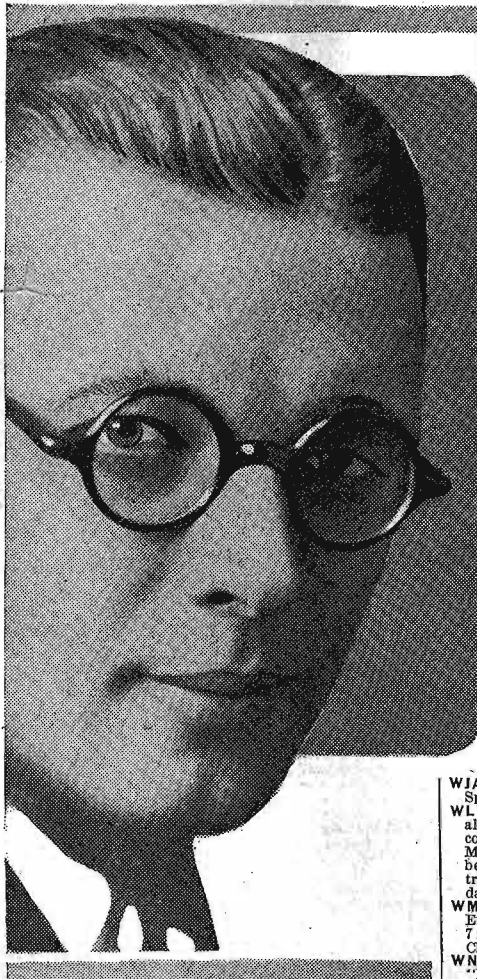

J. Taylor; 10:15-10:55, Bensonians dance orchestra; 11:05-11:30 Bensonians orchestra.

WCAE, Pittsburgh, Pa. (461.3), 3 p. m., program, Loew's Aldine theater; 6:30, William Penn hotel; 9, concert; 11, Sander's Inn dance music.

WEAF, New York, N. Y. (491.5), 4-10 p. m., Elizabeth Hoslop, contralto; 4:10-4:25, Rose Gonerar, pianist; 4:25-4:35, Elizabeth Hoslop; 4:35-4:45, Rose Gonerar, pianist; 4:45-5, "Old New York," Henry Collins Brown; 6-7, dinner music, Waldorf-Astoria; 7-7:15, Robert S. Chree, baritone; 7:15-8:30, program, Mark Strand theater; Joseph Plunkett, director; 8:30-8:45, health talk; 8:45-9, Pasadena Warblers; 9-9:20, Herman Popper's Viennese trio; 9:20-9:40, Pasadena Warblers; 9:40-10, Herman Popper's Viennese trio; 10-10:30, musical program; 10:30-11:30, Hotel Bessert Marine Roof orchestra.

WEEI, Boston, Mass. (475.9), 6 p. m., Jack Renard and his Mansion Inn orchestra; 7:30, C. B. Collins, tenor; 7:40, Sara Locke, pianist; 8, Jutra Gaston, violinist; 8:45, Ed Andrews and his Nautical Garden orchestra; 10, talk.

WFI, Philadelphia, Pa. (394.5), 1 p. m., Bellevue Stratford concert trio; 3, James G. Rodgers, science man of the Orient; 6:45, Bellevue Stratford Roof Garden orchestra.

WGR, Buffalo, N. Y. (319), 2:30-4:30 p. m., WGR's afternoon program; 6:30-7:30, Century orchestra, featuring Charles G. Seelach, violinist; 9-9:30, program, Mrs. Carl Dickerman; 9:30-10, comedy program, featuring E. J. Clare; 11-1 a. m., supper-dance music, Vincent Lopez Hotel Statler dance orchestra, Harold Giesler, director.

WHAR, Atlantic City, N. J. (275), 2 p. m., Seaside hotel trio; 7:30, stories for little folks, Mildred Hagen; 8, Seaside hotel trio.

WHN, New York, N. Y. (361.2), 8-8:30 p. m., Rose-land dance orchestra; 11-11:30, organ recital, Lexington theater; 11:30-12, Silver Slipper revue; 12-12:30 a. m., Owl entertainers.

WIP, Philadelphia, Pa. (508.2), 7 a. m., setting-up exercises; 3, song of the surf; 3:30, Comfort's Philharmonic orchestra; 6:05, Benjamin Franklin concert orchestra; 7, Uncle Wip's bedtime stories.

WJAR, Providence, R. I. (305.9), 7:45 p. m., Berry Spring dance hour.

WLIT, Philadelphia, Pa. (394.5), 12:02 p. m., daily almanac; Stanley theater organ recital; Arcadia cafe concert orchestra; 2, Arcadia cafe concert orchestra; 4:30, Marcella North, pianist; 7:30 p. m., Dream Daddy's bedtime stories; 8, Fairmount Park Symphony orchestra; 9, Stanley theater hour of music; 10, Arcadia cafe dance orchestra.

WMCA, New York, N. Y. (340.7), 6:30-7:15 p. m., Ernie Golden and his Hotel MeAlpin orchestra; 7:30-7:45, songs, Coakley Sisters; 8-9, lecture, Third Church of Christ.

WNYC, New York, N. Y. (526), 6:30-6:40 p. m., "Home Economics," Mrs. Louis Reed Welzmillier; 6:45-7, piano recital; 7-7:30, Original Charleston Five; 7:35-7:45, news of the day; 7:45-8, Original Charleston Five; 8:15-10:15, band concert, Mall, Central Park; 10:15-10:30, talk, Dr. Sydney N. Usher.

WOO, Philadelphia, Pa. (508.2), 11 a. m., organ recital; 12:02 p. m., Golden's Crystal Tea Room orchestra; 4:45, organ recital; 7:30, A. Candelori's concert orchestra; 8, Mark Strand theater program; 8:45, Pasadena Warblers; 9, Herman Popper's Viennese trio; 9:20, Pasadena Warblers; 9:40, Herman Popper's Viennese trio; 10:30, Bessert Marine Roof orchestra; 11, A. Candelori's Roof Garden dance orchestra.

WOR, Newark, N. J. (405.2), 6:15-7:15 p. m., Chateau Baltusrol orchestra, Wallie Osborne, director; 7:15-7:30, sports talk, Bill Wathey; 8:30-9:30, Al Reid's hour.

### Eastern Standard or Central Daylight Saving Time Stations

KDKA, Pittsburgh, Pa. (309.1), 8:45 p. m., concert.

WBMB, Chicago, Ill. (226), 5:30-8 p. m., kiddies' jukebox club; 6-7, Stewart-Warner program; Charlie and Dave, Nate Caldwell, Alamo orchestra; Marie Margot, harpist.

WBZ, Springfield, Mass. (335.1), 6 p. m., Capitol theater orchestra; Rene Dagnais, organist; 8, Aleppo Drum corps, "Shriners"; 8:30, Percy Appleby, tenor; Harold Crumrine, flutist; Ruth Appleby, accompanist; 9, Francis Zirkin, pianist; 9:15, John L. McKay, violinist; 9:40, "At the Theaters," A. L. S. Wood.

WCEE, Elgin, Ill. (275), 10:30-12 midnight, Purple Grackle.

WCX, Detroit, Mich. (517), 2:30 p. m., band concert, Belle Isle; 6, dinner concert, Book-Cadillac hotel; 8, the Detroit Symphony orchestra.

WEAR, Cleveland, Ohio (389.4), 7-8 p. m., music, Loew's State theater.

WGY, Schenectady, N. Y. (379.5), 1:30 p. m., Asia club orchestra; 5:30, Hotel Ten Eyck orchestra; 6:35, Catriacala trio; Mrs. Norma V. Gatricala, soprano.

WJR, Detroit, Mich. (517), 7 p. m., Jean Goldkette's ensemble, Book-Cadillac hotel; 10, Blue room dance orchestra.

WKRC, Cincinnati, Ohio (422.3), 8 p. m., Caldwell & Taylor Original Benzol boys; 9, program, American

Legion of Ohio; 12, Marlon McKay's Bond Hill House orchestra.

WLW, Cincinnati, Ohio (422.3), 7 p. m., dinner concert, Hotel Gibson orchestra, Robert Visconti, director; 10, popular program, courtesy of Liggett Brothers Coal company; sparks, Liggett's Red Hot piano player; 11, Famous Lyric male quartet; violin solos with organ accompaniments, William and Rosemary Stoes.

WOK, Homewood, Ill. (217.3), 6-8 p. m., ballad hour; Ada Allen, soprano; Jimmie Watson, baritone; 8-1, Thora Martens, contralto; Paul Small, tenor; Werner and Spike, accordionists; Marie Wright, soprano; Jimmie Cairns, tenor; Lew Butler, tenor; Buck Weaver, banjoist; Gail Bandell, jazz singer; Langdon Brothers, Hawaiian guitarists; Herman Sinaiko, violinist; LeRoy North, pianist; George Hall banjoist.

WORD, Batavia, Ill. (275), 8:30 p. m., Fred Thelander, baritone.

WSAI, Cincinnati, Ohio (326), 10 p. m., Herbert Spangler, violinist; Helen Nugent, contralto; Ferd Raine, tenor; 11, Carl Schuett, pianist; Leora Lorimer, contralto.

WTAM, Cleveland, Ohio (389.4), 6-7 p. m., Golden Pheasant dance orchestra; 8-9, instrumental hour; Willard Symphony, Walter Logan, director; 9-10, concert program; 11-12, dance music, Frank Wilson's Euclid Beach Park orchestra.

WTAS, Elgin, Ill. (302.8), Purple Grackle orchestra; Herbie Mintz, Tommy Dunlap, Tubby Garon, Maurine Marseilles, Art Stiller, Berger Wedberg.

WTTG, Hartford, Conn. (348.6), 6 p. m., Emil Heimberg's Hotel Bond trio; J. Reginald Kelsey, baritone.

WWJ, Detroit, Mich. (352.7), 6 p. m., dinner concert; 7:30, Goldman band concert.

### Central Standard Time Stations

KFAB, Lincoln, Nebr. (340.7), 6-7 p. m., dinner program; 7:30-9:30, Gillon & Boney Prize candy program; Beishaw's dance orchestra; Clyde Davis, singing violinist; Mart Gauemorst, banjoist; Earle Watson, tenor; John Sloat, pianist; Colonians dance orchestra.

KFNH, Shenandoah, Iowa (266), 7:30 p. m., Henry Field Seed company.

KEVE, University City, Mo. (240), 10 p. m., Orchestra Romaine; Olin Gibson.

KOIL, Council Bluffs, Iowa (278), 7:30-9 p. m., Paramount program; address, Frank Hodson; Mary Berigen, pianist; Margaret Borson, vocalist; Art Doty and his band; 11-12, Hotsy-Totsy orchestra; Hall Mark Six orchestra.

KSD, St. Louis, Mo. (545.1), 9 p. m., program.

KWKH, Shreveport, La. (273), 3:30 p. m., piano music; 4, baseball; 8-9, musical program, Selgel Brothers saxophone.

WCBD, Zion, Ill. (344.6), 8 p. m., mandolin and guitar band; celestial bells; Fred Fassen, organist; L. J. Hire, violist; Erwin Rendall, flutist; Mrs. P. M. LaRose, contralto; Dorothy Bull, soprano; Mrs. Evangeline Rendall, reader.

and company program; 8:30-10, Times studio program.

KFWB, Hollywood, Calif. (252), 6-7 p. m., Big Brother of KFWB; 7-7:45, Radio Doling Question and Answer period, K. G. Ormiston, technical editor; Van Sisters trio; J. Stanley Fulbright, tenor; 8-9, program, Star Motor Car company, Million Dollar orchestra; Frank Stever, baritone; Vic Beall and Frank Pierce, comedy songs; 9-10, program, James Bell, tailor; James Bell's orchestra; Kathryn Martin, soprano; Dave Chudnow, pianist; 10-11, Warner Bros. frolic, direction Charlie Wellman.

KGO, Oakland, Calif. (361), 3-4 p. m., program, Kohler & Chase; 6-7, Theodore Strong, organist; 8, "To Whom Do Cases of Communicable Disease Belong?" Hugh Barrett Dobbs; "Symposium on the New Education," Williams Institute; "Switzerland, Paris and London," Helene Phillips; chats about new books, Joseph Henry Jackson; "Inside Dope on Curing Automobile Ills," Louis P. Signer; Arion trio.

KJR, Seattle, Wash. (384.4), 7-8:25 p. m., Sears-Roebuck and company program; 8:30-10, Post-Intelligence courtesy program; 10-11, Gordon Kilbourne and his orchestra.

KNX, Hollywood, Calif. (336.9), 5:30-6:15 p. m., Wur-litzer pipe organ studio, Town Tattler; 6:15, travel talk, W. E. Alder; 6:30-7, Atwater Kent Radio orchestra, Paul Finstein, leader; 7-7:30, Mutual Motors mirth contest; 7:30-8, program, Columbia Outfitting company; 8-9, program, L. W. Stockwell company; 9-10, program, Globe Ice Cream company; 10-11, Goodrich Silvertown Cord dance orchestra, Lilyan May Challenger, contralto; 11-12, Ray West's Ambassador hotel dance orchestra.

KTAB, Oakland, Calif. (215), studio program.

KTCL, Seattle, Wash. (305.9), 9-10 p. m., National Machine Sales company program.

## Tuesday, September 1

Tuesday, silent night for: CHNC, CNRT, KFKX, KOA, PWX, WAHG, WBAV, WCBG, WCTS, WDAF, WEAO, WHAD, WHAZ, WKAQ, WLIT, WOR, WOS, WSMB, WTAM.

### Atlantic or Eastern Daylight Saving Time Stations

WCAE, Pittsburgh, Pa. (461.3), 3 p. m., Loew's Aldine theater; 6:30, dinner concert, William Penn hotel; 8, program, New York; 8:30, Gold Dust Twins; 9, Eveready hour; 10, grand opera.

(Continued on page 14)









**STATIONS IN ORDER OF WAVE LENGTHS USED**

Meters	Call	Meters	Call	Meters	Call	Meters	Call	Meters	Call	Meters	Call
217.3	WOK	275.3	WJAS	313	CNRA	361.2	WHN	405.2	WOR	468.5	WCAP
226	WBBM	278	KOIL	315.6	KFDM	365.6	WDAF	406	WBAR	468.5	WRC
226	WIBO	278	WCAU	315.6	WAHG	365.6	WHB	410.7	CKAC	475.9	WBAP
240	KFVE	278	WLBL	315.6	WGBS	370	CYB	416.4	WCCO	475.9	WEEI
243.8	WAMD	278	WRBC	319	WGR	370.2	WEBH	421	KIAF	480	WFAA
250	WGBS	280.2	WNAC	319	WSMB	370.2	WGN	422.3	WLW	483.6	WOC
250	WMBB	282.8	WOAN	322.4	KOA	374.8	KTHS	428.3	WSB	483.6	WSUI
252	KFWB	285.5	WKAR	325.9	WSAI	379.5	WGY	428.3	KPO	491.5	KGW
252	WGCP	285.5	WREO	326	WKRC	379.5	WHAZ	428.3	CNRO	491.5	WEAF
261	KFWA	293.9	KJS	330	CYX	384.4	CKY	434.5	NAA	499.7	WMC
265.5	WMAK	293.9	WBAV	333.1	WBZ	384.4	KJR	435	AT9	508.2	KLX
266	KFNF	293.9	WEAO	336.9	KNX	384.4	WMBF	435	CFCN	508.2	WIP
266	WBCN	293.9	KPRC	340.7	KFAB	389.4	WEAR	434.5	CLDS	508.2	WOO
268	WCTS	296.9	KFMQ	340.7	WKAQ	389.4	WTAM	440.9	KLDS	516.9	CJCA
272.6	WBBR	299.8	KFSL	340.7	WMCA	394.5	WFI	440.9	WDFW	516.9	WCX
272.6	WBBJ	299.8	KSL	344.6	WCB	394.5	WLIT	440.9	WOS	516.9	WJR
272.6	WFBH	299.8	WPG	344.6	WLS	394.5	WOAI	447.5	WMAQ	526	WHO
273	WRW	302.8	WJJD	348.6	KFAE	399.8	WHAS	454.3	KFOA	526	WNYC
275	KFAU	302.8	WTAS	348.6	WTIC	399.8	WHT	454.3	WJZ	526	WOAW
275	WCAC	305.9	KTCL	352.7	WWJ	400	PWX	455	KTW	535.4	KYW
275	WHAD	305.9	WJAR	356.9	CFCA	400	PWX	461.3	WCAE	545.1	KFUO
275	WHAR	305.9	WJAR	356.9	CHNC	405.2	KHJ	467	KFI	545.1	KSD
275	WORD	309.1	KDKA	361.2	KGO	405.2	WJY				

**INSTRUCTIONS FOR USE OF TABLES**

THE "Evening at Home with the Listener In" table is not difficult to understand and use. It is this fact that makes it so popular with the readers of Radio Digest. It is presented in three different standard times; Eastern, Central and Pacific. Two of these are presented each week. Listeners using one of the three kinds of time named, should utilize the table printed in that time and so designated by its headline.

For listeners whose standard of time is not shown here, the following instructions should be remembered:

Listeners using **Mountain time:** Use table for Pacific time but add one hour to every figure given. Can also use Central time table by subtracting one hour from every figure given.

Listeners using **Eastern daylight saving, or Atlantic time:** Use Eastern time table by adding one hour to every figure.

Listeners using **Central daylight saving time:** Use Eastern time table. No changes are necessary.

The periods given in the "Evening at Home" tables are only representative of each station's evening sign-on and sign-off hours, and on Sunday, the late afternoon sign-on and sign-off. If a station has an intermittent rather than continuous program, the table cannot show this.

Above is given a list of all stations in the "Evening at Home" tables, arranged in order of the wave lengths used (or supposed to be used) by the stations. This arrangement provides a handy index for the other tables.

The "Evening at Home" tables are corrected every week. The number of changes often run as high as thirty per cent of the whole. Keep the "Evening at Home" tables from the current issue at the side of your receiver.

The material and form of the tables are entirely original with Radio Digest and are protected by copyright. Reproduction of whole or part without permission is denied, and such infringements will be prosecuted.

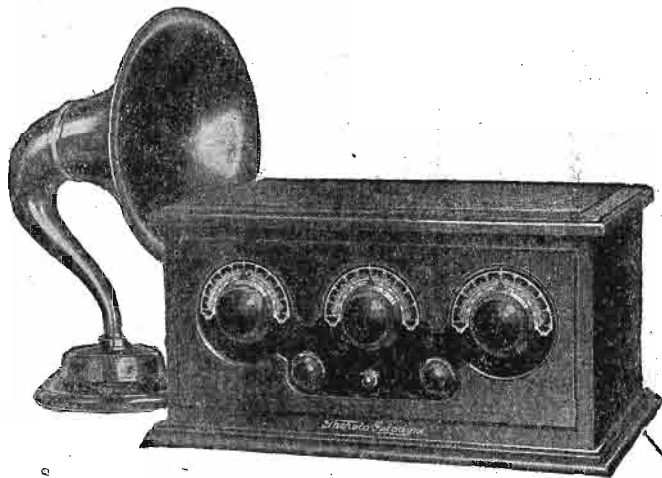

Thorola Loud Speakers with new burnished Bakelite horn and gold throat-band are even better in appearance and performance.



Thorola Low-Loss Doughnut Coils installed in your present set will give you many of the greatest Thorola advantages.

Thorola 4.....\$25 Complete set (3) \$12  
Thorola Jr.....\$15 Per coil.....\$4

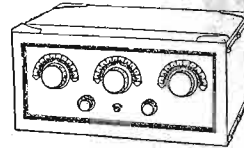

The very proportions of Thorola Cabinets suggest new internal design.

In smart Thorocco Cabinet the 5-tube Thorola Islodynic.....\$85

In stunning Burled Walnut Cabinet with Circassian top the 5-tube Thorola Islodynic is \$115

**ANNOUNCEMENT**

This is of interest to opera-goers, to lecture and symphony patrons as well as to the dancing set, and to those scientifically interested.

Artistic radio has come with Thorola Islodynic, embodying the *Isolated Power* principle made possible only by Thorola Low-Loss Doughnut Coils. They conquer "pick-up" of unwanted stations, waste of power, uncontrollable "oscillation," freak wiring, uncertain operation. Radio experimenters know what all this means. Radio listeners no longer need to know!

With Islodynic action any one station wanted is cleanly selected, even in broadcasting centers. Utmost power is *isolated—focused*—on this one set of signals only. The delicate radio impulses do not conflict, neutralize, offset each other. Full tone, unmodified—full volume, full distance at last are possible, at all wave lengths.

With temperamental factors banished, Thorola Islodynic achieves uniform reception. The same stations keep coming in the same. The set your dealer demonstrates tells what your set will do.

Radio reception is unmistakably elevated. There is a complete Thorola receiver leading its field by far, just as Thorola excels in loud speakers and apparatus.

The Thorola name is surety of radio development not to be eclipsed. The intense interest in the 5-tube Thorola Islodynic at every radio store will tell you where expert opinion centers today. Go and listen.

REICHMANN COMPANY, CHICAGO

**Thorola**  
ISLODYNE





# Radio Digest Illustrated

Published by the Radio Digest Publishing Company, Inc.  
510 North Dearborn Street  
Chicago, Illinois  
Telephones: State 4372, 4373, 4374, 4375

E. C. RAYNER, Publisher

Eastern Office, Park-Lexington Building, 247 Park Ave.,  
New York. Telephones: Ashland 8144, 8145, 8146

Member of the Audit Bureau of Circulations

241  
PUBLISHED WEEKLY

SUBSCRIPTION RATES  
Yearly in U. S. and Possessions and Canada, \$5.00  
Foreign postage, \$1.00 additional. Single copies, 10 cents.

Vol. XIV Saturday, August 29, 1925 No. 8

## A Nation of Rooters

IS FOOTBALL a dangerous sport—one that should be restricted and perhaps abolished? Or is the game one the average boy and youth may play with perfect safety and assurance that the exercise so gained is beneficial to body and brain building?

Tom McNamara, veteran football coach, is starting a series of educational talks on the sport at KOA, Denver. He plans to tell all about it. Included in his series will be the history, principles, training, rules and plays of all kinds.

This coach is nationally known and has many bright spots in his career. He knows football—and better—he knows how to teach it. His word can be accepted as authoritative. He maintains that football of today is a body-building, not body-wrecking sport.

He hopes to convert dubious parents to the advisability of allowing their sons to play the game. He wants to teach the fine points to high school and college players.

Not alone is his series for players, prospective players and their parents, but for the football fan who sits, fascinated, on the cold seats of the bleachers swept by chilled November breezes. McNamara will tell these enthusiasts how to enjoy the fine points.

Football is certainly not the dangerous game it was ten or fifteen years ago, before sane rules were adopted to protect the players. The "flying wedge" is no more. Many other bone-breaking plays have disappeared—ruled out. Today there is no more danger in playing football than baseball.

We believe Mr. McNamara's series of talks will do an immense good for the game and for the youth of the land as well. This nation should take its sports more seriously—not by attending the contests of various sorts, but by engaging in them.

The trouble is that America is a too perfectly organized mob of rooters and rooters only.

## Broadcasting Systems Compared

WILLIAM DUBILIER, well-known Radio manufacturer, likes the British broadcasting system. Fred Smith, director of WLW, comments favorably on the German plan which is not wholly unlike the English. Both men know American broadcasting and should rate as impartial and fair judges.

Is, then, the United States on the wrong track? No! Undoubtedly it takes many more stations to cover this country effectively than it does Europe and the British Isles, and we have no reason to believe that American programs fail to compare favorably with the best of the foreign.

Our system allows the American initiative to have full sway. The government has but few laws governing Radio. Only absolutely essential regulations are in force. As a result it is our belief that broadcasting development has been much more rapid in the United States.

But still—can more wave lengths be found, shall stations continue to split and divide time until their schedules are negligible or will American Radio engineers find a satisfactory method which will allow several stations to broadcast on the same wave length at the same time?

We trust in the ability of the American engineers, the United States government and the public to handle the situation with their usual initiative. We are sure the public will not allow intolerable receiving conditions to become the common thing.

And we wager that American programs will continue to be just as high or higher in quality than foreign programs subsidized through governmental collection of receiving license fees.

## Who's Most Popular Announcer?

WHO will win the 1925 Gold Cup Award of Radio Digest? Who will bear the title of world's most popular Radio announcer for this year? A priceless, solid gold cup, like that given last year to George D. Hay of WLS, is awaiting to be engraved with the name of the winner.

The competition closes Saturday, August 29, at midnight. The votes then will be counted, and the judges will announce the victor in the Digest of September 12. And may the best man win.

## RADIO INDI-GEST

### Grape Fruit

And now Florida is breaking out with new high powered Radio stations. They propose to broadcast the warm Gulf stream, the budding orange trees, the rustle of the cocoanut palms, and the tinkle of ice on glass all during the cold icy disagreeable winter. Tune in some place north of Palm Beach, Where there's also ice and snow; A town that won't entice me from my home In cold and chilly Chicago.

### The Gender of Radio

Dear Indi: Notice where some Radio men are referring to broadcasting stations as "She" same as a skipper refers to his ship. The girl friend says this is because they are so entertaining and render such sweet and pretty music. I say it is because the blame thing talks but does not think. Which is right?

FJORD KEWPIE.

Although we are not in the habit of deciding arguments between the sexes, we think you are both wrong. You can shut a Radio station off, at will you know, hence the "she" reference is all wet.

### A Fish Story

A fisherman friend of ours is off Radio for life. Last Sunday, just as he finished telling the boys at the camp about the big muskie that broke his pole and got away, some one tuned in Zion on the portable and the voice of Voliva was heard saying, "A liar, is lower than the fish that rest on the bottom of the ocean."

### Correct

Willis: Do you think the Radio is driving out the phonograph?

Gillis: I don't know, but it certainly is drowning it out.—Judge.

We are using the above joke for two reasons: first, it seems clever enough to aid us in filling a few lines of space; Second, it will show the Radio editor of a certain New England paper the customary way to give credit for clipped matter. Said N. E. editor used our recent verse entitled "sTatic" on his page under the headline "Our Regular Radio Rhyme" and did not even think of telling the eager world the source of the Rhyme. In so much as the old muse has not been working lately, we fear that the Radio editor up there in the old whaling town of New Bedford will have to use his scissors on some other sheet to fill his (?) "Our" column.

## PERSONS WHO LISP CANNOT BROADCAST

(News Headline)

Fine! Now we can tell that cute little blond, who thays the jutht adorth whittkey and thoda on thultry thummer eveningth with uth how much we really care to have her company and not be afraid that she will broadcast our story to the world.

## Radio to Help Swedes Learn to Talk English

(Another Headline)

Why not try it out on a few Americans?

### Well, What of It?

Dear Indi: Now days when a girl wins a beauty contest the first thing they do with her is to drag her to a microphone and have her say "hello" to a bunch of people who have never heard of her before, thus making her a "Radio Star" and putting her in line for more publicity.

Certain husbands are thinking of banding together and forming a society to legislate marriage ceremonies off the air as being too gruesome for Benedicts to listen-in on. CAP.

### Sum More Tecknickle Stuff

Continuing last week's imbecilic definitions:

FREQUENCY. An attribute of electricity bills first noticed after the fan starts using a home made battery charger.

GRID. The thing used as the basis for pan cakes. Apparently has nothing to do with Radio.

GRID LEAK. When Aunt Jemima spills the batter. GROUND CONNECTION. Combines with condenser for bum jokes, oft times sent to Indi. Most of them deal with coffee grounds.

HARMONIC. Has to do with overtones and oft times causes annoyance, especially when a female trio is announced as being harmonic.

IMPEDANCE. A detour sign in the middle of the only good road in the country.

(More next week, maybe)

After telling of the proposed plan to broadcast records made by famous men in later day British history, an editorial in a New York state paper makes this remark: "Don't give 'em the ether; give 'em chloroform. Let the live ones have a chance!" Rather a neat pun as puns go, say we, although we do believe that some of the has-beens of history could put more life on the air than can some of the alleged performers of today.

Berlin is starting a school for Radio announcers. A compulsory course in all business schools in the U. S. covering the same ground would do much to clear up the telephone congestion in this country. We talk to several business men a day over the telephone and only understand about one half of what they say. We also talk to one or more announcers each day and always get every word, even when they ask for loans.

### Radio Auto-Suggestion

Dear Indi: A lady here has put forward the theory in all seriousness that the recent broadcasting of the sea from Plymouth on a cool evening resulted in her husband catching cold by auto-suggestion!

LONDON BOBBY.

## Who Will He Be?



## Condensed

BY DIELECTRIC

The quality of piano tones from the mike of WLW, Cincinnati, is not far from perfect. In fact, it is almost impossible to believe that such tone is not produced without the aid of Radiophony. In addition to hearing this instrument under favorable broadcasting conditions, listeners were provided with a clever artist rendering a pleasing program in their studio.

WCCO, the Gold Metal station at St. Paul-Minneapolis, undoubtedly pleased most of their audience with soprano solos accompanied by a harpist. At the risk of having the paid critic of NWG think we are copying him, I make bold to state that on few Radio concerts will there appear a feature more musically delightful than this combination—at least where the harp is benefited by good transmission. This column merely directs attention to certain things heard from various stations at different times with some attempt at valuation.

Some months ago, we were tuning to WOS, Jefferson City, Mo., quite often, but of late this has not been the case and no one reason explains the change in listeners habits. The pianist, who formerly entertained from that station is no longer to be heard from it and the schedule of broadcasting is curtailed somewhat. The other evening, they had in place of singing, reciting to musical accompaniment. What did YOU think of it?

WNAC, Boston, celebrated its third anniversary on the air with a program of some length. This is another of the old timers enjoying a large Radio clientele and certainly the popularity is well deserved. Whatever share Jean Sargent has had in placing this station among the leaders, her name is closely linked with the Shepard Stores. The anniversary program included every feature one could imagine as suitable for broadcasting—put out in the usual WNAC manner.

It would be the object of every listener in to catch WHAS, Louisville, Ky., silent during the periods specified were the character of prize offered fully known. You have seen reference in Radio Digest to this contest and know what is required of you to win, so go to it. This arrangement of Foster songs has no counterpart to my knowledge. Much time has been spent and rare musicianship applied to the arrangements. My copy is not pigeonholed; it's in use.

A very interesting evening was arranged for the Radio pageant from the Ritz-Carlton hotel in New York city, including combined orchestras of the larger movie houses and directed by well-known leaders. It is unfortunate that Carl Edwards was unable to lend his talent to the leading of this body of musicians, though listeners were pleased with the artistic work of Dr. Hugo Riesenfeld as director.

While one of those pleasing organ recitals was under way through Station WTAM, the Willard battery studio in Cleveland, two enjoyable numbers made many fans happy.

No more appropriate program could have been arranged to commemorate the marvelous operatic tenor, Caruso, than KDKA, Pittsburgh, presented. Most of the arias so closely associated with his memory were included in numbers selected by the symphony players. This idea of broadcasting concerts dedicated to deceased musicians, such as Victor Herbert and Enrico Caruso, might successfully be emulated by other prominent broadcasting stations.

# Preventing Trouble in Radio Reception

## Part I—Battery Care and Information

By James McDonald

IT IS surprising how much trouble a perfectly good Radio receiver can cause in the hands of those unskilled in its operation. When our Radio engineers design the sets, everything that can possibly cause bewilderment on the part of the owner is eliminated and operation is reduced to two or three large dials, calibrated either in degrees, fractions of a hundred or wave lengths. The owner of the Radio store likes the looks of the receiver, tries it, displays it and finally sells it to a new listener, confident that he has a new booster and Radio enthusiast.

Then the store's phone begins to ring. The set won't work; it won't even emit a groan, much less music. Out goes the service car and a technical man—probably the one who made the installation. Usually it is because the family has run the set about fifteen hours each day for the first week of its use and forgot what the service man told them about throwing the battery on charge—at least occasionally. That point settled, the service man drives back with a sigh of relief, ready for new installations.

Two days later—another hurry up call. The service man is informed that the fan has read somewhere that changing the tubes around in the sockets might help, tried it, and now the blamed thing won't work again. If the set is going to be always in trouble he can take it back. Examination shows that one of the tubes has a pin a fraction of an inch shorter than the others and that, while it works in one socket, the tube cannot function in others. Pulling up the corresponding socket springs in each socket remedies that.

### No One Is to Blame

That is a typical example. Now let us see who is at fault. Not the manufacturer of the set; nothing went wrong in the

experienced Radio man knows can cause trouble, and usually do. The writer hopes to bring these points more firmly to mind and explain just how they are done, to the end that purchasers of complete sets and home builders alike may get better results.

The storage battery is the most frequent source of grief, so we will discuss it first. Electricity is put into it from the electric light socket (through chargers) and withdrawn from it to light the tubes in the receiver. Naturally it can only hold so much and will light the tubes to sufficient brightness only a certain number of hours. When that number of hours has been used up, more electricity must be put in. That operation is called recharging, "putting the battery on charge" or "throwing" it on charge. One must have some means of telling when its supply of electricity is nearly used up and when it has been fully replaced. This is done with a device known as a "hydrometer," an essential to every Radio set owner whose set is operated from a storage battery.

Its usual form is shown in figure 1, as is the method of using it. The inner float

will be found to have numbers up and down its side from about 1100 to 1350 (or 1.100 to 1.350). The pointed end of the device (usually rubber tube tipped) is inserted through one of the filler cap holes in the top of the battery, the bulb is squeezed and, with the tip below the level of the liquid, is then released, which will draw up liquid into the hydrometer. The float will rise and the surface of the liquid will be found even with one of the graduations. Do not take up so much liquid into the hydrometer that the float goes up into the bulb. If the battery has been in use for some time, the reading will probably be 1150 or 1200; if battery has just been on charge, the reading will probably be 1280 to 1320. Those are the minimums and maximums between which the readings will vary and indicate accurately the amount of available current. When reading has been taken, squirt the liquid back into the cell. Be careful not to get it on rugs, floor or clothes.

An amusing incident was recently related to the writer which brought out another suggestion that would otherwise

never have occurred as being necessary. A very charming lady who enjoyed her set, but was not familiar with it in the least, called the "trouble shooter," let him nearly tear the set apart looking for the difficulty, and then explained that she looked in the battery, saw that the "water" was muddy and, wanted nice clean water in her battery and had, therefore, poured out the liquid into the sink and replaced it with pure hydrant water.

That is not just water in the battery; that is a mixture of distilled water and sulphuric acid. The battery will not work on anything else—and the balance between these two liquids must be kept correct. If, when testing your battery, you notice that the level of the liquid is below the tops of the plates, which you can see by peering down through the filler holes, add only "distilled" water, and just enough to bring the level of the liquid about one-quarter inch above the plates. The water evaporates, the acid does not; it is always inside.

When charging the battery, it will be noticed that drops of liquid collect on the

(Continued on page 22)

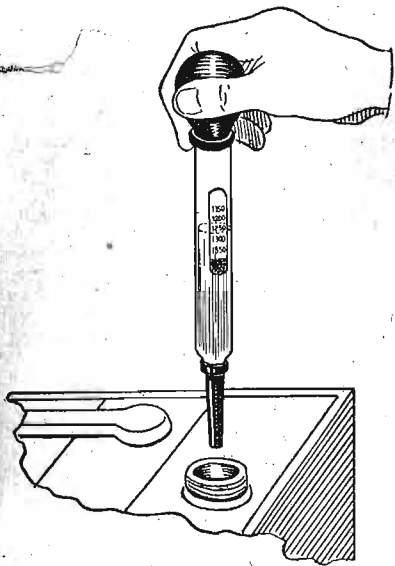

Figure 1

receiver itself. Not the owner of the Radio store; he sold a new set in good condition, with new tubes, batteries and a perfect antenna installation. Not the owner; he bought a Radio that was supposed to bring in entertainment from any of two score stations at the turn of the dials.

No one is to blame. This is just an unfortunate condition which exists for the time being and will gradually be ironed out as Radio progresses and new selling methods are found. The undesirable effects of the situation can be eliminated very easily, however, by the purchaser and owner.

There are certain points in connection with Radio sets that should be attended to every so often just as one has new oil put in the crank case of the car every 500 miles and has the steering wheel parts greased every 5,000. In the one case it is, to prevent mechanical trouble; in Radio it is to prevent electrical trouble. Your Radio set is a delicate piece of mechanism from the standpoint of the energy involved; a few grains of dust that would not stop the movement in a fine watch will, if in the wrong place, pull down the efficiency of a Radio far more than one imagines.

### Receiver Care Easily Learned

It is not at all difficult for any owner of a Radio receiver to learn the things that must be done and how to do them. With all the first class sets on the market now, there are operating directions enclosed that explain the setting up of the set and its accessories and tell something of the tuning. Few of them, however, give the little but important points that the more

Be Prepared to Tune in European Stations During the Trans-Atlantic Test Period This Coming Season

USE A

# VICTOREEN Super Heterodyne Kit

Containing "Tuned" R. F. Transformers of Air Core Construction

Parts Required to Build a Victoreen Super Heterodyne

- 1 Victoreen Kit
- 2 .0005 Variable Condensers
- 8 Vacuum Tube Sockets
- 2 .00025 Grid Condensers with Mounting
- 2 MEG Grid Leaks
- 1 400 OHM Potentiometer
- 2 30 OHM Rheostats
- 2 6 OHM Rheostats
- 2 Double Circuit Jacks
- 1 Single Circuit Filament Jack
- 1 Filament Switch
- 2 Audio Transformers
- 1 1 MFD. Bypass Condenser
- 1 4½ Volt "C" Battery
- 1 7x24-in. Panel
- 1 8x23 Base Board
- Binding Post, Screws and Bus Bar

**\$33.50**  
Kit of 5 Coils

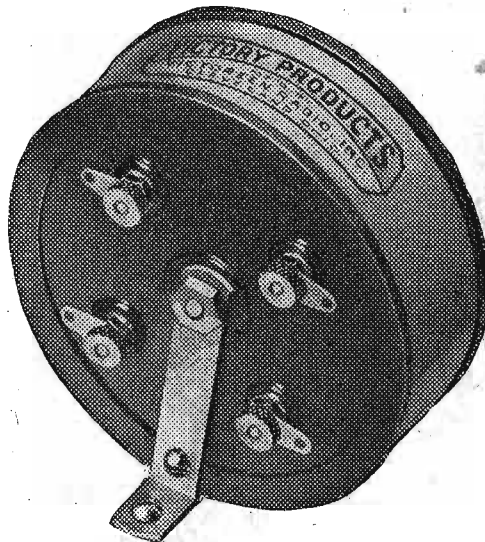

Victoreen No. 170 R. F. Transformer—Neat and Compact

The Victoreen Kit—"Type OM"—Consists of

- 3 "Victoreen" No. 170 R. F. Transformers
- 1 "Victoreen" No. 175 Input Transformer
- 1 "Victoreen" No. 150 Coupling Unit

Should use of Aerial be preferred to Loop, the "Victoreen" No. 160 Antenna Coupler is required, at \$3.50.

### EITHER

UV199 or 201A Type of Tubes may be used—A truly Victoreen Feature.

"B" Battery consumption is remarkably low—8-10 Milliamps, with Potentiometer at negative side—less than some 3 tube sets.

No Oscillations, Howls or Squeals—No Matching of Tubes

Victoreen Air Core Transformers are not merely "matched," but are actually tuned to a guaranteed precision of 1/3 of 1% — another Victoreen feature

Range—Clarity—Volume—Selectivity—Ease of Operation

Ask Your Dealer for a Free Folder and Hook-Up of the Victoreen Set—  
or Write Directly To Us

# THE GEORGE W. WALKER CO.

6534 Carnegie Avenue, Cleveland, Ohio

Branch Sales Offices Are Located at

- |  |  |  |
|--|--|--|
| 50 Church St.....New York City             | 300-B Sugar Bldg.....Denver, Colo.       | 45 Ruggery Bldg.....Columbus, Ohio                 |
| 719 Raymond St.....Philadelphia, Pa.       | 383 Brannan St.....San Francisco, Calif. | 443 So. San Pedro St.....Los Angeles, Calif.       |
| 1323 Wall St.....Dallas, Texas             | 508 So. Dearborn St.....Chicago, Ill.    | Box 321.....Boise, Idaho                           |
| 910 Terminal Sales Bldg.....Seattle, Wash. |  | 332 St. Catherine St. W.....Montreal, Que., Canada |

**PREVENTING TROUBLE**

(Continued from page 21)

top. You are also likely to spill a few drops when testing. This liquid must be removed or it will destroy the battery and make reception noisy. An ordinary dry rag or one dampened with water will not do. Something must be used to neutralize the acid. Ammonia water, available in practically every home, serves this purpose and it is only necessary for the set owner to dampen a rag or sponge with "cleaning" ammonia water and apply as in

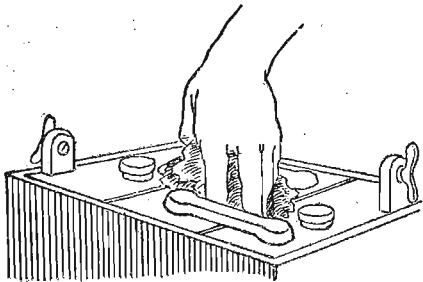

Figure 2

figure 2. Be careful to get under the connecting straps of lead and close up around the lead terminal lugs. The grooves between cells should also be cleaned out thoroughly as it is across these that intermittent leakage could occur to make undesirable noises in the set.

When through thoroughly cleaning all reachable parts, including the lead terminals and the thumb nuts or binding posts, apply vaseline or grease to the lead connecting bars and to the terminal strips. Connect the leads from the set and cover the binding post or thumb nut with the grease. This will prevent corrosion by the fumes and liquid that come from the cells.

The terminals on a battery are known as the "positive" and the "negative." It is essential in charging, and connecting for use, that they be distinguished from one another. If color is used by the maker, the positive post is always painted red and the negative is black or unpainted. Some makers prefer to stamp the case close to the terminals with + (positive) and - (negative) marks. Others abbreviate or spell the terms out and stamp them at or on the connecting posts. While this matter of positive and negative is not important on some chargers, it is on most of those available and should be watched carefully. After awhile one does it auto-

matically. When connecting to the set, however, this is always of importance and usually the receiver will not function if these leads are reversed.

**Care of B Batteries**

There are two types of B batteries in general use. One is the type composed of fifteen or thirty flashlight size dry cells (sealed in) and the other is that composed of 12 or 24 small storage battery cells. A third form is the Edison storage B battery.

There are few precautions relative to the use of the dry cell type as it is practically trouble free and cannot be charged. It should, however, always be set on the side intended by the makers to be the bottom. The small cells which make up the unit (and are contained within the outer metal or cardboard container) are then in an upright position. Thus they will deteriorate at the slowest speed and will give the longest life. These B batteries are made in the two sizes mentioned above and rated as 22½-volt or 45-volt units. When new, they should give this rated voltage if a good quality voltmeter is placed across the terminals. This voltage will gradually drop with the use of such batteries until a point is reached at which a cell is no longer useful. This "dead" point will be further discussed.

Voltmeters all look alike, but vary somewhat in their interior construction. The cheaper ones are known as "low resistance" meters and will give a fairly accurate reading; those higher in price are "high resistance" meters and give a much more reliable idea of the condition of a battery. Whether either type is used, the reading should never be taken after a B battery unit has had a rest of several hours due to the set not having been in operation. Take B battery readings immediately after using the receiver an evening or at least two hours. That will give the voltage being supplied to your set, not that which can only momentarily be obtained due to recuperation.

**When to Discard B Battery Units**

When, on such a test, the meter shows that a unit supplies but 17 volts, although rated at 22½, or can furnish but 34 volts pressure if of the 45-volt size, throw away the low reading battery unit. Some may feel that there is still useful life in the battery and that it could be hooked up with new units, but this should not be done as the chemical action within the old cells has eaten through the zinc cases of the cells to such an extent that the reaction furnishing electricity is irregular

(Continued on page 24)

**BREMER-TULLY'S greatest asset is a reputation for never having released to the public any product that was not more than ordinarily successful.**

**Their greatest hope is that they may continue to be of increasing value to their customers.**

TECHNICAL ABILITY without question, — MANUFACTURING SKILL that is unsurpassed,—and HONESTY OF PURPOSE in advertising only what may reasonably be expected have created ABIDING PUBLIC CONFIDENCE.

**"Once a B-T User,—Always a B-T Booster"**

THE B-T "LIFETIME" CONDENSER is as far ahead today as it was when we first began printing on all cartons "IF YOU DON'T FIND IT BETTER SEND IT BACK."

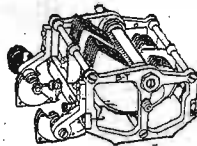

THE TANDEM CONDENSER is a necessity for simultaneous tuning. Real results require a laboratory product,—the "Trimmers" are a vital necessity.

LD-13 .00025 Units \$9.00  
LD-17 .00035 Units 9.50

In straight line wave lengths there is a new size  
L-17 .00035 \$4.75

**Straight Line Frequency Condensers**

Many claims are being made for a condenser that will separate all station "channels" evenly over the dial,—in other words, a S. L. F. Condenser.

POPULAR RADIO, page 195, August, 1925, says:

"There is a great call at the present time for so-called straight-line-frequency condensers, although there is not at the present time (and never will be) any such instrument. This is because it is impossible to make a variable condenser that will have a straight-line-frequency characteristic with all types of coils used in radio . . . even a condenser especially designed for use with a theoretically perfect coil with zero distributed capacity would not give a straight-line-frequency curve with any type of coil now on the market . . . any specific condenser which claims to be straight-line-frequency condenser is so only with one specific type of coil for which the condenser has been designated to operate in conjunction with."

THE B-T S. L. F-17 CONDENSER is designed to cover the broadcast range with B-T "Torostyle" Inductances. It has the same side bar insulators, die-cast rotor and stator and unequalled "Lifetime" adjustable bearing recognized everywhere as B-T developments.

If you do not find it superior to any condenser of this type now on the market your money will be cheerfully refunded.

Price \$5.75

**TO HELP YOU UNDERSTAND**

Those who wish further information will find the relative merits of this type of condenser fully analyzed in "Better Tuning" 8th edition,—also many other live subjects, including



B-T TOROSTYLE FOR EASY WIRING

**THE B-T COUNTERPHASE,** the first successful circuit, so far as we know, employing three stages of Tuned R. F., providing a 6-tube set with but two tuning dials that brings distance on a short indoor antenna. Fully covered by B-T U. S. Patents.

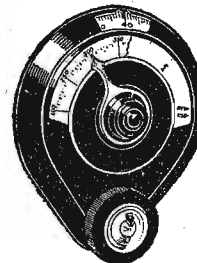

**THE B-T TUNING CONTROL** Combines beauty with high efficiency. 12 to 1 ratio. Suits either right or left hand condensers. Reads in fractional dial numbers, wave lengths or by station call letters.

4-inch—\$2.50

- Put me on your list for circulars on all B-T products,—sockets, "Torostyle" Trans., Variable High Resistances, Audio Trans., etc.
- Send Better Tuning 8th Ed. 10c enclosed.
- Send Better Tuning one year. 50c enclosed.
- If interested only in complete set, check here.

NAME .....

ADDRESS .....

**Bremer-Tully Mfg. Co.**  
532 S. Canal Street CHICAGO, ILLINOIS

**Make Sure of Receiving Your Copy Each Week**

and receive the best service from Radio Digest. Requests for missing copies are numerous. You cannot afford to miss a single issue. Your best protection is a mail subscription. Now is the time to get on the weekly mailing list.

One of the popular Radio Broadcasting Stations writes:—\* \* \* "We find the trouble in this locality is the fact that our listeners are having difficulty in securing copies of Radio Digest." \* \* \*

Many readers miss some of the issues of Radio Digest. It is a disappointment to reach a newsstand sold out. Readers become dissatisfied and Radio Digest loses a reader. Our best efforts are being put forth to have copies always on newsstands. Frankly, we admit that the job is very strenuous.

**YOU CAN HELP**

Advise us promptly of any difficulty you have in getting your copy. Give us the name and address of the dealer who is sold out. Your mail subscription will solve your problem. You will find a coupon in each issue. Today fill out the coupon and mail at once. This insures your copy each week, delivered on time.

Radio Digest Publishing Co.  
510 N. Dearborn Street  
Chicago, Ill.

# Easy Methods of Making Receivers Selective

## Part I—Single Circuit Regenerative Types

By John G. Ryan

**B**ACK in the early days of the public's introduction to Radio, the fall of 1921 and spring of 1922, any concoction of Radio apparatus that would put signals into a pair of head receivers or loud speaker was welcome and satisfied its proud owner. As long as any five or six of the dozen stations then broadcasting could be heard more or less regularly, purchasers and builders were well pleased. Then came more stations and more receivers, running into millions. Single cir-

cuits must be had and, since they should preferably be the grid circuits, the Radio field immediately saw air core, tuned secondary, radio frequency transformers on the market by the score. In over 100 different types and sizes, these still exist.

The latest demand from the immense army of listeners is for both range and selectivity and, at the same time, simplicity of control is wanted. The super-heterodyne fills this to some extent but

The two most widely used single circuit sets are shown schematically in figure 1. Their range is remarkable and, in good locations, with properly installed antennas and grounds, either is apt to do coast to coast on a pair of phones. They are simple to operate and inexpensive to construct. These are the good points.

On the other hand they are bad radiators and will put "birdies" in other receivers located over a wide area. In addition to thus spoiling the other fellow's fun, they will not usually, under present broadcasting conditions, give their owners a great deal of satisfaction, for they cannot eliminate a powerful local or separate moderately distant stations on close wave channels and having equal intensity.

Both of these circuits should be altered to that shown in figure 2. This would not be expensive as each already has the variable condenser for figure 2 and needs only a three circuit coupler to change it over. For most localities this unit can be of the aperiodic fixed primary type that consists of about 10 turns of primary with a rotor tickler at one end of the secondary. Locations where there are too many broadcasters will require a unit with rotor primary also, and may even need a wave trap in the antenna circuit. The construction of a wave trap was outlined on the Questions and Answers page of Radio Digest of July 25 date.

### Low Loss Construction

The advantages of low loss construction have been greatly exaggerated, and

fans have been led to believe that this was the salvation of Radio and would solve all their worries. Nevertheless there is much of merit in low loss types of windings. Any of the baskets, pancakes, herringbones, banks, air spaced and skeletonized windings available are an improvement over the old tube layer wound type, although none of the new types tests up sufficiently better than the rest to make it an outstanding favorite.

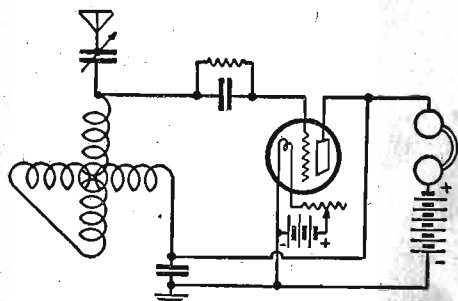

Figure 1

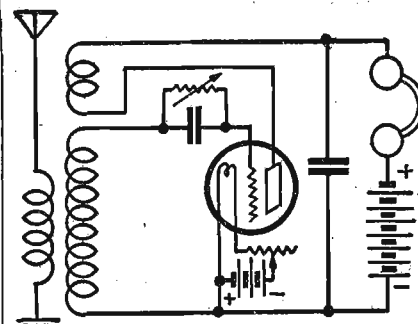
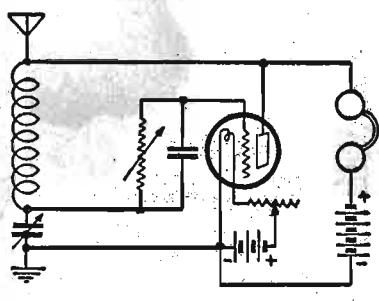

Figure 2

cuit sets disturbed one's neighbors and, in addition, would not separate two powerful locals. Hence, they fell into disfavor in all localities except the far West and the South. The range and selectivity possible in three circuit regeneratives seemed to satisfy for some months and then the desire for range broke out and radio frequency amplification was essential to desirability in a set.

### Range But No Selectivity

Untuned radio frequency transformers of the small, laminated-iron core type enjoyed popularity for some time but they permitted tuning only across the loop connected to the first grid circuit or across the secondary of a coupler attached to an aerial and ground. The selectivity was insufficient for the very great number of stations within the range of such receivers. It was plain that more tuned

the choice of these sets to the man wanting one already assembled and wired is rather limited and the price is beyond the reach of many. There are many kits on the market for those who will construct a set, but the outlay for a seven to nine tube set is rather steep, and the majority of users of Radio sets still have three, four and five tube installations.

Thus we have three major types to consider when discussing problems of selectivity; the regenerative, with or without audio amplification, the five tube set, with or without neutralization, and the super-heterodyne, with either air or iron cores. There are certain points common to all three in the matter of improvement of the selectivity, while there are, of course, other features to be changed that are individual to the exact type of set.

There is one point the reader should understand before building circuit 2. The volume on certain stations may be cut down slightly from that obtained when either circuit of figure 1 is used, but the advantage gained in selectivity should (Continued on page 24)

# Build this phenomenal new radio in 45 minutes

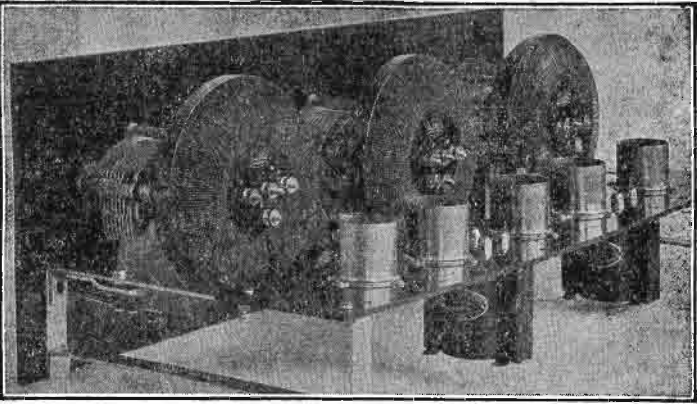
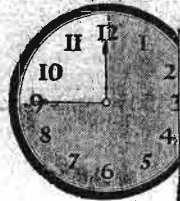

The revolutionary Erla Balloon Circloid-Five Factory-Bilt Kit—as you receive it.

Price \$49.50

This new type kit is factory assembled. Ready cut, flexible, solderless leads make it ridiculously easy to wire. Amazing new inductance principle brings results hardly thought possible. Send for book, *Better Radio Reception*.

**N**OW anyone can build the finest of receivers in only a few minutes. No more wire bending or soldering. Merely attach a few ready cut, flexible eyeletted leads and the job is done. The finished set is unsurpassed even by the costliest factory-built receiver.

But most amazing is the new inductance principle incorporated in this last word in kits—called the Erla Circloid principle of amplification.

Four vital improvements result from this great discovery, which are not found in ordinary sets.

**1. Greater Distance:** Erla \*Balloon \*Circloids have no external field, consequently do not affect adjacent coils or wiring circuits. This enables concentration of proportionately higher amplification in each stage, with materially increased sensitivity and range.

**2. More Volume:** Increased radio frequency amplification made possible by Erla Balloon Circloids gives concert volume to distant signals inaudible with receivers of conventional type.

**3. Increased Selectivity:** Erla Balloon Circloids have no pick-up quality of their own. Hence only signals flowing in the antenna circuit are amplified. Static is greatly reduced for this reason.

**4. Improved Tone Quality:** The self-enclosed field of Erla Balloon Circloids eliminates stray feed-backs between coils and consequently does away with muzzing of signals and distortion. Tone is crystal clear and perfectly lifelike.

Write for free information on kit—also book

See how 45 minutes of fun will give you the newest and most nearly perfected set known to radio science. Easy as A-B-C to finish. Examine it at any Erla dealer's, or send the coupon for full information, illustrations and diagrams free. Also ask for remarkable new book, "Better Radio Reception," describing the sensational new Circloid principle. Enclose 10c for mailing and postage on book.

ELECTRICAL RESEARCH LABORATORIES  
2500 Cottage Grove Ave., Chicago

\*Trade Mark Registered.

ELECTRICAL RESEARCH LABORATORIES, Sec. 78  
2500 Cottage Grove Ave., Chicago, U. S. A.



Send me free information on kit.  Enclose 10c for postage for book "Better Radio Reception."

This sign identifies authorized Erla distributors. All are equipped to give complete radio service.

Name.....  
Address.....  
City..... State.....

Dealers Exclusive franchises are available to high class dealers in localities not open. Write or wire immediately.

# FROST-RADIO

Ask Your Neighborhood Dealer

## MUSETTE

"The Stradivarius of Radio"

\$12.50

Black Finish

(Pacific Coast prices slightly higher)



## MUSETTE

possesses remarkable tone qualities due to its scientific construction from materials of highest acoustical merit. The base and throat are aluminum castings—recognized as the ideal acoustical material. The bell is a casting of Bakelite, highly polished and of extremely graceful proportions. The unit is a special construction, and gives Musette a complete coverage of the entire range of voice and music. If you have tried other loud-speakers, hear Musette and you will appreciate the difference.



48-Page Book of all FROST-RADIO Apparatus FREE!

If you wish a copy of our free catalog of all items we manufacture write us today at our Chicago address.



**Frost Radio**  
**HERBERT H. FROST, Inc.**  
314-324 WEST SUPERIOR STREET, CHICAGO  
NEW YORK CITY CLEVELAND KANSAS CITY LOS ANGELES  
EXPORT OFFICE: 314 WEST SUPERIOR STREET, CHICAGO

### USE NEUTROFORMER IN SINGLE TUBE SET

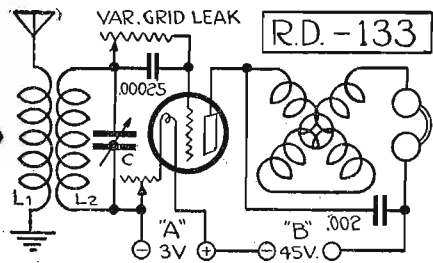

Here is R. D. hook-up No. 133 which uses a unit the same as a Radio frequency transformer in the neutrodyne set. The coil  $L_1$  consists of 10 turns of number 26 dsc. wire on a 3-inch tube which is slipped inside of coil  $L_2$ . This latter coil consists of 53 turns of number 26 dsc. on a 2 3/4-inch tube. C represents a 23-plate condenser attached to the coil  $L_2$ .

To tune, vary C for the wave length variations and follow up with the variometer for regeneration. Keep the two in such relation that it is just below the point where a rushing sound is heard. If properly constructed and operated the set will give excellent results on a 199 tube with an electric light circuit aerial. With the same kind of an aerial and two 199 tubes as audio frequency amplification I have heard Mexico City, stations in California and two Cuban stations. I have a total list of 88 stations.—Fred W. Bradley, Ann Arbor, Mich.

### CHNC, TORONTO RADIO

(Continued from page 5)

associate-engineer and operator of the station; Chas. E. Bodley is the concert master; Arthur Blight is musical director; Miss Eve Baker looks after programs, and Miss Lorena Combs is the hostess.

All of the staff have yet to receive their first pay envelope but in spite of the voluntary nature of the organization, CHNC has long since gained the name of being the "on time" station and this, coupled with the quality of entertainment broadcast from this station and the very high class of transmission, has made CHNC one of the most popular broadcasting stations in that territory where it is heard to advantage.

### GAINING SELECTIVITY

(Continued from page 23)

more than compensate for this. What if you could not hear KFI at 3 o'clock in the morning? You probably will be able to pull WDAF through WGN and hear it without "background" from the latter, which you couldn't do before.

So much for the coupler. If the variable condenser you have been using is of the old style with friction contact to the rotor through the bearings, or with rotor and stator insulated only by thin bushings of fiber through the end plates, it will be worth while to get one of the new ones with pig tail connection, skeletonized metal end plates and side bars of good dielectric; also a vernier, either in the condenser construction or in the dial. Do not omit the bypass condenser shown, which should be between .001 mfd. and .0025 mfd. capacity. It is small, but extremely important in this hook-up.

#### Other Important Factors

If, in assembling any outfit, you can do without a baseboard and attach all units to the panel direct or on brackets, so much the better. Wiring will thus be clear of all solid matter and is easier to put in. If this cannot be done conveniently, use a base panel of bakelite or hard rubber, attached to the front panel with brackets. This permits the wiring of filament leads beneath the sub-base and makes a good looking job. The use of a wooden baseboard is not desirable, but if wood must be used, keep all wiring at least 1/2 inch away from it and, preferably, encased in spaghetti. Paint that baseboard with Radio cement, shellac or paraffine, and do not omit the edges or ends where moisture gets in the easiest.

The batteries play an important part in the use of regenerative outfits, whether single or three circuit. So far as actual operation is concerned, the efficient use of regeneration is in striking the proper balance between filament brilliancy, plate potential and feed-back. The last named is controlled by the operator, but if either of the other two is weak, results will be inconsistent and regeneration at higher wave lengths will be poor or impossible. The filament should be operated according to the voltage, not amperage, measured across the terminals on the socket after the set has been in operation an hour or two. The plate circuit energy should be measured with a voltmeter across the binding posts on the set. This reading also should be taken after set has been running awhile, for, if tested after a rest, the batteries may have

recuperated sufficiently to show a creditable momentary voltage which will later drop when in use.

Some may feel that there should be a connection from the negative A circuit to the ground binding post in circuit 2. There would be slightly better volume and, possibly, slightly wider range, but the selectivity would not be as good, especially if a rotor primary is provided. Something must be sacrificed these days to get selectivity. It might as well be volume. Better get more stations clearly within a 500-mile radius than the same number composed of part of those inside of 500 miles and a few wavering, fading "occasional" at 1,500 and 2,000 miles.

An adjustable or variable grid leak will be found an advantage when using this set. It is surprising how results can be improved by finding the correct value of resistance at this point. Cartridge types of leaks in clips will do. In the writer's opinion it would be better to put the variable grid leak behind the panel where it can be adjusted for best strength and clarity on a fairly distant station when the set is first put into use, or the tube changed, and then left alone. It is too much of a temptation on the panel and either the builder or his family is always playing with it—which does the leak itself no good and makes results inconsistent. The usual suggestions such as "keep the leads short, solder all connections, pull up socket springs and keep the condenser away from the end of the tuner secondary," all apply to this type of set.

In the next issue Mr. Ryan will make suggestions for the improvement of five tube sets now built and suggestions to those contemplating the construction of new ones. Even though they contain three tuned circuits, there are many five tubers that are not selective.—Editor's Note).

will not make noises in the set or later result in no current at a place which is hard to find. These clip connections can be apparently perfect, but only careful examination and shaking will bring to light the fact that unremoved insulation

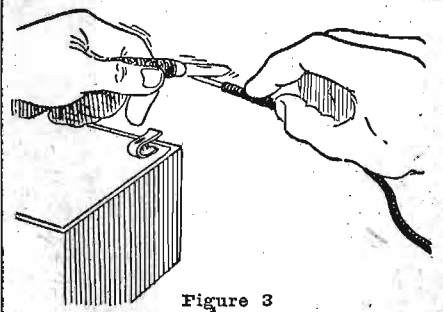

Figure 3

is preventing contact at the points where the clip pinches the wire.

(In the next installment of his series, Mr. McDonald will conclude the battery discussion by considering storage B supplies. He will then tell of the minor mechanical defects in parts due to improper usage or rough treatment.—Editor's Note.)

### ON GERMANY, SMITH

(Continued from page 7)

phonograph music. On the evening of June 19, 1920, this station was connected by telephone line with the state opera house in Berlin, and the lovely music of "Madame Butterfly" went out upon the infinite waves as the first complete opera broadcast to the world. On the day we were at Konigswusterhausen they were dedicating a new set having 10-kilowatt power.

#### Revenue and Centralization

The license fee in Germany is high. Every owner of a receiving set must pay two marks a month, \$6.00 a year. Of this money, for every two marks, one mark ten goes to the broadcasting companies and the remainder to the postal department. With this money the operating companies pay their expenses. There are now in Germany nearly one million owners of sets paying the monthly license. This makes about a quarter of a million dollars yearly to each of the broadcasting companies.

The national culmination of the broadcasting plan in Germany will be the permanent connecting of all stations by telephone lines.

(TO BE CONTINUED)

### PREVENTING TROUBLE

(Continued from page 22)

and intermittent and crackling noises resembling static will be heard. Dry B battery units usually last from four to eight months, depending on the amount of their use.

When connecting B batteries together or to the set, which is usually done with wire covered with insulation containing either rubber or paraffine, there is a tendency to hastily remove the outer covering and slip the apparently bare wire into the clips. Take an extra moment or two to scrape the wire core as shown in figure 3. A good contact is thus provided that

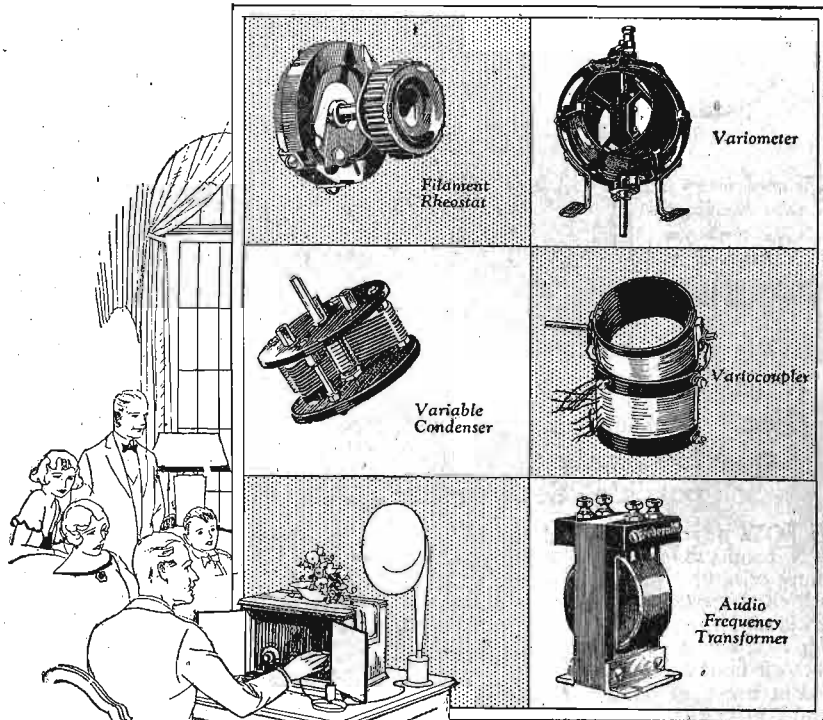

### Quality Parts Matched for Perfect Teamwork

Your "pet" hook-up needs first quality parts—perfectly matched—to give you real radio. Every Federal Standard Radio Part is designed, made, matched and guaranteed by Federal. That is why you find Federal parts in all the better book-ups—that is why you should insist on Federal parts when purchasing.

FEDERAL TELEPHONE MANUFACTURING CORP.  
Buffalo, N. Y.



# Federal

Standard RADIO Products

# The New Radio Book

## HOW TO

### Operate Sets Construct Parts Improve Reception Understand Radio Assemble Circuits

The greatest assemblage of facts and hints, from actual everyday practice, ever gotten together. Edited by the technical staff of Radio Digest, it supplies the demand for a book covering every phase of Radio. Starts at the beginning with simple explanation of Radio reception, with technical explanations of the different parts and leads right on to the more advanced instruction. A complete handbook serving as a ready reference in the Radio field. It gives suggestions on parts and sets which will prove to be a money saver. Blue prints and diagrams are essentially an important part of this book. Special chapter is devoted on "How to Operate," which gives detailed information on the operation of many well known sets.

A general information is vital to the knowledge of anyone interested in Radio. It gives a complete list of all broadcasting stations with a colored map showing their location. The workshop kinks will save you time and money. Now is the time to take advantage of this exceptional offer. **Mail coupon today!**

RADIO DIGEST,  
510 N. Dearborn Street,  
Chicago, Illinois.

Enclosed find \$5.00 for one year's subscription to Radio Digest. The new Radio Book, "Radio Receivers," will be mailed FREE, postage prepaid. This offer only good on subscriptions sent directly to this office, not through agents or agencies.

Name .....

Address .....

City ..... State .....

8-29-25

# A. B. C. Course in Radio Fundamentals

## Chapter XXIII—The Electron Tube as an Amplifier

By David Penn Moreton

THE function of a vacuum tube when used as an amplifier consists in reproducing on a larger scale in the plate circuit, the variations impressed upon the grid or input circuit. If an alternating potential be impressed upon the grid of a three-electrode vacuum tube, by connecting an alternating current generator between the grid and filament of the tube, there will be a pulsating current produced in the plate circuit due to an

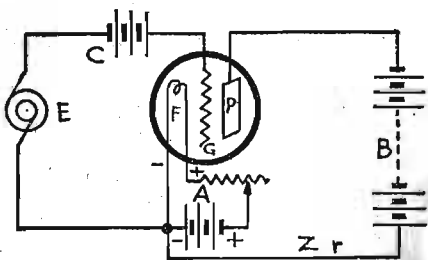

Figure 98

alternating current being superimposed upon the normal steady plate current.

This alternating current in the plate circuit is the same as would flow if the external plate circuit of the tube were connected to an alternating current generator having an internal resistance and capacity equal to that of the tube and generating an alternating electrical pressure equal to  $k \times E_g$ ,  $k$  being the amplification factor of the tube. This important relation may be demonstrated as follows, by considering the operation of the tube shown in figure 98. The filament is heated by the battery A. The grid is connected to the filament through a battery C, which determines the operating point of the tube on the static characteristic curve, and also through an alternating current generator E, which provides the alternating voltage to be amplified. The plate P is connected to the negative side of the filament through a battery B and an external circuit, having an impedance Z,

which includes the internal resistance of the battery but not the internal resistance of the tube.

### Effect of External Factors

Let us first assume that the external plate circuit of the tube has no impedance, that is, the inductance, capacity and resistance are all equal to zero. Under these conditions the potential of the plate  $E_p$  is always equal to the electrical pressure of the battery B, and an alternating grid potential of  $+e$  and  $-e$  volts will produce corresponding variations in the plate current along the plate current-grid voltage static characteristic curve of the tube, corresponding to the particular plate voltage at which the tube is being operated. For example, if the tube is being operated with a plate potential corresponding to that of curve A in figure 99, and the grid potential is varied in value between the points  $+e$  and  $-e$ , the plate current will vary along the curve A between the points  $I_1$  and  $I_2$ .

Let us now assume that there is a resistance  $r$  in the external plate circuit of the tube. The electrical pressure of the battery B is no longer applied to the plate alone but a part of this pressure will appear between the terminals of the resistance  $r$ . Representing the current in the plate circuit by  $I_p$  and the internal resistance of the tube by  $R$  then the electrical pressure of the battery  $E_p$  will be equal to  $(I_p \times r) + (I_p \times R)$ . The filament current  $I_f$  times the resistance  $r$  is the value of the electrical pressure between the terminals of the resistance  $r$ , and the filament current  $I_f$  times the resistance  $R$  is the value of the electrical pressure between the plate and the filament of the tube.

If the grid potential is varied so as to produce an increase in the plate current  $I_p$ , it is obvious that the electrical pressure between the terminals of the resistance  $r$ , which is equal to  $I_p \times r$ , will increase in value. Since the electrical pressure of the battery B remains practically constant, there must, as a result of the increase in the electrical pressure be-

tween the terminals of the resistance  $r$ , be a corresponding decrease in the electrical pressure between the plate and the filament of the tube.

On the other hand if there is a change in grid potential which results in a decrease in the value of the plate current  $I_p$ , there will be a decrease in the electrical pressure between the terminals of

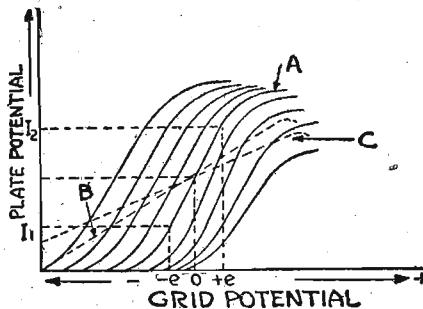

Figure 99

the resistance and an increase in the electrical pressure between the plate and filament of the tube.

It is thus apparent that, on account of the external plate circuit resistance, the plate potential of the tube is not constant, but depends upon the plate current, and varies in just the opposite direction to the variations in the plate current.

### Dynamic Characteristic Curves

It follows from the above discussion that when there is a resistance in the external plate circuit, and the grid potential is varied in value, the operation of the tube no longer follows the static characteristic curve of the tube, which is determined with a constant potential between the plate and the filament, but follows a different curve called the dynamic characteristic. The shape of the dynamic characteristic depends upon the shape of the static characteristic curve of the tube and also on the amount of resistance or impedance in the external plate circuit. The general shape of the dynamic characteristic curve of a tube is shown by curve B in figure 99. All of the solid line curves which correspond in general form to curve A are static characteristic curves for different plate voltages and constant filament currents. If the resistance of the external plate circuit is increased there will be a change in the slope of the dynamic characteristic curve as shown by curve C in figure 99. Each of the curves B and C correspond to a certain plate potential and, if this is changed, there will be a corresponding shift in the curves for a given external plate to filament impedance.

The greater the external plate impedance of a tube, the greater the variation in plate potential  $E_p$  due to a given (Continued on page 26)

## JOBBERS! DEALERS!

Sell your customers a Console Speaker which is designed correctly, for beauty of tone, for long service, and for EASY OPERATION

Of all the Console Speakers built, the Console Master Speaker is the Most Practical

RETAIL PRICE  
**\$49.50**

complete with Loud Speaker and Unit

Biggest Trade Discounts

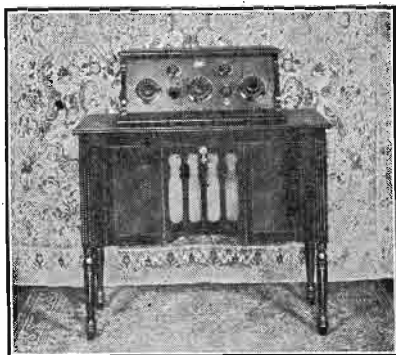

One pull of the handle opens the front for adjustment of batteries or Loud Speaker Unit.

NO MOVING AWAY FROM WALL.  
NO CLIMBING IN AT THE BACK.

Exceptionally large compartment for all batteries and charger. Built-in Speaker of great volume and true tone, the result of life time Phonograph experience. A beautiful piece of Furniture, made in two-tone Mahogany or Walnut.



This Season's greatest seller will be the

**Console Master Speaker**

Line Up Behind It Now

CONSOLE MASTER SPEAKER CO.  
15 East 40th Street  
NEW YORK CITY

## AMSCO ANNOUNCES A SPACE-SAVING S.L.F. CONDENSER

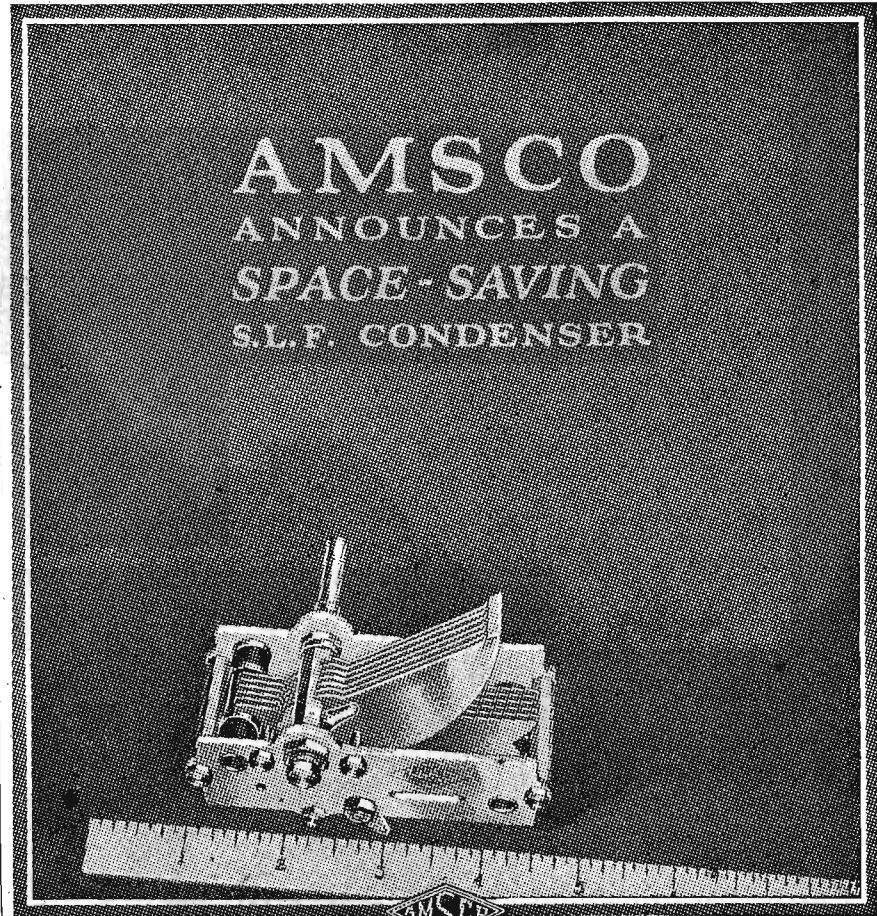

**Solved!** The space problem of the straight-line frequency condenser. The new AMSCO Allocating Condenser is ingeniously designed to save room in the cabinet—yet spreads the stations evenly around the dial, according to frequency. Greatly improves the selectivity of the set—and simplifies tuning. Three sizes—Single or Siamese.

Ask your dealer—or write Dept. O

AMSCO PRODUCTS, INC.  
Broome and Lafayette Streets, New York City  
MAKERS: MELCO SUPREME RADIO RECEIVERS

Half a Heart is the secret. Half a Heart is the shape of the rotor plates.



Half a Heart is the new symbol for efficient S. L. F. variable condensers.

COURSE

From page 25) Current brought about by variation in grid potential. As an example the dynamic characteristic would be parallel to the horizontal grid-voltage axis of figure 99, showing that variations in the grid potential of the tube would produce no variation in the plate current but maximum variations in the potential between the plate and filament of the tube, which would be amplified variations of the grid potential variations.

This last statement may be explained by reference to figure 100. In this figure the plate circuit outside the tube is composed of the battery B and a coil L of extremely high impedance. If an alternating potential is applied between the grid and the filament, there will be an alternating current produced in the plate circuit, or rather, there will be an attempt to produce an alternating current through the coil L which has a very high impedance. Any change in the value of the current in the coil L will result in there being an electrical pressure induced in the coil whose direction at all times is such as to oppose the change in current in the coil.

If the inductance is large, as was previously assumed, the current in the plate circuit will not change a great deal while the alternating counter induced electrical pressure in the coil will be equal and opposite to the alternating pressure tending to produce the plate current variations, which is equal to the amplification factor of the tube K times the alternating electrical pressure  $e_g$  impressed upon the grid. The electrical pressure between the terminals of the impedance coil L will be an amplified reproduction of the potential variation between the grid and the filament.

There is, of course, some current in the plate circuit but it is very small and the dynamic characteristic curve of the tube has very little slope. The variation in the electrical potential between the terminals of the coil L depends upon the current and the impedance of the coil. The impedance of the coil depends upon the resistance of the coil, the inductance of the coil and its distributed capacity.

Resistance vs. Impedance

A high resistance may be substituted for the impedance coil L in figure 100. The electrical pressure between the terminals of the resistance is so great that a very small potential exists between the plate and filament of the tube. Then, in order to have a sufficiently high potential

between the plate and the filament of the tube, and obtain an appreciable current, it is necessary to use a very high B battery potential which is generally undesirable.

When an impedance is used, as shown in figure 100, the resistance of the coil may be made quite low without affecting the operation, since the amplification is due to the induced electrical pressure in the coil which depends upon the inductance of the coil and the rate of change of the current taking place in the coil. This results in a large voltage amplification with a low resistance in the plate circuit and a comparatively low plate battery voltage.

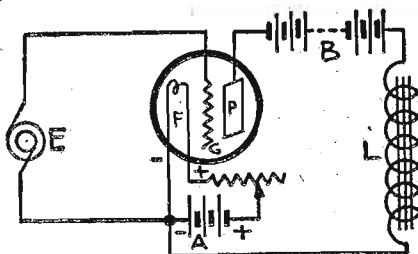

Figure 100

If the inductance coil L, in figure 100, be shunted by a variable condenser, then the natural frequency of the circuit composed of the coil L and condenser may be adjusted to the frequency of the alternating potential applied to the grid of the tube. With this arrangement the impedance of the external plate circuit will be a maximum and becomes greater the less the resistance of the circuit composed of L and the capacity of the condenser.

(Having shown most clearly the action within a single tube used as an amplifier, Professor Moreton will next show how several tubes may be used together in what is known as cascade amplification. If one tube and its transformer amplify twenty times, two tubes in cascade give, not forty, but an amplification of 400.—Editor's Note).

Hear Mooseheart in Peru

Ralph Shugart, engineer of the Moose Station WJJD, Mooseheart, Ill., had a great thrill a few days ago when a letter was received from L. Anciaux who lives in Arequipa, Peru, South America. Senor Anciaux said, among other things, that WJJD came in on his set in South America, 5,000 miles from Mooseheart, with "extraordinary volume despite static, —hard to separate from KDKA." He said the weather was clear but the "atmospheres" were heavy.

The Reader's View

Superpower vs. Smaller Stations

I am a constant reader of Radio Digest, and I would like to express my opinion on a much discussed topic; superpower stations and smaller stations. Superpower stations are a very fine thing for entertainment, but low power stations should not be eliminated from the game. It furnishes me much pleasure to pick up a twenty-watt station a thousand miles away. Distance is still the fad and will continue to be so, because distance is the thrill of Radio, and without a thrill, a thing is worthless.

Some people say that a twenty-watt station on the same wave length with a superpower station causes interference, this is almost impossible, because a superstation drowns out a weaker station.

Just a word about selectivity. Although I have a one-tube set, I am able to tune out a strong nearby station and tune in a weaker station which is but two meters away. I have received a large number of distant stations and I have not experienced any interference that could not be eliminated entirely by sharp tuning.

Some people say: "I don't care for distant reception. Give me a local program and I am satisfied." If you listen in to their set, nine times out of ten you will find that they are unable to pick up stations more than 150 miles distant. They have never received distance, and do not know what it feels like. Give them a dose and they will come back for more.

Most of the trouble experienced would be eliminated if the person operating the set would learn how to do sharp tuning. If a set can't tune stations six meters apart, the proper thing to do is to "junk" it and buy one that will. It does not necessarily have to be a \$250 set, as a low priced set, properly built by recognized manufacturers, will do the trick.

When I pick up my Crosley one-tube receiver, I hear a great number of stations trying to gain admittance to my ear-phones. I let them in one at a time without any interference whatsoever. I have received a total of 137 stations from all parts of the United States, 10-watt, 20-watt, 50-watt, 500-watt, 1,000-watt, and 5,000-watt.

I look forward to the superpower stations for pleasure and enjoyment, but give me distance too. The superstations always furnish good programs, and when I am after entertainment I tune to them.

Let the superpower stations continue to broadcast entertainment for the Radio public, but do not crowd the low power stations entirely off the air.—M. S., Washington, Pa.

Give More Sunday Night Sermons

I wish you would use your good offices to induce more of the larger broadcasting stations, that is, the stations with the more powerful transmitters, to broadcast sermons on Sunday evenings. Quite a number broadcast the usual morning sermons and in many instances sign off for the remainder of the day. It is a matter of general knowledge, I assume, that the great majority of listeners have no sets that will get a day station in full volume unless very near.

The night transmission, of course, is much more effective and satisfactory, and I feel that if the great stations—which are doing so much to elevate mankind—would give us more Sunday night sermons the cause of religion would be advanced and the incidental benefits to society enjoyed and realized.

I am sure Radio Digest does not object to the advancement of this cause and I feel equally sure the big stations are not adverse thereto. I imagine that any suggestions you may feel like making along this line would at least have the thoughtful attention of the great stations. W. C. R., Nashville, Ark.

Waiting for Announcer

Fully agree with J. M. Hill, of Olympia, Wash., about this announcing business, as Mr. Hill sets forth in an intelligent manner.

Oftentimes I get tired waiting to hear the name of the person talking. Of course some may say that it makes no difference who it is if the speaker is worth listening to and tells the truth. We all know that this is not satisfactory to most of us. A talk by the President carries more interest than a much better talk, perhaps, by some other man. I, like most other Radio fans, cannot sit all day and night at the Radio and when I hear fine singing, music or speaking, I like to know the city and station from which I am getting this pleasure. It would not interfere with a speaker, after he has spoken ten minutes, for him to announce his name and the city in which he is speaking. We all naturally suppose that music or a speech is broadcast for the benefit of those "listening in" therefore why not give us the full pleasure of knowing all about it—J. M. Page, Jerseyville, Ill.

TRUE TONE QUALITY



THE DAVEN SUPER-AMPLIFIER



RESISTOR MANUAL The Handbook of Resistance Coupled Amplification. At Best Radio Dealers 25c. Direct by mail, postpaid 35c.

USE THIS FREE COUPON

DAVEN RADIO CORPORATION 158-160 Summit St., Newark, N. J. Please send me the following on Resistance Coupled Amplification:

- Check one
[ ] Resistor Manual. 25c is enclosed.
[ ] Complete Catalog (free).

Name.....
Address.....

FOR DEALERS: Send your letterhead or card, or this coupon and we will have our nearest distributor communicate with you.

VOLUME was formerly the goal of radio engineers. The blare of discordant trumpets succeeded the tinkling of the harp. The goal had been reached.

But true tone quality is the star we now are shooting at. This explains the phenomenal growth of the demand for resistance coupled amplification. The end of the era of distortion is in sight.

Daven engineers have pioneered in resistance coupled amplification. Daven Resistors and Mountings, Ballasts, Amplifier Kits and Super-Amplifiers are standard everywhere.

The Daven Super-Amplifier is the aristocrat of amplifiers. Absolutely no distortion. A revelation to music lovers. It is sold by dealers everywhere, complete, ready to connect with tuner and batteries, for \$15.00.

DAVEN HIGH-MU TUBES

MORE volume of true tone quality is the latest achievement of Daven engineers. The new Daven Tube Type MU-20 increases the amplification of the Daven Super to equal or exceed that obtainable with transformers. 6 volt, 1/4 ampere—\$4.00 each. The Daven Power Tube Type MU-6 for the last, or output stage—\$5.00 each.

DAVEN PRODUCTS ARE SOLD ONLY BY GOOD DEALERS

Newark DAVEN RADIO CORPORATION New Jersey Resistor Specialists Reg. U. S. Pat. Off.

Tuning Marvelously Simplified with KARAS ORTHOMETRIC Condensers

The condenser that brings in KDKA were it belongs—at 53 on the dial. Remember, 52 of the 100 wave lengths must come in below KDKA—

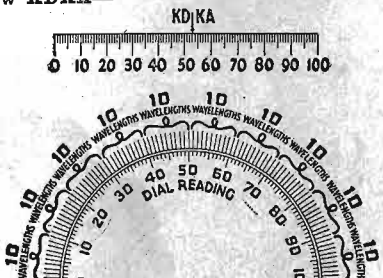
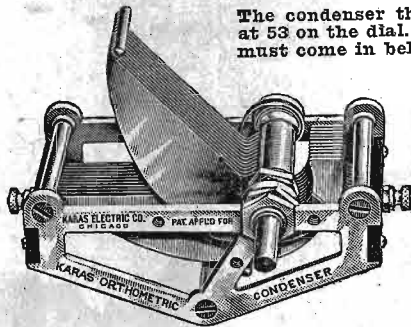

KARAS ORTHOMETRIC CONDENSER Arrangement of Wavelengths on Dial

Spreads Stations. Evenly Over the Dial—No Crowding Whatever

The Karas Orthometric Condenser positively separates all adjoining wave lengths by EQUAL distances on the dial, giving full benefit of the 10 Kilocycle frequency separation fixed by the Government.

Ordinary condensers jam 70 of the 100 Government allotted wave lengths into the first 30 points of the dial—even straight-line-wave length condensers crowd 57 of them below 30.

With Karas Orthometrics each point of the dial corresponds exactly to one of the 100 allotted wave lengths. The result is marvelous simplicity in tuning—better, clearer reception.

The Karas Orthometric is a "job" that will delight the eye of the mechanical critic. Made entirely of brass—frame die stamped, not cast. Every joint soldered. Grounded frame and rotor. Adjustable cone bearings. Spring copper pigtail.

If Your Dealer Is Not Yet Supplied Order On This Coupon!

We are supplying dealers and jobbers as fast as our factory output permits. If your dealer is not yet supplied, order direct on the coupon. Send no money. Simply pay the postman on delivery. Order today!

SIZES and PRICES

- 23 plate .0005, Mfd.....\$7.00
17 plate .00037, Mfd..... 6.75
11 plate .00025, Mfd..... 6.50

KARAS ELECTRIC COMPANY 4049 N. Rockwell Street CHICAGO

For More Than 30 Years Makers of PRECISION Electrical Apparatus

KARAS ELECTRIC CO., 4049 N. Rockwell Street, Chicago.

Please send me.....Karas Orthometric Condensers, size indicated below. I will pay the postman \$..... plus postage, on delivery. This order is subject to your 30 day Money-Back Guarantee.

Size wanted.....

Name.....

Address.....

Dealer's name..... If you send cash with order, we'll send Condensers postpaid.

THE BIG LITTLE THINGS OF RADIO



# DX English Circuit Hears America

## Four Tube British Set Is Exceptionally Good

Here is a hook-up that my friend in England receives America on during any good Radio night. He advises that he has tried all the hook-ups and he finds this the best. I hooked my set like it last

### WORKSHOP KINKS EARN A DOLLAR—

**T**HERE are many little kinks worked out at home that would aid your fellow Radio worker if only he knew about them. There are new hook-ups, new ways of making parts and various unique ways of operating sets that are discovered every day. Radio Digest is very much interested in obtaining such material. Send them in with full details, including stamped envelope, so rejected copy may be returned. The work must be entirely original, not copied.  
RADIO KINKS DEPARTMENT  
Radio Digest,  
510 North Dearborn St., Chicago

February and have no trouble getting coast-to-coast reception.

The plate tuned impedance coil and the regeneration coil may well be honeycombs in an adjustable coil holder although other forms and means of coupling can be used. You do not need a potentiometer in this circuit. The filament rheostats give you the same results and you will probably find that you get much louder signals by cutting down the current on the first tube.

For DX work, the detector tube current should be varied for best results. To switch out the last tube (second audio) turn the switch to the right and cut off the rheostat on that tube. When you've become accustomed to handling this circuit I think you will prefer it to anything you've tried. I know we do.—J. H. Stevenson, Oak Station, Pa.

### Single Wire Aerial and Lead-In

Persons who have no facilities for soldering the lead-in wire to the aerial can drop one end of the aerial wire proper from the insulator so as to make a lead-in, if they are careful to wrap the end of the wire that is to become the lead-in around the aerial.

Distortion is more frequently caused by a distant station on a closely similar wave length than by a defect in the receiver. It may even be that the signals from this interferer cannot be heard, but are sufficient to break up the wave stream of the desired station.

## DIAGRAM OF OVERSEAS RECEIVER

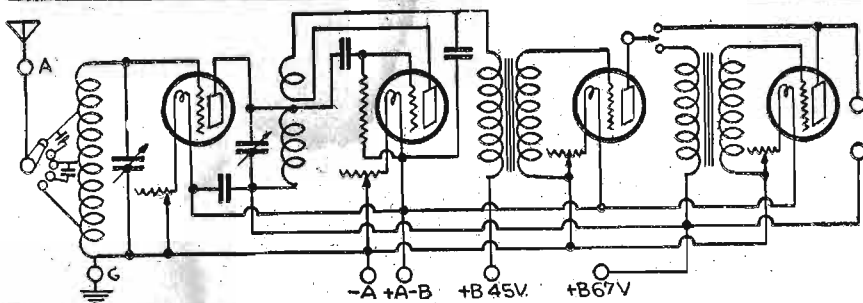

### Two Variometer Hook-Up

I am enclosing my favorite single tube set with which I have obtained exceptional results. It is very easily built and is easy to operate, there being only one tuning control. Using one tube with an aerial 90 feet long, including lead-in, and a WD-12 tube, I get Calgary, Alberta, Los Angeles, Havana, Hollywood and

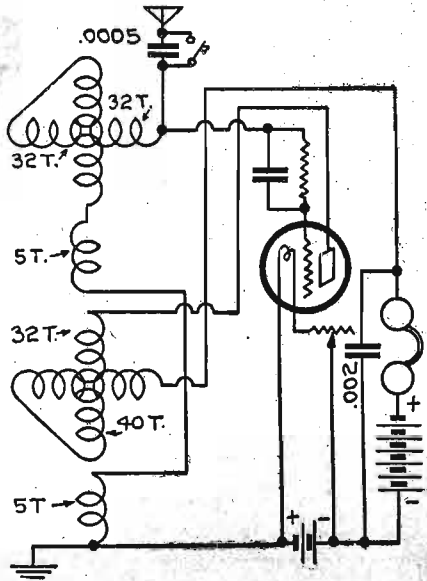

Portland, Ore. In one week 70 stations were logged.

Two variometers are wound on the same 4-inch cardboard tube. The rotors have a diameter of 3 inches. The stator of the aerial variometer consists of 32 turns of number 24 dcc. copper wire. This is then continued 5 turns on each side of the stator of the plate variometer. The plate variometer has a stator of 32 turns of number 24 dcc. wire and a rotor of 40 turns of the same wire on 3-inch tube.

The tuning rotor is 32 turns number 24 dcc. wire on the other 3-inch tube.

The switch in the aerial circuit is closed for long wave lengths and opened for short wave lengths. The .002 mfd. phone condenser is connected across the phones and B battery, which is 22½ volts. Be sure to connect the tuning rotor to the aerial and the rotor of the plate variometer to the phones.—Edward Fulmer, Greer, Ohio.

proven satisfactory, economical and convenient. Inserting phones in jack gives one stage for head phone work, removing plug the signal appears in loud speaker with two stages.—T. B. Taylor, Jacksonville, Fla.

### Hand "Anti-Skid" for Dial

On even the best dials the hand has a tendency to slip at times, and the necessity of gripping hard to prevent slip

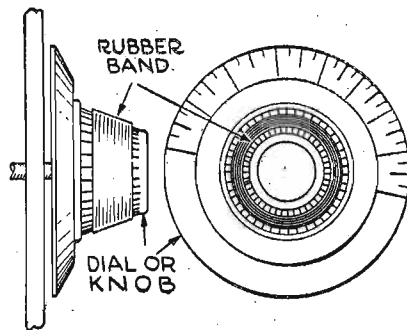

makes fine tuning difficult. Then too, there is hand capacity at certain adjustments of regeneration and wave length

### New Jack Circuit

The single jack arrangement shown in accompanying sketch of detector and two stage amplifier hook-up was due to the fact that only a single jack of the four-spring variety was available. This rig has

which seems to be effective through the Bakelite of which the dials are made. I therefore tried out the idea shown in the attached sketch which solved both of these difficulties very nicely. A large rubber band is all that is necessary.—Robert Harrington, Dayton, O.

## Combines best features of leading circuits

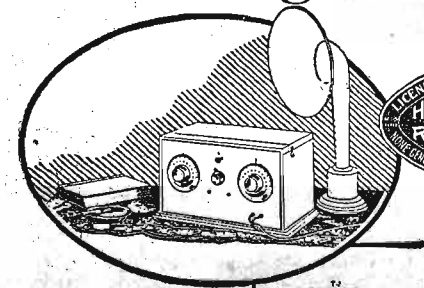

**PRICE, COMPLETE**  
**\$35**

**Unequaled Distance and Volume**

**Reflex Clarity!**

That's the Shamrock-Harkness Two Tube Reflex which has created such a sensation among experimenters and amateurs by its amazing performance. It combines the best features of the most powerful circuits in use today.

Also ask to see the improved **SHAMROCK-HARKNESS THREE-TUBE COUNTERFLEX**  
The wonder set **\$39.50**

**SHAMROCK MANUFACTURING CO.**  
Dept. 38C, Market St., Newark, N. J.

SHAMROCK

FOR SELECTIVE TUNING

*The set for the masses as well as the classes*

**SHAMROCK MFG. CO.,**  
Dept. 38C, Market St., Newark, N. J.

Please send me a copy of "Shamrock Radio Builder's Guide Book" containing diagrams and complete instructions for building 10 sets at prices ranging from \$15 to \$50. I enclose 10 cents (U. S. stamps or coin.)

Name.....  
Address.....

## Get a Good Radio Cabinet

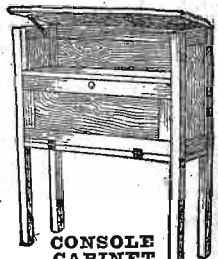

**CONSOLE CABINET No. 37**  
Set up complete packed in each in carton

Panel	Dep.	Batt. Comp.	In.	In.	In.	Price
7x18	9	10x11x18				\$10.50
7x24	9	10x11x24				11.50
7x26	9	10x11x26				11.50
7x28	9	10x11x28				11.50

Additional door makes shelf in front of panel when open, extra .....\$3.00

**No. 37 Two-Door Console**  
Panel Dep. Batt. Comp.

In.	In.	In.	Price
8x30	10½	10x11x30	\$17.50
8x38	10½	10x11x38	20.50
8x32	12	12x11x32	22.50

For Wet "B" Batteries



**Cabinet No. 29**  
Set Up Complete  
Battery Compartment 10"x11"x29" open back with shelf compartment for "B" Battery. Panel front to conceal batteries, over all measurements 11½"x32"x29".  
Set up complete in **\$7.50** carton.....



**Neat-Fit Cabinets**  
Made in all sizes from 7"x9" to 8"x40"  
Inches Price Inches Price  
7x18 .....\$2.40 7x24 ..... 2.60  
7x21 ..... 2.50 7x26 ..... 2.70  
All 7" deep.  
Shipped, knocked down, one each in a carton. All holes bored; screws, hinges and lid support furnished. Easily set up by driving ten screws.

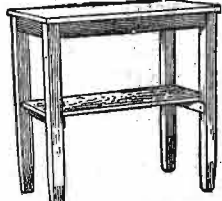

**Radio Table No. 31**  
With Shelf for Battery  
The Best Made, rigid, substantial table, 29" high, 15" wide by 31" long. Packed securely, one each **\$3.50** in a carton.....

## Expect Close Study by Engineers, Public Cooperation to Oust Noise

Rensselaer Polytechnic Institute Professor Tells of Experiments at WHAZ in Efforts to Down All Unnecessary Interference; Says Some Noise Will Always Be Present

TROY, N. Y.—Radio noises cannot be entirely eliminated except by sacrifices which the public would be unwilling to make, but through the close study of engineers of public utilities corporations and Radio broadcasting and the cooperation of the Radio audience, we have every reason to expect that unnecessary noises will rapidly disappear. This salient opinion was expressed by Prof. Wynant J. Williams, associate professor of electrical engineering at Rensselaer Polytechnic Institute, Troy, N. Y., and eminent communication engineer in whose department is the experimental broadcasting station WHAZ. Professor Williams was delivering a demonstration lecture at Hartford, Conn., under the auspices of the American Institute of Electrical Engineers, on "Causes of Interference in Radio Reception," which became a public address in the largest auditorium in the city through the insistent interest of Radio listeners in the problem of Radio noises and congestion of the air. Among other things he said:

### To Limit Noise

"If we wish to limit the amount of noise produced, we must limit the amount of electromagnetic disturbance in the broadcasting medium. The problem consists of maintaining a low power level compared with the power level of the transmitted programs. With regard to the upper power limit for broadcasting there is room for considerable difference of opinion. Our experience with station WHAZ at Troy, has convinced us that there is no necessity for these so-called superpower broadcasting stations. When we know that a 500-watt station can be consistently heard throughout the cool weather (about forty weeks a year for the last three years) all the way across this continent in one direction and in Europe in the other direction, we can hardly be criticized for taking the stand that a power level of approximately this value is sufficiently high to meet the needs of the Radio audience. When it is necessary to lift the power level of the country, when something of national importance is being broadcast, it can be done very satisfactorily by linking together by wire several broadcasting stations chosen on account of their location.

### Why So Noisy?

"Most people wonder why Radio should be so noisy. They forget that most of the applications that engineers have recently made of the findings of science to the solution of our everyday problems have produced considerable noise. For instance, most of us can remember in the early days of the automobile industry how noisy automobiles were. However,

automobile engineers soon found a method of reducing the noise below that point at which the public felt it objectionable. Typewriter designers have at last been able to produce machines which, for all practical purposes, can be considered noiseless.

### Differences in Noise

"Radio broadcasting is the latest child of the physical sciences, and like every other child, we should expect it to be noisy. We do not object to a baby being noisy, for we feel that it shows the child is healthy, and if given a fair chance will grow to be a useful man or woman. However, if the baby is making a noise because its nurse is not properly caring for it, common sense tells us that the thing to do is to change nurses and put the child in the hands of those who are capable of properly caring for it. Similarly with Radio, a number of the noises which we encounter in this field are perfectly natural and show a perfectly healthy development condition. There are, however, other noises which can be directly traced to those who are responsible for this new development. This, however, should give us no cause for worry, for as soon as the Radio public realizes the cause of these unnecessary noises it will unquestionably take steps to change nurses.

### Electromagnetics Cause

"After we have eliminated the unnecessary noises, we cannot expect to have a zero noise level, or, in other words, no noise at all. We must always bear in mind that wherever we have electrical energy there is a possibility of producing an electromagnetic disturbance in the medium used for broadcasting, which will produce noise in a receiving set.

"Noise is sound energy, and since it is possible to transform one form of energy into another it is possible to transform electrical energy into sound energy. In fact, this is the function of the Radio receiving set, so if we wish to limit the amount of noise produced we must limit the amount of electromagnetic disturbance in the broadcasting medium.

### Is Theoretically Simple

"From the technical point of view the interference problem is thus seen to be theoretically simple, whereas practically it is a very difficult one, owing principally to its size. The problem merely consists of maintaining the electromagnetic disturbance at such a low level, compared with the power level of the transmitted programs, that when both of these are transformed into sound energy the resulting noise level will be so relatively low that it will not be generally considered objectionable.

"To give some idea of the relative importance of Radio broadcasting, compared with other utilities which function through the use of electrical energy, and are therefore potential sources of disturbances, I wish you would picture in your imagination what civilization would be without these public utilities. If it were necessary to completely abolish these public services in order that Radio broadcasting might be enjoyed, would you be willing to go without the facilities placed at your disposal by the electric light and power company, the telephone and telegraph company, the railroads and the electric railways? No sane person would be willing to make the sacrifice, and yet at times Radio listeners become so irritated by the noises they receive through interference that they talk and act as if they would.

### No Transmitting Monopoly

"Now, as a matter of fact, all these public utilities, including broadcasting, which use the same medium have to find a way of supplying the public with the quality of service the public has a right to demand without materially interfering with one another. None of these utilities

can have a monopoly of this transmitting medium, and the amount of use allotted to each should be determined wholly upon the relative values to society of the service rendered. This is a problem for the social engineer and must be worked out before a complete solution of the interference problem can be made.

"When the public is educated to the point where it sees interference in its true light all of the unnecessary friction between those who experience interference and those who are unintentionally the cause will disappear. Under this condition the trouble, if it is a real one, can usually be located and corrected in a reasonably short time."

### Austria Claims Highest Set

VIENNA.—The Innsbruck branch of the "Freier Radio Bund," has set up in the Alpine club refuge on the Padaster Joch, in the Austrian Alps what is claimed to be the highest altitude receiving station in the world, though it may be topped by one or two of the French Alpine club stations which it is proposed to put up shortly. The height above sea-level is well over 8,000 feet.

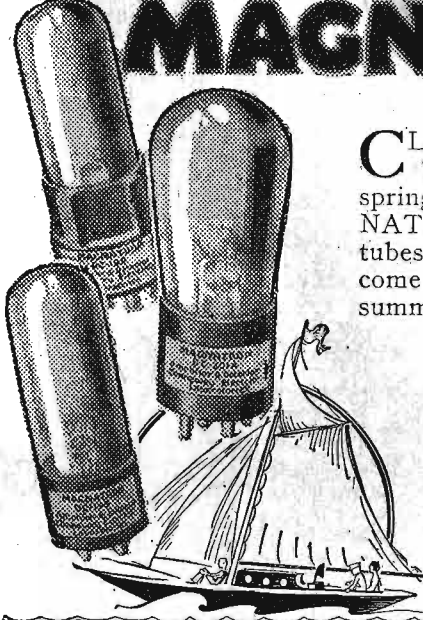

## MAGNATRONS

CLEAR sailing with MAGNATRONS! Summer or winter, spring or fall, you can bank on MAGNATRONS. The excellence of these tubes helps in a large measure to overcome the radio disadvantages of summer.

Good dealers everywhere sell MAGNATRONS in 3 types—the DC-201A and the 199 with large or miniature base. All types \$2.50.

CONNWEY ELECTRIC LABORATORIES  
Magnatron Building  
Hoboken, N. J.

## WALNART DIALOG

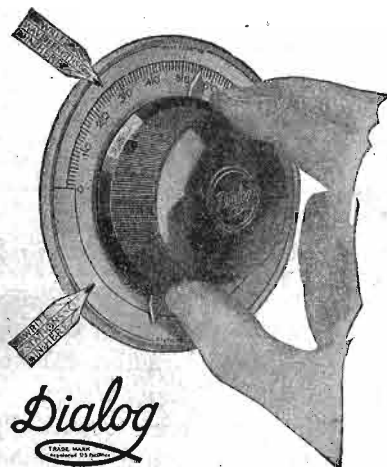

**\$1.25**  
SILVERED DIAL  
GENUINE BLACK  
BAKELITE KNOB  
In GOLD and  
MAHOGANY \$1.50

The only dial that fits  
every set without  
cutting or drilling!

DIALOG is a multiple-action dial on which the BIG knob moves many times FASTER than the pointer. The tiniest turn human fingers can make with the old-fashioned direct-action dial is enough to jump clear over a distant station, but DIALOG lets you turn SLOWER THAN YOUR OWN SENSE OF TOUCH, yet not so slowly that you are always WASTING TIME as you will with other slow-movement dials. The speed of the DIALOG is delicately and scientifically ADJUSTED by a newly patented process, to the exact requirements of modern Radio. It misses NOTHING yet it WASTES NO TIME . . . and you do not have to PAY for delicacy which you cannot USE effectively. DIALOG GETS THEM ALL—and costs only \$1.25!

ANYONE can attach DIALOG in less than one minute with no tools but a screwdriver and with only one screw to tighten. Can be mounted flush against the panel even with a single hole mounting condenser. Knob extends only 1 1/8 inch from panel when installed. May be used without logging disc if desired. DIALOG has no gears, cogs, springs, levers or cams—absolutely nothing to wear and no back lash—entirely NEW and positive principle of construction protected by patents pending. It will last longer than the set . . . longer than the OWNER of the set . . . indeed, it is practically INDESTRUCTIBLE. The BIG KNOB is of genuine Bakelite. The metal logging disc is erasable and removable. DIALOG insures delicate dialing and accurate logging for YOUR set!

WALNART ELECTRIC MFG. CO.

Green St. at Jackson Blvd.

CHICAGO, ILL.

# RADIO'S GREATEST

4th Annual National

## Radio Exposition

at Grand Central Palace

New York

September 12-19 inclusive

Over two miles of exhibits  
covering every phase and  
aspect of the radio industry

HAROLD BOLSTER, Director

J. C. JOHNSON, General Manager

Office, 522 Fifth Avenue, New York

# Questions and Answers

## Adjusting Super Parts

(14182) RJD, Hamilton, Ohio.  
I have a couple of little questions involving a super-het which I wish you would answer for me if possible. Incidentally, I wish to state that you publish the finest list of programs and the only accurate up-to-the-minute list of stations in this country.

In matching the intermediate frequency transformers of a super-het and using a wave meter, from which winding do you remove the wire if the wave length is too high, the primary or the secondary? In matching an input transformer to intermediate frequency transformers how would you go about it? Also, in case of an output transformer. In a super, if tubes are matched and transformers matched what would cause broad tuning?

A.—In matching intermediate frequency transformers and using wave meter a few turns should be removed from the secondary coils if any of them are found to be too high. In matching an input or output transformer to a set of intermediates you would put a variable condenser across the tuned circuit which would be either the primary or secondary or both and adjust for maximum response. When this setting has been determined the capacity at that setting can be found and a fixed setting at that capacity substituted. The tuned circuit of the filter transformer whether input or output should have the same wave length as the peak wave length of the intermediates. In a super, if tubes are matched and transformers are matched broad tuning could be caused by a filter circuit that was not sharp enough or by a poorly designed oscillator circuit or by an inefficient loop tuning circuit.

## Low Loss Coils in Neutrodyne

(14183) RNR, Knoxville, Iowa.  
This has reference to the low loss tuned radio frequency receiver as outlined in Radio Digest of April 25 this year. I have a three tube reflexed neutrodyne and have installed in this set the Rico straight line variable condensers, .0005 mfd. with 3 to 1 audio transformers. The neutrodyne forms are wound as follows: primary of 6 turns, secondary of 65 turns of number 26 dsc. wire. What I wish to know is, shall I use the same capacity of coil that Mr. Walters

## RULES TO FOLLOW WHEN ASKING QUESTIONS

The Question and Answer department offers service to Radio Digest readers without charge but asks that the following suggestions be read carefully before writing.

- 1—Search carefully the back issues which you have, as the point in question has probably been covered several times before.
- 2—Letters for this department should be kept separate from all correspondence to other departments and on other subjects.
- 3—Questions should be written on one side of paper only and each sheet should bear the sender's name and address. All letters should be accompanied by a self-addressed stamped envelope of standard business size.
- 4—Unsigned (or anonymous) letters cannot be answered, either on this page or by letter, nor can those without address.
- 5—No circuits of any standard manufactured receiver will be published.

6—No comparative statements on advertised apparatus will be given except as to efficiency in some particular circuit.

7—Drawing diagrams on a separate sheet of paper will save time and enable us to give all questions more attention.

8—Write each question as a separate paragraph.

9—Make a copy of your letter and diagrams, to which we can refer without re-drawing.

10—The names and addresses of the writers of letters published will not be released except with the writer's permission.

11—We want to be of assistance to you in your difficulties, but are sometimes limited because of the length and time required for the proper consideration of the questions asked. Therefore, please make your letters brief.

has used in his receiver, such as the same size wire, same number of turns in primary and secondary? As I have only a three tube reflexed set I thought perhaps there would be some difference in data on coils.

A.—We wish to advise that if your condensers are full .0005 mfd. the coils to be installed in your receiver should be exactly as described by Mr. Walters. The fact that the set is reflexed does not make any difference in these constants. Since you are going to eliminate some losses which tend to stabilize your reflex you may have some slight trouble through howls and squeals when you first put the rebuilt set into operation. However, if you put bypass condensers from the B

plus end of each transformer to the plus filament circuit, much of the tendency to howl will be eliminated. A little adjusting on the angles of the coils would also be desirable and a vertical shield six inches high and the depth of the cabinet between stages will prevent much inter-stage coupling.

## Oscillator and Autodyne

(14178) ALN, Pueblo, Colo.  
I am going to build the super-heterodyne described in the Radio Digest of June 27 and July 4, except that it will be installed in a cabinet and panel mounted.

I wish to know if I may expect full results in this circuit by using Haynes-Griffin late type filter and intermediate transformers. I wish to wind the oscillator on a 3/8-inch stator and a 2 1/4-inch rotor. Please advise windings on same. Is any heterodyne described in the back numbers of the Digest using the autodyne coil. I do not remember seeing anything covering this principle.

A.—If you are going to use Haynes-Griffin filter and intermediate transformers the writer would strongly advise the purchase of one of their oscillator couplers and the use of their wiring diagram. It is not a good policy to wind ones own oscillator for any make of filter unless one is extremely familiar with all of the data on that filter, chiefly the wave length it is supposed to pass best. We have not

(Continued on page 30)



# EARN

\$50. to \$250. A WEEK

## Be a RADIO Expert

Learn Quickly at Home  
Get into the great new Big-Pay Industry—Radio. If you're earning a penny less than \$20 a week, clip coupon now. SEND FOR AMAZING FREE BOOK. Be a Radio Expert, and draw down big money for easiest and most fascinating work in the world. Positions everywhere. Every community needs its Radio experts. Short hours. BIG PAY. Free book gives all the facts. GET IT NOW—CLIP COUPON. Master Radio Engineers will show you the way to qualify for the fine jobs waiting in Radio. You can do it quickly and easily at home.

Thousands of Jobs Now Waiting  
Get a fine position like Fetzer did quick with N. R. I. training behind him. Fetzer (Picture above) is a successful, big class man—Chief Operator of WEMC, the "Radio Lighthouse." Every day N. R. I. men are taking good places in the Radio field. Thousands of openings await the trained man. Our Free Employment Department helps you get a position. Many other big features. Free Book tells you all about them. No previous experience or education needed. New method makes it easy for you to learn. This course takes you from beginning to end—backed by a guarantee to train you successfully by our tested methods. Stay home, hold your job and prepare for big pay in your Spare Time. Receiving Sets and Instruments.

for learning included in course if you act at once. Many other special features for limited time only. You Get These  
Get This FREE Book! "Rich Rewards in Radio." Read for yourself the unequalled opportunities to cash in big as a Radio EXPERT, a trained man in the World's Fastest Moving Industry. Act NOW. SEND COUPON TODAY. No obligation. You get these receiving sets, from simplest kind to thousand mile receiver, given to you without cost with your course. An UNEQUALLED OFFER. Write quick. Clip coupon now for Special Offer, including Receiving Sets.

National Radio Institute  
Dept. 55KB, Washington, D. C.

**NATIONAL RADIO INSTITUTE**  
Dept. 55KB, Washington, D. C.  
Without obligating me in any way, please send me your free book, "Rich Rewards in Radio." Also complete information on your practical home-study Radio course, with all instruments and short time Special Offer.  
Name .....  
Address .....  
Town ..... State.....

## What becomes of the bass notes in your set?

While the better transformers amplify quite evenly over the entire upper and middle registers of the musical scale, from about 60 cycles downward there is a pronounced loss of amplification, as indicated above. Poorer transformers begin to drop off in amplification even higher on the scale with the result that lowest notes disappear entirely.

There is no variation in amplification over the entire range of musical frequencies with Thordarson Autoformers. No note is too low—no note is too high to be fully amplified by the Autoformer. In addition there are three other advantages.

## THORDARSON Autoformer

Trade-Mark Registered

### All Frequency Amplifier

FULL amplification of those bass notes hitherto largely "lost!" Greater clarity on all signals! Improved reception of distant programs! Better volume control! Those are the four advantages achieved by this latest Thordarson development—the Autoformer. Autoformer amplification is for those who seek the finest reproduction of programs to be had. It may be used with any set in place of the regular audio transformer hook-up. Full directions, with diagrams, for building a Thordarson Autoformer Amplifier are supplied with each instrument. Or

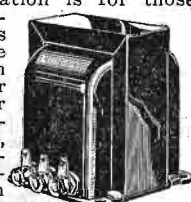

Write for the Autoformer Hook-up Bulletin—Just Out!  
THORDARSON ELECTRIC MANUFACTURING CO.  
WORLD'S OLDEST AND LARGEST EXCLUSIVE TRANSFORMER MAKERS  
Chicago, U.S.A.

## Booth 91 Grand Central Palace

## Lincoln Collapsible Loop Aerials

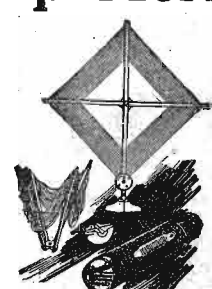

### and Low-Loss Condensers

- Lincoln 4-point Tapped Loop, \$8.00  
Built for any circuit where it is desired to vary the inductance of the loop. Exceptionally fine for Superheterodynes.
  - Lincoln Center-Tapped Loop, \$6.50  
For any set employing radio frequency amplification. For certain Superheterodynes requiring a center tap.
- Condenser Specifications**
- Number of plates.....23
  - Maximum capacity mfd.....0005
  - Minimum capacity mfd.....000011
  - Series Resistance at 600 k.c. (500 meters).....0.75 ohm
  - Height—rotor out.....3 1/4 inches
  - Width.....4 1/2 inches
  - Depth—panel to end.....3 3/4 inches
  - Shaft diameter.....1/4 inch
  - Insulating material.....High-grade rubber plates.....Dur-Aluminum

New York Office  
128 W. 42nd St.  
Ralph Bretzner, Manager  
Manufactured by  
**Lincoln Radio Corporation**  
224 N. Wells St. Chicago

**Finer Selectivity**  
Equip your receiving set with Apex Vernier Dials. They will greatly increase the efficiency of any set. Make tuning positive—bring in distant stations. Your dealer has them. If not, send \$2.00 for Royal Brass Finish—\$2.50 for Satin Silver Finish, or \$3.50 for DeLuxe Gold Plated (24k).  
**APEX SUPER 5**  
This highly efficient tuned radio frequency receiver is most advanced in design and construction. An instrument that meets every critical expectation of the radio enthusiast. Housed in a highly finished walnut cabinet, complete with Jones Multi-Plug Battery Cable. All settings highly gold plated. Sells for \$95 complete excepting accessories.  
At All Good Dealers  
**APEX ELEC. MFG. CO.**  
1410 W. 59th St. Chicago  
Dept. 805B

QUESTIONS & ANSWERS

(Continued from page 29)

published any super circuits in which an autodyne coil is used since reports from our readers would indicate that the use of such a coil does not favor selectivity. That is the only fault of the \* \* \* \* \* super featured by \* \* \* \* \* and users have found it very good in every other way except as to selectivity.

Regeneration on High Wave Lengths (14185) EHW, North Troy, N. Y.

My set is homemade using two tubes, Ambassador coil and their hook-up, Acme .0005 mfd. condenser and Acme transformer; everything the best I could buy. Aerial and lead-in total 80 feet, ground 17 feet, both well insulated. Wave lengths from 230 to 380 meters come in loud and distinct but any wave length above 380 is so faint I cannot hear signals or call letters at all. Could you advise me what is cure for this trouble.

A.—It looks to us as though you did not have enough plate voltage on your detector tube. As the writer recalls it, the Ambassador circuit shows 22 volts on the detector plate, but if you are using a 199 tube this should be increased to 45 or even 67 volts. There should be a by-pass condenser of .002 mfd. connected from the P binding post on the audio transformer to the plus filament binding post on the tube socket. The audio amplifier should have 90 volts of B battery on the plate with a C battery of 4 1/2 volts between the F terminal of the transformer and the negative A circuit on the input side of the rheostat.

Tuned R. F. Is Popular

(14065) GB, Campbellstown, Ohio.

Could you tell me the main circuits employed in the sets now on the market? A.—The circuit employed in the majority of sets on the market at this time is known as the tuned radio frequency and in all cases it is practically the same as the circuit used in either the Freshman or the Marv-O-Dyne, which were shown in recent operating and trouble shooting articles in Radio Digest.

Parker Quick Hook Up Post FOR RADIO

(Patent Pending) For Set Builders and Experimenters No soldering lugs. Plug in your hook up wire and leads. Insures positive contact. Sample 25c One dozen \$2.50 C. E. PARKER Shidler, Oklahoma



RADIO Storage "B" Battery

32 Cells 24 Volts Lasts Indefinitely—Pays for Itself Economy and performance unheard of before. Recharged at a negligible cost. Approved and listed as Standard by leading Radio Authorities, including Pop. Radio Laboratories, Pop. Sci. Inst., Standards, Radio News Lab., Letax, Inc. and other important institutions. Equipped with Solid Rubber Case, an insurance against acid and leakage. Extra heavy glass jars. Heavy, fuzed plates. Order yours today!

SEND NO MONEY Just state number of batteries wanted and we will ship day order received. Extra Offer: 4 batteries (insulates 24 volts), \$12.75. Pay expression after examining batteries. 5 per cent discount for cash with order. Mail your order now!

WORLD BATTERY COMPANY 1219 So. Wabash Ave., Dept. 78 Chicago, Ill. Makers of the Famous World Radio "A" Storage Battery Prices: 6-cells, 100 Amp. \$11.25; 120 Amp. \$13.25; 140 Amp. \$14.00. All equipped with Solid Rubber Case.

World STORAGE BATTERIES

Set your Radio Dials at 230 meters for the new 1900 watt World Storage Battery Station, W5BC, Chicago. Watch for announcements.

ask "are they genuine Radiotrons?"



The second most used circuit is the neutrodyne employed by such manufacturers as are licensed by the Hazeltine corporation, while the third most popular circuit is the reflex. The super-heterodyne would be employed by many more manufacturers if its use were not controlled by patents held by the Westinghouse Electric and Manufacturing company.

Radio Fair Exhibits Need World's Largest Hall Now

NEW YORK.—Radio annihilates space in spreading messages of cheer throughout the world. Who knows but that the Hertzian waves are sweeping on to the very stars.

And now Radio, as America's greatest infant industry, is annihilating space in another way.

The largest hall in the world has been engaged for the Second Radio World's fair, to be held the week of September 14 to 19. It is the 258th Field Artillery Armory, Kingsbridge Road and Jerome avenue. The auditorium is five times as large as Madison Square garden, now being torn down to be replaced by an immense skyscraper office building.

Radio for French Airdromes

PARIS.—Only airdrome, near Paris, has been fitted with Radio installation, and this will be extended gradually to all French airdromes. The purpose is to keep airplanes informed of meteorological bulletins and any information that may be of use to the flyers.

Men to build radio sets in spare time. Leon Lambert, Wichita, Kansas.

PATENT ATTORNEYS

PATENTS. Booklet free. Highest references. Best results. WATSON E. COLEMAN, Patent Lawyer, 644 G Street, Washington, D. C.

Radio Tubes Exchanged

Send us your old tube—any make—any condition—and we will send you our Brand New Guaranteed Tube of whatever type you require (except WD-11) for \$1.75. All shipments by insured Parcel Post C. O. D. Send no money—order today... \$1.75 C.O.D. DAVENPORT RADIO CO. 327 S. LaSalle St. Chicago, Ill.

The CRYSTECTOR Increases Clearness and Purity of Tone. Fits in standard socket in place of detector tube in Neutrodyne and R.F. sets. No change in wiring. Price \$4.00. Money Back Guarantee. Write for descriptive circular. American Radio Sales Co., Not Inc. 3982 Barry Ave. Chicago, Ill.

NO MORE AERIAL GRIEF! The Keystone Gives You 85 Feet in Any Room in the House. Distance, clearness, selectivity! Now all these can be yours without an elaborate and expensive outside aerial. The Keystone Indoor Aerial contains 85 feet of brass wire and yet, because of the way it's made, can be strung in a 15-foot room in less than five minutes time. Costs only \$1.00. Packed in neat carton, sent anywhere upon receipt of price. Dealers and jobbers write for proposition. FERNALD MFG. CO. North East, Pa.

Wisconsin "Hams" to Give Tourist Service

Madison A. R. R. L. Chapter to Forward Visitors' Messages

MADISON, Wis.—Are you touring to strange and distant cities? Would you like to get in touch with friends in your home town, or let them know your whereabouts quickly?

Then just drop your message into one of a group of boxes in your city park and it will be collected by carrier and "Radioed" back home, perhaps for many hundred miles.

RADIO (WICK) SOLDERING IRON (COMPLETE WITH 6 FOOT CORD) WORKS ON D.C. OR A.C. HANDY FOR ALL SOLDERING WORK NO TOY - WILL DO THE WORK OF HIGH PRICED IRON! GUARANTEED ONE YEAR. SEND FOR RADIO CATALOG WITH LATEST HOOK-UPS VAN-ASHE RADIO CO. 927 Pine St. ST. LOUIS, MO. 95c PREPAID

ALL AMERICAN RADIO OWNERS should register for mutual benefits in The American Blue Book WHO IS WHO IN RADIO (Copyright) now being compiled for early publication. Write at once for registration blank. The International Press Association Vanderbilt Building, New York

PePtron A finely balanced tube that will give you astonishing range and natural tone, without the usual tube noises. SOLD DIRECT ONLY TO USER Type P-201-A, 5 volt, .25 ampere Type P-199, 3-4 volt, .06 ampere Both types \$1.55 each Shipped C. O. D. or Parcel Post prepaid if remittance accompanies order. Our guarantee of satisfactory reception or money refunded, accompanies each tube. PEPTRON PRODUCTS CO., YORK, PENNA.

ELIMINATE STATIC! ENJOY winter reception all summer! The Static Eliminator—the newest and most startling thing in Radio—cuts out practically all static without loss of volume! And in addition it will help increase selectivity, tune out local stations, sharpen signals, remove noises, lessen interference and prevent re-radiation! Use it with any receiving set—simply hook up to your aerial lead-in and enjoy perfect reception unmarred by static. Satisfaction guaranteed. Money refunded at once, if returned within 5 days. \$1.00 Postpaid

ANNOUNCING THE NEW BIRNBACH Low-Loss Tuner For distance, volume and selectivity. Price of tuner only \$2.50 Price of complete parts for a single tube receiver, containing a Birnbach Tuner... \$7.50 Information and free hook-up diagrams at all stores of W. T. GRANT COMPANY S. S. KRESGE COMPANY There's a store in your city. If not, write us direct. BIRNBACH RADIO CO. 370 Seventh Ave. New York, N. Y.

Such a project is now being carried out by the Madison, Wis., branch of the American Radio Relay League. Members of this chapter, eager to be at the forefront of developments in Radio, are instituting in Madison a Radio service for tourists, enabling travelers to send messages free of charge to friends and relatives back home.

The Burgess Battery company here will handle these messages over its stations, 9XH and 9EK, in order to advertise the city of Madison to the world.

Where you see these signs in circuits—use Potter Condensers BY-PASS At your dealer's Potter Manufacturing Co., North Chicago, Ill.

22 1/2 VOLT \$2.95 It's OUT—Complete everlasting ready to run non-acid, non-sulphating 22 1/2-volt rechargeable "B" storage battery, \$2.95. Includes chemical. Does not lose its charge standing idle. Special 2-22 1/2 volt (45 volts) \$5.25; 30 volts \$10.00; 11 1/2 volt \$12.50; 135 volts \$14.75; 157 1/2 volt \$16.80. Nearly 3 years sold on a non-red tape, 30-day trial offer, with complete refund if not thoroughly satisfied. Further guaranteed 2 years. Knock-down kits at still greater savings. Complete ready to run "B" battery charger \$2.75. Sample cell 35c. Order direct—send no money—simply pay expressman its cost on delivery, or write for my free literature, testimonials and guarantee. Same day shipments. My large 36-page radio goods catalogue 10c. B. D. Smith, 31 Washington Ave., Danbury, Conn.

MUTER Dependable Products Fixed Condensers Fixed Grid Leaks Automatic Phone Plugs Resistance Units Fixed Rheostats Lightning Arresters Panel Switches Throw Switches Mountings Ground Clamps Lead-In Insulators Complete Aerial Kits Resistance Amplifiers Audio Transformers A Complete Quality Line Endorsed and Used by 55 Leading Set Builders Sold by Leading Dealers Mfd by LESLIE F. MUTER COMPANY Chicago, Illinois

ANNOUNCING THE NEW BIRNBACH Low-Loss Tuner For distance, volume and selectivity. Price of tuner only \$2.50 Price of complete parts for a single tube receiver, containing a Birnbach Tuner... \$7.50 Information and free hook-up diagrams at all stores of W. T. GRANT COMPANY S. S. KRESGE COMPANY There's a store in your city. If not, write us direct. BIRNBACH RADIO CO. 370 Seventh Ave. New York, N. Y.

The TOWN CRIER Radio's Most Beautiful Speaker WRITE today for illustrated description in colors of this beautiful instrument—"The Speaker with the Voice that Thrills." You will be delighted with the artistic stippled finish and the gorgeous colors of the Town Crier models in Green and Golden Polychrome. Ask your Dealer to show you a Town Crier—you will recognize its surpassing excellence instantly. PRICE \$17.50 West of the Rockies \$18.50 GALE RADIO LABS. 2513 Irving Park Blvd. CHICAGO

Radiophone Broadcasting Stations

Corrected Every Week—Part I

United States

AQ6, Canton, O. 425 meters. Hdqts. 135th Field Artillery O. N. G.

FANS 231 meters. 50 watts. University of Washington.

WAVE 237.7 meters. 750 watts. Boise H. Taylor Slogan.

WAVE 237.7 meters. 750 watts. Boise H. Taylor Slogan.

WAVE 237.7 meters. 750 watts. Boise H. Taylor Slogan.

WAVE 237.7 meters. 750 watts. Boise H. Taylor Slogan.

WAVE 237.7 meters. 750 watts. Boise H. Taylor Slogan.

WAVE 237.7 meters. 750 watts. Boise H. Taylor Slogan.

WAVE 237.7 meters. 750 watts. Boise H. Taylor Slogan.

KFIU, Juneau, Alaska. 226 meters. 10 watts. Alaska Light & Power Co. Announcer, O. E. Sboenell.

KFKJ, Portland, Ore. 263 meters. 50 watts. Ashley C. Discant & Son, Ark.

KFKJ, Portland, Ore. 263 meters. 50 watts. Ashley C. Discant & Son, Ark.

KFKJ, Portland, Ore. 263 meters. 50 watts. Ashley C. Discant & Son, Ark.

KFKJ, Portland, Ore. 263 meters. 50 watts. Ashley C. Discant & Son, Ark.

KFKJ, Portland, Ore. 263 meters. 50 watts. Ashley C. Discant & Son, Ark.

KFKJ, Portland, Ore. 263 meters. 50 watts. Ashley C. Discant & Son, Ark.

KFKJ, Portland, Ore. 263 meters. 50 watts. Ashley C. Discant & Son, Ark.

KFOX, Omaha, Neb. 248 meters. 100 watts. Board of Education. Technical High. Announcer, Juno Johnson.

KFPA, Denver, Colo. 234 meters. 50 watts. Fitzsimons General Hospital.

KFPA, Denver, Colo. 234 meters. 50 watts. Fitzsimons General Hospital.

KFPA, Denver, Colo. 234 meters. 50 watts. Fitzsimons General Hospital.

KFPA, Denver, Colo. 234 meters. 50 watts. Fitzsimons General Hospital.

KFPA, Denver, Colo. 234 meters. 50 watts. Fitzsimons General Hospital.

KFPA, Denver, Colo. 234 meters. 50 watts. Fitzsimons General Hospital.

KFPA, Denver, Colo. 234 meters. 50 watts. Fitzsimons General Hospital.

KFUD, Salt Lake City, Utah. 261 meters. 100 watts. University of Utah.

KFUD, Salt Lake City, Utah. 261 meters. 100 watts. University of Utah.

KFUD, Salt Lake City, Utah. 261 meters. 100 watts. University of Utah.

KFUD, Salt Lake City, Utah. 261 meters. 100 watts. University of Utah.

KFUD, Salt Lake City, Utah. 261 meters. 100 watts. University of Utah.

KFUD, Salt Lake City, Utah. 261 meters. 100 watts. University of Utah.

KFUD, Salt Lake City, Utah. 261 meters. 100 watts. University of Utah.

KFUD, Salt Lake City, Utah. 261 meters. 100 watts. University of Utah.

CHALLENGE!

ONE DOLLAR will be paid to the Radiophon submitting the most errors in any one station's listing...

That's just how sure Radio Digest is that this Radiophone station directory is correct!

sometimes the stations are careless and mistakes are made. But Radio Digest is so sure of the exactness of this directory...

With reference to the directory: It appears in five parts, serially continuous...

Five successive issues of Radio Digest will give one the most complete and accurate list of Radiocast stations obtainable.

KFKU, Lawrence, Kan. 275 meters. 500 watts. University of Kansas.

KFKB, Fort Worth, Tex. 263 meters. 200 watts. The Searchlight Pub. Co.

KFKW, Los Angeles, Calif. 238 meters. 100 watts. Garretton and Goodan.

# Tower

The Greatest Values in Radio History

THE Tower Meistersinger Loud Speaker represents the heart's desire of every radio enthusiast who is satisfied with nothing less than the best. Equipped with the famous Tower adjustable unit, the wonderful tone quality is amplified to the maximum degree without distortion through the full throated goose neck and scientifically proportioned bell. An object of beauty, the Tower Meistersinger, with soft tone golden lacquer base and dark mahogany finish bell, is the outstanding value in radio today.

non-acid, age hat- its charge \$5.25; 90 olts \$14.75; a non-red refund if not years. Knock- its ready to run \$1.35. Order sman its cost testimonials charge 36-page 31 Washing-



\$15<sup>00</sup>

The Meistersinger Speaker

(The Greatest Singer)

On sale at all good Radio Dealers

\$3.95

TOWER SCIENTIFIC PHONOGRAPH ATTACHMENT

\$4.95

LITTLE SPITFIRE LOUD SPEAKER

\$2.95

TOWER SCIENTIFIC HEAD-SET

\$8.50

TOWER SCIENTIFIC LOUD SPEAKER

THE TOWER MFG. CORPORATION  
98 BROOKLINE AVE  
BOSTON MASS

WORLD'S GREATEST LOUDSPEAKER VALUES