

New Selective \$8 Crystal Set; Operating the Simplest Possible Super-Het; Low Loss Coil Mounting; Short Wave Regenerative Outfit; The Story of WIP

Radio Digest

EVERY WEEK

Illustrated PROGRAMS

TEN CENTS

REG. U. S. PAT. OFF. & DOM. OF CANADA

Vol. XI

Copyright 1924
By Radio Digest Publishing Co.

SATURDAY, NOVEMBER 29, 1924

No. 8

SAYS ENGLAND LEADS U.S.

BUREAU TELLS FANS HOW TO CHANGE SET

EASY TO MEET NEW WAVE LENGTH ALLOCATIONS

Single Circuit Receiver Easily Remedied
—Other Circuits Can Be Improved with Care

WASHINGTON, D. C.—During the recent Radio conference it was recommended that the broadcast range of wave lengths be extended to include 200 meters.

Some receivers now in use cannot conveniently be tuned below 300 or 250 meters. Dealing with this question a recent bureau of standards statement contained valuable information.

The range of single circuit receivers, that is, where the aerial is part of the tuned circuit, may be extended to the lower wave lengths without much difficulty. This applies to both tube and crystal sets. It can be accomplished by putting a fixed condenser in series with the aerial.

Shortening the aerial likewise reduces the wave length to which the set tunes.

In the two circuit and other more complicated sets, lowering the wave length range may not be so easy.

To increase the range of wave length to which any set will tune, reduce the number of turns in the coils or else decrease number of condenser plates.



BRITON CHIEF ASSAILS OUR BROADCASTS

Calls Programs Inferior

Capt. P. P. Eckersley Criticises American Radiophans — Says Only Few Stations Count

By A. C. Blackall
LONDON.—“America cannot teach us anything.”

So said Captain P. P. Eckersley, chief engineer of the British Broadcasting company, immediately after his arrival home from the third Radio conference at Washington.

“The fact is,” he said, “that America is working on entirely different lines to us. There the public is being catered for from the viewpoint of making Radio broadcasting an electrical hobby, and not an artistic enjoyment. The man in America who considers he is getting the best service is the man who finds he can listen

(Continued on page 2)



Above is the famous, handsome “Red Head Girl,” the lady of mystery at WFAA, Dallas News and Journal. Despite her beauty she steadfastly refuses to divulge her identity. Left is Betty Marlatt, “Betty” of “The Prince of Mah Jongg,” heard recently from CNRT (CFCA), Toronto Star. Right is “Miss Kitty” Nelson, WMC, Commercial Appeal, secretary and assistant program director, who announces and accompanies.

UNIQUE IDEAS FROM KSAC NEWLY ON AIR

DECEMBER FIRST IS NIGHT SET FOR DEDICATION

Kansas State Agricultural College Makes Ether Debut with Original Scheme for Service

MANHATTAN, Kans.—Meet the new Radio debutante, KSAC. She's well worth knowing. Nothing backward about the newcomer, either. Reserve a chapter for her right now in that history of the "Radio Era." She has blazed "air paths" with no precedent except in dreams.

Dedication services December 1 for Station KSAC, Kansas State Agricultural college, Manhattan, Kansas, marks a new epoch in educational achievements. The first institution to harness Radio for the specific purpose of disseminating a systematic course of college instruction, now announces other innovations of history making significance in the new era of Radio.

When the new powerful transmitter starts hurling the gospel of better farming and better living through the ether next month, it will introduce a program without precedent for service and uniqueness of presentation.

Farm Extension Plans

The daily noon-day question box is the first novelty. Ten of the thirty minutes will be used for answering pertinent questions put by farmers. Ten minutes will be utilized for two concise talks on timely matters of paramount interest to the great rural audience.

Another idea that must be chalked up to the progressiveness of the "Ag" school of "College of the Air" fame is the statewide Radio meetings of various organizations fostered by the extension service.

In like manner, 10,000 members of boys' and girls' clubs in Kansas join hands from the distance to listen to inspiring songs and instructive talks on Radio meeting nights. Various other auxiliary organizations of the college, such as livestock shipping associations, farm account clubs, federated women's clubs and marketing organizations are scheduled for programs of particular interest.

Will Furnish School Programs

"Why not substitute a baby grand for the tuning fork in those countless little red schoolhouses?" asks H. Umberger, director of extension.

Then, in the high school. Vocational teachers are scurrying about, financing the purchase of the best receivers. Already a dozen of the larger schools are equipped.

But come back to the dedication service. Listen to this prodigy in action December 1. On the brow of College Hill, the very heart of America, just twelve miles from the geographical center of the United States to be exact, stand the lofty twin towers. The studio and control room is a bee-hive of activity.

The dedication service will last from 7:30 to 12:00 p. m. Central time. The college orchestra, band, male quartet, and glee clubs will furnish numbers to intersperse speeches and entertainment numbers contributed by the public speaking department.

ENGLAND LEADS U. S.?

(Continued from page 1)

to the most distant stations. Thousands of sets are produced with intense sensitivity.

American Wants Distance

"The standard set that you find in anybody's house will have six tubes and the owner will seldom listen to his local station unless there is something specially interesting. Such a man in New York is much more interested in searching round the continent, to Cuba, Los Angeles, Pittsburgh, or anywhere else that has, what is to him, the advantage of distance.

"There are certain misconceptions in England as to Radio activity in the United States. You often hear stories of the 537 stations in America. It is perfectly true that there is that number, but only about 60 of them can really be classed as stations. The rest are ten-watt contrivances in a village, or perhaps a hundred watts somewhere else working for perhaps only two hours a week.

"There are so many stations that they have to divide the time between them. I do not think that their programs are as good as ours, and their most expensive programs do not cost anything like what ours do.

Blasts Toll Broadcasts

"One favorite device which has been resorted to because of the lack of ordinary revenue is 'Selling Time.' Under this firms that desire to advertise will make arrangements for a publicity service by Radio. They will engage a trio or a singer, and by way of introduction the name of the firm will be announced as responsible for the item that is to follow."

To the American reader this data may

FATHER KNICKERBOCKER'S STARS



Jimmy Clark, left, and "Roxy" S. L. Rothafel, right, winners of a Radio favorite contest recently conducted by a New York daily newspaper. "NTG" won first place.

N. T. GRANLUND, WHN's famous announcer, "Roxy" S. L. Rothafel, manager of New York's Capitol theater and announcer for its weekly Sunday night program over WJAF, and Jimmy Clark, widely known for his own and his White Way Entertainers' broadcasting from every New York station, were winners, first to third respectively, in a recent local Radio favorite contest conducted by a New York daily newspaper. "NTG," as Granlund is known to listeners, refused to pose for the camera man.

Municipal Programs at WCCO

MINNEAPOLIS, Minn.—Municipal programs provided by towns throughout the Northwest are included in the program of the Gold Medal Station, Saint Paul—Minneapolis, WCCO, for the coming months. This is one of the ways in which the station is carrying out its slogan of "Service to the Northwest," by providing broadcasting facilities for smaller towns which cannot support stations.

be well known, but Captain Eckersley's statements are regarded with amazement in Great Britain, where the whole organization of Radio is run on totally different lines.

With regard to future possibilities, Captain Eckersley expressed himself now as exceedingly pessimistic so far as long distance reception is concerned. Prior to his visit to America he was confident that the difficulties in the way of relaying American broadcasting in England this winter would be successfully overcome.

His visit, however, has entirely altered his opinion.

CONTENTS

Radio Digest, Illustrated, Volume XI, Number 8, published Chicago, Illinois, November 29, 1924. Published weekly by Radio Digest Publishing Company, 510 N. Dearborn Street, Chicago, Illinois. Subscription rates, yearly, Five Dollars; Foreign Postage One Dollar additional; single copies Ten Cents. Entered as second-class matter at the postoffice at Chicago, Illinois, under the Act of March 3, 1879.

All the Live News of Radio.....	1 to 8
Station WIP—"Watch It's Progress".....	5
An Eight Dollar Crystal Set with Selectivity, Part I—Clear Tones and Short Range, by Victor Andre Mattison, A. I. A.....	9
Advance Programs for the Week at the Larger Stations.....	11 to 14
"Low Loss," What It Is and Why, by Jacques Fournier.....	15
Editorial; Indi-Gest; Condensed by Dielectric.....	16
How to Build the Simplest Possible Super-Het, Part III—Testing and Operating Set, by John G. Ryan.....	17
Helpful Hints to Get the Most from Radio, Chapter XI—Care of Radio Batteries, by Thomas W. Benson.....	19
How to Make a Short Wave Receiving Set, by Kenneth G. Alley.....	21
Questions and Answers.....	22
Radiophone Broadcasting Stations, Part II.....	23

Looking Ahead

Such a Tremendous Hit Has Been the "Simplest Possible Super-Het" that John G. Ryan is planning to devote his article next week to questions and answers enthusiastic fans have been sending in by telegram and special delivery mail. Want range, selectivity and good, clear cut music? Better build the set. A booklet, telling how to build this super-heterodyne and illustrated with full size baseboard and panel layouts, is being prepared and should be ready for distribution by December 10.

The \$8 Selective Crystal Set will be finished with the next article by V. A. Mattison. He will show how to mount the various parts on a panel and give further important directions for the construction of this cheap but efficient receiver.

Low Loss Condensers, How to Tell Them, is the next topic of Jacques Fournier in his series of articles on the subject of "Low Loss." He is also planning to go further and describe a simple, low loss receiving set. This, however, will not appear next week. The receiver must first respond satisfactorily to every test given it in the Radio Digest laboratory.

Two Variometers, One of Them of the Split Type, are the only tuning requisites for the sensitive single tube set Winston Kock will describe next issue on the "Kinks" page. A small investment and a few hours of time will give you a receiving set that will bring in many long distance stations, if you follow Mr. Kock's hook-up.

Telephones and Loud Speakers will be discussed by Thomas Benson in his next article. Important as these are to good quality reception, Mr. Benson's contribution should be of much interest.

Newsstands Don't Always Have One Left

WHEN YOU WANT

Radio Digest

YOU WANT IT!

BE SURE OF YOUR WEEKLY COPY BY SUBSCRIBING NOW

SEND IN THE BLANK TODAY

Publisher Radio Digest, 510 N. Dearborn St., Chicago, Illinois.

Please find enclosed check M. O. for Five Dollars (Six, Foreign) for One Year's Subscription to Radio Digest, Illustrated.

Name

Address

City.....State

Fultone

Trade Mark

The Ford of Loud Speakers

Fultone has been thoroughly tested on regenerative, reflex, tuned radio frequency and super-heterodyne receivers and has proven its ability to handle both faint programs from distant stations and the roaring volume of the locals. This it does without distortion, without blasting and with a pleasing absence of tinny or other metallic noises.

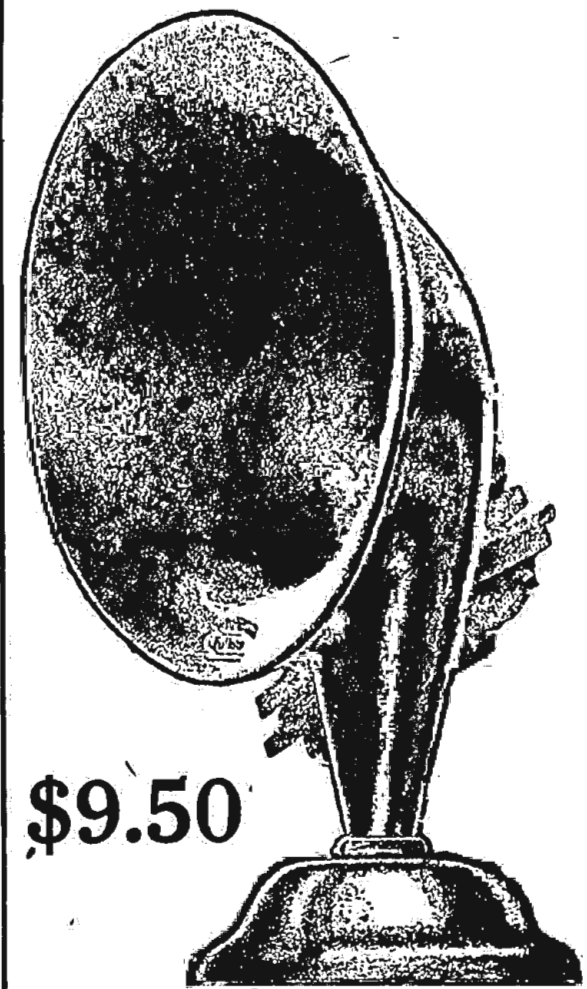

\$9.50

If your dealer cannot supply you, send money order or check for \$9.50

HALL & WELLS, Inc. 128 N. Wells St. Chicago, ILL.

Hansen "BIRD-CAGE" Radios



4 Tube Radio Set \$32.50 Without Accessories

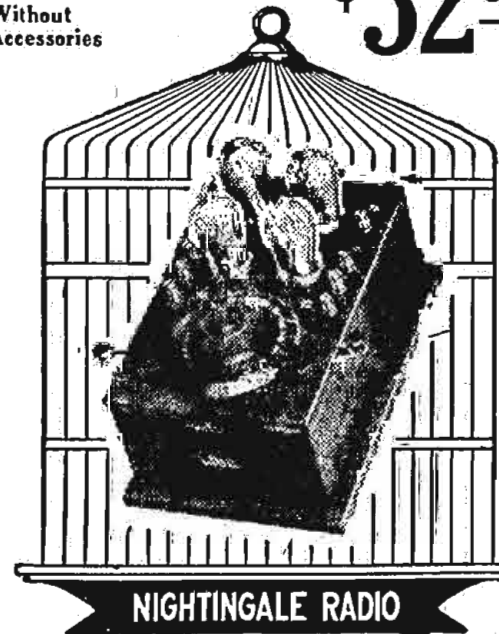

A simplified, loud speaking, long range set at a price within the reach of all. If you want Radio during the long winter nights the Nightingale will give it to you at very nominal cost, and you will be surprised at the remarkable distance and volume you will receive.

Hansen BLUE BIRD. \$57.50

This is a tuned Radio frequency set that is easy to tune and pleases everybody who owns one. You cannot go wrong when you buy it.

AMERICAN CREST. This we believe to be the best high grade 6-tube loop set on the market today. \$150.00

There are only a few good loop long distance sets on the market and this is one of them. It is our pet and we are proud of it.

Write for New Catalogue Dealers and Jobbers—Our line is interesting and profitable.



DIALERS MUST SEE 'EM, AND SO IT GOES

WGN PERSONNEL IS BUSY SHOWING FANS HOW

Announcers, Musical Directors, Entertainers Find Much in Big City to Keep Them Occupied

CHICAGO.—Out into the highways and byways go WGN folks, mingling with the listeners and letting the fans see what the familiar voices look like.

WGN has established a record this fall for public appearances. One week after he had taken a troupe out to Washington park, Chicago, to sing and poke fun before the Broadcast Listeners' association, "Sen" Kaney appeared in person at Balaban & Katz movie houses here.

Then, during the same week, the whole WGN staff—Quin A. Ryan, announcer, Charles H. Gabriel, Jr., musical director, Miss Wahnetta Swain, staff pianist, and Vernon Dickard, tenor—moved their three-ring tent to The Fair, a local department store which was conducting a Radio exhibition. Programs were staged on an elevated rostrum before an appreciative swarm of fans every morning and afternoon, with the Duncan sisters as the star performers.

But That Isn't All

Next to the Radio show at Marshall Field & Company's store, where a public broadcasting studio was erected and outfitted. Morning programs were broadcast in full view of the crowds every day, and in the afternoon Quin Ryan conducted his Rocking Chair time with various celebrities assisting him daily, including Princess Cantacuzene; Patricia Collinge, the actress; Charles Dickinson, president of the Aero Club of Illinois; Allan Dinehart, Claiborne Foster and Walter Conolley, stars of "Applesauce"; J. P. McEvoy, humorist and author of "The Potters"; Jacob Arvey, chairman of the Chicago Radio commission; and Julia Hoyt, the famous stage and society beauty.

And at the same time the station transferred its nocturnal activities from the Drake hotel studio to the Illinois Products exposition, in the American Exposition palace, Chicago.

Ho—hum. The life of a member of a station staff is a snap. Ho—hum!

Ruth Robinson in KGO Production

General Electric Pacific Coast Station Announces Three Radiocast Treats for Coming Week

OAKLAND, Calif.—A new voice among the KGO players will be heard on Tuesday evening, December 2. Ruth Robinson, well known on the stage and screen, will play the leading role in "Merely Mary Ann," a comedy drama in four acts, by Israel Zangwill.

Miss Robinson's entree into Pacific coast audio-drama should prove interesting, as she is thoroughly familiar with the part of "Mary Ann," having played it many times on the stage and before the microphones of WGY, the station of the General Electric company, at Schenectady.

What some of the Grieg incidental music to Peer Gynt means, will be told by Arthur S. Garbett, of San Francisco, on the Sunday afternoon KGO Little Symphony orchestra program, November 30. Mr. Garbett's talk will be illustrated by passages from the Peer Gynt Suite, played by the orchestra under the baton of Carl Rhodehamel.

KGO's Monday evening educational program of December 1 will include a specially prepared English lesson by Wilda Wilson Church, director of the audio-drama. In six lessons previously broadcast Mrs. Church has demonstrated the success of Radio as a means of aiding listeners to help themselves to speak better English.

Siamese Prince Buys Set

LONDON.—Prince Purachatra of Siam has recently purchased a seven tube Radio receiving set in England, and is taking it back to Siam for use in the Royal palace.

NATURE SHOWS FAN RECEIVING SCHEME

HANOVER, N. H.—A destructive thunder storm, one that tears the antenna from its moorings, is the best possible remedy for lack of volume, says one of Station WBZ's audience in a recent applause letter. This fan put 50 feet of the antenna wire underground for a temporary arrangement and received stations with terrific volume. "I never got such volume before," he said.

WGN ENTERTAINERS TRAVEL ABOUT TO MEET FANS



Left to right: Walter Conolley, of "Applesauce"; J. P. McEvoy, of "The Potters" fame; Wahnetta Swain, WGN pianist; Quin A. Ryan, WGN announcer, and Julia Hoyt, society and stage beauty.

Church and Civilization Brought to Northern Wilderness Dam-Tender

Government Man at Post in Deserted Northland Writes Station WLW to Tell of Gratitude He Feels for Men Who Bring Religion to Desolate Country

By Webb G. Welborne

CINCINNATI.—A. L. Mapel, on outpost duty for the United States government as dam-tender, way off the beaten paths of civilization, in the isolation of the upper pine forests of Minnesota with the members of his family, had about concluded that even God had forgotten them.

Missionaries and more missionaries were being sent by the Church year after year to China, India, Africa and to other foreign lands to spread the gospel of Christianity. In all the years no religious emissary ever had been assigned to the remote little town of Brainerd.

Family in Despair

There are no preachers in Brainerd, no churches, no Sunday-school—no facilities for devotional services. The environment benefits those uncivilized semi-savages of other countries so bounteously succored by foreign missions of the American church.

This exiled Christian family, removed from the influences of church activities and religious contact, hungering for a morsel of spiritual stimulant, had drifted into a state of despair. Then, as if a Heaven-sent rescuer, came the Radio, carrying to that churchless little community in the wilderness and to the religious-starved Mapel household, a Christian message and greeting—a sermon. Harmonized with it came sacred music and devotional services, such as

Brainerd never before had heard—from far off Cincinnati. Radio brought the church to the Mapels.

Letter Filled with Gratitude

The Rev. Frederick N. McMillin, pastor of Walnut Hills First Presbyterian church, whose Sunday evening sermons regularly are Radiocast by WLW, was the missionary who ended the religious famine at Brainerd. Dr. McMillin is in receipt of a letter, overflowing with gratitude, from Mr. Mapel, in which he says in part:

"It has been our great pleasure to listen in on your sermons and the church choir. We have much to be thankful for out here in the isolated districts since the advent of the Radio.

Isolated Feeling Gone

"For twenty years I have filled an outpost position among the tall pines and the deep snows, and during all that time I have never had the opportunity to take my family of eight children to a religious service or any kind of public entertainment.

"I often have thought that perhaps the Lord didn't know we were up here since missionaries were being sent to foreign lands, even while there was such a lack of missionary work right here in our own country. Your sermons help drive away the isolated feeling and depression about which the people of your state know little."

HOT SPRINGS TAKES SECOND WBAP MAN

HOT SPRINGS, Ark.—KTHS, the 500-watt class B broadcasting station to be operated from the new three million dollar Arlington hotel, to be opened here next month, has secured the services of E. L. Olds, as technician and operator.



G. C. Arnoux

Mr. Olds comes to KTHS from WBAP, Fort Worth Star-Telegram. He is an experienced Radio man, having served in the U.S. Navy and the Merchant Marine.

KTHS will broadcast on a 375-meter wave length.

G. C. Arnoux, also formerly of WBAP, director of the Arlington station, has been on the job several weeks, superintending the erection of the mammoth towers and installation of studio equipment.

FORT WORTH, Texas.—C. B. Locke, connected with WBAP in an unofficial capacity since it first took the air, has taken the position vacated by E. L. Olds, former announcer and Radio editor of the Fort Worth Star-Telegram.

FRENCH SCIENTIST IS CHECKING SLIPPAGE

PARIS.—Foremost among the scientists of France stands General Gustave Ferrie, who recently created quite a stir in scientific circles by claiming that the world was slipping, and that there was a slight deviation in latitude owing to the erratic motion of the poles.

At the present time he is preparing to collaborate with Mr. Bowie of the Geodetic Survey at Washington, for re-measuring the earth by Radio, and fixing the latitudes and longitudes.

The first of these experimental measurements will be made next year, then several years will be permitted to elapse before further measuring is done. By comparisons of two or more measurements the exact positions of longitudes and latitudes can be determined.

It has been planned to countercheck these measurements by establishing a number of observatories throughout the world. From observations, it has been found that the time signals received at Honolulu, are from three to five seconds late.



Gen. G. Ferrie

HIGH POWER KFI SET SOON TO BROADCAST

DUPLICATE OF WEAFF WILL BE BEST IN ALL WEST

Earle C. Anthony's Station Not to Use Full Power, but Strive for Quality

LOS ANGELES.—Work upon the new transmitter and studio of KFI's huge new station has reached a point where it has become necessary to bar visitors from the studio while alterations are being made.

Earle C. Anthony, owner of the present 500-watt station, while on a trip East last winter became so enamored with the quality of transmission from WEAFF in New York city that he determined that southern California should have a duplicate. Arrangements were made with the American Telephone and Telegraph company and the new set will be the finished product of all the experimental work that has been carried on at WEAFF.

Mr. Anthony's contract was the first to be signed for the new high power set and will be the first to be delivered and on the air.

Dismantle, Rebuild and Enlarge

To accommodate the set practically everything now used in connection with the old will be dismantled or enlarged. The antenna system is being remodeled and the supporting towers are being raised to almost double their former height.

A new studio is being built on the roof of the Packard building, together with a suite of reception, operating and office rooms, which will make it the finest studio of its kind in the West.

It is believed that the new set will be in operation before the middle of December. It will come on the air under its old call letters of KFI and with an output of 1000 watts.

It is not the intention of the new station to use the enormous power (5,000 watts) available to increase the range but rather to develop the quality of signals and to provide a reliable day and night range for the southwestern part of the United States.

Station WGBS Broadcasts Initiation by Level Club

NEW YORK.—Radiophans throughout the country recently had the opportunity to listen for the first time to the broadcasting of a thrilling, secret initiation ceremony. The initiating ceremonies of the Level club—a social organization of Masons made up of many people prominent in various fields of activity—were broadcast from Station WGBS, this city.

RADIO BRINGS TENOR BEFORE MESSENGER

BOSTON.—"Manuel Samazar, tenor, will be unable to continue after the second act," announced the station broadcasting Verdi's "Il Trovatore" recently direct from the Boston Opera House, and, "A messenger will be sent for Gaetano Tommasini who will finish the role." But a messenger was not sent, for Mr. Tommasini appeared immediately on the scene. "I heard what you said on my Radio," was his explanation.

"Masterpiece is a wonder-
 We have tried them all!"
 "California on Loud Speaker
 from Plainfield, N. J."
 "51 Stations in 2 hours."
 "Best set ever put on the market"
 "Beats any set at \$200."
 "Can I be your agent?"
 "It is simply marvelous"

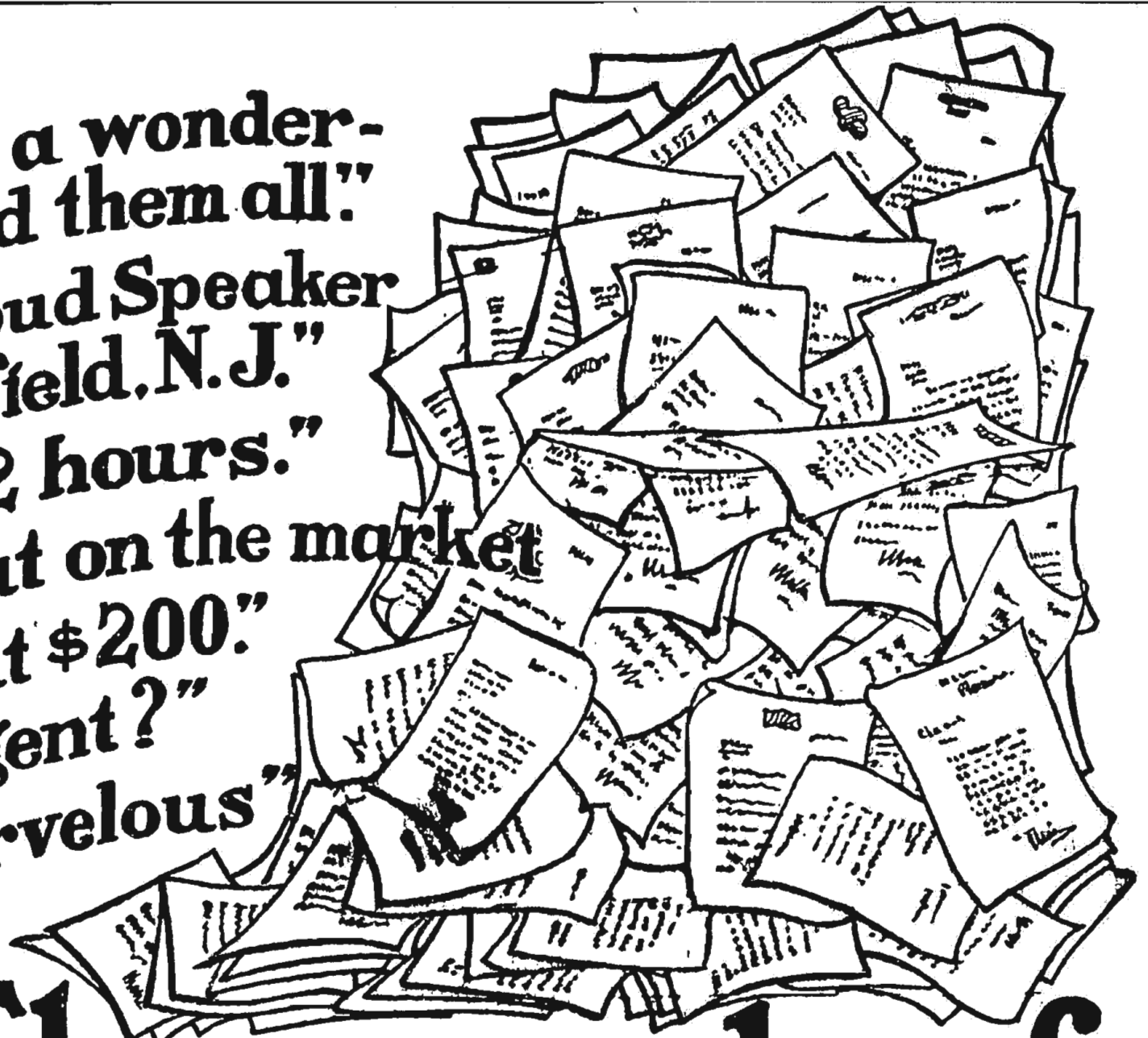

Thousands of

Unsolicited letters of praise prove conclusively that the Freshman Masterpiece is the equal, if not the superior, of any five tube receiver in the world—regardless of price. The statements above, taken from letters received, give a general idea of the tremendous hold that this remarkable set has obtained.

Made of the finest low loss materials and in a beautiful genuine solid mahogany cabinet, it is attractive enough for the most pretentious room, and at sixty dollars, economical enough for the most modest. Combines every single point essential to the perfect receiver. Real distance reception without that squealing and howling. So selective that once a station is picked up—it can be brought in again on the same points on the dials, whenever you want it. And what's more—

IT'S THE EASIEST OF ALL SETS TO OPERATE

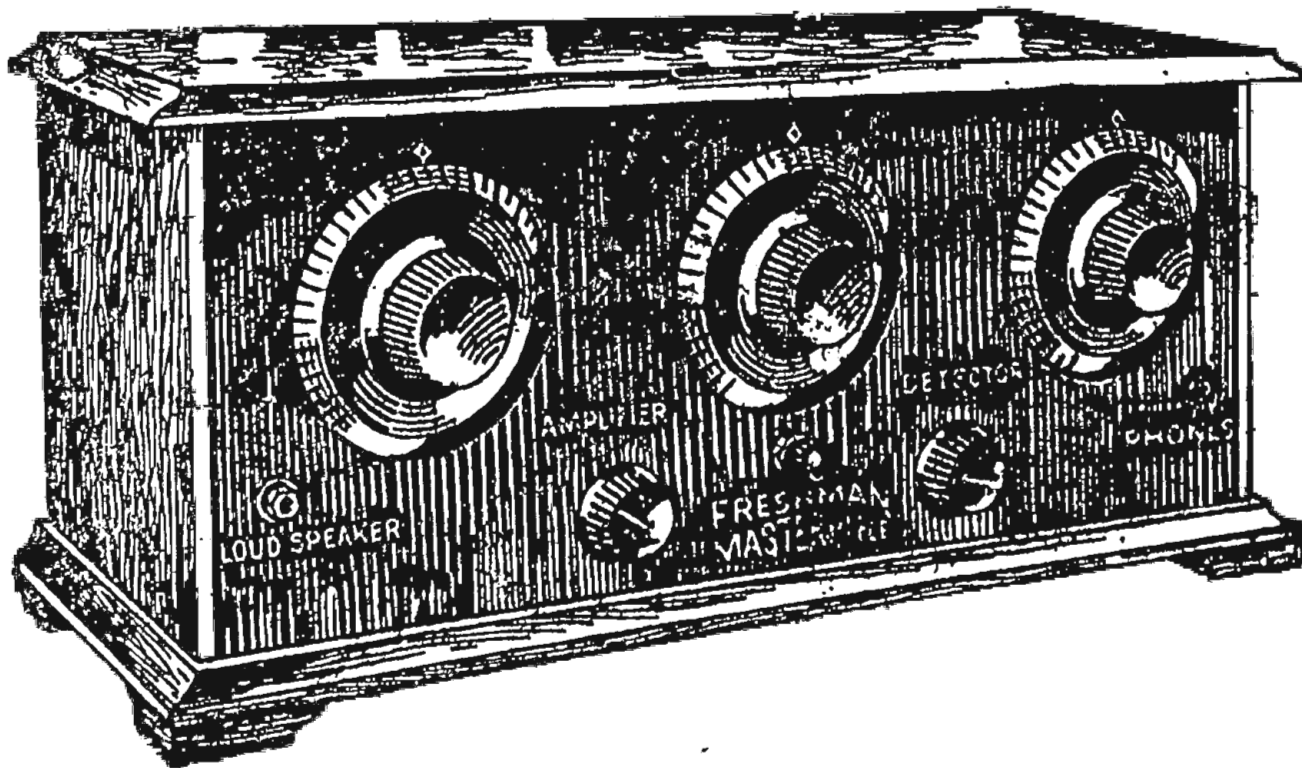

\$60.

**THE GREATEST VALUE
EVER OFFERED IN A
RADIO RECEIVING SET**

**FRESHMAN
MASTERPIECE**

**5 TUBE TUNED
RADIO FREQUENCY SET**

Ask Your Dealer to Install One in Your Home

All genuine Freshman Masterpiece Sets have a serial number and trade-mark riveted on the sub-panel. The Receiver is not guaranteed if number has been removed or tampered with.

Chas. Freshman Co. Inc.
Radio Condenser Products
 106 SEVENTH AVENUE, NEW YORK CITY

IF YOU WANT TO BUILD IT YOUR-
 SELF, YOU CAN BUY THE FRESH-
 MAN MASTERPIECE KIT. ASK
 YOUR DEALER.

Station WIP "Watch It's Progress"

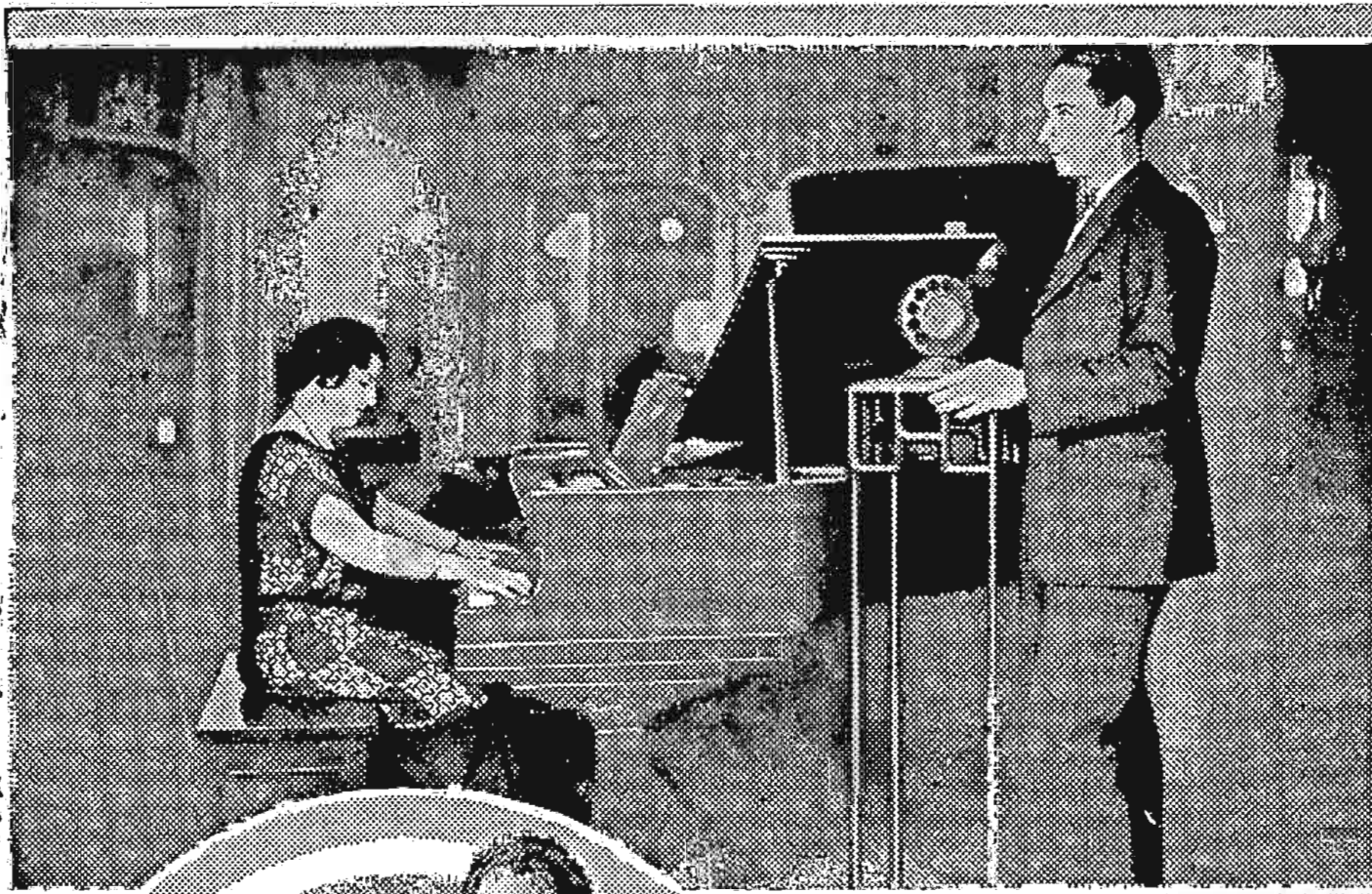

Miss Flora Ripka, accompanist at Station WIP, is seated at the piano, and "H. G.," chief operator, at the microphone.



The most popular member of the staff at Station WIP, is shown above. He is known to more than a quarter million people as "Uncle WIP."



Edward A. Davies, director of the station, who has made WIP one of the outstanding broadcasting stations.

without fear of contradiction, that it is one of the most progressive stations in the United States.

Station WIP is located on the seventh floor of the Gimbel Brothers department store in Philadelphia. Its two large antenna towers are more than 200 feet above the street level. Several years ago, just when broadcasting was becoming popular, WIP had a little one hundred watt station. It was adequate at that time, however, for it was really the first station in Philadelphia of any size. Many a thrill the crystal set listeners in experienced when WIP came on the air with songs, baseball and football scores, and the bedtime stories.

Then came a bigger station, and with its growth in size came the growth in features of all kinds. WIP has broadcast more unusual features than any other station in Philadelphia, and possibly in the entire country. It was the first station to broadcast a speech from the bottom of the Atlantic ocean.

WIP had built a remote control room and studio on the Steel Pier, Atlantic City. E. A. Davies, the station director, in one of his moments of thought, de-

vised the scheme of broadcasting from the bottom of the sea. After much effort a diver was secured, and for the first time in the history of Radio reception a diver told just exactly what he saw on the bottom of the sea.

Then another of WIP's big features was the broadcasting of an entire concert by the convicts in the Eastern Penitentiary. Of course, the wardens couldn't see letting the convicts come to the station studio to do their stuff, so WIP went to the convicts. The first concert was such a tremendous hit that WIP decided to give a (Continued on page 8)

"THIS is station WIP, Gimbel Brothers, in Philadelphia." You no doubt have heard this announcement—it has been heard all over the United States, in England, France, Germany, South America, Hawaii and other places in far corners of the earth. It is one of the largest stations in the country, operating on a wave length of 509 meters, and it can be said,

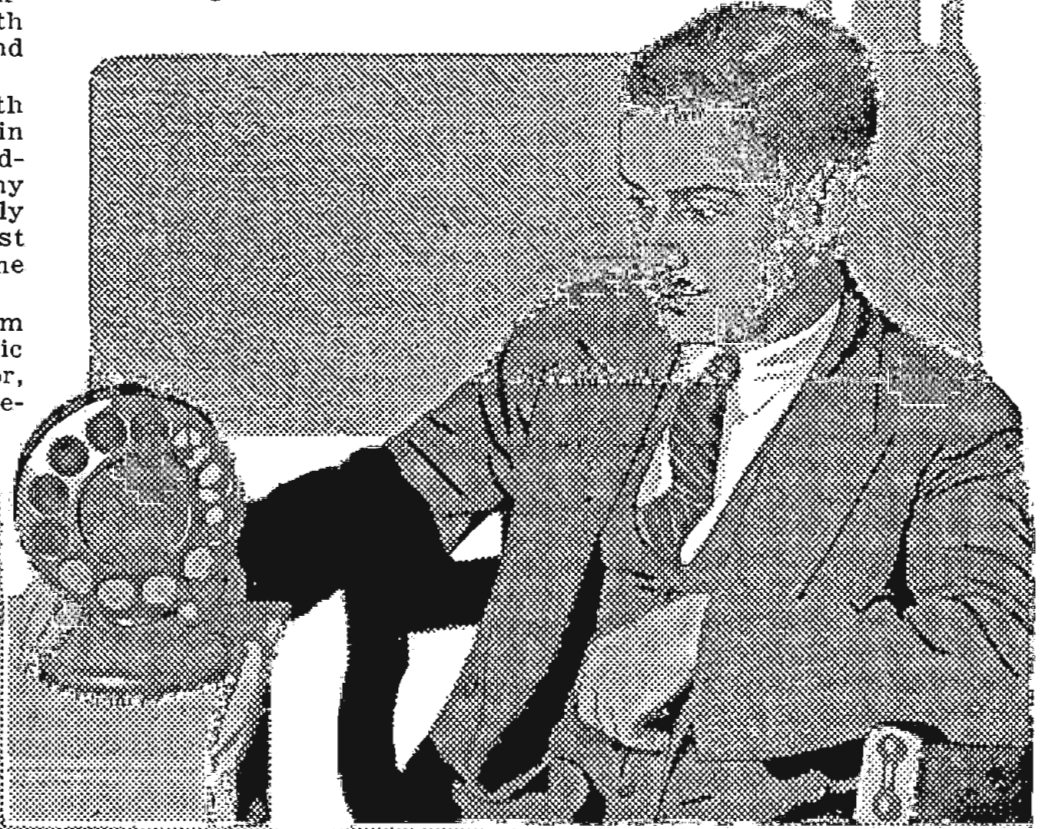

Karl Bonawitz who regularly broadcasts an organ recital through WIP on Saturday evening at 11:05. Mr. Bonawitz is rated as one of the most popular broadcast performers appearing before the microphone at the present day.

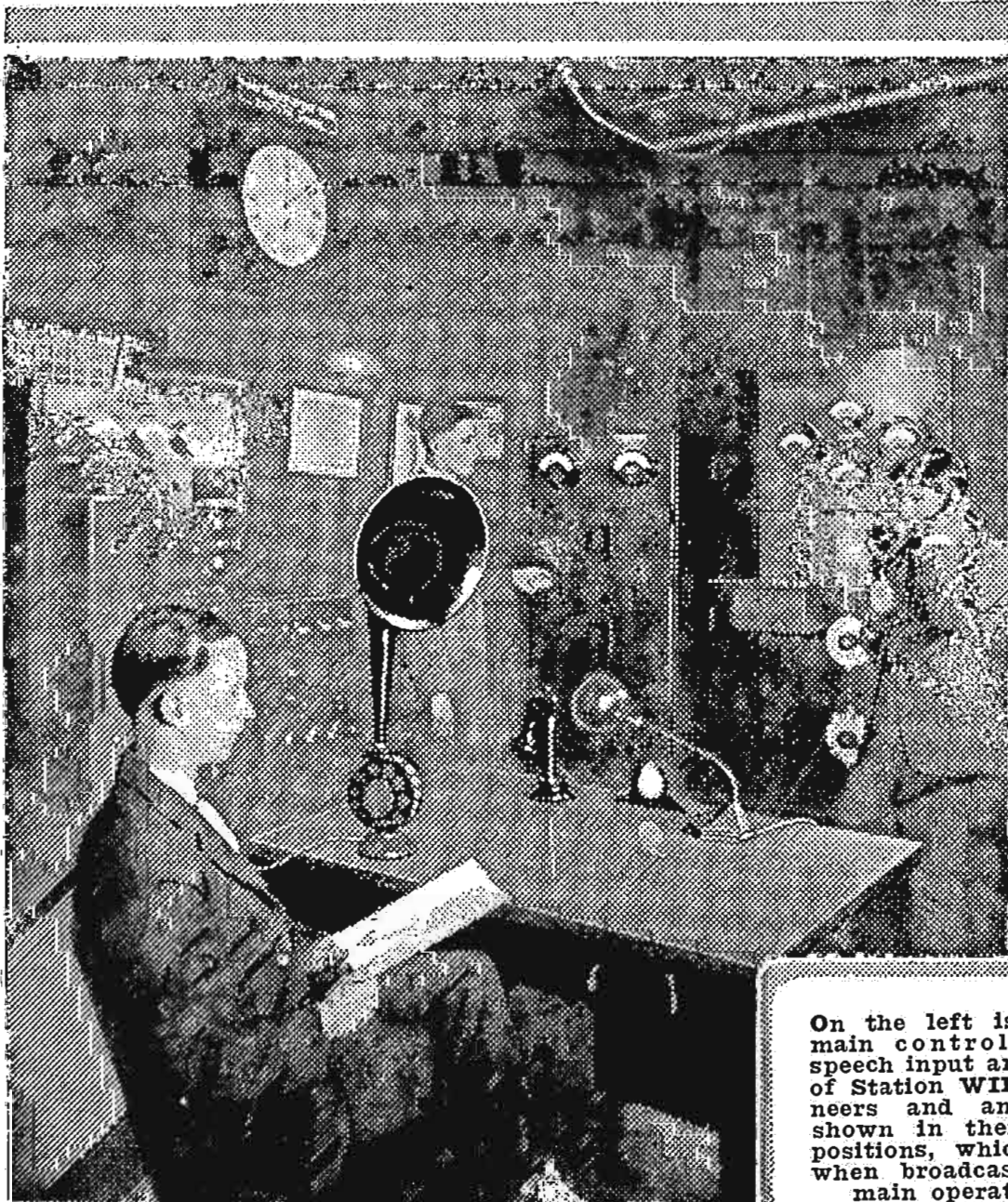

On the left is shown the main control table and speech input amplifier panel of Station WIP. The engineers and announcer are shown in their respective positions, which they take when broadcasting. Right, main operating room.

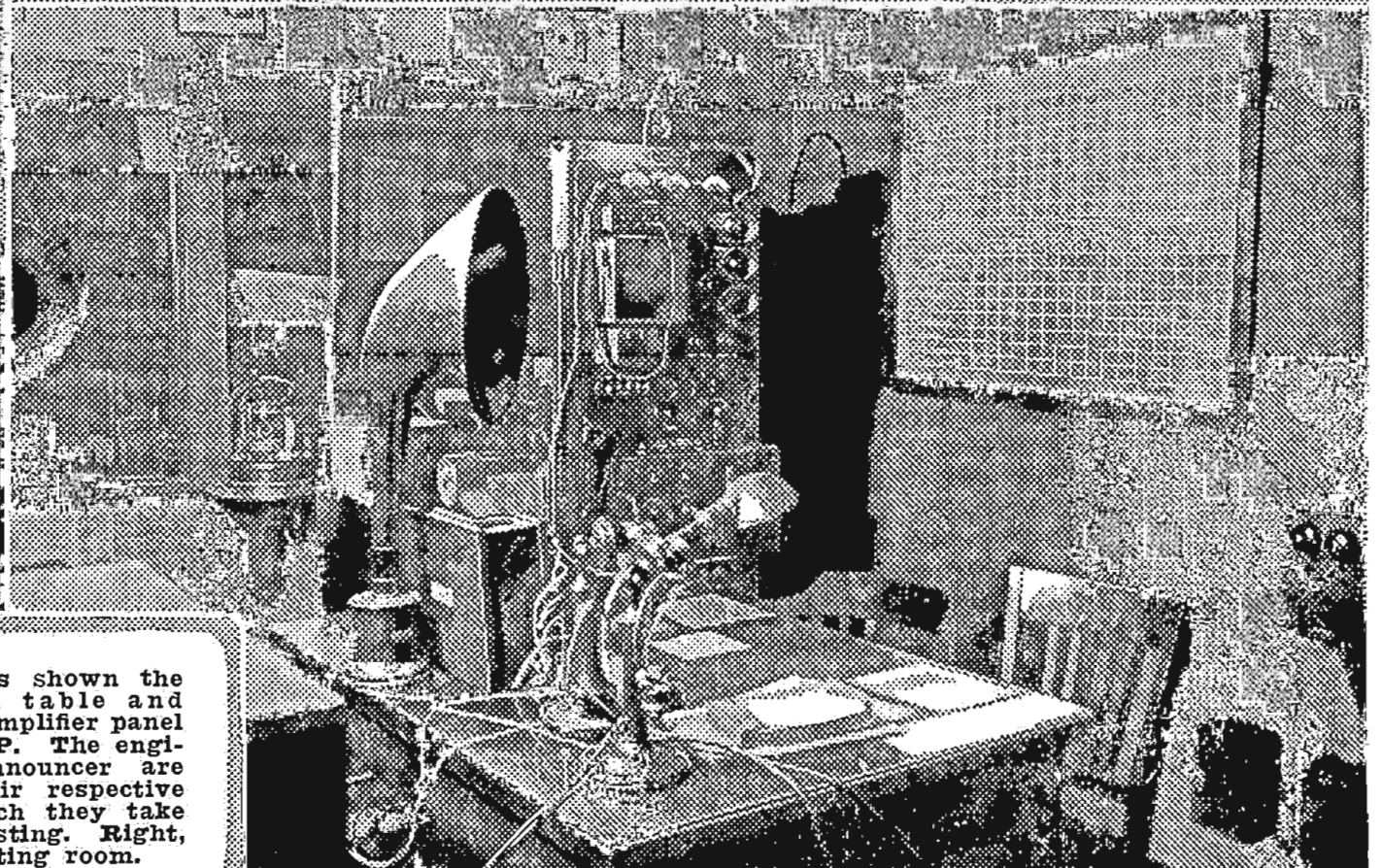

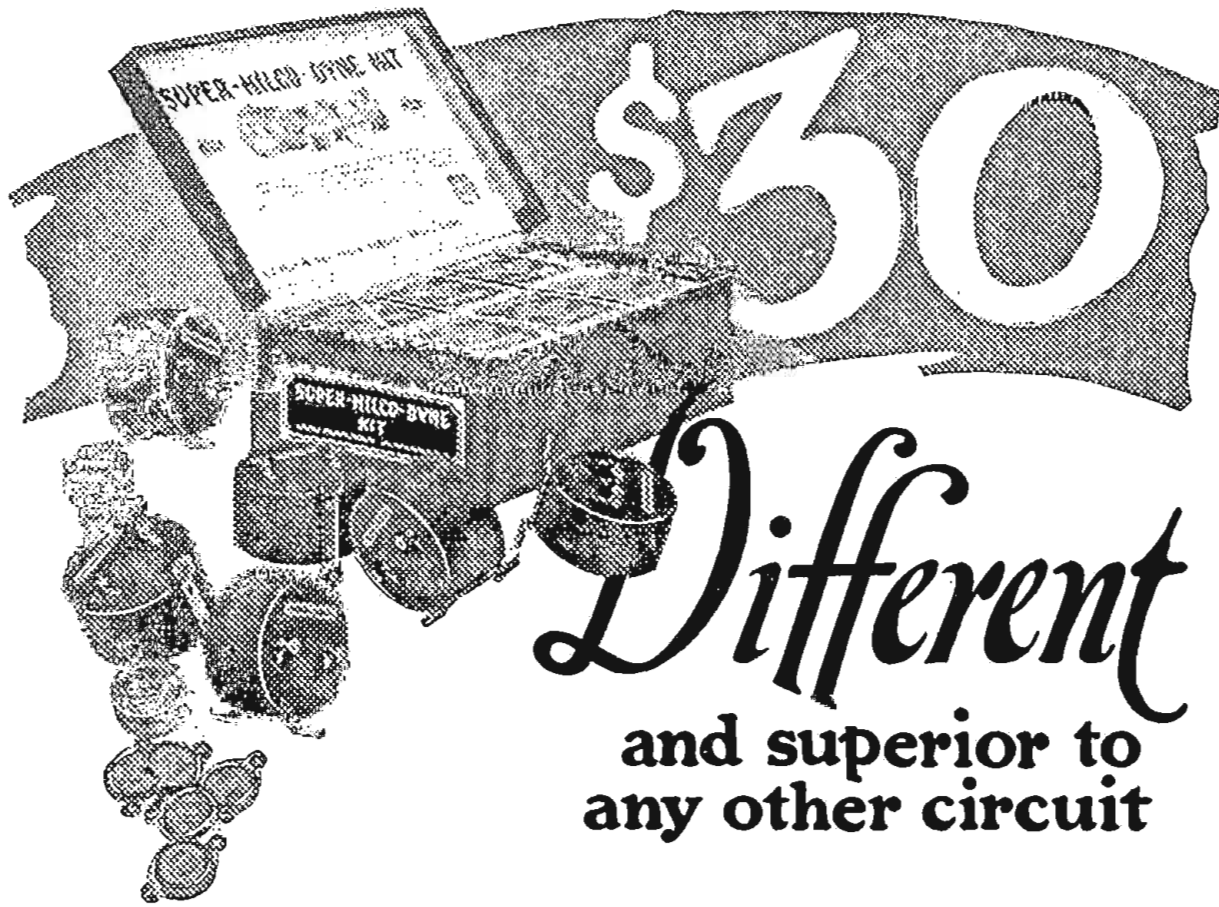

The **SUPER-HILCO-DYNE RECEIVER**—a seven tube set superior in every way and different from the conventional super-heterodyne (note wiring diagram below) is made from the \$30 SUPER-HILCO-DYNE KIT and about \$45 worth of standard radio parts sold by any other dealer. It operates either on storage battery or dry cell tubes.

SELECTIVITY. A fan receiving in New York next to the high voltage elevated railway, tunes in or out all the nearby high powered broadcasting stations and gets what he wants when he wants it.

DISTANCE. A fan receiving in a large metropolitan hotel uses the steam radiator as his antenna and gets coast to coast reception.

TUNING. Only two dials. Stations can be located today, tomorrow, or next month by turning back the dials to the place where those stations came in before.

CONSTRUCTION. Inexperienced fans all over this continent have built these sets without trouble.

RADIATION. Not a squeak, squawk or squeal comes from the SUPER-HILCO-DYNE to bother your nearest neighbor. It does not radiate.

DISTORTION. Absolutely true tone qualities from the lowest note of a bass horn to the highest note of a coloratura soprano.

VOLUME. You can dance any night with a SUPER-HILCO-DYNE RECEIVER. Loud speaker reception on all stations.

WAVE RANGE. 90 to 600 meters.

SIZE OF RECEIVER. Only 7"x28" panel.

Each SUPER-HILCO-DYNE KIT is thoroughly tested and the air core transformers are matched and balanced in our own laboratories. Address Dept. 10.

Here is selectivity, great distance, volume, clarity, easy tuning, simple construction. It is YOUR set, custom built to YOUR requirements. It is the ONE you want; the ONE you have been hoping for. Order from your dealer or send for descriptive literature on the SUPER-HILCO-DYNE KIT and other famous Hilco radio apparatus.

Scientific Radio Apparatus that is distinctively different and superior in efficiency and appearance

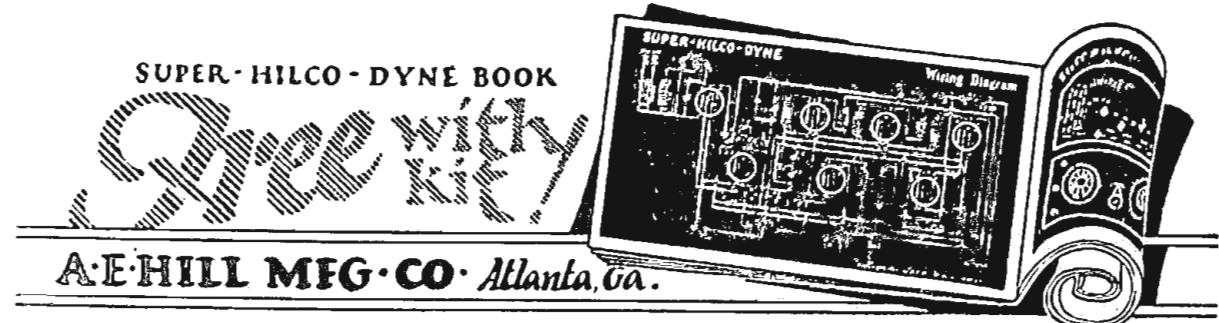

Now You Can Use Laboratory Equipment

These condensers are insulated with Air, Isolantite, Pyrex, Corantum and Quartz. Formerly they were made for scientific laboratory work. Now they can be obtained at the better radio stores. Heretofore inaudible signals can be brought in by NOLOSS. Greater distance, selectivity and reception!

NOLOSS

TRADE MARK
Insulated with Pyrex

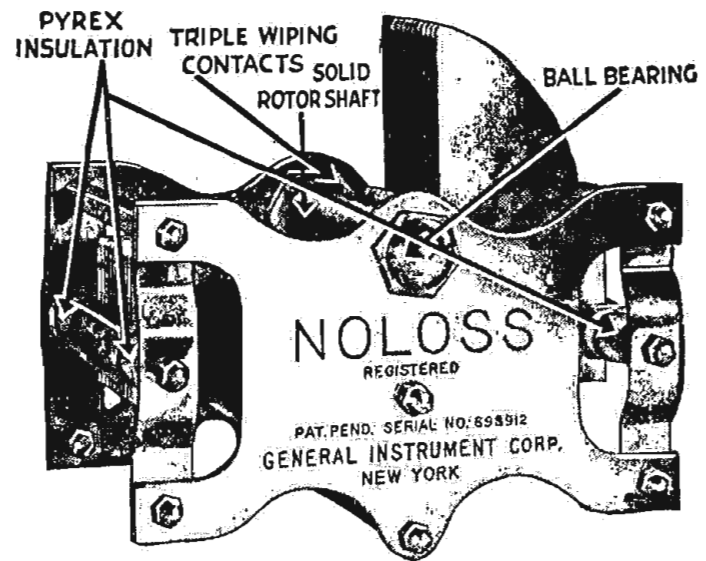

Type	Maximum Capacity	Minimum Capacity	Price
51X	.00025 mfd.	9 mmfd.	\$6.00
51A	.0003 mfd.	11 mmfd.	6.00
51D	.0005 mfd.	13 mmfd.	6.50
51F	.001 mfd.	20 mmfd.	7.00
52D	.0005 mfd.	13 mmfd.	9.00
52F	.001 mfd.	20 mmfd.	9.50

At your dealer's or direct from

GENERAL INSTRUMENT CORP.

423 Broome Street
NEW YORK CITY

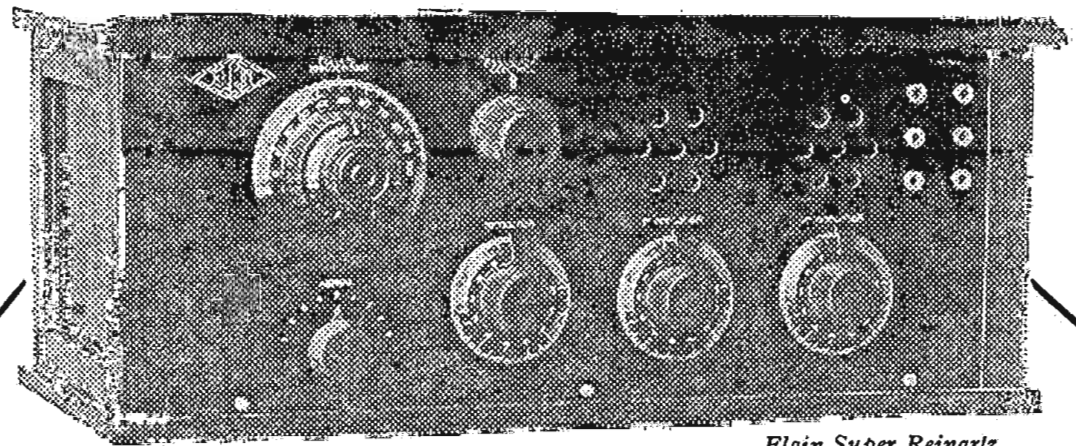

Elgin Super Reinartz 2LO Model Tuner

The Set That Heard London

This astonishing reception was accomplished twice, in two separate cities of the United States during the trans-Atlantic tests last season.

The Elgin Super-Reinartz, 2LO Model Tuner spans the continent nightly at the hands of thousands of Radiophans. Through this highly efficient circuit amazing reception has been obtained. New York is entertained by KGO and Houston, Texas, listens in on WLAG with surprising regularity.

ELGIN Super-Reinartz "The Ford of Radio"

will give you the DX records it has brought to others.

You must learn more about this wonder circuit at once!

Mail the coupon TODAY with your name and address and we will send—FREE of charge—the complete working diagram of the Elgin Super-Reinartz, 2LO Model. There are no obligations, of course.

Dealers: Write for Proposition

Free Coupon

Elgin Radio Supply Co.
Dept. A, 207 E. Chicago St., ELGIN, ILL.

Send at once the working drawings of the ELGIN SUPER-REINARTZ, 2LO MODEL TUNER—The Set That Heard London. I am enclosing stamp to cover postage.

Name

Address

(PLEASE PRINT IN PENCIL)

REASSIGNING WAVES IS NOT EASY TASK

ALLOCATION MAKES BRAIN TEASER FOR OFFICIALS

Stations Try Out New Frequencies Prior to Change Due Nationally in Month

By Carl H. Butman

WASHINGTON.—Delegates to the third Radio conference left with the idea that everything was settled and that new wave lengths for broadcasting would be issued forthwith, but Secretary Hoover's Radio aides have had a terrible time working out the practical details of an equitable distribution of the 53 wave lengths among the sixty-two class B stations now in existence.

After trying out several plans of allocating wave lengths by zones and cities where the larger and more powerful broadcasters are located, a tentative system based on distance between the broadcast stations, has been sent to all Radio supervisors with instructions to confer with local operators and secure their approval.

One Supervisor Reports

Out of nine national districts, only one supervisor has reported a general agreement to the changes in wave lengths suggested. Supervisor R. Y. Cadmus of the third district, having headquarters at Baltimore, reports that all major station owners agree to the wave lengths assigned. Under this district plan, Washington will get a wave length of 491.5 meters, time on which will have to be divided by Stations WRC and WCAP, Philadelphia, which has four stations, will have two wave lengths, 394.5 and 535.4 meters; while Atlantic City will have a single wave of 288.3 meters.

General Plan of Allocation

The general plan of subdividing the wave band between 280 and 545 meters among the class B stations, provides for a separation of from 10 to 50 kilocycles. Stations in the same city will be approximately 50 kilocycles or about 34 meters apart, which should prevent serious interference when both are on the air.

A recent test in Washington, however, when WRC broadcast on 469 and WCAP, on 435 meters, brought a number of complaints of bad interference, chiefly from

ENCOURAGEMENT FOR PROGRAMS



Station WHO, Bankers Life company, Des Moines, received the above 11,000 telegrams, letters and postcards in token of Radiophans appreciation of World Series broadcasts. This might be an incentive to negligent listeners to get busy—and send applause.

crystal set owners. In many other cities, such as in New York, Philadelphia, and especially Chicago, it is understood fans have little difficulty in selecting the station desired during simultaneous broadcasting.

Stations distant from each other 50 to 200 miles will use wave lengths separated by 30 kilocycles; those from 200 to 500 miles apart will have a 20-kilocycle separation, and those over 500 miles apart will operate on wave lengths differing only by 10 kilocycles.

Passengers on Twentieth Century Hear Broadcasts

NEW YORK.—Radio election returns were served to passengers aboard speeding passenger trains successfully for the first time in history the night following Presidential election day, marking an epoch in the progress of Radio transmission.

Approximately a thousand passengers traveling between New York and Chicago aboard the Twentieth Century Limited, heard the news reports.

Football Radiocasts

November 27

Cornell-Pennsylvania at Philadelphia, WEAJ (492), WGY (380), WJZ (455).
 Kansas-Missouri at Columbia, WDAF (411).
 Louisiana-Tulane at Baton Rouge, KFGC (254).
 Penn-Cornell, WIP (509).

November 29

Army-Navy at Baltimore, WCAE (462), WCAP (469), WEAJ (492), WEEI (303), WGY (380), WIP (509), WJZ (455).
 Boston College-Holy Cross, WBZ (337).
 Carnegie Tech-Notre Dame, KDKA (326).

Station WABL to Increase Power
 STORRS, Conn.—After December 1 the Connecticut Agricultural college will increase the power of its Station WABL to 500 watts. The station has been using 200 watts heretofore.

WOS "TRICK" ORGAN GREET'S RADIOPHANS

POPULAR MISSOURI PLANT ON AIR NIGHTS AGAIN

J. M. Witten and Harry M. Snodgrass Bring 745 Telegrams—Want Name for Organ

JEFFERSON CITY, Mo.—"W-O-S, Missouri State Marketing Bureau, Jefferson City, Mis-sour-ahh, 'Watch Our State,'" came back on the night air Armistice eve with 745 prepaid telegrams testifying to its popularity.

J. M. Witten, chief announcer, and Harry M. Snodgrass, "The King of the Ivories" divided entertainment honors.

An innovation sprung at the resumption of the evening programs, was the manually operated, especially constructed organ which played the "Missouri Waltz" when WOS came on and went off the air. The organ plays this one number alone, and because it is so designed, plays it as it is never played elsewhere, having individual characteristics which make the tune easily distinguishable as belonging to WOS.

The instantaneous popularity of the manual organ has brought many letters suggesting a name for it. "The Show-Me Organ," "Jeff Mo-rgan," "Missouri Melodeon" and many other names have been submitted, but WOS officials are awaiting a more appropriate suggestion and closely read all mail from listeners in.

The organ idea is to be credited to J. M. Witten. And so we have a new and original auricular marker to be added to the long list of chimes, bells, songs, whistles etc., used by many stations.

Paul Reese, Announcer for KFI, on Leave of Absence

LOS ANGELES.—Listeners in will miss the voice of their old friend, Paul Reese, of KFI here, as that popular announcer and artist has accepted a vaudeville engagement with the Empire Theaters, Ltd. of London, England.

Fans will remember that last winter KFI succeeded in getting across to 2LO, London, where an entire program was rebroadcast by the latter station to all England and France.

Through this broadcast Mr. Reese received the English offer.

Why it is Better

"MASTER of Every Note in the Orchestral Range" is the proven claim of the Federal No. 65 Audio Frequency Transformer! Volume without distortion is the basis for the beauty of Federal Tone.

From its oversize locking nuts to its heavy brass mounting feet the Federal No. 65 Transformer incorporates the same engineering skill that has made Federal the recognized leader in electrical communication apparatus since 1890.

Insist upon Federal parts for your "pet" hook-up. There are over 130 standard parts bearing the Federal iron-clad performance guarantee.

FEDERAL TELEPHONE & TELEGRAPH COMPANY
 BUFFALO, N. Y.

Boston New York Philadelphia Pittsburgh Chicago
 San Francisco Bridgeburg, Canada



Federal

Standard RADIO Products

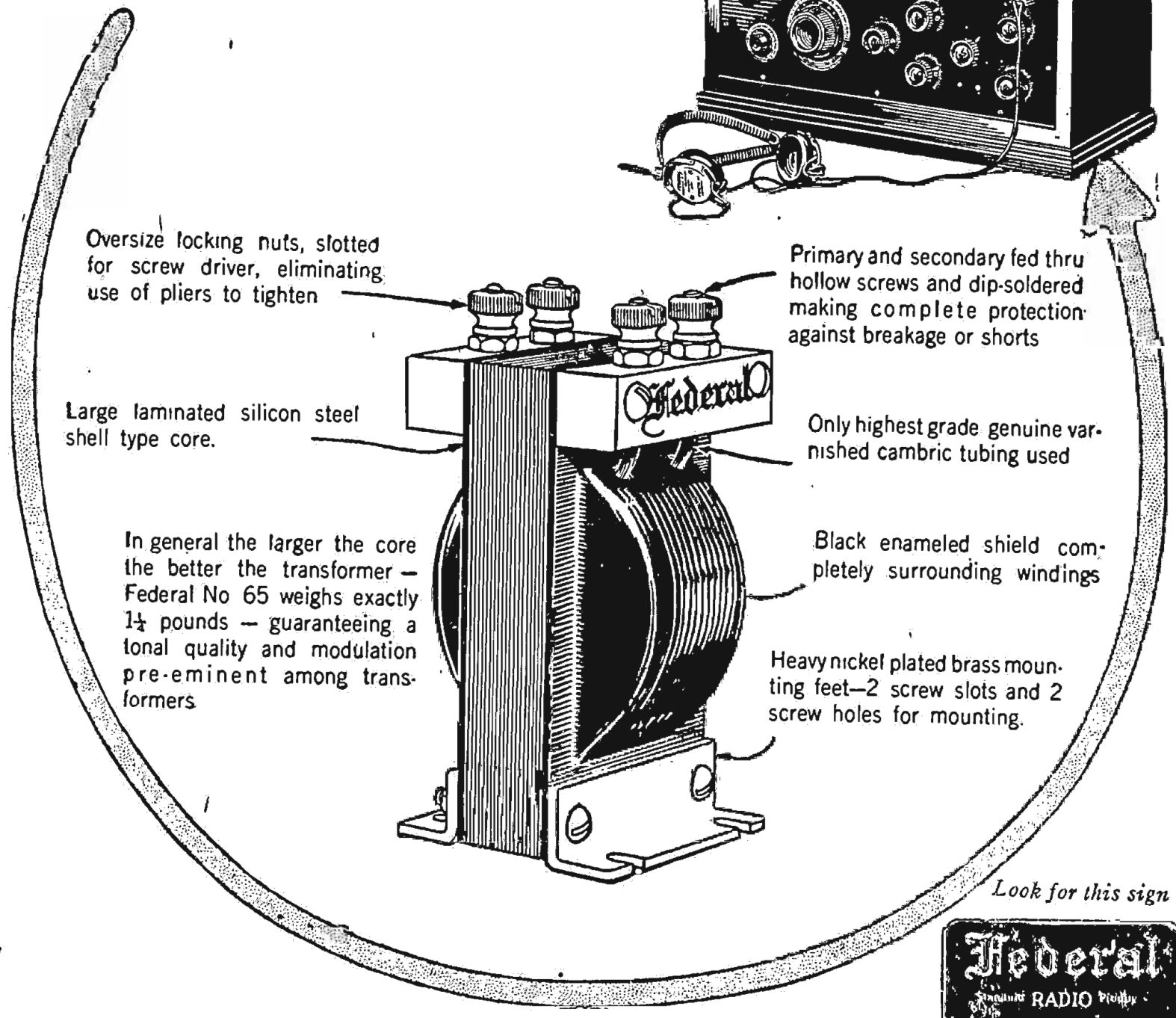
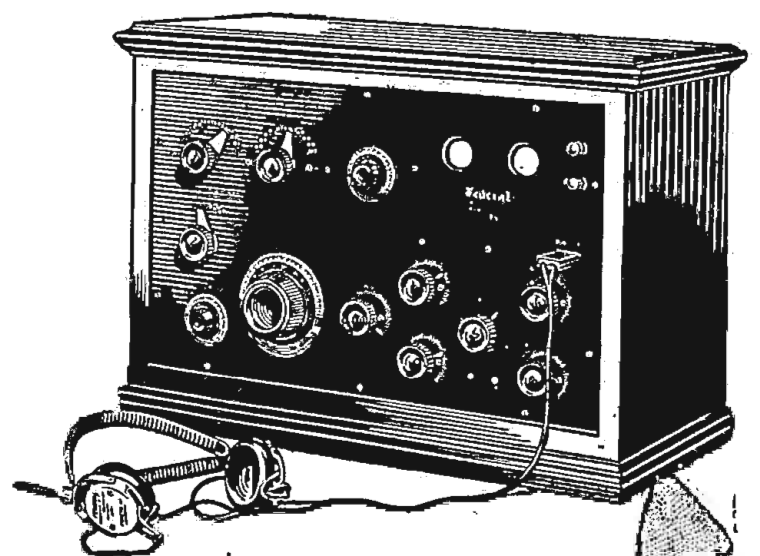

Look for this sign



THE ANTENNA BROTHERS

Spir L. and Lew P.

Free Speech

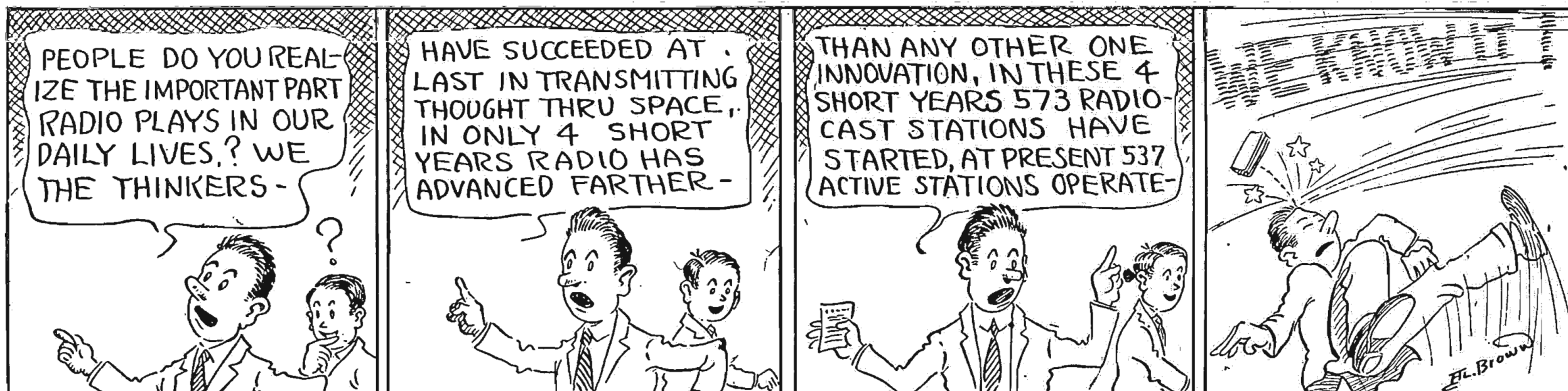

Thornton W. Burgess Exposes False Ideas

Appearing at WBZ, He Tells How "Wild" Animals Are

SPRINGFIELD, Mass.—Because people who are unfamiliar with the habits of wild animals and know them only through books have many mistaken conceptions as to the degree of their wildness and few folks actually know how ferocious some of nature's pets really are. Thornton W. Burgess, nationally-renowned writer of stories for children and a naturalist of recognition, contends that a group of theories about wild animals ought to be exploded.

Through arrangements completed with Station WBZ, Westinghouse company here, he will appear in person at the Hotel Kimball studio every Wednesday night and expose some of the false impressions about so called ferocious beasts.

He has already given one talk on wolves in which his experiences in desolate open countries of the far North were recounted and many interesting comments about the wolf, who is supposed to be a treacherous animal, were passed by the naturalist.

EVOLUTION IS THEME OF KDKA-PITT TALKS

University Studio Begins New Series; Outlines Available

E. PITTSBURGH.—University of Pittsburgh studio, KDKA, educational lectures, are proving themselves very worth while. These, given three times weekly, Monday, Wednesday and Friday, on various subjects, have aroused great interest.

This week marks the fourth of a new series of six talks on "Evolution and Heredity", broadcast by members of the department of biology and zoology.

Syllabuses, containing the outlines of the talks and reading references, have been prepared and are ready for distribution to interested listeners.

Station KOP on 286 Meters

DETROIT, Mich.—Agreeable to arrangements made with the government recently, Station KOP, Detroit Police department, will broadcast on a wave length of 286 meters. This wave band has been assigned for public safety broadcasting work exclusively.

WIP OF PHILADELPHIA

(Continued from page 5)

second and third concert. Over 1,000 telegrams, to say nothing of thousands of letters, were received by WIP, commending it on the convict broadcast.

The station consists of the operating room, the main studio, which is used for solos, speeches, quarters; and the studio auditorium for large choruses, orchestras and bands. There are eleven remote control rooms, located in various parts of the city, not counting the Atlantic City remote control which is used only in the summer.

In both the auditorium and the studio-auditorium the walls are padded and draped in such a manner that there is little reverberation of sound—just a full round tone without echo. The main studio is comfortably furnished with wicker chairs, tables, settees, while fine tapestries cover the walls. A grand piano occupies one corner. Two microphones stand ready to catch the slightest sound.

The operating staff of WIP needs no introduction to most listeners in. You've probably only heard their initials, however. "H. G." is Charles Goudy, better known as Hank, chief engineer of the station, and only recently a benedict.

"C. W." is Charles Weir, operator, and "S. K." is Samuel Kale, operator. "E. D." is Edward Davies, director of the station, and also a well-known baritone. "H. P. I." is Mrs. Helen Pulaski Innes, director of programs, and the woman who gathers together those excellent musical numbers you often hear from WIP. She is very well known in musical circles in Philadelphia, and has been the manager of some of the world's best known music artists. "U. W." is Uncle Wip, in private life, Chris W. Graham.

Uncle Wip, from all indications, is one of the most popular story tellers in the country. He has more than a million and a quarter kiddies who are members of his Kiddies Klub. In fact he has proven so popular that the station had to provide a special corner for him where he receives the children each day.

Abe Lyman Goes to KNX

HOLLYWOOD, Calif.—Abe Lyman's orchestra, noted as being home in the Coconut Grove of the Los Angeles Ambassador Hotel, will no longer be heard from KFI after December 1.

Fans, however, will find Abe and his orchestra if they will tune down the scale to 337 meters and pick up KNX, the Hollywood station of the Los Angeles Express.

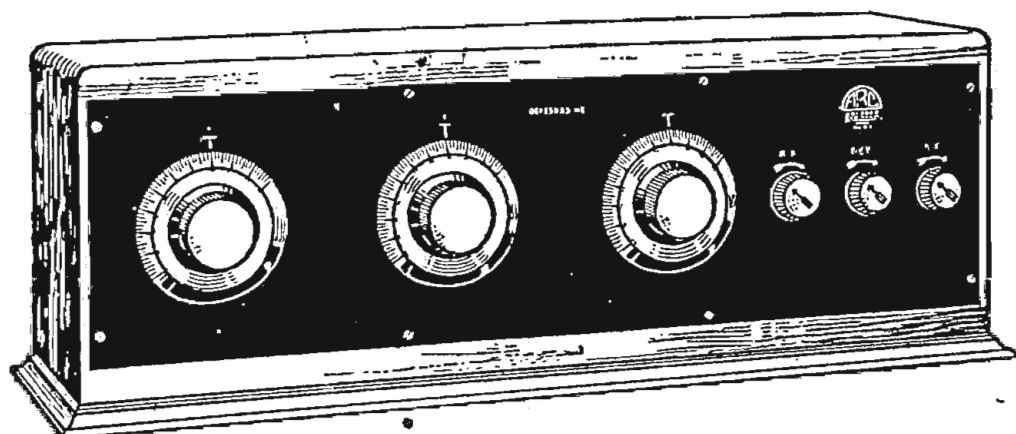

THE Andrews Deresnadyne
 DE-RÉS-NÁ-DÏNE · PATENTS PENDING
 Radio Receiving Set

—the first set to combine selectivity and tone quality with distance and volume

Hitherto in buying a radio set you have had to choose between one with high selectivity and fine tone quality and one with great distance and volume. Up to this time both groups of qualities could not be found in one set.

Now the Andrews Deresnadyne 5-tube Radio Receiving Set, using the new and exclusive principle of the Deresonated and Balanced

Plate Circuit, for the first time successfully combines these absolute essentials of fine Broadcast Receiving. Mr. Robert J. Casey, head of the Chicago Daily News Laboratory, says about it: "The circuit combines selectivity, range and quality in a degree that will astonish the old experimenter." Hear the Deresnadyne at your dealer's. Or write to us for a complete description.

Price \$150 without accessories

ANDREWS RADIO COMPANY · 327 S. LA SALLE ST. · CHICAGO

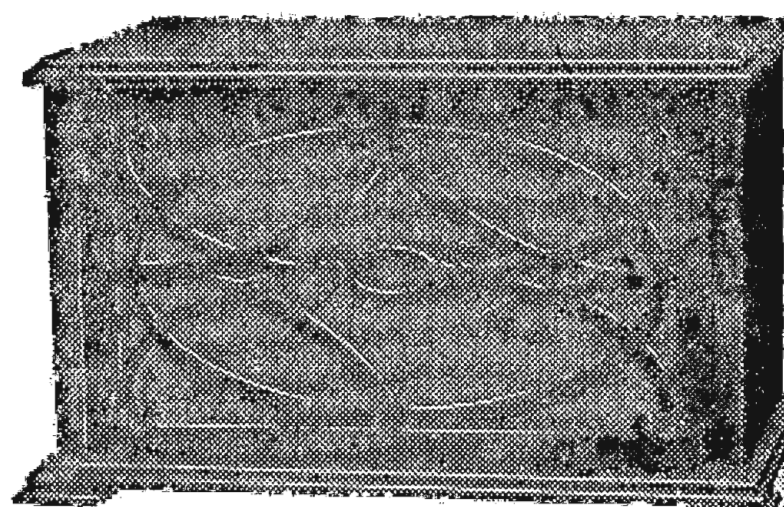

Model "C" Cabinet-Type \$30

The New Cabinet Model

For those who admire the full, round, musical voice of the Audiophone, but prefer a cabinet design, we have brought out this splendid model.

The case is real mahogany. The design is in keeping with the best furnishings. The size, 17x10x10 1/4, is just right for the top of your phonograph or your receiving set. The voice of the Audiophone is

Not a "Phone Unit"

It is a highly developed, electro-magnetic tone mechanism which reproduces with natural quality in most powerful tones, yet has a sensitiveness equal to any loud speaker developed.

The Bristol line includes five Audiophones priced from \$12.50 to \$30.00. If not at your dealer's write for Bulletin AY-3022.

The Bristol Co., Waterbury, Conn.

Bristol
 AUDIOPHONE LOUD SPEAKER

The Voice of the Audiophone



Model "S" Audiophone \$25
 Rubber horn 14 1/2" diameter. Velvet mat finish of mottled bronze and gold; classic base.

An Eight Dollar Crystal Set with Selectivity

Part I—Clear Tones and Short Range

By Victor Andre Matteson, A. I. A.

FOR those living not more than ten or fifteen miles from a broadcasting station, the crystal detector set affords an excellent means of Radio reception, if properly made. For purity of tone, and faithful reproduction, it is acknowledged without equal, within its limited range. Where several broadcasting stations operate simultaneously within the range of the crystal, as is the case in a number of our large cities, a program is usually available to suit almost any taste if the desired station can be selected without interference. This is difficult with most commercial crystal receivers and many tube receivers. Lack of "selectivity," then, is the chief shortcoming of the crystal, next to its limited range. Knowing this shortcoming, the public frequently takes a chance with a cheap "tube set" which in most cases is itself sorely lacking in this same quality of selectivity, and, in addition, is usually the cause of untold annoyance to the neighborhood due to its radiating qualities which produce the well known whistles and howls in other sets.

Construction of a Crystal Set

It is the purpose of this article to describe the construction and installation of a crystal set using a circuit that when properly made is both selective and efficient. Such a receiver is not at the present time commercially available so far as the writer is aware. By the addition of one or two stages of audio frequency amplification of the usual kind, using dry cell tubes if desired, this receiver will satisfactorily operate any loud speaker. The range will, of course, still be that of a crystal, but amply sufficient for the reception of local broadcasting. The quality of tone and faithfulness of reproduction should then be the equal, if not the superior, of any two or three tube sets.

This receiver requires an outside antenna consisting of a single properly insulated wire of approximately 135 feet, including the lead-in, measured from the binding post of set to the end of antenna.

It will not operate on a short antenna, and will not tune satisfactorily on one varying much from the dimensions given, unless changes are made in the coils. If the aerial must be shorter, put more turns on the variometer. It is what may be styled a double circuit loose coupled receiver, with both circuits tuned. Two dials are necessary to operate it. The cost, homemade, may be as low as \$8 exclusive of phones.

Kind of Aerial

An efficient aerial is more important for connection with a crystal receiver, than for any other form of Radio receiver. The horizontal portion of the aerial

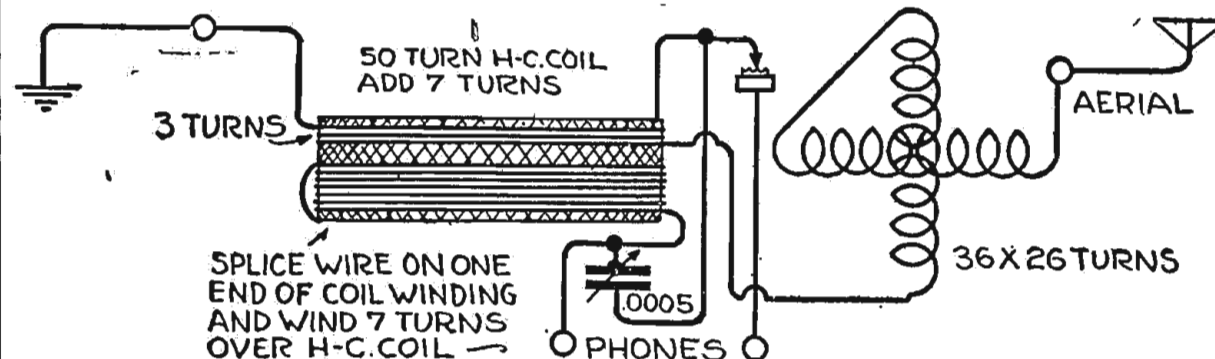

should be located as high above the ground or roofs as possible. It should be kept as far away from other objects, trees, wires, aerials, etc., as possible. It preferably should not point toward the nearest broadcasting station, but run at right angles to the direction of that station, and the lead-in end should point toward the more distant station if practical. The lead-in wire should be kept well away from the walls and coping of the building, preferably as much as 2 feet or more, and must be carefully insulated where it passes into the building, through the window frame or sash. Beware of contact with metal work, such as metal sash, frames or screens.

A single wire only, should be used. All joints and connections must be well made, and soldered, both in aerial and

ground wire. The ground wire should preferably be soldered, otherwise tightly clamped to a portion, scraped or filed clean, of some plumbing or steam fitting. Water piping is best. The ground wire should be as short as practical. A double throw switch is connected with the movable portion connected to the aerial. One terminal is connected to the aerial post of set and the other terminal is connected to the ground wire. This ground wire is also connected to the ground binding post of the set, using a flexible lamp cord, if desired, between the set and the switch for both aerial and ground connection of set. From switch to water

pipe use number 14 solid copper wire. Locate the switch close to the point where the lead-in enters the building, and keep the switch in position to ground the aerial when not in use.

Cabinet and Panel

Any sort of wood cabinet will do, and it can be made of a deep 5 by 9-inch mahogany cigar box if desired. Do not wet, but scrape and sandpaper off all labels and printing; oil or varnish as desired. The panel may be of rubber, bakelite, or the wooden cigar box cover may be used. It should be not less than 9 inches long. A high grade, low-loss pig-tailed condenser is always desirable, but the set will operate with one of the

cheaper kind if well made. The capacity should be .0005 mfd. (23 plates usually). Vernier knob is not desirable, but a vernier knob may be used operating the main dial. Connect rotor to side of coil that does not connect to the crystal. This condenser tunes the secondary circuit, formed of the honeycomb coil.

Variometer Tunes Primary Circuit

The variometer tunes the primary circuit. It is made of two pieces of heavy cardboard mailing tube. The stator is 2 1/2 inches in diameter and 1 3/4 inches wide, and the rotor 2 inches or 2 1/8 inches in diameter, and about 7/8 inch wide or narrow enough to turn freely within the 2 1/2-inch tube. The stator is wound with 36 turns of number 26 dcc. wire and the rotor with 26 turns of the same wire. The shaft may be made of bakelite or a hard wood 1/4-inch rod. The bearings for the shaft may be of wood or brass secured to the stator tube. The shaft should fit with sufficient friction to hold it in any position, otherwise it should turn freely. The windings of the two coils must run in the same direction and are connected together in series. The free end of the stator is connected direct to the aerial binding post. The free end of the rotor is left long enough to make three turns around the honeycomb coil, and then is connected to the ground binding post. These three turns are wound in the same direction as the windings of the honeycomb coil.

(The following and concluding part tells how to amplify this set and also gives the list of parts, their cost, and a panel layout.—Editor's Note.)

Efficient DX Tuning

Get into the habit of using the ear-phones when tuning in a station before turning on the loud speaker. It is easier to control the regeneration in this way and less squealing will be heard in others' receivers.

An **ALL-AMERICAN**
THREE TUBE REFLEX
Tunes through the "Locals"
To the Station You Want

Tour the Country
by Radio with
ALL-AMAX SENIOR

NO longer is it necessary to pay \$200 to get a real modern long-distance receiver—not if you are willing to spend "one delightful evening" wiring up an ALL-AMERICAN receiver—left unwired at the factory in order to cut down the cost to you.

Outstanding selectivity, clearest tone quality, precision manufacture insuring reliability—all are there. No need to envy your neighbor's multi-tube set; you can afford ALL-AMAX SENIOR. Take it home this evening; go on your first "tour of the country" before you retire for the night! Price, complete with full instructions (Semi-finished) \$42.00

ALL-AMAX JUNIOR

A One-Tube Reflex which actually tunes out the locals, or brings them in on the speaker when desired. ALL-AMERICAN reliability throughout. No storage battery required.

Price, complete with full instructions (Semi-finished) . . . \$22.00

THE RADIO KEY BOOK
tells about ALL-AMAX circuits
and many others. The most
up-to-date book on radio you
can get (48 pages). Send for it
now—10c, coin or stamps.



Rauland Manufacturing
Company
Pioneers in the Industry
2640 Coyne St., Chicago

Largest Selling Transformers in the World

EISEMANN
ELECTRICAL EQUIPMENT

Type 6-D

A New Broadcast Receiver —now on demonstration

SPECIFICATIONS

- Circuit: Two stages of tuned radio frequency, detector and two stages of audio frequency. Non-oscillating.
- Tubes: Five.
- Batteries: Storage or dry-cells.
- Cables: Complete set supplied.
- Wave Lengths: 200 to 600 meters, with uniform efficiency of reception.
- Panel: Aluminum. Black crystal-line finish.
- Dials: Sunken design.
- Rheostats: Adequate resistance for all standard base tubes.
- Condensers: Single bearing, low leakage loss.
- Sockets: Suspended on cushion springs.
- Cabinet: Mahogany, with space for "B" batteries.

Type 6-D

Price \$125.00
without accessories

Unquestionably the outstanding offering of the year. Unrivalled performance, handsome appearance and moderate price.

EISEMANN MAGNETO CORPORATION
165 Broadway, New York

Authorized Distributors



in Principal Cities

STATIONS IN ORDER OF WAVE LENGTHS USED

Meters	Call	Meters	Call	Meters	Call	Meters	Call	Meters	Call	Meters	Call
238	KFQX	286	KFKB	341	CHYC	380	WGY	423	WLW	476	WFAA
244	WABN	286	KFGZ	345	WCBD	380	WHAZ	425	CKAC	480	CYL
248	WBBG	286	WAAW	345	WLS	385	WOAI	429	WSB	484	WHAA
263	WGAQ	286	WJAS	360	KJS	390	WJAX	430	CFAC	484	WOC
266	KFNF	286	WKBF	360	KOB	390	WTAM	435	AT9	492	KGW
268	KFPT	286	WTAS	360	WBT	395	KHJ	435	CNRO	492	WEAF
273	WBBR	291	KFKX	360	WCAL	395	WDAR	435	NAA	500	WMC
273	WEBJ	291	WEAO	360	WEAY	395	WFI	435	CFCN	509	KLX
273	WFBH	303	WEEI	360	WGI	400	CPCA	440	WQJ	509	WIP
273	WMAK	309	KFDM	360	WHA	400	PWX	448	WMAQ	509	WOO
273	WRW	309	WVH	360	WHN	400	WHAS	448	CKY	517	WCX
278	WJJD	312	WSAI	360	WJAR	405	WJY	450	KFOA	517	WWJ
278	WLRL	312	KGO	360	WKAQ	405	WOR	455	WJZ	526	WHO
278	WNAC	319	WGR	360	WOI	410	CKCD	455	WCAE	526	WNYC
278	WRBC	326	KDKA	360	WRL	411	WDAF	462	KPI	526	WOAW
283	KFMX	330	CYX	360	WSAC	411	WHB	469	WCAP	526	KYW
283	WHK	330	KFAE	370	CYB	417	WCCO	469	WRC	536	KSD
283	WTAY	337	KNX	370	WEBH	423	KPO	469	WBAP	546	
		337	WBZ	370	WGN	423	WBAV	476			

The Reader's View

Honeycomb Coil Sets

In a recent issue of Radio Digest Mr. Geo. Tate of Dallas, Texas, has some nice things to say of honeycomb coil sets. I quite agree with him as to their efficiency, but if Mr. Tate will try the following method of inserting the phone

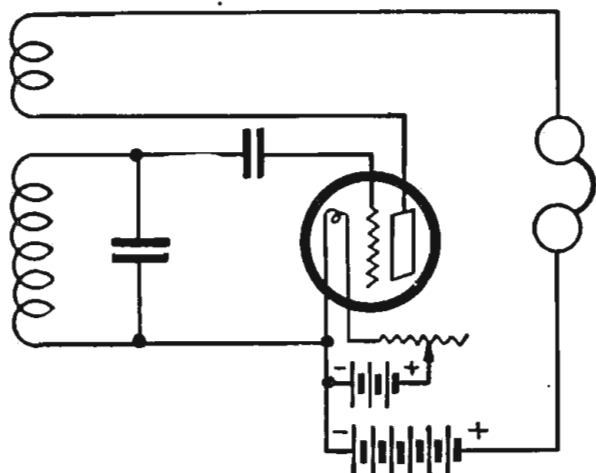

in the plate circuit he will find, I am sure, that he has secured not only the final quality he refers to but a positive freedom from any capacity effect as well, providing, of course, that the B battery voltage is not too high. Both diagrams shown in Mr. Tate's article show phones inserted in the wrong place; wrong, that is, because of the strong capacity effects encountered.

In my own set I have not used an inch

of shielding material and I can handle the coils or condensers without detuning even the weakest signals. CYL has come in on three tubes too loud for head phone comfort and West Coast stations will often operate the loud speaker with fair volume, if I want to sit up for them.—R. B. Eaton, Toronto, Canada.

Automobile Battery Charger

Perhaps some of the rest of the Radlophans would be interested in what I have found to be rather an annoying interference.

For nearly one solid week I have tried to determine what the cause was that made even local reception impossible with a five tube neutrodyne set. I tried out various suggestions, such as arc circuit interference, transmission interference, etc., but in the end I was more than convinced that the trouble was of an external source so I continued searching until I wandered into a nearby garage.

Here I found that they were operating a vibrating type battery charger which was not properly adjusted. It was set correctly and immediately the interference disappeared entirely.

Trusting that this may be of some assistance to others who have not as yet located the source of the interference they are having.—H. E. Miller, Emaus, Pa.

If you want to drill a glass panel, form a small basin with putty where you want to drill and fill it with turpentine. Put a sharpened three-cornered file in the brace and go ahead.

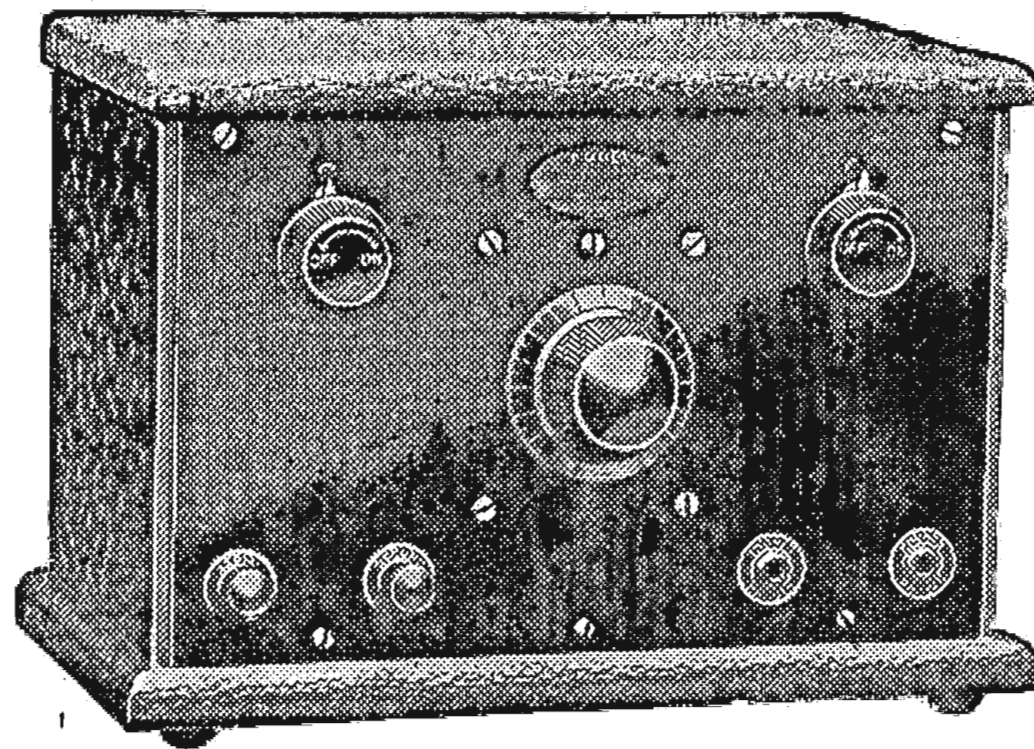

\$1800

Model C-12 Two-tube Receiver. A great distance getter; puts local stations on the horn; single dial tuning.

KODEL

for **Every purpose**
for **Any purse**

\$5 to \$3250

RADIO'S latest triumph—the wonderful KODEL Circuit, brilliant discovery of an independent experimenter. So simple it can be sold at amazingly low prices, so effective that it gives as good or better results than receivers costing much more. Single dial tuning except in the 3 and 4 tube models, which have only two dials.

Powerful, compact, great for distance, works perfectly without an outdoor antenna, all at prices anyone can afford. Cabinets finished in handsome black leatherette. You may use either storage battery or dry battery tubes.

See the KODEL line at your dealer's. If he does not carry these marvelous sets, send us his name and address and we will mail you the interesting KODEL catalog, from which you can order direct. Money returned if any KODEL set does not more than satisfy you.

DEALERS: The KODEL is a sensation wherever introduced. Write for terms.

KODEL MANUFACTURING CO.

Under the same management that made the HOMCHARGER famous
215 West Third Street, Cincinnati, Ohio

FREE! Write for instructive KODEL catalog, entitled "Radio for Every Purpose and Any Purse." **FREE!**



Trade Mark
Reg. U. S. Pat. Off.

GREBE

SYNCHROPHASE
(Trade Mark)

A BROADCAST Receiver that marks another long step forward in radio design and establishes a new set of standards in craftsmanship.



"Of what use is cleverness of speech?"
—Confucius

Words, even though selected and phrased with the greatest deliberation, cannot do full justice to the Grebe Synchrophase—and its performance.

Doctor Wu

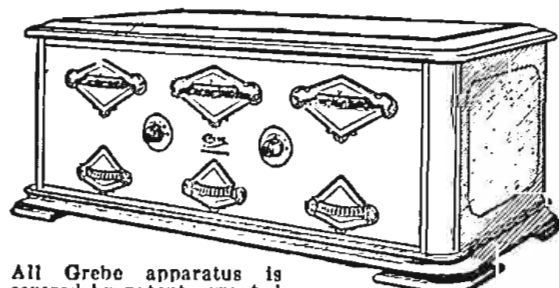

All Grebe apparatus is covered by patents granted and pending.

Ask your quality dealer for a demonstration of the Grebe Synchrophase or write us for literature.

A. H. GREBE & CO., Inc.

Van Wyck Blvd.

Richmond Hill, N. Y.

This Company owns and operates Station WAHG

Western Branch: 443 South San Pedro St., Los Angeles, Calif.

SANTA ARRIVES AT WLW MONDAY

Saturday, November 29

Saturday, silent night for: CHNC, KFAE, KFDM, KOB, WCB, WCX, WDBY, WEAQ, WHAA, WHAZ, WHB, WHO, WKAQ, WLW, WOI, WOO, WOR, WRBC.

CKAC, Montreal, Can. (Eastern, 425), 7 p. m., kiddies' stories in French and English; 7:30, Rex Battle and his Mount Royal orchestra; 8:30, La Presse studio entertainment; 10:30, Joseph C. Smith and his Mount Royal Hotel dance orchestra.

KDKA, E. Pittsburgh, Pa. (Eastern, 326), 6:30 p. m., dinner concert, Westinghouse band; 7:15, Richard the Riddler; 7:30, sport review, James J. Long; 7:45, feature; 8:30, concert, Westinghouse band.

KFI, Los Angeles, Calif. (Pacific, 469), 5-5:30 p. m., Evening Herald table talk, news; 5:30-6, Examiner news bulletins; 6:45-7, lecture; 7-8, dance orchestra; 8-9, special classical program; 9-10, Examiner varied program; 10-11, Packard Radio club "pop" songs; 11-12, Abe Lyman's Coconut Grove orchestra.

KFNH, Shenandoah, Ia. (Central, 266), 7:30 p. m., Bright Sisters string trio; 10:30, request program, Seedhouse bunch.

KFQX, Seattle, Wash. (Pacific, 238), 7-7:45 p. m., children's entertainment; 8-9, Ray Robinson and his Bagdad orchestra; 10-11, orchestra.

KFSG, Los Angeles, Calif. (Pacific, 278), 7:30-9:30 p. m., Auditorium service, sermon, "Divine Healing," Evangelist Aimee Semple McPherson, pastor.

KGO, Oakland, Calif. (Pacific, 312), 8 p. m., orchestra Scottish Rite bodies, Arthur Nord, conductor; Carl Anderson, tenor; Joyce Holloway Barthelson, accompanist; 10-1, Henry Halstead's orchestra.

KGW, Portland, Ore. (Pacific, 492), dance music, George Olsen's Metropolitan orchestra.

KHJ, Los Angeles, Calif. (Pacific, 395), 6-6:30 p. m., Art Hickman's concert orchestra, Edward Fitzpatrick, director; 6:30-7:30, Helen Pirie, David Durand, screen juveniles; Uncle John, bedtime story; 8-10, program, Eagle Radio store; 10-11 p. m., Art Hickman's dance orchestra, direction Earl Burnett.

Headliners of the Week

A MUSICAL program showing many influences will be given at WCAE, Saturday, by the Veterans of Foreign Wars, Malate Post No. 12. May Singhi Breen, whose banjo has been heard from almost every station in New York city will favor WGBS tonight.

If you enjoy the ballads of other years, tune in for June Purcell, ballad singer at KNX, Hollywood, Sunday.

Santa arrives Monday at WLW to talk over Christmas matters with the kiddies. He will do a lot of his interviewing by Radio this year. It is rumored that he is planning a big party. This is also the Monday night of the month set off by WOC for dramatics. "Too Attentive by Half," which has an intriguing title, will be broadcast by the Dramatic club.

"Merely Mary Ann" will be put on by the KGO players Tuesday evening. A well-known actress, Ruth Robinson, who has played the part of Mary

Ann on the stage many times and who has also appeared before the microphone of WGY, will play the leading role.

Wednesday, many ranchers in New Mexico will be interested in the lecture given by Professor Curry at KOB on "Water Table Studies in Mesilla Valley since 1920." Oriental music will be featured at WBBR. Toufic Moubaid, Miconia Karshoun and Elizabeth Awad are the artists.

The Far East will also be represented at WMC Thursday. Synd Hossain, editor of The Asiatic Quarterly, will give an interesting lecture. The Centerville Harmony Four, a rollicking group of singers, will appear at WHAA this same evening.

Marimbaphone selections will be the feature of KFAE Friday night. Few people know what a marimbaphone is or how it is played. The Cooper Sisters will let you in to the secret.

Ralph Emerson, organist; "The Harmony Girls;" "The Kentucky Wonder Bean," Walter Peterson; old-time fiddlers; Ford and Glenn.

WMAQ, Chicago, Ill. (Central, 447.5), 2 p. m., football game; 6, Dudley Crafts Watson; 6:15, post office athletic association program; 8, Hotel LaSalle orchestra; 8:40, Radio photologue, "The Valley of Kings," Prof. James H. Breasted; 9, weekly Chicago theater revue.

WMC, Memphis, Tenn. (Central, 500), 8:30 p. m., classical program, Harry Kohn, violinist.

WMM, Cincinnati, Ohio (Central, 309), 10 p. m., piano solos, Rudy Germain; violin solos, Heinz Loose; popular songs, Bernard and Robinson; 11, Hotel Ains orchestra; 11:20, contralto solos, Marie Turner; piano solos, Lela Lema; tenor solos, Howard Hafford.

WOAW, Omaha, Neb. (Central, 526), 6 p. m., popular half-hour; 6:30, dinner program; 9, program, auspices of Omaha Printing company; 11:15, Wovi frolic, Frank Hodek, Jr., and his Omaha nightingales.

WOC, Davenport, Ia. (Central, 484), 7:30 p. m., International Sunday school lesson, Rev. M. A. Getzender; 9, the Palmer School Radio orchestra, Erwin Swindell, conductor; messages of greeting in foreign languages, G. L. Devdhar, India; Namr Vind, Holland.

WOR, Newark, N. J. (Central, 405), 6:15-7, "Music While You Dine," Ernie Krickett's Palisade dance orchestra; 8-8:30, Schubert string quartet; 8:30-8:50, Cathedral choral club; 8:50-9:05, Schubert string quartet; 10-10:20, Cathedral choral club; 10:20-11, Sanchez and Millstead.

WQJ, Chicago, Ill. (Central, 448), 7-8 p. m., dinner concert, Ralph Williams and his Rainbo Garden orchestra; Harman J. Techtent, baritone; playlet, "Where, But in America," Oscar M. Wolf, Myron Muench, directors; 10-2, Ralph Williams and his Rainbo Skylarks; Jerry Sullivan; The Melodians, Laurie, Eddie and Bennie; Sandy Meek, Scotch tenor; Lindsey Coons, baritone.

WRC, Washington, D. C. (Eastern, 469), 7 p. m., children's stories, Peggy Ablon; 7:15, dinner concert, Irving Boernstein's Washington hotel orchestra; 8:15, Bible talk; 8:30, "Musical Appreciation," Bernice Randall; 9, Caroline Boardman McDonnell, soprano; 9:15, Katherine Floecker Cullen; 9:30, music; 10, special program for transatlantic tests.

WSA, Cincinnati, Ohio (Central, 305), 8 p. m., chimes concert; 8:15, Bicycle male quartet; contralto solos, Helen Nugent; popular songs, Bernard and Robinson; 9, weekly news review, Allison F. Stanley; 9:15, Bicycle mixed quartet; soprano solos, Helen Kessing; 12, popular song review, Bernard and Robinson; 12:30, Freda Sanker's Toad Stool orchestra.

WSB, Atlanta, Ga. (Central, 429), 8-9 p. m., Ed and Grace McConnell; 10:45, Journal hired help skylark.

WTAM, Cleveland, Ohio (Eastern, 390), 9 p. m., WTAM dance orchestra, Dr. Jones, director.

WTAY, Oak Park, Ill. (Central, 283), 6:45-7:45 p. m., William F. Hoke, tenor; Marion Leonard, violinist; Louise Leonard, pianist; 9-9:45, 10:15-11:15, Guyon's Paradise ballroom orchestra.

WVJ, Detroit, Mich. (Eastern, 517), 7:00, the Detroit News orchestra.

Sunday, November 30

Sunday, silent night for: CHNC, CKAC, KFAE, KFQX, KOB, KSD, PWX, WDAF, WEAU, WEEL, WFI, WHAZ, WIP, WJJD, WKAQ, WOI, WOR, WRC, WSAI.

CHYC, Montreal, Can. (Eastern, 341), 8:45 p. m., studio concert, M. Coteomb & Party.

CKAC, Montreal, Can. (Eastern, 425), 4:30 p. m., sacred concert.

CKY, Winnipeg, Can. (Central, 450), 7 p. m., service, Broadway Methodist church.

KOKA, E. Pittsburgh, Pa. (Eastern, 326), 2:45 p. m., concert; 4, Dr. Charles Heinroth, organist; 4:45, Rev. Hugh Thomson Kerr, minister; 6:30, dinner concert, Scalzo's orchestra; 7:30, services, Smithfield Methodist Episcopal church, Rev. Daniel E. Marsh.

Dr. Hugo Riesenfeld (left), directing the Rivoli Ensemble which broadcasts every Tuesday evening at 8:30 p. m., from WEBJ, New York.



Barbara Case, who is well known throughout the State of Michigan for her concert work is also popular over the Radio. She will appear again at WVJ, Tuesday night, December 2.



KNX, Hollywood, Calif. (Pacific, 337), 6-7:30 p. m., dinner hour music; 8-10, program sponsored by Frank New, presenting Newbrook trio; 10-11 p. m., dance music.

KPO, San Francisco, Calif. (Pacific, 423), 8-12 p. m., Art Weidner's dance orchestra; fourth tango lesson, Ethel Suhl.

KSD, St. Louis, Mo. (Central, 546), 4 p. m., hour for housewives; 8, St. Louis Symphony orchestra, Rudolph Ganz, conductor; 11, Varsity club orchestra.

KYW, Chicago, Ill. (Central, 536), 6:35-7 p. m., children's bedtime story, Uncle Bob; 7-7:30, dinner concert, Congress hotel; 8-8:58, Esther Spira, soprano; Kathleen Morris, pianist; Harold Morris, baritone; Betty Madel, dramatic reader; 9:05, Youth's Companion; 9:35-11:30, late show; 12-2, show, Congress hotel studio; Coon-Sanders Original Nighthawks.

PWK, Havana, Cuba (Eastern, 400), 7:30-9 p. m., quartet, Mrs. Caridad de Miguel, director.

WBAV, Columbus, Ohio (Eastern, 423), 9 p. m., dance orchestra, Spring Lakes pavilion.

WBBR, New York, N. Y. (Eastern, 273), 8 p. m., Hawaiian guitar solos, Eric Howlett; 8:10, vocal duets, hymns; 8:20, Bible questions and answers, Judge Rutherford; 8:40, vocal duets; 8:55, Eric Howlett.

WBZ, Springfield, Mass. (Eastern, 337), 6 p. m., Leo Reisman Hotel Lenox ensemble; 6:30, Copley Plaza orchestra, W. Edward Boyle, director; 7:05, bedtime story for the kiddies; 7:30, Hotel Kimball trio; 7:45, "Gotterdammerung," English Grand Opera company; 10:30, Leo Reisman and his Hotel Brunswick orchestra.

WCAE, Pittsburgh, Pa. (Eastern, 462), 2 p. m., Army-Navy football game; 6:30, dinner concert, William Penn hotel; 7:30, Uncle Kaybee; 8:30, musical program, Veterans of Foreign Wars, Malate Post No. 12.

WCCO, Minneapolis-St. Paul, Minn. (Central, 417), 8:30 p. m., musical program; 9, weather report; 9:30, dance program, Original Geo. Osborn's Nicolett hotel orchestra.

WCX, Detroit, Mich. (Eastern, 517), 4:15 p. m., music, "The Venetians;" 6, dinner concert, Hotel Tuller.

WDAF, Kansas City, Mo. (Central, 411), 6-7 p. m., school of the air, piano tuning-in number on the Duo-Art; address, member of the editorial staff of the Star; the Tell-Me-a-Story Lady; music, Hotel Muehlebach Trianon ensemble; 11:45-1 a. m., night-hawk frolic, the "Merry Old Chief" and the Plantation Players.

WOAR, Philadelphia, Pa. (Eastern, 395), 7:30 p. m., Dream Daddy.

WEAF, New York, N. Y. Eastern, 492), 1:45-4 p. m., Navy-Army football game direct from Baltimore, Md., Graham McNamee, announcing; 4-5, Bruno Brothers dance orchestra; 6-7, dinner music, Waldorf-Astoria hotel; 7-7:15, stories for boys, Fred J. Turner; 7:15-7:30, Efin Rosanoff, cellist; 7:30-7:45, Mme. Aliette D'Orme Baker, dramatic soprano; 7:45-8, Jack Glogan, organist; 8-10, concert, Waldorf-Astoria concert orchestra; 10-11, Christian Science oratorio society; 11-12, Vincent Lopez and his Hotel Pennsylvania orchestra.

WEBH, Chicago, Ill. (Central, 370), 7-8 p. m., Oriole orchestra, concert; Radio Sunday school lesson, Dr. Herbert W. Virgin; Hazel O'Neil, soprano; 9-10, Oriole orchestra; Mario Kelly, readings; Longdon brothers, Hawaiian guitarists; Oriole orchestra; The Three Musketeers, songs.

WEEL, Boston, Mass. (Eastern, 303), 2:30 p. m., Army-Navy football game at Baltimore; 7:20-10, program from Mark Strand theater, N. Y. city.

WFAS, Dallas, Tex. (Central, 476), 8:30-9:30 p. m., Mrs. Otis P. Holt, soprano; William H. McRaven, pianist; 11-12, Adolphus Hotel orchestra.

WFI, Philadelphia, Pa. (Eastern, 395), 2 p. m., Army-Navy football game, direct from field; 6:30, Meyer Davis Bellevue Stratford concert orchestra; 7, Sunny Jim, the kiddies' pal; 8, special international program. Greetings to all nations; English greetings, Stanley Rose, of London; English songs, Mae Simington Staugh; French greetings, Maurice Billard; French songs, Amy Jacque, soprano; Italian greetings, Chevalier Luigi Siliti; greetings to Scandinavia, Mathias Moe, Norwegian-Danish consul; Welsh songs, Lewis Brothers' quartet; Irish selection, Four-leaf Shamrock quartet; Scotch selections, Clain Gordon Bagpipe band; greetings to Spain, Canillo De Motta; greetings to Poland, Casimir Sienkiewicz, Polish selections, Roman Nitecki, violinist.

WGBS, New York, N. Y. (Eastern, 316), 6:30-6:45 p. m., York trio; 6:45-7, May Singhi Breen, banjoist; Peter De Rose, pianist; 7-7:15, York trio; 7:15-7:30, May Singhi Breen, banjoist; 9:30-9:40, Sam Comly's movie chats; 9:40-10, Kay Macrae, soprano; 10-10:20, Royal male quartet; 10:20-10:40, Mark Wornow, violinist; 10:40-11, Bernard Mann, pianist.

WGN, Chicago, Ill. (Central, 370), 6 p. m., organ recital Lyon & Healy; 6:30-7, 8-8:30, dinner concert; 8:30-9, classical program, John Loring Cook artists; 10-11, silent for foreign reception.

WGR, Buffalo, N. Y. (Eastern, 319), 6, dinner music, Hallpyrd string quartet; 10-11, Vincent Lopez Hotel Statler dance orchestra in international tests, with Harold Gieser, director; Richard Miller, tenor soloist.

WGY, Schenectady, N. Y. (Eastern, 380), 9:30 p. m., dance music, Phil Romano's orchestra.

WHAS, Louisville, Ky. (Central, 400), 7:30-9 p. m., concert, auspices, Buddie Ridsdale and his Minstrel boys; specialty number, Russell Robinson and Al Bernard.

WHK, Cleveland, Ohio (Eastern, 283), 6 p. m., Ponce de Leon orchestra, Herbert Hayward, director, Grebe's Hanna restaurant; sports, news; 8, Rainbow club entertainers, Jessie, Violet Owens, Alice Crandall, Lucille Phillips, Billie Bugbee, Betty Booth, Bobbie and Dede Fitzpatrick, Ethel Rhode, George Seegitz, O'Mara and Cody, Art Cooke, John Peattie, Scotty Middleton, John Paul, Dean Smith, Bert Lloyd; Al Phillips, Rudy Hopke, Worley Alton, Norman Waldman, WHK-Bellhops orchestra, Dean Smith, director; 10, Ray Stillwell's New York dance orchestra.

WHN, New York, N. Y. (Eastern, 360), 6:30-7:30 p. m., Alamac hotel orchestra; 7:30-8, Hotel Carlton Terrace orchestra; 8-8:15, Good night children, Elizabeth Morrison-Jones; 8:30-9, George Cameron Emstie, pianist; Jeanne La Mar, soprano; 9-9:15, Metropolitan trio; 9:15-9:30, Alfred Dullin, pianist; 9:30-10, City

Betty Ross (right), magazine and newspaper feature writer, is giving a series of intimate chats and close-ups of celebrities of literary and artistic circles, both in America and Europe, Wednesday afternoons at WHN, New York.

College Five orchestra; 10-10:15, Jimmy Flynn, tenor; 10:15-10:30, Fitzpatrick Brothers; 10:30-11, Jimmy Clarke and his entertainers; 11:30-12, Roseland dance orchestra.

WIP, Philadelphia, Pa. (Eastern, 509), 6:05 p. m., Hotel St. James dinner orchestra; 7, Uncle Wip's bedtime stories; 8, "Chemistry In and About the Home," Professor Freeman P. Stroup; 8:15, "Physical Efficiency Look," Frank H. Baker; 8:30, Paly, "The Twelve-Pound Look," students Emilie Krider Norris dramatic school; 9, recital, Helen A. Coles, violinist; Galileo Romanelli, baritone; Charles A. Young, pianist; Helen A. Coles; E. Clapp, pianist; 10:05, Art Coogan and his Club Madrid orchestra; 11:05, organ recital, Karl Bonawitz.

WJG, Mooseheart, Ill. (Central, 278), 7:15-8:15 p. m., moving picture performance; music; 9-12, dance music, Log Cabin.

WJZ, New York, N. Y. (Eastern, 455), 2-4 p. m., Army-Navy game by J. Andrew White, direct from Baltimore, Md.; 7-8, Waldorf-Astoria dance orchestra; 8-8:10, "Faery Tales and History of the South Seas," Mrs. Ethel Watts Mumford; 8:10-8:25, Sandu Albu, violinist, Mrs. Nicholaieff, accompanist; 8:25-8:45, Myrtle Maughan, soprano; Kelth McLeod, accompanist; 8:45-9:15, Sandu Albu, violinist; 9:15-9:45, Lev Gold's Camco orchestra; 9:45-10:30, program, arranged by Ed. Squires; 10:30-11:30, Hotel Astor dance orchestra.

WLS, Chicago, Ill. (Central, 345), 7 p. m., "Big" Ford and "Little" Glenn's trip to Russia; 8-12, WLS frolic, Isham Jones and his College Inn orchestra;

KFDM, Beaumont, Texas (Central, 306), 9 p. m., sacred concert.

KFGZ, Berrien Springs, Mich. (Central, 286), 8:15-8:30 p. m., sacred concert, Radio choir; 8:30-8:45, sacred readings, Prof. E. L. Pearson; 8:45-9:15, chapel service, Pastor John Knox.

KFI, Los Angeles, Calif. (Pacific, 469), 6:45-7 p. m., musical appreciation talk; 7-8, stage acts, features and orchestra, Metropolitan theater; 8-9, concert orchestra, Ambassador hotel; 9-10, Examiner Dance orchestra; 10-11, Packard Six dance orchestra.

KFNH, Shenandoah, Ia. (Central, 266), 3 p. m., services, Methodist church; 6:30, regular sacred song service.

KFSG, Los Angeles, Calif. (Pacific, 278), 7-9:45 p. m., evening service, Angelus temple; Esther Fricko Green, organist; 10-11, organ recital, Roy Reid Briggall.

KGO, Oakland, Calif. (Pacific, 312), 11 a. m., service, First Congregational church, Rev. James L. Gordon, pastor; 3:30 p. m., KGO Little Symphony orchestra, Carl Rhodehamel, director; 7:45, services, First Congregational church.

KGW, Portland, Ore. (Pacific, 492), 6 p. m., church services, "Church of Our Father," Rev. W. J. Elliot, pastor; 7, Colburn concert orchestra.

KHJ, Los Angeles, Calif. (Pacific, 395), 6:30-7 p. m., Art Hickman's concert orchestra, Edw. Fitzpatrick, director; 7-7:30, organ recital, First Methodist Episcopal church, Arthur Blakely, organist; 8-10, program, Martin Music company, by J. Howard Johnson, director.

(Continued on page 12)

ORIENTAL ARTISTS APPEAR AT WB

Where to Hear Concerts

Central Standard Time

THESE are the stations for music lovers to dial, and you can hear, providing you dial correctly and read the programs carefully, everything from jazz to opera.

Saturday, November 29: 6, KGO, WFAE, WGBS, WGN, WOAW; 6:15, WRC; 6:30, PWX, WBZ; 6:45, WBZ, WTAY; 7, WBBR, WFAE, WLS, WQJ; 7:10, WJZ; 7:15, WJJD; 7:30, CKAC, KDKA, KFNF, WCAE, WHAS, WHAZ, WHN, WHO; 8, KNX, KSD, WGN, WIP, WRC, WSAI; 8:30, KHJ, WFAA, WMC; 8:40, WGBS; 8:45, WJZ, WRC; 9, KHJ, WHN, WMAQ, WOAW, WTAY; 9:15, WSAI; 10, KFI, KGO, KHJ, WMH, WQJ; 10:15, WTAY; 10:20, WGBS; 10:30, KFNF; 11, KFI, WMH; 11:15, WOAW; 12, KFI, WCAL, WSAI.

Sunday, November 30: 6, WJZ; 6:15, WGR; 6:20, WEEI; 6:30, KFNF, WLS; 7, WLS; 7:30, KDKA, WDAW; 7:45, CHYC; 8, WQJ; 8:10, WBBR; 8:15, KFGZ, WFAE; 8:30, KHJ, WCAL; 8:45, WLW; 9, KFI, KGW, KHJ, WBBR, WFAA, WGN, WGR, WHN, WOAW; 9:30, WFAA, WOC; 10, KFI, KHJ, KNX; 10:30, KPO; 12, KFSG, KNX.

Monday, December 1: 6, WCX, WGN, WJZ; 6:30, WEEI, WGN; 6:45, WCAE, WFAE, WGY; 7, KSD, WBBR, WCAU, WEEI, WHN; 7:15, WJJD; 7:30, KOB, WCAE, WRBC; 7:45, WDAW; 8, WCAE, WCBD, WFAE, WGR, WHAA, WHAZ, WHO, WLW, WMH, WOC, WSB; 8:15, KFGZ, WHN; 8:30, WFAA, WMC; 8:40, WEEI; 9, KSD, WMH; 9:03, WOO; 9:30, KFAE, WGR; 10, KGO, KGW, KPO, KNX, WOC, WSAI; 10:45, WSB; 11, KFI, KPO; 11:15, WHO.

Tuesday, December 2: 6, KGO, KSD, WGN; 6:30, WEEI, WLS; 6:45, WCAE, WTAY; 7, KDKA, WGY, WQJ; 7:15, WIP, WJJD; 7:30, CKAC, KDKA, KFNF, WEEI, WHAS, WLS, WSAI; 8, KHJ, KNX, WCAE, WFI, WGN, WGY, WHB, WIP; 8:20, WRC; 8:30, KFSG, WFAA, WMC; 8:45, KFI;

9, WCX, WEEI, WLS, WSAI, WTAY; 9:03, WOO; 9:05, WFI; 10, KFI, KGO, KHJ, KJS, KPO, WLW; 10:15, WTAY; 10:20, WGY; 10:30, KGW; 10:45, WSB; 11, KFI, WFAA, WMAQ, WLS; 12, WLS.

Wednesday, December 3: 6, KGO, WCX, WGN; 6:45, KSD, WTAY; 6:30, WFAE, WLS; 6:40, WEEI; 6:45, WCAE; 7, WBBR, WCAU, WHN, WQJ; 7:15, CKY, WJJD; 7:20, WFAE; 7:30, KFNF, WDAW, WHAS, WLS; 7:40, WBBR; 8, KFDM, WDAF, WEEI, WGR, WHN, WMH, WOC; 8:15, WOR; 8:30, KHJ, WCAE, WGN; 9, KNX, WEEI, WGR, WLS, WLW; 9:30, KFI, KFSG, WMH, WOR; 10, KFI, KGW, KNX, WLS, WQJ; 10:30, WEEI, WKAQ; 10:40, WLS; 10:45, KHJ; 11, KNX; 12, KFI.

Thursday, December 4: 6, KGO, WCX, WGN; 6:15, WRC; 6:30, WLS; 6:45, WCAE, WTAY; 7, CKY, WEAQ, WEEI, WGY, WLS, WQJ; 7:30, CKAC, WCAE, WHAS; 8, KNX, WCBD, WFAE, WHB, WMH; 8:10, WBBR; 8:20, WRC; 8:30, WRC; 8:30, WFAA, WGN, WMH; 8:50, WBBR; 9, WCAL, WOC, WTAY; 9:05, WIP; 10, KFI, KGO, KHJ, KPO, WLW, WQJ, WSAI; 10:15, WTAY; 10:30, KJS, WGY, WKAQ, WLW; 10:45, WSB; 11, KFI, KPO, WFAA, WLW; 11:15, KFSG; 12, KFI, KFSG.

Friday, December 5: 6, KGO, WCX, WDAF, WGN, WJZ, WOR; 6:30, WFAE, WLS; 6:45, WFAE, WTAY; 6:50, WGY; 7, WBAV, WCAE, WCAU, WDAW, WFAE, WHB, WQJ; 7:15, CKY, WJJD; 7:30, CNRT, KFAE, KFNF, WHAS, WHO; 8, KNX, KSD, WGR, WOC, WSB; 8:30, WFAA, WGN, WMC; 8:45, KFI; 9, WEEI, WTAY; 10, KHJ; WQJ; 10:15, WTAY; 11:15, KFSG; 11:30, KHJ; 12, KFI, KFSG.

soprano; Jean Webster Erlsman, soprano; F. W. Hinz, tenor; C. J. Sloan, baritone; Roy J. Crocker, pianist. WHN, New York, N. Y. (Eastern, 360), 3-4 p. m., Queens County Christian Endeavor union; 5-5:30, Roseland dance orchestra; 5:30-6:15, Olcott Vail's String trio; 10-11, Gem Bazar entertainers. WHO, Des Moines, Ia. (Central, 526), 7:30-9 p. m., Bankers Life Radio artists; C. A. Lampman, tenor; Westervelt, baritone. WIP, Philadelphia, Pa. (Eastern, 509), 4 p. m., "Sunday talk" meeting auspices Germantown Y. M. C. A.; lecture, "Is Civilization a Success, or What's Wrong with the World," by Wm. Forkell; Harmony Brass quartet. WJAZ, Cleveland, Ohio (Eastern, 390), 9 p. m., program arranged by Radio Apparatus company, Warren R. Cox, vice president and general manager; R. A. C. Concert orchestra; Max Schmitt, director; Ben Burt, pianist; Ben Silverberg, violinist; J. Tarlitzky, violinist; Max Schmitt, cellist; string quartet, selections. WJZ, New York, N. Y. (Eastern, 455), 3:30-4 p. m., "Practical Religion," Rev. Dr. Harry Emerson Fosdick; 4:5-5:45, vespers services, St. George's church; 5:45-6, "The Metropolis of Mankind," Edgar White Burrill; Tom Morgan, baritone; 7-8, Nathan Abas' Hotel Pennsylvania orchestra. WLS, Chicago, Ill. (Central, 345), 6:30-7 p. m., Ralph Emerson, organist; 7-8, musical program, Robert W. Stevens, director. WLW, Cincinnati, Ohio (Central, 423), 7:45 p. m., sermon, Rev. Frederick L. McMillin, Walnut Hills First Presbyterian church; 8:45, Western & Southern orchestra. WMC, Memphis, Tenn. (Central, 500), 11 a. m., services, Calvary Episcopal church, Rev. Chas. F. Blaisdell, pastor. WMH, Cincinnati, Ohio (Central, 309), 7 p. m., sermon, Rev. J. J. Castleberry, Walnut Hills Christian church. WOAW, Omaha, Nebr. (Central, 526), 9 a. m., Radio chapel service, Rev. R. R. Brown, pastor of the Omaha Gospel Tabernacle of the Christian and Missionary Alliance; 2:15 p. m., matinee program, "Green Sisters Quartet"; 6, Bible study hour, under personal direction of Mrs. Carl R. Gray; 9, musical chapel service, Immanuel Lutheran church, Rev. O. A. Henry, pastor; Gus Lof, chorister; George Jerpe, organist. WOC, Gwynedd, Ia. (Central, 484), 8 p. m., church services, Rev. W. A. Tillberg, pastor; 9:30, The Palmer School Radio orchestra, Erwin Swindell, conductor. WOO, Philadelphia, Pa. (Eastern, 509), 2:30 p. m., musical exercises, opening Sunday school session, Bethany temple; 6, organ recital, Clarence K. Gaudin; 7:30, services, Bethany temple; organ recital, Caroline Quigg; sermon, Rev. A. Gordon MacLennan. WQJ, Chicago, Ill. (Central, 448), 8-10 p. m., Ralph Williams and his Rainbo Garden orchestra; Maria Dneprova, Russian soprano; Eleanor Wilson, cellist; Ruth Wilson, pianist; Carl G. Linner, pianist. WRBC, Valparaiso, Ind. (Central, 278), 7:30 p. m., church service, Immanuel Lutheran church. WSAI, Cincinnati, Ohio (Central, 309), 3 p. m., sermon; 3:10, sacred chimes concert. WSB, Atlanta, Ga. (Central, 429), 11 a. m., First Presbyterian church service; 5-6 p. m., twilight sacred service; 7-7:30, Wesley Memorial church service. WWJ, Detroit, Mich. (Eastern, 517), 2 p. m., The Detroit News orchestra; 7:30, services at the St. Pauls Episcopal cathedral.

Monday, December 1

Monday, silent night for: CKAC, CHNC, KFOM, KFNF, KHJ, KYW, PWX, WCAL, WOBY, WEBH, WEAQ, WGN, WHAA, WHAS, WKAQ, WLS, WMAQ, WOR, WRC, WTAY.

KDKA, E. Pittsburgh, Pa. (Eastern, 326), 6:30 p. m., dinner concert, KDKA Little Symphony orchestra; 7:15, children's period; 7:30, "Bringing the World to America," Our World; 8, Girl Scout meeting; 8:15, address, University of Pittsburgh; 8:30, concert. KFAE, Pullman, Wash. (Pacific, 330), 7:30-9 p. m., Vera Bohlike, soprano; Thelma Johnson, pianist; "Retaliation of Chemistry to Medicine," Dr. C. C. Todd; "Important Points in Poultry Raising," Prof. J. S. Carter; "The Progress in Its Relation to Agriculture," Lincoln R. Lounsbury.



Dorothy Wilkins (left) sings as well night at WGN, Chicago. The Richard Friday nights with the Hoot Owls, "ville," are not named after the announcer and twins. W. Spencer Tupman (right) is heard every Tuesday eve

KFGZ, Berrien Springs, Mich. (Central, 286), 7 p. m., bedtime stories; 8:15-9:15, concert, Radio Lighthouse music makers.

KFI, Los Angeles, Calif. (Pacific, 469), 5-5:30 p. m., Evening Herald table talk, news items; 5:30-6, Examiner news bulletins; 8-9, Evening Herald Radiolans dance orchestra; Fritz Kerchoff, vocalist; 9-10, Examiner; Thomas Taylor Drill recital; 10-11 dance orchestra.

KFQX, Seattle, Wash. (Pacific, 238), 7-7:45 p. m., children's entertainment; 8-9, Ray Robinson and his Bagdad orchestra; 10-11, orchestra. KGO, Oakland, Calif. (Pacific, 312), 8 p. m., music, Arion trio; "The Growing of Sub-Tropical Fruits," Prof. R. W. Hodgson; "Cause and Cure of Stammering," Robert Lloyd; "A Lesson in English," Wilda Wilson Church; "Chats about New Books," Joseph Henry Jackson; 10-11 a. m., dance music, Henry Halstead's orchestra.

KGW, Portland, Ore. (Pacific, 492), 5 p. m., children's program, travel story, Aunt Nell; 8, concert, Oregonian concert orchestra.

KNX, Hollywood, Calif. (Pacific, 337), 8-10 p. m., feature program sponsored by Los Angeles Ice and Cold Storage company; 10-11, dance music; 11-12, Abe Lyman's Cocanut Grove orchestra.

KOB, State College, N. M. (Mountain, 360), 7:30-8:30 p. m., musicale. KPO, San Francisco, Calif. (Pacific, 423), 7-7:30 p. m., Rudy Selger's Fairmont hotel orchestra; 8-9, Theodore J. Irwin, organist; 9-10, program, Leda Gregory Jackson, director.

KSD, St. Louis, Mo. (Central, 546), 7 p. m., music and specialties, Missouri theater; 9, music program, Grand Central theater; 11, dance program, Traves' Novelty orchestra.

WBBR, New York, N. Y. (Eastern, 273), 8 p. m., Irene Klempner, soprano; 8:10, vocal duets, Irene Klempner, Thyra Lundberg; 8:20, "Electronic Treatment of Disease," Dr. Mae Work; 8:40, vocal duets; 8:50, Irene Klempner.

WCAE, Pittsburgh, Pa. (Eastern, 462), 6:30 p. m., piano concert, William Penn hotel; 7:30, Uncle Kaybee; 7:45, special feature; 8, weekly music chat, Mrs. Ethel Davis; 8:15, dancing lesson; 8:30, Marie Day Moore, soprano; 9, A. & P. Gypsy string ensemble from WEA; 10, music; 10:30, flight of the mythical dirigible, Billy Cramer's orchestra.

WCAU, Philadelphia, Pa. (Eastern, 278), 6 p. m., Hotel Pennsylvania Meyer Davis dance orchestra; 8, recital and dance music. WCAV, Milwaukee, Wis. (Central, 266), 8 p. m., Hosiery night; WCAV Symphony orchestra; Hazel and Cecelia Cullan, violinist and pianist; Jackie Fingado, soprano.

WCBO, Zion, Ill. (Central, 345), 8 p. m., mixed quartet; string quartet, Mr. and Mrs. L. J. Hire; Richard F. Hire; Hermann Becker; cornet and euphonium duets, Stewart, Dunn; Dorothy Bull, soprano; Ralph Bull, tenor; Mrs. G. R. Sparrow, contralto; Josephine Martin, pianist.

WCO, Minneapolis-St. Paul, Minn. (Central, 417), 8 p. m., sport hour; 8, lecture hour; 8:30, musical program; 11, dance program. WCX, Detroit, Mich. (Eastern, 517), 6 p. m., dinner concert, Hotel Tuller; 7, musical program.

WDAF, Kansas City, Mo. (Central, 411), 6-7 p. m., school of the air, tuning-in number on the Duo-Art; personal message from Roger W. Babson, statistical expert; the Tell-Me-A-Story Lady; music, Hotel Muehlebach Trianon ensemble; 8-9:15, popular program, the Star's Radio orchestra; 11:45-1 a. m., night-hawk frolic, the "Merry Old Chief" and the Plantation players.

WDAR, Philadelphia, Pa. (Eastern, 395), 7:30 p. m., Dream Daddy's bedtime stories; movie review, James A. Nassau; Stanley theater symphony orchestra; 8:45, Laserov quartet; 10:03, Arcadia cafe dance orchestra; features, Fay's Knickerbocker theater.

WEAF, New York, N. Y. (Eastern, 492), 6-7, "dance music," A. H. Tatlow; 7:45-8, Jimmie Clark, pianist; 8-8:10, D. Appleton company; 8:15-9, Anna Fried, violinist; Erna Korn, contralto; 9-10, A and P Gypsies.

WEEI, Boston, Mass. (Eastern, 303), 6 p. m., Jack Renard and his Mansion Inn orchestra; 7, Boston Edison Big Brother club; 7:30, musicale; 7:50, talk, Stanton H. King; 8, program, Fred L. Huddy, baritone; 9:30, "Buddy's Bostonians," Fenway theater; 9:30, Mars and other planets, Dr. Leo Patterson; 9:30, program, Jack O'Brien.

WFAA, Dallas, Tex. (Central, 476), 8:30-9:30 p. m., music, J. Abner Sage, director; Durwood Cline, Martha Robertson. WFI, Philadelphia, Pa. (Eastern, 395), 6:30 p. m., Meyer Davis Bellevue Stratford concert orchestra; 7, Sunny Jim, the kiddies' pal.

WGR, Buffalo, N. Y. (Eastern, 319), 6:30-7:30 p. m., dinner music, Vincent Lopez Hotel Statler dance orchestra, direction of Harold Gleser; 8:50-9, address on "Honey"; 9-10:30, musical program; Honey Producers of Western New York; 10:30-11, recital, Arthur K. Barnes and assisting artists; 11:30, supper dance, Vincent Lopez Hotel Statler dance orchestra, direction of Harold Gleser.

WGY, Schenectady, N. Y. (Eastern, 380), 7:45 p. m., "Mining of Diamonds," A. M. Johnston; Josephine Thayer, soprano; Edward A. Rice, violinist; Walter Hoghen, cellist; Olive Yettrou, pianist; WGY orchestra. WHB, Kansas City, Mo. (Central, 411), 7-8, address, member of the faculty of the Sweeney school; music, Sweeney Novelty trio.

WHK, Cleveland, Ohio (Eastern, 283), 6 p. m., Ponce de Leon orchestra, Herbert Hayward, director, Grebe's Hanna Building restaurant; sports, news items; culinary recipes; 7, Ethel M. Hawes, bedtime story.

WHN, New York, N. Y. (Eastern, 360), 6:30-7 p. m., Alamae hotel orchestra; 7:10-7:30, fashion chats, Mme. Belle; 7:30-8, Hotel Carlton Terrace orchestra; 8-8:30, Roseland dance orchestra; 8:30-8:45, talk, H. W. Cerlough; 8:45-9, Littmann's orchestra; 9:15-9:30, music; 9:30-10, Crystal Palace orchestra; 10-11, Radio Shack orchestra.

WHO, Des Moines, Ia. (Central, 526), 7:30-9 p. m., "Care of Teeth," Emma Welsgerber; Hibbard Cleveland, bass; musical program, Dean Holmes Cowper; 11:15-12, L. Carlos Meier, organist.

WIP, Philadelphia, Pa. (Eastern, 509), 6:05 p. m., Hotel St. James dinner orchestra; 7, Uncle Wip's bedtime stories; dancing lessons for children, direction Miller Conservatory of dancing.

WJJO, Moseheart, Ill. (Central, 278), 7:15-8:15 p. m., Philharmonic orchestra; talk on athletics, Ben Oswald. WJZ, New York, N. Y. (Eastern, 455), 7-8 p. m., Bernhard Levitow's Hotel Commodore dinner concert; 8-8:10, Wall Street Journal review; 8:10-8:20, N. Y. U. Air College.

WLW, Cincinnati, Ohio (Central, 423), 8 p. m., orchestra concert, Roehr's Music Makers; 8:30, talk, Mrs. James C. Layne, Jr.; 9, Cooper orchestra.

WMAQ, Chicago, Ill. (Central, 447.5), 6 p. m., Chicago theater organ recital; 6:30, Hotel LaSalle orchestra. WMC, Memphis, Tenn. (Central, 500), 8:30 p. m., concert, Bigger's Georgia serenaders, Hotel Gayoso.

WMH, Cincinnati, Ohio (Central, 309), 8 p. m., United States Tenth Infantry band, E. G. Fisher, director; 9, Al Bernard and Russell Robinson, singing original songs; 9:30, Blue Grass entertainers.

WOAW, Omaha, Nebr. (Central, 526), 6 p. m., dramatic hour, Davis Studio of Expression; 6:30, dinner program, Sammy Helman's orchestra; 9, opera program, arranged by Lawrence Dodds, tenor.

WOC, Davenport, Ia. (Central, 484), 7:20 p. m., "Better Babies," Dr. A. B. Hender; 8, program, Kable Brothers band; 10, "Too Attentive by Half," Dramatic club.

WOI, Ames, Ia. (Central, 360), 10 p. m., program of popular music. WOO, Philadelphia, Pa. (Eastern, 509), 7:30 p. m., A. Candelori and his Hotel Adelphia French-Room orchestra; 8:30, Harriette G. Ridley, pianist; 9:25, Fox theater grand orchestra, Erno Rapee, director; 10:03, organ recital, Mary E. Vogt; 10:30, Vincent Rizzo and his Hotel Sylvania dance orchestra.

WOR, Newark, N. J. (Eastern, 405), 6:15-7:15 p. m., Cinderella orchestra, Dave Harmon; 8-8:30, "Tartan," talk, Albert Vertheamp; violinist; 8:30-9:45, musical program, Branford theater; 9:45-10:15, Arthur Murray's dance lessons, assisted by the Carolinians.

WRBC, Valparaiso, Ind. (Central, 278), 7:30 p. m., music. WSAI, Cincinnati, Ohio (Central, 309), 10 p. m., songwriters' ensemble, Bernard and Robinson; 10:15, Burns' Country club orchestra.

WSB, Atlanta, Ga. (Central, 429), 5-6 p. m., Bonnie Barnhardt bedtime story, news, markets; 8-9, Song trio; 10:45, Radlow entertainment.

WTAM, Cleveland, Ohio (Eastern, 390), 6 p. m., Philip Spitalny's Music Box orchestra; 8, Girls' club of East High school, concert program, assisted by WTAM Symphonic ensemble, Walter Logan, director.

WWJ, Detroit, Mich. (Eastern, 517), 8:30 p. m., The Detroit News orchestra; F. Eugene Wilson, baritone.

Tuesday, December 2

Tuesday, silent night for: KFAE, KFDM, KOB, PWX, WBBR, WCAL, WCAU, WCBD, WOBY, WEAQ, WHAZ, WHO, WOC, WOI, WOO, WRBC.

CHNC, Toronto, Can. (Eastern, 350), 8:30 p. m., Viggo Klhl, pianist; Lutzi Von Kunitz, violinist; Vera McLoan, contralto; Doris Shipman, soprano.

DA (Central)

Saturday

6, WJZ; 6:30, CKAC; 7, WLS; 7:30, WJZ; 8, 9, KFI; WOC; 9, CKAC; 10, KFQX; 10:30, WHN; 11:45, KFQX; K H J; WSAI;

Monday

6:30, WLW; 7, WJZ; 7:30, WHN; 8, WEA; 8:30, WJZ; 9, KFQX; 10, KFI; 11, WHN; 12, KFQX; KHJ, K

Tuesday

6:15, WJZ; 6:30, WEA; 7:30, WBAV; 8:30, WJZ; 9:15, WCAE; 10, KFQ; 10:30, WJZ; 11:45, WLS; 12, KFQ; KHJ, K

Wednesday

3: 6, WGR; 7, WHO; 7:30, WOO; 8, KNN; 8:30, WJZ; 9, KFQ; 10, WLS; 11:45, WDA; 12, KFQ; KHJ, K

Thursday

6, WJZ; 6:30, WOL; 7:30, KPO; 8, KFI; 9, WJZ; 10, KFI; 11:45, WDA; 12, KFQ; KHJ, K

Friday

6, WDA; 6:30, K; 7:30, WDA; 8:30, WDA; 9:30, WGY; 10:30, WDA; 11:45, WDA; 12, KFQ; KHJ, K

MARIMBAPHONE SOLOS AT KFAE



Where to Hear Talks

Central Standard Time

TALKS, instructive, serious, humorous and even frivolous, are Radiocast daily and below are listed the stations.

- Saturday, November 29:** 6, WDAF, WMAQ; 7, WFL, WIP, WJZ; 7:15, WRC; 7:30, WOC, WRC; 8:30, WGBS; 9, WFAF, WSAI; 9:30, KFSG.
- Sunday, November 30:** 6, WDAF; 7, WMH; 7:45, WLW; 8:25, WBBR; 8:30, KFGZ; 8:45, KFI.
- Monday, December 1:** 6, WDAF; 6:30, KDKA; 6:50, WEEL; 7, KDKA, WCAE, WHB, WJZ; 7:20, WOC; 7:30, WFAF, WHN, WHO; 6:45, WGY; 7:50, WGR; 8:30, WEEL, WLW.
- Tuesday, December 2:** 6, WDAF, WJZ; 6:10, WHN; 6:30, CKY; 6:45, WGY; 6:50, WDAF; 7, WFAF, WFL, WIP, WJZ, WRC; 7:30, WOR; 8, WLS, WRC; 8:30, KHJ; 10, KGW.
- Wednesday, December 3:** 6, WDAF; 6:30, WHN; 7, WFAF, WGR, WHB, WJZ; 7:20, WBBR; 7:30, CKY; 8, WLS; 8:45, KFI; 8:30, KOB; 9:30, WLS; 10, KHJ; 11, KFI.
- Thursday, December 4:** 6, WDAF; 6:10, WHN; 7, WJZ; 7:15, WRC; 7:30, WFAF, WFL, WIP; 7:45, WGY, WRC; 8, WMC; 8:30, KHJ, WBBR, WFAF; 9:30, KHJ.
- Friday, December 5:** 6:30, CKY; 7, WJZ; 7:20, WOC; 7:45, WGY; 7:50, WGR; 8, WLS; 8:30, KHJ, KOB, WCAI; 8:30, WHN; 9:45, KNX; 10, KGW; 11:15, KFSG.

...s and may be heard almost any although they appear at KGW, called the "Sweethearts of Vaudeville" are, by the way, really sisters leader of Le Paradis band which RC, Washington, D. C.

- CKAC, Montreal, Can. (Eastern, 425), 7:30 p. m., Rex Battle and his concert orchestra; 8:30, French Canadian folklore, Conrad Gauthier; 10:30, Joseph C. Smith and his Mount Royal hotel dance orchestra; 12:30, frolics.
- CKY, Winnipeg, Can. (Central, 450), 7:30 p. m., lecture; 8:15, concert, Mason & Risch Piano company.
- KDKA, E. Pittsburgh, Pa. (Eastern, 326), 8:30 p. m., Albert Taylor, organist; 7:15, children's period; 8, feature; 8:30, concert.
- KFI, Los Angeles, Calif. (Pacific, 469), 5-5:30 p. m., Evening Herald news items, table talk; 5:30-6, Examiner news bulletins; 6:45-8, Aeolian Pipe organ recital, Dan McFarland; 8-9, Anthony studio program; 9-10, Examiner; Radio show program; 10-11, Packard Ballad hour.
- KFNF, Shenandoah, Ia. (Central, 266), 7:30 p. m., program, Trinity Lutheran church.
- KFQX, Seattle, Wash. (Pacific, 238), 7-7:45 p. m., children's entertainment; 8-9, Ray Robinson and his Bagdad orchestra; 10-11, orchestra.
- KFSG, Los Angeles, Calif. (Pacific, 278), 6:30-7:30 p. m., Gray studio program, Uncle Jim and associates.
- KGO, Oakland, Calif. (Pacific, 312), 8 p. m., "Merely Mary Ann," KGO players; Arlon trio; 10-11 a. m., dance music, Henry Halstead's orchestra.
- KGW, Portland, Ore. (Pacific, 492), 5 p. m., children's program; 8, agricultural lecture, Oregon Agricultural college extension service; 8:30, concert.
- KHJ, Los Angeles, Calif. (Pacific, 395), 6:30 p. m., Art Hickman's concert orchestra, direction Edw. Fitzpatrick; 6:30-7:30, Prof. Walter Sylvester Hertzog, stories American history, weekly visit of sandman and Queen Titania of Fairyland, Uncle John; 8-10, program presented by Hellman Bank, A. K. Berkland; 10-11, Art Hickman's dance orchestra, Earl Burnett, director.
- KIS, Los Angeles, Calif. (Pacific, 360), 8-9 p. m., special musical program, classical music.
- KNX, Hollywood, Calif. (Pacific, 337), 6-7:30 p. m., dinner hour music; 8-10, Lindsay's Studebaker dance orchestra; 10-11, Abe Lyman's Coconut Grove orchestra.
- KPO, San Francisco, Calif. (Pacific, 423), 7-7:30 p. m., Rudy Selger's Palmont hotel orchestra; 9-10, program, U. S. Army band; Theodore J. Irwin, organist; 10-11, E. Max Bradford's Versatile band.
- KSD, St. Louis, Mo. (Central, 546), 4 p. m., home economics program; 7, Benjamin Rader's orchestra.
- KYW, Chicago, Ill. (Central, 536), 7-7:30 p. m., dinner concert, Congress hotel; 7:30-7:45, "Around the town with KYW Chicago"; 8-8:20, Margaret Martin, soprano; Frank Cowen, tenor; Esther Remington, pianist; Hougstad sisters; 8:20-8:50, speeches, auspices American Farm Bureau federation; 8:50-9:30, music; 10-11:30, at home program; Coon-Sanders Original Night-hawks.
- WBAV, Columbus, Ohio (Eastern, 423), 8 p. m., WBAV orchestra, Frances Handbau, director.
- WCAE, Pittsburgh, Pa. (Eastern, 462), 8:30 p. m., dinner concert, William Penn hotel; 7:30, Uncle Kay-heo; 7:45, special feature; 8, Pittsburgh Council of Catholic Women's choral club; 9, concert, National Carbon company's Eveready entertainers; 10:30, "Sid" and his Loew's Aldine theater gang.
- WCAY, Milwaukee, Wis. (Central, 266), 9:15 p. m., Sundodgers; Blackstone serenaders; Arthur Busse, tenor; Anne Bauman, contralto.
- WCCO, Minneapolis-St. Paul, Minn. (Central, 417), 6:30 p. m., dinner concert; 9, weather report; musical program.
- WCX, Detroit, Mich. (Eastern, 517), 8 p. m., dinner concert, Hotel Tuller; 10, Red Apple club.
- WDAR, Philadelphia, Pa. (Eastern, 395), 7:30 p. m., Dream Daddy's bedtime stories; 7:50, "Both Sides of the Footlights," Arnold Abbott.
- WDAF, Kansas City, Mo., (Central, 411), 6-7 p. m., school of the air, tuning-in number on the Duo-Art; eighth of a series of Radio piano lessons, Maudellen Littlefield; the Tell-Me-a-Story Lady; music, Hotel Muehlebach Trianon ensemble; 11:45-1 a. m., night-hawk frolic, the "Merry Old Chief" and the Plantation players.
- WEAF, New York, N. Y. (Eastern, 492), 8-7, dinner music, Waldorf-Astoria hotel; 7:30-8, John C. Smith

- and his Modern dance orchestra; 8-8:20, Columbia university; 8:30-9, National Carbon company.
- WEBH, Chicago, Ill. (Central, 370), 7 p. m., Oriole orchestra, concert; Jessie B. Teck, soprano; Clarence Deabens, baritone; musical bits, Balaban & Katz Riviera theater; 9, Oriole orchestra; Harry Davis, baritone; musical bits, Balaban & Katz Riviera theater; 11, Oriole orchestra; Nick Lucas, songs; Dean Remick, pianist.
- WEBJ, New York, N. Y. (Eastern, 273), 7-7:15 p. m., Blybrun's reviews of the new photoplays; 7:15-7:45, Dan Gregory and his Crystal Palace orchestra; 8-8:15, Masonic quartet; 8:15-8:30, Henryetta Turner, the ukelele girl; 8:30-9, Al Rienzo's revue, songs and dance music.
- WEI, Boston, Mass. (Eastern, 303), 6:30 p. m., dance selections, Dok-Eisenburg and his Sinfonians; 7, Boston Edison Big Brother club; 7:30, musicale; 8, musicale, Ruth Eastman, soprano; 8:30, C. L. Lyons; 9, program, New York studio; 10, musicale.
- WFAA, Dallas, Tex. (Central, 476), 8:30-9:30 p. m., Cullom sisters; Kinkal Banjo quintet; 11-12, Dwight Brown, organist.
- WFI, Philadelphia, Pa. (Eastern, 395), 8:30 p. m., Meyer Davis Bellevue Stratford concert orchestra; 7, Sunny Jim, the kiddies' pal; 8, National Guard Association of United States banquet, speeches General John J. Pershing, Governor of Penna. Gifford Pinchot; Major D. B. Simpson; 9, Everready Hour, from WEAF; 10:05, Charlotte Cushman club, play to be presented by well-known actresses playing in Philadelphia.
- WGN, Chicago, Ill. (Central, 370), 8-8:30 p. m., dinner concert; 8:30-9, Rowena Mulford, coloratura soprano; Claire Felimeth, contralto; 10-11, dance program, Drake and Blackstone dance orchestras.
- WGR, Buffalo, N. Y. (Eastern, 319), 6-7:30 p. m., dinner music, Hallpryd string quartet.
- WGY, Schenectady, N. Y. (Eastern, 380), 7:45 p. m., drama talk; 8, Times organ recital, All Saint's cathedral; 9, program G. Foreman, director; speeches, Dr. Samuel Gradin; D. & H. Male quartet; WGY orchestra; 11:20, Stephen E. Boisclair, organist.
- WHAA, Iowa City, Ia. (Central, 484), 8 p. m., readings, Mrs. Alice M. Mills.
- WHAS, Louisville, Ky. (Central, 400), 7:30-9 p. m., Carl Zoeller's melodists, Carl Zoeller, director.
- WHB, Kansas City, Mo. (Central, 411), 8-10, musical program, arranged by Metta Legier Jenkins.
- WHK, Cleveland, Ohio (Eastern, 283), 6 p. m., Ponce de Leon orchestra, Herbert Hayward, director, Grebe's Hanna Building restaurant; sports, news items; culinary recipes.
- WHN, New York, N. Y. (Eastern, 360), 6:30-7 p. m., Alamac orchestra; 7:10-7:30, WHN employment broadcasting; 8:30-10, Bertram J. Goodman's orchestra; 10-10:45, Cindarella orchestra; 11:30-12, Club Alabam orchestra; 12-12:30, Parody club orchestra.
- WIP, Philadelphia, Pa. (Eastern, 509), 6:15 p. m., Harry Harburger and his Vaudeville orchestra; 7, Uncle Wip's bedtime stories; 8, Elliott Loster, dramatic critic; 8:15, police band, Lieutenant Joseph Kiefer; 9, Schubert quartet; 10:05, movie talk, Ed M. Orowitz; 10:30, Harvey Marburger and his Vaudeville orchestra from Cafe L'Aliglon.
- WJAX, Cleveland, Ohio (Eastern, 390), 7:30 p. m., Cleveland News program; E. G. Johnson, bedtime story; Don Palmer, Radio talk cartoon; Gladys Beddoe, soprano; Gertrude Lenz, pianist; old-time minstrel program, direction, Harper Garella Smythe; Joe Smith-Martha Lee club orchestra.
- WJJD, Moosheart, Ill. (Central, 278), 7:15-8:15 p. m., concert band.
- WJZ, New York, N. Y. (Eastern, 455), 7-7:15 p. m., "Dogs," Frank Dole; 7:15-8, Joseph Strissoff's Hotel Vanderbilt orchestra; 8-8:10, Wall Street Journal review; 8:10-8:30, "Economics," N. Y. U. air college, Prof. Reid L. McClung.
- WKAQ, San Juan, P. R. (Eastern, 369), 9-10:30 p. m., Euterpe Jazz band, Carmelo Diaz, director.
- WLS, Chicago, Ill. (Central, 345), 6:30 p. m., Ralph Emerson, organist; 7, lullaby time, Ford Rush and Glenn Rowell; 7:15, music; 7:30, Sandler feature; 8-9, talk, Carl Williams; talk, John P. Caso; "Inquisitive Broadcaster," "How has the Agricultural College Helped You in Your Farm Operations?" G. C. Biggar; 9, WLS theater presentation; 10, music; 10:30, Isham Jones and his College Inn orchestra; 10:40, Ford and Glenn time; 11, musicale; 12, midnight revue, Ralph Emerson, Ford Rush, Glenn Rowell, Isham Jones and his College Inn orchestra.
- WLW, Cincinnati, Ohio (Central, 423), 10 p. m., Ohio Rubber quartet and trio; 11, Gordon Kiblor's Black and White Pennsylvanians.
- WMAQ, Chicago, Ill. (Central, 447.5), 6 p. m., Chicago theater organ; 6:30, Hotel LaSalle orchestra; 8, book review, Harry Hansen; 8:20, orchestra concert, Bush Conservatory of Music.
- WMC, Memphis, Tenn. (Central, 500), 8:30 p. m., concert, Hotel Chelsea orchestra, Prof. Frank Pappalardo, director; 11, midnight frolic.
- WNJ, Newark, N. J. (Eastern, 233), 10:30-12:30 a. m., Frank Dally and his Meadow Brook dance orchestra.
- WOAW, Omaha, Nebr. (Central, 526), 6 p. m., "Advice to Lovelorn" period, Cynthia Gray; 6:25, dinner program transmitted from WOAW's studio in the May Seed & Nursery company building, Shenandoah, Iowa; 9, Merry Musical Maids, Hotel Fontencille; 10:30, Wow! frolic, Frank Hodek, Jr., and his Omaha Night-ingles, transmitted from Wow! Roost at Roseland gardens.
- WOR, Newark, N. J. (Eastern, 405), 6:15-6:30 p. m., Halsey Miller and his orchestra; 6:30-7, Man-in-tbo

- Moon stories for children; 7-7:30, Halsey Miller and his orchestra.
- WQJ, Chicago, Ill. (Central, 448), 7-8 p. m., dinner concert, Ralph Williams and his Rainbo Garden orchestra; Excelsior quartet, A. Snavely, first tenor; Rudolph Meyer, second tenor; L. J. Booth, baritone; David Middleton, bass; Dorothy Davie Dillow, soprano; 10-2, Ralph Williams and his Rainbo Skylarks; James Mitchell, baritone; Merrie Boyd Mitchell, soprano; Carl G. Linner, pianist; Nubs Allen, contralto; Viola Graf, soprano; Rogers boys, Larry, Billy; Will Roster, the daddy of them all.
- WRC, Washington, D. C. (Eastern, 469), 7:45 p. m., music; 8, "Show Shopping," Len Hall; 8:15, music; 9, "The Political Situation in Washington Tonight," Frederick William Wile; 9:20, concert, Irving Boernstein's Wardman Park hotel quartet; 10:15, dance program, Meyer Davis' Le Paradis orchestra.
- WSAI, Cincinnati, Ohio (Central, 309), 7 p. m., Hotel Gibson orchestra; 7:30, chimes concert; 7:45, children's stories; Ethel Knapp Behrman; 8, Gibson orchestra; 9, Bernard and Robinson, singing original songs; 9:15, special Cincinnati College of Music program.
- WSB, Atlanta, Ga. (Central, 429), 5-6 p. m., bedtime story, Bonnie Barnhardt; 8-9, Class No. 5 of the State Union Singing Convention of Georgia, colored jubilee singers; 10:45, Radlow entertainment.
- WTAM, Cleveland, Ohio (Eastern, 390), 6 p. m., Guy Lombardo's Royal Canadians orchestra.
- WTAY, Oak Park, Ill. (Central, 293), 6:45-7:45 p. m., Sandy Meek, baritone; Glenn Bruce, reader; Raynor Dalhelm & company orchestra; 9-9:45, 10:15-11:15, Roland Hinkle, tenor; Hawsliin Guitar trio; Guyon's Paradise ballroom orchestra.
- WVJ, Detroit, Mich. (Eastern, 517), 8:30 p. m., Clyde Nichols program.

Wednesday, December 3

- Wednesday, silent night for: CHNC, CKAC, KGO, WCAL, WCBD, WFAA, WGY, WHAA, WHAZ, WOAW, WOI, WMC, WRBC, WRC, WSAI.
- KFAE, Pullman, Wash. (Pacific, 330), 7:30-9 p. m., Glee club orchestra; "Pointers on Dairy Farming," Prof. E. V. Slocum; "Conquest of Diphtheria, U. S. Public Health service.
- KFDM, Beaumont, Tex. (Central, 306), 8 p. m., musical concert.
- KFI, Los Angeles, Calif. (Pacific, 469), 5-5:30 p. m., Evening Herald table talk news items; 5:30-6, Examiner news bulletins; 6:45-7:30, Nick Harria detective stories, music; 7:30-8, vocal recital; 8-9, Evening Herald, Ida May Wall; 9-10, Examiner; Wampus movie program; 10-11, Anthony studio program; 11-12, dance orchestra.
- KFNF, Shenandoah, Ia. (Central, 266), 7:30 p. m., old fiddlers contest.
- KFQX, Seattle, Wash. (Pacific, 238), 7-7:45 p. m., children's entertainment; 8-9, Ray Robinson and his Bagdad orchestra; 10-11, orchestra.
- KFSG, Los Angeles, Calif. (Pacific, 278), 6:30-7:30 p. m., Gray studio program for children, presenting Helen Edwina and Mary Elizabeth Hughes.
- KGW, Portland, Ore. (Pacific, 492), 5 p. m., children's program; fairy story, Aunt Nell; 8, concert, 10, dance music, George Olsen's Metropolitan orchestra.
- KHJ, Los Angeles, Calif. (Pacific, 395), 6-6:30 p. m., Art Hickman's concert orchestra, Edw. Fitzpatrick, director; 6:30-7:30, Prof. Walter Sylvester Hertzog, stories American history; Dick Winslow, screen juvenile and reporter; 8-8:45, Dr. Mars Baumgardt, scientific lecturer; 8:45-10, program presented by Pacific Mutual Life Insurance company; E. S. Nelson; 10-11, Art Hickman's dance orchestra, Earl Burnett, leader.
- KNX, Hollywood, Calif. (Pacific, 337), 7-8 p. m., Ambassador hotel concert orchestra; 8-9, program sponsored by Security Trust and Savings bank; 9-10, features, Dr. A. Zimmerman, director.
- KOB, State College, N. M. (Mountain, 360), 7:30-8:30 p. m., "Results of Preliminary Lettuce Production Tests by Rio Grande Farmers," Prof. Fite; "Water Table Studies in Mesilla Valley Since 1920," Prof. Curry; "Sweet Clover, Its Value and Use as Evidently Intended by Creator," C. A. McNabb.
- KO, San Francisco, Calif. (Pacific, 423), 7-7:30 p. m., Rudy Selger's Palmont hotel orchestra; 8-11, E. Max Bradford's Versatile band.
- KSD, St. Louis, Mo. (Central, 546), 6:45 p. m., Aberg's concert ensemble; Arne Arnesen, violinist; 9, program, Schubert trio.
- KYW, Chicago, Ill. (Central, 536), 6:35-7 p. m., children's bedtime story; 7-7:30, dinner concert, Congress hotel; 7:30-8, musical program; 8-8:30, Sherwood Music school program, Ruth Lathrop, director; 8:30-8:45, "Around the Town with KYW in Chicago"; 8:45-9, music; 9:05, "Good Roads"; 9:10, talk, D. A. Miles; 9:45-2:30, midnight revue.
- PWX, Havana, Cuba (Eastern, 400), 7:30-9 p. m., general staff band, Cuban army.
- WBBR, New York, N. Y. (Eastern, 273), 8 p. m., oriental music, Touffe Moubaid, Meona Karshoum, Elizabeth Avad; 8:15, vocal solo, Fred Twaroschek; 8:20, Bible lecture, W. E. Van Amburgh; 8:40, vocal solo; 8:45, oriental music.
- WCAE, Pittsburgh, Pa. (Eastern, 462), 6:30 p. m., dinner concert, William Penn hotel; 7:30, Sunshino girl; 7:45, special feature; 8, orchestra and artists from Nixon restaurant; 9:30, Olive Carnahan, soprano.
- WCAU, Philadelphia, Pa. (Eastern, 278), 6 p. m., Hotel Pennsylvania Meyer Davis dance orchestra; 8, concert.
- WCAY, Milwaukee, Wis. (Central, 266), 6:30 p. m., Boston Street night; Ilni serenaders; Constance and Sidney Swindells, piano duetists; Lucille Snyderworth, soprano.
- WCCO, Minneapolis-St. Paul, Minn. (Central, 417), 6 p. m., sport hour; 6:30, weekly summary grain markets; 6:50, Henry Bellows, editor Northwestern Miller; 8-8:45, vesper service; 9, weather report, musical program.
- WCX, Detroit, Mich. (Eastern, 517), 6 p. m., dinner concert, Hotel Tuller; 7, musical program.
- WDAF, Kansas City, Mo. (Central, 411), 6-7 p. m., school of the air, tuning in number on the Duo-Art; address, auspices, Health Conservation association; address, speaker, Meat Council of Greater Kansas City; the Tell-Me-a-Story Lady; music, Hotel Muehlebach Trianon ensemble; 8-9:15, program by pupils of the St. Agnes academy; 11:45-1 a. m., night-hawk frolic, the "Merry Old Chief" and the Plantation players.
- WDAR, Philadelphia, Pa. (Eastern, 395), 7:30 p. m., Dream Daddy's bedtime stories; 8:30, concert, Atlantic

- Choral society; 10:03, Arcadia cafe dance orchestra; Arthur Murray's dancing lessons.
- WDBY, Chicago, Ill. (Central, 258), 7 p. m., Bible lesson, Rev. J. C. O'Hair.
- WEAF, New York, N. Y. (Eastern, 492), 6-7, p. m., dinner music, Waldorf-Astoria hotel; 7-7:15, United Synagogue of America; 7:30-7:45, Lillian Wilson Bartlett, soprano; 8-8:10, American Bond and Mortgage company; 8:20-10, New York Philharmonic society.
- WEBH, Chicago, Ill. (Central, 370), 7 p. m., Edna Bodine, songs; Oriole orchestra concert; musical bits, Balaban & Katz Riviera theater; 9, Oriole orchestra; Langdon brothers, Hawaiian guitarists; Marie Kelly, readings; Madeline Reed, contralto; Dennis sisters, songs; 11, Edna Solomon, contralto; Oriole orchestra; John Stamford, tenor.
- WEI, Boston, Mass. (Eastern, 303), 6:30 p. m., dance selections, Dok-Eisenburg and his Sinfonians; 7, cooking class; 7-10, Big Brother club; 7:40, musicale; 8, Lynn night, program, J. J. O'Brien, director; 9, Madame Galbraith, contralto; 9:30, musicale; 10, musicale; 11, Dok-Eisenburg and his Sinfonians; 11:30, Fenway theater midnight organ recital, Lloyd G. Del Castillo.
- WFI, Philadelphia, Pa. (Eastern, 395), 6:30 p. m., Meyer Davis Bellevue Stratford concert orchestra; 7, Sunny Jim, the kiddies' pal.
- WGN, Chicago, Ill. (Central, 370), 8-8:30 p. m., dinner concert; 8:30-9, classical program, Lyon & Healy; 10-11, dance program, Drake and Blackstone dance orchestras.
- WGR, Buffalo, N. Y. (Eastern, 319), 6:30-7:30 p. m., dinner music, Vincent Lopez Hotel Statler dance orchestra; direction of Harold Gesler; 8-8:15, "Life in Winter," Dr. Carlos E. Cummings; 9-10, recital, Elizabeth Retter and assisting artists; 10-11, concert, Niel Nielson company, direction of John L. Young; 11:30, supper-dance music, Vincent Lopez Hotel Statler dance orchestra, direction of Harold Gesler.
- WHAS, Louisville, Ky. (Central, 400), 7:30-9 p. m., Tropical Hawaiian quintet, Frank Plada, director.
- WHB, Kansas City, Mo. (Central, 411), 7-8 p. m., bi-monthly Parent-Teacher association program; "Jury-nelle Courts," Mrs. E. J. Bradbury; Francis Payne, pianist; Mildred Spencer, soprano; Mrs. Arvid Frank, violinist.
- WHK, Cleveland, Ohio (Eastern, 283), 6 p. m., Ponce de Leon orchestra, Herbert Hayward, director, Grebe's Hanna Building restaurant; sports, news; 7, Ethel M. Hawes, bedtime story.
- WHN, New York, N. Y. (Eastern, 360), 6:30-7 p. m., Alamac hotel orchestra; 7-7:30, Club Richman orchestra; 7:30-7:45, talk, Emily Shop; 7:45-8, Jewish Congregation program; 8-8:30, Yorkville Radio trio; 9-9:30, Quinn Piano trio; 9:30-10, Rose-Danceland orchestra; 10-11, Clover Gardens orchestra.
- WHO, Des Moines, Ia. (Central, 526), 7:30-9 p. m., Bankers Life Radio orchestra, W. L. Marsh, director; dancing instructions; Myrtle Williams, soprano; Helen Birmingham, accompanist.
- WIP, Philadelphia, Pa. (Eastern, 509), 6:05 p. m., Art Coogan and his Club Madrid orchestra; 7, Uncle Wip's bedtime stories, songs by Gertrude Fisher.
- WJJD, Moosheart, Ill. (Central, 278), 7:15-8:15 p. m., Junior band; pupils, Misses Gels, Tillery, English.
- WJZ, New York, N. Y. (Eastern, 455), 7-8 p. m., Cafe Boulevard orchestra; 8-8:10, Wall Street Journal review; 8:10-8:20, N. Y. U. air college; 10:30-11:30, Billy Wynne's Greenwich Village Inn orchestra.
- WKAQ, San Juan, P. R. (Eastern, 360), 8-9:30 p. m., Municipal band, Jesus Figueroa, director.
- WLW, Cincinnati, Ohio (Central, 423), 8 p. m., Chubb Steinberg orchestra; 9, Formica band and orchestra concert; Mary Swainey Johanning, soprano; Rosemary Ellerbrook, accompanist.
- WMAQ, Chicago, Ill. (Central, 447.5), 6 p. m., Chicago theater organ; 6:30, the story lady, Georgene Faulkner; 8, lecture, Northwestern university; 8:30, musical program; 9, WMAQ playnight; 9:45, talk, Chicago charities.
- WHH, Cincinnati, Ohio (Central, 309), 8 p. m., organ recital, Clarence B. Reeves; songs, Bernard and Robinson; 9:30, novelty duets, Herman Maurer, band-donlan; William Schwartz, cornet; cello solos, Oscar Krlshe, Clarence R. Reeves, accompanist; 9:45, Auburn's orchestra; 12, session, Royal Order Peacocks.
- WNJ, Newark, N. J. (Eastern, 233), 10:30-12:30 a. m., Frank Dally and his Meadow Brook dance orchestra.
- WOC, Davenport, Ia. (Central, 484), 8 p. m., Erwin Swindell, organist; Mrs. John Malloy, soprano.
- WOO, Philadelphia, Pa. (Eastern, 509), 7:30 p. m., A. Candelori and his Hotel Adelphia concert orchestra; violin recital, A. Candelori; 9, WOO orchestra, Robert E. Eden, director; 10:03, organ recital, Mary E. Vogt; 10:30, Vincent Rizzo and his Hotel Sylvania dance orchestra.
- WOR, Newark, N. J. (Eastern, 405), 6:15-6:50 p. m., Harry Cox orchestra; 8-8:30, Gene Ingraham's Great Notch orchestra; 9:15-9:45, program, direction of Harold Flammer; 10:30-11, program, Harold Flammer.
- WQJ, Chicago, Ill. (Central, 448), 7-8 p. m., dinner concert, Ralph Williams and his Rainbo Garden orchestra; accompanist; Maxine Smith, violinist; Sheppard Levino, tenor; 10-2, Ralph Williams and his Rainbo Skylarks; Fred Jacobson, reader; Sandy Meek, Scotch tenor; the Metodians, Laurio, Edadio, Bennie; Clarence Theders, tenor; Rita McFawn, soprano.
- WSB, Atlanta, Ga. (Central, 429), 5-6 p. m., Bonnie Barnhardt's bedtime story, reports; 10:45, woman's division of the Chamber of commerce.
- WTAM, Cleveland, Ohio (Eastern, 390), 6 p. m., Guy Lombardo's Royal Canadians orchestra; 8, concert program arranged by Cleveland Plain Dealer.
- WTAY, Oak Park, Ill. (Central, 293), 6:45-7:45 p. m., Axel Christens, pianist; ten minute talk, staff of Radio Age; Guyon's Paradise ballroom orchestra.
- WVJ, Detroit, Mich. (Eastern, 517), 8:30, Detroit News orchestra, Templeton Moore, tenor.

Thursday, December 4

- Thursday, silent night for: CHNC, KFAE, KFDM, KFNF, KGW, KOB, KSD, PWX, WCAU, WHAA, WHAZ, WHO, WJJD, WOO, WRBC.
- CKAC, Montreal, Can. (Eastern, 425), 8:30 p. m., Canadian National Railways CNRM.

(Continued on page 14)

orchestra;
 . m., Bible
 6-7 p. m.,
 '15. United
 Wilson Bart-
 id Mortgage
 c society.
 . m., Edna
 ausical bits,
 le orchestra;
 farie Kelly,
 mis sisters,
 le orchestra;
 . m., dance
 ionians; 7,
 0. musicale;
 director; 9,
 sicale; 10,
 Sinfonians;
 al, Lloyd G.
 1:30 p. m.,
 orchestra; 7,
 . m., dinner
 & Healy;
 stone dance
 7:30 p. m.,
 r dance or-
 5, "Life in
 -10, recital,
 -11, concert,
 L. Young;
 Hotel Statler
 30-9 p. m.,
 director,
 7-8 p. m.,
 ram; Juve
 uncis Payne,
 Arvid Frank,
 . m., Ponee
 ctor, Grebe's
 7, Ethel M.
 :30-7 p. m.,
 Richman or-
 45-8, Jewish
 Radio trio;
 se-Danceland
 30-9 p. m.,
 sh, director;
 prano; Helen
 6:05 p. m.,
 ra; 7, Uncle
 Fisher,
 -8:15 p. m.,
 English,
 7-8 p. m.,
 treet Journal
 10:30-11:30,
 estra.
 -9:30 p. m.,
 . m., Chubb-
 nd orchestra
 o; Rosemary
 . m., Chicago
 gene Faulk-
 3:30, musical
 alk, Chicago
 p. m., organ
 Bernard and
 Laurer, bam-
 solos, Oscar
 anist; 9:45,
 ler Peacocks,
 -12:30 a. m.,
 ico orchestra.
 . u., Erwin
 rano.
 7:30 p. m.,
 ncert orches-
 10 orchestra,
 recital, Mary
 otel Sylvania
 i-6:50 p. m.,
 abau's Great
 direction of
 old Flammer.
 . m., dinner
 Garden or-
 ceaster Smith,
 eppard Levine,
 ainbo Skylarks;
 stock, Scotch tenor;
 radio, Bennie; Clarence
 a, soprano.

WSS, Atlanta, Ga. (Central, 429), 5-6 p. m., Bonnie Barnhardt's bedtime story, reports; 10:45, woman's division of the Chamber of commerce.
 WTAM, Cleveland, Ohio (Eastern, 390), 6 p. m., Guy Lombardo's Royal Canadians orchestra; 8, concert program arranged by Cleveland Plain Dealer.
 WTAY, Oak Park, Ill. (Central, 283), 6:45-7:45 p. m., Axel Christensen, pianist; ten minute talk, staff of Radio Age; Guyon's Paradise ballroom orchestra.
 WWJ, Detroit, Mich. (Eastern, 517), 8:30, Detroit News orchestra, Templeton Moore, tcor.

Thursday, December 4

Thursday, silent night for: CHNC, KFAE, KFOM, KFNF, KGW, KOB, KSO, PWX, WCAU, WHAA, WHAZ, WHO, WJJD, WOO, WRBC.
 CKAC, Montreal, Can. (Eastern, 425), 8:30 p. m., Canadian National Railways CNRM.

(Continued on page 14)

WCAE, Pittsburgh, Pa. (Eastern, 462), 6:30 p. m., dinner concert, William Penn hotel; 7:30, Sunshine girl; 7:45, special feature; 8, orchestra and artists from Nixon restaurant; 9:30, Olive Carnahan, soprano.
 WCAU, Philadelphia, Pa. (Eastern, 278), 6 p. m., Hotel Pennsylvania Meyer Davis dance orchestra; 8, concert.
 WCAY, Milwaukee, Wis. (Central, 286), 6:30 p. m., Boston Storo night; film serenaders; Constance and Sidney Swindells, piano duettists; Lucilio Snyderworth, soprano.
 WCCO, Minneapolis-St. Paul, Minn. (Central, 417), 6 p. m., sport hour; 6:30, weekly summary grain markets; Henry Bellows, editor Northwestern Miller; 7-8, vesper service; 9, weather report, musical program.
 WCX, Detroit, Mich. (Eastern, 517), 6 p. m., dinner concert, Hotel Tuller; 7, musical program.
 WOAF, Kansas City, Mo. (Central, 411), 6-7 p. m., school of the air, tuning in number on the Duo-Art; address, auspices, Health Conservation association; address, speaker, Meat Council of Greater Kansas City; the Toll-Me-a-Story Lady; music, Hotel Muellebach Trianon ensemble; 8-9:15, program by pupils of the St. Agnos academy; 11:45-1 a. m., nighthawk frolic, the "Merry Old Chief" and the Plantation players.
 WOAF, Philadelphia, Pa. (Eastern, 395), 7:30 p. m., Dream Daddy's bedtime stories; 8:30, concert, Atlantic

College Helped You in Your Farm Operations?" G. C. Biggar; 9, WLS theater presentation; 10, music; 10:30, Isham Jones and his College Inn orchestra; 10:40, Ford and Glenn time; 11, musicale; 12, midnite revue, Ralph Emerson, Ford Rush, Glenn Rowell, Isham Jones and his College Inn orchestra.
 WLW, Cincinnati, Ohio (Central, 423), 10 p. m., Ohio Rubber quartet and trio; 11, Gordon Kibler's Black and White Pennsylvanians.
 WMAQ, Chicago, Ill. (Central, 447.5), 6 p. m., Chicago theater organ; 6:30, Hotel LaSalle orchestra; 8, book review, Harry Hansen; 8:20, orchestra concert, Bush Conservatory of Music.
 WMC, Memphis, Tenn. (Central, 500), 8:30 p. m., concert, Hotel Chisca orchestra, Prof. Frank Pappalardo, director; 11, midnight frolic.
 WNJ, Newark, N. J. (Eastern, 233), 10:30-12:30 a. m., Frank Dally and his Meadow Brook dance orchestra.
 WOAW, Omaha, Nebr. (Central, 526), 6 p. m., "Advice to Lovelorn" period, Cynthia Grey; 6:25, dinner program transmitted from WOAW's studio in the May Seed & Nursery company building, Shonandoah, Iowa; 9, Merry Musical Maids, Hotel Fontenelle; 10:30, Wow! frolic, Frank Hodek, Jr., and his Omaha Nightingales, transmitted from Wow! Roost at Roseland gardens.
 WOR, Newark, N. J. (Eastern, 405), 6:15-6:30 p. m., Haisay Millor and his orchestra; 6:30-7, Man-in-the

WBAV, Columbus, Ohio (Eastern, 423), 8 p. m., WBAV orchestra, Frances Handbeau, director.
 WCAE, Pittsburgh, Pa. (Eastern, 462), 6:30 p. m., dinner concert, William Penn hotel; 7:30, Uncle Kay-see; 7:45, special feature; 8, Pittsburgh Council of Catholic Women's choral club; 9, concert, National Carbon company's Eveready entertainers; 10:30, "Sid" and his Loew's Aldine theater gang.
 WCAY, Milwaukee, Wis. (Central, 266), 9:15 p. m., Sundodgers; Blackstone serenaders; Arthur Busse, tenor; Anno Bauman, contralto.
 WCCO, Minneapolis-St. Paul, Minn. (Central, 417), 6:30 p. m., dinner concert; 9, weather report; musical program.
 WCX, Detroit, Mich. (Eastern, 517), 6 p. m., dinner concert, Hotel Tuller; 10, Red Apple club.
 WOAR, Philadelphia, Pa. (Eastern, 395), 7:30 p. m., Dream Daddy's bedtime stories; 7:50, "Both Sides of the Footlights," Arnold Abbott.
 WOAF, Kansas City, Mo., (Central, 411), 6-7 p. m., school of the air, tuning in number on the Duo-Art; eighth of a series of Radio piano lessons, Maudellen Littlefield; the Tell-Me-a-Story Lady; music, Hotel Muellebach Trianon ensemble; 11:45-1 a. m., nighthawk frolic, the "Merry Old Chief" and the Plantation players.
 WEAJ, New York, N. Y. (Eastern, 492), 8-7, dinner music, Waldorf-Astoria hotel; 7:30-8, John C. Smith

Thursday, December 4

(Continued from page 13)

CKY, Winnipeg, Can. (Central, 450), 7:30 p. m., Esperanto lesson; 8, Canadian National Railway's program (CNRW).

NOTE THE DRUMS AT WGR NEXT MONDAY



Here is Harold Wolf, the drummer boy of the Vincent Lopez Hotel Statler dance orchestra. If you watch the program pages of the Digest and tune in for WGR, Buffalo, you may learn all there is to know about drums this week. Harold Gieser, director of the orchestra, is featuring them this week. Colegrove Studio, Buffalo.

wer; 8:30, soprano solos, Margaret and Mabel Kountz; organ selections, Kurt Kenkel; 9, Avon dance orchestra; 12, special Peacock program.

Friday, December 5

Friday, silent night for: CHNC, CKAC, KGO, KPO, PWX, WBBR, WCAL, WCOB, WBOY, WEOA, WHAA, WKAQ, WLW, WOI, WRBO, WRC, WSAI.

KSO, St. Louis, Mo. (Central, 546), 8 p. m., Sylvia Gnuu, pianist.

Monday, December 1
WBAP, Fort Worth, Tex. (Central, 476), 7:30-8:30 p. m., "Moments from the Majestic," Majestic theater; 9:30-10:45, Carnegie Harmony Four quartet.

Issue the First License on Increased Power
Station WTAM Permitted to Use 1,500 Watts

WASHINGTON, D. C.—The department of commerce has announced that it had issued the first broadcasting radio station license since the Third Radio Conference authorizing experimental use of increased power.

YOUR CHOICE
CEPREE
Radio Digest
Volume 10
limited supply
65 Copies

A RADIO REFERENCE LIBRARY
You receive 52 issues with your subscription and 13 issues in each bound volume.

Additional Programs
(Received Too Late for Classification)
Saturday, November 29
WBAP, Fort Worth, Tex. (Central, 476), 7 p. m., review, Interdenominational Sunday school lesson, Mrs. W. E. Barnum.

“Low Loss,” What It Is and Why

By Jacques Fournier

IN THE last issue of Radio Digest it was announced that the writer would take up variable condensers in the next article of the series on low loss, but since the type of inductance described in the issue of November 22 is rather fragile, it was decided that it would be better to also tell the fans how to build a more substantial inductance for use in portable or semi-portable receivers.

It will be recalled that in designing inductances which will be low in losses we try to keep down the ohmic resistance, the high frequency resistance and the distributed capacity. In order to build a more substantial type of tuning unit some strips of dielectric material such as bakelite, hard rubber or Pyrex glass must be used. The presence of this dielectric material will slightly increase the high frequency resistance and the method of winding used on this second tuner will slightly raise the losses due to distributed capacity, but this tuner will still have far less losses than the usual tuner wound on solid tubes. Other methods of mounting this inductance than those shown are perfectly feasible and any other method which may appeal to the builder can be used, but the method shown is very rugged and does not require special tools nor the working in heavy brass.

Constructional Detail

Referring to Figure 1, it will be noted that bakelite tubing $2\frac{1}{2}$ inches inside diameter with a wall $\frac{3}{32}$ inch thick is used, and from this tubing two pieces must be cut each $\frac{1}{2}$ inch long. The circumference of the ring thus made is now divided into six parts and a cross should be placed at each of these six points $\frac{1}{4}$ inch from the edge of the ring. Take any two opposite points on one of the rings and drill a $\frac{1}{4}$ -inch hole; the other four points are drilled to pass a 6-32 screw. The six holes on the second ring are each drilled with a number 27 drill to pass a 6-32 machine screw. The strips which connect these rings may be made from any of the three dielectric materials mentioned and they should measure 5 inches in length by $\frac{3}{8}$ inch width, being cut from $\frac{3}{16}$ -inch material. At each end of these six strips a small drilling cross should be marked that is $\frac{1}{4}$ inch from the end of the strip and in the exact center of the width. Take two of these strips and at one end of each drill for a 6-32 machine screw and countersink; at the other end of each of these two strips drill a $\frac{1}{4}$ -inch hole. Considering now the remaining four strips, a hole is drilled at each end to pass a 6-32 screw and these eight holes should be countersunk for flat head screws.

To assemble these pieces in the framework shown in Figure 1 will require ten

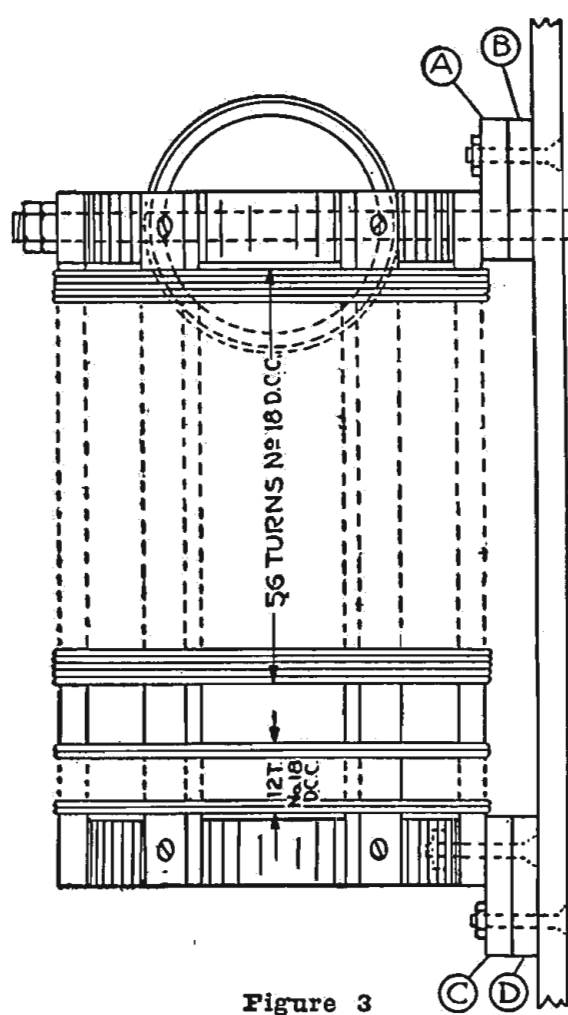

Figure 3

$\frac{3}{8}$ -inch flat head 6-32 machine screws, and ten hexagonal nuts to fit them. This will bring the $\frac{1}{4}$ -inch holes all in line at one end of the assembly and it is through these holes that the $\frac{1}{4}$ -inch shaft carrying the rotor passes. Since this is to be a regenerative tuner with three windings, two of these windings are placed on the form just completed and the third on the rotor which revolves within it.

Number 18 d.c.c. wire is used for all three windings. Begin $\frac{1}{2}$ inch from the end in which the $\frac{1}{4}$ -inch holes are located and wind on 56 turns of wire. This should take up about 3 inches of the total length. Beginning $\frac{1}{2}$ inch from the other end of the form, wind on 12 turns of wire and note that the two windings are in the same direction. This will leave a space of about $\frac{1}{2}$ inch between the windings as shown in Figure 3. The two strips in which the $\frac{1}{4}$ -inch hole was bored are not fastened at one end and if the builder is unable to keep them rigidly in place by tightening the machine screw holding one end, the unattached end may be tied to the bakelite ring during the

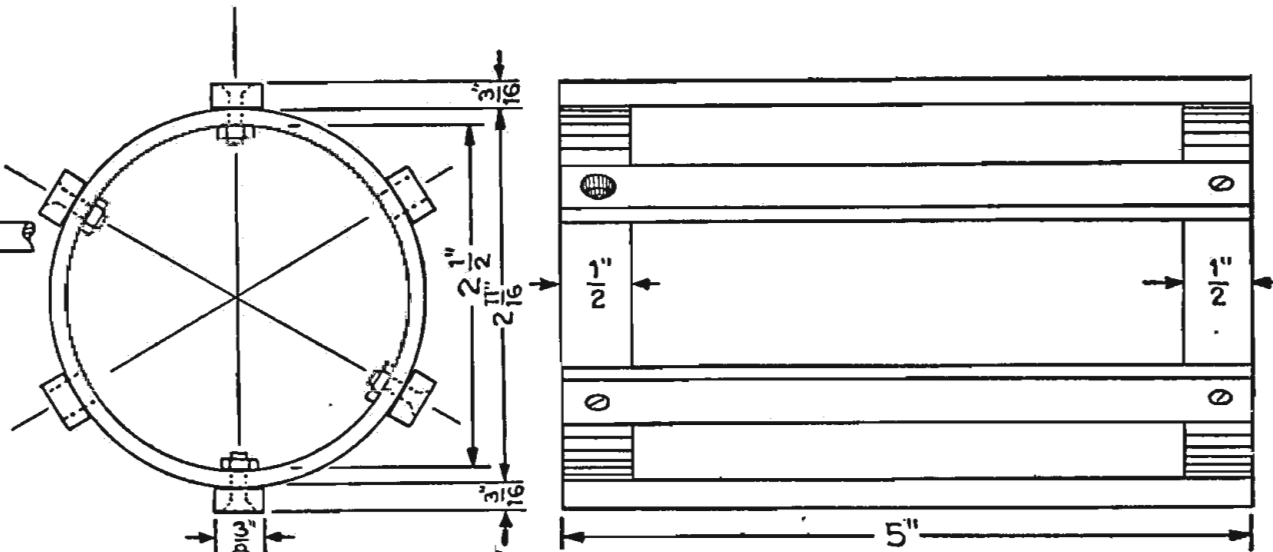

Figure 1

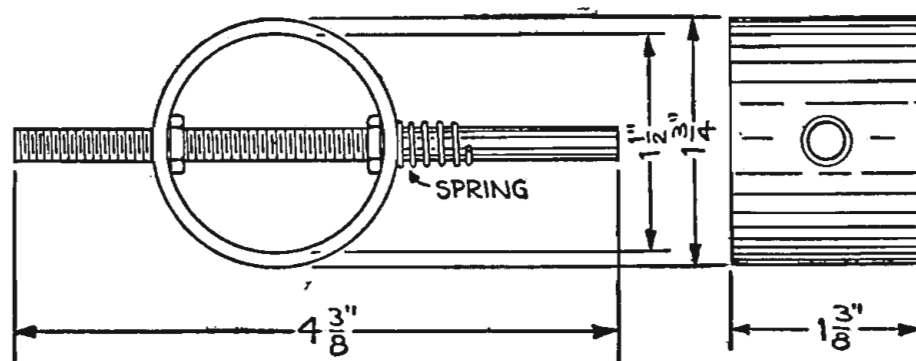

Figure 2

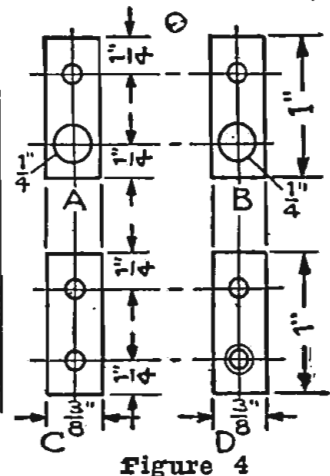

Figure 4

winding process with a piece of thread. The starting end of the 56-turn winding may be fastened under one of the machine screws which hold the strips in place; the other end of this winding may be wrapped around one of the lengthwise strips to hold it from unwinding. These suggestions apply also to the starting and finishing ends of the 12-turn coil.

How the Rotor Is Made

We will now take up the rotor shown in Figure 2. This is constructed of a piece of bakelite tubing with an outside diameter of $1\frac{3}{4}$ inches, the wall being $\frac{1}{8}$ inch thick. The length of this tube

is $1\frac{3}{8}$ inches. A piece of $\frac{1}{4}$ -inch brass rod, threaded for $2\frac{1}{2}$ inches of its length is used as a shaft. Great care should be (Continued on page 20)

The Importance of Good Radio Panels

An inferior panel will reduce the efficiency of your reception through surface leakage. You can avoid this by building your set with

ELECTRASOTE PANELS

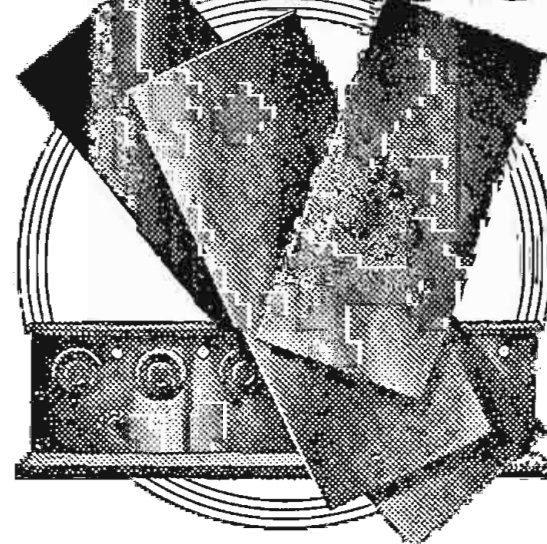

These beautifully finished panels will neither warp nor change color. They are scientifically constructed to reduce surface leakage to a minimum, hence assure increased efficiency of the set.

One of the famous “sote” products introduced by The Pantasote Company, Inc., Electrasote Radio Panels are sold strictly on their merits—yet are

Lower Priced
than other standard panels

Make your Set an “Electrasote Panel Set”—and get results!

On sale at good Radio Dealers

M. M. FLERON & SON, Inc.
Sole Sales Agents
Trenton, - New Jersey

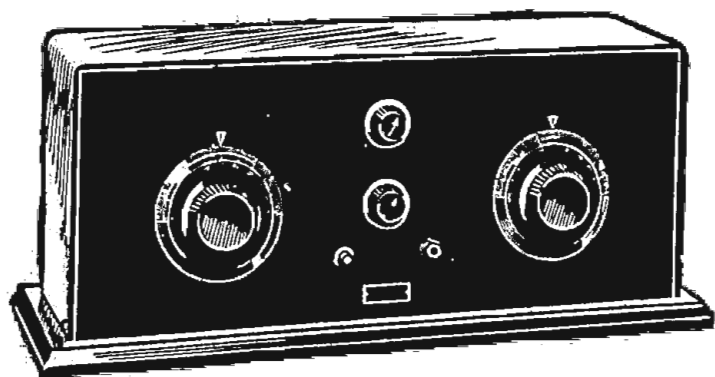

The Halldorson 4-tube set \$75.00

THE HALLDORSON 4-tube set for \$75.00 is one of the greatest values ever offered in radio receivers. Everything formerly found only in high-priced sets you'll now find here.

The set is tuned radio-frequency, easy to tune and operate. Coast-to-coast range. Highly selective-large volume, with a clear mellow tone. Easily logged—a remarkable feature usually found only in 5-tube sets. The workmanship and material are of the

best—standard parts throughout—highly polished mahogany case. The panel is of insulated steel, in a beautiful stucco-ripple finish, with large handsome dials.

See this set at your dealer's today. If he cannot supply you, write direct for complete description.

Also the Halldorson 5-tube Radio Frequency Receiver. A superior set, unequalled for tone quality and all-around performance. A wonderful value at \$115.00.

Halldorson Radio Frequency Receiver

THE HALLDORSON COMPANY, 1772 WILSON AVENUE, CHICAGO

MECO RADIO TUBES



AT LAST!
Volume and Tone Combined

MECO Tubes in your receiving set mean the difference between getting the program “clear as a bell” and chaos. A radical improvement in the construction of MECO Tubes give them longer life as well as assure maximum volume without impairing clear, distinct receptive tones.

Your dealer has MECO Tubes at standard prices or can get them for you from recognized jobbers.

Metropolitan Electric Co.
Des Moines, Iowa

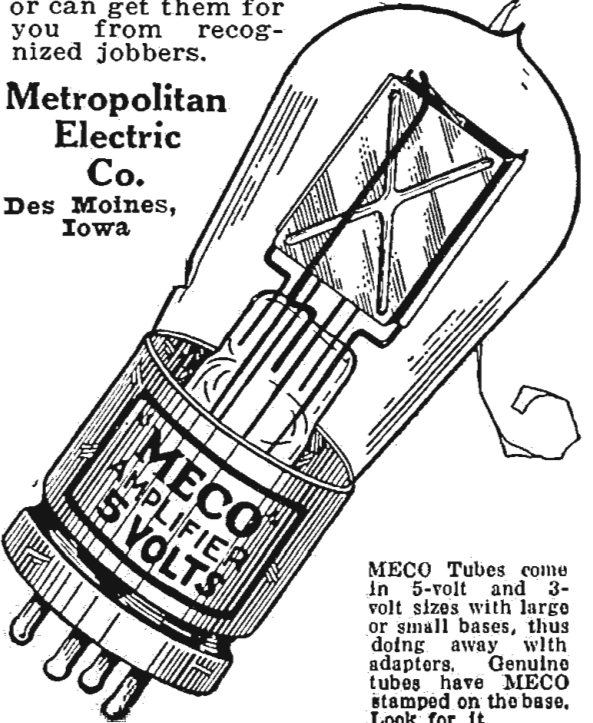

MECO Tubes come in 5-volt and 3-volt sizes with large or small bases, thus doing away with adapters. Genuine tubes have MECO stamped on the base. Look for it.

Radio Digest

PROGRAMS
Illustrated

Published by the Radio Digest Publishing Company, Inc.
510 North Dearborn Street
Telephone: State 4372, 4373, 4374, 4375
Chicago, Illinois

E. C. RAYNER, Publisher

Eastern Office, 611-12 Times Bldg., Times Sq., New York;
Telephone Bryant 4909, 10462

Member of the Audit Bureau of Circulations



241
PUBLISHED WEEKLY

SUBSCRIPTION RATES

Yearly in U. S. and Possessions and Canada, \$5.00
Foreign postage, \$1.00 additional. Single copies, 10 cents.

Vol. XI Chicago, Saturday, November 29, 1924 No. 8

Interference Again

There Is a Time and a Place for Everything

AS WINTER approaches the broadcasting stations are preparing to send out the very best programs and high class entertainment. It is quite evident that the amateur should pay strict attention to the silent periods and also to keep within their wave length assigned to them and not operate during the silent period arranged by the government.

There is a great deal of interference coming from amateurs who have the larger and more powerful stations. In the better grades of receiving sets, especially the super-heterodyne, it is possible to tune out most of the amateur stations, but it is impossible to cut out the spark sets.

All persons owning single circuit sets and sets that radiate should be careful in tuning and if the owner does not know how to tune in without disturbing his neighbor he had better learn from the maker of his set how to do it.

A great deal of trouble can be avoided if set owners will only take heed to the instructions given and try to keep within his own limits and to keep the air from interference that can be avoided. The majority of boys operating sets will be glad to cooperate with those of us who enjoy the broadcasting music and speeches and comply with the laws.

The amateur has great rights in the Radio field and much of the development is due to his activity and he is in a class that wants to do right and will do it if it is properly understood.

Industry of the Future

Radio Bids Fair to Equal the Automobile

LITTLE did the people of twenty-five years ago realize what would be the future of the automobile. In these twenty-five years the automobile industry has grown to be one of the largest, perhaps the largest in the country. With the automobile, as it is with many other enterprises, the simple car finds the largest number of users, and brings the largest profits to the manufacturer because of the quantity sales.

Another industry is breaking ground now that may in another quarter century equal that of the automobile. The manufacturing and marketing of Radio and its accessories. An idea of the immensity to be expected along this line of commercial pursuit is gained by knowledge of the fact that one Radio concern is now suing two or three electrical corporations for alleged infringing upon patents which runs into millions of dollars. This clearly evidences that the future of the Radio is considered worth some very expensive fighting.

It is not difficult to conceive the enormous growth Radio must be destined for. At present sets are by no means uncommon. There is one at least in almost every urban neighborhood, and receiving sets are to be found in many rural communities. Radio in its present state is principally a form of amusement, but practical uses are fast being developed which will make the Radio of the no distant future very much of a convenience, if not an actual necessity.

It is generally conceded that before many years the Radio will begin to replace the telephone. This will, of course, greatly enlarge the sphere of its activity along commercial lines. There can be little doubt that the future of the Radio offers great opportunity in the business and commercial world.

Psychic Phenomena

Why Does Radio Perform Better at Night?

MARCONI and others debate why Radio performs better at night. One theory is that sunlight absorbs much of the strength of the waves. At any rate, darkness admittedly is a better medium than light. On the other hand, scientists scoff when it's claimed that psychic phenomena is at its best in the darkness. If true of Radio, why not of other ether vibrations known hazily as psychic for want of better understanding?

RADIO INDI-GEST

A Melody

A Radio musical reading. Background, "Song of India," violin and piano

Out o'er the waves of a wireless word
Ring sounds of music inspiring;
Peace, to a space chaotic unfurled
Infinite echoes untiring.
O'er tranquil vales, o'er mounts stupendous
Purling streams and waters roaring—
O'er all the world this power tremendous
Sends song triumphantly soaring.

Into crevices, o'er deserts immense
Where ever these waves are mingling;
From you to whither we know not whence—
These psychic powers are winging.
Whether in darkness when nature sleeps
Or through our day dreams fleeting
The eye of life still holds and keeps
This mystic musical greeting.

Out o'er the maze of disordered worlds
These harmony notes vibrating;
From the magnificent heavens unfurled
This spiritual force, creating.
Out o'er the night of a dreaming world
Melodious tones are stealing;
Into our souls and memories
Blend, a peaceful restful feeling.

RHEA SHELDON.

English as She Is Spoke

Dear Indi: Feminine voice through telephone to Fred Smith, studio director at WLW, "I would like to talk about 'dinner courses.'"

She was invited to the Crosley studio. Just before "air time" she was asked for a copy of her talk. Investigation showed her subject to be "Binner Corsets." She gave her talk, but it was about something else for the waist line instead of food.

SPIDER WEBB.

Midnight DX Fishing

By Charles L. H. Wagner

You have missed the joy of Radio unless you've listened in
From midnight to the creepy time when daylight hours begin,
You've never had the thrill of thrills until you've heard the call
Of far-off stations that at last have sealed your ether wall.

Unless you've heard the milk man banging up the neighbor's walks
Competing with a symphony of crashes, howls and squawks,
You have no claim to honors in the air fraternity,
Nor can you wear the emblem of its thirty-third degree.

'Tis only in the morning hours when fishing in the sky
Will in your net bring stations that most always pass you by,
And oh, the pride that swells you up when you are free to boast
That you have logged uncommon calls from Europe to the coast.

When you have heard the kitchen clock strike one and two and three
And still keep hugging to your set in one grand DX spree,
When you have felt the morning chill and grabbed a parlor rug
To wrap around your shivering legs—you've got the Radio bug.

There is no antidote but time to cure this fell disease,
Its microbes lurk in every set and on unwary seize,
And some, like me, do not get well, but take a great delight
In being sick and fishing all hours of the night.

Mrs. Partington Speaks Out

Dear Indi: Mizz Partington says Radiocasting has got baek to normalcy right rapid since the big voting contest is ended and the windjammers has signed off until Congress meets. She says if the Hired Hand had listened good to all these politics talkers he ought to have had a big increase of charter members in his untruth club, that is, if he could have printed his certificates fast enough to supply the deserving ones with one apiece. She says that bunkum used to go pretty good with brass bands and torch lights but it don't go over so well by Radio, seems like. She says Mr. Coolidge won the contest on account he is a "Myobist," to the fullest terms of the newest dictionary, and because he didn't broadcast mueh when



he had nothing to say to anybody. She adds that while she don't favor much disturbance of our constitution, she wishes some by-laws could be passed so Mr. Hoover would only have to license politics broadcasting once in six years instead of four like it is now, to give us time to forget some of our misery before we are into it again. Last night, Henry Field at KFNF and the Coldwater orchestra at KFNG put out nice concerts and Jack Nelson at Moosehart also come in fine.

SIGNING OFF.

Will It Come to This?



Condensed

By DIELECTRIC

The last time I stopped at WJAX a splendid program was under way; not one of high and low degree, but uniformly high throughout. When the dials located the Union Trust studio I thought my stay would be a short one. After I had heard one number sung by the double quartet that was entertaining, I sat still to the finish. Quartet and chorus singing needs to be featured more often.

A great many folks never heard the "Prince of Pilsen" until it was Radiocast from the studio of WLS. It was very well done, both as regards the artists and the skill of those in the control room. You know we don't give half the thought to the men in the control rooms of the various studios that we should. Tuck that away in your files.

When those famous arias from the grand opera of Paggiacci were coming through our muffs from Station WJZ, I sorrowed anew at the prospect of a winter without Radiocasts of performances from some one of the grand opera companies singing in this country. That such a state of affairs exists speaks ill for the vision of those attempting to create musical culture among us. Plan for next year right now, impresarios.

The New York Philharmonic orchestra concerts are being Radiocast again this season by WEA. Don't miss a single one of them. If you can't hear them and entertain your jazz friends too, don't entertain.

Variety spices Radiocast programs as well as other forms of entertainment. Sopranos are born by the bushel every minute; pianists are rated by the pack; first class tenors show up only in half-pint measures (dry, that is), so there is never a lack for entertainers in this group. WBZ had Mr. Cummings to demonstrate the charm of the mouth organ for us. Surprising how well it miked.

WHAS found the Tropical Hawaiian quintet somewhere and took them into their studio, whence came that typical warm-clime music. Not all Hawaiian melodies are entrancing, and some of them can be distinguished solely by their names, though most of the offerings by the Tropicals were gracefully rendered and pleasing.

The last time I listened to WDAR, I Lit, Brothers, on a very indigestive serving (this is the aftermath). But all that is forgotten in the joy of hearing the Arcadian singers from that station more recently. You know you may sing the notes and pronounce the words without "getting behind a fellow's vest," but these Arcadians displayed true musicianship to the extent that I'm waiting to hear them again.

After turning my dial up to the high numbers, KYW came through. Just how many pupils the Sherwood School of Music accommodates I don't know, but if they continue sending out such programs as of recent date then they'll need enlarged quarters. It was worth the price of admission: a receiving set and a few minutes leisure.

On my visits to Cincinnati via Radiocast there is nearly always some good offering to tune in from some one of the stations there. When I landed, WLW had the Virginia entertainers doing various things calculated to hold the interest of listeners in. There is no doubt in my mind about their having a large unseen audience that night.

How to Build the Simplest Possible Super-Het

Part III—Testing and Operating Set

By John G. Ryan

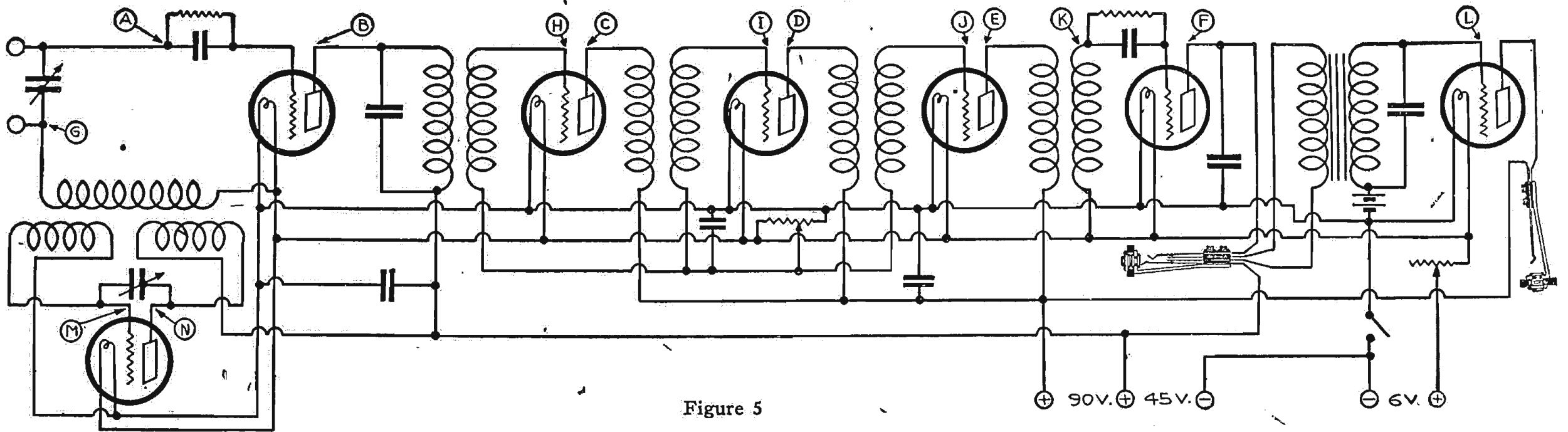

Figure 5

MANY of those who have built this receiver will prefer to connect it to the batteries, a loop and loud speaker and try it at once without testing. There is no reason why this should not be done if instructions for building and wiring have been carefully followed.

The average set builder, including the writer, is always very anxious to try out the set after so many hours of laborious work have been put into it and there is quite a thrill in hearing station after station come in on the loud speaker as the dials are turned.

The method of connecting the batteries is clearly shown in Figure 4. There can be no confusion in the connecting of the loop antenna as there are only two leads from the loop and two binding posts to which they may be connected. Either side of the loop may go to either of the two binding posts and, if a box type of loop is used no difference will be noticed if the leads are reversed. If the flat spiral type of loop is used it will be well to try reversing the leads as it is usually found that the outer end of the loop will

give better results when connected to the loop binding post which leads to the grid leak and grid condenser of the first detector.

Either four 22½-volt B battery units may be used or two 45-volt units. A large 45-volt unit is in reality just two of the 22½-volt blocks in series. In Figure 4 we show four of the 22½-volt

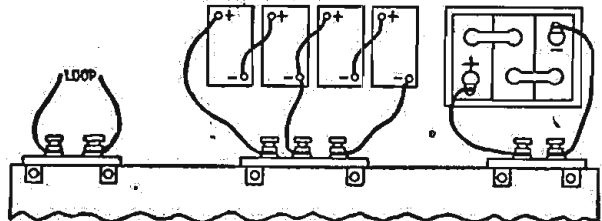

Figure 4

units properly connected to the three binding posts in the center of the rear edge of the set. It will be noted that the negative binding post on the first battery to the right connects to the right hand binding post of these three B battery connections. The positive terminal of this first battery connects to the negative on

the second battery, the positive of this second battery connects to the negative on the third and to the center binding post of the three posts on the set. The positive of this third battery connects to the negative of the fourth and the positive of the fourth battery connects to the left hand binding post of the three provided for B battery connections on the receiver.

The two binding posts at the right hand end of the receiver are for the A battery which should be a storage battery of 6 volts and any number of ampere hours from 60 to 120. On the battery one of the binding posts will either be marked with the large letter P or the three letters Pos. or the lead terminal will be painted red. This terminal should be connected to the inner of the two A battery posts on the set. The other terminal of the battery which may be marked Neg. connects to the end binding post of the receiver. The above connections should all be made with no tubes in the sockets and the filament switch in the "Off" position. Now insert one tube in any socket, turn

the filament switch to the "On" position and turn the rheostat slowly to the right. If the tube lights up dimly it indicates that the A battery circuit is complete and that the B battery circuit is not connected in any way that it will blow out the tubes. Now turn the filament switch off, insert the remaining six tubes and again turn the rheostat to the right. All this was done previously of course, but this second preliminary test is desirable to be sure that connections made since the first test have not been made so that the B battery will blow tubes.

Now plug in the loud speaker in the lower jack and we are ready to tune in a station. Looking at the set from the front, the condenser to the left will hereafter be referred to as the oscillator condenser, while the other one will be referred to as the loop condenser. Set the loop condenser at 50 and slowly revolve the oscillator condenser through its scale. If no signals are heard and no series of whistles is heard, turn the potentiometer about 20 degrees to the

(Continued on page 18)

The "Goode" Two-o-One

A

Le Ton d'argent



BY MAIL ONLY

\$2.39

Postpaid

QUARTER AMPERE AMPLIFIER—DETECTOR RADIO TUBE

GUARANTEED SATISFACTORY

All "GOODE" Tubes Sold Direct to the Consumer—No Dealer Profits

ONE—"Goode" Detector-Amplifier..... \$2.39

THREE—"Goode" Detector-Amplifiers..... 6.42 (All postage prepaid)

The "Goode" Two-o-One A Tube amplifies or detects. It is a quarter ampere, five volts, standard base silvered tube. Send express or postal money order or New York draft to—

The Goode Tube Corporation
Incorporated
Owensboro (Dept. A) Kentucky

Of Course It's a CROSLLEY Better—Costs Less Radio

For ease of tuning, selectivity and long distant reception, you can't beat a Crosley. Actual performances prove this day in and day out. Here are what a few of the happy Crosley users say:

Apponag, Rhode Island. "I purchased my Crosley one tube No. 50 around the first of August and I think it is my duty to express my satisfaction of its performance during the warm spell. Have heard New York, Boston, Pittsburgh, Cincinnati, Chicago, Detroit, Ottawa, Canada, and many other stations."

Dallas, Texas. "The set, Model 51, has already surpassed my greatest expectations. On the night of September 13th, Oakland, California, was received with sufficient volume to be clearly heard throughout seven rooms. Kansas City, Chicago and many other stations were received with respectively greater volume."

Chicago, Illinois. "My Trirdyn has done all that you claimed for it. The first silent night, Monday, September 22nd, using only two tubes, I pulled in twenty-eight stations. On the following night with most of the Chicago stations going full blast, using two tubes, I pulled in Memphis, Cincinnati, Dallas and Omaha." (Names upon request)

These are only a few of the thousands of unsolicited letters that come to us. You, too, can enjoy similar results with a Crosley. And the cost of any Crosley is remarkably low.

BEFORE YOU BUY—COMPARE YOUR CHOICE WILL BE A CROSLLEY

Crosley Regenerative Receivers are licensed under Armstrong U. S. Patent 1,113,149. Prices West of the Rockies add 10 per cent

For Sale By Good Dealers Everywhere

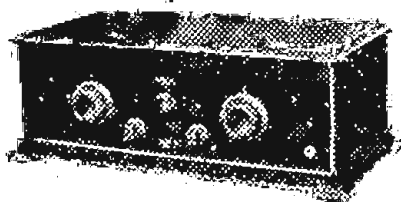

Crosley Trirdyn Special . . . \$75.00

With tubes and Crosley Phones \$90.75

Write For Complete Catalog

The Crosley Radio Corporation
Powel Crosley, Jr., President

11495 Sassafras Street Cincinnati, O.

Crosley Owns and Operates Broadcasting Station WLW

A \$200,000.00 COMPANY STANDS SQUARELY BACK OF EVERY PHONE

TOWER'S Scientific \$2.95

WEIGHS ONLY 8 OZ

Perfect Tone Makes

Plus a few cents postage

SEND NO MONEY

Order by mail if your dealer cannot supply you and we will ship immediately. Written 5-day money back Guarantee with each set. Our next year's production schedule of two million phones UNDOUBTEDLY places us as the

WORLDS LARGEST HEADSET MAKERS

THE TOWER MFG. CO.

98 BROOKLINE AVE. BOSTON MASS.

WORLDS GREATEST HEADSET VALUE

Five-Day Money-Back Guarantee If Not Fully Satisfied. We Guarantee the Scientific to be

1. One of the finest phones on the market regardless of price.
2. The most comfortable—weight only 8 oz.
3. Perfect tone mates.
4. Made of standard double pole construction (no single pole nonsense to save expense.)
5. Made of the best materials money can buy. Powerful magnets, genuine tinsel cords, aluminum cases.
6. Manufactured under ideal working conditions.

"The Choice of The Critical"

Opinions do not answer, facts do. . . . That is why you cannot afford to borrow the jaundiced ideas of your neighbor when choosing your condenser.

Buy a D. X. L. and save being disappointed. This condenser is a straight-line-low-loss type designed especially for super-heterodyne and all super sensitive sets. With grounded rotor plates of brass construction and aluminum end plates. Body capacity entirely eliminated. Approved by the University of Michigan and found absolutely accurate with the U. S. Bureau of Standards.

WRITE FOR FOLDER

If Your Dealer Can't Supply We Will Furnish Direct
Send Money Order

Manufactured by
D. X. L. RADIO CORPORATION
5769 STANTON AVENUE
DETROIT, MICH.

PRICES:

11 Plate.....\$4.00
17 Plate..... 4.25
23 Plate..... 4.50
43 Plate..... 5.00

"IT'S A D. X. L."

SUPER-HETERODYNE

(Continued from page 17)

right of where you had it during this try out. Again revolve the oscillator condenser through its scale and either signals or whistles should certainly be heard. If signals, adjust the potentiometer until signals are at maximum strength without blurring; if whistles are heard, turn potentiometer to the left with the right hand and swing the oscillator condenser back and forth with the left hand until the point is reached in the turning of the potentiometer where the whistles cease. Set the loop condenser at 70 and swing the oscillator condenser slowly through its scale. Signals should be heard, but if they are not, set the loop condenser at 30 and swing the oscillator. Practice will familiarize the builder with the tuning of this set and it will be found that once the potentiometer has been set for maximum signal strength on any one station it can be left in that position, as can the rheostat, and all tuning will be done with the two condensers. The loop tuning condenser will be found to be rather broad, the sharpness of a super-heterodyne being almost entirely in the oscillator condenser. If for any reason the receiver does not work at first, or refuses to work later, the following tests will quickly determine where the error has been made in the wiring or the location of a defective piece of apparatus.

Referring to Figure 5 it will be noted that the circuit diagram has again been drawn, but this time certain points have been lettered as points to which to connect when testing. Tests can be made with a single dry cell and a pair of headphones. The batteries should be disconnected from the receiver when making tests. Connect one of the phone terminals to one side of the dry cell and attach a piece of wire to the remaining dry cell terminal so that it will reach to any part of the set. Touch the end of this long wire to the unconnected phone cord terminal 2 or 3 times so that you are accustomed to the click which results.

To determine whether the pick-up coil of the oscillator coupler is O. K. touch the wire from the battery to the point G and the phone cord terminal to the plus A battery binding post. This should be done with the rheostat turned clear to the right to maximum. To test the loop connect the battery and phones to the points A and G. To test the grid coil of the oscillator coupler connect test terminals to point M and the negative A battery terminal with the filament switch in the "ON" position. To test the plate coil of the oscillator coupler, connect these terminals to the point N and the center B battery binding post. The primaries of the intermediate transformers may be tested by connecting one terminal of our test outfit to the plus 90 B battery binding post and the other to the points C, D or E. To test the secondaries of the first two long wave transformers and the secondary of the filter coupler, connect the test terminals to the plus A battery binding post and points H, I or J. These tests on the secondaries should be made with the potentiometer turned toward the end of the potentiometer to which the plus A battery bus was connected. To test the upper jack and the primary of the audio frequency transformer connect the test terminals to point F and the plus 45 B battery binding post. The secondary of the audio frequency transformer may be tested by connecting to point L and the negative side of the C battery.

It will be noted by reference to Figure 5, that when any of the pairs of points

mentioned in the foregoing test are touched, a complete circuit should result and a click in the phones should be heard. If on touching any of the pairs of points mentioned the click is not heard it indicates either a defective connection to the instrument or a defective piece of apparatus.

Even though the set works and works exceedingly well at first, this should not be taken as the best that can be secured from it. The condenser across the primary of the filter coupler which is of .0005 mfd. capacity is very important and it has been found that even when carefully tested by the fixed condenser manufacturers there is likely to be considerable variation in condensers. If two or three fixed condensers rated at .0005 mfd. are available it would be well to try inserting each of these, one after the other, to determine whether there is any difference in the results considering both volume and clearness.

While UV-201A tubes are not, as a rule, critical as to the amount of grid leak to be inserted in the grid lead when they are used as detectors, it would be well to try other values than that specified in the grid leak mountings. The tubes will function and function very well with two megohms in use but since there is variation in tubes it might be well to try values as low as one megohm and as high as four.

The third and final possible change that might be made is the C battery. C batteries are usually constructed with a tap at three volts as well as at the 4½-volt point. Try the 3-volt point and see whether any difference is noted in the clearness of signals. If a friend has a C battery that you can borrow try connecting it in series with the one which you already have, as occasionally a tube is found which requires 6, 7½ or 9 volts grid bias.

As a last injunction do not be too impatient to get the 3,000 mlie stations. This super-heterodyne will positively work well, even though the wiring is but mediocre and the apparatus is but average quality. It is efficient because it's simple and there is no shielding or other materials put in this set, which while they may cause a theoretical improvement, may also broaden the tuning and decrease the efficiency. The writer does not say that shielding is a bad thing, but as a rule it will be found that shielding is unnecessary and likely to lower the efficiency. The chief point that attracted the attention of Radio Digest was the sharpness and the way it would pull in DX stations through the 9 or 10 locals in and around Chicago. This was not the case on but one model, but proved true with six models which were constructed. Different makes of apparatus were used in these sets, but the general layout and the wiring diagram were the same in all the models.

(Radio Digest is preparing a special booklet telling how to build "The Simplest Possible Super-Het," which includes full size panel and baseboard blueprint layouts. This should be ready for distribution by December 10. The cost will be fifty cents. Next week Mr. Ryan will answer a number of questions asked about the super-het.—Editor's Note.)

Switch Points

Common brass upholstery tacks make good switch points when used on wood panels. It saves time as you do not have to drill the panel, because you can hammer the tacks in the wood panel. If one tack should be misplaced it can easily

be moved to another location. If the tacks should be placed too far apart so that the switch arm goes between, you do not have to raise it with your fingers

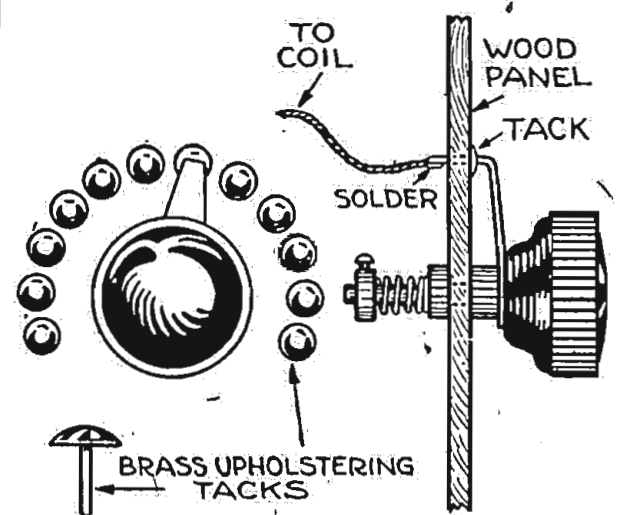

because it raises itself on the curved part of the tack.—Fred Boelter, Minneapolis, Minn.

PREMIER Microstat
THE SLIDING SCALE VERNIER RHEOSTAT

FINE TUNING MADE EASY

Premier "MICROSTAT" is a wonder for tuning in the distant stations. Stands alone in its fineness of adjustment and minute control. Two resistor units—one six ohms and one forty ohms—connected in parallel. Vernier adjustment on high resistor. Noiseless in operation. Insures freedom from sputtering and scratching. Premier "DUOSTAT" combines two rheostats in one. Provides all necessary control of two tubes with one panel mounting. Premier Double Disconnect Potentiometer is the last word in plate current control. Its special feature, a double break switch, automatically disconnects "A" and "B" batteries when lever is off. Prevents battery waste and tube burn out danger.

All three above instruments are typical in design. Each requires only one hole in panel. Bakelite moulded. Silver etched dials. Many other superior features. All one price, \$2.50 each. Write for Free Bulletin No. 94 showing complete line of Premier Quality Radio Parts. Ask your dealer if he has Premier free hook-ups. If not, send his name and receive a set free.

Premier Electric Company
3810 Ravenswood Ave., Chicago

Premier

Quality Radio Parts

Dealers Need This

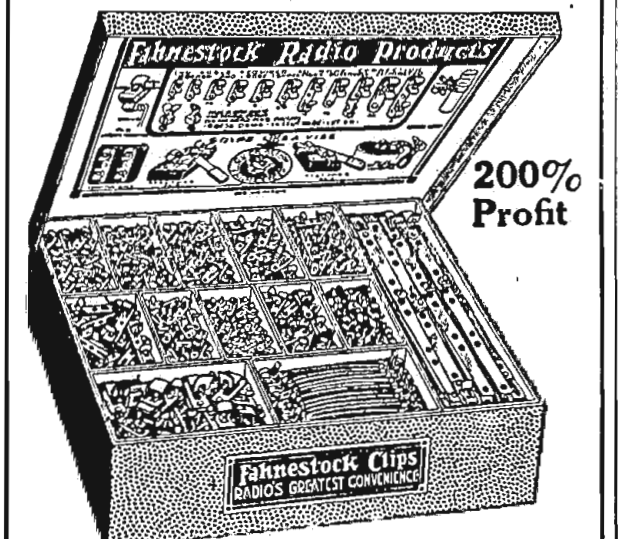

The new FAHNESTOCK Display Case Will stimulate your sales of Fahnestock Radio correct place for his set. A constant invitation to are included. Shows the purchaser instantly the correct piece for his set. A constant invitation to buy Fahnestock Products. Dealers are offered 200% profit on each case, an unusual offer on standard merchandise.

Price to Dealer.....\$17.50
West of Mississippi..... 18.50
Transportation prepaid when money order or check accompanies order.

Contents Retail for \$51.50
Benefits will be supplied at the regular 100 lot prices, shown in catalogue, which comes with case, less discount shown on enclosed sheet. Send check or money order, today.

FAHNESTOCK ELEC. CO.
LONG ISLAND CITY NEW YORK

For Low-Loss Receivers Use the Most Efficient Inductances

Pfanstiehl
VARIOMETER and VARIOCOUPLER

Pat. Pending

Pfanstiehl Variometer, P-301.....	\$4.75
Pfanstiehl Variocoupler, P-300.....	5.00
Pfanstiehl "Three-Circuit" Tuner, P-302.....	5.00
Pfanstiehl Super-heterodyne Oscillator, P-600.....	6.00
Pfanstiehl Coils:	
P-201.....	25
P-202.....	35
P-203.....	50
P-204.....	75
P-205.....	100
P-206.....	150
Pfanstiehl Ultra-Audion, P-225.....	.95
Pfanstiehl Reinartz.....	1.75

PFANSTIEHL RADIO CO.
Highland Park, Ill.
Chicago: 1001 W. Washington St. Heymarket 8010

Make Your Radio Joy
A Sure Thing

The quickest way to spend \$20 is to accidentally make a short circuit in a five-tube set. Zip, and your money is gone as well as your fun—until the radio store opens.

Either style of KANT-BLO means protection against blowing out tubes.

Kant-Blo

SWITCH SIGNAL BINDING POST

Lights on any Short Circuit!
The KANT-BLO is not an extra accessory to your set. It is designed as a B battery Binding Post or as an A battery filament Switch Style—are at all the best radio stores. If your dealer is out of stock send us \$2 for a KANT-BLO Binding Post Style, or \$3 for the Switch Style, and we will ship any number of KANT-BLOS direct to you, charges prepaid.

Manufactured by **GANIO-KRAMER CO., Inc.**
New York
Sole Distributors **APEX RADIO CO.**
503B Fifth Ave. New York

12 Cells 24 Volts Solid Rubber Case

\$3.50 COD SPECIAL

INTRODUCTORY PRICE
For a limited time only, and to introduce this new and superior Storage "B" Radio Battery to the Public, we are selling it for \$3.50. Regular Retail Price is \$5.50. You save \$2.00 by ordering NOW. A finer battery cannot be built than the

World Storage "B" Battery
(12 CELLS—24 VOLTS)

To ten million homes with Radio Sets—and to countless millions of prospective buyers—this WORLD Storage "B" Battery brings a new era of battery economy and performance. Here is a battery that pays for itself in a few weeks—will last for years and can be recharged at a negligible cost. And you save \$2.00 by ordering now.

A Superior Battery Equipped With Solid Rubber Case
Has heavy duty 2-1/8 in. x 1 1/4 in. plates and plenty of acid circulation. Extra heavy glass jars allow ready observation of charge and prevent leakage and seepage of current. It holds its charge, while idle, at constant voltage. You will find this battery a boon to long distance reception. It does away with a great many noises so often blamed on "static." Mail your order today.

SEND NO MONEY
Just state number of batteries wanted and we will ship day order is received. EXTRA OFFER: 4 batteries in series (96 volts), \$15.00. Pay Expressman after examining batteries. 5 per cent discount for cash in full with order. Send your order NOW and save \$2.00.

WORLD BATTERY COMPANY
Makers of the famous World Radio "A" Storage Battery
1219 S. Wabash Ave., Dept. 76 Chicago, Ill.

SAVE \$2.00 BY ORDERING NOW!

FREE

To Each Purchaser of a **World Battery**

A 24-Volt "B" Storage Battery positively given FREE with each purchase of a WORLD "A" Storage Battery. The WORLD Battery is famous for its guaranteed quality and service. Backed by years of Successful Manufacture and Thousands of Satisfied Users. You save 60%.

Prices That Save and Satisfy

Auto Batteries	Radio Batteries
6-Volt, 11 Plate \$12.25	6-Volt, 190 Amps. 12.50
6-Volt, 13 Plate 14.25	6-Volt, 120 Amps. 14.50
12-Volt, 7 Plate 17.00	6-Volt, 140 Amps. 16.00

Shipment Express C. O. D. subject to examination. 5 per cent discount for cash in full with order.

2-Yr. Guarantee Bond in Writing With Each World Storage Battery

Proves satisfactory World performance. Mail this ad with your name and address—we will ship battery day order is received; and give you your choice of "B" Storage Battery or handsome nickel finish Auto Spillover, FREE. Write TODAY.

WORLD BATTERY COMPANY
60 E. Roosevelt Road Dept. L, CHICAGO, ILL.

This FREE "B" Storage Battery takes the place of dry cell "B" batteries. Can be recharged and will last indefinitely. To be sold retail for \$6.00. It is the only battery of its kind equipped with solid rubber case—and insurance against acid and leakage. Take advantage of this remarkable introductory offer NOW! To those who prefer it, we will send FREE a handsome nickel finish Auto Spillover, instead of the "B" Battery. Be sure to specify which is wanted.)

GIVEN FREE
To introduce this new and superior World "B" Storage Battery to the Public

Model A
2400 ohms
\$4.00
List

Model B
3000 ohms
\$5.00
List

Repeater

Phones

"Single Pole"
GUARANTEES MATCHLESS REPRODUCTION

From all parts of critical America, from wireless workers, amateurs, and from those who just insist upon the best, comes enthusiastic indorsement for Repeater Phones. Distance is annihilated, obstacles vanquished by Repeater.

This matchless tone quality is due chiefly to the "Single Pole" feature, exclusive with Repeater.

All the power of the air unleashed flows evenly, smoothly through Repeater's "Single Pole"—you are certain of exact, faithful reproduction.

ASK FOR
our illustrated booklet containing complete details.

DEALERS
In Repeaters you will find a popular appeal. Our discounts will interest you. Write for Merchandising Plan.

The New Improved "Repeater"

MOSS-SCHURY MFG. CO., Inc.
Radio Division
2015 Franklin St. Detroit, U. S. A.

Helpful Hints to Get the Most from Radio

Chapter XI—Care of Radio Batteries

By Thomas W. Benson

IN THIS series of articles set operation will be told in so simple a manner that the uninitiated can follow instructions and get the most out of reception, whether or not he knows anything about electricity or its application to broadcasting and reception. The next two articles of the series will be:

- Chapter XII—Telephones and Loud Speakers.
- Chapter XIII—Hints on Tuning.

THE batteries are the power plant of the Radio set and upon their condition depends much of the pleasure and efficiency of Radio reception. When a set fails to operate properly the first thing to do is check the batteries and make sure they are in good condition. A discharged A battery will cripple the best receiver ever built and a B battery that has fallen off in voltage will cause most multi-tube sets to howl while reflexes will fall off greatly in range, although the volume is cut but slightly.

We will consider the A and B batteries separately while discussing their care and proper operation. Much has been written in these pages on the proper method of connecting and charging storage A batteries, so little need be said on this phase of their care. We will consider then how to get maximum service and life from the battery.

Heating is one of the worst enemies of long life. Never charge or discharge a battery at such a high rate that it heats up over 120 degrees F. Heat causes the plates to buckle, loosening the paste in the plates and reduces the capacity of the battery. The same is true of jars and jolts. Don't slam the battery around or drop it. The automobile type of battery may stand this treatment, but many of the Radio batteries are built with thin plates and will not stand this treatment. This is one argument against sending batteries out to be charged; one is never sure of the treatment they receive and it is

practically impossible to detect mistreatment.

Keep the Battery Clean and Dry

When nearly fully charged a battery will gas and give off an acid spray that settles on the tops of the cells. This spray forms a conducting surface that drains the battery. It is, therefore, good practice to wipe off the top of the battery occasionally with a rag wet with ammonia water. This neutralizes the acid and checks corrosion of the terminals and battery box.

It is necessary to have good connections to the battery at all times so the terminals must be kept clean and free from corrosion. The simplest preventive is to smear the connections with vaseline, but they will corrode in spite of this and must be cleaned often by scraping and wiping with an ammonia soaked rag and re-coated with the vaseline.

A word about specific gravity. An automobile starting battery is usually 1,250 or 1,300 on full charge. This is because the battery is intended for work where currents of 150 amps. are drawn at times and the battery must have practically no resistance to stand the current surge. The high density acid naturally shortens the battery life but it permits the use of a smaller battery for a given load. On the other hand Radio batteries operate with a slow discharge rate with frequently long periods between charges. This duty permits of the use of a lower density electrolyte with a gain in battery life. Therefore if a starter battery is used for Radio the acid can be reduced in strength.

The proper method of doing this is to give the battery a full charge, pour the acid out and dilute it down to 1,200 with distilled water and refill the battery. This will give a longer life to battery by reducing tendency to sulphate and the destruction of the separators. The battery will now read 1,075 when fully discharged. The usual notations on the hydrometer showing full charge and discharge are now disregarded.

Efficiency of Dry Cells

The portability and compactness of receivers using dry cells for filament current source has resulted in their widespread adoption. To obtain full service from dry cells the Number 6 size cell should not be given a greater load than ¼ ampere. Higher efficiency is obtained by working the cells at half this load and it is economy to use twice as many cells are, in fact, moist cells and a warm multiple.

It is general practice to place the batteries close to the set but when this means keeping them in a warm room it tends to shorten the battery life. Dry cells are, in fact, moist cells and a warm place dries the cells out. When the receiver is used in the home it is usually possible to mount the batteries in the basement where it is cooler.

The same facts should be kept in mind when dealing with B batteries of the dry cell type, it being doubly important to mount them in a cool place because the cells are smaller and will fall off in voltage more rapidly. When both A and B batteries are placed in the basement the leads from the batteries may be brought up through a section of elevator signal cable. This cable is carried by most electrical jobbers and is low in cost. By using a common wire for the negative B and positive A it will require a 4-conductor cable and if the A ground is used it can be run in the same cable. Under no condition attempt to run the aerial lead with the battery leads, for the capacity effect between them will drain all the effective energy.

Storage Cells for Plate Voltage

The use of storage cells for plate voltage is entirely practical and economical when a source of charging current is at hand and only troublesome when they must be carried out to be recharged. The rules suggested for storage A batteries should be followed in caring for these

cells, particularly in regards to keeping the connections clean.

The charging rate on the cells should be kept down to the rate recommended by the manufacturer, for the tendency is to charge them at too high a rate, causing spraying of the electrolyte and heating of the cells. Since the reserve space for solution is small in these cells they should be examined once a week and refilled with distilled water.

There are a number of devices on the market that utilize house lighting current to produce the high voltage plate current and some are very effective. They operate on two general principles, in one the current is rectified and filtered by condensers and inductances to give a smooth flow of current, in the other current is generated by a series of thermocouples heated by the lighting current. It is always well to test these devices on one's set before making purchase. They sometimes introduce a loud hum in the receiver or cause it to whistle badly because of the resistance present. On some receivers they function very well and if not overloaded are economical and efficient.

The Alkaline Battery

The ruggedness of the Edison or alkaline battery and freedom from destructive fumes has led to its adoption for plate batteries and despite its low efficiency as a storage cell it gives satisfaction when properly handled. Its disadvantage is that the voltage falls off steadily from fully charged to empty and thus causes variations in the results from the set. This may be overcome by having several extra cells that can be switched in as the voltage falls, thus keeping the voltage practically constant.

Alkaline cells should be fully charged on each charge, partially charging them is of no use for they often drop it in a few hours. When being charged the rate

(Continued on page 20)

Lincoln RADIO PRODUCTS Laboratory

Tested and Approved

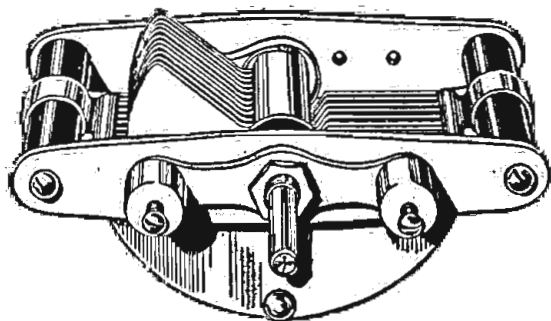

Lincoln Low-Loss Condenser

Lincoln Low-Loss Grounded Rotor Condenser, 23-plate model is most efficient electrically, strongest mechanically. Several radical improvements. List price \$4.50.

Lincoln Oscilloscope

The "superhet" depends for efficiency on its oscillating circuit. The Lincoln Oscilloscope permits such delicate control of oscillations that it produces amazing results. List price \$6.50.

Lincoln "Long 45" Tuner

Condenser, inductance and tickler coil all in one. Add a socket, rheostat grid-condenser and leak... and you have a wonderfully efficient complete set. Coast-to-coast range with clearness of reception equal to big expensive sets. List price \$10.00.

Lincoln Collapsible Loops

Correctly designed mechanically and electrically. Insures quality reception... and is most convenient. List price \$6.50. The Lincoln Collapsible Four-Point Tapped Loop is ideal for "superhet" and other radio-frequency circuits. List price \$8.00.

The Lincoln Kit

Includes the "Long 45" Tuner. Everything for a 1-tube set with coast-to-coast range. Easy to assemble, easy to add to. List price \$21.50.

Write for Catalog

All Lincoln products fully guaranteed. If your dealer cannot supply you, order direct giving his name. Write for illustrated catalog giving full descriptions.



Lincoln Radio Corporation

224 N. Wells St. Chicago, Ill.

The kind of Letters Thordarson gets—No. 8

New Westminster, British Columbia, Canada.

Thordarson Electric Mfg. Co., Huron and Kingsbury Sts., Chicago, Ill.

Dear Sirs: I am at present using three Thordarsons—two in one set and one in another set—and have never come across any other transformer that gives as good results.

Yours very truly,
R. Nairn (signed).

3326 Reading Road, Cincinnati, Ohio.

Thordarson Electric Mfg. Co., Chicago, Ill.

Gentlemen: I have tested practically every type and kind of audio frequency transformer on the market and find yours to be the best for pure tone and high amplification. It sure is very fine.

Yours,
R. P. Lippelman.

THORDARSON Super AMPLIFYING TRANSFORMERS

Standard on the majority of quality sets
Audio Frequency: 2-1, \$5; 3½-1, \$4; 6-1, \$4.50. Power Amplifying, pair \$13.
Interstage Power Amplifying Transformer, \$8.

P.S. Write for some real bulletins!

Peerless—in PRICE-SERVICE-PERFORMANCE

The CLARITRON TUBE 230

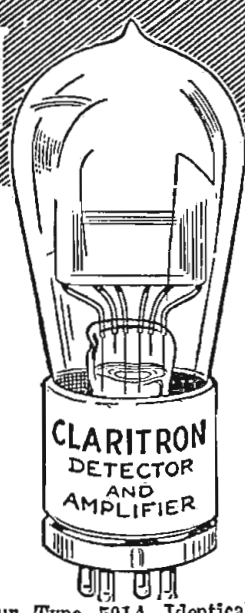

QUALITY TUBES you must have —CLARITRON means QUALITY

It is Peerless in performance — gives beautiful clarity, and round, full volume that delights the ear. A detector of extreme sensitivity and an excellent radio amplifier. It is Peerless in service—its current consumption is less than .18 amps.

The famous New York Testing Laboratories, after exacting tests of the CLARITRON, report that it not only "compares well in general" with a certain standard tube selling at \$4.00 (name on request) but that "the operating cost is lower on the average." The remarkable new filament in the CLARITRON insures service.

It is Peerless in price—it costs you only \$2.30, and YOU ARE GUARANTEED SATISFACTION OR YOUR MONEY REFUNDED. Order Now.

ALL TYPES TUBES—Same quality, same price. Sent Parcel Post C. O. D. or Prepaid on receipt of Postal or Express money order. Our Type 501A identical with UV201A amplifier & SUPERIOR RADIO CO. Dept. D. 176 Shepard Ave. NEWARK, N. J. Detector (5 volts .18 amps)

DIETZEN Adjustable LOUD SPEAKER

At the Price of an Ordinary Pair of Head Phones

DEALERS: write for details

SEND NO MONEY!

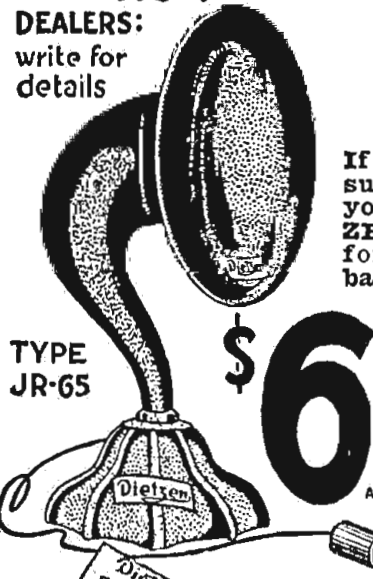

TYPE JR-65

\$6

ORDER BY MAIL
If your dealer cannot supply you we will ship you a complete DIETZEN JR-65 speaker ready for use. Written money back guarantee with each loud speaker.

COMPLETE with specially built DIETZEN adjustable loud speaker unit and plug.

NOT a Head Set Unit

DIETZEN INC. 71 Cortlandt St. Dept. D. New York

MAKERS OF PRECISION INSTRUMENTS SINCE 1889

SPECIAL FEATURES

- Absolute non-metallic sound.
- Permanent Crystallized finish.
- No batteries necessary.
- Specially constructed adjustable unit with gold plated diaphragm.
- Unconditionally guaranteed for one year from date of purchase against mechanical defects of any kind.

SPECIFICATIONS:

Diameter of Horn—9 INCHES
Height 17 INCHES



GET MOST FROM RADIO

(Continued from page 19)

should be high enough to bubble the solution and kept on till the voltage is up to the rating called for by the manufacturer. Slow charging of the cells is ineffective and as high a rate as the battery will stand without overheating should be used.

Dry B batteries should be read with a voltmeter while connected to the set; any block that has dropped to 70 per cent of its rating should be cut out. A hydrometer is used with storage cells and when a battery has dropped 75 points specific gravity from full charge reading it requires recharging. Alkaline storage cells are tested with a voltmeter.

When the batteries are located at a distance from the set they have a tendency to pick up energy from powerful locals that may cause interference and their resistance may affect the operation of the set. Both difficulties are overcome nicely by connecting condensers of 1 mfd. or larger across the leads where they enter the set.

(Telephones and loud speakers will be the subject for the next chapter in Helpful Hints. These parts make sound from electricity and Mr. Benson will describe them in detail.—Editor's Note.)

LOW LOSS—WHAT IS IT?

(Continued from page 15)

used in locating the holes in this rotor tubing to be sure that they are diametrically opposite and midway the length of the tube, otherwise the rotor will wobble. As will be noted in Figure 2, the tubing is held in place on the shaft by two hexagonal nuts within the tubing. With a punch or a very fine drill, make a hole just large enough to pass the wire close to each edge of this 1 3/4-inch tube. Sixteen turns of wire are placed on the tube, 8 on each side of the shaft. The ends should be pushed through the small holes just drilled and bent to keep the wire from unwinding.

To add the rotor to the assembly we now proceed as follows: Push the threaded end of the shaft through one of the 1/4-inch holes of the large form and slip over it a short length of coil spring made of spring brass wire. Then push the shaft on through one of the 1/4-inch holes in the small tube, slip on the two hexagonal nuts and screw them part way along the shaft and finally push the shaft through the second hole in the small tube and the second hole in the large tube. The two nuts within the small tube are now revolved in opposite directions until they tighten up against the inner wall of the tube. Two additional nuts are now placed on the threaded end of the shaft as lock nuts

New Long Distance Crystal Gives Remarkable Results

A recent invention in crystals, called the DX Super-Sensitive Crystal, is amazing Reflex and Crystal Set owners everywhere. It is stated that this marvelous Crystal Detector, which is unlike any other, gets distant stations loud and clear and there is no disagreeable "hunting" for spots because the entire surface is sensitive. Many are finding it far superior for Reflex work and claim it the last word in mounted synthetic crystals. In order to introduce his invention to the radio public, the owner, Mr. Hick, is giving a trial offer with a ten day money back guarantee to anyone who writes him at 1018 So. Wabash Ave., Chicago, Ill. For a limited time these crystals are selling for 35c each or 3 for \$1.00. So just enclose remittance with your name and address and they will be sent postpaid. You have the privilege of returning them within ten days if not delighted with results obtained.—Adv.

and it will be found very easy to adjust these four nuts so that the small rotor revolves in the center of the large coil. As yet no provision has been made to prevent the small coil and the shaft from being pushed backward, but the two lock nuts prevent it from being pulled too far forward.

The four small pieces shown in Figure 1 are made from 3/16-inch pieces of scrap bakelite or hard rubber, cut to the dimensions shown and drilled as indicated. A little care may have to be used while drilling the 1/4-inch holes in items A and B, but this can be done without breaking out the sides. The two mounting holes in the panel of the receiver should be 5 1/2 inches apart, while the 1/4-inch hole for the shaft is 1/2 inch from one of the mounting holes.

Complete Assembly

The completed assembly and the method of mounting this unit on the panel is shown in Figure 3. For mounting this unit to the panel, three flat head 6-32 machine screws 3/4 inch long will be required. It will be noted that to fasten items C and D to the large form it will be necessary to remove the short 6-32 machine screw which holds one of the strips to the bakelite ring and substitute one of the 3/4-inch machine screws. The question will be raised as to whether or not the quantity of dielectric material inserted in the rotor is detrimental to the efficiency of the set. Used for this purpose, this bakelite material will not prove very detrimental to the efficiency of the receiver as it is the resistance of the large secondary coil of 56 turns that we are reducing by means of regeneration. Losses in the small rotor coil which would ordinarily tend to broaden the set are not effective in the feedback regenera-

tive circuit and whether or not the plate circuit tunes sharply is of little importance. The sharpness of tuning all depends on the secondary circuit and regeneration merely lowers the effective resistance of the secondary circuit.

After mounting this unit on the panel with the shaft protruding through the front of the panel, one is ready to put on the dial which indicates the position of the rotor. Before putting this dial on the shaft, slip a spring washer on the shaft and then push the dial tight up against the washer and the panel. This arrangement will prevent the rotor from being pushed backward out of its correct position in relation to the large form yet the dial will not bind against the front of the panel.

(Condensers and their losses will be taken up in the next installment by Mr. Fournier. Their efficiency is just as essential as that of inductances.—Editor's Note.)

Double Feed-back

The circuit in the illustration is a wonder. Its low cost of construction, its selectivity, large volume and capability of bringing in DX stations makes it an ideal set. It is a combination of the Miloplex and super-sensitive circuits.

The primary L1 is a 60-turn spider web coil and the tickler L2 is wound with 40 turns. These coils have a variable coupling. L3 and L4 are spider web coils wound with 40 and 10 turns, respectively. These coils have a fixed coupling. They are spaced about 2 inches apart. All the above coils are wound with No. 22 DCC wire. A variocoupler or a split variometer may be used in place of coils L1 and L2.

The rotor plates of the tuning condenser are grounded. This eliminates the body capacity effect. The plate circuit condenser should be preferably vernier equipped. The condenser in the antenna circuit is a mica fixed condenser. The rheostat is a vernier. Keep all leads as short as possible.

Using a WD-11 tube and a 22 1/2-volt B battery, the local stations come in as loud

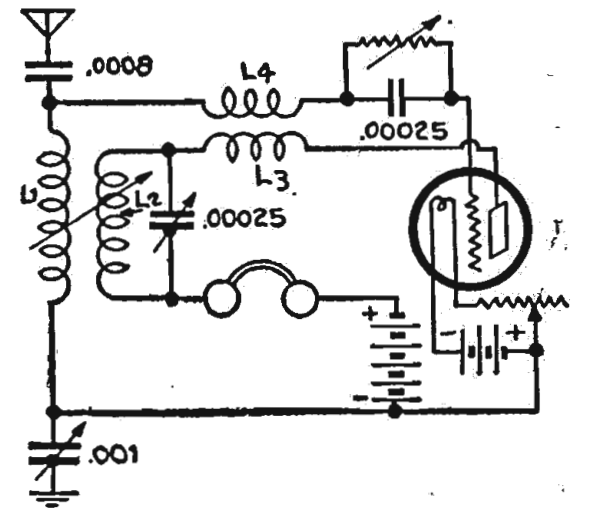

as a plain regenerative set and one-step amplifier. WOS, WJAX and KDKA can be heard 6 inches from the phones.

I have tuned in most of my DX stations while either of the local 500-watt stations were operating.

I have heard the following stations in three evenings. WLW, KDKA, WTAS, WFAD, WSAI, WOC, WMAQ, WOS, WCCO, WCB, WOR, WSB, WJAZ, WGN, WGY, WHB, WHAS, WJAK.—Charles Doyle, Cincinnati, Ohio.

Send NO Money Thank YOUR Favorite Stations

and talent. They appreciate applause as musicians on stage do. Be up-to-date. Get more pleasure out of your radio. Save letter postage and stationery. Use Thank You Cards. **SAMPLE CARD FREE**

ALL THE RAGE Hear what YOU like. Stations gladly put on numbers at your request. We print cards that get ATTENTION. **YOUR OWN NAME AND ADDRESS PRINTED FREE** on each card. Be individual. Good grade cards. Quality printing. Small charge for attention getting Thank You Cards. 100—\$1.35; 200—\$1.95; 300—\$2.45 plus postage. **Money Refunded if Not DELIGHTED** Don't send one cent. Just pay postman after cards arrive. If you prefer to send check or money order with order we prepay postage. You will be more than pleased. Order Today—NOW. A postman will do. **RADIO PRINTERS, 48D, Main St., MENDOTA, ILL**

40-Foot AERIAL MAST \$25.00

WE PAY THE FREIGHT Install this steel aerial mast in a few minutes for greater range and better results. Neat, substantial construction. Mail postcard for literature and full particulars about the **Hercules Aerial Mast** S. W. HULL & CO. Dept. H. 2048 E. 79th St., CLEVELAND, O.

"NOISE" OR MUSIC?

A matter of Perfect Connections **RAJAH SOLDERLESS SNAP TERMINALS** Assure the Positive Electrical Connections That Make Radio Enjoyable



Patented Sept. 23, 1924 Instantly attached by pressing on the base post where connection is made by a phosphor bronze spring that grips the post on opposite sides.



Patented Sept. 23, 1924 Connector secured to wire by screw connection as shown in illustration, and can be used over and over on different wires; attachment being made in a few seconds. FULLY APPROVED BY LEADING LABORATORIES Base studs sold separately for use on B batteries or any place where changes of connection is desired. Metal price. Terminal and Base Stud, as illustrated, 20 cents. Base studs only, each 6 cents. **SPECIAL INTRODUCTORY OFFER: 1 dozen terminals and studs, by mail prepaid...\$2.00** Dealers: Get in line at once for the best selling radio device you ever saw. **RAJAH AUTO SUPPLY CO.** Bloomfield New Jersey, U. S. A.

TRY US! RADIO DEALERS!

We are exclusive Radio Jobbers and **DO NOT RETAIL.** Howard—Crosley Liberty—Day-Fan Receiving Sets Complete line of parts. We Sell to Dealers Only. Write for Catalog! **TAY SALES CO.** 6 N. Franklin St., Chicago

DEALERS!

Write for—Discounts on **FEDERAL ACCURATUNE PREMIER BURNS FROST SHAMROCK DUBILIER REMLER BREMER-TULLY SHAMROCK-HARKNESS REFLEX KITS IN STOCK** **PRAIRIE STATE RADIO CO.** 39 West Adams St. Chicago, Ill.

Specialty Radio Jobbers
Literature, Dealer's Catalogue, Complete Line of Parts, Discount
HUDSON-ROSS 123 W. Madison St. Chicago

REFLEX
Erla—Acme—Harkness
Dealers: Send for Discount
HUDSON-ROSS 123 W. Madison St. Chicago

HUDSON-ROSS
Largest exclusive Radio Jobbers in middle West. Write for discount. 123 W. Madison St. Chicago

SHAMROCK

(FOR SELECTIVE TUNING)

Pages 8 and 9—

of the Shamrock Booklet tells you how to build the **Split Variometer Circuit** This set produces superlative results with local broadcasting stations within a radius of 100 miles.

SHAMROCK MANUFACTURING CO. Dept. 29-B, Market St. Newark, N. J.

I enclose 10 cents (U. S. stamps or coin) for copy of "Shamrock Radio Builder's Guide Book," containing diagrams and complete instructions for building 10 inexpensive sets.

Name.....
Address.....

DEALERS

SUPER-HETERODYNE KITS

Complete Parts and Information

Send For Catalogue

Complete Stock of Nationally Advertised Merchandise

CONTINENTAL TUBES

A 6 Months' Written Guarantee with each tube that it will give absolute satisfaction.

All Claims: with exception of thru negligence—will be honored.

C201A Det. & Amp. Fil. V. 5 Fil. Amp. 25 Pl. V. 15-150 \$2.90 We Will Ship C. O. D.

WRITE We Handle All Standard Radio Mdse. Dealers Write for Discounts

GARADIO CO. 11 N. Ashland Blvd. Chicago

Erla precision parts get the best out of Erla

SUPEREFLEX

circuits; most powerful tube for tube. Ask for Bulletin 24.

Electrical Research Laboratories, Chicago

E R L A

Homemade Short Wave Receiving Set

Buenos Aires Reached with One Tube Circuit

The illustration shows the circuit of a short wave receiver which has given good reception on a 30-foot vertical aerial. The coil P is 6 turns of number 18

WORKSHOP KINKS EARN A DOLLAR—

THERE are many little kinks worked out at home that would aid your fellow Radio worker if only he knew about them. There are new hook-ups, new ways of making parts and various unique ways of operating sets that are discovered every day. Radio Digest is very much interested in obtaining such material. Send them in with full details, including stamped envelope, so rejected copy may be returned. The work must be entirely original, not copied.

RADIO KINKS DEPARTMENT
Radio Digest,
510 North Dearborn St., Chicago

annunciator wire wound on a 4-inch tube, basket weave winding. There are 13 pegs evenly spaced around the circumference and the wire is wound around one peg, skip two, around one, skip two, and so on. When the winding is completed it is tied with silk thread and removed from the form.

Coil S is wound the same as coil P, except that it has 20 turns. Coil T is wound the same as the two preceding coils except that number 22 dcc. wire is used and it is wound on a 2½-inch circle. It is of 15 turns.

Condenser C is of the low loss type and is of .00025 mfd. capacity. G is a .00025 mfd fixed condenser and a 1 megohm grid leak. F is a fixed condenser of 001 mfd. capacity. My set is mounted on a 7 by

COILS USE SPECIAL WINDINGS

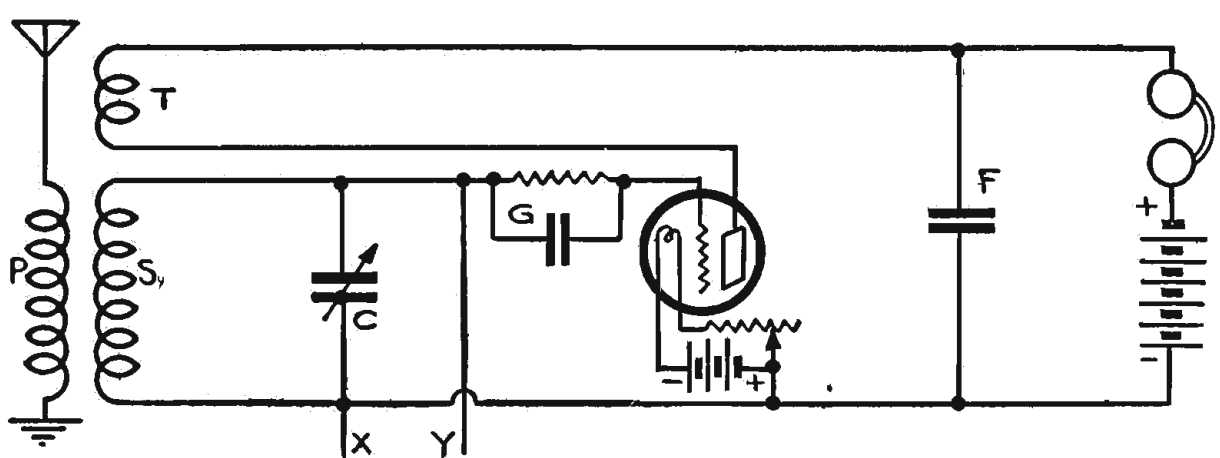

12-inch panel and I use a 200 tube with 22½ volts on the plate. The rheostat should be of the vernier type and the socket should be of bakelite with prongs which make contact with the side of the tube prongs.

Coils P and S are mounted on two small uprights fastened to the baseboard. P is placed 2 inches from S. T is mounted so that it will just rotate inside of S and is mounted at the filament end of the coil.

X and Y are two wires which are left projecting through one end of the cabinet. These are to mount the short wave coils on. The short wave coils are wound the same as P and S, except that there are 15 turns on one, 10 turns on another and 5 turns on the other. To the ends of these three coils are fastened clips which are clipped onto X and Y when the very short waves are desired.

The approximate wave length ranges of the set with different coils is as follows:

Main coil only	70 to 225
With 15 turn coil	40 to 150
With 10 turn coil	35 to 110
With 5 turn coil	30 to 70

To reach the higher wave lengths small fixed condensers may be clipped onto X and Y.

With .00025 condenser	190 to 290
With .0005 condenser	250 to 380
With .00075 condenser	370 to 430
With .00085 condenser	410 to 550

By means of the short wave coils and fixed condensers this set covers a wave band of 30 to 550 meters. This set is very efficient on the very short wave lengths. The tuning is the same as that of any three circuit tuner and is not difficult.—Kenneth G. Alley, Carthage, Ill.

Battery Abuse

A wire placed from one terminal of a battery to the other gives the current a path without resistance and is what is called a short circuit. This is harmful to any battery, and if the wire is left on it may ruin the battery. Such heavy current discharging from a storage battery may cause enough heat to warp the plates.

Series Parallel Switch for Output and Phones

With a series parallel switch placed in the circuit as shown the phones may be used direct from the detector, the output turned to the loud speaker or amplifier, or third, both phones and output can be

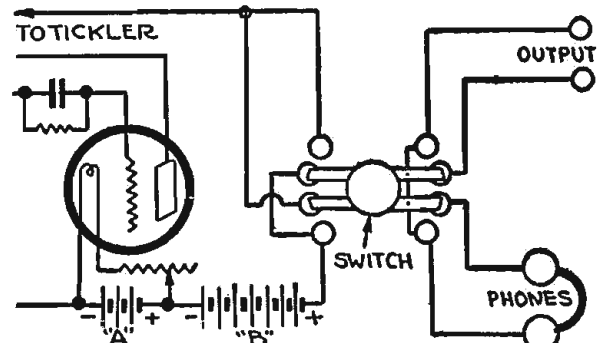

cut in. This switch may be applied to any circuit where there is audio frequency amplification.—James E. White, Petersburg, Ill.

Hydrometer Necessary

Strange though it may seem, a great many fans have not bought a hydrometer for using in testing their storage batteries. This is the only instrument that will accurately tell one the conditions of the battery. And if the battery is not charged at certain intervals its life is materially shortened. It is an investment, not a luxury, to procure a hydrometer.

A condenser in series with the antenna or ground reduces the natural frequency or wave length.

TUNE OUT LOCAL WITH YOUR REFLEX

A TOROFORMER

(A Transformer for Tuned Radio Frequency Amplification)

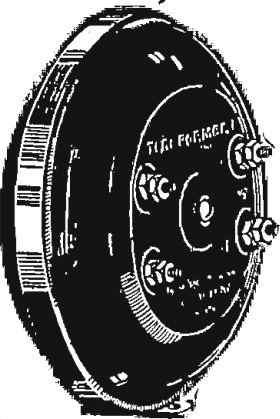

placed ahead of your Reflex will give you a

SELECTIVITY
you haven't dreamed of with

GREAT DISTANCE
than you have ever had before.

It does not pick up stray or unwanted signals, is unaffected by other parts of the circuit and has no effect on other instruments.

Outfit includes complete diagrams and hook-ups.

Priced at only \$5.00

and obtainable at any first-class Radio dealer

A limited number of 5-tube Acme Reflex Sets containing the TOROFORMER can be furnished by us. Full details on request.

THE SEARS MANUFACTURING COMPANY
1455 Leader-News Bldg. Cleveland, O.
Very attractive Dealer Proposition

EVEREADY Radio Batteries

—they last longer

Conspicuous for vitality and endurance—the right batteries by test and proof for every radio use.

NATIONAL CARBON CO., INC.
Headquarters for Radio Battery Information
New York San Francisco
CANADIAN NATIONAL CARBON CO., LIMITED
Factory and Offices: Toronto, Ontario

INTERNAL changes in the MAGNATRON make it even better for radio and audio frequency amplification than ever. And the new list price of \$4 makes MAGNATRON the best vacuum tube buy on the market.

All good dealers sell the MAGNATRON DC-201A and the MAGNATRON DC-199 (both in standard and large base types).

MAGNATRONS

CONNWEY ELECTRIC LABS.
309 Fifth Ave., New York City

STAR-ITE

THE STAR-ITE CRYSTAL

Because many people have had good results with the STAR-ITE CRYSTAL used as a detector with non-regenerative tube sets, we have had a great many letters from radio folks who seem to be of the impression that this is the—as yet unperfected—OSCILLATING CRYSTAL, of which so much has been said in the radio press.

We have secured oscillation with crystals in a laboratory fashion, but would not attempt to sell the STAR-ITE to take the place of amplifying tubes.

We do say that the STAR-ITE is the absolute pinnacle of perfection as a crystal to be used in a REFLEX Set, or a CRYSTAL Set, and as a detector in many non-regenerative tube sets, and are glad to support our belief by making it extremely easy to try one for yourself.

As this crystal is a new one put out by an old firm in the crystal business your dealer may not have it, but try to get him to order one for you, on our money back guarantee. If he does not wish to do so send us his name with a \$1.00 bill at our risk, and we will send you one with the understanding that you may return it, and we will refund you the \$1.00 at any time within 30 days. Gold Cat Whisker in Each Package

Star Crystal Co
1471 525 Woodward Avenue
DETROIT - MICHIGAN

RECEPTRAD KIT

Build the MULTIFLEX Greiff Double Selector 4-tube-Loop Operating

With this kit you can easily build a set that will bring in far distant stations even through local broadcasting—With real volume and clear tone.

Price \$29.50

Sent postpaid on receipt of purchase price, if your dealer can't supply you. Write for free wiring diagram of complete circuit.

RADIO RECEPTOR CO.
59 Bank St.
NEW YORK

Use the DUCON

No antenna—just screw the Ducon into your electric light socket and tune in. A great saving in expense and labor—and great results with your set.

PRICE \$1.50

Sold on a 5-day trial basis by all reliable dealers

Dubilier

CONDENSER AND RADIO CORPORATION

FADA makes it easy to build a 5-tube Neutrodyne

With the new 'FADA' set of knock-down parts and the new FADA book you can build a 5-tube Neutrodyne receiver that will beat anything you ever had. Outfit No. 169-A sells for \$72. It contains everything necessary. The new enlarged FADA book of 76 pages makes every detail of assembling clear. 30 pages of trouble shooting. Large picture wiring diagram. At your dealer's, 75c.

F. A. D. ANDREA, INC.
1581 Jerome Ave. New York

FADA Radio

FREE A MILLION RADIOS

To quickly and thoroughly introduce the new wonder crystals to users and dealers, we are giving away a million complete radio sets. One radio set with every crystal. Set is 5½" in diameter and will take three sets of phones.

AeroMaster CRYSTAL

\$1.00

The perfect detector and rectifier for crystal receiving sets. Superior to fixed detectors for every Aerial Master

Point is a "Hot Spot." Send \$1.00 and we will send you postpaid AeroMaster Crystal together with our famous Free Radio Set, as illustrated.

DEALERS

Help us give away these sets and fill your stores with radio buyers. Serlin & Company, big radio dealers in Detroit, sold 600 in one day.

CONTINENTAL SALES AGENCY
507 Hodgas Bldg. Detroit.

Questions and Answers

General Information

(9041) ER, Covina, Calif.

I have recently purchased a (Nion) fixed detector hoping to get better audibility than with my crystal but am disappointed.

While the fixed detector has the virtue of always being on the job, I can, if I have the patience to "fish" obtain far better and louder reception with the old crystal than with the fixed detector.

Is this as it should be, or have I got to have something else to go along with it to get better results than with the crystal?

How are fixed detectors made and how operated?

How best may I clean a crystal when it gets "old" or fails to bring in as loud as it formerly did?

What is meant by "ratio" in describing audio frequency transformers?

With my crystal set I can receive KFI (469 meters) very good, whereas another station with 395 meters is just barely audible, and still other stations with lower wave lengths cannot be heard at all. Each of the stations referred to is 25 miles away. My aerial is 150 feet long with a 30-foot lead-in from roof of the house. How can I bring in stations of lower wave length?

What is meant by "heterodyne," "ultra-dyne," "neurodyne," and the various other "dynes"?

A.—Generally a crystal with a cat-whisker, which can be moved over its surface, will afford better results than a fixed type, although there are among the latter some very good ones, which comprise an ordinary mineral detector with the cat-whisker supposed to be fastened to a sensitive spot by means of a bit of sealing-wax.

A crystal can be cleansed with soap and water and is often restored to sensitivity by thus removing dust and grease accumulations. Alcohol can be used too.

The ratio of a transformer is expressed in the relative number of turns involved in secondary and primary respectively; as 3½ to 1 ratio indicates that there are that many times more turns in secondary than in primary winding.

Your failure to submit a diagram of your circuit prohibits advising in the matter of wave length limitations. However, it will be advantageous to cut the aerial to 100 feet over all length.

The suffix "dyne" indicates action and coined words or names applied to circuit modifications merely indicate the nature of that action; as is conveyed by an analysis. These various names are applied to differentiate modifications from those employing a standard circuit.

Battery Life

(10687) SM, Wheeling, W. Va.

How low should a B battery be allowed to get before replacing?

Will a heavy fog cause weak signals? During a heavy fog settling after midnight the signals weaken considerably.

A.—The life of a B battery is ended when the voltage drops 30 per cent. The personal factor that determines, not the life of the battery, but how long one wants to use it, is your opinion as to when reception becomes too weak. The smaller the volume of sound that will satisfy you the longer you can use your B battery, within limits.

Atmospheric conditions are responsible often for poor reception, as was probably the case in the incidents of your experience.

They're free. Radio applause cards. Send us your name for quantity. Lettow & Co., 208 Hanover St., Baltimore, Md.

A Super Antenna. Greater volume. Easily and cheaply made. Less wire. Directions 50. Satisfaction guaranteed. Eugene A. Rhea, Garden City, Kans.

Singers and Musicians—Get our latest song hit "Sweetest Girl" (I Long for You). Some song snaps with "Pep." Get this quick. Send two cent stamps. Xint Music Pub. Co., Hinsdale, Mass.

Write for Our Free Book on Patents—Munn & Co., 643 Woolworth Building, New York City; 518 Scientific American Bldg., Washington, D. C.; 407 Tower Bldg., Chicago, Ill.; 360 Hobart Bldg., San Francisco, Calif.; 215 Van Nuys Bldg., Los Angeles, Calif.

S. O. S. S. O. S. S. O. S. A Radio Game, Static, Interference, Fun and Troubles. All the other Christmas presents will be forgotten when you start this game. Get your deck at Dealers or postpaid in Holiday Box \$1.00. Osborn Game Co., Box 702, Kansas City, Missouri.

LATEST WHOLESALE RADIO CATALOG

FREE Simply send name TODAY for big 48-page catalog of latest radio goods at Wholesale. Live dealers and agents wanted. STANDARD RADIO CO., 106 East 13th, Kansas City, Mo.

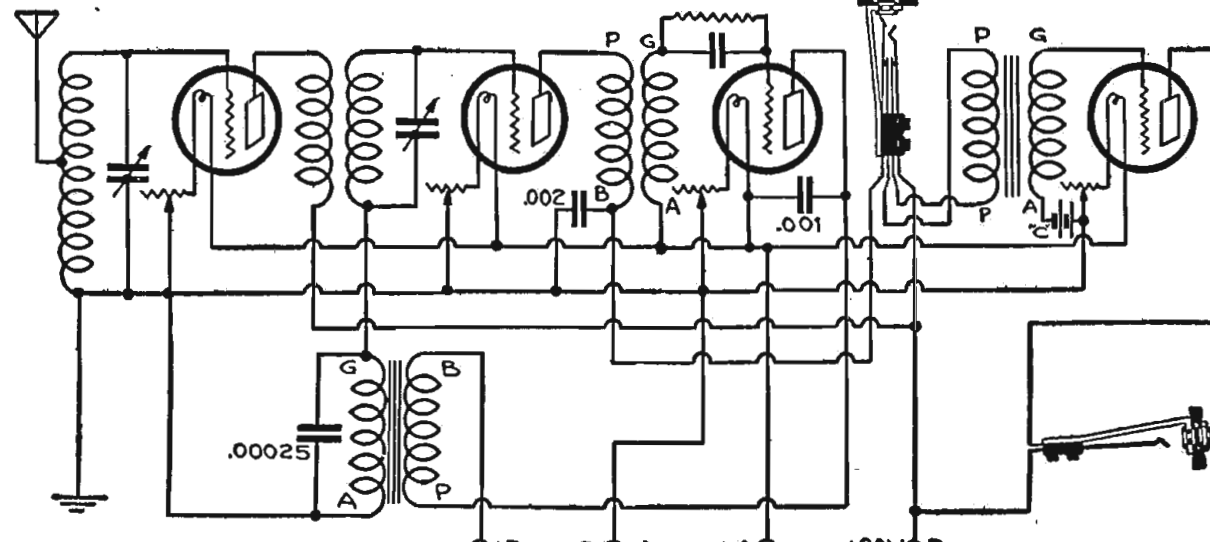
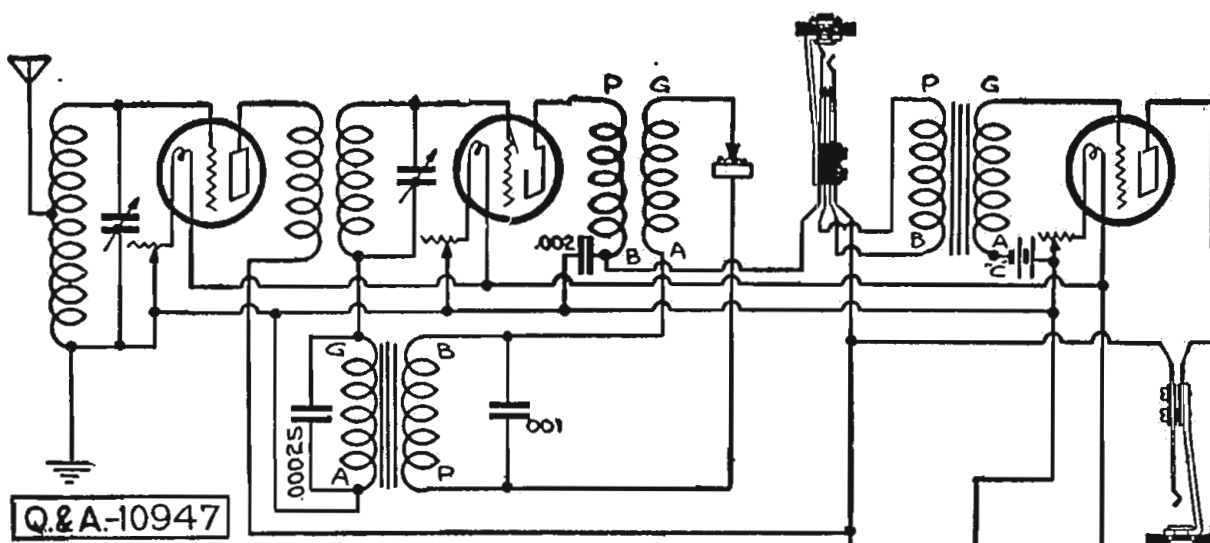

Reflex Changed to a Tube Detector

(10947) RMS, Nevada, Mo.

I have an Erla three-tube reflex that I would like to change from a crystal to a tube detector as I have considerable trouble with fixed crystals. Please publish this information on how to do this. I have a C-301A tube that I would like to use for the detector.

A.—The accompanying illustration shows the Erla reflex with a crystal detector as it should be connected and how this circuit may be changed so that a vacuum tube may be used with the minimum possible changes in the wiring.

Reflex Difficulties

(10722) EET, Freeport, Ill.

I have an Erla three tube which is a wonder for distance and the volume is fair.

The only trouble I find is lack of

selectivity, it is a hard proposition to tune stations out.

You can hear stations for 6 or 7 points on the dials. My aerial is 100 feet with a lead-in of about 25 feet.

WE REPAIR All Types of Radio Tubes \$2.50 Postage Prepaid

Agents and Dealers Special Discount H. & H. RADIO CO., P. O. Box 22A Clinton Hill Sta., Newark, N. J.

SCIENTIFIC FIXED CRYSTAL DETECTOR BEST BY TEST Price, \$1.50

Manufactured by SCIENTIFIC RESEARCH LABORATORIES 502 N. Howard Street Baltimore, Md. If your dealer cannot supply you order direct.

For Sure Results, Solder Up Your Set with SOLOX

The scientific soldering solution that makes sound metallic joints a certainty, with freedom from acid, messy grease or resin. Easy and clean in use and cannot corrode. Most effective and economical of all preparations. Of your dealer or mailed for 50c by the inventors and manufacturers, The D. X. Radio Research Laboratories; Crugers-on-Hudson, N. Y. Money back guarantee. Dealers: Write for attractive proposition to our national distributors. THE CHARLES RADIO CO., 154 Nassau St., N. Y. C.

WHOLESALE FOR DEALERS AGENTS WANTED

DEALERS—We make a specialty of stocking new dealers and radio departments. Our large price list will be mailed free to you on request. Good discounts and prompt deliveries. THE RADIO SHOP OF NEWARK, INC 76 Springfield Ave., Dept. H. Newark, N. J.

Thirty-one Broadcasting Stations Quit in October. 14 New Ones started. A Radio map that does not have a monthly supplemental service is out of date and useless in a short time.

AIR LINE RADIO MAP AND LOG. WITH THE MOVABLE MILE SCALE. Gives this service, and has many other exclusive features. At your dealers or sent prepaid, 50 cents. Money back Guarantee. Dealers and Jobbers write. M. M. CO., 3600 St. John, KANSAS CITY, MO.

Send me your burned-out or broken Power tubes—50 watts or over. Will pay liberally. W. Baker, 36 West 20th Street, New York City.

BIG money selling new household cleaner. Washes and dries windows. Sweeps, scrubs, mops. Complete outfit less than brooms. Over 100% profit. Harper Brush Works, 200 3rd St., Fairfield, Iowa.

S. O. S. S. O. S. S. O. S. No more Radio widows. A game for the whole family. Guaranteed to drag Father from his phones. You even learn the code and stations without trying. \$1.00 to your Dealer or postpaid. Osborn Game Company, Box 702, Kansas City, Mo.

SUPERTRON A GOOD TUBE ALL TYPES—\$4.00

The Best Dealers Sell Supertrons VICTOR RADIO MFG. CO. 32 Union Square New York City

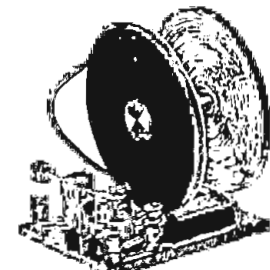

BRING IN Distant Stations

With this new wonder Crystal Set enables you to tune out local when used with audency set. Write for description.

NON SKID CRYSTAL MFG. CO. 5601 E. 15th St. KANSAS CITY MO.

Perfection Coil Antenna Eliminates the Outside Aerial

Just stretch it across a room Price \$2.00 Postpaid Perfection Radio Mfg. Co. 24th and Race Streets Philadelphia

Advertisement for B.M.S. JACKS featuring an illustration of a tool and text: 'B. M. S. JACKS have the exclusive cupped fantail lugs which make soldering easy. The jacks are made of solid brass, while the springs are of phosphor bronze. Made in all styles. Ask your dealer!' BMS JACK

I have used first class material and have been able to get Los Angeles faintly on the loud speaker, so I feel that the set is functioning properly in its parts.

I tried putting fixed condensers in my aerial, but it did not seem to remedy it. I am using a selectoformer in place of variocoupler. Also find that for the last week or so my eleven-plate condenser has developed a little body capacity in the form of a slight whistle when touching the vernier and condenser dials.

A.—We have noted your difficulties in operation of your reflex circuit and the only suggestion we can offer as a measure for increasing selectivity is to use a shorter antenna, probably 75 feet, including lead-in. With the antenna of your description you should experience an improvement in using a fixed condenser, ranging from .0015 mfd. to .00025 mfd., experimentally, between the antenna and selectoformer.

Tuning skillfully is a large factor in realization of the inherent attributes of any circuit.

Contrary to the usual custom some advantage is offered by changing the rheostat adjustment slightly by a somewhat higher setting for the high wave lengths, while for the lower it can be correspondingly reduced. While this has no particular relation to selectivity, it has a refining tonal quality.

It appears that a friction contact has developed in your condenser with resultant capacity effect.

A careful review of circuit with attention to its critical requirements in the matter of assembly and familiarity with its characteristics in operation should afford a highly satisfactory result.

Men to build radio sets for me in spare time. Leon Lambert, 501-H Kaufman Bldg., Wichita, Kansas.

YOUR CRYSTAL SET

will work 400 to 1,000 miles if made by my plans. No tubes or batteries. Copyrighted plans \$1.00. Satisfied customers everywhere. Particulars free.

LEON LAMBERT 501 Kaufman Bldg. Wichita, Kansas

MORE PROFITS

To Dealers who Buy Nationally Advertised Radio Goods from Our Bargain Catalog Write for It Today! AMERICAN RADIO CO. Dept. V 154 Nassau St. New York City

DEALERS SAVE MONEY

By Ordering from Our Bargain Catalog of Nationally Advertised Radio Goods Write for It Today! AMERICAN RADIO CO. Dept. V 154 Nassau St. New York City

UNCLE SAM COILS

Give more volume per tube than any other set

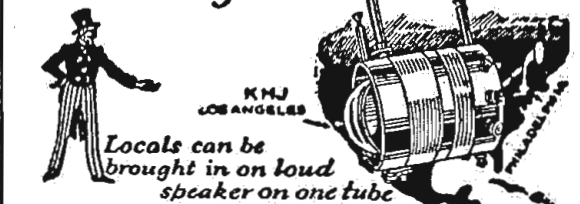

Locals can be brought in on loud speaker on one tube

FREE Ask your dealer or send self-addressed stamped envelope for diagram of circuits using this coil.

UNCLE SAM ELECTRIC CO. 217 E. 6th St. Plainfield, N. J.

MAILED ABSOLUTELY GUARANTEED

D-201A, D-200, D-199, D-12, in standard sizes to fit any socket. The internationally famous DUTCH RADIO VALVE Will be mailed for \$2.25 plus postage Three sent for \$6.50 plus postage (any type). Approved by Popular Radio Laboratories. Order from nearest point. D. R. V. IMPORTING CO. 515 Orange St., Newark, N. J. ST. LOUIS RADIO TUBE LABORATORY 3572 Olive St., St. Louis, Mo.

FOR ANY CIRCUIT IN ANY SET "YOU CAN'T BEAT THE DUTCH"

Radiophone Broadcasting Stations

Corrected Every Week—Part II

FIND MISTAKES AND YOU'LL GET DOLLAR

ONE DOLLAR will be paid to the Radiophon reader of Radio Digest submitting the most errors in any one station's listing in the Directory of Radiophone Stations, which appears in five parts, serially continuously, on the next to last page. Letters must reach Radio Digest's office not later than one week from date of issue corrected. Readers are not limited to correcting one station, but such corrections must be verified by the stations themselves, and NOT by comparison to other so-called accurate Radiocasting directories or lists. Turn in corrections for as many station as you can find—if you can find errors! Use separate sheet of paper for each station submitted and place name and address on each sheet. In case of tie, duplicate awards will be made.

United States (Cont'd)

(Note—The second part of the schedule list appears below. The first appeared last week.)

KFRO, Fort Worth, Tex. 246 meters. 50 watts. Curtis Printing Co.
 KFSG, Los Angeles, Calif. 278 meters. 500 watts. Angeles Temple. Tues, Thurs, Fri, Sat, 3:30-4:30 pm. Tues, 6:30-7:30 pm. Wed, 2:30-4:30 pm; 6:30-7:30 pm. Thurs, Fri, Sat, 7:30-11 pm. Sun, 10:30-12:30 pm. 2:30-4:30, 7-9:30. Mon silent. Pacific.
 KFSY, Helena, Mont. 248 meters. 10 watts. The Van Blaricom company. Announcer, George C. Stocking. Wed, 7:30 pm, music, talks. Sun, 10 am, 8 pm, church services. Mountain.
 KFUD, St. Louis, Mo. 545 meters. 500 watts. Concordia Theological Seminary.
 KGB, Tacoma, Wash. 252 meters. 50 watts. Tacoma Daily Ledger. Announcer, Alvin Steno. Slogan, "This is KGB in Tacoma, Washington, the Lumber Capital of America and the Gateway to Mount Tacoma." Mon, Wed, Fri, 7-9 pm. Pacific.
 KGO, Oakland, Calif. 312 meters. 1,000 watts. Gen. Elec. Co. Announcer, Howard I. Millholland. Daily ex Sat, Sun, 1:30 pm; Sat, 12:30, markets, weather; Mon, Wed, Fri, 3 pm, music. Mon, 4-5:30 pm, orchestra. Daily ex Sun, 4-5:30 pm, orchestra. Daily ex Sat, Sun, 6:45 pm, reports, news. Mon, Tues, Thurs, Sat, 10-11 am, dance music. Mon, 5:30-6 pm, children's half hour. Fri, 5-5:30 pm, girls' hour. Sun, 11-12 pm, 7:45-9 pm, church services; 3:30-5 pm, concert. Pacific.
 KGU, Honolulu, Hawaii. 360 meters. 100 watts. Marion A. Mulrony, The Honolulu Advertiser. Announcer, M. A. Mulrony. Daily, 7:30-9 pm. Tues, Thurs, Sat, special program. 150 meridian. 2 1/2 hours later than Pacific.
 KGW, Portland, Ore. 492 meters. 500 watts. Portland Morning Oregonian. Announcer, Richard V. Haller. Slogan, "KGW, Keep Growing Wiser." Daily ex Sat and Sun, 11:30 am, weather; 12:30 pm, concert; 3:30, 7:15, police reports; 7:30, markets. Mon, Tues, Wed, Fri, 8 pm, concert. Fri, 10:30, Hoot Owls. Wed, Fri, Sat, 10 pm, orchestra. Tues, 8:30 pm, concert. Sat, 11:30 pm, weather. Sun, 0 pm, church services. Pacific.
 KGW, Lacey, Wash. 258 meters. 10 watts. St. Martin's College. Announcer, Sebastian Rub. Slogan, "Out Where the Cedars Meet the Sea." Tues, Fri, Sun, 8:30-9:30 pm, news, concert, lecture. Pacific.
 KHJ, Los Angeles, Calif. 395 meters. 500 watts. Los Angeles Times. Announcer, John Daggert. Slogan, "Kindness, Happiness, Joy." Daily ex Sun, Mon, 12:30-1:30 pm, 2:30-3:30, 6-7:30, 8-10. Sun, 10-12:30 pm. 6:30-7:30, 8-10. Mon, 12:30-1:30 pm. Pacific.
 KHQ, Seattle, Wash. 360 meters. 100 watts. Louis Wasmer.
 KIAF, Siltipoo, Minn. 421 meters. 500 watts. Steele Co. Program Registrar.
 KJL, Stockton, Calif. 273 meters. 5 watts. Gould, The Light Man. Daily ex Sun, 5-6 pm, concert. Wed, Sat, 9-11 pm, dance music. Mon, 9-10 pm. Sun, 10-11 am, church. Pacific.
 KJR, Seattle, Wash. 283 meters. 100 watts. Northwest Radio Service Co. Announcer, Vincent I. Kraft. Slogan, "Radio Headquarters." Daily ex Sun, 5:30-6:30 pm, dinner hour program. Daily Sat and Sun, 8-10:30 pm, studio programs; 10-11, orchestra. Sat, 9-10 pm, orchestra. Pacific.
 KJS, Los Angeles, Calif. 360 meters. 750 watts. Bible Inst. of Los Angeles. Announcer, M. E. Carrier. Slogan, "King Jesus Saves." Tues, Thurs, 8-9 pm, sacred music, lectures, etc. Sun, 10:45-12:30 pm. 6-6:45, 7:15-9:30, church services. Pacific.
 KLS, Oakland, Calif. 360 meters. 250 watts. Warner Bros. Radio Supplies. Announcer, S. Werner. Slogan, "The City of Golden Opportunity." Daily 11:30-1 pm. Sun, 10-11 am. Pacific.
 KLX, Oakland, Calif. 509 meters. 500 watts. Oakland Tribune. Announcer, Seton Bailey. Slogan, "Where All and War meet." Daily ex Sun, 7 news; 7:30, weather. Mon, Wed, Fri, 8-10 pm, talks; entertainment. Pacific.
 KLZ, Denver Colo. 283 meters. 250 watts. Reynolds Radio Co. Announcer, Mrs. William D. Reynolds. Slogan, "It's a Privilege to Live in Colorado." Daily ex Sun, 8:30 am, 10:15, 12:15. Daily ex Sun, Wed, 7:30-8 pm, news, markets. Thursday, 8:15-9:30 pm. Mon, Sun, 9-10:30 pm. Mountain.
 KMJ, Fresno, Calif. 248 meters. 50 watts. San Joaquin Lt. Pr. Corp. Announcer, S. W. Green. Slogan, "Home of the Raisin." Irregular schedule.
 KMO, Tacoma, Wash. 360 meters. 10 watts. Association Station. (Love Electric Co.) Mon, Wed, Fri, 6-7 pm, popular program; 9-10, artist's program. Pacific.
 KNT, Kukuk Bay, Alaska. 263 meters. 100 watts. Walter Heimrich.
 KNX, Hollywood, Calif. 337 meters. 500 watts. Los Angeles Evening Express. Announcer, Wm. Van Why. Daily ex Sun, 10 am and every hour, Town Crier; 12 m. time; 6-7:30, dinner concert; 8-10, feature program; 10-11, dance music. Sun, 8-10 pm, feature program. Pacific.
 KOB, State College, N. M. 360 meters. 500 watts. N. M. College of Agri. & Mech. Arts. Announcer, R. W. Goddard. Slogan, "The Sunshine State of America." Daily 11:15-12 pm, time, reports. Mon, Wed, Fri, 7:30-8:30 pm, concert. Mountain.
 KOP, Detroit, Mich. 286 meters. 500 watts. Detroit Police Dept. Slogan, "Safety First." Daily ex Sun, 6:30, 8:30, reports, police information, emergency. Safety talks. Eastern.
 KPO, San Francisco, Calif. 423 meters. 500 watts. Hale Bros., Inc. Announcer, Clair E. Morrison. Slogan, "The City by the Golden Gate." Daily ex Sun, 12 m. reading. Daily ex Sat, Sun, 1-2 pm, 4:30-5:30 pm, music. Daily ex Sun, 2:30-3:30 pm, studio program. Fri, 12:45-1:30 pm, talks. Sat, 1-2 pm, 3:30-5:30 pm, music. Mon, Tues, Wed, Thurs, 5:30 pm, children's hour; 7-7:30, dinner music; 8-11, concert, lectures, Sat, 8-12 midnight, music.

Sun, 11-12:15 pm, church services, 8:30-10, music. Pacific.
 KQP, Hood River, Ora. 360 meters. 100 watts. Apple City Radio Club. Announcer, H. B. Reas. Slogan, "The Home of the Hood River Apple." Fri, 6:30 pm, music. Wed, 9 pm, special. Pacific.
 KQV, Pittsburgh, Pa. 270 meters. 500 watts. Double-day-Hill Elec. Co. Daily ex Sun, 10:30-11:30 am, music. Daily ex Sat, Sun, 3-4 pm, music. Mon, Wed, Fri, 8-11 pm, Eastern.
 KQW, San Jose, Calif. 360 meters. 50 watts. Chas. D. Harold. Daily ex Sun, 1-1:30 pm. Wed, 8-9 pm, concert. Pacific.
 KRE, Berkeley, Calif. 275 meters. 50 watts. Daily Gazette. Announcer, J. E. Wiggins. Mon, Wed, 8-10 pm, concert. Pacific.
 KSAC, Manhattan, Kan. 273 meters. 1000 watts. Kansas State Agricultural College.
 KSD, St. Louis, Mo. 546 meters. 500 watts. St. Louis Post Dispatch. Daily ex Sun, 9:40 am, 10:40, 11:40, 12:40 pm, 1:40, 2:40, 4. Mon, 7 pm, 9, 11. Wed, 6:45 pm, 9. Fri, 8 pm, Sat, 8 pm; 11:30. Tues, 6 pm, 9. Thurs, silent night. Sun, 9 pm. Central.
 KTHS, Hot Springs, Ark. 375 meters. 500 watts. The New Arlington Hotel.
 KTW, Seattle, Wash. 360 meters. 750 watts. First Presbyterian church. Announcer, J. G. Priestley. Slogan, "Hear Ye, hear ye, the Gospel." Sun, 11-12:30 pm, 3-4:30, 7-9:30, church service. Pacific.
 KUO, San Francisco, Calif. 360 meters. 150 watts. San Francisco Examiner. Slogan, "The Voice of the West." Temporarily off the air.
 KWG, Stockton, Calif. 360 meters. 50 watts. Portable Wireless Telephone Co. Announcer, E. R. Garrow. Slogan, "Voice of the San Joaquin Valley." Daily ex Sun, 4-5 pm, news, concert, markets. Tues and Fri, 8-9 pm, concert. Sun, 2-3 pm, concert. Pacific.
 KYQ, Honolulu, H. T. 270 meters. 100 watts. Elec. Shop, Teves & Joaquin Co., Ltd.
 KYW, Chicago, Ill. 536 meters. 1000 watts. Westinghouse Elec. & Mfg. Co. Announcer, Edward Borhoff. Daily ex Sun, Sat, aft, 9:30 am, 10:30, 11, markets; 10:55, time; 11:05, weather; 11:30, news; 11:35, table talk; 12 m, 12:30 pm, 1, 1:20, 2:25, 2:30, markets; 3, 3:30, 4, news; 4:15, markets; 4:30, 5, news; 6:30, markets. Daily ex Sun, Mon, 6:35-7 pm, bedtime story; 7-7:30 pm, dinner concert; 8, concert; 9, special. Tues, Thurs, 2:30-4 pm, musical frolic. Wed, Fri, 3:30, Tues, Thurs, 10-11:30 pm, "at home" program. Central church; 2:30 pm, chapel; 7, Chicago Sunday Evening club. World Crier every half hour. Central.
 KZM, Oakland, Calif. 360 meters. 100 watts. Western Radio Institute (Hotel Oakland). Announcer, Roswell S. Smith. Daily ex Sun, 6:30-7 pm, entertainment. Pacific.
 NAA, Radio, Va. 435 meters. United States Navy Dept. Daily ex Sun, 9:45-10:40 am, 12:25-12:40 pm, 1:45-2:20, markets, weather; 2:45-3 (Tues only), Dept. interior; 3:25-4:40, 5:05-5:20, markets, weather 10:05-10:20, weather. Wed, 7:45-8 pm, Civ. Ser. Daily ex Sat, Sun, 7:45-8 pm, dept. programs. Mon, 8:25-8:40 pm, Dept. of Interior. Eastern.
 PWX, Havana, Cuba. 400 meters. 500 watts. International Tel. & Teleg. Corp. Announcer, R. O. Farrill. Slogan, "If you hear the tick of a clock you are in time with PWX, at Havana, Cuba." Wed, Sat, 8:30-11 pm, music. Eastern.
 WAAB, New Orleans, La. 268 meters. 100 watts. Valdemar Jensen.
 WAAC, New Orleans, La. 360 meters. 400 watts. Tulana Univ. Announcer, D. Elliott. Fri, 7:15-7:30 pm, reports; 8-9:30, educational and entertainment program. Central.
 WAAD, Cincinnati, O. 360 meters. 25 watts. Ohio Mechanics Inst. No regular schedule.
 WAAF, Chicago, Ill. 286 meters. 200 watts. Chicago Daily Drivers Journal. Announcer, Carl Ulrich. Daily ex Sun, 8:40 am, 10:30, 10:45, 12:30 pm. Daily ex Sun, Sat, 12:45, 3, 4:30, live stock and weather reports. Central.
 WAAM, Newark, N. J. 263 meters. 250 watts. I. R. Nelson Co. Announcer, J. B. Bayley. Slogan, "Electrical Repairing and Manufacturing." Daily ex Sun, 11-12 m, music, talks, markets. Mon, Tues, Wed, Fri, 8-11 pm. Eastern.
 WAAN, Columbia, Mo. 254 meters. 80 watts. Univ. of Mo. Announcer, Ott S. McDaniel.
 WAAP, Omaha, Neb. 286 meters. 500 watts. Omaha Grain Exchange. Announcer, H. B. Horsford. Slogan, "Where Agriculture Accumulates Wealth." Daily ex Sun, 8:45 am, 9:45, 10:45, 11:45, 12:45-1:15 pm, 8, market reports. Mon, 7:30-9 pm, music. Thurs, 7:30 pm, bridge talk; 8, program. Central.
 WABA, Lake Forest, Ill. 266 meters. 100 watts. Lake Forest university. Wed, 8-9 pm, music, talks. Central.
 WABB, Harrisburg, Pa. 266 meters. 100 watts. Harrisburg Sporting Goods Co. Announcer, John L. Strook. Tues, Fri, 8 pm, sports, music. Sun, 9 pm, church services. Eastern.
 WABD, Dayton, O. 283 meters. 5 watts. Parker High School. Announcer, A. H. Schroy. Fri, 7-8 pm. Central.
 WABH, Sandusky, O. 240 meters. 20 watts. Laka Shore Tire Co.
 WABI, Bangor, Me. 240 meters. 100 watts. Bangor Ry. & Elec. Co. Announcer, P. L. Sprague. Slogan, "The Pine Tree Wave." No regular schedule.
 WABL, Storrs, Conn. 283 meters. 500 watts. Connecticut Agri. College. Announcer, Daniel E. Noble. Slogan, "From the Nutmeg State." Mon, Wed, Fri, 7-9 pm. Eastern.
 WAMB, Saginaw, Mich. 254 meters. 350 watts. F. E. Doherty. Announcer, Radio Equip. Co. Announcer, Wm. A. Rorke. Daily ex Sun, 10:15 am, news, markets, weather, stocks; 6 news, stocks, sports, music. Eastern.
 WABN, La Crosse, Wis. 244 meters. 500 watts. Ott Radio Inc. Announcer, W. C. Grover. Slogan, "The City Beautiful on the Old Mississippi." Club, Thirsty Knights. Mon, 8-10:30 pm, entertainment. Thurs, 10-12:30 pm. Central.
 WABO, Rochester, N. Y. 283 meters. 10 watts. Lake Avenue Baptist church. Announcer, Laurence Hukson. Sun, 10:15-12 m, 7:15-9 pm. Eastern.
 WABQ, Haverford, Pa. 261 meters. 50 watts. Haverford College Radio Club. Announcer, Dr. James McF. Carpenter. Tues, 8-9 pm, educational program. Thurs, 9-11 pm, music. Sat, 4-5 pm, sports. Eastern.
 WABR, Toledo, O. 270 meters. 50 watts. Scott High School. Fri, 8:15-9 pm, program by high school students. Eastern.
 WABU, Camden, N. J. 226 meters. 50 watts. Victor Talking Machine Co.
 WABW, Wooster, O. 234 meters. 100 watts. The College of Wooster, Dept. of Physic. Announcer, Victor Andrew.
 WABX, Mt. Clemens, Mich. 270 meters. 150 watts. Henry B. Joy.
 WABY, Philadelphia, Pa. 242 meters. 50 watts. John Magaldi, Jr. Slogan, "Quaker City Sleep, Doggers' Club." "The American Broadcasting Club." Sun, 9 pm, music; 10:30, "Sleep Doggers' Session." Eastern.
 WABZ, New Orleans, La. 283 meters. 100 watts. The Coliseum Place Baptist church. Announcer, V. W. Braddy. Slogan, "The Station with a Message." Wed, 9-10 pm, talks, music; Sun, 11 am, 12:15 pm, 7:30-8:45. Central.
 WAHG, Richmond Hill, N. Y. 316 meters. 500 watts. A. H. Grebe & Co.
 WAR, Sliglit, Wis. 406 meters. 500 watts. Kopp Radio Co. Indefinite schedule.
 WBAW, W. Lafayette, Ind. 283 meters. 250 watts. Purdue University. Announcer, J. W. Stafford. Daily ex Sun, 9:50 am, stocks, markets. Mon, Fri, 7:15 pm, special programs. Central.
 WBAK, Harrisburg, Pa. 400 meters. 500 watts. Pennsylvania State Police. Announcer, Frank P. Gaucher. Daily ex Sun, 10 am, 1:30 pm, 5:45, police reports, fire protection, markets; 12 midnight, police reports. Mon, Tues, Wed, 7:30 pm, special. Eastern.
 WBAN, Paterson, N. J. 244 meters. 100 watts. Wireless Phona Corp. Announcer, H. W. Ryerson. Slogan, "The Silk City of America." Daily ex Sun, 9-11:30 am, 12:30-5:30 pm. Sat morning only. Sun, 10-12 am, 2-5 pm, 7:30-10:30. Eastern.
 WBAO, Decatur, Ill. 275 meters. 50 watts. James Millikin Univ. University activities. No definite schedule.

WBAP, Fort Worth, Tex. 476 meters. 1000 watts. Fort Worth Star-Telegram. Announcer, "The Hired Hand" Club, "Radio Truth League." Daily ex Sun, 10, 11, 12 m, 1 pm, 2, market reports, weather; 6-6:15, "Port of Missing Men." 6:30, sports. Mon, Tues, Wed, Thurs, Fri, 7:30-8:30 pm, 9:30-10:45, concert. Sat, 7 pm, Bible lesson. Sun, 11 am, church; 4 pm, concert. Central.
 WBAY, Columbus, O. 423 meters. 500 watts. The Erner and Hopkins Co. Announcer, H. E. Dwy. Slogan, "Wa Broadcast a Variety." Daily ex Sun, 12-1 pm. Tues, Fri, 8-10 pm. Eastern.
 WBAX, Wilkes-Barre, Pa. 254 meters. 100 watts. John H. Stenger, Jr. Slogan, "In Wyoming Valley, Home of the Anthracite." Wed, 9 pm-12 midnight. Eastern.
 WBAY, New York, N. Y. 492 meters. 500 watts. A. T. & T. Co. Experimental purposes only.
 WBBA, Newark, Ohio. 240 meters. 20 watts. Plymouth Congregational church.
 WBBD, Reading, Pa. 234 meters. 50 watts. Barbey Battery Service. Wed, 10-11:30 pm. Sat, 10-11:30 pm. Eastern.
 WBFF, Atlanta, Ga. 270 meters. 500 watts. Georgia School of Technology. Announcer, Thomas W. Fitzgerald. Slogan, "The Southern Technical Institution with a National Reputation."
 WBBG, Matamoras, Pa. 248 meters. 500 watts. Irving Vermilya. Announcer, Albert N. Labouef. Mon, Wed, Fri, 8-10 pm, music. Sun, 10:45-12 m, church service. Eastern.
 WBBH, Port Huron, Mich. 246 meters. 50 watts. J. Irving Bell.
 WBBJ, West Palm Beach, Fla. 258 meters. 50 watts. Neel Elec. Co. Announcer, R. C. Bender. Slogan, "Where Summer Spends the Winter." Tues, Thurs, Fri, 8-10 pm, bend. Sun, 11-12 m, 7:30-9 pm, church services. Eastern.
 WBBL, Richmond, Va. 283 meters. 5 watts. Grace Tennant Presbyterian church. Announcer, Herbert C. Taylor. Tues, 8 pm. Sun, 11 am, 8 pm. Eastern.
 WBBP, Petoskey, Mich. 246 meters. 100 watts. Petoskey High School. Announcer, Carl Bowman. Wed, 8-9 pm. Central.
 WBBR, Staten Island, N. Y. City, N. Y. 273 meters. 500 watts. International Bible Students' Association. Mon, Wed, Sat, 8-9 pm, lectures, music. Sun, Thurs, 9-10-10:30 pm. Eastern.
 WBBT, Philadelphia, Pa. 234 meters. 5 watts. Lloyd Brothers.
 WBBU, Nonmouth, Ill. 224 meters. 10 watts. Jenks Motor Sales Co.
 WBBV, Johnstown, Pa. 248 meters. 5 watts. Johnstown, Radio Co.
 WBBW, Norfolk, Va. 222 meters. 50 watts. Ruffner Junior High School. Announcer, Lee M. Klinefelter. Slogan, "We're Backed by Workers." Wed, 4 pm, music. Fri, 10 pm. Eastern.
 WBBY, Charleston, S. C. 268 meters. 20 watts. Washington Light Infantry. Announcer, Hugh Eesterly. Wed, 7:30-11 pm, talk, music. Sun, 6:30-9:30 pm, orchestra. Eastern.
 WBBZ, Indianapolis, Ind. 227 meters. 50 watts. Noble Watson. Mon, 8-9:30 pm. Central.
 WBCN, Chicago, Ill. 266 meters. 500 watts. Southtown Economist.
 WBR, Butler, Pa. 1599 meters. 250 watts. Pa. State Police. Announcer, H. Nifong. Daily ex Sun, 9:30 am, 10, 10:30, 1 pm, 1:30, 2, 5:30, 5:45, 6:15, 12, 12:30 am, 1. Eastern.
 WBS, Newark, N. J. 360 meters. 100 watts. D. W. May, Inc. Announcer, M. C. Delaney. Daily, 11-12 m, music; 1-2:15 pm, reports, music. Tues, Thurs, Fri, 7:30-9:30 pm, program. Sun, 12:30-3 pm. Eastern.
 WBT, Charlotte, N. C. 360 meters. 250 watts. Southern Radio Corp. Slogan, "Queen City of the South." Daily ex Sun, 11 am, waether; 12:30-1:30, 7, music; 7:15, markets. Tues, Thurs, 9 pm, music. Mon, Wed, Sat, 10:45 pm, music. Sun, 11 am, 7:30 pm, church services. Eastern.
 WBZ, Springfield, Mass. 337 meters. 1000 watts. Westinghouse Elec. & Mfg. Co. Announcer, A. E. Bach. Daily ex Sun, 6-7 pm, dinner concert; 7-7:40, market reports, talks, bedtime stories; 9:55-10:05, time, weather; 10:05-11, music. Daily ex Sun, Fri, 7:40, 9:55 pm, music. Mon, Wed, 11-12 am, dance music. Fri, 10:30-12 midnight, music. Sun, 10:45 am, services; 7-10 pm, concert. Eastern.
 WCAD, Canton, N. Y. 280 meters. 250 watts. St. Lawrence Univ. Announcer, Ward C. Priest. Slogan, "The Voice of the North Country." Daily, 11 am, weather, reports, time. Wed, 8:30 pm, program. Eastern.
 WCAE, Pittsburgh, Pa. 462 meters. 500 watts. Kaufman & Baer Co., Pittsburgh Press. Announcer, Joseph Sartory. Daily ex Sun, 12:30 pm, news; 3:30, news, music; 4:30, reports; 6:30, music; 7:30, Uncle Kaysbe, 8:30, music. Mon, Tues, 10:30 pm, 10:30 am, services; 3 pm, sermon; 4, 6:30, music. Eastern.
 WCAG, New Orleans, La. 268 meters. 100 watts. Clyde R. Randall. Slogan, "The Little Nolsa from New Orleans." Daily, 7:45-8 pm, children's concerts. Mon, Thurs, 8-9 pm, concert. Central.
 WCAH, Columbus, O. 286 meters. 200 watts. Enteklin Elec. Co. Announcer, C. A. Enteklin. Slogan, "The Heart of Ohio." Daily ex Sun, 11:30-12:30 am, music, news. Tues, 8-10:30 pm. Sun, 10-12:30 pm, 7:30-9, church services; 4, vespers. Eastern.
 WCAJ, Univ. Piece, Nebr. 280 meters. 300 watts. Nebr. Wesleyan Univ. Announcer, J. C. Jensen. Daily 10:30 am, weather. Tues, 7 pm, children's hour. Fri, 9 pm, music, lectures. Central.
 WCAK, Houston, Tex. 263 meters. 10 watts. Alfred P. Daniel. Announcer, Alfred P. Daniel. Slogan, "Where Eighteen Railroads Meet the Sea."
 WCAL, Northfield, Minn. 360 meters. 500 watts. Dept. of Physic. St. Olaf College. Announcer, Kenneth Onsgaard. Slogan, "The Collega on the Hill." Daily ex Sun, Mon, 9:45 am, chapel. Thurs, 9 pm, music. Fri, 8:30 pm, talk. Sat, 12 midnight, music. Sun, 8:30 pm. Central.
 WCAO, Baltimore, Md. 275 meters. 50 watts. Sanders & Stayman Co. Announcer, R. E. Brunner. Daily ex Sun, 12-1 pm. Mon, 8-9 pm. Eastern.
 WCAP, Washington, D. C. 469 meters. 500 watts. Chesapeake & Potomac Tel. Co. Announcer, William T. Pierson. Mon, 7:30-10 pm. Wed, 7:45-10 pm. Fri, 7:30-12 midnight. Sun, 11 am, 4 pm, 7:20-10 pm, jointly with WEAF. Eastern.
 WCAR, San Antonio, Tex. 360 meters. 200 watts. Southern Radio Corp. of Texas. Announcer, L. Tatam. Club, "Royal Order of Prevaricators." Mon, Thurs, Sat, 8:30-9:30 pm, concert. Wed, Sat, 11 pm. Central.
 WCAT, Rapid City, S. D. 240 meters. 100 watts. S. D. State School of Mines. Announcer, J. O. Kammermen. Daily ex Sun, 12:30 pm, 12:30 pm, weather, reports. Thurs, 7:30 pm, concert. Mountain.
 WCAU, Philadelphia, Pa. 286 meters. 250 watts. Durham & Co. Daily, 5:45 pm, markets. Sun, 10:55 am, service; 3 pm, talk; 3:15, talk; 4:10, Bible readings; 6-8, concert. Eastern.
 WCAV, Little Rock, Ark. 360 meters. 200 watts. J. C. Dica Elec. Co. Wed, Fri, 8:30 pm, lecture, music. Sun, 9-10:30 pm, special musical concert. Central.
 WCAY, Milwaukee, Wis. 266 meters. 250 watts. Milwaukee Civic Broadcasting Station. Announcer, D. W. Gellerup. Mon, Wed, Fri, 10:15 am, 11:15, 12:15, weather, market reports; 3-4, Mon, Fri, 8-9 pm. Tues, 9:15-10:30 pm. Wed, 6:30-7:30 pm. Thurs, 10:30 pm. Central.
 WCCA, Allentown, Pa. 280 meters. 10 watts. Cha. W. Helmbach. Wed, 8:15-11 pm. Fri, 6:45-7:45 pm. Sun, 8-11 pm. Eastern.
 WCCB, Ann Arbor, Mich. 280 meters. 200 watts. U. of Mich.
 WCCD, Zion Ill. 845 meters. 500 watts. Wilbur Glenn Voliva. Announcer, J. H. DePew. Slogan, "Where God Rules, Men Prosper." Mon, Thurs, 8-10:30 pm, concert. Thurs, 2:30-3:45 pm, service. Sun, 9-10:45 am, Bible school; 2:30, church services. Every 2nd and 4th Sun, 8-10:30 pm. Central.

WCCB, New Orleans, La. 263 meters. 50 watts. Uhalt Brothers Radio Co. Announcer, Johnny Wilson. Slogan, "Second Port U. S. A." Sat, 9 pm, dance. Sun, 12:30-2 pm, dinner concert; 9, dance music. Central.
 WCBG, Mayfield, Ky. 268 meters. 10 watts. Howard S. Williams. Slogan, "Will Christ Ba Glorified?" Daily 7:30 pm, sermon. Sun, 3 pm, 7:15, service. Central. (Portable, moves often.)
 WCBH, Oxford, Miss. 242 meters. 20 watts. U. of Mississippi. Announcer, W. L. Kennon. Mon, Wed, 8 pm. Central.
 WCBJ, Jennings, La. 241 meters. 10 watts. J. C. Mans.
 WCBK, St. Petersburg, Fla. 266 meters. 500 watts. E. Richard Hull. Mon, Thurs, 7-8 pm. Tues, 8-8:15 pm. Sun, 8-10 pm. Eastern.
 WCBL, Houlton, Me. 230 meters. 100 watts. Northern Radio Mfg. Co. Announcer, Lee J. Bell. Slogan, "Call of the North." Wed, 7:30-10 pm. Sun, 10:30 am, 7 pm. Eastern.
 WCBM, Baltimore, Md. 229 meters. 250 watts. Charles Schwarz. Announcer, C. L. Brunner. Tues, Thurs, 10 pm-1 am. Sat, 9:30-12 mid. Sun, 8:30-10:30 pm. Eastern.
 WCCO, Memphis, Tenn. 250 meters. 20 watts. The Radio Shop, Inc. Wed, Sun, 8:30 pm. Central.
 WCCBQ, Nashville, Tenn. 236 meters. 100 watts. First Baptist church. Announcer, R. G. Monahan.
 WCBR, Boston, Mass. 246 meters. 5 watts. Charles H. Messer. (Portable.)
 WCBT, Worcester, Mass. 233 meters. 250 watts. Clark University, Collegiate Dept.
 WCBU, Arnold, Pa. 254 meters. 50 watts. Arnold Wireless Supply Co. Announcer, F. J. Ambrose. Slogan, "The Little 50 Watt Station in a 50 Kilowatt town." Wed, Sun, 9-10 pm. Set, 10-11 pm. Eastern.
 WCBV, Tullahoma, Tenn. 252 meters. 10 watts. Tullahoma Radio Club. Thurs, educational program. Sun, religious.
 WCBW, Macon, Ga. 226 meters. 20 watts. Maitland Solomon and G. P. Rankin, Jr. Irregular schedule.
 WCBX, Newark, N. J. 233 meters. 100 watts. The Radio Shop. Tues, Wed, Fri, 6-6:30 pm; 7:30-10:30. Eastern.
 WCBY, Buck Hill Falls, Pa. 268 meters. 10 watts. Forks Electric Shop. Announcer, Hugh Kemper.
 WCBZ, Chicago Heights, Ill. 248 meters. 50 watts. Coopetelli Brothers Music House. Announcer, John King. Slogan, "Where the Lincoln and Dixie Highways Meet." Mon, Fri, 8:30-10:30 pm, program. Central.
 WCCO, Minneapolis-St. Paul, Minn. 417 meters. 500 watts. Washburn Crosby Co. Announcer, Paul Johnson. Daily ex Sun, 9:30 am, 9:40, reports, weather; 10:30, markets; 10:45, home service; 11:30, markets; 1:30 pm, markets, weather; 2, woman's hour; 2:30, music; 4, magazine; 4:30, markets; 5:30, children's hour; 6, sport hour; 6:30, dinner concert. Wed, 9 pm, concert. Wed, Thurs, Fri, 7:30 pm, lecture hour. Thurs, Fri, Sat, Sun, Mon, 8 pm, talks, music. Thurs, Sat, 10 pm, dance music. Fri, 11 pm, dance. Sat, 8:30 pm, music. Mon, 8:15 pm, organ. Sun, 10:20 am, 4:10 pm, 7:30, church services. Central.
 WCK, St. Louis, Mo. 360 meters. 100 watts. Stix, Baer & Fuller Dry Goods Co. Announcer, Helen G. Hatfield. Daily, 12-12:30 pm, 3-3:30 pm. Mon, Tues, Wed, Fri, Sat, 3-9 pm. Fri, 11-1 am. Sun, 9-10 pm. Wed, 11:30-1 am. Central.
 WCM, Austin, Tex. 268 meters. 250 watts. Texas Markets & Warehouse Depts.
 WCX, Detroit, Mich. 517 meters. 500 watts. The Detroit Free Press. Announcer, C. D. Tomy. Club, "Red Apple Club." Daily ex Sun, 2 pm, news; 2:15, stock reports; 2:50, weather, markets; 4:15, 6, music. Daily ex Sat, Sun, 8:30-10 pm, alternate weeks, concert. Tues, 10-12 pm, club. Sun, 10:30 am, 7:15 pm, church services. Eastern.
 WDAE, Tampa, Fla. 273 meters. 250 watts. Tampa Daily Times. Announcer, McDonald Thompson. Daily, 5, 7:30. Thurs, 8-10 pm. Eastern.
 WDAF, Kansas City, Mo. 411 meters. 500 watts. Kansas City Star. Announcer, Leo Fitzpatrick. Club, "Nighthawks." Daily ex Sun, 3:30-4:30 pm, music; 5:50, markets, weather; 6-7, educational, bedtime story, music; 11:45, Nighthawks. Mon, Wed, Fri, 9-9:30 pm, concert. Sun, 4-5 pm, music. Central.
 WDAG, Amarillo, Tex. 263 meters. 100 watts. J. Lau-rence Martin. Slogan, "Where Dollars Always Grow." Tues, Thurs, 8-9:30 pm, music. Central.
 WDAH, El Paso, Tex. 268 meters. 50 watts. Trinity Methodist Church South. Mon, Wed, Thurs, Fri, 7:30 pm, concert. Sun, 11 am, Mountain.
 WDAR, Philadelphia, Pa. 395 meters. 500 watts. Lit Bros. Announcer, Harry E. Ebrhart. Club, "Morning Glory." Daily ex Sun, 11:45-12:55 pm, music; 2-3 pm, 4:30-6, music, talks; 7:30-8 pm, Dream Daddy. Mon, Wed, 8-10 pm, entertainment. Fri, 8-10:50, entertainment; 1 am, Club. Eastern.
 WDAU, New Bedford, Mass. 360 meters. 100 watts. Sloum & Kilburn.
 WDAY, Fargo, N. D. 244 meters. 50 watts. Radio Equip. Corp. Announcer, K. M. Hance. Slogan, "The Biggest Little City in the World." Daily ex Sun, 10 am, 11-12:30 pm, markets, news; 2, markets; 5, music, news. Tues, Thurs, Sat, 7:30 pm, entertainment. Sun, 10:30 am, church service; 5 pm, concert. Central.
 WDB, Taunton, Mass. 229 meters. 10 watts. A. H. Waite & Co., Inc. Announcer, Albert H. Waite.
 WDBC, Lancaster, Pa. 253 meters. 50 watts. Kirk Johnson & Co., Inc. Mon, Tues, Thurs, 8 pm. Eastern.
 WDBD, Martinsburg, W. Va. 268 meters. 5 watts. H. E. Burns. Announcer, R. W. Etris. Slogan, "We Do Better Daily." Tues, Thurs, Sat, 9-10:30 pm, talks, music, dance orchestra. Eastern.
 WDBF, Youngstown, Ohio, 246 meters. 50 watts. Robert G. Phillips.
 WDBH, Worcester, Mass. 268 meters. 100 watts. C. T. Shcer Co. Announcer, Chester Gaylord. Slogan, "The Voice from the Heart of the Commonwealth." Daily ex Sun, 11:30-12:30 pm, music, reports; 4-4:30, music, stocks. Mon, Wed, Fri, 7:15 pm. Tues, Thurs, Sat, 5:30 pm. Fri, 3 pm, music. Eastern.
 WDBI, St. Petersburg, Fla. 226-300 meters. 10 watts. Radio Specialty Co., Inc. Announcer, M. H. Bewik. Irregular programs.
 WDBJ, Roanoke, Va. 229 meters. 50 watts. Richardson Wayland Elec. Corp. Announcer, Charles E. Stone. Slogan, "The Magic City of the Old Dominion." Daily ex Sun, 12-1 pm, music; 5:30-6:45, music, news, weather. Wed, Sat, 9 pm, concert. Eastern.
 WDBN, Bangor, Me. 254 meters. 10 watts. Maine Electric Light & Power Co. Announcer, Paul Wetson. "Bangor Radio Club." Daily 3-5 pm, 8-10. Eastern.
 WDBO, Winter Park, Fla. 240 meters. 50 watts. Rollins College, Inc. Slogan, "Rollins College, Maker of Tankers."
 WDBP, Superior, Wis. 261 meters. 50 watts. Superior State Normal School.
 WDBQ, Salem, N. J. 234 meters. 100 watts. Storgo Battery Morton Radio Supply Co. Announcer, Wm. T. Galloway. Mon, 7:30-9 pm. Thurs, 8:15-8:45 pm. organ. Sun, 7:30 pm, church services. Eastern.
 WDBR, Boston, Mass. 250 meters. 100 watts. Tremont Touple Baptist Church. Announcer, Raymond B. Meader. Fri, 7:30-8:30 pm. Sun, 10:30 am; 6:15 pm, church services. Eastern.
 WDBS, Dayton, Ohio. 283 meters. 150 watts. S. M. K. Radio Corp. Announcer, Robert Ewell. Slogan, "Watch Dayton's Broadcasting Station." Tues, Thurs, Sat, 8-10 pm. Sat, 11:45-12:30 am, dance music. Central.
 WDBT, Hattisburg, Miss. 236 meters. 10 watts. Taylor's Book Store. Announcer, W. P. Sprague. Slogan, "Hattisburg, the Hub of South Mississippi." WDBW, Columbia, Tenn. 265 meters. 20 watts. The Radio Den. Announcer, F. O. Draughton. Slogan, "The Dimple of the Universe." Daily ex Sun, 1 pm, markets. Tues, Thurs, Sat, 8-0 pm, music. Central.
 (The third part of the directory of station schedules will appear next week.)



Radiotron
WD-11
The Ideal Dry
Cell Tube

Buy New Tubes Carefully!

All Radiotrons now
reduced to \$4.00

It isn't a genuine WD-11 unless
it's a Radiotron.

It isn't a genuine WD-12 unless
it's a Radiotron.

It isn't a genuine UV-199 un-
less it's a Radiotron.

It isn't a genuine UV-200 un-
less it's a Radiotron.

It isn't a genuine UV-201-a un-
less it's a Radiotron.

Open up your radio set today and lift out one of the Radiotrons. Look at its name and marking. Memorize them. You may not be replacing these tubes today—or to-morrow—or for months to come. But when you do, be sure to know the name. Practically every good set carries genuine Radiotrons, for the maker wants to get the best possible performance from the tubes. And when you replace them, it's important, too, to get the right type of Radiotron. Buyers are careful today. They know that the slightest variation in manufacture means a wide difference in radio results, and that "Radiotron" means standard production. And they look for the marking.

Radio Corporation of America

Sales Offices:

233 Broadway, New York

10 So. LaSalle St., Chicago, Ill.

433 California St., San Francisco, Cal.



This symbol of
quality is your
protection.

Radiotron

REG. U. S. PAT. OFF.