

Details of Broadcasting Republican National Convention—Page 11;  
New Compact Super-Het Described; How to Equip Essex Auto with Set

# Radio Digest

EVERY WEEK **Illustrated** PROGRAMS **TEN CENTS**

REG. U. S. PAT. OFF. & DOM. OF CANADA

Vol. IX

Copyright 1924  
By Radio Digest Publishing Co.

SATURDAY, JUNE 7, 1924

No. 9

## RADIO ZR-3 PILOT AT SEA

### FRANCE INTERESTED IN NOVEL INVENTION

NEW "DEATH-RAY" STOPS  
MOTORS, KILLS MICE

Many Prominent Scientists Express  
Their Opinions Upon Its Merits  
Pro and Con

PARIS.—It is an interesting thing to note that much more attention has been given the "death-ray" of H. Grindell-Matthews by France than by England. A regular war has raged in the Paris press around the remarkable announcement of the motor-stopping beam, and the greatest French scientists have not hesitated to express opinions pro and con.

Prof. Edouard Branly, French pioneer in Radio fields of investigation, is of the opinion that it is merely a great bluff or fake. Professor Langevin, well-known electrical engineer, says he thinks it may be true, but he wants facts. Professor d'Arsonval, chief of the new high  
(Continued on page 2)



### WILL DIRECT BIG ZEPPELIN ON WAY HERE

Largest Air Leviathan Ever  
Built to Depend on Ether  
Weather Reports

*Dodge Storms for Speed*

Fans May Hear Zeppelin's Signal  
As It Crosses Atlantic on  
Voyage from Germany

WASHINGTON, D. C.—Radio will play an all-important part in the delivery of the world's largest airship, the ZR-3, to the Naval Air Station at Lakehurst, N. J., from Fredrickshaven, Germany, within the next few weeks. Every preliminary arrangement for the 4,500-mile trip has compelled consideration of the use of Radio to safeguard the ship and her crew.

"The Goodyear-Zeppelin corporation has been informed that the ZR-3 will be in constant communication with stations in Europe or on this side throughout the trip," states P. W. Litchfield, vice-president of the Goodyear Tire and Rubber company which recently took over the Zeppelin patents and rights for America.

**To Dodge Storm Centers by Radio Reports**  
"The entire future of commercial lighter-than-air transportation is allied closely with the development and perfection of Radio communication.

"Commanders of all commercial and  
(Continued on page 4)



### STATION WOAI WILL HIRE OUT BIRD MAN

SAN ANTONIO, TEX. — Station WOAI, Southern Equipment Company here, has a performer known as "The Bird Man." During one of his recent exhibitions, imitating birds, a phone call was received telling him that he had started two canaries singing and that every time he whistled they would answer him.

On the left is Hazel Dawn, well known musical comedy star now starring in "Keep Kool," who gave a Radio talk with Arnold Abbott, play reviewer of Station WJAR. Above is shown Evelyn Herbert, favorite soprano and one of "Roxies" gang who appear every Sunday night at the Capitol theater concert given through Station WEAF. On the right is Eva Loubens, gifted member of the KGO players, who was heard recently in the famous play, "Seven Keys to Baldpate," which was broadcast from Station KGO, located at Oakland, California.



# No. 3 OFFICIAL BALLOT

## Announcers' Contest

### RADIO DIGEST FIRST ANNUAL GOLD CUP AWARD

Gold Cup Award Editor, Radio Digest,  
510 North Dearborn St., Chicago, Ill.

Please treat this ballot as one vote for:

..... of Station.....  
(Call letters)

Signed .....

Address .....

City.....State.....

If you desire tell below in five or less words what you most like about the announcer for whom you have cast this ballot:

## FANS RALLY TO HELP CHOSEN ANNOUNCERS

### NOMINATE POPULAR VOICES FOR GOLD CUP AWARD

#### Balloting Shows Voters Do Not Understand Bonus Offer—Country Wide Interest Shown

Every mail brings in more and more nominations and votes for the Radio Digest First Annual Gold Cup Award, now being conducted in an effort to select the world's most popular Radio announcer.

Clerks are kept busy tabulating and taking care of the tremendous vote which has been cast as a result of this popular question. The votes are coming in from all parts of the country, and from all indications, the interest that has been aroused far exceeds anyone's expectations.

In the next issue will be given a list of all announcers fortunate enough to have been nominated to date, together with a picture of the gold cup which will be awarded to the announcer polling the most votes.

**Consecutive Held Ballots Get Bonus**  
Radio Digest wishes to emphasize that holding consecutive ballots, turning them in either in groups or all at once, will enhance your favorite announcer's chance of winning this wonderful trophy.

For sending in four consecutive ballots, there will be a ten vote bonus; eight consecutive ballots, twenty-five vote bonus; twelve consecutive ballots, fifty vote bonus; and sixteen consecutive ballots, seventy-five vote bonus.

Voting ballot Number 3 appears on page two as will all remaining thirteen ballots of this contest. The certificate of nomination appears on page five. If you haven't already nominated the announcer who appeals to you most, do so at once and show your appreciation of his (or her) services.

**How to Nominate and Vote**  
Below will be found the rules and regulations governing the Radio Digest First Annual Gold Cup Award to be given to the world's most popular broadcasting station announcer in the competition which will continue until the issue of September 6.

On page five will be found a nomination certificate. All that is necessary for you to do to enter your favorite announcer in the contest is to fill this certificate with your candidate's name and the broadcast station call letters. Write in your name and address and mail to the Gold Cup Award Editor of Radio Digest. This will place your choice of announcers in nomination.

On page two will be found a ballot with which you can vote for your candidate. These ballots, numbered consecutively, appear in each issue of Radio Digest until the close of the contest. Each of these ballots will count for one vote when sent in separately.

**Rules and Regulations of Award**  
All broadcast station announcers are eligible to enter. Nominations can be made either by the announcer or any Radiophan. Nominations should be made by using the "Nomination Certificate" appearing on page five.

Beginning with the May 24 issue a ballot is printed on page 2 of each issue of this publication. These ballots are numbered consecutively from one to sixteen. The voting officially opened with the publication of ballot No. 1 in the May 24 issue. The contest closes with ballot No. 16 published in September 6 issue of Radio Digest, and the official closing date of this contest is midnight, September 8, 1924.

Voting will consist of filling in the ballots with the name, initials or nickname

of the announcer and the station and mailing to the Gold Cup Award Editor.

**Highest Vote Wins Gold Cup**  
The broadcasting station announcer polling the largest number of votes in the contest will be awarded the Radio Digest gold cup. In the event of a tie for the gold cup award each tying contestant will receive the same identical award.

Anyone may vote for their favorite announcer with ballots clipped from Radio Digest.

All votes to be credited must be mailed on or before midnight, September 8, 1924.

The Radio Digest First Annual Gold Cup Award will be made by a committee appointed by the publication.

Any question that may arise during the contest will be decided by the Gold Cup Award Editor. His decision will be final.

## LOUD SPEAKERS RUIN ORDERLY PROCEDURE

### Representative Wants Them Removed from Lower House

WASHINGTON, D. C.—"These loud speaking devices are ruining the orderly procedure in the House," said Representative Albert Johnson of Washington the other day in introducing his resolution to take the loud speaker out of the House of Representatives.

"The screech of a busy sawmill, the quack of a duck, the escaping steam of a locomotive all mixed with the whir of an airplane" is the colorful description which Representative Johnson made of the sound amplifying devices with which the House chamber is equipped. Speaking further regarding the loud speakers he said:

"They catch up every sound from the floor and the result is a loud babel of confusion. There have been more errors in the Congressional Record in the past few months than for years. These can be charged to the loud speaking machines."

## WATCH "DEATH-RAY"

(Continued from page 1)

tension laboratory on the outskirts of Paris, is doubtful; and Commandant Rene Mesny, whose work on the one and one-half and two meter Radio wave on the amplification of light vibrations into sound vibrations with an audion bulb, are internationally known, flatly refuses to take any stock in the claims of the English inventor.

Yet eye witnesses have seen Dr. Matthews kill a mouse, stop motors, and blow up powder, at a distance of sixty feet.

## McLean Succeeds Jackson as Chief of Naval Radio

WASHINGTON.—Captain Ridley McLean, United States Navy, formerly in command of battleship Arkansas, has been designated to relieve Captain O. P. Jackson as director of naval communications.

# CONTENTS

Radio Digest, Illustrated, Volume IX, Number 9, published Chicago, Illinois, June 7, 1924. Published weekly by Radio Digest Publishing Company, 510 North Dearborn Street, Chicago, Illinois. Subscription rates, yearly, Five Dollars; Foreign Postage One Dollar additional; single copies Ten Cents. Entered as second-class matter at the postoffice at Chicago, Illinois, under the Act of March 3, 1879.

"All the Live News of Radio".....	1 to 6
Before They Thought of "Mikes," an announcer puzzle.....	5
Operating and Trouble Shooting for Owners of a Kennedy Portable Receiver.....	7
An Evening at Home with the Listener In, a chart to show when to listen in for your favorite stations.....	8
Thirty-Minute A-B-C Lessons for Beginners, Chapter XII—Catching Radio Waves, by P. E. Edelman.....	9
Advance Programs for the Week at the Larger Stations.....	11 to 14
Compact Nine-Tube Super-Heterodyne Set, Part I—The Circuit, Used Batteries and Controls Necessary, by Harry Abbott.....	15
How to Install a Radio Set in Your Automobile, Part V—Essex Installation and Cabinet Details, by Harry J. Marx.....	17
Three-Circuit Changed to Tuned Radio, Real Hook-Up for DX Reception.....	19
Importance of Well Insulated Aerial and Ground, Leaks Will Drain off Weak Currents, by Dr. Fulton Cutting.....	21
Questions and Answers.....	22
Radio Illustrated, a page of pictures.....	24

## Looking Ahead

**Who Have Been Nominated to Date** in the Radio Digest First Annual Gold Cup Award to the World's most popular announcer, will be listed in the next issue. That the Radiophans have taken hold of the popularity vote with a vengeance, is but a weak statement. Who's best announcer?

**Installing Radio in a Studebaker** will be the next article of this popular series by H. J. Marx, who will include in the article the last of the portable set's details.

**The Zenith Super Six-Tube Portable** is the next set to be described in the "How to Operate" section. The receiver will undoubtedly be very popular this summer. It can be carried anywhere and used without erecting an aerial.

**"The Radio Detective"** is the story about rectification that P. E. Edelman will tell in our next issue. This is Chapter XIII of this simple series describing Radio from the very beginning.

**Combination of Radio Frequency and Regeneration** is the title of an article written by Brainard Foote, a man well versed in the development of Radio. Coming soon.

## Take Radio Digest with You on Your Vacation

WHEN YOU WANT

# Radio Digest

YOU WANT IT!

BE SURE OF YOUR WEEKLY COPY BY SUBSCRIBING NOW

## SEND IN THE BLANK TODAY

Publisher Radio Digest,  
510 N. Dearborn St.,  
Chicago, Illinois.

Please find enclosed check M. O. for Five Dollars (Six, Foreign) for One Year's Subscription to Radio Digest, Illustrated.

Name .....

Address .....

City.....State.....

## USE-IS THE TEST

## Build Your Radio Set With Kellogg Guaranteed Parts

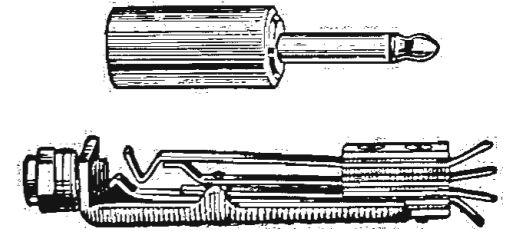

**KELLOGG** Plugs fit all standard jacks. The insulators are sufficiently heavy, of durable material and high dielectric quality. Arranged for the connection of two head sets.

Kellogg Jacks are especially designed for radio work. They are mounted on heavy nickel-plated iron frames with round edges. The nickel-silver springs are securely held in place by two heavy set screws and separated by Bakelite insulating strips. Kellogg jacks have both tip and ring contacts eliminating "sloppy" contacts in the sleeve. Arranged for easy soldering.

Specify Kellogg radio equipment and know you are getting the best.

If your dealer does not handle Kellogg, communicate direct with us.



**Kellogg Switchboard & Supply Company**  
1066 W. Adams · CHICAGO

## USE-IS THE TEST

## HANSEN BIRD CAGE LINE 'NIGHTINGALE'

4-TUBE RADIO SET  
**\$32.50**

WITHOUT ACCESSORIES

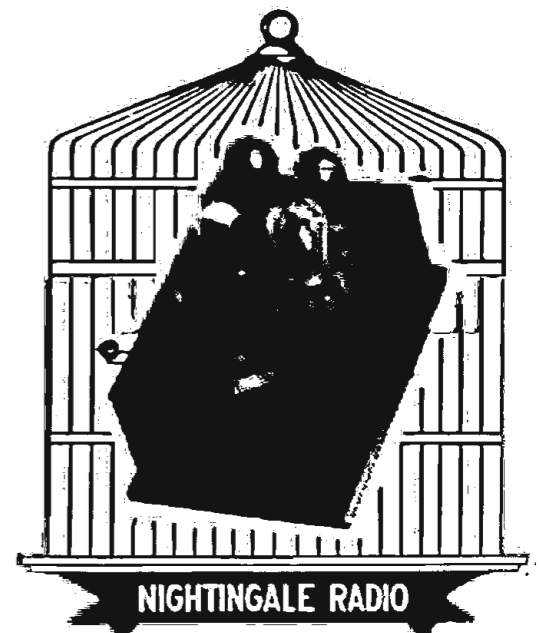

It is simplified Radio at its best and at a price within the reach of all. It is small but has a 2000 mile range with a loud speaker.

Its small size makes it ideal for vacations or auto trips.

One stage of R. F. helps to reduce static.

Hansen **MOCKINGBIRD**..... \$90.00

6 Tube Long Distance Loop Set.....

Hansen **MEADOW LARK**..... \$180.00

6 Tube Set in a Beautiful Spinnet.....

Desk.....

Write for Literature

DEALERS—A wonderfully attractive proposition  
JOBBER—We want one responsible and active distributor in each state.

## National Distributor HANSEN STORAGE CO.

"The Million-Dollar Warehouse Company"

RADIO DEPARTMENT

134 Jefferson Street MILWAUKEE

DISTRICT DISTRIBUTORS

United Auto Supply Co. Columbus, Ohio

Reins & Meiss Co. Cincinnati, Ohio

Penn. Nightingale Co. Bellevue, Pa.

Badger Radio Co. Milwaukee, Wis.

# FOUR PLANTS TO USE WENDELL'S WEDDING

## RED HEADED MUSIC MAKER WINS CHICAGO GIRL

Nuptials June 4 Conclude Romance Many Listeners Knew About —Wife Is Chicago Girl

NEW YORK.—The Red Headed Music Maker, Wendell Hall, is making final arrangements with his bride-to-be, Miss Marlon M. Martin, young newspaper woman of Chicago, for their Radio wedding to be performed Wednesday evening, June 4, in the studio of WEAJ here, and to be broadcast simultaneously through WEAJ, New York; WCAP, Washington, D. C.; WJAR, Providence, R. I., and WMAQ, Chicago, Ill.

The principals of the wedding are insistent that the ceremony be as quiet and devoid of sensation as if it were being conducted in the bride's home.

"Our wedding will not be broadcast because either of us is especially prominent," Mr. Hall states modestly. "That is not the idea. No, sir. There are hundreds of thousands of folks whom I feel almost are personal friends, folks to whom I have been singing along a route that stretched for nearly 4,000 miles.

**People Feel Personal Touch**  
"They all heard me singing directly to Miss Martin back in Chicago from whatever section of the country I happened to be in. Our courtship in a way has been broadcast for the last four months, and people seemed to realize it somehow, for they wrote to me by the thousands. Wrote intimately, just like long-time friends. Lots of them sent foolish little things to me. I like them all. And, because we feel them to be our friends, it seems natural to want to have them all at our wedding."

Miss Martin will be attended by Miss Dorothy Fullerton, daughter of Hugh Fullerton, feature writer and sports authority. "Tom" Campbell, former Yale track team captain and crack sprinter, will be Mr. Hall's best man.

## Station CKAC Begins Tour Boosting Radio

### "Flivver" Equipped with Receiving Set to Cover Country

MONTREAL, QUE.—In order to stimulate interest in Radio throughout the rural districts of the Province of Quebec, and to convince, on the spot, the incredulous, a car of the "flivver" type, equipped with the latest receiving devices, will cover every district populated by French-Canadians, traveling a distance of over nine thousand miles.

Station CKAC, owned and operated by "La Presse" Publishing company here, will be picked up and supply the daily entertainment. The villagers will be shown how Radio works, what it does and brings to even the most isolated homes.

The car has just left on its first lap, heading East. When Quebec province has been entirely covered, the car will head south and cover the parts of New England and New York where hundreds of thousands of French-Canadians are residing.

## Sen. Dill, Radiophan, Gets Credit for Defeat of Tax

WASHINGTON, D. C.—The recent defeat of the proposed Radio tax of ten per cent in the Senate was due in large part to the activities of Senator Dill, of Washington, who was active in explaining to Senators just what this would mean to the Radiophans of the country. Senator Dill knows, too, because he is a Radiophan himself, owning not only a large tube set, but also a crystal set.

The Senator has been and will continue to be a good friend of the fans in the Upper House of Congress.

## RADIOED INVITATION CROWDS BARBECUE

LOS ANGELES.—Edward A. Salisbury broadcast an invitation to a free barbecue from KHJ here recently. Although his home is seventy-five miles from the city and inaccessible except by automobile, 27,000 acceptances were received by mail. On the day set, 15,500 machines arrived, 38,000 persons were fed and it is estimated that thousands more had to go hungry. "The way to a man's heart," etc.

## AUSTRALIA PUTS O. K. ON DIRECTED WAVES

SYDNEY, AUSTRALIA.—Experiments with directed Radio communication between this country and England with the new Marconi short wave "searchlight" beam system of transmissions, is entirely successful, according to the report of Radio engineers. As a result the government will abandon the plans for a large station and will build instead a smaller station adaptable to the beam transmission scheme, saving four-fifths of the cost.

## TWO-YEAR-OLD IS RADIOPHAN

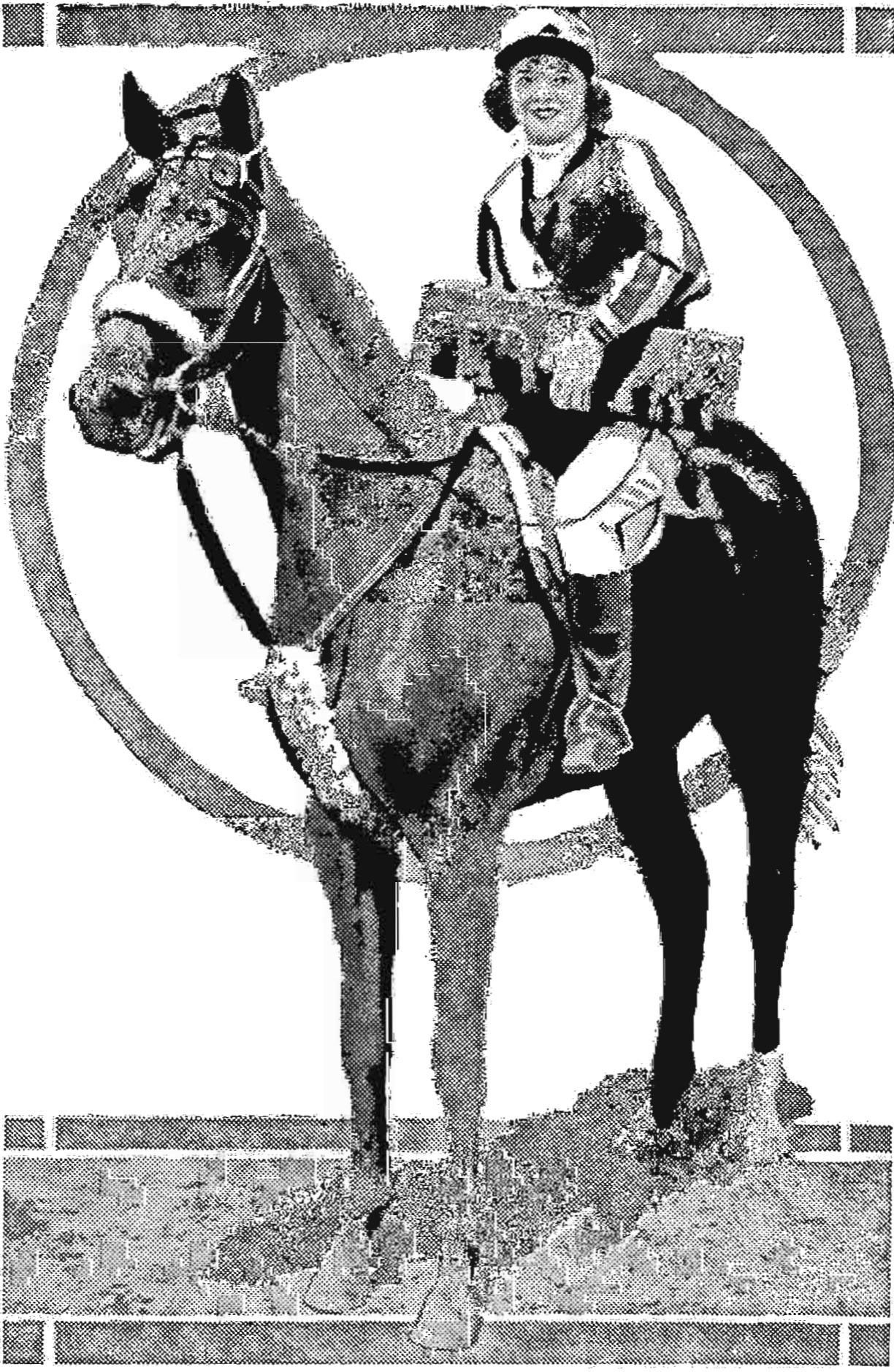

The time has come when even horses are able to listen in over the Radio. They prefer head phones to the loud speakers. Photo shows Miss Hilda Ferguson, popular actress, "up" on her two-year-old filly "Radio," at the Jamaica Race Track.

### Gives Lessons in Journalism

CINCINNATI.—T. C. O'Donnell, editor of the Writer's Digest, is giving a series of lessons in journalism for writers and aspiring authors over Crosley Station WLW here. These are scheduled for every Friday afternoon at 4 p. m. Eastern time.

### Chinese Newspaper on Air

SHANGHAI.—Regular broadcasting has been started by Shun Pao, the first Chinese newspaper to take up Radio. Programs are sent four times daily and comprise chiefly of lectures in Chinese and music.

# SIX-STATION LINKING IMPRESSES HOOVER

## TALK FROM WASHINGTON HEARD ALL OVER U. S.

Tells Listeners His Vision of Future —Home Life Better for Radio He Says

WASHINGTON.—Speaking before a microphone at his own desk here, Herbert Hoover, secretary of commerce, addressed the National Electric Light association convention held at Atlantic City recently while his talk was broadcast from Station's WEAJ, WCAP, WJAR, WGY, KDKA, and KYW.

Secretary Hoover was impressed by the occasion and said, "This arrangement has both its advantages and its disadvantages. It saves time, and that is an advantage in my kind of a job. But it lacks the personal touch, and that is a disadvantage. To talk to the unresponsive face of a microphone in a lone room has much the same inspiration on the speaker as a lecture directed to a doorknob. However, I have a receiving set at my elbow.

**Sees Broadcasts Build Home Life**  
"There are today 600 broadcast stations. All this will add not only great intellectual and stimulative force to the nation, but it will materially help to build up home life. For in the comfort of our own firesides, father can smoke, mother can knit and the family can make remarks upon the performance in terms not permitted in public places.

"Our governmental relationships to this particular problem are complex in administration, simple in principle. We seek to preserve the ownership of the road through the ether as public property that we may maintain initiative by holding it a free field for competition; to keep alive free speech; to avoid censorship, to prevent interference in the traffic."

## Uses Radio to Close Sale of Real Estate

### While Ship Is at Sea, Birmingham Man Makes Deal

BIRMINGHAM, ALA.—Radio has been used to close an important real estate deal here, and one that is believed to be the only one ever closed through the agency of the ether.

The steamship Leviathan was two days out at sea. On board was a carefree crowd. No unlikelier setting could have been selected for a business deal in Birmingham, Ala., but out of the unclouded sky came news of an impending deal in real estate, and by Radio went confirmation.

Ira A. Watson, local clothier, was on the steamer end of the transaction and A. W. Synder, Birmingham real estate dealer, was on the other end in Birmingham. Snyder had cabled Watson a proposal at his London hotel, and Watson having sailed, was Radioed at sea by his London hotel. The proposal suited him and he promptly Radioed Snyder to that effect.

## French Farmers to Erect Small Broadcast Station

PARIS.—Farm inhabitants and small-town people of southern France have found Radio so useful in keeping track of the grain and other commodity markets that they have decided to erect a small broadcasting station to specialize in the dissemination of news for farmers.

Concerts will be given also, as the people want to be able to hear music without having to pay for expensive tube sets to get the Paris and London music.

CKCH, Ottawa, one of the Canadian National railway's plants uses a full size locomotive bell, handsomely finished in heavy silver plate, as its distinguishing mark on the air.

## THE ANTENNA BROTHERS

### Spir L. and Lew P.

### Part V—The End of the Squawk

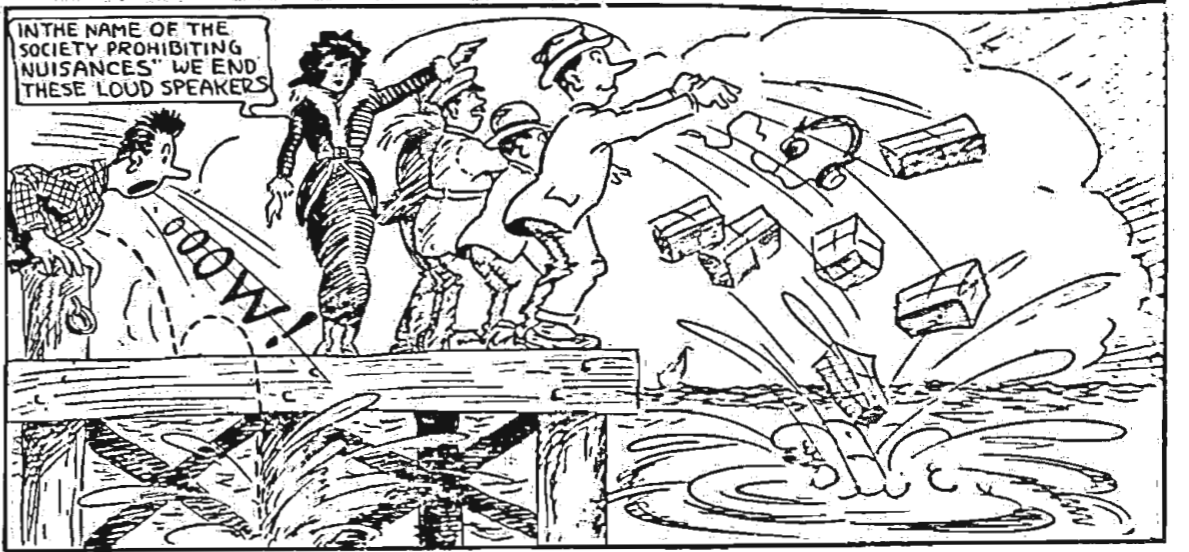
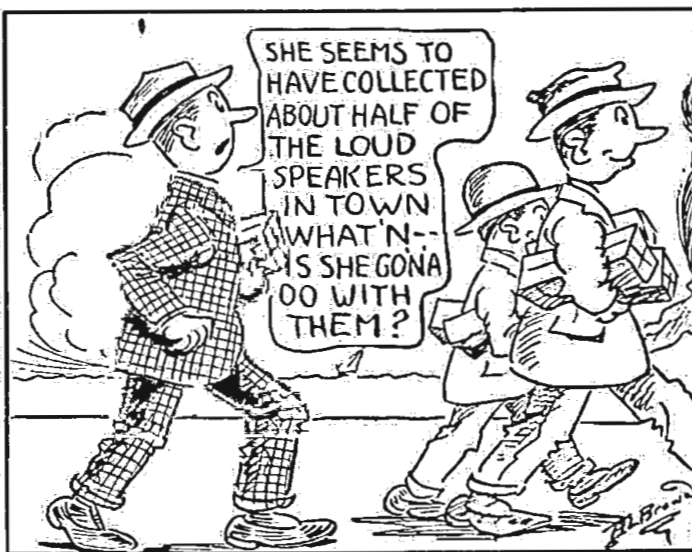
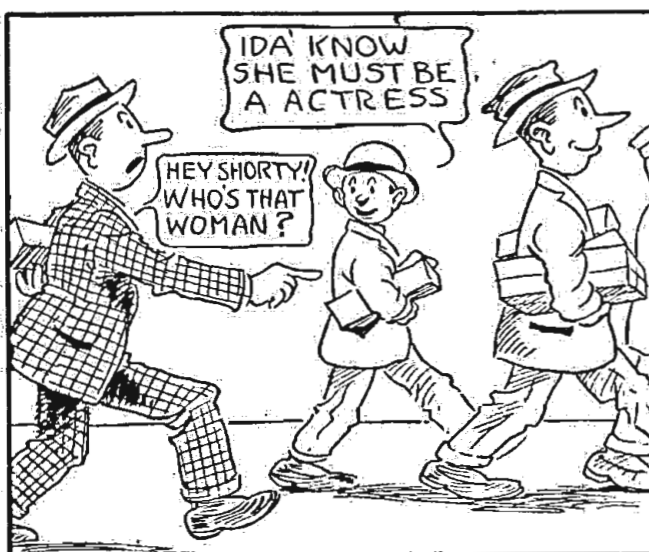

# ZR-3 TO USE RADIO FOR ATLANTIC TRIP

WORLD'S LARGEST AIRSHIP TO START SOON

Expects to Be in Constant Touch with European or American Stations Throughout Trip

(Continued from page 1)

At sea the ZR-3 will be at sea in the mid-Atlantic during the first few days of the ZR-3 flight, will be asked to give reports, noting their ships' positions. These reports will be used by the navigator and his assistants to make regular charts, using barometers and isotherms as does the federal weather bureau.

This information will enable the ZR-3 to run outside of storm centers, taking the side that offers a possible helping wind. If this information points to a direct line from New York to New York as being the most advantageous, the crossing may be made in much less than the 96 hours now estimated.

"Meteorological information is as essential to the commander of an airship on a long trip as it is to steamers. It is possible that in the future weather stations will be maintained in all parts of

# UNCLE SAM'S NEW AIR LEVIATHAN—THE ZR-3



The largest and fastest Zeppelin in existence, the ZR-3, which will shortly begin its 4,500-mile trip from Friedrichshaven, Germany, to the United States, directed by Radio weather reports. Storm centers will be avoided, and it is believed the estimated 96 hours required for the trip will be cut considerably. The ZR-3 is being delivered to the U. S. Government by Germany in payment of war claims. Photo posed for Radio Digest.

the civilized world to furnish airships with this information.

### Fans May Hear Voice of ZR-3

"It is not unlikely that many of the popular broadcasting stations in the United States will be asked to co-operate with the navy when the ZR-3 is put to the experiments in behalf of commercial aviation for which she was constructed.

"It may be possible, by re-broadcasting, for Radiophans throughout the land to hear the voice of the ZR-3 Radio operator while the ship is high over the mid-Atlantic."

The ZR-3 will be equipped with an improved type of aircraft Radio outfit, of greater power than any used in this country heretofore. The apparatus is enclosed in such a manner as to insure perfect safety while sending, although hydrogen gas may be present in the Radio cabin compartment. A wave length of 1,400 meters is now used. At least one Naval vessel will take station in mid-Atlantic to serve as a Radio communicating center between the European and American stations, relaying messages to and from the airship all the way over.

The present record for Radio broadcast transmission is held by Station WGN, Zenith-Chicago Tribune, Chicago, whose voice has been heard 9,670 statute miles. Hobart, Tasmania, was the point reached.

# RX DEFINES RADIO, SCIENTIST HOLDS

Dr. C. S. Page Says "Life Atom" Is Only True Energy Possible

CHICAGO.—Dr. Calvin Samuel Page, well-known scientist of this city, who has been nominated for the Nobel physics prize, spoke on "Rx, the Life Atom," recently at a luncheon of the Chicago Electric Club.

According to Dr. Page, Rx shows exactly what electricity is, disproves the Einstein theory of relativity, defines Radio, light, heat and gravitation and is the only known energy. He said the discovery of Rx was the most important in the history of science.



## The GREBE CLARIFIER

THE first practical, workable solution of the problem of radiation from regenerative receivers. Unlike the "wave-trap" it increases signal intensity.

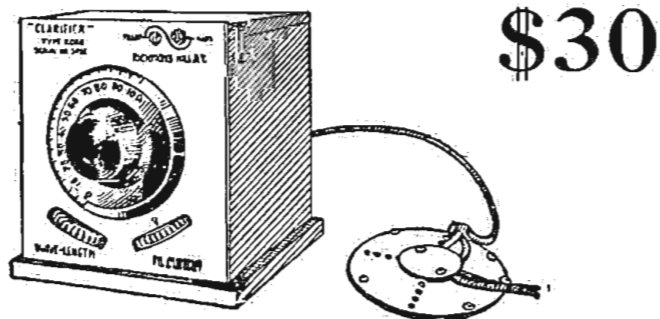

- Increases Selectivity
- Increases Signal Intensity
- Improves Quality
- Prevents Radiation

And—

Is Easily Connected

Ask your dealer or write for literature

**A. H. GREBE & CO.**

Richmond Hill, N. Y.

Western Branch—451 East 3rd St., Los Angeles, Cal.

## Lower DIELECTRIC Loss

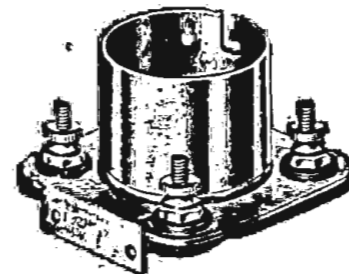

UV 199 or Standard base. List

# 50c

THAN BAKELITE, FIBRE OR COMPOSITION SOCKETS

## —and Unbreakable!

If a Walnut Socket ever breaks or fails you in any way, you get a new one free! That's how good they are. No wonder they're standard on leading sets. Over half a million in use. Approved by Radio News Laboratories. Ask your dealer first.

## WALNART SENSIBLE SOCKETS

Bakelite Insulation, Heavy genuine phosphor bronze contact springs; low resistance; high elasticity (to insure perfect contacts). Nickel or dull black enamel finish. For base or panel mounting. Unconditionally guaranteed by world's largest producer of unbreakable sockets. Trial will convince.

"Makers of good goods only"  
**WALNART ELECTRIC MFG. CO.**

Dept. 438 Chicago

## Bristol Single Control Radio Receiver

Using Grimes Inverse Duplex System  
Patents Pending

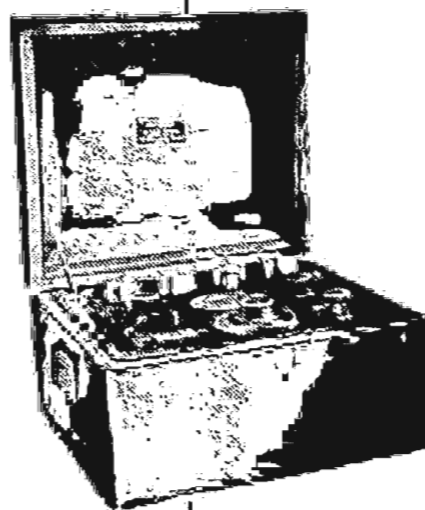

### Most Simple to Operate

The set for those who want results with little effort. Anyone in the family can quickly learn to operate it because technicalities and guesswork are eliminated—One Control Dial does it all.

### Does Not Interfere With Your Neighbor

Other close by reception is not disturbed when you tune in with this non-reradiating Receiving Set. It gives you a comfortable sensation of freedom to be able to change from one station to another knowing that you will not interfere with your neighbor's receiving.

### Choice of Aerial or Loop

Where conditions make it difficult to install an outside aerial, as in congested sections of cities, good results can usually be had by using inside Loop. In fact, the directional feature of the Loop often brings in stations not possible with a stationary aerial.

Mounted in solid mahogany case with walnut finish, the Bristol Single Control Radio Receiver is handsome in appearance. The price is \$190.00. Bulletin AY-3013 describing this set will be mailed on request.

## BRISTOL

TRADE MARK  
**AUDIOPHONE**  
REG. U. S. PAT. OFFICE

## Loud Speaker



This is known everywhere as the Loud Speaker with the quality tone. Not only is the tone natural and without mechanical distortion, but is sufficiently big in volume to be easily heard in a large room or all through the house. Comes to you ready to use—no auxiliary batteries are required.

Made in three models:

- Audiophone Senior.....Price, \$30.00
- Audiophone Junior.....Price, 22.50
- Baby Audiophone.....Price, 12.50

**THE BRISTOL COMPANY, Waterbury, Conn.**

# BEFORE THEY THOUGHT OF "MIKES"



The boisterous baby shown above is none other than M. of Station W. Look next week on this page and you will see just who we mean.

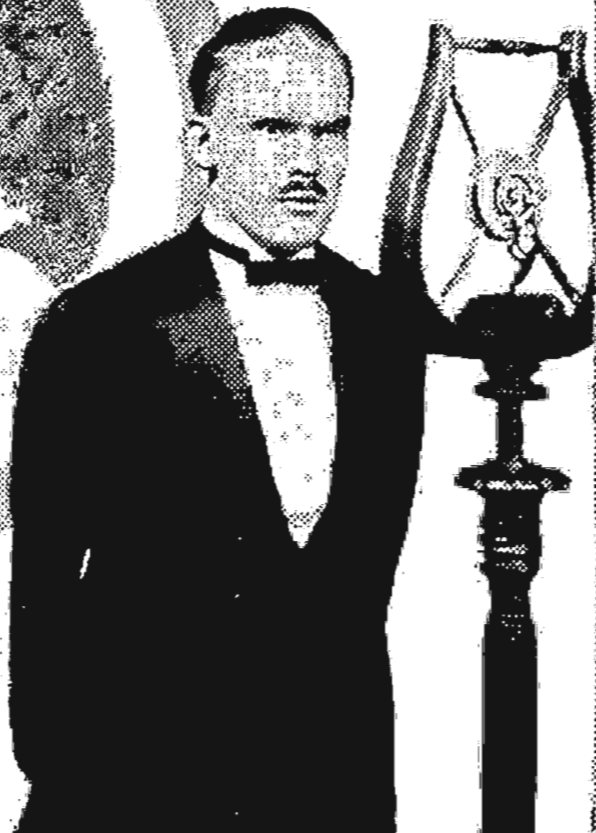

The young man shown below at the microphone, goes by the name of John T. Schilling and is announcer at Station WHB, located in Kansas City, Missouri; the "Heart of America." The one next to him is Carl E. Haymond, announcer at Station KFOA, located in the Rhodes department store, Seattle, Washington.



This youngster holding up his hand like a traffic cop, is announcer at Station W, located in the upper part of New York state.



## 36 STATIONS YIELD \$16,500 FOR SONGS

### RELATES HOW SOCIETY'S COFFERS ARE FILLED

E. C. Mills Tells House Committee Figures on Yearly Payments to Composers' Club

WASHINGTON, D. C.—But thirty-six broadcast stations in the United States out of more than 500 are paying the American Society of Authors, Composers and Publishers \$16,500 a year for the privilege of broadcasting songs copyrighted by members of the Society, E. C. Mills, one of the officials of the society, testified before the House committee on patents during the recent course of hearings when several copyright bills including the Newton and Johnson measures were under consideration.

Going into some detail regarding the amounts paid, Mr. Mills said that WEAJ in New York is paying the society \$500, as is also WCAP of this city. WOR is paying the society \$750 a year.

Mr. Mills stated that the Radio corporation and the other "big four" are not paying anything to the association.

#### Ninety Per Cent of Songs Fail

Discussing the several bills under consideration by the committee, Mr. Mills contended that less than ten per cent of the American society songs are commercially valuable. Mr. Mills said that the society is not hostile to Radio, although he admitted that all of the members of the society are not agreed as to the value of Radio publicity.

Charles H. Tuttle, counsel for the National Association of Broadcasters, also appeared before the committee in rebuttal. Mr. Tuttle's testimony took on much the same style as that given before the Senate committee on patents several weeks ago. He called attention to the fact that the listeners in are paying nothing for the service, and, therefore, the broadcasters are anxious to keep their expenses as low as possible.

#### Attacks Pooling of Music

Samuel Spring, representing the First National Exhibitors' association, made a strenuous protest before the committee against what he denominated "the pooling" of music by the American Society.

He contended that the society is a monopoly and it is against the public interest. He said that the society is really a tax gathering organization which has spies all over the country. He said that both Radio and the moving picture theaters helped to "plug" a song.

#### WEAO to Use University Chimes

COLUMBUS, O.—Music from the chimes of the Ohio State university in the near future will be a feature of the programs from WEAO, the university's broadcaster. The chimes, dedicated in 1915, are considered among the finest in the country, and will be used to sign off the WEAO programs

#### John T. Schilling, WHB

W AY back in 1915 and 1916 Mr. Schilling received his initiation into the mysteries of Radio. Then receiving equipment consisted principally of a long wave tuner and a cat-whisker Galena detector.

The ambition in those days of the listeners was to receive the time signals from NAA at Arlington and the weather forecast from NAR at Key West. Since that time, his work in the Radio field has been varied, having had experience in instruction, development work, operating, engineering, and announcing.

During the war he served in the capacity of instructor at the Radiophone school at New London with the rate of Chief Electrician (Radio) U. S. N. After the war, he was employed in the testing and experimental laboratories of the De Forest company at New York, and later he was connected with the International Radio Telegraph company.

At the call of the wanderlust which comes in every young man's life, he migrated to San Francisco, and from there to various parts of the west coast, Honolulu, Panama, Mexico and the Orient. Signing the ship's papers as Radio operator, he became known forever after as "Sparks."

A short time later, four months were spent in the vicinity of Tampico, Mexico, in the construction and erection of several transmitting sets. This work was stopped by the Mexican government, so, for the past two years, since the opening of WHB, he has been its regular announcer. His voice is the one you hear proclaiming nightly that Kansas City, Missouri, is the "Heart of America."

## SECOND CITY GETS FOUR NEW PLANTS

Chicago Firms Vie for Time on Ether—Two Plan 1,000 Watts

CHICAGO.—Four new broadcast stations, two of which will use the maximum power permitted, 1,000 watts, are being planned for this vicinity.

The Sisson hotel and the Medinah Country club, in Du Page county, will begin the installation soon of the larger sets. The Medinah Country club expects to have its outfit in operation by midsummer.

The Saal Plusformer company and the Watch Tower Bible and Tract society are planning smaller stations. What wave lengths will be assigned to the two larger broadcasters is a puzzle, as Chicago's class B wave allocations are badly crowded now.

#### Bedtime Stories Now at WBZ

SPRINGFIELD, MASS.—Westinghouse Station WBZ here has added Thornton Burgess bedtime stories as a feature of its evening programs. Mr. Burgess, known throughout the country for his famous children's stories of which he has written more than 2,000, makes his home in Springfield.

#### Carl E. Haymond, KFOA

R EMEMBER the little shaver last week who was wearing the fur cap? Well, he was born in Geneva, Iowa, on July 8, 1896. His folks said he wanted to enlist in the army as soon as he heard we were at war with Spain.

He received his preliminary education in the town where he was born and packing his grip he left the old homestead to enter college, far above Cayuga's waters'—Cornell.

While at college, he was picked as all-state right tackle in his junior year. Some speed to the boy in those days, yes, and even now.

When war broke out, Carl rushed to the colors and signed as a Radio operator. When the enemy heard that he had enlisted they decided that it would be a good time to sign the armistice, throwing a perfectly good Radio operator out of a job.

Dame fortune smiled at him, and he was picked as announcer for the first broadcast station in the northwest, old KFC, at Seattle. Their first program was the Dempsey-Willard fight returns, July 4, 1921.

Mr. Haymond recently developed the Haymond circuit, a very sensitive receiving set which is now being used from coast to coast.

He is married to a charming woman (omit love notes when writing Carl) and has a son two years old, Carl Dexter, who is a rabid Radiophan like his Dad. The only vices of the senior Haymond are his pipe and a marshmallow milk shake when he is through announcing at the KFOA studio.

## Police Department Plans to Broadcast Reports of Crime

BIRMINGHAM, ALA.—The Birmingham police department is working on a plan to broadcast reports of murders, burglaries and the description of those wanted by authorities.

Heads of the police department believe that this procedure will do much to eliminate crime. They suggest that the city install receiving and sending sets, and that all cities all over the country do likewise. The plan may soon be put into effect by the Birmingham police.

## NEW HONOR COMES TO AUDION INVENTOR

LEE DE FOREST DESCENDANT OF HUGUENOT

Hold Tercentenary Celebration of Huguenot-Walloon Colony Founded in New York in 1624

NEW YORK.—Lee De Forest, inventor of the vacuum tube so well known to Radiophans, is to be honored this month as one of the direct descendants of the man who brought about the first settlement of New York State. Jesse De Forest, just 300 years ago, induced Holland to permit a group of French and Belgian religious exiles, which he had banded together, to settle in what was then New Netherland.

It is in observance of this anniversary that a Huguenot-Walloon tercentenary celebration is being held throughout this month and June. Although living 300 years apart, the two De Forests had remarkably similar traits and experiences. Through ten generations is found a predominant strain, the desire to explore. One devoted his indomitable spirit of adventure to seeking out unknown lands; the other to discovering and utilizing hitherto unknown physical and electrical forces.

The paralleling of the lives of the two De Forests is intriguing and of great interest to students of heredity.

**MASTER YOUR RADIO**—Fix your own when it gets out of order and avoid service charges, disappointments, failures. Trouble key and test systems quickly located cause of weak reception, dead circuits, interfering noises, rattles, squeaks, hisses, hummings, poppings, howls, whistles. Simple, effective remedies. Applies to any type receiver. The "Trouble Shooter," 12 chapters, 13,000 words, a book you must have to keep your receiver in efficient working order. Postpaid 50c, coin, stamps, money order. Radio Information Service, Galveston, Texas. Adv.

## NOMINATION CERTIFICATE

### Announcers' Contest

Radio Digest First Annual GOLD CUP AWARD  
GOLD CUP AWARD Editor, Radio Digest,  
510 N. Dearborn St., Chicago, Ill.

Dear Sir:

I nominate .....

Station .....  
Broadcasting Station

Signed .....

Address .....

Town ..... State.....

# WOAW'S STORY LADY INVENTS ALL TALES

## GRACE SORENSON DOESN'T LIKE ANIMAL STORIES

Finds Time to Edit Child Paper,  
Write Verses and Compose  
Songs Besides

OMAHA.—Station WOAW boasts a unique feature in the original stories which Miss Grace Sorenson broadcasts to thousands of kiddies all over the country every Thursday evening at 6 o'clock, Central time. She has been doing this since last Thanksgiving.

Miss Sorenson claims to be the only "story teller" who makes up every one of her own stories. In fact, she often invents her stories as she stands before the microphone and most of the time speaks from notes. The WOAW staff doesn't know just exactly where she got her gift of "story telling" but it is significant to note that her father is famous as a historian.

### Doesn't Think Bear Stories Good

Her juvenile listeners never hear any animal stories because Grace does not think they are good for children.

The amusing adventures of the eleven-year-old girl, Petty Patch, have proved most popular.

Miss Sorenson spends a good deal of her spare time editing "Every Child's Magazine," published in Omaha, of which she is the owner and editor. Her flair for writing extends into versification, and she has a book of homemade jingles to her credit. She also composed "Sing Peace Today," a song which has been popularized in the schools since it has been sung from WOAW.

# VOTES AGAINST BEAR STORIES FOR YOUNG



Miss Grace Sorenson of WOAW is one of the few bedtime story tellers who invent their stories at the microphone. She does not believe in telling the children animal stories, but confines herself to adventures of little children.

meters with a steady wave. He believes that short waves do not follow ordinary transmission laws.

The short wave set just completed was designed for use when the Shenandoah goes to the North Pole where it will be daylight most of the time.

## Holds Graduation in Radio School Course

Students Who Pass Examinations  
Get Kansas Aggy Certificate

TOPEKA, KANS.—The Kansas State Agricultural college "Radio school" has had its first graduation, and more than 3,000 listeners in fifteen states will receive certificates of "attendance" this month. The course was broadcasted by KFKB, Brinkley-Jones Hospital association, Milford, Kans.

After the lectures in each of the agricultural courses were radiated, examination questions were sent to all who had enrolled. Examination papers were corrected and graded by the faculty and returned.

# THORDARSON

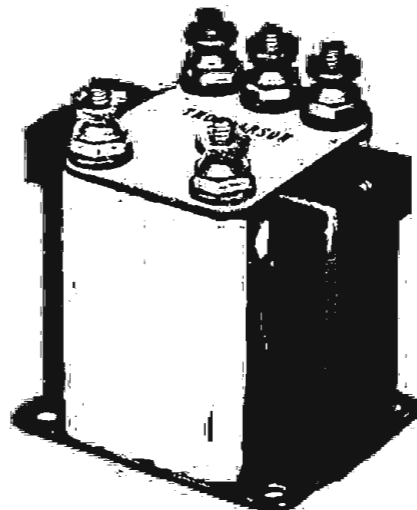

## POWER AMPLIFYING TRANSFORMERS

Price per pair, \$13.00

The new Thordarson Power Amplifying Transformers (push pull) are designed for use as third stage audio frequency amplifiers, to provide high power amplification for operating loud speaking devices.

With power amplification, not only is it possible to increase volume, but, since two tubes replace the usual one, the distortion and howling which usually accompany the overloading of a single tube on the third stage is done away with entirely.

The Thordarson Power Amplifying Transformers are well constructed electrically and are capable of indefinitely carrying the additional load without breaking down.

In tonal purity these transformers equal the Thordarson Super Audio Frequency transformer whose rich quality and even amplification has made it the popular transformer of the day.

**THORDARSON**  
ELECT. MFG. CO.  
500 W. Huron St. CHICAGO

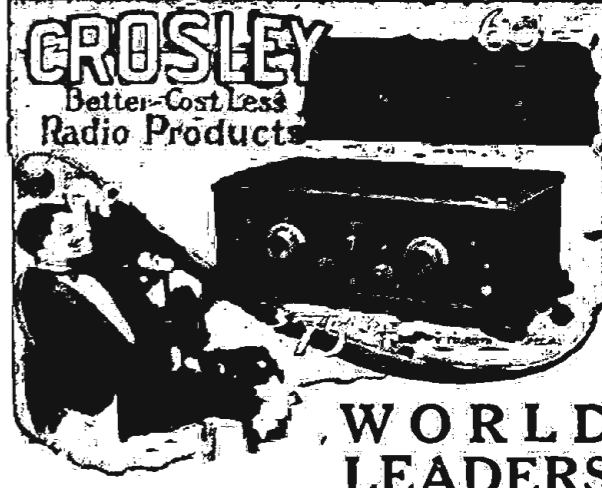

**CROSLEY**  
Better—Cost Less  
Radio Products

## WORLD LEADERS

IN EVERY field of endeavor there is always a champion—a man, a product or a thing that takes the leadership, not by accident, but because of actual merit. In the new industry of radio, a leader has already arisen—Crosley Radio Receivers.

In new inventions, new simplified devices and new ways and means of giving greater radio value at a lower price, Crosley has constantly led. As a result, the purchaser of a Crosley Radio Receiver, knows that he is getting the last word in radio perfection.

This is evidenced by the fact that Crosley is building more radio receivers than any other manufacturer in the world.

Above are illustrated two good reasons for Crosley supremacy—the Crosley Trirdyn 3R3 and Crosley Trirdyn 3R3 Special. These instruments are the latest radio engineering triumphs—three tube sets giving five tube efficiency.

They contain the following attractive features: Tuned Radio Frequency Amplification, Regenerative Detector referred back on the first tube, and an additional stage of Audio Frequency Amplification.

They are non-radiating, thus entirely eliminating neighborhood interference. For ease of picking up new and distant stations, perfect calibration and extreme selectivity, the Trirdyn is unexcelled.

The only difference between the two models is in the size and style of the Cabinets. The Trirdyn 3R3 Special is completely self-containing, having places for the necessary dry batteries, headphones and other accessories. Over 200 experts have thoroughly tested the Crosley Trirdyn. Their opinions are one and the same. "There is no receiver to compare with it at any price."

Licensed under Armstrong Regenerative Pat. No. 1,113,149  
Before you buy see the Crosley line

For Sale by Good Dealers Everywhere

**The Crosley Radio Corporation**

Powel Crosley, Jr., President

Formerly  
THE PRECISION EQUIPMENT CO.  
AND CROSLEY MANUFACTURING CO.

6491 Alfred St. Cincinnati, Ohio  
CROSLEY OWNS AND OPERATES BROADCASTING  
STATION WLW

## NEW SHORT WAVE FOR POLAR BLIMP

Design for Shenandoah Outfit Follows Successful Tests with Daylight Transmission

WASHINGTON.—Radio engineers of the U. S. naval research laboratory are so impressed with the results of their recent experiments with short wave transmission and reception in daylight that they have designed a new short wave transmitter for the naval airship Shenandoah, according to Dr. A. H. Taylor, chief of the laboratory.

Through the co-operation of amateurs in over forty states, some stations distant a thousand or more miles, NKF, at Bellevue, D. C., has secured excellent results in two-way communications on 100 meters, in Radiotelegraphy and Radiophone transmission tests. The reliability of short waves and their ability to carry for long distances, especially in the daytime, Dr. Taylor points out, has resulted in the construction of a transmitter which will go as low as eighty

## The ACME DUO-POWER UNIT

is a high grade charger and battery combined in one cabinet, thereby eliminating the possibility of incorrectly connecting battery wires to charger; the usual mess of unsightly wires, cables, clips, etc., and the carrying to battery to charger to battery for use.

THREE  
SIZES

80

120

160

Ampere Hour  
Capacity

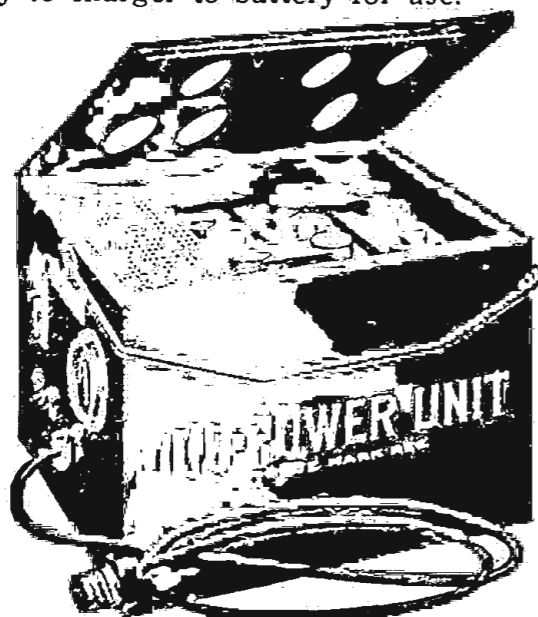

CHOICE  
ANY TYPE  
CHARGER

Bulb  
Vibrator

or ACME  
SUPER-SILENT

Whichever  
You Prefer

PRICES \$25.00 to \$40.00

Depending on Type Charger and Capacity of Battery

This DUO-POWER UNIT can be used while set is in operation; charger or battery can be used separately. All parts are easily accessible should adjustments or repairs ever become necessary. Will also charge your WET "B" BATTERIES.

Wire or write for full details on this and other  
ACME products—"For Better Results."

The ACME ENGINEERING CO., Inc.  
DEPT. D-2 LOUISVILLE, KY.

## HEAR THE DIFFERENCE!

LABORATORIES USE  
THE LOW LOSS  
GENERAL INSTRUMENT CORPORATION  
GROUNDED ROTOR CONDENSER

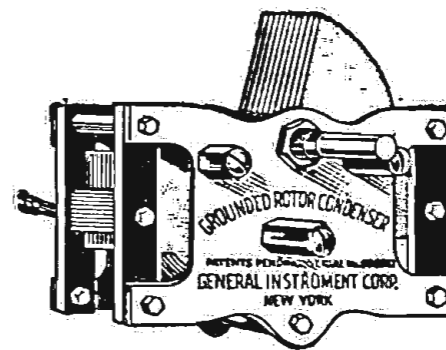

They prefer it because actual tests have proved that dielectric losses have been practically eliminated. This makes it possible for your receiving set to surprise you with a new power.

Based on Greater Selectivity, More Distance  
and a Remarkable Increase in Volume

Replace Your Old Condenser with the New Low Loss  
Grounded Rotor Condenser and

HEAR THE DIFFERENCE

Type	Minimum	Maximum	Price
Type 46X 11 Plate	5 MMFD.	.00025 MFD.	\$4.50
Type 46A 13 Plate	6 MMFD.	.0003 MFD.	4.50
Type 46D 21 Plate	9 MMFD.	.0005 MFD.	5.00
Type 46F 43 Plate	15 MMFD.	.001 MFD.	5.50

AT YOUR DEALER

Otherwise send purchase price direct to us and you will be supplied.

**GENERAL INSTRUMENT CORP.**



423 Broome Street  
NEW YORK CITY



# OPERATING AND TROUBLE SHOOTING

## For the Owner of a Kennedy Portable Receiver

**O**PERATING and Trouble Shooting" is a Radio Digest feature whose purpose is to study the late models of various standard receiving sets and to show the newly initiated broadcast listener, who has purchased such a set, how he can operate it to get the best there is in it and how he can overcome minor difficulties which may be causing some trouble. On page 7 this week the Kennedy Portable Receiver is described. Radiophans with other sets will also find these articles worth while reading, particularly the notes on trouble finding.

**T**URN tube control clockwise until tubes light. If you are using UV-199 or C-299 tubes with fresh A batteries, do not turn on any further than necessary to light tubes properly. If using WD-12 or C-12 tubes, turn until arrow points straight up. If using UV-201A or C-301A tubes, turn somewhat past this point. As the batteries decrease in strength with use, the knob will have to be turned even further in order to obtain the same results.

In determining the best setting for this control after a station is tuned in, turn the knob as far to the right as is necessary to get the best signal but no further.

### Tuning

When tuning in stations, use head phones plugged in at Stage 1. Set Tuning dial at 50. The fine tuning knob arrow should point straight up. Adjust Tube Control as described above. Increase Volume dial until a hiss is heard in the phones. Leave Volume dial at a point a few degrees above that at which hissing occurs (usually about 40-45), and find the carrier wave whistle of a broadcasting station by turning Tuning dial slowly in either direction. By turning the Fine Tuning knob slowly from one side to the other, get as nearly as possible at the center of this whistle (i.e., where it dies out, but will come back when Fine Tuning knob is turned in either direction.) Reduce Volume control until signal is clear. For best results, work the Volume and Fine Tuning controls together at this point, by turning one with each hand. If louder signals are now desired, plug phones in at Stage 2.

It may be necessary to turn the Tube Control slightly to the right to supply the proper filament current for the third tube which is now in the circuit.

### Aerial and Ground Connections

The aerial should be a single wire as long as possible—60 to 150 feet, or more—the longer the better. Good results may be obtained by throwing an insulated wire over the limb of a tree or by connecting to a wire fence. The higher and better insulated the aerial, the louder the signals. The aerial wire should be

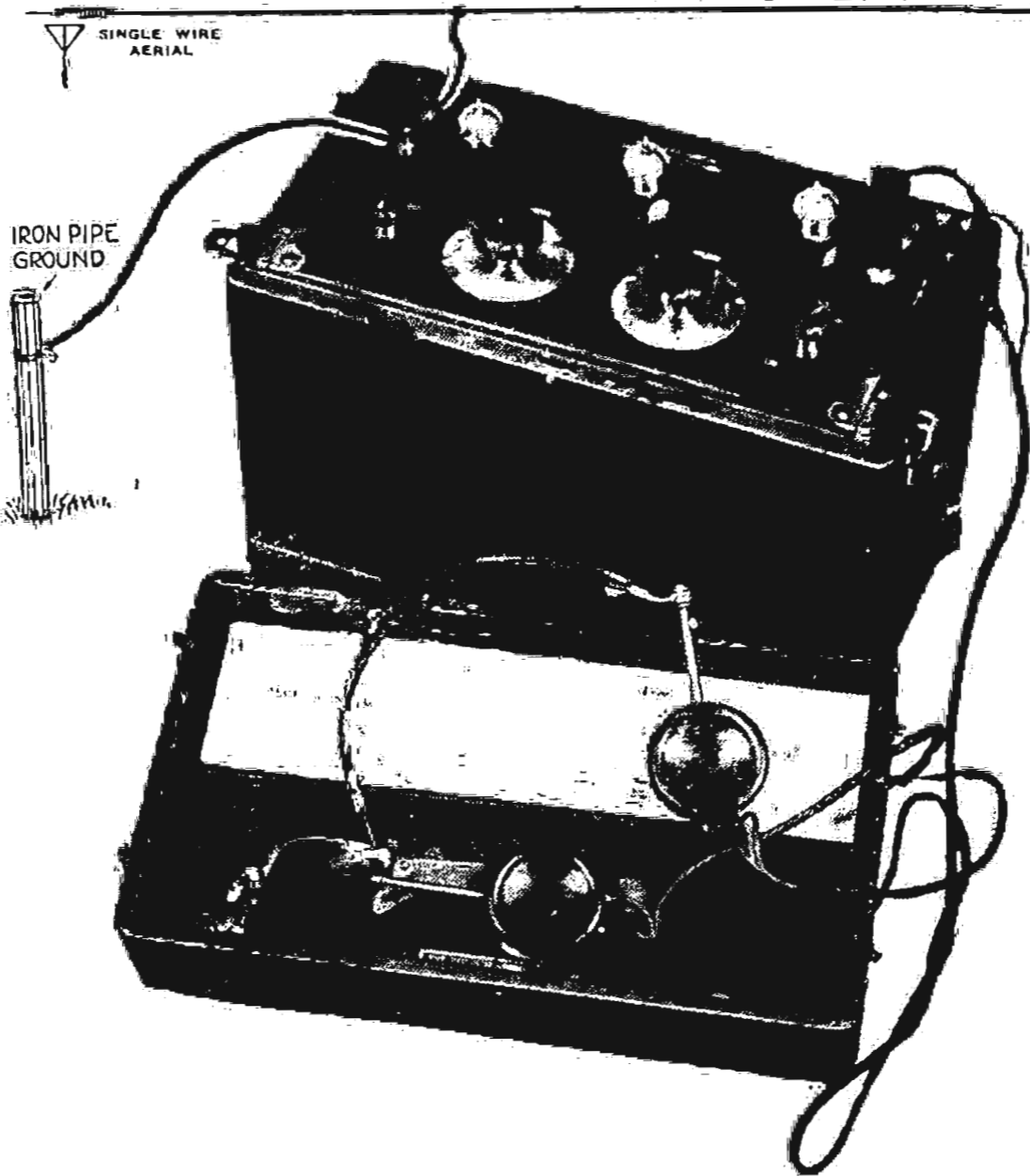

brought to the binding post on the panel marked ANT. The ground binding post (GND) should be securely connected to another wire fence, the auto frame, (see A battery instructions, a metal stake driven in the moist ground or to a piece of wire about 50 or 100 feet long, laid on the ground or in the water. Be sure that all metallic connections to ground and aerial wires are clean. It is usually necessary to scrape fence wires, etc., with a knife before a satisfactory connection can be made. The effectiveness of unusual antenna systems can be determined only by trying them out.

### Batteries

Instructions for properly connecting A and B batteries will be found in the cover of the battery compartment.

For storage battery tubes, 6-volt tubes (such as UV-201A and C-301A) require a 6-volt storage battery as a source of filament current. When using this form of A battery, disconnect the two long internal A battery leads from the dry cell to the -A and +A clips. Then run leads from the 6-volt battery to these clips. Be sure that the +A clip in the receiver and that the - or negative terminal of the storage battery is connected to the -A clip.

The leads from the storage battery may be ordinary insulated fixture wire. They should be run through the small hole in the battery compartment cover and then knotted on the inside of the cover leaving a length of wire inside the instrument sufficient to prevent strain on the -A and +A clips.

The automobile battery may be used with UV-201A or C-301A tubes, if it is of the standard 3-cell, 6-volt type. A handy

method of obtaining the necessary connection is by means of running the leads from the -A and +A clips on the receiver to a plug in dash light socket.

If the + and - terminals of the battery supply cannot be readily identified the proper connections can be determined by trying both ways. The set will not operate properly with the wrong connections. Some few automobiles use 8-volt or 12-

volt storage batteries. In such case, care must be taken to use no more than 3 cells of the battery in series (6 volts). If however, this is not convenient, a separate external resistance of 10 to 15 ohms may be used to reduce the current supplied to the tubes.

If more than 6 volts is supplied to the vacuum tubes, they will be burned out or seriously injured.

When the car battery is used as a source of filament current, the frame of the receiver must not be used as a ground for the receiver itself, but one of the other forms of ground should be used as explained in the operating instructions.

### For the New Dry Cell Tubes

For dry cell tubes (UV-199 or C-299, WD-12 or C-12), use three number 6 dry cell A batteries connected as shown below.

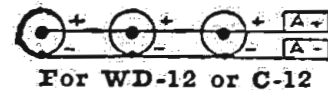

For WD-12 or C-12



FOR UV-199 or C-299

Note that for UV-199 or C-299 tubes the batteries are in series. In WD-12 or C-12 tubes, the batteries are in parallel.

### B Battery Connections

Place three small size 22½-volt B batteries in the large end compartment. Connect them together as indicated below.

For UV-199 or C-299 tubes, connect the clip to the wire marked 22V as shown by the solid line. This places a voltage of 45 on the plate of the detector tube.

For WD-12 or C-12, UV-201A or C-301A tubes, connect the clip tagged 22V, as shown by dotted line.

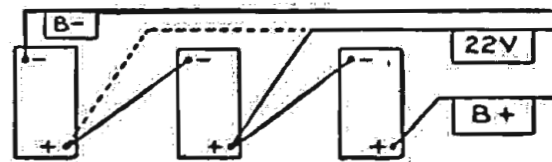

The positive terminal of the B battery connected to the +B battery clip places a voltage of 67½ on the plates of the two amplifier tubes.

(The new Zenith Super Portable six-tube suitcase set will occupy the attention next week of "How to Operate and Find Trouble."—Editor's Note)

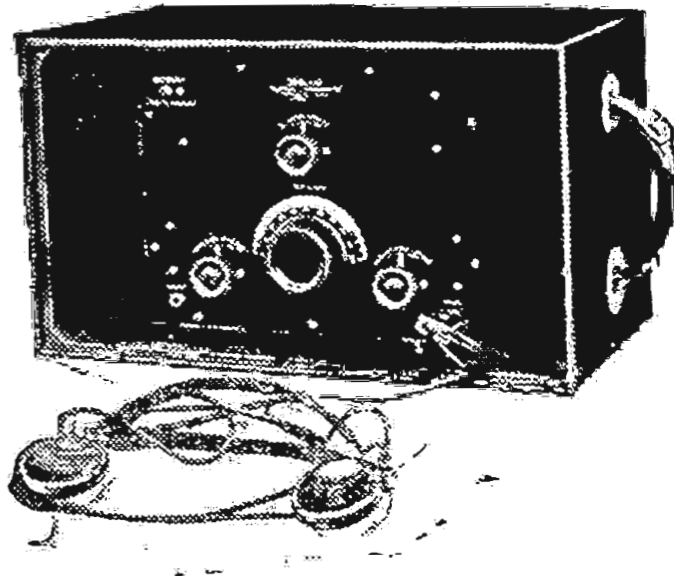

## National Praise for Federal No. 102 Special Receiver

**F**ROM every city, town and hamlet, Federal Dealers are writing us for additional No. 102 Special Federal Receivers.

The tone quality, selectivity and distance range of this new "CONVERTIBLE" set have made it a national favorite.

Besides complete sets for every pocketbook, there are over 130 standard radio parts bearing Federal's iron-clad performance guarantee.

If you do not know the name of the Federal Dealer in your neighborhood, write

FEDERAL TELEPHONE & TELEGRAPH CO.  
Buffalo, N. Y.



**Federal**  
Standard RADIO Products

Boston, New York, Philadelphia, Chicago, Pittsburgh  
San Francisco, Bridgeburg, Canada, London, England



Look for this sign



*Any radio set  
good works better  
with DE Forest  
audions!*

DE FOREST RADIO TEL. & TEL. CO., Dept. R. D. 10, Jersey City, N. J.

AN EVENING AT HOME WITH THE LISTENER IN (SEE INSTRUCTIONS FOR USE BELOW)

Table with columns for Station and City, Met., Monday, Tuesday, Wednesday, Thursday, Friday, Saturday, Sunday. Lists broadcast schedules for various stations like CFCN, CKAC, CKCD, etc.

Instructions for Use.—All the hours above are given in Central Standard Time. If your city uses Eastern Time, add one hour to each of the periods stated; if your city uses Mountain Time, subtract one hour; if your city uses Pacific Time, subtract two hours. If in addition, your city uses daylight saving time, add one hour to this result. This table includes only the evening broadcasts, and, on Sunday, the late afternoon program.

STATIONS IN ORDER OF WAVE LENGTHS USED

Table with columns: Meters Call, Meters Call, Meters Call, Meters Call, Meters Call, Meters Call. Lists stations like WBBR, WMAV, KFNF, etc. with their respective wave lengths.

French Celesta Added to WLW's Musical Equipment

CINCINNATI.—A French celesta has been added to the musical equipment of Crosley Radio corporation's WLW studio here. Its beautiful bell-like tones record through the microphone with perfect clarity, and the harmonics are such as to give pleasing tones regardless of the composition played.

The celesta is built like a piano with similar keyboard and one pedal for ex-

pression. The little felt hammers strike upon steel bars and the scale ranges from an octave below middle C to three octaves above.

Permission to establish four broadcasting stations has been granted by the ministry of public work of Brazil, to the Brazilian Radio Telegraph company for the purpose of broadcasting information, lectures and concerts. The four stations are to be located at Sao Paulo, Belle Horizonte, Bahia and Pernambuco.

Advertisement for FADA Radio featuring a large image of a woman and the text: Summer Advantages of Neutrodyne. IN THE summer time, Neutrodyne maintains the advantages of good radio reception—you can bring in signals on Neutrodyne receivers that are too weak for other receivers to get. The FADA "One Sixty" is a remarkably efficient Neutrodyne receiver. Buy a FADA "One Sixty" Neutrodyne receiver and enjoy all the advantages of summer radio at its best. F. A. D. ANDREA, INC., 1581 Jerome Ave., New York.

Station WCAP Heard in Vienna WASHINGTON.—Evidence that American jazz is about to girdle the Seven Seas via Radio is found in two letters which the Davis Le Paradis band here has received lately from Radiophans in Vienna, Austria who report that they picked up a concert given by the band through WCAP a few weeks ago. The letters establish a new broadcasting record for WCAP.

Coto advertisement featuring an image of a detector and text: Coto Compact Variocoupler operates splendidly with series condensers in standard circuits and standard sized sets. But what a portable set you can build for spring and summer use! Just cut a piece of paper 4x8 inches. That's the size of a set that will get real D. X. with plenty of volume. COTO-COIL CO. 87 Willard Ave., Providence, R. I.



# 30 Minute A-B-C Lessons for Radio Beginners

## Chapter XII—Catching Radio Waves

By P. E. Edelman

**I**N THIS series of articles the story of Radio is told in so simple a manner that the uninitiated can follow theory and practice whether he knows anything about electricity or its application to broadcasting and reception or not. The series consists of twenty-five chapters, of which the five next will be:

Chapter XIII—The Radio Detective.  
 Chapter XIV—Tuning In.  
 Chapter XV—Working Through Interference.  
 Chapter XVI—The Power Voice of Radio.  
 Chapter XVII—Reproducers, The Finishing Touch of Radio.

**T**O OPERATE a receiving set it is necessary to intercept sufficient of the available Radio energy coming from a broadcast station, so that the detector will operate. There are several methods of doing this.

### Aerial

The most generally used means for catching Radio waves is the aerial. It enables more energy to be put into a re-

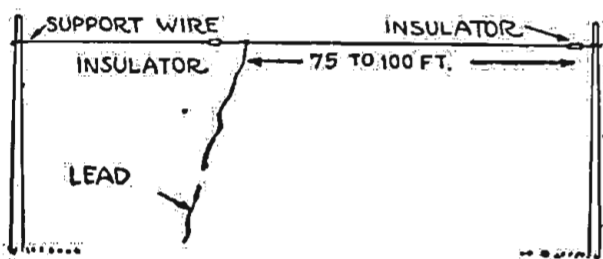

Figure 111

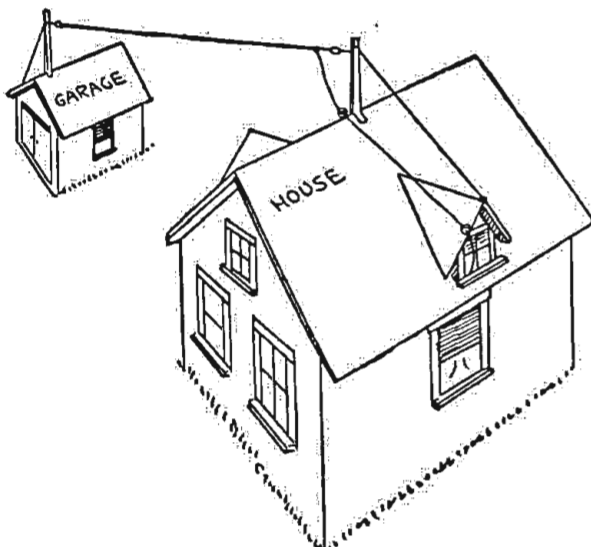

Figure 112

ceiving set than can be had from substitutes such as the loop.

Probably the best form for an aerial for broadcast reception is a straight wire about 100 feet long suspended to clear nearby objects, as indicated by Figure 111. This can be done as in Figures 112 or 113.

The aerial wire should preferably be stranded, and the wire should be put up in a substantial manner. The lead-in wire must not touch the roof and should be insulated from the building. It can be brought into a room by means of an insulated bushing in a board, as shown in Figure 115. The underwriters require lightning arrester installation and permit an indoor ground connection. There is usually very little danger from lightning caused by an aerial, and more acci-

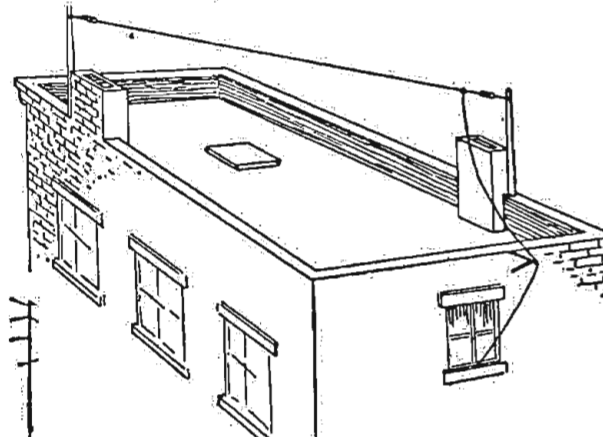

Figure 113

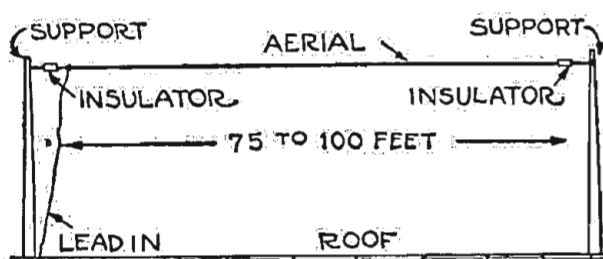

Figure 114

dents occur from careless stringing of wires which can short circuit by touching power lines.

There is no advantage in using more than one wire in receiving, but it is important to have this well insulated and clear from metal roofing, etc.

### Indoor Aerial

Where an outdoor aerial is not feasible, good results can be had with a well con-

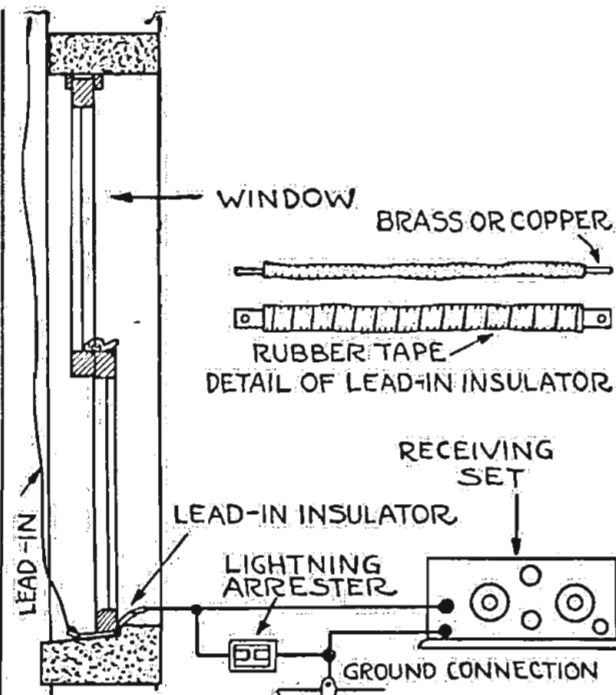

Figure 115

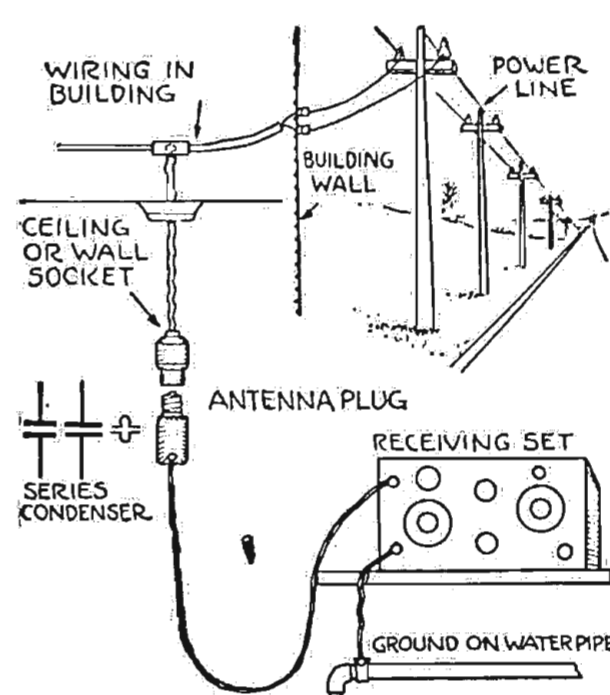

Figure 117

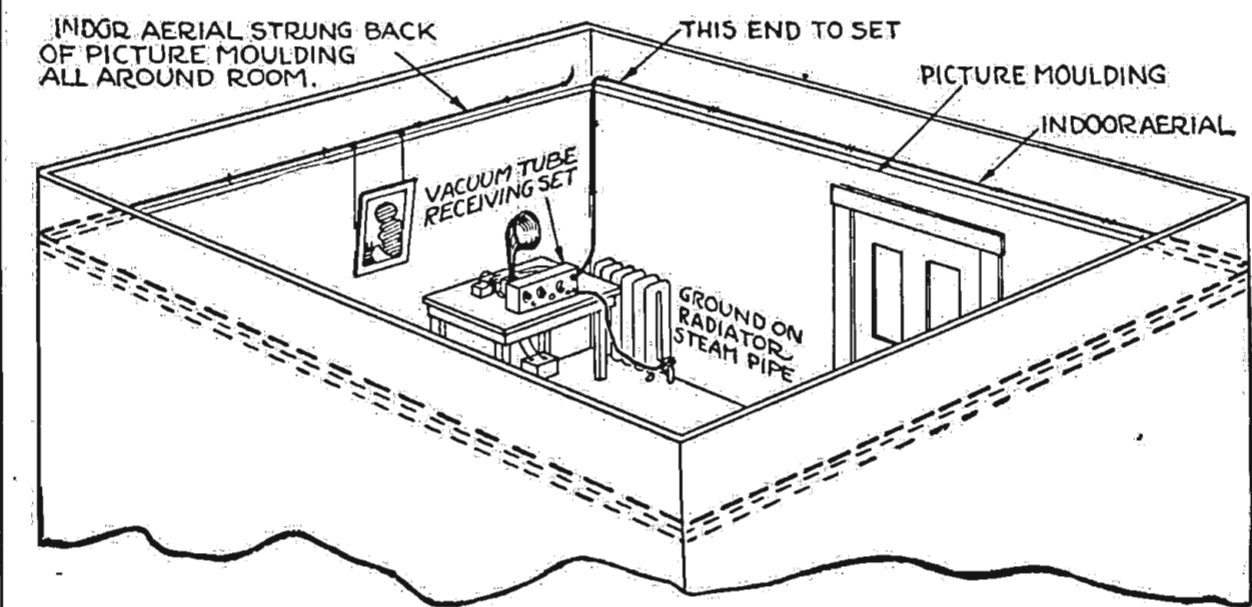

Figure 116

structed indoor aerial. Insulated wire is preferred for use in an indoor aerial, and may comprise from 25 to 100 feet concealed behind picture moulding, as illustrated in Figure 116. For novelties, there are several other types of indoor aerial. Sometimes connection is made to a buzzer or telephone line.

In many localities a so-called antenna plug gives good results. It consists of two small mica condensers to insulate the line from the receiving set, but allow Radio frequency to pass. When an antenna plug or socket attachment is used as an aerial, the wiring in the building acts as the aerial wire. Sometimes this operation is not feasible because of the kind of wiring or excessive interference from interruptions in the lighting circuit, making noise in the reproducer of the receiving set.

### Phantom Aerial

A so-called phantom aerial is a capacity effect permitting reception by use of a ground connection only. A circuit is shown in Figure 118 which gives good results on local broadcasting reception without an aerial, and sometimes over long distances. Usually the receiving set and its connections form a small condenser 2 with the ground.

### Loop

A loop will usually not pick up more energy than a phantom arrangement as in Figure 118, but has a directional effect. A loop is shown in Figure 119 and con-

sists of a coil or inductance of larger diameter than is usually employed in a receiving set. It really gets little energy compared to what an aerial can pick up, but also gets less interference and permits selection between stations of the same wave length provided they are located nearly at right angles with respect to the receiving station. Usually a loop requires one or more stages of Radio frequency amplification to boost the incoming energy so that it will operate a detector. A suitable circuit is indicated in Figure 120.

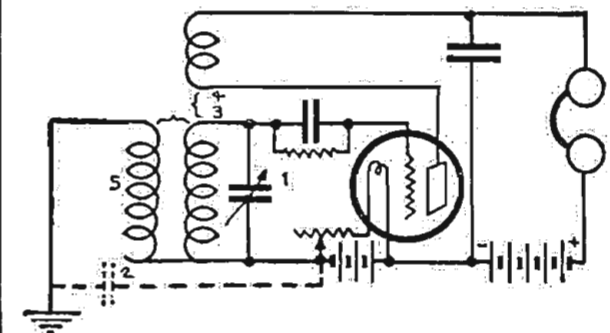

Figure 118

A loop acts like a coil. In Figure 121 there are diagrammed three broadcasting stations and two differing loops. Loop Number 1 is pointed in line with station Number 1 and is at right angles to station Number 2. Waves from station Number 1 will set up current in loop Number 1, but waves from station Number 2 will

not. The lines of force in the field sent from station Number 2 thread through but do not cut the wire in loop Number 1. Another way of regarding this directional effect is that the field of force from station Number 1 strikes the front of

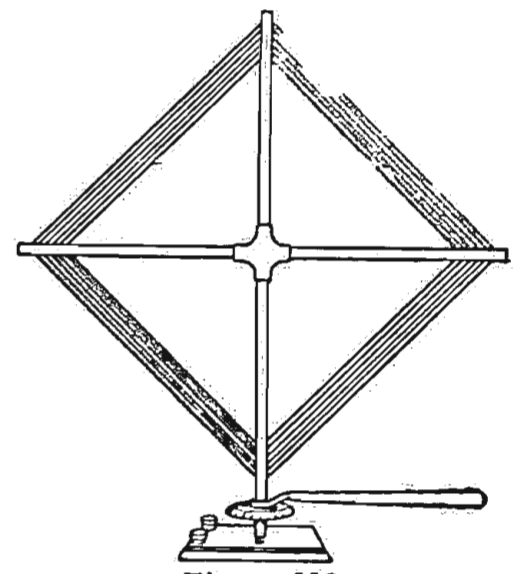

Figure 119

loop Number 1 first and the back side later, thus setting up a current in the loop, whereas station Number 2 sends out a wave front which strikes both sides of loop 1, together so that the opposed effects do not send current through the wire in the loop. A loop Number 2, however, will get no energy from station Number 1, but will get some from either station Number 2 or Number 3. For instance in the example shown, loop Number 2 can

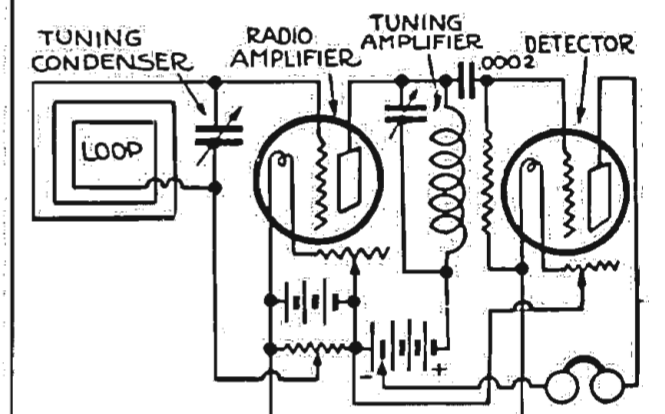

Figure 120

get energy from station Number 3, but less than if it was pointed towards station Number 3.

The effect is as if the size of this loop Number 2 was the dimension B instead of (Continued on page 10)

## THE PORTABLE AUTOMOBILE RADIO SET

Requires 2 Special Radio Frequency Transformers and Condensers

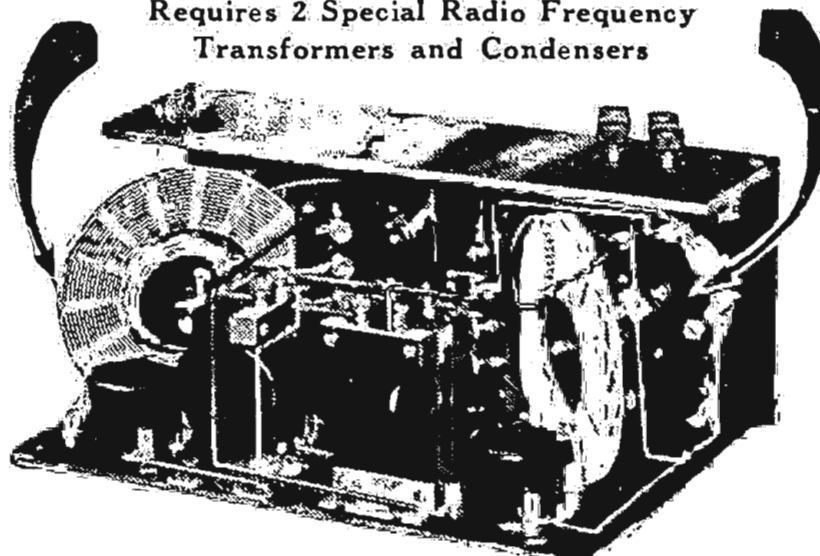

The Transformer Units Used by the Author of the Article on Page 17 are "LINCOLN BUILT" These variable transformers were designed especially for this circuit. It was necessary to build them special because ordinary transformers would not give the proper results. Each Unit consists of primary and secondary windings, with variable coupling and a .00025 variable condenser.

**PER PAIR** .....\$19.85

See your dealer first. If he cannot supply you order direct. When ordering direct send money order to avoid delay.

Send for catalog of other Lincoln Products  
**LINCOLN RADIO CORPORATION, 224 North Wells St., CHICAGO, ILL.**

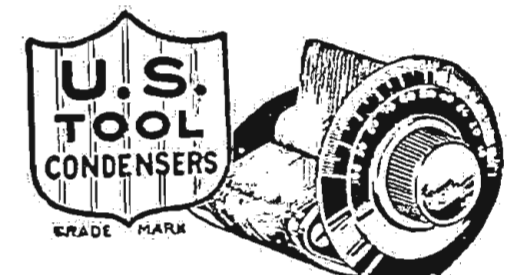

## It's Capacity that Counts!

Good condensers are designed according to microfarads, not number of plates alone. U. S. Tool Condensers are designed for correct capacity.

**100% GUARANTEED**  
**End Plates of CELERON**

**For** Superheterodyne  
 Inverse Duplex  
 Superdyne and  
 Four Circuit Tuner Circuits

Condensers of recommended capacity for all known circuits are also carried in stock by leading radio retailers.

Write for Booklet

**U. S. TOOL COMPANY, Inc.**  
 122 Mechanic Street NEWARK, N. J.

### THIRTY MINUTE A-B-C

(Continued from page 9)  
 At right angles, the station B becomes zero. If station Number 1 is a local broadcasting station of 100 meters and station Number 3 is a distant station with a 360-meter wave length, loop Number 2 can be used to

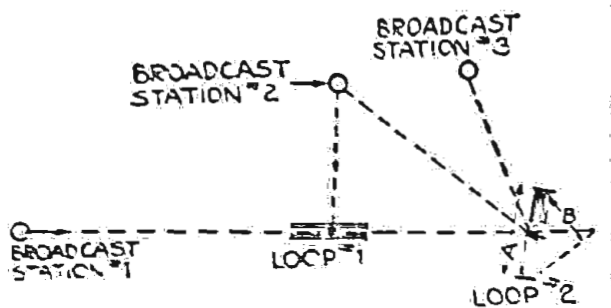

Figure 121

listen to station Number 3 without hearing station Number 1.

#### Loop Connections

Loop sets usually employ Radio frequency amplification but results can be had from a loop with a vacuum tube set on local broadcasts if suitable connections are made. Usually the loop will be connected through a series condenser to the

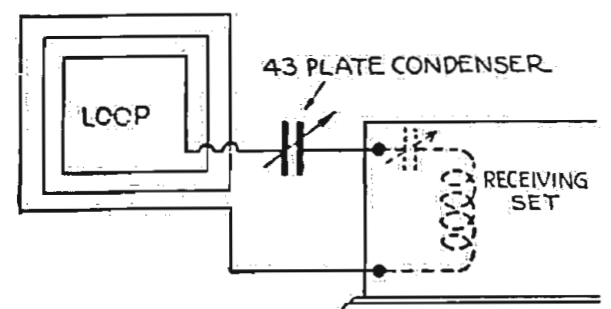

Figure 122

standard type of receiving set at its terminals marked aerial and ground. This is shown in Figure 122.

#### Non-directional Loop

A loop will not act as just explained if one end is grounded as shown by Figure 123, but this will sometimes increase the energy available for the receiving set, by phantom action, as shown in Figure 118.

Loops do not work very well inside of steel buildings, especially if the walls contain metal lath. In such cases, when they do get sufficient energy to work, the directional effect is likely to be erratic. Sometimes the loop in a steel building will work on all stations only when located in the corner of a room, cornerwise.

Except for locations within a few blocks of a broadcasting station, it is not feasible to use a loop to operate a simple crystal type set satisfactorily. A single-tube set employing regeneration will get enough energy from a loop up to a distance of ten miles from a broadcasting station. The range of a loop can be extended to reach as far as a good aerial by employing two or three stages of Radio frequency amplification.

#### Size of Loop

The larger the size of the loop the fewer the turns used for a given wave length, but bulky sized loops are unsightly so that most loops will be made from 18 inches to perhaps three or four feet in diameter. A suitable size for broadcast reception with a parallel tuning condenser of .001 mfd. maximum size, is made by supporting 100 feet of wire spaced as turns 1/2 inch apart on a framework 3 1/2 feet across. The wire used should be number 14 to 18 in size and may be insulated if desired.

In first picking up a station, a loop has

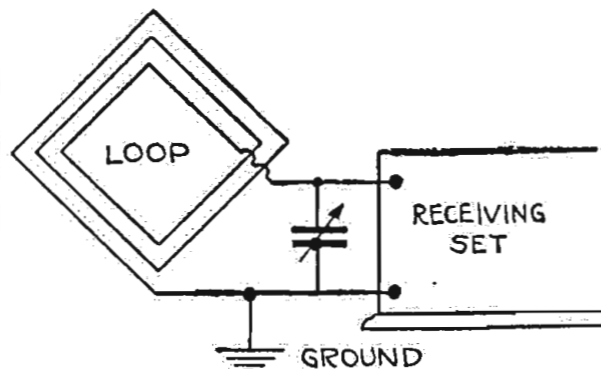

Figure 123

to be pointed approximately correctly to get enough energy to operate the set. Reference to a map showing stations will show directions, which may be checked up.

An important point to remember is that after the waves cut the wire of the aerial or loop, a Radio frequency electric current is caused in the wire and flows rapidly back and forth. Essentially the process of catching waves thus comprises the step of changing them from radiated waves to electric waves in the input circuit.

("The Radio Detective" is the mysterious title of Mr. Edelman's next chapter, to be given next week. But then its not as mysterious as it sounds, when told in the simple language of the "Thirty Minute" series. It will tell what a detector really does.—Editor's Note.)

# NOW—NATION-WIDE RECEPTION ON THREE [3] TUBES GUARANTEED

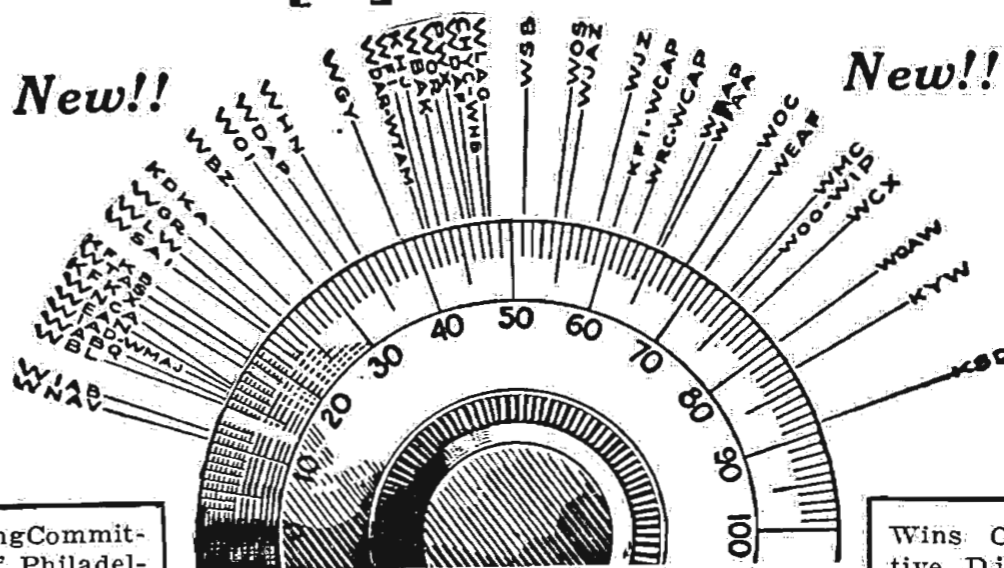

## THE NEW DE LUXE AMBASSADOR

Scoring Committee of Philadelphia, Pa., hears 49 stations from Cuba to Los Angeles sign off in 8 1/2 hours.

Wins Competitive Distant Test of "New York Evening World." The only PERFECT score.

This set completes two months building and discarding 104 sets for this now unique success. With genuine Litzendracht wire entirely winding the incomparable genuine Ambassador coil I have created a 3-circuit design without equal for quality, and priced so that the whole world may buy.

### Never Before in Radio a Success Like This

The Radio Shack is the first to discover the ideal use in this country of Litzendracht wire. With its aid the new "De Luxe Ambassador" achieves the modern ultimate of what both rankest amateur and ardent expert have sought. The amazing performance, selectivity, DX, volume on loud speaker, dwarf all description. The "dying signals" are almost unknown. Extraordinary distance reaches the detector faithfully and clear. The marvelous tuning coil even has no taps to make unsightly panel and dead-end loss. The contacts are self-cleaning, self adjusting and compensating. The whole design goes snugly behind a 7x10 panel. There are no imitations.

- KIT CONSISTS OF**
- 1 DRILLED 7 x 10 Radion Mahogany Panel, engraved in Gold.
  - 1 Genuine Ambassador Master 3-Circuit Litzendracht Tuning Coil.
  - 1 Genuine Comsco Bakelite-End Condenser.
  - 1 Triploid Mounting Socket.
  - 2 Premier Hegeloh Audio Transformers
  - 4 Brunswick Under-slung Foundation Brackets.
  - 2 Brunswick Jacks with Gold-Plated Fronts; 1 for phones; 1 for loud speaker.
  - 1 Freshman Mica Grid Condenser.
  - 1 Standard Glass-Enclosed Grid Leak.
  - 2 30-Ohm Shackton Bakelite Rheostats.
  - 2 Moulded Mahogany Dials grained to match panel.
  - 5 Lengths Professional Round Bus-Bar.
  - 1 Set of 7 Moulded Engraved Binding Posts completely mounted.
  - 1 Special Blue Print for this circuit. Not an ordinary hook-up.
- Clear picture form child can understand and make. All packed in handsome box. Complete. Only \$25.95 C. O. D.

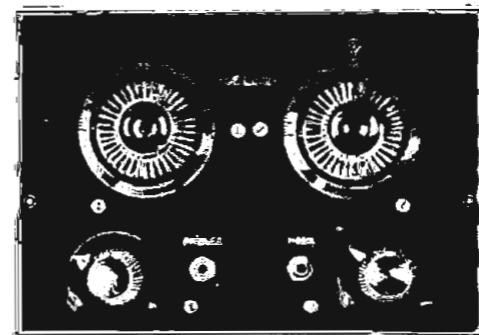

**\$25.95**

C.O.D. Send No Money

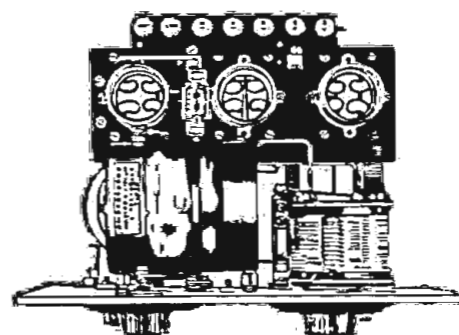

We ship C. O. D. When shipment arrives pay your postman. Then build your "De Luxe Ambassador" under our **WRITTEN MONEY-BACK GUARANTEE**. No radio knowledge or skill needed. Only 1 to 2 hours' time. You can't go wrong. Remember, you buy SAFELY from The Radio Shack, the Largest Radio Dealers in America—built upon Quality, Service and Value.

#### ACCESSORIES

- Everything needed to operate after building is listed here—
- 3 Type 201-A Tested Tubes .....\$11.70
  - 1 60-Ampere Hour Storage Battery ..... \$11.25
  - 2 45-Volt Extra Large Enco "B" Batteries ..... \$6.50
  - 1 pr. 3'00-ohm Head Phones and Cord ..... \$3.75
  - 1 Phone Plug, Double ..... \$0.90
  - 1 Antenna Equipment ..... \$1.50

Complete outfit, \$35.60 (Parts Also Sold Separately)

#### CABINET FREE

Order Building Kit and Accessory Outfit both together, and we will send Fine Mahogany Finish Cabinet FREE.

Be First in Your Town—Send Your Order Now

Largest Radio Dealers in America

## The RADIO SHACK

Executive Offices, Dept. RD531  
 55 VESEY ST., NEW YORK CITY  
 Goods shipped C.O.D.  
 Just pay the postman

EVERY ARTICLE SOLD ON WRITTEN MONEY-BACK GUARANTEE

We acknowledge all orders same day received, and ship same day or next day. Written Money-Back Guarantee with every purchase. We answer all letters we get on same day we get them. This is Radio Shack SERVICE, which continues after sale.

Mark X here ONLY if you want DL Amb. Set \$25.95

THE RADIO SHACK, Executive Offices, Dept. RD531, 55 Vesey St., New York, N. Y.

BIG FREE CIRCULAR MARK X HERE

Mark X here ONLY if you want ALL additional accessories.

Ship me C. O. D., subject to your WRITTEN Money-Back Guarantee, the goods for which I have marked X in the proper square (or squares). I will pay postman on delivery.

If you want special selections from list of accessories, attach a letter to this coupon

NAME (print plain).....

ADDRESS .....



## FREE Battery Bulletin with Station Calls

This brief treatise on battery upkeep, an up-to-date list of station call letters, and wiring diagram for basement installation of batteries is yours for the asking. Write us today.

Let us again remind you that the type AB F-F battery charger is a Triple Duty Battery Charger, charges Radio "A," Radio "B," and Auto batteries. The type 6 F-F charger charges Radio "A" and auto batteries.

Type AB, price \$20; West of the Rockies, \$22; Type 6, price \$16; West of the Rockies slightly higher.

### THE FRANCE MFG. CO.

10420 Berea Road Cleveland, Ohio

London Office 24 Maddox St.

Melbourne, Australia P. O. Box 1727

## A \$200,000.00 COMPANY STANDS SQUARELY BACK of EVERY PHONE

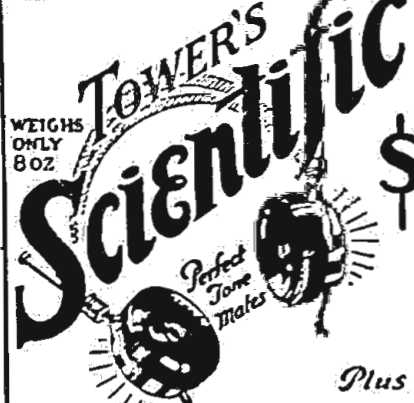

WEIGHS ONLY 8 OZ  
**Scientific**  
 Perfect Tone Mates  
**\$2.95**

WORLD'S GREATEST HEADSET VALUE

Five-Day Money-Back Guarantee If Not Fully Satisfied. We Guarantee the Scientific to be

1. One of the finest phones on the market regardless of price.
2. The most comfortable—weight only 8 oz.
3. Perfect tone mates.
4. Made of standard double pole construction (no single pole nonsense to save expense.)
5. Made of the best materials money can buy. Powerful magnets, genuine tinsel cords, aluminum cases.
6. Manufactured under ideal working conditions.

Plus a few cents postage  
**SEND NO MONEY**

Order by mail if your dealer cannot supply you and we will ship immediately. Written 5-day money back Guarantee with each set. Our next year's production schedule of two million phones UNDOUBTEDLY places us as the

WORLD'S LARGEST HEADSET MAKERS  
**THE TOWER MFG. CO.**  
 98 BROOKLINE AVE. BOSTON MASS.

# WENDELL HALL'S MARRIAGE ON AIR

## Wednesday, June 4

### Headliners of the Week

Silent night for: CKAC, KFAF, KGO, WAAW, WFAA, WFL, WGY, WIP, WMC, WOAW, WRC, WSAI.

CKAC, Montreal, Can. (Eastern, Daylight, 425), 1:45 p. m., Mount Royal Hotel classic concert; 4:30, Mount Royal Hotel dance orchestra.

KDKA, E. Pittsburgh, Pa. (Eastern, 326), 11:15 a. m., Daugherty's orchestra; 5:30 p. m., dinner concert. Pittsburgh Athletic Association orchestra; 8:30, children period, Drama League of Pittsburgh; "Happy Lil Sal Come sing"; 8, Black Cat orchestra; Marshall Ray, tenor; Ralph Kennedy, monologist.

KFAE, Pullman, Wash. (Pacific, 330), 8:30 p. m., Hawaiian music, guitar trio, Horace Trimble, Reginald Cooper, Rex Turner; "Crude Oil and Its Products," Prof. L. J. Smith.

KFI, Los Angeles, Calif. (Pacific, 469), 6:45-7:30 p. m., detective stories revealed by Detective Nick Harris; concert; 8-9, Evening Herald concert; 9-10, Examiner concert; 10-11, Hollywoodland Community orchestra; 11-12, Ambassador-Max Fischer's Coconut Grove orchestra.

KFNF, Shenandoah, Iowa (Central, 266), 12:30 p. m., farmer dinner concert; 7:30, Smith-Belding trio.

KFOA, Seattle, Wash. (Pacific, 455), 8:30 p. m., program, U. S. S. Seattle, flagship of the Pacific Fleet, Lieut. Kelly, director.

KFSG, Los Angeles, Calif. (Pacific, 278), 2:30-4:30 p. m., auditorium service, organ and choir; "Message of Faith," Almee Semple McPherson; 6:30-7:30, "Kozy Hour," program by children; "Children's story," Frances Henkle.

KGO, Oakland, Calif. (Pacific, 312), 3:00 p. m., "A Vision of What Education Might Be," Mrs. George H. Hoyt; 4-5:30, Concert orchestra of the Hotel St. Francis.

KGW, Portland, Ore. (Pacific, 492), 3:30 p. m., children's program; 8, concert; 10, dance music, George Olsen's Metropolitan orchestra; Lenore Hatter, Arthur Ewell, pianists.

KHJ, Los Angeles, Calif. (Pacific, 395), 12:30-1:15 p. m., concert; 2:30-3:30, program, courtesy of Barker Brothers, arranged by Claire Forbea Crane; 6-6:30, Art Hickman's Concert orchestra; 6:45-7:30, chil-

**T**HIS is Shrine week in Kansas City. There will be a different Shrine band on the air every night.

Wednesday night Ralph F. Seymour will explain the first real American dance, that of the Indian. This will be very interesting as Mr Seymour has made a careful study of the Indian at first hand. Wendell Hall resigns from the bachelor club, too, Wednesday at WFAF. The wedding will be rebroadcast by WCAP, WJAR and WMAQ.

WGI will hold one of the largest Radio parties ever put over the air Thursday evening at 8:00 p. m. Forty entertainers are on the bill and six announcers. It will be "at home" for the "Joy Spreader," the man of mystery of Amrad. Better hold this date open.

Those who are interested in hearing about the land of cherry blossoms and kimonos should tune in Friday for WJZ, and the talk given by Dr. R. B. Tensler who is the head of St. Luke's International Hospital in Tokio. All poets should get the

beautiful island of Porto Rico via WKAQ and listen to Evaristo Chevremont read his own poems.

Listeners in, especially the younger element, will want to tune in to the luncheon tendered the marble champions of the United States, which will be broadcast through Station WIP at 3:00 p. m., Saturday. The marble champions of every state in the Union and last year's marble champion will be present and have something to say.

Please do not miss the interesting talk to be given Saturday at WRC by our southern neighbor, Don Beltran Mathieu, the Ambassador from Chile, that long, thin country which follows the backbone of southern South America.

Monday WGY will introduce to you the compositions of Robert H. Terry. These will consist of songs, violin and piano solos.

Of course the big thing Tuesday is the Republican National convention, to go on the air from WJAX, WFAF, WJAR, WCAP, KYW, WMAQ, WGN and others.

"Citizenship in the Public Schools," Ella M. Probst; 9:15, business message; 9-10, dance program—Nankin Gate orchestra, Dick Long, dir.—

WLS, Chicago, Ill. (Central, Daylight, 345), 1-2 p. m., Josh Stanford, tenor; speaker, Jo n. C. Her; Ford Ruh and Glenn Howell; speaker, "A Review of Agricultural College Experiments," "Book Fattor"; 3:45-4:15, music, Clarence Jones and Company; speaker, "Keeping Pace," Mrs. Elizabeth K. Maurer; "The Humanitarian Side of Large Industries," Hortense Dickenson; 8:30-8, Frank Westphal orchestra; music dept. Sears Roebuck & Co.; 8-9, "Our Soil and Crop Association," Gov. Len F. Earl; "The Value of the Pig Club Work and How I Enjoyed It," Lillian A. Chabanel; "The Home Advice Work," Ruth Burk; Ferdie Plicks, cornetist; "Relation of the Manufacturer to the Farm Bureau," Henry P. Wright.

WLW, Cincinnati, O. (Central, Daylight, 309), 8 p. m., sacred song recital, Lillian Aldrich Thayer Kettler—ent School of Music, Mrs. James Langdon, Mrs. Harry Reese, Julia O'Neal, Edith Brelsted, Helen Mueller, Loretta Nagel, Margaret Boerr, Hilda Dahnman, Richard Fluke, F. Lee Pugh, Gordon Outerout, soloists; Lucille Scharringhaus, pianist; Reuben Phillips, pianist; 9:30, concert, Italian music, Sam Vora, Cesar Baroni, baritone; Angelo Bouno, mandolinist.

WMAQ, Chicago, Ill. (Central, Daylight, 447.5), 1 p. m., speeches, Chicago Association of Commerce luncheon; 2:35, Lyon & Healy program; 4:20, Items of interest to women; 4:30, pupils, Cosmopolitan School of Music; 6, Chicago theater organ; 6:30, Georgene Faulkner, story lady; 8, weekly program, Northwestern university; 8:30, Indian dances, Ralph F. Seymour; 8:40, impersonations, Catherine Lyons; 9, talks, Chicago charities; 9:15, Mr. Gladys F. Moore, Diana Tyson.

WOC, Davenport, Iowa (Central, 484), 12 m., chimes; 8:30 p. m., "Henry W. Grady's 'The New South,'" C. A. Russell; 6:30, sanderson's violin; 8, Erwin Swindell, organist; Mrs. A. P. Griggs, contralto; Harry Y. Mercer, tenor.

WOO, Philadelphia, Pa. (Eastern, Daylight, 509), 11-10 a. m., organ recital, Mary E. Vogt; 12:02 p. m., Wanamaker Crystal Tea Room Orchestra, Robert E. Golden, director; 4:45, organ recital, Mary E. Vogt; 7:30, Havana Casino orchestra, Vincent Rizzo, director; 9:00, WOO Symphony orchestra, Robert E. Golden, director.

WQQ, Kansas City, Mo. (Central, 360), 7:30-8:00 p.



The pretty maiden above, Marion M. Martin, will be heard to say "I Do" over four Radio stations, WFAF, WJAR, WCAP and WMAQ on Wednesday, June 4 at Wendell Hall's (right) wedding in the studio of WFAF. It won't be hard to "get 'em up" Thursday, June 5, when Grace Adams East plays her cornet at KGO.



dren's program. Prof. Walter Sylvester Hertzog, the Melrose School of Musical Arts; Dick Winslow, juvenile reporter; bedtime story, "Uncle John"; 8-10, Roberts' Golden State band, Harold William Roberts, director and manager; Lester Hugo Castle, baritone; Dr. Mars F. Baumgardt, lecturer; 10-11, Art Hickman's Dance orchestra.

KPO, San Francisco, Calif. (Pacific, 423), 1-2 p. m., Rudy Selger's Fairmont Hotel orchestra; 2:30-3:30, Jack Fall's Entella Cafe orchestra; 4:30-5:30, Rudy Selger's Fairmont Hotel orchestra; 5:30-6:30, Children's hour stories; "Big Brother"; 7-7:30, Rudy Selger's Fairmont Hotel orchestra; 8-11, E. Max Bradford's Versatile band.

KQV, Pittsburgh, Pa. (Eastern, Daylight, 270), 5-5:30 p. m., "Twilight tale" and Diary of Snubs Our Dog" for the kiddies; 9-10, address, Rabbi Benjamin A. Lichter; Cantor Leon Pesson, tenor; Frances Thomas Edwards, accompanist.

KSD, St. Louis, Mo. (546), 6:45 p. m., Abergh's Concert ensemble; 9, Arno Weachtel, violinist; 11, dance music—Rodemich's orchestra.

KYW, Chicago, Ill. (Central, Daylight, 536), 6:45 p. m., children's bedtime story; 6-6:30, dinner concert, Congress hotel; 8-8:58, Sherwood Music school, Ruth H. Lathrop, director; 9:45-12:30, midnight revue.

PWX, Havana, Cuba (Eastern, 400), 8:30 p. m., Municipal band of Havana, Modesto Praga, leader.

WBAH, Minneapolis, Minn. (Central, 417), 12:30-1:30 p. m., Dick Long's Trio and soloist; 7:00-7:30 p. m., lecture hour, Dr. J. W. Holland.

WBAP, Fort Worth, Texas (Central, 476), 9:30-10:45 p. m., concert, Original Green River Orchestra of Wichita Falls, Texas.

WBAY, Columbus, Ohio (Eastern, 390), 12 m., piano music, Ila Lombach Owens.

WBRR, New York, N. Y. (Eastern, Daylight, 273), 8 p. m., Marie Kalla, soprano; Matilda Kridel, pianist; 8:20, "What is your credit at the Bank of Health," Dr. Louis R. Welzmler; 8:30, music; 8:35, Bible story for young people, Mrs. J. F. Stephenson.

WBZ, Springfield, Mass. (Eastern, Daylight, 337), 6 p. m., dinner concert, WBZ trio; 7-10, "Road Conditions in New England"; 7:30, bedtime story for the kiddies; 7:40, WBZ trio; Gertrude Clifford, soprano; Mrs. Eleanor T. LaZazzera, accompanist; 8:30, St. Clair Wilson, pianist; Joseph Lopes, baritone; 9:30, D. Lee Chestnut, trombonist; Alice N. Cook, organist; 10:30, Sid Reinherz, pianist; 11:30, dance, Leo Roisman and his orchestra; 12, Dunham quartet.

WCAE, Pittsburgh, Pa. (Eastern, Daylight, 462), 3 p. m., Fred Rosenfeld, pianist; 6:30, dinner concert; William F. an hotel; 7:30, Sunshing-Girl; 7:45, Joe Jacobson, character singer; 8:30, "My Mountain Allegheny

WX, Detroit, Mich. (Eastern, 517), 4:15 p. m., Thies-Reichman's Oriole Terrace orchestra; 8:00, dinner concert; 7:00, concert, artist pupils, Prof. Alfred Blackman; dance music, Temple Ball Room orchestra.

WDAF, Kansas City, Mo. (Central, 411), 3:30-4:30 p. m., Geary's Missourians; 6-7, School of the Air, piano tuning-in number, Duo-Art; address, speaker from the Health Conservation Association; the Tell-Me-a-Story Lady; music, Fritz Hanteln's Trianon Ensemble; 8-9:15, program arranged and presented by entertainers from Shrine Convention; 11:45-1 a. m., Nighthawk Frolic, Plantation Players from the Hotel Muebach.

WDAR, Philadelphia, Pa. (Eastern, Daylight, 395), 11:45 a. m., Daily Almanac; 12:02 p. m., organ recital, Stanley Theater; 12:30, Arcadia Cafe Concert orchestra; 2, Arcadia Cafe Concert orchestra; 7:30, Dream Daddy's bedtime stories; 10, Howard Lenlin's Arcadia Cafe Dance orchestra.

WFAF, New York, N. Y. (Eastern, Daylight, 492), 11-11:15 a. m., young mothers' program; 11:15-11:30, address, President Nicholas Murray Butler; 4:00-4:30 p. m., James A. N. Caruso and His Nassau Country Club orchestra; 4:30-4:45, Adelino G. Cross; 4:45-5:00, George W. Davis, tenor; 5:30-6:00, stories and songs for children; 6:00-7:00, dinner music, Hotel Waldorf Astoria; 7:00-7:30, Synagogue services; 7:30-7:40, United Clear Stores sport talk, Thornton Fisher; 8:00-8:15, George O'Brien, tenor; 8:15-8:30, talk, auspices of American Agriculturist; 8:30-9, lecture on Psychology, Gardner Murphy; 9:00-9:10, talk, American Bond and Mortgage Co.; 9:10-9:20, Gold Dust Twins; 9:30-9:40, Chieftan orchestra; 9:40-10:30, Radio Wedding of Wendell Hall, the Eveready Red Head, and Marian M. Martin.

WEO, Columbus, O. (Eastern, 360), 1:30 p. m., garden talk, member Ohio State university faculty; 4 p. m., agricultural lecture, faculty member; music, University talent.

WEAY, Houston, Texas (Central, 360), 12-1 p. m., Rice Hotel orchestra; 6-7, Rice Hotel orchestra.

WFAA, Dallas, Texas (Central, 476), 10:30-12:30 p. m., address, Hon. Thomas B. Marshall, at Austin College, Sherman, Texas; 12:30-1, musical recital, popular entertainers.

WFI, Philadelphia, Pa. (Eastern, Daylight, 395), 1 p. m., Meyer Davis Bellevue Stratford Concert orchestra; 3:00, Mary Bray, contralto; Loretta Kerk, accompanist; 6, Sunny Jim, the Kiddies' Pal; 6:30, Meyer Davis Bellevue Stratford Concert orchestra.

WGI, Medford Hills, Mass. (Eastern, Daylight, 360), 7 p. m., meeting of the Big Brother club; 7:30, "Health-o-gram," Rev. B. M. Heald; drama, Gladys R. Brigham, director; "The Cushman Cop," "Gilt for Tat," Martha Elsie Fitzgerald; popular song hits, Don Ramsey.

WGR, B. are orceit 21 one time.

Radio Dealers' Musical program; 6:30-7:30, Vincent Lopez Hotel Statler orchestra; 9:00-10, concert, direction of A. A. Van De Mark for the Buffalo Radio-phones Corporation; 10-11, concert, direction of X. J. Erisman for H-O Cereal Company; 11:30, Vincent Lopez Hotel Statler orchestra.

WGY, Schenectady, N. Y. (Eastern, 380), 5:30 p. m., "Adventure Story," Youth's Companion.

WHA, Madison, Wis. (Central, 360), 7:30 p. m., "The University of Wisconsin Summer Session in the Four Lakes Country," Dean Scott H. Goodnight.

WHAS, Louisville, Ky. (Central, 400), 4-5 p. m., Alamo theater orchestra; Walnut Theater orchestra; 7:30-9, concert, Mrs. Jane W. Murrell, director; Readings; Mrs. Cordia Greer Petrie; Tekla Mncr, pianist.

WHB, Kansas City, Mo. (Central, 411), 2:00-3:00 p. m., Ladies' Hour Program, visiting Shrine band; 7:00-8:00, Shrine entertainers; talks, speakers from the Shrine Convention; announcements to Shriners concerning assembling spots and parade position.

WHN, New York, N. Y. (Eastern, Daylight, 360), 2:15-2:30 p. m., Grace Haley, soprano; 2:30-2:45, Mae Goefrey, contralto; 3:45-4:15, Tom Rellly's Kings of Syncopation; 7:30-8:00, Mall Hallett's Roseland orchestra; 8:00-8:10, Eva Dunn, pianist; 8:10-8:30, John Paluhl's Hawaiian orchestra; 8:30-8:50, Union of Orthodox Jewish Congregation of America; 8:50-9:00, AGEN Macpeak, soprano; 9:15-10:00, Dan Gregory's Dancing Carnival orchestra; 10:00-10:30, M. Witmark's Black & White program.

WIP, Philadelphia, Pa. (Eastern, Daylight, 509), 3 p. m., artist recital, Dorothy Bringham, pianist; Emma Thompson Mills, soprano; Helen Seull Mankay, contralto; Emille Loeben, accompanist; 6:05, St. James Hotel Duo orchestra; 7, Uncle Wip's bedtime stories.

WJZ, New York, N. Y. (Eastern, Daylight, 455), 1 p. m., Schrafft's Tea Room orchestra; 3:45, Howard Johnson, pianist; 4, fashion talk, Eleanor Gunn; 4:30, Hotel Commodore Stringed ensemble; 7, "Story for Boys and Girls," Florence S. Vincent; 7:30, Irving Selzer's Cafe Boulevard orchestra; 8:30, popular songs, Rose Fowler, William J. McKenna; 9, "Golf," Inna Brown; 9:30, Mrs. Emil Coleman, soprano; 10, Anna Pinto, harpist; 10:30, Emil Coleman's Trocadero orchestra.

WKAQ, San Juan, P. R. (Intercolonial, 360), 8-10 p. m., Municipal band of San Juan, Jesus Figueroa, conductor.

WLAG, Minneapolis-St. Paul, Minn. (Central, 417), 10:45 a. m., household hints; 11:35-12:00 m., surprise program; 2:10-2:30 p. m., "The Woman Reautiful," Maudo Hart; 2:10-4, daylight concert; 4-4:30, "The Children's Stories," Alpha Sweeney Radio

m., music, the Liberty Theater; Liberty Theater orchestra; feature numbers.

WOB, Newark, N. J. (Eastern, Daylight, 405), 2:30-2:45 p. m., "Roses," Robert Pyle; 2:45-3, Mme. Haille De Luca, mezzo soprano; 3:00-3:15, orchestra of S. S. George Washington; 3:15-3:30, Frank Nemet, tenor; 3:30-3:45, Mme. Haille De Luca; 3:45-4:00, Frank Nemet; 6:15-7:00, Baudistel's Olympic Park orchestra; 8:00-8:15, "Under the Spreading Chestnut," G. A. Falzer; 8:15-8:30, joint recital, Frank Munn, tenor; Robert H. McConnell, baritone; 8:45-9:00, "Alaska," James Albert Wiles; 9-9:15, talk, Dr. Carl W. Ackley; 9:15-9:30, Frank Munn, Robert H. McConnell; 9:45-11, Leo Friedman Entertainers; augmented by the Pennington Record orchestra.

WOS, Jefferson City, Mo. (Central, 440.9), 8 p. m., "Control of Sheep Parasites," Dr. J. W. Connaway; 8:20, Old Time String trio.

WRC, Washington, D. C. (Eastern, 469), 3 p. m., fashion developments, Women's Wear; 3:10, songs; 3:25, report, National Conference board; 3:30, songs; 3:50, current topics, editor of The Outlook; stories for children, Peggy Albion; 6:15, talk, auspices Smithsonian institute.

WSB, Atlanta, Ga. (Central, 429), 10:45 p. m., Dixie-Land Serenaders.

WTAM, Cleveland, Ohio (Eastern, 390), 8 p. m., Plain Dealer program, "Akron (Ohio) Night," Talent, Musical clubs of Akron; WTAM program; piano solos, Prof. Bernard Melzak; reading, Mrs. Donald Smith; vocal solos, Palmetto Ruffo, tenor; violin solos, Hymler Baron.

WVJ, Detroit, Mich. (Eastern, 517), 8 a. m., setting-up exercises, R. J. Horton; 12 m., Goldkette's orchestra; 3 p. m., Detroit News orchestra; 8:30 p. m., Detroit News orchestra; vocal numbers, Francis Firth and pupils.

## Thursday, June 5

Silent night for: KFAE, KFOA, KQV, KSD, WCAP, WDAR, WGR, WOO, WOS.

CKAC, Montreal, Can. (Eastern, Daylight, 425), 8:30 p. m., Canadian National Railway Entertainers; Lino Monte, tenor; Berth Suave, pianist; Mrs. H. S. Hall, soprano; Ed Quinlan, baritone; Madame Izzard, violinist; "Don't Try to Beat the Train," William Booth.

CKY, Winnipeg, Can. (Central, 450), 8 p. m., Canadian National Railway program.

...and instrument... (Continued on page 10)

**STA-RITE BATTERY CO.**  
LOUISVILLE, KY.

Department 5







roadcast

IZ, WLAG,  
OC, WOR,

W, WBAI,  
WFI, WGI,  
AW, WOC,

A, KFAE,  
AO, WFAA,  
LAG, WOC,  
A, KFAT,  
AE, WDAF,  
WGI, WGY,  
IZ, WLAG,  
OR, WRC,

Daylight, 360), 7  
... Louis B  
... R Sabuto S  
... baritone, 2 4  
... 4:45-4  
... leader, 4:15-4  
... baritone; Robert  
... boy soprano; 5-  
... Laboratory of M  
... Royal P...  
... enor; 8:20-9, Ver  
... izis, leader; 9-9  
... 9:15-9:45, J n  
... la Serenaders; 9 4  
... Fitzpatrick Bros  
... Jimmy Doyle, ten  
... 10:45-11, Arr  
... Danzer, soprano;  
... no  
Daylight, 509), 1 p  
... 6:05, Harold Len  
... 7, Uncle Wip  
... 8:15, Cecil  
... Hol...  
... Kinne, condu  
... Glee Club, Jeanette  
... Harold Lennard's

390), Midnig  
... Solos, duo s  
... Plectrum orchestra  
... arano; Ruth S  
... e South-M...  
... Lee  
... saxophone; Ed  
... Webb M  
... duets, B  
... ban) sol  
... Jazz, A...  
... Whipple; ex  
... Cobby H  
... lo and his R

Daylight, 455), 7  
... 7:20, W  
... Lila H  
... of Broadcas  
... en Davis, ban  
... exerci...  
... Venice or he

417),  
-12 m.  
es nec  
Golden

na'l i  
er tri:  
peakers  
ham; 9,  
plant

chimes:  
H; 3:45,  
Schol

), 11 a.  
D...  
Jert E.  
Vogt.  
p. m.  
alter L.  
Western  
school (f

30-2 45  
Brooker.  
s; 3:15-  
15-7:45  
Brandoff  
Nicolai  
ature of  
Oulok-  
Thomas,  
a Chal  
Edward  
Caffrey.

m. chil  
ing mu  
3:30, talk  
Hazel C.  
Mathier.  
U. S.

10 p. m.  
20, facul  
y  
chestra.  
8-9 p. m., Geor  
Band; 10:45, Ba k

WTAM, Cleveland, Ohio (Eastern, 390), 9 p. m., Sat-  
urday evening dance, WTAM Dance orchestra, Ev  
Jones, director; Mona Gray Malting, soprano.  
WJZ, Detroit, Mich. (Eastern, 517), 8 a. m., setting-  
exercises, R. J. Horton; 3 p. m., Detroit News orche-  
tra.

Sunday June 8

Silent night for: CKAC, KFAE, KFAF, KFDA, KGO,  
KSD, WAAW, WBAH, WDAF, WDAR, WGR, WNN,  
WIP, WDD.  
CKAC, Montreal, Can. (Eastern, Daylight, 425), 4:30  
p. m., studio concert.  
KFI, Los Angeles, Calif. (Pacific, 469), 10-10:45 a. m.,  
L. A. Church Federation service; 4-5 p. m., matinee  
vesper concert; 6:45-7:30 Russian music, Althea  
Olliver, soprano; 8-9, Ambassador Hotel concert; 9-10,  
Examiner concert; 10-11, De Luxe concert.  
KFNF, Shenandoah, Iowa (Central, 266), 3 p. m.,  
church services; 6:30, regular sacred song service.  
KFSG, Los Angeles, Calif. (Pacific, 278), 10:30-12:30  
p. m., organ, chimes and choir; sermon, Aimee Semple  
McPherson; 2:30-4:30 p. m., choir; Temple band; vocal  
and instrumental numbers; address, Aimee  
(Continued on page 11)

WEAY, Houston, Texas (Central, 360), 12-1 p. m., Rice  
hotel orchestra; 2:30-3:30, Studio concert; 6-7, Rice  
Hotel orchestra; 8:30-10, McMillan's dance program.  
WFAA, Dallas, Texas (Central, 476), 12:30-1 p. m.,  
address, C. A. Jay; 3:30-4, popular and favorite  
music Old Fiddlers Charles Cornett, director; 8:30-  
9:30, recital, Bolcanto Male Quartet; 11-12, dance  
music, Adolphus Hotel orchestra, Lawrence Morrell,  
director.  
WFI, Philadelphia, Pa. (Eastern, Daylight, 395), 1 p.  
m., Meyer Davis Concert orchestra; 3, Dorothy Fox,  
soprano; 4, Ted Baxter's Novelty orchestra; 6, Sunny  
Jim, the Kiddies' Pal; 6:30, Meyer Davis Concert  
orchestra; 8, WSAW trio from Allentown; 10:15, Charlie  
Kerr's Symphonic Dance orchestra.  
WGI, Medford, Hillside, Mass. (Eastern, Daylight, 360),  
7 p. m., meeting of the Avard Big Brother club;  
7:30, talk on current events, David M. Cheney; 7:45,  
popular song hits, C. P. Keene; 8, musicale.  
WGR, Buffalo, N. Y. (Eastern, Daylight, 319), 12:30-1  
p. m., organ, George Albert Bouchard; 2:30-4, The  
Radio Dealers' Musical Program.  
WGY, Schenectady, N. Y. (Eastern, 380), 8:30 p. m.,  
danco music, orchestra of Hotel Ten Eyck.  
WHAS, Louisville, Ky. (Central, 400), 4-5 p. m., Wal-  
nut Theater orchestra; Alamo Theater orchestra; 7:30-9,  
Sylvian trio, Jontie Elizabeth Stoll, violinist; Myri  
Christman, flutist; Evelyn Kaiser, pianist; fifteen-min-  
ute musical specialty, Clem E. A. Ellert.  
Sweeney Radio  
(11), 2-3 p. m.

WRU, Washington, D. C. (Eastern, 469), 3 p. m., fash-  
ion developments, Women's Wear; 3:10, Arthur Mc-  
Cormick, baritone; 3:20, "Beauty and Personality,"  
Elsie Pierce; 3:25, current topics, editor "The Re-  
view of Reviews"; 3:35, Ethel Grant, pianist; 4,  
songs; 6, stories and songs for children, Peggy Al-  
bion, Mary Glenn.  
WSB, Atlanta, Ga. (Central, 429), 8-9 p. m., concert  
honoring Cincinnati Conventin, Junior Chamber of Com-  
merce; 10:45, Biltmore Hotel orchestra.  
WWJ, Detroit, Mich. (Eastern, 517), 8 a. m., setting-  
up exercises, R. J. Horton; 12 m., Goldkette's or-  
chestra; 3 p. m., Detroit News orchestra; 8:30, De-  
troit News orchestra; Anne Campbell, Detroit News  
poet; Gene LaPlantie, soprano; Judge Victor Le  
Blanc, baritone.

Saturday, June 7

Silent night for: CKAC, KFNF, KFAE, KFDA, KQV,  
WAAW, WBAP, WDAR, WGR, WLW, WDD,  
WDS, WWJ.  
CKAC, Montreal, Can. (Eastern, Daylight, 425), 7 p.  
m., kiddies' stories in French and English; 7:30, Mount  
Royal Festival orchestra; Napoleon Bonaparte  
concert.

WHAS, Louisville, Ky. (Central, 400), 4-5 p. m., Ala-  
mo Theater orchestra; Walnut Theater orchestra;  
7:30-9, concert, auspices William K. Fries; Arthur  
Findling, baritone.  
WHB, Kansas City, Mo. (Central, 411), 3-3:30 p. m.,  
ladies' hour program, direction Geo. Parrish; an-  
nouncements to departing Shriners on the eve of the  
Shrine convention; 7-8, popular dance music, Sweeney  
Radio orchestra.  
WHK, Cleveland, Ohio (Eastern, 283), 9 p. m., concert  
program arranged, Wm. Taylor Son & Co., Louis  
Rich and his orchestra.  
WHN, New York, N. Y. (Eastern, Daylight, 360), 2:15-  
2:45 p. m., Snappy quartette; 3-3:15, L. Wolfe Gilbert,  
songs; 3:45-4:15, Original Indiana Five—Tom Norton,  
leader; 5:15-5:30, Andrew Pendleton, entertainer; 9:30-  
10, Hotel Carlton Terrace orchestra; 10:15-10:30, Jew-  
ish cornet solos, Art Schryer; 11:30-12, S. S. City  
of Seattle, Atlantic City Line orchestra.  
WIP, Philadelphia, Pa. (Eastern, Daylight, 509), 3 p.  
m., recital, artist students, Ada Turner Kurtz studios,  
Mildred Kay, soprano; Mrs. Aisic May Pollard, so-  
prano; Elnna Aberle, soprano; Arnold V. Bent, tenor;  
4, "Light, the Kitchen Helper," H. A. Parsons; 4:15,  
Mah Jongg lesson, Mr. and Mrs. Wei Lum Wong; 6:05,  
Jordan-Lewis Dance orchestra; 7, Uncle Wip's bed-  
time stories.  
WJY, New York, N. Y. (Eastern, Daylight, 405), 7:30  
p. m., "Financial Independence at 30," Rolph Rush-  
more; 7:45, Super-A. Leach, baritone; 8:45, "Bull  
Head," E. Conder; 9, People's chorus; 9:45, Ber-  
mudez.  
Long similar lit., Dr. W. J. Monat.  
struc... Daylight, 455,  
one or two others to clear up stray

STA-RITE BATTERY CO.

LOUISVILLE, K...

Department 5

Sunday, June 8

TABLE FOR MAKING TIME TRANSITIONS

Continued from page 13)
concert of vocal numbers.
... concert of vocal numbers.
... concert of vocal numbers.

WBAF, Fort Worth, Texas (Central, 476), 11 a. m.-12:15 p. m. church services, First Christian Church.
WCAE, Pittsburgh, Pa. (Eastern, Daylight, 462), 3 p. m. radio church services; 6:30, dinner.

WFAA, Dallas Texas (Central, 476), 6-7 p. m. Radio B. L. class, Dr. William M. Anderson; 7:45-9, roof garden service, City Temple Presbyterian church.
WFL, Philadelphia, Pa. (Eastern, Daylight, 395), 7:30 p. m. services, Arch street Presbyterian church.

WIP, Philadelphia, Pa. (Eastern, Daylight, 509), 4:30 p. m. services, Dr. W. B. Wilkinson; 7:30, services, Holy Trinity church.
WJ, Philadelphia, Pa. (Eastern, Daylight, 395), 7:30 p. m. services, Arch street Presbyterian church.

Monday, June 9

Silent night for: CKAC, KFNF, KFDA, KYW, WFI, WHAS, WIP, WLS, WMAQ, WRC, WSAI.
CKAC, Montreal, Can. (Eastern, Daylight, 425), 1:45 p. m. Mount Royal Hotel luncheon concert; 4:20, Mount Royal Hotel concert.

Table for making time transitions with columns for Eastern Daylight Saving Time, Eastern or Central Daylight Saving Time, Central or Mountain Daylight Saving Time, Mountain or Pacific Daylight Saving Time, and Pacific Time. Rows show corresponding times for each 15-minute interval.

HOW TO USE. If a station is giving a program at 8 o'clock Mountain daylight saving time and you wish to find what this is equivalent to in Eastern time, find 8 o'clock in the third or Mountain daylight saving row. Then immediately above it in the same vertical column will be found the figure 9 in the Eastern time row. This indicates that the program would be heard at 9 o'clock Eastern time.

WCAE, Pittsburgh, Pa. (Eastern, Daylight, 462), 4:30 p. m., Sunshine Girl; 6:30, dinner concert, William Penn hotel; 7:30, Uncle Kaybee; 8:30, Sequilla club of Pittsburgh; 11, late show.
WCB, Zion, Ill. (Central, 345), 8 p. m., Mrs. John D. Thomas, soprano; Vocal trio; Miriam Hollingshead, flutist; Mrs. L. J. Fire, violinist; Mrs. Carl Huth, harpist; Mark Whiteside, haritone; Mrs. Hulda Klammer, reader.

WDAF, Kansas City, Mo. (Central, 411), 3:30-4:30 p. m., music, the Star's Radio Trio; 6-7, the School of the Air, piano tuning-in number, the Duo-Art; address, speaker from the University of Kansas, Lawrence, Kans.; the Tell-Me-a-Story Lady, weekly "request" night for bedtime stories; music, Fritz Hanlein's Trianon ensemble; 8-9:15, program by the Star's Radio orchestra and the WDAF minstrels; 11:45-1 a. m., Nighthawk Frolic, the Plantation Players from the Hotel Muehlbach.
WDR, Philadelphia, Pa. (Eastern, Daylight, 395), 11:45 a. m. Daily Almanac; 12:02 p. m., organ recital, Stanley theater; 12:30, Arcadia Cafe Concert orchestra; 2, Arcadia Cafe Concert orchestra; 7:30, Dream Daddy's bedtime stories; 8, intimate talk on flowers, Edwin Matthews; Dorothy Powers, songs; 10, Howard Lanin's Arcadia Cafe dance orchestra.

WFAA, Dallas Texas (Central, 476), 12:30-1 p. m., address, "Texas Summer-time Tonicizing Toning," C. E. Osborne, physical director, Y. M. C. A.; 8:30-9:30, dance music, Lone Star Five orchestra.
WFL, Philadelphia, Pa. (Eastern, Daylight, 395), 1 p. m., Meyer Davis Bellevue-Stratford Concert orchestra; 6, Sunny Jim, the Kiddies' Pal; 6:30, Meyer Davis Bellevue-Stratford Concert orchestra.
WGR, Buffalo, N. Y. (Eastern, Daylight, 319), 12:30-1 p. m., organ, George Albert Bouchard; 2:30-4, The Radio Dealers' Musical program; 6:30-7:30, Vincent Lopez Hotel Statler orchestra; 9-10, mixed concert program, joint direction of Rev. E. A. Leichter, baritone, "The Singing Preacher," and W. H. F. Tenny, author of "Songs of the North"; 10-11, concert, direction of J. F. Chipman and Gertrude Hutchinson for the Chipman Studios; 11:30, Vincent Lopez Hotel Statler orchestra.

WIP, Philadelphia, Pa. (Eastern, Daylight, 509), 4 p. m., Mah Jong Lesson, Mr. and Mrs. Wei Lun Wong; 6:05, St. James Hotel Dinner Dance orchestra; 7, Uncle Wip's bedtime stories.
WLV, Cincinnati, O. (Central, Daylight, 309), 8 p. m., Armo band, Frank Simon, director; talk, Bob Roberts.
WMAQ, Chicago, Ill. (Central, Daylight, 447.5), 4:30 p. m., pupils, Mrs. Charlotte Clowes.
WMAW, Omaha, Neb. (Central, 360), 6 p. m., speakers' hour; 6:30, dinner program, Randall's Royal orchestra; 7:45, program, Henry G. Cox.
WOC, Davenport, Iowa (Central, 484), 12 m., chimes; 3:30, lecture, 5:45, chimes; 0:30, aandman's visit; 8, musical program; 10, music.
WOD, Philadelphia, Pa. (Eastern, Daylight, 509), 11 a. m., organ recital, Mary E. Vogt; 12:02 p. m., Wanamaker Crystal Tea Room orchestra, Robert E. Golden, director; 4:45, organ recital, Mary E. Vogt; 7:30, Hotel Adelphia Bureau of Health; 8, health talk, Philadelphia Bureau of Health; 9:10, Fox Theater Grand orchestra; 10:30, dance music, Hotel Sylvania orchestra, Vincent Rizzo, director.
WOQ, Kansas City, Mo. (Central, 360), 7:30-8 p. m., music, Liberty theater; pipe organ, Grand Avenue temple.
WDS, Jefferson City, Mo. (Central, 440.9), 8 p. m., "Tragedies of the Missouri Penitentiary," J. Kelly Pool; Missouri State Prison band; Harry M. Snodgrass, pianist.
WDC, Washington, D. C. (Eastern, 469), 3 p. m., fashion development; 8:25, current topics; 9:25, current topics; 10:25, current topics; 11:25, current topics; 12:25, current topics.

ing Today," Mrs. William A. DuPuy; 4, songs, 4:10, book review, auspices League of American Penwomen; 6, stories for children, Peggy Albion; 6:20, talk on education, auspices National Educational association.
WSA, Cincinnati, D. (Central, Daylight, 309), 8:30-10 p. m., band and orchestra concert.
WSB, Atlanta, Ga. (Central, 429), 8-9 p. m., North Carolina concert; 10:45, Warner's Seven Aces.
WWJ, Detroit, Mich. (Eastern, 517), 8 a. m., setting-up exercises, R. J. Horton; 9:30, talk, woman's editor, Detroit Daily News; 3 p. m., Detroit News orchestra; 7, Detroit News orchestra.
WVA, Kansas City, Mo. (Central, 360), 8:00-9:30 p. m., program of classical music, popular artists of WOQ.
WRC, Washington, D. C. (Eastern, 469), 6 p. m., children's stories and songs, Peggy Albion, Marguerite Meakin; 8, Katherine F. Cullen, pianist; 8:30, Elizabeth Davon, soprano; 9, The Political Situation in Washington Tonight, Frederick W. Wile; 9:15, Sidney Seidenman's Shoreham Hotel orchestra.
WSB, Atlanta, Ga. (Central, 429), 8-9 p. m., violin recital; 10:45, Biltmore Hotel orchestra.
WWJ, Detroit, Mich. (Eastern, 517), 8:00 a. m., setting-up exercises, R. J. Horton; 9:45, Fred Shaw, pianist and songster; 3 p. m., Detroit News orchestra; 7:00, Detroit News orchestra.

WVA, Kansas City, Mo. (Central, 360), 8:00-9:30 p. m., program of classical music, popular artists of WOQ.
WRC, Washington, D. C. (Eastern, 469), 6 p. m., children's stories and songs, Peggy Albion, Marguerite Meakin; 8, Katherine F. Cullen, pianist; 8:30, Elizabeth Davon, soprano; 9, The Political Situation in Washington Tonight, Frederick W. Wile; 9:15, Sidney Seidenman's Shoreham Hotel orchestra.
WSB, Atlanta, Ga. (Central, 429), 8-9 p. m., violin recital; 10:45, Biltmore Hotel orchestra.
WWJ, Detroit, Mich. (Eastern, 517), 8:00 a. m., setting-up exercises, R. J. Horton; 9:45, Fred Shaw, pianist and songster; 3 p. m., Detroit News orchestra; 7:00, Detroit News orchestra.

WVA, Kansas City, Mo. (Central, 360), 8:00-9:30 p. m., program of classical music, popular artists of WOQ.
WRC, Washington, D. C. (Eastern, 469), 6 p. m., children's stories and songs, Peggy Albion, Marguerite Meakin; 8, Katherine F. Cullen, pianist; 8:30, Elizabeth Davon, soprano; 9, The Political Situation in Washington Tonight, Frederick W. Wile; 9:15, Sidney Seidenman's Shoreham Hotel orchestra.
WSB, Atlanta, Ga. (Central, 429), 8-9 p. m., violin recital; 10:45, Biltmore Hotel orchestra.
WWJ, Detroit, Mich. (Eastern, 517), 8:00 a. m., setting-up exercises, R. J. Horton; 9:45, Fred Shaw, pianist and songster; 3 p. m., Detroit News orchestra; 7:00, Detroit News orchestra.

WVA, Kansas City, Mo. (Central, 360), 8:00-9:30 p. m., program of classical music, popular artists of WOQ.
WRC, Washington, D. C. (Eastern, 469), 6 p. m., children's stories and songs, Peggy Albion, Marguerite Meakin; 8, Katherine F. Cullen, pianist; 8:30, Elizabeth Davon, soprano; 9, The Political Situation in Washington Tonight, Frederick W. Wile; 9:15, Sidney Seidenman's Shoreham Hotel orchestra.
WSB, Atlanta, Ga. (Central, 429), 8-9 p. m., violin recital; 10:45, Biltmore Hotel orchestra.
WWJ, Detroit, Mich. (Eastern, 517), 8:00 a. m., setting-up exercises, R. J. Horton; 9:45, Fred Shaw, pianist and songster; 3 p. m., Detroit News orchestra; 7:00, Detroit News orchestra.

light concert; 4-4:30, magazine reading; 5:30-6, children's stories; 7:30, J. Cooperman; 6-6:15, "Sport Review," Louis McKenna; 6:15-7, dinner concert; 7:30-8:15, farm lectures.
WLW, Cincinnati, Ohio (Central, Daylight, 309), 4 p. m., "The Silver Black Fox," courtesy of the Great Northern Fox company; 4:20, French lesson, Mme. Ida Teimpidis; 10, convention concert, Christian Endeavor orchestra, North Presbyterian church; Erhard trio; Kathleen Molyneux, accompanist; 10:30, Ho-Down, Jake Rutz's Pumpkin Vine orchestra; Donald Balm, whistler; Tunzl Melody trio; Anne Kaufman, soprano; Gus Rihard, pianist; 12 midnight, Chub-Steinberg orchestra.
WMAQ, Chicago, Ill. (Central, Daylight, 447.5), 4:20 p. m., items of interest to women; 4:30, pupils, Glenn Dillard Gunn School of music; 5, child life stories; 6, Chicago theater organ; 8, talk, Harry Hansen; 8:20, "Relation Between Boy and His Dad," C. R. Barnore; 8:40, French lesson; 8:55, U. of Chicago lecture; 9:15, Lyon & Healy program.
WOAW, Omaha, Neb. (Central, 360), 6 p. m., piano recital, pupils of Martin W. Bush; 9, program, Knights of Columbus.
WOQ, Kansas City, Mo. (Central, 360), 8:00-9:30 p. m., program of classical music, popular artists of WOQ.
WRC, Washington, D. C. (Eastern, 469), 6 p. m., children's stories and songs, Peggy Albion, Marguerite Meakin; 8, Katherine F. Cullen, pianist; 8:30, Elizabeth Davon, soprano; 9, The Political Situation in Washington Tonight, Frederick W. Wile; 9:15, Sidney Seidenman's Shoreham Hotel orchestra.
WSB, Atlanta, Ga. (Central, 429), 8-9 p. m., violin recital; 10:45, Biltmore Hotel orchestra.
WWJ, Detroit, Mich. (Eastern, 517), 8:00 a. m., setting-up exercises, R. J. Horton; 9:45, Fred Shaw, pianist and songster; 3 p. m., Detroit News orchestra; 7:00, Detroit News orchestra.

Popular Songs Sell With Radio Plugging Victor Releases Show Six of Eight Hits are Broadcast

NEW YORK.—That "plugging" by Radio makes instead of kills, a song as the attitude of the Victor Phonograph company in their latest record releases. Out of a total of eight dance numbers listed, six have been released by the National Association of Broadcasters over the Radio. Everyone of them were made hits by the broadcast route. Each day it is being proven that popular music is broadcast music, and that no other publicity method compares with broadcasting. The American Society has long argued that broadcasting is harmful to music. Apparently, however, they have not been able to sell this idea to all their members, many of whom believe that broadcasts offer them gratuitous service superior to any other known method of plugging.

APIA, SAMOA, BOASTS ITS OWN RADIO PAPER

White Residents Compromise Circulation List of 20 CHICAGO.—Apia, Samoa, has a Radio Magazine! A typewritten, nine-page Radio bulletin has been received here from the U. S. Consul at Apia. It is issued to the white residents there. At the bottom of the first page the circulation notice reads, "This issue, 20 copies." The bulletin is filled with various Radio news items, DX records and advice to the amateur operators, not forgetting to mention the editorial page. WHB, Kansas City, seems a popular broadcaster in Samoa. Among the technical items is one reading, "After the leads have been connected to your receiver, with required tubes, batteries, etc., you will be ready for the test. If under these conditions you cannot tune in the desired station, take a low resistance lead from your aerial just above the receiver and solder it to the lake or bay. Amateurs may not know how to solder a lead to the lake as stated above, but these things are TECHNICAL facts and you are not supposed to know. If this fails, try some hook-up of your own."

Intercity Radio Telegraph Company Still in Business

NEW YORK.—The Intercity Radio Telegraph company of this city was declared by a recent Washington dispatch to have gone out of business. This statement is erroneous. The company has not gone out of business, and in fact is the only commercial Radio telegraph company operating on the Great Lakes. The Intercity company has been successful so far in its action against Secretary Hoover to cause the department of commerce to issue a license for its New York station. The department of commerce, however, has appealed the case to the supreme court of the United States and the hearing has been set for the October term.

CKY Asks Shut-Ins' Names; Messages of Cheer Follow

WINNIPEG, MAN.—Every lunch-hour, Station CKY of this city asks for names to be added to its list of shut-in listeners. Several names are announced from this list each day and suitable words of cheer are spoken to the shut-ins. It is surprising what joy the messages bring to the recipients, especially to crippled children. Parents of some of these have assured CKY that the mere mention of a child's name has brightened the life and proved more beneficial than any other form of cheering.

www.americanradiohistory.com



# Compact Nine-Tube Super-Heterodyne Set

## Part I—The Circuit Used, Batteries and Controls Necessary.

By Harry Abbott

LIKE every other man whose hobby has been Radio for a number of years, I've always wanted a super-heterodyne receiver. I started out with a single-tube that brought in all the amateurs in the New York city territory and the old De Forest experimental phone station at Highbridge, New York; this was promoted into a three tube affair just about the time WJZ got into action in Newark in 1921. A little later, a step of tuned impedance Radio frequency was put in front of the original set, and early last year a stage of transformer-coupled Radio frequency was also inserted.

Then came the reports of the wonders of reflexing, so, with a new panel, the assembly of parts was revamped into a reflex. This was finally cajoled into satisfactory operation and functioned well for some months, when Radio Digest began its series on the Neutrodyne. Once again the parts were re-arranged and neutroformers took the place of Radio frequency transformers, and incoming signals were neutrodyned into clear music and clean cut speech.

But all the time I wanted a "Rolls-Royce." Theoretically it gave the best amplification and greatest selectivity of any circuit known, and selectivity around New York city is most essential. The fan that can separate WEAJ, WJZ and WJY on Manhattan Island has a real receiver. The objections to constructing such an outfit were the number, of controls, the size of the panel necessary and the number of tubes. I had five tubes of the 199-299 class; it would be necessary to purchase four more for the set I had in mind.

### Controls Necessary

Careful study of all the available "dope" on super-heterodynes convinced me that the controls could be brought down to two or two-and-a-half. I say "half" because it looked as though the oscillator coupler would require a touch on about one-fourth of the stations and the potentiometer a slight re-adjustment on a quarter of the stations. This diagnosis was later proved very nearly correct—two-and-a-quarter controls would be more accurate.

The circuit that looked best to me is shown in Figure 1. It called for nine tubes, which could be of either the '99 or 201-A class. Personally, I liked the '99s and since each drew but 0.06 ampere, mine would require only 0.54 ampere, and six dry cells in series-parallel would furnish that. The matter of panel size was next up for consideration, and, as the circuit shows, I had to put two condensers, two variable grid leaks, one potentiometer, four rheostats and one filament switch on the panel. Much drawing paper was used in making layouts and the dimensions were finally brought down to 24 inches by 8 inches.

Several points which came out during construction and when first putting the set into operation, and which may not at first be clear to our readers, may as well be covered here. Filament control jacks cannot be used, as all nine tubes must be lit whether detector, first or second stage of audio are in use. I had them in at first but found that, after getting signals on the detector, plugging in the audio amplifiers threw off my previously made adjustments. Since I wanted all programs on the loud speaker anyway, and immediately shifted into two steps of audio frequency after getting stations on the detector, I did not mind the elimination of the filament-control feature.

Then there is the matter of shielding. To many there will seem to be an excess of shielding in this set; some will feel that such an amount of shielding might cut down volume. Since iron core, shielded, intermediate wave transformers are used my "egg-crate" shields do not noticeably affect the volume but serve merely to keep the oscillator frequency, the intermediate frequency and audio frequency well separated and from interfering with each other.

### Batteries Used in Set

Last, but a long way from least, is the matter of B batteries. I found in previous sets that it was much better to operate a detector from one B and the audio amplifiers from another. To get my super-het working I found it advisable to have a third B for the oscillator and intermediate long wave stages. The extra initial investment in B batteries is well worth its cost because none of them are overworked, they wear out evenly and last longer. The small cells of a B battery should not be asked to furnish more than a few milliamperes of current and putting too many tubes on a set of batteries runs them down prematurely. My super, then, used two 90-volt batteries, one 45-volt battery and a 6-volt C battery.

If there is any secret to this circuit I should say it lay in the fixed mica condensers. My super shows seven besides the two grid condensers, and sets constructed along similar lines may require one or two others to clear up stray

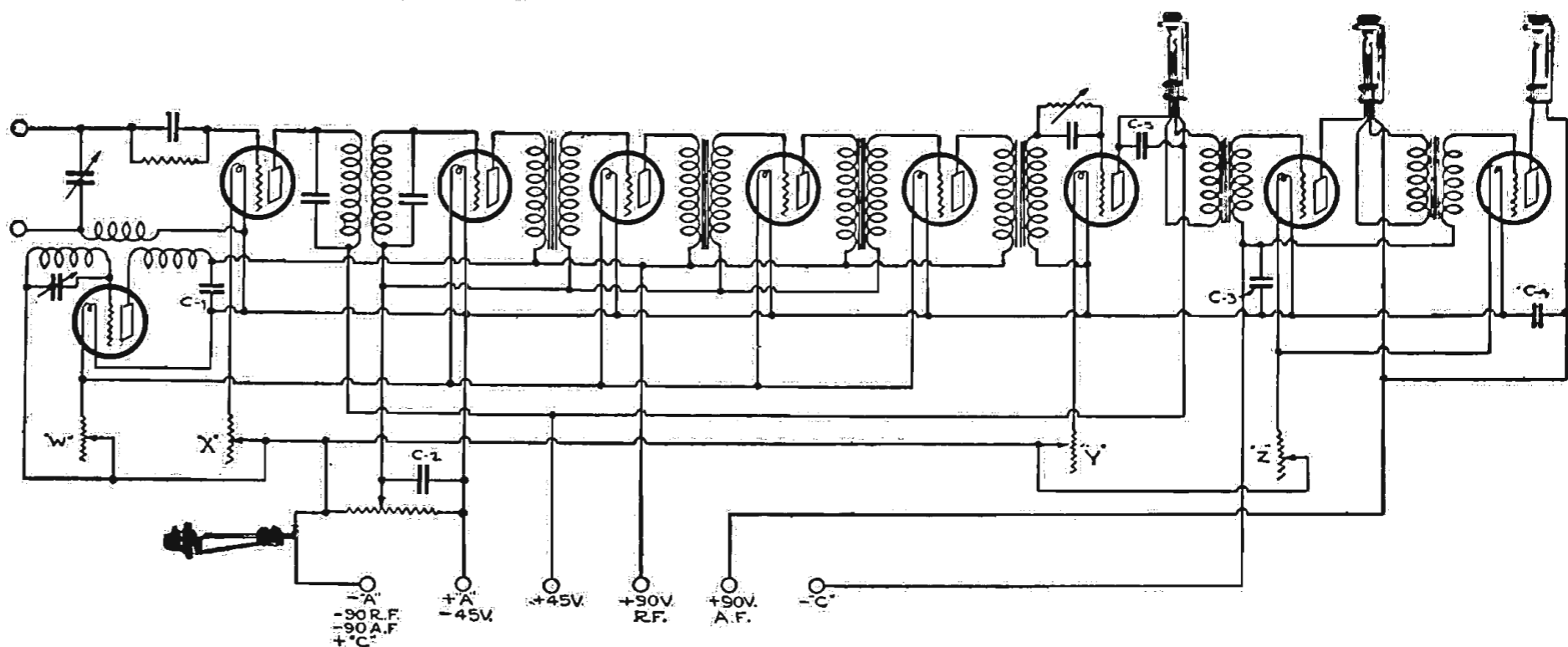

Figure 1

whistles. It seems to be the usual practice, when writing about one's receiver, to give a long list of stations heard on the loud speaker. I can see no use in doing that.

Getting down to the set itself, there is a panel 24 inches by 8 inches and a baseboard 13 inches by 23 11/16 inches. Variable units go on the panel while those that need no attention are mounted on the baseboard. In all there are 27 units, exclusive of jacks and fixed condensers; on the panel are (from left to right) a variable condenser, with grid leak above it, another variable condenser with potentiometer above it, two rheostats, the filament switch, two more rheostats and, finally, the second grid leak. Of these units only the two condensers are used in tuning.

The wiring diagram is given with this first article and some consideration of it might be advisable. At the left end, the

oscillator coupler will be noted just above the first tube. This may be of any convenient type either purchased, homemade or adapted from a standard instrument. The one in my set resembles two Reinartz coils placed parallel to each other; one is larger than the other and its inner turns are the grid coil while the outer turns are the plate coil. The pick-up coil connected in the grid return of the first detector is the smaller of the two pancakes.

A tuned input transformer will be found in the plate circuit of the first detector and the grid circuit of the first long wave amplifier tube. The values of this unit will depend entirely on the transformer used in the intermediate amplifier. For the transformers incorporated in my outfit, two 1,000 turn coils of the air-cell variety shunted by .00025 fixed mica condensers, passed a frequency corresponding to the peak frequency of the

long wave transformers. Some arrangement should be made for the adjustment of these two coils in their proximity to each other as the circuit is accurately tuned by this means.

The four long wave, iron core transformers connecting the long wave amplifiers, and the last of these amplifiers with the detector, may be any of the

(Continued on page 20)



# WD-11

Radiotron WD-11 is famous as the tube that really made possible the swift growth of radio in the home, as we know it today.

Inexpensive to operate—using but one 1½-volt dry cell—doing away with the need for storage batteries—it has lowered the cost of Radio.

**Price \$5.00**

Radio Corporation of America

Sales Offices--Dept. 315  
233 Broadway, New York

10 South LaSalle St., Chicago, Ill.      433 California St. San Francisco, Cal.

Be sure that every vacuum tube you buy is marked **RADIOTRON.**

# Radiotrons

REG. U. S. PAT. OFF.

## STA-RITE RADIO BATTERIES SAVE YOU 60%

And Guarantee You in Writing 2 Years of Better Battery Performance

STA-RITE RADIO BATTERIES are made especially for Radio and the big saving is made possible by coming direct to you instead of through distributors, dealers, etc. Boxes are made of oak, finished in mahogany and the plates very thick and will give a steady discharge over a long period. No premiums, just good, honest battery value.

**TRY TO BEAT THESE PRICES**

2 Volt for W. D. 11 and 12 .....	\$4.00	6 Volt 60 Ampr...\$	7.50
4 Volt for U. V. 199 Tubes.....	7.00	6 Volt 80 " .....	8.50
		6 Volt 100 " .....	10.00
		6 Volt 120 " .....	12.10
		6 Volt 150 " .....	14.00
		6 Volt 200 " .....	17.00

**RADIO B. STORAGE**  
Glass Jars, Heavy Plates—  
Case of 12 Cells, 24 V.....

4.90

Get Yours Today—NOW—Send No Money

The batteries are fully guaranteed in writing and shipped subject to examination on the day your order is received. You pay on delivery or deduct 5 per cent if full cash accompanies order. You may deduct 10 per cent if two or more are ordered at one time.

## STA-RITE BATTERY CO.

Department 5      LOUISVILLE, KY.



# SOLVED!

## FRESHMAN

### DOUBLE ADJUSTABLE CRYSTAL DETECTOR

*The World's Best for crystal or reflex sets*

## This crystal detector makes two tubes do the work of four!

**FREE!** Send for Freshman Building Plan of N. Y. Times Reflex—gives panel layout, circuit and parts required. Operates Loud Speaker on two tubes!

# \$1.50

FRESHMAN Double Adjustable Crystal Detector for panel or base use, complete with crystal.

Freshman Super - Crystal 50c With Non-Metallic Housing

No more searching for the sensitive spot, merely turn the knob as you would a dial!

At your dealer's; or send purchase price to be supplied postpaid.

## Chas. Freshman Co. Inc.

Radio Condenser Products  
106 Seventh Ave., N. Y. C.

# Radio Digest

PROGRAMS  
Illustrated

Published by the Radio Digest Publishing Company, Inc.  
510 North Dearborn Street  
Telephone: State 4372, 4373, 4374, 4375  
Chicago, Illinois

E. C. RAYNER, Publisher  
Evans E. Plummer, Managing Editor  
Charles F. Smisor, Editor  
Harry J. Marx, Technical Editor

Eastern Office, 611-12 Times Bldg., Times Sq., New York;  
Telephone Bryant 4909, 10462

Member of the Audit Bureau of Circulations



PUBLISHED WEEKLY

SUBSCRIPTION RATES

Yearly in U. S. and Possessions and Canada, \$5.00  
Foreign postage, \$1.00 additional. Single copies, 10 cents.

Vol. IX Chicago, Saturday, June 7, 1924 No. 9

## Idiosyncracies of Sets

Receiver May Become Almost Human to You

WRITING from that deep perspective that is sometimes obtained from sitting in a chair in the editorial sanctum of a daily newspaper office, an editorial writer of the Buffalo (N. Y.) Evening News made some interesting comments recently on Radio. The remarks were highly retrospective and may be illuminating to some Radiophans in presenting Radio in a rather unusual way.

The editorial follows:

"A Radio set is a well-nigh perfect toy. With use, it develops idiosyncracies that make it as personal as an old rag doll. You can order it whole from some exclusive accessories shop or assemble it bit by bit from the ten-cent store. You even can contrive spare parts for it out of handy odds and ends at home. You can build it in miniature and install it in a walnut shell or enlarge upon it and incorporate it in the architecture of your house.

"You can lavish upon it all the cunning hand skill that you possess or you can make it a research laboratory for experimentation in the technical theory of Radio.

"When all else palls, you can take your plaything to pieces and put it together again.

"Tuning in is the more absorbing because it can be either a game of skill or a game of chance, according to the way you play it.

"You can play a game of precision in which you calculate, tabulate and control all the permutations and combinations. Or you can vary the quality of your sport, as the musician does the tempo of a classic to turn it into jazz, merely by shifting the accent from what you hear to whence you hear it. Now you dart hither and yon through the ether, intent solely upon picking up some station more remote than the farthest anyone you know has caught. This game has all the excitement of the chase. Doggedly you stalk your quarry into the small hours of the night, gladly sacrificing sleep to add one more city to your collection. Distance, indeed, lends enchantment.

"Just to take your chance, though, on the turn of the magic knob, is the real adventure. Space becomes a new world which you explore with all the zest of a discoverer. You range its pathless expanse bewildered by its extent, fascinated by its variety, lured by its mystery. Your quest never grows monotonous, for only in dreams do your surroundings change as completely, unaccountably and irrevocably as in Radio. Charmed by the lovely tones of a violin lifting its voice in some familiar melody, your hearing violently is assailed by a deadly fusillade of code. You silence the attack finally but the violin music is as irreclaimable as the "Lost Chord." If you can't endure this philosophically, stick to the phonograph."

## Antenna Protects, Not Endangers

Radio Set Is as Good as a Lightning Rod

THERE is a great deal of misunderstanding in regards to lightning arrester protection for aerials used in Radio reception. To understand better the reason for and the action of the lightning arrester let us examine the conditions. Lightning is caused by a cloud disturbance in which the natural reservoir of electricity is stored up in the clouds becomes of such a value that it will break down the air insulation between the cloud and another cloud or the earth. The discharge will never take place until the cloud is near an object that has a charge of opposite polarity or a charge of much lower potential.

Lightning will strike insulated objects because of the difference in potential between the cloud and the object and this becomes so great that the insulation breaks down and a discharge takes place. If a Radio set happens to be in such a house the blame is placed on the set. As a matter of fact, the aerial of such a set might drain off the difference in the potential so that no bolt of lightning will take effect.

A Radio aerial acts in the same manner as a lightning rod. The static charges of the earth are allowed to leak off from an aerial so that the danger of lightning striking a building is lessened.

## RADIO INDI-GEST

### How I Tuned in the Coast

Another rising of the sun.  
Another day's work has begun.  
I tackle it without much zest,  
For, broken, was my last night's rest.  
Thought 'twould be a fine old caper,  
After reading program, last night's paper,  
Concert at Tacoma and at Los Angeles.  
I'll get up at 3 a. m. and tune in these.  
The wife looked at me in amaze.  
"You sure have got the Radio craze.  
You howl that thing in the middle of the night,  
And this family'll have one good fight."  
I used discretion and nothing said.  
Climbed the wooden-hill and went to bed.  
Soon tucked in, the dog with me,  
After setting "Big Ben" to ring at three.  
I was sawing away and goin' mighty strong,  
When, Bang! went that darned alarm clock's gong.  
First kicked the dog from off the bed,  
Then stumbled over shoe and bumped my head.  
Finally got "Big Ben" quieted down  
(Only woke up about half the town),  
Slipped on the stairs, I was goin' such a pace,  
Came near landing right on my face.  
But the dog and I, still unafraid,  
Kept on with our shirt-tail parade.  
Went down cellar, charger switch to throw,  
Stepped on a chunk of coal. Oh, Hell-o.  
Coming up the stairs, stepped on the cat.  
Nice long scratch I got for that.  
My wanderings o'er, in my bare feet,  
In front of the Radio took my seat.  
Now, says I, 'Aint I got fun?  
I'll have San Francisco in on the run.  
So I jockeyed the tuner-dials, put on and off the power,  
And I set and twiddled dials for about an hour.  
And the howls, groans and walls sure came in kiting,  
Just like twenty tom-cats in the backyard fighting.  
Head phones broken, so used the loud speaker,  
This, of course, didn't make the howls any weaker.  
And then, all at once, it came in a billing,  
North Pole expedition and you Mr. MacMillan.  
Trust you in the Arctic Circle have listened in,  
Signing off. Good Night. Chicago, 9XN.  
Now, some fans lie and some fans boast.  
But That's how I tuned in the Coast.  
I sure was disgusted, dog looked it too,  
So we went to bed, without more adieu.  
Now they say "Charity, at Home Begins,"  
And likewise it "Covers a Lot of Sins."  
But, when we met that morn, the dog and me and Mable,  
Charity wasn't used at our breakfast table.  
JAS. L. CADOGAN.

### Yeh, Yeh, Go as Far as You Like, But Get Off at the End of the Line

My Gracious Indi: In re the announcers' world contest, may I be permitted to nominate you? Your line is perfect, especially when you print my jokes. F. P. A., R. H. L., Heywood Brown, Don Marquis and all the other notorious columnists are copying your style. \* \* \* Yeh, they're putting periods at the end of their sentences.  
SPIDER WEBB.

### Mrs. Partington Speaks Out



Dear Indi: Mrs. Partington says she listens to all kinds of music, Clastical, High brow, Conservatory and plain Garden kind. She's heard lots of violins and Fiddles, both. She's listened to Saxaphones that laugh, and Harps that make you cry; Organ music that does 'em all, but at some of these night-bird frolics they don't have nothing but

Jagg music and she don't like Jagg. She knows one poor feller who has already gone from Jagg to Dope; He is Ernie Rogers, W. S. B.'s printing office feller.  
SIGNING OFF.

### Hear! Hear!

Here's to you, Indi, and here's to your nibs. Here's to the gang that sends in the contribs. Here's to the column we all like the best. Here's to the RADIO INDI-GEST!  
SIMPLY WADDLES.

### Which Probably Would Be Plenty

Dear Indi: A tenant in Sheffield has been brought into court for not paying her rent—refusing to do so until the landlord removes the antenna from the roof. However, her fear was not of lightning, but merely that this apparatus would permit said landlord to hear everything that the old lady said in her own house!  
LONDON BOBBY.

### Shh! Lightning Pays for Protection

Editor, Radio Indi-Gest, Illuminated,  
Dear Sir:  
What good is a lightning arrester anyhow? I had one up for three years but the lightning never came near it so I took the darned thing down.  
EDDY CURRENTS.

## Give the Kid a Chance



## Condensed

By DIELECTRIC

China is not to be counted among the backward nations of the world in the matter of Radio broadcasting. To prove which, the press has accepted the modern viewpoint and, with one of its representatives now in the field, will give to China what so many of our great dailies are providing listeners in this country. The Shun Pao, first Chinese newspaper to take up broadcasting is on the air four times daily with lectures in Chinese and musical programs. Will we be able to pick up the weird strains from their peculiar instruments and translate them?

General Squier, although no longer at the head of the United States Signal Corps, is as actively engaged in working out Radio problems as when his wired wireless experiments attracted the attention of experts both in and out of the army. Using a new system of code transmissions the General has succeeded in reducing the time element, which is a big factor, by eliminating eight out of the thirteen units necessary with the Morse code. It is said that this system will reduce by hundreds of thousands of dollars the annual cost of commercial code transmissions. Patient investigation is required of an inventive genius.

Now that the spring sports season has returned we fans who enjoy such things may tune to baseball reports and, possibly, a blow by blow report of herculian golfers' championship contests. Not only may the results of games between the big leagues be received but college baseball will again receive its share of attention by some of the broadcasting stations. WNAC, the Sheperd Stores station in Boston, will be on the job giving for all who care to listen each play made on the home grounds of Harvard university. The cheers, bands and comments thrill!

Since I thought of this great Gold Cup Award after you read about it in Radio Digest, no blame attaches to me for springing such an excellent idea. All I want to do here is to urge you to give consideration to your votes. Remember that the announcer whom you consider worthy of being so highly honored will, as a matter of course, indicate the qualifications desired in those who direct our studio announcements. The man or woman chosen will be a subject of study by all others in the field, so that your ideal should be placed high. Here's where the people choose.

When will these obstructionists ever learn? Lesson after lesson is given free to every theatrical producer in the modern method of Radio publicity, yet the howls continue about broadcasting ruining box office receipts. Most important to managers is the reaction evidenced in an innovation sponsored by Ralph Kettering, author of the play, "Easy Street," which had its "first night" before the microphone at Station KYW. When the first performance was given in the Playhouse there were no vacant seats. This would seem to be the wisest procedure in matters of this kind.

It looks very much as though Radio receiving sets would figure in the summer vacation equipment this season to a larger extent than ever before. Improvement in design of set has no doubt had something to do with this. Better broadcasting has tended to remove the dread entertained by fans heretofore when receiving during the summer months was contemplated. In any case, what the vacationist may expect is service directly intended to appeal to him in particular. WJZ already has begun a financial service intended for the man resting from office duties. Many sets are already on the market showing various ways and means of enjoying Radio, both for automobile and camping use. What could be sweeter than to sit by a campfire and hear your favorite station.

# How to Install a Radio Set in Your Automobile

## Part V—Essex Installation and Cabinet Details

By Harry J. Marx

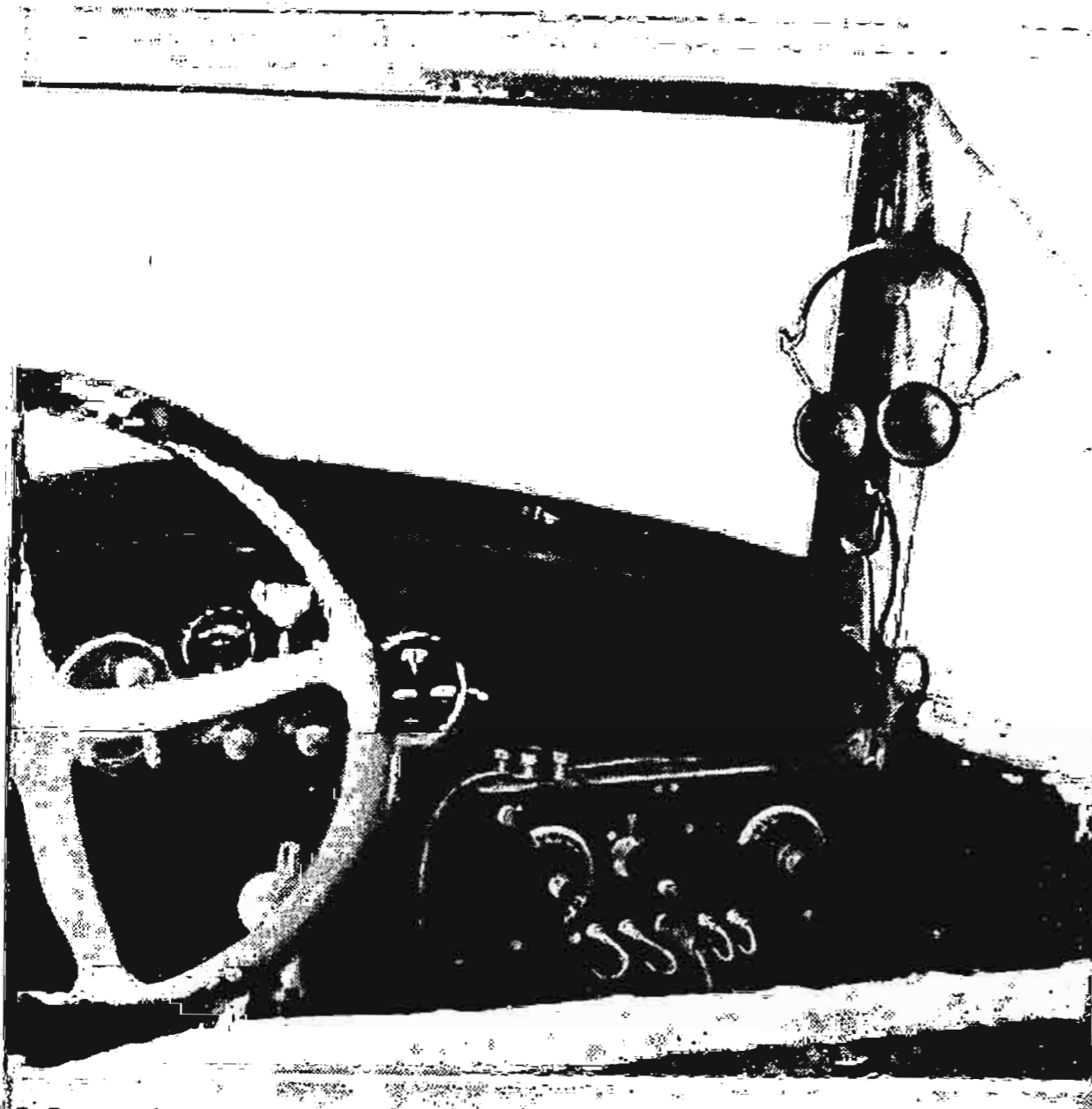

Showing installation of auto set below Essex dashboard.

THE American motorist of today is demanding much in his touring cars. He likes its smooth performance and quietness, he demands ease of riding and what is becoming more evident in his distinct desire for those accessories which are provided to increase his comfort and that of his passengers while driving. It is obviously only a matter of a short time before the Radio equipped cars will be in popular demand. If not equipped, at least provision made so that such equipment can be conveniently attached when called for. We will soon see auto blanks with the notation provided for a check mark if the Radio equipment is to be included in the original purchase. Until this time comes this detail must be taken care of by the purchaser of the car.

### Convenient Set Installation

The Essex touring car is another of the list of cars that permit convenient set installation under the dash board as has been shown in all of the previous articles. The dash board on the right side for a strip of about 14 or 15 inches is clear and allows freedom of attachment of clamps or angles to support the set. The set is so fastened so that the front cover projects just far enough to permit accessibility to the four binding posts. A small loop aerial can be braced against the front windshield with very short connection to

the two loop binding posts. The windshield clamp provides a convenient hook for hanging the receivers. The ground connection as in previous articles is made to the framework of the car or to the ground stake when stopping the car.

Another accessory to the Radio equipment consists of 50 to 80 feet of lamp cord with a small lead weight attached to one end to be thrown over a limb of a convenient tree when stopping, thus providing an outside antenna that will give a decidedly increased volume of reception when making any stopovers.

The storage battery in the car amply takes care of the demand for current for lighting of the tube filaments while four of the small 22½-volt B battery units conveniently placed out of sight take up little room and are more than sufficient for the demands of the plate circuit.

A loud speaker can be carried where convenient with a long cord and plug so as to permit reception in any part of the car most convenient to the passengers.

### Local Stations on Loud Speaker

Local stations can be consistently brought in on the loud speaker even when driving. Stations further away of course will necessitate the use of head sets. The

receiver is properly cushioned when mounting, the vibration of the car is apt to continuously cause a movement of the dials. One way to overcome this would be to take some thin sheet rubber and cement it on the rear edge of the dial so that when the dial is fastened on the shaft this rubber rests against the panel thus providing enough friction surface to

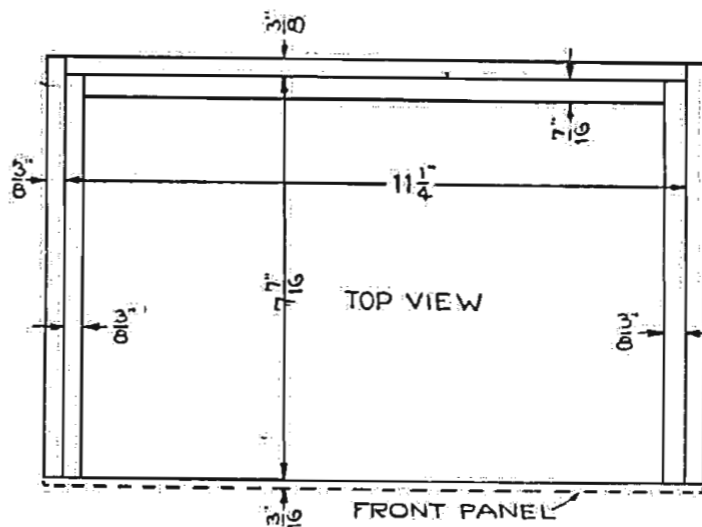

Here is shown the top, front and end views of the completed cabinet suitable for enclosing the portable automobile set. On page eighteen is given detailed drawings of pieces of wood required to make the cabinet. The use of quarter-sawn oak is suggested but not absolutely mandatory.

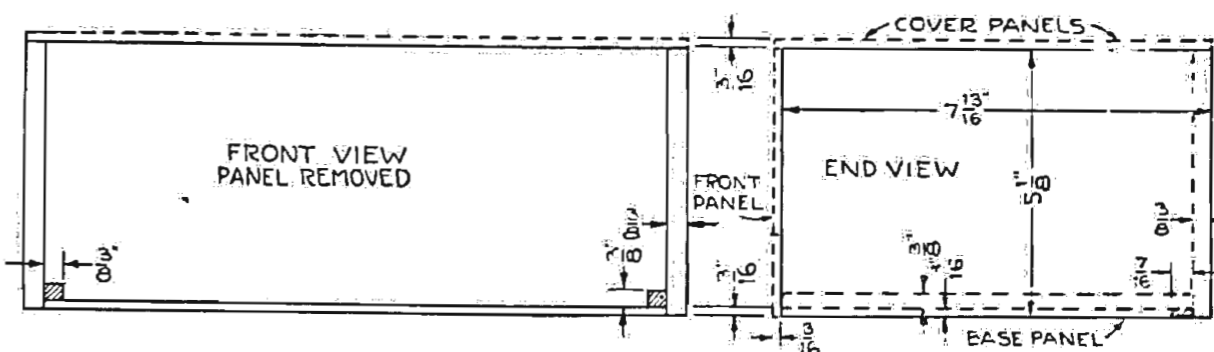

main difficulty in long distance reception with a set of this type is that the tuning adjustments, because of the rather critical selectivity, with a car running at any reasonable speed, its no simple matter to turn a dial with a small gradual movement. Another factor is that unless the

retain the dial in position in spite of vibration but at the same time not being sufficient to prevent easy turning for tuning.

This vibration of the car is one of the main reasons for not using crystal detection. (Continued on page 18)

## Guaranteed Head-Sets

RED-HEADS are guaranteed radio phones. You run no risk when you buy them. Money back if, after 7 days' trial, you're not satisfied that they're the best receivers on the market at the price. Why not act right now and get a pair? It'll mean getting the maximum from broadcasting from the day you put them into use.



**RED-HEAD RADIO RECEIVERS NOW READY**

The new 1924 Model F | The new "Red-Head" Jr.  
\$6.50 Per Pair Complete | \$5.00 Per Pair Complete

"Red-Heads" sent prepaid on receipt of price if you are unable to get them at your dealers.

**THE NEWMAN-STERN COMPANY**  
DEPT. R. D., NEWMAN-STERN BUILDING, CLEVELAND, OHIO

## KEYSTONE RADIO LIGHTNING ARRESTERS

**\$1.50**

At All Dealers

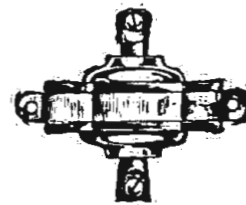

Buy your Keystone Arrester today—install it according to instructions supplied, and forget about lightning. Made of Bakelite—weather-proof. No vacuum to lose. Approved by Underwriters. At all Dealers, \$1.50.

Manufacturers of over a million Lightning Arrestors

**ELECTRIC SERVICE SUPPLIES CO.**  
17th and Cambria Streets, Philadelphia  
53 W. Jackson Blvd., Chicago  
50 Church St., New York

## BUELL E. J. Flewelling RADIO APPARATUS

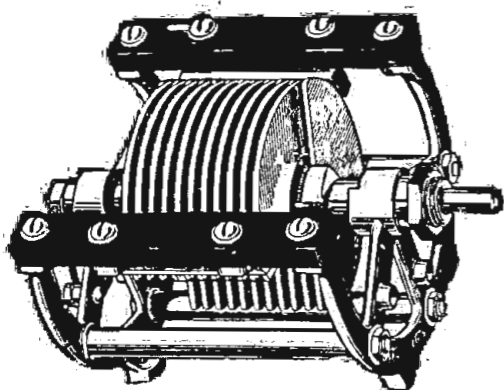

**THE MOST STURDY**  
of the New Type  
**LOW LOSS CONDENSERS**

**BUELL MANUFACTURING CO.**  
2977 Cottage Grove Ave., CHICAGO

## Adjustable Resistors for Radio Circuits



### Something New!

The Bradleyohm is just what you need for shunting audio-frequency transformers; for making resistance amplifiers; and for many special circuits. It is made in three sizes.

Bradleyohm 10—10,000 to 100,000 ohms  
" 25—25,000 to 250,000 " " " 50—50,000 to 500,000 " " "

Go to your dealer today and ask for the Bradleyohm.

**ALLEN-BRADLEY CO.**  
290 Greenfield Ave. Milwaukee, Wis.

Use the  
**Bradleyohm**  
THE PERFECT RESISTOR

Parcel Post prepaid on all orders above \$5.  
Express Money Order, Certified Check, Bank Draft accepted; also C. O. D.  
Guarantee with all merchandise.



349  
Fulton St.  
BROOKLYN  
N. Y.

**JUST OFF THE PRESS** OUR NEW CATALOGUE AND PRICE LIST. SEND 4c IN STAMPS TO COVER POSTAGE FOR SAME

Complete Parts for  
**Neutrodyne 5-Tube Set**  
1 7x26 Panel  
1 Triple Socket  
2 Single Sockets  
2 Neutrodons  
3 Neutroformers  
2 All American Transformers  
1 Battery Switch  
3 4" Dials Fada Type  
1 Power Rheostat  
1 Vernier Rheostat  
8 Binding Posts  
1 Closed Circuit Jack  
1 Filament Control Jack  
27 Ft. Insulated Tubing  
27 Ft. Tinned Bus Bar  
2 Fixed Condensers .006 Mfd.  
1 Fixed Condenser .00025 Mfd.  
1 Grid Leak 2 Megohms  
1 Diagram for Above Set  
Our Price \$32.50

Complete parts for Fada 5-Tube Neutrodyne Sets  
ALL GENUINE FADA PARTS. LIST PRICE \$65.00. OUR PRICE \$51.00. Assembled in cabinet ready to operate, \$71.50.  
Complete parts for Freed-Eisemann 5-Tube Neutrodyne Sets  
GENUINE PARTS. LIST PRICE \$80.00. OUR PRICE \$62.50  
Fada 160 Neutrodyne  
Factory-made machines. LIST PRICE \$120.00. OUR PRICE \$89.50.  
Freed-Eisemann 5-Tube Neutrodyne NR5  
Factory-made machines. LIST PRICE \$150.00. OUR PRICE \$125.50.  
Fada Neutrodyne Kit  
3 NEUTROFORMERS—2 NEUTRODONS. LIST PRICE \$25.00. OUR PRICE \$21.00.  
Freed-Eisemann Neutrodyne Kit  
3 NEUTROFORMERS—2 NEUTRODONS. OUR PRICE \$22.50.  
Shamrock Kit  
3 NEUTROFORMERS—2 NEUTRODONS. OUR PRICE \$15.45. SUPERDYNE COILS \$5.75.

**PORTABLE AUTO SET**

(Continued from page 17)

tors. If these detectors are adjustable they have a constant habit of jumping out of position, making it almost impossible to consistently receive. The only alternative is the use of a crystal with a fixed

rub down the first coat and apply the second coat over it.

If the black finish however, is desired, a little lamp black added to the shellac will give the desired effect.

(Installation of sets become more popular as time passes and readers are looking forward each week for a description that

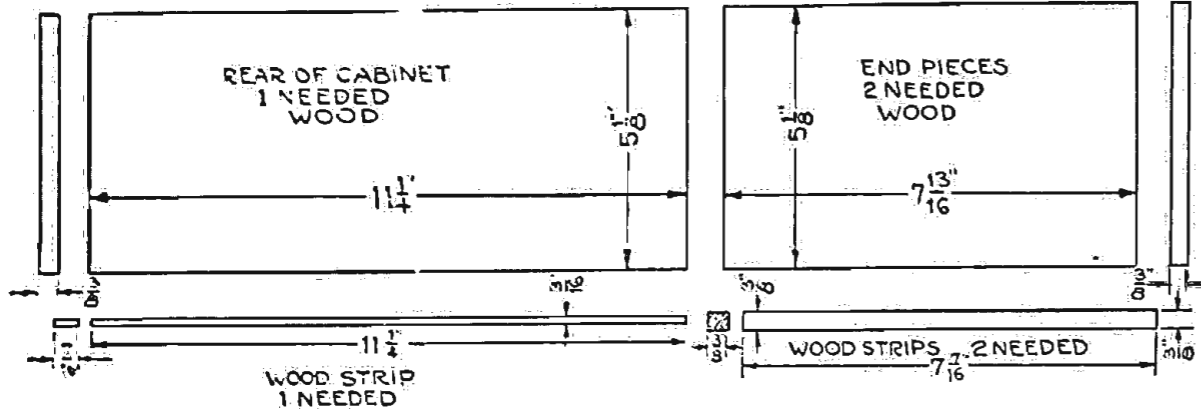

adjustment that will not be effected by vibration.

**Cabinet Details**

The illustrations show three views of the assembled cabinet and four views of the detailed pieces required to make it. This cabinet assembly is required where the set is to be directly installed in the car. The next article will show the suitcase assembly.

Quart red oak of 3/4-inch finished stock is used throughout, with the exception of the small strip 3/16 by 7/16 by 11 1/4 inches. It is advisable that this be well glued in addition to a firm screwing together of the units. Ample clearance is provided for all parts inside of this cabinet.

**Finish**

The simplest and most advisable form of finish on this wood is to use smooth sand paper, rubbing all surfaces down and eliminating all rough scratches and holes. Then give both the inside and outside of the cabinet a small coat of very thin high grade shellac. If necessary

will aid them in equipping their car. Owners of the Studebaker car will be interested to know that the next week's instructions will be especially for this car. Be sure to get your copy.—Editor's Note.)

**Review of Books**

**Vacuum Tube Receiver.** By O. F. Hessler. A book that tells how to make a simple set. How to make the cabinet. It includes a 27 by 36-inch layout blueprint. Price, 75 cents.

**How to Retail Radio.** A new book telling of tested plans and methods and policies for the dealer in Radio. Financing, location, store equipment and arrangement. Price, \$2.

**Home Radio—How to Make It.** By A. Hyatt Verrill. This book is particularly adapted for the amateur who desires to know how to make Radiophones. Twelve full page illustrations and diagrams. Price, 75 cents.

**Radio for the Amateur.** By A. H. Packer and R. R. Haugh. The underlying principles of Radio thoroughly explained in simple language and understandable illustrations. This book will teach you how to construct and operate a receiving set successfully. Price, \$1.50.

**Amateur Radio Call Book.** We have a few copies of this valuable book of the fourth edition. It contains a list of amateurs, special amateurs, technical and training stations. Tells how to construct a Reinartz tuner, detector and amplifier. A two-color map comes with it. Original cost, \$1. While they last, 50 cents.

**Radio Reception.** By Harry J. Marx, Technical Editor Radio Digest Illustrated, and Adrian Van Muffling. A simple treatise on Radio reception. Beginning with the elementary principles of electricity it carries the reader on into the essentials of Radio telephony. The most successful methods of Radio reception are explained and special attention given to practical tuning. Price, \$2.00.

**Elements of Radio Communication.** By Ellery W. Stone. A splendid, well connected, complete, accurate and up-to-date discussion of every phase of Radio telegraphy and Radiotelephony. Written in simple language. The subject is presented from the physical rather than from the

mathematical standpoint, avoiding the use of higher mathematics. Price, \$2.50.

**The Radio Amateur's Handbook.** By A. Frederick Collins. A new revised edition of this book is just out. It is a complete authentic and informative work on Radio. Fully illustrated. Price, \$1.50.

**The A. B. C. Vacuum Tubes.** By E. H. Lewis. It is a book for beginners who have no knowledge of either Radio or electricity and sets forth the elementary principles of theory and operation of the vacuum tube. No attempt has been made in this book to describe all the possible circuit arrangements, but those shown may serve as suggestions to experimenters who desire to evolve their own circuits. Price, \$1.00.

**Ideas for the Radio Experimenter's Laboratory.** By M. B. Sleeper. This book tells in a simple way the how and why of Radio apparatus. Comprehensive data are given on such necessary laboratory instruments as the oscillator, wavemeter, direction finder, Radio compass, vacuum tube, characteristic measuring set and detailed advice given on the winding of various kinds of standard inductance coils. Price, 75 cents.

The book department of the Radio Digest is prepared to send you any of the books on Radio published, whether listed in our Book Review or not. Let us know what book you want, send us your check and we will see that the book is mailed to you. Postage stamps in payment for books not accepted. Send money order or check. Radio Book Department, Radio Digest, 510 N. Dearborn St., Chicago, Ill.

Avoid unnecessary apparatus in the receiving set. Simplicity is a feature of many of the most efficient installations.

**Takes the MYSTERY out of RADIO!**

Just one book answers every question about this modern miracle

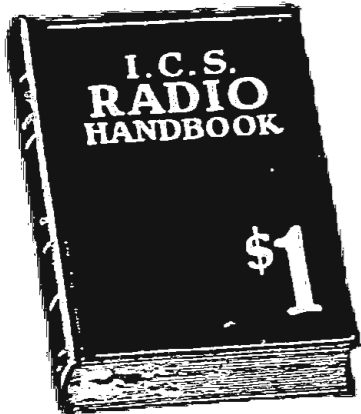

50,000 SOLD  
514 PAGES

Compiled by  
**HARRY F. DART, E.E.**  
Formerly with the  
Western Electric  
Co., and U. S.  
Army Instructor of  
Radio.

Technically Edited by F. H. Doane

BE A RADIO expert—it's easy for the 50,000 who own this compact, complete Radio Handbook. Written in good, plain, understandable language. Crammed full of facts, every one useful and important. Explains how receivers and transmitters work, how to build and operate them. Whatever you or your friends want to know, it's here. Will save you many times its small cost.

**TELLS ALL ABOUT:** Electrical terms and circuits, antennas, batteries, generators and motors, electron (vacuum) tubes, every receiving hook-up, radio and audio frequency amplification, broadcast and commercial transmitters and receivers, super-regeneration, codes, license rules. Many other features.

Nothing else like it. Make this extraordinary book your radio library—just this one little giant is all you need. Everything in one index, under one cover, in one book, for one dollar. The biggest dollar's worth in radio to-day. Combines the knowledge of many expensive works. Buy this and save the difference. Stop experimenting in the dark. Before you spend another cent on parts or even touch a dial, sign and mail the coupon below and get this unique guide to successful radio.

Send \$1 to-day and get this 514-page I. C. S. Radio Handbook—the biggest value in radio to-day. Money back if not satisfied.

TEAR OUT HERE

INTERNATIONAL CORRESPONDENCE SCHOOLS  
Box 8275-J, Scranton, Penna.

I enclose One Dollar. Please send me—post-paid—the 514-page I. C. S. Radio Handbook. It is understood that if I am not entirely satisfied I may return this book within five days and you will refund my money.

Name.....  
Address.....

**ALL-AMERICAN**

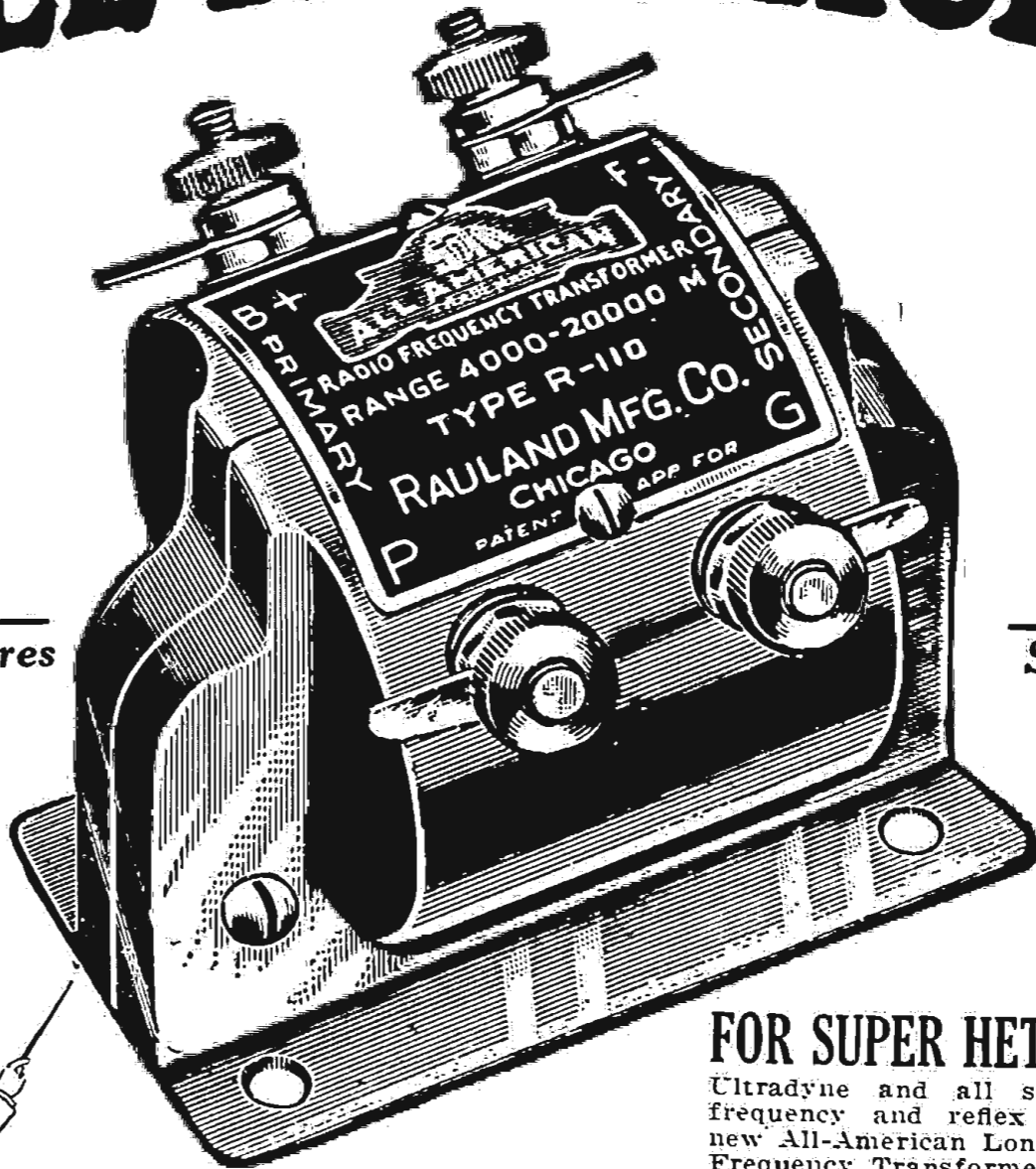

At All Stores

Six Dollars



**FOR SUPER HETERODYNE**

Ultradyne and all straight Radio frequency and reflex circuits, this new All-American Long Wave Radio Frequency Transformer is the finest amplifying instrument that you can buy at any price.

There is much in common between a great symphony orchestra and a properly designed Super Heterodyne set. When the orchestra director swings his baton, unless each instrument is correctly modulated, the performance jars on one's ears. Similarly, in a Super Heterodyne, if any one instrument under or over "plays" its part, the listener is disappointed. The All-American Long Wave Transformer was designed to perform in Radio frequency circuits as an instrumental masterpiece in the hands of an artist. That it actually "plays its part" in perfect harmony with other fine Radio instruments assembled in the set, is in no small degree responsible for the superb reception that is being enjoyed by those who have All-American equipped Super Heterodynes.

**SPECIAL OFFER!** Just out! New All-American booklet, "Hook-Ups and Hints"—32 pages of up-to-the-minute Radio information. Tells you how to hear farther and better. Send 10c, coin or stamps. Worth a dollar.

**RAULAND MFG. CO., 2648 COYNE STREET, CHICAGO**

# Three Circuit Changed to Tuned Radio

## Old Circuit Gets Good DX Distance Average

I wish to mention for the benefit of those who build this set that all connections must be soldered, aerial well insulated and the instruments set well

## WORKSHOP KINKS EARN A DOLLAR—

**T**HERE are many little kinks worked out at home that would aid your fellow Radio worker if only he knew about them. There are new hook-ups, new ways of making parts and various unique ways of operating sets that are discovered every day. Radio Digest is very much interested in obtaining such material. Send them in with full details, including stamped envelope, so rejected copy may be returned. The work must be entirely original, not copied.

RADIO KINKS DEPARTMENT,  
Radio Digest,  
510 North Dearborn St., Chicago

apart, especially variometers. Also keep the grid and plate circuit separated well or at right angles if it is necessary to wire closely. I contribute the good volume to a well insulated aerial and lead-in, and, last but not least, an excellent ground. The ground is made to a water pipe, or an 8-foot pipe driven into the ground in a damp place in the soil, with all wires soldered.

The best working condition was found with 30 or 31 volts on the detector plate. I might say that the set would not work well with .00025 grid condenser but found that .000025 was the proper capacity. The grid leak can be set at the proper point and allowed to remain at that setting.

In regard to tuning, I wish to say that with a little experience both variometers and rotor of the coupler can be left at the best receiving point and all tuning done with the primary condenser, potentiometer and Radio tube vernier rheostat.—W. C. Wessler, St. Louis, Mo.

Spider web inductances show themselves superior to other forms of tuning apparatus.

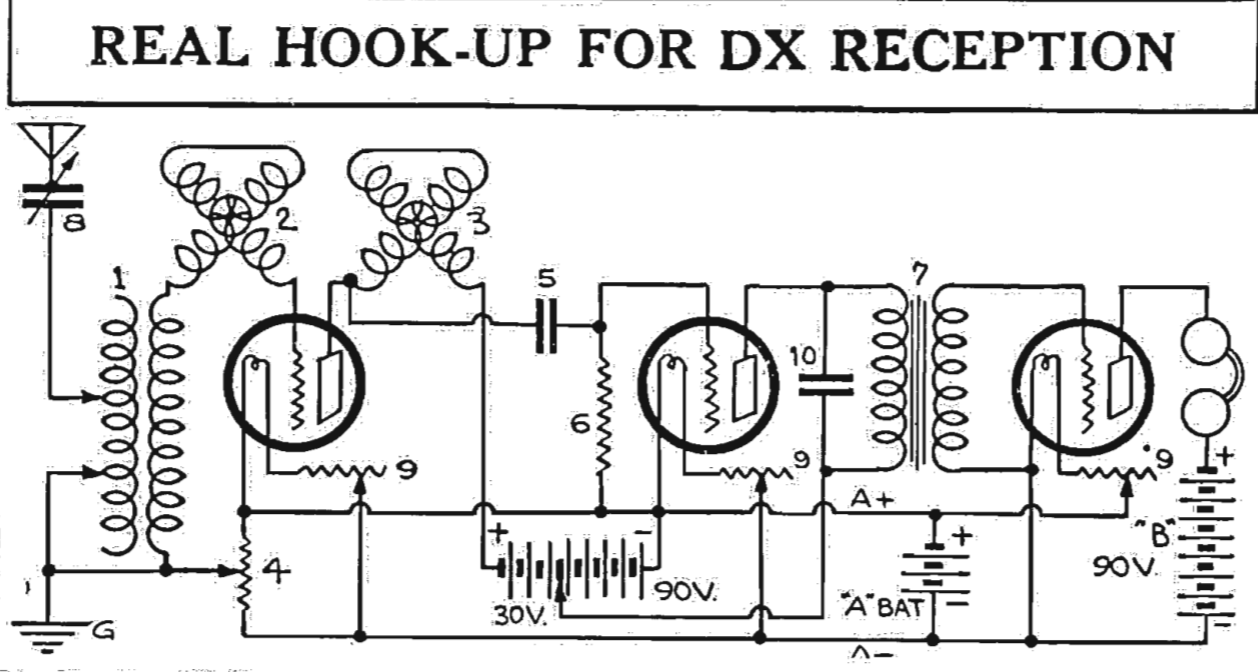

### Long Distance Crystal Set

With the use of a variometer hooked up as shown I have been able to hear stations 1000 miles distant. I wound my own variometer, using a 3 1/2-inch cube for the stator and winding on 13 turns of number 28 dcc wire on each side of the 1/4-inch rotor shaft. The rotor has 15

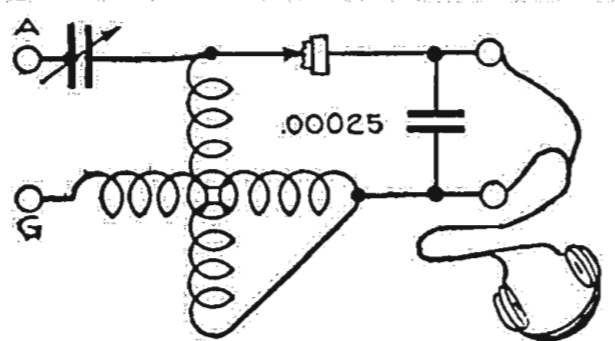

turns of number 30 dcc wire on each side of the shaft or a total of 30 turns. The illustration shows the hook-up.—A. Hunter, Council Bluffs, Iowa.

### Cutting Out Reradiation

A wave trap cannot be used to cut out reradiators or heterodyning from another receiver. The reason for this is that although wave traps can be used to cut out waves of a constant or steady wave length,

such as the broadcasting of an interfering station, it cannot be used to eliminate waves of a varying frequency such as those caused by the improper tuning of another regenerative set. The wave length of these reradiations are changed every time the offending dial twister twirls his dials, and so to cut him out it would be necessary to keep on tuning the wave trap all the time to keep up with him. This, by the way, ought to make an interesting and exciting indoor sport some night when the static is bad and the broadcasting poor.

It is more economical to purchase a duolateral coil than to wind one.

## Amplifying Crystal for Use with Loud Speaker

Radiophans who have a one or two-stage amplifier in a cabinet separate from the tuner (which is the preferable method) will find that a crystal detector set can be amplified to loud speaker volume on the locals. The crystal has no peer for clear and sweet reproduction of music and speech, but lacks distance-getting qualities. A well-built crystal detector set, made so that it will tune to suitable sharpness, is well worth while with an audio amplifier for the locals on either phone (one stage) or loud speaker.

Steamboats on Lake Geneva, Switzerland, are being used with receivers.

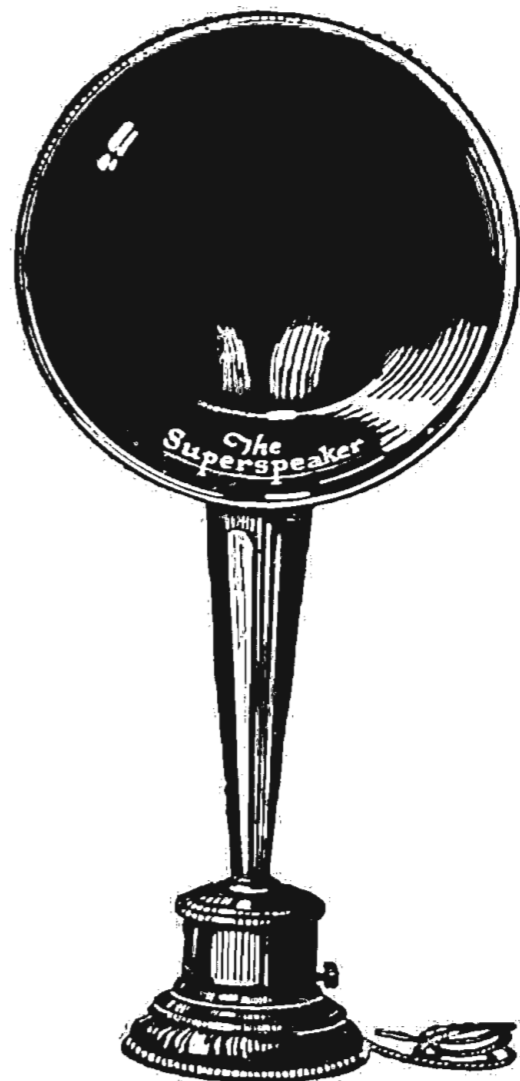

## The Superspeaker

### EXCLUSIVE MERIT

in this record breaking reproducing instrument is the result of positive, cam-operated, micrometer adjustment which brings in, sweet and clear, stations you have never before heard except through your headset. No rubber spring to harden and wear out.

Big, substantial, non-metallic horn, handsomely finished in ebony gloss—Nothing electrical but the performance—Makes good every recommendation of the dealer who sells it. Radio Merchants, get our highly profitable proposition.

**JEWETT RADIO & PHONOGRAPH COMPANY**  
5680 Twelfth Street  
DETROIT MICHIGAN

### FOR EFFICIENCY

*Pfanstiehl*

#### PARTS

Variocoupler .....	\$5.00
Variometer .....	4.75
Silencer .....	8.00
Oscillator for Superheterodyne .....	6.00
2-Stage Amplifier .....	17.50

Special inductances for all circuits

Manufactured by  
**Pfanstiehl Radio Service Co.**  
Highland Park, Ill.

### WAVE TRAP

Simplifies tuning. Eliminates interfering stations, thereby improving the selectivity of your set. Selects between conflicting stations. Special white quantity lasts. D131 Each.....\$4.95

### WOOD CABINETS

Highest grade Mahogany finish Cabinets. Hinged top. These cabinets are being sold at less than one-half regular value.

D57 Wood Cabinet, panel size 7"x10".....	Each \$2.50
D58 Wood Cabinet, panel size 7"x12".....	2.75
D59 Wood Cabinet, panel size 7"x14".....	3.00
D60 Wood Cabinet, panel size 7"x18".....	3.50
D61 Wood Cabinet, panel size 7"x21".....	3.75
D62 Wood Cabinet, panel size 7"x24".....	4.00

Baseboards (Mahogany Stained) for use with above cabinets

7x10.....25c	7x14.....35c	7x21.....45c
7x12.....30c	7x18.....40c	7x24.....50c

### PLATE CIRCUIT "B" BATTERIES

The highest grade of battery made at prices lower than they ever were sold before.

D80 2 1/2 Volt Small .....	\$1.15
D81 2 1/2 Volt Medium .....	1.45
D82 2 1/2 Volt Large .....	1.95
D83 4 1/2 Volt Medium .....	1.95
D84 4 1/2 Volt Large .....	2.50
D85 4 1/2 Volt Extra Large .....	3.50
D86 360 Hour 1 1/2 Volt Twin Double Duty "A" Battery .....	.75

### Audio Frequency Transformers

The following transformers are guaranteed standard makes, and will produce very efficient results.

D63 Dietzen 3 to 1 Ratio.....	\$3.95
D64 Dietzen 5 to 1 Ratio.....	3.95
D65 Dietzen 10 to 1 Ratio.....	3.95
D66 Acme Audio .....	4.25
D67 Amertran .....	5.95
D68 U.V. 712 R.C.A.....	5.75
D69 U.V. 714 R.C.A.....	5.75

### MISCELLANEOUS

D163 Spaghetti Tubing, per yd.....	\$0.09
D164 Synthetic Crystal .....	.30
D165 Ground Clamps .....	.17
D166 Black Rubber Binding Posts.....	.05
D167 Nickel Plated Binding Posts, 2 for.....	.05
D168 No. 18 Annunciator Wire, half pound coil .....	.39
D169 6 ft. Phone Cord with Tips.....	.79
D170 20 ft. Extension Cord with Tips.....	1.95
D171 Wall Insulators, Porcelain.....	.05
D172 Tubular Porcelain Lead-in Insulators, 6" .....	.10
D173 Reinartz Coil .....	1.45
D174 Cockaday Coil .....	2.42
D175 2" Dial and Knob.....	.25

## Modell's

ESTABLISHED 1910

America's Greatest Radio Retailers

\*191 FULTON \*71 CORTLANDT BROOKLYN  
Cor. Church Near Washington \*81 Flatbush Av.  
\*14 CHURCH ST. 15 Whitehall St. Post Radio Elec.  
Cor. Cortl. Cor. Stann St Corp.  
(\*Open Sat. Ev'g's) \*\*241 W. 42d St. (\*\*Open Ev'g's)  
Bet. 7th & 8th Aves.

MAIL ORDER DEPT.  
58 Church St. NEW YORK CITY

## The "Goode" Two-o-One

# A

Le Ton d'argent

**Guaranteed**

BY MAIL ONLY  
**\$2.39**

Postpaid

### QUARTER AMPERE AMPLIFIER-DETECTOR RADIO TUBE

GUARANTEED SATISFACTORY

All "GOODE" Tubes Sold Direct to the Consumer—No Dealer Profits

ONE—"Goode" Detector-Amplifier..... \$2.39

THREE—"Goode" Detector-Amplifiers..... 6.42

(All postage prepaid)

The "Goode" Two-o-One A Tube amplifies or detects. It is a quarter ampere, six volts, standard base silvered tube.

Send express or postal money order or New York draft to—

**The Goode Tube Corporation**  
Incorporated  
EVANSVILLE - INDIANA

### S. HAMMER RADIO CO.

303 Atkins Ave., Brooklyn, N. Y.

Never Before at This Price!!

#### Improved Cockaday 4 Circuit Receiver

These Are Genuine Complete Parts

1 Panel, 7x24	2 Ameco Switch Levers
1 Precision Cockaday Coil	3 48,000 Ohms Lavite Resistances
2 Ameco 26 Pl. Cond.	1 .00025 Dubilier
5 Melco Tube Sockets	1 .0005 Dubilier
1 Ameco 6 Ohm Rheostat	1 Pr. Como Dup. P. P. Transformers
3 Ameco 20 Ohm Rheostats	1 Panel, 1x12
2 Amplex Grid Densers	1 Sub Panel, 3x2 1/4
1 Durham Var. Grid Leak	1 7x24 Baseboard
1 Ameco 400 Ohm Potentiometer	11 Switch Points
1 Bradley Leak	2 Switch Stops, Wire, etc.
2 Patent Doub. Jacks	LIST PRICE.....\$72.45
1 Patent Single Jack	OUR PRICE.....\$51.00
2 Amertran Transformers	

#### COMPLETE STANDARD PARTS FOR Neutrodyne 5-Tube Set

1 7x26 Panel, Drilled	1 Filament Control Jack
1 Single Sockets	27 ft. Insulated Tubing
1 Triple Socket	27 ft. Tinned Bus Bar
2 Neutrodons	2 Fixed Condensers, .006 Mfd.
3 Neutroformers	1 Fixed Condenser, .00025 Mfd.
1 Battery Switch	1 Grid Leak, 2 Megohms
3 4 in. Dials, Fada Type	1 Diagram for Above Set
1 Power Rheostat	
1 Vernier Rheostat	OUR PRICE.....\$30.50
8 Rinding Posts	
1 Closed Circuit Jack	

Wired Complete in Mahogany Cabinet..... \$48.50

5-Tube Neutrodyne Set, wired complete in a mahogany cabinet—Genuine FADA Parts.  
**\$70.00**

565.60 FADA KNOCKDOWN PARTS No. 107-A Sealed in Fada's Factory. Complete \$49.00

COMPLETE KNOCKDOWN PARTS  
**8 TUBE SUPER- HETERODYNE**  
Receptrad Kit  
Our Price **\$89.50**

SETS

Crosley V 1-Tube.....\$13.50	Crosley NJ Super 4-Tube.....\$53.50
Crosley 51 2-Tube..... 15.25	Fada 160..... 88.00
Crosley 5B 3-Tube..... 34.50	Fred-Bisman Neutrodyne NR 5.....121.00
Crosley NJ 4-Tube..... 41.00	25% Deposit Required on Sets

ALL MAIL ORDERS SHIPPED PROMPTLY. Orders over \$5.00 will be shipped prepaid. Money orders or C. O. D. Not insured unless insurance charges included. Write for Price List.

**NINE-TUBE SUPER**

(Continued from page 15)

several makes now on the market, but as mentioned above, be sure the peak efficiency frequency of these units corresponds with the frequency to which your input transformer is tuned. Only four rheostats are included in my set; that was all I found necessary. On the other hand, among the seventeen articles by supposed authorities which I have saved, I find that many say five should be used, so, I have left panel space for a fifth should any experimenter building this set desire to put it in. In the hook-up shown, the oscillator tube and the four long-wave amplifiers are all on one rheostat. Some may desire to put the oscillator on a separate rheostat, hence a fifth one.

**Grid Leaks**

Two grid leaks are shown and, no matter what type of tubes are used, they certainly should be variable for best results. The potentiometer may be either 200 or 500 ohms; it apparently makes little difference. The operating point will usually be found a little to one side of center. The five fixed condensers shown are respectively: C-1 is .002 mfd. mica; C-2 is 1.0 mfd. mica; C-3 is .6 mfd. mica; C-4 is 1.0 mfd. mica; C-5 is .006 mfd. mica. (Continued)

**Holder for Alcohol Lamp**

The illustration shows a holder for an alcohol lamp or blow torch which is made of soft pine, although, of course if a person has a chunk of oak or any other piece of hard wood it would be more presentable. Very often you need both hands to hold the lamp and the small base of the torch makes it very unstable. I did not have

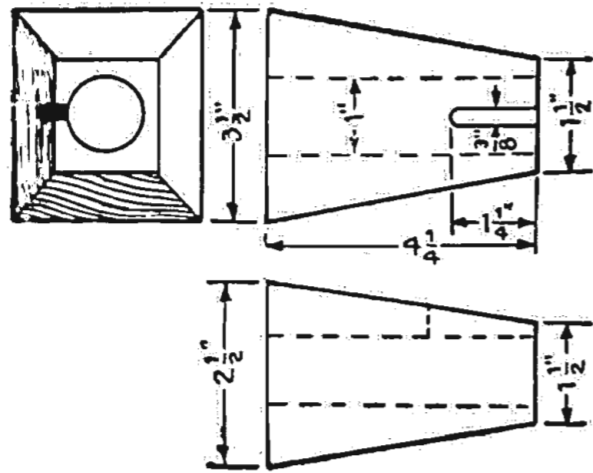

a large bit so I made a circle of small holes and gouged it out with a half round chisel. A 1-inch bit would make the operation more simple. The 3/4-inch long slit, 1/2-inch wide, is for the rubber tube and flow pipe.—Matthew Williamson, Philadelphia, Pa.

Ground the cores of the amplifying transformers. This will insure quieter and more stable operation.

Electric light for farms, camps, garages, homes, for a few cents a day. New electrical discovery. No outside wires. No electric bills. Don't bother with candles and lanterns. Have a flood of electric light with our midget Raylo outfit by simply pushing a switch. Easy to install—with hammer and screw driver. Anyone can do it in 30 minutes. No special knowledge is necessary. 25 cents worth of chemical, supplies power for two weeks. Any drugist sells it—we tell you how to use it. No matter where you are you can have a constant current of electricity bringing you light. An outfit that will operate for years. Equipment includes wire, staples, wall switch, drop light fixture, powerful reflector, mazda lamp, battery system, battery recharger (2 month supply) and instructions. COMPLETE FOR ONLY \$2.00 P. P. prepaid. No circulars issued. Order direct from this adv. including remittance. Money back in full if not satisfied. AGENTS: We want one user agent in each locality to whom customers can be referred. Act quick, send \$2.00 for complete agent's working outfit.

**IRVING ELECTRIC CO.**  
836 Lakeside Pl. Chicago, Ill.

**The Reader's View**

**Announcing Letters Clearly**

It strikes me that the present annoying difficulty of hearing distant station signals, due to poor announcing, would be done away with to a large extent if all announcers would use the signalers' alphabet employed in the field overseas, when it was imperative that the correct letters be heard. Variations in pronunciation of the letters are as follows: A, ack; B, beer; D, don; M, emma; P, pip; S, esses; T, tock; V, vick; Z, zed.—M. C. Anderson, Ottawa, Canada.

**Relay Night**

Permit me to suggest through your columns an innovation in broadcasting which we will call "Relay Night." Meaning that one night be set aside each week for re-broadcasting a varied program from all over the country. Believe this will be endorsed by most Radiophans.—John F. Dwiggins, Detroit, Mich.

**Deaf Hear by Radio**

I am writing you this letter and will be glad if you can find space in the Radio Digest for it. You can use it as you think best. I have been deaf for several years. People cannot talk to me but must write down what they wish to say. Today I was at the home of a friend who has a Radio set. He told me to put the headpiece on and I did and heard Station WJAZ, Edgewater Beach hotel, Chicago, broadcasting music. I heard it all as plain as I ever could before I became deaf. I also heard

**MONEY**

A prominent company, amply financed, whose business is quiet, is interested in the possibilities of the Radio industry. Will consider proposition to manufacture parts or sets. Or furnish capital for expansion. In answering write very fully what your proposition is, in order to save valuable time.

Address  
Box X43, Radio Digest  
510 N. Dearborn St. CHICAGO

**1.00 STAR-ITE**  
**YOU CAN'T LOSE ON THIS**

To get a Star-ite Crystal into your set, in time for the Presidential Conventions, when crystal sets all over the country will hear the "big stuff," we make you the following liberal offers. Just write on a postcard and say you would like to try a Star-ite and we will send you one postpaid on your promise to pay for or return this crystal within fifteen days or—

You can send a dollar bill for a Star-ite with several options in case you do not agree with us that it is the apex of crystal making to date. 1st. You can have your dollar back when you return the crystal. 2nd. We will send you two B-Metal Loose Talking Crystals in exchange. 3rd. You can have three of our Standard Quality Krystals, One Special Silicon, One Bolivia Pyrite and One XXX Galena. 4th. One of our \$1.00 Type E. Detectors (Semi-Fixed).

We believe you will keep the Star-ite and that your pleasure with it will lead to orders from your dealers and friends, who, we think, will hurry to get them.

We have some open territory for live distributors

**Star Crystal Co**  
1414 525 Woodward Avenue  
DETROIT - MICHIGAN

a sermon from Jefferson City, Mo., and special music from Davenport, Iowa and Montgomery, Ala. Radio is great. I believe that it will help me to regain my hearing. At least I am going to listen in often. It is a Godsend to one who is afflicted as I am, and I know that I will get great good from its use. It would please me to have every deaf person in the United States read this letter. Again I say, Radio is one of the greatest inventions of the times.—Cliff R. Crook, Great Bend, Kan.

A cell is a single unit source of electrical

**Worksman Radio Service**  
"THE ACCENT IS ON SERVICE"  
14-16 Vesey St. NEW YORK

**VARIOCOUPERS**  
\$3.50 Workrite 180° Silk Wound.....\$2.95  
3.50 Flsher, Large, 90°.....2.75  
2.75 Flsher, 180°.....2.25  
4.25 Special Bank Wound Coupler for Haynes Circuit (with diagram).....3.25  
7.00 Ambassador Coil (with diagram).....5.50

**VARIOMETERS**  
\$3.50 Workrite.....\$2.95  
5.00 Pathe Moulded.....2.25  
3.50 Flsher, Large.....2.85

**CONDENSERS**  
\$2.00 R. C. 11 plate.....\$1.05  
2.25 R. C. 23 plate.....1.35  
2.75 R. C. 43 plate.....1.65

**VERNIER CONDENSERS**  
\$4.00 R. C. 23 plate.....\$2.25  
5.00 R. C. 43 plate.....2.95

**PHONES**  
\$18.00 DR. SEIBT IMPORTED "SUPER HEADSET".....\$6.90  
\$12.00 N. & K., Imported.....\$6.90

The above items are just a few of our numerous attractive priced articles, which are contained in our BULLETIN OF RADIO PARTS. Gladly sent to you upon request.

We are headquarters for "Radion" and "Bakelite Dilecto" Panels. The best panel material available. Mail orders promptly attended to. Will ship C. O. D. unless remittance accompanies order.

**B-METAL**  
Why B-Metal is the Standard Crystal Of the Radio World Today

B-Metal Loud Talking Crystals have been on the market for two full seasons and have been steadily gaining in popularity. Their users get unusual results as thousands of unsolicited letters testify.

The raw materials for B-Metal are procurable in but one locality and we have combed the earth for improved grades, but have felled thus far to find them. We have improved our treatment several times and our B-Metal today is at least 100% superior to our B-Metal of 1922.

We pass but 10% of the crystals we make as being good enough to maintain our B-Metal standard of quality. 90% are discarded and this is the strongest asset B-Metal enjoys.

One user writes "I have tried all makes as they come out since I bought one of your first B-Metals, but for volume, sweetness and for distance, I always fall back on my B-Metals of which I have several." Your test ones are simply wonderful."

**Every B-Metal guaranteed to satisfy.**  
**Tested four times on music.**

**B-METAL REFINING CO**  
14 WFL 525 WOODWARD AVENUE  
DETROIT, MICHIGAN

energy, while a battery is composed of two or more cells connected together in series, or parallel to obtain characteristics required of the battery.

**QUARIES**

Prices Effective to June 21st  
Mention second choice to be shipped if article ordered is out of stock.

**Lighting Arrestors**  
Brach, regular \$2.50 list.....\$ 1.88  
Brach, regular \$2.00 list.....1.50  
Brach Storm King......75  
Frost.....1.13

**BATTERY CHARGERS**  
Reetlign or Tungar.....\$14.50  
Gold Seal Homecharger.....13.22

**CONDENSERS**  
17 Plate—Standard.....\$ 1.04  
Vernier, with dial.....1.87  
23 Plate—Standard.....1.12  
Vernier, with dial.....1.98

**LOUD SPEAKERS**  
Manhattan.....\$19.20  
Western Electric 521W.....17.50  
Baldwin Standard.....19.25  
R3 Magnavox.....24.30  
M1 Magnavox.....24.80  
Western Electric 10D.....39.50  
Western Electric Via. Att.....9.25  
Baldwin C Unit.....5.21

**TRANSFORMERS**  
Acme A 2.....\$ 3.55  
All American, 5 to 1, 10 to 1.....3.45  
Amertran.....5.10  
Phusiformer.....7.13

**PHONES**  
Western Electric.....\$ 8.50  
Baldwin C.....8.43  
Paent 2200 ohm.....2.85  
Frost 2000 ohm.....2.85

**SETS**  
Radola Type Set, 1 tube.....\$ 7.50  
Crosley 51.....13.85  
Pads 160 Neutrodyne.....30.00  
Tridyne.....48.75

Complete Parts for Super-Heterodyne 8-Tube, including drilled panel (Formica), engraved blueprints and pictures, solid walnut cabinet.....\$99.50

**ELECTRIC FANS**  
Well-known Polar Cub Elec. Fan, 6-inch; operate either on A. C. or D. C.....\$ 3.09

**VALLEY RADIO SUPPLY CO.**  
2206a Locust St. ST. LOUIS, MO.

Write for Agent's Confidential Price List. Always include Parcel Post and Insurance.

**HUDSON-ROSS**  
Sells only Guaranteed Radio Apparatus.  
Send for discounts.  
123 W. Madison St. Chicago

5000  
**RADIO DEALERS**  
buy from  
**HUDSON-ROSS**  
123 W. Madison St. Chicago  
Send for dealers discount.

**HUDSON-ROSS**  
Largest exclusive Radio Jobbers in middle West.  
Write for discounts.  
123 W. Madison St. Chicago

**ARROW BATTERY**  
**SLASHES Prices TO CONSUMERS ONLY**

Prices Smashed! Quality Not Sacrificed

Here is real battery quality, guaranteed to you, at prices that will astound the entire battery-buying public. Order direct from factory. Put the Dealer's Profit in your own pocket. You actually save much more than half, and so that you can be convinced of true quality and performance, we give a **Written Two-Year Guarantee**

Here is your protection! Noneed to take a chance. Our battery is right—and the price is the lowest ever made. Convince yourself. Read the prices!

Special 2-Volt Radio Storage Battery, \$3.75  
Special 4-Volt Radio Storage Battery, 6.00  
6-Volt, 60 Amp. Radio Storage Battery, 7.00  
6-Volt, 80 Amp. Radio Storage Battery, 8.00  
6-Volt, 100 Amp. Radio Storage Battery, 9.50  
6-Volt, 120 Amp. Radio Storage Battery, 11.50  
6-Volt, 140 Amp. Radio Storage Battery, 13.00

We ask for no deposit. Simply send name and address and style wanted. Battery will be shipped the day we receive your order Express C. O. D., subject to your examination on arrival. Our guarantee accompanies each battery. We allow 5% discount for cash in full with order. You cannot lose! Act quick. Send your order today—NOW.

**Arrow Battery Co.**  
1421 South Wabash Ave.  
Dept. 5 Chicago, Ill.

**WE REPAIR THE FOLLOWING RADIO TUBES**

Dealers and Agents write for Special Discount Mail Orders Solicited and Promptly Attended to

**WD-11, WD-12, Our Specialties**

WD-11.....\$2.50	DV-6A.....\$2.50
WD-12.....2.50	UV-199.....2.50
UV-200.....2.50	C-299.....2.50
UV-201.....2.50	UV-201A.....2.50
C-300.....2.50	C-301A.....2.50
C-301.....2.50	Marconi.....2.50
DV-6.....2.50	Moorhead.....2.50
DV-1.....2.50	6 V. Plain Det.....2.50
DV-2.....2.50	6 V. Plain Amp.....2.50

**H. & H. RADIO COMPANY**  
P. O. Box 22-A  
Clinton Hill Station NEWARK, N. J.

**MAGNATRON**  
MAGNATRON DC-199 knows no superior among dry cell tubes. Whether as detector or as amplifier, it will give better results in your set. It and the MAGNATRON DC-201A are unqualifiedly endorsed by experts.

Your dealer has these tubes. They list at \$5.

**CONNEWEY ELECTRIC LABORATORIES**  
309 Fifth Avenue NEW YORK CITY

**Gives You What Other Rheostats Cannot**

**PREMIER "MICROSTAT"**  
Trade Mark Reg. U. S. Pat. Off.  
Super-Vernier RHEOSTAT

The "Microstat" gives you what you expect of any good Rheostat—and then some. Because of its new principle—its two windings in parallel—the "Microstat" enables you to control to the most minute degree the current delivered to the filament of Radio tubes. Without this most important quality your set is not as efficient as it should be. No other Rheostat can give you this infinite control.

"Microstat" handles any tube. Cap. 3 Amp. Absolutely noiseless—two windings in parallel—one 6 ohms, other 40 ohms—Bakelite moulded. Silver etched dial.

A Reel Engineering Job.  
**YOUR DEALER KNOWS—ASK HIM**  
Send for Bulletin No. 92

**Premier Electric Company**  
3810 Ravenswood Ave. Chicago

# Value of Well-Insulated Aerials and Grounds

## Leaks Will Drain off Weak Currents

By Dr. Fulton Cutting

THE Radio user who desires efficiency, volume, range and selectivity cannot attach too much importance to insulation of the aerial and ground.

As the collector of feeble Radio impulses, the antenna is of supreme importance, and on a par with it, in carrying away the waves after they have been through the receiving apparatus, is the ground connection.

An analysis of Radio broadcasting will, very probably, explain this most clearly. The wave that is sent out from a broadcasting station travels over an ever-widening area, gradually becoming weaker and weaker as it goes hundreds or perhaps thousands of miles through more or less absorbing atmosphere and over imperfectly conducting ground.

The receiving antenna may be pictured in the mind as the "fingers of the air." To make use of this feeble impulse, the aerial must be sensitive. Once the wave strikes the wire, it begins a journey to the receiver that may be as weakening as the projection from the distant station.

### Main Cause of Weakening

The main cause of this weakening is poor insulation. A point of poor insulation is a point where there is a "leak." That is, the current is able to flow off the aerial wire and into the roof or the walls of the house. This involves a loss which manifests itself in weaker signals.

Impulses picked up by a distant receiver are so very minute that the most effective collective device possible should be used, and every possible method of insulation be utilized in order to give them a "clear track" into the set. When an antenna is on the roof, the lead-in should be held away by insulation from the sides of buildings. The lead-in should also be run through the wall or window in a porcelain tube or like insulation.

Inside the room short leads are best, but regardless of whether the lead is long

or short, it should be insulated just as well as the wire on the outside of the house or apartment. The popular theory that inside or outside wooden, stone or brick walls will not deduct from the efficiency of an aerial is false. The Radio listener who has his lead-in tacked to the surface of a building may not think that power is diminished, yet there is probably a loss here that is reducing his range and selectivity. Even if the wire has an insulating covering it should not be run directly against a wall. The very proximity of the wall may cause a loss.

### Ground Wire Needs Insulation

After passing through the receiving instruments the signal currents flow into the ground, and here insulation is again highly important. At first sight it seems unimportant by what path the impulses get into the ground. One would think that the more paths that were provided, the better. This, however, is not the case. Only one ground should be provided and that one the best ground available.

The important thing about the ground connection is that it have as low a resistance as possible. High resistance reduces the signal strength. The singular thing about Radio currents is that they do not follow the path of least resistance. The word resistance is here used in its technical sense of electrical resistance. They follow the easiest path to be sure, but this is not necessarily the path of least resistance. The easiest path for Radio currents is the shortest path. We can, therefore, have the following queer condition:

Suppose a Radio receiving installation has two ground connections, one near the receiver and the other at some distance from it. Most of the signal current will flow into the ground through the nearer ground connection. Very little of it will flow through the distant ground connection. If, therefore, the nearer ground connection happens to have a large resistance,

the signal strength will be reduced. Now, if the nearer ground is removed the current must flow through the distant ground connection—it has nowhere else to go, and if the resistance of this ground is low the signal strength will be greater than when there were two grounds.

The practical application of all this is to be sure to support the ground wire on insulators up to the point where it is connected to ground. Water pipes are about the best thing onto which to connect the ground wire, and the connection at this point should be as positive as possible.

### Avoid Loose Contacts

Many condensers are designed so there is a friction contact to the movable plates, that is, the contact is made by the shaft touching a piece of metal. This is a cheap and easy way to make a connection, but it will develop into a loose contact and dust collecting between the shaft and the contact point decreases the efficiency of the entire set. Good firm connections, usually made in the form of pigtailed by wire fastened to the shaft of bearing, form a far superior contact. Scratching and grinding noises in the phones are often traced to a friction contact on a variable condenser.

Sliding and friction contacts are all loose connections and are a source of trouble. It must be remembered that most of the energy radiated by the transmitting station is lost in space. Only the smallest fraction of the current broadcast is picked up by a receiving station. A loose contact places resistance in the path of the feeble impulses passing through the receiving set and the sound is greatly decreased if not inaudible in the phones.

Eighty colleges and universities in the United States operate radio broadcasting stations.

### Socket Binding Post Wrench

When building my neutrodyne set I found it very difficult to tighten up the binding post connections on the tube sockets after they had been placed in position.

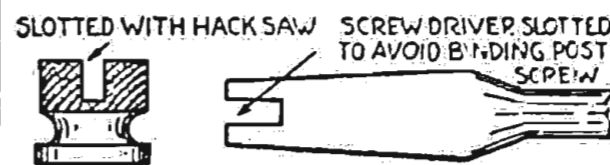

Later I rebuilt the set and before placing the sockets I took off all the tops of the posts and slotted each one with a hack saw. I then made a small slotted screw driver out of a piece of hard sheet brass and now have no loose binding posts.—K. E. Anthony, Brookline, Mass.

Fifty magazines with other than Radio as their chief field have found it profitable to devote a department to Radio.

More than thirty periodicals are devoted exclusively to Radio. Many of these are unknown to the average Radiophan.



ARAGON SILVER RADIO FREQUENCY OUTFIT  
PRICE \$30.00  
ARAGON RADIO COMPANY  
CHICAGO

The Greatest Discovery in Radio  
Build Your Own Neutrodyne Set  
The Aragon Silver Radio Frequency Outfit  
CONSISTING OF  
3 Supersensitive SILVER Condensers  
3 Perfectly Adjusted Coils  
2 SILVER Neutralizing Condensers  
3 4 in. Dials With 25 ft.  
Aragon Silver Wire  
Price \$30.00  
PREPAID  
Special Terms to Dealers  
ARAGON RADIO CO.  
6 E. Lake St. CHICAGO

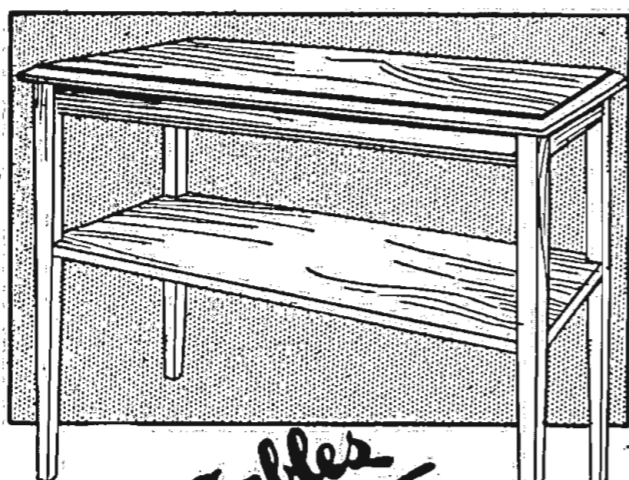

Radio Tables Buy Direct Save Money

\$9.00 DELIVERED TO YOUR HOME

Don't use a valuable table for your Radio when you can buy a specially designed table at this low price. Made of hardwood, mahogany or walnut finish; size 15x32. Shipped KD, parcel post prepaid. Money refunded if not satisfied.  
ACME SALES CO., Evansville, Indiana

1924  
Acme Sales Co., Evansville, Ind.  
Enclosed is \$9.00. Send your special Radio table, prepaid, in \_\_\_\_\_ finish.  
Name \_\_\_\_\_  
Address \_\_\_\_\_



Dealers Need This  
200% Profit

The new FAHNESTOCK Display Case  
Will stimulate your sales of Fahnestock Radio Products. 14 of the most popular styles and sizes are included. Shows the purchaser instantly the correct piece for his set. A constant invitation to buy Fahnestock Products. Dealers are offered 200% profit on each case, an unusual offer on standard merchandise.  
Price to Dealer.....\$17.50  
West of Mississippi..... 18.50  
Transportation prepaid when money order or check accompanies order. Subsequent orders at regular price of \$20.00.  
Contents Retail for \$51.50  
Refills will be supplied at the regular 100 lot prices, shown in catalogue, which comes with case, less discount shown on enclosed sheet. Send check or money order, today.  
FAHNESTOCK ELEC. CO.  
LONG ISLAND CITY NEW YORK

## Mr. Dealer!!

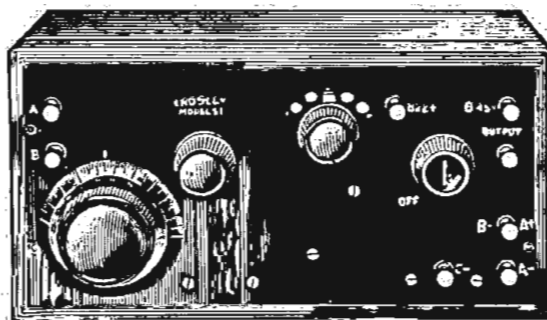

### Crosley Model 51

Are you cashing in on this sensational success? It's going big everywhere. Be ready! Let us keep you supplied.

Get our big catalog—sent ONLY to Dealers. Ask for A1002. No others need apply.

WAKEM & McLAUGHLIN  
225 E. ILLINOIS ST., CHICAGO

## 8 1/2 HOURS ON THE AIR With Two Tubes

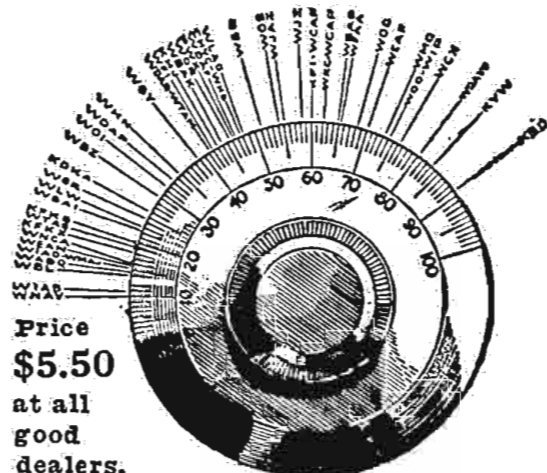

### Uncle Sam MASTER TUNING COIL

Does the Trick  
This is a calibration of a set submitted to a committee of engineers in Philadelphia. Ask your dealer or send us a stamped envelope—self addressed—for wiring diagram and panel layout of this set.  
UNCLE SAM ELECTRIC CO.  
Plainfield New Jersey

## The Twitchell Auxiliary Tuner

Patents Pending. Name Registered

### MORE THAN A WAVE TRAP

A TWITCHELL AUXILIARY TUNER connected to any make of tube receiving set will positively cut out any local broadcasting or code stations so you may tune in all long distance stations any time regardless of local conditions.

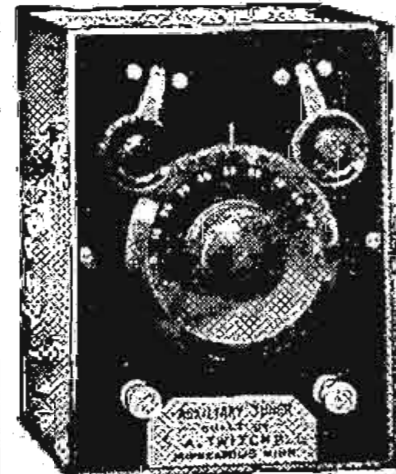

Unlike any wave trap, THE TWITCHELL AUXILIARY TUNER does not ever decrease but in many cases increases the volume from distant stations. These TUNERS are in daily use within 400 feet of large broadcasting stations and enable their owners to easily and completely cut out the local station and bring in distant stations at any time on a loud speaker. This instrument will also enable you to bring in programs sent out on longer waves than you can tune in without it, thus bringing all the broadcasting stations within the wave length range of the many sets of limited range now in use.

Copyrighted diagram of this tuner, 50c, or with all parts, \$9.00. Complete instrument in walnut cabinet, ready to use, \$15.00.

A New and Wonderfully Efficient Coil for the Reinartz circuit for those who want the best. Price \$3.00, or with blueprint for either one or three tubes, \$3.50. This circuit brings in both coastals loud and clear and is the most successful Reinartz modification yet produced.

All goods prepaid. These instruments are easy to build, easy to operate. Everything clearly shown.

1925 WESTERN AVE. S. A. TWITCHELL MINNEAPOLIS, MINN.

World Battery  
Saves You 50%

Famous Guaranteed Quality and Service—Backed by Years of Successful Manufacture and Thousands of Satisfied Users.

Prices That Save and Satisfy

Auto Batteries	Radio Batteries
6-Volt 11 Plate, \$12.25	6-Volt 60 Amps, \$ 8.50
6-Volt 13 Plate, 14.25	6-Volt 80 Amps, 10.00
12-Volt 7 Plate, 17.00	6-Volt 100 Amps, 12.50
	6-Volt 120 Amps, 14.50
	6-Volt 140 Amps, 16.00

Special 2-Volt Storage Battery for W.D. 11 and 12 tubes will run 200 hours on one charge. Rechargeable. \$5.00.  
Special 4-Volt Storage Battery for U.V. 199 tubes. Same features as 2 Volt. \$8.00.  
Shipment express C.O.D. subject to examination. Discount for cash in full with order.

2-Yr. Guarantee Bond in Writing With Each World Storage Battery proves satisfactory World performance. Mail this ad with your name and address and we will ship battery day order is received; and give you a 45-Volt "B" Battery and Hydrometer Free with each battery purchased. Write today.

World Battery Company  
Dept. L, 60 E. Roosevelt Rd. CHICAGO  
45 V. B. BATTERY and HYDROMETER

# Questions and Answers

**Microphone in Circuit**  
(08163) MCA. Wilkes-Barre, Pa.  
Will you show in the Digest how to hook-up a "microphone transmitter," such as used by the army or navy? Can they be used on a 5-tube set? That is, can it be used to broadcast (even for a limited distance, and how far?) from, say, an Atwater Kent outfit?

I enclose rough draft of transmitter which, it is claimed, "Nearly every one or two-tube Radio receiver can be connected into a Radio transmitter, and that they may sometimes save lives and property when connected to the Radio receiving outfit." I shall appreciate it if you will advise through the Digest or personally how to use it—connect and its action.

A—A microphone can be added to any regenerative set merely by connecting it in series with the ground lead, but is of no value in a circuit employing Radio frequency amplification, and in any case has a range of a mile or so, only.  
However, to carry out such a plan of operation is a violation of the law unless you have both an operator's and station license.

### Flivver Set

(08155) JSM. Batavia, Ill.  
I have made the "one condenser flivver super set" and it sure works fine. Thanks for such a fine hook-up, and one that works. What I would like to know is this: What is the wave length of the variocoupler shown in the issue of May 12, 1923 page 15? I cannot get St. Louis. Is it possible to bank wind the primary so as to make the coil shorter? Why do you show the minus of the B battery connected to minus of the A battery? See issue of June 2, 23. I am using a 23-plate condenser and one UV-199 tube.

Should more than one tube be used for audio frequency?  
A—The variocoupler offered in May 12, 1923, issue of Radio Digest will tune to wave lengths from 200 to 550 meters. About fifteen additional turns will certainly

accomplish the higher wave length desired.

Bank winding is feasible and will not act as a detriment to efficiency.

It is immaterial which side of A battery B negative connects to. Ordinarily it is advisable to connect to grounded side if one side of A is grounded, otherwise it is a matter of convenience.

Two stages of audio frequency amplification are recommended for satisfactory loud speaker operation.

### R. F. and Flewelling

(05904) G. M. C., Chicago.  
Have been waiting with what little patience I possess for you to publish the Flewelling, using Radio frequency ampli-

### GIVE YOUR SET A CHANCE

Why choke it with an obsolete, unsightly and dangerous antenna?  
Inside your house is the place for your aerial, not on top. Get away from that summer static, and get wider range, clearer reception and less interference. Equip now with this Dan Dee inside wonder aerial. Works on any set. Six ft. long by 1/2 inch in diameter.  
Price \$2.50  
**DAN DEE AUTO SIGNAL CO.**  
P. O. Box 597, Denver, Colorado

### 1,000 MILES ON A CRYSTAL SET

Send for plans and specifications, simple to build cheap and effective, no variable condensers, batteries, tubes or transformers. Got 20 stations in one night from Winnipeg. Full instructions, for one dollar.  
**GEO. OXTON**  
336 Colony St. Winnipeg, Canada

**MY LATEST 'SB' BALLOON AERIAL**  
Behold the phenomenon of a fine antenna wire suspended perpendicular to the ground. Greater results guaranteed. Just right for peak reception on the week-end, etc. Costs only a few cents for each inflation of pilot balloon. Price complete, \$5.00 plus postage. C. O. D. or M. O. Includes three 30-inch balloon bladders; gas fixtures for jug; special duraluminum antenna wire; large, handy windlass with terminal snap connections and instructions.  
**EVERET SCANLON, Radio Specialties,**  
Lakewood, R. I., via Providence P. O.

**The Traffic Cop of the Air**

He arranges in orderly fashion the mass and jumble of Broadcasting Stations that are seeking entrance to your set and brings 'em in, one at a time, so you can enjoy them! Never red-eyes, but nearly always increases volume. Add a Ferbend Wave Trap to your set and "Police" your reception. Regulate the Traffic!

Guaranteed to tune out any interfering station. The price is \$8.50. Shipment is made parcel post C. O. D. plus a few cents postage. If you prefer, send cash in full with order and we will ship postage prepaid. Send us your order today.

**FERBEND ELECTRIC COMPANY**  
23 E. South Water St. Chicago, Ill.



**ON ONE TUBE**

Broadcasting from Atlantic Coast, Mexico, Hawaii, Canada and Cuba heard in California by users of **CROSS COUNTRY CIRCUIT**. Range due to simplicity of set and only one tuning control. Easily and cheaply built by any novice. Dry cell tubes may be used. All instructions, blue print panel layout, assembly photo, etc. Postpaid 25c. Stamps accepted.

**VESCO RADIO CO.**  
BX D-117 OAKLAND, CAL.



Built up to a high Standard  
Not down to a low price

## CARTER PORTABLE JACK

 \$1.50

For extending loud speaker or head set. Just the thing for Summer use. Extend the loud speaker onto the porch or into the garden.

For camping, summer touring, boating, etc.

Takes any standard plug.  
Any dealer can supply

**Carter Radio Co.**  
1236 S. WABASH ST. CHICAGO

fication, but as there seems little likelihood of your doing this, would like a circuit by return mail. At present I have three stages of audio and get Denver and the West coast almost any night, but want to use a loud speaker.

A.—We are directing your attention to page 13 of May 12 issue of Radio Digest for a diagram showing the method of adding two stages of Radio frequency amplification to the Flewelling circuit. This addition may be attended by many difficulties unless you have an expert's under-

**158 GENUINE Foreign Stamps. Mexico War Issues. Venezuela, Salvador and India Service, Guatemala, China, etc., only 5c. Finest approval sheets 50 to 60%. Agents Wanted. Big 72-p. Lists Free. We Buy Stamps. Established 20 years. Hussman Stamp Co., Dept. 153, St. Louis, Mo.**

### CAUGHT

With worn out dry cell "B" batteries? Purchase the "economy way." Build yourself a rechargeable "Hawley" knock-down "B" storage battery, consisting of large size Edison elements, special molded glass vials, extra heavy and flat bottom (not ordinary thin test tubes) special nickel wire, 200 bore hard rubber perforated separators, rubber stoppers, chemical electrolyte, in fact everything for the actual construction of battery. An 8 page illustrated folder, showing very simple putting together, making of a charger and charging, free with all orders. 45 volt \$6.25, 90 volt \$9.50, 100 volt \$10.50, 150 volt \$14.25, 200 volt \$17.00. Thirty day trial or money refunded. Pioneer dealer. Complete sample, prepaid, 35c.  
**B. D. Smith, Danbury, Conn.**

### ULTRADYNE TRANSFORMERS

1 Input Transformer and 3 Intermediate Transformers \$20.00  
Tuning, Oscillating Coils, \$ 4.00 per pair.....

Full instructions and Blue Prints furnished with each Kit. Absolutely guaranteed. These transformers are suitable for any Super-Heterodyne circuit. Put up in handsome Kit display box. Special discount to dealers. Prompt delivery. Write for special circular.

**SYMPHER MANUFACTURING COMPANY**  
1524 Fernwood Ave., Toledo, Ohio

### What About It?

Isn't it about time to stop experimenting with multiple control circuits and build one that, combining ease of assembly and operation, loudness, clarity and selectivity of signals, as well as beautiful appearance, is excelled by none?

## THE ELGIN SUPER-REINARTZ RADIO RECEIVING SETS

Embodies all the advantages of the well known Elgin Reinartz (the set which was largely responsible for the popularity of this wonderful circuit) and many others. It is much louder, more selective, requires no storage battery, and can be used with excellent results on a short or loop aerial.

It has brought in California stations two thousand miles from Elgin, clearly and without interference on a loud speaker with only one tube, and that while our powerful local station was broadcasting three miles away.

Could you ask for more.

Write for circular giving one, two and three bulb hook-ups of this remarkable circuit. IT IS FREE.

**ELGIN RADIO SUPPLY CO.**  
207 East Chicago Street ELGIN, ILLINOIS

**PATENT ATTORNEYS**  
PATENTS. Booklet free. Highest references. Best results. **WATSON E. COLEMAN, Patent Lawyer,** 644 G Street, Washington, D. C.

**AMBITIOUS MEN, 18 UP.** Become Railway Mail Clerks—Mail Carriers. \$1,400—\$2,300 year. Steady work. Full particulars free. Write immediately. **Franklin Institute, Dept. L97, Rochester, N. Y.**

**SALESMEN, Sell coal in Carload Lots.** side or main line. Experience Unnecessary. Earn week's pay in an hour. Liberal drawing account arrangement. **Washington Coal Company, 900 Coal Exchange Building, Chicago.**

**WE NEED CASH**  
Large Radio Stock at a Sacrifice. Subject to Prior Sale. Write for a List with Prices. Address R. D. 15, Radio Digest, 510 North Dearborn Street, Chicago.

**PATENTS Procured.** Send sketch or model today for examination, prompt report and advice. No charge for preliminary advice. Write for free Booklet and blank form on which to disclose your idea. Highest references. Promptness assured. **Clarence A. O'Brien, Registered Patent Lawyer,** 201 Security Bank Building, Directly across the street from Patent Office, Washington, D. C.

**INSIDE AERIAL**

12 INCHES DIAMETER  
Substance for Outside Antenna  
110 Feet. Standard Copper Wire  
NOT A LOOP  
BUT A FULL SIZE ANTENNA  
Often doubles tone getting far stations in series with outside antenna

COMPLETE POSTPAID \$7

NO DANGER from LIGHTNING  
Of \$5, if four set owners' addresses are sent to us.  
Details about KILLING NOISE in Radio Sets FREE!  
**INTER-STATE SIGNAL CO., DEPT. 1, COLUMBUS, OHIO**



### Stop Interference WITH A NOLTE WAVE TRAP COIL

Guaranteed to eliminate interference without overlapping or reduction in signal strength  
Postpaid \$1.25  
**NOLTE MFG. CO.,**  
61 Gantier Ave. Jersey City, N. J.

Burned Out or Broken  
**Radio Tubes Repaired**

Including  
WD-11 or C-11.  
WD-12 or C-12.  
UV-199 or C-299.  
UV-201A or C-301A.  
UV-200 or C-300.  
UV-201 or C-301.  
DV-1 or DV-2.  
DV-6 or DV-6A.

**\$2.50**

All Tubes Guaranteed to Work Like New

**Radio Tube Exchange**  
220 S. State Street, Room 204  
CHICAGO  
Phone Wabash 0118  
MAIL ORDERS GIVEN PROMPT ATTENTION

standing of its theory and practice. It is not recommended, except as an experiment. Back issues can be obtained at ten cents a copy, if you have not the number referred to.

## Bankrupt Stock

**Cunningham Regenerative one tube long range sets \$10.50 Each**

Prepaid while they last  
Formerly sold at \$32.50

No Circulars. Order from This Ad.  
**S. A. TWITCHELL**  
1925 Western Av., Minneapolis, Minn.

## "ROLLS ROYCE" Radio Tubes

Like their name, significant of quality. Durable and powerful. Bring in distance with a maximum of volume and clearness.

Type 200.....5 volts, 1 Ampere Detector Tube.  
Type 201A.....5 Volts, .25 Ampere Amplifier and Detector.  
Type 199.....3-4 Volts, .06 Ampere Amplifier and Detector.  
Type 199.....3-4 Volts, .06 Ampere With Standard Base. Amplifier and Detector.  
Type 12.....1 1/2 Volts, .25 Ampere Platinum Filament. Amplifier and Detector.

**"THE ROLLS ROYCE OF RADIO TUBES"**

**ALL TYPES \$2.50**

**ALL TUBES GUARANTEED** to work in Radio Frequency. Especially adapted for Neutrodyne, Reflex and Super-Heterodyne Sets.  
SHIPPED PARCEL POST C. O. D. WHEN ORDERING MENTION TYPE

**ROLLS ROYCE TUBE CO.**  
21 Norwood St. (Dept. D), Newark, N.J.



## The New Marvel BEACON CRYSTAL DETECTOR

The Beacon Will—When Others Fail

Gold Point Replaceable Crystal  
Positive Contact Vernier Adjustment

Especially adapted for reflex circuits. Will improve the reception of any crystal set. Every beacon is thoroughly tested in our laboratory and fully guaranteed. The gold point and vernier adjustment gives it positive contact at all times. Replaceable crystal and glass cover make the Beacon the most efficient and economical crystal detector on the market.

**Price, \$1.50—For Sale by All Reliable Dealers**

**JOBBER—DEALERS:** This is a fast seller. Write for discounts.  
**Midwest Electric Specialty Co.,**  
106 North La Salle Street, Chicago, Ill.



Great radio sensation coming

## SHAMROCK-HARKNESS REFLEX

(Licensed-registered manufacturer)

Two tubes operate loud speaker — with wonderful clarity, selectivity and volume.

Watch for further announcement  
**SHAMROCK MANUFACTURING CO.**  
Dept. 31, Market St. Newark, N. J.

## SHAMROCK

(FOR SELECTIVE TUNING)



# Duo-Reflex

Tube for Tube—the Most Powerful Circuits Ever Built. Write for free Bulletin No. 16

**Electrical Research Laboratories**  
CHICAGO.  
E. R. L. A.



"THE AIR IS FULL OF THINGS YOU SHOULDN'T MISS"



No. 7111 Eveready "A" Dry Cell The best battery for use with dry cell tubes



No. 766 "B" Battery, 22 1/2 volts Six Fahnestock Spring Clips

# More Power for Summer Radio

WHEN you take radio away with you—take Eveready Radio "A" and "B" Batteries, the batteries whose great power lasts longer. Remember, summer's the time when radio signals are weaker.

Batteries do get used up in time. The ones you've been using, though partly exhausted, may be satisfactory for the strong winter signals, but are probably inadequate for the weaker summer signals.

For a "B" Battery use the familiar standard 22 1/2-volt Eveready "B" Battery No. 766. It has variable taps for "soft" detector tubes. Put two, three or four in series to provide sufficient power for amplifying tubes.

To light the filaments of your dry cell vacuum tubes for the longest time, use Eveready Dry Cell Radio "A" Battery No. 7111. The Eveready "A" will astonish you by its long-sustained vigor. It is advisable to use two

Eveready "A's" connected in multiple for each WD-11 or WD-12 tube—this gives the "economical eighth" ampere drain per cell which insures maximum economy and longer life. For sets employing from one to three UV-199 tubes use three Eveready Dry Cell Radio "A" Batteries No. 7111 connected in series.

The greatest electro-chemical laboratory known created these famous dry cell batteries on which radio largely depends. The experience of thirty years in battery making stands back of them.

Buy Eveready Radio "A," "B" and "C" Batteries—lively, peppy, long-lived producers of power.

For your light-weight sets to take camping or on hikes, Eveready has suitable small batteries.

Manufactured and guaranteed by NATIONAL CARBON COMPANY, INC., New York—San Francisco Headquarters for Radio Battery Information Canadian National Carbon Company, Limited, Toronto, Ontario

Informative and money-saving booklets on radio batteries sent free on request. If you have any questions regarding radio batteries, write to G. C. Furness, Manager, Radio Division, National Carbon Company, Inc., Thompson Ave. and Orton St., Long Island City, N. Y.

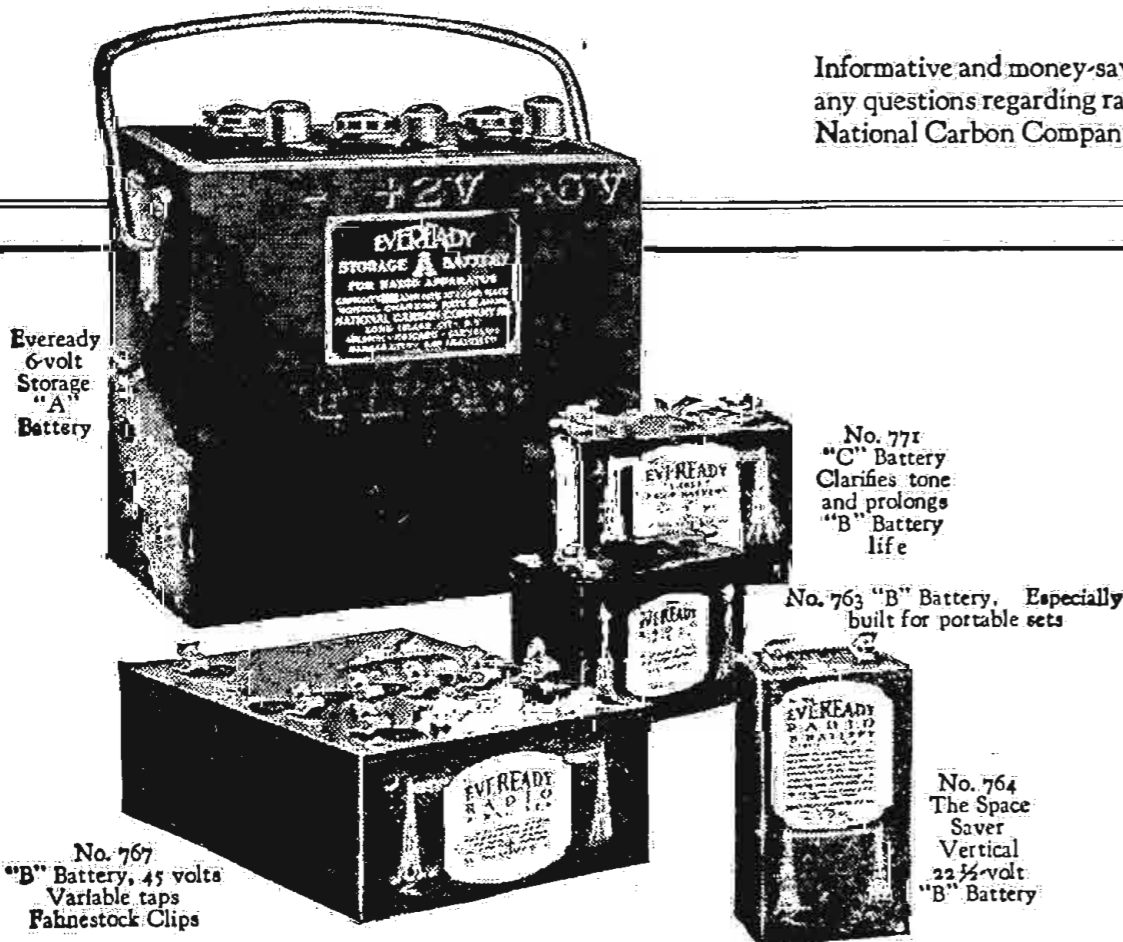

Eveready 6-volt Storage "A" Battery

No. 771 "C" Battery Clarifies tone and prolongs "B" Battery life

No. 763 "B" Battery, Especially built for portable sets

No. 764 The Space Saver Vertical 22 1/2-volt "B" Battery

No. 767 "B" Battery, 45 volts Variable taps Fahnestock Clips

# EVEREADY Radio Batteries —they last longer