

© C18588429

# Radio Digest

EVERY WEEK

# Illustrated

TEN CENTS

REG. U. S. PAT. OFF. & DOM. OF CANADA

Vol. VII

Copyright, 1923  
R. D. P. Co. Inc.

SATURDAY, OCTOBER 20, 1923

No. 2

## TREAT SICK WITH RADIO

### CKAC, LA PRESSE, HEARD IN LONDON

Anniversary Program Picked Up  
by Londoner—Cablegram  
Tells of Feat

MONTREAL, CAN.—Many reports had reached Station CKAC, La Presse plant here, that its signals had been heard on both coasts, in far Juneau, Alaska, Denmark and in the Bay of Biscay, France, but only recently has an English amateur picked up the only French and English station in the world. For the occasion of its anniversary, CKAC had a specially high class program. This had been announced in England. Following its broadcasting a cablegram was received from W. S. Stephenson, managing director of the General Radio Co., Ltd., of London, which stated that reception had been good although much interference had been experienced.



### PROMINENT PHYSICIANS STUDY WONDER OF AGE

Ailments Send Out Distinct Frequencies  
—Medico-Physicists Cure by Transmitting Opposing Wave into Body

By J. L. Newman

CHICAGO.—Of all the wonders of the world which man, during the ages, has discovered and applied, of all the mysteries which have been revealed to those who have thought and sought, none is as great as Radio—the energy wave which is all and in all.

That a Radio set, designed for the purpose, may be used not only to heal the sick but to learn what ails them, to diagnose and cure; that the mysterious impulse or radiant energy which emanates from everything, may be measured and controlled so that man may live virtually without pain; that the cosmic radiation may be harnessed so as to assure future generations surcease from disease and attendant sorrow, was emphasized recently in Chicago by eminent physicians of all schools during the twelfth annual convention of the American Association for Medico-Physical Research.

#### Skeptics Change Views

The organization numbers nearly 2,000 members, citizens of almost every nation under the sun. Among the delegates were men and women who said they had long been skeptical as to the use of Radio principles as diagnostic and curative agents but who were now enthusiastic proponents. Among the delegates were men known as having accomplished what were termed wonderful cures by means of a few electric tubes and the energy eternal and supreme which is borne by the ether.

Most of the discussion of the convention related

(Turn to page 5)

### Radio Pilot in Lifeboat New English Contrivance

Marconi Company Shows Novel  
Means of Rescue at Sea

LONDON, ENGLAND.—A new type of Radio installation for ships' lifeboats was exhibited by the Marconi company at the recent Shipping Exposition at Olympia.

The set is so compact as to be capable of being placed between the after thwarts of a lifeboat. The receiver embodies the principle of a direction finder, so that the lifeboat may inform rescuers of her bearing and then guide them toward her. The aerial consists of a single wire supported by light masts; the range of communication, with a wave length of 600 meters, is fifty miles.

### Railway Traffic Officers Hear WCX on Fast Train

DETROIT.—While members of the American Association of Passenger Traffic Officers were speeding between Chicago and Montreal recently, C. W. Williamson did some experimenting with Radio. While the train was traveling at high speed, he suddenly picked up WCX, the Detroit Free Press.

Most anyone would like to be a great, strong stone wall, if Peggy Wood, above, were to be the "Clinging Vine." Miss Wood, who is appearing in the play by that name, recently appealed over Station WDAP, Drake-Board of Trade, Chicago, for help for the children of the poor. Sylvia Field, left, is the delightful comedy heroine in "Connie Goes Home," now playing in New York, a special matinee of which was given recently before the microphone of Station WOR, L. Bamherger & Co., Newark

# IMMIGRANTS SHOW INTEREST IN RADIO

## RECENT ARRIVALS TALK OF PURCHASE OF DEVICES

### Examination of Aliens at Ports Reveals Knowledge of Parts and of Their Use

### SPECIAL REWARD OFFER

#### Coupon Number 21

This Special Reward Coupon appears each issue in Radio Digest until further notice. When sent in, accompanied by necessary remittance, according to the rules governing same, apparatus can be secured. See apparatus list and rules of offer below.

Save Me—I Am Valuable

Recent examination of immigrants at ports along the Atlantic coast, especially at New York city, showed, it was said, that Radio was known to most of them, that nearly all of them were interested either in the operation or the purchase of receiving sets.

Even those who were least informed, who had come from countries where the rate of illiteracy was highest, had heard of the lights in a box which sang and talked and made funny noises. Many among the men evinced knowledge as to the building of Radio sets.

Not only to the immigrant but to the naturalized and the native-born person the parts offer of Radio Digest is of peculiar value. This is evidenced by the constant growth of the number of inquiries and the demand for parts.

When you order parts remember that changes, caused by the alteration of parts as they are made in the factories, appear in the lists as they are published. Therefore it is necessary that you order from the latest issue of Radio Digest.

#### Rules to Remember

One thing emphasized to those contemplating taking advantage of the special offer; that is, that the number of coupons necessary and the cash remittance, depend on the item sought by the purchaser. The eight classes of items follow:

#### Class A Articles

For two consecutively numbered coupons and thirty cents (\$0.30) any one of the following articles will be sent: 1 Carter Imp Jack and Plug; 1 Carter 15-Ohm Resistance Unit; 1 Schindler .0005 mfd. Built-up Mica Condenser; 1 Schindler .0005 mfd. Built-up Mica Condenser; 1 Schindler .001 mfd. Built-up Mica Condenser; 1 Schindler .002 mfd. Built-up Mica Condenser; 1 Schindler .0025 mfd. Built-up Mica Condenser; 1 Martin-Copeland Sta Put Plug; Walnut Standard Tube Socket; Walnut UV-199 Socket; Dubilier Micadons Type 601 (.0001, .00025, .0005, .001, .002, .0025, .003 or .004 mfd.); Premier Grid Condenser (.00025 or .0005 mfd.); Premier Variable Resistance; 1 Carter 25-ohm Resistance Unit; Standard Socket Adapter for Delta Midget Tube; Electrad Grid Leak (1 or 2 megohms, with clips); Amisco 3-inch Dial; Amisco Inductance Switch; Freshman Micon Condensers (.00005, .00025, .00035, .0005, .001, .0015, .002, .0025, or .003 mfd.); Teleradio V. T. Socket; B Metal Mounted Crystal; Aerovox Lightning Switch; Aerovox Series Parallel Switch; Aerovox Contact Lever; Na-Aid Small Space Socket; Se-Ar-De Vernier Adjuster; 3" Radion Dial, black; 2 1/2" Radion Dial, black; 3" x 1" Radion knob with shafts, 3/4" or 1/2", black; 3" Radion Dial, rhbed surface.

#### Class B Articles

For four consecutively numbered coupons and sixty cents (\$0.60) any one of the following articles will be sent: 1 Carter .04 mfd. Special Fixed Condenser; 1 Carter Jack Switch; 1 Carter Hold-Tite Jack, One Spring Open Circuit; 1 Carter Hold-Tite Jack, Two Spring Closed Circuit; 1 Carter Hold-Tite Jack, Three Spring Filament Control; 1 Carter Hold-Tite Jack, Four Spring Closed Circuit; 1 Carter Hold-Tite Jack, Five Spring Filament Control; 1 Federal Universal Phone Plug; 1 Federal Open Circuit Jack; 1 Federal Closed Circuit Jack; 1 Federal Double Circuit Jack; 1 Martin-Copeland Sta Put Plug; 1 Martin-Copeland WD-11 Socket; 1 Martin-Copeland WD-11 Adapter; 1 Martin-Copeland UV-199 Socket; 1 Martin-Copeland UV-199 Adapter; 1 Martin-Copeland Pull Switch; 1 Martin-Copeland 5-point Inductance Switch; 1 Carter "Tu-Way" Plug; 1 Martin-Copeland SPST Knife Switch; 1 Martin-Copeland SPDT Knife Switch; 1 Martin-Copeland DPST Knife Switch; 1 Martin-Copeland DPDT Knife Switch; Walnut Variable Grid Leak; Walnut Inductance Switch; Dubilier Micadons Type 600 (.0001, .00025, .0005, .001, .002, .0025, .003, .004, or .005 mfd.); Dubilier Micadons Type 610 (.002, .0025, .003, .004, or .005 mfd.); Dubilier Micadon Type 601 (.006 mfd.); Dubilier By-Pass Condenser (.1, .25, or .5 mfd.); Premier Universal Tube Socket; Premier Radio Dial (3/4, 1/2, or 1/4 in. black or white face); Premier Universal Radio Jack, Open Circuit; Premier Universal Radio Jack, Two-Circuit Three Spring; Premier Universal Radio Jack, Two-Circuit Four Spring; Premier Universal Radio Jack, Filament Control Three Spring; Premier Switch Lever and 10 Points; Amisco 6-Ohm Rheostat; Freshman Fix-O Grid Leak and Condenser; Freshman Variable Resistance Leak (with or without condenser); Freshman Micon Condensers (.006 or .005 mfd.); Teleradio 6-Ohm Rheostat; Teleradio 30-Ohm Rheostat; Teleradio Lightning Arrestor; B-Metal Crystal Tube Detector Type A; B-Metal Adjustable Detector Type D; Aerovox Rheostat; Se-Ar-De Vacuum Tube Socket; 3 1/2" Radion Dial, black; 4" Radion Dial, black; 4" Radion Dial, black, rhbed surface.

#### Class C Articles

For six consecutively numbered coupons and ninety cents (\$0.90) any one of the following articles will be sent: 1 Carter 6-Ohm Vernier Control Rheostat; 1 Federal Panel Mount Socket; 1 Federal 6-Ohm Rheostat; 1 Federal 3-Ohm (Power) Rheostat; 1 Ampertite Automatic Filament Control (with mounting); 1 Martin-Copeland Marco Rheostat; 1 Martin-Copeland Series Parallel Switch; 1 Martin-Copeland DPDT Panel Switch; 1 Martin-Copeland 7-Point Inductance Switch; 1 Martin-Copeland 9-Point Inductance Switch; 1 Martin-Copeland 11-Point Inductance Switch; Walnut Variable Grid Leak with .00025 mfd. Condenser;

Walnut Variable Condenser (3-plate .00006 mfd.); Dubilier Ducon; Dubilier Micadon Type 600 (.006 mfd.); Dubilier Micadon Type 610 (.01 or .02 mfd.); Dubilier By-Pass Condenser (1 mfd.); Premier Universal Radio Jack Filament Control Five Spring; CRL Variable Grid Leak, without condenser; Premier No. 250 Variable Resistance, panel mounting; Thordarson Vernier Rheostat; Ritter Loss Aerial; Martin-Copeland Variable Grid Leak; Amisco Multiple Point Inductance Switch; Amisco 20-Ohm Rheostat; Amisco 50-Ohm Rheostat; Freshman Antenna; Freshman Micon Condenser, .01 mfd.; Teleradio Variable Condensers (3-plate or 11-plate); Set "Read 'EM" Binding Posts (8); B-Metal Crystal Tube Detector Type B; Illinois Cushion Resilient Socket; Aerovox Antenna Plug; Aerovox Potentiometer; Aerovox Crystal Detector; Se-Ar-De Adjustable Vernier Condenser; Radion Panel 3" x 7" x 1/2", black or mahoganite; Radion Panel 3" x 7" x 1/2", black.

#### Class D Articles

For eight consecutively numbered coupons and one dollar and twenty cents (\$1.20) any one of the following articles will be sent: 1 Carter 20-Ohm Vernier Control Rheostat; 1 Chindler Radio Frequency Transformer; 1 Martin-15-Point Inductance Switch; 1 Martin-Copeland 13-Point Inductance Switch; Walnut Variable Condenser (5-Plate Copeland 13-Point Inductance Switch; 1 Martin-Copeland .0001 mfd.); Electrad Varlohm, with mica condenser; Dubilier By-Pass Condenser (2 mfd.); CRL Variable Grid Leak with Condenser; Resistor (Type A or 2A); Thordarson Variable Condenser, .00025 mfd.; Amisco 300-Ohm Potentiometer; Freshman Micon Condenser, .015 mfd.; Teleradio Variable Condenser, 23-plate; Aerovox Crystal Detector and Condenser, mounted; Se-Ar-De Variable Grid Leak, with condenser mounting; Fil-Ko-Stat; R. S. C. Variable Condenser 3-plate; Radion Panel 3" x 7" x 1/2", mahoganite; Radion Panel 3/16" x 7" x 1/2", black; Radion Panel 3/16" x 9" x 1/4", black; Radion Panel 3/16" x 10" x 1/2", black.

#### Class E Articles

For ten consecutively numbered coupons and one dollar and fifty cents (\$1.50) any one of the following articles will be sent: 1 Carter 6-Ohm Automatic Control Rheostat; 1 Carter 20 Ohm Automatic Control Rheostat; 1 Demcal 3-Plate Variable Condenser; Walnut Variable Condenser (13-Plate .00025 mfd.); Turney Genuine Reinartz Coil; Dubilier Varlohm (.0004 or .0006 mfd.); Resistor (Type B); Delta Midget Tube and Socket; Thordarson Variable Condenser, .0005 mfd.; Freshman Micon Condenser, .02 mfd.; B-Metal Crystal Tube Detector Type C; Aerovox 3-Gang Socket; Aerovox Double Slide Tuning Coil; Na-Aid 3-Plate Vernier Condenser, with dial; Radion Panel 3" x 7" x 1/2", mahoganite; Radion Panel 3" x 7" x 1/2", black; 1 Federal Potentiometer, 1850 ohms.

#### Class F Articles

For twelve consecutively numbered coupons and one

dollar and eighty cents (\$1.80), any one of the following articles will be sent: 1 Acme Pot-Rheo (potentiometer and rheostat); Walnut Variable Condenser (23-Plate .0005 mfd.); Dubilier By-Pass Condenser (3 mfd.); Premier Variable Condenser without dial (.00035 mfd.); Thordarson Variable Condenser, .011 mfd.; Amisco Compensating Grid Condenser; Freshman Micon Condenser, .025 mfd.; Teleradio Variable Condenser; 43-plate; Se-Ar-De 3-Plate Condenser; Radion Panel 3" x 7" x 1/2", mahoganite; Radion Panel 3" x 7" x 1/2", black; Radion Panel 3" x 9" x 1/4", mahoganite; Radion Panel 3" x 10" x 1/2", mahoganite.

#### Class G Articles

For fourteen consecutively numbered coupons and two dollars and forty cents (\$2.40) any one of the following articles will be sent: 1 Federal 7-Plate Variable Condenser; 1 Federal 11-Plate Variable Condenser; 1 Federal 21-Plate Variable Condenser; 1 Federal Anticapacity Switch; 1 Demcal Variable Condenser 11-Plate Walnut Variable Condenser (43-Plate .001 mfd.); Dubilier Varioden (.001 mfd.); Dubilier By-Pass Condenser (4 mfd.); Premier Variable Condenser with dial (.00078 mfd.); Premier Hegehog A. F. Transformer, 4 to 1 Ratio; Thordarson A. F. Transformer, 3.5 to 1 Ratio; Thordarson Variable Condenser, with vernier knob and dial (.0005 mfd.); Thordarson Variable Condenser, with vernier knob and dial (.00025 mfd.); Ritter Grand Crystal Set, Amisco Double H. C. Coil Mounting; Na-Aid 13-Plate Precision Condenser, with dial (.000297 mfd.); Na-Aid 23-Plate Precision Condenser, with dial (.000523 mfd.); Se-Ar-De 9-Plate Condenser; Se-Ar-De 17-Plate Condenser; R. S. C. Variable Condenser, 23-plate; Radion Panel 3" x 7" x 1/2", mahoganite; Radion Panel 3" x 10" x 1/2", mahoganite; Radion Panel 3" x 12" x 2 1/2", black; Radion Panel 3" x 14" x 1 1/2", black.

#### Class H Articles

For sixteen consecutively numbered coupons and three dollars (\$3.00) any one of the following articles will be sent: 1 Federal Audio Frequency Transformer No. 226 W; 1 Demcal 23-Plate Variable Condenser; 1 Acme Audio Frequency Transformer; 1 Acme Radio Frequency Transformer (R-2, R-3, or R-4); Walnut Variable Condenser (13-Plate vernier); Walnut Variable Condenser (23-Plate vernier); Dubilier Duratran (R. P. Transformer); Premier Micrometer Variocoupler with dial; Premier Variable Condenser with dial (.0015 mfd.); Premier Variable Condenser with vernier (.0004 mfd.); Premier Hegehog A. F. Transformer, 10 to 1 Ratio; Premier Hegehog A. F. Transformer, Tube Socket Type, 4 to 1 Ratio; Thordarson A. F. Transformer, 6 to 1 Ratio; Thordarson Variable Condenser, with vernier, knob and dial (.001 mfd.); T. B. H. Radio Head Set, 2,000 ohms; Tulip Loud Speaker, 15-inch, white; Teleradio Vernier Condenser 23-plate; Teleradio 2,000-Ohm Head Set; Na-Aid Tuned R. F. Transformer, one stage; Na-Aid 43-Plate Precision Condenser with dial (.001 mfd.); Se-Ar-De 35-Plate Condenser; R. S. C. Variable Condenser, 43-plate; Radion Panel 3" x 12" x 2 1/2", mahoganite; Radion Panel 3" x 14" x 1 1/2", mahoganite.

# CONTENTS

Radio Digest, Illustrated, Volume VII, Number 2, published Chicago, Illinois, October 20, 1923. Published weekly by Radio Digest Publishing Company, 123 West Madison Street, Chicago, Illinois. Subscription rates, yearly, Five Dollars; Foreign Postage One Dollar additional; single copies, Ten Cents. Entered as second-class matter at the postoffice at Chicago, Illinois, under the Act of March 3, 1879.

"All the Live News of Radio"..... 1 to 9
An Evening at Home with the Listener In..... 5
Two Weighty Events in Air World..... 7
Radio Telephoto from Japan..... 8
Dry Cell Tube Circuit in Simplex Form..... 10
Further Details of Miloplex Hook-up..... 11
Radio Programs..... 12
Flawing Answers to Questions..... 14
Simple Explanation of Radio for Everybody, Chapter III, Part II—Rectification and Receiver Essentials, by M. W. Thompson..... 15
Editorials; Indi-gest; Condensed, by Dielectric..... 16
How to Build a Push-Pull Power Amplifier Set, by H. J. Marx..... 17
Key Locates Troubles in Receivers..... 19
New Apparatus on the Market..... 21
Questions and Answers..... 22
Broadcasting Stations, Part II—Station Schedules..... 23
Radio Illustrated, a Page of Pictures..... 24

## Looking Ahead

King Miloplex Reigns Supreme—At least you would think so were you to read the host of letters now pouring into the office of the Digest, and testifying to the great success various reader-builders have attained. King Miloplex III, the ultimate in development by the Mystery Man, appears this week. Watch for his article next week.

You Can Learn Code Easily—if you want to take the pains to do it properly. R. H. Allison will soon tell you how to go about learning the various dot-and-dash symbols so that you can "eavesdrop" on your friend, the code amateur, and find out what he is talking about.

What Is an Inductance, and Why? Both the variable and fixed inductance, best described as "some kind of coil of some kind of wire," will be discussed and explained in his clear and impressionable manner by Marvin W. Thompson in the next issue.

Adding a Variometer to a Single Tube Reflex helped one Radiophan reader so much that the Digest next week will give his altered circuit as Hook-Up Diagram R.D.-102. Try this out on your "Erla" or any other single tube reflex.

What's Good or Bad about Your Audio Frequency Transformers? H. J. Marx will tell you next week. He will show just how to proceed to test the A. F. step-ups for their voltage amplification.

Distance Consistently Using Combined Tickled and Tuned Plate—That's what Newell N. Jones of Griswold, Iowa, claims, so see his hook-up on the "Kinks" page of the next Digest.

Newsstands Don't Always Have One Left

WHEN YOU WANT

# Radio Digest

YOU WANT IT!

BE SURE OF YOUR WEEKLY COPY BY SUBSCRIBING NOW

SEND IN THE BLANK TODAY

Publisher Radio Digest, 123 West Madison St., Chicago, Illinois.

Please send enclosed check M. O. for Five Dollars (\$5.00) for One Year's Subscription to Radio Digest, Illustrated.

Name .....
Address .....
City..... State.....

## 'Abroad at Home'



### Where Shall We Go Tonight?

To New York, Cuba, Atlanta, San Francisco or perhaps Honolulu? Far distant stations are continually being brought in clearly and distinctly with a Crosley Model X-J. Unsolicited letters from users, telling of new distance records are received daily. You, too, at a very small cost, can enjoy the many pleasures and conveniences that this new Crosley Model affords.

## CROSLEY MODEL X-J \$65

A 4-tube radio frequency set incorporating one stage of Tuned Radio Frequency Amplification, Detector and two stages of Audio Frequency Amplification, with jack to plug in on three tubes for head phones; new Crosley multistats; universal rheostats for all makes of tubes; new condenser with molded plates; filament switch and other refinements of detail. This receiver is exceptionally efficient in long range reception. It will bring in stations at almost unbelievable distances clearly and distinctly.

We unhesitatingly claim the Model X-J is the best radio receiver ever offered, regardless of price. The Crosley Model X-J together with the complete Crosley line of receivers, ranging in price from \$26 to \$150, are for sale by best dealers everywhere.

## CROSLEY Better-Cost Less Radio Products

List prices on our equipment west of the Rockies 10% higher in Canada add duty. Write for Free Catalog CROSLEY MANUFACTURING COMPANY Powel Crosley, Jr., President 10493 Alfred St. Cincinnati, Ohio



## WALNART Variable Condenser Vernier or Plain

Every day Walnut Variable Condensers are selling in larger and larger numbers. Special construction prevents the plates from getting out of alignment and short circuiting. They are held in slotted studs which permits of condensers being readily cleaned without fear of bending plates.

Catalog of full line on request. We also make Walnut inductance Switch, Variable Grid Resistance, Tube Sockets and Vernier Dial Adjusters.

Ask your dealer to show you these quality radio products or write us.

WALNART ELECTRIC MFG. CO. Dept. 405 1249 West Van Buren St. CHICAGO, ILL.

# RADIO BEACONS AID FOR NIGHT FLIERS

## ARMY AIR SERVICE BUILDS FIRST AIRPLANE GUIDE

Airmen Can Determine Bearings from Automatic Ether Signals—Experiment at McCook Field

By Carl H. Butman

WASHINGTON.—American transcontinental air pilots will fly on cross-country trips guided from field to field by Radio beacons when the plans of the Army Air Service and Signal Corps are perfected. This new Radio navigation development for aiding fliers along the Army Model Airways is not yet ready for use, but work on the first Radio beacon at Wilbur Wright Field at Fairfield, Ohio, will be undertaken shortly by the Army Signal Corps.

The new aerial Radio beacon is the result of experiments conducted at the Radio laboratory of the Signal Corps under the direction of Capt. W. H. Murphy, during the past several months. A model directional Radio transmitter was successfully tried out at the laboratory and later used in practical tests at McCook Field, Dayton, Ohio, up to distances of about forty miles. Experiments with both single and crossed loops were employed, the best results being obtained with the latter.

### How Radio Air Beacon Works

The apparatus to be installed at the first station will be a five kilowatt transmitter which will send out successive signals of a distinct type every five seconds, separated directionally by thirty degrees. That is, taking the station as a center and the exact North bearing as zero or 360 degrees, a significant code signal such as two dashes, is transmitted.

This signal would only be audible at maximum strength for each dash on the line directly north or south of the station. Rotating clockwise, the station would follow the initial signal by transmitting every five seconds another distinctive signal of two dots; each successive signal indicating an angular distance of thirty degrees. An aviator, equipped with a standard Radio receiving set, on picking up the station, would wait for the initial two-dash signal, then, with watch in hand, he would count the succession of signals until a pair of dots was received at equal intensity. By counting the number of elapsed seconds from the initial or north signal to the maximum signal, the flier will know his compass bearing in degrees from the beacon.

### Would Aid Night Flying

With the new station in operation, Air Service and Signal Corps experts expect pilots within a range of approximately 200 miles can be served with a directional signal. When each air field is so equipped, it will be possible for fliers to travel from field to field in bad fog or at night with increased safety.

Fixed ground beacons of this type are favored against the development of special directional finding equipment on aircraft. This is in order to keep all special equipment on the ground, and use only standard Radio equipment for communication and navigation on aircraft, thus saving space and weight.

The only drawback is that the direction or its reciprocal may be used, but as the pilot is usually approaching, there is little likelihood of his being north and thinking he is south or vice versa.

One useful adaption for this Radio beacon signal is its use by Naval airplane carriers or battleships carrying airplanes for calling and "guiding home" their seaplanes after long reconnaissances or when lost in fog or darkness. Postal officials may also find use for Radio beacons in aiding their air mail planes on long trans-continental flights.

Recent developments in England indicate that a strong effort will soon be made to relieve the amateur Radio operator in that country from having to pay a proposed increase in license and buy his apparatus from the British Broadcasting Company.

## GUEST BOOK RECORD FOR WNAC VISITORS

BOSTON, MASS.—An innovation at WNAC, The Shepard Stores, in a corner of the broadcasting studio is the WNAC guest register, a large leather bound book, in which all studio visitors are requested to sign. This is to be kept as a permanent record of all the artists who are broadcast through WNAC, as well as all visitors to the studio.

## FT. WORTH THIEVES LIKE WINTER BEST

FT. WORTH, TEXAS.—That certain forms of theft are influenced by climate was indicated here recently by police reports showing that with the approach of winter the purloining of Radio sets increases. During the winter of 1922-23 many sets were stolen; during the summer none was "lifted." The first theft of this season was reported a few days ago.

## "NIFTY" MAKES A NIFTY GRID LEAK



Miss Gertrude McDonald, one of the "Nifties of 1923"—and she looks it, doesn't she?—shows how to make a grid leak using a piece of hard rubber, a pair of binding posts and a stroke of a soft lead pencil. ©K. & H.

## Seeks Michigan Dead Spots with Set Mounted in Auto

DETROIT.—G. L. Wakeman, of Bay City, Mich., is making extensive investigation in the vicinity of Alpena, Mich., to find the so-called "blind spots" or sections where Radio communication does not penetrate. To gather all possible data, Mr. Wakeman has equipped a car with a receiving set. He is experimenting by tuning in, or attempting to tune in, as he drives his auto between Bay City and Alpena.

## Costa Rica Gets Plant

WASHINGTON.—A report from Costa Rica states that two Mexican engineers have recently arrived there to make arrangements for the installation of the Radio station which was given to the Costa Rican government by the Mexican government. "La Cabana," a public park in San Jose, has been selected for the site of the new station.

A Citizens' Radio Club has been organized in Omaha, Neb., to protect the legal rights of broadcasting stations and listeners in.

# FORESEES WEATHER MONTHS IN ADVANCE

## OCEAN SHIPS TO TELL CONDITIONS AT SEA

Daily Forecast Maps Soon to Be Prepared; Officials Sanction New Plan

By Strachan McMillan

LOS ANGELES.—The next great step in the science of meteorology will be the connected use of Radio so as to determine conditions of the weather out over the Pacific Ocean which shall enable forecasters to predict what the weather will be in California and on the Pacific Coast as much as three months in advance.

This is according to L. H. Blochman, who is now a visitor at the Rosslyn hotel, in this city, who has recently completed a graduate course of study on the weather at the University of California.

The plan as proposed by Mr. Blochman for predicting the weather so much farther in advance than is now possible, has reached the point where it has received the official sanction of E. A. Beals, chief of the weather bureau, Pacific Coast division, who has announced it as "the most scientific yet evolved." It is to be based on weather reports as received from ships at sea on all parts of the Pacific Ocean.

### Plan Preparation of Maps

If the present plans which are now being tried out by the weather bureau at San Francisco prove feasible, daily weather maps will be prepared shortly from data received twice daily by Radio from the ships at all points on the Pacific.

All known sorts of weather conditions travel from the Pacific eastward over the land. When weather reports are received from many boats in widely scattered parts of the Pacific, it will prove but a simple matter to plot the movements of these storms and to predict when they will reach the coast. In fact, this form of forecasting the weather has been in use since 1921, when the method was inaugurated by the San Francisco office of the weather bureau.

The activities and studies of Mr. Blochman are similar to those which are being conducted at the present time by Professors Alexander McAdie and A. Lawrence Rotch of Harvard university, in connection with the United States Weather Bureau at Washington, D. C.

## FLASH FROM ARCTIC ENDS LONG SILENCE

Believe MacMillan Outfit Again in Range

HARTFORD, CONN.—With an end reached in the three weeks' "silence," during which the Arctic exploration party, headed by Captain Donald B. MacMillan, was unable to communicate with thousands of amateur listeners, who have been waiting anxiously for the faintest "whisper" from the North, advising the world of their safety, Radio engineers are now convinced that the approach of the long Arctic winter will see Radio contact permanently established with WNP.

All fears that atmospheric conditions, coupled with the known disastrous effect of the aurora borealis on transmission, might have rendered practically useless the powerful equipment on board the Arctic schooner "Bowdoin," vanished recently with the report that a faint message giving the vessel's location as "latitude 78:30," was picked up by two amateur Radio stations.

Although the receipt of this fragment of a message may have been due to a temporary gap in the absorbing curtain of the aurora, the engineers believe that it is the forerunner of positive connection with the Arctic Radio, which will continue un-failing throughout the coming winter.

Vacuum tubes are very cheap in England, some selling for \$3.38, while German or Dutch tubes can be bought much cheaper.

## THE ANTENNA BROTHERS

Spir L. and Lew P.

## A Little Varnish Remover

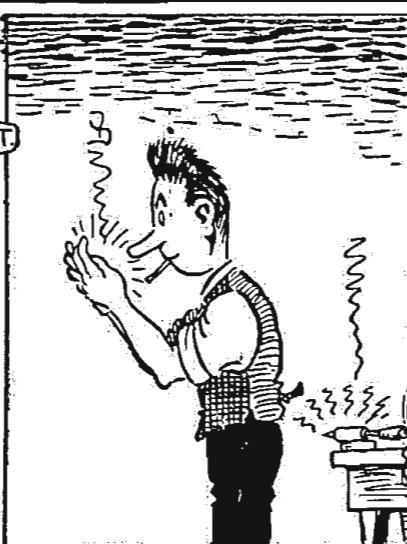

## TINY MOVIE VAMP IS RADIOPHAN

"Aren't you going to stay and listen to my Radio?" asks Baby Peggy of the Universal-Jewel company of motion picture producers. She has won just renown by her representation of leads in child plays, including in their casts a trained chimpanzee, a pony and a bull dog. She is a little vamp and never fails to give pleasure to young folks and old



### WNAC Adds Mechanical Orchestra to Equipment

Electrical Violin and Cello with Piano Produce Fine Music

BOSTON.—A mechanical orchestra has been added to the equipment of WNAC, the Shepard Stores, consisting of a piano, violin and cello. The instruments are all played by electricity, and are visible as they play. The piano accompaniments harmonize perfectly, the whole giving the effect of an orchestra of from three to eight pieces. Instead of the regular violin bow this instrument has small revolving disc bows, driven by motor, one disc for each of the four strings of the two instruments. The machine is capable of playing all four strings at once, producing stringed quartet and other harmonies of great tonal beauty.

### Editor Appreciates WWJ

DETROIT.—The staff of Station WWJ, the Detroit News, has just received a box of cigars and a box of candy from the Osceola (Ark.) Times as an appreciation of the first broadcasts WWJ is giving the Southwest.

## STATIONS TO HERALD NAVY'S BRAVE AGTS

PLANTS ALL OVER COUNTRY TO CELEBRATE OCT. 27

*Ships' Bands in Every Port to Acclaim, with League, Glories of Sea Force*

WASHINGTON.—Twelve or more broadcasters in as many cities will spread tidings and entertainment pertaining to Navy Day on the evening of October 27, according to officials of the United States Naval league.

The second annual celebration of Navy Day will be aided throughout the country by officers of the navy and officials of the Navy League, assisted by the Marine band, and by ships' bands in practically every port. Eighteen broadcasters have been invited to participate and so far six have indicated they would co-operate for at least an hour when speeches and entertainment will be furnished by the Naval personnel.

### Stations Aiding Celebration

Stations KFJC, Post-Intelligencer, Seattle, Wash.; WOAW, Woodmen of the World, Omaha, Neb.; KFAF, Western Radio corporation, Denver, Colo.; WMC, Commercial Appeal, Memphis, Tenn.; WRC, Washington Radio corporation, Washington, D. C., and KSD, St. Louis (Mo.) Post Dispatch, have signified their willingness to co-operate.

Other stations which have been invited to participate are WBZ, Springfield, Mass.; WJZ, New York; WGY, Schenectady, N. Y.; KDKA, Pittsburgh, Pa.; WSB, Atlanta, Ga.; WLAC, Raleigh, N. C.; WFAA, Dallas, Tex.; KDN, San Francisco; KFI, Los Angeles; KYW, Chicago; WFAV, Miami, Fla., and WAAC, New Orleans.

### To Amuse Isolated Cribmen

CHICAGO.—Radio concerts will soon vary the routine of marooned caretakers on this city's lake cribs, which are water intakes located from two to four miles off shore. Corporation Counsel Busch recently approved contracts for immediate installation of the sets.



The Ideal Radio Instrument for the Home—

The New **GREBE** Broadcast Receiver

THIS Receiver is contained in a beautiful walnut cabinet that has compartments for all necessary batteries. The 20-ft. silk-covered wire is the only antenna required.

Write for "Grebe Radio in the Well-Appointed Home."

Licensed under Armstrong U. S. Pat. No. 1,112,149

A. H. GREBE & CO., Inc., Richmond Hill, N. Y.

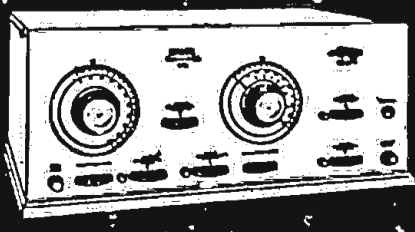

# Morrison

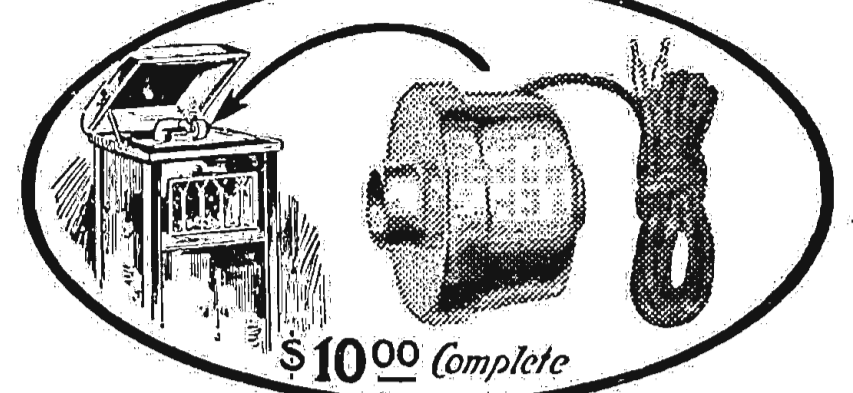

Loud Speaker

## THOUSANDS

of people are listening in every night to this season's wonderful concerts and programs—music and voices made real and clear through the reproducing perfection of Morrison Loud Speaker. All harshness and vibration are eliminated—even with extreme amplification. True tone and full volume are guaranteed. Soft, mellow tones or loud full notes at your pleasure by the turn of a dial. There is nothing to get out of order.

For  
**Phonographs**  
or **HORNS**

Whole families can now enjoy an evening's concert together—can ask their friends in for dancing. For you can attach Morrison Loud Speaker to the tone arm of your phonograph and have the best sound box possible. Or use Morrison Loud Speaker with a Horn—in either case it takes but a moment's time to attach.

*We guarantee satisfaction—  
or your money back.*

Nickel Plated Model— **\$10.00**  
complete with 5 ft. cord

If your dealer cannot supply you, order from us direct.

## DEALERS

MORRISON LOUD SPEAKER is being merchandised with astounding success by some of the best known jobbers and dealers in the country. Why? Because the Morrison is as good as we say it is, because we aid our jobbers and dealers with helpful merchandise methods at all times. There is business in your territory. Write or wire for our proposition.

*Beautifully illustrated catalog  
Free on Request.*

**Morrison Laboratories, Inc.**  
343 Jefferson Avenue, East, Detroit, Mich.

# RADIO DIAGNOSES ILLS AND CURES

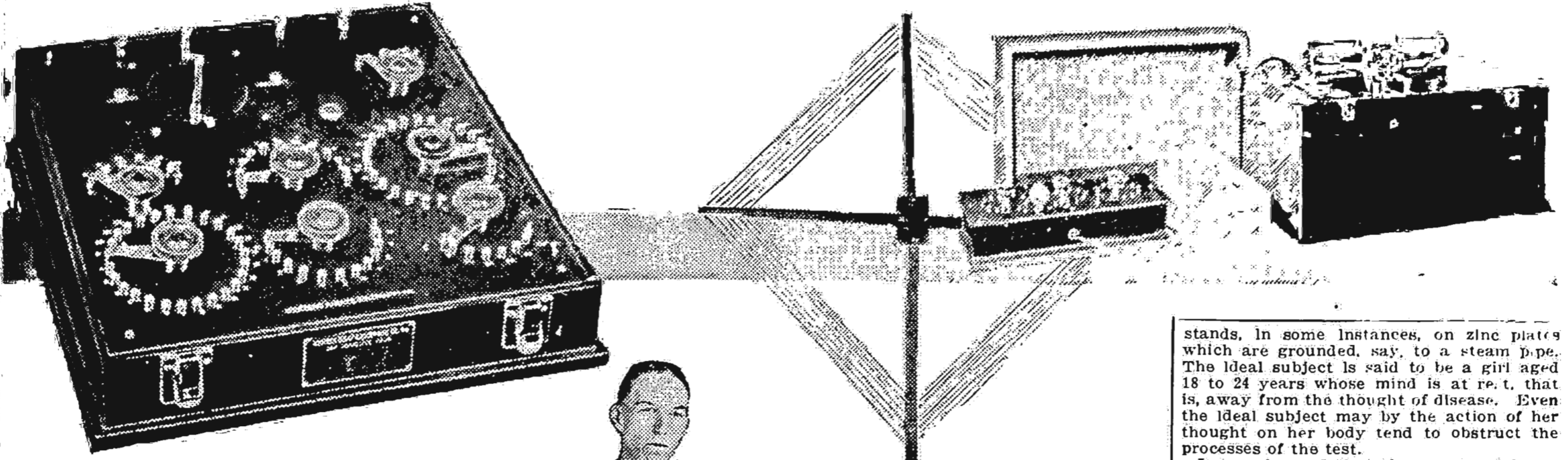

## TREAT SICK WITH RADIO

(Continued from page 1)

to the use of Radio principles and the best manner in which their efficacy could be made known not only to the laymen but to the medical profession as a whole. Among the topics were "Electro-Ionization of the Blood Components," presented by Dr. Rea Buchanan of Lincoln, Neb.; "Principles of the Modern Theory of Electricity and Their Bearing upon Radiotherapy," by Dr. Gustav Kolischer, Chicago; "Miracles of Galvanism," by Dr. Madge Patton Stephens, Terre Haute, Ind.; "High Frequency and Some of Its Applications," by Dr. Leslie C. Sammons, Shelbyville, Ind., and "Some Essential Points in Diagnosis by Electronic Methods," by Dr. Samuel King, Warren, Pa.

### Diagnoses and Treats

"The world stands at the threshold of its greatest discovery," said Dr. Frederick Dugdale of Boston, Mass. "And like most revelations of the kind it ultimately becomes simple. The electronic energy or radiation of all things, 'alive or dead,' animate or inanimate, is applied to both the diagnosis and the treatment or cure of disease. Science now knows that energy issues from or is part of all things, visible and invisible, palpable and impalpable. It remained for the application of the principles of Radio to give to suffering humanity what even the most hardened scoffers are beginning to admit is nature's greatest boon—"Radio"—her gift to those who knowingly or otherwise violate her laws."

The theory thus summarized by Dr. Dugdale was presented in part in 1916 by Professor Thompson of England. For his scientific research in and proof of what was termed the electronic theory he received the Nobel prize.

The electron is said to be the smallest particle of matter. It is negative in character; the proton is positive. Together they form a miniature solar system. The proton is the sun; the electron is a satellite.

### Radio Activity Determines Substances

The difference between substances such as wood, metal, food and the like is the difference between the groupings and the speed of their respective electrons. This energy or life is known as Radioactivity.

All substances may be considered as broadcasting stations. (This was the gist of the addresses to the convention; it is the hub or core of the research of the last few years.) These substances put "signals" on the air which vary as do the assembly and rate of activity of their electrons. All of the sensory organs—nose, eyes, ears, mouth and touch—are receiving sets. Every nerve track in the body is a receiving set.

When the electronic system is applied to the healing art the natural laws of Radio-telegraphy are applied, it was said. This is the basis of the entire theory of Radiotherapy, that is, healing by means of the principles of Radio.

### Experiments First Ridiculed

Ceaseless research in the face of derision and bitter opposition resulted in the discovery, it was reported, that diseased spots in the human or any other "animate" body radiate variously, that is, the kind of disease may be determined by its rate or mode of radiation, by its wave length.

It was learned, too, that one drop of blood containing countless billions of electrons emits vibrations which indicate what disease may be present in the body, and its location. As the blood courses through the body it absorbs the vibrations or wave lengths of the tissues. These vibrations, be they from well or ill tissue, may be recorded by the application of Radio principles. By means of a Radio receiving set, designed to permit application in relation to therapy or healing, the "wave length" of a disease may be tuned in, other wave lengths may be excluded, and the pathologic condition or ailment of the patient determined.

### Blood Drop Radiates Disease

The drop of blood, which condenses the vibrations of the body as a whole, will, when placed in what is known as a col-

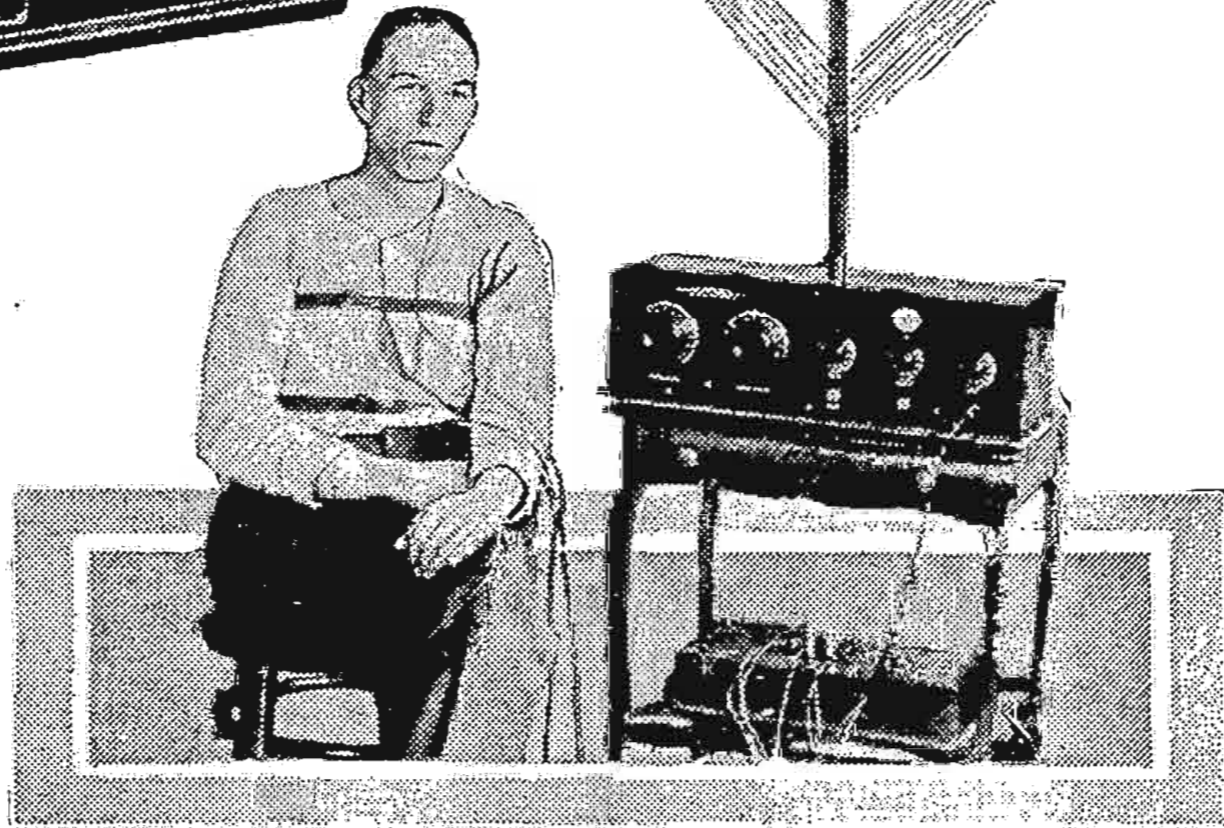

So successful has the work in Radio therapeutics been that many manufacturers have gone into the making of satisfactory devices. While many different styles exist practically all operate on paralleling principles. Above are two such devices, while below is the patient of a "Radio Doctor."

lector, grounded, say, to an ordinary radiator and attached to a rheostat of special design, show unerringly the nature and location of disease. These reactions are

amplified by suitable means. The subject (any person whose body is used as an automaton, that is, whose sympathetic nervous system is used as a detector) or patient

stands, in some instances, on zinc plates which are grounded, say, to a steam pipe. The ideal subject is said to be a girl aged 18 to 24 years whose mind is at rest, that is, away from the thought of disease. Even the ideal subject may by the action of her thought on her body tend to obstruct the processes of the test.

It was learned that the impulse (almost like a Radio wave length) of streptococci, as determined by a modified Radio apparatus, was 60, sarcoma (a form of cancer), 58; carcinoma (another form of cancer), 50 and tuberculosis, 42. It was also learned, it was reported, that most of the ills of mankind are due in one way or another to an unidentified, universal taint (psora) which root disease is susceptible to treatment by special Radio apparatus. Where the patient is in the office of the Radio doctor or 1,000 or more miles away, the results are the same, it was said.

### How Healing Wave Is Broadcast

According to recent experimenters Radio may be used not only as a receiving set, that is, to record the kind and location of disease, but may be used as a broadcaster or transmitter (on the order of "wired wireless") of healing waves through the medium of the ether. As an instance—it is said to be possible to diagnose the disease of a man in Chicago by means of a suitable Radio instrument in New York City and to send to the patient in the western city healing waves as they issue from a machine in the eastern metropolis, using wires for transmission. Not long ago a railway engineer working out of Duluth, Minn., (this was one of many illustrations) was treated successfully for cancer by a Radio contrivance located at the head of the lakes.

By creating a Radio vibration similar to that issued by a disease in a human body it is possible, it is said, to cancel or neutralize the disease. This theory and practice are upheld by such an eminent authority as Sir James Barr, formerly president of the British Medical Association.

### Diagnosis Methods Unfailing

One of the various methods in which Radio is used to diagnose and treat disease is that in which the operator or physician taps the abdomen of a patient (or subject other than the patient) or draws a glass tube across his body. Alteration in the volume of sound thus obtained or the manner in which the glass tube sticks to the skin indicates the kind and location of disease. The radiant energy of consumption is sent, as an illustration, to one part of the body, that of cancer to another. And there is never confusion nor a mistake.

A form of treating disease by Radio principles is that in which the patient sits in a wooden chair to the back of which is attached a device which collects his energy. The energy is lead by wires to and through the Radio healing set. As the energy passes through the latter device certain characteristics of the radiation are changed after which it is lead back by another set of wires and applied to the patient.

### What Happened to KPO

Perhaps the most concrete illustration of the manner in which Radiotherapeutic instruments function was that in which the waves used recently by a practitioner in San Francisco interfered, it was said, with the broadcasting of Station KPO, Hale Brothers, of that city. The operator of the latter station, hindered by the working of the Radio healer, finally found it several floors below in the same building. This was a denial, it was argued, of the charge that radiant energy does not issue from a Radio healing device.

During the convention here Dr. Buchanan demonstrated with an ordinary Radio tube the manner in which Radio is applied to detect or diagnose and treat disease. "I built a Radio set," he said, "along the lines of the Hartley circuit. Experiments proved in effect that the aerial transmitted Radio frequency or electronic Radio waves, or an electronic force closely allied, capable of healing disease. The electronic waves make the blood a better carrier of oxygen which in connection with another process effects a cure."

### Riddle of After Life Soon Solved?

That the world may look for even greater things along these lines was the prediction of William H. Hunt, electronic expert of Chicago. "The close kinship of the forces of the human body to the Radio forces, now quite well understood," said he "is truly a stupendous discovery. While we believe that the human energies—vital forces, if

(Continued on page 14)

## AN EVENING AT HOME WITH THE LISTENER IN

(SEE INSTRUCTIONS FOR USE BELOW)

Station and City	M-t.	Monday	Tuesday	Wednesday	Thursday	Friday	Saturday	Sunday
CFCA Toronto, Ont.	400	7:00-8:00	7:00-8:00	7:00-8:00	7:00-8:00	7:00-8:00	7:00-8:00	5:45-6:45
CFGN, Calgary, Alta.	440	12:00-1:00		11:00-2:00			11:00-1:00	
CKAC, Montreal, Que.	430		6:00-8:30		6:00-8:30		6:00-8:30	3:30-4:30
KDKA, E. Pittsburgh, Pa.	326	4:00-8:00	4:00-8:00	4:00-8:00	4:00-8:00	4:00-8:00	4:00-8:00	6:30-7:30
KDZE, Seattle, Wash.	455	10:30-12:30		10:30-12:30		10:30-12:30		
KFAF, Denver, Colo.	360	9:00-10:00	9:00-10:00		8:30-9:00	9:00-10:00		
KFL, Los Angeles, Calif.	469	8:45-1:00	8:45-1:00	8:45-2:00	8:45-1:00	8:45-2:00	8:45-2:00	10:00-1:00
KGW, Portland, Ore.	492	10:00-12:30	10:00-1:00	10:00-1:00	10:00-1:30	10:00-1:30	10:00-1:00	8:00-10:00
KHJ, Los Angeles, Calif.	395	8:45-12:00	8:45-12:00	8:45-12:00	8:45-12:00	8:45-12:00	8:45-12:00	10:00-12:00
KPO, San Francisco, Calif.	423	10:00-12:00	10:00-12:00		10:00-12:00		10:00-2:00	10:00-12:00
KSD, St. Louis, Mo.	546	8:00-10:00	8:00-10:00	8:00-10:00		8:00-10:00	8:00-10:00	
KYY, Chicago, Ill.	636		8:00-9:00	8:00-9:00	8:00-9:00	8:00-9:00	8:00-9:00	
NAA, Radio, Va.	435	6:45-7:20	6:05-7:20	6:25-7:40	5:45-7:40	7:05-7:40		
PWX, Havana, Cuba	400			8:00-10:30			8:00-10:30	
WBAP, Fort Worth, Texas	476	7:30-10:30	7:30-10:30	7:30-10:30	7:30-10:30	7:30-10:30	7:00-7:30	5:00-6:00
WBAP, Columbus, O.	390	7:00-9:00						
WBZ, Springfield, Mass.	337	6:30-8:00	6:30-8:00	6:00-8:00	6:30-8:00	6:30-8:00	6:30-8:30	7:30-8:30
WCAP, Washington, D. C.	469		5:30-6:30		8:45-11:00		5:30-11:00	5:20-8:00
WCBD, Zion, Ill.	345	8:00-10:00				8:00-10:00		2:30-5:30
WCF, Detroit, Mich.	517	7:30-9:00	7:30-11:00	7:30-9:00	7:30-9:00	7:30-9:00		6:15-7:15
WDAF, Kansas City, Mo.	411	8:00-1:00	11:45-1:00	8:00-1:00	11:45-1:00	8:00-1:00	11:45-1:00	4:00-5:00
WDAJ, College Park, Ga.	258	7:30-11:30	7:30-11:30	7:30-11:30	7:30-11:30	7:30-11:30	7:30-11:30	7:30-11:30
WDAP, Chicago, Ill.	360		7:00-1:00	7:00-1:00	7:00-1:00	7:00-1:00	7:00-1:00	9:15-11:15
WDAR, Philadelphia, Pa.	395	6:30-9:55	6:30-7:00	6:30-10:00	6:30-7:00	6:30-12:00	6:30-7:00	
WDT, New York, N. Y.	405			6:00-7:00		10:00-11:00		
WEAF, New York, N. Y.	492	6:30-9:00	6:30-9:00	6:30-9:00	6:30-9:00	6:30-9:00	6:30-10:00	6:30-9:00
WFAA, Dallas, Tex.	476	8:30-9:30	8:30-12:00		8:30-9:30	6:30-9:30	8:30-12:00	9:30-11:00
WFL, Philadelphia, Pa.	395	6:00-8:30	6:00-8:00	6:00-6:30	6:00-8:00	6:00-6:30	6:00-6:30	6:30-7:30
WGI, Medford, Mass.	360		6:00-7:30	6:30-8:00	6:00-7:30	6:30-8:00	6:30-8:00	7:30-10:00
WGR, Buffalo, N. Y.	319	6:30-9:00	5:30-7:45	5:30-9:00	5:30-7:45	5:30-9:00	5:30-7:45	
WGY, Schenectady, N. Y.	380	6:45-9:00	6:45-9:00		6:45-9:00	6:45-10:30		5:30-6:30
WHA, Madison, Wis.	360	7:30-8:30		7:30-8:30		7:30-8:30		
WHAS, Louisville, Ky.	400		7:30-9:00	7:30-9:00	7:30-9:00	7:30-9:00	7:30-9:00	4:00-5:00
WHAZ, Troy, N. Y.	380	8:00-9:30						
WHB, Kansas City, Mo.	411		8:00-10:00		8:00-10:00			8:00-10:00
WHK, Cleveland, O.	360	5:00-5:30	5:00-5:30	5:00-8:55	5:00-5:30	5:00-5:30	5:00-5:30	7:00-8:55
WHN, Brooklyn, N. Y.	360	6:30-11:00	8:30-11:00	6:30-11:00	8:30-11:00	8:30-11:00	6:30-11:00	8:30-11:00
WIP, Philadelphia, Pa.	509	5:00-6:30	5:00-11:00	5:00-6:30	5:00-10:00	5:00-6:30	5:00-11:00	3:30-4:30
WJAX, Cleveland, O.	390		6:30-8:30		7:00-9:30			
WJZ, Chicago, Ill.	448		10:00-2:00	10:00-2:00	10:00-2:00	10:00-2:00	10:00-2:00	6:00-9:00
WJY, New York, N. Y.	405		6:30-10:30		6:30-10:30	6:30-10:30		5:00-5:30
WJZ, New York, N. Y.	455	6:30-10:00	6:30-10:00	6:00-10:00	6:30-10:30	6:30-10:30	6:30-10:30	7:30-9:30
WKAQ, San Juan, P. R.	360		7:00-8:30				7:00-8:30	
WLAG, Minneapolis, Minn.	417	7:30-10:00	7:30-10:00	7:30-12:30	7:30-10:00	7:30-10:00	7:30-12:30	7:45-8:45
WLW Cincinnati, O.	309	8:00-10:00	10:00-12:00	8:00-10:00	10:00-12:00			
WMAQ, Chicago, Ill.	448		7:00-10:00	7:00-10:00	7:00-10:00	7:00-10:00	7:00-10:00	4:30-5:00
WMO, Memphis, Tenn.	500	8:30-9:30	8:30-12:00		8:30-9:30	8:30-12:00		
WNAC, Boston, Mass.	278		7:00-9:00	8:00-10:00	7:00-9:00	7:00-9:00	8:00-10:00	5:30-7:30
WOAT, San Antonio, Texas	325		9:30-10:30					9:30-10:30
WOAW, Omaha, Neb.	526	9:00-10:00	9:00-10:00		9:00-10:00	9:00-10:00	9:00-10:00	9:00-10:00
WOC, DuPont, La.	484	8:00-9:00		8:00-11:00	8:00-9:00	8:30-9:00	9:00-10:00	7:00-10:00
WOO, Philadelphia, Pa.	509	6:45-10:00				6:45-10:00		
WOS, Newark, N. J.	405	5:15-10:00	5:15-6:30	5:15-10:00	5:15-6:30	5:15-6:30	5:15-10:00	
WOT, Jefferson City, Mo.	441	8:00-9:30		8:00-9:30		8:00-9:30		
WSAL, Cincinnati, O.	309		7:00-9:00		7:00-9:00		9:00-11:00	
WSB, Atlanta, Ga.	429	8:00-12:00	8:00-12:00	8:00-12:00	8:00-12:00	8:00-12:00	8:00-12:00	7:30-9:15
WSY, Birmingham, Ala.	360	8:00-8:45		8:00-8:45		8:00-8:45		8:00-9:00
WTAM, Cleveland, Ohio	390			7:00-8:30			8:00-10:00	
WWJ, Detroit, Mich.	517	7:30-9:00	7:30-9:00	7:30-9:00	7:30-11:00	7:30-9:00		4:30-5:30

Instructions for Use.—All the hours above are given in Central Standard Time. If your city uses Eastern Time, add one hour to each of the periods stated; if your city uses Mountain Time, subtract one hour; if your city uses Pacific Time, subtract two hours. This table includes only the evening broadcasts, and on Sunday, the late afternoon program.

# PHILADELPHIA COPS TO TOTE AIRPHONES

CARRY DEVICE ON BACKS, CHIEF PROPOSES

Auxiliary Police Force of Radiophans Also Suggested by Quaker City Officials

By W. E. Johnson

PHILADELPHIA.—Police of Philadelphia soon will be walking their beats with tiny Radio sets strapped to their backs, by means of which they can be kept constantly in contact with headquarters, if the plans of Superintendent of Police Mills carry through.

The superintendent, who has asked for a liberal appropriation out of the next municipal loan for construction of a city broadcasting station, explained today his plans to utilize Radio in a practical and larger way in the drive against crime.

Each Cop to Get Set

"We propose," he said, "to equip each policeman with a small portable set. Not only the patrolmen and traffic men would be so equipped, but all members of the force now assigned to keep moving about the city in automobiles watching for robbers and car thieves.

"The plan contemplates the use of some sort of signals, perhaps a siren during the day and a light at night, which would notify policemen throughout the city to listen in for instructions. A policeman on his beat could then obtain information as accurately and as promptly as if he were at his own particular station house. Every policeman in the city would be reached and instructed simultaneously.

Would Have Citizens Aid

"In time we hope to establish an auxiliary police force, composed of Radio enthusiasts, who will volunteer their services. There are in Philadelphia at least 200,000 sets. The police bureau could adopt a code for communication with trustworthy owners who have civic pride enough to co-operate with the force.

"For instance, thieves representing themselves as electric, gas or telephone inspectors, at times gain entrance to dwellings to commit crimes. At once, upon receiving the description of such a criminal, the police bureau could send his description broadcast, asking the auxiliary force as well as the regular policemen to be on the lookout for him."

# COMPARES AIRPHONE TO VALUABLE VIOLIN



Efrem Zimbalist, world famous violinist, listens in to the broadcast tones of a violin, comparing the reproduced sound with that from the one he has in his arms, a recently purchased \$33,000 "Titan" Stradivarius. It is to be hoped that the test did not condemn Radio in the opinion of Zimbalist, who is a regular listener in © K & H.

The station, if authorized, will be sufficiently powerful to reach New York, Chicago and the New England states. It probably will be located either atop the 547-foot city hall tower or on some hill in Fairmount park.

# Sweden Buys Most of U. S. Radio

WASHINGTON, D. C.—Radio apparatus valued at \$682,885, weighing 618,512 pounds, was exported from the United States during the month of July, according to a recent announcement by the Department of Commerce. Of this apparatus by far the greater portion, amounting in value to \$443,599, was sent to Sweden; the second largest amount, valued at \$83,841, went to Argentina. Large quantities of apparatus were sent to France, England, Mexico and Australia.

# 100 Operator Jobs Open on Ship Board Vessels

Vacation's End Brings Usual Dearth of Radio Experts

WASHINGTON.—Radio operators seeking employment will find excellent opportunities this winter for real Radio work on board ships of the United States shipping board which call at every port in the world. The annual "turn-over" of Radio personnel is large, due to several causes. Among them is the fact that many college men spend their summer vacations sailing the "briny deep" as marine Radio operators, and then return to their studies at the end of the season. It is reported that approximately 100 first-class Radio operators will be needed on government vessels alone during the next few months.

On the first of last July, the government increased the pay of all its commercial operators approximately fifteen percent. The monthly rates of pay now in effect range from \$85 to \$125 a month. A few positions pay a higher salary.

# HOOVER LABELS NEW RADIO BILL WINNER

Secretary of Commerce Sees Latest Measure Adopted by Both Houses

WASHINGTON, D. C.—A new Radio bill will be introduced in the forthcoming session of Congress. It is probable that the bill will be much simpler than the one passed by the house of representatives, but which failed of passage during the latest session because of the disapproval of the senate.

Secretary of Commerce Hoover in whose department Radio control is included feels that the department now has experience enough to prepare a much better bill. It is expected that Representative White, of Maine, who handled the bill in the house will again take charge.

Mr. Hoover said recently that he did not believe there would be any trouble in having the bill passed during the coming session.

For the PORCH—  
The New GREBE Broadcast Receiver

This highly efficient Instrument brings you all of the joys of radio. Its 20-foot silk-covered wire, readily concealed, gives you crystal-clear reception.

Ask Your Dealer

A. H. GREBE & CO., Inc.  
Richmond Hill, N. Y.

Licensed under Armstrong  
U.S. Pat. No. 1,113,149

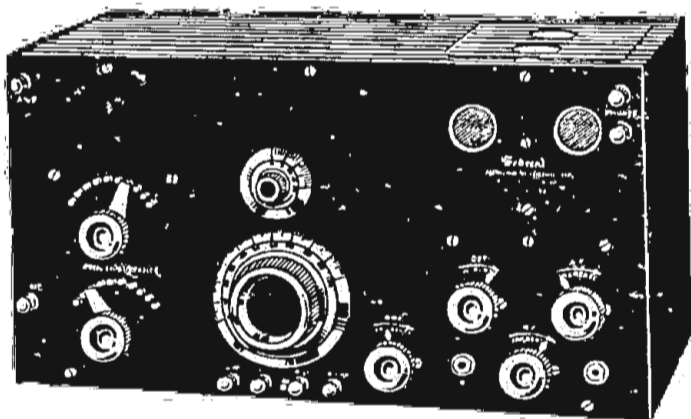

# You Can Cover an Unusual Range of Distance with this Federal DX Set—Type 58

TUNE in DX stations while local stations are broadcasting—you can completely eliminate interference from other stations.

This high degree of selectivity is combined with clear reception of both voice and music over an unusual distance.

All units in this set, as in other Federal sets, are Federal Standard quality; covered by the binding Federal Guarantee, which assures your complete satisfaction.

130 Federal Standard Radio parts offer the radio enthusiast a complete line of guaranteed parts of one quality—the best.



**Federal**  
Radio Equipment

Federal Telephone and Telegraph Company

Factory: Buffalo, N. Y.

Boston      New York      Philadelphia      Chicago  
Bridgeburg, Canada      San Francisco      Pittsburgh      London, England

# Something New—

# E. T. Flewelling Sockets

Would You—  
Go This Way

Across  
A  
Room—

or This?

Tubes do not shake loose as proven by a 3,000 mile test trip with the set mounted on the floor of an automobile. Tubes enter socket with a twist requiring no downward pressure with the danger of glass breaking in your hand. A wiping, self-cleaning terminal is the secret of positive electrical contact.

This is the only socket designed especially for Radio Frequency, and the Flewelling super-circuits. In it Mr. Flewelling has reduced internal capacity losses to a minimum.

Then why make a weak Radio signal that has traveled a long distance wander about inside your set?

Short direct connections are assured by the unique terminal construction used in the new Flewelling Socket. This socket cuts wiring difficulties in half by mounting direct on terminals of rheostats, transformers and tuning elements.

E. T. Flewelling says:

"The amount of incoming energy that we can place upon the grid of the tube is the measure of the efficiency of our sets. If we consume the energy in low efficiency apparatus and bewilder it with a thousand and one by-roads in the shape of stray capacity effects very little of it will reach the grid of the tube and long distance reception suffers."

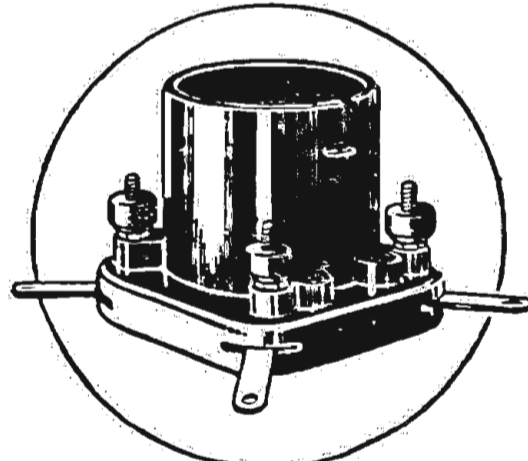

Standard Tube Socket \$1.00. At your dealer or, until he is supplied, post paid upon receipt of price.

**BUELL MANUFACTURING COMPANY**  
2977 Cottage Grove Avenue  
CHICAGO

# TWO WEIGHTY EVENTS IN AIR WORLD

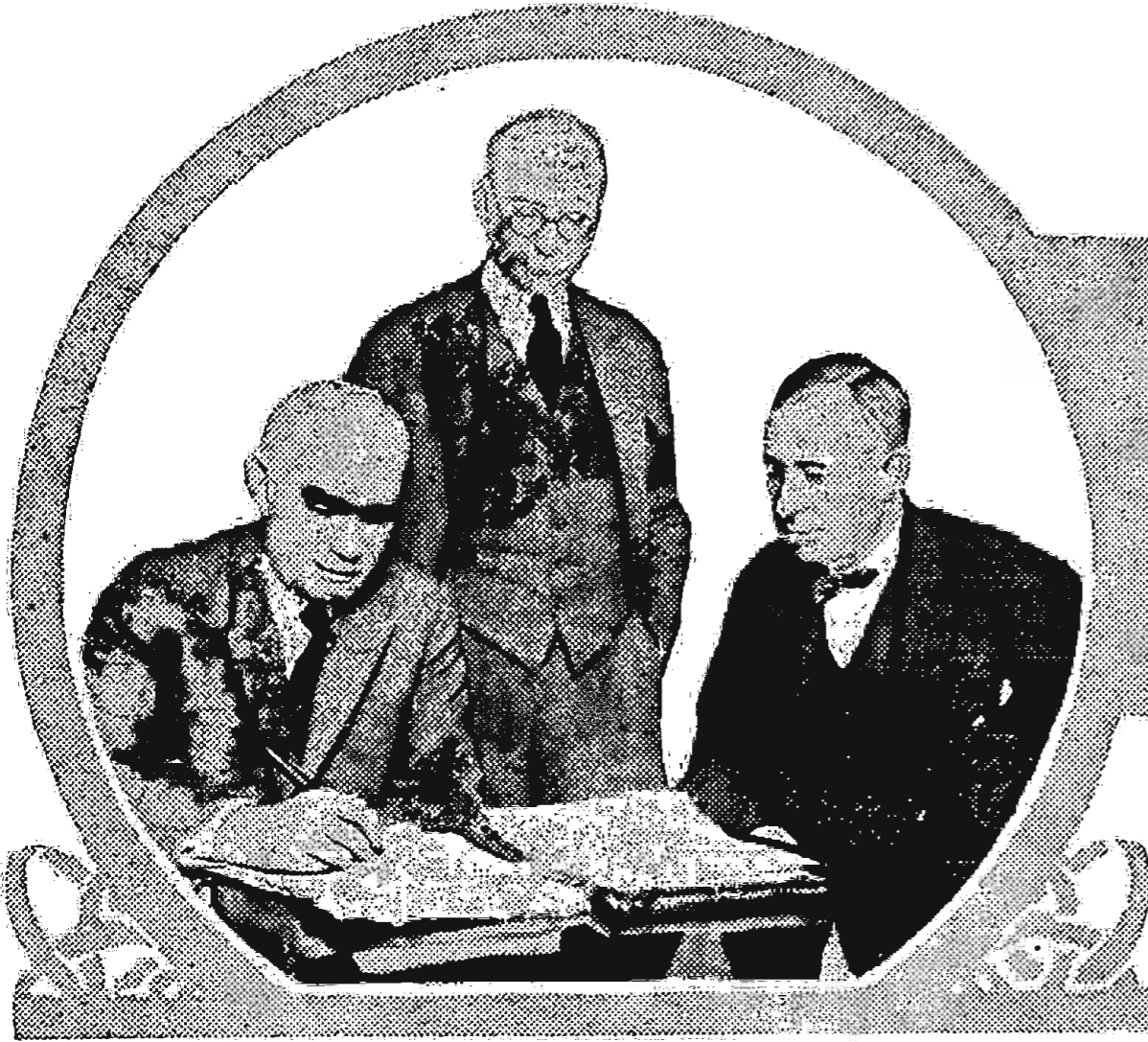

## Sees Radio's Greatest Problem as Interference Caused by Re-radiation

Howard Campbell, WWJ Engineer, Says Corrective Measures to End "Bedlam" Must Be Taken If Broadcasting Is to Be Advanced

(By Howard E. Campbell, Chief Radio Engineer, The Detroit News, WWJ.)

What place is held today in the United States by regenerative detector receiving sets? Why is the use of regenerative detector receiving sets prohibited by law in England?

It is estimated that three-fourths of all vacuum tube receiving sets in use today in the United States operate on the regenerative detector principle. There are more of these sets in operation than there are crystal detector sets. Why? Because at a relatively small expense the old crystal detector set can be rebuilt or replaced by a single-tube outfit which will enable the Radio amateur to hear stations from ten to twenty times as far distant. Because the idea of making a single tube perform the double duty of detector or rectifier and amplifier appealed almost universally to the shrewd American public.

With the advent of vacuum tube Radio telegraph transmitting sets, code signals were sent in "CW," which is an abbreviation of "continuous waves" of Radio frequency. Crystal detector sets could not distinguish these modern signals, but a regenerative tube detector can; hence its

popularity with amateur Radio telegraphers.

### Cause Interference

These statements answer to a certain extent the first question, but there is another side to the question which is demanding universal attention. Simple as these regenerative sets are, they have a characteristic fault. In regeneration they act as miniature transmitters and send out into space an interference during the entire time they are in operation which is picked up by other receiving sets within a radius of from two or three city blocks to eighteen or twenty miles, depending on the circuits used in the regenerative receiver interfering and the sensitiveness of the sets picking up the interference. If one set does this, hundreds and thousands of them in a large city generate a veritable bedlam of interference and affect each other and every other type of receiving set, from the cheap crystal outfit to the thousand dollar six to nine-tube outfit.

This interference is a hundred times more extensive and dangerous to the future development of the art than most Radio enthusiasts realize. The average experienced operator of such a set will tell you that he never allows his regenerative tube to oscillate, and therefore does not retransmit or send out interference.

To every Radiophan the name of Dr. Lee DeForest is one to conjure with, but the news that he has sold his holdings in the DeForest Radio Telephone and Telegraph Company need not worry the Radio world, for he will remain with the new owners as consulting engineer. In the circle are, from left to right, Dr. DeForest signing the transfer documents, J. F. McNamara, of the Metropolitan Trust Co., and Edward H. Jewett, head of the purchasing group. To the right are Officers Tamburino and Pickerill of the Leviathan, holding copies of messages sent and received during a recent trip. In all they were 4,000—a record-breaking number © K. & H.

He means that he has passed the experimental or amateur stage where the tube "spills" or oscillates violently in his crude attempts at tuning and does not send out those disagreeable whining sounds which we all know so well.

### All Tubes Oscillate

It will, therefore, come as a distinct shock to such enthusiasts to be told by Radio engineers that no tube will re-

generate without oscillating, and that unless he makes adequate provision in his circuit to prevent retransmission, his set will send out a constant interfering wave of noticeable intensity even while it is considered stably adjusted to receive a program from a certain station. This interference is very sharp; that is, it covers a very small band of frequencies, but,

(Continued on page 3)

## THE 1923 RADIO SENSATION



Never before in the history of Radio has a set of the quality and performance of the Michigan Midget been offered at anything like the price.

No longer is it necessary to buy parts and build your own set and save money. Michigan "Midget" has done that for you. It puts a long range, high-grade radio receiving set within the reach of everybody's pocketbook.

It is extremely selective—easy to adjust—tunes sharply, receiving all broadcasting wave lengths up to 600 meters. Works equally as well with dry cell tubes as with standard six volt tubes. Its light weight (weighs only 6 pounds) makes it ideal for touring, camping, etc.

The cabinet is mahogany finish, made in Grand Rapids, the world's greatest furniture center.

**PRICE \$27.00**

Also ask about the Michigan "Midget" Two Stage Amplifier \$30.00 and our exclusive line of Condensers, Variocouplers, Variometers, Rheostats, etc. When you send for circular, give us the name of your favorite radio dealer.

**MICHIGAN RADIO CORPORATION**

GRAND RAPIDS, MICHIGAN

## Just Consider

—the essential features necessary to make an audio frequency transformer a good one—

1. High Amplification.
2. Minimum Distortion.
3. Low Interstage Linkage.
4. Convenient Mounting.
5. Compactness.

Cotoco transformers make these ideal features facts. And the finish will surely please you.

"Built First to Last"

**\$5.00**

At Your Dealer's

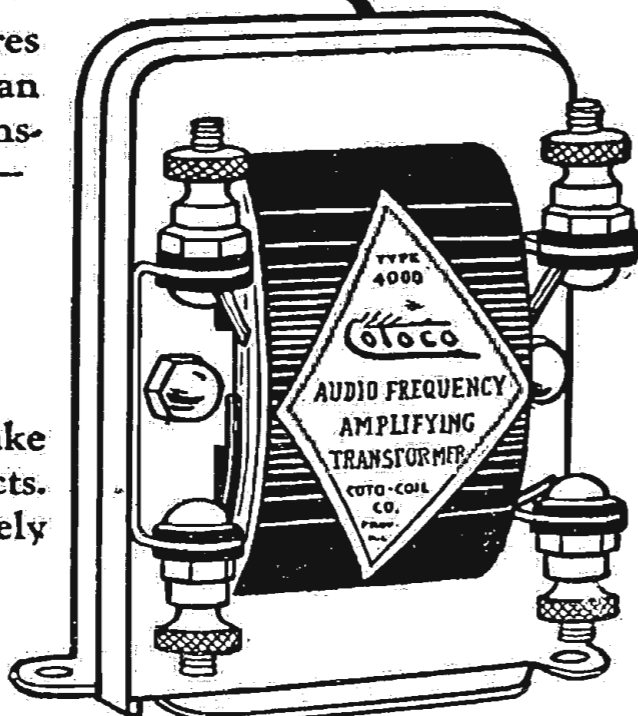

PACIFIC COAST BRANCH:

329 Union League Bldg. LOS ANGELES

**COTO-COIL CO. PROVIDENCE**

### RE-RADIATION PROBLEM

(Continued from page 7)

given from three to ten sets in an immediate locality, all receiving a program from one particular station, it is a foregone conclusion that each set will be tuned just a little differently from all the others with the result that the entire band of audible frequencies from this station is blanketed, and any super-sensitive receiving set in that neighborhood is completely and effectually barred by interference from receiving this program. Furthermore, it is entirely too much to expect that these transmitting receiving set operators will all stick to the program from one station and send out a band of interference on that wave length alone. They will have different tastes, and divide their attention about equally between all stations within range which are broadcasting, thus blanketing all of them.

The example of the effect upon a super-sensitive receiving set is cited, because it foreshadows the dire result imminent unless the growth of this evil is checked and finally eliminated. The super-sensitive set will pick up an amount of interference today which the average set would not pick up for a year or two to come when the number of sets in operation is double or treble, and providing, of course, that retransmitting sets are then used in their present proportion.

#### Concentration on One Station

With the average set in operation today, a lot of dissatisfaction with the quality of transmission of programs from distant stations is directly due to distortion caused by interfering waves from neighboring re-transmitting receiving sets, and finally a lot of more or less momentary periods of inaudibility of programs from distant stations, which is generally attributed to the phenomenon of fading, is in reality caused by pronounced periods of interference as explained above, when a number of operators are concentrating on that particular broadcast.

The idea is not supported by proof, and the suggestion would no doubt cause general surprise that possibly certain stations locally noted for pronounced fading may in reality be so near the middle of the tuning range, and so popular, that they draw this concentrated fire of Radio receiver interference. Trouble due to fading from natural causes is serious enough at certain times of the day without its being increased by artificial means.

The above indictment is written around the regenerative detector single tube or triple tube sets where two stages of audio

### RADIOTELEPHOTO FROM JAPAN



This picture, which shows the ruins of the U. S. Embassy building at Tokio after the earthquake, reached Los Angeles by Radio from Honolulu, where the original arrived by steamer. It was then relayed by Radio from Los Angeles to New York © P. & A.

frequency amplification are employed, because they are by far the most numerous offenders, but retransmission is not confined to them entirely. Freely oscillating Radio frequency amplifiers, ahead of any type of detector with or without audio frequency amplifiers, create disturbances of various degree, according to the size of the antenna or loop system used in conjunction with them.

All of the above statements which are made positively are supported by fact. The questions raised are of extreme importance to all Radio enthusiasts and amateurs, and if you, for one, are not satisfied that they are true, then investigate until you are convinced, and govern yourself accordingly.

#### It's Up to Fans

Are we individually going to allow the Radio engineer or manufacturer of equipment to solve this problem for us? They can only take care of new installation and new equipment. We must take care of our own existing equipment, and call an immediate halt on this woeful impediment

to progress. We must do it now for mutual protection, and not wait until the

### KELLOGG CONDENSER



**Very true!**  
rotor plates bolted  
at ends—no "shorts"

Now when it comes to condensers real radio bugs can appreciate this: heavy aluminum plates securely bolted across to assure uniform air space between the plates; a five-plate vernier gives "clean cut" tuning; heavy Bakelite end pieces make a rigid mounting; no "shorts" because it is impossible for plates to touch.

Here is a condenser that will be true to you. The price, which is always standard, is \$8.75 for 43 plate and vernier but that does not prevent the real radio rascal from having it wrapped up to take home—this very night. Another thing, this price includes dial and vernier knob.

Use—Is the Test

**KELLOGG SWITCHBOARD & SUPPLY COMPANY**  
CHICAGO

whole structure of Radio business topples over from sheer lack of a sound foundation or defective first story.

This citing of conditions, causes and effects, would not be complete without offering solutions to problems, and remedies for abnormalities. Your attention is invited to the opinions of various reputable Radio engineers and designers that the use of "neutrodyne" or compensating capacities across the elements of Radio frequency amplifier and regenerative detector tubes will prevent undesirable "feedback" or regeneration, and resultant retransmission.

A single stage of transformer coupled Radio frequency amplification ahead of the ordinary regenerative detector will damp out to a great extent the retransmission of interference, and at the same time increase sensitivity to a marked degree.

### FORMICA

A Laminated Phenolic Condensation Product  
**SHEETS TUBES RODS**  
**RADIO PANELS**  
POLISHED BLACK FINISH

CUT PERFECTLY SQUARE  
TO ANY SIZE

- 1/32" THICK 1/2¢ PER SQ. INCH
- 1/16" THICK 3/4¢ PER SQ. INCH
- 3/32" THICK 1¢ PER SQ. INCH
- 1/8" THICK 1 1/2¢ PER SQ. INCH
- 3/16" THICK 2¢ PER SQ. INCH
- 1/4" THICK 2 1/2¢ PER SQ. INCH
- 3/8" THICK 4¢ PER SQ. INCH
- 1/2" THICK 5 1/4¢ PER SQ. INCH

SEND FOR COMPLETE PRICE LIST.  
PROMPT ATTENTION TO MAIL ORDERS.  
DEALERS PRICES ON APPLICATION.

**STARRETT MFG. CO.**  
519 SOUTH GREEN ST. CHICAGO

### COLUMBIA ALL-CIRCUIT VARIOMETER

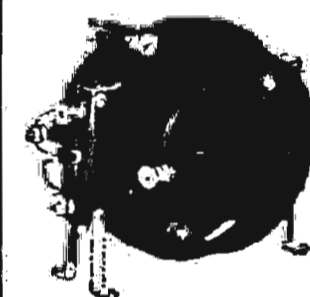

With split stators, providing for all present day circuits and permitting most future circuits in which a variometer may be used, this black bakelite moulded, green silk instrument is the one to buy. It is pig-tailed and built for selectivity. This

variometer can be used for MILOPLEX circuits.

Price \$5.50

Ask to see the nationally known Columbia line of licensed bakelite apparatus. Known satisfaction. A few more Columbia items:

- Moulded Bakelite Variocoupler..... \$6.00
- Geared Three Coil Mounting..... 5.00
- Geared Two Coil Mounting..... 3.50
- Inside Coil Mounting—Vernier..... 6.00
- All-Meter Variocoupler—150 to 2600 meters..... 7.00
- Mounted Coils, Coil Plugs, etc.

Write for our free literature

**COLUMBIA RADIO CORP.**  
157 NORTH UNION STREET, CHICAGO

### THE

### AUDIOPHONE

Quality of reproduction such as only the original itself can equal. Speech that is so distinct that the voice heard is the actual voice of the speaker. Music that requires no tolerant imagination to be recognized as music of the finest type.

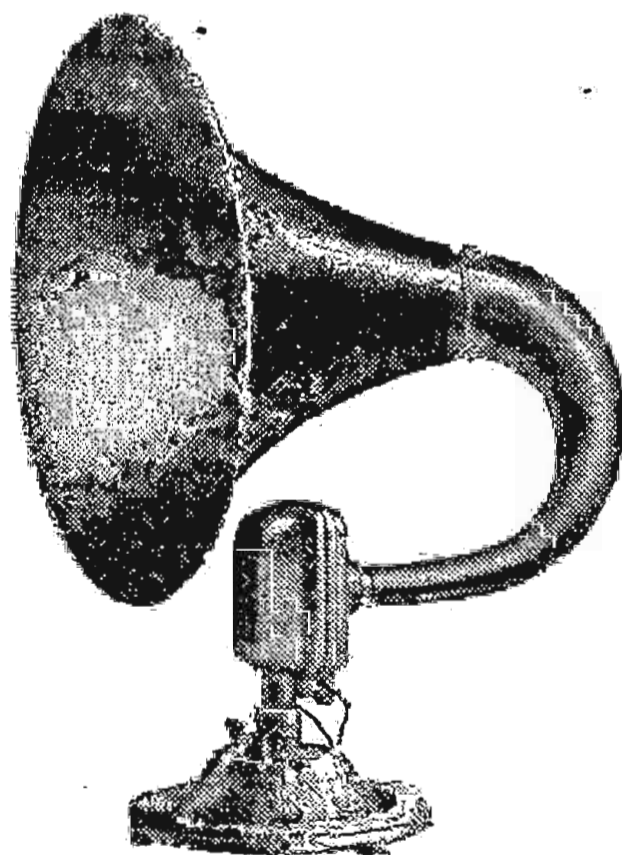

### Bristol's Single Stage Power Amplifier



gives additional VOLUME with any two stage amplifier. No separate batteries required. It provides the additional volume necessary to bring in very distant stations on the loud speaker.

Write for bulletin and address of the nearest dealer handling our instruments

**THE BRISTOL COMPANY**  
WATERBURY, CONN.

Boston New York Philadelphia Pittsburgh Detroit Chicago St. Louis San Francisco

### Metaelectric Soldering Iron

The all-metal quality instrument—  
guaranteed

A solution to the small soldering problems of the discriminating assembler.

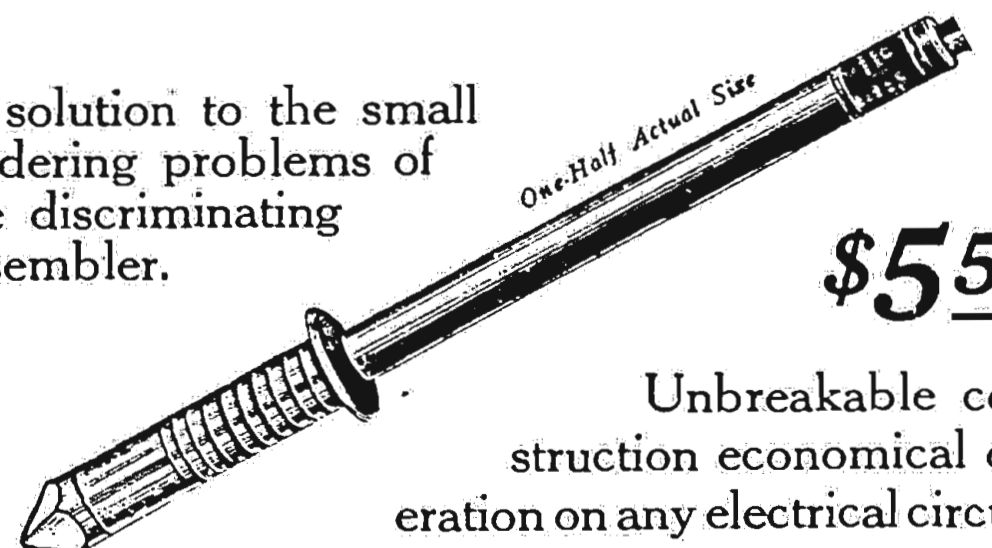

**\$5.50**

Unbreakable construction economical operation on any electrical circuit.

From your dealer or write

**POST ELECTRIC COMPANY, Manufacturers**  
30 EAST 42nd STREET Dept. 509 NEW YORK CITY



# PRINCE OF WALE'S RANCH TO GET SET

## HEIR TO BRITISH THRONE ARDENT RADIOPHAN

### Will Equip Canadian Farm—Has Desire for Broadcaster at Buckingham Palace, Too

TORONTO, CAN.—The "R. P." ranch, the Prince of Wales's ranch near High River, Alberta, is to be equipped with one of the best sets obtainable soon according to a statement given Radio Digest by the Prince's private secretary in Winnipeg, prior to the Royal party entraining for Quebec.

The ranch is twenty-eight miles from High River, the nearest town, and on his recent visit to the ranch the Prince missed the use of a Radio set.

"The Prince, his father, King George, and in fact all members of the Royal family are very enthusiastic Radiophans," said the private secretary. "They have several sets in their many residences throughout the British Isles and the Prince has a high powered one of his own. He follows with great interest all the activities in the Radio world and while on his trip to the ranch expressed regret that the ranch was not equipped with a high powered set.

### Prince Wants Broadcaster Too

"He stated that before he returns on his next visit he will have one installed so that he can keep in touch with the outside world. While in England he has spoken on three occasions at a broadcasting station to hundreds of Radiophans all over the British Isles and has already expressed a desire to have a broadcasting station installed at Buckingham palace where King George and other members of the Royal family can broadcast messages from time to time.

"A few months ago a large hospital in Scotland was opened by the Prince via Radio. It was his intention to open the hospital personally but at the last minute his plans were changed and he was required to cancel many functions. He was approached, however, and requested to open the hospital by Radio as a large set had been installed in the hospital for the use of the patients."

### Radio Grows in Britain

According to the Prince's secretary, Radio is gaining greatly in popularity in the British Isles. He predicted that this

# DEVICE GIVES TRUE PIANO TONES

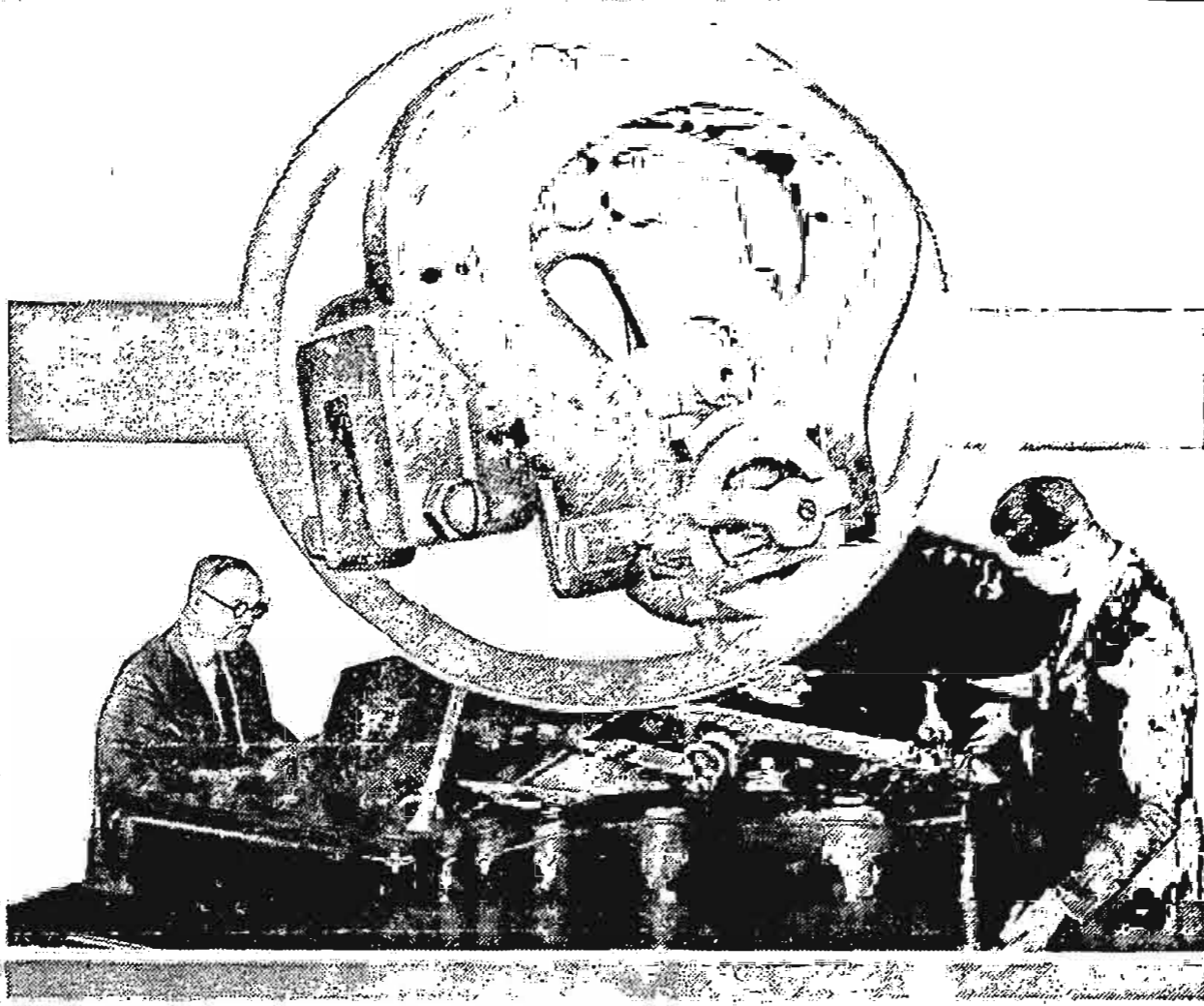

The remarkable instrument shown in the center insert is the new piano microphone developed and now used by the General Electric Company at their Schenectady station, WGY. Three of the devices are attached to the piano sounding board to pick up the high, middle and low notes respectively. The vibrations of the piano jar the floating armature of the three microphones, which are really miniature alternating current generators of special design. The jarring of the armatures makes electric currents that correspond in amplitude and frequency with the original piano tones. These electric currents are then superposed and used to modulate the high frequency carrier wave radiated by WGY. By individual control of each of the three "dynamo" microphones it is possible to blend the low, middle and high notes together so as to produce on the air an almost exact reproduction of the original piano sound

winter would see the new science at its height. All British plants manufacturing equipment are operating day and night to meet the demand.

Asked if there is much demand for American made goods the secretary stated that as far as he knew there was a better demand for the American made goods than those produced by the British manufacturer chiefly because the American made goods were more up-to-date and comparatively cheaper. He attributed this

to the fact that the British manufacturer was aiming for goods that will give long service and the raw materials were costly with the result that the finished articles were high.

# GIVE that boy of yours the keenest ears in radio this Christmas—the receiving set that brings in the broadcast of half the continent as clearly as it was sent out. For his happiness and your reputation in his eyes, no matter what you spend—\$25 or \$150—be sure it's marked



DE FOREST RADIO TEL. & TEL. CO.  
Dept. R. D. 2 JERSEY CITY, N. J.

If Located West of Pennsylvania, Address

DE FOREST RADIO TEL. & TEL. CO.  
Western Sales Division  
Dept. R. D. 2 5680 12th St., DETROIT, MICH.



## YELLOWTIP MICROMETER ADJUSTING CRYSTAL DETECTOR

The every-purpose detector—fixed or changeable adjustment, just as you wish. Tune with the YELLOWTIP. No hunting or looking for a sensitive spot. Just "A Twist of the Wrist—It's Set." Micrometer adjustment in a moment, fixed indefinitely. Ideal for reflex and other circuits. **\$2**

Write for folder and name of your nearest dealer.

WHOLESALE RADIO EQUIPMENT CO.

Exclusive Factory Representatives  
35 WILLIAM ST., NEWARK, N. J.

Dealers and Jobbers write for attractive proposition.

# 536 METER WAVE ON TEST AT KYW

## NEW LENGTH OVERCOMES POOR RECEPTIONS

### Station Stronger Than Ever; U. S. Cancels Order to Reduce Power

CHICAGO.—Thousands of Radiophans all over the United States and Canada were agreeably surprised, they reported, when they received recently, more clearly than ever, the programs broadcast by Station KYW of this city.

Since May 15, when the wave length of the station was reduced by governmental order from 400 to 345, listeners in had experienced difficulty in receiving KYW. The sending power of the plant had been obstructed so as to reduce considerably the area of its audiences.

### Buildings Absorb Power

Investigation by engineers in the employ of KYW showed that surrounding steel buildings, attuned to the 345-meter wave length, absorbed a great part of the radiation. Steps were then taken to correct the condition. A series of tests gradually reduced the amount of sending power lost.

But the greatest step forward was that in which Station KYW, by authority from Washington to A. E. Beane, federal Radio supervisor for this district, was enabled to increase its wave length to 536 meters or 560 kilocycles. Marked improvement in transmission was immediately noted by listeners in. The new wave length will be tested during a 30-day period.



## Ask your Dealer about "HEGEHOG"

(Trade Mark)  
AUDIO TRANSFORMER \$3.50

This little wonder is the surprise and talk of Radio Engineers everywhere. Fix in your mind's eye an AUDIO Transformer about the size of an English walnut and you have the "HEGEHOG" for size. Then recall the best Radio amplification you ever heard, and you have the "HEGEHOG" for volume and tone quality. Our new patented design and construction (100% shielded) makes this possible. It's a real bit of engineering, and we would like to have YOU try one.  
Ratios 1 to 3, 1 to 4 and 1 to 5.....\$3.50  
1 to 10..... 4.50

Premier Electric Company  
3810 Ravenswood Avenue, CHICAGO, U. S. A.

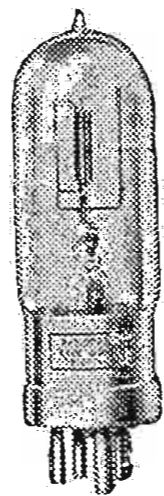
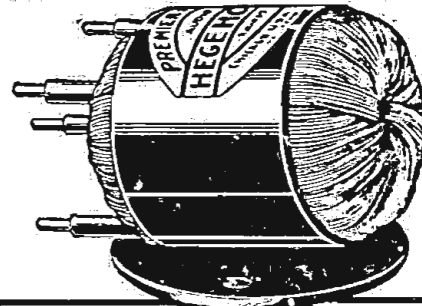

# WD-11

Radiotron WD-11 is famous as the tube that really made possible the swift growth of radio in the home, as we know it today.

Inexpensive to operate—using but one 1½-volt dry cell—doing away with the need for storage batteries—it has lowered the cost of radio.

Price  
**\$6.50**

Radio Corporation of America

Sales Offices—Dept. 3002: 233 Broadway, New York  
District Sales Offices:

10 South LaSalle St., Chicago, Ill. 433 California St., San Francisco, Cal.

Be sure that every vacuum tube you buy is marked RADIOTRON.



This Symbol of quality is your protection

# Radiotrons

REG. U. S. PAT. OFF.

## DRY CELL TUBE CIRCUIT IN SIMPLEX FORM

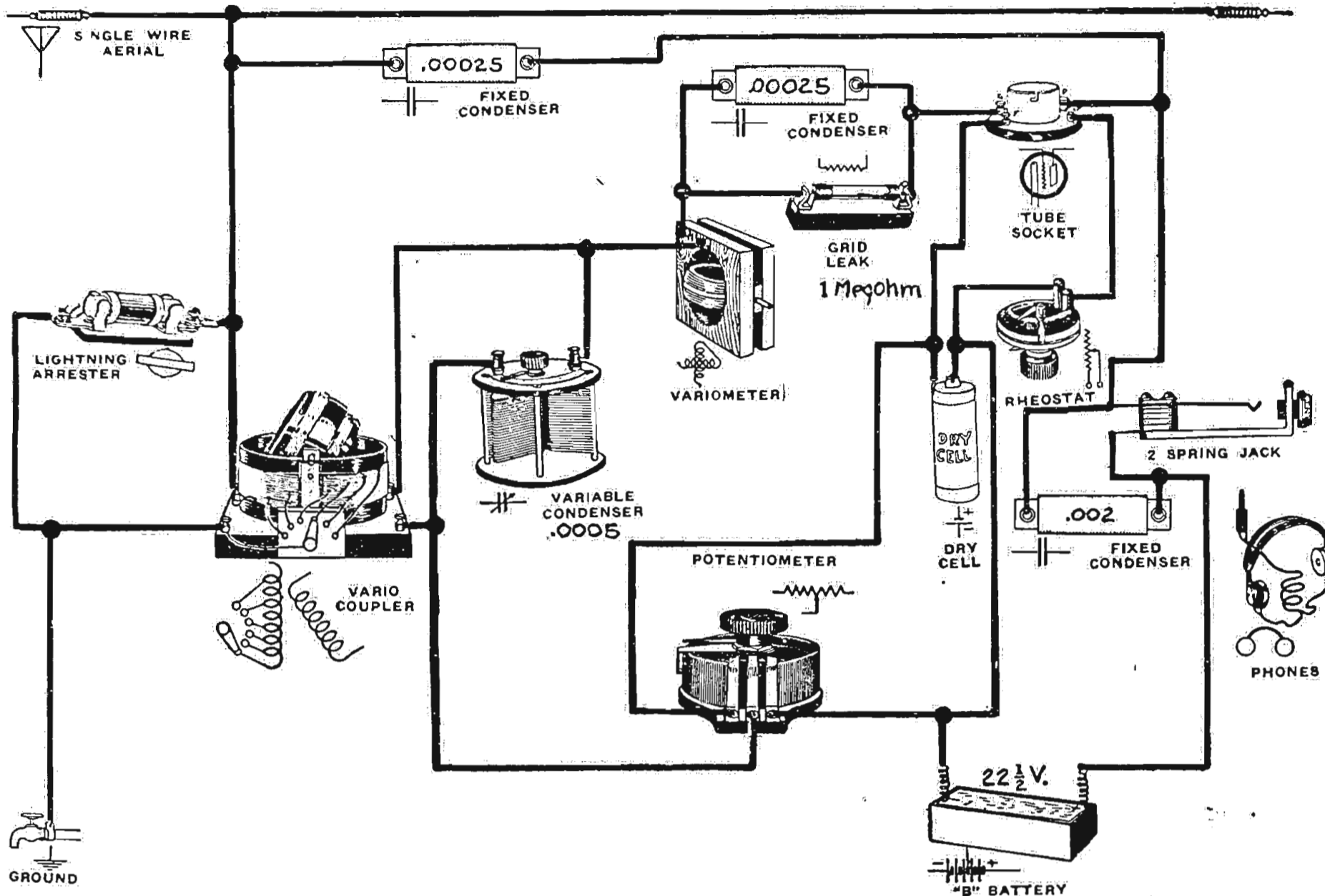

THE diagram given this time is especially suited for the use of dry cell tubes. In addition, the connections for a lightning arrester are indicated. Most of the newer fans in Radio are somewhat at a loss as to the proper connections for this safety device. The same method of application holds true for all circuits.

The circuit is regenerative because of the capacity feedback between the plate

and antenna. The secondary circuit is especially selective for long distance work because of the variometer and variable condenser, in addition to the variocoupler rotor control. The use of a high resistance potentiometer not only helps to get the best out of the tube but is also beneficial for long distance tuning.

No variable grid leak is necessary. The plate voltage can be 22 1/2 volts as indicated or more as required for best operation of

the tube. The use of the open circuit jacks enables easy plugging in of the phones.

### This Is Worth Knowing

The 43-plate condenser is considered good for short wave work; it is essential for the long wave; hence to eliminate another change over switch it is retained in the circuit when tuning for the broadcasting stations.

## Causes and Remedies of Noises in Receiving Sets

Noise in a Radio set can be attributed to many causes. One of the most persistent trouble makers is the B battery. After several months of use the cells start to deteriorate, and this makes itself known in annoying scratches in the ear phones. The only remedy is to replace the batteries.

Poorly constructed variable grid leaks are particularly troublesome, because the moving arm cannot be properly tightened when the device is manufactured and the connection to the resistance line is not so good as it might be. The tips of the vacuum tube base must be cleaned often; a surprising difference in results will often be noticed after this is done. The same applies to the contact springs in the tube socket.



## The Saturn "Above the Ordinary" Radio Products

**Automatic Plug**  
Terminal tips inserted, or removed in a moment. Perfect electrical connection without taking apart or soldering. Your satisfaction with the Saturn Automatic Plug unreservedly guaranteed.

**Perfect Jack**  
A difficult soldering job made easy by crowfoot offset and solder-flex compound on blades. Brass brackets, nickel-plated, with rounded corners. Blades of spring German Silver. Solid silver contact points. Right in every detail.

Your order filled by mail promptly  
Every order absolutely guaranteed

**Prices**

No. 1—Single Circuit, Open.....	50c
No. 2—Single Circuit, Closed.....	55c
No. 3—Double Circuit, Closed.....	75c
No. 4—Single Filament Control.....	75c
No. 5—Double Filament Control.....	80c

The SATURN Mfg. & Sales Co.  
48 Beekman Street  
New York, N. Y.

# COMPLETE STANDARD PARTS FOR THE MYSTERY MILOPLEX

### RHEOSTATS

	List Price	Our Price
MARVEL Rheostat, 6 ohms.....	\$.35	.35
MARVEL Rheostat, 20 ohms.....	.45	.45
MARVEL Rheostat, 25 ohms.....	.45	.45
MARVEL Rheostat, 30 ohms.....	.45	.45
MARVEL Rheostat, 40 ohms.....	.55	.55
MARVEL Rheostat, 50 ohms.....	.65	.65
Potentiometer, 200 ohms.....	.55	.55
Potentiometer, 400 ohms.....	.65	.65
Potentiometer, 1,850 ohms.....	2.20	2.20

### VARIABLE CONDENSERS

	List Price	Our Price
Variable Condenser, .0005 (Same as 23 plate).....	\$5.50	3.00
Variable Condenser with Vernier, .0005 (Same as 23 plate).....	6.50	4.50
Variable Condenser, .001 (Same as 45 plate).....	6.00	3.50
Variable Condenser, with Vernier, .001.....	7.50	5.00
Walnut Variable Condenser, .00025.....	1.75	1.75

### VARIOMETERS

	List Price	Our Price
Moulded Variometer.....	\$6.00	\$4.39
Variometer, All Circuits.....	5.50	5.50

### VARIOCOUPERS

	List Price	Our Price
Webster Variocoupler with dial, Type IA.....	\$4.50	\$2.19
Moulded Coupler.....	5.50	4.19
Moulded Bakelite Variocoupler.....	6.00	6.00
All-Meter Variocoupler, 150-2500 meters.....	7.00	7.00

### GRID-LEAKS

	List Price	Our Price
Freshman Grid-Leak with Condenser.....	\$1.00	\$ .79
Freshman Grid-Leak.....	.75	.69

### MISCELLANEOUS

	List Price	Our Price
Switch Lever, 1-A, 1 1/2" Radius, 1 3/8" Knob, 5/8" Shaft.....	\$.75	\$.35
Presto Aerial Superscaler, Adjustable; can be attached to electric light socket or telephone.....	3.00	2.00
Rogers Receiving Radiometer; can be used like Radio Frequency Transformers.....	3.00	3.00
Combination Socket and Rheostat with Vernier.....	3.00	2.29
B-Metal Ever-Ready Tube Detector, Type B.....	1.50	1.50
Erla Reflex Crystal.....	.89	.89
Hydrometer Perfect.....	.85	.65

1 .0005 Variable Condenser	1 .002 Phone Cond.	1 Socket, Bakelite base	3 Dry Cells
1 Estro Variometer	3 3/4 inch Dials	1 Bakelite Panel, 9x14 1/2"	12 ft. sq., brass, bus wire
1 .00025 Variable Condenser	1 Potentiometer	1 DeForest D.V.-6 Tube	1 Set Readem Bind. Posts
1 Variable Grid Leak and Cond.	1 Rheostat, 6 ohms	1 B Battery, 22 1/2 volt	ONLY

## WEBSTER RADIO APPARATUS

### SPECIAL ON UNITS

(Enclosed in substantial beautiful mahogany cabinets)

	List Price	Our Price
Webster 1-A Tuner Unit.....	\$35.00	\$17.50
Webster 2-A Detector Unit.....	15.00	7.50
Webster 3-B Audio Frequency Amplifier Unit.....	27.50	17.00
Webster 3-A Audio Frequency Amplifier Unit.....	17.50	8.50
Webster 4-A Radio Frequency Amplifying Unit.....	17.00	7.50

Single Tube Webster Receiving Set (Non-Regenerative Type), without head set and tube, in beautiful mahogany cabinet; list price, \$30. Our price, while they last, only \$20.00

The above Webster Receiving Set complete with Baldwin Phones, B Battery, Dry Cells and Tube; list price, \$41.30. Our special price as long as we have them \$32.50

### TRANSFORMERS

	List Price	Our Price
Webster Radio Frequency, 5 A-1, wave length 200 to 500; 5 A-2, wave length 300 to 1200; 5 A-3, wave length 500 to 2,000; \$4.00.....	\$3.19	\$3.19
All American, Ratio 1-5.....	\$4.00	\$4.00
All American, Ratio 1-10.....	\$4.00	\$4.00

### PHONE RECEIVERS

	List Price	Our Price
Webster Double Head Phone Receivers, 2500 ohms.....	\$7.00	\$3.49
Double Phone Cord.....	1.00	.75
Baldwin Type C Unit.....	6.00	3.49
Baldwin Type C Double.....	12.00	6.95

### LOUD SPEAKER

	List Price	Our Price
Audiophone Loud Speaker (Large Size).....	\$22.50	\$22.50
Loud Speaker Cord, 20 feet, 4 tips, our price.....	1.00	1.00

### WIRE

All kinds of wire put up in 1/4 pound spools, No. 18 to No. 28, silk, cotton and enamel, double or single.....45 cents a spool  
Same wire as above on 1/2 pound spools.....75 cents a spool  
Hook-up Wire, No. 14 square brass, cut in 10 foot lengths.....15c

## Webster Madera Clear-Speaker

AT LAST—REAL SPEECH—REAL MUSIC—FROM DIE-CAST WOOD HORN

Finished Crystallized Black and Mahogany Complete with unit

**\$15.00**

Height 12 inches  
Diameter Bell 10 inches

**ABSOLUTELY GUARANTEED**

Natural tone from Radio made possible by a new process discovered! We break down wood to original fibre, forcing it into steel dies under twelve tons pressure.  
You and I would not think of making a violin of metal or cardboard, expecting to receive wonderful tones. Why use it for radio horns? Talking machine people gave up metal horns years ago.  
The best violins are made of wood, whose fibres are very close together. The tighter the fibres the better the tone quality. We compress fibres closer than they are in any wood.

**\$28.50**

### WIRE

All kinds of wire put up in 1/4 pound spools, No. 18 to No. 28, silk, cotton and enamel, double or single.....45 cents a spool  
Same wire as above on 1/2 pound spools.....75 cents a spool  
Hook-up Wire, No. 14 square brass, cut in 10 foot lengths.....15c

## Webster Madera Clear-Speaker

AT LAST—REAL SPEECH—REAL MUSIC—FROM DIE-CAST WOOD HORN

Finished Crystallized Black and Mahogany Complete with unit

**\$15.00**

Height 12 inches  
Diameter Bell 10 inches

**ABSOLUTELY GUARANTEED**

Natural tone from Radio made possible by a new process discovered! We break down wood to original fibre, forcing it into steel dies under twelve tons pressure.  
You and I would not think of making a violin of metal or cardboard, expecting to receive wonderful tones. Why use it for radio horns? Talking machine people gave up metal horns years ago.  
The best violins are made of wood, whose fibres are very close together. The tighter the fibres the better the tone quality. We compress fibres closer than they are in any wood.

## ALL THE PARTS R. D.-99

## LONG DISTANCE RECEIVER

(See September 29th issue Radio Digest)

3 Sockets; 3 Rheostats; 2 A. F. Transformers; 2 Double Circuit Jacks; 1 Open Circuit Jack; 1 Radiometer; 1 Variable Grid Leak and Condenser; 1 .0005 Variable Condenser; 1 .005 Fixed Condenser; 1 75 Turn Honeycomb Coil, Mounted; 1 Single Coil Mounting; 1 Set Readem Binding Posts; 1 Bakelite Panel, 7x16 1/2.

OUR PRICE **\$30.25**

### TUBES

	List Price	Our Price
De Forest Tube, D V 6.....	\$6.50	\$5.00
W D-12 or C-12.....	6.50	5.45
W D-11.....	6.50	5.45
C-299.....	6.50	5.75
Cunningham 301 A.....	6.50	5.75
U. V. 200 Radiotron.....	5.00	4.35
Cleartone, Detector or Amplifier.....	7.00	4.00

Readem Binding Posts, Set composed of 1 antenna, 1 ground, 1 A Battery+, 1 A Battery-, 2 telephones, 1 B Battery+, 1 B Battery..... \$ .75

### H. C. COIL MOUNTING

	List Price	Our Price
Three Coil Mounting with Dial.....	\$5.00	\$3.85
Geared Three Coil Mounting.....	5.00	5.00

## FREE

Choice of following items on purchases of Five Dollars or over:

- Freshman Grid Leak and Condenser
- Webster 1-A Dial Knob, 3 1/2 inches, 3/16 shaft
- WEBSTER SWITCH LEVER
- TWO CIRCUIT JACK
- OPEN CIRCUIT JACK

## We Are Responsible Folks. Money Promptly and Cheerfully Refunded If You Are Not Satisfied

All Orders Mailed Promptly. Parcel Post Prepaid on \$5.00 or Over

Quality Merchandise at Low Prices

# Economical Radio House

4600 Lincoln Avenue, Chicago

Everything in Radio Write Us

We Personally Guarantee All Goods

# Further Details of the Famous Miloplex Hook-Up

## Part IV—Introducing King Miloplex III, the Real One

By the Mystery Man

**L**ISTEN—Miloplex fans from six to sixty. Remember, the Biblical saying, "The truth shall be revealed even unto babes"; not that I didn't intend to give you the true story, the real King Miloplex, but making good on a promise, so here it is, just as my good friend Brownie (the artist) pictures it, all dolled up and "roarin'" to go. Yet retaining the simplicity of a girl from Main street.

In it you will find something new in circuit compilation, also a something that should interest you as a foundation for further experimental work, a circuit generally known as a single circuit, yet in reality a three circuit scheme of which the rotor of the variometer in parallel with the variable condenser compose the third or oscillating control circuit, though in no wise mechanically connected to the circuit.

Many will call this circuit a wave trap—maybe it is—yet several engineers give us as many separate opinions as a cur dog has

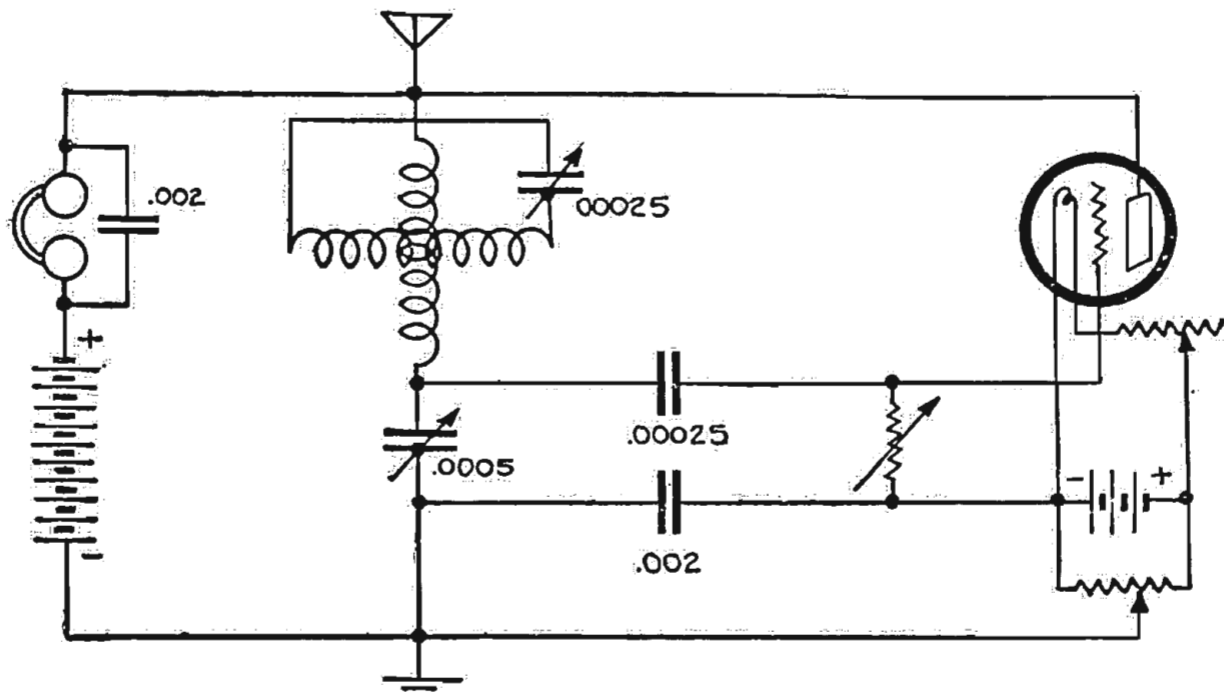

mentioning manufacturers name, viz., a wife, son, dog, my life in urance isn't paid and fifth, who will marry me vice? They say that the best speeches made in Congress are those in which the orator takes full advantage of the clock. So let it be, but my best articles are written when I see Maggie the cook reading Jiggs in the funny papers; then I know I'm going to have ham and cabbage. Let's eat!

(TO BE CONTINUED.)

### Loading Circuits Equally

When there is more than one tuned circuit each circuit must be equally loaded to secure resonance or equilibrium. Many who have sets with two or more circuits simply put a loading coil in the primary circuit and wonder why they do not get results. A single coil will do for a single circuit set but two coils must be used in a two-circuit set—one in the primary and one in the secondary. In a tuned plate regenerative set three coils are necessary—one in the primary, one in the secondary, and one in the plate circuit.

### Use of Patented Circuit

For private use, a Radio amateur may utilize any circuit. Sets cannot be made at a profit which use the patented circuit. To sell sets made of any circuit that is patented is an infringement of the patent and the producer is therefore liable.

**GENUINE EDISON ELEMENTS** (new) for making "B" Batteries, obtained from U. S. Government. A positive and negative element—6c; glass tube—3c; all other parts at reasonable prices. Postage, etc., 50c extra per order. Free instructions. **TODD ELECTRIC COMPANY**, 109 West 23rd Street, New York.

# FREE

## Your Choice

of one bound volume with each annual subscription

Limited Supply

Greatest Collection of Radio Information Ever Published

- Reinartz Long Distance Circuit
- Ultra-Reinartz Circuit
- Flewelling "Fiver" Circuit
- Grimes "Invers Duplex" Circuit
- Single Tube Reflex Circuit
- Armstrong "Super-Heterodyne" Circuit
- Two, Three and Four Tube Reflex Circuits
- A. B. C. Lessons for Radio Beginners

In addition to these features these volumes contain many instructive articles, receiving set diagrams, how to make articles, new apparatus, pictures and illustrations, hook-up diagrams, broadcasting stations, technical articles and book reviews.

# 65 Numbers

65 Numbers in the Bound Volume; 52 Numbers in Year's Subscription. Volumes 2, 3, 4, and 5 Now Ready.

Your choice of one Bound Volume is free and postpaid with your one year's subscription or renewal.

This offer good only in the U. S. and possessions. One dollar additional for Canadian or foreign countries.

Additional volumes are \$2.00 each, but are only available to annual subscribers. This on account of our limited supply.

Orders for these Bound Volumes must be mailed us direct with full remittance, as they can not be supplied on orders through subscription agencies or news dealers.

Remittance must be by check, money order or draft. (Stamps not accepted.)

**COUPON** 10-13

Radio Digest, 123 W. Madison, Chicago

**CHECK OFFER DESIRED**

- One year's subscription and choice of one volume. Send Vol. .... \$3.00 or M. O. enclosed .....
- One year's subscription and choice of two volumes. Send Vols. .... \$7.00 Check or M. O. enclosed .....
- One year's subscription and addition of Volumes Nos. .... \$11.00

Be sure to write plainly your name and address, giving city and state.

that each experimenter has always placed the inductance in a fixed position relative to the energizing circuit which is to be controlled.

My use of it is within, or at center of, the magnetic field, it being quite generally admitted that the greatest inductance or transformer value (if one so desires to term it) is thus obtained—while in addition, through being able to rotate this inductance through the magnetic field, it is variable as to coupling, affording a flexibility that is wholly desirable. In total then, we maintain a separate oscillator which is variable both as to capacity and to inductive coupling.

Many are going to ask just what the action of this circuit is. And my answer is—"Lordy, if I knew I'd be as happy as a deaf and dumb man in a boiler factory." Fools enter, you know, where angels dare not tread. Several times I have had the theory right on the tip of my tongue, when, bang! the Plexy would go prancing into either a "super" or "heterodyne" effect and I'd have to swallow my tongue.

However, several are now fussing or playing with it (yes, engineers), and I'm going to have some fun reading their verdict. The technical editor of Radio Digest will shortly give you his theory; following it, Engineer Forbes is going to tell me his story. Forbes, you know, is a crack on transmitting, hence I anticipate his view-

point will give the Miloplex another pedigree. Anyway the fun is on and you are welcome—yes, requested—to tell me through Radio Digest what you think the theory is.

The next step in my series will be to amplify the Miloplex and I'm going to try and get this to you for next week's story, although a gentleman in Dallas tells me he amplified circuit one, so methinks he will beat me to it on circuit three. Go to it, Doc, but first get in touch with an ear specialist and have him send me the bill—I'd rather owe it to him than beat him out of it.

Don't believe all you see in the papers. Snakes, didn't I just mail the typesetter three dozen pencils with erasers on for causing me to say mutual inductance in place of mutual conductance. I phoned him, but he swore he followed copy; yes, indeed, even if it went out the window, say I. Don't forget, friend fan, that your Plexy will be no better than the parts you use in building it. I have five good reasons for not

### 2650 MILES

with ONE TUBE. Broadcasting from Atlantic Coast and Cuba heard in California by users of the **CROSS COUNTRY CIRCUIT**. This range is due to simplicity of set and operation as only one control is used for tuning. Easily and cheaply built. Dry cell tubes may be used. Complete instructions, with panel layout, assembly views, etc., postpaid for 25c. Or further information for rad stamp.

**VESCO RADIO SHOP**, Bx. 117, Oakland, Cal.

### ONE OF MANY TESTIMONIALS

Gentlemen:

Your new "Wizard Miloplex" is the very best circuit that you have ever published. It has the Flewelling beat three times over. I was very skeptical when I first saw it but booked it up to satisfy my curiosity and had the surprise of my life. The first station that I heard when I switched on the storage battery was the Atlanta Journal and they came in so loud that I had to take off the phones. This circuit is also very selective. I can tune out WJAX and tune in WGY, which is a difficult proposition here in Akron (Ohio) just thirty miles from WJAX. The circuit seems to be really super-regenerative. I am using it with boneycombs and find that it works equally well for the two-hundred-meter waves and those above the broadcast lengths. You certainly made a scoop in publishing that circuit.

I thank you.

A. E. McCullough.

pedigrees as to just what it is and the theory of its action. So call it what you will as I am primarily only interested in knowing that it is the final one real trick that makes the King step out and do the unusual.

The idea of retarding or controlling oscillations in a major circuit through maintaining a separate oscillator is not new. Our good friend Marconi used some such scheme in his old number 103 tuner, while later experimenters have used it in various circuit combinations, though I am believing

### Reinartz Coil \$1.85

The Improved Basket Weave, Covering All Broadcasting Wave Lengths

With each coil we send FREE two large blueprints, picture hook-up and panel layout, list of materials, and fully illustrated instructions for construction and operation.

Buy before the fall rush sets in

We sell all parts required for this wonderfully efficient receiver—panel, coil, condensers, socket, vernier rheostat, variable gridleak, dials, switches, posts, contact points, wire, spaghetti, etc. (no tubes or phones) for only \$9.85. Postage additional on all shipments.

Send no money **PAY THE POSTMAN.** All Goods Shipped Parcel Post C. O. D.

**RADIO SURPLUS STORES**, Helena, Montana

### Improved Ground Clamp

Equipped with Fahnestock Patent Wire Connectors

Easily Attached

No Soldering. For Radio Use Only

At Your Dealers

## Fahnestock Electric Co.

Long Island City, N. Y.

# \$1,000 In Prizes

Offered by Fountain Pencil Co.

**YOU** may win \$500 by writing the name Fountain Pencil (using capital F and capital P) the greatest number of times in the space provided below. Plain every-day writing such as you write, not fancy or pretty, is all that is required to WIN BIG.

We are advertising our new (patents pending) automatic Silver and Gold Fountain pencils. Will write 10,000 or more words without taking pencil off paper. Most marvelous pencil ever invented.

**RULES**

- Contest is open to anyone, anywhere, except employees of Fountain Pencil Co.
- Whoever writes legibly the name Fountain Pencil the greatest number of times with the least number of words or a rubbing or touching, in the space herewith provided, or any space exactly the same size, will win 1st prize, second highest, 2nd, etc.
- Pen or pencil may be used. Pretty writing not necessary. Copperplate, short-hand reduction barred.
- All typing contestants will receive full amount of prize tied for.
- Three disinterested Minneapolis people will act as Judges. Contestants agree to accept Judges' decision as final and conclusive.
- Final report of contest will be mailed to all who "Qualify".
- Answers mailed up to mid night Nov. 17, 1923 will be accepted. Two more weeks allowed for "Qualifying".

**HOW TO WIN!** See how many times you can write Fountain Pencil in the blank space provided above (3 1/2 x 2 1/2 in.). You may write your answer on another sheet exactly same size as space above.

**THERE ARE 25 PRIZES.** Why shouldn't the first prize of \$500 be yours? You don't have to be a good writer to win. A poor writer has a good chance as anyone. Surely you can win one of 25 PRIZES

To reward those who are willing to give us a little extra help in advertising our new pencil we have worked out the following plan: If you win First Prize and have purchased one Gold (or two silver) Fountain pencil for \$6 you would win \$500 under Class A Prizes; under Class B, purchasing one \$3 Silver Pencil you would win \$150; under Class C, purchasing no pencil, you would win \$20. It is not necessary to buy a pencil or spend a cent to win. Just write Fountain Pencil as many times as you can in above space or similar space and mail in your answer at once. **YOU CAN DO AS WELL AS ANYONE.** Go Ahead and WIN.

**Newest Thing In Pencils**

The Fountain Pencil is not an ordinary mechanical pencil, it is automatic,—the lead feeds out as you use it. No adjusting, fusing or screwing. Just start writing and then write away to your heart's content. Has less mechanism than others, nothing to get out of order. Illustration shows beautiful chased engraved Lady's Silver Fountain Pencil, price \$3, two for \$5. Gentleman's is same price, similar in design, only longer with safety clip. The Gold Pencil is a real beauty, only \$6 (Lady's or Gent's). They make most wonderful gifts for Christmas, Birthdays, etc.

Prize	Class A	Class B	Class C
1st Prize	\$500.00	\$150.00	\$20.00
2nd	200.00	75.00	15.00
3rd	100.00	30.00	10.00
4th	50.00	20.00	5.00
6th	25.00	10.00	3.00
6th to 10th	10.00	5.00	2.00
11th to 25th	5.00	3.00	1.00

Class A - If you mail \$5 pencil order  
Class B - If you mail \$3 pencil order  
Class C - If you order no pencil

Prize money on Deposit at Metropolitan National Bank

**Fountain Pencil Co.** Minneapolis, Minn. Your Name \_\_\_\_\_ Address \_\_\_\_\_

I want to win. I wrote Fountain Pencil in above space following number of times \_\_\_\_\_

**Fountain Pencil Co.** 708 So. 5th St. Minneapolis, Minn.

# STATION WINTER OPENINGS ADD INT

## The Week's Headliners on the Air

**I**F IT is a lovely moonlight night Tuesday tune in at midnight for WFAA and hear the Gibson Mandolin and Guitar club, or Bagley's Whispering Jazz Orchestra at WGI.

On Wednesday if you are very serious, WDT offers you a grand opera singer, Harriet De Young Kaplan, and if you are not, Henry Walter Graham, the humorist, will tell funny stories at KYW.

For lovers of the harp Margaret DeGraff will play Thursday at WGY. Martha Gomph, also a harpist, will be heard at WGR. WLW's special Thursday program this week will be a Russian night.

If you prefer Irish music, you can spend a pleasant evening Friday with WGY. Radio like the movies has some very young stars to delight the hearts of grown-up folks. Harold Stelk, the boy soprano, will be heard at WOC, and Jeannette Shirley, a six-year-old pianist, will be heard Friday at KHJ. Do not miss Bertha Iles' reading of children's plays at WMAQ.

Saturday go to the vaudeville via KSD's broadcasting of the Missouri Theater specialties and then spend the rest of the evening dancing to music from KGW, WDAP, WMAQ, WBZ, WOC, WFAA, WWJ, and WIP.

If you are not too tired Sunday night, the Hawaiian musical recital of the MacDowell Sisters at WFAA will be romantically suggestive of the South Seas.

The program to be given by the Georgine Servoss Choral Club Monday night at WGY will be full of favorite classical selections.

Drama notes: WGI, Amrad Players; WGY, "The Hottentot"; WLW, Russian play, "The Bear."

## Tuesday, October 16

**KDKA, E. Pittsburgh, Pa. (Eastern, 326), 6:15 p. m.,** Dinner concert, Grand Symphony Orchestra. David Broudy, director; 7:45, Children's period; 8:30, Tenor solos; "Darius," "Three Sons," "A Sprengisandi," "Gjigjan," "Tari," "Goodbye," G. Rogmaldur, Palsion; Soprano solos, Irene Madonna; Trio selections; "Because I Love You, Dear," "American Life," "Melody in F," Trio from the Pittsburgh Ladies' Orchestra, Frances Young, violinist; Alma Crombie, cellist; A. D. Liefeld, pianist; Cornet solos; "Calm as the Night," "Young Werner's Farewell," Theodore Liefeld, cornetist; Quartet numbers: "Night in June," "All Hall America," "Mexican Serenade"; Mandolin solos; "Believe Me If All These Endearing Young Charms," "My Old Kentucky Home," A. D. Liefeld.

**KGW, Portland, Ore. (Pacific, 492), 3:30 p. m.,** Talk on "The Hot School Lunch," Jeannette P. Cramer; 8:00, Talk for farmers, Paul V. Maris; 10:00, Dance music, George Olsen and his orchestra.

**KHJ, Los Angeles, Calif. (Pacific, 395), 12:30-1:15 p. m.,** Music, News; 2:30-3:30, Matinee musicale; 6:45-7:30, Children's program, "The Sandman," 8:00-10:00, De Luxe Program.

**KSD, St. Louis, Mo. (Central, 546), 8:00 p. m.,** Program, Advertising Club glee singers; 11:30, Dance music, Dave Silverman's Orchestra.

**KYW, Chicago, Ill. (Central, 536), 11:35 a. m.,** Table talk, Mrs. A. J. Peterson of Peoples Gas Co.; 2:35 p. m., Studio program; 5:00, Latest news; 6:50, Children's bedtime story; 8:58, Musical program, Sammie Williams; Herbie Mintz, pianist; A. W. "Sen" Kaney, specialty act; 9:01, Program, American Farm Bureau Federation.

**WBAP, Fort Worth, Texas (Central, 476), 7:30-8:30 p. m.,** E. Clyde Whitlock; 9:30-10:45, Fort Worth Harmony Club.

**WBZ, Springfield, Mass. (Eastern, 337), 7:30 p. m.,** Twilight tales for the kiddies; First lecture in the Household Management course; Agnes H. Craig; 8:00, Concert, Harriet Ely, pianist; Milton J. Aronson, violinist; 9:00, Bedtime story for Grown-ups, Orison S. Marden.

**WGX, Detroit, Mich. (Eastern, 517), 11:00-12:00** midnight, Red Apple Club, Will Collins, Bernice Baeburn.

**WDAP, Chicago, Ill. (Central, 360), 1:35 p. m.,** Drake Concert Ensemble; Blackstone String Quintet; 7:00, Drake Concert Ensemble; Blackstone String Quintet; 10:00, Fredrick W. Agard, tenor; Bob Cougle, pianist; Jack Chapman's Orchestra.

**WDAR, Philadelphia, Pa. (Eastern, 395), 12:00-12:54 p. m.,** Organ recital, Stanley Theater; Dinner music, Arcadia Cafe Concert Orchestra; 2:00-3:00, Song recital; 4:30-5:55, Piano recital, Edna Finestone; 7:30-7:45, Bedtime stories, Dream Daddy; 7:45-8:00, Dramatic Review, Walter Greenough.

**WDT, New York, N. Y. (Eastern, 405), 12:00-1:00 p. m.,** Songs, Bob Evans; "Keep on Trying," Bryon Gay; Piano solos, Robert Hood, Bowers; "Nobody Else But You," "Moon Light Nights," Wolfe Gilbert; Songs, Hugo Frey; "Susan," "Where the Sacramento River Flows," Bob Evans.

**WFAA, Dallas, Texas (Central, 476), 12:30-1:00 p. m.,** Address, DeWitt McMurray, editor Semi-Weekly Farm News; 8:20-9:30, Program, Tell Me This Club of the Dallas Journal in orchestra, song and expression; 11:00-12:00 midnight, Gibson Mandolin and Guitar Club.

**WFI, Philadelphia, Pa. (Eastern, 395), 1:00 p. m.,** Dinner music, Meyer Davis Bellevue Stratford Concert Orchestra; 3:00, Popular program; 6:30, Dinner music, Bellevue Stratford Concert Orchestra; 7:00, Bedtime stories by Cousin Sue; 8:00, Educational talk and song recital; 9:30, Radio play by Strawbridge and Clothier Radio Players.

**WGI, Medford Hillside, Mass. (Eastern, 360), 3:00 p. m.,** Amrad Women's Club; "Hospitality Talk," Marjorie Drew; Selections on the Chickerling Ampico and Brunswick; 5:00, "Twilight Tales," Eunice L. Randall; 6:00, Late news flashes; 6:15, Weekly review of conditions in the Iron and Steel Industry; 7:00, Bayley's Whispering Jazz Orchestra.

**WGR, Buffalo, N. Y. (Eastern, Standard, 360), 12:30-1:00 p. m.,** George Albert Bouchard, organist; 4:00, Margaret Blakeslee, violinist; Martha Gomph, harpist; tea time music, Stadler Palm Room; 6:30-7:00, George Albert Bouchard, organist; 7:00, Digest of the day's news; topics of scientific interest.



Miss Idella Banker (above), from the Cincinnati Conservatory of Music, will sing on the big opening program for the winter season at Station WLW, the Crosley company. Her voice is pure lyric soprano.



Mrs. A. J. Peterson (left) talks each day from 11:05 to 11:35 a. m. Central time from Station KYW. Mrs. Peterson is responsible for many recipes for the newlywed housewife successfully attempts.

**WGY, Schenectady, N. Y. (Eastern, 380), 2:00 p. m.,** "Courses in Home Nursing," Anna McGee; 7:45, A Few Moments with New Books, William F. Jacob; "Legend," WGY Orchestra; "Polish Dance," Free-love Miller, pianist; Selections for String Trio, Edward Rice, violinist; Leo Killen, violinist; Ernest Bursleigh, cellist; "Modern Laundry Service," William A. Bidwell; "Le Papillon," "To the Rising Sun," Free-love Miller; "Spring's Awakening," Peter Schmidt, clarinetist; "Shapodite," Orchestra; Football strategy, American Boy; "Humoresque," Edward Rice; "Valse Chromatique," Free-love Miller; "Song Without Words," Ernest Bursleigh; "Gavotte Piquante," Orchestra.

**WHAS, Louisville, Ky. (Central, 400), 4:00-5:00 p. m.,** Selections, Strand Theater Orchestra, Harry S. Currie, conductor; "Just Among Home Folks"; Selections, Rialto Theater-organ; 7:30-9:00, Concert, Ray Pfaff and his orchestra; Reading, "An Interesting Historical Episode."

**WIP, Philadelphia, Pa. (Eastern, 509), 1:00 p. m.,** Organ recital, Karl Bonawitz, Germantown Theater Organ; 3:00, Artist recital; 7:00-7:30, Bedtime stories by Uncle Wip; 8:00, Dramatic Review; 8:15, Concert; 9:00, Short talk; 9:15, Recital.

**WJAX, Eastern, 390), 7:30 p. m.,** Concert program arranged by the Cleveland News Leader; 7:30, Bedtime story, E. G. Johnson; 7:45, Thow's Syncopators in an orchestral program; Soprano Trio, Edith Cannon, Dorothy Maskell, Rose Seton.

**WLW, Cincinnati, Ohio (Eastern, 309), 10:00 p. m.,** "A Japanese Sunset," "Tin Roof Blues," "Electric Girl," Circle Orchestra; Piano solos, Claire Harkness; "Life and Happiness," May Cornell Stolber; Circle Orchestra.

**WMAQ, Chicago, Ill. (Central, 447.5), 4:30 p. m.,** Program, pupils, Glenn Dillard Gunn School of Music; 7:30, First of series of programs, arranged by consuls of foreign countries; 9:00, Dance music, Blue Fountain Room, Hotel LaSalle; 9:15, The Whitney Trio, instrumental.

**WOC, Davenport, Iowa (Central, 484), 12:00 m.,** Chimes concert; 3:30 p. m., Educational program, A. G. Hinrichs; 5:45, Chimes concert.

**WOO, Philadelphia, Pa. (Eastern, 509), 11:00-11:30 a. m.,** Organ recital, Mary E. Vogt; 12:00-12:55 p. m., Dinner music, Wanamaker Tea Room Orchestra; 4:45-5:00, Organ recital, Mary E. Vogt.

**WWJ, Detroit, Mich. (Eastern, 517), 9:30 a. m.,** "Tonight's Dinner" and a special talk by the Woman's Editor; 9:45, Fred Shaw, popular pianist and songwriter and Margery Richmond, pianist in their "Ironing Day" program; 3:00 p. m., Detroit News Orchestra; 7:00, Detroit News Orchestra, Town Crier; Mrs. Annabelle Tollo, soprano; Miss Tollo, pianist; Alf D. Fleming, baritone; Rev. Sanborn, speaker.

## Wednesday, October 17

**CFCN, Calgary, Alta. (Mountain Standard, 440), 11 p. m.-1 a. m.,** Plaza cabaret dance program; other special musical numbers.

**KDKA, E. Pittsburgh, Pa. (Eastern, 326), 6:15 p. m.,** Dinner concert, KDKA Little Symphony Orchestra; 7:30, Literary program, Marjory Stewart; 7:45, The Children's Period; 8:30, Orchestra numbers; "Castles in Spain," "Dance Espagnole," "Gypsy Airs," "The Land of Joy," "Frangese," "Il Trovatore," KDKA Little Symphony Orchestra; Contralto and tenor duet; "Hunting Scene," Mrs. Woesthoff and Mr. Thompson; Tenor solos; "On Away! Awake! Awake! Awake!" "Love's Garden of Roses," "Minor and Major," "Three Shows," "Malcolm Thompson; Contralto solos; "Noble Lee, soprano; Sallie Manke, accompanist; "Mrs. Perkins' Close Call," Henry Walter Graham, Chicago's humorous story teller; 9:05, Reviews of the latest books, Llewellyn Jones.

**PWX, Havana, Cuba (Eastern, 400), 9:00-11:30 p. m.,** Municipal band, national and foreign music.

**WBAP, Fort Worth, Texas (Central, 476), 7:30-8:30 p. m.,** Sam Losh; 9:30-10:45, Texas Hotel Orchestra.

**WBZ, Springfield, Mass. (Eastern, 337), 6:00 p. m.,** "La Sirene Overture," "A Dream," Bauernanz, "Song to the Evening Star," "Coppelia Ballet," "Marguerite Waltzes," "Minuet Soperita," "Pas de Volce," Adagio, "On the Old Plantation," WBZ Trio; 7:00, Third lecture in the radio course, "Alerting Currents," "Frequency," Edward H. Goodrich; 7:30, Twilight tales for the kiddies; "Proper Illumination to Prevent Eye Strain," Frank E. Dow, M. D.; Humorous program; 8:00, Convention, National Council of Congregational Churches, addresses, Dr. Sherwood Eddy, Dr. Harry Emerson Fosdick.

**WDAP, Chicago, Ill. (Central, 360), 1:35 p. m.,** Drake

Concert Ensemble; Blackstone String Quintet; 7:00, Drake Concert Ensemble; Blackstone String Quintet; 10:00, Hugh Michel, tenor; Jack Chapman's Orchestra.

**WDAR, Philadelphia, Pa. (Eastern, 395), 12:00-12:54 p. m.,** Organ recital, Stanley Theater; Dinner music, Arcadia Cafe Concert Orchestra; 2:00-3:00, Orchestra selections, Arcadia Cafe Concert Orchestra; 4:30-5:55, Piano and song recital; 7:30-7:45, Bedtime stories by the Dream Daddy; 7:45-8:00, Current topics, Arthur D. Keese; 9:00, Song recital, piano solos, Edna Finestone; Dance music, Arcadia Cafe Orchestra, Howard Lanin, director; Special WDAR features.

**WDT, New York, N. Y. (Eastern, 405), 12:00-1:00 p. m.,** Morning Song from Peer Gynt Suite, Peerless Trio; "April Morn," William Gibson, Lillabelle Barton; "Winds of the South," Miss Barton; "Gavotte," Mr. Adams, cellist; "By the Waters of the Minnetonka," Mr. Gibson; "Allegro," The Peerless Trio; "My Heart at Thy Sweet Voice," Miss Barton; "I Feel Thy Angel Spirit," Miss Barton and Mr. Gibson; "I Love the Moon," Miss Barton; "Calm as the Night," Arthur D. Keese, violinist; 7:00-8:00, Stage and Screen, Charles Reed Jones; Vaughn De Leath's Merry Makers; Harriet De Young Kaplan, soprano; Madam Blanche Waldo Dewey, whistler; Recital, Mr. Selegren; Sara Sagalowitz, soloist.

**WFAA, Dallas, Texas (Central, 476), 12:00-1:00 p. m.,** Address, Victor Schoffelmeyer, field representative of The Dallas Semi-Weekly Farm News.

**WFI, Philadelphia, Pa. (Eastern, 395), 1:00 p. m.,** Dinner music, Meyer Davis Bellevue Stratford Concert Orchestra; 3:00, Song recital and piano solos, Loretta Kerk; 6:30, Dinner music, Meyer Davis Bellevue Stratford Concert Orchestra; 7:00, Bedtime stories by Cousin Sue.

**WGI, Medford Hillside, Mass. (Eastern, 360), 3:00 p. m.,** "Twilight Tales," Eunice L. Randall; 6:00, Late News Flashes; 6:45, Girls' Hour, "Camp Fire Girls," by "Big Smoke"; 7:30, "Science Up to Date," Scientific American; "This Week's Judge"; Musical program.

**WGR, Buffalo, N. Y. (Eastern Standard, 360), 12:30-1:00 p. m.,** George Albert Bouchard, organist; 4:00, Margaret Blakeslee, violinist; Martha Gomph, harpist; Tea time music, Stadler Palm Room; 6:30-7:00, George Albert Bouchard, organist; 7:00, Digest of the day's news; 8:45, Address, the Rev. Louis Sudemeyer, St. James Evangelical Church, chairman religious education committee, Erie County Sunday School Council, on "Religious Training of Children"; 9:00, Concert, Edward Messersmith and Sons, of Niagara Falls.

**WHAS, Louisville, Ky. (Central, 400), 4:00-5:00 p. m.,** Selections, Strand Theater Orchestra, Harry S. Currie, conductor; "Just Among Home Folks"; Selections, Alamo Theater Organ; 7:30-9:00, Concert, Ches Meyer's Orchestra, Ches Meyer, pianist and director; Bob Atwood, drummer; Ed Reddick, saxophonist; J. Millburn Stone, saxophonist; Ed Steitz, cornetist; Charles H. Dannaker, player of tuba; H. K. Hopkins, banjoist; Lowell Nichols, trombonist; Paul Seyfert, violinist; Reading, "An Interesting Historical Episode."

**WIP, Philadelphia, Pa. (Eastern, 509), 3:00 p. m.,** Program of popular dance music; 6:02, Dinner music, Jordan-Lewis Dance Orchestra, Bob Lewis, director; 7:00, Bedtime stories by Uncle Wip.

**WLW, Cincinnati, Ohio (Eastern, 309), 4:00-5:00 p. m.,** Fireman's Band of the Oklahoma City Fire Department (enroute to Richmond, Va., where the International Fire Engineers Convention is to be held); 8:00, Part One, "America," Syrian Temple Shrine Band; Invocation, Dr. Frank Stevenson; March "138th U. S. A. Field Artillery," Syrian Temple Band; Overture, "Slavonic Rhapsody," August Schaefer, cornetist; The best loved southern melodies, Syrian Temple Band; Part Two: Concert, Karl Kirksmith, cellist; Idella Banker, soprano; Thomeie P. Williams, accompanist; Address: Nationally famous speakers attending the 29th Annual Convention of the Ohio Valley Improvement Association, P. Crosley, Jr., president of the Crosley Mfg. Co.; Part Three: Syrian Temple Shrine Band, trombone comedy, "Hot Trombone," "Songs and Sayings," Syrian entertainers; Humoresque, "Pop Goes the Weasel," Novelty, "The Cuckoo," March, "The Man Among Men."

**WMAQ, Chicago, Ill. (Central, 447.5), 1:00 p. m.,** Weekly talk, Chicago Assn. of Commerce Luncheon; 4:30, Program, Cosmopolitan School of Music and Dramatic Art; 7:00, Georgene Faulkner, the Story Lady, stories for children; 7:30, Lecture from Northwestern University; 9:00, Dance music, Hotel LaSalle Orchestra, E. E. Scheetz, Jr., director; 9:15, Weekly program, Leon & Healy.

**WOC, Davenport, Iowa (Central, 484), 12:00 m.,** Chimes concert; 3:30 p. m., Educational lecture, Clyde G. Kern; 6:30, Sandman's visit; 7:00, Educational lecture for farmers, "Alfalfa and Soils," M. H. Hoffman; 8:00, Pipe organ recital, Mrs. Frank W. Elliott; Mrs. O. D. Doran, soloist; 10:00, Artist musical program, Erwin Swindell, director; Mrs. Albert Potter, soprano; Mrs. Paul Boyd, mezzo-soprano; Harry Y. Mercer, tenor; Manington Bent, bass; Dorothy Smith, pianist.

**WOO, Philadelphia, Pa. (Eastern, 509), 11:00-11:30 a. m.,** Organ recital, Mary E. Vogt; 12:00-12:55 p. m., Dinner music, Wanamaker Tea Room Orchestra; 4:45-5:00, Organ recital, Mary E. Vogt; 7:45, Dinner music, Hotel Adelphia Roof Garden Orchestra; 8:30, Short talk; 9:30, Organ recital, Mary E. Vogt.

**WOS, Jefferson City, Mo. (Central, 440.9), 8:00-9:30 p. m.,** Program of musical numbers; Short addresses and other features, employees of the Missouri State Highway Commission, Mrs. C. F. Wassler, director; Address, by a specialist of the Missouri College of Agriculture.



Jane Johnston Rupp (circle above), soprano soloist October 18 at Station WJAX, "The Wave from Lal" the winter opening of WLW, Cincinnati, Wednesday.

**WTAM, Cleveland, Ohio (Eastern, 390), 8:00 p. m.,** Orchestral selections by the WTAM Orchestra; Violin solo, Ben Silverberg, Miss Sharp, accompanist; Soprano solos by Florence Wasson, Mrs. J. Powell Jones, accompanist; Banjo solos, Danny Russell, Carl Smitzer, accompanist; Baritone solos by Arthur Parry, Mrs. J. Powell Jones, accompanist; Cello solo by Max Schmidt, Miss Sharp, accompanist.

**WWJ, Detroit, Mich. (Eastern, 517), 9:30 a. m.,** "Tonight's Dinner," by the Woman's Editor; 9:45, Public health service bulletins; 3:00 p. m., Detroit News Orchestra; 7:00, Detroit News Orchestra; Town Crier; Vocal selections by pupils of George Carris.

## Thursday, October 18

**KDKA, E. Pittsburgh, Pa. (Eastern, 326), 6:15 p. m.,** Dinner concert, Grand Symphony Orchestra, David Broudy, director; 7:30, International Sunday School Lessons, Allegheny County Sabbath School Association; 7:45, The Children's period; 8:00, Program for the farmers, Frank E. Mullen; 8:45, Quartet numbers: "The Cavalier's Song," "Tally-Ho," "The Sweetest Flower That Blows," "Tally-Ho," "The Glory," Blanchard Riestler, first tenor; Robertson Tilton, second tenor; William Hasselman, first bass; Carl Ruhe, second bass; Piano solos: "Romance," Sharp; "Soaring," Scilliana; Impromptu, "F Sharp Minor," "Elin Tanz," Marie Vortelber; "Within These Hallowed Dwellings," Carl Ruhe, bass; "This Flower You Gave to Me," Robertson Tilton, tenor; "It Was Not So To Be," William Hasselman, bass; "Ah How So Fair," Blanchard Riestler, tenor.

**KGW, Portland, Ore. (Pacific, 492), 3:30 p. m.,** Women's program, Child Training; 8:00, Dramatic program; 10:00, Dance music, George Olsen and his orchestra.

**KHJ, Los Angeles, Calif. (Pacific, 395), 12:30-1:15 p. m.,** Music, News; 2:30-3:30, Matinee musicale; 6:45-7:30, Children's story, "Uncle John"; 8:00-10:00, Mexican concert, Jose Arias.

**KPO, San Francisco, Calif. (Pacific, 423), 1:00-2:00 p. m.,** Rudy Seiger's Fairmont Hotel Orchestra; 4:30-5:30, Seiger's Fairmont Hotel Orchestra; 8:00-9:00, "Mary," "Her Rose," Edwin Ferguson, tenor; "What's in the Air Today?" "Moon of My Delight," Mrs. H. F. Coykendall; Bass solo, Jack Darrell; Dr. C. M. Noel, speaker; "Kashmiri Song," "Sacrament," Edwin J. Ferguson, tenor; "Gracelienne Fantastique," Bosena Kalas, pianist; "Homeing," "Dawn," Mrs. H. F. Coykendall, soprano; Dr. C. M. Richards, accompanist; 9:00-10:00, Songs popular during the World War, Gladys Salisbury, organist.

**KYW, Chicago, Ill. (Central, 536), 11:35 a. m.,** Table talk, Mrs. A. J. Peterson of Peoples Gas Co.; 2:35 p. m., Studio program; 5:00, Latest news; 6:50, Children's bedtime story; 8:00-8:58, Herbie Mintz, pianist; A. W. "Sen" Kaney, specialty act; Mandolin and his band; 9:05, Twenty Minutes of Good Reading, Rev. C. J. Fernin.

**WBAP, Fort Worth, Texas (Central, 476), 7:30-8:30 p. m.,** Fort Worth artists; 9:30-10:45, Fort Worth artist.

**WBZ, Springfield, Mass. (Eastern, 337), 7:30 p. m.,** Twilight tales for the kiddies; "Dialogue," 6th lecture in Short Story Writing, Dr. J. Berg Esenwein; 8:00, Concert, Mrs. W. W. Macalpine, soprano, Mrs. M. F. Ford, pianist; 9:00, Bedtime story for grown-ups, Orison S. Marden.

**WDAP, Chicago, Ill. (Central, 360), 1:35 p. m.,** Drake Concert Ensemble; Blackstone String Quintet; 7:00, Drake Concert Ensemble; Blackstone String Quintet; 10:00, John Stamford, tenor; Jack Chapman's Orchestra.

**WDAR, Philadelphia, Pa. (Eastern, 395), 12:00-12:54 p. m.,** Organ recital, Stanley Theater; Dinner music, Arcadia Cafe Concert Orchestra; 2:00-3:00, Concert, Arcadia Cafe Concert Orchestra; 4:30-5:55, Short talks and song recital; 7:30-8:00, Bedtime stories, Dream Daddy.

# BEST TO CURRENT WEEK'S PROGRAMS



Harry Geise (left) has returned from the East where he has been making records and will "tickle the ivories" again for KYW listeners nightly, beginning October 15. Richard D. Wyckoff (above), who is broadcasting "Talks to Investors," Friday evenings over WEAF



action first at Station KYW, Chicago, will be heard Shrine Band Trio (below) are planning to help The members are Billy Waterworth, Eddie Ball and

**WDT, New York, N. Y. (Eastern, 405), 12:00-1:00 p. m.**, Concert, Madam Lillian Croxton, soprano; Gertrude Stimbugh, pianist.

**WFAA, Dallas, Texas (Central, 476), 12:30-1:00 p. m.**, Address, A. B. Jolley, country farm demonstration agent; 8:30-9:30, Elks' Orchestra and Vocal Quartet.

**WFI, Philadelphia, Pa. (Eastern, 395), 1:00 p. m.**, Dinner music, Meyer Davis Bellevue Stratford Concert Orchestra; 3:00, Song recital, Strawbridge and Clothier Male Quartet; Piano solos, Loretta Kerk; 6:30, Dinner music, Meyer Davis Bellevue Stratford Orchestra; 7:00, Bedtime stories, Cousin Sue; 8:00, Boy Scout Radio Corps; 8:30, Program of popular songs; 8:45, Dance music, Jack Leroy and his Manhattan Melody Men from Cathay Tea Garden.

**WGI, Medford Hillside, Mass. (Eastern, 360), 5:00 p. m.**, "Twilight Tales," Eunice L. Randall; 6:00, Late News Flashes; 7:00, "Bits of Wisdom," George Brinton Seal; Radio drama by the Amrad Players.

**WGR, Buffalo, N. Y. (Eastern, Standard, 360), 12:30-1:00 p. m.**, George Albert Bouchard, organist; 4:00, Margaret Blakeslee, violinist; Martha Gomph, harpist; Tea time music, Stadler Palm Room; 6:30-7:00, George Albert Bouchard, organist; 7:00, Digest of the day's news; Boy Scout Radiograms; Employment bulletin; Story from "The American Boy" magazine; 8:00, Dinner-dance music; Banquet and ball, Buffalo Real Estate Board.

**WGY, Schenectady, N. Y. (Eastern, 360), 2:00 p. m.**, "Republican Platform and Principles," Mrs. Jessie W. Slater; 7:35, Open air talk, Jud Landon; 7:45, Prologue; Introduction of artists; "C Minor," Ethel Mincoff and Irene Cooley, pianists; "Chrysanthemum," "Rain," Mardi Kenny, soprano; "Mazurka," Margaret DeGraff, harpist; "Cinka Panna," "Minuet," Adelbert Purga, violinist; "Over the Hills to Arden," Tommy Cammidge; "Solfeggietto in C Minor," "Berceuse," Mary Danaher, pianist; Xylophone and Saxophone Medleys, Fred Paige Wyatt; "Cohen Visits Dr. Coug," Lillian Fisher, reader; "Largo Movement," Ethel Mincoff and Irene Cooley, pianists; "Unbel di," Mardi Kenny; "Ballad," "Imitation of Mandolin," Margaret DeGraff, harpist; "The Drug Clerk," Lillian Fisher; "Waldestrauschen," Mary Danaher; "I Think I'll Get Wed in the Summer Time," Tommy Cammidge; "Mazurka de Concert," Albert Purga, violinist; Selections for two pianos, "Rondo Movement," Ethel Mincoff and Irene Cooley.

**WHAS, Louisville, Ky. (Central, 400), 4:00-5:00 p. m.**, Selections, Strand Theater Orchestra, Harry S. Currie, conductor; "Just Among Home Folks"; Selections, Rialto Theater organ; 7:30-9:00, Concert, Ella Sharrard Violin Quartette; Walter Bodeman, first violinist; Christine Jansing, second violinist; Dorothy Nest, third violinist; Theodore Williams, fourth violinist; Four-minute digest of International Sunday School lesson, Prof. William C. Hatfield; Four-minute Radio Forum talk.

**WIP, Philadelphia, Pa. (Eastern, 509), 1:00 p. m.**, Organ recital, German Theater Organ; 3:00, Song recital; 7:00-7:30, Bedtime stories by Uncle Wip; 8:00, "Where to Go and How to Get There," by Eugene Hogle, Secretary of the Automobile Club of Philadelphia; 8:15, Dance music, Ace Brigade and His Ten Karlins from Hotel Walton; 9:00, Organ recital, Karl Benawitz, Germantown Theater organ; 9:30, Recital.

**WJAX, Cleveland, Ohio (Eastern, 390), 8:15 p. m.**, First number of the second concert of the Cleveland Symphony Orchestra, Symphony No. 3, "Eroica," E. Flat, Op. 55 (Beethoven) Allegro con brio, Marcia Funebre, Scherzo, Allegro molto; 9:30, Popular selections by the Hotel Hollenden Orchestra, Mr. Carl Rupp, director; Vocal solos, Jane Johnston Rupp.

**WLW, Cincinnati, Ohio (Eastern, 309), 4:00 p. m.**, Classical piano selections, Adelaide Apfel; 10:00, Russian Program; Opening selections, Cincinnati Conservatory of Music; "Russian Airs," Helman Weinstein, violinist; Songs in Russian, Mrs. Helen Hersey Tutbill; "A Legend," "The Volga Boat Song," Cincinnati Conservatory; Badario in one

act, "The Bear"; Elena Popova, Helen McCoy; Grigory Smirnov, Joseph Flicke; Luka, Joseph Schreck; Descriptionist, Carolyn Weinbrey; "Oh, Thou Bilowly Harvest Field," Mrs. Helen Hersey Tutbill; Russian Airs, Helmann Weinstein, violinist; Popular Entertainment: George Webb's Hawaiian Entertainers; Miami Dance Orchestra.

**WMAQ, Chicago, Ill. (Central, 447.5), 4:30 p. m.**, Program to be announced; 7:00, Weekly talk, Rockwell Stephens, auto editor; Weekly talk to Boy Scouts; 7:30, Speaker, Art Institute of Chicago; 9:00, Dance music, Blue Fountain Room; 9:15, Program, Prof. Alexander Nakutin.

**WOC, Davenport, Iowa (Central, 484), 12:00 m.**, Chimes concert; 3:30 p. m., Lecture, Karl G. Stephan; 5:45, Chimes concert; 6:30, Sandman's visit; 8:00, P. S. C. Orchestra; V. B. Rochte, baritone, popular music released.

**WOO, Philadelphia, Pa. (Eastern, 509), 11:00-11:30 a. m.**, Organ recital, Mary E. Vogt; 12:00-12:55 p. m., Dinner music, Wanamaker Tea Room Orchestra; 4:45-5:00, Organ recital, Mary E. Vogt.

**WWJ, Detroit, Mich. (Eastern, 517), 9:30 a. m.**, "Tonight's Dinner," Woman's Editor; 3:00 p. m., Detroit News Orchestra; 7:00, Detroit News Orchestra; Town Crier; The Detroit News Male Chorus,

## Friday, October 19

**KDKA, E. Pittsburgh, Pa. (Eastern, 326), 6:15 p. m.**, Organ recital, Lucille Halle; 7:45, Children's period; 8:15, Boy Scout program, Richard Victor, scout master; 8:45, "Yellowstone Trail," Selection from "Travata," "The Queen of Sheba," "Introduction and Ensemble," Solo for clarinet; "Final Valse," "Moonlight in Florida," "Three Dances from Henry VIII," "My Old Kentucky Home," "Lucia Di Lammermoor," "Bowl of Panisles," Westinghouse Band, T. J. Vestine, director.

**KGW, Portland, Ore. (Pacific, 492), 3:30 p. m.**, Lecture, "Nutrition of the School Child," Margery M. Smith; 8:00, Solos; 8:15, Studio program, dance music, George Olsen and his orchestra; 9:00, "Oregon Resources," lecture, University of Oregon extension division; 10:30, Hoot Owls with Pantages Frolic.

**KHJ, Los Angeles, Calif. (Pacific, 395), 12:30-1:15 p. m.**, Music, news; 2:30-3:30, Matinee musicale; 6:45-7:00, Children's program; 7:00-7:30, Organ recital, Arthur Blakeley, organist; 8:00-10:00, Jeanette Shirley, pianist, 6 years of age.

**KSD, St. Louis, Mo. (Central, 546), 8:00 p. m.**, Program, Choir of Central Presbyterian Church, Mrs. Katherine Cowan, soprano; Mrs. Charles H. Austin, contralto; Waldo Finke, tenor; Frank Ingalls, bass; Mrs. Frank A. Neal, accompanist.

**KYW, Chicago, Ill. (Central, 536), 11:35 a. m.**, Table talk, Mrs. A. J. Peterson of Peoples Gas Co.; 5:00 p. m., Latest news; 6:50, Children's bedtime story; 10:00-11:30, Late Show, Herbie Mintz, pianist; Harry Glese, pianist; Wendell W. Hall, KYW's Music Maker; Mary Lee, soprano; Sallie Menkes, accompanist; Pennsylvania Railroad Chicago Orchestra.

**WBAP, Fort Worth, Texas (Central, 476), 7:30-8:30 p. m.**, Fort Worth artists; 9:30-10:45, Texas Christian University.

**WBZ, Springfield, Mass. (Eastern, 337), 6:00 p. m.**, Dinner concert, "Undine Overture," "La Source," "Pixie Pranks," "Dance of the Hours," Selection, "Mignon," "Song of the Volga Boatman," "Divertissement," "To Spring," "Love's Dream," "The Eagle's Nest," WBZ Trio; 7:30, Twilight tales for the kiddies; Current book review, R. A. McDonald; "Safeguarding the Child," Leo D. Woeduck; 8:00, Concert, Mrs. George E. Howes, soprano; Margaret Haskins, pianist; WBZ Trio program; Scherzo from "Septet," "Bourree," Cello solos, Selections, "Herodiade," "Dance Macabre," WBZ Trio; 9:00, Bedtime story for grown-ups, Orison S. Marden.

**WDAF, Chicago, Ill. (Central, 360), 1:35 p. m.**, Drake Concert Ensemble; Blackstone String Quintet; 7:00, Drake Concert Ensemble; Blackstone String Quintet; 10:00, George R. Hill, baritone; Rosemary Hughes, soprano; Jack Chapman's Orchestra.

**WDAR, Philadelphia, Pa. (Eastern, 395), 12:00-12:54 p. m.**, Organ recital, Stanley Theater; Dinner music, Arcadia Cafe Concert Orchestra; 2:00-3:00, Concert, Arcadia Cafe Concert Orchestra; 4:30-5:55, Piano solos, Edan Finestone; Song recital; 7:30-7:45, Bedtime stories by the Dream Daddy; 7:45, Book review, Doris Hyde; Short talks; Radio play by the Walter Greenough Players; 10:10, Dance music, Howard Lanin and His Arcadia Cafe Orchestra; Program of popular songs.

**WDT, New York, N. Y. (Eastern, 405), 12:00-1:00 p. m.**, Astrology, Dr. Arthur Brooks; Bob Miller, tenor; Lewis Planni, pianist; Jimmy Flynn, songster; 11:30-12:00 midnight, Vaughn De Leath's Merry Makers in a dance program.

**WFAA, Dallas, Texas (Central, 476), 12:30-1:00 p. m.**, Address, "Israel, in the Midst of Nations," Dr. Robert Stewart Hyer; 8:30-9:30, Becanto Male Quartet.

**WFI, Philadelphia, Pa. (Eastern, 395), 1:00 p. m.**, Dinner music, Meyer Davis Bellevue Stratford Concert Orchestra; 3:00, Song recital; John Owens, tenor, Caroline Hoffman, accompanist; 7:00, Safety Talk by Stanley Cowman, of U. S. Fidelity and Guaranty Company.

**WGI, Medford Hillside, Mass. (Eastern, 360), 3:00 p. m.**, Amrad Women's Club; "Save New England Pine," Mrs. D. H. Goodwin; Selections, Chickering Ampico and Brunswick; 5:00, "Twilight Tales," Eu-

nice Randall; 6:00, Late News Flashes; 6:45, Condition of Massachusetts Highways; 7:30, Readings, Charles L. H. Wagner, poet-composer; Musical program.

**WGR, Buffalo, N. Y. (Eastern Standard, 360), 12:30-1:00 p. m.**, George Albert Bouchard, organist; 4:00, Margaret Blakeslee, violinist; Martha Gomph, harpist; Tea time music, Stadler Palm Room; 6:30-7:00, George Albert Bouchard, organist; 7:00, Digest of the day's news, road reports; 9:00, Concert, Rialto Sereaders from the Mandarin Cafe, Buffalo.

**WGY, Schenectady, N. Y. (Eastern, 360), 2:00 p. m.**, "How to Buy China"; 6:30, Children's program; 7:35, "Your Health Examination and Your Child's"; 7:45, Radio farce, "The Hottentot," by WGY Players; Celise, Arline Montgomery; Ollie Gilford, Edward E. St. Louis; Mrs. Ollie Gilford, Margaret V. Smith; Swift, Frank Oliver; Alex Fairfax, John Loftus; Mrs. Chadwick, Lola Sommers; Peggy Fairfax, Rose Cohn; Larry Gilford, Jerome Lovenheim; Perkins, Robert Parry; Sam Harrington, Edward H. Smith; Cap, Reggie Townsend, Charles S. Baumes; Orchestra selections; 10:30, Irish night program; WGY Orchestra; Walter Reagles, tenor; Edward A. Rice, violinist; Ernest Burelign, cellist.

**WHAS, Louisville, Ky. (Central, 400), 4:00-5:00 p. m.**, Selections, Strand Theater Orchestra, Harry S. Currie, conductor; "Just Among Home Folks"; Selections, Alamo Theater organ; 7:30-9:00, Soprano solos, Hazel McClennan; Ruth Finley, accompanist; Guitar and mandolin duets, Billy Hinkle, Jean Kohlhepp; Saxophone solos, Alvin Marcus; Hazel Schott, accompanist; Reading, "An Interesting Historical Episode."

**WIP, Philadelphia, Pa. (Eastern, 509), 3:00 p. m.**, Artist recital; 6:45, "Radio Baseball Dope," by Monte Cross; 7:00-7:30, Bedtime stories by Uncle Wip.

**WMAQ, Chicago, Ill. (Central, 447.5), 4:30 p. m.**, Program, Busli Conservatory of Music; 7:00, "Wide Awake Club," arranged by Mrs. Frances Ford; Children's plays, Bertha Iles; 7:30, Weekly musical lecture, Mrs. Marx E. Oberndorfer; 9:00, Dance music, Hotel La Salle Orchestra; 9:15, Program arranged by Prof. Alexander Nakutin.

**WOC, Davenport, Iowa (Central, 484), 12:00 m.**, Chimes concert; 3:30 p. m., Lecture, C. C. Flannigan; 5:45, Chimes concert; 6:30, Sandman's visit; 8:00, Musical program, Erwin Swindell, director; Harold Stekl, boy soprano; Dorothy Roser, pianist; Catherine O'Brien, reader; Walter Kiestek, violinist.

**WOO, Philadelphia, Pa. (Eastern, 509), 11:00-11:30 a. m.**, Organ recital, Mary E. Vogt; 12:00-12:55 p. m., Dinner music, Wanamaker Tea Room Orchestra; 4:45-5:00, Organ recital, Mary E. Vogt; 9:00, Program of popular music; 10:10, Dance music, Hotel Adelphia Roof Garden.

**WOS, Jefferson City, Mo. (Central, 440.9), 8:00-9:30 p. m.**, Regular concert of musical numbers and addresses.

**WTAM, Cleveland, Ohio (Eastern, 390), 9:00 p. m.**, Dance program by the WTAM Orchestra.

**WWJ, Detroit, Mich. (Eastern, 517), 9:30 a. m.**, "Tonight's Dinner," Woman's Editor; 3:00 p. m., Detroit News Orchestra; 7:00, Detroit News Orchestra; Town Crier; Anne Campbell, News Poet; Mrs. Ross Beaumont, reader; Thelma A. Allen, contralto; Nick Shaver, baritone.

## Saturday, October 20

**CFCN, Calgary, Alta. (Mountain Standard, 440), 10:00-12:00 p. m.**, Plaza cabaret dance program; Other special musical numbers; Early morning tele program.

**KDKA, E. Pittsburgh, Pa. (Eastern, 326), 6:15 p. m.**, Dinner concert, KDKA Sextet, Victor Saudek, director; 7:30, "Bringing the World to America," prepared by "Our World"; 7:45, The Children's Period; 8:30, Concert by the trio, Clara Huhn, soprano; Roy Strayer, tenor; George Wahl, bass; Earl Mitchell, accompanist; Quintet from the KDKA Little Symphony Orchestra.

**KGW, Portland, Ore. (Pacific, 492), 3:30 p. m.**, Children's program, music by children, story by Aunt Nell; 10:00, Dance music, George Olsen and his orchestra.

**KHJ, Los Angeles, Calif. (Pacific, 395), 12:30-1:15 p. m.**, Pupils of Davis Musical College; 6:45-7:30, Children's program, "Uncle John"; 8:00-10:00, Grace Senior Brearley, pianist.

**KSD, St. Louis, Mo. (Central, 546), 8:00 p. m.**, Orchestral concert, organ recital, vocal and instrumental specialties, Missouri Theater.

**KYW, Chicago, Ill. (Central, 536), 11:35 a. m.**, Table talk, Mrs. A. J. Peterson of Peoples Gas Co.; 5:00 p. m., Latest news of the day; 6:50, Children's bedtime story; 8:00-8:58, Herbie Mintz, pianist; Harry Glese, pianist; Wendell W. Hall, KYW's Music Maker; Mary Lee, soprano; Sallie Menkes, accompanist; A. W. "Sen" Kane, specialty act; 9:05, "Under the Evening Lamp," by the Youth's Companion.

**PWX, Havana, Cuba (Eastern, 400), 9:00-11:30 p. m.**, Dora O. Snel, soprano; Estrella Herrera, pianist; Juan Odina, flutist.

**WBZ, Springfield, Mass. (Eastern, 337), 7:00 p. m.**, Dinner concert, Hotel Kimball Trio, Jan Geerts, director; 7:30, Twilight tales for the kiddies; "Bringing the World to America," prepared by "Our World Magazine"; "This Week's Judge"; 8:00, Concert, Bert Young, tenor; Mr. Loew, baritone; Mrs. Miriam M. Thomsen, accompanist; 9:00, Bedtime story for grown-ups, Orison S. Marden; 9:30, Dance music, Bolton and Cipriano Orchestra.

**WOAP, Chicago, Ill. (Central, 360), 1:35 p. m.**, Drake

Concert Ensemble; Blackstone String Quintet; 7:00, Drake Concert Ensemble; Blackstone String Quintet; 10:00, Betty Holmes, soprano; Bob Brown and his ukulele; Fred Ross, composer; Melodians Quartette; Jack Chapman's Orchestra.

**WDAR, Philadelphia, Pa. (Eastern, 395), 12:00-12:54 p. m.**, Organ recital, Stanley Theater; Dinner music, Arcadia Cafe Concert Orchestra; 2:00-3:00, Concert, Arcadia Cafe Concert Orchestra; 4:30-5:55, Music recital; 7:30-8:00, Bedtime stories by the Dream Daddy.

**WOT, New York, N. Y. (Eastern, 405), 12:00-1:00 p. m.**, "Tinkerman and the Winged Tangle"; Jules Lavoya Harmonists, dance program.

**WFAA, Dallas, Texas (Central, 476), 12:30-1:00 p. m.**, "Citizenship and Tolerance," Judge James G. Wilson; 8:30-9:30, Smith Family, song, instrument, recitation; 11:00-12:00, Footwarmers' Orchestra.

**WFI, Philadelphia, Pa. (Eastern, 395), 1:00 p. m.**, Dinner music, Bellevue Stratford Concert Orchestra; 3:00, Dance music; 6:30, Dinner music, Meyer Davis Bellevue Stratford Orchestra; 7:00, Bedtime stories by Cousin Sue; 8:00, Short talks and song recital.

**WGI, Medford Hillside, Mass. (Eastern, 360), 7:30 p. m.**, Twenty-ninth of a series of talks on New England Business Problems, Arthur B. Curnick; Musical program.

**WGR, Buffalo, N. Y. (Eastern Standard, 360), 12:30-1:00 p. m.**, George Albert Bouchard, organist; 4:00, Margaret Blakeslee, violinist; Martha Gomph, harpist; Tea time music, Stadler Palm Room; 6:30-7:00, George Albert Bouchard, organist.

**WGY, Schenectady, N. Y. (Eastern, 360), 9:00 p. m.**, Kenmore Hotel Orchestra.

**WHAS, Louisville, Ky. (Central, 400), 4:00-5:00 p. m.**, Selections, Strand Theater Orchestra, Harry H. Currie, conductor; "Just Among Home Folks"; Selections, Rialto Theater organ; 7:30-9:00, Concert, auspices Mrs. Emory Nold; Reading, "An Interesting Historical Episode."

**WHK, Cleveland, Ohio (Eastern, 283), 8:00 p. m.**, Popular selections by the WHK Trio. Vocal numbers by favorite entertainers.

**WIP, Philadelphia, Pa. (Eastern, 509), 1:00 p. m.**, Organ recital, Karl Benawitz on Germantown Theater organ; 3:00, Dance music; 7:00, Bedtime stories, Uncle Wip; 8:15, Artist recital; 9:00, Dance music.

**WMAQ, Chicago, Ill. (Central, 447.5), 8:00-10:00 p. m.**, Musical program, Mrs. Mae Graves Atkins; Dance music, Hotel La Salle Orchestra; Music broadcast direct from The Chicago Theater.

**WOC, Davenport, Iowa (Central, 484), 12:00 m.**, Chimes concert; 3:30 p. m., Lecture, C. C. Hall; 5:45, Chimes concert; 6:30, Sandman's visit; 8:00, Dance program, P. S. C. Orchestra; V. B. Rochte, baritone, baritone soloist.

**WOO, Philadelphia, Pa. (Eastern, 509), 11:00-11:30 a. m.**, Organ recital, Mary E. Vogt; 12:00-12:55 p. m., Dinner music, Wanamaker Tea Room Orchestra; 4:45-5:00, Organ recital, Mary E. Vogt.

**WWJ, Detroit, Mich. (Eastern, 517), 9:30 a. m.**, "Tonight's Dinner," Woman's Editor; 3:00 p. m., Detroit News Orchestra; 5:00, Football scores; 7:30, The Detroit News Orchestra and football scores.

## Sunday, October 21

**CFCN, Calgary, Alta. (Mountain Standard, 440), 10:45-12:00 a. m.**, Grace Presbyterian Church service; 7:30-9:00 p. m., Knox Presbyterian Church service.

**KYW, Chicago, Ill. (Central, 536), 11:00 a. m.**, Church services, Orchestra Hall, Chicago; Dr. F. P. Shannon, pastor; 7:00 p. m., Sunday Evening Club service.

**WBZ, Springfield, Mass. (Eastern, 337), 11:00 a. m.**, Church services, South Congregational Church, Rev. James Gordon Gilkey, pastor.

**WDAP, Chicago, Ill. (Central, 360), 9:15 p. m.**, Drake Concert Ensemble.

**WOAR, Philadelphia, Pa. (Eastern, 395), 12:00-12:45 p. m.**, Organ recital, Stabley Theater; Dinner music, Arcadia Cafe Concert Orchestra; 4:30-5:55, Song recital; 7:30-7:45, Bedtime stories by the Dream Daddy; 7:45-8:00, Moving picture review, by James A. Nassau; 8:00, Short talks; Song and piano solos; Dance music, Howard Lanin's Arcadia Cafe Orchestra; Program of popular songs.

**WFAA, Dallas, Texas (Central, 476), 2:30-3:30 p. m.**, Radio Chapel Bible Class, Dr. William M. Anderson, Jr., pastor; 9:30-10:00, Sacred recital by First Methodist Episcopal Church, South; 10:00-11:00, Hawaiian musical recital, the MacDowell Sisters.

**WFI, Philadelphia, Pa. (Eastern, 395), 4:00 p. m.**, Church services; 7:30, Services and organ recital from Arch Street Presbyterian Church.

**WGI, Medford Hillside, Mass. (Eastern, 360), 4:00 p. m.**, "Adventure Hour," Youth's Companion; Concert program, Edison Laboratory Phonograph; Stories by Arturo; 8:30, Talk on World Unity, auspices of Massachusetts Federation of Churches; Musical program, Mrs. Lettie Griffin, Stevens, soprano; Mrs. Martha B. Clifford, alto; Gladys W. Hodnot, alto; Doris Dutcher, violinist; J. Frederick Roberts, pianist.

**WGR, Buffalo, N. Y. (Eastern Standard, 360), 3:00 p. m.**, Vesper service, choir music, St. John's Lutheran Church.

**WGY, Schenectady, N. Y. (Eastern, 360), 11:00 a. m.**, Church services, State Street Presbyterian Church, Rev. P. A. MacDonald, pastor; 3:30 p. m., Program by WGY Symphony Orchestra; 7:30, Church services, State Street Presbyterian Church.

**WHAS, Louisville, Ky. (Central, 400), 9:57 a. m.**, Organ music; 10:00, Church services, Seventh Day Adventist Church, Rev. Dr. R. G. Bryant, pastor; 4:00-5:00 p. m., Concert, auspices Mrs. Jean Webster Murrell.

## Monday, October 22

**WDAP, Chicago, Ill. (Central, 360), 1:35 p. m.**, Drake Concert Ensemble; Blackstone String Quintet.

**WFI, Philadelphia, Pa. (Eastern, 395), 1:00 p. m.**, Dinner music, Bellevue Stratford Concert Orchestra; 3:00, Short educational talk; Piano solos; 6:30, Dinner music, Meyer Davis Bellevue Stratford Orchestra; 7:00 p. m., Children's Own Half Hour, stories by Cousin Sue.

**WGR, Buffalo, N. Y. (Eastern Standard, 360), 12:30-1:00 p. m.**, George Albert Bouchard, organist; 4:00, Margaret Blakeslee, violinist; Martha Gomph, harpist; Tea time music, Stadler Palm Room; 6:30-7:00, George Albert Bouchard, organist; 7:00, Digest of the day's news; 9:00, Mixed program, featuring W. H. Tenny, composer, and his "Songs of the North."

**WGY, Schenectady, N. Y. (Eastern, 360), 2:00 p. m.**, "Setting the Table Correctly"; 7:45, Address, "Coal Mining," F. L. Stone; "Trees," "Starry Night," "Indian Summer," Georgine Servoss Choral Club; "When the Shadows Fall," Mrs. Robert Simpson, reader; "The Water Lily," "Humoresque," Choral Club; Selections for two pianos, "Peer Gynt Suite," Marion M. Rulson and Alva Knapp; "Landy," "Swallows," Choral Club; "Souvenir," Edward Rice, violinist; "Dance of the Snowflakes," Georgine Servoss Choral Club.

**WHAS, Louisville, Ky. (Central, 400), 4:00-5:00 p. m.**, Selections, Strand Theater Orchestra; Harry S. Currie, director; "Just Among Home Folks"; Selections, Alamo Theater Organ.

**WHAZ, Troy, N. Y. (Eastern, 380), 9:00 p. m.**, Albany Railroad Y. M. C. A. Night, concert program and address.

**WIP, Philadelphia, Pa. (Eastern, 509), 3:00 p. m.**, Short talk; 6:45, "Radio Baseball Dope," by Monte Cross; 7:00-7:30, Bedtime stories by Uncle Wip.

**WOO, Philadelphia, Pa. (Eastern, 509), 11:00-11:30 a. m.**, Organ recital, Mary E. Vogt; 12:00-12:55 p. m., Dinner music, Wanamaker Tea Room Orchestra; 4:45-5:00, Organ recital, Mary E. Vogt; 7:45, Dinner music, Hotel Adelphia Roof Garden Orchestra; 8:30, Short talk by Ralph Bingham; 9:00, WOO Orchestra, Robert Golden, director; 10:10, Organ recital, Mary E. Vogt.

**WOS, Jefferson City, Mo. (Central, 440.9), 8:00-9:30 p. m.**, "Radio Famous Missouri State Prison Concert Band," Virgil W. Combs, bandmaster.



# BEST TO CURRENT WEEK'S PROGRAMS

Concert Ensemble; Blackstone String Quintet; 7:00, Drake Concert Ensemble; Blackstone String Quintet; 10:00, Betty Holmes, soprano; Bob Brown and his orchestra; Molodians Quartette;

Eastern, 395), 12:00-12:54 p. m., Dinner music; 2:30-3:00, Concert; 4:30-5:35, Songs by the Dream

360), 12:00-1:00 p. m., "The Dream"; Jules Lavoye

12:30-1:00 p. m., James G. Wilson; instrument, saluta-

395), 1:00 p. m., Concert Orchestra; music, Meyer Davis D. Bedtime stories and song recital.

360), 7:30 p. m., "The Dream"; Musical

360), 12:30-1:00 p. m., organist; 4:00, Harry S. Currie, harp; 6:30-7:00, Room; 6:30-7:00, Room; 6:30-7:00, Room;

360), 9:00 p. m.,

4:00-5:00 p. m., Harry S. Currie, harp; Selections, Concert, auspices of Interesting Ill-

360), 8:00 p. m., Trio. Vocal num-

509), 1:00 p. m., Farmington Theater Bedtime stories, 2:00, Dance music.

8:00-10:00 p. m., Mrs. A. Adams; Dance Music broadcast

484), 12:00 m., C. C. Hall; Iman's visit; 9:00, V. B. Rochte,

509), 11:00-11:30 a. m., 12:00-12:55 p. m., Tea Room Orches-

17), 9:30 a. m., 3:00 p. m., football scores; 7:30, football scores.

## er 21

Standard, 440), 10:45-11:00 a. m., Church service; 7:30-8:00 p. m., Church service.

1:00 a. m., Church service; Dr. F. F. Shan-

337), 11:00 a. m., Evening Club serv-

9:15 p. m., Drake

395), 12:00-12:45 p. m., Dinner music; 1:30-5:35, Song re-

the Dream Daddy; James A. Nassau; piano solos; Dance

2:30-3:30 p. m., Ham M. Anderson, vocal; 4:00, Hawaiian

395), 4:00 p. m., organ recital from

360), 4:00 p. m., Companion; Con-

monograph; Stories of Unity, auspices of

360), 4:00 p. m., Musical pro-

360), 4:00 p. m., Musical pro-

360), 4:00 p. m., Musical pro-

360), 4:00 p. m., Musical pro-

360), 4:00 p. m., Musical pro-

360), 4:00 p. m., Musical pro-

360), 4:00 p. m., Musical pro-

360), 4:00 p. m., Musical pro-

360), 4:00 p. m., Musical pro-

360), 4:00 p. m., Musical pro-

360), 4:00 p. m., Musical pro-

360), 4:00 p. m., Musical pro-

360), 4:00 p. m., Musical pro-

360), 4:00 p. m., Musical pro-

WFL, Cincinnati, Ohio (Eastern, 309), 4:00 p. m., Classical piano selections, Adelaide Apfel; 10:00, Russian Program: Opening selections, Cincinnati Conservatory of Music; "Russian Airs," Heiman Weinstein, violinist; Songs in Russian, Mrs. Helen Hersey Tutthill; "A Legend," "The Volga Boat Song," Cincinnati Conservatory; Badario in one

WFI, Philadelphia, Pa., (Eastern, 395), 1:00 p. m., Dinner music, Meyer Davis Bellevue Stratford Concert Orchestra; 3:00, Song recital; John Owens, tenor; Caroline Hoffman, accompanist; 7:00, Safety Talk by Stanley Cowman, of U. S. Fidelity and Guaranty Company. WGI, Medford Hillside, Mass. (Eastern, 360), 3:00 p. m., Amrad Women's Club; "Save New England Pines," Mrs. D. H. Goodwin; Selections, Chickering Ampico and Brunswick; 5:00, "Twilight Tales," Eu-

Odina, flutist. WBZ, Springfield, Mass. (Eastern, 337), 7:00 p. m., Dinner concert, Hotel Kimball Trio, Jan Geerts, director; 7:30, Twilight tales for the kiddies; "Bringing the World to America," prepared by "Our World Magazine"; "This Week's Judge"; 8:00, Concert, Bert Young, tenor; Mr. Loew, baritone; Mrs. Miriam M. Thomson, accompanist; 9:00, Bedtime story for grown-ups, Orisca S. Marden; 9:30, Dance music, Bolton and Cipriano Orchestra. WDAP, Chicago, Ill. (Central, 360), 1:35 p. m., Drake

WOO, Philadelphia, Pa. (Eastern, 509), 11:00-11:30 a. m., Organ recital, Mary E. Vogt; 12:00-12:55 p. m., Dinner music, Wanamaker Tea Room Orchestra; 4:45-5:00, Organ recital, Mary E. Vogt; 7:45, Dinner music, Hotel Adelphi Roof Garden Orchestra; 8:30, Short talk by Ralph Bingham; 9:00, WOO Orchestra, Robert Golden, director; 10:10, Organ recital, Mary E. Vogt. WOS, Jefferson City, Mo. (Central, 440.9), 8:00-9:30 p. m., "Radio Famous Missouri State Prison Concert Band," Virgil W. Combs, bandmaster.

### Single Control Circuit Requires but Few Parts

The accompanying circuit is recommended for every one who is looking for a simple, compact and efficient circuit. The diagram is self-explanatory. As proof of its efficiency, a set was built along the lines of the circuit. On July 5, at 10 p. m., through light static signals from WJAZ, Chicago, 90 miles away were heard

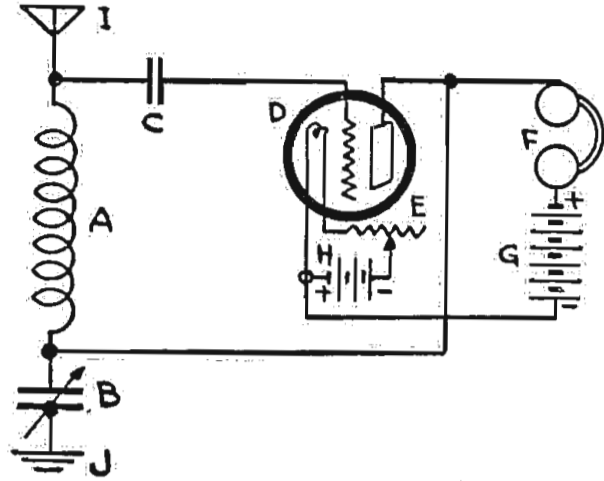

with 1 1/4 volts on the plate and .9 volt on the filament. With 3 volts on the plate and 1.1 volt on the filament, signals came in as loud as local stations on a crystal set. In both cases an aerial 50 feet long and with an average height of 17 feet was used, the end pointing toward Chicago.—E. C. Plepkorn, Milwaukee, Wis.

### Remedying Phone Receivers

Telephone receivers like the other parts of the receiving set often develop troubles of their own. If signals cannot be heard on one of a pair of telephone receivers it is possible that the diaphragm is resting on the magnet poles; consequently it cannot vibrate. Under these circumstances, it is advisable either to tighten the cap a little or to place a thin paper washer beneath the diaphragm, where it rests on the case.

When the cap is removed, if the diaphragm is not held up by the action of the pole-pieces, it is evident that the poles of the receiver have, in some way or other, lost some of their permanent magnetism. This might have been caused by excessively large currents having been passed through the coils or by accidental connection with an alternating current source or by accidentally dropping the receivers. In any event, the only recourse is to have the receivers re-magnetized. For this operation, it will be necessary to take the receivers to someone skilled in this practice, inasmuch as the removal of the magnets calls for considerable care on account of the extremely fine wire with which the magnet coils are wound.—Peter J. M. Clute, Schenectady, N. Y.

### You Don't Need Tubes

to get out of town. If you want new stations on your crystal set WRITE ME TODAY. Mine works 400 to 1,000 miles without tubes or batteries! Thousands have bought my plans and now get results like mine. CHANGES OFTEN COST LESS THAN A DOLLAR. Send self-addressed envelope for further information. Leon Lambert, 501 South Volusia, Wichita, Kansas.

## FLEWELLING ANSWERS TO QUERIES

By E. T. Flewelling

(Editor's Note.—This department is written by Mr. Flewelling, the inventor of the famous super circuit. From the questions sent him each week care of Radio Digest, he picks the one considered most informative for all and answers it in this column.)

### Controlling the Whistle

(Submitted by M. C., Swannanoa, N. C.) Question. The one condenser super which I have built in exact accordance with your articles in The Radio Digest works splendidly as a plain regenerative, but I have been unable to secure any worth while results with it as a super. I have been able to get the whistle of many stations, but I have not been able to hear any words or music because of the loudness of the whistle. When I adjust the grid leak with a 201-A tube with from 45 to 90 volts on the plate, the whistle starts and stops with a click, and I have been unable to control the tone or volume of it to any great extent. Can you tell me what the trouble is?

Answer. Your letter stated so plainly the action of your set that it is not very difficult to see what the trouble with it is. The entire secret of the Flewelling super (if there is such a thing as a secret) lies within the grid leak. I do not believe that there is manufactured at the present time a perfectly suitable grid leak for the Flewelling super circuit, but there are loads of them that I am sure will operate better than the one you have judging from its action as you describe. What is needed is a grid leak with a long gradual range of adjustment and you will find, with such a leak, the tone of the whistle can be controlled from a slow click, click, up to a shrill whistle, which will finally become so high in pitch that you will be unable to hear it. With such a leak in the circuit, one is able to start and stop the action of the tube exactly as is needed, and you will find that the whistle will then be far less objectionable and that the stations will come in very loud and very clear.

You speak of reception of the whistles from the broadcast stations on a plain regenerator, and it might be well for the benefit of other readers to state that with a correctly operating super, the carrier waves from the broadcasting stations are not received as whistles but as squeals, these squeals increasing in loudness as the station is tuned in. The tuning adjustment at the last point is exceedingly fine and care should be taken that you do not tune past a station as one is very apt to do when using a tuning condenser that is too large. Always use a smaller condenser and a larger inductance in preference to a large condenser such as .0005 and its companion inductance.

### Short Aerial Rids Locals

If your local station comes in too loudly and drowns out others, a smaller aerial will help in tuning it out, with a smaller condenser connected between aerial and ground. And if all measures to get rid of the local station fail, why not enjoy its concerts? It is working hard for you, and it is nobody's fault that you are so close to it that you are bound to hear it. Broadcast stations have to be closer to some people than to others.

A little patience in learning to handle your receiver yields rich returns in satisfaction from fine signals. Remember that "Rome wasn't built in a day," and keep on getting more and more familiar with your set and how it works.

### TREAT SICK WITH RADIO

(Continued from page 5)

you will—are infinitely higher in their vibratory frequencies than are the finest of the Radio wave trains, we are on the threshold of the conclusion that they are of the true wave form and that it remains only for some competent physicist to discover the fundamental frequencies and lengths, and finally determine the harmonics.

"When that time comes we shall know not only how to detect, determine, measure and cure disease; we shall also have made a great stride toward solving the innermost, hidden mysteries of life, perhaps immortality."

### RADIO STOCKS WANTED

I can use some radio close-outs to feature in a special radio sale. Particularly interested in standard advertised lines but might consider other items if high-grade. Address, MID-WEST RETAILER, BOX N-300, RADIO DIGEST

## ROCKY MOUNTAIN RADIO PRODUCTS

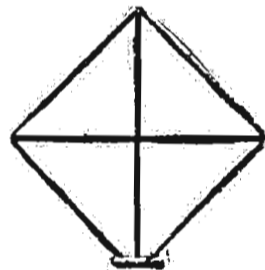

### Crystals

ANY STYLE OF RADIO Material at Lowest Prices! NEW K-D SPRING LOOP AERIAL

List Price \$1.00

Distributors BUS, AERIAL, MAGNET WIRE

Write for Discounts

Rocky Mountain Products Co. 9-C Church St., New York

## GAMBLING?

YOU ARE IF YOUR RADIO TUBES ARE UNPROTECTED

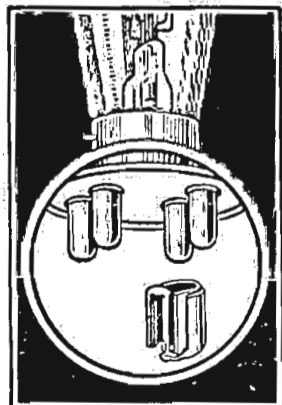

Your Vacuum Tubes are the most delicate parts of your Radio Set.

They are easily blown out—you have probably already had this exasperating experience—it is apt to happen at any time.

"B" Battery wires accidentally crossed for only an instant with the filament leads or sudden excess current from the "A" Battery will do it.

You can prevent this and save yourself money and inconvenience and relieve your mind at a trifling cost.

### INSTALL RADECO SAFETY FUSES

on all your tubes. Applied in an instant to one of the filament terminals. Will fit any standard tube going in any standard socket.

Price 50 cents each, sent postpaid and fully guaranteed. Do not delay. Order now. Specify type of tube used.

DEPT. 6

### RADIO EQUIPMENT COMPANY

Manufacturers and Distributors of Standard Radio Equipment  
630 WASHINGTON STREET BOSTON, MASS.  
New England's Oldest Exclusive Radio House  
Dealers:—Write for our proposition

## 10,000 Western Electric 5 Watt "E" Tubes, Type CW-931 or VT-2 Tubes!

WITH A HIGHER AMPLIFYING FACTOR THAN ANY OTHER TUBE MADE!

Almost a third of these 10,000 Western Electric VT-2 Tubes have been sold! A brand new genuine Western Electric VT-2 Tube for \$7.45 isn't a purchase that can be made every day—that's evident from the way orders are piling in. Remember there only was 10,000 of them—so you'd better hurry if you want your tubes.

These genuine Western Electric 5-watt "E" tubes, type CW-931, or commonly known as VT-2 tubes were designed and built specially to conform to the specifications of the U. S. Signal Corps. They are built to be used both for Radio and Audio Frequency Amplification and for CW and phone transmitting. The characteristics of the tube are as follows:

Filament: 4.8 to 7 volts Power Output: 5 watts  
Plate Voltage: 45 to 350 volts Filament is of pure platinum  
Equipped with standard base to fit standard socket

All merchandise GUARANTEED by us to be of BEST QUALITY All mail orders shipped to you PROMPTLY



"The largest Radio Store in America"  
509 S. State St. Dept. RD-1120 Chicago, Ill.

### Limit of Operation

The ordinary receiver will work very well up to a certain limit, but when this point is passed the deflection of the diaphragm begins to vibrate against the magnets, and make the headphones sound tinny and very unpleasant. Therefore the sound should be kept down below this point. A receiver may be improved by placing a paper washer under the diaphragm, so as to bring it a little farther away from the pole pieces. This will do away with some of the rattle. The thickness of this paper is of great importance, and some experimenting is necessary to get it right.

Do not let the telephone cords hang over the table so as to touch your storage battery. Acid will soon ruin the cords.

## CABINETS

Direct from the manufacturer. Beautifully made of BIRCH, finished in MAHOGANY, edges moulded, hinged top, 7 inches deep inside. Baseboard included.

Panel sizes given

7x9	.....\$2.00	7x21	.....\$3.40
7x12	.....2.40	7x24	.....3.90
7x18	.....3.00	7x28	.....4.50

Special sizes to order.

## WITTENMEIER

4857 N. Leavitt St. CHICAGO, ILL.



THE PERFECT SYNTHETIC CRYSTAL DETECTOR, SENSITIVE OVER ENTIRE SURFACE. No Hunting for "Spots." Loud and Clear. Endorsed by thousands of satisfied users. Sensitiveness Guaranteed. Price, Mounted..... 50c

14 K. GOLD SUPERSENSITIVE RUSONITE CATWHISKER. Permanent. Will Not Oxidize. Price..... 25c

RUSONITE REFLEX CRYSTAL. Manufactured Expressly for Reflex Circuits. Will Stand Up Under Heavy Plate Voltage. Guaranteed. Price, Mounted..... \$1.00

Order from your dealer or direct from RUSONITE PRODUCTS CORP. 15 Park Row New York, N. Y.



# Simple Explanation of Radio for Everybody

## Chapter III, Part II—Receiver Essentials and Rectification

By M. W. Thompson

THE following article is the fourth of a series for Radio beginners, written by Marvin W. Thompson, well known in air-phone circles for his understandable style of approaching his subject, and his ability as a Radio engineer. Mr. Thompson is now an associate editor on the staff of Radio Digest. A preliminary outline of the Chapters to follow is:

- Chapter IV—Inductances—Fixed and Variable.
- Chapter V—Condensers—Fixed and Variable.
- Chapter VI—Vacuum Tubes.
- Chapter VII—Antennas and Grounds.
- Chapter VIII—Regeneration.
- Chapter IX—Audio Frequency Amplification.
- Chapter X—Loud Speakers.

IN THE first half of this chapter it was brought out that a vacuum tube contained (1) a filament of tungsten wire, (2) a grid of fine wire surrounding the filament and (3) a plate of thin sheet metal surrounding the grid; so, to proceed:

### The Electronic Stream

When the filament of our tube is connected to a battery it heats up to a red glow or brilliancy, depending on the type of tube, and throws off millions of electrons or small particles with negative charges. These electrons seek a surface which is positive in its relation to the filament and that surface is provided by the plate. The plate is connected to the positive side of a battery and the negative side of that battery is connected to one

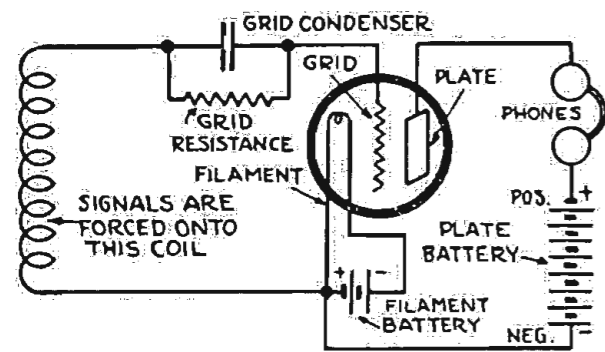

Figure 13—The vacuum tube connected to an oscillating grid circuit and to head telephone receivers

side of the filament. Thus we have electrons streaming across the gap between filament and plate, tending to stabilize the lack of negative electrons which exists on the plate, and a battery which is constantly removing them from the plate and

feeding them back into the filament. This action will continue as long as the circuit is unbroken, the filament is heated and the battery functions.

charge plays an important part in the tube's action. The grid is between the filament and plate and acts as a control over the num-

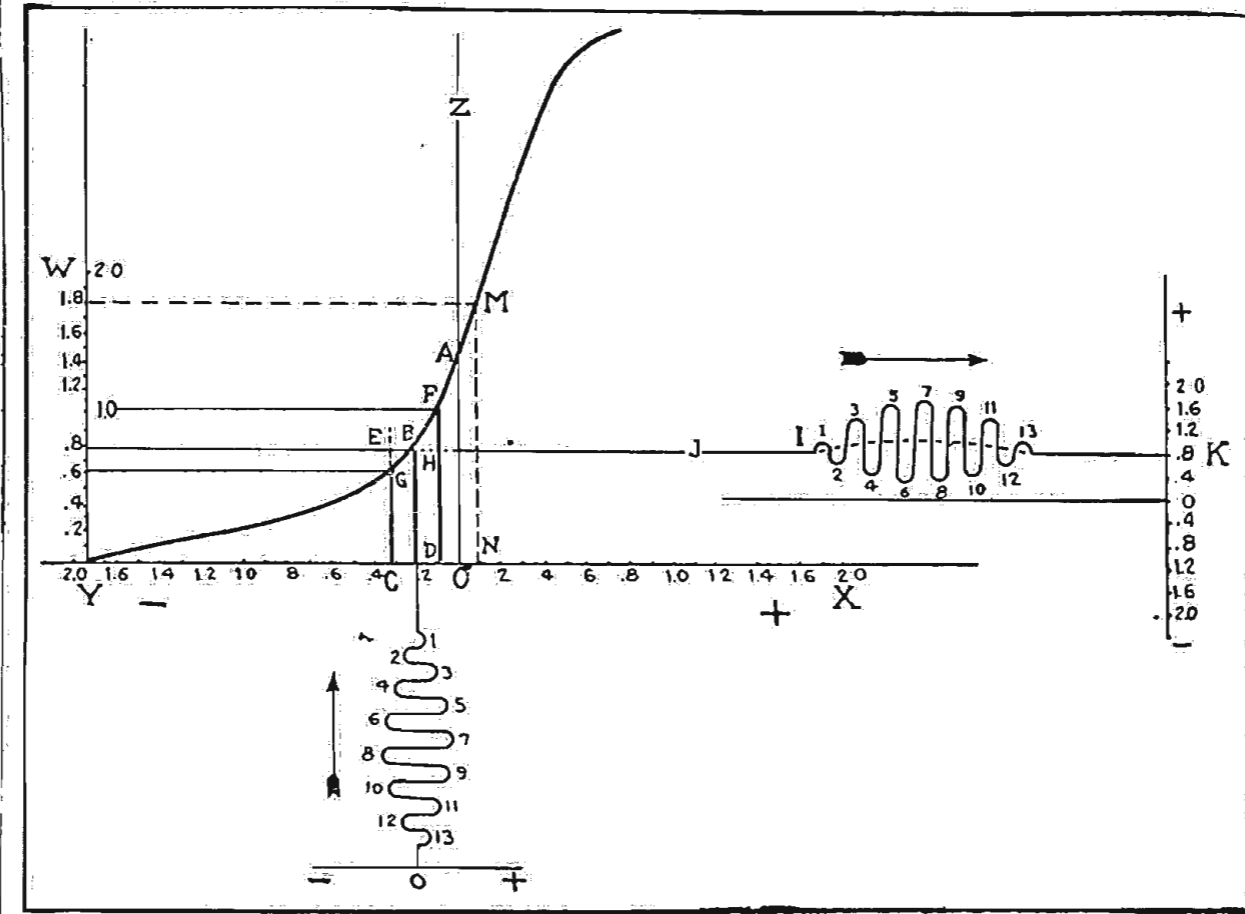

Figure 14—The characteristic curve of a tube used as a detector with incoming oscillations on the grid at the bottom and outgoing plate circuit pulsations at the right

### Space Charge

This brings us to the term "space charge." The number of electrons which can be in motion from the filament to the plate at any given instant has a limit. This number is increased, either by raising the temperature of the filament or increasing the voltage of the battery connected to the plate, until a point is reached where continued increase of these factors does not increase the current flowing in the plate circuit. We have now reached the capacity or maximum space charge of the tube. This matter of space

charge of electrons that go across. If the grid is made positive in relation to the filament, two things occur. The electrons are attracted away from the filament in greater quantities, and (1) most of them, because of momentum, pass the grid and travel to the plate, while (2) a few of them adhere to the grid, tending to neutralize its positive charge. If, on the other hand, the grid is made negative, it repels the negative electrons, tends to push them back onto the filament, and less electrons get through to the plate. Thus, when the grid is positive, more cur-

rent flows across the space and in the plate circuit; when the grid is negative, less current flows.

### The Characteristic Curve

If we connect the tube to incoming alternating current and insert a pair of head telephone receivers in the plate circuit, as in Figure 13, we can tell what occurs in the tube by reference to Figure 14. This represents what is called the characteristic curve of a tube, let us use a UV-199. The plate battery in Figure 13 gives 40 volts, the filament is set to draw .06 ampere. Figure 14 shows us the amount of current that will flow in the plate circuit if the charge on the grid is changed and varied. The vertical distance WY represents 2 milliamperes of current in the plate circuit, the line OY shows the grid 2 volts negative, the line OX shows the grid 2 volts positive. The line OZ is a line drawn vertically from the point at which the grid is neutral. To see how this works out, let us say the grid is made .1 volt positive, N; then follow line NM to the curve and across at right angles to line YW, where we find the current flowing in the plate circuit is 1.8 milliamperes. Another case: the grid is made .33 volt negative, we follow up line CG to G and across and see that the plate current is .6 milliamperes. Now we are ready to begin our explanation of how a tube works as a detector.

### The "Lower Bend"

If, when the grid is at 0, our drawing a vertical line to the curve brings us to point A, the grid resistance and grid condenser are adjusted so that the grid is .2 volt negative and drawing a vertical line will put us at the point B. To function as a detector, a tube must be operated at (Continued on page 20)

## Your pilot over the RADIO WAVES

Whatever the radio course you have set for yourself, here is your one best guide.

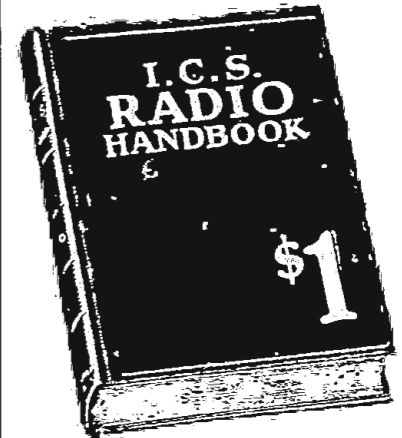

JUST OUT — 562 PAGES

Compiled by HARRY F. DART, B.S.E.E. Formerly with the Western Electric Co., and U. S. Army Instructor of Radio.

Technically Edited by F. H. DOANE

THIS is what you want in a radio book. It answers your every question as it occurs to you. Look up the thorough index, turn to the page, and there you are! The most complicated facts about radio and electricity explained as easily as the most simple ones.

Everything included. Compiled by an expert formerly of the Western Electric Co., the organization that knows most about radio in the world, and edited by another famous engineer. Understood by thousands of laymen because written especially for them. Yet—and here is the real marvel of this book—the advanced amateur, constructor and experimenter also find in it the data they need for calculating the constants of transmitters, receivers and associated apparatus for all radio purposes.

SOME OF THE FEATURES: Electrical terms and circuits, antennas, battery construction and maintenance, generators and motors, vacuum tubes (really explained), every receiving hook-up, radio and audio frequency amplification, broadcast and commercial receivers, super-regeneration, codes, license rules, etc.

Send \$1 to-day and get this 562-page I. C. S. Radio Handbook—the biggest dollar's worth in Radio. Money back if not satisfied.

TEAR OUT HERE —

INTERNATIONAL CORRESPONDENCE SCHOOLS  
Box 8279-B, Scranton, Penna.

I enclose One Dollar. Please send me—post-paid—the 562-page I. C. S. Radio Handbook. It is understood that if I am not entirely satisfied I may return this book within five days and you will refund my money.

Name.....  
Address.....

NOTHING IS WORTH WHILE UNLESS IT IS RELIABLE

YOUR EARS know the difference with this condenser

Reliable Neutralizing Condenser

ONLY 75¢

For tuned radio frequency and all latest type circuits—the Reliable Micro-Air Condenser makes your messages so much clearer that even the most makeshift radio set is vastly improved.

Clearness—increased tuning range—neutralized capacity reactance of inductive couplings—vernier adjustment of the grid condenser—all available with this highly important member of your set. Make it "Reliable!"

Reliable Audio and Radio Frequency Amplifying Transformers

Surely, you can overcome distortion and secure better amplification with these two Reliable transformers.

The "Audio" is made in three favorite ratios. Fully enclosed. Shielded type. Priced at \$4.50 and \$5.00.

The "Radio" types reduce static to a minimum and are made in four types of all necessary ranges. Price \$2.75.

Manufactured by  
**The Reliable Parts Mfg. Co.**  
2819 Prospect Avenue, Cleveland, Ohio  
Jobbers and Dealers Write

**RADIO AT N.Y. PRICES**

U.S. MAIL

**BUILD YOUR OWN RADIO SET**

<p><b>Cockaday Circuit, Complete</b></p> <p>CONSISTING OF</p> <ul style="list-style-type: none"> <li>1 Cockaday coil and 7 pigtail connections</li> <li>2 .0005 variable condensers</li> <li>1 socket</li> <li>1 panel, 7x18</li> <li>2 dials, 3-inch</li> <li>1 grid leak and condenser</li> <li>1 rheostat</li> <li>1 switch lever</li> <li>1 base board</li> <li>12 feet bus bar</li> <li>7 switch points</li> <li>7 marked binding posts</li> <li>1 Jack</li> <li>Wiring diagram and instructions</li> <li>Cat. K 178</li> </ul> <p><b>\$13<sup>65</sup></b></p>	<p><b>Reinartz Circuit, Complete</b></p> <p>CONSISTING OF</p> <ul style="list-style-type: none"> <li>1 Reinartz coil and 16 pigtail connections</li> <li>2 3-inch dials</li> <li>1 .0005 variable condenser</li> <li>1 11-plate condenser</li> <li>1 socket</li> <li>1 rheostat</li> <li>3 switch levers</li> <li>1 7x14 panel</li> <li>1 base board</li> <li>8 marked binding posts</li> <li>12 feet bus bar</li> <li>1 grid condenser</li> <li>2 dozen switch points and stops</li> <li>Wiring diagram and instructions</li> <li>Cat. K 179</li> </ul> <p><b>\$10<sup>85</sup></b></p>		
<p><b>Flewelling Circuit, Complete</b></p> <p>CONSISTING OF</p> <ul style="list-style-type: none"> <li>1 .0005 variable condenser</li> <li>3 .0005 mica condensers</li> <li>1 7x12 panel</li> <li>2 coil honeycomb mount</li> <li>1 variable grid leak and condenser</li> <li>1 50 turn honeycomb coil</li> <li>1 75 turn honeycomb coil</li> <li>2 coil mounts with straps</li> <li>1 dial, 3-inch</li> <li>8 marked binding posts</li> <li>1 base board</li> <li>1 Wiring diagram and instructions</li> <li>Cat. K 180</li> </ul> <p><b>\$12<sup>45</sup></b></p>	<p><b>Ultra Audion Circuit, Complete</b></p> <p>CONSISTING OF</p> <ul style="list-style-type: none"> <li>1 7x12 panel</li> <li>1 .0005 variable condenser</li> <li>1 socket</li> <li>1 variometer</li> <li>1 vernier rheostat</li> <li>1 grid leak</li> <li>1 .0002 mica condenser</li> <li>7 binding posts</li> <li>1 base board</li> <li>10 feet bus wire</li> <li>Diagrams and instructions</li> <li>Cat. K 181</li> </ul> <p><b>\$9<sup>65</sup></b></p>		
<p><b>Dietzen Vernier Condenser</b></p> <p>14 Plate <b>\$2.65</b></p> <p>24 Plate <b>\$2.95</b></p> <p>46 Plate <b>\$3.45</b></p>	<p><b>DIETZEN Midget Tube</b></p> <p>1½ Volt, Operates on one dry cell, either with or without B battery. Wiring diagram Free with each tube.</p> <p><b>\$1.00</b></p> <p>Socket 40c</p>	<p><b>A.B.C. "B" Battery</b></p> <p>22½ V. Small....\$ .95 Medium... 1.45 Large... 1.95</p> <p>45 V. Small.... 1.95 Medium... 2.50 Large... 3.50</p> <p>1½ volt twin double duty "A" battery .75</p>	<p><b>Loop Aerial</b></p> <p>Set up in 5 minutes. All parts complete</p> <p><b>\$1.00</b></p>

**Modell's**

ESTABLISHED 1929

71 Cortlandt Street  
Dépt. G. NEW YORK

We Pay Parcel Post Charges on All Orders. Money Order or Personal Check Accepted. Money Refunded if Not Satisfactory

**America's Greatest Radio Mail Order House**

# Radio Digest

## Illustrated

REG. U. S. PAT. OFF. AND DOM. OF CANADA

Published by the Radio Digest Publishing Company, Inc.  
123 West Madison Street  
Telephone: State 4843, 4844, 4845  
Chicago, Illinois

E. C. RAYNER, Publisher

Chas. F. Smisor, Editor Evans E. Plummer, Managing Editor  
H. J. Marx, Technical Editor M. W. Thompson, Associate Editor

Eastern Representative, Jacob Miller, Times Bldg., Times Square,  
New York; Telephone Bryant 4909

Pacific Coast Representatives

E. J. Wood, 251 Kearney St., San Francisco  
Telephone Kearney 1472

H. M. Morris, 417 Western Mutual Life Building, Los Angeles  
Telephone 12011

Member of the Audit Bureau of Circulations

58  
PUBLISHED WEEKLY

SUBSCRIPTION RATES

Yearly in U. S. and Possessions and Canada, \$5.00.  
Foreign postage, \$1.00 additional. Single copies, 10 cents.

Vol. VII Chicago, Saturday, October 20, 1923 No. 2

### Broadcast Music Does No Harm

Artists Gain Popularity through the Phonograph

MANY players, singers and teachers were much alarmed when the first talking machines came out. They dreaded the "canned music" and thought the demand for "fresh music" would decrease. However, some of the talented artists were of a different opinion and furnished music to be recorded and used by all those who purchased records. They found that success was better attained by the broadcast of their music throughout the nation to all owners of phonographs.

The famous Sousa band gained popularity by "canned music," as the leader dubbed it. As for the "canned music," is not Sousa and his band more popular than ever?

Today there is a new alleged enemy of "fresh music" as well as of the phonograph. The Radio, undoubtedly the greatest scientific marvel of all time, is making many musicians and managers tremble in their boots. Is there any reason for their apprehensions? No one can say for certain; opinions differ widely.

It seems likely, all things considered, that Radio will do "fresh music" no more harm than "canned music" has done to John Philip Sousa and others.

### Education on the Air

Many Schools and Colleges Have Radio in Their Courses

RADIO has been more or less dependent on education for its success. Perhaps in the not too distant future education will be dependent on Radio to a very large extent. At present it is difficult to think seriously about either of these subjects entirely apart from the other. Some kind of Radio course is included in the curricula of most schools and colleges as they open their fall and winter terms. Such courses vary from the very popular, for those who simply wish to know enough of the fundamentals to get the most from their receiving sets, to the very technical for those who are interested in Radio research, designing, operating and other professional work. Many correspondence courses in Radio are being offered by various institutions active in that branch of educational work.

Radio is being used more and more as an accessory in educational work, and in many programs a noticeable improvement is being made in broadcasting material of educational value.

There are many subjects which lend themselves readily to Radio broadcasting, and it is not too much to expect that in the near future many of our educational institutions will use Radio lecture courses as a supplement to their regular work in the classroom.

### Farm Radio News Covers Country

Local Reports to Be Furnished by Radio from Arlington

AGRICULTURAL reports are now being broadcast by Radio telegraph as well as by Radio telephone direct from the Department of Agriculture through the Arlington Radio Station. The new service is designed to speed up the dispatching of market news and is the result of co-operative arrangements with the Navy Department to establish remote control stations for the Department of Agriculture.

The broadcasting of market news from the four long wave, high-powered Radio telegraph stations of the Navy Department makes it possible for Radio telegraph operators virtually anywhere in the United States to receive up to the minute agricultural price quotations.

With the use of Radio and wire telegraphy the Department of Agriculture has established the most complete and efficient market news service to farmers and other agricultural interests developed anywhere in the world. Farmers in practically any section of the country can now receive reports of agricultural prices and movements at the leading market centers the same day, and in many cases within a few hours after the news develops. Trained reporters in the markets collect the information and file it for immediate dissemination by telegraph and Radio.

## RADIO INDI-GEST

### WALLA WALLA NEWS BULLETIN

WALLA WALLA (By Indi-Gest Broadcaster), September nth.—Wild nights of terror and riot scenes have been common here since Chief Announcer Bramdin Bray declared martial law to quell the disturbance caused by a mistaken identity. Lem Stebbins, famous for his invention, the Stebbins souper degenerative circuit, arrived on the mail boat and was taken for the Mystery Man who invented the so-called Miloplex now being featured extensively in columns surrounding the Weekly Indi-Gest. Lem claims he is not the inventor, but the dark-skinned natives claim he is, as the Miloplex, when it works, works very much like the famous degenerative set. Lem claims he can make the Miloplex look like a sick baby with his new hypodramatic-taj-mahal ultra-abundant modifications of his own hook-up. The latter claim made the natives sore and so Announcer Bray had to call out the troops to protect Lem's life. As a climax, the natives have raised a flaming antenna and threaten to call the legislature into special meeting to impeach Bray and his political hangers-on who have not been hung yet.

### A-B-C Lessons for Indigest Beginners

Chapter XVII—Ohm, Sweet Ohm  
BY GOSH

**R**IS for Rheostat,  
That makes tubes bright and dim,  
So you can hear the music best,  
Whenever it comes in.

### Lots of Room. Send Her in

Drear Indi: Don't care much for your "Kink Dept" but would join a "Drink Dept" at once. Have you room this week for my new "Per-Plex-D" circuit? A.B.T.

### Boys Love Radio

Mother shakes her fist for silence,  
Father curses us for noise,  
As he holds his ear-muffs tighter;  
They don't seem to love us boys.

We can't see the fun of sitting  
Just as quiet as can be,  
Turning, twisting some old door-knobs—  
Hearing music? "Hully Gee!"

But it sometimes works out dandy;  
Pa and ma forget the clock,  
And we stay up three hours longer,  
So we're trying not to talk.

STEP-DOWN BILL.

### Marked "Personal"

Turkey Creek, Wisconsin.

Editor Radio Indi-Gest,  
Chicago.

Hon. Sir: As one of the oldest living and most respected citizens of this here town, having held public office when only 47, I want you should give me some help. Its this way. There was a drummer come around to Smith's Hardware Store and when they wouldn't handle his Radio outfits, me being progressive, I took the only sample he had, 100 foot antenna and all. Of course it was the town talk, and they said old man Tucker bought another gold brick.

Just the same the first night I heard a Mr. Davenport's gal singing and him bragging about how tall his corn grows, and a feller singing a song on the edge of the beach in Chicago.

Well next day the smart elick who fixes Lizzies in the garage he comes up to see what the outfit looks like. As soon as he gets his eyes on it he knows more than the man who made it. He says, "Pap there aint no use using all those batteries. Eliktricity is eliktriety. One battery will do the job better. They seen you was a sucker and sold you a string of them."



Me not being smart to it and him fixing spark plugs, etc., I let him go to it. Well when he got through with his tinkering, it was as dead as a paterfied tom-cat. I says, "You put 'em haek those batteries, the whole bunch. Eliktricity in a Lizzie aint even the 47th cousin by marriage to whats in my Radio." It make me so mad I says, "I don't know which is dumber you or it." He don't know nothing and I aint had no tune outen it since. Even the lights gone on the blink. About all he aint monked with is the ant-emma and the pipe in the ground. Inside the box looks the same but I got a notion its a wreck.

Now mebbly you could tell me what to do to get her going again. Don't send none of those highergliff pictures like come on the box but write it out in plain words. Much oblige.

DAN'L TUCKER.

P.S. Never mind. The drummer come to town again. Got her going in no time and I heard what oats and corn cost Chicago people and all kinds of tunes. Jnst as much oblige.

MORAL: If you're a Radiophan, beware the tinkerin' man.  
H. K. C.

### He's Writing for Indi-Gest

Dear Indi: What's become of the fellow who used to ask how many miles a 400-meter wave length station could send? DOTANDASH.

### Dusting Off the Old Ones

A chap was arrested for assault and battery and brought before the judge.

Judge to Prisoner: "What is your name, your occupation and what are you charged with?"

Prisoner: "My name is Sparks, I am an electrician and I am charged with assault battery."

Judge (after recoverlug his equilibrium): "Officer, put this guy in a dry cell."  
Eo Ess.

## RADIO ROMANCE

"OR WHAT RADIO SETS THINK ABOUT"

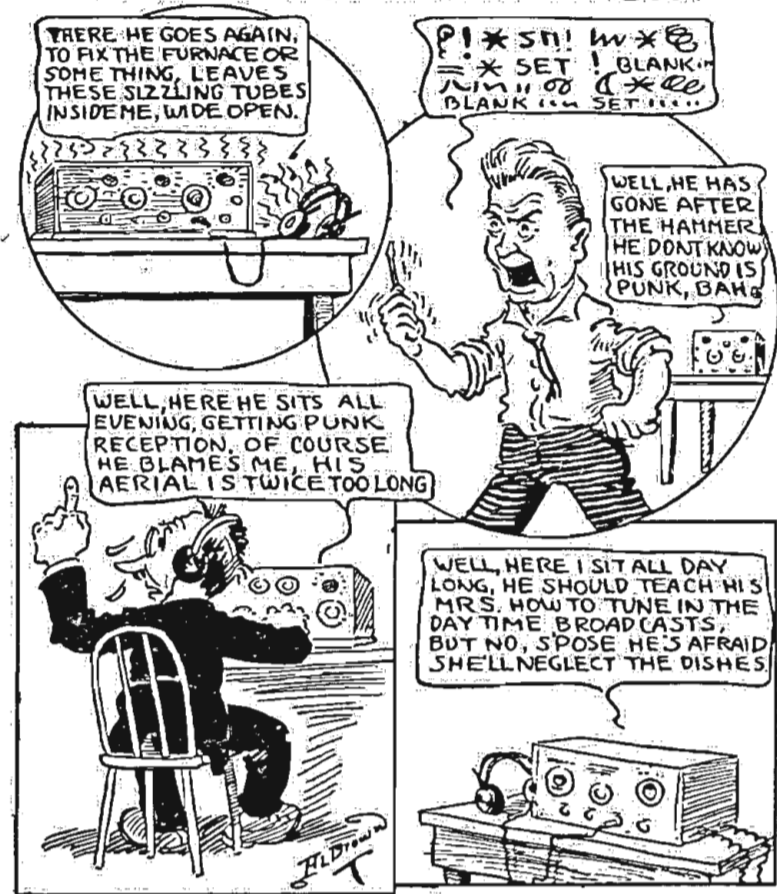

## Condensed

By DIELECTRIC

If you recall how familiar static made itself with listeners in during the month of August, you will appreciate the difficulties Radiophans experienced in England while listening for broadcasting from this country. WHAZ should feel some pride in having reached Mr. Hill, of Liverpool, England, with an entire program of songs between the hours of 3:00 and 4:30 on the morning of August 28th, and this through terrific static. The reception was at times adequate to put on a loud speaker. It seems likely that this winter will find others across the water getting our broadcasts in fairly good volume.

What are the actual conditions existing in respect to Radio patents, etc., no one knows at the present time—beyond the members of the Federal Trade Commission. Their report having been completed and now in preparation for submission to Congress when it meets in December, we purchasers of Radio sets and apparatus may soon check up our surmises with what have been found to be facts. Every fan who indulges in trying out new hook-ups, some of which entail the purchase of units in addition to those on hand, feels himself subjected to unfair treatment on the part of the big Radio interests. We shall see!

Radio weddings have been the vogue at some broadcasting stations and at expositions, though few such ceremonies have been broadcast when taking place in a church. When Mr. and Mrs. Hutchings, of Winston-Salem, N. C., were united in marriage at the First Methodist Church of Fort Worth, Tex., all who tuned in WBAP at noon of that day were able to hear the entire proceedings. That is a pretty comfortable way in which to attend a formal function of any character. No one makes mental note of your bed slippers, smoking jacket and 1,000 w. briar, nor do they criticize the manner in which you allow yourself to be steered up the aisle. Yet you hear it all and picture the lovely bride.

Amateurs in the United States may well anticipate picking up signals from fellow fans in Cuba before a great while, in view of a presidential decree allotting wave length and power to amateurs on that island. At present we have not much choice as to whom we shall tune in. Amateur station 6XJ at Trinucu, operated by Frank H. Jones, is the first to be heard in this country. His station has been picked up in many states and with fair volume. The broadcast fan, content only to listen to concerts, etc., is losing a great deal of pleasure from his set. Those code signals which cause you so much annoyance would sound very differently in your ears—IF you understood them. I admit that a test signal is an abomination in any receiver. Learn the code.

In order to enlist the attention of the average Radio broadcast listener beyond a certain hour in the evening (I am not referring to the DX-ers) a station must have an unusual program, either in quality or features. The head of the company now in control of the Hollenden hotel in Cleveland is quite aware of this and is planning accordingly. It is expected that a transmitting set will be installed in the near future and programs of such a nature put on the air that fans all over the country will sit up late at night to hear the entire program. New features must be found else the station will not operate. Question listeners anywhere whose sets are capable of tuning in the Drake hotel station, WDAP, Chicago, and you will find a great majority of them keeping this station in the set. Let's have your station call, Mr. Mack.

# How to Build a Push-Pull Power Amplifier Set

## Transformers Can Be Made at Home

By H. J. Marx

EVERY fan at some time or other gets the power amplifier fever. The manufactured article in most cases is way beyond the reach of his pocket-book, so he looks about for instructions to make his own. Unfortunately there has been a decided lack of data. In addition it's no small task to wind transformer primaries and secondaries considering the high number of turns and the frail wire (gauge 40) this requires. These factors have been the real reason for lack of more definite articles on the subject.

There is no reason why the fan cannot construct his transformers by using coil windings from standard audio frequency transformers. Undoubtedly there are numerous transformers lying around inactive that can be used for the purpose. This reservation, however, is recommended for attention. It is advisable to use only such windings where the ratio

(secondary windings). In connecting to the circuit the grid of one tube connects to the G terminal of the first secondary, and the grid of the other tube is connected to the F terminal of the second. The joined connection at the center is then connected to the negative side of the C or biasing battery.

The same procedure is followed for the PP-2 combination except that a connection is made to the primary joint which leads to the B+ or plate battery. The secondary joint has no connection, and the loud speaker is connected across the outside of the two secondaries.

### Theory

The principle of the push-pull transformers is the use of two tubes working in conjunction. One builds up the current while the other is at its weakest point of grid potential and vice versa. In this way, one stage using two tubes gives

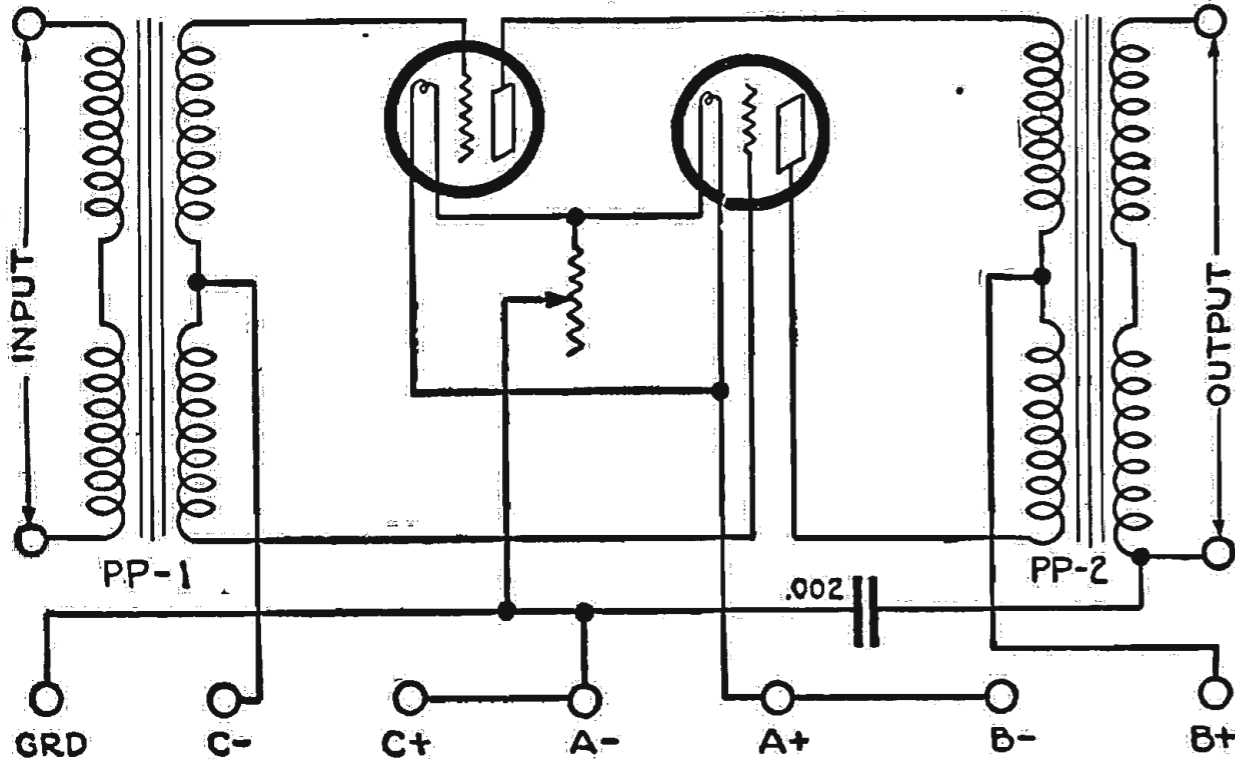

is not greater than five to one. High ratios in power amplifiers are very likely to create unnecessary distortion.

### Using Separate Transformers

Before taking up the constructional unit core duo transformers a few words may well be devoted to the statement, that, for trial, the transformers can be connected as separate units. For example, in type PP-1 in the circuit, connect the B+ of one to P of the other (primary windings) using only the P of the first transformer, and B+ of the second as the input connections. Then connect the F of the first to the G of the second

higher efficiency of amplification without the attendant distortion. The final result is a much more uniform and desirable operation of the loud speaker.

### Construction of Single Core Unit

Take your transformers of the same

## MARVEL

AT THE MERCHANDISE AT THE PRICES QUOTED AT THE GUARANTEE

\$18 Westinghouse Rectigon Battery Charger...\$14.63  
STORAGE BATTERIES  
Guaranteed for Two Years

List Price	Our Price
\$17.00 6 Volt 60 Amp.....	\$ 9.25
21.00 6 Volt 80 Amp.....	11.75
<b>ADVANCE "B" BATTERIES</b>	
1.75 22½ Volt, small.....	.75
3.00 22½ Volt, large.....	1.45
4.75 45 Volt Small.....	2.00
5.50 45 Volt Large.....	2.90
Brands Superior Phones, Genuine.....	5.25
Nerco.....	3.00
<b>AUDIO TRANSFORMERS</b>	
\$4.00 Thordarson 3 to 1 ratio.....	\$3.25
4.50 Thordarson 6 to 1 ratio.....	3.75
F. M. C. Transformers 6 to 1 ratio.....	3.25
\$7.00 Pioneer moulded bakelite Variocoupler.....	4.75
8.50 Pioneer moulded bakelite Variometer.....	4.50
180 degree Variocoupler with spider web rotor, silk wound, 90 turns on stator.....	3.50
Freshman Ver. Leak—50c. with condenser.....	.65
Ritter Portable K.D. Loop complete.....	1.00
Glass Enclosed Crystal Detector.....	1.00
Saturn Automatic Plug.....	1.00
Pacent Twin Adapter.....	1.00

Only money orders accepted. Must include postage. Our merchandise is guaranteed by the manufacturer and is of the highest quality. Send for monthly price list.

**MARVEL RADIO SPECIALTY CO.**  
132 Nassau Street, Dept. R. D., NEW YORK

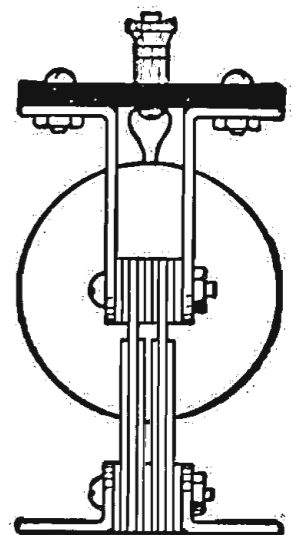
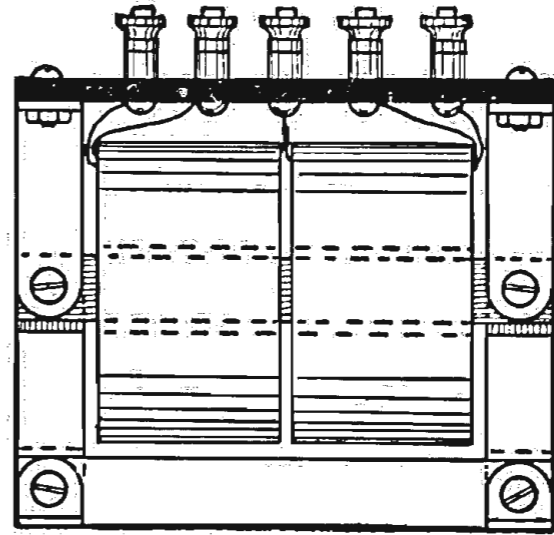

type and ratio; if four alike are not available two and two will do, but the two sets of windings in the same unit must be alike. Remove the windings (primary and secondary in one unit) from their core. It is best to tag the four ends so that no mistake will be made afterwards in identifying them.

Procure a sheet of silicon transformer steel not thicker than .02 inches. Cut this into strips ½ inch wide. Measure the width of two windings and add 1½ inches. Cut about 100 pieces this length. Now measure the thickness of one winding from inside edge of hole to outside. To this add 1¼ inches and cut 20 pieces. Then cut 40 pieces ⅝ inches shorter than the last.

The illustrations show how these strips are assembled to build up the core. Not more than four of the middle sized strips are used on the ends. These simply bind the complete core unit together. The idea is to create a magnetic gap between the two ends of the core. As many strips should be used as will compactly fit into the hole of the windings. Holes are drilled through all the strips at the four corners.

They are then assembled with the coils as shown. The coils should have their windings in the same direction. This is best taken care of by observing that the

respective leads from the primary and secondary project from the same sides on both coils.

The small angles used on the base for mounting, and on top for holding the terminal strip, can be made up of strip brass or bought. A small strip of panel stock mounted on top serves very effectively for mounting the binding posts to which the connections are made.

These angles should be clamped underneath the four machine screws and nuts that hold the core together. No shielding is necessary. The same method of con-

(Continued on page 18)



ON APPROVAL FOR 30¢  
**ZOBEL-STEIN LABORATORIES**  
322 9TH ST. BROOKLYN, N.Y. SOUTH 2650

## LEARN RADIO

Here's your opportunity. Radionees you. Win success in this fascinating field. Trained men in demand at highest salaries. Learn at home, in your spare time.

### Be a Radio Expert

I will train you, quickly and easily, to design, construct, install, operate, repair, maintain, and sell all forms of Radio apparatus. My new methods are the most successful in existence. Learn to earn

**\$1,800 to \$10,000 a Year**

**FREE** Wonderful, home-construction, tube receiving set, of latest design. Write for "Radio Facts" free. Engineer Mohaupt.

**American Electrical Association**  
Dept. 310 4513 Ravenswood Ave., Chicago

## WILLARD

WILLARD RADIO COMPANY  
291 BROADWAY,  
New York City

**"THE BEST FOR LESS"**

### REINARTZ CIRCUIT

EVERY PART COMPLETE

1 Reinartz wound coil, 1 tube socket, 1 rheostat, 1 23-plate .0005 MFD. variable condenser, 1 13-plate .00025 MFD. variable condenser, 3 inductance switches, 23 switch points and nuts, 6 switch stops and nuts, 8 binding posts, 2 3" dials, 1 variable grid leak, 1 .002 MFD. phone condenser, 23 feet bus bar wire, 1 high-grade panel ALREADY DRILLED AS PER DIAGRAM

**\$10.95**

Two-Stage Audio Frequency Amplifier—Parts complete in every detail for this Circuit—\$11.00

#### CONDENSERS

3 Plate Variable; value, \$1.75.....	\$1.05
11 Plate Variable; value, \$2.50.....	1.20
13 Plate Variable; value, \$2.50.....	1.20
17 Plate Variable; value, \$3.50.....	1.85
23 Plate Variable; value, \$3.50.....	1.35
43 Plate Variable; value, \$4.50.....	1.95
13 Plate VERNIER; value, \$5.50.....	\$3.75
23 Plate VERNIER; value, \$6.00.....	4.00
43 Plate VERNIER; value, \$6.50.....	4.25

**VARIOCOUPLER**—Celeron Condensite and Litz Wire Wound Secondary; Value \$4.50. Special.....\$2.25

**AUDIO FREQUENCY TRANSFORMER**—Designed for use with W. D. 11 Tubes, list, \$4.50; price.....\$2.75

**BALL BEARING INDUCTANCE SWITCH**—value, 75c; special.....\$.25

**V. T. SOCKETS**—Nickel, brass sleeve, composition base; value, \$1.00; special at......40

**EXTRA SPECIAL**—Telephone 3000 Ohms Headsets; \$9.00 value; reduced to.....3.50

Vernier Dial Adjuster. List, 35c; special..... .25

### FLEWELLING CIRCUIT

EVERY PART COMPLETE

2 honeycomb coils, 1 2-coil mounting, 2 coil plugs, 3 .006 condensers, 1 variable grid leak, 1 grid leak, 1 23-plate .0005 MFD. variable condenser, 1 Vernier rheostat, 1 tube socket, 8 binding posts, 20 feet bus bar wire, 1 3" dial and 1 high grade panel ALREADY DRILLED as per Diagram in Booklet of instruction sent free.

**\$11.95**

Two-Stage Audio Frequency Amplifier—Parts complete in every detail for this Circuit—\$11.00

**BEST QUALITY JACKS, Single Circuit;**

value, 65c; special at.....	\$.30
Double Circuit; value, 90c; special at.....	.45

**MULTIPLE POINT INDUCTANCE SWITCH** with Knob and Dial (15 Switch Points).....\$1.45

**LIGHTNING ARRESTERS** approved by underwriters......90

**THREE-INCH DIALS**—Unbreakable—heat resisting composition—high finish; special.. .30

**TWO-INCH DIALS**—Same design—for rheostats and potentiometer; special at.....\$.25

Filament Rheostat, 6 ohm.....	.65
Filament Rheostat, 20 ohm.....	.80
Filament Rheostat, 50 ohm.....	.90
With 2" Dial, 15c extra.....	

**TELEPHONE PLUGS**......60

**FRESHMAN VARIABLE RESISTANCE LEAK** and MICA CONDENSER Combined. .75

Half the pleasure of Radio is in building your own sets. Many pleasurable and profitable hours can be passed in this way. Our service department will be glad to give you any information you need. Just drop us a line.

Every article advertised above is guaranteed by the manufacturer and by us—Mail orders filled immediately—transportation PREPAID on all orders of \$5.00 or over east of the Mississippi River. Send cash, check or money order—absolutely no goods sent C. O. D.

## B-METAL

The Crystal That Brought Joy to 100,000 Radio Users Last Season.

Sent on approval. Pay us when you are satisfied. That's how sure we are that it will please you. Just pass the good news on to a dealer so others may enjoy B-Metals too. Just send us the name of dealer who hasn't heard of B-Metal when remitting.

### LOUD TALKING RADIO CRISTAL

The B-Metal Type C Fixed Detector for Your Reflex Set—Try One and Know

The price is reasonable when you see what it does. Thousands in use. Read one of the many reports.

**\$2.50** B-Metal Refining Co. July, 1923.

Gentlemen:—Your Type C detector is working fine and am sorry I have not written you before. I believe it makes my set work 100% better than the old cat-whisker.

CHAS. J. KNAPP, Moultrie, Ga.

**B-METAL REFINING COMPANY**  
3134 Trumbull Avenue, Detroit, Mich.  
Chicago Branch, 53 West Jackson Blvd.  
For Sale by All Dealers

### LOUD TALKING CRYSTAL DETECTOR

**TRIPLE HONEYCOMB COIL CIRCUIT**

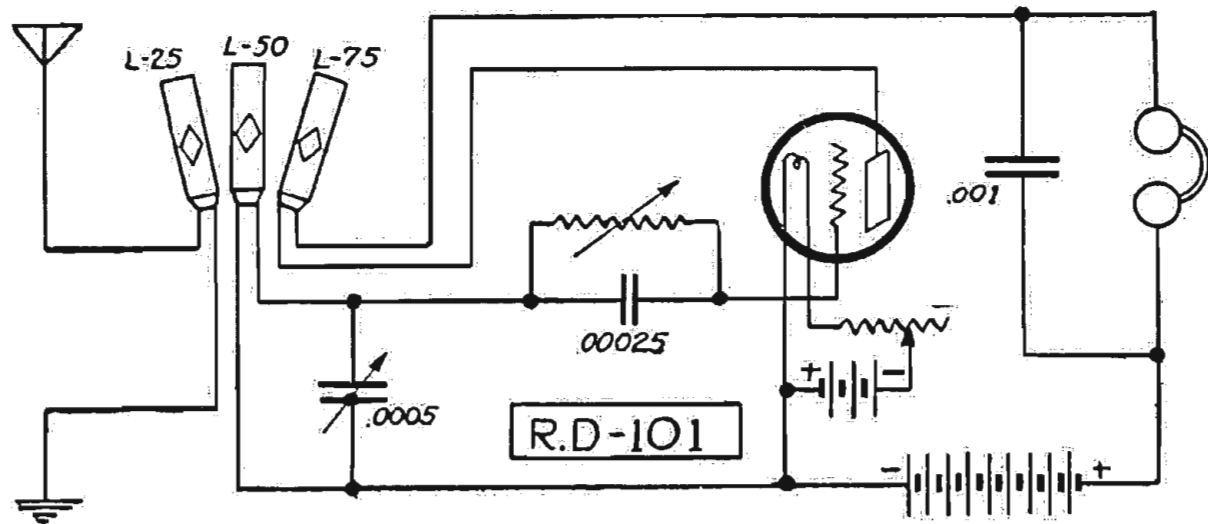

ONE of our regular readers, Mr. J. Paul Miller of 1525 North 56th St., Philadelphia, Pa., has sent a hook-up for us to pass along to our large family of fans. He explains that it is very selective and as loud as any ordinary one tube hook-up. We agree with him. Just check up the following list of broadcasting stations that he has tuned in during thirty days of August and September: WMAF, WIP, WOO, WDAK, WCAU, WFI, NAA, WBZ, WSB, WOC, WHAS, WOS, WGR, WGM, WCAP, WEA, WBAK, WJAR, WCBD, WJY, WJAZ, WOR, WJZ, WLW, WDT, WSAI, WDAP, WHAV, WRC, KDKA, WJAX, WLAC, KSD, WOAW, WGY, WCAE, WWJ, KYW, WAAQ, PWX.

**Description**

The coils fit into three coil mounts on outside of panel. The primary and secondary coils are close together at all times. The tuning is done by the variable condenser and a slight variation of tickler coil by opening it. Every wave length from 287 to 546 meters is found on the condenser dial from zero up to 100, and is always found in the same place. I used the UV-200 and 201-A tubes, the latter being slightly better if plate voltage is increased to about 40 volts. The WD-11 and WD-12 should work equally well as either of these. The conventional two step audio may be added in place of the phones if desired. I use same both ways.

**PUSH-PULL AMPLIFIER**

(Continued from page 17)

necting the windings as described before holds true here. The type PP-1 has the central secondary tap and the type PP-2 has the central primary tap.

The two types and the binding posts should be correctly marked in order to avoid any confusion when connecting them in the circuit.

**The Amplifier Circuit**

The proper circuit for using these transformers is shown in the illustration. The first, or type PP-1, is connected in the circuit as transformers are usually used,

with the exception that the secondaries are connected to the grids of two tubes. In order to build up the negative potential on the grids of the two tubes, a C, or biasing, battery of 6 to 9 volts is connected as shown. The plate current of the two tubes must now be added together, and the energy thrown into one circuit to operate the loud speaker. The two

**Loop Antenna**

The loop is coming more into favor each day, because it makes a set more portable and does away with the outdoor aerial.

It is shipped knocked down but complete—all binding posts, wire, etc. Postpaid in U. S. A. **\$1.25**

**Robbins Woodworking Co.**  
Dept. C LIBERTYVILLE, ILL.

plates cannot be connected directly together as the action of the one will oppose the other. Therefore they are connected to the ends of the two primaries of the transformer PP-2, the center of which is connected to the usual B battery positive. By induction, then, the two are combined in the secondary of this transformer, to which the loud speaker is connected.

This amplifier circuit can be used in conjunction with a detector or even one or two stages of audio frequency amplification, as desired.

**Review of Books**

**Getting Acquainted with Radio Receivers.** By Paul Godley. Gives general working principles of a radio set, the parts used, and their relation to each other. Price, 25 cents.

**Home Radio—How to Make It.** By A. Hyatt Verrill. This book is particularly adapted for the amateur who desires to know how to make Radiophones. Twelve full page illustrations and diagrams. Price, 75 cents.

**Elements of Radiotelegraphy.** By Elery W. Stone. The text was written for the guidance and instruction of Radio students in the communication service of the Navy. It is an instruction book for Radio schools. Price, \$2.50.

**Radio for the Amateur.** By A. H. Packer and R. R. Haugh. The underlying principles of Radio thoroughly explained in simple language and understandable illustrations. This book will teach you

how to construct and operate a receiving set successfully. Price, \$1.50.

**Amateur Radio Call Book.** A complete list of Amateur, Special Amateur, Technical and Training Stations of the United States and Canada. Commercial Land Stations, Army and Naval Land Stations of the U. S., High Powered Transoceanic Stations and their Schedules. Also how to make a Reinartz tuner, detector and one-stage amplifier. A large two-color map is inserted. Price, \$1.

The book department of the Radio Digest is prepared to send you any of the books on Radio published, whether listed in our Book Review or not. Let us know what book you want, send us your check and we will see that the book is mailed to you. Postage stamps in payment for books not accepted. Send money order or check. Radio Book Department, Radio Digest, 123 W. Madison St., Chicago, Ill.

If you want louder signals, use a longer aerial, more tubes, higher plate voltage, more sensitive loud speakers, and more careful tickler and receiver adjustment.

**Do you Know why the Mu-Rad sells, Mr. Dealer?**

Simply because to hear the Mu-Rad is to buy it! One of Chicago's largest radio stores sells the Mu-Rad entirely by demonstration. Their records show that 8 out of 10 demonstrations result in a sale! That's profitable business!

**Write for Mu-Rad Franchise**

We are the exclusive distributor of the Mu-Rad Receiver in the states of Illinois, Indiana and southern Wisconsin. If your store is in any one of these three states, Mr. Dealer, write us today for details of our special exclusive territory proposition. Winter's here—there's need for haste!

We also carry a complete stock of WESTERN ELECTRIC CO. GENERAL RADIO CO. parts. Write for details and discounts.

**Chicago Radio Apparatus Company**

Jobbers of Good Radio Merchandise  
General Offices: 497 South Dearborn  
CHICAGO

**POSITIVE RESULTS**

are being obtained by thousands of satisfied users of the

**EASTERN COIL SETS**  
for the  
**COCKADAY CIRCUIT**

The remarkable features which are making this circuit (4 circuit tuner) more popular each day are its simplicity of construction and control—wonderful selectivity—distance records—clearness and loudness of reception, and the fact that all capacity squealing, interference, etc., are eliminated.

Made as per specifications of Mr. Cockaday, using No. 18 wire with D coil bank-wound.

**COMPLETE ASSEMBLED SET OF B, C AND D COILS. \$275**  
PRICE .....

Hook-up, directions and material list furnished FREE with each set of coils.

Mail Orders Filled. Dealers Communicate  
**EASTERN RADIO MFG. CO.**  
22 Warren Street, Dept. R. D., NEW YORK, N. Y.

**What About It?**

Isn't it about time to stop experimenting with multiple control circuits and build one that, combining ease of assembly and operation, loudness, clarity and selectivity of signals, as well as beautiful appearance, is excelled by none?

**THE ELGIN SUPER-REINARTZ RADIO RECEIVING SET**

Embodies all the advantages of the well known Elgin Reinartz (the set which was largely responsible for the popularity of this wonderful circuit) and many others. It is much louder, more selective, requires no storage battery, and can be used with excellent results on a short or loop aerial.

It has brought in California stations two thousand miles from Elgin, clearly and without interference on a loud speaker with only one tube, and that while our powerful local station was broadcasting three miles away.

Could you ask for more? Write for circular giving one, two and three bulb hook-ups of this remarkable circuit. IT IS FREE.

**ELGIN RADIO SUPPLY CO.**  
207 East Chicago Street ELGIN, ILLINOIS

**DUPONT PYRALIN SHELSTONE**

Loud Speaker  
With  
**Nath. Baldwin Head Set**  
Type C  
Perfect Results



Shelstone is made of Dupont's Pyralin, is transparent and one of the most attractive Loud Speakers on the market.

It is built differently to take advantage of the most correct acoustic principles and reproduces music and speech with a clear tone.

Loud Speaker with phones .. \$15.00

Loud Speaker postpaid ... 3.00

Satisfaction guaranteed. C. O. D. or cash with order. Dealers write for discounts.

**THE SHELSTONE COMPANY**  
185 Clinton Avenue NEWARK, N. J.

**"MAKE Perfection YOUR Selection"**

Buy Reliable Parts Direct from the Distributor and Save  
Every Product Sold on an Absolute Money Back Guarantee

**Neutrodyne 5 TUBE SET**

- The Neutrodyne Circuit is the last word in Radio and is the best set that can be made today.
- Drilled Formica Panel 7x24x3/16
  - 5 Bakelite Sockets
  - 3 Neutroformers
  - 2 Neutrodons
  - 2 Franco Audio Transformers
  - 1 "A" Battery Switch
  - 3 Dials, 4 inch
  - 1 Klosner Rheostat
  - 1 Amsco Power Rheostat
  - 8 Binding Posts with Names
  - 3 Jacks
  - 27 Feet Spaghetti
  - 28 Feet No. 14 Tinned Copper Wire
  - 2 Condensers, .006 Dubilier
  - 1 Grid Leak and Condenser. Freshman
  - 1 Dubilier Condenser, .002
- Special price for complete parts for 5 tube set  
**\$32.50**

**Cockaday Circuit Complete**

- 1 Eastern Cockaday Coil
  - 2 Amsco 23 Plate Condensers
  - 1 Panel 7x14x1/2
  - 2 Dials, 3 inch
  - 1 Bakelite Socket
  - 1 Tubular Leak, 2 meg.
  - 1 Dubilier Condenser, .00025
  - 1 Klosner Rheostat
  - 8 Name Binding Posts
  - 12 Feet Tinned Copper Wire No. 14
  - 6 Feet Cambric Spaghetti
  - 1 Switch Lever
  - 7 Contact Points and Nuts
  - 2 Contact Stops and Nuts
  - 1 Diagram
- Our special price for complete Cockaday Set  
**\$11.98**

**Erla Reflex Circuit Complete**

- Operate a loud speaker on one tube with this wonderful set.
- 1 Formica Panel 7x14
  - 1 Erla Reflex Transformer
  - 1 Caldwell Bakelite Coupler, 700 Meters
  - 2 Switch levers
  - 1 Amsco 23 Plate Condenser
  - 1 Klosner Vernier Rheostat
  - 1 Crystal Detector with Crystal
  - 2 Bakelite Sockets
  - 1 Dial, 3 inch
  - 1 Jack
  - 1 Dubilier Condenser .001
  - 1 Dubilier Condenser .002
  - 1 Erla Bezel
  - 8 Name Binding Posts
  - 12 Ft. Tinned Copper Wire, No. 14
  - 6 Ft. Cambric Spaghetti
  - 12 Contact Points and nuts
  - 2 Contact Stops and nuts
  - 1 Franco Audio Transformer
- Our Special Price Complete  
**\$19.90**

Complete parts for Erla two-tube set, including two Reflex and two Audio Transformers, price..... **\$28.90**

Complete parts for Erla three-tube set, including three Reflex and three Audio Transformers, price..... **\$37.90**

**Perfection Radio Corporation**

Mail Order Dept. 59 Cortland Street, New York City Add Parcel Post  
Do Not Send Stamps  
N. Y. RETAIL STORES  
78 Cortland St. 119 West 23rd St. 128 Chambers. 368 Livingston St., Brooklyn.  
208 page complete Radio catalogue free with order of \$5.00 on request.  
Otherwise prepaid for 25 cents.

**BLUE PRINTS**  
How to Make  
**a Reinartz Receiver**

Blue Prints for the construction of a Reinartz Receiving Unit and two step amplifier.

Description of apparatus and details of tuning.

**WINDING A REINARTZ COIL**

Send only money orders—no checks or stamps. Coins at your own risk.

**Flewelling Receiver**

Blue Prints for the construction of a Flewelling Receiving Unit and two step amplifier.

**ALL DETAILS FOR ASSEMBLY**

Description of apparatus and accessories and details of tuning.

Send only Money orders—no checks or stamps. Coins at your own risk.

**Radio Digest Publications**

123 W. Madison St., Chicago, Ill.

**Only 50¢ Each**

# Key Locates Troubles in Receivers

## Work of Many Engineers Benefits All Amateurs

A TROUBLE shooter's key for locating troubles and defects in Radio receiving sets has been devised and given out for the benefit of Radiophans. It is the combined work of several engineers

### WORKSHOP KINKS? EARN A DOLLAR—

THERE are many little kinks worked out at home that would aid your fellow Radio worker if only he knew about them. There are new hook-ups, new ways of making parts and various unique ways of operating sets that are discovered every day. Radio Digest is very much interested in obtaining such material. Send them in with full details, including stamped envelope, so rejected copy may be returned. The work must be entirely original, not copied.

RADIO KINKS DEPARTMENT,  
Radio Digest,  
123 W. Madison St., Chicago

who have worked out the various problems and boiled down the information for handy use.

Opposite the various letters of the key are placed the different troubles encountered by the Radiophan; opposite the line diagnosing each difficulty combinations of numbers will be found which tell where the trouble is. Since difficulties arise from a number of causes, the different numbers tell each individual item of trouble. If one cause given is not the reason for the difficulty, each of the other items given should be followed until the source of the trouble is located. This key is invaluable to those who cannot read a diagram or who do not know the different Radio construction symbols. It will also aid advanced amateurs.

#### TROUBLE SHOOTER'S KEY

(A) No signals, no noises. Weak signals; no noises.

(a) No signals in detector circuit. No noises. 2, 3, 4, 13, 29, 32, 41.

(b) Signals in detector weak. 1, 2, 4, 6, 7, 13, 29, 32, 34, 35.

(B) With knocking, scraping, scratching or popping sounds in the detector circuit.

(a) Noises affected by tuning. 9, 17, 18, 21, 25, 26, 30, 31.

15c Lettered binding posts, complete, set eight, 60c; two sets, \$1.00. Prepaid, same day. Stamps accepted. Everything in Radio. Ask for quotations. List for stamp. Kladag Radio Laboratories, Kent, Ohio.

**Genuine Nathaniel Baldwin Head Phones \$7.95**

Type C. Mica Diaphragm, new stock. A limited number only.

Before you build your set, write for our free list of bargains on all new, standard and guaranteed radio merchandise.

**North Shore Radio Works**  
Dept. 12, 813 Mulford St., Evanston, Ill.

(b) Noises not affected by tuning. 11, 12, 13, 25, 26, 28, 30, 31, 38, 41.

(C) Knocking, scraping, scratching or popping sounds in amplifier circuit, but not in detector. Turn filament of detector off and listen in on the amplifiers. If knocking continues, it is the amplifier units. 5, 12, 27, 41.

(D) Howls, hisses, squeals, whistles and grunts in detector circuit.

(a) That are affected by tuning. 17, 18, 19, 21, 26, 40.

(b) That are not affected by tuning. 3, 6, 20, 21, 26.

(E) Howls, hisses, squeals, whistles and grunts in amplifiers. 16, 23, 24, 41.

(F) Humming or buzzing sounds. 22, 33, 34, 36, 37.

(G) Unsteady or wavering signals. 8, 9, 10, 12, 25.

#### APPENDIX

1—Tickler coil connections reversed, no regeneration. Remedy, reverse coil or leads.

2—Batteries run down.

3—Tubes not making proper contact with socket terminals. Tighten.

4—Polarity of battery reversed.

5—Transformer burned out.

6—Grid condenser shorted.

7—Aerial or ground disconnected.

8—Coils loose and vibrating, causing unsteady signals by varying induction between coils.

9—Too low capacity in antenna regeneration is difficult to control at extremely low capacity, where 11 or 13-plate condensers are used in the antenna and set is unstable. Place fixed condenser of .00025 mfd. in parallel.

10—Rain causes leaks of the aerial, etc., making signals unsteady.

11—Poor connections to aerial or ground.

12—Defective rheostat and unsteady filament current.

13—Telephone windings broken or burned out.

14—Storage battery capable of delivering current to detector tube but drain on battery from amplifiers is sufficient to reduce voltage in detector filament below critical point.

15—Lighting amplifier tubes, after adjusting detector, throws the detector tube out of adjustment when operated on the same battery; always tune in detector with amplifiers lighted if using same battery.

16—Primary of transformer reversed.

17—Too much B battery voltage on detector plate.

18—Too much inductance on tickler coil.

19—Too high grid leak resistance.

20—Plate leads touching grid condenser or its leads or near them.

21—Excessive detector filament voltage.

22—Ground and plate leads parallel and close together.

23—Causes of howling in stages in excess of two are difficult to assign. A good remedy is to place a fixed condenser of .001 capacity across the secondary of last transformer.

24—Transformers too close together.

25—Tube oscillating intermittently because of poor connections to antenna or ground. This is often a difficult trouble to locate.

26—Excessive grid charge; detector tube paralyzed. This may result in a howl of any pitch at intervals of ten to twenty per second. Remedy, decrease filament voltage, loosen tickler coupling, or decrease plate inductance and lower the grid leak resistance.

27—Moisture in transformer, causing shorts between turns or layers. In this case the noise may be heard with primary of transformer, telephone and battery in series. Remedy: place transformer in oven and dry out at moderately high temperature and impregnate with paraffin.

28—Plate and grid coil leads interchanged with B battery shorted to negative filament. This produces a terrific knocking.

29—Phone condenser shorted.

(Continued on page 20)

## Telephone Magneto Box as Battery Container

Why all this talk about mixing up the leads from the A and B batteries, etc.?

Take a hint from the old fashioned telephone magneto box. This has a phone hook protruding from the side, upon which you hang the phone. The action switches in the local or microphone battery, cut in and out the line and the like.

Put a short upright on your Radio set, with a similar hook on which to hang the headset, and always hang it up. The weight of the phones will depress the hook lever, which should be provided with a suitable sliding switch and contact point. To these connect the negative sides of both batteries, then to regular binding post on set.

When you take the headset off the hook, the action will automatically switch in the A and B batteries, and when you hang it up it will open the circuit on both. Very simple isn't it? Again, it makes an arrangement which is very convenient. You can pick up the headset any moment; try if there is anything doing; if not, hang up, thus doing away with connecting and disconnecting battery wires.—J. P. Robinson, Jacksonville, Fla.

## DEALERS PROMPT SHIPMENTS LIBERAL DISCOUNTS

**ERLA REFLEX CRYSTAL**



ALL PARTS IN STOCK

Note!! We are the largest exclusive Radio Jobbers in the Middle West

**HUDSON-ROSS**  
123 W. Madison St. Chicago

## Rametra Special for October

**Fada**  
Complete mark-down parts for the 5 tube Fada Neutrodyne Receiver including drilled engraved Bakelite Panel and Base Board..... **\$65**  
Absolutely guaranteed on our money back basis.

**AMPERITE—Automatic Filament Control.**  
Unmounted ..... \$1.10  
Mounted .....

**Langbein and Kaufman Variometers** ..... \$6.00

**Langbein and Kaufman Variocouplers** ..... \$6.00

We personally consider both these variometers and couplers to be the best on the market.

Our stock consists of a most complete line of all standard radio apparatus. Just let us know what you want and we will ship it to you immediately at regular manufacturers' prices.

All shipments made immediately on receipt of purchase price.

**RADIO & MECHANICAL TRADING CORP.**  
23 Warren Street NEW YORK CITY

## KEYSTONE RADIO LIGHTNING ARRESTERS

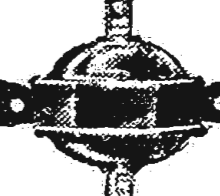
**\$2.00**  **\$2.00**

Should be on every aerial the year 'round. Provides highly efficient lightning and static protection for the home. Fully approved by Fire Underwriters. Can be installed outdoors. Has no vacuum to lose. Install one in your aerial lead now—be safe. This pioneer radio arrester is backed by 31 years' experience in lightning arrester design.

For sale by Dealers everywhere, or sent postpaid for \$2.00. Write for circular.

**Electric Service Supplies Co.**  
17 & Cambria Sts. Philadelphia  
Monadnock Bldg., Chicago  
50 Church St., New York

## TRIGGER OF NEW YORK RADIO

EVERYTHING SOLD ON MONEY-BACK GUARANTEE. WE HANDLE NO BOOTLEG MERCHANDISE.

**COCKADAY COMPLETE PARTS GUARANTEED \$12.50 ASSEMBLED \$17.50**  
Add \$2.50 to each for Cabinet

**ERLA REFLEX 3 TUBE BEST OF PARTS \$45.00 ASSEMBLED \$67.50**

**COCKADAY 3 TUBE Unassembled \$32.50 INCLUDE CABINET ASSEMBLED \$42.50 DISTANCE VOLUME SELECTIVITY**

**LOUD SPEAKER Bristol .....20.00 Atlas .....18.00 Magnavox ..30.00 Mercury .... 6.00 Music Master .....26.00**

Indoor Aerial .....	\$1.75	Baldwin's Original .....	\$8.50
Hydrometer .....	.50	Jefferson Transformer .....	2.75
Voltmeter, 50 Volts .....	1.65	Amertran Transformer .....	5.50
Freshman Variable Grid and Leak .....	.70	Acme Transformer .....	3.75
Remler Moulded Variometer .....	4.00	Wave Trap .....	7.00
Freed-Eisemann 180° Coupler .....	2.00	D. C. Charger .....	5.75

We carry a complete line—from screws to sets.

You can purchase with an absolute guarantee. We carry no factory seconds or salvage merchandise. Goods shipped immediately. Please be sure to include postage on orders under \$10.00.

### TRIGGER OF NEW YORK

160 EAST 59TH STREET, NEAR THIRD AVENUE, NEW YORK CITY

## AT LAST The Genuine Reinartz

Covers all broadcasting wave lengths now used  
Each coil bears a facsimile of John L. Reinartz's signature

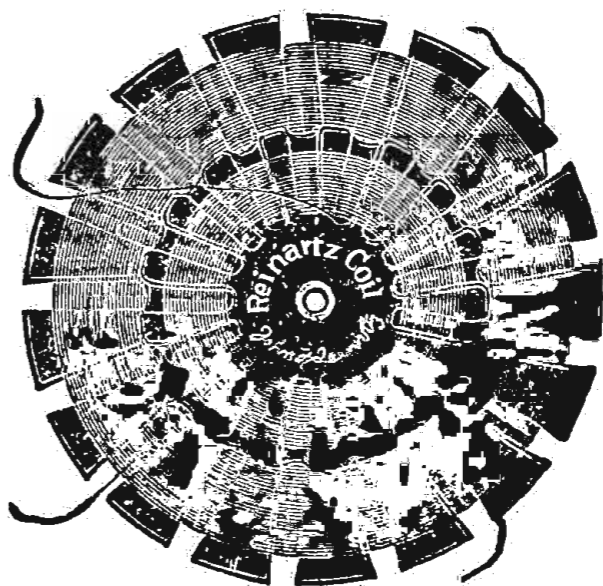

Made under John L. Reinartz's specifications by the Eugene T. Turney Laboratories, Inc., exclusively

Primary Coil ..... 57 turns 8 taps  
Secondary Coil ..... 45 turns 2 taps  
Diameter 5 1/2 inches. Bakelite cores

Packed in individual boxes. With new copyrighted Reinartz hookup. List, \$2.50. Standard packages, 3 doz.

Jobbers and Dealers write for discounts

## Tristan Sales Corporation, Dept. C.

1 UNION SQUARE NEW YORK

- REGIONAL REPRESENTATIVES
- Baker-Smith & Co., 741 Call Building, San Francisco, Calif.
  - Walter I. Ferguson & Co., 208 Baltimore Bldg., Kansas City, Mo.
  - Geo. H. Chamberlain, 375 Broad St., Elyria, O.
  - J. H. Lyte, 65 North 63d St., Philadelphia, Pa.
  - O. P. Smith Co., 205 W. Harrison St., Chicago, Ill.
  - C. L. S. Holmes Co., 601 Boston Block, Minneapolis, Minn.

RADIO FOR EVERYBODY

(Continued from page 15)

point B, the lower bend in the characteristic curve. (The upper bend may be used, but rarely is.)

Below this curve is shown an incoming stream of Radio waves, modulated by one voice wave. (Before they get to the grid, remember, the grid is at .2 volt negative.) These waves will be alternately positive and negative, as previously explained, and will add positive and negative charges to the grid. Wave 1, being a positive wave, makes the grid a little less negative than .2 volt and more plate current flows. Wave 2, being a negative wave, makes the grid a little more negative than .2 volt and less plate current flows. As each succeeding wave is a little stronger, there will be a greater change in the plate current with every wave. Which brings us to the reason for operating at the point B of the curve.

Result in the Plate Circuit

Examine the diagram carefully and you will see that wave 3 lessens the grid negatively to .1 and increases the plate current by the amount HF. Wave 4 increases the negative charge to .3, which lessens the plate current by the amount EG. HF is greater than EG. On the right of the diagram is another subsidiary diagram showing the effects in the plate circuit of the single voice wave. The line JI represents the current in the plate circuit when the grid is as shown on the characteristic by the point B. This current is steady, direct and amounts, as shown, to .8 milliamperes positive. As wave 1 affects the grid, it will be seen that an increase is caused in line JK, as shown by 1. As wave 2 affects the grid, the value of JK is decreased, as shown at 2, but not as much below normal as it was increased at 1. When wave 3 lessens the grid charge negatively from .2 volt to .1 volt, variation 3 in our line JK is the value HF in height; when wave 4 increases the grid charge from .2 volt to .3 volt, variation 4 of JK is EG in height. As we said before, HF is greater than EG.

Since all our variations above normal, or .8 milliamperes, are greater than the alternate variations below .3, the average value of the voice wave is the dotted line. As, for the note C, there will be, in one second, 256 such undulations as shown by the dotted line, the diaphragm of the head phones will vibrate 256 times per second and we will hear the note C.

Grid "Leak" and Condenser

It was stated earlier in this installment that a few of the negative electrons adhere to the grid in their leap through the

space, and this fact explains the presence of the grid condenser and grid resistance in the circuit. Were some means not provided for these electrons to leak off, they would gradually collect to such an extent that the grid would be so negative that no plate current would flow. The grid condenser is inserted so they will not run off too rapidly through the coil to the filament and so permit the grid to become positively charged; the grid resistance provides a path for them to leak off gradually. When these two units, and particularly the grid resistance, are adjusted to the correct values the grid is kept at the right value for the tube to function on the lower bend of the characteristic.

The Essentials to Reception

To receive Radio signals then, we need inductance as provided by wire, capacity as provided by two parallel surfaces, a detector and a pair of head telephone receivers. If a tube detector is used, we must also have a grid condenser, grid leak (grid resistance), a battery to heat the filament (A battery), and a battery in the plate circuit (B battery). Since all tubes do not function best with the same amount of power on the filament, it is customary to heat the filament from a battery supplying more power than it requires and to cut down the power supplied with a variable resistance termed a rheostat.

In the next chapter we will take up the various types of inductances available and their various uses in receiving circuits.

(TO BE CONTINUED.)

RECEIVER TROUBLE KEY

(Continued from page 19)

- 30—Dust, etc., between plates of variable condenser. When the antenna condenser is shorted, a knock or click is heard as the train of oscillations in receiver is stopped with increase of wave length.
31—Getting fingers against metal parts connected to oscillating circuit while tuning.
32—Primary circuit not tuned.
33—Grid condenser on bottom of cabinet or on the table may pick up vibrations or hum from high circuit.
34—Grid coil disconnected.
35—Tube oscillating below critical filament temperature. This is often the cause of weak signals. Remedy: less plate inductance, less B battery, higher antenna capacity, lower head phone by-pass capacity.

New tubes at cut prices, repairs free. Vacuum Electric Works, Toledo, Ohio.

36—Caused by having plate directly connected to aerial or by a faulty connection causing leaks from plate circuit to ground.
38—Static.
39—Improper bank windings.
40—Two broadcasters of the same wave, or your neighbor listening in with his set oscillating.
41—Poor connections and worn apparatus. Pull set apart and re-wire.

The Reader's View

Electro-Static Coupling

Regarding the letter of Mr. B. W. Banyar, Independence, Mo., in your issue of August 4 as to his set causing a nearby crystal set to receive DX, which he thought was due to "re-radiation," contrary to the opinions of Radio engineers.

There can be no doubting the facts as given by him but the effects he described are not due to re-radiation but to electrostatic coupling between his antenna and his neighbors. When sets are as close together as his and his neighbor's, his antenna acts as one plate of a condenser and his neighbor's antenna acts as the other plate. Hence changes in the charge on his antenna will cause similar changes in the near-by antenna, hence, reception.

However, if the antennae are at some distance apart they act so feebly in this manner that no reception will be had in the crystal set.

A set can radiate squeals as he describes in his last paragraph but this in no way indicates that the set can "re-radiate" music.—F. C. Sutter, Detroit, Mich.

Frying Caused by Light Wires
The following may be of interest to J. O. Pennock, Minn.; Question Number 3654. After much experimenting I discovered that the frying noise came from street light wire rubbing against the limbs of a tree; this caused an arc that could be seen flickering very faintly from my window. The flicker was in unison with the arc. When the wire was removed by the lighting company the trouble stopped. The frying could be heard by connecting the phone direct to the aerial and ground.—C. J. Bodenstein, Rochester, N. Y.

Eliminating Ground Hum

In your June 23 number I note that you say there is no way to eliminate ground hum on a crystal set. It can be eliminated by an induction coil parallel with the crystal and phone line or even by putting the fingers across (in shunt with) the crystal and cat-whisker. Try it.—W. J. Copp, Zion City, Ill.

IF YOU CAN'T BUY THEM AT YOUR DEALER'S SEND DIRECT TO US

"Red-Heads" are guaranteed radio phones. You run no risk when you buy them. Money back if, after 7 days' trial, you're not satisfied that they're the best receivers on the market at the price. Why not act right now and get a pair? It'll mean getting the maximum from broadcasting from the day you put them into use.



RED-HEAD RADIO RECEIVERS

These remarkable head-sets are made by The Newman-Stern Co., one of the pioneer radio-manufacturing houses in America.

JUST OUT

The new 1924 Model F \$6.50 PER PAIR Complete
The new 1924 "Red-Head" Jr. \$5.00 PER PAIR Complete

This is the standard 3,000 ohm "Red-Head." The 1924 Model F has eleven improved features. Sensitive and fine-tuned; aluminum case; famous brown-red ear caps; military headband; high-grade cord.

"Red-Heads" sent prepaid on receipt of price if you are unable to get them at your dealer's.

THE NEWMAN-STERN COMPANY Dept. RD Newman-Stern Bldg. Cleveland

MISSING WHAT YOU GET
YOUR set is probably bringing in DX stations you never hear because your rheostat cannot control your filament action. The Fil-Ko-Stat gives infinite adjustment and enables you to magnify the weak stations and bring them in strong and clear.
Full resistance 30 Ohms, adjusted to ALL TUBES. \$2 At All Dealers in High Grade RADIO SUPPLIES
" Avoid the use of inferior powdered carbon rheostats."
FIL-KO-STAT
Made and Guaranteed by Dx Instrument Co., Harrisburg, Pa. Sole International Distributors. Radio Stores Corp., 218 W. 34, N. Y. City

WE REPAIR THE FOLLOWING RADIO TUBES
Dealers and Agents write for Special Discount Mail Orders Solicited and Promptly Attended to
WD-11 } OUR SPECIALTIES } 5 WATT TRANSMITTERS
WD-12 }
UV-199 .....\$3.50 C-299 .....\$3.50
UV-200 ..... 2.75 C-300 ..... 2.75
UV-201 ..... 3.00 C-301 ..... 3.00
UV-201A ..... 3.50 C-301A ..... 3.50
WD-11 ..... 3.50 WD-12 ..... 3.50
DV-6 ..... 3.00 DV-6A ..... 3.50
UV-202 ..... 4.00 C-302 ..... 4.00
UV-299 ..... 3.50
H. & H. RADIO COMPANY
P. O. Box 22-A
Clinton Hill Station NEWARK, N. J.

Positive Radio Helps
For Storage Battery Tubes Use Eveready Storage "A" Batteries.
For Dry Cell Tubes Use Eveready Dry Cell Radio "A" Batteries.
For all Vacuum Tubes Use Eveready "B" Batteries.
EVEREADY Radio Batteries - they last longer

Super Values
Flewelling Circuit Complete
Reinartz Circuit Complete
OUR PRICE \$13.20
OUR PRICE \$11.05
All the necessary screws, nuts and miscellaneous small parts which are necessary to complete the set are included in the above prices. Any part in either of these circuits may be purchased independently at the advertised cut prices.

LOUD SPEAKERS
PHONES
TUBES
CONDENSERS
AUDIO TRANSFORMERS
ALL Mail Orders Shipped Promptly. Send Money Order, including Postage
Write for Our Catalogue
HANES-ZENER CO., 3 West 29th Street, New York City
The RADIO MAIL ORDER HOUSE—Known for Low Prices

REAL RADIO PERFORMANCE!
New Principle of Tuned Radio-Frequency Gives Remarkable Results WITH THE MELCO-SUPREME
The Radio-Frequency Amplifying Receiver that— Operates with merely a 10 FT. WIRE—not even a ground necessary. Offers exceptional CLARITY without the slightest loss of tone quality. Assures unusual program SELECTIVITY through its single tuning adjustment. Affords real LONG DISTANCE by covering all Broadcasting ranges from 180 to 610 Meters. We also manufacture a complete line of parts under the AmSCO Brand. Write for our complete literature.
AMSCO PRODUCTS, Inc. Broome & Lafayette Sts. NEW YORK CITY
Price Only \$140
Complete knock-down parts for Melco-Supreme, including drilled engraved Bakelite panel and solid mahogany cabinet. Price \$90

# New Apparatus on the Market

**T**HIS transformer itself consists essentially of a core of especially chosen silicon sheet steel with a carefully built winding assembled integrally with the core and supplied with conveniently located terminal screws.

It has a comparatively low ratio of transformation, approximately 3 to 1, is so designed that it serves admirably for use with any of the vacuum tubes in common use.

While, for the last four years transformers played a big part in radio in all of its phases, it is only within the last two years that its superiority for voice and music amplification has been fully considered. For amplification of this kind of radio signals as exemplified by broadcast radio telephony it is essential that the amplifying transformer which is to serve satisfactorily must amplify all tones in the same degree without the introduction of foreign sounds. It must amplify the voice or music without the loss of smoothness and roundness; it must do this without adding to these sounds in the least.

The Federal Amplifying Transformer accomplishes this very efficiently. It makes possible a vacuum tube amplifier which will enable you to hear the long distance broadcast station with the same softness and clearness as you hear the nearby station. It makes possible the vacuum tube amplifier which will reproduce music as loudly and with the same

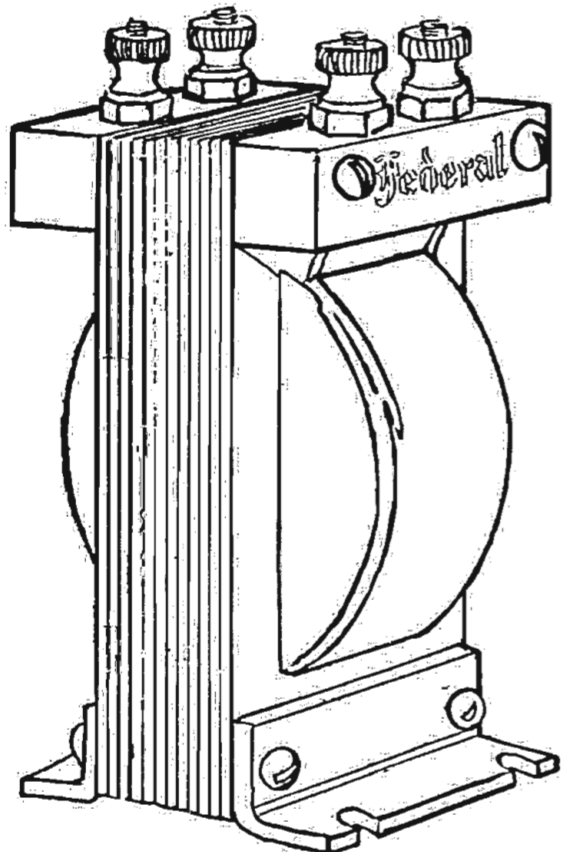

impurity as if you were in the broadcasting studio.

- Impedance of primary (secondary open) ..... 69,000 ohms
- Impedance of primary (secondary closed) ..... 2,500 ohms
- Impedance of secondary (primary open) ..... 610,000 ohms
- Impedance of secondary (primary closed) ..... 23,000 ohms

This transformer, manufactured by the Federal Telephone and Telegraph company of Buffalo, N. Y., is known as Type 65.

**T**HE development of radio has led to the use of a potentiometer as well as a rheostat in vacuum tube circuits. Both of these units are necessary for the successful operation of gaseous detector tubes and for radio frequency amplification. Realizing this, the Acme Apparatus

Company of Cambridge, Mass., has developed the Pot-Rheo which combines a 200

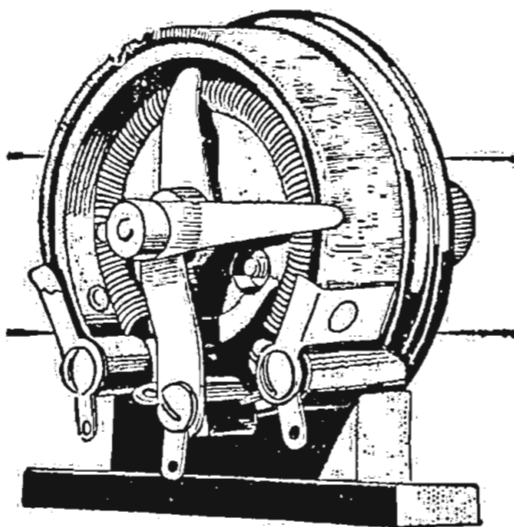

ohm potentiometer with a 3-ohm rheostat in one mounting with separate controls, reducing the space taken by a set whether panel or table type and bringing the controls in close proximity.

This unit is shown in the illustration. The potentiometer is wire wound to 200 ohms, having terminals at each end and one connected to the movable arm. The arm is controlled by a solid shaft and bakelite moulded knob. The rheostat is wire wound, having a terminal at one end and one connected to the movable arm. The arm is controlled by a tubular shaft and bakelite moulded knob. The shafts of these two elements are concentric and insulated from one another. The rheostat knob contains a pointer under which is a graduated scale for indicating the degree of resistance in series with the tube. An off position is provided for tuning off the filament.

For table mounting a moulded base and screws are provided. If a panel mounting is desired the base may be removed and the whole mounted by means of the extra long screws supplied for the purpose.

Several excellent mechanical devices feature the apparatus—long bearings for the shafts, a moulded insert with set screw in the rheostat knob, noiseless and smooth operation of the arms on the windings and an attractive small clock mounted on a board.

It is interesting to note that the arm of a potentiometer is usually connected to a radio frequency circuit, making it necessary for the high frequency currents to flow through the potentiometer winding back to the filament. With the Pot-Rheo a by-pass condenser is provided by the insulation between the concentric shafts supplying a radio frequency path to the filament.

**T**HERE is no question nor doubt that every Radiophan, after a short experience, realizes the value of instrument control both in receiving and transmitting sets. Unfortunately the number of instruments required and their high prices prevent, as a rule, their use.

The Hoyt Peep-hole Meter will help fill the demand for an efficient low-priced type of instrument which will be within the range of the pocketbooks of most Radiophans. Not merely is this instrument neat and compact but in addition it has the advantage of utmost simplicity as to mounting. One hole 3/4 inch in diameter drilled in the panel is all that is required. The cylindrical body of the

meter passes through this hole while the large dial face bears up flush against the panel. A drilled metal plate passes over the body and lies flush against the back of the panel. A crossbar passing through slots in two lugs, projecting from the back of the body, has a drilled hole at each end through which screws pass, which in turn bear up against the metal plate on the back of the panel, and thus securely fastens the meter in position. These meters are calibrated as follows: the ammeter from 0 to .3 or 1.2 amperes, the voltmeter in from 0 to 6 or 10 volts. In addition, this range can be increased by means of multipliers which can be purchased separately. By using these two types of instruments, the filament voltage and amperage can be accurately kept

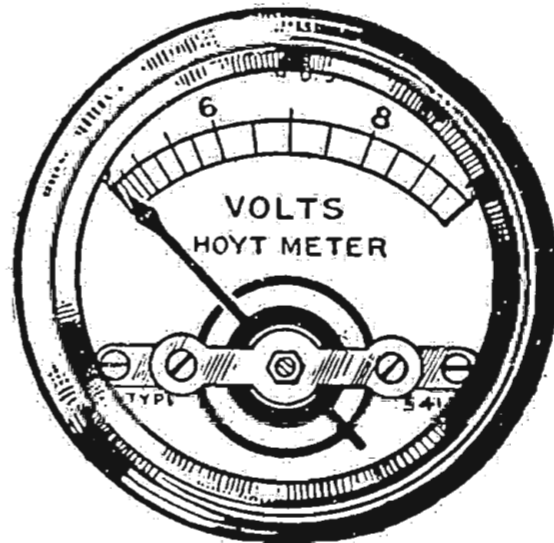

under control. These electrical measuring instruments are manufactured by the Burton Rogers Company of Boston, Mass.

**R**ADIO frequency amplification is coming into general use because of its ability to bring in distant stations with minimum distortion. In addition, it permits the use of a crystal as well as a vacuum tube detector. One of the newer efficient types of radio frequency transformers placed on the market is manufactured by the Acme Apparatus Company

of Cambridge, Mass. This transformer is made in four different types, namely, R1,

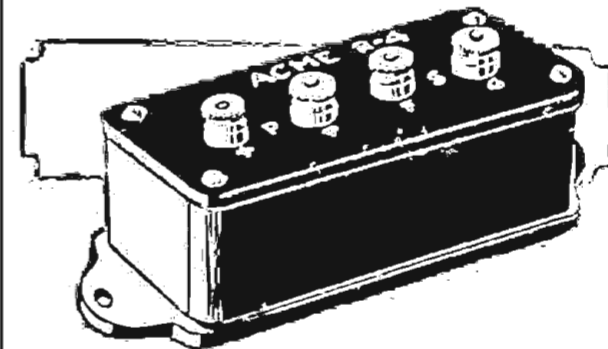

R2, R3, and R4. It1 has its peak at about 220 meters, R2 at about 340, R3 at about 380, and R4 at about 300 meters. The transformer is well made and presents an unusual and neat appearance. It is encased in a moulded form the cover of which is screwed down, and in addition holds the four binding posts for terminals. The base has two projecting lugs drilled so that the unit can be fastened to any baseboard for support. All connections are plainly marked so as to prevent error. The operating efficiency of this transformer is very high; it is well adapted to long distance reception.

### Battery Markings

The markings on the primary side of both radio and audio frequency transformers are usually P, indicating a connection to the plate of the tube, and B, indicating a connection to the positive side of the B battery. The secondary posts are marked G, which is connected to the grid of the amplifying tube and F, connected to the negative filament of the amplifying tube.

Never pick up a wire lying on the ground or dangling from a pole. The wire might be a "live" one. Report fallen wires immediately to the police department or power company.

## Carter "Hold-Tite" JACKS



Self-adjusting lock nut eliminating space washers.

Perfect contact of plug always assured.

- Phosphor-Bronze Springs—Low Resistance.
- Insulation, Westinghouse "Micarta"—No Leakage.
- Contact Points Pure Silver—Self-Cleaning.

Ask your dealer. Catalog of other new Carter Improved Radio Products on request.



## Marvel-Capacity-Switch

- Three-Ways
- Series Parallel
- Direct-Ground



Receives long waves in the parallel position, short waves in the series position, and waves of medium length in the direct-ground by eliminating the condenser.

Patents Pending. Instructions for mounting given with each instrument. Strictly of anti-capacity type.

The only dial-mounted switch in the market.

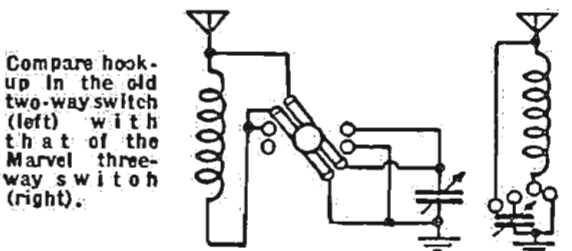

Compare hook-up in the old two-way switch (left) with that of the Marvel three-way switch (right).

List Price \$1.25

Attractive discounts for dealers and jobbers. Write for descriptive circular. If your dealer can't supply you, send purchase price to

MARVEL-SWITCH CO.

28 WEST 25TH STREET, NEW YORK

## The B.T. Universal Vernier Tuner



(The Original 3-Circuit Coupler)

is an entirely new instrument, a fitting companion for the real Vernier Condenser.

It has given a new meaning to close tuning in a great many of the most desirable circuits known.

Buy it for results—experiment later if you wish.

Price \$5.00

Our new free booklet will improve your knowledge of tuning. Send 2c for postage and your dealer's name.

BREMER-TULLY MFG. CO., 532 S. Canal Street, CHICAGO, ILL.

## NEW TYPE Variable Resistance Leak



ONLY THE KNOB SHOWS ON THE PANEL

This device is especially built for use as a tuning instrument. Its construction is such that it will withstand unusual usage. Fully guaranteed. Absolutely no pencil markings.

Can be mounted on any panel in a few seconds. It will enable you to get stations you have never heard before.

Complete with either .00025 or .0005 Freshman Condenser..... \$1.00 Without Condenser..... .75

At your dealer's, otherwise send purchase price and you will be supplied without further charge.

Chas. Freshman Co. Inc. Radio Condenser Products 108 Seventh Avenue New York



- WD-11-12, UV-199, UV-201-A C-301-A ..... \$3.50 each
  - UV-200, C-300, AP Detectors.. 2.75 each
  - UV-201, C-301, AP Amplifiers. 3.00 each
  - DV-6, DV-6-A ..... 3.50 each
- And Guarantee Them Equal to New

OUR NEW 6V 1/4 AMP. DETECTOR AND AMPLIFIER \$4.10 This Tube Is a Revelation—Fully Guaranteed

QUICK SERVICE—Include with your order remittance to cover repair plus parcel postage for one pound per tube. All orders shipped C. O. D. unless accompanied by remittance plus postage. If preferred, tubes will be returned C. O. D. repair charges.

### SPECIAL

LOUD SPEAKER, nickel-plated—21" high. Undistorted reproduction. Regular Price ..... \$ 15.00 Our Price ..... 9.50

Shipped prepaid.

ABALENE RADIO, 14 Vesey St., New York, N. Y.

## Radio Bargains for THIS WEEK

- Hedgehog Transformer ..... \$3.15
- Reflex Crystal ..... .89
- Battery Test Clips (each)..... .05
- 199 Tube Adapter..... .49
- Licensed Neutrodyne Parts..... 19.98
- Rheostats, 6, 25, 40 ohm..... .69
- Variocoupler or Variometer (180 degree) each..... 1.28
- Eria Reflex Transformer..... 4.65
- Murdock 2000 Ohm Phones..... 3.65
- Jewell Lightning Arrester..... .98
- Cico Two-way Plug..... .49
- Cockaday Coll, each..... 1.89
- Contact Points or Switch Stops, per dozen..... .10
- Special Prices on Tubes, Magnet Wire, etc.

Clip this List—Check Items You Want Enclose With Money Order

Your Order Will Be Filled By Return Mail Postage Free—Satisfaction or Money Back

FANS LIST OF BARGAINS FREE RADIO BARGAINS 17 N. LA SALLE ST-CHICAGO

# Questions and Answers

## Two Variometer Hook-Up

(5313) J.J.N., Chicago, Ill.  
Will you please advise best hook-up for a two variometer set, using following material: Two Estro variometers; 1 23-plate variable condenser; 1 C. R. L. grid leak and condenser; 2 Howard rheostats; 1UV-

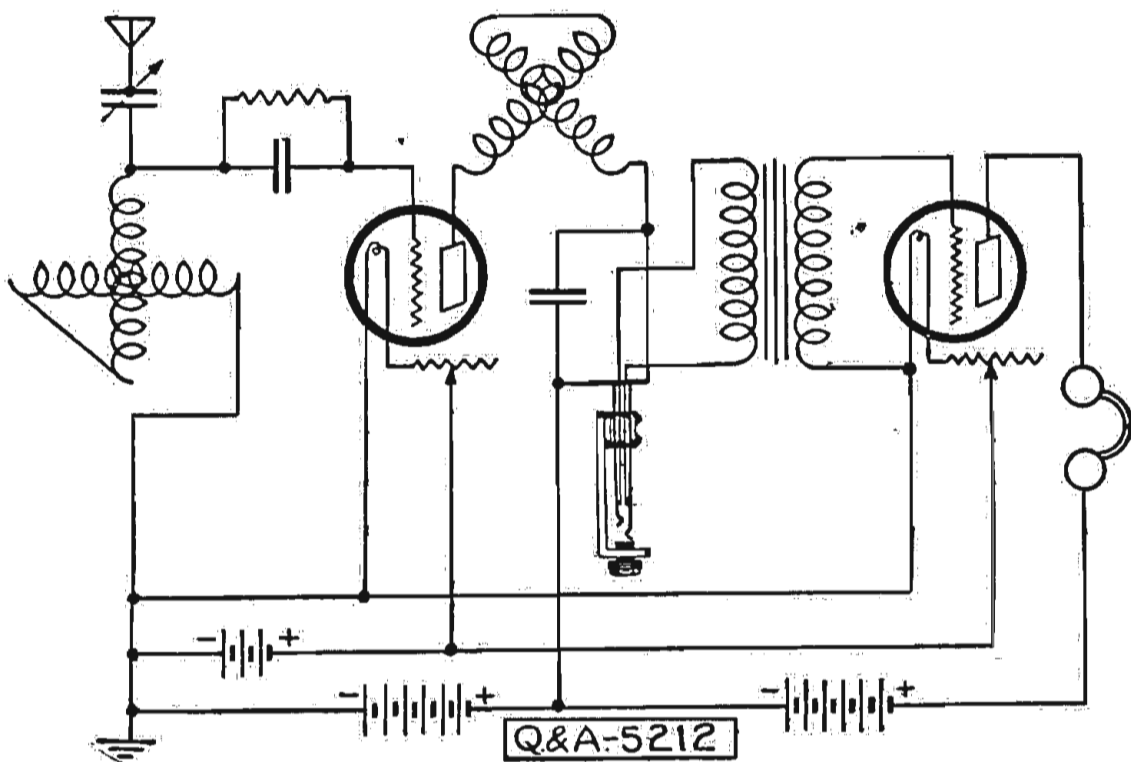

200 detector tube, and 1 UV-201A amplifier tube.

Would a transformer in connection with the above prove valuable? If so, please include in hook-up.

A.—Complying with your request we are publishing a hook-up suitable for your case. An audio frequency transformer will be necessary. The use of jacks is recommended.

## Honeycomb Coil Set

(4671) D.B., Atlanta, Ga.

Some months ago I assembled a honeycomb coil set, using two stages of Radio and two stages of audio frequency. Now I am not dissatisfied with the results obtained from this set, as it brings in everything I could possibly want to hear loudly enough to be heard a hundred yards away, but I have been told that a spiderweb tuner will be more selective for short waves. Therefore, I purchased three Goodman fans and three honeycomb coil plugs. I ground off the tapered part of the plugs with an emery wheel, drilled a hole through the center of the plug and in the handle of the fan, and bolted the fan to the plug. (I split one plug in two with the drill, then proceeded to take a hammer and break out the metal connection parts; I soldered them to the metal ends of the other fan.) Thus I had three spider web coils which were interchangeable with the honeycomb coils.

I wound the first or primary coil with 35 turns of number 22 wire, cotton covered, the secondary with 60, which was all the fan would hold, and the tickler with 50 turns. It seems to me that this arrangement of the spider web coils with the honeycomb plugs should work satisfactorily, but the best I can get out of it, using all tubes, is about as good as ordinarily received on a cheap crystal set. I have reversed the leads to the tickler without any better results.

What I want to know is this: are my variable condensers, which are 43 plate

in the ground series and 23 plate vernier across the secondary, the proper capacities; what is the correct number of turns for the primary, secondary and tickler for spider web coils on the forms I have? The turns will average 2 1/4 inches in diameter. I could, of course, find this out by experi-

menting but I want to know approximately where to start experimenting.

A.—Your limitations are undoubtedly due to tickler and secondary coils. We suggest that you change their positions, using the 50 turn coil, or even forty turns, as the secondary and the 60 turn coil, or even 70 turns, as a tickler coil. There will be little difference in effectiveness of the two types of coils under discussion. Forty, 40 and 70 turn coils for primary, secondary and tickler respectively are recommended.

The present condenser capacities are correct.

## WD-11 and WD-12 Tubes Repaired

- WD-11 or WD-12.....\$3.50
- C-300 or UV-200..... 2.75
- C-301 or UV-201..... 3.00
- C-302 or UV-202..... 3.50
- C-301A or UV-201A..... 3.50
- Moorehead Detectors..... 2.75
- Moorehead Amplifiers..... 3.00
- DV-6 or DV-6A..... 3.00
- Also the new UV-199..... 3.50
- NEW DX 1 1/2 VOLT TUBES. 4.00

All tubes guaranteed to work like new  
Mail Orders Given Prompt Attention  
"24 Hour Service"

## RADIO TUBE CORP.

55 HALSEY STREET NEWARK, N. J.

Tubes Sent Parcel Post, C. O. D.

## C W Transformer

(4710) LES, Oskaloosa, Kas.

I am trying to build a C. W. transformer. I have two pounds each of number 28 and number 18 dcc. magnet wire. I also cut some strips 1 inch by 7 inches from black sheet iron for the core. How much should I wind on the primary, filament and secondary? I would like to get about 750 volts from the secondary. I intend to use a radiotron 5-watt tube. The current is 110 volt, 60 cycle.

A.—The primary should have 400 turns of number 18 wire; for the high voltage secondary use 3,000 turns of number 28 wire; for filament secondary use 40 turns of number 14 wire. This will give approximately 750 volts and 11 volts secondaries. The 11 volts secondary can be cut down for use on the filament by means of a rheostat.

Construction of the core as cited is correct in detail.

## Grimes Inverse Duplex

(4718) WS, Chicago, Ill.

I have built a 3 tube Grimes Inverse Duplex and have had wonderful results with it with the exception that whenever I get a distant station the set begins to fry very badly. This is most pronounced at night; it cannot be heard when a local station is on. It is not static.

A.—The action cited indicates either a poor connection, incorrect tuning or a

leaky condenser, in all probability the last. This is often caused by too much solder with the above details in mind will undoubtedly reveal the source of disturbance.

Never attach Radio aerials or anything else to poles carrying wires of any sort.

## Body Capacity on Distance

(4832) ABI, Syracuse, N. Y.

I have a standard three circuit receiver. I receive local stations loudly and clearly and free from body capacity effects but when listening to out of town stations, for instance, WGY, only sixty miles distant, the body capacity effects are extremely troublesome. The slightest movement of the hand or body distorts the music into squeals and howls. The panel is shielded. Will you kindly explain the cause of and remedies for this trouble?

A.—A properly shielded panel should be effective in the elimination of body capacity because the lines of force extending beyond the coils of circuit would be grounded through the shielding. We could suggest no better method. It may be that your difficulty is due to the cabinet or the type of panel but as you fail to give us any descriptive data we are unable to assist you more definitely.

## Latest Radio Sensation

Has Become Indispensable

**3 IN 1**  
PRIMARY  
SECONDARY  
AND CONDENSER

No Taps No Trouble



Only \$4 Only \$4

## VERNI-TUNER

(Trade Mark)

Saves Space - Labor - Money

HANDSOME APPEARANCE  
FINEST WORKMANSHIP  
MORE SELECTIVE—  
THAN ANY OTHER COUPLER

For all regenerative circuits, for Home Combined Tuned Radio Frequency and Reflex, also Belnartz, Flewelling, Cockaday, etc.

FREE BOOKLET of 14 Latest Circuits with each Verni-Tuner  
At your dealer or postpaid on receipt of purchase price. Write for leaflet.

**HORNE ELECTRIC & MFG. CO.**  
Mercer & Colgate Sts. Jersey City, N. J.

## TWO SUPERSENSITIVE CIRCUITS

(Both Copyrighted)

My Highly Improved Belnartz brings in all important stations on both coasts and Mexican border, loud, clear and without distortion. We dance to music from Atlanta received on one loud Baldwin unit. Build one of these wonderful sets from my blueprints and specifications, price 50c, or with a perfect and complete double wound spiderweb coil, \$3.00 by mail. No other windings used. Photo of my set on a glass panel with every order.

This copyrighted circuit is the most successful of any Belnartz modification yet produced, and is imitated the most. Thousands are in use.

My W. D. II Circuit is especially designed for use with the "Pickle" tube and brings out the full value of that little tube as no other circuit can. Stations 1000 miles away come in clearly on one tube. This set is small, complete, portable. For the man who wishes the highest efficiency, this is the set to build. Price of blueprint and specifications, 50c, or with complete and perfect windings, \$3.00. Photo of set with every order.

Sets built from these plans will receive all broadcasting stations operating under the new laws. Their wave length range is from 170 to 800 meters.

## AUXILIARY TUNER

This new instrument connected to your present receiving set with one wire enables you to easily bring in both the long and short wave stations which you cannot get with your present equipment. It also enables you to eliminate that local interference so you may listen to distant stations.

Copyrighted diagram and complete instructions for building and operating this instrument, 50c, or with all parts, including Condenser, Coils, Switches, and Panel, \$3.50. Complete instrument, \$15. All goods prepaid.

These instruments are easy to build, easy to operate. Everything clearly shown.

## S. A. TWITCHELL

1925 Western Avenue, Minneapolis, Minn.



## ALL-AMERICAN AMPLIFYING TRANSFORMERS

## One of our quarter-million enthusiastic boosters writes

"I have just built a four circuit tuner, a duplicate of Mr. Lawrence Cockaday's receiver. I am getting unexpected results, distance with volume, and free from the noises that ordinarily come with other sets. I am using 'All-American' Transformers, Type R-13, ratio ten to one, in the first stage, and Type R-21, ratio five to one in the second with results which I find I cannot get by using other transformers."

The "All-American" are the largest selling transformers in the world.  
Any dealer can supply you.

## Rauland Mfg. Company

Pioneers in the Industry

200 N. Jefferson St., Chicago

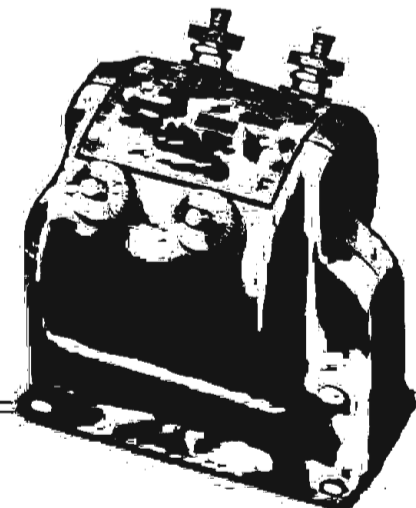

Special Offer! We shall be glad to send you a 32-page booklet of hookups on receipt of two cents to cover postage.



### World Radio Batteries

**SAVE YOU 50%**

WRITTEN 2YR GUAR

By reducing our overhead—and because of huge purchasing power and factory-consumer selling, we are able to maintain high quality and at the same time offer a battery at prices 50% lower.

**LOOK AT THESE PRICES**

- 8 Volt—60 Amp. .... \$ 8.50
- 6 Volt—80 Amp. .... 10.00
- 6 Volt—100 Amp. .... 12.50
- 6 Volt—120 Amp. .... 14.50
- 6 Volt—140 Amp. .... 16.00

These batteries are designed especially for Radio work and will bring in D. X. Signals loud and clear. **SEND NO MONEY**—we ship C. O. D., subject to inspection, or allow 5% discount for cash with order. Reference: Any bank in Chicago.

**FOR DRY CELL TUBES**

- 2 Volt Storage Battery for W.D.-11 and W.D.-12 ..... **\$5.00**
- 4 Volt Storage Battery for U.V.-L99 Tubes ..... **\$8.00**

Capacity—200 Hours on one full charge  
**GUARANTEED FOR TWO YEARS**

Written guarantee with each battery assures you full protection. Thousands of satisfied users all over the country. Order your **WORLD BATTERY TODAY** and get perfect reception this fall.

**WORLD BATTERY COMPANY**  
c/o E. Roosevelt Rd., Dept. L, Chicago, Ill.



### Worksman Radio Service

"THE ACCENT IS ON SERVICE"

14-16 Vesey St. NEW YORK

Our appreciation of your orders is expressed in the quality of our merchandise and prompt service.

**VARIOCOUPLERS**

- \$3.50 Workrite 180° Silk Wound.....\$2.95
- 3.00 Mills 180° Silk Wound..... 1.95
- 3.50 Fisher, Large, 90°..... 2.25
- 2.75 Fisher, 180°..... 1.75

**VARIOMETERS**

- \$3.50 Workrite.....\$2.95
- 8.50 Remler, Molded..... 4.45
- 3.50 Fisher, Large..... 2.85

**CONDENSERS**

- \$2.00 R. C. 11 plate.....\$1.05
- 2.35 R. C. 23 plate..... 1.35
- 2.75 R. C. 43 plate..... 1.65

**VERNIER CONDENSERS**

- \$4.00 R. C. 23 pl.....\$2.25
- 5.00 R. C. 43 pl..... 2.95

**SOCKETS**

- \$1.00 Magnus, Aluminum.....\$0.45
- .75 Bakelite..... .45
- 1.00 Bell Panel Mounting Socket..... .75

**PHONES**

- \$8.00 Brandes Superior.....\$5.25
- 12.00 N. & K., Imported..... 5.50
- 5.00 Nerco..... 2.50
- Ambassador..... 3.89

**Complete Parts for Cockaday Sets**

Including 7x14x3/16 panel, Standard tested apparatus furnished throughout..... **\$12.75**

Mail orders promptly attended to. All orders amounting to \$5.00 or more will be shipped prepaid. Will ship C. O. D. unless remittance accompanies order.