

Radio Digest

EVERY
WEEK

Illustrated

TEN
CENTS

TRADE-MARK

Vol. III

Copyright, 1922,
R. D. F. Co. Inc.

CHICAGO, ILL., SATURDAY, DECEMBER 16, 1922

No. 10

HOOVER URGES ACTION

SHOW USE OF RADIO AS AID TO SLEUTH

EXPOSITION AT GOTHAM TO
HEAR WM. J. BURNS

Dept. of Justice Chief Will Tell Hopes
for Ether Waves in Detec-
tion of Crime

NEW YORK.—How Radio is being employed and may be employed by police and other agencies for the detection of crime will be demonstrated in an intensely interesting manner at the American Radio Exposition which is to be staged in Grand Central Palace, December 21 to 30. William J. Burns, director of the Department of Justice at Washington, is much interested in Radio as applied to the work of his department, and has accepted an invitation to speak at the exposition.

In a letter to Harold Bolster of the American Radio Exposition committee, Director Burns says, "Will be very glad to speak at the Exposition and believe it would be interesting to compare the archaic methods of criminal investigation of the past with the methods of the present; also what we hope to do in the future with Radio, which is the last word. I will explain how we expect to use Radio in the next Bureau of Identification which we are at present organizing in my department."

In addition to Director Burns' talk there will be several demonstrations of how Radio has been employed by police chiefs of European cities.

A concentrated effort is being made by the management and the numerous exhibitors participating in this exposition to make it a thoroughly representative one of what is best in the Radio industry. To this end many more "stunts" and demonstrations are planned which will be designed not only to interest established Radiophans but new converts to Radio.

PLAN TO JOIN CHINA WITH U. S. BY RADIO

Federal Telegraph Co. Increases
Capital to Provide Funds

LOS ANGELES.—The Federal Telegraph Co. is now planning to unite the United States and China by a direct Radio system, which contemplates not only trans-Pacific communication but internal connections within the republic of China. The company is increasing its capital stock to provide funds.



LEGISLATION BY CONGRESS NEEDED NOW

Secretary of Commerce Asks
Haste on Much Delayed
Radio Law

"Interferences" One Aim

Tabling White Bill Said to Have
Stunted Meteoric Growth of
New Industry

(By L. M. Lamm, Special Correspondent)

WASHINGTON.—"It is imperative if the development of the Radio art and its more general use are not to be greatly retarded," says Secretary of Commerce Herbert Hoover, in his annual report to Congress, "that the regulatory powers of the Department in connection with 'interferences' should be greatly extended." The Secretary points out that legislation now before Congress has been supported by the conference representing all groups of producers and users of Radio apparatus.

Demanding that the necessary legislation be incorporated by Representative White's bill, be considered by Congress at once, Secretary Hoover pointed out the importance of the legislation. The report of the conference referred to was very complete in all details, and the delay of the White bill is said to have interfered seriously with the meteoric growth of Radiophony.

High Lights on Bill

Restriction of transmitting ranges and wave lengths and control of the location of Radiophone broadcasting stations, with the idea foremost in mind that Radio communication is a public utility and as such must be regulated by the Federal government in the interest of the public; are the essential points covered by the impending legislation.

Above all other considerations, the one that the public was to be considered was not forgotten, and the proposed legislation, when acted upon by Congress, will revise the present Radio communication

(Continued on page 2)

U. of I. Profs Invent New Detector Tube

Declared Sensitive Detector with
Ten Plate Volts

URBANA, ILL.—A new type of detector tube has been perfected here in the laboratories of the University of Illinois. The tubes have been filed with the Patent Office in Washington, and application made for patents. They represent the result of research and development work by H. A. Brown and Dr. C. T. Knipp, of the University.

It is found that these tubes are sensitive detectors at any applied plate voltage from zero to 30 or 40 volts. They are most sensitive at 10 volts.

Now there are Radio thieves. They call at a house when the man is away and represent themselves as Radio inspectors, thus gaining access to the premises.

WOR PUTS STRAINS OF "RIGOLETTO" ON AIR

NEWARK, N. J.—The complete opera "Rigoletto" was broadcast from Station WOR by the Puccini Grand Opera Company on December 7. This was the second in a series of operas being given from this station. The members of the orchestra are from the Metropolitan Opera under the direction of Maestro Del' Orifice, of the San Carol Opera House, of Naples, Italy.

Among the artists of the Chicago Civic Opera Company who have been heard by Radiophans in opera broadcast is Irene Pavloska. She sang rôles in "Carmen," "La Bohème" and the "Snow Maiden." Miss Pavloska is a Canadian by birth, but for several years has been an American citizen. She is particularly famed for interpretation of Suzuki in "Madame Butterfly." She made her debut at the Auditorium Theater seven years ago Hoover Art Photo

HOOVER URGES ACTION

(Continued from page 1)

laws of the United States in such a manner as to make them the most complete and model Radio regulations in the world.

Effect of Bill on Broadcasters

The owners of receiving stations only are more concerned with the proposed legislation affecting broadcasting stations. Related to all stations, therefore including broadcasting stations, is the provision in the bill that the secretary of commerce have control of the establishment of all Radio transmitting stations except amateur, experimental and government stations, and of the operation of all non-governmental Radio transmitting stations. It is also recommended that he have control of the erection and establishment of certain classes of Radio stations, among these being broadcasting stations.

The secretary of commerce shall also assign a specific wave length to each Radiophone broadcasting station (except government and amateur), which length shall be within the limits pertaining to the class of service of that station.

Broadcasting Plants in Four Classes

Radio broadcasting stations are divided by the bill into four general classifications for the purpose of regulation. These are government, where the broadcast is by departments of the Federal government; public, including the broadcasting by public institutions; state governments or political subdivisions as cities and counties, universities and such others as may transmit informational and educational service; private, where broadcasts, without charge, of news, entertainment or other service are made by any station; and toll, when a charge is made for the use of the broadcasting station.

Station Range Limitations

Broadcasting station ranges will not be unlimited, if the bill is unchanged by Congress, for it is specified that the secretary of commerce assign to each of these stations a permissible power based on the normal range of the station, such normal ranges for the different classes of service, to have the following average values:

- Government broadcasting stations, 600 miles.
- Public broadcasting stations, 250 miles.
- Private and toll broadcasting stations, 50 miles.
- Another provision is that the same wave length not be assigned to stations within the following distances of one another:
 - Government broadcasting stations, 1,500 miles.
 - Public broadcasting stations, 750 miles.
 - Private and toll broadcasting stations, 150 miles.

FANS LAUD CHICAGO OPERA BROADCASTS

"Wonderful," Says Letter from Listener in Maryland

CHICAGO—Letters are pouring into the opera office from all parts of the United States expressing enjoyment of the operas which have been sent by Radio from the Auditorium Theater. J. E. Smith of Wilmington, Delaware, writes of one evening's performance, "All of the voices were particularly clear and good." Joel Gutman of Baltimore, Md., says, "It is a wonderful thing to broadcast your opera, and it gave both my wife and myself great pleasure to be seated in our home a thousand miles away and to be able to listen perfectly to this wonderful performance. May you long continue in this most remarkable work."

Other enthusiastic long distance listeners are Charles D. Hayden of Sea Cliff, L. I. and Miss Marietta Jackson of Frankfort, Ky., both of whom have written requests for the exact dates on which operas are to be broadcast since it is done only twice a week. The enthusiasm created both in Chicago and throughout the country by sending opera over the air is unmistakable evidence of the American public's enjoyment of good music.

During the fourth week, "Rigoletto" was broadcast on Wednesday, December 6, and "Aida," the following evening.

In "Rigoletto," Angelo Minghetti was the Duke of Mantua; Cesare Formichi, Rigoletto; Edith Mason, Gilda; Virgilio Lazzari, Sparafucile; William Beck, Count Monterone. Panizza conducted.

The cast for "Aida" was unlike that when it was first broadcast. It was Claudia Muzio (debut) as Aida; Edouard Cotreuil, the King of Egypt; Ina Bour-skaya, Amneris; Charles Marshall, Radames; Virilio Lazzari, Ramfis; Cesare Formichi, Amonasro. Polacco conducted.

Tells Duty of Citizens

COLUMBUS, O.—Station WPAL, of the Superior Radio & Telephone Equipment Co., inaugurated the first of its weekly forum talks this week when John R. King, prosecuting attorney of Franklin county, spoke on "The Duty of Citizens." One talk by a prominent citizen on some subject of general interest will be featured in broadcasting by Radio every Friday afternoon, the company has announced.

Novices can pick up quite a few pointers by joining a Radio club, where the real bugs will teach them much.

Declares Radio Remakes Family Circle Crushed by Excitement Lust

Anne Faulkner at WMAQ, Chicago, Aids Appreciation of Music Among Laymen Through Special "Hearing America First" Programs and Talks

By Vera Shipman

"Radio is redrawing the family circle," says Mrs. Max Obendorfer (Anne Faulkner) who is helping the American Radio audiences enjoy music as a part of everyday life through the broadcasting programs of Station WMAQ, the Chicago Daily News.

"The home is the world's greatest institution. What it has suffered through the war and the aftermath of jazz and excitement lust, is being re-made by the family listening in on America's rejuvenator—Radio. The farm life, the life in the small or far off community is being centered again at home after dissatisfaction and the city craze. Radio in the home entertains the whole family. Father can sit in his comfortable chair and listen to music and read his paper between numbers; mother can do the thousand-and-one odd jobs which are in her realm while she listens in; brother can hear the ball scores sooner than they get them at the corner drug store; sister can hear the new music or the various talks on beauty culture which many stations broadcast; baby can be put to sleep by the bedtime story."

Programs Educational and Enjoyable

The larger cities are making their broadcasting programs educational along with enjoyable entertainment. The General Federation of Women's clubs, of which Mrs. Obendorfer is musical chairman, has issued a course of study called "Hearing America First" as a suggestion for musical clubs of the country. It deals with American music, its origin in the Indian and Negro melodies and the influence

brought in by emigration from other lands.

Every nation has brought with its migrating people a music of its country, for the European countries are musical in their daily lives. These have all been influences upon the so-called American music.

In harmony with this, every Friday evening, Mrs. Obendorfer broadcasts a half hour of American music, its ideals and its aspirations through this series called "Hearing America First." The layman is hearing it, the musician, and the totally uninterested. Some seed of interest ripens and the message takes root, through the spoken voice or the attendant musical number on each program.

Analyze Symphony Numbers

In further musical appreciation for the listeners in at home, Mrs. Obendorfer broadcasts each Friday evening a half hour to an hour long talk with illustrative music by Mr. Obendorfer at the piano, studying the programs of the Chicago Symphony orchestra concerts given every Friday afternoon and Saturday night.

From this, there have been definite accomplishments already, according to Miss Waller, director of Radio musical programs for the News. Miss Waller states that letters show interest in these illustrative talks and a new interest shown in the ticket sale of the symphony concerts. Listeners in who have never heard a symphony before and who have scoffed at such music as "high-brow" have begun to attend and to enjoy them because they really understand the music.

CONTENTS

Radio Digest, Illustrated, Volume 3, Number 10, published Chicago, Illinois, December 16, 1922. Published weekly by Radio Digest Publishing Company, 123 West Madison Street, Chicago, Illinois. Subscription rates, yearly, Five Dollars; Foreign, Six Dollars; single copies, Ten Cents. Entered as second-class matter April 27, 1922, at the postoffice at Chicago, Illinois, under the Act of March 3, 1879.

"All the Live News of Radio".....	1 to 7
Receiving Record Contest.....	4
KHJ, Largest in the West.....	4
King Kay of "The Voice of the South".....	5
Radiophone Broadcasting Station Directory, Three Parts, Part I.....	8
Navigation Commissioners Report to Secretary of Commerce.....	9
Editorials; Condensed by Dielectric; Indigest, Humor Column.....	10
Regenerative Tuner and Detector Panel, by A. C. Tabbot.....	11
Hook-Up to Reduce Static Trouble, and Nine Other Workshop Kinks.....	12
Flewelling Panel Data; Reinartz R.F. Amplifier, by Harry J. Marx.....	13
Easy Method for Learning the Code, by Thomas W. Benson.....	14
Questions and Answers.....	15
Radio Illustrated, a Page of Pictures.....	16

Looking Ahead

A Flewelling Set in Photo Diagram. Next issue page 7 will show, by the clear, photographic-diagram method, just how the very successful Flewelling Super-Regenerative Circuit is laid out. Page 6 will tell how to operate the set described on page 7. If you haven't tried this wizard hook-up yet, buy next issue before your newsstand dealer says, "Sold out."

Complete Details and Diagram of the Panel Layout for Harry J. Marx's five tube Radio and Audio Frequency circuit will be given in the next issue. This is in response to numerous telegrams and special delivery letters from fans who are anxious to construct this set—not an experimental set, but one that is in successful use. Mr. Marx has been collecting data on reflex circuits and promises an interesting article on the subject in one of the early issues.

Radio Frequency Amplification. Laurence C. F. Horle, research engineer of the Federal Telephone and Telegraph Company, has furnished an especially interesting article, "Radio Frequency Amplification" and the performance curves of various types of transformers, in addition to his recommendations of the proper use of Radio frequency transformers in a number of different hook-ups.

Technical bugs—watch for the start of this article in the December 23 issue. A Multimillionaire Radiophan—Col. Edw. H. R. Green, son of the late Hetty Green, is spending millions to further the development of Radio. Pictures and descriptive article of great work being accomplished will appear in an early issue. Col. Green has erected a large experimental station at Buzzards' Bay, Massachusetts, to help worthy amateurs without means for research. Prizes for new ideas and a summer school for Radiophans are two of the salient features of the big venture.

Peeps at Station WBAP, Fort Worth, Texas, coming soon. Ever heard the call from the "Lone Star State"? Watch for these pictures.

You Don't Know Where the Calls Come from, if you haven't copies of Radio Digest with its Radiophone Broadcasting Station Directory. All the new stations in and all the dead ones out—every week. Now given in three parts. Part I this issue. Part II will appear December 23.

Newsstands Don't Always Have One Left

WHEN YOU WANT

Radio Digest

YOU WANT IT!

BE SURE OF YOUR WEEKLY COPY BY SUBSCRIBING NOW

SEND IN THE BLANK TODAY

Publisher, Radio Digest, Illustrated, 123 West Madison St., Chicago, Illinois. 3-10

Please find enclosed check M. O. for Five Dollars (Six, Foreign) for One Year's Subscription to Radio Digest, Illustrated.

Name

Address

City State

MURDERESS SOUGHT BY BROADCAST NET

DESCRIBE CLARA PHILLIPS, ESCAPED CONVICT

Los Angeles Plants Come to Aid of Police—Message Caught Far Away

LOS ANGELES, CALIF.—For the first time in history an "air dragnet" has been used in an attempt to catch a noted criminal. At regular intervals all day December 5 the following message was broadcast from all Los Angeles broadcasting stations, at the request of the Los Angeles police:

"Escaped from the county jail at 2 a. m., Clara Phillips, convicted murderess. Age 23. Weight, 122 pounds. Eyes, blue. Hair, brown. Finger prints, thirty over twenty-three and one over one.

Notify sheriff's office, Los Angeles, if anyone answering this description."

According to reports received here the message was picked up as far east as New Mexico and Utah and as far north as southern Oregon.

Mrs. Obendorfer through Station WMAQ has pioneered in the movement of bringing educational music to the American home by Radio, and to her is due the credit of making these programs valuably interesting.



WHY LOOK FURTHER

for a **XMAS GIFT?**

Radio Reception

by Harry J. Marx, Technical Editor "RADIO DIGEST," and Adrian Van Muffling

A clear explanation of the operation of Radio Receiving Sets, with Simple Instructions on Tuning and the Calculations of Wavelengths.

Sent by Insured Mail with a Xmas Card to any address you request.

Only \$2.00

Mail Your Order Today to

Harry J. Marx

900 WILSON AVE. CHICAGO

For People Who Care PREMIER VARIABLE CONDENSERS

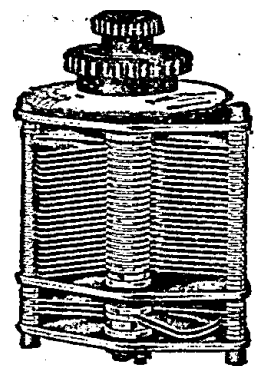

PLENTY OF CAPACITY—coupled with the proper provision for variation to the smallest degree. These are essential elements in a variable condenser.

RIGID CONSTRUCTION—Head, rotor and stator plates are hard aluminum, all other materials brass and bakelite.

You will find PREMIER CONDENSERS designed and made for maximum efficiency.

SPECIFY BLACK OR WHITE DIAL

PRICES—All Capacities

11 Plate—Cap. .0039 M. F., 1/4" shaft.....	\$3.00	\$3.50
23 Plate—Cap. .0078 M. F., 1/4" shaft.....	3.50	4.00
43 Plate—Cap. .015 M. F., 1/4" shaft.....	4.50	5.00

NOTE—Vernier type condensers, listed below, are only furnished complete with Dial and Knob.

11 Plate, with 2 plate vernier—Cap. .0040 M. F.....	\$4.50
23 Plate, with 2 plate vernier—Cap. .0079 M. F.....	6.00
43 Plate, with 2 plate vernier—Cap. .0154 M. F.....	7.00

You can well be proud to show your friends.

PREMIER BUILT PRODUCTS

WRITE FOR BULLETINS 102 AND 203

PREMIER ELECTRIC COMPANY
Manufacturers—Est. 1905
3802-3810 RAVENSWOOD AVE., CHICAGO

MAMMOTH ORGAN GIVES FANS TREAT

WJAX BROADCASTS TUNES OF WORLD'S LARGEST

Unusual Character of Huge Instrument Lends Especial Interest to Cleveland Program

CLEVELAND, O.—An unusual feature recently broadcast by Station WJAX, the Union Trust Company of this city, was the organ recital by Edwin Arthur Kraft, a well-known Cleveland organist, at the new public auditorium recently.

This program was of especial interest to Radiophans because of the unusual character of the organ upon which the recital was played. The Cleveland Public Auditorium organ is the largest in volume of any organ in the world and has been the cause of such interest upon the part of musicians as well as much curiosity upon the part of the public.

Organ Mammoth in Size

The organ occupies a space 30 by 30 by 20 feet and requires a 70 horsepower motor to run the bellows. Three hundred miles of wire were used in its construction. It has 5 manuals, 125 black keys, 180 white and 32 pedal keys. It has 160 different stops, each stop giving the effect of a different instrument, any one of which may be played alone or together with any or all of the others, with the result that almost any desired orchestral effect may be obtained. The Cleveland organ has the greatest variety of tonal color of any organ in the world. Some idea of the range of this organ is indicated by the fact that the largest pipe of the organ is 25 inches by 30 inches by 33 feet long, and the smallest pipe 1/8 inch in diameter and only 3/4 inch long. There is also an echo organ placed 325 feet away from the main organ, which makes it possible for the organist to obtain particularly unique effects.

TALKS AT WOR ON HISTORY OF MUSIC

Philip Gordon Broadcasts "Musical Appreciation" Every Monday Evening at Newark Plant

NEWARK, N. J.—Every Monday at 6:15 p. m., Eastern time, Philip Gordon, musical director of the South Side High School of this city, and correspondent for several musical publications, broadcasts "Musical Appreciation" from Station WOR, L. Bamberger & Company. Mr. Gordon started his series of interesting talks on music some time ago. He took the early history of music as the subject of his preliminary talks and illustrated them by his own compositions. He is a pianist of much skill and can very ably illustrate his talks and bring out the salient points discussed. The next phase Mr. Gordon spoke on was the various instruments in the band and orchestra, describing them and their uses. He is now considering the lives and works of various famous composers.

Air Waves to Link Pacific Isles with Rest of World

OTTAWA, ONT.—F. C. T. O'Hara, deputy minister of trade and commerce, who attended the first pan-Pacific commercial conference held at Honolulu, as the representative of the Canadian government, has arrived home.

Among the resolutions adopted at the conference was one seeking the assistance of various governments to obtain for the press the use of government Radio stations for the transmission of news in order to bring the peoples of the Pacific islands in closer touch with the outside world.

FIRE CHIEF PICKS UP MINSTRELS' CONCERT

URBANA, O.—Chief George Donovan, of the local fire department, picked up a concert by Coburn's Minstrel Company, broadcast from the Atlanta Journal station, WSB, this week. As the Coburn minstrels rehearsed in the city hall over the fire department headquarters during all the month of August, many of the musical numbers had "that familiar ring" to the chief.

CUBAN WAVES COVER DISTANCE TO CANADA

LONDON, ONT.—Several local Radiophans heard distinctly every number of a program given last week by Station PWX in Havana, Cuba, a distance of not less than 1,800 miles. Local Radio enthusiasts have commonly listened to concerts from points in Texas, Florida and Louisiana, but this is the first instance locally recorded of messages being received clearly from Cuba.

DOUBLES POWER TO SET NEW RECORDS

MANAGER OF WEAY PLANS NEW STATION

Houston Broadcaster Credited with Long Distance Marks, Seeks New Laurels

HOUSTON, TEX.—Not satisfied with a record of reaching points in Canada, Cuba, California and New York, Will Horwitz, manager of WEAY, Iris Theater Radiophone broadcasting station, is building a new plant exactly twice as powerful as the one now in operation.

"We are more than pleased with results we have obtained from our plant after six months' operation," Horwitz said in announcing the purchase of equipment for the new plant. "We realize, however, that although we do get reports from far off places now and then, it is probable that regular reception is out of the question for places more than 500 miles from our station. We are trying to supply them regular daily service and that is why we are anxious for a more powerful plant."

A large pipe organ in the theater gives Southwest Texas noonday and afternoon concerts regularly. The Iris Entertainers, a trio of professional musicians, send concert programs twice weekly, while on Sunday evenings, the sermons of Dr. James B. Leavell of the First Baptist Church are sent out.

One of the most elaborate studios in Texas is used for special entertainers who appear at WEAY. The studio is located in the editorial rooms of The Houston Post. The Post is "father" of Houston's Radio plants, it being the only newspaper in Houston now taking an active part in furnishing programs and announcing special events for Radiophans.

SOUTH SEA ISLES HEAR COAST 'BUGS'

Waves of Los Angeles Amateurs Traverse Distance of 4,300 Miles

LOS ANGELES, CALIF.—Another step toward bridging the Pacific Ocean by amateur Radio has come about through the agency of a British receiving set at Apia, Samoa, and local amateur Radio stations have added other laurels to their already enviable records.

A letter recently received by V. M. Bitz, of this city, from E. E. Dunwoodie, operator of the Radio station at Apia, British Samoa, reports that 6ZG V. M. Bitz, 6ZX, J. V. Wise, Walnut Grove, Calif., 9ZAF, Reynold's Radio Company, Denver; and 6XJ, Los Angeles; "Dean" Farran, who operated the old 50-watt KHJ, have been heard in the South Sea Islands at a distance of about 4,300 miles airline from Los Angeles.

Amateur Radio can well expect to reach Australia and it is believed that it won't be long until the Pacific gap will be crossed. Last year the Atlantic was successfully covered by the American amateurs and this year it begins to look like the Pacific will also be bridged.

Airphones Carried News of His Arrest, He Says; Sues

LOS ANGELES, CALIF.—Not only was he arrested without proper authority and placed in jail without having a charge lodged against him, but the news of his arrest was broadcasted all over Southern California from a Los Angeles Radio station. Having alleged these things, William M. Bleakmore, a public school teacher, brought suit last week against Raymond B. Dunlap, police officer, asking \$15,000 damages.

The complaint disputes Dunlap's right to make the arrest, says that Bleakmore was confined in jail, "among criminals," and that the news was broadcasted.

RADIO RECIPES WIN MOTHER



When her mother admonished her for spending so much time experimenting with Radio and told her it would be more to her credit if she would "learn something about cooking instead," Miss Emily Exner decided to listen in on all Radio lectures on domestic science and make typewritten copies of each. When presented the long record of recipes that came through the air, Miss Exner's mother was won to the cause. She now declares Radio is "just wonderful" © K. & H.

College Alumni Hear Phone at Alma Mater

Thirty Graduates Listen In on Program from WOC

COLUMBUS, O.—Central Ohio alumni of the Palmer School of Chiropractic, of Davenport, Iowa, listened to a program broadcasted from Station WOC at their alma mater a few nights ago. The members of the association were guests of Dr. B. L. Miles at his home in Westerville, north of here, where the Radio program was received.

SETS TO CONNECT FUR TRADER WITH MARKET

Hudson Bay Post Will Install Receivers in Spring

EDMONTON, ALTA.—With the opening of the Mackenzie River to navigation next June, there will be sensitive Radio receiving sets installed at Hudson Bay posts all the way down the river to Stefansson's "Friendly Arctic," in the delta of the river, 2,000 miles north of Edmonton and 200 miles north of the Arctic Circle. These will enable the fur traders to keep in touch with the fur market.

THE ANTENNA BROTHERS

Spir L. and Lew P.

To the Hives for Honeycomb Coils!

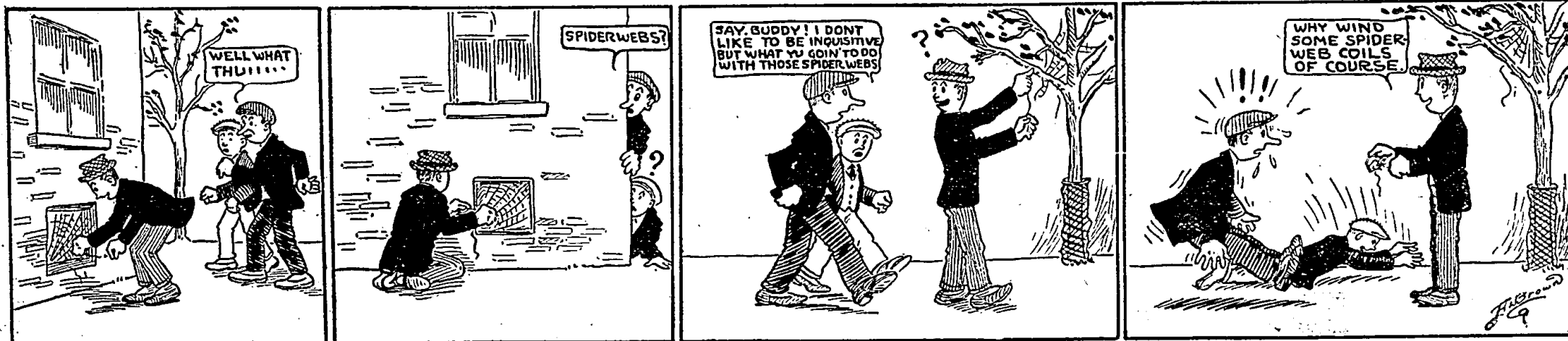

KHJ, LARGEST ON THE COAST

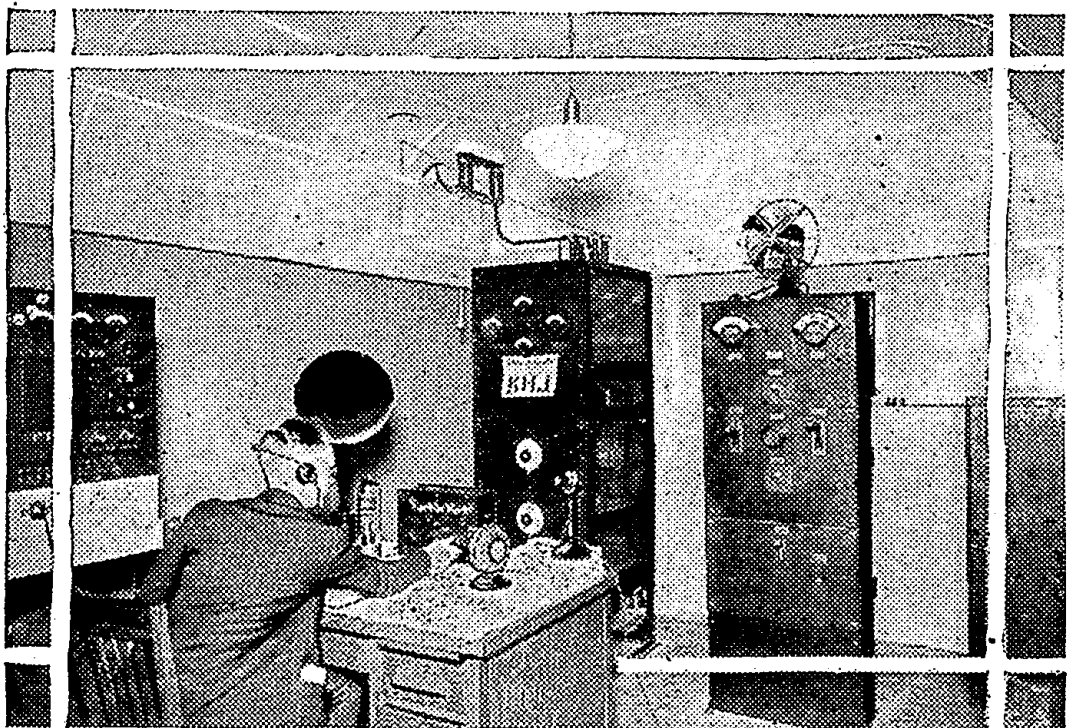

Yes, this is KHJ, in operation. Input panel, transmitter panel and power panel, reading from left to right. KHJ, 500 watts, has done a great deal for Radio in the Southwest since Nov. 1st. The plant is heard regularly now in the central states and often in the eastern states. "Uncle John," the bedtime story telling genius and "Cousin Bill," the humorous news reader, are on the job in the studio, a beautifully furnished room with proper broadcast acoustics. This is just the instrument room. The back in the foreground belongs to G. C. Farmer

evidence, distance receiving records of 1,000 statute miles or more for Radiophone broadcasting stations found in the "Broadcasting Station Directory," page 8, of any two consecutive issues, may send in such records.

2. Distances must be measured AIR-LINE and expressed in statute miles. Disregard of this rule may cause amateurs to be declared ineligible.

3. Call signals of station heard, its location and the mileage, as defined in Rule 2, must be given in reporting record. Otherwise record will not be considered.

4. Distances are verified by the contest department of this publication, using a Geo. F. Cram Co. standard Radio map of the United States. Owing to much variance in maps, the distances are only given to the nearest 25 miles and are claimed accurate only within 50 miles. This leeway is believed necessary.

Ether Waves Play Part in Drive Against Tuberculosis

COLUMBUS, O.—Radio is being used here by health officials in the battle against tuberculosis which is to be connected with the nation-wide educational campaign to stamp out the white plague.

From broadcasting stations in Columbus, Cleveland, Toledo, Dayton, Akron, Cincinnati and other Ohio cities, short talks are being given on health in general and prevention of tuberculosis.

Special Christmas Offer to Readers of Radio Digest

The PEERLESS

Variable Condenser

\$1.25 postpaid and fully guaranteed. Capacity .0005

Large production and elimination of jobbers' and retailers' profits make this ridiculously low price possible.

Order direct from manufacturer TODAY

CONTINENTAL SPECIALTY CO.
5146-48 Carmen Ave. Chicago, Ill.

Phantom Tuner

\$19.75 will bring one of these marvelously sensitive instruments to your address, prepaid. No serial, ground, loop or radio frequency used. All parts highest quality. Cutler Hammer, Remler, Dubeller, etc., mounted on genuine bakelite panel. Complete instructions furnished for wiring. No soldering necessary. Have music on strip of lamp cord one hour after set arrives. Our Phantom sets over distance and is practical using detector only. Wind lamp cord in auto top and tune in music while driving. We've done it often. Send stamp for booklet and learn the Phantom story.
VESCO RADIO SHOP, Box D-704, Vacaville, Calif.

THE ONLY GENUINE AND GUARANTEED

The New "All Wave" Coupler

TRADE MARK

Wave Length—150 to 3000 Meters

FLAT AND BACK WOUND

Eliminates the use of all Variometers, Variocouplers and Loading Coils, inasmuch as it performs in one compact unit the functions of all of these devices combined.

For the Novice—The "All Wave" Coupler enables the greenest novice to attain the same results attained by the expert in building the simplest, most compact and most efficient radio receiving set possible.

Be Prepared for increases in the wave lengths of the broadcasting stations which are necessitated by their increasing number.

Unusual Results Attained—Individual users of the "All Wave" Coupler have written us that in Rhode Island it is nothing unusual to bring in stations as far south as Havana, Cuba, while in Mobile, Alabama, Newark, N. J., is brought in daily.

Beware of Imitations—Of the "All Wave" Coupler. Look for the trademark, "All Wave" on the rotor.

\$9.00 Six efficient Hook-ups sent upon receipt of 10c stamps or Free with each "All Wave" Coupler

Thousands of Satisfied Users
Guaranteed with an Absolute Money-Back Guarantee to Operate as Advertised

CAPITOL PHONOLIER CORPORATION

Dept. "R. D." 54-60 Lafayette Street, New York City



Patents Granted and Pending

RECEIVING RECORDS? SEND 'EM IN—

IN the last issue of RADIO DIGEST the complete, verified list of receiving records was published. During the week, the following new and superseding records were made. In order to inform new readers, the rules of the contest are repeated below the list of new records.

Station—Miles Away—Holder and Location

- WPA—1050, E. A. Unger, Oxford, Mich.
- KNT—2425, J. H. Wall, Rensselaer, N. Y.
- WDAV—1275, J. H. Wall, Rensselaer, N. Y.
- WEAK—1100, J. H. Wall, Rensselaer, N. Y.
- WFAW—1250, J. H. Wall, Rensselaer, N. Y.
- WLAJ—1450, J. H. Wall, Rensselaer, N. Y.
- WNAF—1375, J. H. Wall, Rensselaer, N. Y.
- WEAY—1950, H. Gow, Seattle, Wash.
- WOI—1525, R. H. Strong, Bicknell, Calif.
- KSD—1675, R. H. Strong, Bicknell, Calif.

- PWX—2400, R. H. Strong, Bicknell, Calif.
- KQP—2100, G. A. Walter, McDonald, Pa.
- KLX—2225, C. J. Lohman, McDonald, Pa.

Rules to Remember

The rules to follow in the contest are but few and easily followed. They are:
1. Amateurs who are able to beat the records given, or who can claim with good

MAGNAVOX Radio

The Reproducer Supreme

IN Radio, there are no substitutes for the Magnavox electrodynamic principle.

When you purchase Magnavox apparatus you assure yourself the utmost satisfaction.

R-2 Magnavox Radio
with 18-inch horn
(as illustrated)

For store demonstration, large audiences, dance halls, etc. \$85.00

R-3 Magnavox Radio
with 14-inch horn

For homes, offices, amateur stations, etc. \$45.00

At good dealers everywhere

THE MAGNAVOX CO. New York Office
Oakland, Cal. 370 Seventh Ave.

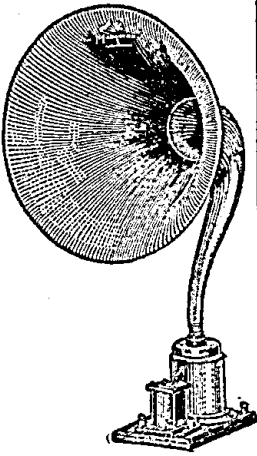

Headquarters for
Radio Supplies and Equipment
Radio Department
COMMONWEALTH EDISON ELECTRIC SHOPS
72 West Adams Street
Chicago, Ill.



WHEN the archer misses the center of the target, he seeks for the cause within himself," said Confucius.

If your results are not what they should be you need a Grebe Receiver.

A. H. GREBE & CO., Inc.
Richmond Hill, N. Y.

Doctor My

Good-Bye Outdoor Antenna

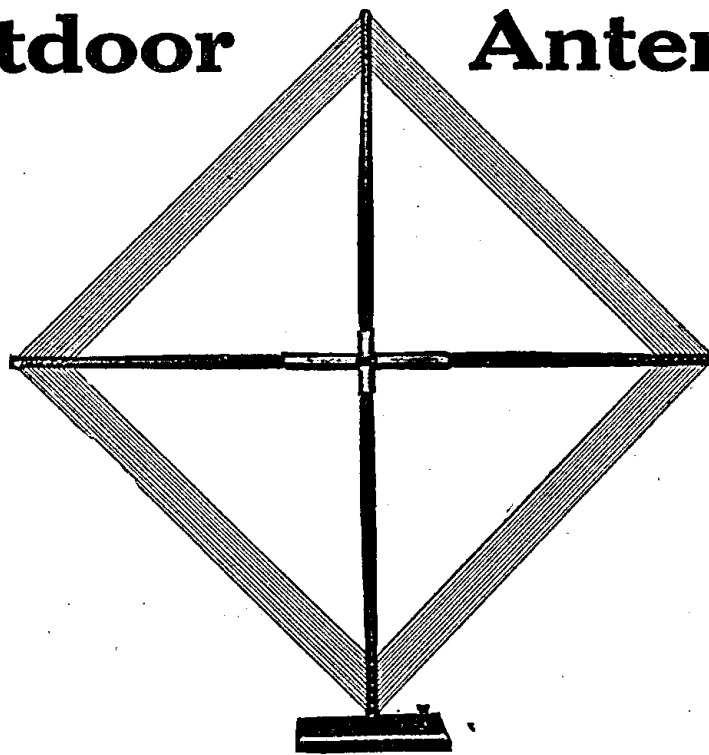

TUNE IN YOUR FLEWELLING SET WITH A

"RADI-UN LOOP AERIAL" List \$7.00

A 24-in. Loop Aerial, swivel base, shipped completely assembled, all ready to use. Weighs, all boxed, 4 lbs.

- Myer's Tubes, WD-11, Cunningham and Radiotrons
- Erla Variable Grid Leak and Condensers
- Dubilier Condensers
- Howard Rheostats and Potentiometers
- Coto Coils, Mounted Honeycomb Coils, Brackets and Variable Condensers
- Baldwin Clarophone, Single Units and Headsets
- United Vernier Condensers, 11, 23 and 43 Plates
- Immediate Delivery

Dealers Write for Special Discount Sheet

HUDSON ROSS, 123 W. Madison St., Chicago

KING KAY OF "VOICE OF THE SOUTH"

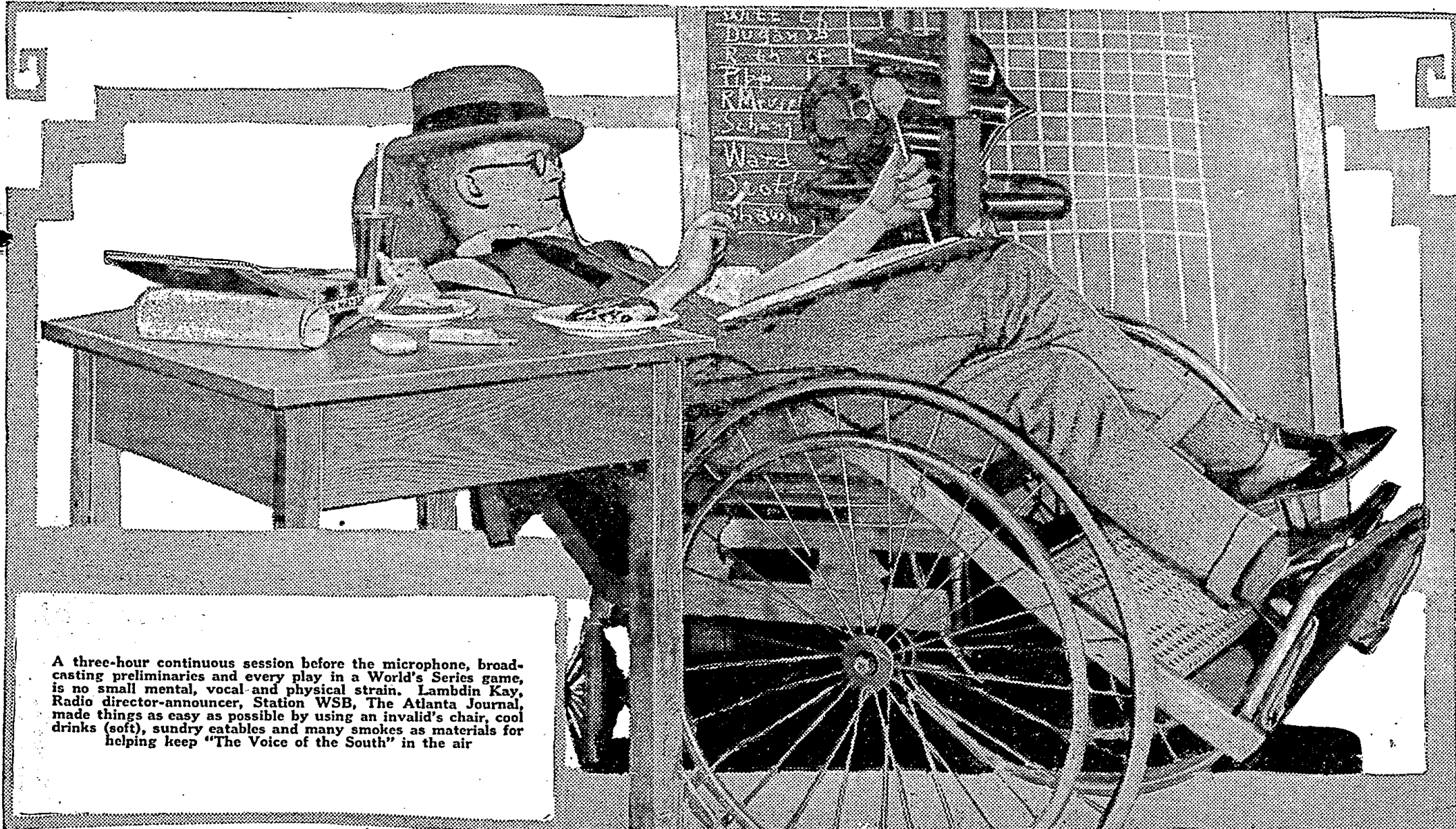

A three-hour continuous session before the microphone, broadcasting preliminaries and every play in a World's Series game, is no small mental, vocal and physical strain. Lambdin Kay, Radio director-announcer, Station WSB, The Atlanta Journal, made things as easy as possible by using an invalid's chair, cool drinks (soft), sundry eatables and many smokes as materials for helping keep "The Voice of the South" in the air

VOICE OF 'VOICE OF SOUTH' SPEAKS UP

LAMBDM KAY LAYS BARE STORY OF LIFE

WSB Announcer Tells of Canned Sauerkraut Gift from Fan—Denies He Is a Mark Twain

By Lambdin Kay

(Director-Announcer, WSB, Atlanta Journal)

Might as well make this an autobiography for the editor of RADIO DIGEST, as the hero of the piece has to do most of the talking and writing, anyhow, at WSB Radiophone broadcasting station of The Atlanta Journal. Here goes:

Name, Lambdin Kay; age, thirty; height, inconsiderable; hair, red and fading (numerically); condition of servitude, single; habits, irregular; hobby, was golf until Radio brought twenty-five-hour day; experience, stenog., sales manager, publisher, movie magnate, shoe polish peddler, press agent, reporter, editor, Radio director-announcer; weakness, poetry (trying to write it); politics, nil; ambition, eight hours sleep; idol, Rip Van Winkle; aversions, cats, O. O. McIntyre, English peas, four-flushers, arithmetic, trap-drummers, alarm clocks.

Voice of the South from Brooklyn

Birthplace (announced at risk of shocking Digest readers who have heard southern accent), Brooklyn, N. Y. Ameliorating circumstances; mother, a Texan; father, Missourian. Raised in New Orleans, Texas and Georgia, barring youthful interlude in Kansas City, "The Heart of America," as WHB Sweeney has nicknamed it.

Radio record: thought up "The Voice of the South" out of own head as slogan; likewise three-note chimes as station signature—first stunts of kind in Radio (cheers and applause—and contradictions). Helped introduce America's first nightly "Owl" concert at WSB last June.

Becomes Famed and Defamed

Told the world about Atlanta's million-dollar midnight fire and got my paper in trouble, and my picture in The Literary Digest. Have had grossly deceived listeners guess I'm something like John Sharp Williams, William Jennings Bryan, Col. Henry Watterson and Mark Twain—which I ain't.

Have received undeserved gifts from enormously kind fans ranging through canned sauerkraut, sky-blue garters, one alligator, fancy cookies, two monkey wrenches, potted fern, safety razor, flocks of confectionery and cigars, complete

"suite" of winter underwear, etc., and so on.

Creed of Lambdin Kay

Believe an announcer is meant to be heard; that he should always be conscious he is talking personally to the farthest listener within the station's range; that every solitary soul complimentary enough to tune in is entitled to hear, and deserves to hear, and ought to hear everything that's going on; that the average bug gets a bigger thrill by identifying rotten jazz music coming from a station 2,000 miles away than by hearing grand opera from his home station; that the human race is a fine institution; that a broadcasting station's opportunity and obligation as a public servant are an awesome thing; and that running one is more fun and more work than any other job on earth.

Wooster Prexie Talks by Radio

WOOSTER, O.—An address by Dr. Charles F. Wishart, president of Wooster University, together with a musical program by college artists, was broadcast from the headquarters of the Canton-Wooster club at Canton on the night of December 11, the anniversary of the great Wooster fire in 1901.

Wooster alumni clubs in Cleveland, Canton, Youngstown, Mansfield, Toledo, Columbus and other cities listened in.

Park Receiver Brings Revenue

COLUMBUS, O.—Many people are taking advantage of the opportunity to hear the Radio concerts given here every eve-

ning in the dance pavilion at Indianola park. The Radio feature is a paying proposition, according to men connected with the park management.

To Yearly Subscribers Only

Limited Number of

BOUND VOLUME TWO

RADIO DIGEST

Volume Two

13 Numbers

July 15—October 7, 1922

Now Ready for Delivery. Parcel Post Prepaid, Only \$2.00

On account of the limited supply, the sale of these bound volumes No. 2 is limited strictly to those readers of the Radio Digest who have subscribed for a year. By subscribing now for one year to the Radio Digest you get both BOUND VOLUMES 1 AND 2, 26 numbers, with one year's subscription for \$7.00.

ALL ORDERS MUST BE SENT DIRECT.

No orders on this offer will be accepted through subscription agencies, news dealers or other sources. Check, money or express orders (no stamps) must accompany all orders.

TEAR HERE—MAIL

COUPON

PUBLISHER, RADIO DIGEST ILLUSTRATED, 123 West Madison St., Chicago, Illinois.

I have already subscribed to the Radio Digest for one year, so please reserve me one bound volume Number Two for which I am enclosing check—M. O. for Two Dollars.

Please reserve me Bound Volume Number One and also Number Two and one year's subscription to the Radio Digest Illustrated, for which I am enclosing check—M. O. for Seven Dollars.

Name
Address
City State

MICON TESTED MICA CONDENSERS

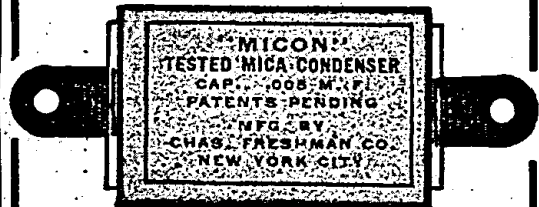

Assure—

- Absolute noiselessness
- Clarity of tone
- Accuracy
- Constant fixed capacity

Size	Price	Complete diagram of the Armstrong Super-Regenerative Circuit FREE with every purchase of MICONS
.00025	\$0.35	
.0005	.35	
.001	.40	
.002	.40	
.0025	.50	
.005	.75	
.01	1.50	

Sizes .0025 and .005 are especially adapted for the new Armstrong Super-Regenerative Circuit. Micons come in all capacities from .00025 to .01

At your dealers—otherwise send purchase price and the desired Micons will be sent without further charge

Chas. Freshman Company, Inc.
97 Beekman St. New York City

Supply—
Limited
Better
Hurry

LARGEST SHIP HAS GREAT RADIO ROOM

MAJESTIC IN DRYDOCK INTERESTS ENGINEERS

Liner Talks to Either Side of Atlantic at Will—Call Signal is GFWV

BOSTON, MASS.—Radio men were greatly interested in the Radio equipment of the great liner Majestic, the largest ship in the world, which was docked and repaired in drydock here in the largest drydock in the world. The equipment is most complete, the transmitting equipment consisting of a 3-tube British Marconi CW set, the tubes being about the size of our American 1/2 kilowatt American type. Wave lengths used range between 1800 and 1400 meters, and as on most of the British liners, her antenna consists of a single wire, a type that is becoming more common for commercial use, as well as for broadcasting purposes.

With this apparatus the Majestic's operators are in communication with either side of the Atlantic at all times, and in fact it is not uncommon for them to "work" Marion, Mass., while lying in the English channel. The call letters of the ship are GFWV, the G indicating that the ship is under British registry.

Description of Receiving Equipment
Included in the receiving equipment is a Marconi "all-wave" tuner, suitably provided with dead-end switches for cutting out the unused portions of the circuits. A Bellini-Tosoli conical antenna is used for a direction finder, the Majestic having installed on board its own Radio compass by which the ship can obtain its positions from shore Radio beacons. A quenched spark transmitter, working on 450, 600 and 800 meters, is employed as an auxiliary transmitter for communicating with ships using a quenched spark or damped wave system.

There has recently been installed on the Majestic one of the new automatic transmitters, by which it is possible to dispatch traffic at an enormous speed. An average of 500 messages a day are sent from such a ship as the Majestic, so assuming that expert hand operators could handle 100 messages per hour, it would take at least five hours to clear them. One land station could not devote so much time to any one ship.

In order to expedite matters, the messages are punched out on a tape, which is then run through an automatic transmitter at a speed of 100 words per minute, although this can operate at a speed of 250 words. Four expert operators are constantly on duty on the Majestic.

Lighthouse Keepers Organize Radio Club

Initiation Fee to Be One Post Card Approving Scheme

WASHINGTON.—The Bureau of Lighthouses has announced that some of the men at the Bureau have been dabbling with Radio receiving sets recently and these men have announced that their experience might be valuable to lighthouse keepers and other members of the Lighthouse Service who would like to enjoy the pleasures of the Radio concerts sent out by broadcasting stations. The men in the Washington Bureau are therefore proposing to organize a Radio club among the Radiophans of the service. They state in their announcement that the initiation fee will be one postal card or letter stating approval of the scheme. They further say "the dues will be a word from you from time to time telling us of your difficulties, your results and any other information you might deem interesting."

TELMACO
RADIO SUPPLIES STORES
Prompt Service—Quality Goods—Priced Right
Radio Division
TELEPHONE MAINTENANCE CO.
20 S. Wells St. Franklin 3986
5206 W. Madison, Austin 7011. 1122 E. 47th St.
Look for the TELMACO Sign

DELICATE SOLDERING
Both the manufacturer's and amateur's problem on all fine work is readily solved by the instrument constructed for this particular purpose.



LISTS AT **\$6.00** ONE-HALF ACTUAL SIZE LISTS AT **\$6.00**
Awarded Certificate of Excellency, N. Y. Evening Mail Radio Institute
From your dealer or write
POST ELECTRIC COMPANY, Dept. 509, 30 E. 42nd St. NEW YORK

Book Reviews

Vacuum Tube Receivers. By O. F. Heslar. A book that tells how to make a simple set. How to make the cabinet. It includes a 27 by 36-inch layout blue print. Price, 75 cents.

The Armstrong Super-Regenerative Circuit. By George J. Eltz, Jr., E. E. This is a De Luxe edition of this famous circuit. Profusely illustrated and fully explained. Fifty-two pages. Price, \$1.00.

Radio Receivers for Beginners. By Snodgrass and Camp. Answers the universal question, "How can I receive Radio?" Price, \$1.00.

Home Radio—How to Make It. By A. Hyatt Verrill. This book is particularly adapted for the amateur who desires to know how to make Radiophones. Twelve full page illustrations and diagrams. Price, 75c.

Elements of Radiotelegraphy. By Elery W. Stone. The text was written for the guidance and instruction of Radio students in the communication service of the Navy. It is an instruction book for Radio schools. Price, \$2.50.

Radio for the Amateur. By A. H. Packer and R. R. Haugh. The underlying principles of Radio thoroughly explained in simple language and understandable illustrations. This book will teach you how to construct and operate a receiving set successfully. Price, \$1.50.

Radio Communication. By John Mills. The fundamental principles and methods upon which recent developments are based are emphasized. The vacuum tube is treated in a simple, fundamental and up-to-date manner. Present methods and tendencies of the art are explained in a chapter which is non-mathematical. Price, \$2.00.

The A B C of Vacuum Tubes. By E. H. Lewis. Is a book for beginners who have no knowledge of either Radio or electricity and sets forth the elementary principles of theory and operation of the vacuum tube. No attempt has been made in this book to describe all the possible circuit arrangements, but those shown may serve as suggestions to experimenters who desire to evolve their own circuits. Price, \$1.00.

Experimental Wireless Stations. By S. E. Edelman. This book assumes that the reader has some knowledge of fundamental electricity and mathematics and is a readily understandable text for beginners in the art of Radio communication who desire to start with the elements. Earlier editions of this book were published during the war. The 1922 edition has been revised and enlarged so as to cover the

SURPLUS Army Receiving Sets

One tuner, inductively coupled, primary and secondary circuit. Variable primary and secondary condensers. Century buzzer and dust-proof crystal mounting. Also 50-ft. of silk covered flexible wire, screw driver and other accessories. This apparatus is mounted on 3/8" Bakelite panel and inclosed in a solid oak, dust-proof cabinet, with sufficient space for installation of tube apparatus.

WESTERN ELECTRIC 2200 OHM RECEIVERS

Each Receiver Cap is equipped with a removable Sponge Rubber Ear Cushion. One Aviator's Felt Lined Leather Helmet. One WESTERN ELECTRIC SIGNAL CORPS TYPE Microphone Transmitter.

There is a limited number of these excellent outfits which can be purchased for **\$20.00**

25% With Order, Remainder C. O. D. Express Prepaid on an Order of Four.
Address
J. M. MARVEL
13 Richmond Ave. DAYTON, O.

progress made in the last few years. Price, \$3.00.

The book department of the Radio Digest is prepared to send you any of the books on Radio published, whether listed in our Book Review or not. Let us know what book you want, send us your check and we will see that the book is mailed to you. Postage stamps in payments for books not accepted. Send money order or check. Book Department, Radio Digest Illustrated, 123 W. Madison St., Chicago, Ill.

San Diego to Have First Municipal Plant in West

SAN DIEGO, CALIF.—San Diego, the Border City of the Southwest, known as "The Harbor of the Sun," will receive the honor of having the first municipal Radio broadcasting station in the West.

The new station is to be owned and controlled by the city of San Diego, and will be operated in the interest of the various departments of city activity and will include the general advertising of the municipality. The station will be located on the old Exposition Grounds, probably in the building now occupied by the large, outdoor, world-famous pipe organ.

The transmitter equipment will be of the standard 500-watt type. It is the intention of the Southern city to secure a Class B government license if possible. The new municipal Radio station is expected to be a New Year's Gift to the invisible world of listeners in, as the city has hopes that the station will be in operation on January 1, 1923.

Brooklyn, New York, has a pioneer Radio club in one of its high schools, organized in 1910.

TINIEST SET WINS IN \$200 PRIZE CONTEST

Boy Scout Gets Prize for "Finest Receiving Outfit"

COLUMBUS, O.—Winners in the Columbus Dispatch Radio contest, in which \$200 in prizes were awarded, have been announced in the eight classes as follows: Smallest receiving set, Donald Spurgeon; most unique receiving set, James Siegfried; finest receiving set made by Boy Scout, Billie Loeffler; most efficiently constructed crystal detector set, Homes Ruggles; finest constructed receiving set, Charles W. E. Wendt; most efficiently constructed vacuum tube detector set, William Hasson; most efficiently constructed vacuum tube detector and amplifying set, Ray Valentine; set having most home-made parts, Allen Blanchard. All of the winners live in this city.

The contest was such a pronounced success that the time limit for the display of the remarkable sets has been advanced a week in order to allow hundreds of interested persons time in which to visit the display.

THE ONLY KNOB and DIAL WITHOUT A SET SCREW
ASK YOUR DEALER
4 in., \$1.50 3 in., \$1.00
TAIT KNOB & DIAL CO., Inc.
11 East 42nd Street NEW YORK CITY



Radio "A" and "B" Batteries

Announcing the DXB-1202-G

A Radio "B" Battery in Solid One-Piece Glass—A Real Storage Battery—Thick Plates and Thick Separators—24 Volts—2 Ampere Hours—Non-Slop and Non-Leak in any Position—Without the Makeshift of Undesirable "Jelly Electrolyte."

The USL Line is Complete

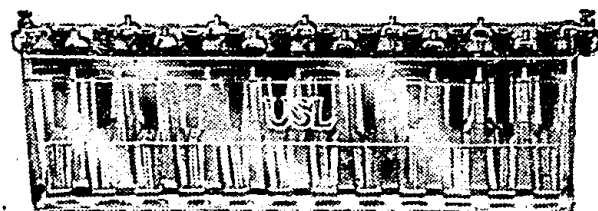

USL Radio "A" Battery

In solid one-piece hard rubber, 6 Volts; 65-75 Amp. Hrs. Type DXA-305. List Prices:
Battery and Handle.....\$20.00
Cover, extra 2.00
Tray, extra 1.75



USL Radio "A" Batteries

In White Oak—Mahogany or Mission Finish

Type	Ampere Hours	Volts	List Prices
DXA-303-X ...	24-30	6	\$12.50
DXA-305-X ...	65-75	6	16.00
DXA-307-X ...	95-105	6	22.00
DXA-309-X ...	130-140	6	28.00

USL Radio "B" Battery

In Glass—Type DXB-1202-G Charged—ready to use. List Price, \$8.00.



USL Radio "B" Battery

In Rubber, Type DXB-1202, 24 Volts; 2 Amp. Hours Charged; ready to use. List Price\$11.00

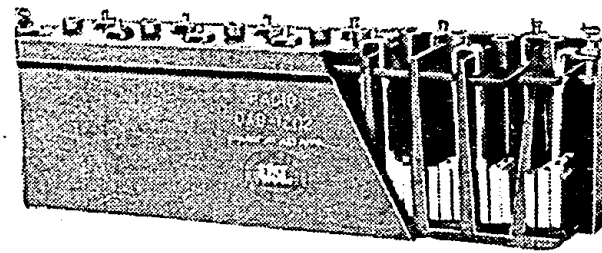

Non-Slop, Non-Leak in any position

List Prices Effective December 1, 1922
In Canada 20 Per Cent. Additional

Guaranteed Under the Standard USL Service Policy

U. S. Light & Heat Corporation
Niagara Falls, N. Y.

Factories: Niagara Falls, N. Y.—Niagara Falls, Canada—Oakland, Cal.
127 Central Distributing Points and DEALERS EVERYWHERE
5250 USL Battery Stations

STANDARDIZING MEET SCHEDULED JAN. 12

BUREAU OF STANDARDS IS AFTER INFORMATION

Technical and Trade Associations Invited to Aid in Deciding Uniform Tests of Sets

WASHINGTON.—The Bureau of Standards has called a conference on Radio standardization to be held on Friday, January 12, in New York City.

The purpose of the conference is first to consider broadly whether a formulation of standards for Radio apparatus and service shall be made; second, if so, what general classes of apparatus or service should be included, and third, what procedure shall be recommended for carrying out the conclusions reached by the conference. If the conference decides that Radio standards should be formulated, it is expected that they will be prepared with special consideration of the wide range of interests which are concerned with the subject, and that these standards may ultimately be adopted with the approval of the American Engineering Standards Committee as an American standard.

Issue Invitations

Invitations are being issued to all of the national associations of an engineering and technical nature which are known to be interested in Radio standardization. The representation of Radio manufacturers will in general be through the trade associations of which they are members. While it is desired to make the conference thoroughly and broadly representative, it is expected that the organizations invited will limit their representation to one or two persons in order that the conference may be as effective as possible.

Need for Conference Felt

The desirability of calling a general conference on Radio standardization has been apparent in many ways, and this call is issued by the Bureau of Standards at the specific request of the following associations and organizations:

Institute of Radio Engineers, National Radio Chamber of Commerce, Radio Apparatus Section of the Associated Manufacturers of Electrical Supplies, National Retail and Dry Goods Association, American Radio Relay League, Radio Corporation of America.

These organizations have pointed out that there is need for greater uniformity in the methods of describing, rating, and testing of performance of Radio apparatus.

Debating by Radio Now

CHICAGO.—Long distance chess, by means of the telegraph, has been common for many years. The long distance debate only awaits the solution of the wave length question, permitting two-way conversations to be carried on freely. When this time comes, the "City" clubs of Chicago and Boston, for instance, might engage in nightly discussions upon subjects of civic importance. The debate will have a prominence never heretofore approached, and tremendous benefits in the way of good government will be reaped by the people.

RADIOPHANS

Buy direct from us at Wholesale Prices! Look at these Low Prices on Standard, Guaranteed Highest Quality Products.

- \$16.00 "A" Battery, 60 A. H. \$10.50
- \$20.00 "A" Battery, 90 A. H. \$13.25
- \$25.00 "A" Battery, 120 A. H. \$15.50

Many other equally good offerings in our Complete Price List. Write for it.

FREDERICKS' ELECTRIC COMPANY
NEWARK, NEW YORK

DISTRIBUTORS FOR

Crosley Radio Frequency Sets

Special price on twenty-five Detector Tube Sets, all complete, A-B-Batts Head Set, Tube and Wire, while they last **\$25**

LakeSide Supply Co.
Tel. Harrison 3840 339 So. Wabash Ave., Chicago, Ill.

NEW YORKER HEARS "CARMEN"

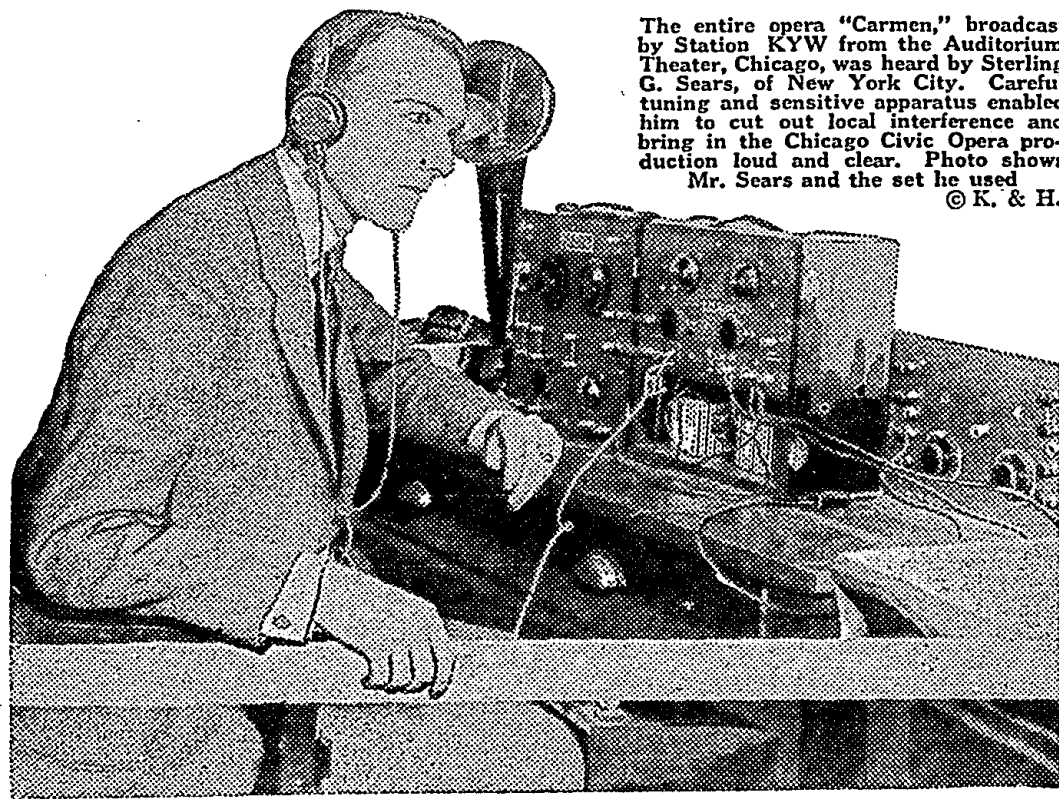

The entire opera "Carmen," broadcast by Station KYW from the Auditorium Theater, Chicago, was heard by Sterling G. Sears, of New York City. Careful tuning and sensitive apparatus enabled him to cut out local interference and bring in the Chicago Civic Opera production loud and clear. Photo shows Mr. Sears and the set he used. © K. & H.

HEALTH SUBJECTS INTEREST WCAH FANS

COLUMBUS, O.—One of the most interesting programs given from Station WCAH of the Enteklin Electric Company, Columbus, was the paper on "Trachoma" delivered this week by Paul Mason of the Ohio State Department of Health. The paper was prepared by Dr. R. B. Tate, of the division of communicable diseases, and is a part of the series of health subjects given weekly from WCAH.

toria Budget, Astoria, Ore.; WPAG, Central Radio Co., Inc., Independence, Mo.; KFBJ, Guy Greason, Tacoma, Wash.; WSAJ, Grove City College, Grove City, Pa.; WCAP, Kalamazoo College, Kalamazoo, Mich.; KFCL, Los Angeles Union Stock Yards, Los Angeles, Calif.; WOAR, Henry P. Lundskow, Kenosha, Wis.; KFCQ, Motor Service Stn., Casper, Wyo.; WOAZ, Penick Hughes Co., Stanford, Texas; WOAQ, Portsmouth Radio Assn., Portsmouth, Va.; WCAW, Woodmen of the World, Omaha, Nebr.; KFDF, Wyoming Radio Corp., Casper, Wyo.

Long Island people have complained to the Public Service Commission that Radio waves have influenced their light and power meters to register for electricity not consumed. This is probably a hallucination, as there is no likelihood of such a possibility.

BROADCASTING PLANTS INCREASE 46; LOSE 29

Twenty-two Licensed on 360 Meters, One on 400

CHICAGO.—During November the Department of Commerce licensed 46 broadcasting stations and cancelled 29. Three of those deleted were transferred to other ownership and have been recorded as new stations. The gain for the month therefore was seventeen stations, which indicated that the looked-for saturation point in broadcasting stations has not yet been reached.

Twenty-two stations were licensed to do public service broadcasting on 360 meters and one, the Mercantile Trust Co., San Francisco, Calif., was licensed on 400 meters during the two weeks ending December 2. The new 360-meter stations are as follows:

WOAK, Collins Hardware Co., Frank-

fort, Ky.; WPAC, Donaldson Radio Co., Okmulgee, Okla.; KFGH, Leland Stanford Jr. Univ., Stanford Univ., Calif.; WOAH, Palmetto Radio Corp., Charleston, S. C.; WTAC, Penn Traffic Co., Johnstown, Pa.; KFDC, Radio Supply Co., Spokane, Wash.; WRAA, Rice Institute, Houston, Texas; WTAU, Ruegy Battery & Elec. Co., Tecumseh, Nebr.; WOAN, James D. Vaughan, Lawrenceburg, Tenn.; WOAL, Wm. E. Woods, Webster Grove, Mo.; KFGG, As-

RADIO DOCTOR

A positive guarantee to call and make your Radio Set work and operate satisfactorily.

GROVE WESTON

Phone Nevada 5629 101 S. Kedzie Ave. CHICAGO

JOHN F. BOWBIN President **ERSCO** FRANK J. FENCL Secretary

ELECTRIC AND RADIO SUPPLY CO.

NOT INC.

Full line of Electric and Radio Supplies; also Cunningham Detector, Amp. Tubes, Auditorium and A. P. Det. Tubes—Amplifiers

165-67 NORTH WELLS STREET
CHICAGO, ILL.

BRILLIANTONE RADIO PRODUCTS

- Dept. G, 874 Columbus Ave., New York City
- \$8.00 WESTINGHOUSE W. D. 11-1/2 V. Tube with socket.....\$6.50
- .90 FIRTH double closed Jacks..... .50
- FRESHMAN Var. Grid Leak and Cond... 1.00
- 7.00 RADIO CORP. U. V. 712 Audio Transformer..... 6.00
- 15.00 WESTERN ELECTRIC Phones (2,200 ohms)..... 9.00
- 8.00 BRANDES Superior Head Sets..... 6.75
- 8.00 FEDERAL Head Sets..... 6.00
- 1.25 PATHE 4 inch dials..... .75
- 4.50 ARROW Variometers..... 2.25
- 1.85 BRADLEYSTAT..... 1.50

Special 1 1/2 V. Tube Set in portable genuine mahogany cabinet, entirely assembled. Most remarkable results..... **\$15**

6.00 B.R.P. Variometers, kiln dried, mahogany 3.00
6.50 B.R.P. Variocoupler (Panel or Lab.)..... 3.50
Send money order but do not add postage for mailing. Package will come Parcel Post Collect.

SWELLS EVERY NOTE INTO FULL RICHNESS MAKES YOUR OUTFIT COMPLETE

\$5.00 AT ALL GOOD DEALERS
WITHOUT RECEIVERS

SHIELTONE SOUND SPEAKER

STATES ELECTRIC COMPANY, Agents
24 Clinton Street Newark, N. J.

SPIROLA GIVE A SPIROLA CHRISTMAS!

and let the whole family listen to REAL MUSIC all the year through! Nothing adds so much to a two-stage set as a high-grade loud speaker. SPIROLAS are BETTER LOUD SPEAKERS. REAL CABINET TYPE—not just the usual horn enclosed in a cabinet. Powerful, beautiful, with an INCOMPARABLE TONE. We make a complete line of the highest class construction throughout, with fine hand rubbed finishes. SPIROLAS are and have always been sold under moneyback guarantee to equal in volume and far surpass in beauty and tone any other up to twice their price.

SPIROLA DUPLX—For use with any headset. Separate tone chamber for each phone, eliminating interference. Satin black finish, nickel fittings. **\$3.85**

Oak (OO) or mahogany (DM) finish, bronzed throat **\$4.85**

At dealers or postpaid (G. O. B. if preferred). If desired, we will send in holiday package direct to recipient, carefully following your instructions. DEALERS! We can fill holiday rush orders!

L. H. DONNELL MFG. CO., DEPT. B. BOX 70, ANN ARBOR, MICH.

THRIFT NEWS FOR THE SHREWD BUYER

Chicago Salvage Stock Store

509 S. STATE STREET

Radio Supplies purchased here are sold under a positive guarantee of satisfaction. We carry the largest new stock of first quality merchandise.

\$8.50 value, 3000 ohm guaranteed HEAD PHONES.....\$3.65

COMPLETE PARTS FOR REGENERATIVE SETS
This includes 2 Variometers, 1 Coupler, 3 Dials, 1 Rheostat, 1 Cunningham Detector Tube, 1 Bakelite Socket, 1 Mahogany Cabinet, 7x18 Formica Panel, 6 Binding Posts, 1 Switch Lever, 12 Switch Points, 2 Stops and 1 Diagram to construct this set. Set is capable of receiving 1,000 miles if installed with outdoor aerial.....\$17.95

- ### VARIABLE CONDENSERS
- \$4.30 Value, 43 Plate, now.....\$ 1.75
 - \$3.70 Value, 23 Plate, now..... 1.45
 - \$3.30 Value, 11 Plate, now..... 1.35
 - \$2.30 Value, 5 Plate, now..... 1.25
 - \$2.10 Value, 3 Plate, now..... 1.15
 - U. S. A. Signal Corps Aviation Type 194-W Western Electric Phones... 7.95
 - MAGNAVOX, Loud Speaker, Type R3, \$45.00 Value, now..... 34.95
 - U. S. Army Signal Corps, Type B. C. 14-A Crystal Receiving Set..... 23.95
 - \$5.00 Value VARIOMETERS..... 1.95
 - \$4.50 Value VARIOCOUPERS..... 1.75

- ### HONEYCOMB COILS
- 1,500 Turn, \$1.50 1,250 Turn, \$1.50
 - 25, 35, 50, 75 and 100 Turn, 40c
- \$1.00 Value RHEOSTATS.....45c
 - SPONGE RUBBER EAR CAPS, pair..... 50c
 - DIALS, 2-, 3- and 3 1/2-inch..... 25c
 - CRYSTAL DETECTORS..... 75c
 - \$4.50 Value Thordarson Amplifying TRANSFORMERS... \$2.95
 - 22 1/2-Volt "B" BATTERIES..... 1.65
 - \$3.65 VALUE LIGHTNING SWITCH..... 2.65
 - LIGHTNING ARRESTERS... \$0.95
 - 2-SLIDE TUNING COILS..... 1.95
 - 3-COIL HONEYCOMB MOUNT-INGS with Knobs..... 3.95
 - 2-COIL HONEYCOMB MOUNT-INGS, with Knobs..... 2.45
 - SPAGHETTI TUBING, yard... .10
 - PHONE CAPS, for mostly all phones.....\$0.25
 - SIGNAL CORPS HOT WIRE AMMETERS..... 5.45
 - ANTI-CAPACITY SWITCHES. 1.50
 - LIGHTNING SWITCHES..... 2.65
 - HYDROMETERS, now at..... .45

LARGE VARIETY OF CABINETS AT CUT PRICES
FORMICA PANEL, SQUARE IN., 1 1/2 c
BLACK OR BROWN—CUT TO ANY SIZE
We Guarantee All Merchandise Purchased of Us.
Mail Orders Filled Same Day Received
CHICAGO SALVAGE STOCK STORE
509 S. STATE ST. CHICAGO, ILL.

Radiophone Broadcasting Stations

Corrected Every Week—Part I

AG1, Presidio of San Francisco, Cal. 50 mi. Signal Corps. U. S. A. Sun, 7-9 pm, instruction. Pacific.

A06, Canton, O. 425 only. 75 mi. Hdqtrs. 135th F. Artillery. U. S. G. Wed, Fri, music. Sun, church services. Eastern.

AS6, San Antonio, Tex. 480 only. U. S. Army. Camp Travis. Mon, 7:30-8:30 pm, Thurs, 9:30-10:30 pm, music. Central.

CFAC, Calgary, Alta., Can. 430 only. 400 mi. Western Radio Co. Ltd. Daily ex Sun, 3:30-4:30 pm, Daily, 7:45-8:45 pm, Mountain.

CFCA, Toronto, Ont., Can. 400 only. 500 mi. Toronto Star. Daily ex Sun, 12 m, weather; 2:30-3:30 pm, news, music; 5:30-6, news; 8-9, concert. Sun, 8:30-9:30 pm, concert. Eastern.

CFCB, Vancouver, B. C., Can. 440 only. 1,500 mi. Marconi Co. Daily ex Wed, Sun, 3:30-4:30 pm, Daily, 8:30-9:30 pm, reports, news, music. Pacific.

CFCE, Halifax, N. S., Can. 440 only. 150 mi. Marconi Co. Mon, Wed, Sun night, music, entertainment.

CFCF, Montreal, P. Q., Can. 440 only. 500 mi. Marconi Co. Daily ex Sun, 1-1:30 pm, Mon, Wed, Fri, 7:30-9 pm, Eastern.

CFCH, Iroquois Falls, Ont., Can. Abtibi Power & Paper Co. Ltd.

CFCI, Walkerville, Ont., Can. Motor Products Corp.

CFCN, Calgary, Alta., Can. 440 only. 300 mi. W. W. Grant Radio Ltd. Experimental station. Sat, Sun, after 11:30 pm, Mountain.

CFCX, London, Ont., Can. The London Advertiser.

CFPC, Fort Frances, Ont., Can. International Radio Develop. Co.

CFTE, Toronto, Ont., Can. The Bell Telephone Co.

CFYC, Vancouver, B. C., Can. Victor Wentworth Odium.

CFZC, Montreal, Que., Can. Can. Westinghouse Co. Ltd.

CHBA, Calgary, Canada. 410 only. 1,000 mi. W. W. Grant Radio Ltd. (Morning Alberta.) Daily, 8:45-10 pm, news, stock quotations, music. Mountain.

CHCA, Vancouver, B. C., Can. Radio Corp. of Vancouver, Ltd.

CHCB, Toronto, Can. Marconi Co.

CHCC, Edmonton, Alta., Can. Can. Westinghouse Co. Ltd.

CHCF, Winnipeg, Man., Can. Radio Corp. of Winnipeg, Ltd.

CHCQ, Calgary, Alta., Can. 400 only. 150 mi. Western Radio Co. Ltd. Daily ex Sun, 3:30-4:30 pm, Daily, 7:45-8:45 pm, Mountain.

CHCS, London, Ont., Can. London Radio Shoppe.

CHCZ, Montreal, Que., Can. B. L. Silver.

CHCZ, Toronto, Ont., Can. Globe Printing Co.

CHCC, Vancouver, B. C., Can. Can. Westinghouse Co. Ltd.

CHVC, Toronto, Canada. 410 only. 200 mi. Metropolitan Motors Co. Daily ex Sat and Sun, 5-5:30 pm, news, concert. Eastern.

CHXC, Ottawa, Ont., Can. 400 only. 50 mi. J. R. Booth, Jr. Mon, Wed, Sat, 8:30-10 pm, music, entertainment. Eastern.

CHYC, Montreal, Que., Can. Northern Elec. Co.

CHBC, Montreal, Que., Can. 420 only. 75 mi. Dupuis-Freres. Wed, Fri, 9-10 pm, music. Eastern.

CJCA, Edmonton, Alta., Can. 450 only. 1,000 mi. Edmonton Journal, Ltd. Daily ex Sun, 12 m, reports, concert; 8:30-10 pm, concert. Western.

CJCB, Nelson, B. C., Can. 400 only. 100 mi. James Gordon Bennett. Daily, 8-9 pm, music, news, reports. Pacific.

CJCD, Toronto, Canada. 410 only. 200 mi. T. Eaton Co. Daily ex Sat and Sun, 4-4:30 pm, concert. Sat, 12-12:30 pm, concert. Eastern.

CJCE, Vancouver, B. C., Can. 420 only. 150 mi. Vancouver Sun. Daily ex Sun, 12:30-1:30 pm, 3:30-5, 8-10, music, news. Pacific.

CJCF, Kitchener, Ont., Can. 420 only. 100 mi. News Record Limited. Mon, Tues, Fri, Sat, 9-9:30 pm, Thurs, 8 pm on, concert. Eastern.

CJGG, Winnipeg, Canada. 410 only. 1,000 mi. Manitoba Free Press. Daily ex Sun, 10-10:30 am, news; 12-1 pm, reports. Mon, Thurs, 8-10 pm, concert. Tues, 7-8 pm, music. Fri, 5:30-6:45 pm, music. Sun, 8 pm, every other week starting August 20. Central.

CJGH, Toronto, Ont., Can. United Farmers of Ontario.

CJCI, St. John, N. B., Can. 400 only. 75 mi. McLean, Holt & Co., Ltd. Daily, 8-9 pm, music, news, weather. Eastern.

CJCN, Toronto, Ont., Can. Simons, Agnew & Co.

CJCS, Halifax, N. S., Can. Eastern Telephone & Telegraph Co.

CJCY, Calgary, Alta., Can. Edmund Taylor.

CJGC, London, Ont., Can. 430 only. 75 mi. London Free Press. Daily ex Sun, 9:30-10 am; 12-1 pm, news; 3:30-6 pm, weather, news; 8-9, music, entertainment. Eastern.

CJNC, Winnipeg, Man., Can. 400 only. 1,000 mi. Tribune Newspaper Co. Daily ex Sun, 9:30-10 am, 1-2 pm, Mon, 5:30-6:45 pm, Tues, 8-10 pm, Fri, 7-8 pm, Sun, 3-4 pm, Central.

CJSC, Toronto, Ont., Can. Evening Telegram.

CKAC, Montreal, Can. 430 only. 1,000 mi. La Presse. Daily 2 pm, reports, 3:30, markets, 4:45, musical teas, news, 5:30 specials, Tues, Thur, Sat, 7 pm, kiddies' stories, 7:30-9:30, music, entertainment. Sun, 4 pm, sacred concert. Eastern.

CKCB, Winnipeg, Man., Can. T. Eaton Co., Ltd.

CKCD, Vancouver, B. C., Can. 410 only. 150 mi. Vancouver Daily Province. Daily ex Sun, 8:30-9:30 pm, music, entertainment, news. Pacific.

CKCE, Toronto, Ont., Can. Can. Ind. Telephone Co.

CKCK, Regina, Sask., Can. 420 only. 1,500 mi. Leader Pub. Co. Daily ex Sun, 10-10:30 am, news; 1:15-2 pm, markets, news, music. Mon, Wed, Thurs, 7:30-8:15 pm, sports, music. Tues, Fri, 7:30-9 pm, concert. Mountain.

CKCR, St. John, N. B., Can. 400 only. 75 mi. Jones Elec. Radio Co., Ltd. Daily 4-5 pm, concert, reports. Atlantic.

CKCS, Montreal, Que., Can. The Bell Telephone Co.

CKCZ, Toronto, Ont., Can. Westinghouse Co., Ltd.

CKCG, Toronto, Ont., Can. Radio Equipment & Supply Co. Ltd.

CKOC, Hamilton, Ont., Can. 410 only. 100 mi. Worthworth Radio Supply Co., Ltd. Mon, Wed, Fri, 8:30-9:30 pm, concert. Sun, church services. Eastern.

CKQC, London, Ont., Can. 410 only. 50 mi. Radio Supply Co. Mon, Wed, Fri, 7:30-8:30 pm, music, entertainment. Eastern.

CKZC, Winnipeg, Man., Can. Salton Radio Eng. Co.

DD5, Denver, Colo. 340 only. 200 mi. Fitzsimmons General Hospital. Daily ex Sun, 8:15 pm, weather, news, concert. Thurs, 8:15-9:30 pm, special concert. Mountain.

DM4, San Antonio, Tex. 1,500 mi. U. S. Army, Kelly Field. No regular schedule.

DM7, San Antonio, Tex. 200 mi. U. S. Army, Brooks Field. No regular schedule.

DN4, Denver, Colo. 340 only. 200 mi. Colorado National Guard. Daily ex Sun, 8:15 pm, weather, news, concert. Thurs, 8:15-9:30 pm, special concert, speech. Mountain.

KDZB, Bakersfield, Calif. 100 mi. Frank Siefert. Daily ex Sun, 7:30-8:15 pm, reports, music. Sun, sacred program. Irregular. Pacific.

KDKA, E. Pittsburgh, Pa. 400 and 485 only. 2,000 mi. Westinghouse Elec. & Mfg. Co. Daily ex Sun, 10-10:15 am, 12:30-1 pm, music; 3:00, sports; 7:00-9, news, features, markets, entertainments; 9-9:55, concert; 9:55-10 pm, time. Sun, 10:45 am, church service; 2:45 pm, Bible story; 3 pm, 7:30, church service. Eastern.

KDN, San Francisco, Calif. 485, 510 also. 500 mi. Leo J. Meyberg Co. Daily, 1-2 pm, 8:30-9, 4:30-5:30, 7-7:15, music, reports, concert. Pacific.

KDOW, New York, N. Y. S.S. America. Home port in New York.

KDPM, Cleveland, O. Westinghouse Elec. & Mfg. Co.

KDPT, San Diego, Calif. 250 mi. Southern Elec. Co. Daily 7:30-9 pm, news, weather, concert, lecture. Pacific.

KDYL, Salt Lake City, Utah. 485 also. 500 mi. Salt Lake Telegram. Daily ex Sun, 7-8 pm, news, music, entertainment. Pacific.

KDYM, San Diego, Calif. Savoy Theater.

KDYO, San Diego, Calif. Carlson & Simpson.

KDYQ, Portland, Ore. Oregon Inst. of Technology.

KDYR, Pasadena, Calif. Pasadena Star-News Pub. Co.

KDYS, Great Falls, Mont. 485 also. 1,000 mi. Great Falls Tribune. Daily 12 m, weather, time. Daily ex Tues, 8-10 pm, concert etc. Sun, 4 pm, church services. Mountain.

KDYV, Salt Lake City, Utah. Cope & Cornwell Co.

KDYW, Phoenix, Ariz. 100 mi. Smith Hughes & Co. Daily ex Sat, 7-8 pm, Mountain.

KDYX, Honolulu, T. H., Hawaii. 500 mi. Honolulu Star-Bulletin Co. Ltd. Daily ex Sun, 12:15-1:15 pm, reports; 6:30-7:30 pm, entertainment, music, talks. Sun, 11 am-12:15 pm, 5-6, church services. 120th Meridian.

KDZA, Tucson, Ariz. Arizona Daily Star.

KDZB, Bakersfield, Calif. Frank E. Siefert.

KDZE, Seattle, Wash. 500 mi. The Rhodes Co. Daily ex Sun, 10:30-11 am, 3:30-4:30 pm, news, music. Mon, Fri, 7-8 pm, concert. Wed, 8-9 pm, concert. Pacific.

KDZF, Los Angeles, Calif. Automobile Club of Southern California.

KDZH, San Francisco, Calif. Cyrus Pierce & Co.

KDZM, Fresno, Calif. 485 also. 50 mi. The Herald-Buford Co. Daily ex Sun, 8:15 am, 4-6 pm, news, reports. Daily ex Tues, Fri, 7-8 pm, reports, music. Tues, Fri, 8-9 pm, Pacific.

KDZI, Seattle, Wash. Seattle Radio Assn.

KDZK, Reno, Nev. 50 mi. Nev. Mch. & Elec. Co. Wed, Fri, Sat, Sun, 8-9 pm, music, entertainment. Pacific.

KDZL, Ogden, Utah. Rocky Mountain Radio Corp.

KDZM, Centralia, Wash. 50 mi. Hollingworth Hdwe. & Radio Supply Store. Daily ex Sat & Sun, 8-9 pm, music. Pacific.

KDZP, Los Angeles, Calif. Newberry Elec. Corp.

KDZQ, Denver, Colo. 500 mi. Wm. D. Pyle. Daily ex Sun, 6:45-7:15 pm, news, 9-10 pm, concert. Mountain.

KDZR, Bellingham, Wash. 200 mi. Bellingham Pub. Co. Daily ex Sun, 7-8 pm, 8:30-9 pm, music, news, sports, reports. Sun, 7-8 pm, church service. Pacific.

KDZT, Seattle, Wash. Seattle Radio Assn.

KDZW, San Francisco, Calif. Claude W. Gerdes.

KDZZ, Everett, Wash. 50 mi. Kinney Bros. & Sep-

KFCF, Walla Walla, Wash. Frank A. Moore.

KFGH, Billings, Mont. 100 mi. Electric Service Station, Inc. Daily, 7:30-9 pm, music. Mountain.

KFGK, Colorado Springs, Colo. Colorado Springs Radio Co.

KFCL, Los Angeles, Calif. Los Angeles Union Stock Yards.

KFCQ, Casper, Wyo. Motor Service Stn.

KFDA, Baker, Ore. Adler's Music Store.

KFDB, San Francisco, Calif. Mercantile Trust Co.

KFDD, Spokane, Wash. Radio Supply Co.

KFDE, Boise, Idaho. St. Michael's Cathedral. Sun, 11:15-12:30 pm, 8-9:15 church services. Mountain.

KDFD, Casper, Wyo. Wyo. Radio Corp.

KDFS, San Francisco, Calif. John D. McKee.

KFEB, Taft, Calif. City of Taft.

KFEC, Portland, Ore. Meier & Frank Co.

KFED, Polytechnic, Mont. 100 mi. Billings Polytechnic Institute. Mon, 8-9 pm, lectures. Mountain.

KFEG, Tacoma, Wash. Guy Greason.

KFFA, San Diego, Calif. Dr. R. C. Shelton.

KFFE, Pendleton, Ore. 100 mi. Eastern Oregon Radio Co. Daily, 7:30-8 pm, music. Pacific.

KFFB, Astoria, Ore. Astoria Budget.

KFGH, Stanford Univ., Calif. Leland Stanford Jr. Univ.

KFI, Los Angeles, Calif. 500 mi. Earle C. Anthony, Inc. Daily ex Sun, 1-1:30 pm. Daily ex Mon & Fri, 7:40-8:20 pm, Tues, Sat, 2-3 pm. Sun, 10:45-11 am, 4-5 pm, 7:40-8:20. Pacific.

KFV, Yakima, Wash. 250 mi. Foster-Bradbury Radio Store. Daily ex Sun, 3-4 pm. Mon, Wed, Fri, 8-9 pm. Pacific.

KFZ, Spokane, Wash. 300 mi. Doerr Mitchell Elec. Co. Tues, Wed, Fri, Sat, 7-8:30 pm, music etc. Pacific.

KGB, Tacoma, Wash. 200 mi. Tacoma Daily Ledger-William A. Mullins Elec. Co. Daily ex Sun, 7-9 pm, Sun, 5-7:30 pm. Entertainment, news, weather, tides, police reports. Pacific.

KGG, Portland, Ore. 500 mi. Hallock & Watson Radio Service. Daily ex Sun, 5-6 pm, music, entertainment, 7:30-8 pm, reports. Sun, 9-10, music. Pacific.

Co. Daily, 5-5:30 pm, 7:30-8:15, news, concert. Pacific.

KNV, Los Angeles, Calif. Radio Supply Co.

KOB, State College, N. M. 485 also. 500 mi. N. M. College Agri. & Mech. Arts. Daily ex Sun, 11:55-12 m, reports. Mon, Wed, Fri, 7:30-8:30 pm, concert. Mountain.

KOG, Los Angeles, Calif. 300 mi. Western Radio Elec. Co. Daily ex Sun, Wed, 5-5:30 pm, code, news. Mon, Fri, 7:40-8:20 pm, music. Wed, 4:30-5 pm, code, 8:20-9 pm, music. Pacific.

KON, San Diego, Calif. 200 mi. Holzwarner Inc. Daily ex Sun, 4-5 pm and 8:15-9, concert, news. Sun, 10-11 am, 4-5 pm and 8:15-9, church service. Pacific.

KOP, Detroit, Mich. Detroit Police Dept.

KPO, San Francisco, Calif. 300, 600 also. 500 mi. Halo Bros., Inc. Daily ex Sun, 11-12 m, 3:30-4:30 pm, concert. Wed, 7:30-8:15 pm, concert. Sun, 11-12:15 pm, church service. Pacific.

KQL, Berkeley, Calif. Univ. of Calif.

KQP, Hood River, Ore. 350 only. 50 mi. Hood River News. Daily ex Sat, Sun, 7 pm, news. Tues, Fri, Sun, 8:30-9:30 entertainment. Pacific.

KQV, Pittsburgh, Pa. 300 mi. Doubleday-Hill Elec. Co. Daily ex Sun, 12-12:30 pm, 2:30-3, music, lectures. Mon, Wed, Fri, 10-11 pm, music, entertainment. Eastern.

KQW, San Jose, Calif. 345 also. 500 mi. Chas. D. Herrold. Daily ex Sun, 1-1:30 pm. Wed, 8:15-9 pm, concert. Pacific.

KQY, Portland, Ore. 200 mi. Stubbs Elec. Co. Daily, 1-2 pm, Pacific.

KRE, Berkeley, Calif. 200 mi. Maxwell Elec. Co. Every other Sat, 8:15-9 pm. Sun, 1-2 pm, 6-7. Pacific.

KSD, St. Louis, Mo. 400 & 485 only. 1,500 mi. St. Louis Post-Dispatch. Daily ex Sun, 9:40 am, 10:40, 11:40, 12:40 pm, 1:40, 2:40, 4, 8, Sun, 8:15 pm, Central.

KSL, San Francisco, Cal. 50 mi. The Emporium. Daily ex Sun, 10-11 am, concert, news; 2-3 pm, concert, educational talk. Sun, 2-3 pm, concert and educational talk. Pacific.

KSS, Long Beach, Calif. Prest & Dean Radio Co. No regular schedule.

KTW, Seattle, Wash. 500 mi. First Presbyterian Church. Sun, 11-12:30 pm, 3-4:30, 7-9:30, church service. Pacific.

KUO, San Francisco, Calif. 485, 525 also. 1,500 mi. San Fran. Examiner. Daily ex Sun, 9-10 am, concert, chat to housewives; 11-12, reports; 3-3:30 pm, lecture, news; 5:30-6:45 pm, concert; 9 am, 12 m, 6:45 pm, weather report. Wed, 3:30 pm, health bulletins. Sun, 9-10 am, concert; 5-6 pm, concert, news. Pacific.

KUS, Los Angeles, Calif. City Dye Works & Laundry Co.

KUV, El Monte, Calif. 500 mi. Coast Radio Co. Daily ex Sun, Sat, 4-4:45 pm. Mon, Thu, 8:20-9 pm, Sat, 3-4 pm. Pacific.

KVQ, Sacramento, Calif. 300 mi. Sacramento Bee. Daily ex Sun, 6:30-7:30 pm, news, reports, music. Sun, 6-7 pm, reports, music. Pacific.

KWG, Stockton, Cal. 1,500 mi. Portable Wireless Telephone Co. Daily ex Sun, 4-5 pm, news, concert, markets. Tues and Fri, 8-9 pm, concert. Sun, 2-3 pm, concert. Pacific.

KWH, Los Angeles, Calif. 485 also. 250 mi. Examiner. Daily ex Sun, 1:30-1:40 pm, 5:30-6, 6-6:15, 8:20-9, reports, entertainment. Sun, 8:30-9 pm, church service. Pacific.

KXD, Modesto, Calif. Herald Pub. Co.

KXS, Los Angeles, Calif. Braun Corp.

KYF, San Diego, Calif. Thearle Music Co.

KYG, Portland, Ore. 700 mi. Radio Service Bureau, Inc. Tues, Thu, Sat, 9-10 pm, concert. Pacific.

KVI, Bakersfield, Calif. Bakersfield Californian.

KVJ, Los Angeles, Cal. 485 also. 1,000 mi. Leo J. Meyberg Co. (Hamburgers.) Daily ex Sun, 4-5 pm, concert, markets, weather, news. Mon, Thurs, Sat, 8-9 pm, same program. Pacific.

KYQ, Honolulu, Hawaii. Electric Shop. No definite schedule.

KYW, Chicago, Ill. 400 and 485 only. 2,000 mi. Westinghouse Elec. & Mfg. Co. Daily ex Sun, 9:25 am, 10, 1:20 pm, 2:15, 2:30, markets; 3 (3:30 ex Mon, Wed, Fri), 4, 4:15, 4:30, 5, news, sports, (6:30 Mon only, news, reports, sports); 6:50, bedtime stories; 8-9, music; 9, news, sports; 9:05 special. Sun, 3:30 pm, chapel. Central.

KVY, San Francisco, Calif. The Radio Telephone Shop.

KZC, Seattle, Wash. 100 mi. Public Market & Department Store Co. Daily ex Sun, 6:45-7:15 pm, music, news, agriograms. Pacific.

KZM, Oakland, Calif. 200 mi. Western Radio Institute (Hotel Oakland). Daily ex Sun, 6:45-7 pm, news. Pacific.

KZN, Salt Lake City, Utah. 485 also. 1,000 mi. Deseret News. Daily ex Sun, 3-4 pm, reports, music, 8-9:30 pm, music, news, bedtime stories etc. Mountain.

KZV, Wenatchee, Wash. Wenatchee Battery & Motor Co.

KZY, San Francisco, Calif. Atlantic-Pacific Radio Supplies Co.

NOF, Anacostia, D. C. 412 only. 600 mi. U. S. Navy Dept. Mon, Tues, Thurs, 7:15-7:30 pm, lecture. Mon, Thurs, 6:45-7 pm, lecture. Tues, Thurs, 7:45-8 pm, health lecture. Wed, Fri, 8:30-9:45 pm, band concert. Eastern.

PWX, Havana, Cuba. Cuban Telephone Co.

WAF, Dayton, O. McCook Field, U. S. Army.

WAB, New Orleans, La. Valdemar Jensen.

WAD, Cincinnati, Ohio. Tulane Univ.

WAE, Cincinnati, Ohio. 200 mi. Ohio Mechanics Inst. Fri, 2:30-4:30 pm, and Sat, 8:15-10:15 pm, Cincinnati Symph. Orchestra concert. Central.

WAAF, Chicago, Ill. 485 only. 300 mi. Chf. Daily Drivers Journal. Daily ex Sat & Sun, 8:30 am, 10:30, 10:45, 12:30 pm, 3, 4:30, stock reports. Central.

WAAB, St. Paul, Minn. 500 mi. Commonwealth Elec. Co. Mon, Fri, 12:15-1 pm, pipe organ concert. Mon, 8:45-9:30 pm, entertainment. Tues, 8-9:30 pm, entertainment. Wed, 1:15-2 pm, pipe organ. Sun, 3:30-4:30 pm, Central.

WAAL, Boston, Mass. 50 mi. Eastern Radio Inst. Mon, Wed, Fri, 9-10 pm, music. Eastern.

WAAM, Milwaukee, Wis. 500 mi. Gimbel Bros. Daily ex Sun, 10 am, 11:10, 12:10 pm, 1:25, 3-4. Ex Sun, Wed, 7:30-8:30 pm, Central.

WAAN, Newark, N. J. 300 mi. I. R. Nelson Co. Daily ex Sun, 11-11:55 am, 3-4 pm, music. Wed, 8-9 p.m. special program. Eastern.

WAAP, Columbia, Mo. Univ. of Mo.

WAQ, Charleston, W. Va. 40 mi. Radio Service weather, baseball. Eastern.

WAAR, Wichita, Kan. 200 mi. United Elec. Co. Daily, 12-1:30 pm, music, news; 5, weather; 7:15-7:30, sports, markets; 9:45-12, talks, music; and code on C. W.; 10:30, weather. Tues, Fri, 8 pm on, concert. etc. Central.

WAAS, Greenwich, Conn. 600 mi. New England Motor Sales Co. Daily ex Sun, 9:30 am-5:30 pm, every half hr. Eastern.

WAAT, Huntington, W. Va. Groves-Thornton Hdw. Co.

WAAS, Decatur, Ga. 70 mi. Jersey Radio Co.

WAAT, Jersey City, N. J. 70 mi. Jersey Review. Wed, 7-8 pm, concert, lecture. Sun, 7-8, church service, concert. Eastern.

WAAV, Athens, O. 500 mi. Athens Radio Co. Daily, 7-9 pm, miscellaneous. Central.

WAAW, Omaha, Neb. 485 also. 500 Omaha Grain Exchange. Daily ex Sun, 9:45, 10:45, 11:45, 12:45, 1:20, 8 pm, market reports. 8:15-9 pm, music. Central.

WAAX, Crafton, Pa. Radio Service Corp.

WAAY, Youngstown, O. 500 mi. Yoehling Rayner Music Co. Daily ex Sun, 5:30 pm, reports; 8:15-9 pm, music. Eastern.

WAAZ, Emporia, Kan. 250 mi. Hollister-Miller Motor Co. Daily ex Sun, 7-8 pm, weather, entertainment. Central.

WAH, Eldorado, Kans. 485 only. The Midland Refining Co. Daily ex Sat, 10:30 am, 1:30 pm, markets, weather. Sat, 1 pm, same. Central.

WAJT, Marshall, Mo. Kelly-Yawter Jewelry Co.

WAJU, Yankton, S. D. Yankton College.

WBAU, W. Lafayette, Ind. 50 mi. Purdue University. Fri, 7:15-7:30 pm, educational lecture. Central.

(NOTE—The second part of the station schedule list will appear next week.)

Continued—

THE BROADCASTING station directory is the most complete and authentic list of Radiophone plants. Letters are being sent various stations every day for information. No other paper or source provides the data given here. The idea is original and a service which RADIO DIGEST has maintained from the start. Every public service broadcasting station is to be found now, not only in the location index, but in the schedule list. The latter, however is divided, one third appearing this week, the second third to appear next week, and the last part, together with the state, city, station index, to appear the week following.

The station schedules, given here, are listed alphabetically by call letters. Following the call is given the city and state, the wave length (PROVIDING a wave length other than 360 meters is used), the miles range of the station, the owner of the station, the schedule of operating hours, and the kind of time used.

The state, city and call list appears with the last third of the station schedules and is merely an index. One wishing to find the calls of the stations in his vicinity, will find this index useful. Three successive issues of RADIO DIGEST will give one the most complete and accurate list of broadcasting stations obtainable.

KFAA, Glendale, Calif. 355 and 485. 250 mi. Daily Press. Daily ex Sun, 4:15-5:15 pm, news etc. Mon, Wed, Fri, 7-8 pm, concert. Pacific.

KFAD, Phoenix, Ariz. 485 also. 100 mi. Mon, Wed, Fri, 8-9:15 pm, concert, weather, stocks, markets. Sun, morning church service. Mountain.

KFAE, Pullman, Wash. 200 mi. State College of Wash. Program Irregular.

KFAF, Denver, Colo. 1,000 mi. Western Radio Corp. Daily ex Thurs & Sun, 8-9 pm, music, reports, news. Mountain.

KFAJ, Boulder, Colo. 250 mi. Univ. of Colo. No definite schedule. Univ. activities. Mountain.

KFAN, Moscow, Idaho. The Elec. Shop.

KFAP, Butte, Mont. Standard Pub. Co.

KFAQ, San Jose, Calif. City of San Jose.

KFAR, Hollywood, Calif. Studio Lighting Service Co.

KFAS, Reno, Nev. 300 mi. Reno Motor Supply Co. Mon, Tues, Thurs, 8-9 pm, music. Pacific.

KFAT, Eugene, Ore. 100 mi. Pac. Radio Co. Tues, Thurs, Sat, 7-8 pm, music. Sun, 8:45-9:15 pm, church service. Pacific.

KFAU, Boise, Ida. 485 also. 200 mi. Boise H. S. Mon, Wed, Fri, 9:30-10 am, 2:30-3:00 pm, reports, news, 8:15-9 pm, concert. Tues, Thurs, Sat, 9:30-10 am, 2:30-3:00 pm, reports, news, 7:45-8:15 concert. Mountain.

KFAW, Santa Ana, Calif. 485 also. 100 mi. Radio Den. Daily ex Sun, 4-4:30 pm, news, reports, music. Mon, Thurs, 8-9 pm, concert. Pacific.

KFAY, Medford, Ore. 500 mi. Virginia Radio Service. Mon, Fri, 9-10 pm, Wed, 9-12 pm. Special programs other days. Pacific.

KFBA, Lewiston, Idaho. Ramey & Bryant Radio Co.

KFBB, Havre, Mont. F. A. Burrey & Co.

KFBC, San Diego, Calif. 100 mi. W. K. Azbill. Thurs, Bible lesson for foll. Sun. Sat, lectures.

KFBD, Hanford, Calif. 100 mi. Calif. Radio Lab. Daily ex Sun, 3-4 pm, 8-9, Sun, 5-6 pm. Pacific.

KFBE, San Luis Obispo, Calif. 50 mi. R. H. Horn. Daily ex Sun, 4-5 pm, 7-8. Pacific.

KFBG, Tacoma, Wash. First Presbyterian Church.

KFBH, Marshfield, Ore. Thomas Musical Co.

KFBI, Boise, Idaho. 170 mi. Boise Radio Supply Co. Daily ex Sun, 5-5:30 pm, police reports, music. Mon, Wed, Fri, 7:45-8:15 pm, concert. Tues, Thurs, Sat, 8:15-9 pm, concert. Mountain.

KFBK, Sacramento, Calif. 300 mi. Kimball-Upson Co. Daily ex Sun, 3-4 pm, 6-6:30, concert, news. Sun, 8-9 pm, church service. Pacific.

KFBL, Everett, Wash. Lees & Foster.

KFBM, Astoria, Ore. Cook & Foster.

KFBN, Oakland, Calif. Borch Radio Corp.

KFBQ, Prescott, Ariz. Savage Elec. Co.

KFBS, Trinidad, Colo. Chronicle News & Gas & Elec. Supply Co.

KFBV, Laramie, Wyo. Bishop N. S. Thomas.

KFBW, Colorado Springs, Colo. Clarence O. Ford.

KFC, Seattle, Wash. 700 mi. Northern Radio & Electric Co. Daily, eight hours, miscellaneous. Pacific.

KFCB, Phoenix, Ariz. 500 mi. Nielsen Radio Supply Co. Mon, Wed, Fri, 8-9 pm, music. Tues, 8-10, sports. Mountain.

KFCG, Wallace, Ida. 380 only. 100 mi. Auto Supply Co. Daily, 7:30-8:30. Pacific.

KFCD, Salem, Ore. 100 mi. F. S. Barton. Daily ex Sun, 12-1 pm, 8-9, music, news. Sun, 3-4 pm, church service. Pacific.

KGN, Portland, Ore. 100 mi. Northwestern Radio Mfg. Co. Irregular schedule.

KGO, Altadena, Calif. 350 only. 300 mi. Altadena Radio Lab. Mon, Wed, Fri, 5:15-6 pm, reports, code lessons, agriograms. Tues, Thurs, 7:40-8:20 pm, concerts. Sat, 7:40-9 pm, concert. Sun, 2-3 pm, church service. Pacific.

KGU, Honolulu, Hawaii. 485 also. 150 mi. The Honolulu Advertiser. Daily, 7:30-9 pm, Tues, Thurs, Sat, special program. 150th meridian. (Three hours later than Pacific.)

KGW, Portland, Ore. 200 mi. Ship Owners Radio Service Inc. (Daily Oregonian.) Daily, 3:30-4:30 pm, news etc. Mon, 7:30-8:30 pm, concert. Wed, 8-10 pm, concert. Fri, 8-9 pm, concert. Sun, 7-8 pm, church service. Pacific.

KH, Lacey, Wash. 50 mi. St. Martins College. Tues, Fri, Sun, 8:30-9:30 pm, news, concert, bedtime story. Pacific.

KHD, Colorado Springs, Colo. 485 also. 50 mi. Daily ex Sun, 8:15 am, weather. Daily ex Sun, Mon, 7-7:30 pm, music. Mountain.

KHI, Los Angeles, Calif. 400 and 485 only. 2,000 mi. Los Angeles Times. Daily ex Sun, 12:30-1:15 pm, 7-7:30, 8-9:30. Sun, 10-11 am. Pacific.

KHJ, Seattle, Wash. Louis Wasmer.

KHJ, Sunnyvale, Calif. 500 mi. Radio Shop. Tues, 8:15-9 pm, Fri, 7:30-8:15 pm. Pacific.

KJQ, Stockton, Calif. C. O. Gould.

KJ, Seattle, Wash. 200 mi. Northwest Radio Service Co. Daily ex Sun, 8-9 pm, miscellaneous. Pacific.

KJS, Los Angeles, Calif. 100 mi. Bible Inst. of Los Angeles. Tues, Wed, 12-12:30 pm, sacred music, lecture. Sun, 11:30-12:30 pm, sacred music, sermon. Pacific.

KLB, Pasadena, Cal. 300 mi. J. J. Dunn Co. Mon and Fri, 7:30-8:15 pm, concert. Sun, 3-4 pm and 8-9, concert. Pacific.

KL, Del Monte, Calif. Monterey Elec. Shop. Daily, 12-1 pm, weather, markets, news; 7-8 pm, concert. Pacific.

KLP, San Francisco, Calif. 500 mi. Collin B. Kennedy Corp. Mon, 7:30-8:30 pm, Thurs, 8:30-9 pm. Sun, 4-5 pm. Pacific.

KLS, San Francisco, Calif. 300 mi. Warner Bros. Radio Supply Co. Daily, 12-1 pm. Sat, 7:30-8:15 pm. Pacific.

KLX, Oakland, Calif. 500 mi. Oakland Tribune. Daily ex Sun, 7:15-7:30 pm, news, entertainment. Tues, 7:30-8:15 pm, Fri, 8:15-9 pm, and Sun, 3-4 pm, concert. Pacific.

KLZ, Denver, Colo. 485 also. 200 mi. Reynolds Radio Co. Daily ex Sun, 7:30 pm on, news, markets, bedtime story, concert. Sun, 8-9 pm, church service. Mountain.

KMC, Reedley, Calif. 100 mi. Lindsay-Weatherill & Co. Mon, Wed, Fri, 8:30-9 pm, concert. Pacific.

KMJ, Fresno, Calif. 200 mi. San Joaquin Lt. & Pr. Corp. Tues, Fri, 7-8 pm, music. Sun, 5-6 pm, music. Pacific.

KMO, Tacoma, Wash. 200 mi. Tacoma Times. (Love Electric Co.) Daily ex Sun, 11-1 pm, 6-7, 9:15-10, concert, news, lecture. Pacific.

KNI, Eureka, Calif. T. W. Smith.

KNJ, Roswell, New Mex. 485 also. 750 mi. Roswell Public Service Co. Daily, 8 pm, news, reports, concerts. Mountain.

KNN, Los Angeles, Calif. 100 mi. Bullock's. Mon, 2:30-3:30 pm. Wed, 2:15-3 pm. Thurs, 4-5 pm. Pacific.

KNT, Aberdeen, Wash. 400 mi. Grays Harbor Radio

Navigation Commissioner Tells of Radiophony's Great Growth in Report

Apparatus Greatly Improved—Industry Investment Thought Several Hundred Millions—Seven New Transoceanic Plants—Unexpected Growth Results from Broadcasting—Need New Laws

(By L. M. Lamm, Staff Correspondent)

WASHINGTON.—The commissioner of navigation has just submitted to Secretary of Commerce Hoover a very interesting report on Radio Communication for the fiscal year ended June 30, 1922. The commissioner says:

"During the past year much has been done to improve apparatus used for Radio communication and to extend the scope of its usefulness. Transmitters and receivers have been greatly improved, with the result that a much greater number of transmitting stations can now be operated in a close proximity than was possible only a few years ago, and signals can be received over much greater distances. Perhaps in no other line of endeavor has there been more activity and progress through improvement of apparatus and extension of the field of service.

Size of Industry Great

"The bureau has no way of determining the amount of money invested in this enterprise, but it doubtless runs into several hundred million dollars and affords employment to a very large number of people. It is not expected that Radio will ever supplant our land wire or cable systems, but it already is used to a considerable extent for communication between points where the land wire systems are difficult to maintain or between points where it is physically impossible or too expensive to construct such systems.

"The constant improvements being made in this method of communication have resulted in a marked extension of the services not only throughout the United States, but for international communication. During the fiscal year just ended, seven additional commercial transoceanic transmitters were placed in operation, providing at the present time for this means of communication with the following countries: Great Britain, Italy, France, Germany, Norway, Poland and Japan. Plans are under way for the extension of this means of communication to China and South America.

"In addition to the above international services we have a commercial station which provides a means for communicating with several points in Central America.

"The largest and most unexpected development in Radio has been in the broadcasting service. At the beginning of the year this service was being carried on by a few stations in an experimental way only and it was not until about the middle of the year that the possibilities and importance of this service were fully appreciated. Broadcasting is a natural function of Radio in that signals sent out from a transmitter may be received in all directions, and, although this service may be said to be only in the experimental or development stage, there were licensed at the end of the fiscal year, 382 broadcasting Radio transmitting stations, two of which are in Hawaii and one in Porto Rico.

"This service is furnished the public without cost. The stations are being operated by electrical companies, newspapers, department stores, educational institutions, and State or municipal governments. The stations are at present furnishing musical entertainment, lectures on varied subjects, sermons, Government reports, time signals, and weather forecasts.

Warns Against Interference

"The signals from some of the most powerful of these stations have been received over distances of several hundred miles, which makes it incumbent that due consideration be given to the power, wave lengths, and range of such stations, else they may seriously conflict with the operation of Radio stations beyond our northern and southwestern borders.

"As stations used for receiving only are not required by law to be licensed, the bureau has no record of the number of such stations in use but the information furnished the bureau indicates that there are at a conservative estimate 600,000 such stations now being used with the prospects of rapid and continued growth if the service can be properly regulated.

States Old Laws Deficient

"Existing law, designed primarily to regulate wireless as a life-saving device on ships at sea, to prevent unnecessary interference between operating stations and place them in charge of competent operators necessarily is inadequate to meet

the conditions brought about by the broadcasting service and the increase in the use of this means of communication. At the suggestion of the President, therefore, a Radio conference of the foremost Radio experts of the Government with men of recognized attainment in the scientific field was held the latter part of February. There was laid before and approved by this conference a bill carrying out the recommendations of the conference which was introduced in the Senate and the House on June 9, 1922. In drafting this bill it was recognized that before it could become law the rapidly advancing conditions of the art might render any specific technical regulations obsolete. The proposed legislation, therefore, was drawn in most general terms in order that the regulations might be changed as the art itself changed. This could only be done by conferring on the Secretary of Commerce, having jurisdiction of the administration of the law, broad powers of supervision, regulation, and control. It is more or less an emergency measure, the act to regulate Radio communication of August 13, 1912, remaining the basic law upon the subject.

International Laws Need Revision

"The need for a revision of the International Radiotelegraph Convention is rec-

ognized. All transoceanic and ship Radio stations must operate in accordance with the terms of this agreement. When the last international conference was held in London in 1912 we had only one transoceanic station which had at that time been used only to a limited extent for commercial communication with Germany and the matter of allocating wave lengths was not given consideration. This is one of the most important problems to be decided at the next conference, which will probably be held in Paris during 1923.

"In 1912 commercial vessels were using only the wave lengths of 300, 450, and 600 meters for communication, but with the development of new types of apparatus and the increasing use of Radio for ship-to-ship and ship-to-shore communication it is necessary that this means of communication on longer wave lengths and over greater distances be provided for in the international agreement. At the present time, ships in the transoceanic service using the better type of equipment are able to maintain communication with land during the entire voyage, and in order that this important service may be carried on in an orderly manner, suitable provisions to insure this should be embraced in the next convention."

RADIO BARGAINS!

To reduce stock, we make the following sensational prices, for cash on the items named, subject to prior sale:

Catalog Number	Article	Regular Price	Sale Price
C D	Crystal Mounted Detector.....	\$ 1.50	\$0.68
T L-1	Rheostat.....	1.25	.60
O R-1	No. 18 Variometer assembled complete.....	4.50	2.95
O R-2	No. 20 Variometer assembled complete.....	4.50	2.95
O H-3	Varlo Coupler.....	4.00	2.68
D-3	Dial and Knob, metal, 3/2 in.....	.85	.60
C-3	Dial and Knob, 3 in.....	.50	.35
D R-1	Grid Condenser.....	.20	.10
P C	Fiat plate Condenser (.002 cap).....	1.30	.98
D R-2	Grid Condenser and Leak.....	.30	.15
H R-1	Switch Lever, 1 in.....	.25	.15
H R-2	Switch Lever, 1/2 in.....	.45	.20
C P-1	Contact Points, per doz.....	.30	.15
C P-2	Switch Stops, per doz.....	.30	.15
B P-1	Binding Post, each.....	.10	.05
G L-1	Tuning Coil—2 slide.....	3.00	1.75
L-1	Leich Head Phones (3000 Ohm).....	7.50	4.25
K-1	Kellogg Head Phones (2200 Ohm).....	10.00	7.10
H C-1	Holzer-Cabot Head Phones (2200 Ohm).....	8.00	6.00

COILS—Complete line, from 120 to 26,500 wave lengths, at bargain prices, complete line. Send for price list.

Postage prepaid. Send cash with order, or goods will be sent by express C. O. D. Order by Catalog Number. Money-back guarantee.

GARDEN CITY RADIO COMPANY
5837 Ohio Street, Chicago

A Partial List of the Impressive Array of Exhibitors at the

American Radio Exposition

The Official Exposition for American Manufacturers

Grand Central Palace, New York City

December 21st to 30th

(Sunday excepted but Christmas Day included)

LIST OF EXHIBITORS

Western Electric Company, Inc.
Radio Corporation of America
National Carbon Company, Inc.
General Insulate Company
Pacent Electric Company
DeForest Radio Telegraph & Telephone Co.
Sleeper Radio Corporation
C. Brandes, Inc.
Sound Wave Corporation
J. Burgess Davis
Davis Radio Company

Hutchinson Radio Company
Manufacturers Patent Company
Novo Manufacturing Company
Henry Hyman & Company
The Holtzer-Cabot Electric Company
Clapp-Eastham Company
Stromberg-Carlson Telegraph Mfg. Co.
National Airphone Corporation
Dubilier Condenser & Radio Corp.
American Radio Relay League
Coto-Coil Company
Post Electric Company

Copper Clad Steel Company
Weston Electrical Instrument Co.
Signal Electric Mfg. Co.
Scholes Radio & Mfg. Corporation
Malone-Lemmon Laboratories
Formica Insulate Co.
A. H. Grebe & Co., Inc.
Radio Mica Products Co.
Electric Storage Battery Co.
Radio Digest Illustrated
Burgess Battery Company
Crosley Mfg. Company

Experimenter Publishing Company
Radio Industries Corporation
Jewett Mfg. Corporation
Feri Radio Mfg. Company
Bel-Canto Corporation
Tait Knob & Dial Company
Ackerman Brothers Company, Inc.
Electrical Record
Experimenter's Information Service
American Radio & Research Corporation
Executive Radio Council, 2nd District
National Radio Chamber of Commerce

The Exposition is being organized with the endorsement of the NATIONAL RADIO CHAMBER OF COMMERCE, and sanction of the Radio Apparatus Section of the ASSOCIATED MANUFACTURERS OF ELECTRICAL SUPPLIES.

For particulars address

AMERICAN RADIO EXPOSITION COMPANY
120 BROADWAY, NEW YORK CITY

TELEPHONE, JOHN 0009

Radio Digest Illustrated

TRADE-MARK

Published by the Radio Digest Publishing Company, Inc.
123 West Madison Street
Telephone State 4844-4845
Chicago, Illinois

E. C. RAYNER, Publisher
Chas. F. Smisor, Editor
Evans E. Plummer, Managing Editor
Harry J. Marx, Technical Editor

Eastern Representative, Jacob Miller, 2126 Broadway, New York
Telephone Columbus 2390

Western Representatives
E. J. Wood, 251 Kearny St., San Francisco
Telephone Kearny 1472
H. M. Morris, 417 Western Mutual Life Building, Los Angeles
Telephone 12911

58
PUBLISHED WEEKLY

SUBSCRIPTION RATES
Yearly.....\$5.00 | Foreign.....\$6.00
Single Copies, 10 Cents

Vol. III Chicago, Saturday, December 16, 1922 No. 10

This Is a Radio Christmas

Holidays Are Near—What Do They Mean to You?

THOUGHTS of Christmas are uppermost in our minds these days. The youth again thinks of Christmas and what it will bring to him. The older person turns his thoughts back a few years and enumerates just what happened to him in those years of his youth. There is not an ambitious person living that does not look forward to the time of surprises. A package addressed to him never ceases to be a source of curiosity until opened, and then to know the donor.

The Radiophone has opened up a new field in the line of entertainment and enjoyment. The manufacturers of high grade Radiophones and parts have been taxed to their utmost in making delivery to the retailer so that he can supply his trade. The consumer has profited by experience through buying the article of last year "made up just to sell," and now he wants something better this year. The better apparatus is being sought, and when it appears on the shelves of the retailer, it does not stay there long.

Radiophones at the best are delicate affairs, for they must pick up the weak waves and reproduce them as they were impressed on the transmitter, and no "made up just to sell" part will do that efficiently. The person who desires to obtain a Radio receiving set is not usually interested in the technical details involved in the construction of the various parts. What he wants to know is that he is getting something that will perform its duty without experimentation on his part, and that he is buying it from a dealer who will stand back of the goods he sells.

When a person feels confident that the instrument he is buying will do what is claimed for it, then he will not hesitate in making a purchase. At this time of the year a Radiophone can be sold as easily as any other piece of furniture sold to fill the place of a present to the whole family. There is nothing better than to wake up this Christmas day and find that all of us can listen in at home on some entertainment given in a distant city.

This is a Radio Christmas! Radio is undoubtedly the first science in history that has come to the front within such a short space of time. The amount of business carried on in this line will be enormous. It will reach figures beyond possible estimate at this time. The future of the business will rest largely on the kind of apparatus sold. If the buyer gets results he is going to be a booster, and boosters are what one needs in any kind of business. The right kind of instruments gets results.

Special programs that will include the leaders among public officers, statesmen, educators and the musical and entertainment world in general are being arranged for the holidays, all with the main idea of introducing Radio to the uninitiated and to firmly establish it in its proper place.

Radio Churches of the Future

The Best Sermons to Be Heard Everywhere

THERE is a movement afoot sponsored by a business expert to establish a Radio community church. In this church, at different hours each Sunday, religious services for all denominations will be conducted by Radio. It is the intention to eventually establish Radio services by which isolated communities will get the best sacred music and the best preaching available.

The services will be picked up in the homes by millions of people when Radio outfits become accepted by the entire public.

Man's greatest invention is the art of communication. The first form was speech. People began coming out of their separate and individual caves and congregated in small settlements as soon as they were able to trade ideas and disarm each other's suspicions by exchanging words.

Writing was the next great invention which enabled people to communicate over long distances without coming face to face. Then came printing. With it came the first germ of real civilization.

Next was the telegraph, evolved from the primitive system of communicating long distances by relays of tom-toms or puffs from beacon fires. The telephone crowded close on the heels of the telegraph.

Now it's Radio.

Condensed

By DIELECTRIC

The optimism of Hiram Maxim strikes a responsive note in the breast of nearly every amateur Radiophan in the country. We are as sure as he that the day is fast approaching when messages may be exchanged between fans in every country in the Western Hemisphere, and not so far distant when "communication will be established with English speaking peoples in South Africa." The basis for our belief is to be found in the exchange of Radio messages between the Porto Rico Radio Club and the American Radio Relay League. The first of such messages was relayed from San Juan through two stations in this country to a station in South Manchester, Conn. It required only one hour and twenty-seven minutes for a return message to be received in San Juan transmitted from Hartford. Do you doubt Mr. Maxim's prophecy?

When broadcasting stations were importuned to use their equipment to broadcast the whereabouts of some stranded individual, out of touch with other members of his family, a great many dissatisfied supercraftsmen conceived the idea of apprising the listening Radio world of their readiness to consider offers from business concerns in need of such superb ability as they possessed. Strange as it may seem, I have yet to hear of any broadcasting station taking advantage of this unique opportunity to advance a utilitarian cause, such as this. It is entirely within reason to suppose that to broadcast a column of "situations wanted" would automatically reduce the number of listeners in to that particular station, or stations. Station WOO was flattered recently in receiving a letter from a fan in Maine, who wished to confer upon them the privilege of broadcasting his extraordinary accomplishments. His offer is to be listed among the "strays."

What a change hath Radio wrought! I have been pondering in my mind what much used phrase most aptly describes the transformation which has taken place since this wonderful thing has begun its marvelous development. Many an orator, and not a few writers, have been fond of referring to some ephemeral object as having "vanished into thin air"; meaning, of course, its subsequent non-existence. Well! How does that jibe with what we know of "air"? Thin? Why, there is hardly a time when the air is not "jammed" with more things than the human mind can take cognizance of. Even as I sit here, the air about me is filled with music—yes, and jazz—produced by nearly every known means: reports of games, stock quotations, the weather, positions of ships; lectures that are high-brow, and some vaudeville that is a few flights down; these and many other interesting items which the electro-magnetic waves are rushing through the—thin (?)—air. Let me suggest that hereafter, when in need of a vacuous receptacle, something other than air be chosen.

The greater the number of receiving sets there are, the larger is the list of those desiring to learn the code. Some of course will never seek to solve the mysterious meaning of certain dots and dashes, always to be heard when the set is in use, but others want to know all that may be known by listening in. These learn the code letters by some of the broadcasting stations now teaching them. Station KOG, on the Pacific coast, is setting aside a specified time daily when lessons in Radio telegraphy are available to those choosing to use them. This is perhaps the surest means of mastering the code.

Whatever the new system of identification of criminals may be, it is certain that the ease with which a fugitive from justice may now make his way from one point to another (it is not so easy even now) will vanish into—the fourth dimension, when that system is coupled with Radio.

Let the good work go on with greater vigor, and eventually (but why not now) the Metropolitan Opera Company will see the light and accede to the request of thousands of fans all over the country for opera broadcasted from this house. Could they but see the cripples and suffering inmates of hospitals and homes, eager for music of this character, their hearts would be softened. As I remarked previously in this column, the broadcasting of operas can have but the most beneficial results so far as attendance at performances is concerned. I sincerely hope their office has been swamped with demands for granting a reasonable request.

If the invention of Edouard Belin, of France, proves practical, then I prophesy a tremendous demand for his device which makes possible the sending of code messages intelligible only to the one for whom they are intended. This demand may include no one outside of bootleggers, but it's safe to conclude that they will grab every set manufactured until there are no members of the fraternity without one. The idea lends itself to more respectable pursuits than the one just mentioned, however, and would be found most useful in time of war, when secrecy in communication is essential to success.

Silent periods are sometimes rare in homes where other than deaf mutes reside, and it is not always possible to secure agreement on this point between persons of a communicative nature, yet it will be urged with greater persistency that broadcasting stations provide periods when there will be no interference with distant stations, when the latter are sought by listeners in. A station in Canada has recently announced silent periods and Canadian fans will appreciate this consideration. More stations in the United States will ultimately fall into step with the modern program which includes such periods.

RADIO INDI-GEST

Just Talk But No Eats

Willie—"Pa, what is a Radio reception?"



Dad—"It's a party with the usual talk and music, but with nothing to eat."

A Tale of Woe

We sailed from San Francisco, on
A bright and sunny day,
And had scarcely passed the Farallones
When they found a stowaway.

The captain sternly asked him why
He'd come aboard by stealth.
He said: "Oh, captain, hear my tale—
I did it for my health.

"I've not the coin to pay my fare,
Yet I must surely flee,
Or else the neighbors' phonographs
Would be the death of me.

The stowaway fell to the deck
And fainted dead away.
The passengers, with outstretched flasks,
Approached him where he lay.

The stowaway sprang to his feet
And loud in anguish cried:
"You said you had no phonograph.
Oh, captain, you have lied!"

The captain passed the insult by
And said in pitying tone:
"Why, that noise ain't no phonygraft—
That there's our Radiophone."

The stowaway, he heaved a sigh,
"My flight is vain," said he.
"Just one last chance," and straight he jumped
Right over in the sea.

—A. H. HUTCHINSON.

Speaking of Radio



Listening in has become the greatest indoor sport.

You can't judge a radio fan by the flatness of his ears. He may use a loud speaker.

Tune in with the infinite and forget the coal shortage and Mustapha Kemal.

The poor fish that swallowed Jonah must have suffered a lot of local interference.

If Edison ever sends one of his questionnaires to departed spirits there will be great admiration above for the patience of mere mortals who have had to listen to so much similar broadcasting.

When man bought the Radio and added a loud speaker, his wife quickly got a divorce. She couldn't stand the competition.

There's more in the air these days than can be seen.

Something Quenched the Spark



Fay: "My engagement is temporarily off."
Ray: "Sort of spark-gap. Eh?"

Regenerative Tuner and Detector Panel

By A. C. Tabbot

MOST amateurs like to construct their own set, probably because they can experiment with it in order to get the best results. However, experience is a hard as well as an expensive teacher, and I recommend that an amateur, before building his set, select reliable data which has given good results.

The set which I am about to describe has a wonderful record, and, in comparison with the standard three-bulb sets, detector and two audio, gives even better results. A few of the cities heard on this set are: Pittsburgh, Pa.; Houston, Texas; Kansas City and St. Louis, Mo.; Indianapolis, Ind.; Louisville, Ky.; Detroit, Mich.; Newark, N. J.; New York City. I heard the new station in San Juan, Porto Rico, the first night of broadcasting. These are not freakish records, but actual results that I can get almost any night.

For long distance receiving I find that thoroughness in the little things is what counts. For instance, the aerial should be

26 S. C. C. wire, 25 turns being wound on and then a space of 1/2 inch is left, the winding being continued for 25 more turns

The back of the two panels should be covered with tinfoil, which may be stuck on with shellac. This should be grounded

good control for this tube. A storage B battery of about 18 volts is used. The primary condenser and the vernier

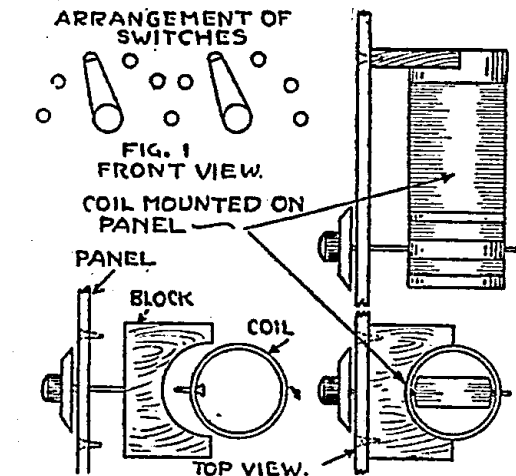

a single wire, and as high as possible, mine being 75 feet high at one end and 20 feet at the lead-in end. The higher the aerial the better. The aerial wire is 125 feet long including the lead-in. The ground consists of 20 feet of 1-inch galvanized iron pipe, driven into the ground, and onto which is soldered a No. 6 ground wire. The set can be made easily by following the directions.

Making the Coils

Secure from your grocer two pasteboard containers (such as are used for oatmeal and salt), the outside diameters of which

on the other side. This space is for the tickler shaft, which is 1/4-inch threaded brass rod. The winding is then shellaced and allowed to dry.

Cut a section 1 1/2 inches wide from the 3 1/2-inch tube. Use a sharp hacksaw for cutting. Upon this tube wind 50 turns of No. 28 S. C. C. wire. Twenty-five turns are wound on and then a 1/2-inch space is left for the tickler shaft. Then wind the remaining 25 turns.

The connections for the tickler are made from the wires of a telephone receiver cord and should be brought through the side of the 1/4-inch tube and also through the side of the 3 1/2-inch tube, through two small holes near the tickler shaft. The soldered connections are fastened to the inner surface of the tickler with heavy shellac and paper which is pasted over the connection.

Switch Contact Arrangement

The contacts for switches are located on the circumference of two circles, which interlock as shown in Figure 1. The coil is mounted on the back of the panel where it is supported at the upper end by a block of wood 3/8-inch thick, carved to fit the surface of the tube. The lower end is supported by the tickler shaft.

The circuit used is the Armstrong back coupled inductive regenerative circuit, as shown in Figure 2. Figures 3 and 4 show the front and back of the tuner panel respectively. Figures 5 and 6 show the front and back of detector panel.

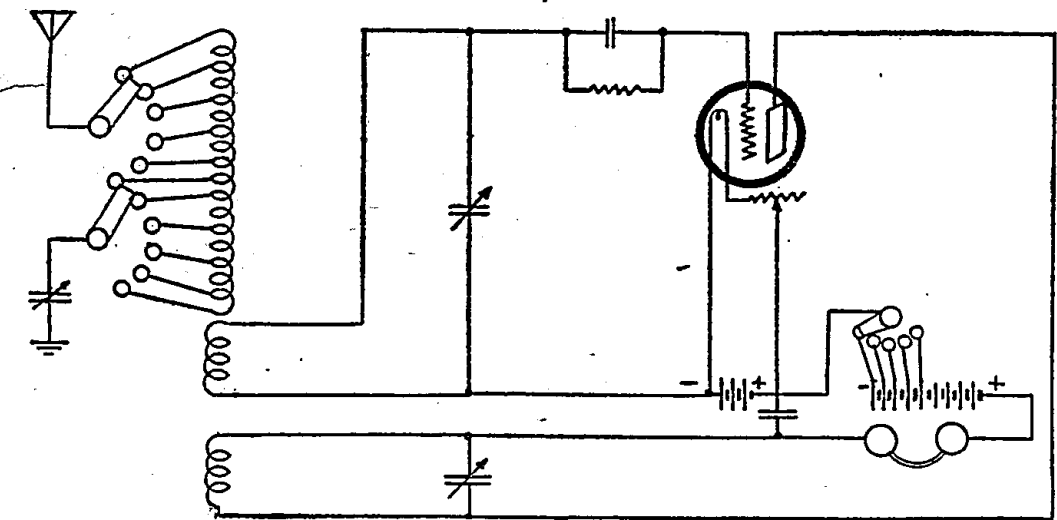

are about 4 1/2 inches and 3 1/2 inches respectively. Give each tube a thick coat of orange shellac and bake them in an oven about half an hour, but do not heat to burn. The 4-inch diameter tube is cut 8 inches long. Wind upon this closely and evenly 200 turns of No. 28 S. C. C. wire, leaving a space of 1 inch to start with and taking off taps every 10 turns up to 40, and every 40 turns thereafter up to 200.

The taps may be taken by breaking the wire and tying a knot at the desired place, the two free ends of each knot being used as the tap. The wire is secured at each end by running through two needle holes punched in the tube at the ends of the winding. The ends are left free for connection.

The secondary is then wound, leaving a 1/2-inch space between it and the primary. The secondary consists of 50 turns of No.

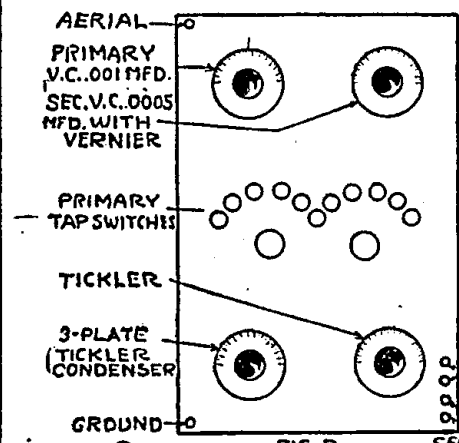

FIG. 3 FRONT VIEW

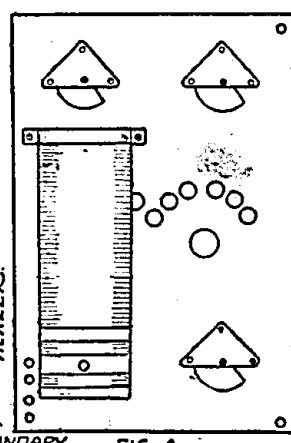

FIG. 4 BACK VIEW

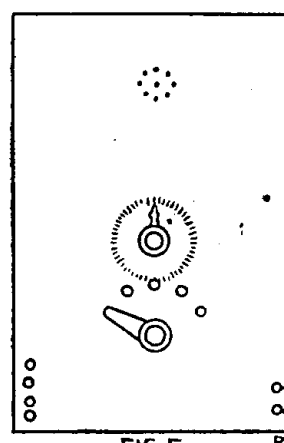

FIG. 5 FRONT VIEW

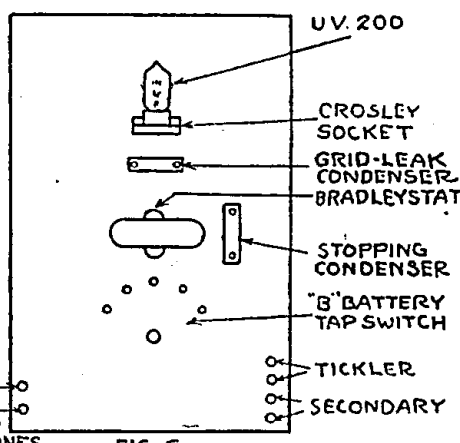

FIG. 6 BACK VIEW

to act as a shield, because the body capacity effect in this set is very marked. The tinfoil should be scraped away from around all contacts passing through the panels.

Other Apparatus Used

A .001 mfd., or 43-volt plate, variable condenser is used in the ground lead. A .0005 mfd. or 23-plate variable condenser with vernier attachment is used across the secondary. Shunted across the tickler winding is a three-plate vernier condenser. The front and back of detector panel is shown in Figures 5 and 6. It consists of a UV 200 tube mounted in a Crosley panel mounting socket, one fixed grid leak and condenser of .0005 mfd. capacity, one Bradleystat, one stopping condenser of .001 mfd. capacity of one five-contact switch for taps off of B battery.

The UV 200 tubes are very critical. I have found the Bradleystat to give very

of the secondary condenser, as well as the three-plate condenser across the tickler winding, may be dispensed with, but tuning under these conditions is very critical.

Keep Antenna Resistance Low

It is important that the resistance of the antenna system be kept as low as possible, for the less resistance there is in the antenna the greater will be the strength of current which flows from the antenna to the receiving set. Provision should also be made for keeping the system practically stationary. This is particularly necessary in short continuous wave transmission, as considerable wave length variation results if there is swaying in the lead-in or antenna wires. When a counterpoise is used it should be thoroughly insulated from the ground by the use of wooden supports.

IMPROVED REINARTZ CIRCUIT

My highly improved circuit brings in all important stations on both coasts and Mexican border. We dance to music from Atlanta received on one loud Baldwin unit. Build yourself one of these super-sensitive sets from my blueprints and specifications. Price 50c, or with completed double wound spiderweb coil \$3.00 by mail. No other windings used. Photo of my set on a glass panel with each order. Everything clearly shown. Cheap and easy to build. Easy to operate.

S. A. TWITCHELL
1925 Western Avenue, Minneapolis, Minn.

SOLDERING KITS

PRICE 45c COMPLETE

RADIO CONNECTIONS MUST BE SOLDERED
Consists of Soldering Copper, Soldering Fluid, Solder, and Directions
Callender Soldering Process Company
12 S. Jefferson St. Chicago, Ill.

NO OTHER CALL BOOK

HAS

A large map, size 2 feet by 3 feet
printed in two colors

showing location of every Broadcasting Station in
United States and Canada; change of time area
and location of each of the nine districts

CONTAINED IN

THIRD EDITION

AMATEUR

RADIO

CALL BOOK

With an Official List of all Amateurs, Special Amateurs and
Broadcasting Stations of
UNITED STATES AND CANADA

ALSO

How to Construct and Operate a Honeycomb Coil Set, Detector
and Two-Step Amplifier

ALL UNDER ONE COVER

PRICE, \$1.00 COMPLETE

(DO NOT SEND STAMPS)

Order from your dealer—If your dealer hasn't them, send direct.

DEALERS WRITE FOR PROPOSITION

RADIO DIRECTORY & PUBLISHING CO.
45-R VESEY STREET NEW YORK, N. Y.

DEALERS

Our Weekly Radio Comic Strips, pasted on your window, will attract attention and boost sales.

Free Sample Sent on Request

RADIO CARTOON SERVICE
234 Cambridge Ave. Jersey City, N. J.

Carter "TU-WAY" Radio Plugs take two head sets and all types cord tip terminals. Price \$1.50. Write for Bulletin on Carter "HOLD-TITE" Jacks and other products. CARTER RADIO COMPANY, 209 South State Street, CHICAGO

RADIO MAILING LISTS

22,400 Radio Dealers, covering U.S. by states	Per list \$7.50
3,612 Radio Mfrs., covering U.S. by states	Per list \$5.00
3,757 Radio Supply Jobbers, covering U.S. by states	Per list \$5.00
260 Radio Stations	Per list \$4.00
257 Mfrs. who make and assemble complete Radio Sets	Per list \$4.00
25,000 Radio Amateurs & Mfrs. of Radio Stations	Per list \$7.50

Ask for price list covering Canada and England. Send remittance with order. Trade Circular Addressing Co., 166 W. Adams St., Chicago, Ill.

SOMERVILLE TERMINAL TAGS 5c

READINGS
ANTENNA HI-VOLTAGE +
GROUND HI-VOLTAGE -
OUTPUT LO-VOLTAGE +
INPUT LO-VOLTAGE -
TICKLER MODULATION

"Slip under any Binding Post—Like Washers" "The Original and Best" at Your Dealer or Direct
Somerville Radio Laboratory
43 CORNHILL, BOSTON, MASS.

Hook-Up to Reduce Static Trouble

Single Circuit Tuner Is Used with No Antenna

I have been using a hook-up which may seem rather odd, but it is one which will give great relief when static is heavy and signals fairly strong. It cuts down signal

WORKSHOP KINKS? EARN A DOLLAR—

THERE are many little kinks worked out at home that would aid your fellow Radio worker if he only knew about them. There are new hook-ups, new ways of making parts and various unique ways of operating sets that are discovered every day. RADIO DIGEST is very much interested in securing such material. Send them in with full details, including stamped envelope so rejected copy may be returned. The work must be entirely original, not copied.

RADIO KINKS DEPARTMENT,
RADIO DIGEST,
123 West Madison St., Chicago, Ill.

strength a little, but this is balanced by the freedom from interference. In using this hook-up it may be necessary to cut down some with the rheostat to prevent the tube from oscillating. I have received WJZ a distance of about 400 miles with this. You will note that there is no aerial used. A standard single-circuit tuner is used with one stage of audio frequency amplification. All apparatus is of my own construction.—Edward F. Harrington, St. John, N. B.

Attaching Aerials to Trees

Many amateurs attach one or both ends of an aerial to a tree or trees, then in a high wind the aerial is broken. Take the precaution to connect a coil spring in between the insulator and the rope that



ties it to the tree limb. This will keep the aerial taut and will prevent a break when the wind blows.—Hilton Martin, Gadsden, Alabama.

Base for Receiving Set

After making and assembling a loose coupler crystal radio set which I mounted on a base 19 inches long, 6 1/2 inches wide and 3/4-inch thick I found the most convenient place to put it was on the library table. This marred the table top to some extent. At ten cent stores rubber buffers can be purchased cheaply. I procured four of these buffers and attached one at each corner of the base on the

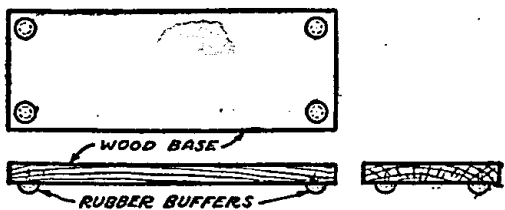

underside. These buffers are not only harmless to the table top but they suffice for a good insulation.—Raymond M. Beattie, Cohoes, N. Y.

Changing Hook-Up for Signals

After I had connected my set I found I could get nothing but local concerts and "buzz" stations. I went over the wiring several times but could find no shorts or other troubles common to amateurs. Just

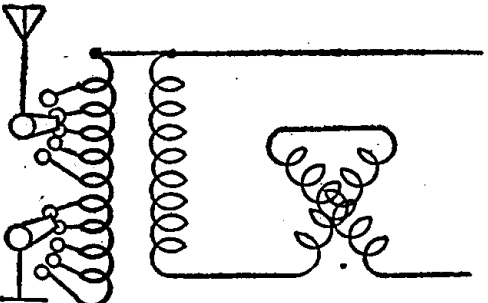

as I was about to give up I accidentally connected one end of the variocoupler secondary to one end of the primary. As a result part of the hook-up appeared as shown in the diagram. Now I get stations as far as Detroit, WWJ. The local stations WIZ, WMH, and WLW come in very much louder.—R. Hoffman, Cincinnati, Ohio.

Using Bare Wire

Tuning coils may be wound with bare wire by winding a piece of waxed silk fishing line between the turns at the same time to prevent the turns from touching.

NO AERIAL USED IN CIRCUIT

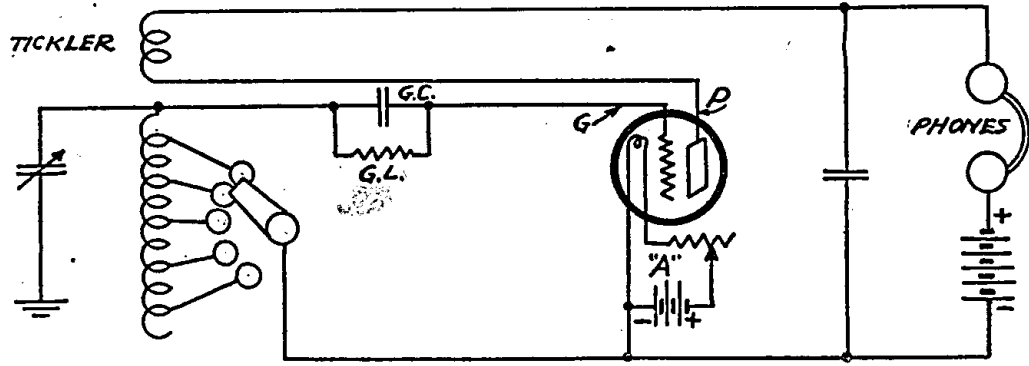

Enamel for Loud Speaker Horn

There are many home constructed loud speaker horns, either in metal or wood. Unless they are given some kind of a finish their appearance will be crude. A good enamel substitute may be made of lamp black mixed with shellac. If a white ivory is desired, white lead and white shellac may be mixed together. Any of the colors coming in powder form may be used. The white shellac is used for the lighter colors and the orange shellac for the darker ones. Colors mixed with shellac produce a glossy surface.—Glenn E. Ganfin, Escanaba, Mich.

Testing B Batteries

The only reliable way to test "B" batteries to find out if they are still capable of giving good service is by means of a voltmeter. New cells will show a spark when the two terminals are touched together, but cells have been found serviceable long after a spark could no longer be obtained, and short-circuiting the battery shortens its life, so this method is not to be recommended.

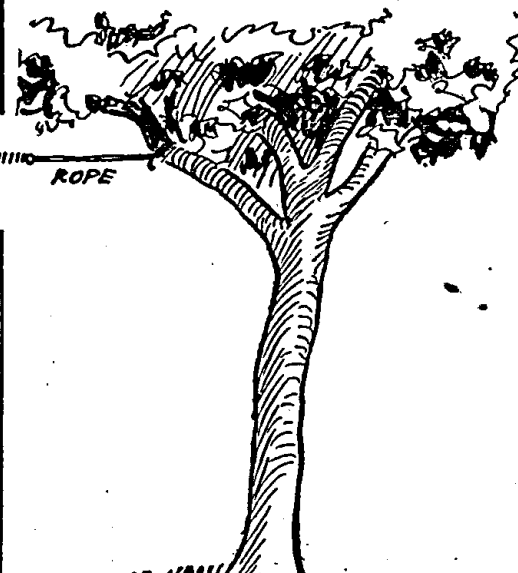

In testing these dry cells, if the pointer of the voltmeter swings back and forth continuously when a battery is being tested, the connections to the battery should be examined, and if they are making good contact, the battery should be discarded as it will cause noises in the receiver when used.—J. M. C.

Crystal sets must necessarily be electrically perfect. A loose connection of any kind will spoil one's chances of hearing music.

Install your lightning switch or air gap outdoors.

"ALL-AMERICAN" Amplifying Transformers

Two years of successful use all over the world guarantees permanent satisfaction. Radio and Audio Frequency. SEND FOR CIRCULARS. RAULAND MANUFACTURING CO. 35 South Dearborn Street Chicago

World Radio and Auto Batteries SAVE YOU 50%
WRITTEN 2 YR. GUARANTEE

We defy price competition; a glance at the prices below will convince you that the World Battery is the best buy on the market. Batteries shipped immediately. Express C. O. D. Begin now to get 100% battery service at half cost. Mail order today.

Automobile Prices		RADIO PRICES	
6 Volt, 11 Plate - \$12.50	Ford, Chev., Mitchell, Hup., Grant, Elgin, Velle, Saxon.	6 Volt, 40 Amps. \$ 8.50	6 Volt, 60 Amps. 10.00
6 Volt, 13 Plate - \$14.50	Overland, Buick, Reo, Paige, Hudson, Nash, Stude., Dort.	6 Volt, 80 Amps. 12.50	6 Volt, 100 Amps. 14.50
12 Volt, 7 Plate - \$18.00	Maxwell, Dodge, Regal, Frank, Briscoe and Crow-Elkhart.		
Give year and model of car			

World Battery Co., 1219 S. Wabash Ave., Dept. 6, Chicago

Leclanche Cells Make Good Radio B Battery

Many amateurs are experimenting at present with various forms of storage B batteries with more or less success, but the average amateur has no means of recharging such batteries, and sulphuric acid solution in open jars or test tubes is a somewhat dangerous nuisance.

Modification of the old Leclanche cell gives good results and it is easily and cheaply built, can be renewed for a few cents and the solution is not nearly as destructive as sulphuric acid.

The materials required are 20 or more (depending on voltage required) one-inch test tubes, 20 pieces of zinc rod 1/4-inch by 4 inches, 20 carbons from an old B battery, a cigar box and a broken storage battery jar.

Cut holes through the lid of the cigar box for the test tubes to fit into. Cut the battery jar into strips 1/2-inch by 5 inches. Place a strip of this between each carbon and a zinc with a rubber band around top and another around bottom to hold them together. Put one of these sets in each test tube. Solder wires from the zinc of one cell to the carbon of the next, connecting all the cells in series. The carbon terminal is positive and zinc is negative. Make a solution of 2 ounces of sal ammoniac in one pint of water. Fill each cell with this solution and add a drop or two of oil on the surface of each to prevent evaporation.

This battery will not give quite as high voltage as the same number of dry cells but there is no limit to the number of cells you may connect in series. When the battery gets weak add more sal ammoniac to each cell. Zincs should last six months and carbons indefinitely.—Chas. Middleton, Westville, Ind.

Reduce Filament Current

In operating a receiving set which employs several tubes, always reduce the filament current supplied to each tube a little by turning down the rheostat before removing one or more tubes, from their sockets or before switching off the tubes, one by one. This prevents the last tube burning from receiving an increased voltage due to the removal of the other tubes from the circuit and a consequent reduction in the load on the battery.

It is advisable to increase the resistance in the filament circuit of the detector tube before removing the telephone plug from amplifier jack in order to plug in on the detector alone. Operators of sets having automatic filament control jacks will avoid burning out of detector tubes by heeding this. Special precautions of this nature should be taken when the set is being operated at the same time the battery is being charged.

Inexpensive Panels

The sides of an old rubber battery jar provide the best kind of material for making small panels. These may be procured from a battery station. Select a side that is smooth and cut it out. This work may be easily done with a small saw. This material makes a fine appearing and serviceable panel for small cabinets or small units.—Quintin Gould, Casper, Wyo.

RADIO PANELS

Cut exactly to size and shipped the same day your order is received—1/4 in. thick, \$0.01 1/2 per sq. in.; 1/2 in., .02c. Made of the highest grade of black fiber. This material possesses high dielectric strength, is inexpensive, unbreakable, takes a nice finish, and is easy to work.

We Pay Postage—Try Us.
RADIO INSTRUMENT & PANEL CO.
26 North Desplaines Street Chicago, Illinois

MAKE THIS A RADIO CHRISTMAS

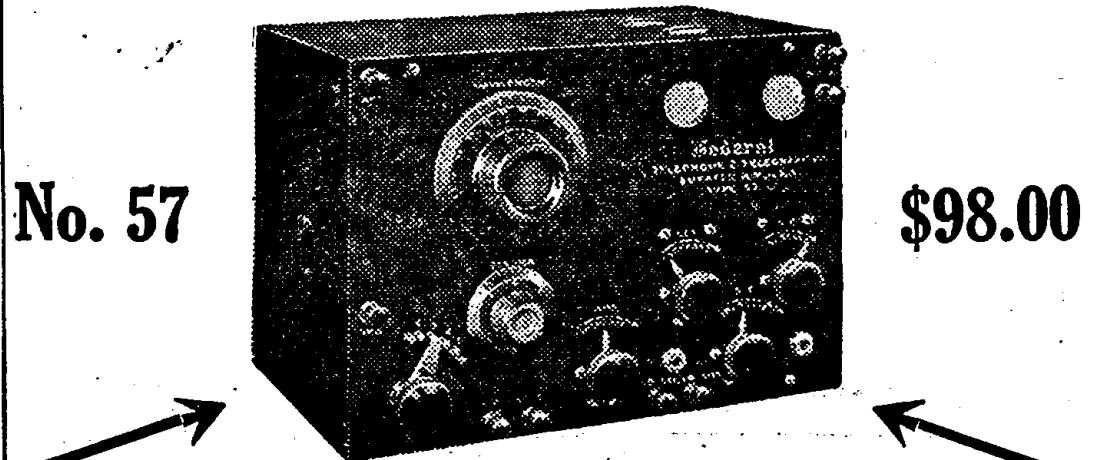

No. 57

\$98.00

THE Federal

—No. 57—

Radio Frequency Receiver

GREATEST
SELECTIVITY
AND
SENSITIVITY

of any Receiving Instrument yet made

Tune in the Station You Like Best

Write for Bulletin No. 119-W

Federal Telephone and Telegraph Company
BUFFALO, N. Y.

CHICAGO OFFICE: 805 STEGER BUILDING, CHICAGO, ILL.

Flewelling Panel Data—Reinartz R.F. Amplifier

Details Given on Two Popular Hook-Ups

By H. J. Marx

How to Make Panel for Famous Flewelling Set

THE illustration gives the dimensions for the layout of the panel utilizing the Flewelling circuit described in the December 2 number of RADIO DIGEST, an illustration of which appeared on page 10 of the December 9 number.

The A+ and B- binding posts have been combined so that only three are accounted for at the base of the panel. The snap switch, Number 5, as indicated in the first panel description has been omitted as the advantage gained in shunting across the condenser is insufficient to warrant its use.

Location of Apparatus

The panel used for this purpose was Formica, 7 inches by 9 inches by one-eighth inch. The holes were first laid off, marked and center punched. This layout should be made on the face of the panel and the lines drawn with a sharp pencil rather than a scriber. If the layout is made on the back of the panel and the holes punched and drilled from the back, there is a decided tendency for the drill to tear the reverse side of the hole which would be on the front of the panel.

Another method would be to make an accurate layout on a sheet of paper, which can then be laid or pasted in spots on the panel and the holes center punched through the paper from that layout. Care should be taken, however, that the paper is not permitted to move and thus spoil the accuracy of the location of the holes. The eight holes at the top center of the panel are for the standard double honeycomb coil mounting. The outer four corners of these eight carry the mount itself, while the inner four are for the flexible leads and should be rounded off on both sides, which fasten to the coil blocks and are passed through these holes to the proper apparatus terminals on the other side of the panel. Naturally the locations of these holes are apt to vary somewhat for different variations of apparatus, but the actual variations are not very apt to be great enough to effect the approximate location in mounting. The three drill holes immediately below are for the mounting of a combination socket rheostat which was described on the "Mart" page of one of the recent issues of the Digest.

The center hole, which is slightly larger, is for the shaft, while the two outer holes are for countersunk head screws. The combination socket rheostat need not necessarily be used, simply that it presents an opportunity for compact mounting of these two units in one.

Grid Leak Mounting

The two small holes just below the three described above, are for mounting one of the small variable grid leaks of the pencil mark type with a .00025 mfd. grid condenser fastened to the same screws on the back of the panel. These are easily obtainable at any of the Radio stores and sell for about 20 cents each. There are a number of other types of variable grid leaks which are also well adapted for this circuit, but due to the compactness of this panel, space is somewhat lacking for any of the larger units.

The two 17/64-inch holes, a little below and to the right and left of the ones just mentioned, are for the variable condenser shaft. These shafts are, as a rule, standardized at one-quarter inch.

Condenser Holes Vary

The remaining drill holes used for mounting the variable condensers are not given, due to the variation encountered in the numerous types of this apparatus on the market at the present. In order to account for proper clearance, care should be taken to purchase such type that outside dimensions are not excessive for proper mounting on the panel.

The maximum diameter of the dials should not be greater than three inches. Only seven binding posts are necessary. As stated before, the two center ones on the previous hook-up diagram have been combined, since the positive A battery and negative plate battery are connected together anyway.

Condenser Bank

The condenser bank, composed of the three .006 mfd. fixed condensers and the grid leak, is assembled together and placed on the base of the panel. It is suggested that all connections be well soldered in order to avoid high resistance joints.

No dimensions are given for location of the screw holes for fastening the panel to the cabinet, since this is left to the option of the reader depending upon the particular type of cabinet contemplated.

Attention is again called to the fact that successful operation of this circuit depends primarily upon the proper adjustment of the variable grid leak, Number 7, which is mounted on the front of the panel. The adjustment of the grid leak, Number 9, in the rear of the panel merely requires a low resistance which can be accomplished by a number of black lines between the two terminals of the grid leak.

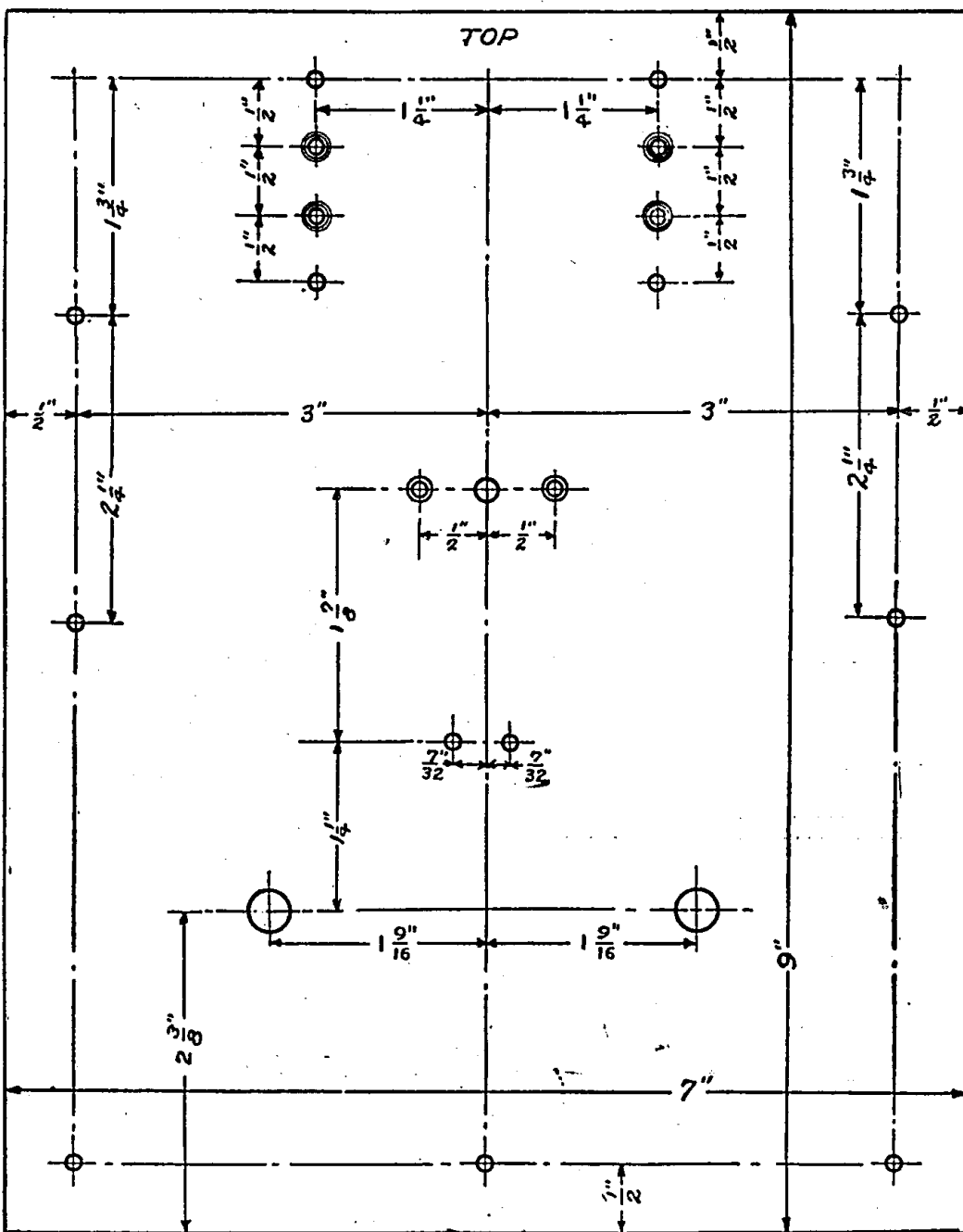

The whistle, which is apt to be rather noticeable, is eliminated by the proper adjustment of the first mentioned grid leak. The amplifier circuit described in the last issue can be mounted on a panel of similar size and style with binding posts located to match. This may be described in an early issue.

Mixing Battery Solution

For a home-made storage battery, mix a solution of 2 per cent sulphuric acid and 80 per cent water. Do not make the mis-

take of pouring the water into the acid. That would be disastrous. Water, when poured into sulphuric acid, develops a high temperature.

Permanent Crystal Contact

Make a wall or dam of beeswax around the outer edge of the crystal and fill the pocket thus formed with mercury. It is only necessary to stick the point of the cat whisker in the mercury.—Frank Friede, Chicago, Ill.

Reinartz Tuner Added to by Two R.F. Stages

THE November 25 issue of RADIO DIGEST featured the construction of two panel units using the Reinartz circuit with two stages of Radio frequency amplification. In addition, details of the spiderweb coil winding were given. Since then, numerous requests have been received for details of a similar panel unit, including two stages of Radio frequency amplification.

Unfortunately, it is not feasible to construct a separate Radio frequency panel which can simply be connected over to the detector panel, as the circuit necessitates alterations in the detector panel. The Reinartz tuning unit must be inserted before the stages of Radio frequency.

Due to the high efficiency of the Reinartz circuit, Radiophans are apt to anticipate a little too much when adding Radio frequency, and they are therefore cautioned to somewhat subdue their anticipations, as Radio frequency amplification has often proven a joker of unknown value. In some cases the results are gratifying, while again in others they have been somewhat disappointing. The last has not always been due to the inefficiency of the circuit, but rather a lack of knowledge concerning the theory, operation and construction of Radio frequency amplifying apparatus.

The circuit given in the illustration is undoubtedly practical and has given very efficient reception, but considerable care should be taken in selection, construction and assembly of the apparatus.

Additional Parts Required

The parts numbered 1, 2, 3, 4, 5, 6, 7, 8, 9, 10 and 11 are the same as in the previously described detector panel, with the addition of two extra filament rheostats (10).

Number 12 is the Radio frequency transformer, two of which are required. Number 13 is an amplifying vacuum tube, two of which also are required, together with the necessary sockets. Number 14 is a 200 to 600-ohm potentiometer for the control of the grid potential of the two amplifying stages.

In addition an extra binding post is required for the positive terminal of the 60-volt B battery used on the plate circuits of the two stages of Radio frequency amplification. The size of the panel will have to be increased to about 7 by 18, although these dimensions can be altered to suit the taste of the constructor.

The tuning operations remain the same as before, with the addition of the two extra rheostats, which should present no difficulty, and the potentiometer. The potentiometer knob should be set at midway position and can then be altered for best possible adjustment in conjunction with the balance of the tuning.

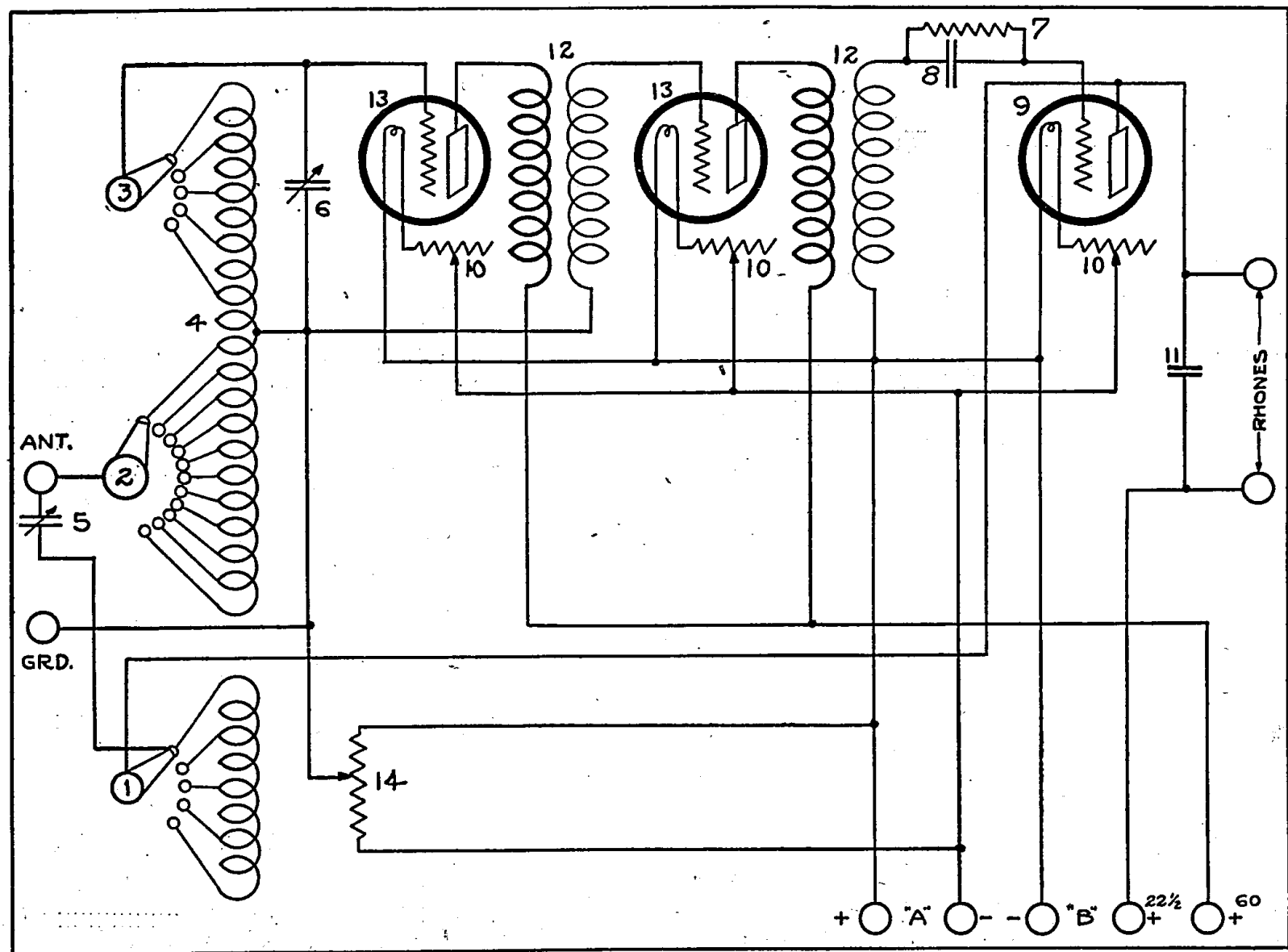

Easy Method for Learning the Code

By Thomas W. Benson

MANY persons enticed into the Radio field by the broadcasted concerts have become interested in the code messages they pick up from time to time. They may express curiosity as to what they are and where they are from but seem loath to learn the code. To gain sufficient proficiency in copying code messages requires not a little practice and many are discouraged after the first two or three attempts to interpret the dots and dashes.

In the "good old days" when it was absolutely necessary for one to be able to "copy," the labor expended in mastering the code was not noticed so much as it is today when anyone can be amused by the Radiophones. Therefore a simple and easy method of learning the code is a necessity not realized previously.

Systems for Memorizing Code

There are for sale various methods purporting to teach the code with a few hours' practice. The claims are usually carried out to the extent that one can memorize the signals in that length of time, but when the actual reception of a message is attempted, why, that is something else again.

Systems of phonograph records and the machine code senders are of great assistance in study, but one does not really need such aids when they are located near any of the coastal or government stations handling much business. Even amateur transmitters will give one plenty of practice in code work.

Defects in Memorizing

The main defect with most shortcut methods is that they tie the letters up visually with the respective signals instead of with an oral signal. Some use key words starting with the letter represented by a given signal. This means that one must split the received signal up into the component dots and dashes and then visualize them and the respective letter. Meanwhile the sender has shot over two or three let-

ters that are lost. The easiest and best method of learning the code is to tie the letters up with sounds, forgetting that those sounds are composed of dots and dashes.

Let us see how this can be done. Take, for instance, the letter A, indicated by . — and calling a dot, "Dit," and a dash, Daa, we can form a word as it were Diddaa. Just say this over a few times, repeating the letter A each time and notice how the sound Diddaa becomes tied up with the letter mentally without actually realizing it is a dot and dash.

Second Step in Oral Method

Now take its opposite, the letter N, or — . and treat it the same way, getting the word Dadit. Here again we have a sound that can be linked to the letter without having to separate the signal into a dash and a dot.

This forms the basis of what the writer believes the easiest and quickest way of learning the code. Another point overlooked in studying the code is the fact that in receiving a signal is given for which a letter must be written. On a code chart as usually studied the letters are printed first and the signal follows; the proper way would be to have the signal first, followed by the letter.

Speed Code Chart

Working along these lines we can then make up a speed code chart as follows:

DitdaaA	DaditN
DadidditB	DadadaaO
DadiddaditC	DidadaditP
DadiditD	DadadidaQ
DitE	DidaditR
DididaditF	DididitS
DadaditG	DaaT
DididditH	DididaaU
DiditI	DidididaaV
DidadadaaJ	DidadaW
DadidaK	DadadiditX
DidadiditL	DadidadaY
DadaaM	DadididaZ

In preliminary practice one should say the words over under their breath and write the letter on a sheet of paper till it becomes natural to write down the letter without particular attention to what the letter is.

Don't Stop for a Letter

One can then listen in on code and try to pick out letters, never stopping to think over a letter. If it doesn't "jump out" on the paper naturally, go right on and leave a space. After a little practice the number of letters missed will decrease until one is copying everything they hear.

The next step is to copy behind the sender. That is, practice saying the words under your breath, but while saying one write the letter from the one previous. That is not as hard as it would seem as will be found after a few minutes' practice. A good operator will copy perfect stuff two or three words behind the sender without difficulty, and some carry on a conversation at the same time.

No guarantee goes with this method of learning the code. I can't furnish hundreds of references as to its efficiency, but I do claim it is quicker, easier and better

than the old method of visualizing dots and dashes and mentally looking over the code chart to find the letter. Several friends have tried this method to their entire satisfaction and I offer it to those who have struggled with the other methods without success.

Distance Covered by Aerial

A Radio wave from the average aerial is dissipated equally in all directions. This means that its amplitude should decrease approximately according to the square of the distance covered. For broadcasting purposes this is all right, but for station to station communication a great waste of energy is evident. Economical service of the future, and service that will produce a minimum of interference, must rely on highly directional waves, or waves that can be concentrated and sent in a single given direction. The perfection of apparatus for producing these waves will mark a great step toward the universal usage of Radio, for communication, for remote control, and for power transmission.

Wessco

W. E. SUPPLY & SERVICE CORPORATION
18 MURRAY STREET, New York

2 Blocks South of Chambers, between Broadway and Church St.

We Are Giving Away These Beautiful Crystal Sets

HAVE YOU RECEIVED YOURS?

Don't forget Christmas is coming and this makes an excellent gift

FREE

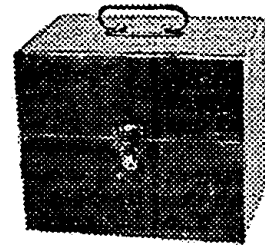

FREE

This set will receive everything broadcasted within a 25-mile radius of your home. Highly polished mahogany case with nickel-plated fittings.

Buy \$20.00 worth of Radio supplies and receive this beautiful Crystal Set absolutely FREE.

With each purchase of \$10.00 or more we are giving free of charge a \$1.75 B Battery.

Do You Need Radio Supplies?

OUR PRICES SPEAK LOUDER THAN WORDS

All Merchandise offered is Standard, Guaranteed, and is of perfect workmanship. Mail orders must include postage. TERMS—Money Orders with Orders—checks not accepted.

PRICE Complete **\$35.00** INCLUDING PHONES, TUBES, AERIAL and BATTERIES

"Better Than The Best"
AERIAL-A
The Radio Tube Set That Made Good In a Night

\$45.00 Magnavox	\$32.50	Thordarson Grid Condensers	\$ 0.15
\$24.00 A Battery, 100 amp., 6 V.	16.75	\$1.50 Thordarson Vernier Rheostat	1.10
\$19.00 A Battery, 80 amp., 6 V.	11.45	\$5.50 Fort Wood Tuning Coil	3.94
\$14.50 A Battery, 60 amp., 6 V.	8.75	\$3.00 Knockdown 2-slide Tuning Coils	1.50
\$1.00 Rheostat32	4-in. Composition Red Fibre Tube45
Switch Arm10	3 1/2-in. Composition Red Fibre Tube42
\$5.00 23-pl. Variable Condenser	1.65	3-in. Composition Red Fibre Tube39
\$5.50 43-pl. Variable Condenser	1.95	Johns-Manville Eik. Comp. Tubes, 4-in.35
\$4.50 Variometer, guaranteed, high quality	2.40	Johns-Manville Eik. Comp. Tubes, 3-in.25
\$4.25 Variocoupler, guaranteed, high quality	2.25	\$1.75 Crystal Detector	1.10
Unassembled Variocoupler, complete	1.00	75c Crystal Detector35
Unassembled Variometer, complete	1.25	\$1.50 Multi Jack	1.15
Insulators09	\$1.50 Twin Adapter	1.15
Contact Points, dozen04	\$1.25 Universal Plug95
Bronze Bus Bar, tinned, ft.02	\$18.00 WESTINGHOUSE BATTERY	13.75
75c Sockets23	CHARGERS	
\$3.00 BATTERY, 22 1/2 V. VARIABLE, HIGHEST QUALITY, GUARANTEED, LARGE SIZE	1.45	\$19.50 WESTINGHOUSE BATTERY	15.00
\$1.75 B Battery, 22 1/2 V. variable, highest quality, guaranteed, small size75	70c Open Circuit Jack60
3-plate Vernier Variable Condenser70	55c Closed Circuit65
Guaranteed Genuine Bakelite Panels—7x10, \$1.25; 7x18, \$1.85; 9x10, \$1.45; 5x5, 47; 5x9, .95; 6x12, \$1.25; 7x9, \$1.15; 12x14, \$3.00; 7x24	3.00	\$1.00 2 Circuit Jack80
50c Mica Condensers25	Knobs07
\$1.00 All Moulded V. T. Sockets25	125 ft. Coils, No. 14, Phosphor Bronze Tinned Wire40
\$1.50 MICROSTATS95	40c K. D. Crystal Detector16
Sphagotti, per length07 1/2	Magnet Wire20 per cent discount off List
\$2.00 Chelton Lightning Arresters	1.25	Rotors15
HOMCHARGER	1.95	\$3.00 Radio Frequency Transformers	1.65
\$3.00 Moulded Variocoupler, highest quality	4.50	\$1.00 Bethlehem Radiophone Plug75
\$8.00 Moulded Variometer, highest quality	4.50	75c Battery Hydrometer25
Panel, guaranteed insulation, 7x10, 75c; 9x10, \$1.00; 6x9, 70c; 7x9, 70c; 7x18, \$1.35; 6x12, \$1.25	13.25	\$1.05 Improved Potentiometers	1.10
HOMCHARGER DE LUXE	2.35	Knife Switch, S. P. S. T.14
\$4.50 Thordarson Transformers	2.35	Knife Switch, D. P. D. T.22
			\$6.50 Wessco Audio Transformers, highest quality, guaranteed	3.25
			\$6.75 Westinghouse Storage Battery	5.05
			\$8.00 Brandes Phones	5.75
			\$5.00 Shamrock Variocoupler	2.75

Vernier Variable Condenser

The simple vernier variable condenser shown in the illustration is made by using

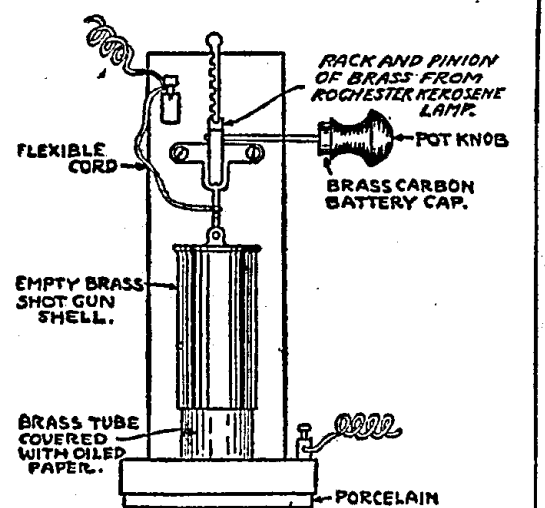

the rack and pinion, or the wick raising device, from an old fashioned kerosene lamp. It has worked out nicely in practical use.—Lewis Ellthorpe, Clinton, Wis.

Inside Wires

Securely fasten all wires inside buildings in a workmanlike manner. They should not come closer than 2 inches to any electric light or power wire, unless separated therefrom by some continuous and firmly fixed non-conductor, making a permanent separation.

SAVE MONEY ON HIGH GRADE VARIABLE CONDENSERS

Direct from Manufacturers

Take the middleman's profit and selling costs for yourself. We sell you direct. These extremely accurate instruments made by experienced condenser people are minus the decorative frills that add to cost. Price reduced to rock bottom without sacrificing quality in the least. Satisfaction or your money back. Write today for very interesting circular.

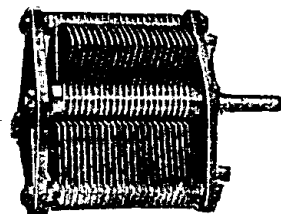

PRICES
21 Plate \$2.55
43 Plate \$2.95

Complete with Mounting Screws

Your Order Filled by Return Mail

No stamps, checks or money orders needed. Pay postman. Send the order TODAY, enclosing 5 two-cent stamps to cover cost of mailing, and receive your condenser in a day or two.

Manufacturers' Radio Association
91 East Kinney Street, NEWARK, N. J.

"THIS IS A RADIO XMAS"

ATTENTION! RADIO FANS

See the Radio sensation of the world at the

PERMANENT RADIO FAIR

the Radio buying center of the United States

If your dealer does not sell the Radio apparatus you have heard about, why not visit the Radio Fair where the leading representative Radio manufacturers have their exhibits on display and where you can have a demonstration of any receiving set by expert Radio engineers.

FAIR OPEN UNTIL MAY 30, 1923.

Nearly 100 standard Radio manufacturers exhibit at the

PERMANENT RADIO FAIR

Hotel Imperial, Red Room, Broadway & 32d St., New York City

Questions and Answers

Broadcasting on a Loop

(1157), WMEH, Greenville, N. C.
 As a beginner I am trying to build a set to receive which will have two stages of Radio frequency, detector, and two stages of audio frequency. Will you please give me a diagram that I may use as a guide.

What size of grid condenser should I use in this set? Is .00025 mfd. O.K.? How large a B Battery is required? Please name the parts I will need to make a tuner for this set? Will one variocoupler and two variometers be sufficient?

Can I receive broadcasts 500 to 600 miles on a loop aerial four feet square and wound with five turns of No. 18 double cotton covered wire?

Would there be any advantage in using a variometer between the plate and primary side of transformer on the first tube of Radio frequency?

Can I use an automobile storage battery to light the filaments?

A.—You will find on page thirteen of both the July 1st and August 19th issues diagrams of the wiring circuit suited to your requirements.

An outside aerial is recommended rather than a loop. The latter does not afford satisfaction except with the very highest quality of apparatus and expert manipulation.

There would be no advantage in a variometer in circuit as suggested.

An automobile battery may be used for lighting filament. Be sure you use no more than six volts.

A .0005 mfd. grid condenser will be best, while for B batteries, one 21 and one 80-volt battery will be needed. Your variocoupler and variometers are all right for this set.

Honeycomb Mounting

(1463), EJT, Bellfont, Kans.
 I have been reading the RADIO DIGEST for some time and have a few questions to ask:

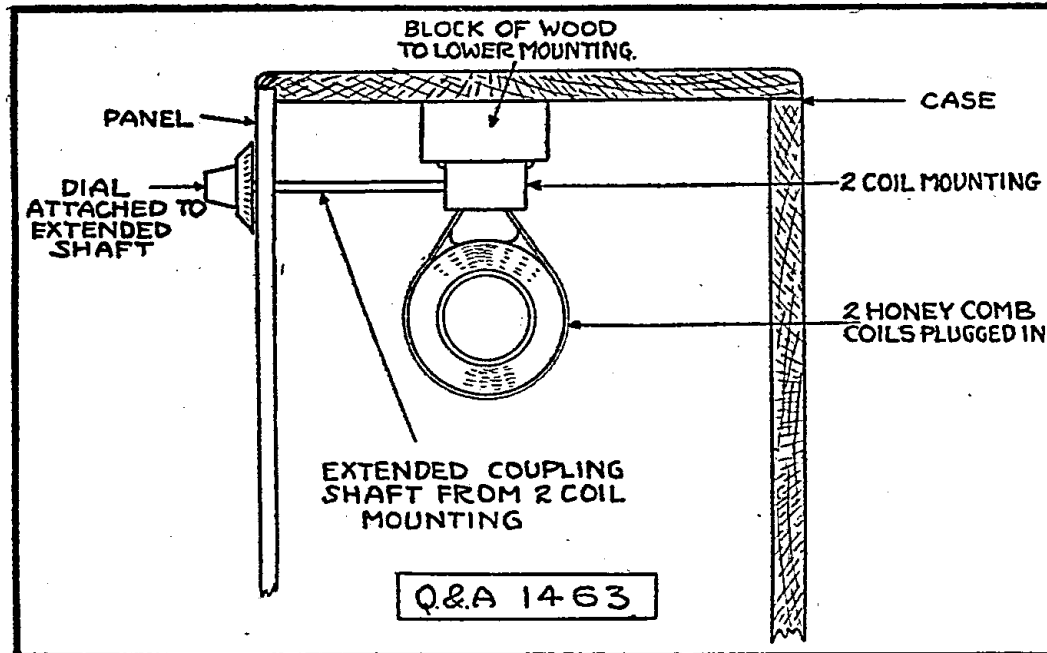

Please draw a sketch illustrating how the instruments, of the "Simplified Armstrong Super-Regenerator" Fig. 1, of the July 29th issue, are placed in a cabinet. I wish to put the two coupled coils inside the cabinet. Could you please suggest or

illustrate how to manipulate them with a dial and knob?

What is the best wire to use in connecting a set? I want something that will not break when bent. What size wire

A.—The sketch you ask is shown on this page, numbered Q. & A.—1463.

Use tinned No. 14 copper wire. Insulate with "spaghetti" tubing. This will give neat and efficient connections. If a lead must be flexible, ordinary lamp cord (stranded inside) is very good. Use same size wire throughout. Lamp cord can connect A battery and B battery to set.

J or W.E. type VT-1 tubes are excellent for use in this set. No batteries need be disconnected when not in use. Simply turn off the tube at the rheostat and all is O.K.

Regenerative Tuner

(1151), HAS, Cleveland, O.

I have a regenerative set which used cardboard tubes for the variocoupler and the variometers, and their rotors. I changed the rotors from tubes to wooden forms, and rewound the variometers with 30 turns of No. 22 wire on both sides of the shaft. The rotors also have 30 turns of the same wire on both sides of the shaft. The variocoupler primary has 66 turns of No. 22 wire and a tap taken off the ground side every 10 turns for six switch points, a tap every single turn for six points is taken off the aerial. The rotor has 34 turns on both sides of the shaft. This set worked fine with the tube rotors, but now I cannot tune fine enough to stop the flute-like hum of the carrier wave, but can hear the concert. I am sending a drawing of the set for your diagnosis.

A.—The changes you have made in your receiving set are all right. The only way that can be easily devised to cut out carrier waves is to have an antenna series condenser or vernier adjustments on your variometer controls.

Big Christmas Magazine Saving

By special arrangements with the leading magazines the Radio Digest offers you the opportunity to subscribe to your favorite magazines at bargain prices. You will save money by taking advantage of the subscription reduction listed below

Only orders mailed direct to the Radio Digest will be accepted. Orders sent through subscription agencies, news dealers or other sources will not be accepted under this special offer. This offer is good only to midnight, December 31, 1922. Letters must bear postmark before that time or they will be returned. Check, Money or Express Orders (no stamps) must accompany all subscriptions. No other special offers whatsoever of the Radio Digest or other publications will apply on these special clubbing offers.

1 The Delineator...\$2.00 RADIO DIGEST 5.00 Canada \$1.25 extra VALUE \$7.00	5.75	12 Peoples Home Journal...\$1.25 RADIO DIGEST 5.00 Canada \$0.75 extra VALUE \$6.25	5.00	21 Cosmopolitan...\$3.00 Harper's Bazaar 4.00 RADIO DIGEST 5.00 Canada \$2.25 extra VALUE \$12.00	9.50	30 Good House-keeping...\$3.00 Motor Boating... 3.00 RADIO DIGEST 5.00 Canada \$1.25 extra VALUE \$11.00	9.00
2 Everybody's Magazine...\$2.50 RADIO DIGEST 5.00 Canada \$0.75 extra VALUE \$7.50	6.25	13 McClure's Magazine...\$3.00 RADIO DIGEST 5.00 Canada \$0.75 extra VALUE \$8.00	6.25	22 Cosmopolitan...\$3.00 Motor Boating... 4.00 RADIO DIGEST 5.00 Canada \$2.25 extra VALUE \$12.00	9.50	31 Harper's Bazaar...\$4.00 Motor Boating... 4.00 RADIO DIGEST 5.00 Canada \$2.75 extra VALUE \$13.00	10.00
3 The Designer...\$1.50 RADIO DIGEST 5.00 Canada \$1.00 extra VALUE \$6.50	5.25	14 Pictorial Review...\$1.50 RADIO DIGEST 5.00 Canada \$0.75 extra VALUE \$6.50	5.25	23 Cosmopolitan...\$3.00 Motor Boating... 3.00 RADIO DIGEST 5.00 Canada \$1.25 extra VALUE \$11.00	9.00	32 Harper's Bazaar...\$4.00 Motor Boating... 3.00 RADIO DIGEST 5.00 Canada \$1.75 extra VALUE \$12.00	9.50
4 Adventure...\$6.00 RADIO DIGEST 5.00 Canada \$1.65 extra VALUE \$11.00	9.75	15 Modern Priscilla...\$2.00 RADIO DIGEST 5.00 Canada \$1.00 extra VALUE \$7.00	5.60	24 Hearst's International...\$3.00 Good House-keeping... 3.00 RADIO DIGEST 5.00 Canada \$1.75 extra VALUE \$11.00	9.00	33 Motor...\$4.00 Motor Boating... 3.00 RADIO DIGEST 5.00 Canada \$1.75 extra VALUE \$12.00	9.50
5 Woman's Home Companion...\$1.50 RADIO DIGEST 5.00 Canada \$1.25 extra VALUE \$6.50	5.25	16 Review of Reviews...\$4.00 RADIO DIGEST 5.00 Canada \$0.75 extra VALUE \$9.00	7.00	25 Hearst's International...\$3.00 Harper's Bazaar 4.00 RADIO DIGEST 5.00 Canada \$2.25 extra VALUE \$12.00	9.50	34 Everybody's Magazine...\$2.50 The American Magazine... 2.50 RADIO DIGEST 5.00 Canada \$1.25 extra VALUE \$10.00	8.50
6 The American Magazine...\$2.50 RADIO DIGEST 5.00 Canada \$1.25 extra VALUE \$7.50	6.25	17 Amateur Radio Call Book...\$1.00 RADIO DIGEST 5.00 Canada \$0.75 extra VALUE \$6.00	5.00	26 Hearst's International...\$3.00 Motor Boating... 4.00 RADIO DIGEST 5.00 Canada \$2.25 extra VALUE \$12.00	9.50	35 The Delineator...\$2.00 The Designer... 1.50 RADIO DIGEST 5.00 Canada \$1.50 extra VALUE \$8.50	6.75
7 Collier's Weekly...\$2.50 RADIO DIGEST 5.00 Canada \$3.25 extra VALUE \$7.50	6.00	18 Review of Reviews...\$5.00 Home Study Course in Radio... 3.00 RADIO DIGEST 5.00 Canada \$0.75 extra VALUE \$13.00	8.75	27 Hearst's International...\$3.00 Motor Boating... 3.00 RADIO DIGEST 5.00 Canada \$1.25 extra VALUE \$11.00	9.00	36 Adventure...\$6.00 The American Magazine... 2.50 RADIO DIGEST 5.00 Canada \$2.15 extra VALUE \$13.50	12.25
8 The Mentor...\$4.00 RADIO DIGEST 5.00 Canada \$1.25 extra VALUE \$9.00	7.50	19 Cosmopolitan...\$3.00 Hearst's International... 3.00 RADIO DIGEST 5.00 Canada \$1.75 extra VALUE \$11.00	9.00	28 Good House-keeping...\$3.00 Harper's Bazaar 4.00 RADIO DIGEST 5.00 Canada \$2.25 extra VALUE \$12.00	9.50	37 Pictorial-Review...\$1.50 Modern Priscilla 2.00 RADIO DIGEST 5.00 Canada \$1.00 extra VALUE \$8.50	7.10
9 Farm and Fireside...\$0.50 RADIO DIGEST 5.00 Canada \$1.00 extra VALUE \$5.50	4.75	20 Cosmopolitan...\$3.00 Good House-keeping... 4.00 RADIO DIGEST 5.00 Canada \$1.75 extra VALUE \$11.00	9.00	29 Good House-keeping...\$3.00 Motor Boating... 4.00 RADIO DIGEST 5.00 Canada \$2.25 extra VALUE \$12.00	9.50		
10 Boys' Life...\$2.00 RADIO DIGEST 5.00 Canada \$1.00 extra VALUE \$7.00	5.75						
11 Scribner's Magazine...\$4.00 RADIO DIGEST 5.00 Canada \$0.75 extra VALUE \$9.00	7.25						

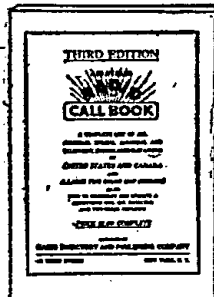
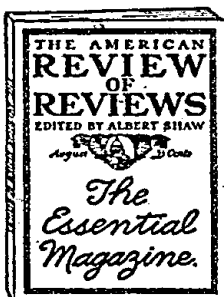
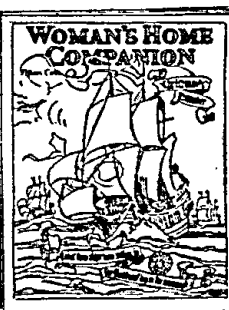

Special Christmas Club Offer COUPON

NOT GOOD AFTER DECEMBER 31, 1922

RADIO DIGEST, ILLUSTRATED,
 123 West Madison St., Chicago, Ill.
 Please find enclosed check M. O. (no stamps)
 Dollars for Special Christmas Club
 Offer No..... Magazines to be mailed to
 Name
 Street Address
 City..... State.....

Radio Illustrated

Virgilio Lazzari, Italian bass-baritone of the Chicago Opera. Here he is Sparafucila in "Rigoletto" Moffett Photo



Adolph Bolm, director of the Chicago Opera Ballet, in an interesting study Daguerre Photo



Amelita Galli-Curci has just returned to the Chicago Opera and may be heard soon by listeners in Kessler Photo



Even opera stars enjoy listening to opera broadcasts. The four lady members of the Chicago opera company were guests on the training ship "Commodore," stationed at Chicago. Left to right, Lt. E. L. Carlson, Mary McCormick, Hazel Eden, Melvina Passmore, Ensign A. C. Forbes, Ina Bourskaya, and Lt. L. K. Winan Chicago Opera Photo

M. O. ...