

# Radio Digest

SELECTED RADIO TECHNICAL ARTICLES

AMATEUR • EXPERIMENTAL  
ENGINEERING • SERVICE  
SHORT WAVE • TELEVISION  
ELECTRONICS • COMMERCIAL  
COMMUNICATION  
BROADCAST OPERATING

## HIGHLIGHTS FROM THIS ISSUE

- Equipment for Radiotherapy  
—Radio Engineering
- The Shunt-Excited Antenna  
—I. R. E. Proceedings
- Audio Amplifier Checking  
—Electronics
- Full-Range Superhet Selectivity  
—QST
- Broadcast Antenna Developments  
—RCA Review
- U.H.F. Power Amplifier Tube  
—Bell Laboratories Record
- Improving Superhet Response  
—Radio

SEPTEMBER, 1937

25¢  
U.S.A. & CANADA

# RADIO

LIMITED

TECHNICAL PUBLISHERS · 7460 BEVERLY BLVD. · LOS ANGELES

Please Send



for **six**  
twelve issues

to \_\_\_\_\_  
\_\_\_\_\_  
\_\_\_\_\_

IN U.S.A. AND CANADA, \$1.00 FOR SIX ISSUES (12 FOR \$2.00 ELSEWHERE, \$1.25 FOR EACH SIX ISSUES.

And Send



for **one**  
two years

to \_\_\_\_\_  
\_\_\_\_\_  
\_\_\_\_\_

IN U.S.A. AND CANADA, \$2.50 FOR ONE YEAR (10 ISSUES); TWO YEARS \$4.00. PAN-AMERICAN COUNTRIES, \$3.00 PER YEAR. ELSEWHERE \$3.50

RADIO  
NUMBER

Now We Have F  
Amplifier Messur  
The Shunt: Extrac  
for  
H. F. Transmitt  
Advanced 10-20  
Audio Amplifier C  
What the Cathod  
Improving Work S  
Consumes' Exotic  
Equipment for Rad  
Broadcast Antenn  
Lower Atmosphere  
Power Amplifier T  
The Technical Fiel  
Editors: W. W. Smith  
Name Change: Separate  
US for \$1.00 in U.S.A.  
Baltimore, Md. 4

# RADIO DIGEST

● NUMBER 2

SEPTEMBER, 1937 ●

## Table of Contents

Now We Have Full-Range Superhet Selectivity - James J. Lamb	3
Condensed from <i>QST</i>	
Amplifier Measuring Technique - E. F. Kiernan	14
Condensed from <i>Electronics</i>	
The Shunt-Excited Antenna - J. F. Morrison and P. H. Smith	19
From <i>Proceedings of the Institute of Radio Engineers</i>	
R. F. Transmission Lines - Everett L. Dillard	35
From <i>The Radio Engineer</i>	
Advanced 10-20 Superhet - H. G. Mustermann	42
From <i>All-Wave Radio</i>	
Audio Amplifier Checking with the Oscillograph - John F. Rider	49
From <i>Successful Servicing</i>	
What the Cathode-Ray Oscillograph Shows -	51
From <i>Successful Servicing</i>	
Improving Weak Signal Response in Superhets - Morton E. Moore	55
Condensed from <i>Radio</i>	
Consumers' Research Looks at Radio -	64
From <i>Radio Engineering</i>	
Equipment for Radiotherapy - Aaron Nadell	70
From <i>Radio Engineering</i>	
Broadcast Antenna Developments - Raymond F. Guy	74
From <i>RCA Review</i>	
Lower Atmosphere Ionization - E. J. Williams	86
Condensed from <i>The T. &amp; R. Bulletin</i>	
Power Amplifier Tube for Ultra-High Frequencies - A. L. Samuel	89
From <i>Bell Laboratories Record</i>	
The Technical Field in Quick Review -	96

Editors: W. W. Smith, Raymond L. Dawley. Managing Editor: M. M. Lloyd

RADIO DIGEST, September, 1937 no. 2. 25c per copy; by subscription, twelve issues for \$2.00 (6 for \$1.00) in U.S.A. and Canada. Published bi-monthly by Radio, Ltd., 7460 Beverly Boulevard, Los Angeles. Entire contents copyright, 1937, by Radio, Ltd.

# RADIO

LIMITED

TECHNICAL PUBLISHERS · 7460 BEVERLY BLVD. · LOS ANGELES

Please Send



for <sup>six</sup>  
twelve issues

to \_\_\_\_\_  
\_\_\_\_\_  
\_\_\_\_\_

IN U.S.A. AND CANADA, \$1.00 FOR SIX ISSUES (12 FOR \$2.00)  
ELSEWHERE, \$1.25 FOR EACH SIX ISSUES.

And Send



for <sup>one</sup>  
two years

to \_\_\_\_\_  
\_\_\_\_\_  
\_\_\_\_\_

IN U.S.A. AND CANADA, \$2.50 FOR ONE YEAR (10 ISSUES), TWO YEARS  
\$4.00. PAN-AMERICAN COUNTRIES, \$3.00 PER YEAR. ELSEWHERE, \$3.50

# RADIO DIGEST

● NUMBER 2

SEPTEMBER, 1937 ●

## Table of Contents

Now We Have Full-Range Superhet Selectivity	- James J. Lamb	3
Condensed from <i>QST</i>		
Amplifier Measuring Technique	- - - E. F. Kiernan	14
Condensed from <i>Electronics</i>		
The Shunt-Excited Antenna	- J. F. Morrison and P. H. Smith	19
From <i>Proceedings of the Institute of Radio Engineers</i>		
R. F. Transmission Lines	- - - - - Everett L. Dillard	35
From <i>The Radio Engineer</i>		
Advanced 10-20 Superhet	- - - - - H. G. Mustermann	42
From <i>All-Wave Radio</i>		
Audio Amplifier Checking with the Oscillograph	- John F. Rider	49
From <i>Successful Servicing</i>		
What the Cathode-Ray Oscillograph Shows	- - - - -	51
From <i>Successful Servicing</i>		
Improving Weak Signal Response in Superhets	- Morton E. Moore	55
Condensed from <i>Radio</i>		
Consumers' Research Looks at Radio	- - - - -	64
From <i>Radio Engineering</i>		
Equipment for Radiotherapy	- - - - - Aaron Nadell	70
From <i>Radio Engineering</i>		
Broadcast Antenna Developments	- - - - - Raymond F. Guy	74
From <i>RCA Review</i>		
Lower Atmosphere Ionization	- - - - - E. J. Williams	86
Condensed from <i>The T. &amp; R. Bulletin</i>		
Power Amplifier Tube for Ultra-High Frequencies	- A. L. Samuel	89
From <i>Bell Laboratories Record</i>		
The Technical Field in Quick Review	- - - - -	96

✦ Editors: W. W. Smith, Raymond L. Dawley. Managing Editor: M. M. Lloyd ✦

RADIO DIGEST, September, 1937 no. 2. 25c per copy; by subscription, twelve issues for \$2.00 (6 for \$1.00) in U.S.A. and Canada. Published bi-monthly by Radio, Ltd., 7460 Beverly Boulevard, Los Angeles. Entire contents copyright, 1937, by Radio, Ltd.



# We Make Our Bow

... or perhaps we should say our second bow. Two months ago there appeared our first RADIO DIGEST, a little fellow of 34 pages, which was offered at a few newsstands and radio parts stores. So quickly were they gone that it left us slightly dizzy.\*

Taking our cue, the size of RADIO DIGEST has been trebled to 104 pages and it is now offered to radiomen everywhere.

RADIO DIGEST will endeavor to bring you in each issue outstanding material from the entire field of radio—except from the business and entertainment angles. By all means, continue to read your favorite journal devoted to your "specialty" in radio, but for covering the rest of the field RADIO DIGEST will, we hope, fill the gap resulting from the fact that few radiomen can find the time to read the more than twenty excellent papers now in the field.

What would you like to see in RADIO DIGEST? Won't you tell us? Your letters will be of the greatest help in guiding us to select the type of material you want.

We want publicly to offer our grateful thanks to the publishers of the following papers whose gracious permission to use their material has made RADIO DIGEST possible: RADIO, QST, All-Wave Radio, Radio Engineering, Communications and Broadcast Engineering, Service, Successful Servicing, Radio News, Bell System Technical Journal, Bell Laboratories Record, RCA Review, Journal of the Institute of Radio Engineers, The Radio Engineer, Broadcast News, Revista Telegráfica, T. & R. Bulletin, Radio Review, and Electronics. From many RADIO DIGEST has first choice ahead of all others in the field. Several whose best material will be brought our readers regularly are not otherwise available to the general public. In addition to those mentioned, the leading foreign journals and trade and house organs will be combed regularly for unusual material.

RADIO DIGEST is presented by Radio, Ltd., publishers of RADIO magazine, who have also recently become publishers of the "Jones Radio Handbook" and a complete line of well-known radio texts.

The present RADIO DIGEST has no connection with the magazine of the same title which ceased publication several years ago.

\*A few copies which were not shipped to dealers are available at 10c each; they will not be included in subscriptions.

## Now We Have FULL-RANGE SUPERHET SELECTIVITY

BY JAMES J. LAMB

THE FULL range of receiver selectivity ideally desirable in amateur communication would embrace band-widths from the minimum required for c.w. telegraph signals to the maximum required for high-fidelity 'phone. In practice, this might mean a total effective band-width range of from less than 100 cycles to over 20 kc. Furthermore, in order to cope with the wide variety of interference conditions encountered with the different types of signals, the selectivity should be continuously variable throughout this 200-to-1 range and should also include the additional feature of ability to reject a particular interfering signal even within the band-width range for which the receiver may be adjusted, especially in c.w. telegraph reception.

Unquestionably this is a large order. Actually, full-range variable selectivity meeting these ideal specifications is now within our reach. In this article we shall attempt to show one method of approach by practical circuit arrangements and graphical performance data.

The full range encompassed may be covered by the same i.f. amplifier in three steps, each capable of giving continuously variable band-width between its minimum and maximum limits. These are from 100 cycles or less to approximately 3.5 kc., from 3.5 to approximately 9 kc., and from 9 kc. to over 20 kc. These are total band-width figures at 10 per cent maximum response; or, to put it differently, total band-width at ten times resonance input.<sup>1</sup> For the highest selectivity range, the familiar variable-selectivity quartz crystal filter is used; for the medium range, a Transfilter unit<sup>2</sup> in the same variable-selectivity circuit carries on in place of the quartz crystal; and for the broadest range, variable-selectivity interstage transformer coupling fulfills the job with the filter circuit switched out. Since the band-width requirements of c.w. telegraph and 'phone reception have been found to be satisfied by the two higher-order ranges of selectivity, using the

<sup>1</sup> J. J. Lamb, "Receiver Selectivity Characteristics," QST, May, 1935; *The Radio Amateur's Handbook*, 14th Edition (1937), p. 88.

<sup>2</sup> J. J. Lamb, "A New I. F. Coupling System," QST, April, 1937.

crystal filter and Transfilter respectively, only these two ranges will be treated in detail in the present article, the "straight" transformer-coupled i.f. selectivity being shown in each case simply for comparison.

#### *The Experimental Set-up*

The i.f. amplifier used in the experimental investigation included two stages of intermediate-frequency amplification with two 465-kc. air-tuned air-core transformers in addition to the filter unit, a diode second detector, and a "flat" two-stage audio amplifier with 6L6 output. The two i.f. transformers of this unit were adjusted for a relatively broad frequency characteristic to provide a fair amount of tolerance near resonance to accommodate minor deviations in frequency of the several quartz crystals and Transfilters used. A Rawson Type 501 milliammeter was connected in the second-detector circuit to indicate the rectified d.c. and a General Radio Type 583A power output meter was connected to the 6L6 stage for audio output measurement. The first i.f. stage was preceded by the filter circuit and this, in turn, was preceded by a 6L7 first detector. For i.f. selectivity, sensitivity and noise-ratio measurements, the grid circuit of the first detector was connected to the output of a G.R. type 605A standard signal generator. An auxiliary i.f. amplifier, second detector and audio unit was used for aural monitoring throughout the tests, its i.f. input being taken off in parallel with the input to the

grid of the first i.f. amplifier following the filter unit.

In making the selectivity tests, the second detector of the main unit was used as a vacuum-tube volt-meter to indicate i.f. amplifier output. This method of output indication prevents the frequency characteristic of the audio amplifier from affecting the measured selectivity.

The standard procedure for making selectivity tests was followed in all other respects, throughout the hundreds of readings which were taken in obtaining the data presented here and in checking and rechecking those of a critical nature.

The input signal throughout the measurements was in the intermediate-frequency range, of course, the first detector serving simply as the input coupling amplifier. The results obtained fully represent actual superhet receiver performance. However, they were checked thoroughly by using the first tube as the mixer in a converter circuit both with signal generator input and in the reception of communication and broadcast signals.

Since many of the measurements were made at extremely high filter selectivity, careful adjustment of the signal-generator tuning and measurement of the frequency deviation from resonance were necessary. In these measurements, the frequency reading from the magnified tuning scale of the signal generator was checked by measurement



of frequency increment in audio beat-note output of the auxiliary monitoring receiver unit. The stability of the 605A signal generator, which is of the oscillator-amplifier type, is exceptionally good.

The general procedure in making selectivity measurements for each of the various i.f. circuit combinations was as follows:

The i.f. gain and signal input level were adjusted to give second-detector current corresponding to that obtained with what would be considered a "normal" signal-delivering output well above the background noise level. This reference current was 40 microamperes through the diode load resistor of 100,000 ohms, the signal input on i.f. resonance ranging between 10 and 40 microvolts. For most of the curves the signal generator's attenuator was then set for 2, 10, 100 and 1000 times this resonance and then on the other side. In certain special cases where there were irregularities in the selectivity curve, additional readings were taken for the particular frequencies at which these occurred. Before starting each run a preliminary test was made to insure that overloading

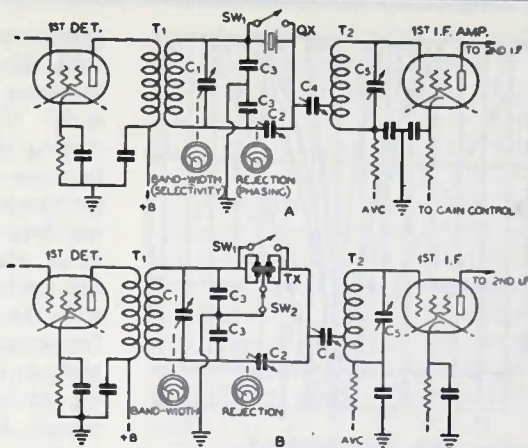

FIG. 1—QUARTZ CRYSTAL FILTER AND ROCHELLE SALT "TRANSFILTER" CIRCUITS FOR CONTINUOUSLY VARIABLE SELECTIVITY BY TUNED IMPEDANCE CONTROL.

- $C_1$ —50- $\mu$ fd. variable midges (Bandwidth control).  
 $C_2$ —15- $\mu$ fd. variable with low-capacitance crystal mountings such as National CHR and Bliley BC3; 25- $\mu$ fd. for higher-capacitance mountings such as Bliley CF1 (Rejection or phasing control).  
 $C_3$ —Each 75- $\mu$ fd. or 100- $\mu$ fd. fixed mica.  
 $C_4$ —50- $\mu$ fd. trimmer type (Output coupling capacitance).  
 $C_5$ —75- $\mu$ fd. variable (Output transformer tuning).  
 $T_1$ —Input transformer, 5.5-mb. primary closely coupled to 1.2-mb. tuned secondary.  
 $T_2$ —Output transformer, 1.2-mb. winding tapped approximately  $\frac{1}{4}$  turns from inside (ground) end.  
 $T_1$  and  $T_2$  are shielded from each other.  
 $QX$ —465-kc. filter crystal.  
 $TX$ —465-kc. Transfilter (Brush Type A).  
 $SW_1$ —S.p.s.t. filter switch.  
 $SW_2$ —S.p.s.t. switch to open ground of Transfilter with  $SW_1$  closed.

would not occur at any stage in the lineup for the maximum input level which would be used in the run. Furthermore, each run was made at least twice to check for possible erroneous readings in frequency settings or input microvolts.

The tuning of the i.f. coupling transformers was also checked for each filter combination to make sure that the "straight" selectivity

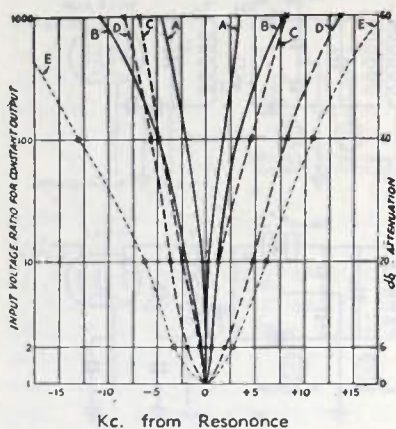

FIG. 2—SELECTIVITY CURVES FOR THE VARIABLE-BAND-WIDTH CIRCUITS OF FIG. 1.

A, crystal filter maximum selectivity; B, crystal filter minimum selectivity; C, Transfilter maximum selectivity; D, Transfilter minimum selectivity; E, straight superhet without either filter.

characteristic was not off resonance for the particular circuit in use.

#### Filter Circuits

Previous experience with variable-selectivity filter circuits using quartz crystals gave preference to the arrangement of Fig. 1A which provides both variable band-width control and variable rejection. The operation of this circuit has been treated previously<sup>3</sup> and need not be repeated in detail here. Band-width is varied by adjustment of the parallel-tuned impedance as indicated in the diagram, maximum band-width

(minimum selectivity) occurring with this circuit tuned to crystal resonance and decreasing band-width (increasing selectivity) occurring as the parallel-tuned circuit becomes reactive (either side of resonance). With the impedance matching which this circuit provides, the overall c. w. gain of the receiver is practically the same with the input circuit adjusted for "optimum" (medium-high) selectivity as it is with the crystal shorted out and the input circuit adjusted for maximum "straight" superhet gain. Either side of this point the over-all gain decreases slightly, both toward maximum band-width and toward extreme minimum band-width.

Preliminary tests with Transfilter circuits showed that the simple choke-condenser input and resistance output coupling given in April QST<sup>2</sup> was considerably less satisfactory than a coupling circuit giving more favorable impedance matching. The Transfilter unit is of fairly low impedance and accordingly cuts the gain of the input amplifier or first detector when fed directly from its plate. The same circuit used for the crystal filter was found to overcome these advantages and to give nearly the same overall gain with the Transfilter as with the crystal, even though the Transfilter unit has a ground connection which might be expected to impair the operation of the balanced circuit. A preferred Transfilter arrangement is shown in Fig. 1B. In practice, it has been found

<sup>3</sup> J. J. Lamb, "Developments in Crystal Filters," QST, Nov., 1933; "Interference and Noise Reduction in Communication Receivers," Proc. Radio Club of America, Nov., 1936; U. S. Patent No. 2,054,757; The Radio Amateur's Handbook, 14th Edition (1937), pp. 104-106.

satisfactory to use the Transfilter interchangeably with a crystal of the same frequency (465 Kc.) in this circuit.

With the Transfilter, selectivity is varied by the same method as with the crystal filter; that is, by variation of the parallel-tuned impedance which constitutes the input to the divided circuit. Although the selectivity-control condenser settings are not exactly the same as for a quartz crystal of corresponding frequency, minimum selectivity occurs with the input circuit resonant to the Transfilter frequency and increasing selectivity occurs as the input circuit is tuned either side of resonance. The resonance setting (maximum band-width) comes at lower tuning capacitance with the Transfilter than with the crystal because the Transfilter capacitance to ground is apparently greater by 10  $\mu\text{fd.}$  or so. The adjustment is still well within the range of the condenser, however.

#### Measured Performance

The range of selectivity obtainable with these two circuits is shown in Fig. 2. Curve A is for the crystal filter at maximum selectivity, Curve B for the crystal adjusted for minimum selectivity, Curve C for the Transfilter circuit with the maximum selectivity adjustment and Curve D is for the Transfilter with the minimum selectivity adjustment. Curve E is the transformer-coupled selectivity characteristic of the i.f. amplifier without either filter ("straight" superhet). It is especially interesting to

note that the selectivity range with the Transfilter practically continues on from where the crystal range reaches its broadest. This is illustrated even more clearly by the total bandwidth curves of Fig. 3 which are plotted from the same data. The principal difference between the selectivity of the crystal filter at its broadest and of the Transfilter at its sharpest is that the Transfilter selectivity characteristic is somewhat broader near resonance, giving a slightly greater effective bandwidth.

The crystal filter provides selectivity from the highest that may be used for c.w. telegraph signals with slow-speed keying to a band-width sufficient for reception of 'phone signals under adverse interference conditions. Throughout this range

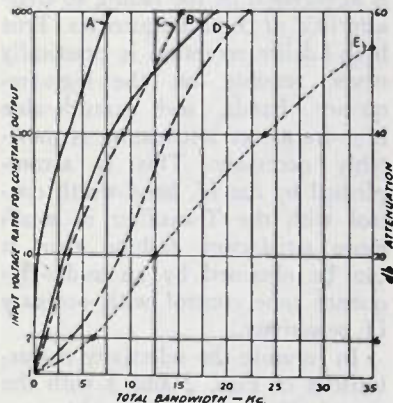

FIG. 3—TOTAL BAND - WIDTH CURVES CORRESPONDING TO THE SELECTIVITY CURVES OF FIG. 2 TO SHOW MORE CLEARLY THE FULL-RANGE COVERAGE OF THE CRYSTAL AND TRANSFILTER CIRCUITS OF FIG. 1.



the crystal filter also provides adjustable rejection or control of symmetry of the response characteristic for elimination of a particular interfering carrier even within the normal band-width range. The Transfilter selectivity range carries on from this point to a band-width sufficiently great for speech reception with entirely adequate fidelity. In fact, the Transfilter selectivity at its broadest is generally useful for broadcast program reception, providing fidelity fully as good as that customary with the average broadcast receiver.

This range is especially adapted to short-wave broadcast reception where it is desirable to constrict the frequency band of the receiver anyway because of the noise and adjacent-channel interference which is aggravated by the fading so characteristic of these frequencies. True high-fidelity reception is practically never feasible on the high-frequency bands, and considerable high-frequency attenuation is inevitably necessary. This is accomplished by the i.f. band-width control with the Transfilter in much more satisfactory fashion than it can be obtained by an audio-frequency tone control with ordinary i.f. selectivity.

In running the selectivity characteristics of Figs. 2 and 3 with the crystal filter, the band-width control  $C_1$  of Fig. 1 was set at slightly less than half capacitance for maximum selectivity and at approximately  $\frac{1}{2}$  capacitance for minimum selectivity. The minimum selectiv-

ity setting is, of course, that at which the balanced input circuit is resonant to the crystal frequency, while the maximum selectivity setting is that at which the input circuit is inductively reactive for the crystal frequency. The rejection or phasing control  $C_2$  was set to make the selectivity characteristic approximately symmetrical at 100 times resonance input; that is, so that the frequency deviations above resonance and below resonance were approximately equal for constant output with 100 times resonance input. The crystal-filter selectivity characteristic can be steepened on either side, of course, by other adjustments of the rejection control.<sup>3</sup>

In obtaining the Transfilter curves, the 50- $\mu$ fd. bandwidth condenser  $C_1$  was set at approximately  $\frac{1}{3}$  capacitance for minimum selectivity and at approximately  $\frac{1}{2}$  capacitance for maximum selectivity; that is, the input circuit was *capacitatively* reactive at maximum selectivity. The phasing control  $C_2$  was set near minimum capacitance. The phasing control has but slight effect on the symmetry of the resonance curve with the Transfilter, the rejection action being noticeable only at frequencies far removed from resonance in contrast to effective rejection action up to within a few hundred cycles of resonance with the crystal filter. The phasing condenser is effective in neutralizing stray capacitance coupling across the Transfilter, however, and improves the steep-

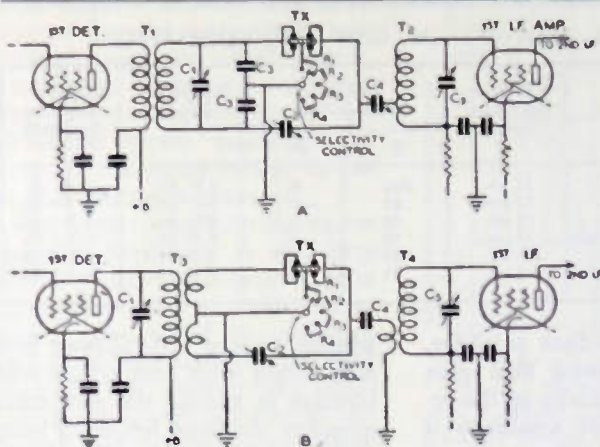

FIG. 4—IMPEDANCE-MATCHING TRANSFILTER CIRCUITS WITH VARIABLE RESISTANCE CONTROL OF SELECTIVITY.

The resistance in the common lead is varied in approximately logarithmic steps. Fixed resistor units of good r.f. characteristics should be used. The total resistance is 10,000 ohms, which is sufficient.

$R_1$ —1000-ohm  $\frac{1}{2}$ -watt

$R_3$ —2500-ohm  $\frac{1}{2}$ -watt

$R_2$ —1500-ohm  $\frac{1}{2}$ -watt

$R_4$ —5000-ohm  $\frac{1}{2}$ -watt

Other circuit values in A are the same as in Fig. 1. The input and output transformers of B are Hammarland crystal-filter type.

ness of the skirts of the resonance characteristic.

A matter of some importance in judging the relative merits of selective i.f. circuits, in addition to their contribution of selectivity, is their effect on the overall gain and effective sensitivity. In connection with crystal filters, for instance, there is considerable divergence of opinion as to whether this or that particular arrangement is the better in point of how little it reduces the gain of the receiver. In our experience, the impedance-matching crystal filter circuit of Fig. 1A has practically negligible effect on the c.w. gain of the receiver as compared to the gain with the crystal shorted out and the circuit tuned

to i.f. resonance for "straight" superhet operation. This refers particularly to the c.w. gain with the crystal filter circuit adjusted for optimum selectivity, at which adjustment the second-detector input (and the c.w. beat-note output) is maximum. The gain is actually reduced at minimum selectivity (maximum bandwidth) although the listener might get the opposite impression because the

interference and background noise increase when the selectivity is reduced so that the gross sound output becomes greater. However, the net c.w. signal output is less, as is also the effective sensitivity of the receiver.

In the circuit arrangement of Fig. 1B, using the Transfilter, the gain is also negligibly affected as compared to the straight superhet gain. In practice, differences of a few decibels in overall gain are readily compensated by adjustment of the receiver's gain control—provided, of course, the receiver has a proper margin of surplus amplification to start with. This should be true with any good receiver having



TABLE I—RELATIVE C.W. GAIN AND SENSITIVITY

I.F. Circuit	I.F. Input For Const. Output	Relative Voltage Gain		I.F. Noise Equiv.	Relative Effective Sensitivity
		%	db		
Straight Super	17 $\mu$ v.	100	0	2.0 $\mu$ v.	0 db
Transfilter Broad	22 $\mu$ v.	87	-2	1.32 $\mu$ v.	+ 3.5 db
Transfilter Sharp	25 $\mu$ v.	70	-3.5	0.80 $\mu$ v.	+ 8.0 db
Quartz Xtal Filter Broad	35 $\mu$ v.	50	-6	0.60 $\mu$ v.	+10.5 db
Quartz Xtal Filter Opr.	20 $\mu$ v.	85	-1.5	0.35 $\mu$ v.	+15.0 db
Quartz Xtal Filter Sharp	23 $\mu$ v.	74	-2.5	0.30 $\mu$ v.	+16.5 db

a two-stage intermediate amplifier.

Of more importance than gain is the effective sensitivity of the receiver. This effective sensitivity is by no means a simple matter of how much amplification the receiver has. It is, rather, a matter of signal-noise ratio. It is best expressed in terms of the receiver's noise equivalent.

The noise concerned is the receiver "hiss" noise, which would be the lowest possible noise background under ideal receiving conditions. The noise equivalent will be determined primarily by the signal-noise ratio at the input of the receiver but will be affected by the subsequent selectivity because the noise power output is generally reduced in proportion to the reduction in effective bandwidth of the receiver.

Table I gives typical quantitative comparisons of the overall gain and effective sensitivity of the i.f. amplifier for the various orders of selectivity obtained with the circuit of Figs. 1A and 1B. In making these measurements, the receiver gain control was left fixed. The unmodulated c.w. signal input was

adjusted to give 500-milliwatt beat-note output with each circuit combination in making the gain measurements, the input frequency being tuned to i.f. resonance. The noise-equivalent measurements were made in a similar manner, the c.w. beat oscillator being "on" for both the signal output and noise output measurements. It should be emphasized that receiver noise output should always be measured (or judged) with a carrier present in the second detector. The noise output with no carrier has little significance, since the second detector always has r.f. signal voltage present in actual reception. The c.w. noise equivalent in microvolts is calculated by substitution in the following simple equation:

$$NE = E_s \frac{\sqrt{P_n}}{\sqrt{P_s}}$$

where

$NE$  = noise equivalent in microvolts.

$E_s$  = signal input microvolts.

$P_n$  = noise power output with no signal input.

$P_s$  = signal beat-note power output.

The signal input was sufficiently great so that the noise output was negligible with the signal present, and the beat oscillator voltage was always large enough so that the signal output power varied as the square of the signal voltage in the range of the measurements.

The relative sensitivity figures are especially interesting in that they show the large signal-to-noise ratio improvement with increasing selectivity. In the case of c.w. reception with the crystal filter at maximum selectivity, for instance, the sensitivity is about 700 per cent of the straight superhet sensitivity, while the 'phone sensitivity with Transfilter-sharp or crystal-broad selectivity is raised over 300 per cent.

In the range of adjustment of the selectivity or bandwidth control with these circuits, the resonance frequency of the crystal filter varies but a few cycles. With the Transfilter, the resonance frequency variation is a few hundred cycles at the most, although here again the variation is so small as to be hardly noticeable if the signal is first tuned in on resonance with the filter adjusted for maximum selectivity.

In a previous article,<sup>2</sup> suggestion of varying the selectivity by adjustable resistance in the common ground connection of the Transfilter was made. Impedance-matching circuits incorporating resistance control of selectivity are shown in Fig. 4. The circuit of Fig. 4A is the same as Fig. 1B with zero resistance in the ground lead from the Transfilter and the input circuit adjusted for

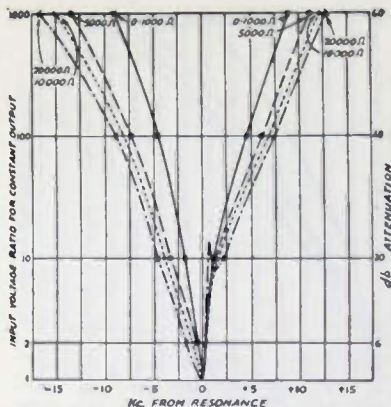

FIG. 5—SELECTIVITY CURVES FOR RESISTANCE VARIATION OF BANDWIDTH OBTAINED WITH THE CIRCUIT OF FIG. 4A,  $C_1$  SET FOR MAXIMUM SELECTIVITY WITH ZERO RESISTANCE.

Zero- and 2500-ohm resistance curves practically coincide with the 1000-ohm curve and are not shown. Note the sharper "nose" and wider broadening in the skirts as compared with the impedance variation curves of Fig. 2.

maximum selectivity ( $C_1$  adjusted for slightly higher capacitance than the resonance setting). Fig. 4B is of a type in which impedance step-down at the input is obtained by a transformer with a low-impedance secondary instead of the divided-capacitance stepdown used in the other circuit. When used as a crystal filter, the circuit of B is of the fixed-selectivity type.<sup>3</sup>

The selectivity curve of Fig. 5 shows the decrease in selectivity which occurs as the resistance in the ground lead from the Transfilter is increased. The curves for zero resistance and for 2500-ohm resistance are not shown since they practically

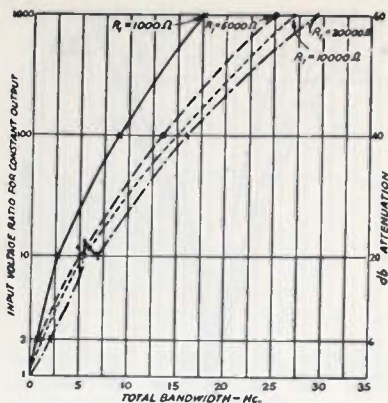

FIG. 6—TOTAL BAND-WIDTH FOR RESISTANCE VARIATION.

coincide with the 1000-ohm curve. The most interesting feature of these selectivity curves is the "notch" which appears with 20,000-ohm resistance. This double-hump effect indicates the equivalent of over-coupling with a transformer. As compared to the selectivity curves of Fig. 2, it is apparent that increased resistance tends to broaden the nose of the selectivity characteristic less effectively, while the skirts of the curves spread out more rapidly. They also show that the selectivity characteristic is generally less symmetrical with resistance variation than with variable impedance control. The curves of Fig. 6 show the

total bandwidths for the various values of resistance.

The gain of the circuit falls off somewhat more rapidly with increasing bandwidth as compared to the gain variation with impedance control of selectivity, although the loss is not especially noticeable in practice. On the whole, adjustable impedance control of selectivity appears to be preferable to resistance control with the Transfilter, just as it has been found to be preferable with the quartz crystal filter.

#### Band-Pass Transfilter Characteristics

An interesting band-pass type of selectivity characteristic was obtained with two similar Transfilter units connected in parallel in the circuit of Fig. 7. Except for the additional unit, the circuit is identical with that of Fig. 1B. The two units had the same rated frequency of 465 kc. and actually differed only 200 cycles in resonance frequency. The band-pass curve of A of Fig. 8 was obtained with the bandwidth control condenser  $C_1$  critically ad-

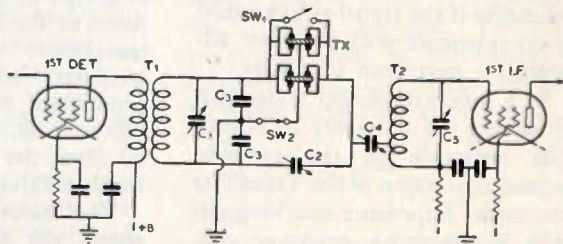

FIG. 7—VARIABLE-SELECTIVITY BAND-PASS CIRCUIT USING TWO TRANSFILTER UNITS IN PARALLEL. CIRCUIT VALUES BEING THE SAME AS IN FIG. 1B.

The resonance frequencies of the two units differ approximately 200 cycles.



justed so that the same output was obtained on both "humps" with constant signal input. Mid-frequency of this selectivity curve is approximately 1.2 kc. lower than the maximum selectivity curve obtained with the input condenser  $C_1$  adjusted for slightly greater capacitance than the broad-band adjustment. The greater broadening of the selectivity curve near resonance is especially desirable in broadcast program reception, although the overall c.w. gain with this circuit is practically the same as with a single unit.

#### Practical Applications

Detailed suggestions for incorporating these full-range selectivity methods in existing receivers are hardly necessary. For instance, many sets with two-stage 465-kc. amplifiers and crystal filters are also adaptable to the Transfilter by simple plugging-in of this unit in place of the crystal and slight re-adjustment of the filter circuit. At the present time 465 kc. is the only frequency for which the Transfilter units are available. For greatest convenience in operation, of course, an additional switch to change from crystal to Transfilter would be included. As shown in the circuit of Fig. 1B, the ground lead of the Transfilter should be opened when switching to crystal or "straight super". Otherwise, the Transfilter capacitance to ground throws the input circuit out of balance for crystal and straight superhet operation.

Further interesting and useful selectivity characteristics are obtained with two variable-selectivity crystal

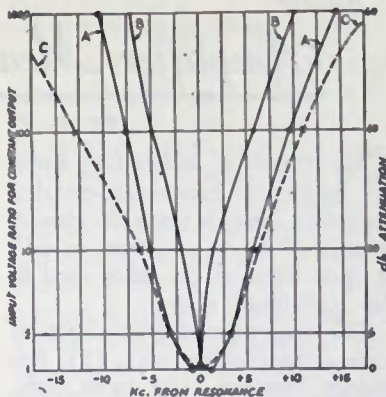

FIG. 8—MAXIMUM AND MINIMUM SELECTIVITY CURVES OBTAINED WITH THE BAND-PASS CIRCUIT OF FIG. 7.

filter circuits in cascade. With one filter adjusted for minimum selectivity and the other for optimum selectivity, for instance, independent rejection control in c.w. reception makes it possible to eliminate two interfering heterodynes of different frequencies, whether both are on the same side of resonance or on opposite sides of resonance. The crystals may differ 100 cycles or so in frequency without appreciably impairing operation, it has been found. In fact, such a difference actually may prove advantageous, since it gives a band-pass characteristic in the region near resonance.

With present production control facilities and the manufacture of both types of filter elements promising even better tolerances, we can look forward to wide-spread use of such cascaded electro-mechanical circuits in our receivers.

## *Amplifier Measuring Technique*

BY E. F. KIERNAN

THE DESIGN of satisfactory audio frequency transformer-coupled amplifiers depends upon the characteristics of the transformers as well as upon those of the tubes used in the individual stages.

The important characteristics of audio transformers are: (1) frequency response, (2) turns ratio, (3) working power level, (4) physical dimensions, (5) primary inductance, (6) insertion loss, and (7) phase shift. The frequency response is usually given by the manufacturer by means of a curve or by a statement of the deviation in decibels for a specified frequency range. The turns ratio is generally given directly, or indirectly, by specifying the impedance values between which the transformer will serve as a matching device. The working power level is specified on power output and modulation transformers and on some high fidelity units, but is not as frequently specified as might be desired. The physical dimensions are usually given, but the primary inductance, insertion loss, and phase shift are seldom indicated, and for this reason these characteristics must usually be measured by the user if knowledge of them is essential for design purposes.

A more or less standard arrange-

ment of apparatus for frequency response measurements is shown in figure 1. The beat frequency oscillator, suitably terminated, feeds through the gain-set into the device being measured. A suitable load in the form of a non-inductive resistor is connected across the output. The oscillator output is maintained constant at some convenient level reference or zero by means of the volume indicator. This latter device should preferably be a vacuum tube volt-meter.

To measure the gain, or amplification, the oscillator, adjusted to zero level, is set at the reference frequency. The volume indicator is switched to the load and the gain-set adjusted until the volume indicator again reads zero level. The gain in db is then read from the dials of the gain set. Data for a frequency response curve is obtained by varying the oscillator over the desired range and repeating the adjustments.

If the device being measured is designed to operate in a circuit delivering an appreciable amount of power, the above measuring procedure may fail to give a true picture of the performance at rated output. The development of class AB and class B audio amplifiers wherein the d.c. plate and grid currents may



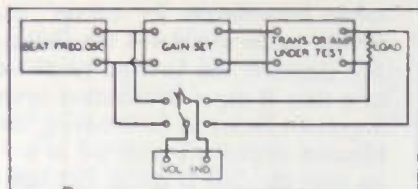

FIGURE 1—SET UP LABORATORY EQUIPMENT FOR DETERMINING THE FREQUENCY CHARACTERISTICS OF AUDIO FREQUENCY AMPLIFIERS.

change several hundred per cent during the passage of a signal, makes it imperative to take measurements at the rated output level. Saturation of transformer cores at high signal levels causes an increase in the harmonic distortion and a falling off in response at the low frequencies.

In figure 2 are shown two curves purporting to portray the response of an audio amplifier. Curve A was supplied by the manufacturer with the amplifier. Curve B was obtained by the writer from data acquired in a measuring arrangement as shown in figure 1. To develop the rated output required a signal input at  $-40$  db level. The input level during the measurement, at reference frequency, was at  $-90$  db; the V.I. reading zero level in both positions. The conditions under which curve A was obtained are not known.

Voltage and power transfer characteristics of the class B amplifier shown in figure 3 are given in the curves of figure 4. Curve A is the voltage transfer characteristic; curve B is the variation of power output with frequency at constant distor-

tion. Although the voltage transfer data were obtained at a level approaching the rated output of the transformer (200 watts) the curve does not give a true picture of the performance. Curve B indicates insufficient primary inductance, due in this case to an undersized core, as shown by the falling off in power transfer at the low frequencies. The voltage transfer characteristic fails to show the terrific harmonic distortion taking place due to core saturation, as the peak amplitude of the distorted wave was approximately the same as that of a sine wave. Leakage reactance was responsible for the drooping high fre-

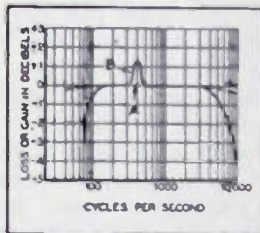

FIGURE 2—TWO RESPONSE CURVES REPRESENTING THE SAME AUDIO AMPLIFIER

quency end of curve B. These faults were overcome by increasing the core size, and by breaking the primary and secondary up into several sections each, which were wound alternately one over the other.

The use of a cathode ray oscilloscope for checking harmonic distortion is entirely practical, contrary to many opinions. This is especially true if the distortion is composed mainly of even harmon-

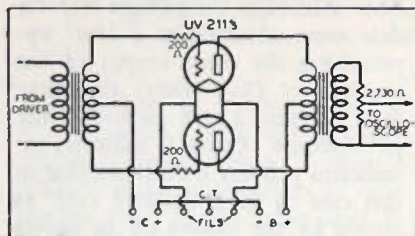

FIGURE 3—A HIGH POWER CLASS B AUDIO AMPLIFIER PUSH-PULL CIRCUIT.

ics which cause flattening of a sinusoidal signal trace. Figure 5 is a sketch of an oscilloscope trace having 2.35 per cent harmonic distortion as measured on a General Radio Type 636-A wave analyzer. Slightly over 2 per cent was due to the second harmonic, the balance to the fourth and higher. Other harmonic combinations might be more difficult to observe; however, a reference trace taken at the output of the oscillator and inscribed on a transparent mask mounted over the end of the tube will facilitate comparisons. We may expect to obtain eventually cathode ray tubes with two sets of control elements, such as are now available in Europe, which will enable the technician to observe two independent traces simultaneously.

Where a large number of measurements are to be made, a great deal of time may be saved through the use of a motor driven frequency response plotting device.<sup>3</sup>

Although it is generally advisable to take measurements on transformers under actual working conditions, it is possible to obtain val-

uable information in certain instances under simulated conditions. For instance: the leakage reactance of a class B input transformer is an important factor in determining the effective impedance inserted in series with the class B grids. The leakage reactance is difficult to evaluate; however, the arrangement of figure 6 can be used to obtain data to show the variation of the inserted impedance with frequency.<sup>4</sup> A resistor is connected across the primary to simulate the plate circuit of the driver tube. Resistor R is a decade resistance box. A beat frequency oscillator together with an audio amplifier is used as a source of voltage. The decade box is adjusted until the two voltmeters read the same. The value of R is then

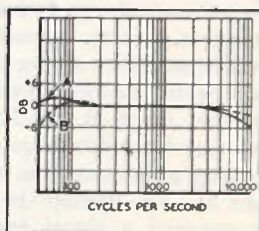

FIGURE 4—TRANSFER CHARACTERISTIC (CURVE A) AND POWER OUTPUT

the impedance of the half secondary at the given frequency.

When measuring the frequency response of an individual transformer designed for use in voltage amplifiers, the arrangement of figure 7 is used. The resistor in the primary simulates the impedance of the device out of which the transformer is to operate. The volt-

meter readings are converted to db variations from the value at the reference frequency.

If the turns ratio of an audio transformer is not known but the values of the impedances between which it is designed to operate, are available, the turns ratio may be found from the relation

$$N^2 = \frac{R_s}{R_p} \quad (1)$$

If no data is obtainable, the ratio may be measured by placing a known voltage of 400 cycles, or thereabouts, across the primary and measuring the secondary voltage with a vacuum tube voltmeter. The

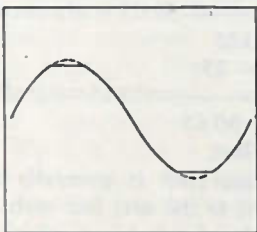

FIGURE 5—OSCILLOSCOPE TRACING OF WAVE SHAPE IN AMPLIFIER

voltage ratio will very nearly equal the turns ratio.

In transformers having the windings divided into equal halves, the impedance of either half taken separately, or of the two in parallel, is equal to one-fourth the value of the two in series aiding.

The power handling capabilities of a transformer may be ascertained with the arrangement of figure 8.

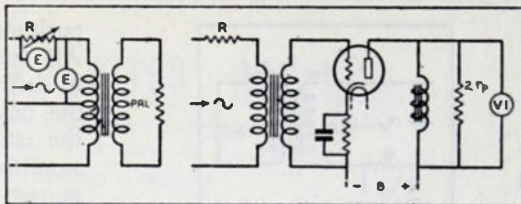

FIGURE 6—(LEFT) SHOWS AN ARRANGEMENT WHICH MAY BE USED TO DETERMINE TRANSFORMER IMPEDANCE. FIGURE 7—(RIGHT) SHOWS A METHOD OF SIMULATING THE IMPEDANCE OF THE TUBE FEEDING THE AMPLIFIER

The secondary is loaded with a resistor of appropriate value. A variable source of voltage, of low frequency and good wave form, such as the commercial power line adjusted by means of a regulating transformer, is applied to the primary. The value of the highest voltage allowable across the primary without excessive distortion of the magnetizing current wave form as observed in the oscilloscope, determines the power handling capability. Knowing the turns ratio and load resistor value, the power may be calculated from the expression.

$$W = \frac{E^2}{R} \quad (2)$$

Although physical dimensions of a transformer are readily obtainable directly if not available from manufacturers' data, the winding terminal arrangement may present some difficulty if the diagram has become lost. The terminals common to any one winding may be found readily with a continuity or ohmmeter. Split windings may be phased out by placing a low value



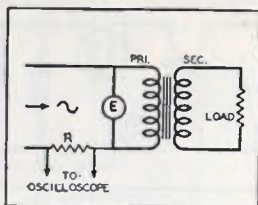

FIGURE 8—CIRCUIT FOR DETERMINING POWER HANDLING CAPABILITIES OF TRANSFORMER

of A.C. across one section and measuring the voltage across the two sections in series, then again with one section reversed.

The primary inductance of an audio transformer is most conveniently measured by means of the Hays bridge<sup>5</sup> which is arranged to pass d.c. through the winding, when necessary, during the measurement. The arrangement shown in figure 6 may be used to obtain an approximation from the expression

$$X_L = 2\pi fL \quad (3)$$

The accuracy is low and the result will vary with the voltage and frequency used.

Quantitative insertion loss data is seldom available; it may at times, however, be of importance. In one instance a pair of 6L6 tubes in

push-pull operation, under class AB<sub>1</sub> conditions could not be made to deliver the 30 watts specified by the tube manufacturer. Suspecting the rating to represent an "ideal" amplifier, a check was made of the output transformer losses as follows—the transformer turns ratio was 3.5, the r.m.s. voltage from plate to plate was 433, the secondary load was 500 ohms, the power delivered to the resistor was 25 watts. Therefore,

$$N^2 = \frac{Z_1}{Z_2} \text{ or } Z_1 = 500 \times 3.5^2 = 6125$$

$$\text{ohms (plate to plate) and } W = \frac{E^2}{R}$$

$$= \frac{433^2}{6125} = 30.65 \text{ watts out of tubes.}$$

$$\text{Also } \frac{25}{30.65} = 0.815 = 0.9 \text{ db insertion loss.}$$

Phase shift is generally not apparent to the ear, but with the approach of television, which covers from the lowest audio to the lower radio frequencies, this factor will become of increasing importance.

#### REFERENCES

<sup>1</sup> Dickey, Edward T., "Notes on the Testing of Audio Frequency Amplifiers." *Proc. I.R.E.* Aug. 1927.

<sup>2</sup> Diamond, H., and Webb, J. S., "The Testing of Audio Frequency Transformer-Coupled Amplifiers." *Proc. I.R.E.* Sept. 1927.

<sup>3</sup> *Electronics*, Feb. 1937, Page 53.

<sup>4</sup> Barton, Loy E., "Recent Developments of the Class B Audio and Radio Frequency Amplifiers." *Proc. I.R.E.* July, 1936.

<sup>5</sup> Terman, F. E., "Measurements in Radio Engineering."

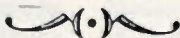

## THE SHUNT-EXCITED ANTENNA

BY J. F. MORRISON AND P. H. SMITH

*Bell Telephone Laboratories*

THE ADVANCES in broadcast antenna design made during the last decade have been primarily directed toward increasing the intensity of radiation at the ground level with a concurrent reduction in the intensity at elevations above the ground. The reasons which make this form of distribution desirable and the advances made in that direction are well known to the radio engineer, so that it is not necessary here to emphasize the importance of continued work toward that objective. However, the concentration of thought on the radiation characteristics has distracted attention from a consideration of the many other problems that are associated with the present design practice.

Antennas such as are used for broadcasting are connected at the base through the generator or coupling impedance to the ground, and it is generally understood that the coupling impedance as viewed from the antenna in no way affects the radiation characteristics of the antenna. In fact, as far as the radiation characteristics are concerned, the antenna may be connected di-

rectly to ground without affecting its performance. It might at first appear difficult to couple power efficiently into a vertical antenna grounded at its base, particularly at frequencies other than the resonant frequency of the antenna. However, consideration of the problem will indicate that this can be accomplished by using a very small portion of the antenna, at its base, as a coupling impedance. The impedance across this coupling section may then be transformed to the characteristic impedance of a concentric transmission line by an inclined conductor and series capacitance. A sketch of the shunt-excited antenna, series capacitance and concentric transmission line is shown in figure 1.

The advantages afforded by the shunt-excited antenna are immediately evident. In the first place, antenna structure cost is less since no base insulators are required and the more rigid support which can be provided at the base permits the use of smaller cross-sectional dimensions in the case of the self-supporting type vertical radiators. Filter devices for obstruction light



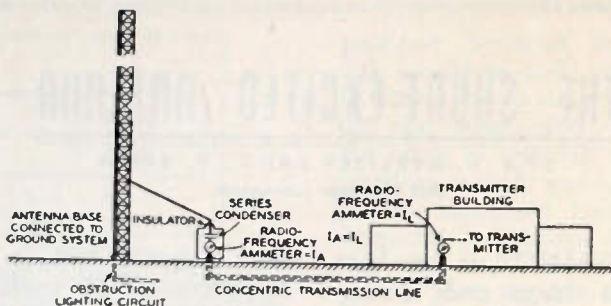

FIGURE 1—COUPLING ARRANGEMENT FOR THE SHUNT-EXCITED ANTENNA

circuits are not required and the circuits may be run directly to the antenna base and thence vertically up the antenna structure. Difficulties caused by lightning are reduced and the need for static drain devices is eliminated. The resistance of the radiating system is permanently adjusted, by methods described later, to equal the characteristic impedance of a transmission line. This feature eliminates the need for coupling transformers and also makes possible a standardization of antenna current meter scales for all installations using the same type of transmission line. When the transmission line is correctly terminated by the resistance of the radiating system and a series resonating capacitance, the current reading at the sending, or transmitter, end of the line is a direct indication of the current entering the radiating system, as the losses in well-designed lines are negligible at broadcast frequencies. The hazards of contact with high voltages

which exist with insulated structures are removed since the base of the structure is at ground potential.

Figure 2 was prepared from impedance data taken on an experimental antenna 200 feet high and four inches in diameter. This figure shows the resistance and reactance at the base of the inclined conductor as a function of the coupling section height and distance to the base of the vertical structure, when the system was operated at the resonant frequency of the antenna. Resistance values less than 100 ohms which are generally required to match a concentric type transmission line were obtained when the inclined conductor was at an angle of about 45 degrees and the sides of the triangle thus formed were less than 0.035 wavelength long. It will be noted that the sign of the reactance at the base of the inclined conductor is always positive so that it is only necessary to use a series condenser

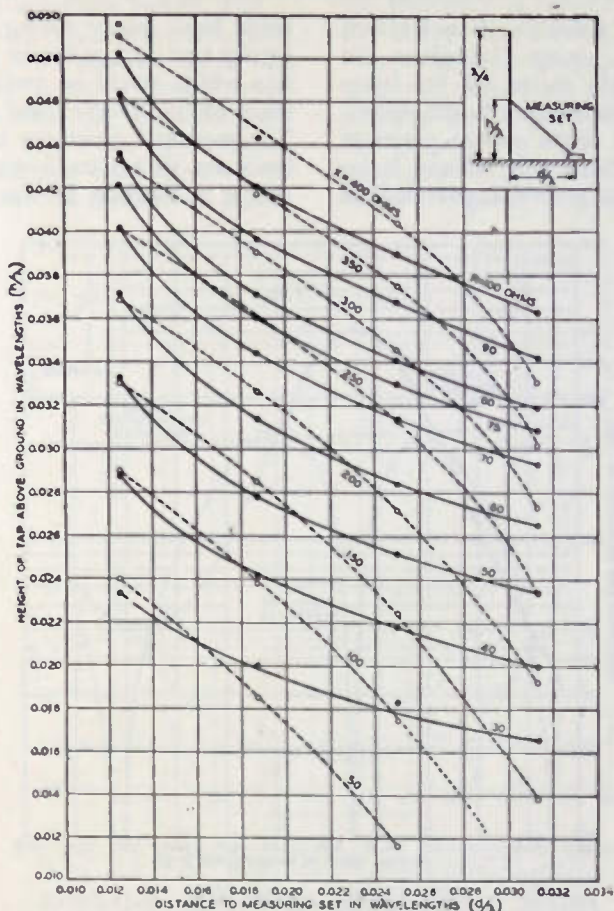

FIGURE 2—RESISTANCE AND REACTANCE OF A FOUR-INCH DIAMETER SHUNT-EXCITED ANTENNA.

to adjust the antenna impedance to unity power factor.

The results obtained with the experimental antenna were sufficiently encouraging to justify the continuance of the investigation with an antenna having physical di-

mensions that might commonly be used in practice. The work was conducted at Detroit, Michigan, where through the courtesy of the Detroit Daily News a 400-foot Blaw Knox uniform cross-section vertical radiator at station WWJ

was made available. It is six feet, six inches square throughout the entire height except for the lower 22 feet which tapers to the dimensions of a single conical porcelain insulator. Since this radiator is insulated from ground, it provided the

antenna input power during field intensity tests and to obtain information which would be useful in the study of the shunt-excited antenna. The measured resistance and reactance are shown on figure 3 plotted as a function of the antenna

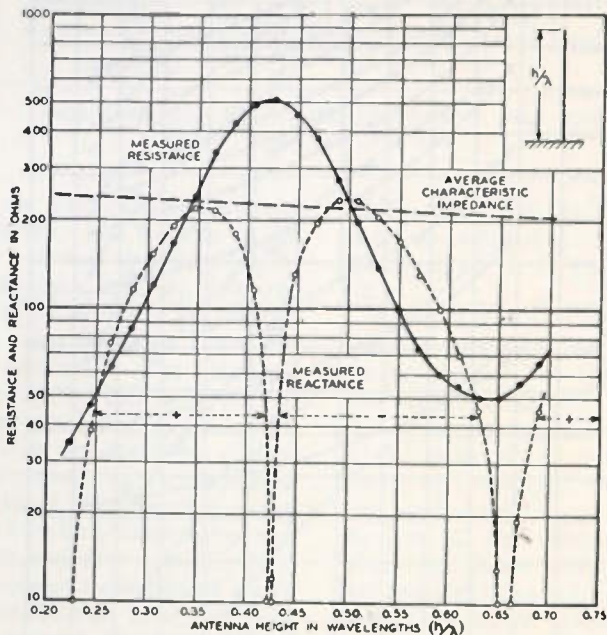

FIGURE 3—RESISTANCE, REACTANCE, AND CHARACTERISTIC IMPEDANCE OF THE WWJ UNIFORM CROSS-SECTION VERTICAL RADIATOR.

opportunity of studying its performance when either series or shunt-excited for comparison purposes.

#### *Impedance at the Base of Insulated Antennas*

A study of the impedance at the base of the insulated antenna was made in order to determine the an-

height in wavelengths. It will be noted from these data that the anti-resonant frequency (as defined by unity power factor at the base) occurred at an antenna height of 0.425 wavelength instead of 0.5 wavelength which might be expected from transmission line

theory of a uniform lossless line.

Since the capacitance of the base insulator was shunted across the measuring device, it would be expected to affect the impedance data. However, in the case of the antenna studied, the capacitance of the base insulator was about 30  $\mu\text{f}$ ds.

the frequency is varied. Irregularities in the data which are not evident from separate resistance and reactance curves are more readily observed and a better check upon the accuracy of the impedance measurements is provided. The solid curve represents a locus of the

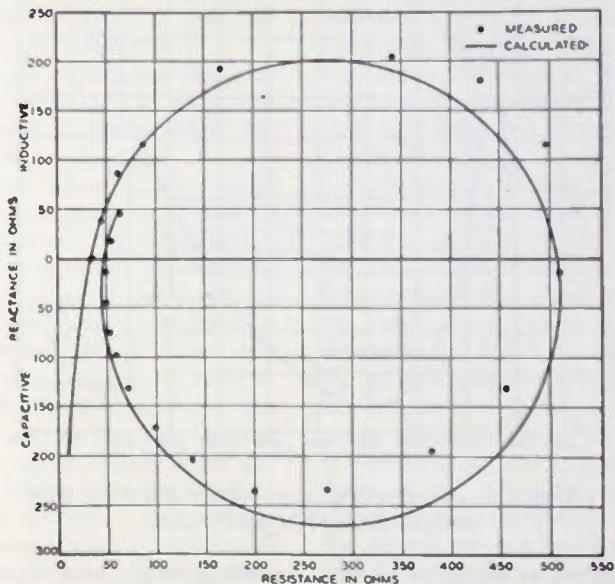

FIGURE 4—LOCUS OF IMPEDANCE VECTORS AT THE BASE OF THE WWJ UNIFORM CROSS-SECTION VERTICAL RADIATOR

and at the frequencies used its effect upon the data was slight.

The data shown on figure 3 are re-plotted on figure 4 as a series of impedance vectors, thus combining resistance and reactance on a single plot. In this manner of depicting the data, a curve which connects the points represents their locus as

calculated impedances based upon a transmission line formula for a line with distributed losses<sup>1</sup>.

It appeared that the impedance measurements at the antenna base were including the effects of a series inductance not considered in

<sup>1</sup> E. Siegal and J. Labus, "Impedance of Antennas," *Hochfrequenz und Elektroakustik*, Vol. 43, pp. 166-172; May, 1934.



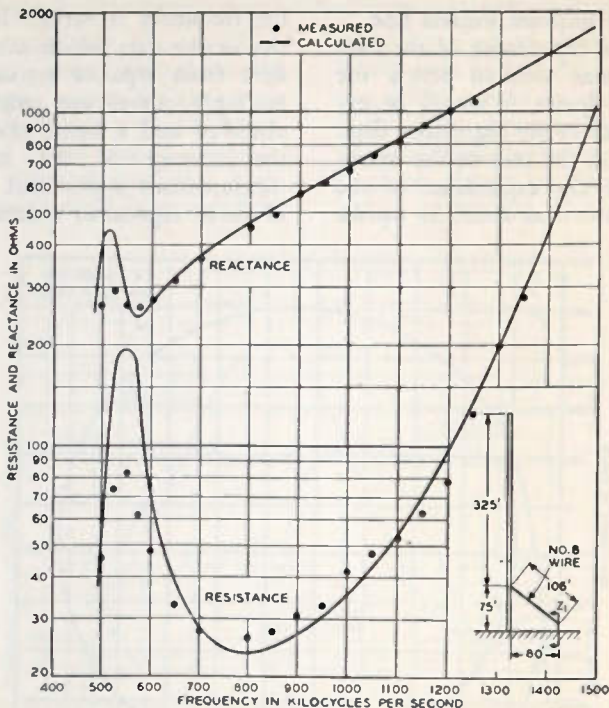

FIGURE 5—RESISTANCE AND REACTANCE OF THE SHUNT-EXCITED ANTENNA.

these equations as the locus of the measured impedance vectors is raised vertically from the computed curve. It was also found that the measuring impedance vectors were rotated around on the locus curve in a clockwise direction. This latter is the effect that would be produced if the antenna had a greater electrical length than the formulas would account for. However, measurements of the standing current wave on the antenna, which will be explained later, indicate that the

physical height was about 95 per cent of the electrical length and this value is in close agreement with that predicted by the transmission line formulas.

Siegal and Labus have found excellent agreement between computed and experimental impedance data for horizontal antennas arranged so that the effect of the ground was largely eliminated. Since the data presented here were taken between an antenna base and ground, it is probable that the



ground influenced the data in a manner not taken into account by the formula. This is to be expected, however, as in actual practice an impedance may be encountered by the ground currents in distributing through the ground network, and formulas for computing the radiation resistance are developed on the assumption of a perfectly conducting ground plane.

It may be significant that the differences between the computed and measured reactance when the antenna was operated at one-quarter and three-quarter wavelengths were respectively 25 and 75 ohms positive reactance. These differences correspond to the effect of an additional series inductance of 6.8 microhenrys. If, in addition, a lumped capacitance of about 200  $\mu\text{pfd}$ s. is also assumed to exist in shunt with the antenna base, the computed values for the antenna impedance agree closely with the measured results over the band of frequencies studied. It is known that the base insulator contributed about 30  $\mu\text{pfd}$ s. to this apparent shunt capacitance.

#### *Impedance of the Shunt-Excited Antenna*

The shunt-excited antenna may be analyzed into the following components: (A) The vertical portion above the tap point of the inclined conductor and (B) the vertical portion below the tap point. The impedances of these two portions with respect to ground are in parallel and form the terminating impedance for a third component

comprising the inclined conductor. A calculation of the impedances at the base of the inclined conductor using this concept of circuit mechanics has been found to agree to a good approximation with the measured values.

To arrive at quantitative values for the impedance of the antenna above the tap point of the inclined conductor, the same locus of the impedance measurements which were made at the base of the insulated antenna was assumed to apply to the section above the tap. The frequency at which any one impedance at the base was measured was modified by the ratio of the total height of the structure to the height of the section above the tap point, thereby obtaining a new frequency at which approximately the same antenna impedance might be expected to exist at the tap point. Thus the plot of impedances at the base of the structure as a function of frequency is shifted along the frequency axis to obtain the impedance data for the antenna above the tap point.

The impedance of that portion of the antenna between the tap point of the inclined conductor and ground was considered to be a pure reactance because of its short length. The reactance was computed from its physical dimensions based on the static formula for a straight conductor in free space. At the higher frequencies where the length of this section becomes a larger fraction of a wavelength, it was realized that the reactance

would depart somewhat from a linear relationship with frequency. Based on transmission-line theory, this departure from linearity with frequency would be proportional to the tangent of the electrical length. This correction, although taken into account, was small even at the highest frequencies considered. It was found also that effectively an additional inductance could be considered in series with the computed reactance of the structure between the tap point of the inclined conductor and ground. When this inductive reactance or its equivalent effect is included in the calculations for the impedance at the base of the inclined conductor, close agreement is obtained with the measurements. It is interesting that its value (which in this case was 6.8 millihenrys) was found to be the same as the value observed in the case of the insulated antenna when it was operated at one-quarter and three-quarter wavelengths.

If the inclined conductor is considered as a single wire transmission line, its input impedance is a function of its resistance, characteristic impedance, electrical length, and terminating impedance. Its terminating impedance is considered to be the resultant value of the antenna impedance above the tap in shunt with the total reactance below the tap point. The correlation of calculated impedance at the base of the coupling line with the measured data is shown on figure 5. The discrepancy between the cal-

culated curve and measured points may be partly due to coupling effects between the antenna and coupling line which were not considered.

The impedance at the base of the inclined conductor may be adjusted to the desired impedance by two methods:

1. The distance between the base of the antenna structure and transmission line termination may be varied. This adjustment changes in length, but does not noticeably influence the terminating impedance of the inclined conductor.
2. The height of the vertical coupling section may be varied. This adjustment changes all parameters but has the greatest influence upon the terminating impedance of the inclined conductor. The changes are, to a certain extent, compensating. Consequently, the adjustment is not critical and the desired impedance can be obtained within very close limits.

It is suggested that in practice the distance between the antenna base and the transmission line be fixed and adjustments made according to method number 2. This suggestion is made merely in the interests of simplicity of design

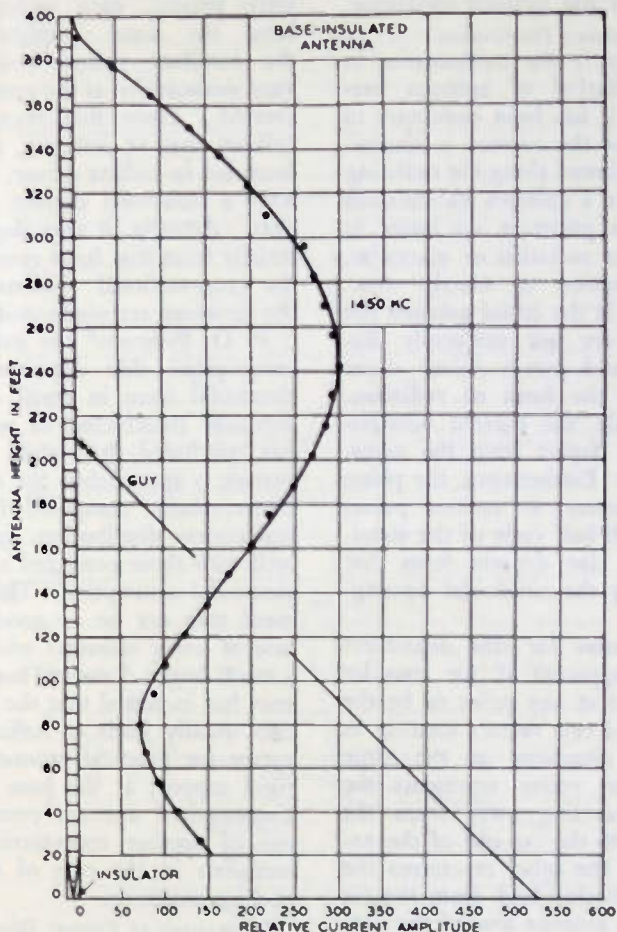

FIGURE 6—CURRENT DISTRIBUTION OF THE WWJ UNIFORM CROSS-SECTION VERTICAL RADIATOR.

practice, where it is desirable to predetermine the physical location of the concentric transmission line termination. The data on figure 5 were taken using a No. 8 B & S gauge copper wire as the inclined

conductor. In practice, it is expected that a larger conductor will be used with correspondingly lower characteristic impedance. This would have the desirable effect of increasing the resistance to reactance ratio at



the base of the inclined conductor.

#### *Current Distribution*

To simplify the mathematics in the computation of antenna performance, it has been customary to assume that the current is sinusoidally distributed along the radiating element. In a uniform transmission line which possesses no losses in the form of radiation or otherwise, this assumption is strictly true. However, in the actual antenna the constants are not uniformly distributed, and power losses occur mainly in the form of radiation. As a result, the current distribution must depart from the sinusoidal form. Furthermore, the phase of the current at various points within each half cycle of the standing wave also departs from that implied by the sinusoidal assumption.

The reason for this departure<sup>2</sup> becomes apparent if we consider the current at any point to be the resultant of two vectors rotating in opposite directions at the same rate. One vector represents the current traveling away from the generator to the far end of the antenna and the other represents the current reflected back from the far end of the antenna toward the generator with a smaller amplitude due to radiation losses. From such an illustration it may be seen that the resultant vector is at no time equal to zero amplitude and its phase is continually changing as the components rotate. If no losses

were present, each vector would have the same amplitude and the resultant vector would then vary sinusoidally as the components rotated. From this reasoning it follows that an antenna, which is intended to radiate power, will not have a sinusoidal current distribution. Actually, it may depart materially from that form even though the cross-sectional dimensions of the structure are made uniform.

P. O. Pedersen<sup>3</sup> has extensively investigated this departure from sinusoidal form in small diameter antennas constructed of wire and has concluded that while the departure is appreciable, the radiation characteristics, computed from actual current distribution, agree very well with those predicted using the sinusoidal assumption. This agreement may not be as good in the case of tower radiators which have a much larger diameter, but experience has indicated that the assumption usually leads to sufficient accuracy for practical estimates. The rigid support at the base of the shunt-excited antenna permits the use of smaller cross-sectional dimensions in the case of self-supporting structures.

#### *Measurement of Current Distribution*

The current distribution which is sometimes referred to as the standing wave on a radiating element can be measured with an acceptable degree of accuracy if some

<sup>2</sup> There is not at present any rigorous solution.

<sup>3</sup> "Radiation from a vertical antenna over flat perfectly conducting earth," Danmarks Naturvidenskabelige Selskab, on Commission by G. E. G. Gad, Vimmelskiftet 32, Copenhagen, 1935.



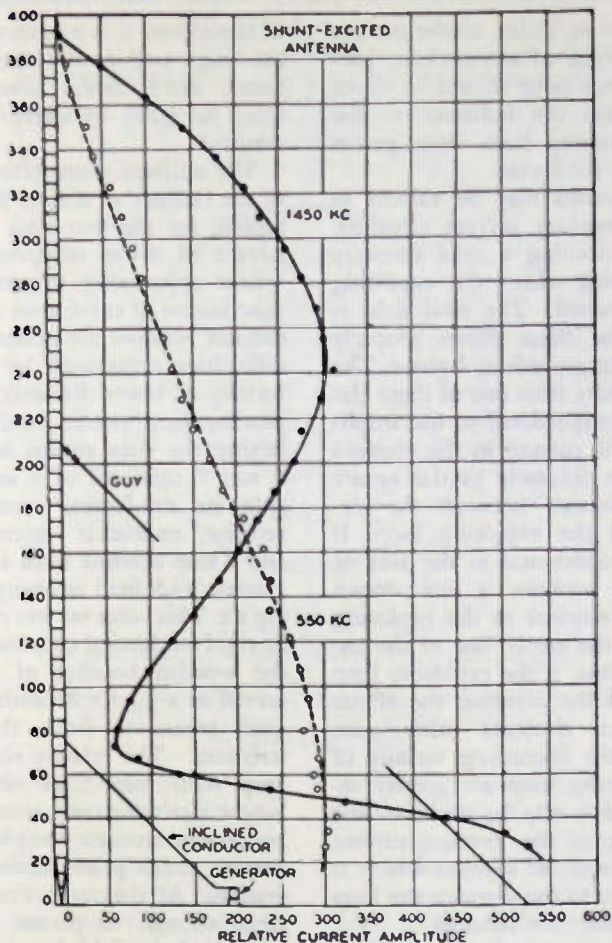

FIGURE 7—CURRENT DISTRIBUTION ON THE SHUNT-EXCITED ANTENNA.

important precautions are taken in the collection of data. The measurements are usually made by placing an exploring loop circuit, which contains a current indicating device, in proximity to the antenna

progressively at many points throughout its length and plotting the data thus collected as an index of the current distribution along the antenna.

Since the exploring loop circuit

is taken as an index of the current at each point of observation, particular precautions should be taken to minimize the influence of the field emanating from other points along the conductor.

The antenna may be viewed as many elementary current elements, each contributing a field intensity at the point where the exploring loop is located. The total field is the sum of these effects properly added in magnitude and phase. The field intensity from one of these elements is proportional to the amplitude of the current in the element and varies inversely as the square of the distance between the element and the exploring loop. It is also proportional to the sine of the angle between a line drawn from the element to the exploring loop and the center line of the antenna. Thus, if the exploring loop is close to the antenna, the effects of current elements other than those in the immediate vicinity of the exploring loop are greatly reduced and it may be said that the loop samples the average current along a length of antenna which is comparable to the distance the loop is away from the antenna.

If the antenna is non-uniform in cross section, the field which is picked up at each sampling point when the loop is held close to the antenna is affected by the varying distances and angles to the current elements due to the antenna configuration and is likely to give erroneous results. In those cases where, owing to the configuration

of the tower, it is necessary to hold the loop well away from the antenna, more careful consideration must be given to interpreting the results.<sup>4</sup>

The uniform cross-section design of the radiator at station WWJ presented, for the first time since the advent of tower radiators, an excellent opportunity to measure the distribution of current on a full size radiator without the aforementioned difficulties occasioned by non-uniformity of tower diameter. The exploring loop circuit used for collecting the data shown on figures 6 and 7 consisted of a small variable air condenser, vacuum tube rectifier, multiscale microammeter and a loop antenna from a Western Electric 44A field intensity measuring set. This latter set was chosen for its rigid mechanical construction and the wooden housing of the loop served as a jig for obtaining a constant separation from the tower structure. The relative size of this loop with respect to the tower height was sufficiently small to give reasonably accurate samples of the current at the points under consideration. At the same time it was large enough to permit sufficient pickup of the field from the small currents provided by a low power oscillator. A rope suspension was arranged for carrying the apparatus up and down the tower and also served as a support for the apparatus at the measuring points. When making measurements, the

<sup>4</sup> H. E. Gibring and G. H. Brown, "Tower Antenna for Broadcast Use", *Proc. I.R.E.*, vol. 23, pp. 311-358; April, 1935.

## BASE-INSULATED ANTENNA

Dotted circles calculated on assumption of sinusoidal current distribution and a perfect conducting plane earth.

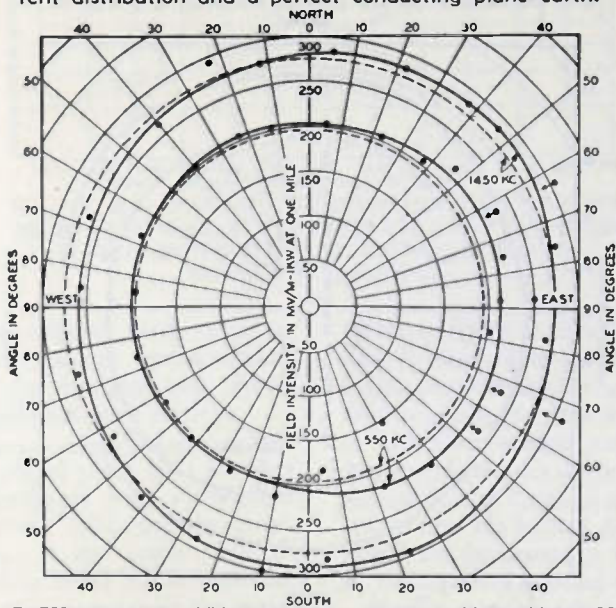

FIGURE 8—UNATTENUATED FIELD INTENSITY DISTRIBUTION ABOUT THE WWJ ANTENNA (SERIES-EXCITED)

loop was oriented to cut the magnetic field at right angles by supporting it firmly against one corner of the tower. In addition, it was located at the same point with respect to the tower cross members of each section, where a measurement was made.

Figure 6 shows the current distribution measured by this method when the tower was insulated at its base and excited at a frequency of 1450 kilocycles. 1450 kilocycles is the frequency at which maximum ground plane field intensity was observed and also corresponds to

a standing wavelength of about 0.64 wavelength. By observing the standing wave at 1450 kilocycles, it will be noted that the length of the wave between the two minimum points (top of the antenna and 80 feet above ground) is 320 feet. Since one-half of the wavelength in free space at 1450 kilocycles is 339 feet, the ratio of 320 to 339 indicated that the apparent wave velocity on the radiator was about 95 per cent of the free space value. Figure 7 is a plot of similar data taken when the antenna was shunt-excited. The 550- and



## SHUNT-EXCITED ANTENNA

Dotted circles calculated on assumption of sinusoidal current distribution and a perfect conducting plane earth.

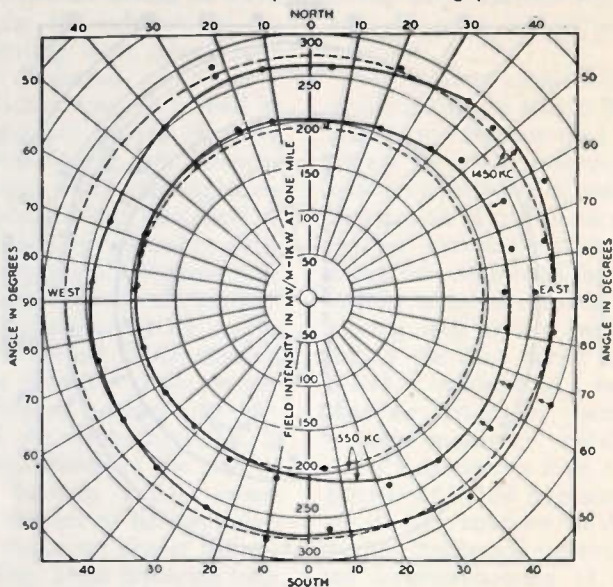

FIGURE 9—UNATTENUATED FIELD INTENSITY DISTRIBUTION ABOUT THE WWJ ANTENNA (SHUNT-EXCITED)

1450-kilocycle frequencies correspond closely to the 0.25- and 0.64-wavelength mode of operation. When making the measurements below the tap point of the inclined conductor, the exploring loop was placed so that little, if any, field was picked up from the inclined conductor. Therefore, these data represent only the current relations in the vertical portion of the radiator. It will be noted from the 1450-kilocycle curve that the distribution is substantially the same as in the case of the insulated antenna except in the region below

the tap point where the current builds up to much larger values. This is to be expected as the voltage with respect to ground must go to zero at the base.

While in this case, the current amplitude in the vertical section below the tap is larger than in the case of the insulated antenna, it was believed that the phase relations between the current in that section and the current in the inclined conductor would produce a cancelling effect upon the radiated field. To determine more definitely the effects of the exciting circuit



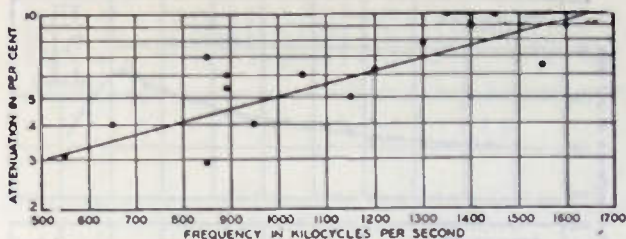

FIGURE 10—AVERAGE ATTENUATION IN THE FIRST MILE FROM THE WWJ ANTENNA. ATTENUATION IS COMPARATIVELY LOW, BUT INCREASES AT HIGHER FREQUENCIES.

upon the radiated field, comparative field intensity measurements between the insulated and shunt-excited antenna were made.

#### *Field Intensity Measurements and Data*

The ground plane field intensity was investigated with a Western Electric 44A field intensity measuring set. A low power oscillator was used to excite the antenna but for comparison purposes the measured data were corrected to correspond to a power level of 1000 watts and a constant distance of one mile from the antenna. The results at frequencies which corresponded to an antenna height of about 0.25 and 0.64 wavelength are shown in polar form on figures 8 and 9. It will be seen from these data that the field intensity distribution patterns for the base-insulated and shunt-excited antenna are substantially the same.

The measured field intensity corrected for 1000 watts was plotted as a function of the physical height of the radiator in wavelengths for both methods of excitation and is

shown in figure 11. It will be noted that in the region of 0.35 wavelength physical height the measured field was slightly less in the case of the shunt-excited antenna. It was found that this slight departure was caused by losses in the ground system near the base of the antenna, which can be overcome by the use of an improved ground system.

In the case of either the series or shunt-excited antenna, there appears to be little economical justification for antenna heights between 0.25 and 0.5 wavelengths on the basis of increased signal strength. Theoretical conclusions and measured results show that the field intensity curve rises very slowly for antenna heights between 0.25 and 0.4 wavelength. For example, only 12 per cent or one decibel improvement in field intensity can be expected under the best of conditions, when the antenna height is increased from 0.25 to 0.4 wavelength. This fundamental fact makes it difficult to justify the intermediate heights as 5 to 10 per

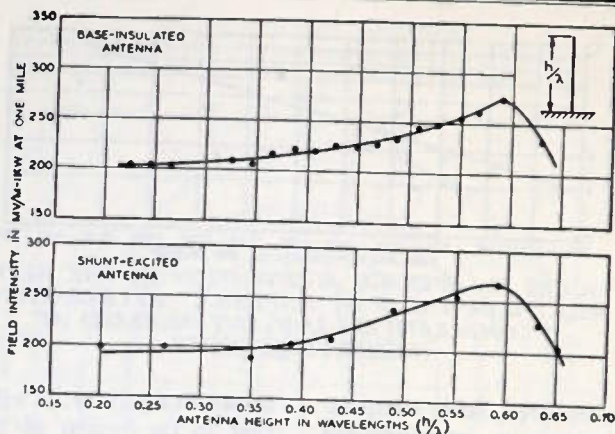

FIGURE 11—MEASURED FIELD INTENSITY FROM THE WWJ ANTENNA AS A FUNCTION OF THE ANTENNA HEIGHT IN WAVELENGTHS.

cent is considered good accuracy in the measurements of field intensities. On the other hand, 32 per cent or 2.4 decibels improvement can be expected if the antenna height is increased from 0.25 to 0.55 wavelength and what is probably more important in the case of high power stations, a substantial increase in the fading free area is realized.

Through the courtesy of the National Life and Accident Insurance Company, field intensity tests were made at distances ranging from 35 to 110 miles in several directions from the 0.58 wavelength vertical

radiator at station WSM in Nashville, Tenn. Automatic recording equipment was used for the collection of these data. The antenna was excited by the shunt and series method alternately every hour between midnight and 8 a. m. over a period of three weeks. An examination of these data showed that there was no discernible difference in the fading characteristics between the two methods of excitation.

(Acknowledgement: The authors wish to acknowledge the co-operation of the management and technical staffs of Radio Stations WWJ, Detroit, Mich., and WSM, Nashville, Tenn., in the collection of data given in this paper.)

WITH MOST applicants asking permission to increase power, it is unusual to find N.B.C. seeking F.C.C. sanction to decrease power at one of their outfits from 2500 to 50 watts. Another company has applied for a 3-watt broadcast ticket on 550 kc.—RADIO.

# R. F. TRANSMISSION LINES

BY EVERETT L. DILLARD

*A Practical Discussion of the Two-Wire Open Type and Concentric Tube Non-Resonant R. F. Transmission Lines.*

FROM THE lower broadcast to the ultra high frequencies the non-resonant transmission line is becoming more and more the means whereby radio frequency power is transferred from transmitter to antenna. The accepted practice is to place the antenna in the clear at some distance from the transmitter proper. By this means the transmitter, the building housing it and other nearby obstructions are placed outside of the strong induction field of the antenna. This reduces absorption losses and undesirable re-radiation from nearby semi-resonant objects, at the same time improving the efficiency of the radiator. It is apparent, then, that a complete study of antenna systems must include not only the subject of antenna design but also a thorough investigation of transmission lines if the subject is to be adequately covered.

In brief, there are but two types of transmission lines — resonant and non-resonant. Both are used

to transmit, in a sense, radio frequency power.

All transmission lines, whether of the single or multiple wire or even of the concentric tube type, possess distributed constants; that is to say, the inductance and capacity is distributed along the length of the wire and is not concentrated or "lumped," as in an ordinary coil or condenser combination. In this respect the transmission line is similar to an antenna. From this it is evident that, unless certain precautions are observed, there will exist standing waves along the wire lengths.

The non-resonant or untuned line is the more commonly used transmission line system employed on the broadcast and police frequencies and has found very ready application on the high and ultra-high frequencies. As its name implies, it is a line which does not have pronounced standing waves along its length. Whether the system is but a few feet or several thousand feet long makes but little

difference. The line acts as though it were of infinite length, no standing waves are present, and there is a smooth distribution of voltage and current everywhere along the line, which in practical cases is maximum at the power source and tapers off gradually in amplitude as the antenna is approached.

The resonant line and the non-resonant line look exactly alike on first glance. In the open two-wire type both consist of two closely-spaced wires running parallel for some distance, but *electrically* there is a difference and an important one. In order to make a transmission line behave as an infinite line (that is, to operate without the presence of standing waves) the line must be terminated at the receiving terminal (the antenna end) in a pure resistance which has a value in ohms equal to the surge impedance of the line. The antenna tuned to resonance as it is in most all cases simulates this condition when the line is properly coupled to the antenna circuit.

An untuned feeder system may consist of one, two, three, four and even more parallel wires. Increased constructional difficulties of the multi-wire type of line where three or more parallel wires are used, and the danger of appreciable feeder radiation from an improperly adjusted single wire feeder restrict commercial usage and acceptance to the more familiar two-wire type of line.

The three-wire transmission line is but an adaptation of the two-

wire type with the middle (third) wire grounded. Where four, six, eight and even greater numbers of wires are used in the system it is possible to secure a somewhat lower surge impedance with less loss than is possible with the more conventional two-wire line.

The two-wire transmission system is easy to construct. Its surge impedance can be calculated quite easily, and when properly adjusted and balanced to ground, undesirable feeder radiation is minimized since the current flow in the adjacent wires is in opposite directions and the magnetic fields of the two wires are in opposition to each other. It cannot be said that the open type of line will completely suppress line radiation but in a properly adjusted line radiation can be suppressed to a satisfactory degree. Only in the co-axial or concentric tube line can radiation be entirely suppressed.

It has been said that when a two wire line is terminated at the receiving terminal (antenna end in the case of a transmitter) with the equivalent of a pure resistance equal to the surge impedance of the line that the line then becomes a non-resonant line and pronounced resonances disappear. It is then the problem to find a way to go about calculating the surge impedance of any two wire transmission line, which impedance we will call  $Z_s$ .

Any two parallel conductors separated from each other have a capacity between them that is distributed along their length, and any



conductor, even though it be only short lengths of wire, will possess some inductance along its wire length.

It can be shown mathematically that the true surge impedance of any two wire parallel line system is equal to

$$Z_s = \frac{\sqrt{z}}{\sqrt{y}} \quad (1)$$

Where  $Z_s$  = the surge impedance of the line in ohms,

$z$  = the impedance in ohms per centimeter length of line.

$y$  = the admittance in ohms per centimeter length across the line.

Therefore:

$$Z_s = \frac{\sqrt{r + j\omega L}}{\sqrt{g + j\omega C}} \quad (2)$$

Where:

$r$  = resistance per cm. length, i.e. the static value, assuming uniform current distribution along the line, and

$g$  = conductance per cm. length (reciprocal of resistance) assuming uniform voltage distribution along the line.

For high frequency transmission lines where the terms  $r$  and  $g$  are of negligible value as compared to the reactive components of the total impedance and admittance terms as given in Equation (2), these can be neglected and by cancellation of the upper and lower  $j\omega$  terms we have the more familiar formula which reduces to

TABLE A

Wire Gauge Number B & S	Wire Diameter in Inches
2	.257
4	.204
6	.162
8	.1285
10	.1019
12	.0808
14	.0641
16	.0508
18	.0403

$$Z_s = \frac{\sqrt{L}}{\sqrt{C}} \quad (3)$$

Substituting the known formulas for  $L$  and  $C$  in Equation (3) which involve the diameters of two parallel evenly spaced wires of a known spacing from wire center to wire center, the formula reduces to a more usable form for practical calculation. For two parallel wires, knowing the above factors, we have

$$Z_s = 276 \log_{10} \frac{2S}{d} \quad (4)$$

Where:

$S$  is the exact distance between wire centers in some convenient unit of measurement, and

$d$  is the diameter of the wire measured in the same units as the wire spacing,  $S$ .

Since  $\frac{2S}{d}$  expressed a ratio only, the units of measurement may be centimeters, millimeters, or inches. This makes no difference in the

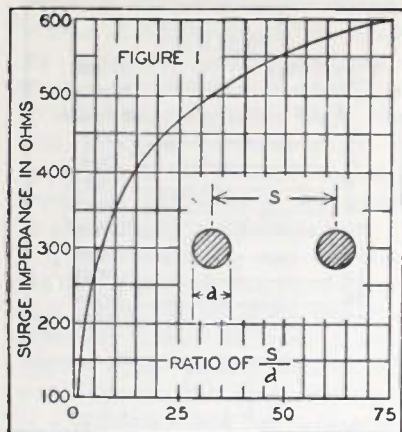

answer so long as the substituted values for  $S$  and  $d$  are in the same units.

Equation (4) is surprisingly accurate so long as the wire spacing is relatively large as compared to the wire diameter. Error in computation will arise when the two wires are in close proximity to each other. An examination of the formula will also show that it is impossible to obtain with the open type of two wire line a characteristic impedance of less than 83.08 ohms, for this is the computed surge impedance under the extreme conditions where the wire spacing  $S$  is equal to the wire diameter  $d$ . This would be the hypothetical condition where the two wires would absolutely touch one another and yet be insulated from one another. It can be seen that the losses in such a theoretical line would be quite high, so for commercial applications surge impe-

dance values of less than 200 ohms are seldom used in the open type two wire line and even at this comparatively high value of  $Z_s$ , the wire spacing  $S$  is still uncomfortably close, being only 5.3 times the wire diameter  $d$ .

Chart No. 1 gives in graphical form the correct surge impedance of any two wire line if the ratio of  $S$  to  $d$  is known. The chart is self explanatory and transmission engineers will find it sufficiently accurate for practical purposes. To assist in arriving at the ratio of  $S$  to  $d$ , wire diameters in inches for the commonly used wire gauges are given in Table A.

As a further aid to those who are not mathematically inclined and who prefer to construct their transmission lines from even more practical data, the reader's attention is directed to Table B. Here the correct spacing in inches is given for all practical wire sizes for lines having a  $Z_s$  of 200, 300, 400, 500 and 600 ohms.

Formula (4) is the general form in which the equation of a two-wire line is mostly given. However, in practical cases the surge impedance that is desired usually is known as is also the wire size to be used, and the unknown for which the solution must be made generally is  $S$ , the wire spacing. By transposition and solving for  $S$ , Formula (4) is given the more practical form

$$S = \frac{d}{2} \text{ anti-log } \frac{Z_s}{276} \quad (5)$$

where  $S$  and  $d$  have the same meaning as in (4).

The two parallel wire line, while easy to construct, does have three obvious disadvantages. First, the line does radiate some energy; second, its surge impedance at convenient wire spacings is far too large to match directly to the center of a half wave Hertz (74 ohms), or to the ground junction of the quarter wave Marconi (37 ohms), without a coupling network, and third, the two wires must be balanced electrically to ground.

Since both the second and third disadvantages apply to the type of antenna used mostly on the lower broadcast and police frequencies the co-axial cable has come into almost universal use for connecting such antennas to the transmitter, the two wire open line still remaining popular for the higher frequencies.

To one who is not familiar with concentric tube lines the neatness of the installation and the seemingly small diameters of such lines even for relatively high powers provide a striking contrast to the two wire feeder system. Typical outside dimensions and power ratings for unmodulated carrier conditions are: 1000 watts, between  $\frac{1}{2}$  and  $\frac{5}{8}$  inches O.D.; 5000 watts, approximately  $\frac{7}{8}$  inches O.D.; and 50,000 watts,  $2\frac{1}{2}$  to 3 inches O.D. Most cables commercially obtainable approximate a surge impedance of 70 ohms.

A cross sectional end view of a co-axial cable is shown in figure 2.

As in the parallel wire line the

power lost in a properly terminated line is the sum of the effective resistance losses along the length of the cable, and the dielectric losses between the two conductors. In a well designed line both are of negligible importance, the actual measured loss in a good line being less than 0.5 per 1000 feet at one megacycle.

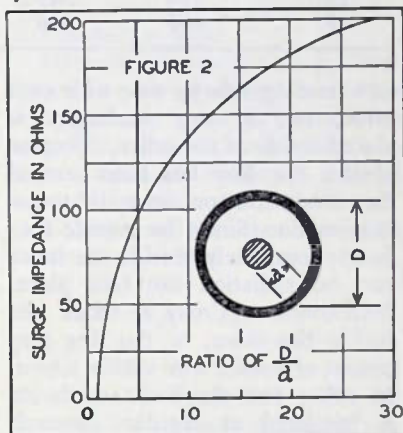

Of the two losses the effective resistance loss is the greater, and since it is largely due to the "skin effect" the line loss, all other conditions the same, will increase directly as the square root of the frequency. Such lines are almost always made of soft copper tubing, having a very low d.c. resistance, which with the large conductor surface available (high frequency currents tend to travel on the outside of a conductor) will make the line losses of negligible importance for the line lengths normally used.

Examination of figure 2 shows that instead of having two conduc-

TABLE B  
*Correct Wire Spacing in Inches, Center to Center,  
 for Surge Impedance Values of*

Wire Gauge Number B & S	200 Ohms	300 Ohms	400 Ohms	500 Ohms	600 Ohms
6	.42	.987	2.28	5.26	12.1
8	.339	.783	1.81	4.17	9.61
10	.269	.621	1.44	3.31	7.62
12	.213	.493	1.14	2.62	6.04
14	.169	.391	.903	2.08	4.79
16	.134	.309	.716	1.65	3.80
18	.106	.246	.568	1.31	3.01

tors running side by side with each other, one of the conductors is placed inside of the other. Because of this the line has been termed the concentric or co-axial transmission line. Since the outside conductor completely shields the inner one, no radiation can take place. Both conductors may be tubes, one within the other, or the line may consist of a solid wire within a tube. In either case the inner conductor is insulated at regular intervals from the outside tube by a circular insulator of either pyrex or some non-hygroscopic ceramic material with low high-frequency losses. The insulators are slipped over the inner conductor and held in place either by some system of small clamps or by "crimping" the wire immediately in front of and behind each insulator. If the insulator fits snugly over the inside conductor, this latter method is to be preferred as the mean or average distance of the outside diameter of the inside conductor from that of the inside diameter of the outside conductor remains more uniform and the calculated results will be more ac-

curate than if some other system using clamps or small metal collars to hold the insulating spacers are used. Moisture must be kept out of the tube if best results are to be secured. It is therefore necessary to solder or otherwise join tightly the line sections together so that no leak occurs.

This only prevents water from seeping into the line in outdoor installation. The co-axial cable may be either buried in the ground or suspended above ground. In most installations the tubing is buried in the ground—going into the ground at the transmitter house and coming out of the ground directly at the base of the antenna, at the tuning house.

To avoid condensation of moisture on the inside walls of the line it is the general practice to fill the line with dry nitrogen gas at a pressure of approximately 35 pounds per square inch. The nitrogen gas not only prevents the gathering of moisture but also detects any leakage in the line. If pressure cannot be maintained uniformly in the line over long periods of



time, it is a certain indication that somewhere there is a leak. Naturally this leakage generally takes place at the points where the sections are joined together in what is presumably a watertight and airtight connection.

Filling a line with dry nitrogen gas also greatly increases its power capacity, a power capability rating of three to one being quite common for the nitrogen filled line as compared to a line operating under normal atmospheric pressures. Nearby metallic objects cause no loss and the cable can be run up air ducts, wire conduit, elevator shafts just as easily as a flexible hose. Insulation troubles can be forgotten.

It is this characteristic which makes the co-axial cable so valuable where transmitter installations must be made in large buildings, such as is the case with a majority of police transmitters. Even at frequencies as high as 100 megacycles line losses can be kept within tolerable limits. For the smaller powers flexible co-axial cable can be secured in long line lengths up to several hundred feet, thus doing away with the need for couplings or sections.

The derivation of the formula for computation of the characteristic surge impedance of a concentric tube line also goes back to the fundamental equation given, (1). Stated in its most general form it is given as

$$Z_s = 138 \log_{10} \frac{D}{d} \quad (6)$$

Where:

D is the inside diameter of the outer tube, and

d is the outside diameter of the inner tube.

As in the case mentioned before the dimensions of D and d may be in millimeters, centimeters, or inches so long as both are given in the same units, since this involves only a ratio.

However, this formula is not that which is most generally used since here again we generally know what surge impedance we want and it is more practicable to have a method for solving either for D or d.

Transposing the above formula to a more practical form we have:

$$D = d \text{ anti-log} \frac{Z_s}{138} \quad (7)$$

Or, where D is known and it then becomes necessary to solve for d to obtain a given desired impedance, then:

$$d = \frac{D}{\text{anti-log} \frac{Z_s}{138}} \quad (8)$$

Remembering again those of our friends who do not care to juggle equations, the attention of the reader is called to Figure 2, which gives the graphical solution covered by the formulas given.

It can be seen that the chart reads either way:  $Z_s$  can be found instantly when knowing the ratio of D/d, or conversely the ratio of D/d can be found at once for any given surge impedance,  $Z_s$ .

## ADVANCED 10-20 SUPERHET

BY H. G. MUSTERMANN

IN THIS article is described a receiver built specifically for 10-meter work. Nevertheless 20-meter coils are also provided, as a receiver that performs well on 10 always works a little better on 20. A set of 5-meter coils is contemplated for the near future. This will permit the reception of crystal controlled transmitters on this band.

High gain in the r.f. stages is of most importance for a 10-meter receiver and is most difficult of attainment. High-inductance coils and small tuning capacities are imperative if this high gain is to be realized. For this reason the somewhat odd construction shown in the high-frequency section is used. Four 20- $\mu\text{mfd}$ . midget tuning condensers are ganged to a PW-0 type drive unit. The 500-degree scale of this unit provides adequate mechanical band spread. The coil sockets are placed as close as possible to the condensers in a raised position. This gives shortest tank leads. APC air trimmers are mounted right in the coils. The first r.f. stage is trimmed with a panel mounted condenser ( $C_9$ ). This takes care of antenna variations.

A shelf of  $\frac{1}{8}$ " thick aluminum

is mounted an inch above the chassis, and supports the entire high-frequency section with the exception of the drive unit. This is bolted direct to the chassis, being raised a half inch. Both the drive unit and the shelf are fastened to the chassis by means of long 6/32 bolts and Cardwell half-inch spacers. Two of the latter make up the inch height for the shelf. This shelf should be fastened in about a dozen places to the chassis to keep it rigid.

Another set of half-inch spacers raises the tuning condensers to the proper height above the shelf for ganging to the drive unit. Great care should be exercised in lining up this unit with the four condensers. Shim brass washers should be added to the condenser mounting spacers to place the condensers at the exact height necessary. To check the alignment, loosen the couplings. They should be able to spin free on the shafts. The National type TX-9 were found to be superior to others in eliminating play. It is most important that there be no play between the drive unit and the oscillator condenser.

The resistors and bypass condensers for the high-frequency section

are mounted beneath the shelf. They should be wired in place before the shelf is fastened to the chassis. Connection wires between this unit and the parts beneath the chassis are run through grommets in the chassis. They should be cut about a foot long and connected to the shelf first. Liberal use of double mounting lug strips, both beneath the shelf and beneath the chassis, tie all loose wires and small parts securely in place.

The back partition is fastened to the chassis with a length of half-inch aluminum angle. The inter-stage shields each have their rear and bottom edges turned over a half inch. Use of angle strips at these points instead of the turned-over edges would be an easier method of construction. The holes in these shields through which the shaft assembly runs should be large enough so that they do not touch. The hole in the panel through which the drive unit shaft extends should also be made quite large—about an inch in diameter.

#### *Intermediate-Frequency Amplifier*

The two-stage i.f. amplifier incorporates both a crystal filter and a noise silencer. Most of the 10-meter work at W2TP is done on phone, therefore a crystal filter favoring phone signals was felt to be most desirable. The new Brush Crystal Transfilter provides a bandwidth which is a compromise between that of the regular crystal-filter and the straight transformer-coupled amplifier.

Jim Lamb's crystal filter circuit

provides best impedance match to and from the Transfilter, which is of low impedance. The crystal is across but half of the input transformer, while the output transformer is tapped down. Both of these transformers are of standard type, the output transformer being an ordinary beat oscillator type the same as used in the beat oscillator stage. The only difference is that the b.f.o. transformer used for crystal output has the internally mounted grid leak and condenser removed. This is a simple process.

Two mica fixed condensers are connected across the secondary of the Transfilter input transformer to provide a capacitative center tap. The 50- $\mu$ fd. condenser,  $C_{10}$ , is mounted under the chassis and is controlled with an extension shaft and insulated coupling. As both sides of this condenser are above ground, an insulated mounting is necessary. A small piece of bakelite does the trick. This condenser is the selectivity control when the Transfilter is switched in. With the filter switched out it serves to tune the input transformer secondary to resonance. The regular internally mounted secondary trimmer condenser, not shown in the diagram, is left in circuit. It is useful in determining the setting of  $C_{10}$ , both being connected in parallel.

The crystal switch is mounted on a bracket under the chassis and is also controlled from the panel with an extension shaft and coupling. It should be wired so that when

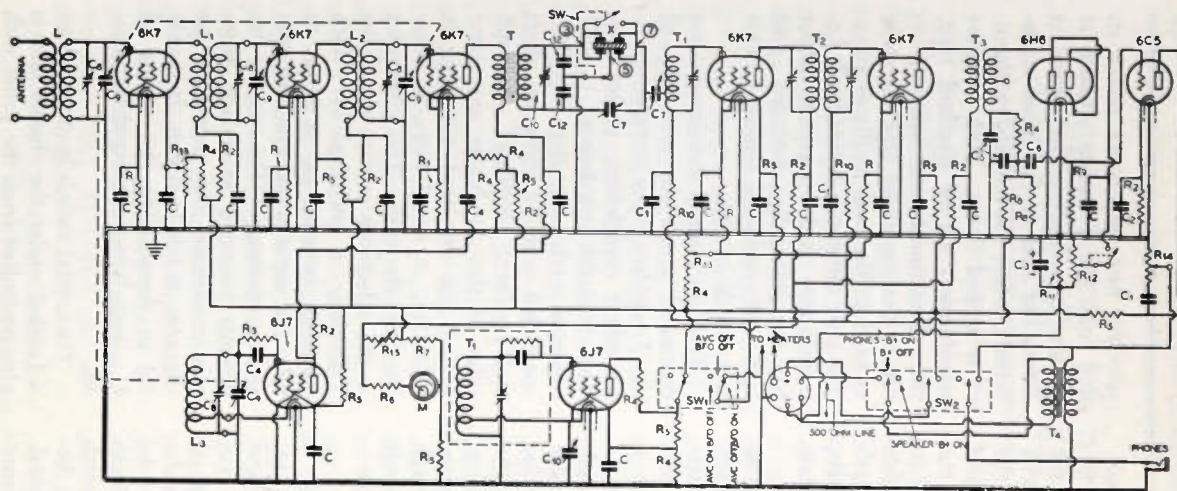

**SCHEMATIC DIAGRAM OF THE RECEIVER PROPER. NOTE CRYSTAL FILTER CIRCUIT**

C—0.1 mfd. 400 volt tubular paper condenser (17)  
 C<sub>1</sub>—0.1 mfd. 400 volt tubular paper condenser (4)  
 C<sub>2</sub>—5 mfd. 50 volt tubular electrolytic condenser (1)  
 C<sub>3</sub>—25 mfd. 50 volt tubular electrolytic condenser (2)  
 C<sub>4</sub>—0.001 mfd. mid-

get mica condenser (2)  
 C<sub>5</sub>—0.0025 mfd. mid-get mica condenser (2)  
 C<sub>6</sub>—0.006 mfd. mid-get mica condenser (1)  
 C<sub>7</sub>—Mica trimmer condenser, 30 mmfd.  
 C<sub>8</sub>—Air trimmer condenser (6)

C<sub>10</sub>—Midget tuning condenser (2)  
 C<sub>11</sub>—Dual 8-8 mfd. filter condenser (1)  
 C<sub>12</sub>—0.0005 mfd. mid-get mica condenser (2)  
 R—350 ohms, 1/2 watt (4)  
 R<sub>1</sub>—1,500 ohms, 1/2

watt (1)  
 R<sub>2</sub>—2,000 ohms, 1/2 watt (7)  
 R<sub>3</sub>—25,000 ohms, 1/2 watt (1)  
 R<sub>4</sub>—50,000 ohms, 1/2 watt (7)  
 R<sub>5</sub>—100,000 ohms, 1/2 watt (7)  
 R<sub>6</sub>—500 ohms, 1/2 watt (1)  
 R<sub>7</sub>—1,000 ohms, 1/2 watt (1)

R<sub>8</sub>—1 megohm, 1/2 watt (2)  
 R<sub>9</sub>—2 megohms, 1/2 watt (1)  
 R<sub>10</sub>—200,000 ohms, 1/2 watt (2)  
 R<sub>11</sub>—500 ohm 25 watt resistor (1)  
 R<sub>12</sub>—10,000 ohm potentiometer (1)  
 R<sub>13</sub>—25,000 ohm potentiometer (2)  
 (See Next Page)



the crystal shorting section is closed the other section is opened, and vice-versa. This removes the crystal entirely from circuit in the "off" position of this switch.

Two mica trimmer condensers,  $C_7$ , are also used in the filter circuit. One serves to adjust the coupling to the Transfilter output transformer, while the other is useful in balancing the crystal bridge circuit.

Four types of transformers are used in the i.f. amplifier. The first,  $T_1$ , is of the iron-core type. This helps to offset any signal loss in the Transfilter circuit. The output transformer,  $T_{11}$ , is a standard b.f.o. type, as previously mentioned, with the grid leak and condenser removed.  $T_2$  is of the air-core type, while  $T_3$  is a diode transformer with untuned, low-impedance secondary. The center tap of the secondary is unused.

#### *The Silencer System*

Various types of noise-silencer circuits were available for this receiver. The Lamb noise silencer, cut in ahead of the filter circuit,

is theoretically the most effective. This would, however, involve the addition of three more stages, an extra i.f. stage and two silencer stages. The simplified Watzel-Bohlen second detector silencer circuit is therefore used. The Griffin "saw" automatic silencer was considered, as was an automatic version of the present silencer which was worked out for this receiver by Bohlen and Watzel. Both Griffin and Watzel recommended the manually-controlled circuits in preference to the automatic for most effective noise suppression on weak signals. More elaborate versions of the circuit used at present in the receiver are theoretically superior—in practice the present circuit is as effective as any, as well as being the simplest in point of number of parts necessary. The built-in switch on the noise silencer control cuts it completely out of circuit when reception of strong signals is desired without blocking.

The beat oscillator circuit is standard except for the addition of

#### RECEIVER DATA (Continued)

$R_{14}$ —500,000 ohm potentiometer (1)  
 $R_{15}$ —500 ohm wire-wound potentiometer (1)  
 $R_{16}$ —500 ohm 10 watt resistor (1)  
 $SW$ —Type 3242J switch  
 $SW_1$ —Type 62 switch  
 $SW_2$ —Type 763 switch  
 "PHONES"—Type A1—single-circuit phone jack

$T$ —Type IFC (iron core) 465 kc. i.f. transformer  
 $T_1$ —Type IFCO beat oscillator type transformer  
 $T_2$ —Type IFC (air core) 465 kc. i.f. transformer  
 $T_3$ —Type IFD twin diode transformer  
 $T_4$ —Type T-6226 plate-to-line transformer  
 $T_5$ —Type T-6194 line-

to-single or P-P grids.  
 $T_6$ —Type T-6806 pentode to 10 or 2000 ohms  
 $T_7$ —Type T-6409 150 ma. smoothing choke  
 $T_8$ —Type T-7429 150 ma. swinging choke  
 $T_9$ —Type T-7062 power transformer, 745 volt c.f. at 145 ma., 6.3 volts at 4.5 amps., 5 volts at 3 amps

a panel vernier control. This is mounted under the chassis the same as the selectivity control condenser. As the frame of the condenser is at ground potential it is bolted directly to the chassis. Another extension shaft and coupling are used. Cardwell couplings are preferable for use under the chassis because they are small.

chassis feeds the 6F6 pentode output tube. As a large Western Electric cone speaker is used, the output transformer has an impedance of 2000 ohms to match the speaker. The wattage output of the 6F6 is more than sufficient to take care of the cone speaker. Reasonable room volume is all that is required.

A common ground to the chassis is shown in the power supply diagram. If the receiver and power chasses are connected together, this will short the noise resistors  $R_{11}$  and  $R_{12}$ . It would be better to float the minus B lead in the power unit free of the chassis to avoid this.

The best of receivers is handicapped if it cannot be easily and effectively controlled. A glance at the front panel photo shows that this receiver is quite adequately controlled. The upper left knob is the antenna trimmer, this being connected across the first r.f. coil in place of the APC trimmers used on the other high-frequency stages.

This takes care of different antennas without resorting to a screw-driver adjustment. The corresponding control at the upper right of the panel is the i.f. gain control.

Eight controls are ranged along the bottom of the panel. That at the extreme left is the audio gain control. It is connected so as to be effective for both earphone and

### COIL-WINDING TABLE FOR 10-METER BAND

Coils	No. Turns	Winding Length	Pri-Sec. Spacing
L Pri.	3	Closewound	
L Sec.	4½	½"	¼"
L1 Pri.	4	Closewound	
L1 Sec.	4¾	½"	¼"
L2 Pri.	4	Closewound	
L2 Sec.	4¾	½"	¼"
L3 Cat.	1½	Closewound	
L3 Sec.	4½	½"	⅛"

### FOR 20-METER BAND

L Pri.	6	Closewound	
L Sec.	9¾	¾"	¼"
L1 Pri.	7	Closewound	
L1 Sec.	10¾	7/8"	¼"
L2 Pri.	7	Closewound	
L2 Sec.	10¾	7/8"	¼"
L3 Cat.	2½	Closewound	
L3 Sec.	11	7/8"	⅛"

All coils wound with No. 24 d.s.c. wire. Cathode sections of L3 coils are separate windings. APC-25 trimmers in L1, L2 and L3.

### Audio System

Two audio stages are employed, one on the receiver chassis and one on the power supply chassis. The 6C5 on the receiver proper switches either to a pair of phones or to an output transformer. This transformer has an output impedance of 500 ohms. A 500-ohm line-to-grid transformer on the power-supply

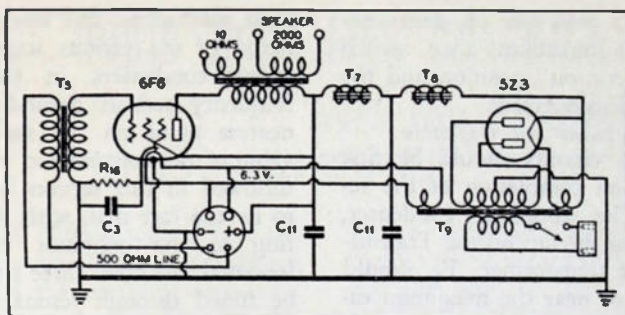

SCHEMATIC DIAGRAM OF POWER AMPLIFIER AND  
POWER-SUPPLY UNIT

speaker use. The next control, going from the left, is the beat oscillator vernier condenser. Next in line comes the r.f. gain control. This varies the screen voltage on the first r.f. stage. The small knob just to the left of the dial controls the phone-speaker-B plus switch. In the center position this switch cuts off the high voltage, this position being used while transmitting. On either side of the center position the high voltage is on. In the left position the phone circuit is closed, the phones being plugged into a jack on the back of the chassis, while in the right position the 500-ohm line to the output stage is closed.

The small knob just to the right of the dial controls the a.v.c. and b.f.o. circuits. This is also a three-position switch, giving the three switching combinations shown on the diagram. The ground contact of this switch is bent slightly so that it also makes contact when the switch is in the center position.

This provides an "a.v.c.-off — b.f.o.-off" position which is useful at times.

The next three controls, in order, are the noise silencer potentiometer, Transfilter switch and selectivity control. The noise silencer has a built-in switch to throw it out of circuit, while the filter switch is of the two-position type.

The signal strength meter is of the balanced bridge type. This is of value in determining the comparative strength of incoming signals, also in providing a check on the variations in strength of any particular station. In order to secure the most easily readable scale a standard meter from an RME receiver is used. This is calibrated in both an R scale and in decibel variations. These meters can be secured direct from the Radio Mfg. Engineers in Peoria, Ill. A 500-ohm variable resistor is mounted on the chassis for adjustment of the meter calibration. This should be adjusted so that the meter needle

reads zero with the i.f. gain control set at maximum, a.v.c. switch in the "a.v.c.-on" position and the antenna disconnected.

#### *Adjustment and Operation*

The i.f. circuits should be first lined up on completion of the receiver. The coupling condenser,  $C_7$ , feeding the tap on the Transfilter output transformer,  $T_1$ , should be set at or near the maximum capacity. The other balancing trimmer condenser, also labelled  $C_7$ , should be set at or near minimum. Neither setting is critical. With the Transfilter switched in and the a.v.c. turned on, a test signal should be tuned in to a peak reading on the R meter. All the i.f. circuits should be then trimmed for maximum meter swing.

With the crystal switched out the secondary trimmer in transformer,  $T_1$ , should be adjusted so that the selectivity condenser,  $C_{10}$ , tunes to resonance in its center position. This will give a proper range of control for this latter condenser with the Transfilter both in and out of circuit.

If the secondary windings on the high-frequency coils are made identical as to number of turns and spacing, little difficulty should be had in tracking these circuits. A slight change in the spacing will bring the stages into perfect track.

No tendency toward oscillation is had anywhere in the receiver. This is due to the care taken in

both mechanical and electrical isolation of the various stages. The bypass condensers in the high-frequency section ground to the nearest point on the shelf. The value of the construction procedure followed in this section is attested to by the fact that, with the coupling to the oscillator condenser loosened, the other three stages may be tuned through resonance, with the dial, without the slightest effect on the frequency of a c.w. signal. This is a bit unusual in 10-meter supers. A ground bus is used to support the bypass condensers in the i.f. section in a convenient position. The shield lug of each tube socket in the receiver should be soldered to a lug on its adjacent socket mounting bolt. In the i.f. section each lug should again connect directly to the nearest point on the ground bus.

The operation of the Transfilter has proven its installation to be worthwhile. With the filter in circuit it is found that, while the signal drops only slightly as compared to the no-filter position, the background noise is either greatly reduced or eliminated. The setting of the selectivity control determines the effectiveness of the Transfilter. In its most selective position it is possible to bring through, with little or no QRM, a weak phone signal that is blotted out without the filter by a strong adjacent signal.



## AUDIO AMPLIFIER CHECKING *with the Oscillograph*

• BY JOHN F. RIDER

WITH THE introduction of the new small screen cathode-ray tubes and the resulting economies which they make possible, an ever increasing number of servicemen are becoming owners of cathode-ray oscillographs. Now, more than ever before, many servicemen are surveying these shiny new instruments with their array of knobs and wondering just how the new instruments will help them speed up their service work.

Those using the cathode-ray oscillograph for the first time will probably be disappointed. It is going to take a considerable amount of experience and study before one will be able to save time in service operations through the use of the oscillograph. At the beginning, if one is an average serviceman, he will attempt to do things with the oscillograph that it was never meant to do. He will find the large number of controls confusing; and he will run across all sorts of puzzling effects. But with experience and study, an understanding of just what the instrument is capable of will come, and then he will find himself amply repaid for all the effort expended.

The peculiar adaptability and usefulness of the cathode-ray oscillograph over all other types of measuring instruments is that it permits the visual observation of waveforms. Whereas the ordinary type of instrument can tell us only the magnitude or the size of a given voltage or current, the oscillograph can tell us not only the magnitude but its waveform. As such it is to be expected that the oscillograph will be especially useful for making measurements which involve waveform considerations, while other instruments will be better adapted for measurements where the waveform is of no special importance.

The greatest usefulness of the oscillograph in the service field lies in the ease with which it makes possible the checking of audio amplifiers. We do not mean to imply that the oscillograph cannot be used for making any r-f. measurements, but rather we should like to dispel any impression that measurements, quantitative or otherwise, can be made on r-f. amplifiers in receivers. There are two reasons why the oscillograph, as produced commercially for service use, is not adapted for

making r-f. measurements. In the first place, the signal voltages found in the radio and intermediate-frequency amplifiers of receivers are too small to permit a reasonable deflection of the cathode-ray beam and in the second place, the input capacity of commercial oscillographs is of the order of 50  $\mu\text{mfd.}$ , so that the detuning of the circuits caused by placing the oscillograph across the r-f. circuit renders the test meaningless.

On the other hand, in the case of audio-frequency measurements, the signal levels found in receivers are appreciably higher and furthermore it is possible to use the internal amplifiers included in commercial oscillograph units. The input capacity of the oscillograph for audio-frequency work is, of course, small enough to be entirely negligible. We further stress the application of the oscillograph to a-f. measurements because most r-f. measurements can be made indi-

rectly through their effect on the final a-f. waveform. Thus, for example, if distortion is taking place in the mixer stage of a receiver, then this can be located by noticing that no distortion is present when the signal is applied to the first i-f. stage but that it does appear when the signal is applied to the first detector.

With this article we present a number of interesting oscillograms which explain graphically the operation of audio amplifiers and which should be of value in that they illustrate both normal and abnormal conditions of operation. To avoid the necessity for constantly referring to the text, we have included a description of each oscillogram in the accompanying caption. While the oscillograms shown by no means constitute a complete treatment of all the phases of audio-amplifier tests with the oscillograph, the more important cases are treated.

*(See following pages for oscillograms.)*

## *Talking Tape Keeps Potato Growers Posted*

**A** NEW "TALKING-TAPE" machine to furnish potato growers with up-to-the-minute market news has been developed by Bell Laboratories. This automatic crop news service is a new recording and reproducing device, the first installation of which was offered on an experimental basis by the New Jersey Bell Telephone Co. to the Department of Agriculture.

The device employed is a magnetic tape recorder. As the tape passes under the pole-pieces of an electromagnet, voice currents flowing in its coils make a permanent magnetic pattern in the tape. When passed under the pole pieces a second time, this varying magnetism sets up currents in the magnet coils which, suitably amplified, are a reasonably faithful copy of the original currents. This device appears to have possibilities for news distribution.

## What the Cathode-Ray Oscillograph Shows

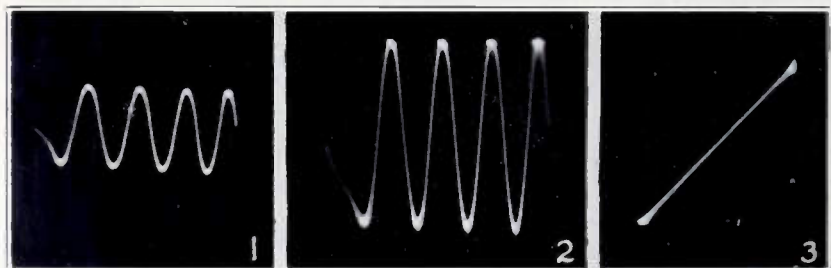

### Normal Amplifier Operation

Fig. 1. The input signal obtained by using the linear sweep on the horizontal plates of the oscillograph and connecting the vertical plates to the input of the amplifier stage. Fig. 2. Amplified output of the stage, obtained by connecting the vertical plates to the amplifier output. Note that both these oscillograms have identical waveforms, but different amplitudes. Fig. 3. Amplifier characteristic showing the linear relation between the input and output voltages; this pattern was obtained by connecting the vertical plates to the output and the horizontal plates to the input of the stage.

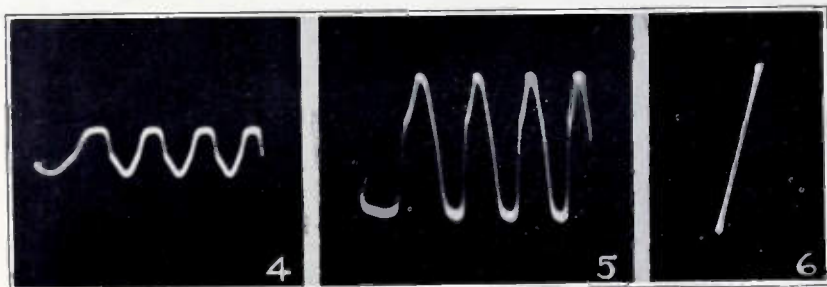

### Normal Amplifier Operation with Complex Wave Input

Figs. 4, 5, and 6 are similar to Figs. 1, 2, and 3, except that these oscillograms were made with a complex wave input instead of a sine wave. The output oscillogram, Fig. 5, is similar to the input, Fig. 4, except that the positive and negative peaks are reversed. This occurs also in Fig. 2, but does not show as the peaks are alike. This phase reversal is characteristic of a tube, which shifts the phase by about  $180^\circ$ . Fig. 6 shows that the plate voltage changes follow the input voltage changes, as the trace is a straight line. Note that the oscillograph controls for Fig. 6 are adjusted for equal gain of both amplifiers, so that the trace represents the actual grid and plate excursions to the same scale. In Fig. 3 the oscillograph controls were adjusted to obtain a trace inclined at about  $45^\circ$ . This latter adjustment makes it easy to see if the trace is linear.

## Overload of an Amplifier

Figs. 7 to 14 were made by connecting the vertical plates across the amplifier output and using a sine-wave input. For a low value of input signal, Fig. 7 shows the output to be a sine wave and Fig. 8 shows the corresponding characteristic to be linear. As the input signal is increased, Fig. 9 shows an increased output, but with some distortion, since the stage is operating at a high signal level. Note that the upper part of the characteristic, Fig. 10, is slightly curved.

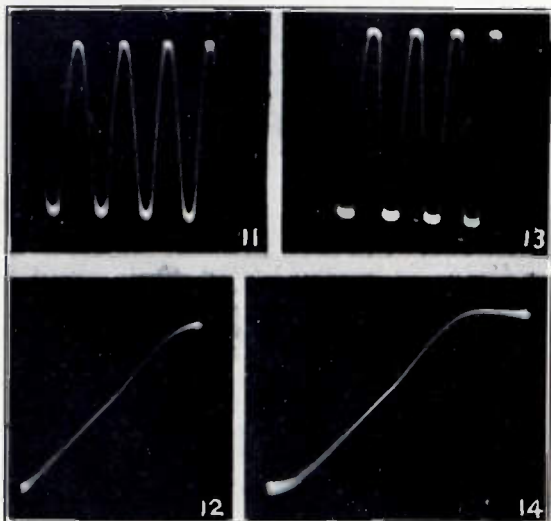
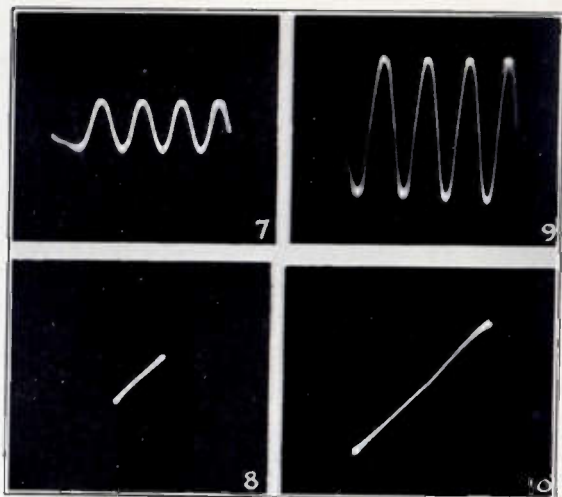

A further increase in signal input does not produce an appreciable increase in output, Fig. 11, but it does introduce distortion, shown by the flattening of the peaks. The characteristic, Fig. 12, shows a greater flattening of the peaks. A still greater input increases the distortion, as shown in Figs. 13 and 14.





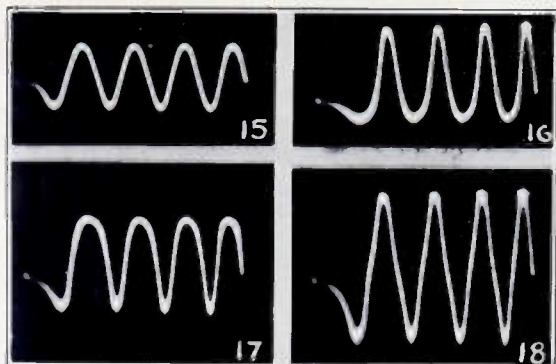

### Push-Pull Amplification

Fig. 15 is the sine-wave input to the push-pull stage. When only one tube is excited, the output, Fig. 16, shows the distortion, due to the curvature of the tube characteristic. When the other tube is excited, the output shows the same type of distortion, Fig. 17, with the phase reversed. With both tubes excited, the flat peak produced by one tube combines with the sharp peak produced by the other, so the overall output is symmetrical, Fig. 18, and can have no even harmonics.

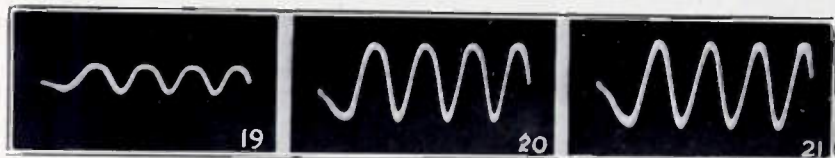

### Distortion Due to Load Mismatch

When a tube is improperly matched to its load, distortion is generally produced. Fig. 19 shows the distorted output caused by too small a value of load impedance, while Figs. 20 and 21 show how the distortion is reduced for increasing values of load impedance. A power loss also occurs when the amplifier is incorrectly matched to its load.

### Estimation of Gain

The input-output voltage characteristic can be used to indicate the approximate gain of a stage. Figs. 22 to 25 show this characteristic for a stage of variable gain, the input signal (horizontal deflection) being constant for all traces. The gain equals the ratio of the vertical and horizontal projections, drawn dotted on the oscillograms in white ink. Note that the gain increases as the vertical height increases. Both oscillograph amplifiers must be adjusted for equal gain to obtain accurate results.

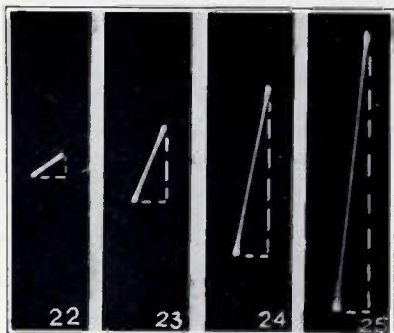

## Phase Distortion

The signal through an a.f. amplifier is a complex wave and contains many different frequencies. If too small a value of coupling capacity is used in a resistance-coupled stage, the relative phases of these frequencies will be altered, so that the output will not be the same as the input. Fig. 26 shows the input signal and Fig. 27, how the waveform is changed when a small coupling condenser is used. As the coupling capacity is increased, Figs. 28 and 29, the output waveform becomes more nearly the same as the input, Fig. 26. More important than the phase distortion, which normally is undetectable by the ear, is the frequency distortion, which takes place under the above conditions.

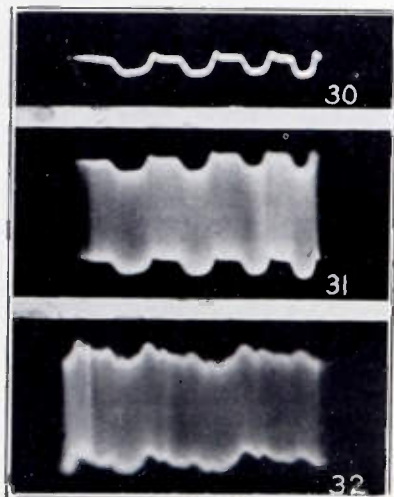
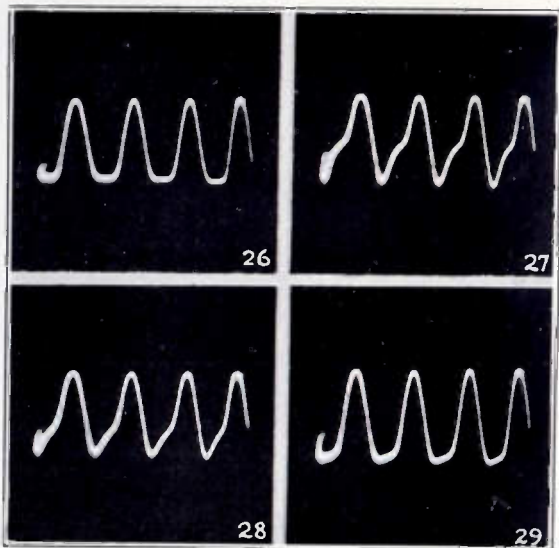

## Hum and Noise

It is sometimes difficult to obtain a stationary pattern because of the presence of hum voltage. The waveform of the hum voltage which may be present is shown in Fig. 30 and the same voltage superimposed on an a.f. signal may be seen in Fig. 31. Note that the pattern appears solid because the sweep is synchronized at a multiple of the hum frequency. When the receiver output contains noise, the pattern will appear fuzzy, as shown in Fig. 32.



## Improving

# WEAK SIGNAL RESPONSE

## in Superhets

BY MORTON E. MOORE

IN THE article to follow I have attempted to set forth and explain certain principles which I have found to be of the utmost importance in the design and construction of a super-heterodyne receiver for amateur use.

The problem of the design of a receiver for the specific purpose of weak signal reception is materially different from the problem of designing a receiver for any other use whatsoever.

It is safe to say that the majority of sets used by the amateur do not satisfactorily meet the requirements for a receiver for the reception of weak signals.

What is required is that truly weak signals shall be sufficiently amplified to the point that they may be heard, and that they be heard with as little accompanying interference as possible.

We are therefore interested in the design of weak signal amplifiers as opposed to the design of high level amplifiers. We are interested

primarily in the detection of weak signals and not in the linear detection of high-level signals, since in general we need only to be able to understand the intelligence of a radiophone signal, without regard to the problem of high fidelity reception, and since the reception of c.w. signals will permit of all the distortion within the receiver which would arise from any system of detection or amplification.

### *"Low C" Tuned Circuits*

Starting with the tuned circuit, it has been repeatedly demonstrated that the best results, as regards amplification, are to be had when circuits having a high L-C ratio are employed. When low L circuits are employed, the impedance of the parallel-tuned circuit is considerably lower than when high L circuits are employed, which simply means that the induced voltage across the grid of the tube is correspondingly lower and the gain of the amplifier correspondingly less than when high L circuits are em-

ployed (also low  $C$ , obviously). The writer has made calculations of the L-C ratios of the tuned circuits employed in the r.f. and detector circuits of amateur receivers manufactured by several nationally known manufacturers, the above mentioned circuits supposedly having very high L-C ratios. The writer has also made calculations of the L-C ratios which it is *possible* to use on the basis of a reasonable allowance for minimum capacity. The possible L-C ratios are usually several times greater than the L-C ratios employed by the manufacturer. It is sufficient to say that the highest possible L-C ratios will be obtained only when the minimum capacity of the circuit is kept very low, and the coil wound so that it tunes to the highest required frequency with this value of capacity. This means that there shall be no padding condensers used for band spreading; the use of padding condensers can be obviated by the use of small condensers of fixed capacity in series with the tuning condensers, adjusted so that the total variation of capacity effected by varying the tuning capacity is sufficient to give the required band spreading.

#### *Circuit Resistance*

The L-C ratio is, however, not the only thing which affects the performance of the tuned circuit. The effective resistance of the circuit has a very large bearing upon the performance of the circuit. Both the impedance and "Q" of a tank circuit are inversely proportional

to the circuit resistance  $R$ , and the highest values of impedance and circuit  $Q$  will result when  $R$  is at a minimum. Now it so happens that the presence of a conducting material in the field of a coil increases the effective resistance of the coil through losses in the material as induced eddy currents, and if the material should have a permeability greater than unity, then also through hysteresis.

#### *Coil Shielding*

Until recently it has not been feasible to manufacture i.f. transformers with iron cores because with materials formerly used the core loss was so great that the performance of the circuit would not equal the performance obtained with air cores. The moral of this is to keep the shielding well away from the coils, especially at the ends of the coils. From the theory of electricity and magnetism it is possible to calculate the effect upon a given coil by the introduction of a conducting material within its field, but unless certain simplifying assumptions are made, the calculations are quite involved, and for practical application to the design of shielding are rather without value, since they are very laborious to make, and since the simplifying assumptions usually only approximate the actual case to begin with. However, a few simple suggestions are in order.

Have the coil removed from the shielding at least two coil diameters at the ends and at least one coil diameter at the sides with normal



shapes of coils such as the National SW-3 coils. For very long coils of small diameter, more space should be left at the ends, while for coils of large diameter and short length, more space should be left at the sides. The difference between proper and improper shielding can hardly be appreciated without actually comparing the two.

I have in mind a certain pre-selector which I constructed in one of my weaker moments. The pre-selector was housed in a very small can, coil and all, and fitted inside the cabinet of an FB7 receiver. I was hardly able to notice any change in the performance of the receiver after installing the pre-selector. There was no image suppression, and the signal-to-noise ratio of the receiver was still the same. I later took the pre-selector from inside the cabinet and tacked it onto the outside, putting the coil in the very center of a spacious shield can. The images completely disappeared, the signal-to-noise ratio was immensely improved, and the pre-selector now was really a worthwhile addition. And the only change was to put the coil in the center of a large can where it could really get down to business. Pull those padding condensers out from inside your pre-selector and first detector coil forms at least!

#### Coil Construction

As to coils themselves, there is not much information available on

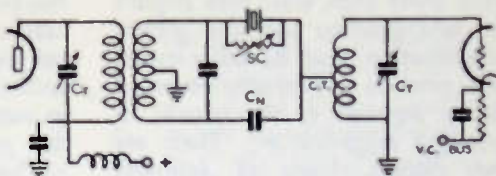

#### THE MOST SUCCESSFUL CRYSTAL FILTER CIRCUIT TRIED.

$C_T$ —Tuning con- SC—Variable selec-  
denser tivity control  
 $C_N$ —Neutralizing tivity control  
condenser (see text)

form factors, wire sizes, etc. The design of coils for high frequency work seems to be a moot question, and as to the best design, there is not much which can be definitely said. However, again a few generalities are in order. Small coils, wound with small wire, are out. Coils should be of reasonable diameter. Further, if the turns are spaced some distance apart the performance will be improved. The National SW-3 coils furnish an example of construction embodying the above principles.

#### Vacuum Tube Choice

Having disposed of the tuned circuit, let us now consider the other element in the circuit which requires attention, the vacuum tube itself. The function of a vacuum tube in an amplifier is to amplify the signal as much as possible, or as much as is required. There are many different types of tubes available for amplification, but for the purpose of r.f. amplification the tetrode and the pentode seem the

only likely ones, since they require no neutralization and give greater amplification than do other types. The pentode is generally conceded to be superior to the tetrode in point of amplification. There are two distinct classes of pentodes available for r.f. amplification. The first class is intended for use in the i.f. stages of broadcast receivers for use with a.v.c. This class is commonly known as the variable  $\mu$  tube, and is represented by the '58 and 6D6. When driven over the whole range of grid swing possible, this type of tube gives the greatest amplification obtainable. However, this pre-supposes a high signal level. It is perfectly ridiculous to expect a weak incoming signal to swing the grid of the first tube over a range of from 10 to 30 volts as is required with this type of tube before it really gets down to business. The advantage claimed for this type of extended (remote) cut-off tube for use in i.f. channels is the reduction of cross talk at high levels, the cross talk resulting from a grid going beyond cut-off and the amplifier acting as class "C". It is apparent that when working at low levels with the bias near zero, we are well away from cut-off bias, and therefore the broad cut-off tube has absolutely no preference over the sharp cut-off tube as regards cross modulation (when working at low-bias with weak signals). The gain of a broad cut-off tube when working at very low signal levels is poor, and such tubes should *never* be used for

the purpose of weak signal amplification when maximum weak signal response is desired, the fact that such tubes are commonly employed in commercially made receivers for this purpose notwithstanding.

The other type, known as the sharp cut-off type, is highly desirable for weak signal amplification, and will give excellent results when used for this purpose.\* Pentodes of this class are the '57 and 6C6. Though these tubes will give excellent gain when operated under rated conditions, the gain at low signal levels may be considerably improved by reducing the bias from the rated value to from 1 to 1.5 volts, and increasing the screen voltage to from 125 to 150 volts. The emission from the filament in this type of tube is sufficient to handle the above conditions while still giving reasonable life.

#### *Metal Tubes*

It will be noted that so far nothing has been said of the metal tube. We shall now issue a word of caution about the use of metal tubes. Owing to the fact that most,

\*The mutual conductance of a type 58 at 1 volt bias and 150 volts screen voltage (normal plate voltage) is approximately the same as for a 57 under the same conditions. However, the plate current on the 58 will be excessive under these conditions. To bring the plate current down to a safe value, it will be necessary to increase the bias to a value that cuts the mutual conductance to less than half that of the 57 operating under the first mentioned conditions. In other words, the mutual conductance of a 57, for a given plate current, is higher than that of its variable  $\mu$  cousin, the 58. If we run both tubes at the maximum safe plate current, the 57 will have the higher gain.—EDITOR.

if not practically all, pre-r.f. amplifiers are coupled to the detector through an *untuned* primary which is inductively coupled to the tuned circuit of the detector, and owing to the fact that the plate-to-filament capacity of the tube is directly across the primary of the coupling transformer above mentioned, it will immediately be apparent that at high frequencies it is desirable to keep the plate-to-filament capacity of the tube as low as possible. This is one of the reasons for the use of acorn tubes at ultra-high frequencies. Since metal tubes in general have from 2 to 2½ times the output capacity of glass tubes, and since they differ but little from glass tubes in operating characteristics, they will not produce as satisfactory results as glass tubes at high frequencies such as 14 and 28 Mc. In the i.f. stages where the plate-to-filament capacity becomes a part of the tuning capacity of the primary circuit, the above statements do not apply, and metal tubes may be used to advantage because of their small size.

Let us consider the remaining requirements for weak signal amplifiers. The pre-r.f. amplifier is the most important one to consider. It should employ a sharp cut-off tube as previously explained. It should be run wide open at all times (1 volt bias for a 57 or 6C6), and no gain control of any kind whatsoever should ever be used on this stage. Further, though the introduction of regeneration will bring

**T**HE design of a receiver for weak signal reception is a problem which is not to be treated in the manner usually accorded the design of receivers for other purposes, and unless the particular problems encountered are carefully studied and their solution considered, there can be no hope of obtaining a satisfactory receiver for weak signals when the job is finally finished.

about more amplification, and in cases of receivers lacking in gain, will enable weak signals never before heard to be heard, it *should not be employed since, though amplification is increased, the noise is increased all out of proportion to the increase in gain.*

If a receiver is incapable of bringing in weak signals without regeneration, then there is something sadly lacking in the receiver, and said receiver is in serious need of attention, and the solution does *not* lie in the addition of regeneration pre-r.f.. I cannot too strongly emphasize this point. Ever notice how with the old "detector and one step" the noise of the detector increased as the point of oscillation of the detector was approached? Ever notice the loud hiss just before the detector broke into oscillation? Well, to be effective, a regenerative r.f. stage must be operated just below the point of oscillation in order to get gain, and the resulting noise is thus amplified by



the receiver, which absolutely ruins the signal-to-noise ratio. The r.f. can never be operated under the condition of oscillation, and if it is not operated *just below* the point of oscillation, then it is not regenerative in the true sense of the word. Therefore, regenerative r.f. is "out".\*

The output signal level from the first detector, even though a good stage of high-gain pre-r.f. precedes it, will not be high when considering weak signals, and the *first* i.f. stage should therefore employ a sharp cut-off tube, or at the very worst, nothing with a more remote cut-off than the 6L7 used in the control position of noise silencer circuits in the first i.f. stage. It has been recently demonstrated by Western Electric that the sharp cut-off tube is in every way superior to the broad cut-off type, and such tubes are employed in the Western Electric 10-A receiver, the last word in high fidelity broadcast receivers. The ham might well learn a lesson from this and use such tubes as the '57, 6C6, and 6J7 in his receiver, since their superior weak signal amplification is unquestioned.

The other important item having to do with weak signal response of the receiver is the system of detection employed. Diode detection is linear when operated at high level. At low levels the output is very, very low, and there is a certain threshold level below

which it will not operate, and this threshold level is sufficiently high to class it as absolutely worthless for weak signal detection. And this goes for the second detector. When signals after having passed through the i.f. amplifier are so weak that they can just be heard, then the second detector must be a weak signal detector. This is preferable to adding regeneration to the pre-selector.

What may be said of the second detector goes doubly strong for the first detector, for here we are *really* dealing with weak signals. By the way, did you ever notice anyone using a diode for a first detector? No! Why not? Must be because they aren't so good for weak signals, as they have surely tried about everything else. Plate circuit detection is considerably more sensitive at low levels than diode detection, has more distortion, is somewhat suitable for weak signal detection, but is not nearly so sensitive as grid leak detection. Grid leak detection, when used with a small grid blocking condenser and high value of grid leak, is extremely sensitive to weak signals and is the finest weak signal detector for general use known. It has more distortion than does plate detection, but it must be pointed out that it was used for broadcast reception with good results long before plate detection made its appearance. Grid leak detection should by all means be used for weak signal detection, and that goes for both first and second de-

\*This contention was made also in "Intermediate Amplifier Design", C. P. Bane, RADIO for March, 1936.



ectors. To this there will always be those who will say that after going through the i.f. channel the level should be high (and in this they miss the very point of weak signal reception, for weak signals are very weak) and that "anyway, you can always add audio amplification". Now it is obvious that 10,000 times zero is still zero, and if there is no signal except noise to amplify, then no amount of audio amplification will make the signal appear. Further, what is wanted is a weak signal detector, in order that the strong signals shall not obtain unholy preference over the weak signals when vying for the operator's attention.

So far we have considered only the matter of obtaining sensitivity within the receiver, and to the reader it might appear that we had forgotten all about the noise which accompanies the signal and which we wish to do away with if possible. But in obtaining weak signal sensitivity, we have done the very things which must be done to meet the requirements of a high signal-to-noise ratio. We have utilized high "Q" circuits, tubes especially designed for weak signal amplification, and employed special weak signal detectors. By utilizing high "Q" circuits, while leaving the noise voltage of the tube constant, we have increased the signal voltage over what it would be with a low "Q" circuit and have therefore improved the signal-to-noise ratio. By utilizing sharp cut-off tubes we have obtained the maxi-

imum weak signal amplification, and have reduced the tube noise from what it would be had broad cut-off tubes been employed, since sharp cut-off tubes have less shot effect (in proportion to signal) than broad cut-off tubes. By utilizing detectors designed for weak signals we have made it possible to obtain greater response to weak signals while leaving the noise inherent in the circuit approximately the same as it would be had other detectors been employed.

#### *The Mixer Circuit*

There is yet another principle which I wish to advocate which will lead to an improved signal-to-noise ratio of the receiver itself. It has to do with the mixer circuit. The output of the mixer (modulated detector to you) is proportional to the product of the oscillator and signal voltages. Therefore, with a given signal voltage, the

**A** word of caution to the operator himself is highly in order. It is obvious that there is no point in obtaining a fine signal-to-noise ratio in the receiver itself if the operator is going to ruin it by improper operating. By this I mean that one should not use a loud speaker, since the external noises within the room are then competing with the signal for the operator's attention, and the effective signal-to-noise ratio of the receiver and operator together will be low. Use earphones.

greatest output will ensue with the largest permissible value of oscillator voltage. However, though the output increases with increase in oscillator voltage, when the oscillator voltage is greater than the signal voltage, the increase in noise is out of proportion to the increase in signal output. Therefore, it is desirable to provide some means of controlling oscillator output to match the signal level. This can be done by varying the screen and plate voltages through a potentiometer.

There are a few other tricks to the obtaining of a high signal-to-noise ratio. So far we have considered only the inherent noise within the receiver. Now it is perfectly obvious that the addition of a crystal filter, whereby the selectivity of the receiver is increased greatly, will reduce to a great extent interference arising from outside sources. Such a filter is a most worthwhile addition to any set for amateur use. The installation of a system of "delayed" instantaneous automatic volume control (noise silencing) is also highly worthwhile, and the system developed by Lamb is undoubtedly a worthwhile adjunct to any receiver. There is, however, little if any, sense in operating the receiver with a.v.c. and noise silencing in use at the same time. Therefore, the a.v.c. being in use only when the "silencer" is not in use, the best results will be had if a switch is incorporated in the circuit of the noise silencer to throw it from noise silencing to

a.v.c. by inserting the proper sized condenser across the diode resistor of the noise detector. This system has the advantage that it does not pass the signal from which the a.v.c. voltage is obtained through the crystal filter, and therefore the a.v.c. will be more sensitive in its action than had the signal been passed through the filter and then used to obtain a.v.c. in the usual way.

#### *The Crystal Filter*

As regards crystal filter circuits, I have used the accompanying circuit for some time and find it superior to any of the other circuits which I have tried, for with this circuit, variable selectivity is had *without* sacrifice of amplification as is the case with circuits which obtain their selectivity control by detuning of the secondary of the i.f. transformer. The selectivity control is made of an 11-point Yaxley switch and a group of small 1/2-watt carbon resistors. The resistors are mounted around the switch in order of increasing resistance. They should start with a value of approximately 5000 ohms and proceed in increasing size, the idea being to have the total resistance after the addition of each resistor increase in somewhat near geometric progression, the final total value being a few megohms.

It is safe to say that all the various methods of noise suppression, such as audio filters, peaked audio, and many others will give results which justify their inclusion in the

**T**HE author condemns the practice of wearing earphones on the cheek bones, a practice which he says must have originated in the stone age and should have died many years ago. For the same reason that a loudspeaker is not used with this receiver (see preceding

page), earphones should not be worn on the cheek bones. Wear the phones directly over the ears and have them fit as tightly as it is comfortable to have them fit in order to keep out extraneous noises within the room.

receiver, and are to be recommended. But they should be used with caution. When all is said and done, much may be made of the following point.

There are many times when it is necessary to have the signal appear with as natural a tone as it is possible to have it appear. The reason for this is that many times the crystal filter is a hindrance in point of selectivity instead of a help. And it must not be forgotten that the human equation, aural selectivity of the human ear, is a very great weapon in dealing with QRM, the ear being able to distinguish between two signals in close proximity by simply distinguishing between the pitch of the signals.

Many times this form of selectivity will do the trick when the crystal filter is absolutely useless. For the ear to function satisfactorily in this respect we must at least be able to remove or cut in our audio filters from the circuit at the flip of a switch in order that we may be able to determine if they are of

any help under the given conditions. It is for this very reason that I prefer to run the headphones directly out of the second detector, as in this way it is possible to obtain a perfectly natural tone to the signal, and because I have found aural selectivity to be very useful on a number of occasions, I have yet to see the audio amplifier which did not to some extent change the character of the signal and introduce noise in the low frequency region of the audio range.

#### *Location*

It must be realized, of course, that in a noisy location, where the man-made noise is of such intensity that it masks weak signals to a much greater extent than the inherent set noise even in a noisy receiver, the improvement will not be noticeable. But in a good location and with a good, tuned, "anti-noise" receiving antenna the difference is remarkable. The signals below R5 that you are able to hear will be increased 100%.



## CONSUMERS' RESEARCH

### *Looks at Radio*

*Remember "100,000,000 Guinea Pigs" and "Your Money's Worth"? Herein, the organization responsible for those books—Consumers' Research—turns its attention, through the medium of a disinterested writer, to radio.*

IT IS BELIEVED that most of the objections to present day radios which are cited by Consumers' Research are those which any engineer who is at all honest with himself would find. Several of the points taken by Consumers' Research are, we believe, open to reasonable doubt; these will be given more attention in later paragraphs.

Some of the things to which Consumers' Research takes exception are not in the province of the engineer, and in some cases these objections can be charged almost exclusively to the sales and advertising policies of the retail dealers. It is unfortunate that in a good many cases the manufacturer's advertising lends itself to the extreme distortion which characterizes the claims made by none too ethical or even unscrupulous dealers. However, the problem of what to do about such dealers lies with organizations such as the Better Business Bureau rather than with the manufacturer who builds the set.

Let us consider in detail some of the matters to which Consumers' Research takes exception, not only in the manner pursued by the manufacturer in his advertising, but in design and construction of receivers as well.

Some comment is made on the question of the number of tubes used in the receivers and especially with regard to the advertised number of tubes. It is pointed out that multi-purpose tubes while tending to reduce the actual number of tubes in the set, at the same time effect some saving in power consumption. There is some question in our mind if this latter point has any value whatever, as after all the only saving afforded by a dual-function tube is in the elimination of one heater, and this means probably only 0.3 amperes at 6.3 volts—a negligible amount of power. However, one real objection (in which we are again in agreement with Consumers' Research) to a multi-purpose tube which applies especially to the so-called pentagrid con-



verter is, of course, the well-known inefficiency of these tubes at the higher frequencies, a point which is leading to a return to the old method employing physically separate tubes for oscillator and mixer. This latter point, strangely enough, ties in with another mentioned by Consumers' Research; it is said that where cost is an important factor in the selection of a radio receiver, due consideration should be given to the earlier models of manufacturers still in business. This, however, would mean going in for receivers of the vintage of about 1933, a matter of doubtful advantage (in the opinion of this writer) even where the manufacturer may still be in business.

There is one angle in connection with multi-purpose tubes which this writer does not feel has been given fair consideration by the report of Consumers' Research. The public demand for exceptionally low cost sets, and the wide interest in automobile receivers—which to please the public, must be entirely hidden when installed in the car—led to the wide use of this type of tube for its low-cost associated circuits and its great saving of space. That this type of tube has found its way into larger sets is just one reason why prices have remained uniformly low.

While we are on the subject of costs it will be well to consider what Consumers' Research has to say. The report states in effect that prices greater than about \$150 are not justified so far as fidelity, se-

lectivity, or sensitivity are concerned. This writer finds himself in agreement with this contention, especially where it relates to needless refinements such as tone compensators, etc. However, where a large increase in price is obviously due to exceptionally massive or ornate cabinets, it is a matter entirely for the customer to decide; if he wants a glorified packing crate embellished with so-called "tasteful" carvings and what not, *caveat emptor*.

Speaking of cabinets, Consumers' Research finds that radio cabinets are designed as furniture (*sic*) rather than as efficient baffles for loud speakers; we suspect that most set makers will agree with this point. It is pertinent, however, to note further the comment to the effect that the deficiency in the low frequency response occasioned by this serious lack of baffle area is supposedly corrected by making the circuit response so poor over the rest of the audio range that the loss of the low frequencies is not too noticeable. Add to this the effects of cabinet resonance and we have the complete picture of what far too many sets sound like.

Advertising of the sort that some manufacturers indulge in comes in for plenty of criticism—and justly so. Here again, though, the retailer may be responsible for over-playing some of the catch words and phrases that the manufacturer's advertising staff has coined—without really knowing what it's all

about—to attract the attention of the public.\* But to this extent the manufacturer is responsible; if his advertising, which is usually carried nation-wide in the popular magazines and in the daily papers, gives the retailer too much leeway then he must expect severe criticism.

But this argument of excesses in advertising is as old as advertising itself. It is really too much to believe that any rational person, even the father of the particular "brain-child" that is being touted, a la Hollywood, as the World-Wonder-Super-Colossal-Super, can make the set do all that is claimed for it.

*\*On submitting this material to Consumers' Research for its comment, the following remarks, among others, were appended to the previous comments:*

*"It is no excuse to say that the ideas are difficult to express—because advertising men pride themselves in getting across difficult ideas. Their sin is in the fact that they, for good business reasons, like to say things in unclear terms so that much of the real truth is hidden. It is often what they omit to say that is important, and what many people will think they meant. There is no possible question of lack of ability on their part to say what they please if they happen to wish to say that which is of use to the consumer. I need hardly tell you that by a nice choice of words an advertising man can avoid difficulty with the Federal Trade Commission and with the Better Business Bureau and other such agencies and still give the consumer just the shade of impression which helps to mislead him into an unwise or uneconomic purchase. Our objection is not to picturesque or popular statements, but to false statements and false impressions. It should be added that advertising men don't use "technical" terms out of ignorance. They have their own persuasion value to the man to whom they are mystical, and it is not uncommon for the advertising men to call in the engineers to "say some technical terms" in order that the former can pick out some good phrases for the next batch of copy (the accurate technical significance of which the advertising men will comprehend almost as poorly as will their lay audience)."*

Luck, persistence, and common sense play so great a part in the results that can be achieved with any given set that it is pure asinine to advance some of the claims that we frequently see in print.

Along the same lines is the problem of yearly models. Any engineer knows that the refinements introduced this year will in all probability be commonplace items on next year's sets—either that or they will be entirely discarded in favor of something about which more advertising blurbs can be created. Possibly Consumers' Research, and certainly this writer, feels that radio sets aren't ever going to be a replacement item in the sense that a car is. In the first place, how many sets are bought as musical instruments? Comparatively few, if the truth is told; and those that are bought for the musical entertainment (or education) which they may be able to supply will not be replaced until something with a vastly improved quality of reproduction is attained in the new designs. Even true music lovers won't get excited over the addition of another third or half octave to the present frequency range of the set. And how many advertisements give a true picture of whatever improvements there may actually be? But, on the other hand, how is the public to be told? "Cycles" and "band width" mean less than nothing, although advertisements—some of them!—bristle

with such terms. Here, we do not feel that the manufacturer is being misleading other than through a lack of appreciation of the fact that his prospective buyers just don't know what to make of all the "technical" terms. Some of them (the buyers) may even "fall" for this display of erudition and buy a set simply because they think that the manufacturer behind the advertisement must be good because his ads read so complicated and "technical."

What we have been driving at is that there is no sound reason for the mad rush to come on the market with "next year's models." The automobile industry learned an expensive lesson back in the days when a "new" model rattled itself apart before the draftsmen completed their preliminary drawings on the "newer" model. It might be well to give some thought to the idea of building a set to last for a couple of years at least. In connection with this, we can suggest that some recent issues of *The Wireless World* be consulted for some very relevant remarks.

The matter of combination long- and short-wave receivers comes in for its share of attention. Consumers' Research feels—as does this writer—that short-wave reception, is, at best, so uncertain and unsatisfactory that the utmost consideration ought to be given to dropping this feature from many models. It is doubtful if few, other than the comparatively negligible

number who become short-wave addicts, use the short-wave facilities once the initial thrill has evaporated. The network stations carry re-broadcasts of all important foreign events, and, picked up by extremely sensitive receivers under technical control, the programs as re-broadcast are almost certain to be far better than the same thing picked up on a home receiver which in all probability is bringing in at the same time all of the power company's leaky insulators and assorted ignition, X-ray, and other noises.

It seems to many competent observers that the money spent by the set manufacturer on short-wave circuits could well be diverted to improving such matters as side-band trimming, cabinet resonance, and detector distortion—just to mention a few. And, although Consumers' Research apparently hasn't suggested it, let us put in our little argument for a receiver that can be used in a vicinity like New York, Philadelphia, Boston—any area well covered by high-quality stations—and that will give truly high-fidelity reception from the local stations. We may be wrong, but it is our guess that some alert manufacturer could make himself some nice business with such a set; and it wouldn't have to cost a fortune, either. Introduced and advertised for what it is—a good local receiver—such a job would appeal to a great number of people with enough discrimination to want mu-



sic rather than a lot of nearly unintelligible propaganda delivered in bad English and tossed about by three or four thousand miles of assorted thunder storms.

Circuit noises come in for plenty of attention in the Consumers' Research report—and rightly so. Far too many receivers have such a terrific amount of 60 and 120 cycle hum that it seems almost as if there were no power supply filtering at all. It is the belief of this writer that much of this is due to the use of the field coil of the conventional dynamic speaker as the filter choke. Let it be stated here that we have never known an engineer—ourselves included—who had even a faint idea of how much inductance a speaker field would show under d-c load; rather, these fields are invariably specified as "so many ohms resistance." That, of course, gives some control of their regulation of the power supply, but that's about all. Little wonder, then, that we find filters using quantities and quantities of microfarads in an attempt to smooth out the ripple!

However, power supply noise isn't all. There is the noise supposedly inherent in mixer tubes, especially those of the pentagrid variety; there is noise generated in resistors, especially when they are worked just on the verge of overload; likewise with condensers. There is noise caused by thermal emf's; by chemical action—a prolific source of noise especially if the set is used in humid locations; and by a host of other causes, some

of which, we suspect from personal experiences, may never occur to engineers until sad tales drift back from the field.

RADIO ENGINEERING had recently, in an introductory note to a certain article on automatic selectivity control, a very pointed observation to the effect that the fewer controls on the set, the less likely it will be for the user to jam things up. This point was later taken up by a writer in *The Wireless World*, and apparently it is tacitly concurred in by Consumers' Research. However, this latter's comment is directed more toward the variable selectivity idea; we wonder if there isn't a profitable suggestion contained in their thought? Suppose that a set's selectivity were to be adjusted on installation to meet local requirements; suppose that the manufacturer were to guarantee satisfactory local reception provided the selectivity adjustment remained untouched, once set; suppose further that the customer wanted satisfactory distant reception (if he knew what he meant by that!) then the selectivity could be sharpened but with the distinct understanding that local reception would be impaired—from a quality standpoint, that is.

Such an arrangement would be, to say the least, novel, and undoubtedly worthy of a trial at least. It would remove the stigma of adding another gadget to increase the selling price; it should do away with both tone controls and variable selectivity controls.



But it ought to keep everybody happy—the coil people would still sell their variable coupling coils (although the variable feature would be under lock and key in so far as the average user was concerned); the set manufacturer could claim, with a fair degree of truthfulness, that each of his sets would be individually adjusted to the requirements of the user.

In concluding this analysis of some of the faults which Consumers' Research finds with the present-day radio sets, we are impressed especially with one point—the discussion given in their report on the matter of safety from electrical shock. Speaking subjectively for a moment, this writer in a varied career has been closely associated with organizations and individuals intensely interested and concerned with safety in industry—and in the home. We can state unequivocally that many of these former associates felt so keenly the danger imminent in the average radio set that their families were, literally, forced to do without sets in their homes; and in those homes where they were grudgingly permitted, the sets were so hedged about with safeguards (not put there by the manufacturer) that they were almost reminiscent of a high-voltage switchboard.

Not so long ago the metropolitan press carried a story of the electrocution of a youth who, in attempting to remove a tube from the socket—with the set "on"—came into contact with the tube prongs

and some grounded object at the same time. Presumably, the contact with the tube prongs was established before the prongs had entirely left the grip of the socket springs. Such an occurrence ought to be impossible. In the first place, it should be impossible to get at the chassis, *even for tube replacement purposes*, when the set is connected to the line. Service men, and others who appreciate the inherent danger, would not be seriously handicapped by this.

The question of ac-dc receivers, with their direct connection to the line, is of sufficient importance to warrant the most serious consideration. Chief among the points to be considered is that of providing a ground connection for these sets—which would probably mean doing away with the idea of using the chassis for a common return circuit; this would not be such a bad idea even for those sets which are isolated from the line by a transformer. The use of a high-conductivity ground bus might assist in the elimination of some of the miscellaneous noises that are due to the admixture of 60 cycle, direct audio- and radio-frequency currents, all trying to get to ground through a conductor that, at best, may not be any too good electrically.

The matter of making radio sets safe is an urgent one and deserves immediate study. The problem is not insurmountable, nor is the cost of making a set safe anything to become alarmed about.

## Equipment for RADIOTHERAPY

BY AARON NADELL

RADIO FREQUENCIES at present used in medical practice are obtained either from vacuum tube or quenched gap oscillators, and operate into a wide variety of loads the nature of which depend upon the therapeutic results desired.

Frequencies found advantageous range from 1,000 kc. to 30 Mc. Current medical opinion inclines to believe that specific frequencies have no selective effect either upon body tissues or malignant micro-organisms. Proper choice of frequency in accordance with the results desired is, however, important biologically.

Applications of r.f. to medical purposes can be divided, very broadly, into three general classes: means for raising the temperature of body tissues; means for exciting the "electric knife" and similar surgical instruments; means for producing ultra-violet radiation either without or within the body.

Current medical terminology distinguishes between diathermy and short-wave therapy. Diathermy is the term applied to treatment with frequencies of the order of 1,000 kc.

applied by direct contact of electrodes with the body of the patient. The thermal effect produced by this method depends rather largely upon the ohmic resistance of the tissues through which the current must pass. Short-wave therapy uses from 30 to 9 meters, roughly. Direct contact with the electrode is employed for some purposes, while for others the patient is placed between the plates of a condenser or in the field of an induction coil.

The primary purpose of both treatments is to raise the body temperature. Increase of body temperature is followed by several distinct reactions, all of which may be favorable to the patient under certain circumstances.

An indirect benefit results from the stimulation of blood and lymph circulatory systems. Both capillary blood vessels and small lymph passages are dilated by heat. Increased circulation may result in direct washing away of body poisons or harmful deposits. It also brings to the heated tissues a larger number of the germ-eating white corpuscles of the blood.

Nevertheless, some types of radio fever are dangerous to some types of infections. Thus diathermy, which acts mainly upon the surface and subcutaneous tissues, may prove harmful in the case of carbuncles, driving the infection into the unheated deeper layers. Short-wave therapy, on the other hand, has been found helpful in such cases because the temperature rise is more evenly distributed in three dimensions.

A very wide variety of electrodes and of techniques is required both by reason of the number of diseases now being treated by radio-therapy, and by reason of the construction of the human body, in which the great divergence in the nature of the tissues alters heating effects according to the locality involved.

The three types of heating mechanism, conductive, inductive and electro-static, operate differently upon different tissues, and choice among them is made by the physician. The equipment is so built that any of the three types of electrodes can be plugged in as required.

Many of the electrodes, particularly among the contact type, must at times be introduced into orifices of the body for direct application to the seat of the trouble. They are, consequently, made in many different sizes and shapes. The condenser plates are made in a number of different sizes, for concentrated or diffused application of heat. To enable them to fit the contours of the part of the body to be

treated, they often consist of sheets of soft metal foil, which is readily bent and shaped, thoroughly insulated in heavy layers of rubber or felt or both. The induction coil may take the form of a heavily insulated flexible cable that can be curled into a spiral and laid upon the body, or twisted into a helix about an arm or a leg.

The contact electrode is often used in association with a condenser plate, particularly for internal applications. Thus, in the treatment of sinus infections, a condenser plate the size of a large saucer may be propped in front of the patient's face at the end of a stiff cable, and a small contact electrode introduced into the nostril. Or two contact electrodes may be introduced into the orifice, or one into the orifice and a contact electrode placed upon the surface of the body nearby. Or the condenser effect may be used entirely. In some sinus treatments, to continue with that example, heavily insulated plates are bound upon the patient's forehead. Still another method in such cases is to place the patient's head between two plates—insulated against accidental contact and burns—which do not touch the patient at all.

The design of the apparatus is always such as to assist the physician in avoiding accidental burns. One precaution is to key the output by means of a foot switch, operated by the physician, which is never closed when contact electrodes are being applied or removed, but only



after a firm and broad contact has been established. When a large contact electrode is applied to a rounded surface—a shoulder, for example—soft metal foil is used and shaped to press upon a relatively large area. The object here is to avoid contact at a few points only, which would result in high current density at those points and again be likely to burn the subject.

Double precautions are taken in the matter of electrode leads. They are heavily insulated to avoid accidental burns, but in use are also carefully kept away from the patient's body in order not to heat portions of his anatomy where heat might possibly stir up trouble rather than allay it.

Temperature tests are made by inserting small thermometers or thermocouples into the tissues, either during the treatment or immediately after the r.f. has been switched off. Intra-muscular increases of temperature amounting to as much as 9.1 degrees F have been recorded after twenty-minute applications of 10.5 meters, with equipment nominally rated at an output of 420 watts. Intra-muscular temperatures as high as 107 degrees F and subcutaneous temperatures up to 106.9 degrees F have been recorded in this way.

The electric knife may here be considered a generic term applied to three types of surgical apparatus. The knife itself cuts flesh, and to a lesser degree, fatty tissues, by direct application of r.f. at very high current densities. The desiccator, or

electro-coagulator, applies a slightly broader surface at lower current densities, and sears flesh.

The desiccator is favored in the more modern type of tonsil removal, or "tonsil coagulation." In one method, an electrode is placed against the back of the patient's neck, and the desiccator is applied to the tonsil. A more modern method eliminates the contact plate at the back of the patient's neck and substitutes a two-electrode desiccator or coagulator. The principle in every case is the same; current density is high enough to sear flesh only at the point where the coagulator is applied.

The electric knife is essentially a coagulator which consists of an extremely thin, stiff wire of steel or tungsten, with correspondingly higher current density. It cuts human flesh very readily, so readily that the thin stiff wire does not even bend appreciably as it is drawn through the tissues.

A variety of the electric knife consists of a closed loop of thin, stiff wire. The loop is pressed into the flesh and then drawn through a shorter or longer distance and pulled up again. A section of tissue as much as a quarter-inch deep is removed — without bleeding and with little chance of infection—for microscopical or other examination, as, for example, in cases of suspected cancer.

In place of radiotherapy or electric knife loads, ultra-violet light generators may be plugged into the



oscillator for internal or external use. One large "sun lamp" consists merely of a quartz bulb containing mercury, and a bit of argon to assist ionization. The bulb, under its reflector, is surrounded by a few turns of inductance which is energized by the oscillator. Different types of bulbs will give a wide spectrum, ranging principally from 2800 to 3100 Angstrom units, or a narrow spectrum in which the predominating frequency is close to 2500 A.u. The vapor in the latter is under lower pressure, and the bulb remains cold.

Extremely small ultra-violet generators of the latter type are available, some not much larger than the tip of a radio jack. These, firmly fastened to the end of an equally thin but well-insulated cable or catheter, which carries r-f, can be introduced into the lungs and other deep-seated organs, bringing the germicidal properties of ultra-violet light to infections not easily attacked by any other form of treatment.

Oscillators are of two general types, one using standard vacuum-tube circuits, and one using the quenched spark gap. In the latter, the electrodes are of tungsten and,

to obtain relatively high energy at frequencies up to 30 Mc., are ground with optical precision and spaced at less than 1 mil. The gap is not sealed, but open to forced draft which provides cooling and facilitates quenching. Three frequencies are present in the gap: the 60 cycles of the power supply; the 20,000-cycle wave-train frequency, and the 30 Mc. tuned frequency.

The oscillating circuits are conventional, and may be described as the tuned spark or primary circuit, a tuned secondary or tank circuit, and the output or "patient" circuit.

The latter presents a special problem because of the great variety of electrodes used, and the number of ways in which each electrode may be applied. A mere change in the position of the patient, with reference to the electrodes, may detune the output circuit. A condenser, or in some models an inductance or a loose coupler, is provided, and is continually adjusted during treatment as required, adjustment being made by reference to a hot-wire ammeter, and the condenser, tuner or coupler reset for maximum reading whenever the patient shifts position with reference to the electrodes, or the electrodes themselves are changed or adjusted.

**I**N THE MAY issue of *The Illinois Guardsman* there was published a comprehensive article on "What About Our Bands". The article discloses an alarming fact: that our bands are faced with practical extinction!

Yes, all the trombone players in the Army and National Guard might have to go back to the line as gun-toting soldiers instead of horn toters.—  
RADIO.

# BROADCAST ANTENNA DEVELOPMENTS

BY RAYMOND F. GUY  
*N.B.C. Engineer*

ONE OF THE first important contributions to the knowledge of antennas was the discovery by Marconi in 1895 of the effect of raised aerial wires or antennas, when used in conjunction with radio transmitting and receiving apparatus. This discovery marked the beginning of the development of our modern antenna systems.

To generalize a bit, the main improvement of the modern antennas for broadcasting has not been a large increase in the amount of wave energy radiated, but has been the "compressing" of the same amount of energy down close to the earth where the receiving antennas are located. The poorest transmitting antenna may be very efficient at radiating power, but at the same time be very ineffective in serving its purpose by diverting energy high into the air, utterly wasting much of it. It costs approximately \$5.00 per watt to install a 50,000 watt station and approximately \$15.00 per watt to install a 5 kilowatt station. It is not good economics to waste 25 to 50 per cent of this costly power by directing it toward the upper atmosphere where it is either dissipated or reflected to cause fading.

## *Measurement of Network Coverage*

The need for specific coverage or "circulation" data on its own and associated stations led the NBC in 1933 to undertake to measure and evaluate the coverage given by each of the then 90 odd NBC network stations. There followed the most comprehensive and thorough coast-to-coast study of field intensity coverage ever undertaken, and, simultaneously, there were sorted, analyzed and tabulated, the contents of five million individual audience-mail letters. Statisticians counted and tabulated these letters station by station and by individual counties. During the field intensity survey of each of these 90 odd stations, 18 measuring cars were driven 232,218 miles throughout 1,250,000 square miles (40 per cent of the area of the United States); to make 21,316 individual field intensity measurements, not counting repeats or checks, in four months consecutively elapsed time. The field intensity contours for each station measured were carefully plotted and correlated with the mail analysis, and counted heavily in the evaluation of the coverage.

The coverage of a station is affected by a number of factors, some

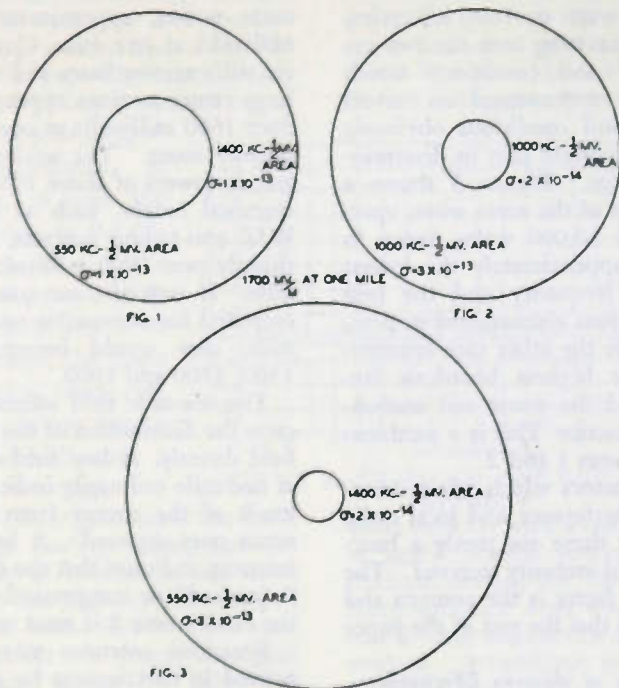

FIGURES 1, 2, 3—COVERAGE FACTORS.

of which can be controlled and some of which cannot. They are:

- 1—Power.
- 2—Antenna design.
- 3—Soil conditions as they determine the rate of decay of waves over the earth.
- 4—Interference from other stations.
- 5—Local noise levels.
- 6—Frequency assignment.

The field intensity of a station varies as the square root of the ratio of one power to another. The frequency assignment has a consider-

able effect upon the coverage obtainable. Ordinarily changes of power and frequency may be made only with consent of the Federal Communications Commission and consequently are not under direct control of the broadcaster. Figure 1 shows a comparison of the areas which can be served by a 50,000-watt station over average soil when operating on approximately the highest broadcast frequency in one case, and approximately the lowest broadcast frequency in the other case. Figure 2 shows the difference



in area which exists with a station of 50,000 watts on 1000 kilocycles, when transmitting over the two extremes of soil conditions which might be encountered in actual practice. Soil conditions obviously play an important part in determining coverage. Figure 3 shows a comparison of the areas when operating with 50,000 watts, using in one case approximately the lowest broadcast frequency and the best soil conditions encountered in practice, and in the other case approximately the highest broadcast frequency and the worst soil encountered in practice. This is a combination of figures 1 and 2.

Other factors which affect coverage are interference and local noise levels, but these are partly a function of field intensity received. The remaining factor is the antenna and it is to this that the rest of the paper is devoted.

#### *Evaluation of Antenna Effectiveness*

Because the amount of energy radiated by an antenna does not express its effectiveness in giving service along the surface of the earth, a ready means of evaluating antenna effectiveness other than power output divided by power input is required. There is another reason. There has been no suitable means available for measuring the power output of an antenna.

Measurement of average field intensity at one mile provides this method of evaluation quite satisfactorily. (In some cases attenuation within one mile makes a small correction desirable.) The type "T"

antennas produced, with 50 kilowatts power, approximately 1200 millivolts at one mile. Guyed towers with narrow bases and tops and large center sections appear to produce 1600 millivolts at one mile or slightly more. The uniform cross section towers of about 195 degrees electrical height, such as the new WJZ anti-fading antenna, produce slightly over 1800 millivolts at one mile. If each of these quantities is corrected for attenuation within one mile, they would become about 1300, 1700 and 1900.

The one-mile field intensity indicates the distribution of the radiated field directly. A low field intensity at one mile ordinarily indicates that much of the energy from the antenna goes skyward. A high field intensity indicates that the energy is "squashed" or compressed close to the earth where it is most useful.

Broadcast antennas may be improved in effectiveness by going to great heights, but economic factors usually make it impractical to do so. For the lower broadcast frequencies a height of about 190 electrical degrees will usually serve to prevent serious fading within those areas receiving serviceable field intensities, with powers up to at least 50 kilowatts.

#### *Top Tuned Antennas*

Due to the proximity of airlines with heavy traffic, it is sometimes necessary to build an antenna to less than 190°. If the restrictions are not too rigid, it is possible to approach the performance of an ideal antenna by using a lumped loading system



at the top of the tower. This expedient is a modern and tremendously improved version of the old familiar flat top. The improvement consists of adding a lumped capacity flat top with lumped series inductance, if necessary, to raise the current loop to the optimum point on the tower. If the tuning coil is used and it is large enough, the tower characteristic and current distribution may be varied at will over a tremendous range.

The WMAQ antenna was built with top loading because of the proximity of commercial air lines. It is 490 feet high, operates on 670 kilocycles with 50,000 watts and has a 60-foot steel saucer out-rigger at the top. Eighty feet below the top there is a sectionalizing system containing insulators and a tuning coil.

This tuning coil and the weather proof copper housing weigh over 1500 pounds and cost approximately \$1500. The assembly is practically air tight and is insulated for the 70,000-volt peaks which are often obtained during modulating conditions. The reactance required in this tuning coil to obtain the desired current distribution is approximately 400 ohms for this antenna height. The current in the coil under the optimum conditions of adjustment is over 50 amperes. The

insulators not only have to be adequate for the high voltages developed, but also must support the upper 80 feet of the tower and the 60-foot out-rigger, up to a 100-mile

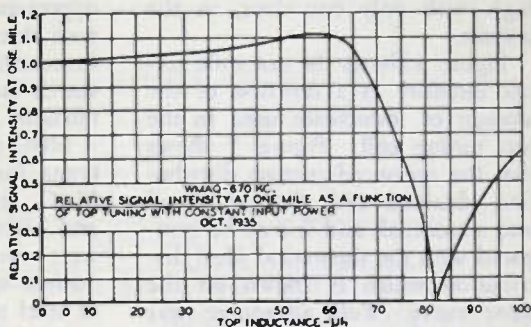

FIGURE 4—GRAPH OF ONE-MILE SIGNAL INTENSITY.

wind velocity, with a suitable factor of safety. Several preliminary mechanical designs for the sectionalizing structure were discarded before a final satisfactory design was evolved. In addition to the other problems, the lighting circuits for the tower had to be carried through and beyond this point. This was accomplished by making the coil large, of one inch IPS copper tubing, and running the circuits through the tubing.

The manufacture of this coil was quite a problem in that short lengths had to be brazed together and then formed into a coil. It could not be made in one piece. The lighting wires had to be installed in the tubing before it was formed. All of the supporting insulation is built of micalex with sufficient insulation to carry the design up to the corona point. Special clamps and other

parts had to be built to make the corona point as high as reasonably possible. The entire coil assembly is inside a copper can approximately six feet in diameter and six feet high with only one door, in the bottom.

Figure 4 shows the one mile signal intensity as a function of the amount of inductance used in the top tuning coil. Figure 5 shows that the measured current distribution obtained with the top tuned was sinusoidal, and it may be compared with the theoretical ideal distribution which is shown on the same curve. Full advantage was taken of the opportunity to study thoroughly this first ideal design of a top tuned antenna system, but lack of space prevents showing all of the many other measurements made. One of the most important things that these measurements showed was that there were no factors in the design of such a tower that could not be satisfactorily evaluated by the design engineer.

*A Study of the Effect, on Distant Transmissions, of the Vertical Pattern of a Broadcast Antenna*

It is established that the "squashing" of the vertical field of an antenna increases the primary service area. However, how does this effect the transmission to distant points?

Various theories had been advanced as to exactly what happens to a broadcast wave in its path from a transmitting antenna to a receiver at a distant point. No very exact measurements were available to show how the energy from the transmitting antenna should be

concentrated to obtain the most favorable distant transmission. For instance, does a wave bounce several times between the heaviside layer and the earth? In 1934 the opportunity presented itself to make such observations and measurements in connection with some other research on directive broadcast transmission.

NBC designed a directional antenna for station WPTF, Raleigh, N. C., and in 1934 had adjusted it and placed it in operation. There were two identical antennas with 50-foot wooden bases and 320 feet of steel above them, tapering from an 11-foot square at the steel base to a 3-foot square at the top. These antennas had 30-foot steel saucer outriggers and associated tuning apparatus at the tops which were used for adjusting the effective electrical height and current distribution. These are "tuned top" antennas.

For the purposes of the experiments to be described, these antennas were operated independently of each other under different adjustments to obtain a quick means of switching from one condition of vertical field distribution to another. Relays were available for switching purposes at each tower and these relays were controlled remotely by push buttons in the transmitter building. The original purpose of the relays was to change from directive to non-directive transmission at sunset, but for the purposes of this experiment they were used to disconnect and suitably detune one antenna while the other one was

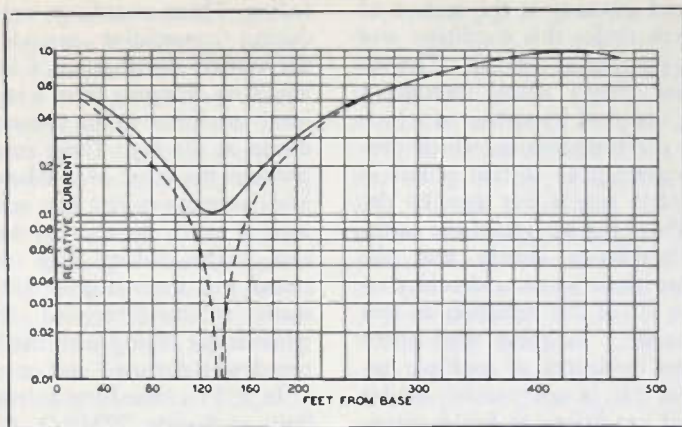

FIG. 5.—GRAPH OF MEASURED CURRENT DISTRIBUTION.

being used and vice versa.

One antenna was adjusted for normal current distribution. The other antenna was adjusted by means of the top tuning system to produce a minimum signal intensity at the surface of the earth. The latter adjustment gives a vertical distribution pattern as shown in figure 6. With the facilities provided, these conditions could be alternated practically instantaneously. By means of field intensity measurements on the ground and in an airplane, the vertical patterns of these two antennas were measured and checked against the calculated patterns. A recording station was established four miles from the station to keep a continuous check upon the adjustments during the transmission. Previously established recording stations made continuous recordings of field intensity at Corbin, Kentucky; Marion, Illinois; Emporia, Kansas; Albuquerque, New Mexico; Oklahoma City, Ok-

lahoma; Duluth, Minnesota; Urbana, Illinois; Columbus, Ohio, and Boulder, Colorado.

The transmitting conditions were alternated at twenty-minute intervals between the hours of 12 midnight to 6 a.m., of which the hours of 3 to 6 a.m. are shown in the figures. KPO operated on the same frequency until 3 a.m. after which the channel was clear for this experiment. Only a few of the many recordings are shown, for lack of space, although the experiment continued over a period of approximately two weeks to evaluate properly temporary changes in long distance transmitting conditions. With the exception of Corbin, Kentucky, which was within the sky wave range of the transmissions from WPTF, no recording stations received any signal during transmissions with zero ground signal intensity. The recordings did not indicate zero because of the static level, but no signal was heard. The



measured intensity at the surface of the earth under this condition was .2 of 1 per cent of normal. The experiment shows many interesting points, the most important of which is that the transmission which provides coverage to distant points is confined to angles less than 10 degrees above the surface of the earth. This establishes clearly that the ideal broadcast antenna should concentrate all of the radiation as low as possible. In these tests there were no evidences of multiple reflections. It is not possible under practical conditions to build antennas high enough to obtain the indicated ideal distribution because they would in some cases be 3,000 feet in height. Other mechanical complications, in addition to the height, present difficulties which make such a radiator impracticable.

*Effect of Current Distribution on Fading*

Early in 1934, NBC designed a directional antenna for Station WHIO, Dayton, Ohio. One of these towers was utilized in an interesting experiment that showed the reduction of fading which can be accomplished by controlling the current distribution. The WHIO antennas have an electrical height of approximately 135 degrees and have at the tops steel saucer outriggers with tuning coils which make possible a wide variation in the effective electrical height. Upon the completion of one tower and before the second one was erected, recordings of fading were made to show the effectiveness of the tuned top in reducing high angle radiation and

fading. These recordings were made during consecutive periods when the vertical distribution of field was varied by changing from a top tuned ideal condition to an untuned condition at the top. These conditions produce the effect of a substantially ideal antenna in one case compared with a short antenna in the other case. The fading with the top tuned was unnoticeable with automatic volume-controlled receivers whereas the fading with the top untuned was distorted and unusable.

In 1935 a tuned-top antenna was built at Station WMAQ, Chicago, Ill. This was 490 feet high, top-tuned to raise the effective electrical height from 130 degrees to 190 degrees. A comparison was made of the fading at 60, 85, and 125 miles when the transmitting conditions were alternated between the old ineffective WMAQ antenna, the new antenna with the top tuned and the new antenna with the top untuned. Comparisons were also made of the fading from this station, operating normally, and other Chicago stations also operating normally. Space does not permit showing these recordings, although they did demonstrate effectively the superiority of an antenna of the ideal or approximately ideal characteristics compared with the obsolete "T" types supported between 300-foot towers.

*Mechanical Design of Antenna Towers*

Much thought has been given by the NBC to the mechanical specifications for radio towers. It is rather common practice to design broadcast antennas for an indicated wind



velocity of 90 miles per hour, corresponding to an actual wind velocity of 68 miles per hour. A search of recorded wind velocity over periods of approximately 50 years, in many localities, indicates that a tower designed for 90 miles indicated velocity is safe, although the figure could not be reduced much before it became unsafe. Cost estimates covering a 500-foot guyed antenna of uniform cross section designed for different wind velocities were, for a 90-mile indicated wind design \$16,969, a 100-mile design \$18,260, a 120-mile design \$19,621, and 140-mile design \$22,207.

A factor of considerable importance which is often overlooked is the difficulty in determining the wind conditions which cause the failure of a radio tower. The government maintains wind reporting stations at many locations, but they record only average conditions in the immediate vicinity and these would not necessarily hold true for an antenna located several miles away, or even several hundred feet away. The literature was searched to find all of the data published concerning the variation of wind velocity over various sections of a tower at given instants.

There is comparatively little information available on this subject. The wind velocity is higher at the top of a high tower than it is at the base by a rather considerable amount although tower designers ordinarily do not design antennas for such a condition. In mechanical specifications for NBC's radio towers full

allowance is made for these conditions and in the case of the WJZ antenna it was specified that the top section should be designed for a wind load of 35 lbs. per square foot and the lower section for a wind load of 25 lbs. per square foot, from any angle. Thirty-five lbs. per square foot is equivalent to an indicated wind velocity of 125 miles per hour or an actual wind velocity of approximately 95 miles per hour.

Generally speaking, a guy wire, with full wind loading on the tower, should not be required to carry more tension than one-third of its ultimate strength. In addition the guy wires should be initially stressed to not less than one-half of the stresses they will be subjected to under full wind loading conditions. The object of this specification is to reduce the slack in the guys and so minimize whipping of the tower which would introduce extremely high transient stresses in the guys during gusts of wind. It is not believed that the scope of this article is wide enough to warrant going further into this particular phase of the subject.

#### *Ground Screens*

Where there is high base voltage on a tower the reduction of dielectric losses in the earth merits careful consideration. These losses are the result of heating of the earth between the lower part of the antenna and the actual ground wires which customarily are buried. High base capacity should introduce very little loss, but interposition of the earth may introduce considerable

loss which, fortunately, can be rather easily reduced. The first application of the ground screen and the quantitative measurements of the reduction of losses on broadcast frequencies was at station KOA, Denver, Colo., 1934. Those tests consisted of making measurements of field intensity at one-mile distance with constant power input, over the broadcast spectrum, without a ground screen. The entire performance was then repeated with a ground screen in position. This entailed making painstaking measurements of antenna resistance and reactance over the broadcast spectrum under each condition since the antenna input power could not have been determined without them. The screen consisted of galvanized iron fencing of approximately  $\frac{3}{4}$ -inch mesh, 50 feet square. Figure 7 shows the improvement in average one-mile field strength over the broadcast spectrum obtained by the use of this ground screen. An equal improvement obtained by increasing the power of this station would have cost over \$30,000 whereas the ground screen cost approximately \$300.

#### *New WJZ Antenna*

Over ten years ago, Stuart Ballentine\* pointed the way to the modern broadcast antenna, but the high cost and mechanical problems proved to be a deterring influence on rapid development. Several years ago high steel radiating towers made their appearances. The

\**Proc. IRE—Vol. 12, 833-839, 1924.*

first designs were less than ideal in that they had wide bases or wide mid-sections producing variations in inductance and capacity, which in turn produced current distributions quite different from the sinusoidal distribution desired.

Brown and Gehring† recently demonstrated in model experiments an effect which had been anticipated mathematically. Briefly, the benefits expected from antennas built with slightly greater than one-half wavelength were only partly obtained because of the cross sectional variation throughout the length. This produced non-sinusoidal current distribution which led to the distortion of the vertical field pattern. Some concentration of the vertical field at low angles above the earth was obtained, but not to the extent anticipated. The diameter or cross section of an antenna is not important within sensible limits so long as it is substantially uniform throughout its length.

Variations result in reducing the radiation at low angles and increasing it at high angles. Brown and Gehring showed conclusively that this is true. It has been proven to be true in measurements of actual antennas, but not quite as conveniently as can be shown with model experiments in which changes in shape can be readily made, other conditions remaining unchanged. The measured 1800 millivolts at one mile obtained at WJZ, Bound Brook, N. J., near New York City, represents about the maximum that

†*Proc. IRE—Vol. 23, 311-355, 1935.*

can be obtained, at present at least, with antennas built to about one-half wavelength height. The 1800 millivolts recorded includes no corrections upward for ground loss within one mile, or other factors which represent the last unavoidable losses in any man-made instrument. When correction is made for earth loss within one mile, which in this case is 6 per cent, the WJZ field becomes 1910 millivolts per meter. NBC, in its studies of antennas, coverage, etc., has measured the one mile field intensities of many radio stations. On an equal power basis, WJZ has the highest field ever measured, as it should have.

Prior to approval of the WJZ project, careful calculations were made of the improvement which could be obtained by the construction of a new tower, including the population which would be added to the service area, those who would be relieved of fading, etc. After the antenna was placed in service on November 15 the letters from the listening audience were carefully tabulated on maps to show where fading had been eliminated, where it was just noticeable and where it still existed and these maps were then compared with the engineering estimates of improve-

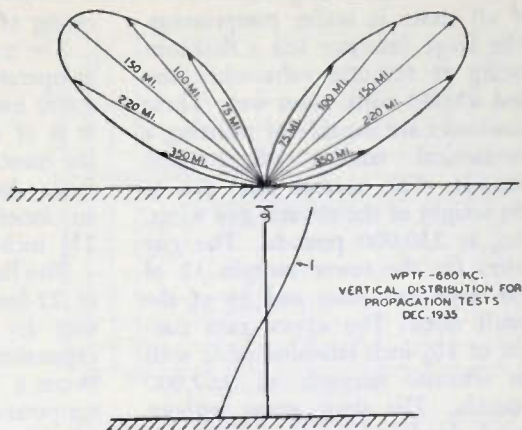

FIG. 6—VERTICAL DISTRIBUTION PATTERN FOR PROPAGATION TESTS.

ment which had been made prior to construction. This new antenna is 640 feet high, is triangular in shape, and has  $61\frac{1}{2}$ -foot faces. The tower is built to withstand an actual wind velocity at the top of 95 miles per hour and at the bottom of approximately 70 miles per hour.

Particular attention was given in this design to reducing or eliminating arc-overs of the insulators due to high static charges. A study was made of the potential gradient of the tower and also an estimate was made of the static potentials which might be developed across the guy-wire sections. As a result the insulators are very close together near the tower and are separated increasingly toward the bottom of the guys. These insulators are built in such a manner that the failure of the porcelain will not permit them to pull apart. The porcelain



at all times is under compression. The large insulator has a flashover rating of 100,000 volts when dry and 85,000 volts when wet. These insulators are capable of resisting a mechanical tension of 200,000 pounds. The normal load due to the weight of the towers, guy wires, etc., is 230,000 pounds. The guy wires for the tower contain 12 of the large insulators and 33 of the small ones. The upper guys consist of 1¼-inch stranded cable with an ultimate strength of 162,000 pounds. The static stress without wind loading on these guys is 24,000 pounds and under full wind loading conditions is 48,000 pounds. The bottom guys consist of 1-inch stranded cable with an ultimate strength of 103,000 pounds, a static stress without wind loading of 15,400 pounds, and a full wind loading stress of 30,000 pounds.

Directly beneath the base of the antenna is a copper ground screen 48 feet square and radiating from the ends of this copper screen are 120 radials of buried copper ribbon each 600 feet long. Altogether there are over 90,000 feet of buried copper ribbon in the ground system of WJZ.

The antenna is connected to the transmitter through a coaxial tube transmission line of greatly improved design. It has a dry flashover rating of 95,000 volts and a wet flashover rating of 85,000 volts. Although the line is not the largest coaxial type ever built it has, so far as is known, the highest voltage

rating of any ever built.

The transmission line is designed to operate with 500 kw. carrier and 2,000 kw. peak modulation power. It is of coaxial tube aluminum alloy construction with an outer tube inner diameter of 10 inches, and an inner tube outer diameter of 2¾ inches.

The line is 500 feet long, is built in 22-foot sections, and has provision for the 10-inch longitudinal expansion which would develop between a -40° and +120° range of temperatures. The line is supported above ground at 22-foot intervals. At each support a small trolley on ball bearings is free to move on a weather enclosed track. The inner conductor is free to move independently of the outer one as it will to a minor extent. The slenderness ratio of the inner tube is so low, and the resistance to movement so low, that buckling and short circuit could not occur. The clear air sparkover voltage in "coax" lines usually is considerably greater than can be obtained because of the necessity of imperfect insulating supports between tubes. A new type of conical porcelain insulator is used in the line which makes possible a design in this case with only 15 per cent difference between an ideal line without insulators and the actual line. The heat loss per insulator is only 3.8 watts on 500 kw.

The tower lighting consists of 100-watt lamps on each corner at the 105, 210, 315, 420, and 535-foot levels and a 1,000-watt Fres-



nel lens aviation beacon at the top, flashing red at 40 cycles per minute. The lighting is controlled by a Weston light meter which automatically operates at a pre-determined value of light intensity.

Judging by the response from listeners, which was immediate and enthusiastic, the severe selective fading along Long Island Sound, in Westchester important areas, has been eliminated. The signal was at the same time increased five decibels. If the increase obtained with the new antenna were to be obtained, instead, by increasing power, 115 kw. would be required. Sixteen thousand square miles have been added to the WJZ primary service area. This is equivalent to an area 126 miles square.

The writer wishes to take this

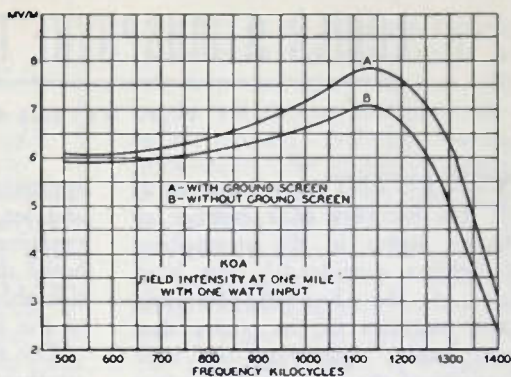

FIGURE 7—IMPROVEMENT OBTAINED BY USE OF GROUND SCREEN.

opportunity to acknowledge the efficient and untiring work of Mr. Lester Looney, Mr. Carl Dietsch and Mr. William Duttera, Engineers of the NBC Radio Facilities Group. These men have taken a very prominent part in building up the Radio Facilities of NBC over a period of many years. The antennas described in this paper were largely engineered by Mr. Duttera.

**A** SPECIAL EMPLOYMENT survey of the entire radio industry is being planned by the Bureau of Labor Statistics, U. S. Department of Labor. The government's survey will largely be confined to radio manufacturers who are now on the mailing list of the Bureau of Labor Statistics and contributing monthly data to that Bureau.

A normal or average week's employment will be the basis of the proposed survey. Detailed data on wages, working hours, total earnings, number and sex of employees, overtime, bonuses, holidays, union affiliations, and specific employment conditions will be obtained. It is reported that the survey has been urged by labor organizations and also is supported by several radio manufacturers. It will be the first survey of this nature in ten years.

## LOWER ATMOSPHERE IONIZATION

BY E. J. WILLIAMS

THE RECENT announcement of the discovery of a number of ionized layers in the atmosphere at heights considerably less than that of the Kennelly-Heaviside Layer suggests to the writer that some notes regarding the conductivity of the air near the surface of the earth may be of interest.

A molecule of a gas is ionized when an electron, or negative charge, is removed from it. Both the electron and the remaining positive part are known as small ions. If an electric field is applied to the ionized gas, the ions will move, the rate of movement being known as the mobility of the ions, the movement itself constituting an electric current.

The small ions are often captured by specks of dust or small drops of moisture, known as nuclei, thus forming large ions. The mobility of these large ions will, due to their size, be smaller than that of the small ions. The air over land is more dust-laden than over the sea, and in consequence, there will be more large ions over land areas than over sea, and they will outnumber the small ions, the reverse being the case over the sea. The actual number of small ions is

approximately the same over land and sea, the reason for this being explained later. It must be remembered that winds will have a considerable effect on the distribution of the ions.

The agents causing the ionization are three in number, viz., (a) radiation from radio-active substances (radium, uranium, thorium, potassium, etc.) in the earth; (b) radiation from similar matter in the atmosphere (radon, thoron); and (c) the penetrating radiation, commonly known as "Cosmic Rays."

The radiations from radio-active matter are usually denoted as  $\alpha$ ,  $\beta$  and  $\gamma$  rays.  $\alpha$  rays consist of positively charged particles. This has been proven by magnetic deflection. The particles are actually atoms of helium, differing from the ordinary atom in their charge.  $\beta$  rays are formed of negatively charged moving particles (a stream of electrons).  $\gamma$  rays differ from  $\alpha$  and  $\beta$  in that they do not consist of particles, but are similar to X-rays, being an electro-magnetic radiation with a frequency of the order of  $10^{16}$  kcs. per sec.

All three rays are capable of producing ionization, but the  $\gamma$  rays having much greater penetrating

TABLE I.		
Approx. Number of Ions per cu. cm. of Air.		
	<i>Over Land</i>	<i>Over Sea</i>
Large.....	1,000 to 80,000	200
Small.....	600	600

power than the other two, can come from greater depths in the earth, and, therefore, are emitted in larger quantities and will affect the atmosphere to a greater height. The ionization by  $\alpha$  rays from the earth is probably restricted to a few inches of the atmosphere near the ground.  $\beta$  rays can produce slight ionization up to heights of 30 feet, while  $\gamma$  rays are appreciably effective up to one mile.

The radio-active gases in the atmosphere were originally produced from the radio-active matter in the earth. In the atmosphere there is no very absorbing medium, and the  $\alpha$  rays are, therefore, responsible for most of the ionization from this source. A greater quantity of  $\alpha$  rays than  $\beta$  and  $\gamma$  are emitted from radium and its emanations. The radiations from gases in the air decrease with height, and are probably appreciable up to about three or four miles above the earth's surface. The radio-active gases being rarer over the sea than land, the ionization caused in this way will be much smaller over water than land.

The universal penetrating radiation was first suggested when it was discovered that the ionization of the atmosphere tended to increase with height after the first

kilometer or so. The two ionizing agents mentioned above would result in a continuous decrease with height. It appears that there must be an ionizing radiation coming from above. The ionization appears to be due to fast downward moving particles, but these particles are generally considered to be a secondary radiation, the primary radiation being electro-magnetic, with a frequency higher than that of  $\gamma$  rays. The radiation appears to consist of at least four components, with different absorption coefficients. No variations in intensity of rays with sidereal or solar time have been discovered; it is therefore improbable that rays have their source in the stars or sun.

Among the suggestions that have been made to explain the radiation, the most important is that of Dr. R. A. Millikan, who considers that the rays are formed in interstellar space by the production of various elements from hydrogen, the various components being due to the formation of particular elements. Excluding hydrogen, about 99 per cent of all matter is made up of helium, carbon, nitrogen, oxygen, magnesium, aluminum, silicon, iron, nickel, and cobalt. These elements can be arranged in four groups, as those readers familiar with the Periodic Table in Chemistry will at once appreciate, the groups being:

- (a) helium (2)
- (b) carbon (6), nitrogen (7), oxygen (8);
- (c) magnesium (12), aluminum

- (13), silicon (14);  
 (d) iron (26), nickel (27), cobalt (28).

The numbers in brackets are the atomic numbers of the elements, and, for convenience, can be considered as representing the number of revolving electrons in one atom of that particular element. (According to Rutherford's theory, atoms consist of a central positively charged nucleus around which revolve a number of negatively charged electrons.) Thus, an atom of carbon would contain 6 revolving electrons. The atomic weight of carbon being 12, means that the nucleus contains 12 protons, and, since the whole atom is neutral in charge, must also contain 6 further electrons. Millikan suggests that these four groups correspond to the four components of the penetrating radiation in the manner already stated.

It has also been suggested that thunderstorms may be the source of part of the radiation.

Of the three sources of ionization discussed, the radio-active matter in the air is most effective over land, and the penetrating radiation is most effective at sea. The percentages of the ionization caused by the various agents in free air at sea level are shown here.

The effect of the penetrating radiation is obviously the same over land and sea, and it therefore follows that the degree of ionization of the air will be less over water than land, actually ions being formed about six times as rapidly over land

TABLE 2.

Agent.	Over Land.	Over Sea.
Radio-active Matter:		
Earth .....	30% to 40%	Nil
Air .....	nearly 50%	Nil
Penetrating Rad.	20%	100%

than sea. The death rate of the small ions is, however, more rapid over land areas, due to more dust in the air, and this results in the number of small ions over land and sea being approximately equal.

Now if  $S$  is the resistivity of the atmosphere and an electric field of intensity  $F$  is applied, then the current  $i$  through unit area is given by

$$i = \frac{F}{S}$$

the current being due to streams of positive and negative, small and large ions.

The conductivity— $\frac{1}{S}$ —is proportion-

al to the mobility of the ions, *i.e.*, conductivity is proportional to  $(nk + NK)$  where  $k$  and  $K$  are mobilities, and  $n$  and  $N$  the numbers of small and large ions respectively. In clear air,  $NK$  is usually negligible compared with  $nk$ , owing to the low mobility of the large ions, and even in large towns,  $NK$  only approaches  $1/5$  of  $nk$ .

From this it follows that the conductivity of the air mainly depends on the number of small ions present, and will be almost the same over land and water.



# Power Amplifier Tube for Ultra-High frequencies

• BY A. L. SAMUEL  
*Bell Telephone Laboratories*

THE DEVELOPMENT by the Laboratories of an amplifier tube capable of handling a moderate amount of power at frequencies as high as 300 megacycles per second now makes possible an appreciable extension of the usable portion of the radio-frequency spectrum. The use of conventional vacuum tubes at these very high frequencies has been found unsatisfactory because of certain effects which at lower frequencies are of secondary importance. For an appreciation of these effects, certain concepts are necessary.

One of them has to do with the time required for the electrons to travel from the cathode to the anode within the tube structure. This time is the so-called electron transit time. At low frequencies it can be neglected; at high frequencies it must be considered. One effect it produces is a lag in the phase of the output current with respect to the grid potential. The calculation of this delay is complicated by an important distinction which must be drawn between the

rate of arrival of electrons at the plate and the plate current. As an electron approaches the plate it induces in that plate an image charge. The magnitude of this charge varies with the proximity of the electron to the plate. The flow of current in the conductor to provide this charge actually constitutes the plate current. Viewed in this light the component of plate current due to any given electron commences to flow when this electron leaves the cathode and ceases to flow at the instant of the electron's arrival at the plate. Nevertheless, the net effect of the transit time, as may be shown by a detailed analysis, is to produce an appreciable phase difference between the grid potential and the plate current.

A further consequence of the finite transit time is that under operating conditions (that is with alternating potentials on the tube electrodes) the electrons arriving at the plate usually will have velocities greater than the velocity corresponding to the potential of the anode at

the instant of their arrival. The excess energy corresponding to the greater velocity is obtained from the alternating component of the electrode potentials, and its dissipation at the plate in the form of heat decreases the useful output obtainable from the tube. Part of this energy comes from the grid circuit, and is responsible for the so-called input impedance or active grid loading. The practical effect of this input loading in an amplifier is to increase the power demands placed upon the input supply. Its effect is by no means negligible even at only moderately high frequencies, and at ultra-high frequencies this input loading becomes of major importance.

A second important concept for the correct understanding of ultra-high-frequency tube design has to do with the increased importance played by the interelectrode capacitances and the lead influences. The difficulties encountered in the use of the simple three-element tube as an amplifier at moderately high frequencies as a result of feedback or singing caused by the interelectrode capacitances, are, of course, well known. Such difficulties are greatly increased at higher frequencies. They may be largely overcome by the use of a multi-element tube structure. At ultra-high frequencies, lead inductances common to both input and output circuits produce a similar effect, and so must be avoided in the tube design.

The large charging current required by the interelectrode capaci-

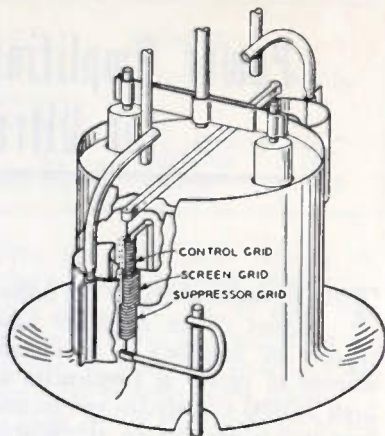

FIGURE 1—PERSPECTIVE SKETCH OF THE HIGH-FREQUENCY DOUBLE PENTODE.

tances at high frequencies affects the cathode design. At low frequencies the rate at which electrons leave the cathode at any instant is identical with the rate at which they arrive at the anode. At high frequencies this is no longer true. The peak instantaneous emission may greatly exceed the value that would be required for operation under identical voltage conditions but at a lower frequency. The high charging current is also responsible for an increase in the resistance losses in the tube leads. The resistance of these leads is, of course, greatly increased at high frequencies because of the so-called "skin" effect. Resulting losses decrease the efficiency of the tube and may, in a power tube, produce enough local heating to cause a more or less rapid deterioration of the lead-to-glass seals, which may ultimately

destroy the vacuum. Short, heavy leads are therefore required for ultra-high-frequency operation.

The interelectrode capacitances together with the lead inductances are responsible for still another difficulty. The frequency to which the input and output circuits of an amplifier may be tuned is set by the natural frequency formed by the interelectrode capacitances and their associated lead inductances. For most practical purposes the operating frequency of an amplifier must be well below these values. This places an upper limit on the permissible values that the interelectrode capacitances and lead inductances can have.

Many of the factors which have been discussed can be compensated by reduction in dimensions. It can be shown, in fact, that if all the dimensions of a vacuum tube are reduced in the same proportion, the transconductance, plate current, and amplification factor for fixed electrode potentials will remain unchanged while the values of interelectrode capacitances, lead inductances, and electron-transit time will be reduced in direct proportion to the reduction in size. Unfortunately, a reduction in dimensions without a corresponding reduction in all operating voltages is possible only at the expense of an increased demand on the emission capabilities of the cathode. The required emission per unit area must vary inversely as the square of the linear dimensions. Added to this is the increased demand caused by the

high-frequency charging currents already discussed. The available emission is fixed by the character of the cathode surface, and cannot easily be increased. A proportionate reduction in cathode dimensions, therefore, is not feasible. Furthermore, the proportionate reduction of the anode dimensions would require an increase in the power dissipation per unit area—again inversely proportionate to the change in linear dimensions. While the heat-dissipating ability of the anode can be increased in a number of ways, most of these will increase the tube capacitances. The high grid temperatures which may result from the reduction in dimensions also makes necessary the introduction of cooling provisions. Because of these effects one must combine a reduction of dimensions with the introduction of special mechanical arrangements to overcome the otherwise harmful effects of this reduction.

All these factors have necessarily been taken into account in the development of the new tube. As may be seen in Figure 1, it consists of two relatively large concentric metal cylinders and two sets of tube elements diametrically opposite each other outside the outer cylinder. The cylinders act as a shield between the input leads to the control grid and the output side of the tube, as supports for the screen and suppressor grids and as a radio-frequency bypass condenser between them, and as low-impedance leads interconnecting the two sets of screen



TABLE I

*Operating Characteristics and Constants of the Double Pentode Tube*

Filament current (each side).....	5.0 amperes
Filament potential (each side).....	1.5 volts
Rated anode dissipation (each anode).....	15 watts
Rated screen dissipation (each side).....	5 watts

*At Anode and Screen Potentials of 500 Volts and Anode Current of 0.030 Ampere-Characteristics of each Side*

Transconductance.....	1250 micromhos
Anode resistance.....	200,000 ohms
Normal control grid potential.....	-45 volts

*Interelectrode Capacitances (When Properly Mounted)*

Direct control grid to control grid.....	0.02 micromicrofarad
Direct plate to plate.....	0.06 micromicrofarad
Total control grid to ground (each side).....	3.8 micromicrofarads
Total plate to ground (each side).....	3.0 micromicrofarads
Control grid to plate (each side).....	0.01 micromicrofarad

*Lead Inductances*

Total grid to grid.....	0.07 microhenry
Total plate to plate.....	0.08 microhenry

*Rating as Class A Amplifier*

Maximum direct plate potential.....	500 volts
Maximum direct screen potential.....	500 volts
Maximum continuous plate dissipation (each).....	15 watts
Maximum continuous screen dissipation (total).....	10 watts
Maximum output at 150 megacycles with distortion down 40 decibels.....	1 watt
Nominal stage gain at 150 megacycles.....	20 decibels
Nominal control grid potential.....	-45 volts

*Rating as Class B Amplifier*

Maximum direct plate potential.....	500 volts
Maximum direct screen potential.....	500 volts
Maximum space current (total).....	150 milliamperes
Maximum continuous plate dissipation (each).....	15 watts
Maximum continuous screen dissipation (total).....	10 watts
Maximum output at 150 megacycles.....	10 watts



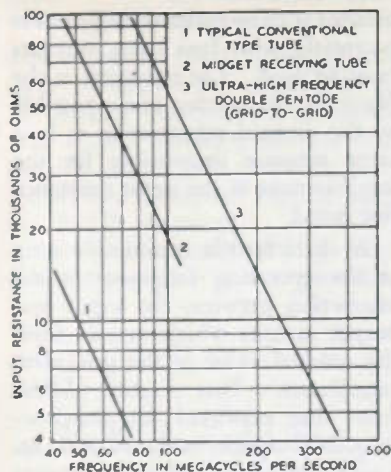

FIGURE 2 — PUSH-PULL INPUT SHUNTING RESISTANCE AS A FUNCTION OF FREQUENCY.

and suppressor grids. The control grids are of an unusual design, consisting of a cooling fin to which are attached loops of tungsten wire encircling the thoriated tungsten filament. These control grids project through the slots in the cylinders and are in turn surrounded by loops of wire attached to the inner and outer cylinders and acting as the screen and suppressor grids respectively. The control grids are supported directly on their leads which project through one face of the tube envelope. The semi-cylindrical anodes are also supported directly on their leads which project through the opposite face of the tube envelope. This unusual construction is made desirable by the ultra-high-frequency requirements which have just been described.

In spite of the unusual form of the tube, electrically it is the equivalent of two conventional negative-grid, pentode tubes. Its performance at frequencies as high as 300 megacycles is quite comparable with the performance of conventional tubes at much lower frequencies.

Operating characteristics and constants are listed in Table I. Special attention is directed to the values of interelectrode capacitances and lead inductances. It will be observed that while the interelectrode capacitances are low they have not been reduced in proportion in the reduction of operating wavelength. A more important feature, however, is the reduction of the lead inductances.

For a tube which is to be used at ultra-high frequencies, certain characteristics not ordinarily considered are of particular significance.

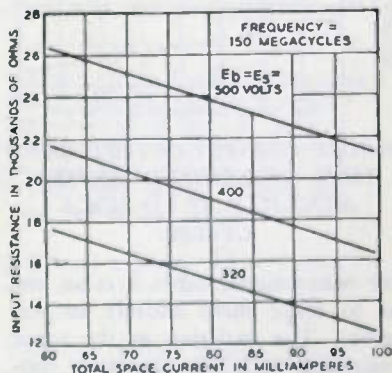

FIGURE 3—VARIATION IN INPUT RESISTANCE WITH OPERATING CONDITIONS AT 150 MEGACYCLES.

One of the most important of these is the active grid loss which, as already mentioned, comes about because of appreciable electron transit time. Figure 2 gives a plot of the push-pull input shunting resistance of this tube as a function of frequency. The value of 30,000 ohms at 150 megacycles is to be compared with 2,000 ohms, a typical value for two conventional tubes in push-pull. At 300 megacycles the input resistance of the twin pentode is still above 6,000 ohms, while

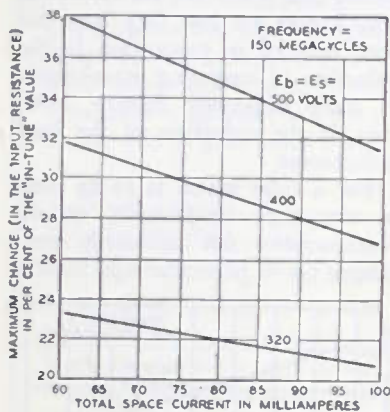

FIGURE 4—INPUT-OUTPUT REACTION DETERMINED EXPERIMENTALLY AT 150 MEGACYCLES.

for conventional tubes it is so low as to make them entirely inoperative. The variation in the input resistance with the operating conditions of the tube for a constant frequency of 150 megacycles is shown in Figure 3. It is evident that if a high value of input re-

sistance is to be realized, high anode potentials with low space currents must be used. The reduction in the filament-grid spacing made possible by the unusual construction is in a large measure responsible for the improvement in the input resistance just noted.

A characteristic measurable only at the operating frequency is the interaction between the input and output circuits which results from the residual value of the grid-plate capacitance. This reaction differs from that predicted for the low-frequency capacity measurements on a cold tube because of the inductance of the screen-grid lead, and because of the electron space charge. The reaction can be measured by observing the variation in the input impedance resulting from the tuning and loading of the output circuit. Experimentally determined values are given in Figure 4.

The double pentode tube has been found useful as a high quality class A amplifier, as a class B amplifier, as a frequency multiplier, and as a modulator at frequencies of 300 megacycles per second and below. Its performances in these various modes of operation is quite comparable to the performance of conventional pentodes of similar ratings at much lower frequencies. Stable operation with some gain has been obtained at frequencies as high as 500 megacycles. When operating as a class A amplifier at 150 megacycles, an output of 1 watt is obtained with the distortion 40 dec-

ibels below the fundamental. Under these conditions the stage gain is 20 decibels. Outputs of 10 watts with a plate efficiency of 60 to 70 per cent and a gain of 10 decibels are secured when this tube is used for class B operation.

The development of this tube demonstrates that power amplifier

tubes of the negative-grid type are usable at higher power levels and frequencies than have been reported previously. This type of development removes a practical barrier which, up to the present, has prevented the successful utilization of frequencies that extend above one hundred megacycles.

### Radio Remarks That . . .

**T**HE NEW YORKER introduces the megacycle as a vehicle. Discussing a television demonstration in Gotham, this magazine says that the images which were sent over to the Empire State building by wire came back to RCA building on a *megacycle*.

**T**HE LATEST invention pounced upon by paranoia victims is television. According to a late report, the sufferers aver that enemies watch them out of mirrors, by way of television.

**T**HE BROADCAST industry has invested a total of \$40,000,000. 24,500,000 homes in the United States are equipped with sets and 4,500,000 receivers are installed in cars.

**T**HE NEW light-polarizing glass is available from Land-Wheelwright laboratories, Boston, Mass. It is called "Polaroid" and is a special sort of safety-glass in which the central shatter-proofing layer is replaced by a special layer containing a vast number of crystals. It is seriously being considered as a means of cutting down headlight glare (polarize lamps one way and windshields another). Cure? Yeah—and costly. Maybe less costly when we all wear them—on our cars, not in our eyeglasses.

**A**FTER a skidding automobile crashed through a bridge rail in Boston, telephone cables held it suspended until rescuers extricated the driver unhurt. Good wiring!

**W**9FWN and W9ESZ have noticed a fluttering of their 10-meter signals only when metal planes of the Northwest Airlines are flying almost directly over FWN's antenna. They are trying to justify the suggestion of reflections.

**I**T IS unlawful to run a radio in a Boston hotel lobby on Sunday without a special permit.

# THE TECHNICAL FIELD

## in Quick Review

**R**ADIO DIGEST briefly summarizes for its readers the contents of leading radio articles in current technical publications, some of which may appear later in RADIO DIGEST.

**ANTIDOTES FOR BUG POISON**, by G. S. Granger—One of the most useful and abuseful adjuncts to radio telegraphy is the semi-automatic transmitter key, better known as the "bug". The sorry results caused by those who sacrifice everything for the sake of its speed is well-known to all amateurs. Mr. Granger explains the principles of the key and carefully outlines its proper use.

**5 AND 10 SUPERHET**, by S. O. Oehman—An attempt to overcome the reticence of hams toward superhet receivers on the 5 meter band, by solving the two principle objections formerly held against its use: noise and lack of vari-

### ALL-WAVE RADIO

AUGUST, 1937  
Manson Publications Corp.  
16 E. 43 St., N.Y.C.  
25c a copy—\$2.50 yearly

able selectivity control.  
**A. C. OPERATED BIAS SUPPLIES FOR 'PHONE AND C. W. TRANSMITTERS**, by W. E. McNatt—Presenting practical, concrete information about a.c. operated bias supplies. Both low and high voltage units are considered, as are the voltage regulator and power transformer. A small but sufficient amount of mathematics is included to make his system clear.

**THE RME-69 RECEIVER AND THE NATIONAL "1-10"**—Descriptions of these commercial models operating between 600 and 10 meters and 1-11 meters respectively.

August, 1937—

**DAY PROPAGATION AT MEDIUM FREQUENCIES**, by Raymond M. Bell and Paul S. LeVan—Describing the data obtained from experiments upon the day propagation of frequencies between 550-1500 kcs, obtained from 60 stations under similar receiving conditions, this discussion throws a new light upon the propagation of these frequencies for those interested in this particular phase of radio.

### COMMUNICATION & BROADCAST ENGINEERING

25c a copy—\$2.00 yearly  
Bryan Davis Pub. Co., Inc.  
19 E. 47 St., N.Y.C.

**NEW AIRCRAFT RADIO RECEIVERS**, by Stanley J. Gustof. Mr. Gustof describes here the construction features of the latest receivers being used in commercial and small private planes.

**MIXER CIRCUITS**, by Albert Preisman—This second installment of the discussion of these circuits contains much interesting information—both descriptive and mathematical— not previously revealed.



*In the July, 1937, COMMUNICATION & BROADCAST ENGINEERING*

**300 K.W. GRID CONTROLLED RECTIFIER**, by *J. M. Williams*—High d-c voltage single section power rectifiers are relatively new. This short but informative description of such a rectifier operating at Rocky Point, Long Island, the RCA Communications Transmitting Center, is therefore especially interesting. The rectifier supplies plate voltages from 8,000 to 20,000 volts d-c to high power tubes for transmitting commercial messages to various parts of the world. An induction type phase shifter is used to regulate the output voltage magnitudes by changing the phase relationship between the grid anode voltage and the primary voltages of two low capacity grid transformers. The range, providing for a gradual rise in d-c rectifier voltage, is secured by turning the rotor of the phase shifter. Turning torque is supplied by a small d-c motor, gear-reduction unit, and a magnetic clutch.

**PERFORMANCE OF A DIRECT LATERAL RECORDING SYSTEM**, by *Frank W. Stellwagen*—Although the general theory and the performance of the individual component parts in direct lateral recording systems have been discussed previously this article for the first time reveals the detailed data on the recording-playback system, showing overall performance as well as that of the component parts. The article is complete with machine specifications, performance curves, and layout diagrams.

**PORTABLE HIGH-SPEED LEVEL RECORDER**, by *A. W. Niemann*—In the field of sound measurements a great demand exists for sensitive, portable, high speed level recorders. The recorder here described contains several new features. It can be used, by an interchanging of potentiometers, both to retain permanent records of electrical

measurements in db units, and acoustical measurements in phone units. The apparatus consists of an input potentiometer, amplifier, rectifier, and motor driven disk, which, coupled to the input potentiometer by a magnetic clutch, can vary the potentiometer setting to hold the rectified output of the amplifier constant. A recording stylus in contact with a moving strip of wax paper indicates the changes. Various potentiometer ranges can be used; as high, for instance, as 0.75 db for electrical measurements. The phone potentiometer used in recording sound intensity has a variable reaction to correspond to that of the human ear. Its frequency response changes, as does that of the ear, at different signal intensities.

**SNOW STATIC EFFECTS ON AIRCRAFT**, by *H. M. Hucke*—Condensing a previously presented report on the United Air Lines' study of this problem as it affects radio reception.

**TELEVISION STUDIO CONSIDERATIONS**, by *W. C. Eddy*—There are many technical problems which must be surmounted before television can be widely produced. Assuming that this will be done, however, it is interesting to anticipate, as this article does, the possible changes that will be required in broadcast entertainment and technique before the commercial success of television can be expected.

**THE LOW POWER TRANSMITTERS**, by *John P. Taylor*—Last month Mr. Taylor described several of the standard transmitters available for low power broadcast stations. The current issue contains the second installment of the series, in which the W. E. 301A/301B and the Collins 300E/300F transmitters are discussed.

**DEVELOPMENTS IN 1938 RECEIVERS**—This year mechanical improvements and constructional refinements are most in evidence. Some limitations are cited in the methods of realignment in case of circuit constants caused by ageing, heat or humidity. Little change is made in acoustical features other than that both positive and negative feedback are used in some models for better frequency response. Glass tubes, such as the G types, are used more. Tuning ease is stressed. No increase of either the ultra-high or extra-low frequency ranges are apparent. Prices are generally higher, but present indications are that a greater value will be obtained for the money.

**DIRECTIONAL ARRAY FIELD STRENGTHS**, by *A. R. Rumble*—Careful consideration of two salient features is involved in the designing of any directional antenna array: the shape of the pattern and the absolute magnitude of the signal strength contours in the pattern. In this discussion a method is indicated for computing the performance of directional arrays and comparing them with the performance of a single vertical radiator of the same height. The mathematical results obtained are especially useful in the planning of improvements in broadcast radiation systems.

**RELAYS IN TUBE OUTPUT CIRCUITS**, by *E. E. George*—Virtually every commercial application of the vacuum tube requires a relay in the plate circuit of the final tube. This article describes a method for obtaining a visual comparison of the tube and relay characteristics by superimposing the relay characteristic on the tube characteristic with the origin of the relay curve corresponding to the plate supply voltage and zero plate current. This permits the determination of the circuit conditions for developing the optimum relay magnetomotive force. The effect of varia-

# electronics



AUGUST, 1937  
50c a copy—\$5.00 yearly  
McGraw-Hill Pub. Co., Inc.  
330 W. 42 St., N.Y.C.

tions of voltage or relay and tube characteristics is easily seen.

**VIDEO AMPLIFIER DESIGN**, by *R. L. Freeman and J. D. Schantz*—A video amplifier is one that is responsive to picture signals, and, therefore, is

an extremely good audio as well as a very wide band radio frequency amplifier. It is used in the studio for amplification and for impedance matching purposes; in the transmitter for amplification and modulation; in the receiver for amplification, and often times in all three components of a television system as a polarity changer. In the design of such an amplifier the frequency response, phase shift and transient response must be considered. Practical data, including an example, for the design of such an amplifier is given here.

**RADIO TUBE NOISE**, by *Hugh G. Hamilton*—Commercialization of the screen grid tube produced tremendous increases in radio receiver sensitivity. The problem of background noise, however, has been an undesirable accomplishment. A considerable amount of this noise is introduced by slight electrical fluctuations in the tubes. In addition to the known effect of tube noise due to the shot effect, gas ionization, x-rays and secondary emission, on the ultimate sensitivity of an amplifier, other electrical or mechanical variables may set up disturbances of even a higher order of magnitude. These may be outlined as follows: (1) Variable electrical leakage deposits; (2) Presence of conducting threads of carbonaceous material lodged between elements; (3) Variable or sliding contact between metal parts, nominally at the same potential; (4) Poor welding of the elements to their lead wires and intermittent short circuits between elements; (5) Mechanical vibration of elements. The importance, prevalence, and effects of each of these individual sources of noise are considered.

**THE FOURTH C. C. I. R. AT BUCHAREST PAVES THE WAY FOR CAIRO**, by James J. Lamb and John C. Stadler—Reporting the results of the International Radio Consulting Committee's recent meeting, the two representatives of the International Amateur Radio Union present encouraging information of increased recognition for amateur radio.

**PICK YOUR SPOT ON YOUR NEIGHBORS' SUPERS**, by George Grammer—Revealing the information which explains how beat interference from amateur signals arises in broadcast band superhet receivers, this article describes how beats with popular local stations can be avoided.

**A 50-WATT C.W. 'PHONE TRANSMITTER FOR 220-VOLT D.C.**, by M. P. Mims—The sorry plight of a brother ham secluded from the average world, and

**BATTERY PERFORMANCE FROM THE R. A. C. POWER SUPPLY**, by George Grammer—A recent highly practical application of the a.v.c. principle in radio for regulating the voltage output of power supplies makes possible the use of rectifier-type power supplies which duplicate battery performance—without the life factor. The operation of three circuits are discussed by Mr. Grammer: adaptation of the RCA circuit, essentials of Bell Laboratory development, and details of a practical voltage-regulated power supply for amateur receivers, speech amplifiers, and other devices requiring like voltages and currents.

**UNIT-STYLE PORTABLE STATION**, by Clinton B. De Soto and Byron Goodman—Construction considerations of a four-unit portable rig designed for use under three conditions—on field days, during vacation trips, and for emergencies—are outlined by the authors. Since a six-volt battery is all that is needed for operation, in addition to the units themselves, this rig is quite



SEPTEMBER, 1937  
25¢ a copy—\$2.50 yearly  
American Radio Relay League  
West Hartford, Conn.

in a place where the only source of power is a 220-volt system, prompted the research made by the author, resulting in the successful rig described by him here.

**BEAM TUBES IN A PUSH-PULL AMPLIFIER**, by Clark C. Rodimon—Further information on the beam

transmitter tube, the RK-48, presented as a sequel to the article one month ago which was devoted to the RK-47.

**CLASS-B AUDIO DRIVER CONSIDERATIONS**, by Douglas Fortune—The performance of an otherwise perfect Class-B audio stage may be impaired by an inadequate driver or by imperfect driver transformer design. To insure against this, the author points out some of the important considerations in the design of a driver stage which will deliver perfect quality to the Class-B grids.

*From the August, 1937, QST*

convenient for emergency purposes. The transmitter can be operated on 'phone or c.w. The units consist of a dual Genemotor assembly, a class B modulator, a four-tube superheterodyne receiver, and a 35-watt input crystal-controlled transmitter.

**56 MC. CONVERTER OF HIGH STABILITY**, by Byron Goodman—A simple solution to the principle of 56 Mc. c.w. reception—that of obtaining a stable high-frequency oscillator—is suggested: use of a higher intermediate frequency, thus abolishing image difficulties; placement of the oscillator on the low side of the signal frequency, and incorporation of high C.

**DE-LUXE 'PHONE TRANSMITTER WITH GROUPED CONTROLS AND CABLE TUNING**, by S. L. Baraf and Frank Edmonds—Aimed for those desiring to be on the air with a definite frequency and with a high quality signal, this article explains something new in transmitter construction regarding simplified tuning and control protection.



**VERSATILE 60 WATTS OF AUDIO**, by *Ray L. Dawley*,—In answer to numerous requests for a description of a self-contained modulator capable of sufficient output to modulate the "Bi-Push", the T20 rig, and other transmitters of similar power capabilities, Mr. Dawley presents an amplifier that will meet these conditions and, in addition, can also be used to drive a higher power modulator, as well as being suitable as a high power public address amplifier.

**THE SIMPLEST UNIVERSAL ANTENNA COUPLER**, by *W. W. Smith*—A surprising number of things can be done with a tapped coil and variable condenser—antenna coupling and tuning for instance. The combination, when built up to enable different methods of connection, makes a unit that is surpassed in its utility only by its versatility. Details of the connections that make possible proper "matching", so called, of the feeder and the transmitter; loading adjustment, and harmonic suppression are discussed in detail.

**MAKING LIFE MORE SIMPLE**, by *F.*

**SCIENCE AND SOCIETY**, by *David Sarnoff*—An address delivered by the president of RCA before the American Physical Society, at Washington, D. C., on April 30, 1937.

**TELEVISION STUDIO DESIGN**, by *R. M. Morris* and *R. E. Shelby*—Describing in detail the present plant and equipment in Radio City.

**RECENT DEVELOPMENTS IN DIVERSITY RECEIVING EQUIPMENT**, by *J. B. Moore*.

## RADIO

JULY, 1937  
30c a copy—\$2.50 yearly  
RADIO, Ltd.  
7460 Beverly, Los Angeles

**Alton Everest**—The application of the constant current type of curves to vacuum tube characteristics is relatively new. Graphical class C amplifier design and calculation becomes a very simple process, however, when one familiarizes himself with the interpretation and application of these charts. This method of presenting tube characteristics is extremely useful and should become widely popular if encouraged.

**INSTANTANEOUS, REMOTE CONTROLLED QSY (PART II)**, by *Dave Evans*—There are many advantages in instantaneous bandswitching, known to every amateur operator. During the amateur's approximately annual appraisal of his rig, Mr. Evans suggests some simple changes that, if incorporated, will provide this desirable end. In the February issue of RADIO, he described an exciter unit incorporating remotely controlled, instantaneous QSY and band change. In the current installment a method is explained for applying the same band-changing and QSY features to a high power amplifier stage designed to take one kilowatt input.



JULY, 1937  
50c a copy—\$1.50 yearly  
RCA Institutes Technical  
Press  
75 Varick St., N.Y.C.

Discussing the most recent design of the diversity receiving equipment for the reception of high frequency trans-oceanic radio signals.

**GRAPHICS OF NON-LINEAR CIRCUITS**, by *Albert Preisman*—Introducing quite general graphical constructions for solving non-linear circuits based upon the point-by-point method of solving differential equations.



August, 1937—

### IDLING CHARACTERISTICS OF ELECTROLYTIC CONDENSERS, by L. W. Appleton—

Users of electrolytic condensers are confronted with the "shelf-life" factor, the extent of deterioration of the anode film from the time of shipping to the time of use. This article discusses these characteristics of the wet-type electrolytics.

**INDUCTANCE OR CAPACITY TUNING**, by W. E. Bonham—Further discussing and mathematically deriving the effects in circuits of tuning by these systems, Mr. Bonham concludes his article with this, the second installment. The author's first article appeared in *Radio Engineering* for July.

**DYNAMIC SYMMETRY IN RADIO DESIGN**, by W. C. Eddy—In introducing the principle of Dynamic Symmetry to radio design engineers, the author reveals that nature's laws of design have been reduced to the common denominator of a mathematical progression by botanists some time ago. Dynamic Symmetry is a form of good composition, not a series of rules demanding strict adherence. It can be considered as a system of two-dimensional co-ordination assisting the engineer in designing apparatus which is both pleasing to the eye and durable. The article in the current issue is the second of a series

**SERVICING MOVIE SOUND**, by W. W. Waltz—Some of the remarkably simple trouble-shooting tests employed by experienced sound engineers in sound motion picture work are revealed by Mr. Waltz. A block schematic diagram, in which the batteries admittedly should be replaced by rectifiers and perhaps the photocell amplifiers removed, illustrates

## Radio Engineering

25c a copy—\$2.00 yearly

Bryan Davis

Publishing Co., Inc.

19 E. 47 St., N.Y.C.

In the July, 1937, Issue—

**THE NEW RECEIVERS.** One of the several articles appearing in various magazines concerning the latest models of radio receivers. Like the others, it emphasizes the fact that a majority of the improvements are in the line of increased convenience for the user, with less changes made in bettering set performance.

**TUBES IN TRANSIT**, by Stanley W. Todd—The substantial losses incurred by the transportation companies during the earlier days of tube and set shipping made necessary a study of the packing problem. Improvements in tube structures have helped materially, but the scientific packing developments described here have done even more.

devoted to this subject.

**PLATE EFFICIENCY OF CLASS "B" AMPLIFIERS**, by Paul Adorjan—Manufacturers' ratings of plate dissipation usually are expressed as "watts averaged over any audio frequency cycle". The designer himself must determine the average plate efficiency of his tubes. Tubes considered here are for use in class B amplifiers. The necessary mathematical method to be used by designers in calculating the watts dissipated in a tube under any conditions of operation, and hence to determine the optimum condition of operation, is carefully outlined.

## RADIO NEWS

AND  
SHORT WAVE RADIO

SEPTEMBER, 1937

25c a copy—\$2.50 yearly

Teck Publications, Inc.

461 Eighth Ave., N.Y.C.

the general layout, and assists in the understanding of the examples used. Means of localizing the trouble, checking the various parts, and correcting the faults are dealt with.

**BIG-SCREEN TELEVISION PICTURES**, by the *Television Reporter*—One of the more frequent criticisms

of cathode ray television is that the size of the pictures is not sufficient

for practical use. At an I.R.E. convention, however, an electron gun able to project images of a size and quality comparable to home movies was shown. The gun is a tube about 18" long and produces an image about 1½ by 2¼ inches on its self-contained fluorescent screen. The brilliance of this image is sufficient to permit simple optical projection on a large external screen. An image enlarged to 3 by 4 feet was presented with sufficient clarity to be visible by the large assemblage.

**1937 OLYMPIA TRANSMITTER**, by *G. McL. Wilford*—In this, the first of three articles dealing with the individual units of a modern transmitter, Mr. Wilford discusses the exciter. The rig is designed for two-band operation without changes in either the exciter or the p.a. Changing the positions of switches and the antenna coupling are all that is required. The exciter is designed for the 14 and 28 Mc. bands, but should work with equal efficiency in the 7 and 14 Mc. bands, or the 3.5 and 7 Mc. bands. It supplies 200 watts to the p. a., and in itself will operate as a high efficiency low power transmitter.

**SEVENTH ANNUAL B. E. R. U. CONTESTS, 1937**—Detailed listing of the participants in the annual transmitting and

**THE TINY TOT**, by *A. J. Haynes*—Although tiny in size, 6½" by 4-11/16" by 6¾", this receiver will give results equal to the best of larger super-regens, either for home or portable use. Its radiation is negligible and it operates from any power supply capable of supplying 250-300 volts d.c. and 6 volts a.c. or d.c. for the filaments. It makes use of the new "small drain" tubes, is simple to construct, and has excellent sensitivity and selectivity. A transmitter to complete the portable-mobile rig will be described next month.



JULY, 1937  
1/6 a copy  
Radio Society of Gt. Brit.  
33, Victoria St., London

receiving contests, sponsored by the British Empire Radio Union, is included in this report of the contest results.

**DUMMY AERIALS—THEORETICAL CONSIDERATIONS**, by *J. H. Edwards and H. G. Coleman*—Dummy antennas which are the actual equivalent of those daily in use, are the subject of the authors' work. Explaining the proper combinations of inductances, condensers and resistors necessary to simulate the various types of antennas, the article provides complete analyses for dummies of different electrical lengths: ¼ wave, ½ wave, ¾ wave, etc.

**THE "RADIO" W. A. Z. PLAN**—A column quoting the February issue of **RADIO** on the advantages of the Worked All Zones Plan and the use of the W.A.Z. map issued by that publication.



# 21 Years Old...

*Born Before Broadcasting Began*

The Magazine "RADIO" is today the recognized world-wide authority of amateur, shortwave, and experimental radio.

**Authoritative      Accurate      Reliable**

"RADIO" has withstood the test of time, the most stringent test of all. Its readers' faith is reflected in its growing size and circulation. "RADIO" has helped many a radio man along the road to success in radio, both as a hobby and commercially. It is ready to serve you, too. One copy will convince you. The slogan "You can depend on it if you see it in 'RADIO'" is more true today than ever before.

Next time you visit your newsdealer or radio parts store, ask him for a copy of "RADIO"—just plain "RADIO"—that's all. "RADIO" contains 100 pages per issue plus a great yearbook number of 200 pages. 30c per copy; yearbook, 50c.

## Regular features . . .

*100 pages each issue 30c*

In addition to a host of technical and constructional articles in each issue, regular features include:

**DX Department — Hams Across the Sea—W.A.Z. Zone Reports—The Open Forum — Calls Heard — Postscripts — Question Box — Articles and Photo Contests.**

"RADIO" is written by engineers of national repute, and to add pep, variety, and sparkle to its content it accepts and pays for many from "outside" sources. More profusely illustrated than any magazine in its field.



**SUBSCRIBE!** Save \$2.40 by taking a two-year subscription at \$4.00. Or save 33% from newsstand prices by taking a 5-issue trial subscription at \$1.00 (this offer good for NEW subscribers only). Rates quoted are for U.S.A. and Canada; other rates quoted on request.

RADIO, Ltd., Technical Publishers, 7460 Beverly Blvd., Los Angeles

Enclosed please find \$..... for my subscription to "RADIO".

Name..... Call.....

Address.....

City.....

**YOU CAN DEPEND ON IT, IF YOU SEE IT IN "RADIO"**

Complete Your . . .

# Amateur Radio Library

WITH THE FOLLOWING BOOKS:

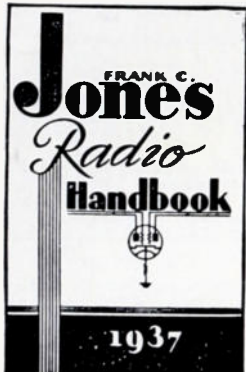

**JONES RADIO HANDBOOK** is the standard text of the field. Over 450 pages. Profusely illustrated. Completely revised; not a rehash of previously published material—a library in itself. New equipment is shown throughout, including dozens of receivers and transmitters from the smallest to the largest. \$1.50 per copy in continental U.S.A.; elsewhere, \$1.65 or 7s., postpaid.

**JONES ULTRA HIGH FREQUENCY HANDBOOK** is a reprint of the u.h.f. chapter in the big "Jones Radio Handbook". The most complete work of its kind. U.h.f. and micro-wave practice is described in detail together with complete transmitters, receivers, and all associated apparatus. \$0.50 (or 2s.) per copy, postpaid anywhere.

**JONES ANTENNA HANDBOOK** is a reprint of the antenna portion of the big "Jones Radio Handbook". Need more be said? \$0.50 (or 2s.) per copy, postpaid anywhere.

**AMATEUR RADIOTELEPHONY** is the first work written expressly for the "phone man" and is devoted entirely to the technicalities peculiar

to this field; all general systems of modulation and amplification are described together with complete transmitters, measuring equipment, and the like. Questions and answers for preparation for the special-privilege Class-A license examination are included. 128 pages; thoroughly illustrated. \$0.75 (or 3s. 2d.) per copy, postpaid anywhere.

**RADIO AMATEUR NEWCOMER** tells how to start right in amateur radio, how to learn the code, pass the license examination, and build your first simple yet effective equipment. The first book which every beginner should have. No mathematics, no "deep" theory. \$0.25 (or 1s.) per copy, postpaid anywhere.

**"RADIO" ANTENNA HANDBOOK** is a book on antennas and nothing else! Everything worth telling about them is gathered together into this one book. Much of the material is in no "general" handbook. Those who break records long ago learned that the antenna is the all-important factor, more important by far than the receiver used or the power of the transmitter. Get the most from your station by using the proper antenna. \$0.50 (or 2s.) per copy, postpaid anywhere.

**"RADIO" BINDER.** This binder in brilliant imitation leather holds your copies of "Radio" neatly and in addition takes the great annual handbook by "Radio". Makes a real library of your "Radio" literature; each copy is removable separately. \$1.50 in U.S.A.; elsewhere, \$1.75 (or 7s. 3d.).

**W.A.Z. MAP** including "DX Zones of the World". Outline map, 34"x28" on heavy white paper. Only \$0.25 (or 1s.), postpaid anywhere. (5 international postal reply coupons will be accepted as 25c.)

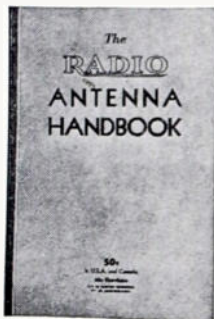

## RADIO, LTD.

TECHNICAL PUBLISHERS

7460 Beverly Blvd.

Los Angeles, Calif.



