

# RADIO DESIGN

HANDBOOK OF CONSTRUCTION FOR STUDENTS & SET BUILDERS



Pilotone Electric Receiver — Television —  
Audio Frequency Transformers — Power  
Amplifiers — Modern Power Supply Units —  
Hail to the Graf Zeppelin — The Radio Beacon

The SG-105 Screen Grid Regenerative Receiver  
Six Tube TRF Receiver with ABC Power Supply



Vol. 1

WINTER ISSUE

No. 4

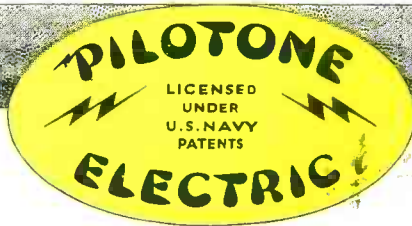

# Here's the A-C Kit you've been waiting for!

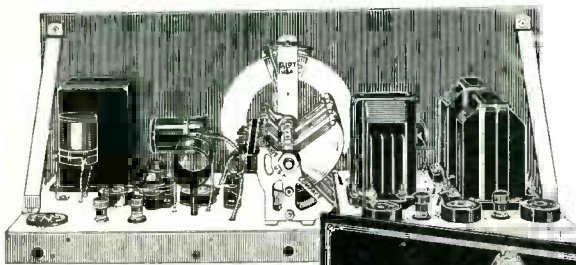

Above—"The Works" showing built-in "A" Power.  
At Right—Front Panel, beautiful in its single control simplicity. Standard size 7" x 18" fits all cabinets and consoles.



## CUSTOM-SET BUILDERS

As rapidly as manufacturing permits, stores are being supplied. If your local store cannot supply you, write us direct and we will see that you are taken care of.



Use this Pilotone "B" Eliminator No. K-107 (designed especially for this receiver) or Pilot "B" Pack No. 5, or any other standard battery eliminator.



**Can be assembled for about ONE-HALF the cost of any similar receiver!**

*Including Built-in "A" Power*

Think of it! A 6-tube all-electric receiver with features found only in the most expensive factory made sets

... at a price that seems unbelievable ... all because the Pilotone Kit is produced by the World's largest Radio Parts Plant!

All-metal construction insures greatest accuracy, ease of construction and professional appearance.

**PILOTONE "B" POWER SUPPLY EXTRA**

## Features!

- Latest commercial-type all-metal construction.
- All holes stamped—no drilling!
- Single control. Illuminated Dial.
- No batteries—all electric A-C operation with built-in "A" power.
- Uses all standard A-C tubes which are correctly biased, giving highest quality reproduction.
- New compensated triple gang tuning condenser.
- Latest push-pull amplification.
- Simplified construction means simplified assembly.
- Full size construction Blue Prints furnished.
- Licensed under U. S. Navy Patents.

**PILOT ELECTRIC MFG. CO.**  
 323 BERRY ST.  **BROOKLYN, N.Y. INC.**  
 TRADE MARK REGISTERED  
**"WORLD'S LARGEST RADIO PARTS PLANT"**

1929 - #65 ASA

# RADIO DESIGN BLUE PRINTS

## **BP-101**

Full Size Assembly and Wiring Blue Print for Short Wave Wasp Receiver. (Parts Kit K-101.)

## **BP-102**

Full Size Assembly and Wiring Blue Print for Six Tube Pilotone Electric TRF Receiver. (Parts Kit K-102.)

## **BP-103**

Full Size Assembly and Wiring Blue Print for S250 tube Power Amplifier. (Parts Kit K-103.)

## **BP-105**

Full Size Assembly and Wiring Blue Print for Five Tube Shield Grid Regenerative Receiver. (Parts Kit SG-105.)

## **BP-108**

Full Size Assembly and Wiring Blue Print for Six Tube all Electric TRF Receiver. (Parts Kit K-108.)

## **BP-39568**

ABC Power Supply  
Data Blue Print

For weeks past, draftsmen in the RADIO DESIGN laboratory have been making full size assembly and wiring blue prints for receiver and amplifiers, described in RADIO DESIGN. They are full size, each print averaging 24 by 30 inches.

FOR ONLY 10c EACH YOU CAN NOW OBTAIN BLUE PRINTS THAT PREVIOUSLY SOLD FOR ONE DOLLAR. USE THE COUPON BELOW.

**RADIO DESIGN PUBLISHING CO.**  
INCORPORATED  
103 BROADWAY, BROOKLYN, NEW YORK

# 10

**CENTS EACH**

RADIO DESIGN PUBLISHING COMPANY, INC.  
103-A BROADWAY, BROOKLYN, NEW YORK

Enclosed find ..... for which send me blueprints checked below :

..... BP-101 ..... BP-103 ..... BP-105 ..... BP-39568  
..... BP-102 ..... BP-104 ..... BP-106 .....

Name .....

Address .....

# •• BOOKS ••

The radio experimenter or custom set builder who keeps up to date in the advancement of his profession is the man who takes best advantage of his opportunities—and he is not only the “authority” but usually the man who has money in the bank.

The books listed below can be promptly shipped and have been selected because of their technical merit and their timeliness in supplying accurate information about recent developments.

## **RADIO AMATEURS HANDBOOK..... \$1.00**

By F. E. HANDY. This third revised handbook tells all about short wave transmitters and receivers. Entirely “how to make it.” The standard textbook of every amateur. 211 pages, over 200 illustrations.

## **THE RADIO MANUAL..... \$6.00**

By G. E. STERLING and R. S. KRUSE. A most complete book on modern commercial radio communication. The one book worth two or three times its cost. Over 900 meaty pages and 1,000 photographs and drawings.

## **PRACTICAL TELEVISION ..... \$3.75**

By E. T. LARNER. One of the few really practical books on television, and a necessity for experimenters. 172 pages, 100 illustrations.

## **WIRELESS PICTURES AND TELEVISION . . \$2.50**

By T. THORNE BAKER. With no hesitation “the second” important book on television. Historical review and details of present day successful systems. 188 pages, with many illustrations.

Order the books that you desire and inclose check or money order. Shipment will be made within ten hours (except on foreign books temporarily out of stock). You can not make a better investment.

**RADIO DESIGN, PUBLISHING COMPANY, INC.**  
**ONE HUNDRED THREE BROADWAY, BROOKLYN, NEW YORK**

# RADIO DESIGN

**MAGAZINE OF CONSTRUCTION FOR STUDENTS & SET BUILDERS**

KIMBALL HOUTON STARK, *Editor*

JOHN KAUL, *Associate Editor*

JOHN GELOSO, *Technical Consultant*

Vol. I

## CONTENTS OF THIS ISSUE

No. 4

EDITORIAL .....	73
THE PILOT SG-105 SCREEN GRID REGENERATIVE RECEIVER .....	75
<i>By John Geloso</i>	
THE K-108 TUNED RADIO FREQUENCY RECEIVER .....	83
<i>By John Kaul</i>	
RADIO PHYSICS COURSE .....	91
<i>By Alfred A. Ghirardi</i>	
THE PILOTONE ELECTRIC RECEIVER .....	101
<i>By Frank T. Sullivan</i>	
AUDIO FREQUENCY TRANSFORMERS.....	109
<i>By Kimball Houton Stark</i>	
USING MODERN ABC POWER SUPPLY UNITS.....	116
<i>By the Laboratory Engineers</i>	
"ONE-SEVENTY-ONE" AMPLIFIER AND POWER SUPPLY.....	120
<i>By the Laboratory Engineers</i>	
THE AIRPLANE RADIO BEACON.....	125
<i>By Zeh Bouck</i>	
THE PILOTONE "B" POWER SUPPLY UNIT.....	128
<i>By the Laboratory Engineers</i>	
HAIL TO THE GRAFF —EPPELIN.....	130
<i>By Zeh Bouck</i>	
PILOT DEMONSTRATES TELEVISION.....	133
<i>By Kimball Houton Stark</i>	

**RADIO DESIGN MAGAZINE IS PUBLISHED BY  
RADIO DESIGN PUBLISHING CO., INC., 103 BROADWAY, BROOKLYN, N. Y.**

Radio Design Magazine is published quarterly or four times during the year. Subscription price is 50 cents for the four issues in the United States and possessions and in all foreign countries. U. S. coin as well as U. S. stamps accepted. Checks and money orders should be drawn to the order of Radio Design Publishing Co., Inc. Subscriptions are always started with the current issue.

The contents of this magazine are copyrighted and must not be reproduced in the United States without giving full credit to the publication. Translation into foreign languages must not be made unless permission is obtained.

**CHANGE OF ADDRESS: PLEASE NOTIFY AS FAR IN ADVANCE AS POSSIBLE.  
WRITE OR PRINT NAME AND ADDRESS CLEARLY TO AVOID MISTAKES.**

This Pilot Moisture-Pruf Transformer was taken from stock, immersed in a beaker of water for one entire week. Then it was wiped dry, installed in a receiver and worked just as beautifully as ever!

**Entirely Unaffected  
by Immersion  
in Water!**



**ALL TYPES**  
Made in 2 to 1 and 3½ to 1 ratio Audio Transformers, Output Filter and Output Transformers, "B" Power Supply Chokes and Push-Pull Transformers for power amplifiers to operate dynamic speakers.

## **PILOT'S New Family of Moisture-Pruf Transformers**

Efficiency-destroying moisture can never lower the performance of these new-type transformers . . . Wound on our own machines, impregnated by Pilot's special vacuum process, encased in genuine bakelite, molded in our own presses—every step is under the vigilant control of practical radio engineers in the world's largest radio parts plant!

**PILOT ELECTRIC M'FG. CO.**  
323 BERRY ST.  **BROOKLYN, N.Y. INC.**  
TRADE MARK REGISTERED  
**"WORLD'S LARGEST RADIO PARTS PLANT"**  
RADIO PARTS BUILDERS  
SINCE 1908

# RADIO DESIGN

MAGAZINE OF CONSTRUCTION FOR STUDENTS & SET BUILDERS

## EDITORIAL

**W**ITH this Volume I, No. 4, RADIO DESIGN ends its first year. In the past twelve months the contents of the publication has so pleased its readers that today RADIO DESIGN has approximately twenty-three thousand paid subscribers and a sale over the counters of radio dealers throughout the United States of some odd thirty thousand, the total circulation being well over fifty thousand copies.

Of the print order of fifty-three thousand copies of Vol. 1 No. 3 absolutely no copies are left and there has been and will be no dealer returns.

Every copy of RADIO DESIGN is in the hands of radio experimenters and set builders and letters are being received from day to day asking, "Where can I obtain back copies of the magazine?" and "Here's my half dollar. I saw your advertisement in the last issue and don't want to miss RADIO DESIGN for the coming year."

### RADIO DESIGN

engineers will be pleased to answer the technical radio questions of RADIO DESIGN readers at no cost.

The publishers of RADIO DESIGN appreciate your past confidences and desire me to express their obligations to you. I am also to tell you of future plans and how these plans are today being executed, to make RADIO DESIGN even more a "necessity" to you during the year 1929.

### AN APOLOGY AND A PROMISE

First, however, I desire, in the name of the publishers and in my own name, to personally apologize to every RADIO DESIGN reader who may in the past have written to us asking technical questions, ordered books, or blue-prints, or to those who may have not received promptly, copies of the magazine.

We have done our best to keep right "down-to-the-minute" with all correspondence, shipment of book orders, as well as in the mailing of individual copies, but the terrific speed with which our circulation has increased and the necessity for an every-

**RADIO DESIGN**  
has the second largest paid circulation of any radio magazine in the United States.

day expansion of facilities, temporarily was too much for us and it was impossible during the past few weeks to treat all of our good friends as courteously and as promptly as has been our ideal.

We promise in the future to be more prompt and courteous to you. Now I wish to tell you of our today and our future.

### THE SIZE OF THE MAGAZINE WILL BE INCREASED

Beginning with Vol. 2 No. 1, the page size of RADIO DESIGN will be increased to a seven and one-half inch by ten inch print page, overall dimensions being eight and one-half by eleven and three-quarter inches, or the same size as Radio News and Radio Broadcast. This increase in size will enable us to use larger photographs and drawings and to eliminate the necessity of running illustrations lengthwise of the pages, all leading to making the magazine more easy to read and of more service to you.

With the beginning of the new year and with the first issue of the new size, the RADIO DESIGN subscription price will be increased from twenty-five cents to fifty cents for four issues.

### RADIO DESIGN

full size blue-prints for practically all published receivers, amplifiers, etc., will be available at a cost of

**TEN CENTS EACH**

We feel that this increase in price is even more than justified for RADIO DESIGN in the future, I am sure, will be much more valuable to you than it has in the past and that you even would be willing to pay three or four times this fifty cents to be sure of securing every copy published.

### RADIO DESIGN

will increase its print page size to seven and one-half inches by ten inches with the next issue.

#### RADIO DESIGN BLUEPRINT SERVICE

In addition to the drawings and photographs in the magazine, RADIO DESIGN will, in the future, supply full size assembly and wiring blueprints of practically all equipment, radio receivers and amplifiers described in the magazine.

The blue-prints averaging twenty-four inches by thirty-six inches in size will be available at a cost of only ten cents each. These blue-prints will be the work of expert draftsmen, designed to be legible and to give construction, assembly and wiring information.

#### RADIO DESIGN TECHNICAL QUESTION SERVICE

The technical staff of the magazine have organized themselves and will in the future be available to every reader for consultation and for answering any and all technical radio questions, at no cost other than a two cent stamped, and addressed envelope.

Questions should be numbered and accompanied whenever possible by illustrations or drawings of the particular circuits or apparatus about which you desire information. All enclosures of this kind will be returned with complete and correct answers.

Please be considerate, however, in regard to the number of questions and please do not ask us to supply you with drawings of circuit diagrams of special receivers or other apparatus.

#### RADIO DESIGN BOOK SERVICE

All future issues of the magazine will contain reviews of radio and allied technical books and bulletins.

The important radio books will be carried in stock and shipment will be made within a matter of hours after receipt of orders.

If you desire books which we may not at the moment have in stock they will be obtained for you at standard list prices and shipped immediately.

#### RADIO DESIGN LABORATORY

Paralleling the expansion of the office and publication facilities of the magazine, the laboratory floor space and equipment has been increased and men who have been familiar with technical radio developments

### RADIO DESIGN

laboratory engineers and the publishers pass on every article before published, insuring correct information and economy in construction.

for years past have been added to the laboratory staff, enabling publication in the future of much added material both from a purely technical as well as from a constructional point of view.

As a matter of fact absolutely no piece of apparatus or equipment described in the magazine is considered worthy of publication until it has passed the rigid standards of the publishers from a commercial point of view, and the technical "yard-stick" of the radio engineers in the RADIO DESIGN laboratory.

The contents of the magazine will in the future, as in the past, not be confined to radio alone but will include many articles having to do with the development of allied arts including, aeronautical radio communication, sound film and record reproduction, and, not the least, television.

### RADIO DESIGN

can supply you with any technical or radio book.

The Pilot flying radio laboratory will continue to carry on serious experimental work in cooperation with other radio laboratories and experimenters, along the lines of the work described by Mr. Zeh Bouck in his article in this issue, telling about tests made on the radio beacon system in collaboration with the Bureau of Standards.

#### SHAKE HANDS WITH YOUR EDITOR VIA THE MAIL BOX

And now in closing I certainly wish to tell you that I personally want to do my very best to make every future issue of the magazine interesting and instructive to you.

There will be no let up with the blue-pencil in an effort to obtain accuracy and dependability, that every statement may be technically correct.

The contents of the magazine in the future depends upon both you and me. True. I have some ideas and I think them reasonable but I am certain that neither of us can make RADIO DESIGN what it should be, and in my belief the magazine that will benefit the radio industry, if we do not tell each other our desires and make our criticisms constructive.

Be frank with me, write to me, tell me whether you think a story is a good one or a bad one and why. Tell me your own experiences because I shall always be happy to tell you mine, as well as those of other experimenters and readers.

**RADIO DESIGN HAS ONE IDEAL OF EXISTENCE, AND THAT IS TO BE IN REALITY THE FINEST RADIO CONSTRUCTION AND EXPERIMENTAL MAGAZINE IN THE UNITED STATES.**

You men are on the "firing-line" as much or even more than I. Let's line up and "go-over-the-top," to radio success and happiness together.

KIMBALL HOUTON STARK, Editor.



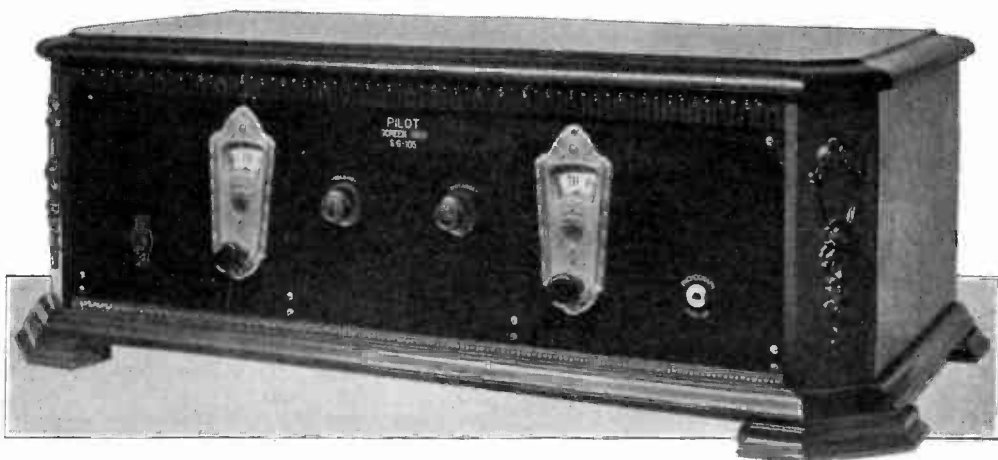

## THE PILOT SG-105 SCREEN GRID REGENERATIVE RECEIVER

By JOHN GELOSO

*Chief Engineer, Pilot Electrical Mfg. Co., Inc.*

**T**HE meetings of the Institute of Radio Engineers in New York City provides in addition to its technical lectures and discussions an opportunity for the technical men of the industry to get away from their laboratories and to meet one another during the hours previous, to gathering at the Engineering Societies Building.

If one could take a census of various New York restaurants and hotels, on the evening of an Institute meeting, they would find groups of engineers and executives enthusiastically discussing, across dinner tables, the ways and means and problems of the industry, and sometimes solving some of them.

I had the pleasure recently of attending one of these "get-together" dinners just before a particularly interesting lecture was delivered before the Institute. At the table with me was the president of a large radio manufacturing company, his chief engineer and in addition a consulting radio engineer whose name is known and respected throughout the industry.

Our round table conversation centered around screen grid tubes, and the various circuits using these tubes recommended and published up to that time.

I shall not attempt to tell you the long details of our various opinions, but only my own conception which I stated to these men rather emphatically and with which they were in reasonable agreement.

It was my feeling that, as a general fact, screen grid tubes are all right, but my experience had indicated that the majority of troubles met with in using screen grid tubes had in the past been due to the design of circuits not particularly suited to the tubes themselves.

As soon as the tubes themselves were available, many experimenters used them in circuits, whereby three or four screen grid tubes were used as radio frequency amplifiers, and in both America and Europe efforts were made, and circuits were published, describing the use of screen grid tubes not only as radio frequency amplifiers, but also as detector tubes and as audio frequency amplifier tubes.

Manufacturers, in addition to the experimenters, attempted to capitalize on circuits employing the tubes, and did not hesitate to recommend two, three or four screen grid tubes in a given circuit.

In my opinion, one or two stages of radio frequency amplification in a circuit designed around the screen grid tube provides even more than the necessary selectivity and sensitivity required, and eliminates immediately any necessity for using a large number of tubes, with the possible disadvantage of added complications, both mechanically and electrically.

### THE SG-105 USES AN AC SCREEN GRID TUBE.

To prove my contentions, to myself and to others, I designed the Pilot SG-105 all-electric five-tube screen grid regenerative receiver.

This receiver, after several weeks' test and actual use, has proven to me that the opinion that I stated to my friends was a reasonable one, and that opinion was "that a properly designed receiver circuit utilizing a single screen grid tube, would incorporate advantages over and beyond receivers then employing screen grid tubes and to such a degree that the receiver would represent a basic improvement in the art of radio broadcast reception.

As can be seen from the schematic circuit diagram of Fig. 1, the circuit arrangement

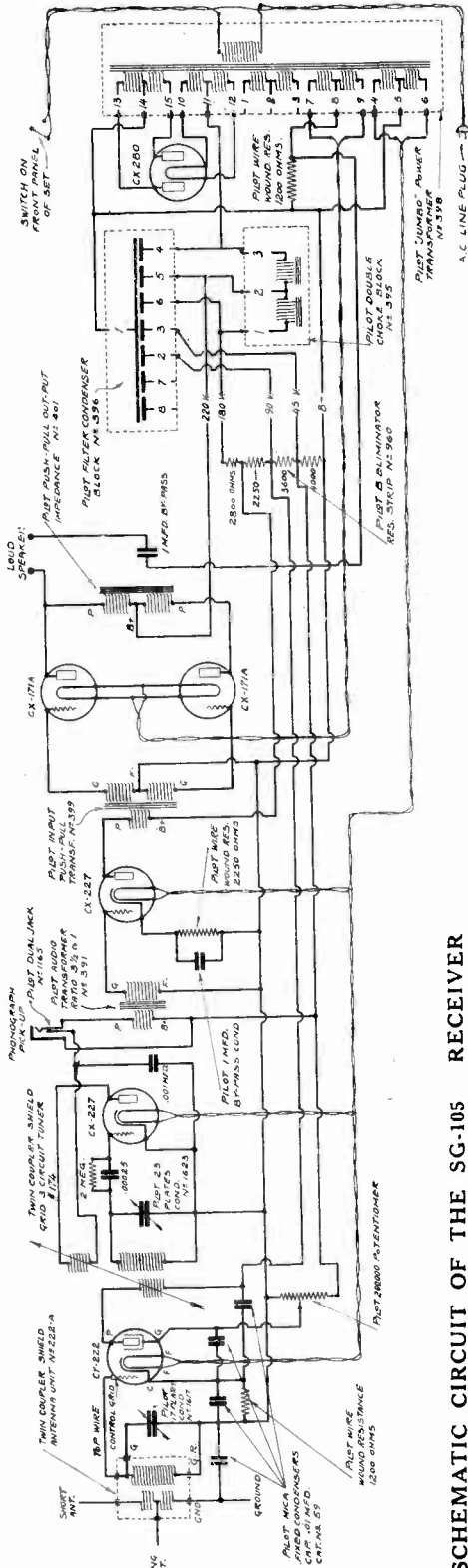

SCHEMATIC CIRCUIT OF THE SG-105 RECEIVER

of the receiver is as follows: The antenna is inductively coupled to the grid circuit of the a. c. screen grid tube. The output of the screen grid tube is coupled by a screen grid three circuit tuner providing inductive regenerative control feeding into a UY-227 detector tube. A phonograph jack is provided in the plate circuit of the detector tube, so that the audio frequency amplifier portion of the receiver may be used in combination with a phonograph and phonograph pick-up.

Transformer audio frequency coupling is employed between the detector tube and the first UY-227 audio amplifier tube, the gain ratio being 3½ to 1. The plate circuit of the UY-227 is coupled to two UX-171A tubes in push-pull arrangement, using a Pilot No. 399 input push-pull transformer, and a No. 401 push-pull output impedance to couple the amplifier circuit to the loudspeaker.

The Pilot No. 398 "jumbo" power transformer supplies 2½ volts filament current to the a. c. screen grid tube, the detector tube, and to the first audio frequency amplifier tube. Separate secondary transformer windings supply 5 volts to the filaments of the two UX-171 push-pull amplifier tubes and to the UX-280 full wave rectifier tube.

This same transformer also, of course, supplies the plate voltages of 90 volts to the screen grid tube, 45 volts to the detector tube, 135 volts to the first audio frequency amplifier tube, and 220 volts to each of the two push-pull amplifier tubes. Of the 220 volts supplied to the UX-171 tubes, 180 volts is actually on the plates of the tubes, 40 volts being utilized for the grid bias voltages.

Volume control is provided for by varying the voltage on the screen grid of the UY-222 tube, a Pilot 200,000 ohm potentiometer being connected between the B minus (—) and the 45 volt terminal on the No. 960 fixed resistor.

The grid bias voltage of 1½ volts for the screen grid tube is obtained by taking the voltage drop across a 1200 ohm fixed resistor connected between the cathode and the grid, the resistor being effectively by-passed by a .01 mfd. fixed condenser.

The detector tube input circuit includes a .00025 mfd. grid condenser shunted by a two megohm grid leak.

The first audio frequency amplifier tube has a grid bias voltage of approximately 9 volts, obtained by taking a voltage drop across a 2250 ohm fixed resistor connected between the grid and the cathode of the tube. This resistor is also shunted by a one mfd. condenser to effectively by-pass audio frequency currents.

The two UX-171 push-pull amplifier tubes have approximately 40 volts grid bias on each grid. This voltage is obtained by the voltage drop across a 1,200 ohm resistor connected to the center tap of the five volt "jumbo" transformer secondary winding.

Particular care has been taken to by-pass all radio frequencies around impedances that would otherwise tend to decrease the total radio frequency gain of the circuit, reduce over all fidelity by the cutting of side bands or allowing radio frequency currents to circulate in the high voltage or filament power supply circuits.

I wish to point out in particular at this time that the actual arrangement of the connection wires in the SG-105 receiver has been studied very carefully and only after several receivers were wired, was a circuit arrangement arrived at, that eliminated to the last degree all possibility of radio frequency feedback in various portions of the circuit, caused by circuit loops, length of radio frequency leads or the susceptibility of the circuit to a. c. "hum" pick-up.

#### PARTS REQUIRED FOR CONSTRUCTION

The complete list of all parts necessary for the construction of the SG-105 receiver (incorporating, of course, the ABC power supply) is as follows:

- 1 SG-105 Front Panel.
- 1 SG-105 Sub-panel.
- 1 1623 Variable Air Condenser.
- 1 1617 Variable Aid Condenser.
- 1 222-A Twin Coupler Shield Grid Ant. Coil.
- 1 174 Shield Grid Three Circuit Tuner.
- 2 1282 Illuminated Vernier Dials.
- 1 1165 Midget Jack.
- 1 42-W Bakelite Toggle Switch.
- 1 938 Pilot 200,000 Ohm Potentiometer.
- 1 398 ABC "Jumbo" Power Transformer.
- 1 381 Giant Audio Transformer.
- 1 399 Push-pull Input Transformer.
- 1 401 Push-pull Output Impedance.
- 1 396 "Jumbo" Filter Condenser Pack.
- 2 801 By-pass Condensers.
- 1 53 Mica Condenser.
- 1 51 Grid Condenser with grid leak and clips.
- 4 59 Mica Condensers.
- 1 395 "Jumbo" Double Choke.
- 1 960 Fixed Resistor.
- 1 959 Fixed Resistor.
- 2 956 Fixed Resistor.
- 3 216 Sub-panel Sockets.
- 4 217 Sub-panel Sockets.
- 4 35 Sub-panel Brackets.
- 1 each Binding Posts, Ant., Gnd., Short Ant., L. S. + L. S. —
- 744 Miscellaneous Hardware.
- 1 BP-108 Blue Print.

#### ASSEMBLY INSTRUCTIONS

It is best in assembling the receiver to first mount all parts on the 23" by 7" bakelite sub-panel.

The position of these parts looking down on the top of the receiver is indicated by the drawing of Fig. 2, and the photograph Fig. 3. Looking from the receiver front it will be seen that above the sub-panel and at the rear left hand end of the sub-base panel is mounted the No. 398 power transformer, No. 396 filter condenser block, and the No. 395 double choke coil. Then going toward the right, comes the No. 401 output push-pull impedance, two tube sockets, and the No. 399 input push-pull transformer, and then another socket.

The grid condenser and leak, the No. 960 resistor strip, four other sockets, five binding posts, and the No. 381 audio transformer is also mounted on the top of the sub-base panel. Looking from the receiver front, the socket on the extreme left at the front is for the UX-280 full wave rectifier tube, while the socket just back of the volume control potentiometer and to the right of the left hand

variable condenser is for the Twin Coupler screen grid antenna circuit tuning coil.

Fig. 4 is a bottom view line drawing of the receiver sub-base panel, the same view being shown photographically in Fig. 5 and shows that under the sub-panel is mounted the fixed by-pass condensers and the three fixed resistors for the grid bias circuits.

Looking at the receiver front panel as shown by the illustration at the heading of this article (which shows the receiver mounted in a cabinet), we see that the "on" and "off" switch is mounted at the lower left hand corner of the panel and the phonograph pick-up jack in the lower right hand corner.

Between the two vernier dial controls are mounted two additional knobs, the one on the left being a volume control (the 200,000 ohm potentiometer), the one on the right being the distance (or the regeneration) control. The photograph referred to illustrates the SG-105 receiver mounted in a Corbett cabinet, making a very fine appearance. All of the parts which are shown in this front panel illustration are, of course, mounted directly on the front panel as is evident by the drawings of Fig. 2 and Figs. 4 and the photographs of Fig. 3 and Fig. 5.

It is best to mount all of the parts underneath the sub-panel first, for some of the resistors and fixed condensers screw heads and nuts will be underneath the "jumbo" power transformer, filter condenser, and choke coils when these units are assembled in place on top of the sub-base panel.

After assembling, all parts on the sub-base panel, wire up the filament circuit connections to all tubes, twisting the wires to reduce possible a. c. current "hum" pick-up. I must again emphasize the necessity of keeping all wires in exactly the positions shown on the drawings and photographs shown here, and in detail on the full assembly and wiring blueprint No. BP-105. After the sub-base panel has been wired complete, the front panel can be attached to the sub-base panel by screwing the front panel up against the ends of the four No. 35 bakelite panel brackets, and in addition by the two nickel-plated bracket supports at each end of the receiver.

The wiring for the vernier dial lamps, although not shown in the drawings of Figs. 2 and 4 or on the schematic wiring diagram of Fig. 1, should be connected in parallel with the UX-171A five-volt filament circuit (preferably at the No. 398 power transformer terminals Nos. 1 and 9). In wiring the No. 398, power transformer, No. 396 condenser block and No. 395 choke coils, it will be noted that all terminals are numbered and that this numbering is likewise shown in the schematic and picture diagrams and on the large blueprint. Check this wiring over several times to make certain that you have all leads connected to their correct terminals and properly soldered.

I do not know that I have ever read an article telling how to construct a radio receiver, without pointing out with emphasis the necessity of using care in soldering. The two points that are important, are the use of a hot iron and of absolutely no flux or acid. Use only a resin-core solder.

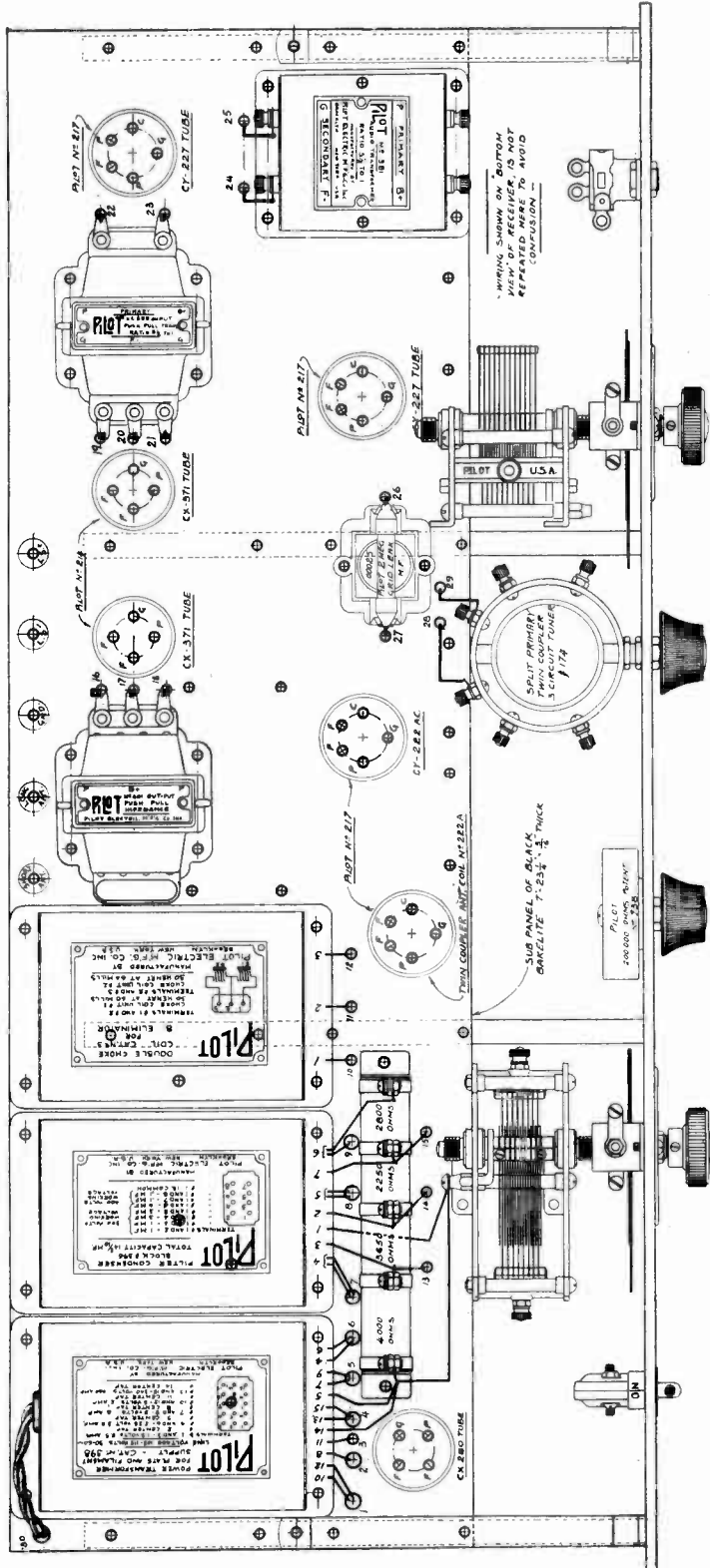

**TOP ASSEMBLY AND WIRING DIAGRAM OF THE SG-105.**

*Fig. 2. Line drawing of the SG-105 receiver showing exact position of parts and wiring on top of the sub-base panel as well as all parts mounted on the rear of the front panel. Assembly of all parts on the rear of the front panel as well as brackets and braces for fastening the sub-base panel to the front panel is clearly illustrated.*

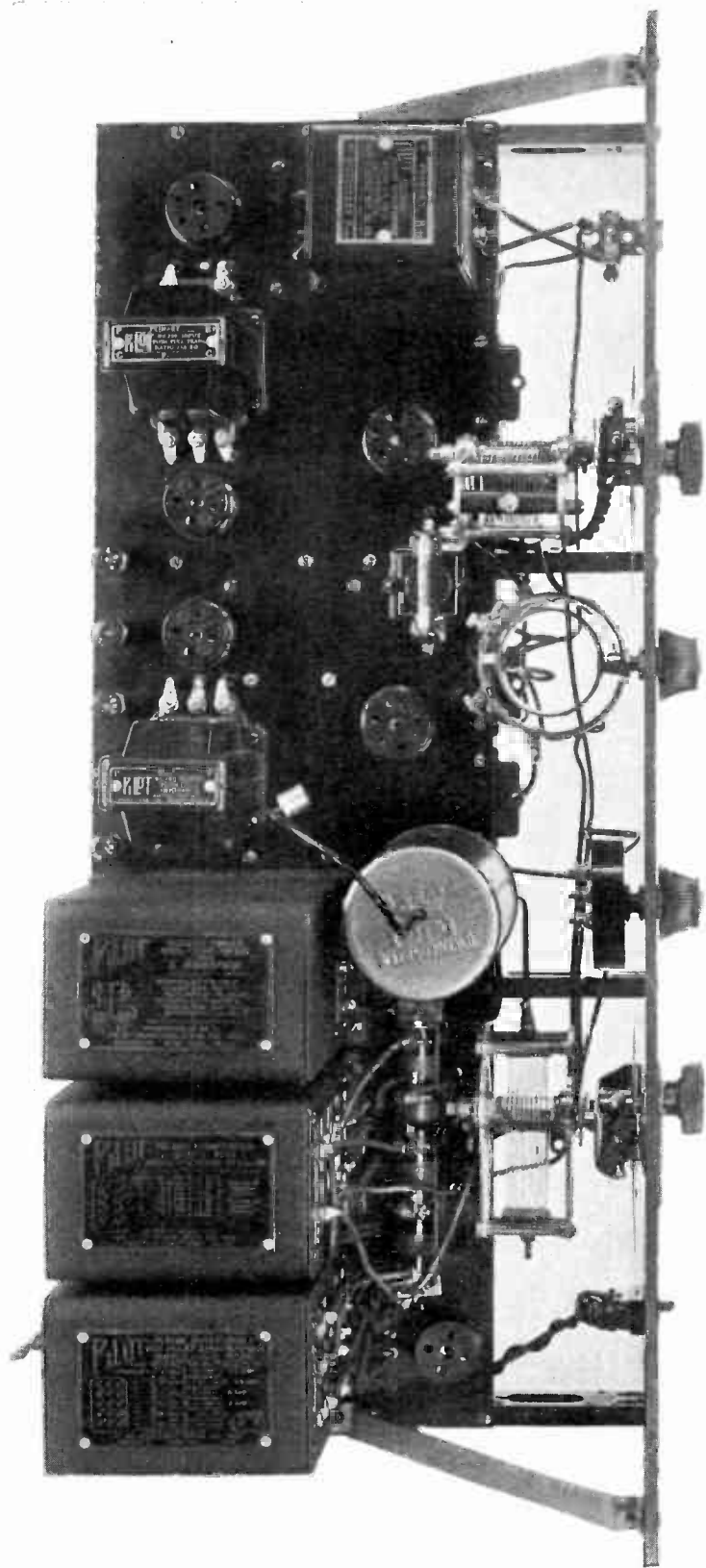

### PHOTOGRAPH OF TOP OF ASSEMBLED SG-105 RECEIVER

*Fig. 3. This photograph clearly shows the clean-cut appearance of the assembled and wired receiver. The use of the Pilot No. 398 power transformer, No. 395 choke coil, and the No. 396 filter condenser block, assembled at the left rear of the sub-base panel provides complete ABC power supply.*



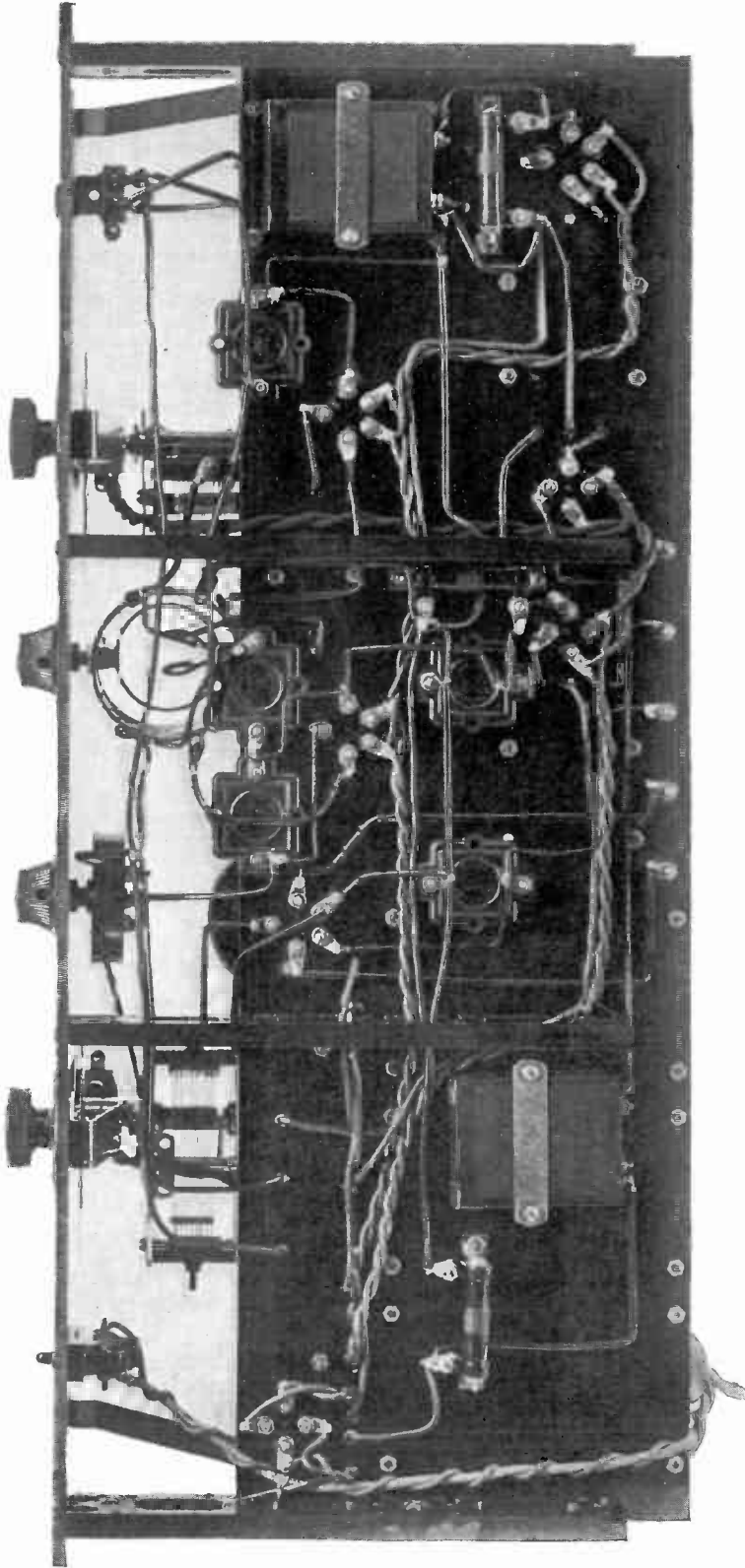

**PHOTOGRAPH OF BOTTOM OF SUB-BASE PANEL OF THE COMPLETED SG-105 RECEIVER**

*Fig. 5. This photograph illustrates the same view shown by the line drawing of Fig. 4 and clearly shows the details of all wiring. Note the twisted leads connecting all alternating current filament supply circuits.*

## TUBES REQUIRED

When you have finished wiring your receiver you are ready for the first test, and to every one who has ever assembled and wired a receiver for themselves, this is the moment that never lacks its thrill and its feeling of satisfaction in the "I have made a beautiful job of that receiver and I am proud of it." When you are all ready for the first test you will need the following tubes:

- 1 UY-222 a. c. screen grid tube
- 2 UY-227 a. c. tubes
- 2 UX-171A a. c. tubes
- 1 UX-280 full wave rectifier tube.

Fig. 2, in addition to the schematic diagram of Fig. 1, shows the proper sockets for each tube.

With the on-and-off switch at the extreme lower left hand end of the receiver panel in its "off" position and with the attachment plug attached to the 110 volt 60 cycle lighting circuit, we are ready to see "what happens."

Snap the on-and-off switch to the "on" position and if you have done a good wiring job and made all connections properly, all tubes of the receiver will light up without any attendant "fire-works."

Everything so good so far, and we can snap "off" the switch for a moment and attach the antenna and ground leads as well as the loudspeaker to the binding posts at the rear of the sub-panel, and set the distance knob or regeneration control so that the rotating coil is at right angles to the vertical coil or in position of minimum regeneration. Set the volume control as far as it will go toward the left.

Snap on the switch "on" again and after giving the tubes several minutes to heat up, slowly rotate the two vernier condenser dials throughout the broadcast range.

When you pick up a signal, tune it in carefully by rotating the vernier dial knobs slowly and for increased volume turn the potentiometer knob "volume" control to the right, as desired. For receiving distant stations or for selecting one station from another (through atmospheric disturbances, "man-made static" or because of interference between broadcasting stations themselves) adjust the regeneration or "distance" control knob so that the maximum signal strength with the desired quality is obtained without the set actually oscillating. The regeneration control will be found to be reasonably smooth in operation over the entire broadcast range, the signal strength increasing as more and more regeneration is added to the circuit, up until just previous to the time the set actually oscillates. Obviously care should be taken in adjusting the regeneration control, for with excess regeneration or with the set actually oscillating distortion will be introduced by the cutting of the side bands of the received signal.

The SG-105 receiver will be found to operate very satisfactory with the usual antenna available and in particular because of the sensitivity of the receiver due to the use of the

screen grid stage of tuned radio frequency amplification. A shorter antenna than usual or one having a length of only 40 or 50 feet may be used with fine results as regards reception of even distant stations, and, of course, the shorter antenna wire gives the receiver increased ability to separate one station from another when they are operating in nearly the same frequency channels.

## THE SG-105 HAS A PHONOGRAPH PICK-UP JACK

Seemingly, the phonograph pick-up jack has taken the place of the now obsolete phone jack, and well it may be. Those of you who have phonographs either of today's design or of the vintage of ten years or so ago can obtain very fine phonograph record reproduction, using the new electrical cut records, a magnetic phonograph pick-up and the SG-105 receiver.

In the radio broadcasting studio the artist's voice or the music of an orchestra is converted into electrical energy and radiated into space to be received in your home with your SG-105 receiver. The receiver converts the electrical energy back into sound energy.

In the phonograph recording studio the artistry of the performer is recorded on a sound record as mechanical energy. When you bring that record into your home and play it on your usual phonograph you transform that mechanical sound record back into sound. When you play that same record on your phonograph which is equipped with an electrical pick-up device, the sound energy of the record is directly transformed back into electric energy. By plugging the pick-up connection leads into the phonograph pick-up jack on the front panel of your SG-105 receiver you use the audio frequency amplifier portion of the receiver to amplify the electrical energy from the pick-up and listen to the reproduced sound record through your regular radio loudspeaker.

## I AM SURE THAT YOU WILL BE PLEASED WITH THE SG-105

Because I believe that the SG-105 receiver uses a screen grid tube at its optimum operating efficiency in combination with a circuit which allows high gain radio frequency amplification, extremely good selectivity and high quality over-all reproduction of speech and music, I am sure that you, too, will be pleased with its performance.

Certainly, we chaps who build our own receivers and amplifiers and who are able to utilize "last-minute-proven" circuit arrangements long before the regular manufacturers of factory-built receivers can use them—we should be in the forefront of radio design and be able to demonstrate the results of our work to our friends and make the truthful statement, that "This set that I have just finished represents the last word in radio."

I am sure, too, that after your friends have "listened-in" on your SG-105 and found out how little the parts cost, that they will also become SG-105 builders and enthusiasts.



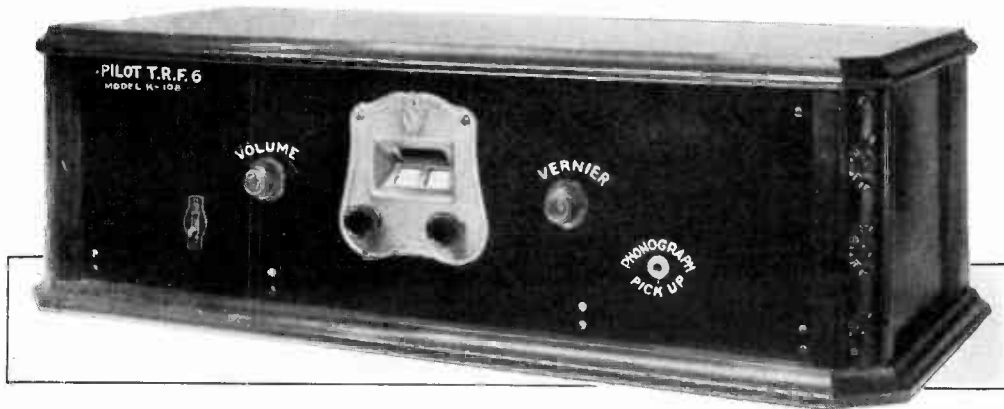

## THE PILOT K-108 T-R-F RECEIVER

*A Six Tube Set Complete with Built in ABC Power Supply*

By JOHN KAUL

**U**PON the announcement of the completion of the design and construction of the K-108 Receiver, a good friend phoned me asking for complete information. As this incident clearly illustrates the question that arises in the minds of the average experimenter and custom set builder, I give you below the data furnished the man who built the first receiver other than those developed in RADIO DESIGN laboratory.

The Pilot K-108 is a tuned radio frequency receiver, designed at the urgent request of many radio fans, who insist on a two-dial control with compensating condenser for DX.

The set uses the No. 381 large audio transformer in the first stage and push-pull amplification in the second stage, with two UX-171 tubes. It is built upon and around a bakelite sub-panel and a bakelite front panel. Suitable adjustments are provided on the inside of the set for various tube circuit and antenna variations.

The ABC power pack is built right into the set, which makes the K-108 a complete unit, ready to operate from the lamp socket.

The writer personally is "sold" on the two-dial control with compensating condenser as the ideal set, and in offering it to readers for their approval he is sure that a great many experimenters will find it very much to their own personal liking.

### THE COMPLETE K-108 CIRCUIT

Let us have a look for a moment at the schematic circuit arrangement of the K-108 as shown in the drawing of Figure 1.

Beginning at the left of the diagram we see that the antenna circuit of the receiver has connected in series with it a Pilot No. VM-82 micrograd condenser and a No. 59 .01 mfd. fixed condenser. The micrograd

has a capacity of .001 mfd. and is, of course, variable, the adjustment of which, with a given antenna, allows tuning the antenna circuit to its maximum efficiency.

The No. 59 condenser is inserted in the ground side of the antenna circuit to prevent any probable short-circuit between the 110 volt line and the ground, due to possible mistakes when wiring the set.

Shunted across the primary coil of the first tuned radio frequency circuit is a No. 350 resistograd or adjustable resistance which is used to control the volume of the set and which also increases and decreases the regenerative sensitivity of the circuit by increasing or decreasing the effective input circuit load.

The first radio frequency circuit is tuned by a 17-plate condenser independent of the following two tuned stages, which are both controlled from a single dial. The two stages of radio frequency amplification use UX-226 tubes feeding into the input circuit of a UY-227 detector tube, which has in series with it a .00025 mfd. condenser, around which is shunted a 2 megohm grid leak.

It will be noted that in the grid circuit of the second UX-226 tube is a No. 1001 adjustograd. The adjustograd is adjusted once at the time the receiver is given its first test and controls the amount of regeneration desired in the circuit.

In series with the detector plate circuit is a phonograph pick-up jack which is of course short-circuited when the circuit is used as a radio receiver.

The detector tube feeds into one stage of audio frequency amplification, using a UY-227 tube, the coupling being by means of a No. 381 audio frequency transformer.

The output of this first stage of audio frequency amplifications feeds through a No.

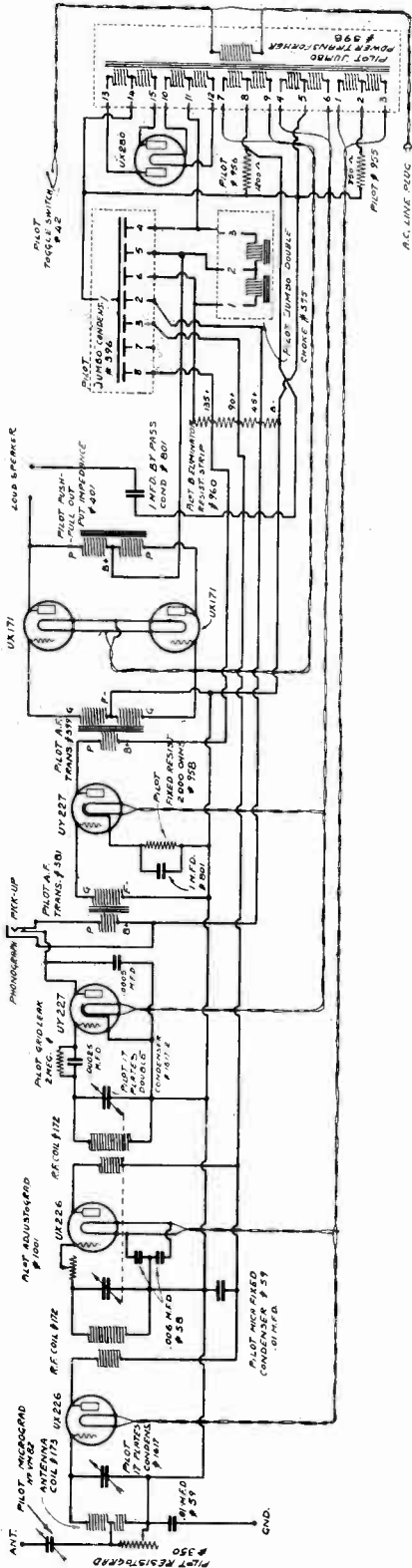

Fig. 1. Schematic circuit diagram of the K-108.

399 input push-pull transformer to two UX-171 tubes in push-pull audio frequency amplification circuit arrangement.

The loudspeaker is coupled to the amplifier circuit by a No. 401 push-pull impedance in which is incorporated a 1 mfd. by-pass condenser, which prevents the high voltage plate supply from reaching the loudspeaker winding.

Now we come to the grid voltage potentials, which from past experience is seemingly somewhat of a problem to the usual experimenter, and particularly so since the advent of the a.c. tubes and the introduction into receiver circuits of the necessary power units for providing all required A B and C circuit voltages.

A grid bias potential of about 5 to 6 volts is on the grids of the first two radio frequency UX-226 amplifier tubes, these voltages being obtained by the voltage drop across the No. 955 850 ohm resistor connected between the B (—) common terminal and the center connection of the No. 398 power transformer secondary winding, the outside terminals (one) and (three) of which provide the 1½ volts required to light the filaments of both tubes.

While this 1½ volt transformer winding is a very low resistance path for the plate d.c. component of the two UX-226 tubes, and therefore very satisfactory for this purpose, it offers an extremely high impedance to the radio frequency component.

To eliminate this difficulty and to prevent any possible radio frequency coupling between the filament wires and power transformer windings, two .006 mfd. fixed condensers are shunted across the filament terminals of the socket, the grid return of the two radio frequency tubes being then connected to the center of these two condensers.

Although the two radio frequency coils Nos. 172 and the double 1617-2 variable condenser used in the circuit were specifically designed for the circuit and matched for uniformity of dial readings, an added refinement is incorporated in the circuit, a midgeet variable condenser having a capacity of 25 micro-microfarads being connected in parallel with the second variable condenser and radio frequency coil.

This condenser is adjustable, of course, from the front panel and allows the circuit to be tuned so that both tuned radio frequency circuits are in absolute resonance.

There is a grid potential of 8 to 9 volts on the grid of the UY-227 first audio frequency amplifier tube, this voltage being obtained by the drop in voltage across a No. 958 2,000 ohm fixed resistor connected between the cathode and the grid return of the tube, the resistor being by-passed by a 1 mfd. fixed condenser to effectively by-pass all audio frequencies.

The UX-171 tubes used as a push pull audio frequency amplifiers have grid voltages of between 40 and 45 volts, obtained by the drop in voltage across a No. 956 1,200 ohm fixed resistor connected to the center tap No. 8 of the power transformer secondary winding No. 7 and No. 9 (which supplies the

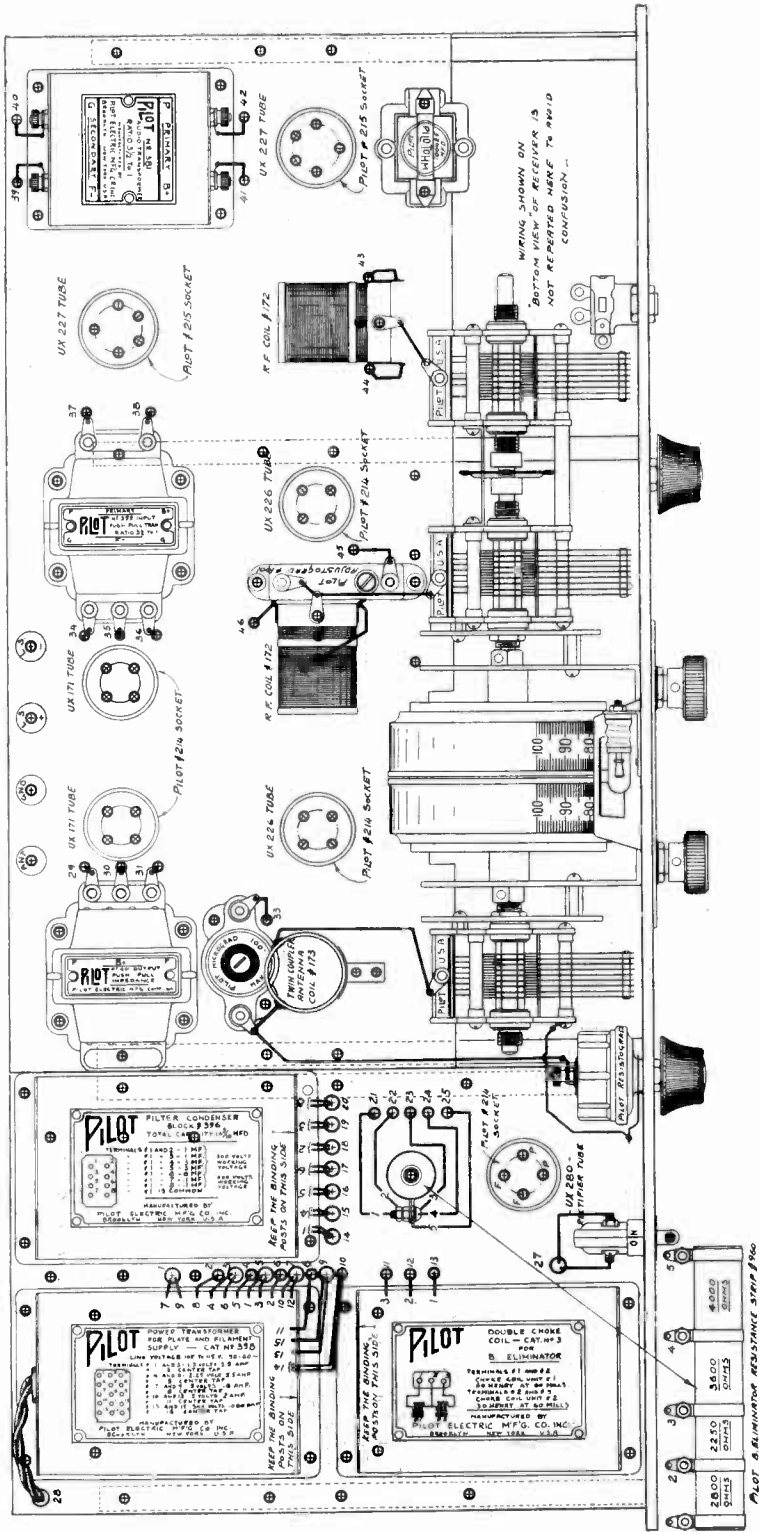

**LINE DRAWING OF TOP VIEW OF THE K-108 RECEIVER**

Fig. 2. The complete layout and wiring of the receiver can be understood from this drawing. Note in particular that the type of tubes to use in each socket is marked just above the sockets. The No. 960 fixed resistor shown at the lower left is actually mounted on the ABC sub-panel in a vertical position as indicated.

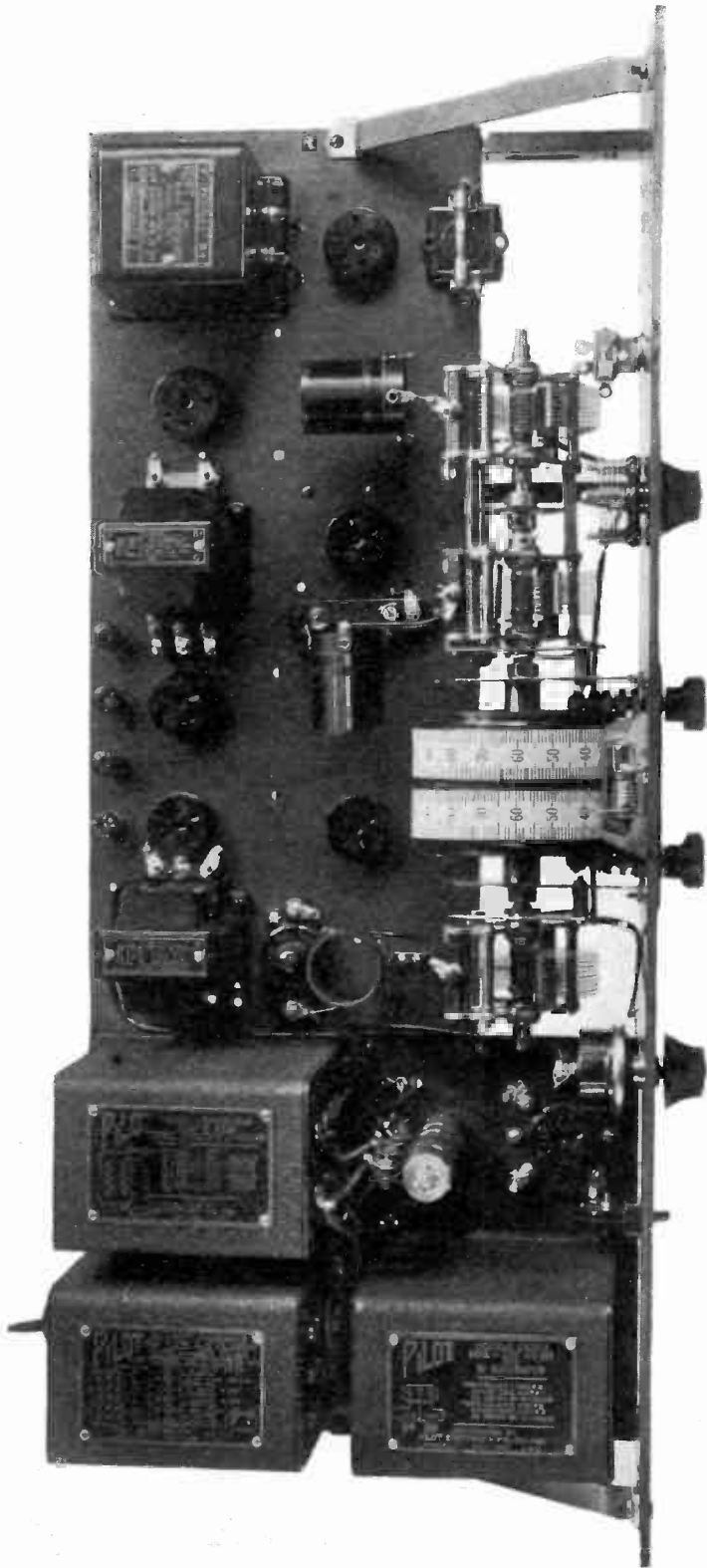

### PHOTOGRAPH OF TOP VIEW OF THE K-108 RECEIVER

*Fig. 3. The top view of the six tube K-108 T-R-F receiver as seen by the eye of the camera. The ABC power supply unit at the left end is assembled on a separate sub-panel making an individual unit, separate from the receiver sub-panel proper.*

filament current for the UX-171 tubes). The ABC power supply circuit uses a Pilot No. 398 "Jumbo" Power Transformer, a No. 396 "Jumbo" Condenser unit and a No. 395 "Jumbo" Double Choke Coil. The B circuit voltages are obtained by taking off taps on the No. 960 fixed resistor for all tubes except the 171 tubes, which use the full 220 volts. The receiver, of course, is completely "all electric," it being only necessary to connect to the 110 volt 60 cycle alternating current lighting line. The attachment plug primary circuit is opened or closed by the No. 42 toggle switch, as desired.

#### FRONT PANEL APPEARANCE

The assembled receiver when mounted in a cabinet has a very pleasant appearance, as shown by the photograph at the top of page eighty-three.

The panel itself is bakelite with a dark walnut finish that contrasts very beautifully with the old bronze finish of the illuminated vernier drum dial.

All knobs are of walnut to match the finish of the panel.

The "on" and "off" switch is at the lower left of the panel front, the pick-up jack at the lower right.

To the left of the drum dial is the resistograd or volume control and at the right the midget vernier control knob for selectivity. The dimensions of the front panel itself are 24" x 7", which is a size standard with practically all cabinets manufactured, so that the complete receiver may be installed in any table or console type cabinet.

#### LIST OF PARTS FOR THE K-108

1	701	7"x24"x3/16" Walnut Bakelite Front Panel.
1	702	7"x16 1/4"x3/8" Black Sub-panel (for receiver).
1	703	7"x7"x3/8" Black Sub-panel (for ABC Eliminator).
1	1617	Variable Condenser.
1	1617-2	Double Condenser.
1	1281	Double Drum Dial.
1	350	Resistograd.
1	1165	Midget Jack.
1	42	Toggle Switch.
1	J-7	7-plate Midget Condenser.
1	395	"Jumbo" Double Choke Coil.
1	396	"Jumbo" Condenser Block.
1	398	"Jumbo" ABC Transformer.
1	960	Fixed Resistor.
5	214	Sub-panel Sockets.
2	215	Sub-panel Sockets.
1	381	Giant Audio Transformer—3 1/2 to 1.
1	399	Input Push-Pull Transformer.
1	401	Output Push-Pull Choke.
1	1001	Adjustograd.
1	173	Antenna Coil.
2	172	R. F. Coils.
4	35	Bakelite Sub-panel Brackets 8 1/2"x1".
2	801	1 Mfd. By-pass Condenser.
1	955	850 Ohm Fixed Resistor.

1	958	2000 Ohm Fixed Resistor.
1	956	1200 Ohm Fixed Resistor.
2	58	.006 Bakelite Fixed Condensers.
1	51-M	.00025 Bakelite Fixed Condenser.
1	52	.0005 Bakelite Fixed Condenser.
1	VM82	Micrograd.
1	756	Grid Leak.
1	704	Screws, nuts, washers, wire and spaghetti.
1	BP-108	Assembly Blue Print.

#### ASSEMBLY INSTRUCTIONS

If one purchases the complete kit of parts the front panel and sub-panel in the kit come with all holes drilled, so that assembly work can be started immediately. If one does not purchase the complete kit of parts, but obtains the full size assembly wiring blueprint No. BP-108, it will be necessary, in addition to the purchase of the Pilot parts themselves, to purchase and drill the panels.

The full size sub-panel lay-out is given on the blueprint No. BP-108 and this lay-out can be used as an actual panel drilling template.

In the K-108, the sub-panel assembly is divided into two units. The receiver proper and the complete ABC power supply unit.

The first assembly work that should be done is to fasten the three resistors and the two No. 801 by-pass condensers on the bottom of the ABC power supply sub-panel. The standard four-prong socket, the No. 950 fixed resistors and the three-power units can then be mounted on the top of the sub-panel.

Before actually mounting the power units and resistors it is well to attach all wiring to the terminals of the units so that this wiring can be carried through a hole in the sub-panel so that wiring underneath both the ABC power supply and receiver panel can be easily done when final connections are made. The power supply sub-panel when completely assembled and with all wiring connections made, can be fastened to the two No. 35 bakelite sub-panel brackets and set aside until the assembly and wiring of the receiver panel proper has been completed.

Figure 2 is a line drawing of the top of the assembled receiver showing exact location of all parts.

Figure 4 is a line drawing of the bottom of the receiver showing location of all parts that are assembled and wired underneath the sub-panel.

It will be noted that all holes are numbered and that the wiring has been shown in very heavy lines and with complete instructions as to the wires that should be twisted together to reduce possible alternating current hum pick-up.

From the line drawings and photographs of Figures 2, 3, 4 and 5 one can get a clear idea of the entire assembly and the wiring of the receiver.

The radio frequency inductance coils are mounted in the three positions shown, all at right angle to each other so that the possibility of electromagnetic and electrostatic coupling between the coils is at its absolute

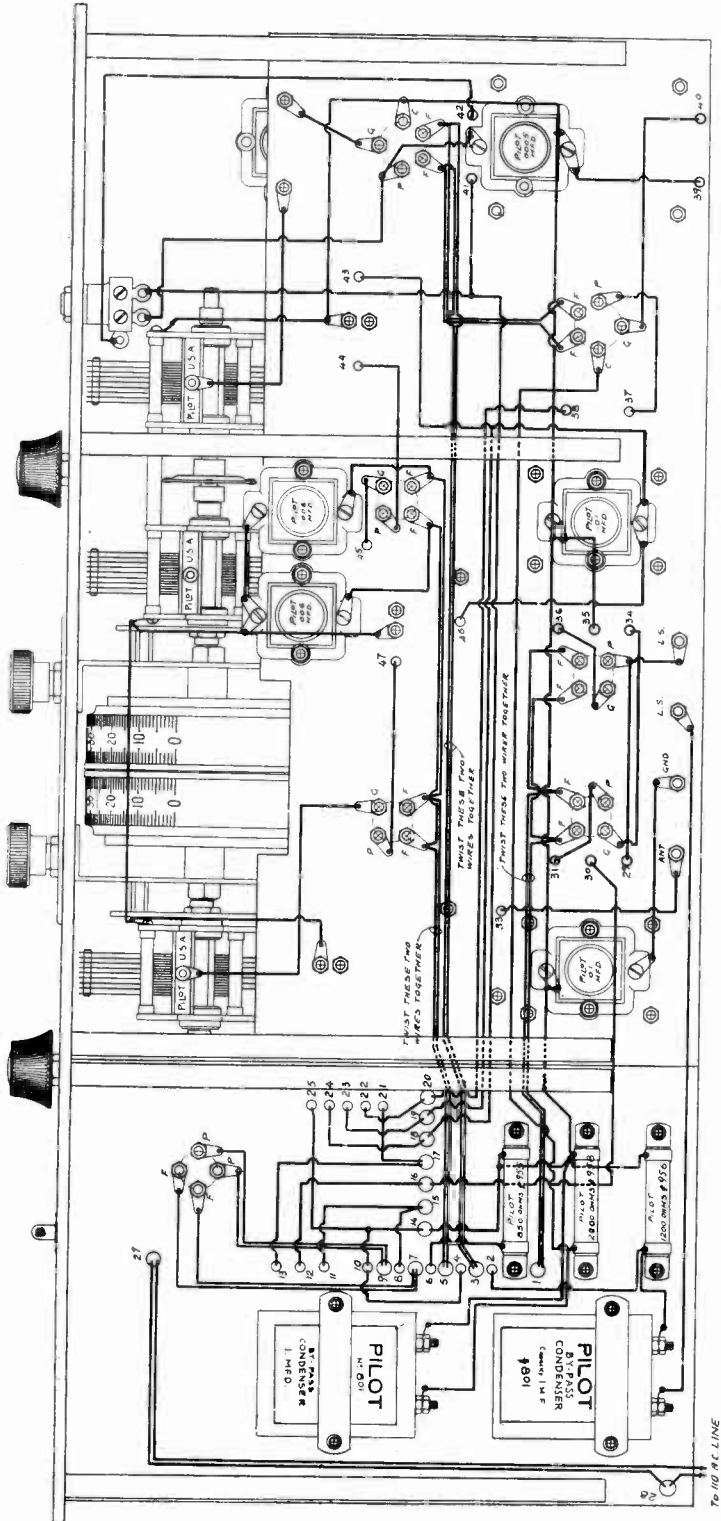

### LINE DRAWING OF BOTTOM OF K-108 RECEIVER

Fig. 4. Showing in detail all wiring and indicating that wiring carrying alternating current for filament supply should be twisted to reduce to an absolute minimum the possible "hum" pick-up.

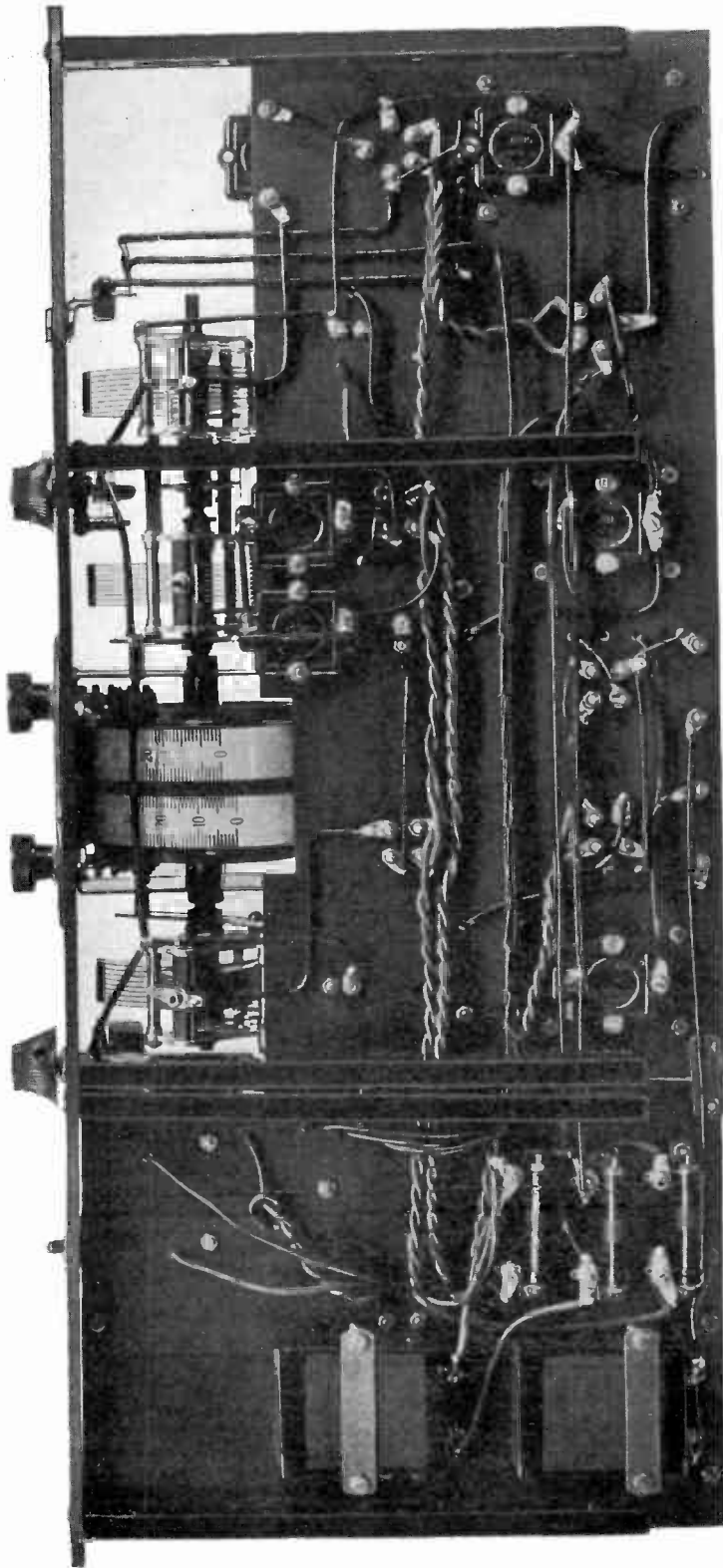

### PHOTOGRAPH OF BOTTOM OF SUB-PANEL OF THE K-108 RECEIVER

*Fig. 5. This photograph shows very clearly the wiring of the entire receiver below the sub-panels. Note the brass strap at the rear of the panels fastening the ABC power supply and receiver sub-panel together. All a.c. power supply wiring indicated twisted.*

minimum. The micrograd is mounted at the left hand end of the receiver sub-panel looking from the front of the receiver and directly back of the antenna inductance.

The other two radio frequency coils are mounted between the tube sockets and right in back of the variable tuning condensers.

In designing the set particular care was taken to keep all the radio frequency wires as short and direct as possible to prevent efficiency losses and aid in circuit stability.

On the front panel proper is mounted the illuminated double drum dial and attached to it the three tuning condensers.

It will be noted that the two variable condensers which are operated as one, are coupled to each other by the No. 12-A insulated flexible coupling. The procedure of assembly of the parts on the top and bottom of the receiver sub-panel itself is not so important as the screw heads of practically all parts are not covered up by other parts, so that the entire assembly work can be completed as one desires, the only important part being that when the assembly is finished that all parts are in the exact positions shown by the drawings and photographs.

#### WIRING UP THE RECEIVER

When all assembly work has been completed on the receiver panel proper it is suggested that all connections be made on the sub-panel itself previous to attaching the sub-panel to the front panel and that these connections be checked very carefully with the drawing to make certain of no mistakes.

After the wiring has been completed on the sub-panel it can be attached to the front panel by the three bakelite sub-panel brackets and at the right hand end by the heavy brass panel brace. Likewise the complete ABC power supply assembly can be attached to the panel by the bakelite panel brackets and with the metal panel brace on the left hand end. In addition a heavy brass strap is provided which is used to fasten the two sub-panels together at the rear, thus making the entire assembly mechanically rigid and solid, which is of importance because of the weight of the ABC power unit.

#### THE FIRST TEST

With the receiver completely assembled and wired we are ready for the first test. Place a UX-280 full wave rectifier tube in

the extreme left hand socket and the other tubes in their proper sockets as indicated by the drawing of Figure 2. Connect the antenna and ground and loudspeaker to their binding posts and of course attach the 110 volt 60 cycle lighting circuit to the receiver using the usual attachment cord and plug. With all connections made the "on" and "off" switch can be thrown to the "on" position, and if all wiring has been done in accordance with the drawings, photographs and blueprints supplied with the complete kit, the tubes will light up.

Rotate the volume knob or the one at the left of the vernier dial some 6 or 8 turns to the left. Now slowly rotate the 2 vernier knobs so that the dial readings are in step with each other and no difficulty will be had in picking up a broadcast signal.

Assuming that you are receiving a broadcast program, first adjust the micrograd No. VM-82 knob for maximum signal strength. This adjustment varies the capacity of the antenna circuit so that it is balanced with the two stages of radio frequency amplifications or such that the left hand vernier dial reading will be practically the same as the right hand reading over the entire wave length range.

If the circuit, after this adjustment has been made, seems particularly critical or if there is an excess amount of regeneration or oscillation present, adjust the screw of the adjustograd No. 1001 until this undesirable regeneration is reduced to a minimum without affecting the sensitivity of the receiver.

Particularly good results will always be obtained if, when in tuning in any weak station, a final adjustment is made with the vernier knob at the right. This vernier knob controls the 25 micro-microfarad mdiget condenser connected in parallel with the third variable condenser in the tuned radio frequency amplifier circuit and adjustment of this vernier condenser allows the three circuits to be brought exactly into tune with each other.

#### PHONOGRAPH PICK-UP JACK

As in the majority of all modern receivers, the K-103 is provided with a phonograph pick-up jack. This pick-up jack is connected to the audio frequency amplifier portion of the receiver so that the usual loudspeaker used for radio reception can be used for photograph record reproduction.

### THE IDEAL OF RADIO DESIGN IS TO BE THE FINEST RADIO CONSTRUCTION AND EXPERIMENTAL MAGAZINE IN THE UNITED STATES

*Future issues of the magazine will contain important articles by prominent radio engineers and experimenters including developments in short waves, television, power amplification, and modern radio broadcast receiver design and construction.*



# RADIO PHYSICS COURSE FOR HIGH SCHOOL STUDENTS

By ALFRED A. GHIRARDI

(Continuation of Chapter 2)

## About Electric Currents and Things Which Happen in Electrical Circuits

**21. ALTERNATING CURRENT:** It is perhaps difficult for the average non-technical person to grasp the idea of the flow of alternating current along a wire, but possibly a simple explanation may make this clear. Let us consider a fixed point in a wire carrying an alternating current. Starting at some instant when current just begins to flow, let us observe its strength and direction over a short period of time. The current begins to flow in one direction, gradually increasing in strength to a maximum value, then still flowing in the same direction, it decreases again to zero. Now it begins to increase in strength once more but has reversed its direction, reaches a maximum strength and decreases again to zero. It now reverses once more and the cycle is completed over and over again. A chart showing the cycle of events is given in Fig. 12. Here the flow of current in one direction is drawn

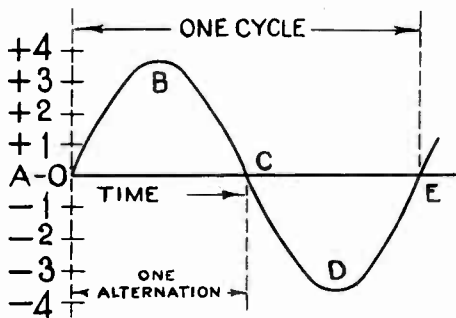

Fig. 12. Graphical picture of one cycle of alternating current.

above the zero line ACE, and the polarity indicated positive by the plus (+) sign, and the flow in the opposite direction is drawn below this line and the polarity indicated negative by the minus (-) sign. The current, starting at A rises to a maximum positive (+) value B in one direction and decreases to a maximum negative (-) value D, and back to zero at E. The next cycle is a duplicate of this. The reader will notice the similarity between this curve and those discussed in Chapter 1. From A to C is termed one alternation, from A to E is one cycle. The number of complete cycles or reversals of current per second is called the frequency, expressed by the symbol "f." This term frequency is very important, since it determines the many peculiar effects produced in alternating current circuits.

Alternating current used for electric lights in the home generally has a frequency of 60 cycles, that is, it incorporates 60 positive (+) and 60 negative (-) values each second or a total number of reversals or alternations of 120 or two times the frequency per second. Alternating currents used in radio vary all the way from 16 cycles 300,000,000 cycles per second and more. High frequency currents have many peculiarities totally different from those of the same currents at lower frequencies. For instance, if we take a coil consisting of a few hundred turns of insulated copper wire, we can send a low frequency alternating current through it very readily. If the voltage applied is kept constant and the frequency is increased, the current flowing through the coil decreases, or in other words the "resistance" of the current path increases. If the frequency is raised to a very high value, the current seemingly no longer flows through the wire of the coil, but apparently flows across the surface from one turn to the next through the insulation and air space between turns.

This phenomenon will be studied in more detail in a later chapter.

**22. MAGNETISM:** The reader is perhaps familiar with the common horseshoe magnet used in boyhood days to pick up nails and needles. In ancient days, it was found that certain stones, called "lodestones," had the property of attracting small pieces of iron. This property of attracting iron and steel is called "magnetism," and the body possessing it is called a magnet. Later it was found that these stones had the property of imparting magnetism to other pieces of iron or steel when they were rubbed together. We do not know just what magnetism is, but it makes itself evident as an attractive force along certain definite lines and directions. The ends of a magnet where the forces of attraction or repulsion is greatest, are called the magnetic poles. Actually there are no visible lines of force existing around a magnet, but the study of magnetism is very much simplified by representing these magnetic forces by lines extending from one pole through space to the other pole and having the same indicated direction at every point, as the forces themselves. The lines of force are assumed to come out of one pole, called the north pole, and pass through the surrounding medium back to the other pole called the south pole, where they enter the magnet and return to the north pole, thus completing the magnetic circuit. The space adjacent to the magnet enclosing these lines of force is termed the "magnetic field." Every

magnetic line of force must enclose a complete circuit, so it is impossible to have a magnet with only one pole.

**23. MAGNETIC EFFECT OF CURRENTS:** Whenever an electric current flows through a conductor magnetism is produced. The fact that a conductor, carrying a current, possesses an external magnetic field can be proven by bringing a small compass needle near the wire and noting its deflection. The magnetic field around a straight wire carrying a current consists of circular magnetic lines of force having the axis of the wire as their center. These circles are very close together near the wire and gradually thin out as the distance from the wire increases. Fig. 13(A) shows the circular magnetic fields around a wire in which the current from a battery is flowing in the direction shown by the arrows.

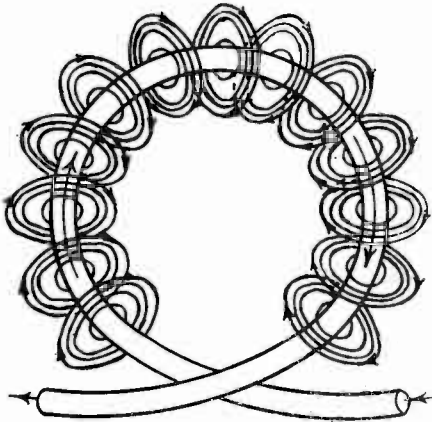

Fig. 13 (A). Magnetic lines of force existing around a conductor carrying an electric current

If the direction of the current in a straight wire is known, the direction of the circular magnetic field around it can be determined by the right-hand rule: Grasping the wire with the fingers of the right hand, with the thumb extended in the direction of current flow, the direction in which the fingers are pointed will indicate the direction of the magnetic lines of force. This is graphically shown in Fig. 13 (B), which shows a length of wire through which current is flowing in a direction indicated by the arrow, or from the bottom toward the top of the illustration. The circular magnetic fields are shown having a direction as indicated by the arrows, which is also the direction indicated by

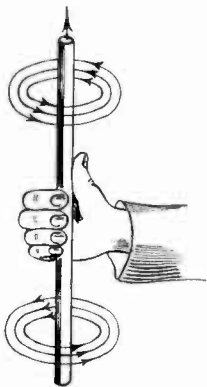

Fig. 13 (B). Illustrating the "right-hand" rule for determining direction of magnetic lines of force.

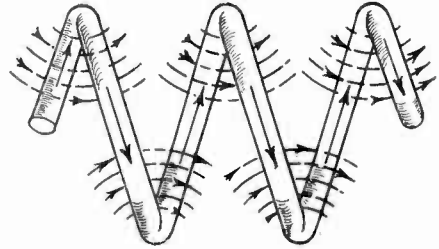

Fig. 13 (C). Magnetic fields existing around the individual turns of wire of an inductance.

the pointing of the finger tips.

If the long straight wire is wound into the form of a coil as shown in Fig. 13(C), several things happen to the magnetic field. Remembering that the circular magnetic fields exist all along the length of the wire of the coil, it is evident that the fields existing around the adjacent turns of the wire will react upon each other. The parts of the circular magnetic fields of each turn which lie inside the coil are in the same direction as those of every other turn. The result is that they aid each other to produce a strong total magnetic field inside the coil winding, and the magnetic lines of force become straight to within a short distance of the ends of the coil. On the outside of the coil, the same action takes place, with the result that the magnetic field of the coil takes the form

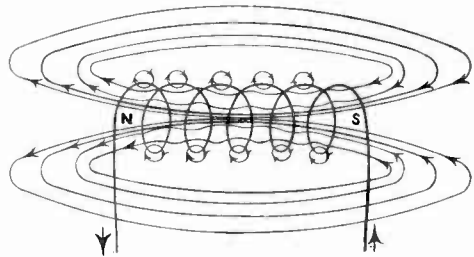

Fig. 13 (D). The total magnetic field of an inductance coil.

shown by the lines in Fig. 13(D). The magnetic lines are close together inside the coil, producing a dense field there, while at the poles they spread out creating a weaker field in the medium surrounding the coil. If you look at one end of the coil, and the current is flowing around in the same direction that the hands of a clock move, or to the right, then the end of the coil nearest you, is the south magnetic pole. If the current flows in a counter-clock wise direction, or left-hand direction, then the end of the coil nearest you is the north magnetic pole of the coil.

**24. ELECTROMAGNETIC INDUCTION:** In the previous paragraph it was stated that a current flowing through a conductor produces a

magnetic field, in and surrounding that conductor. If a wire forming a closed circuit is moved across a magnetic field or if the magnetic field is moved across the wire, so as to cut the magnetic lines of force, (the effect is a maximum when the moving wire or field is at right angles) a current of electricity is induced in the closed circuit. In both cases the strength of the induced current depends upon the following factors:

1. The strength of the magnetic field.
2. The speed at which the lines of force are being cut.
3. The number of wires cutting the lines of force per second.

**25. INDUCTANCE:** The electromagnetic field produced by a current flowing through a wire varies with the current. When a steady direct current is sent through a wire, a steady electromagnetic field is produced, and no current is induced in either the conductor itself or in an adjacent conductor.

When an alternating current flows through a wire, since it changes its direction once every alternation, or twice every cycle, the electromagnetic field produced by it does likewise, and since the current varies in strength and area, of course, the induced current also varies. When the current begins to flow along the wire, the circular electromagnetic fields originating at the electrical center of the wire, travel away from the center in ever increasing diameters, and of course, extend into space beyond the wire. Consequently until the circular fields become of greater diameter than the wire itself, the fields by the action explained in Section 24, induce in that same wire a second current. It can be proved that this induced current is in a direction opposite to the main current and therefore opposing it. When the current flowing through the wire decreases or stops flowing, the circular electromagnetic fields collapse and in so doing again cut the wire, but in succeeding ever diminishing diameters, inducing in it a current in the opposite direction, which is in the same direction as the original applied current. Consequently, this induced current tends to prolong, or prevent the main current from flowing. This property of a wire or coil to act inductively upon itself or upon another circuit is called "inductance," expressed by the symbol  $L$ , the unit of measurement of inductance being "the Henry." The amount of inductance possessed by a circuit depends upon its physical form and dimensions. Thus a single straight wire has a comparatively low inductance, the same wire, however, when wound into a coil of many turns has a high inductance.

Inductance in a circuit, opposes the flow of alternating current.

**26. CAPACITY:** If two metal plates are insulated from each other with some material such as waxed paper, or air they form an electrical condenser, or capacitance, that is, a device capable of containing a quantity of electric charges.

If a voltage is applied to the two plates by means of a battery a current will flow into the condenser until it is charged to the same voltage as that of the battery. If the battery is

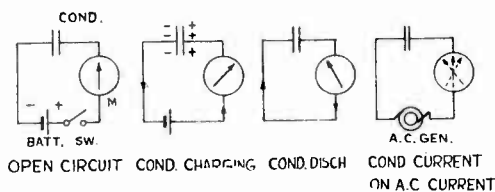

Fig. 14. Showing the charge and discharge of a condenser in an electrical circuit.

now removed and the two terminals of the condenser are touched together a spark will be produced by the discharging current, flowing out of the condenser, which is of course in the reverse direction to the charging current.

When a condenser is connected in an alternating current circuit it is charged to a voltage equal to the maximum applied voltage during the first quarter cycle, is discharged during the next quarter cycle, is charged again in the opposite direction during the third quarter cycle, and discharged again during the last quarter cycle. This is repeated over and over again during each cycle. Actually no current flows through the condenser itself since the alternate plates are insulated from each other, but the charge and discharge currents flowing in the external circuit, would make it appear as though a current was flowing through the condenser itself if a current indicating device were connected in series in the circuit. This is shown in Fig. 14. The unit of measurement of capacity is called "the Farad," and is expressed by the symbol  $F$ , capacity itself being expressed by  $C$ .

**27. INDUCTIVE REACTANCE:** From the previous explanation it is evident that inductance tends to oppose the flow of the current in an alternating current circuit. This opposition effect may be considered as an apparent resistance additional to the natural or direct current (zero frequency) resistance of the circuit and the total effect is called "inductive reactance," expressed by the symbol  $X_L$  to distinguish it from the direct current resistance  $R$ .

Since inductive reactance causes an opposition to the flow of current it is expressed in ohms like resistance.

In a circuit containing inductance only the current lags  $90^\circ$  (degrees) behind the applied voltage, so that

$$E = 2 \times 3.1416 \times f \times L \times I \quad (7)$$

where

$E$  = the applied voltage

$I$  = the current

$L$  = the inductance in henries

$f$  = the frequency in cycles per second;

therefore,

$$2 \times 3.1416 \times f \times L = \frac{E}{I} \text{ ohms}$$

where the inductive reactance

$$X_L = 2 \times 3.1416 \times f \times L \quad (8)$$

**28. IMPEDANCE:** Since most alternating current circuits contain resistance, inductance, and capacity, their combined effect is termed "impedance," expressed by the symbol  $Z$ .

Impedance in a circuit containing inductance, capacity and resistance in series can be expressed by the equation:

$$Z = \sqrt{R^2 + (2 \times 3.1416 \times f \times L)^2} \quad (9)$$

Where

- R = resistance in ohms.
- f = frequency in cycles per second.
- L = inductance in henries.

Since the effects of inductance are exactly opposite to those of capacity, the effective reactance is obtained by subtracting the smaller one from the larger one.

In dealing with alternating currents, Ohm's Law, must therefore be modified slightly. The current I in any circuit is equal to the voltage E applied to the circuit divided by the impedance Z of the circuit.

$$I = \frac{E}{Z} = \frac{E}{\sqrt{R^2 + (2 \times 3.1416 \times f \times L)^2}} \quad (10)$$

**29. CAPACITANCE REACTANCE:** The strength of the charge and discharge currents in a condenser, depends on the capacity C of the condenser, the applied voltage E, and the frequency f. Thus the condenser may be considered as a part of the circuit having an apparent resistance in ohms, called its "capacitive reactance," represented by the symbol Xc.

In a circuit containing capacity and resistance in series, the current leads the applied voltage by 90° (degrees), and the impedance is

$$Z = \sqrt{R^2 + \left(\frac{1}{2 \times 3.1416 \times f \times C}\right)^2} \text{ ohms} \quad (11)$$

where

C = capacity in farads.

The expression

$$\frac{1}{2 \times 3.1416 \times f \times C} \quad (12)$$

is the equation of capacitance reactance, Xc.

From this formula it can be seen that as either the frequency or the capacity, or both is increased, the resistance which a condenser offers to the flow of alternating current de-

creases. Hence capacity in a circuit aids the flow of alternating current. This is exactly opposite to the effect of inductance in a circuit.

**30. RESONANCE:** From formula 10, it can be seen that if we have an alternating current circuit to which a definite voltage E is applied, a maximum current I will flow when the impedance Z is made as small as possible. Now let us examine formula 10. In order to make Z as small as possible, we must reduce the resistance R to zero and make the inductive reactance XL equal to the capacitance reactance Xc so that

$$XL - Xc = 0$$

It is quite impossible to make R equal to zero, since all conductors have some resistance, but for any given frequency f, we can choose the inductance and capacity so that the inductive reactance XL equals the capacitance reactance Xc, so that

$$2 \times 3.1416 \times f \times L = \frac{1}{2 \times 3.1416 \times f \times C}$$

In a circuit containing inductance, capacity and resistance in series, the impedance Z, is

$$\sqrt{R^2 + \left(2 \times 3.1416 \times f \times L - \frac{1}{2 \times 3.1416 \times f \times C}\right)^2}$$

If the inductive reactance equals the capacitance reactance in such a circuit, then

$$Z = \sqrt{(R)^2 + (0)^2} = \sqrt{R^2}$$

Therefore

$$Z = R$$

The circuit then operates as though there were neither inductance nor capacity present, and it is said to be in "resonance" with the impressed alternating frequency.

This resonance effect is applied in practically all of our present radio receiving circuits today where the minute voltages set up in the aerial circuit are made to produce the largest currents possible. The usual circuit to obtain resonance is one having a variable condenser connected across or in parallel with a fixed inductance.

## CHAPTER 3

### *The Broadcasting Stations—How Radio Waves Travel, Fading and Skipping*

**31. BROADCASTING:** In Chapter 1, it was stated that instead of transmitting sound waves directly, as in the case of one person talking to another across a room, a radio telephone transmitter converts them into corresponding electrical waves.

The sound waves vary in intensity and form due to the presence of harmonics. The human voice includes a range of from about 200 to 3,000 cycles per second and the average frequency during ordinary speech is about 800 cycles per second.

The first step in broadcasting is to change the air or sound waves into corresponding electric current, or more exactly speaking, to make the sound waves control an electric current.

This is accomplished by the microphone.

**32. THE MICROPHONE:** The most popular form of microphone is the carbon type. Its operation is similar to that of the common telephone transmitter. Fig. 15 shows a cross sectional view of a simplified microphone. The diaphragm A, of thin aluminum or iron, is rigidly fastened to the polished carbon button B and is held fixed around its outside edge by the insulated case E. A second carbon button D is fastened rigidly in place and the space C is filled loosely with carbon granules.

A connection is taken from each of the carbon buttons, so that current must flow from one button through the carbon granules to the other one. The air waves created by the performer

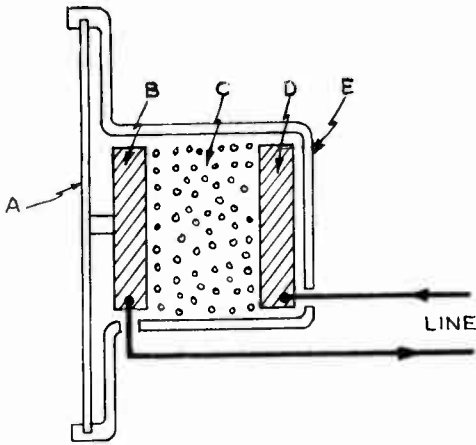

Fig. 15. Principal of construction and operation of a typical microphone of the carbon granule type.

in the broadcast studio strike against the diaphragm and cause it to vibrate back and forth very rapidly, following the motion in the air produced by the sound wave. This air wave vibrates the button B, causing alternate compressions and de-compressions of the carbon granules. The resistance of these granules varies greatly as the pressure upon them is changed, being very high during a de-compression when the particles are held loosely, and comparatively low during compressions when they are packed tightly. Thus the movement of the diaphragm alters the electrical resistance of the microphone and so varies the current flowing through it in exact accordance with the sound waves.

There are other types of microphones in addition to the carbon granule type which has been described. Among these are the "electrostatic" and the "glow" microphones.

All microphones, however, are, as can be seen from the above explanation, devices for converting sound waves in a gaseous medium (the air) into electrical currents, the amplitude of which vary in accordance with the variation of the pressure of the air waves striking against the diaphragm of the microphone.

The microphone used in a radio broadcasting studio has a dramatic as well as a technical existence and its effect upon the broadcast artist parallels the older "stage-fright" of the vaudeville or dramatic actor, when he or she faces their audience in a theatre.

But the microphone, or as it is sometimes called in studio language, the "mike," is to some artists even more dreadful than the "stage fright" that they contend with, across the footlights.

For where an artist in a theatre can only affect and be affected by the audience in that theatre, conditions are quite different in the broadcast studio where not just a theatre full of people, but where literally millions

of "listeners-in" are always ready to criticize, sometimes harshly, the technique and the ability of the radio artist.

The broadcast "mike" does not applaud, has no emotional expression to tell the artist if his or her work is pleasing, but always presents a cold mechanical reaction to the very best or to the poorest efforts of the performer.

The microphone is in reality a device which functions practically as an exact opposite to the loudspeaker, transforming sound into electrical energy, while the loudspeaker transforms electrical energy into sound.

The proper use of microphones in the broadcasting studio is in this day of high quality broadcasting a real art in itself.

Fig. 16 at (A) shows the steady direct current flowing through the microphone when the diaphragm is undisturbed, and the variation in current produced by transmitting the sound of "a" as in "father," is shown in (B) of this same figure. Fig. 16 (C) and (D) shows the variation of the current when this same "a" as in father is impressed upon a high frequency

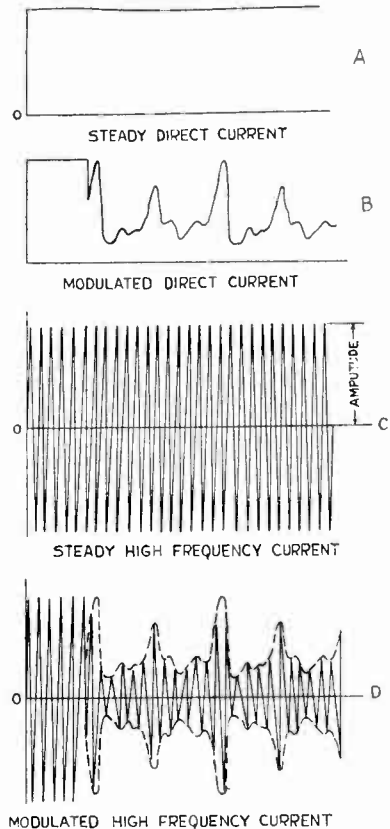

Fig. 16. Drawings illustrating the modulation of direct and high frequency alternating current by impressed speech frequencies.

alternating current. It is evident that the microphone acts merely as a variable resistance in the circuit.

Fig. 17 shows a common form of microphone used in most studios. This type is arranged to utilize both the forward and backward movements of the diaphragm to produce better variation or modulation of the current. The mechanism is suspended by springs to prevent noises due to accidental jarring, and is enclosed in a housing to improve its appearance.

Another conception of a microphone, operates by change in capacitance due to the movement of one diaphragm separated from another one by one a few thousandths of an inch. This is known as the condenser microphone. The galvanometer type operates by the movement of a coil of wire in a strong magnetic field. The coil moved in the field by the diaphragm has small currents set up in it which vary in strength corresponding with the movements of the diaphragm.

The microphone changes the sound waves or vibrations into corresponding variations in electric current. Since the audible range of vibrations extends from about 16 to 20,000 cycles per second, it is evident that the current in the microphone circuit must vary over this range during a broadcast program. The next problem is to transmit the varying current through space to the receiving station.

**33. TRANSMISSION:** The two ways in which energy can be transferred from the transmitting antenna to the receiving aerials are by electromagnetic induction effect and by electrostatic and electromagnetic wave radiation into space. Fig. 18 shows a simple circuit for transmission by inductive effect.

If a direct current is sent through wire AB, a magnetic field will be set up around it as soon as the current starts to flow, and will col-

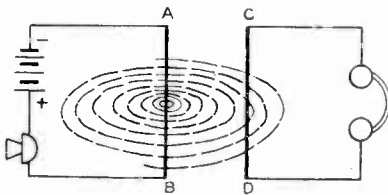

Fig. 18. Electro-magnetic induction.



(Courtesy WOR)

Fig. 17. Microphone used in present day broadcasting stations.

lapse as soon as the current stops. If an alternating current is sent through it, there will be a constantly changing magnetic field, which is set up and collapses every time the current changes in direction. Since the strength of the magnetic field at any instance depends upon the strength of the current at that instant, the field strength grows to a maximum and then diminishes to zero, over and over again.

If the conductor CD is located in this varying magnetic field, a current will be induced in it by the action of the field, and this current will be an exact duplicate of that flowing in AB. This action is called electromagnetic induction and is the principle upon which all transformers operate.

If AB is an antenna carrying alternating current and CD is a receiving aerial near it, then it is

evident that the magnetic field around AB will induce currents in the receiving aerial. However, as the distance from antenna AB is increased, the strength of the magnetic field decreases very rapidly, that is, the electromagnetic field strength is inversely proportional to the square of the distance. It is evident then that this system of transmission by pure electromagnetic induction would be unsuitable for broadcasting, since enormous power would be

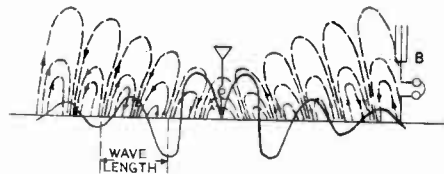

Fig. 19. Wave forms of energy transmission by electro-magnetic wave radiation.

necessary to transmit signals over any appreciable distance.

**34. WAVE TRANSMISSION:** In Fig. 19 the common open type transmitting circuit is shown. In this circuit the disturbance in space is caused primarily by electrostatic and associative electromagnetic fields which travel outward in all directions in the form of waves. Open circuits are much more effective radiators of electrical energy than closed ones, but even with an open circuit radiator enormous power would be necessary to send out waves having

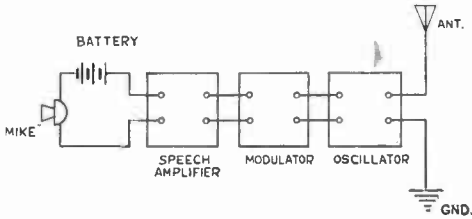

Fig. 20. Fundamental arrangement of circuit elements of a radio transmitting station.

frequencies from 16 to 6,000 cycles per second, over long distances. The radiation from any given circuit increases greatly as the frequency of the current in the circuit increases. This is one of the reasons why it is possible for amateurs transmitting at frequencies above 6,000,000 cycles per second (below 50 meters wavelength) to reach nearly around world employing powers of a few watts. It is due to these transmission characteristics that in order to transmit over long distance with the expenditure of a reasonable amount of power, the open circuit type antenna or radiator must be used. Currents of very high frequencies, running into millions of cycles per second, are employed for broadcasting.

**35. MODULATION:** The practical way of transmitting radiophone programs by means of currents of very high frequencies is to use a high frequency current which varies in strength according to the intensity and frequency of the sound waves to be transmitted. A steady current of very high frequency, determined by the operating wavelength of the station is generated by means of large vacuum tubes operated as os-

cillators. This is shown in Fig 15 (C) previously referred to. Notice that it is an alternating current and that the height or strength of the current during each cycle is exactly the same as during any other cycle.

The fact that vacuum tubes connected to a source of direct current and a special circuit can be made to generate alternating currents of high frequency, commonly called oscillations, is really the foundation of our present broadcasting systems.

If the voice current of Fig. 15(B) is allowed to regulate the flow of the radio frequency current of Fig. 15(C), that is, to modulate it, the result is high frequency current of Fig. 15(D) called the modulated oscillating current. This current is no longer of constant amplitude but its strength varies in exact accordance with the variations in strength and frequency of the voice current, or the spoken sounds. That is, the steady oscillating current is modulated by the voice current. This is accomplished by a vacuum tube known as the modulator tube.

A simple analogy which may make the action clear, is to think of the oscillating current as a steady stream of water flowing out of the nozzle of a hose. The voice current is represented by an adjustable opening in the nozzle which varies continuously in size. If this variation in the opening is made to take place, the diameter of the stream will be varying constantly to conform to the size of the opening in the nozzle.

**36. RADIATION:** The modulated oscillating current goes to the antenna circuit where it produces waves which radiate in all directions. The frequency of the waves is the frequency of the high frequency current, so that the frequency or wavelength of the station is con-



(Courtesy WOR)

Fig. 21. Interior of a radio broadcasting studio during the transmission of an early morning "daily dozen" program.

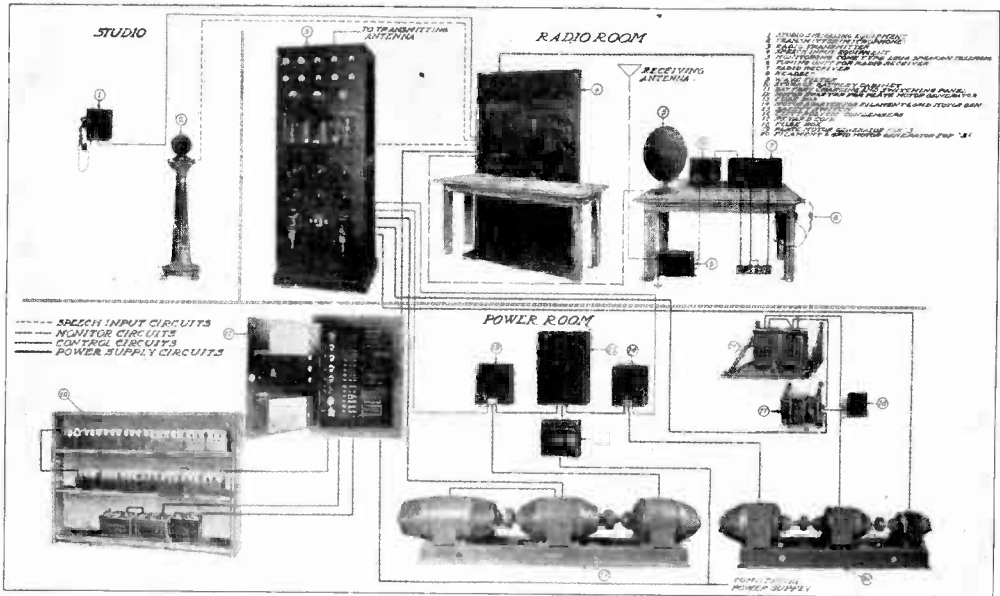

Fig. 22. Pictorial arrangement of apparatus and connections of transmitting apparatus in a modern broadcasting station.

trolled by adjusting the oscillator tube circuit. The actual broadcasting equipment is made up of units related to each other as shown in Fig. 20.

The exact way in which the electrostatic and electromagnetic waves travel through space is not completely known. There are many theories attempting to explain their observed behavior, and many of our most able scientists are experimenting constantly to shed new light on electromagnetic radiation mysteries.

### 37. THE BROADCASTING STATION:

The speakers or artists perform in a studio, Fig. 21 where the microphone is located. This is usually a large room made sound proof so that no outside noises can affect transmission. The windows are covered with heavy draperies and the walls and floor are padded to improve the acoustic properties of the room and to prevent reverberation which might cause blasting in the reception of the program. A signal system is included to enable the announcers to communicate with the control room.

Since the amount of current handled by the microphone is necessarily small it must be amplified in order to be strong enough to affect the modulator tube when impressed upon it. This is done in the control room by a speech amplifier. Since there is very wide variation between the loudness of voices and of musical instruments, the speech amplifier must be capable of adjustment so that when a particularly loud part of a program comes through, the operator can cut down on the control and not allow as much current to pass through the amplifier. This is necessary in order to avoid over loading of both the transmitting and receiving apparatus and unnaturalness in reception. In most stations it is possible to cut down to a small fraction of the maximum volume.

This operation is accomplished continuously by a station operator and is known as monitoring. If the monitor operator is not quick and constantly on the alert, the loud notes of an orchestra come in like thunder and the low, soft tones may be lost entirely.

The next part of the transmitter is the modulator. This is a vacuum tube device and in the usual plate power variation or Heissing method of modulating it varies the plate power going into the oscillator tubes. The oscillator tubes are usually connected in a Meissner circuit for generating high frequency oscillations.

The plate circuits of the vacuum tubes used as oscillators must be supplied with high-voltage, direct-current power. The filaments of all the tubes take quite a large current at low voltage. In order to provide this, some stations employ motor generator sets operating directly from the electric light and power lines. The output passes through a coil and condenser filter combination designed to take out the commutator ripples. Other stations transform low voltage a. c. to high voltage and then rectify it, changing it to direct current by special types of large vacuum tubes called Kenatrons.

The station equipment also includes a receiving set tuned to the wavelengths used in commercial ship work. One operator is constantly on duty at this set to listen for possible S O S distress signals, so that the broadcast station can be taken off the air immediately to avoid possible interference.

**38. REMOTE CONTROL:** If the broadcasting originates at some point removed from the station, as in the case of a football game, the microphone and usually the speech amplifier are installed at the field and a wire telephone line is run to the transmitting apparatus in the broadcasting station. Usually existing tele-



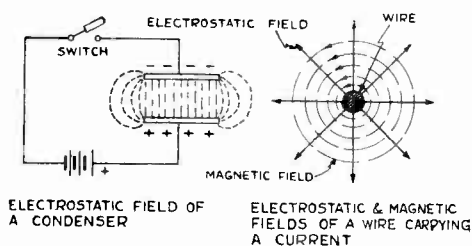

Fig. 23. Electro static fields.

phone lines are rented from the telephone company. Some stations employ a portable radio-telephone transmitter of low power which is sent to the scene of activity and the program is broadcast directly from there to the main broadcasting station, where it is re-broadcast with increased power.

The complete equipment for a 1,000-watt station is shown pictorially in Fig. 22. The storage batteries are used to operate the speech amplifier and the radio receiving set.

**39. WAVE PROPAGATION:** An explanation of the way in which the radio waves are produced and travel in space enables one to understand and appreciate the wonders of radio transmission and the many difficulties encountered. We cannot see, hear, or feel these waves, but it is possible to visualize their actions by the things they accomplish.

The electrostatic lines of force, Fig. 23(A) and (B) are radial about the conductor, while the magnetic field is concentric about it. The two fields are always at right angles to each other. The strength of the electrostatic field depends upon the charges. In the antenna, when the current ceases to flow at the end of a cycle, the charge is greatest and the electrostatic field around it is maximum.

When the current has its maximum value, the electric field around the antenna is zero, since at this time the rate of change of the current is a minimum. When the charges are at rest on a conductor, the electric lines of force are also at rest and extend out radially from it. These lines are supposed to have a certain amount of inertia or resistance to any changes that may take place, so that if the charges on the conductor change rapidly from a condition of movement to one of rest, as is the case in a high frequency alternating current, the lines lag behind and they behave as if they were detached from the antenna, and start to travel away from it at a speed of 186,300 miles per second. This is the radiated electrostatic field which plays the important part in transmission.

Just as the motion of a charge, with its associated electrostatic field, sets up an electromagnetic field around the conductor carrying it, so the motion of the radiated electrostatic field travelling away from the antenna sets up its own magnetic field as it travels. When the radiated electrostatic field is at its maximum value, the magnetic field which it creates is also at its maximum value. It is important to keep clearly in mind the fact that the radiated magnetic field which is produced wholly by the moving radiated electric field

is entirely distinct from the magnetic field of induction which is produced by the antenna current, and which does not travel any great distance from the antenna. The radiated magnetic field and radiated electrostatic field are closely related. We cannot have the first without the latter.

The two radiated fields move outward from the antenna at all times perpendicular to each other, the magnetic field being parallel to the ground and the electrostatic field being perpendicular to it. At the same time, both fields are at right angles to the direction of propagation of the waves. At great distances from the antenna, the electric waves would be exactly perpendicular to the earth, if the earth were a perfect conductor. Actually the resistance of the earth's surface causes the waves to tip forward somewhat as shown in Fig. 19.

Possibly the following description by Dr. Fleming will serve to make this clear.

"If we can imagine a being endowed with a kind of vision enabling him to see the lines of electric strain and magnetic flux in space, he, standing at any spot on the earth's surface, would see, when the antenna was in action, bunches or groups of electric strain fly past. Near the earth's surface these strain lines would be vertical. Alternate groups of lines of strain would be oppositely directed, and the spectator would also see groups of magnetic flux fly past, directed in a horizontal direction or parallel to the earth's surface. The strain and flux lines would move with the velocity of light, 186,300 miles per second or 300,000,000 meters per second, and the distance between two successive maxima of electric strain, directed in the same direction, would be the wavelength of the wave."

At the receiving station the antenna may take the form of an open wire or a loop. In either case the radiated waves from the transmitter striking across it, cause currents of electricity to flow in the receiving circuit.

**40. FADING OF SIGNALS:** In some localities the signals from certain stations especially short wave stations, seem to fade in and out in an irregular manner. This usually is more marked at night than in the daytime. The probable explanation of this curious phenomenon is that as the waves travel outward from the transmitting antenna, they may be considered as taking the form of ground waves

(Please turn to page 108)

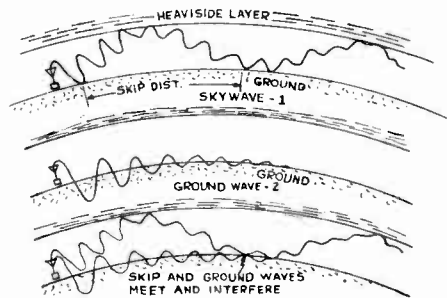
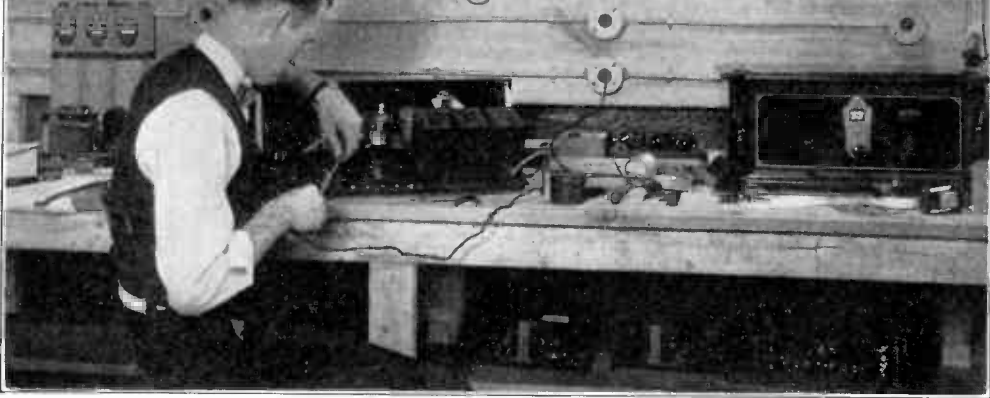

Fig. 24. Fading and skipping action of radiated electro-magnetic waves.

# FOR THE CUSTOM SET BUILDER



**L**ETTERS received from thousands of custom set builders, tell me with emphasis, that they do not wish to "experiment" with receiver circuits, panel lay-out, and methods of amplification and oscillation control, or with any other of the problems that are difficult even for the engineering departments of large radio manufacturers—problems that these self same manufacturers are spending tens of thousands of dollars and employing the best engineering talent obtainable to solve.

\* \* \*

They state that they would far prefer the engineering and experimental departments of the radio manufacturers to do this research, experimental and engineering work that they may be supplied with complete receiver kits or with correctly designed parts that will easily fit together and work together according to instructions and blue-prints supplied by the manufacturer.

\* \* \*

I believe that this condition is worthy of explanation. It seems to me that there are two basic reasons: First, that the circuit arrangements in use today employing high efficiency radio frequency amplification, shield grid tubes, and alternating current power circuits, require real engineering ability over and beyond that required at any previous time, and second because the ultimate radio broadcast receiver purchaser, when he pays his good money for a custom built receiver, wants to have delivered to him a receiver that has "looks," comparable to if not of better and more pleasing in appearance than any factory built receiver.

\* \* \*

The use of well designed and well built radio parts alone will not accomplish the desired results, but the correct use of such parts in circuits designed with engineering skill, and fore-

sight and assembled into receivers according to blue prints supplied by the engineers and using mechanical methods of construction not available to the ordinary custom set builder, except by the cooperation of the manufacturer, will result in the customer being happy and satisfied with his purchase.

\* \* \*

Every custom set builder that uses only such high grade parts, and circuit designs and information obtained from and with the assistance of the radio manufacturer, it seems to me for a second time, is in a position to make real money selling radio sets to an enormous number of people that cannot be adequately satisfied by the complete set radio manufacturer.

\* \* \*

The man who buys a radio receiver today, wants a receiver incorporating the engineering progress of the radio art as it exists *today*, without waiting months for the complete radio receiver manufacturer to construct many expensive tools and dies and buy special machinery, and even build a special factory, as many of them are prone to do, before they are actually ready to deliver to their possible customers the merchandise, that by that time may be technically out of date and style.

\* \* \*

Certainly the custom set builder is the "up-to-the-present-minute" radio man, capable of supplying the set that meets and goes beyond the today's requirements. And let us not forget such a receiver as the custom set builder delivers to your home and installs—costs you a figure in dollars and cents that not only pleases, but that means real **ECONOMY**.

*John Galoto*

Technical Consultant, RADIO DESIGN.



## THE PILOTONE ELECTRIC

*Complete Instructions for Assembling, Wiring, and Operating  
the All-Electric Pilotone Six Tube A. C. Receiver*

By FRANK T. SULLIVAN

**F**OR many months past broadcast listeners, experimenters, and custom set builders, throughout the country have been insistent in their demands for a six tube all-electric receiver, obtainable in kit form and incorporating the major requirements of the most efficient receiver possible to design and yet obtainable at a price that spells economy.

To accomplish such a result is no small order for any radio engineer and one which cannot be achieved quickly, or without serious consideration.

The obtaining in any receiver of the technical requirements of relative ten kilocycle selectivity, necessary sensitivity for distant reception, the absence of critical adjustments and the ability to re-create the actual artistry, technique, and temperament of the broadcast artist within one's home, is in itself no small problem.

If when such a receiver is created and made available at a cost of materials at least one half less than the expectations, one can be content with the expenditure of a great deal of hard "midnight-hour" work.

It is just such kind of work, just such intensive experimentation, long and careful testing of one circuit after another, one method of connection after another, and one lay-out arrangement after another, that finally resulted in the near perfect mechanical and electrical design of the Pilotone Electric receiver.

Not content with my own opinions and conceptions, a number of the early models of the Pilotone receivers were placed in the hands of practical experienced radio engineers, and tested in their homes and in the homes of many

advanced enthusiastic radio set builders. When these men came to me voluntarily, and told me that they were delighted with the operation and quality of reproduction of the receiver, that they were exceedingly pleased with its construction and design and that they were astounded at the low cost of the parts necessary—only then did I truthfully feel that I had accomplished the problem that I had set out to really solve.

Frankly, nearly everyone to whom I talked and to whom I demonstrated and let "listen-in" for themselves, tell me that the Pilotone Electric is the kind of a receiver that they would like to have in their home and prove it in the majority of cases by the immediate purchase of the Pilotone receiver complete kit of parts.

### **SIMPLE TO OPERATE AND GIVES "CLOSE-UP" QUALITY REPRODUCTION**

The Pilotone Electric is an extremely easy receiver to operate. All the family from the grandmother to the four-year-old boy can for themselves enjoy the thrill of snapping the "on" and "off" switch, rotating the knob of the Pilot illuminated vernier dial, and adjusting the small knob on the left of the receiver front panel to vary the ability to receive distant stations and the volume of the received broadcasted program.

In designing a radio receiver, as in nearly all engineering work, the ideal condition must usually be a compromise. Obviously the two most important factors in this day of good high power broadcasting, and a large number of stations are "selectivity" and "quality." The circuit design of the Pilotone receiver is such



Fig. 2. Showing the Pilotone Electric receiver installed in a console cabinet complete with loud speaker

that relative ten kilocycles selectivity is obtained without cutting of side-bands, and consequent distortion, or lack of quality as regards the radio frequency amplification portion of the circuit.

Care has been taken to design the constants of the detector tube circuit so that no overloading will occur, under normal operating conditions.

One stage of low ratio audio frequency amplification is employed after the detector and the output of this stage of amplification feeds directly into a push-pull circuit providing high quality (and high volume, if desired) reproduction. A fixed condenser is arranged in the output circuit to prevent the high voltage direct current from going through the loud speaker coil windings.

### THE ALL-METAL CHASSIS AND PANEL MAKES ASSEMBLING QUICK AND EASY

Without question the time has arrived when custom set builders and experimenters are particularly happy to have the engineering department of the radio manufacturer do the serious experimental work required in designing the receivers which they are to build. For this reason the list of parts necessary for the construction of the Pilotone Electric receiver includes a steel front panel, in which all holes are punched, and in addition a metal sub-base panel, likewise with all holes ready for immediate assembly.

This plan also makes possible supplying a panel beautifully finished in grain walnut and decorated with gold border lines matching the golden bronze finish of the vernier illuminated dial, and the front panel knobs.

The photograph on page one hundred and one, and Fig. 2 shows the receiver mounted in both table and console cabinets and the table cabinet illustration in particular, shows the front panel appearance.

### PARTS LIST

The complete list of parts for the Pilotone receiver, includes the following items:

- 1 No. 738—7 in. by 18 in. Walnut Finish Steel Front Panel.
- 1 No. 739—Special Metal Sub Base-Panel.
- 2 No. 36—Angle Brackets.
- 1 No. 404—Filament Power Transformer.
- 1 No. 42-W—Toggle Switch.
- 1 No. 1282—Illuminated Dial with No. 1256-W Knob.
- 1 No. 350—Resistograd with No. 1257-W Knob.
- 1 No. 1703—Triple Compact Condenser.
- 1 No. 1001—1000 ohm Adjustograd.
- 1 No. 277—Receptacle.
- 2 No. 172—R. F. Coils.
- 1 No. 173—Antenna Coil.
- 2 No. 801—By-Pass Condensers (1 mfd.)
- 2 No. 68—Type M Mica Condensers (.006 mfd.)

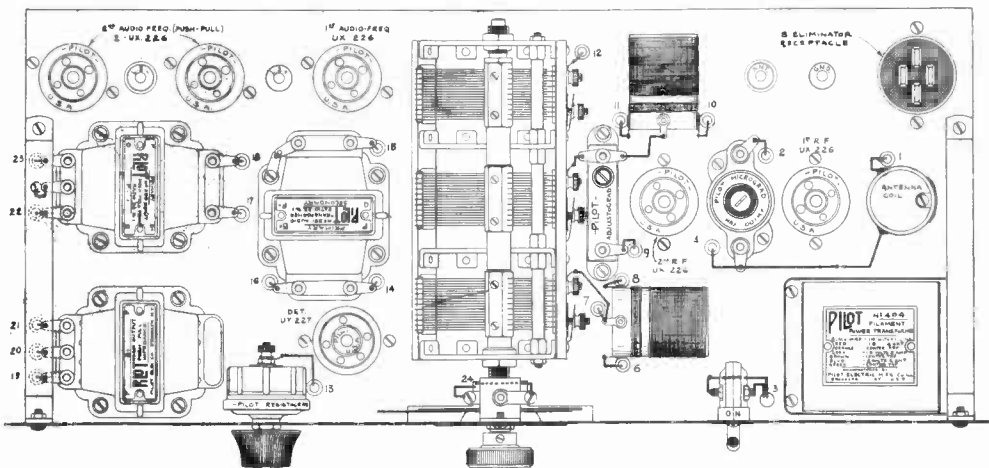

Fig. 3. Picture, assembly and wiring diagram, looking down on the top of the receiver.

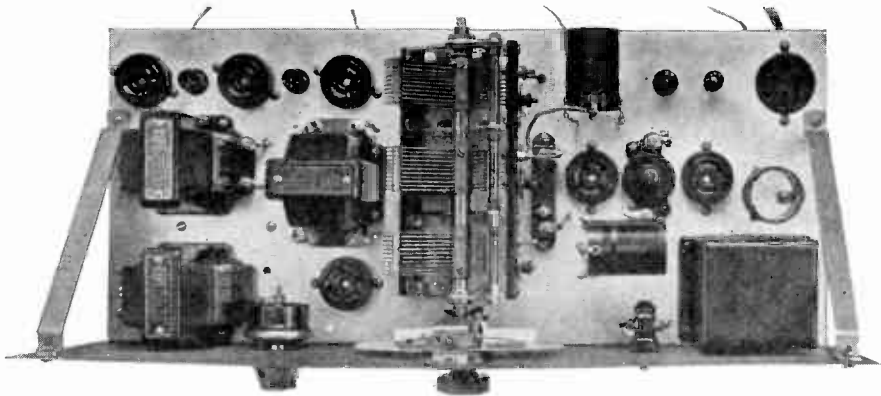

Fig. 4. Top view photograph of the Pilotone Electric receiver.

- 1 No. 62—Type M Mica Condenser (.0005 mfd.)
- 1 No. 51-M—Type M Mica Condenser with Special Grid Leak Clips.
- 1 Set of 4—Binding Posts as Follows—L. S. (—); L. S. (+); Ant.; Gnd.
- 1 No. VM82—Micrograd.
- 5 No. 216—Sockets.
- 1 No. 217—Socket.
- 1 No. F-43—2½ Volt Bulb.
- 1 No. 391—Audio Transformer (3½ to 1 Ratio).
- 1 No. 399—Input Push-Pull Transformer.
- 1 No. 401—Output Push-Pull Impedance.
- 1 No. 958—Fixed Resistor—2,000 ohms.
- 1 No. 954—Fixed Resistor—650 ohms.
- 1 No. 756—2 Megohm Grid Leak.
- 1 No. 734—6 Ft. Double Cord With Plug.
- 1 No. 735—Package of Assorted Screws, Nuts, Lock Washers, and Soldering Lugs.
- 1 No. 736—Package of Assorted Rubber Covered Wire.
- 1 No. 737—Package of Hardware.
- 1 No. BP-102—Assembly Blue Print.

#### ASSEMBLY INSTRUCTIONS

Fig. 3 shows in reduced scale the top view of the receiver completely assembled and wired. It will be noted that all terminals are numbered, making the actual wiring easy to follow and practically certain of elimination of mistakes. The same view as seen by the camera is shown in Fig. 4.

Figure 5 shows the wiring an assembly of the sub-base panel looking at the bottom, and illustrated by photograph Fig. 6.

The additional photographs Figs. 7, 8 and 9 show the oblique rear top view and the right and left hand ends of the assembled receiver.

I especially suggest, however, that before you start the actual assembling of the receiver, that you study very carefully the full sized construction blue-print supplied with the complete kit of parts.

When you are thoroughly familiar with the location of the parts on the panel and sub-base panel, take all of the parts out of their cartons and check them against the complete list of materials and arrange them nicely on your work table so that the actual assembly can be started.

Start first with the front panel and mount in the center the illuminated dial. Then on the left hand the resistograd and on the right the toggle switch. Be sure that the name plate of the toggle switch on the front of the panel is mounted with the "on" designation at the top, and also that the word "on" marked on the bakelite switch case is facing the top of the receiver. With the assembly of these three parts on the front panel, the panel should now be fastened to the sub-base panel using the four oval head oxidized screws, and additionally secured and braced by the attachment of the two nickel-plated brackets on each end, thus fastening the panel and sub-base panel together as a rigid solid unit.

Now refer again to the bottom sub-panel views of Fig. 5 and 6, and mount the detector grid condenser (.00025 mfd.) and grid leak in the position shown. Now attach the two fixed condensers (.006 mfd.) fastening them to the sub-base panel by one machine screw in the center, and making certain that the other two terminal lugs of these condensers do not touch the metal sub-base panel. It will be best to tighten two regular hexagon nuts on the machine screw before placing the condensers in position, and then fasten them in place with the third nut, so as to space them away from the metal sub-panel.

In the same way attach the fixed condenser (.0005 mfd.) at the left of the center line of the panel and just below the front left hand socket, using only the left hand terminal lug of the condenser for attachment.

Now we can mount the triple variable condenser into position. To do this loosen the machine screw holding the illuminated dial to the front panel so that the dial will be free to move slightly and align itself with the condenser shaft, when the condenser shaft is inserted through the hole in the hub of the dial. When both the dial and condenser are lined up nicely, fasten the condenser permanently into position, by the round head machine screws passing through the sub-base panel, with the screw heads of course at the bottom. Tightening the machine screw holding the vernier dial into position will provide an extremely substantial solid assembly of both dial and condenser.

Now mesh the rotor plates of the condenser full into the stator plates. Hold the meshed



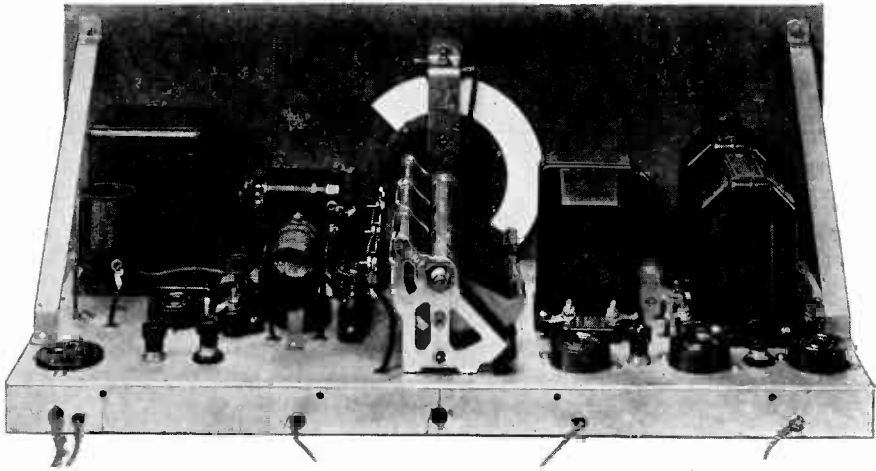

Fig. 7. Oblique rear top view of the Pilotone Electric receiver.

ant part of a radio receiver; the radio frequency inductance coils. Mount them in position as shown in the top assembly views Figs. 3 and 4, noting in particular that the antenna coil is the one mounted vertically at the extreme right hand end of the receiver, and that it has only two soldering lugs. The other two coils are identically the same but have three soldering lugs and are mounted at right angles to each other just to the right of the variable condenser.

The filament power transformer is now mounted on the sub-base panel, at the extreme front right, making sure that the connecting leads from the transformer are passed through the holes provided in the sub-base panel.

In Figs. 5 and 6 showing the details of the assembly of the bottom of the sub-base panel you will note that a 2,000 ohm. fixed resistor is mounted at the right of the right hand hole, and that a 650 ohm fixed resistor is mounted just to the left of the left hand hole through which the connection leads come from the power transformer. These two resistors are fastened to the sub-base panel with the same machine screws that are used for attaching the power transformer, and the assembly should be made, of course, at the same time.

We are nearly through now and only have to fasten in position the five No. 216 sockets for the UX-226 tubes and the one No. 217 socket for the UY-227 detector tube. The socket designations are clearly shown in the top view of the sub-base panel assembly in Fig. 3.

And now for the last assembly work, that of attaching the two No. 801 by-pass condensers (1 mfd.) using the machine screws and metal straps provided in the hardware box, placing them in the exact positions indicated in the bottom sub-base assembly view of Figs. 5 and 6.

It is always difficult to describe the assembly of a receiver without seemingly using a great many words to describe simple operations, but only the experienced set builder can recognize the extreme care that needs to be taken in the lay-out of a receiver, that the desired results be

obtained, hence the importance of making perfectly clear the exact position of each part and its method of assembly.

If these instructions are carefully followed by the set builder, the whole assembly work of the receiver can be accomplished very quickly and when the job is done, I think everyone will be pleased with the clean cut appearance and the mechanical security of the finished job.

#### CONNECTING UP THE PILOTONE ELECTRIC

Just as it was important before proceeding with the assembly of the receiver, so it is important to study carefully the wiring of the receiver as shown by the top and bottom assembly views of Fig. 3 and 5, and the schematic wiring diagram shown in Fig. 10 before proceeding with this work. In Figs. 3 and 5, the exact position of each wire is shown pictorially, all holes through the sub-base panel being designated by figures identical in both views.

Before beginning the actual wiring job and looking at the bottom of the sub-base panel bend the socket springs up and away from the metal panel to eliminate any possibility of short circuiting.

It is also well to thoroughly *clean* each connection wire before soldering with a bit of sandpaper or emery paper or even with a knife blade, so that the solder will flow easily and make a secure joint.

Possibly the most important consideration in soldering is to use a *hot* soldering iron for many thousands of set builders know to their disappointment that a cold iron and a poor cold soldered joint results only in a high resistance, high frequency connection that greatly lowers the overall efficiency of the receiver. A cold soldered joint which is made with acid-core solder or acid flux will eventually lead to not only a high resistance connection but to a corroded connection and a continual source of trouble. For that reason I must emphatically suggest that you *use only clean metal contacts between connections, a hot iron and always a resin-core solder.*

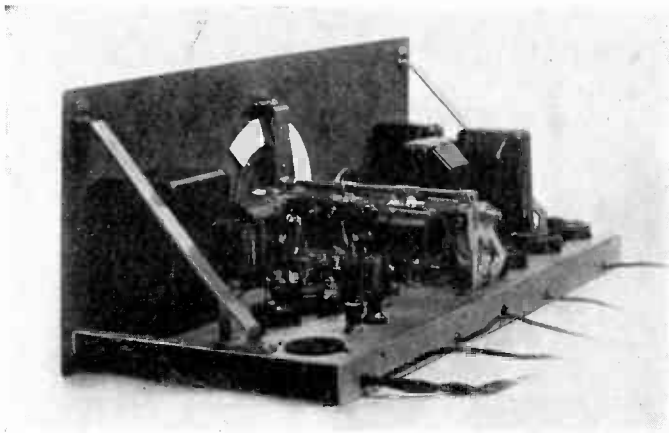

Fig. 8. Partial left-hand end view of the assembled receiver.

We will begin our wiring job from the filament power transformer. It will be noted from Fig. 5 that some of the wires leading from the filament power transformer are colored and particular attention should be taken to connect these wires to the exact terminals shown. The filament wiring is in all cases twisted, for it carries alternating current and twisting the wires reduces the effect of the external magnetic fields, and prevents "hum" in the finished receiver by reducing the possible pick-up of the alternating filament current by the balance of the wiring in the receiver. For example taking the blue colored two volt filament circuit wires, twist them together and after passing them under the 650 ohm fixed resistor, we run them parallel to the front panel and solder them to the filament terminals of the UY-227 detector tube socket. In the same way all of the other filament wires are twisted together and placed in the positions shown in the drawings and photographs and securely soldered to their terminals. For all other connections except for the "B" power connecting leads use the black rubber covered wire furnished. The only wires that are twisted, with the exception of the filament wires, are the leads from the "B" power attachment plug to the power transformer and the leads connecting the "B" power attachment plug to the 110 volt a. c. attachment cord and to the toggle "on" and "off" switch.

All wiring from terminals on the top of the sub-base panel that connects to terminals on the bottom of the sub-base panel can be easily checked by carefully following the pictorial lay-out of both views, and noting carefully the numbers of the designation holes. For example, taking the ANT. binding post as shown in the bottom sub-base panel view of Fig. 5, we see that the connecting wire passes through hole No. 2. Checking hole No. 2 in the top sub-base panel view of Fig. 3, we find that the wire that comes through hole No. 2 is soldered to one terminal of the micrograd. Following through all of the other wiring of the receiver, checking carefully every step as we go, the complete receiver can be completely wired up with nicely soldered joints in the course of a couple of hours.

**USE CARE IN MAKING THE INITIAL ADJUSTMENTS TO YOUR RECEIVER THAT MOST EFFICIENT RESULTS MAY BE OBTAINED**

With the receiver completely finished, we are now ready for our first initial adjustments to allow the most efficient operation of the receiver over its entire wave length range.

As will be understood, the filament current supply of the receiver is self contained, being supplied directly from the alternating current lighting line by the No. 404 filament power transformer. Extending through the rear of the sub-base panel are four connecting leads. A black wire on the extreme right hand

looking from the front of the receiver, is to be connected to the "B" minus (—) terminal of the power supply. Then comes a red wire which is to be connected to the positive (+) 90 volts power supply. This red lead supplies 90 volts to the plates of the radio frequency tubes and to the first audio amplifier tube. Then comes a blue wire which is to be connected to the positive (+) 45 volt power supply terminal. This blue lead supplies 45 volts to the detector tube plate circuit. And finally on the extreme left hand end of the receiver we find a grey lead which supplies a positive (+) 180 volt potential to the plate circuits of the last two audio frequency amplifier tubes in push-pull arrangement.

No "C" battery external connections are necessary, as the correct negative grid bias voltages for all tubes except the UY-227 detector tube, which of course does not require a negative grid bias are obtained through resistances connected to the center taps of the secondary transformer windings.

The "B" power voltages required as specified above, should be obtained by the use of a "B" power supply. (The Pilotone "B" power supply No. K-107, described on page 134 of this issue of RADIO DESIGN is particularly adapted to supplying the necessary high voltage requirements of this receiver.)

Assuming that the receiver has been properly connected to the 110 volt alternating current lighting circuit and that with a "B" eliminator correctly connected to the four connecting leads, and that antenna, ground, and loud speaker connections have been made, we are ready to proceed with the initial balancing adjustments required.

After throwing the "on" and "off" switch on, the right panel front to the "on" position it will be necessary to wait a few seconds to give the heaters within the tubes time to become hot and allow normal operation. Turn the control knob at the left of the panel completely to the right and after this has been done turn it back again to the left until it turns freely. Now carefully and slowly rotate the vernier dial knob from 0 to 100. If the receiver has a tendency to oscillate under these conditions it means that the circuit is practically adjusted



to the point of its maximum operating efficiency, and in every receiver constructed so far, this condition has obtained at the time of the first test.

In so far as the antenna circuit is conductively coupled to the first radio frequency amplifier circuit the length of the antenna and ground leads will affect the tuning of the first stage of radio frequency amplification. It is therefore, necessary to adjust the overall condenser and the radio frequency inductance characteristics of this circuit by tuning the antenna circuit such that its wave length will agree with the wave length of the associated tuned radio frequency amplifier circuits over the entire wave length range.

This is easily done by adjusting the VM82 micrograd condenser. Tune the receiver so that a reasonably strong broadcast signal is received and after care is taken to adjust the vernier dial exactly at the point of maximum signal intensity, rotate the knob of the micrograd condenser until a maximum signal is secured. This adjustment should be made every time the receiver is used on a different antenna or ground connection, but once made for a given antenna no future adjustment is required. Now to secure an additional degree of perfection of balance of the three tuned circuits we must balance the actual wave lengths of the other circuits to a point of near perfect equality.

The No. 1703 triple variable condenser, used in the Pilotone Electric receiver has on the insulating strip on the right hand side, looking from the receiver front, three small compen-

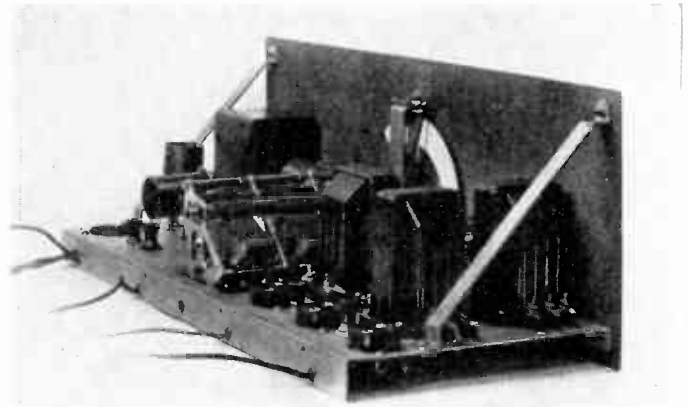

Fig. 9. Partial right-hand end view of the assembled receiver.

sating condensers, adjustable by the small knurled nuts. While receiving, as previously, a broadcast signal and after the micrograd condenser has been adjusted carefully to compensate for antenna circuit tuning, the compensating adjustment on the variable condensers should be made. In the majority of cases it will not be found necessary to change the adjustment of the compensating condensers for the last two tuned radio frequency stages (or the ones nearest the front panel) for the accuracy with which Pilotone condensers and coils are constructed and tested allows the resulting wave lengths of these first two circuits to agree very accurately.

The first radio frequency stage or the one associated with the antenna circuit, however, may possibly require some adjustment. Looking from the front of the receiver the two compensating condensers closest to the panel front are those for the two stages that will

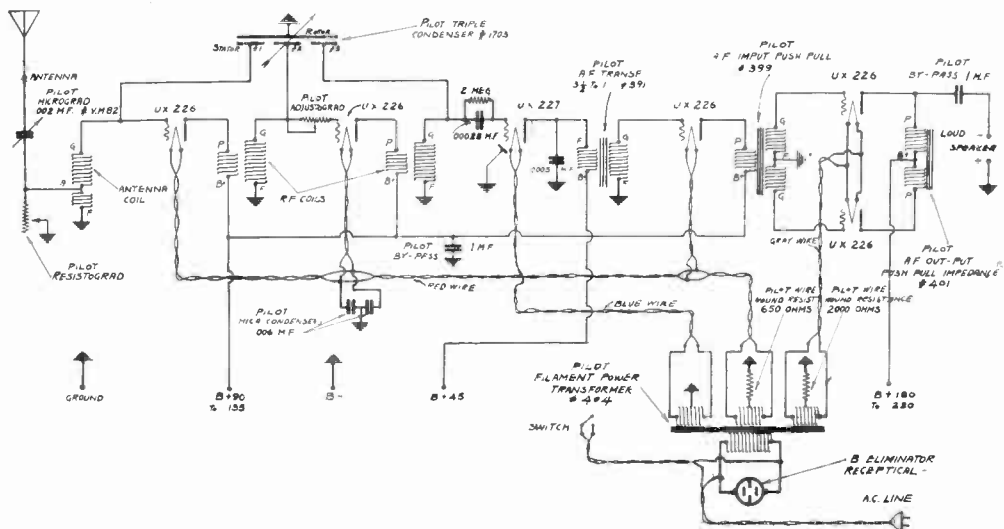

Fig. 10. Schematic wiring diagram of the Pilotone Electric receiver.

probably *not* require any adjustment, while the rear adjustment is for the first radio frequency amplifier stage.

With a given incoming signal, this rear antenna condenser compensating adjustment can be rotated slightly in either direction until again the maximum signal results.

A finer balance can be obtained if necessary, of course, by careful adjustment of all three compensating condensers. It is well after adjusting the compensators on the variable condenser to finally secure a complete balance by a second adjustment of the VM82 micrograd.

The volume control on the left of the receiver panel front, will affectively control any tendency of the circuit to oscillate in the majority of instances, but if when this control knob is turned all the way in or completely to the

right, oscillation still takes place, it can be quickly removed by a slight adjustment of the No. 1001 adjustograd, which you will remember is located on the sub-base panel just to the right of the variable condensers.

#### EVERYDAY OPERATION

Now your Pilotone Electric receiver is finished and the few hours that you have spent in its assembly, wiring and adjustment, I am sure will repay you with much happiness and satisfaction. Certainly when you have finished this receiver and enjoyed a good evening's broadcast reception, you will feel particularly pleased in obtaining a high quality receiver at a price which, as I stated in my first paragraph, can only spell *economy*.

## RADIO PHYSICS COURSE

(Continued from page 99)

and sky waves. The ground wave is greatly weakened as it travels through obstructions like frameworks of steel buildings, etc. The sky wave apparently goes up into the air perhaps fifty or a hundred miles and is reflected so that it comes down again to combine with the other wave which has travelled along the earth. The two waves arriving at the receiving aerial combine to produce the resulting wave which affects the receiving apparatus. Since the sky waves travel a much longer distance than the ground waves Fig. 24, it is possible that the two are not in phase with each other when they meet. When they are both in the same phase at the time of meeting, the resultant signal is strong; when they differ in phase the resulting signal is weak. The constant minute to minute variation in distance travelled changes the phase relation with consequent fading or swinging of the signal. Fading is a function of frequency, being more troublesome as the frequency is increased. It is more pronounced at night than during the day and decreases as the distance from the transmitter is increased. The reflection action on the sky wave is explained by a theory advanced by Sir Oliver Heaviside.

**41. HEAVSIDE LAYER:** Seventy-five or a hundred miles up, the atmosphere surrounding the earth is very rare. The molecules, consisting of equal positive and negative electrical charges, are split up—ionized—into positive and negative portions by the ultra-violet light from the sun during the day. This ionized layer of atmosphere is a conductor, and is known as the Heaviside layer. During the day the layer comes closer to the earth because of additional ionization of the molecules by the sun. At night, during the absence of the sun, the positive and negative portions of a part of the molecules reunite, and the layer rises from the earth. During the day the sky wave is very materially reduced by absorption from the conductive Heaviside layer, and so practically all of the energy comes through the ground waves, to all but those receiving stations located close to the transmitting station. At night, both the

ground waves, to all but those receiving stations located close to the transmitting station. At night, both the ground and sky waves are stronger so the received signal is much stronger.

**42. SKIPPING:** The Heaviside layer is always present then, but at varying heights, depending on the sunlight and changes in barometric pressure. Due to the varying height and possible uneven surface at places, the angle of reflection of the sky wave is constantly changing so that the phase relation between the ground and sky wave changes with the consequent fading. With very high frequency, low wavelengths, this effect of the Heaviside layer is so marked that the radio-waves appear to skip over certain localities entirely, and reception in those places is impossible. That is, the intensity of received signals first decreases as the distance from the transmitter is increased reaching a value too low to be detected. As the distance is further increased, the signals become readable again.

The skip distance at night is much greater than in the daytime. It gradually increases up to about midnight. It is also greater in winter than in summer, because the ionization is less then, due to shorter periods of sunlight.

It has been found that on 15 meters the daylight skip is about 900 miles and is about 1,000 miles at night. On 27 meters the day skip is 100 miles and night skip is 450 miles. On 33 meters the day skip is 100 miles and night skip is 400 miles. On 50.2 meters there is no apparent skip. The amount of skip decreases as the wavelength is increased, and above about 150 meters the effect is negligible so that the signal transmissions from broadcasting stations are not affected.

About an hour before sunset there usually occurs a rise in the average intensity of radio signals, then a drop at sunset, and a rise to a first maximum about an hour later. During the night the average intensity varies but shows its greatest value about two hours before sunrise. The sunrise effect is similar to the sunset effect but reversed.

# AUDIO FREQUENCY TRANSFORMERS

*Number one . . . of little dramas in the life of the largest radio parts factory in the world*

By KIMBALL HOUTON STARK

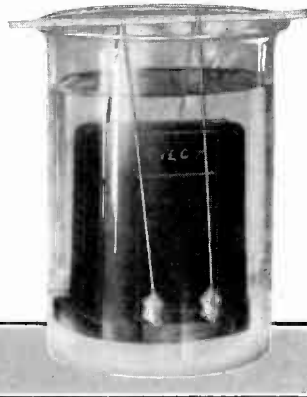

**M**Y first introduction to audio frequency transformers was in the early part of 1917. Amplifiers were at that time in the front line trenches of radio engineering both as regards their technical capabilities and because of their importance in military and naval communication during the war.

Well do I remember some of the earlier transformers of that day, constructed in the same way as the usual telephone transformer, or spark coils; a bundle of soft iron wires, some three or four inches long, a half inch in diameter, around which a primary coil was wound. Then on the outside of this primary coil came the secondary winding. Wooden coil ends were slipped over the ends of the core, and the whole assembly mounted on a wooden block with leads coming out to binding posts.

Later came the conventional closed core type transformers and hundreds of thousands of amplifiers were built during the later days of the war and mounted in radio equipment made under special contract for the United States Army and Navy, obviously, for use under the most severe conditions. These closed core transformers, certainly a great improvement, still had relatively little iron in the core and insulation even as required by rigid government specifications, did not always protect the coil. The result, expansion of the coil due to wide temperature changes and humid conditions both as met with in tropical countries and on board naval vessels.

Both expansion of the coil and the absorption of moisture obviously was due to improper impregnation of the coil winding, the absorption of moisture being the most disastrous. As quick as an infinitesimal bit of moisture penetrated the coil windings and broke down the insulation, trouble became apparent that eventually led to short circuiting the turns and completely destroying the transformer.

## TRANSFORMER TROUBLES IN THE EARLY DAYS OF BROADCASTING

Along during the year nineteen twenty-three, after broadcasting became popular and radio receivers were being manufactured

by the thousands, audio frequency transformers gave many manufacturers not only a productive nightmare, but an empty pocketbook.

It so happened that I was associated at that time with a radio manufacturer who used many thousands of transformers in high-grade complete receivers. I remember shipments were going out each day, a hundred receivers or more a day. Over night letters came pouring into the factory saying, "My set has gone dead. It was O. K. last night and I was receiving a wonderful program when all of a sudden everything went dead, the tubes of the receiver still burning. I can't understand it, for I just purchased my set a week ago." I had to read letter after letter like this, some of them referring to receivers a day old, some a week old, and some of them months.

What was to be done? Here was a problem extremely difficult to eliminate both commercially and technically and with audio frequency transformers going bad one after another, a large production schedule was shattered, resulting in tremendous dollars and cents losses.

Night and day worries and work by the entire engineering staff finally placed all the blame on the audio frequency transformers.

How did it happen? Very fine magnet wire as was used for the secondary windings of the transformers was extremely scarce those days. The insulating coating on the wire was found not to be uniform because in many instances the acid solution used to clean the wire previous to the time the enamel coating was placed on it had not been completely removed. With only an infinitesimal speck of acid remaining on the wire, corrosion eventually resulted, and the fine wires short circuited or broke altogether and the receiver became inoperative.

As an indication of the magnitude of troubles that many manufacturers were experiencing at that time, a veteran radio salesman reported to me that he saw one day in Tampa, Florida, some two hundred high-grade receivers, selling at an average of one hundred and fifty dollars each, laying in the warehouse of a radio distributor,

returned by customers as defective and all because of damaged audio frequency transformers.

I am relating these early experiences and conditions because they contain a terrific object lesson and so emphatically illustrate the reverse condition that exists today as regards the manufacture and use of audio frequency transformers.

At the time that I assumed the editorship of Radio Design, one of the radio engineers employed by the Pilot Electric Mfg. Co., Inc., was one of the men with whom I was associated on radio work during the war and who at that time did a great deal of work in connection with the design and manufacture of audio frequency transformers. He knows intimately the problems that troubled us at that time and aided in their solution. He also knew my interest in transformers, both past and future.

It was an extreme pleasure to me to accept his invitation to be conducted through the Pilot factory and be shown how present-day audio frequency transformers are designed, manufactured and tested. The things I saw on that trip so impressed me that I have sub-captioned this story, "Little Dramas in the Life of the Largest Radio Parts Factory in the World."

#### HUNDREDS OF THOUSANDS OF CORE LAMINATIONS PER DAY

After a good morning handshake, my engineer friend (we will call him the usual fictitious Bill) said, "Let's start at the beginning and go right up the line," and so my first impression was that of seeing special automatic high-speed punch presses, stamping out iron laminations for the transformer cores and doing it at the rate of nine thousand pieces an hour.

It is only possible to use such automatic machinery when production requirements run into enormous quantities, for each press costs thousands of dollars. The dies for the presses, even though made of the finest tool steel, hardened under scientific temperature control, become dull quickly and require constant sharpening and inspection for wear.

All tools and dies are made in the Pilot tool room, which employ some thirty experienced toolmakers and die-sinkers. A tolerance of one ten-thousandth of an inch to these men is part of their day's work.

After the laminations are punched they are cleaned with sawdust to eliminate the oil and lubrication used during

the punching process. Then they go to a row of tumbling machines which round the corners of all the edges, remove the scale, etc. Bill told me that special attention is taken in purchasing sheet steel in strip form for punching laminations and that all purchase orders specify steel with a given metallurgical content. Even frequent chemical analysis of production runs and shipments are made such that the unit magnetic flux density, permeability and low hysteresis losses of the completed transformer will be uniform under given conditions.

#### PILOT TRANSFORMERS ARE ENCLOSED IN A GENUINE BAKELITE ONE-PIECE CASE

From the punch press department we went over to the bakelite molding department. Here a row of thirty-eight special hydraulic and electrically operated molding presses turn out thousands of bakelite pieces a day, not only transformer cases, but for the construction of some two hundred different radio parts. Rather than use the old-fashioned method of pouring the bakelite powder into each mold separately, practically all parts are molded from the bakelite powder made into the form of "pills," each pill containing just enough powder to mold one piece.

This method is, however, not employed for the transformer cases, for they are rather large and to secure a better distribution and insure perfect cases, accurately measured amounts of bakelite powder is carefully placed in each mould.

The hydraulic molding presses are of course heated by steam, and are capable of exerting thousands of tons of pressure on the moulds during the molding process. Each transformer case as it comes from the molds

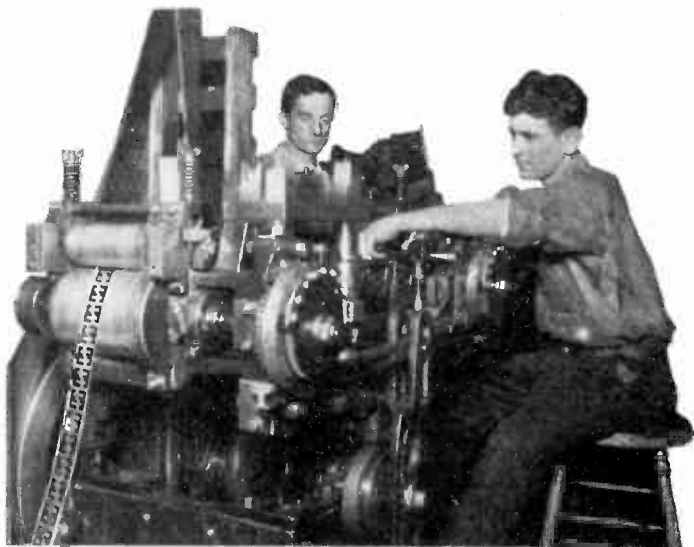

Fig. 1. Automatic punch presses stamp out audio frequency transformer core laminations at an amazing speed, and are operated day and night.

is carefully inspected for flaws and rough edges.

In the Pilot factory the bakelite molding presses, even as the automatic screw machines and punch presses, are on a day and night production schedule, and thousands of cases are turned out each day.

I knew Bill's liking for details, and the enormous amount of hard work spent in working out the production engineering problems allowing the use of such high-speed automatic tools, punches and presses as were being used. Every part of each operation fascinated me not only because of results accomplished, but because of the speed and precision with which thousands and thousands of parts are produced each day, all under accurate production control and test inspection, and the way he weathered the storm of my million-and-one questions is a real tribute to Bill.

I could see Bill's face beam and break into smiles as he told me one clever thing after another, and how one difficult problem had been solved, with every man ready to tackle a harder one, but I relatively knew that he was holding out on me, and that he was going to show me the most impressive and most important part of his work as a climax.

#### TRANSFORMER COIL WINDING

Up on the sixth floor we found one of the largest coil winding departments that I have ever seen.

Most radio manufacturers are content to purchase their audio frequency transformer coils as well as other types of coils used, from outside sources, but the Pilot policy is to manufacture every bit of its product within its own factory and within the scope of its own production and test control. Thousands of dollars have been spent in designing special coil winding equipment and adapting machinery and men to the specific requirements of Pilot production methods.

A long row of coil winding machines are kept busy nearly every day in the year, and each machine automatically winds fourteen delicate transformer coils at one time, so that one can easily realize that the total number of coils produced daily, runs into large numbers. To realize the number of thousands of miles of enameled copper wire used each day is astounding.



Fig. 2. Moulding bakelite audio frequency transformer cases.

Coil winding, using small sized wires, such as are required in audio frequency transformers, necessitates extremely close control of the winding machines, careful and accurate adjustments to each moving part and strict attention of each operator during the winding process.

The number of turns of each winding is of extreme importance and all of the automatic coil winding machines have been designed and developed to absolutely eliminate human errors during operation. A green light flashes on when the operator nears the required number of turns (indicated by revolution counters) and a red light flashes on instantly when the exact required number of turns has been wound on the insulating cores. Extreme care is taken in winding the coils to mechanically secure the leads both at the beginning and at the end of the windings.

After each unit of fourteen coils are completely wound the entire unit is cut up into individual coils, by a special machine using high-speed steel cutting disks.

#### VACUUM DRYING AND IMPREGNATION

Here begins another series of important

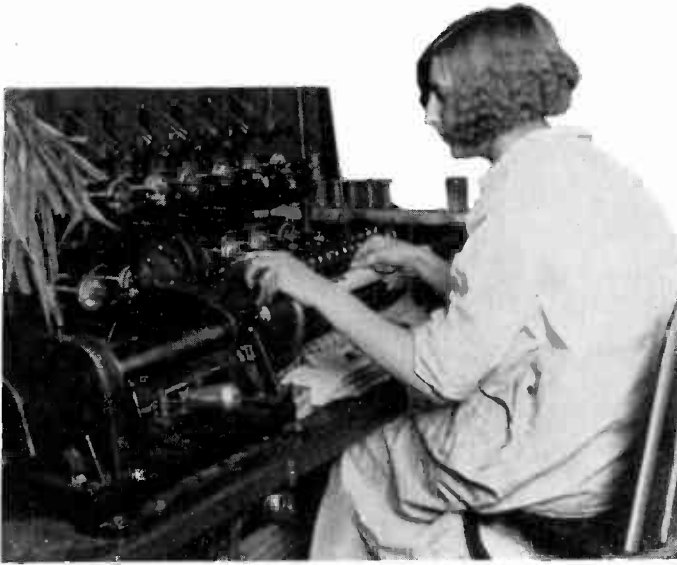

Fig. 3. Automatic coil winding machines turn out thousands of transformer coils each day.

operations, that is the electrical testing of the coils. As each coil comes from the cutting machine it goes to the test and inspection bench and is tested for continuity of winding. After the coil receives its first test and is found perfect, then it goes to vacuum drying ovens and is given a heat treatment that absolutely eliminates all possibility of moisture remaining either in the windings or in any of the paper or cardboard used for insulation.

The next operation is impregnation. All coils are immersed in special impregnating solutions that thoroughly insulate and hermetically seal the coil against moisture absorption.

#### EACH TRANSFORMER COIL MUST PASS TWENTY-FIVE EXACTING TESTS

Now comes a series of electrical tests, and as Bill and I reached the special test bench, he introduced me to Mr. John Geloso, chief engineer of the Pilot company.

Mr. Geloso took particular pleasure in pointing out to me the very ingenious testing equipment which he has designed for audio frequency transformers, and in pointing out to me not only the policy of careful inspection and tests given each product manufactured in the Pilot factory, but also he gave me the engineering design reasons for many details of the construction of audio transformers. In addition he proved his conclusions with practical reasons for his engineering specifications based on the circuit requirements of present-day radio receivers.

As the tray of coils that we had been following through the factory reached the test bench, Mr. Geloso, personally, put them through their paces, and explained each operation and what it meant. In these tests

each coil receives six individual tests which I am listing one by one, because it is on the success of these tests and on the repeat check of all of these tests that the efficiency and reliability of each transformer depends.

First, however, let me give you just a bit of an idea as to the type of equipment used in these tests. We see before us a direct current voltmeter, some seven or eight inches in diameter, with a large open scale reading. At the left of the voltmeter is a thousand cycle electrically maintained tuning fork oscillator.

Mr. Geloso explained that the current from the oscillator is coupled to the primary and secondary windings of the transformer coil under test and to a sensitive vacuum tube voltmeter, readings being taken on the large instrument before us. In addition the entire set-up incorporates a sensitive direct current megohm meter. It was explained that each coil is tested on a dummy core, such that the test conditions will be the same as those under actual use.

(1) Placing the dummy core and coil in position, Mr. Geloso quickly placed the leads from the coil into clip terminals and closed the switches of the test instrument. An immediate reading gave proof of the continuity of the circuit of both primary and secondary coil windings, which constitutes number one of the six tests.

(2) By pressing a button, the instrument circuit was arranged for the megohm test and proof of total absence of leakage between the individual turns of the primary coil individually and the secondary coil individually was obviously indicated by the fact that no decreased reading was indicated on the instrument due to leakage of the coils under test. Additional proof, however, that a leaky coil (such as might be caused by one turn of a coil winding laying on top of another turn with thin enameled insulation between or by any discrepancies in the process of manufacture up to this point, such as moisture still being present in the coil because of deficiencies in vacuum tank drying or impregnation) would be clearly indicated, was demonstrated by Mr. Geloso, for placing his fingers across the primary terminals to which the primary coil was attached, the voltmeter showed a decreased reading, indicating a leakage current. Shifting to the secondary coil terminals, the same condition obtained.

(3) This test is the same as test No. 2 above for primary coil and secondary coil windings individually except that this test

checks for leakage between the primary and secondary windings themselves.

(4) The reversal of leads such as might occur by the coil leads being twisted previous to their being soldered to the terminals on the transformer case is also immediately indicated by a decreased reading on the voltmeter, such coils of course being immediately rejected.

(5) Mr. Geloso was particularly pleased to put his test instrument through its most difficult paces for us and showed us that by winding a couple of turns of wire around the outside of the coil and leaving them open, that nothing happens to the voltmeter indications, but as quickly as they are shorted, an immediate indication was shown by the voltmeter, and he explained to me that in this way he was able to check extremely accurately the possibility of short circuited turns in each winding. It can be recognized that this is an extremely sensitive test for in the majority of instances if a transformer coil winding should be shorted between turns, usually a whole layer of winding is shorted rather than one or two turns, and the voltmeter drops back nearly to zero. Three turns indication in some eight or ten thousand gives one an idea of the sensitivity of this test.

(6) The last and final test is that of gain ratio or the step-up in voltage due to the primary and secondary transformer coil windings with a given signal input. As is usual in production tests, this is not a measured check, for each transformer is given a high figure of merit and this reading is taken as a standard. No coil or transformer which shows an indication of voltage gain lower than the standard is accepted.

Personally, I could appreciate the feelings of Mr. Geloso as he so courteously explained all of these things to us and I likewise appreciated his pride in the success of a good job well done, for part of my own worries during the war was the testing of some eight or nine hundred special radio compass receivers. I knew of the enormous speed with which these instruments had to be designed, manufactured, and tested, at that time, and also the extreme importance of rigid test specifications and of never letting one receiver get my O. K. on its test card unless it was right, for life and death depended on the reliability of each receiver. I could not help but be pleased with the thought that here was an engineer in peace time



*Fig. 4. Every Pilot audio frequency transformer must pass twenty-five exacting tests before it leaves the factory. It must be right.*

holding the test specifications of the parts manufactured under his supervision to as rigid or even a more rigid standard.

#### CORE ASSEMBLY

Meanwhile the bakelite cases and laminations which we had seen manufactured earlier in the morning had not been standing idle, but had been transferred by conveyor from the fifth floor to the sixth floor of the Pilot factory.

Going over to the lamination assembly department, Bill pointed out to me immediately an extremely clever stunt and a very practical and common sense one. In the old days I remember how audio frequency transformer cores were assembled, counting the laminations or guessing at it as closely as possible and letting the impossibility of putting any more laminations in the core justify the end of the operation. In the Pilot factory the number of laminations used in each core is uniform, never varying a single lamination each way. This is accomplished by weighing the laminations for each assembly. Obviously the quantity as well as the quality of the iron that goes into audio frequency transformers is important and here we see an instance of uniformity of the assembled transformer and careful workmanship. As quickly as the laminations are assembled into the transformer core, the assembly is routed back to the electrical test bench and again the six rigid electrical tests, that I have previously told you about, is given each as-

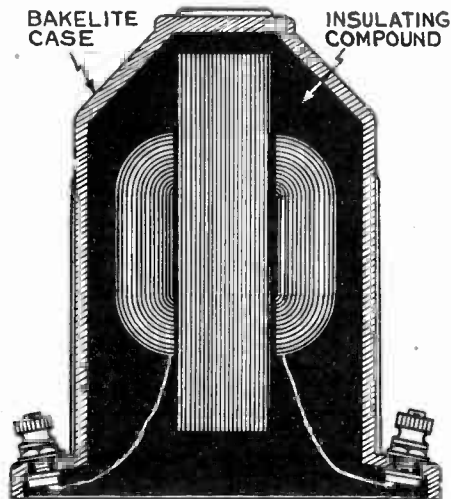

Fig. 5. Line drawing of Pilot moisture proof transformer showing that the entire core and coil assembly is hermetically sealed in the bakelite case.

sembled coil and core. This time, of course, the tests are made with the actual core in place rather than by use of the dummy core.

#### THE CORE AND COIL ARE ASSEMBLED IN THE BAKELITE CASES

After the second series of six individual tests is given the assembled coil and core, it is taken over to the bakelite case department, inserted in the case, the leads properly checked and soldered to their correct terminals.

Again the transformer goes back to the test bench and receives for a third time the same six tests to insure that the operator has not reversed the leads when making connections, and to make absolutely certain that the assembly is near perfect.

#### MOISTURE PROOF TRANSFORMERS

As Bill and I were discussing the thoroughness of the tests given each transformer during the assembly and as I was telling him how much better transformers were being made today than six or seven years ago, he gave me a rather significant look and said, "Remembering all of our old past experiences and troubles and even though you tell me that what you have seen so far proves to you the quality of our present-day transformers, now I am going to show you the real reason why we feel that the Pilot transformer, over and beyond its electrical characteristics, is a mighty good one."

Following a tray of assembled transformers that had passed their last series of electrical tests, we found ourselves in a second impregnation department. You remember that I have told you how each individual coil is given a long-time impregnation in special impregnating tanks. In this department we

found that the coil and core of the transformer is impregnated with a second special insulating compound by pouring each case full and hermetically sealing the entire assembly within the bakelite case. Tanks of insulating compound are kept at constant temperature by continual check with thermometers.

Bill explained that in reality the process consists of two pourings, the first pouring being at a lower temperature so as to under no circumstances injure the coil winding. Then when this first pouring has cooled slightly a second pouring is made which entirely seals up the transformer. This second solution is at a higher temperature than the first and cools with a glossy finish, giving the transformer a beautiful finished appearance.

#### AGAIN EVERY FINISHED TRANSFORMER GETS ITS FINAL ELECTRICAL TEST

After the transformer had been finally finished, and the impregnating compound has hardened into a solid block it goes back again, and receives its last series of six electrical tests, making twenty-five separate tests on each instrument.

Fig. 5 illustrates a cross sectional view of the finished Pilot moisture-proof transformer. The solid black of the drawing illustrates the fact that the insulating compound completely covers and seals in both the coil and core of the transformer.

#### WHY MOISTURE-PROOF TRANSFORMERS?

It seemed hardly possible to me, but after we had seen a tray of transformers receive the final electrical tests Bill told me that he had arranged a second little "climax" for the morning that we were going to have lunch with Mr. Geloso, so that he could tell us a bit more about "the reasons why."

Across a restaurant table Mr. Geloso summarized for us the necessity for the engineering specifications of present-day audio frequency transformers and told us of the various types of transformers that Pilot is manufacturing and why all of them are hermetically sealed against moisture absorption.

"You know," he said, "audio frequency transformers are designed today, using practically the same methods that were employed years ago; however, today transformers are required to operate under entirely different circuit conditions. In 1925 and 1926 even, very seldom were higher plate circuit voltages used than about 90. Today high power amplifier and in particular push-pull circuits require plate circuit voltages of the order of 200, 300 and even 450 volts.

These higher voltages necessitate that the transformer coil be put through vacuum drying processes and impregnated in high insulating compounds, and over and beyond that, that extreme attention be given such details as the thickness of the enamel insulation on the wire, the insulating characteristics of the special papers used between the turns, etc.

There is another condition over and beyond the higher voltages employed that also



necessitates most perfect insulation and hermetically sealing each transformer in an insulating compound so that the absorption of moisture and consequent transformer destruction is normally impossible.

And that condition is brought about by the fact that radio broadcast receivers are used in the homes of millions of people today not only all over the United States, but all over the World. Even in the United States the variation in temperature conditions and in humidity or in the quantity of moisture in the air presents a wide variation in different sections of the country.

Audio frequency transformers without the proper impregnation and not hermetically sealed very often break down, sometimes it is in Maine or California, and again a trouble letter will come in from North Dakota, or Florida.

From what you have told me of your own past experiences, I think that you can realize and appreciate the fact that when we seal our transformers in a solid block of insulating material as we do, that we have completely safeguarded not only our own responsibility as a manufacturer of the highest quality transformers that we know how to make, but that we have also given each purchaser of Pilot transformers a security against destruction, that we can do in no other way. He can be assured when he buys a Pilot transformer that he will not only have an instrument capable of high quality reproduction of speech and music when used in properly designed amplifier circuits, but that the transformer can be depended upon month in and month out throughout years.

To check up on the degree of insulation and the ability of Pilot transformers to not absorb moisture, I immersed a transformer in a beaker of water and left it there for some thirty days. After removing the transformer and wiping the outside of the case clean to reduce possible surface leakage between terminals, the transformer was connected up in a push-pull amplifier circuit and functioned as well as if it had not had such a severe test.

Such a test, with the transformer actually immersed in water, is equivalent to using the transformer under the most humid conditions for many months, if not years.

It is also a fact that the proper impregnation and insulation of transformer coils practically eliminates the possibility of break down of windings due to the use of the higher plate voltages required for present day circuits.

To provide transformers adaptable to nearly all requirements we are turning out in the factory seven different types. These include:

The No. 390 transformer which has a two to one ratio or a step-up of the voltage of 1 in the primary winding to 2 in the secondary winding.

The No. 391 is exactly the same of course, except that the voltage step-up ratio is  $3\frac{1}{2}$  to 1. The choice between the use of these two types is largely a matter of personal

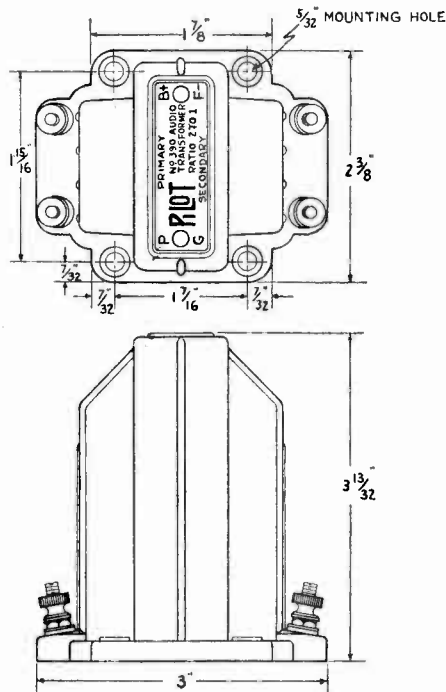

Fig. 6. Dimensions of Pilot moisture proof transformers.

preference. We generally use a No. 391,  $3\frac{1}{2}$  to 1 ratio transformer in the first stage of amplification, followed by a No. 390, or sometimes where we desire a maximum voltage step-up, two No. 391's are used.

Obviously, when voltage step-up is not of importance, and when high quality is the first consideration, we use two of the No. 390 lower step-up ratio transformers.

It is a fundamental fact of course, that in using any audio frequency transformers the power transformation characteristics of the input circuit of the system must match the output circuit of the system from which it is desired to transfer power. All Pilot transformers are designed with this consideration in mind and the impedance values of the primary and secondary of the coil windings are such as to be efficient when used with the vacuum tubes now available.

The No. 392 audio frequency output filter contains a choke coil or a single coil wound on the transformer core. The P and B (+) terminals are connected directly in series with this coil winding and the (+) and (-) terminals are connected in series with this same coil winding and with a 1 mfd. condenser. The output filter is connected in an amplifier circuit is exactly the same way as a transformer, but due to the condenser in series with the (+) and (-) terminals the direct current supply for the plate circuit of the amplifier circuit cannot go through the loud speaker. Only the alternating current voltages contained in the signal being received, effect the loud speaker.

(Please turn to page 119)

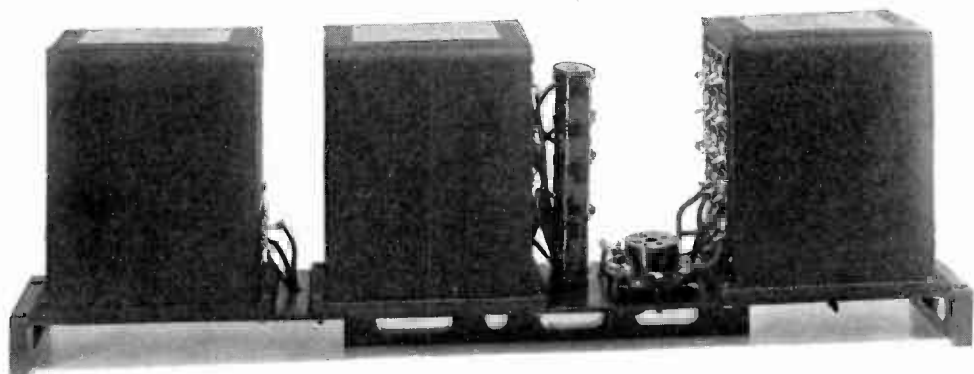

## USING MODERN ABC POWER SUPPLY UNITS

BY THE LABORATORY ENGINEERS

**T**O provide for the A, B and C radio receiver and amplifier circuit current and voltage requirements using present-day alternating current tubes, the Pilot Electric Mfg. Co., Inc., have designed and recently placed on the market, three units, the No. 398 Power Transformer, the No. 396 Filter Condenser Block and the No. 395 Double Choke Coil Unit.

Mechanically all three of these units are very compact, each of them being 5½" high, 5" long and 3" wide, allowing them to be used in various positions in a receiver or amplifier, the over-all dimensions of an entire ABC power unit being relatively small compared to the size of the power supply units previously available. All three of the units are mounted in substantial steel cases having a black Japanese lacquered finish, all connections being brought out to genuine moulded bakelite connection plates with brass inserts. Special large flat-head machine screws, screw into these inserts, circuit connections being soldered to the connection terminals under each screw head. To make it practically impossible to wire these units incorrectly in any circuit, the screw terminals are numbered, the numbers themselves being moulded in the bakelite terminal block. All blueprints and construction information for the use of the units show not only the schematic connections of the electrical system of the unit itself, but indicate clearly all terminal numbers.

### POWER TRANSFORMER

The No. 398 power transformer incorporates a primary winding, an efficiently designed iron laminated core and five secondary windings. The secondary voltages available are 1½ volts, 2¼ volts, 5 volts, a second 5 volts and a high voltage winding of 540 volts. All secondary windings are provided

with center taps enabling circuit connections to be made to the transformer, so that the necessary C bias voltages can be obtained by taking the voltage drop across fixed resistors connected between these center taps and the grid returns of tubes.

The transformer has sufficient current carrying capacity to supply the current requirements for five or six UX-226 tubes, one or two UY-227 tubes, one or two UX-171 tubes, two vernier dial lights and the filament current for a UX-280 full wave rectifying tube, in addition to the necessary high voltage for the B circuits of the receiver or amplifier, requiring not more than 60 milliamperes at 220 volts.

If it is desired to use a BH Raytheon rectifier tube instead of a UX-280 tube, the transformer secondary terminals, 10, 11 and 12, are not used. The UX-280 rectifying tube, however, gives an effective B voltage output of approximately 20 volts higher than does the Raytheon tube.

### FILTER CONDENSER BLOCK

The No. 396 filter condenser block comprises sections of 1, 1, 3, 3, 6, and also two .1 mfd. of capacitance or a total of over 14 microfarads.

These fixed condensers are manufactured in the Pilot factory under exceedingly rigid inspection and tests, and the design of the condensers as well as the quality of materials used is such that the finished condenser can be given a 10 year guarantee, providing the normal operating voltage specified is not exceeded.

### DOUBLE CHOKE COIL

The No. 395 double choke coil unit consists of two individual laminated iron cores on each of which is wound a single inductance coil. The two coils are connected in series and an additional connection is provided for the center tap. The total over-

all inductance is 60 henries (each coil having 30 henries of inductance), which is sufficient to provide an effective alternating current surge transient reduction (or choking) effect, in filter circuits carrying rectified a.c. voltages, where not more than 60 milliamperes direct current output is required.

The units may be arranged either lengthwise or sidewise. If they are used lengthwise, the complete A B C power unit may be mounted on a bakelite strip and together with the rectifier tube socket and fixed resistors for B and C voltages, will require a space in a receiver cabinet or on a sub-panel only 19½ inches long by 3 3/16 inches wide by 5½ inches high.

A photograph of an A B C power supply unit made up "lengthwise" in shape is shown by the illustration on page 122. Arranging the units "sidewise" the base panel dimensions will need to be only 13" long and 5" wide, and a unit made in this way is illustrated by Fig. 1. The small dimensions of these units when assembled as suggested will allow them to be placed at the rear or at the end of practically all radio set chassis when installed in table or console cabinets.

#### CIRCUIT CONNECTIONS

Fig. 2 shows a schematic wiring diagram of the three "Jumbo" A B C Power Supply units using a UX-280 full wave rectifying tube. The various voltage terminals are plainly numbered. The diagram of Fig. 3 is an

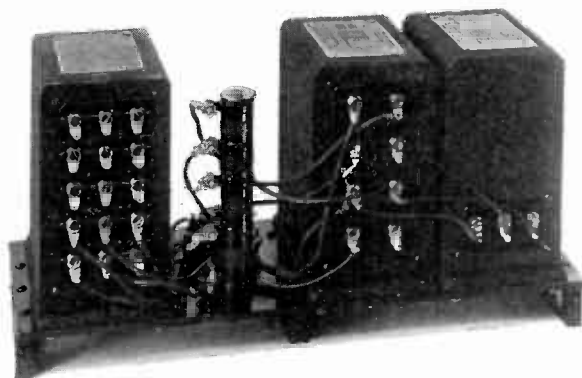

Fig. 1. Showing Pilot ABC units mounted "sidewise" on a bakelite base panel.

illustration of the same connections as in Fig. 3, with the exception that the circuit is arranged to use a BH Raytheon Rectifier tube.

#### C VOLTAGE CONNECTIONS FOR UX-226 TUBES

Figs. 2 and 3 show the connections that should be used with the No. 398 Power Transformer, No. 395 Double Choke Coil and No. 396 Filter Condenser Block, and both

drawings show resistances No. 1, and No. 2 connected to the center tap No. 2 of the 1½ volt secondary terminals No. 1 and No. 3, and to the center tap No. 8 of the 5 volt secondary winding, having terminals No. 7 and No. 9 of the No. 398 Power Transformer Unit.

NUMBER OF UX 226 USED	VALUE OF #1 RESISTANCE	PILOT CAT. NUMBER
1 TUBE	1500 OHMS	# 963
2 TUBES	850 "	# 955
3 TUBES	650 "	# 954

These resistors are connected to the center taps of the secondary windings in order to provide for C circuit voltages. Fixed resistor No. 1 is to take care of the C circuit voltages required by all UX-226 tubes, the filament circuits of which are supplied by the 1½ volt secondary winding of the transformer. In order to obtain the correct C

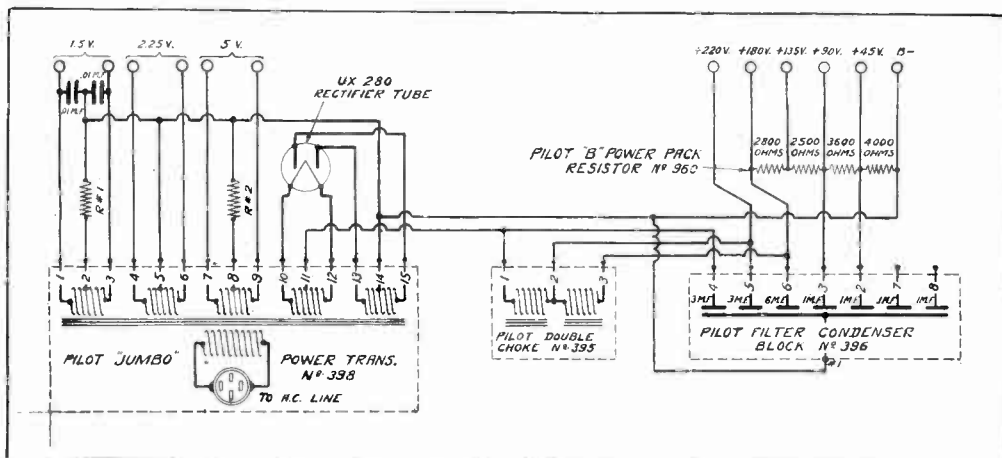

Fig. 2. Circuit of the new Pilot ABC power supply units using a UX-280 full wave rectifier tube.

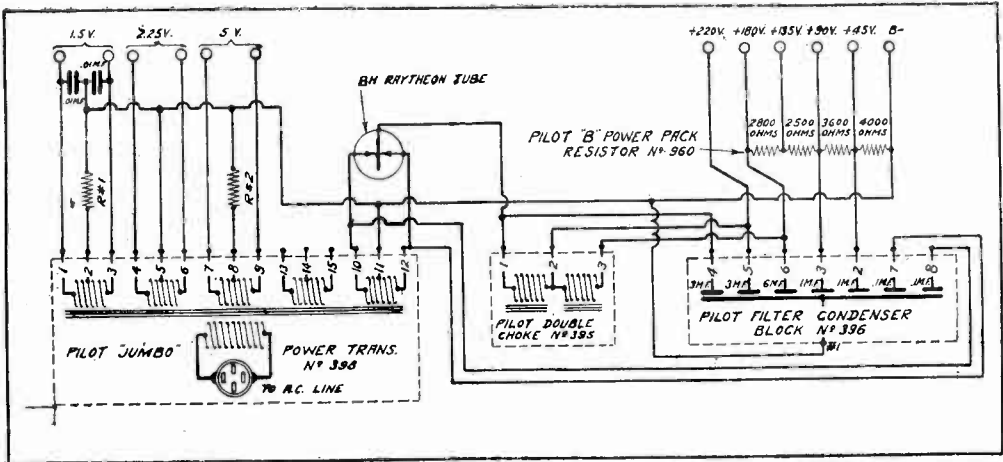

Fig. 3. Using Pilot ABC units with a Raytheon rectifier tube.

voltages, the grid return lead of every UX-226 tube used must be connected to the B minus (B-) of the receiver circuit. When using approximately 90 volts on the plates of the tubes, the value of the fixed resistor should be as in the table above.

These values for the fixed resistors are recommended because in using them with the average UX-226 tubes, the A. C. "hum" pick-up is at a minimum. When more than three UX-226 tubes, however, are employed, it is recommended that you use a Pilot four hundred ohm rheostat, in place of the fixed resistor so that the C bias voltage may be adjustable.

When using 135 volts on the plates of the tubes, the value of the No. 1 fixed resistor for minimum "hum" should be as follows:

NUMBER OF UX-226 USED	VALUE OF #1 RESISTANCE	PILOT CAT. NUMBER
1 TUBE	3000 OHMS	# 964
2 TUBES	2000 "	# 958
3 TUBES	1000 "	# 962

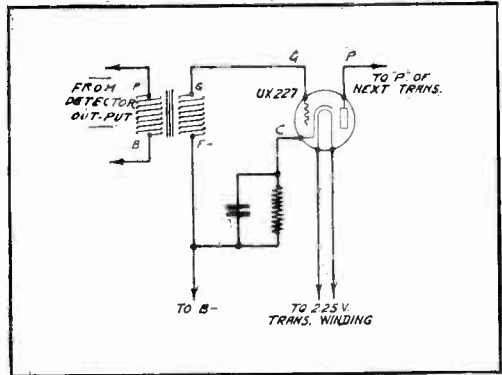

Fig. 4. Position of C bias resistor in circuit using UX-227 tube.

#### C VOLTAGES FOR UY-221 TUBES

The UY-227 tube when used as a detector does not of course require any C bias voltage; therefore, no fixed resistor is needed.

In using the UY-227 tube, however, as a radio or audio frequency amplifier, a C bias

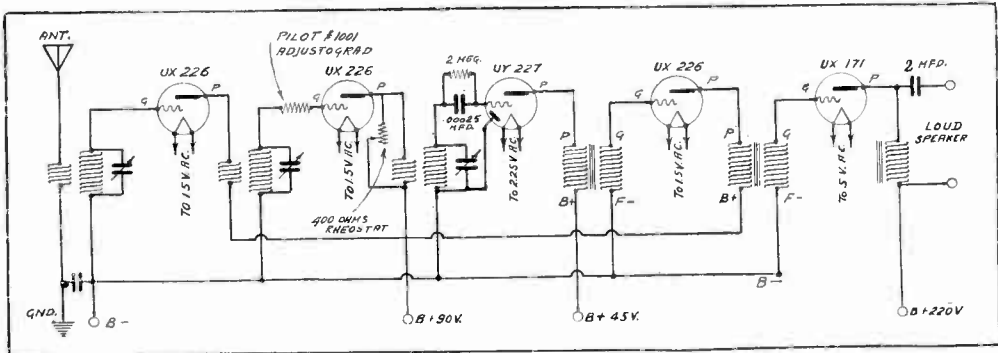

Fig. 5. Schematic circuit illustrating grid bias connections for UX-226, UY-227 and UX-171 tubes using the new Pilot ABC power supply units.

is required and the most practical method of obtaining it is to insert a fixed resistor of the proper value between the cathode C of the tube and the B minus (—) of the receiver or amplifier circuit. Fig. 4 illustrates the method of connection, and also shows that the grid bias fixed resistor should be shunted by a by-pass condenser having a capacity of not less than .5 microfarad, one microfarad being, however, an advantage.

When using 90 volts on the plate of the tube, the C bias fixed resistor should have a resistance of two thousand ohms, the Pilot No. 958 resistor being suitable. When higher plate voltages of the order of 135 or 180 volts are used with the UY-227 tube, the tube will be found to operate at its maximum without requiring a change in the value of the fixed resistor, but this condition applies only to the UY-227 tube.

#### PROPER RESISTANCE VALUE FOR GRID VOLTAGE RESISTORS FOR UX-171 TUBES

In Figs. 2 and 3, fixed resistor No. 2 is used to furnish the C bias grid voltage when using UX-171 tubes, in parallel or push-pull audio frequency amplifier circuits.

The grid return of the tube or tubes should be connected to the B minus (—) of the receiver or amplifier circuit, as is shown in Fig. 5, which is a schematic circuit diagram of a typical five-tube tuned radio frequency receiver.

When using 180 volts on the plates of the UX-171 tube or tubes (corresponding to an output voltage from the power supply unit of 220 volts), the correct value of fixed resistor No. 2, to obtain the proper grid bias voltage should be:

NUMBER OF UX171 USED	VALUE OF #2 RESISTANCE	PILOT CAT. NUMBER
1 TUBE	2250 OHMS	# 951
2 TUBES	1200 "	# 956

Using the above fixed resistor values, the C bias voltages placed on the grid of the tube or tubes will be approximately 40 to 45 volts, permitting the tube to work in the straight line portion of its characteristic curve, or at its maximum efficiency.

## AUDIO FREQUENCY TRANSFORMERS

(Continued from page 115)

Such an output filter is necessary when using 112, 171, 210 or 250 type vacuum tubes for the high voltage plate circuit carries a current too heavy for the loud speaker windings to stand without possible magnetic saturation.

The output transformer No. 394 serves the same purpose as does the output filter just described. The action is different, however, for in addition to keeping the high voltage plate current out of the speaker windings the ratio of transformation is chosen so as to aid in the securing of high quality reproduction.

At this time in particular, push-pull amplifier circuits are extremely popular and to provide equipment for this type of circuit we are making the No. 399 push-pull input transformer and the No. 401 push-pull output impedance.

I hope, at some other luncheon to tell you about some of the work we have done with push-pull amplifier circuits for not only have we been able to achieve extremely high quality reproduction but we have used in this work circuit arrangements that achieves the result by use of tubes no larger than

the 171 type rather than using the more expensive 210 or 250 type tube.

There is just one other instrument that we are manufacturing in a bakelite molded case and impregnating by the same process that you have seen this morning, and that is the No. 393 "B" power supply choke coil. This choke coil is perfectly satisfactory for power supply devices from which one does not desire a greater amount of current than 45 milli-amperes, which is sufficient for the usual five or six tube receiver.

At this current drain the No. 393 choke has an inductance of some 30 henries increasing to about 80 henries when only 20 milliamperes is required.

Mr. Geloso told me as we were leaving after lunch, that he truthfully felt that in portraying, as I have attempted to do so here, the inner workings of the Pilot radio parts factory that it would be interesting to all radio experimenters from the point of view of the design, engineering and manufacture of Pilot apparatus, and in addition in aiding the experimenter to understand the Pilot policy of supplying the highest quality parts at the lowest possible cost.

**PLEASE DO NOT FORGET THAT RADIO DESIGN ENGINEERS  
WILL ANSWER YOUR TECHNICAL RADIO QUESTIONS.  
LET THEM HELP YOU ENJOY RADIO**

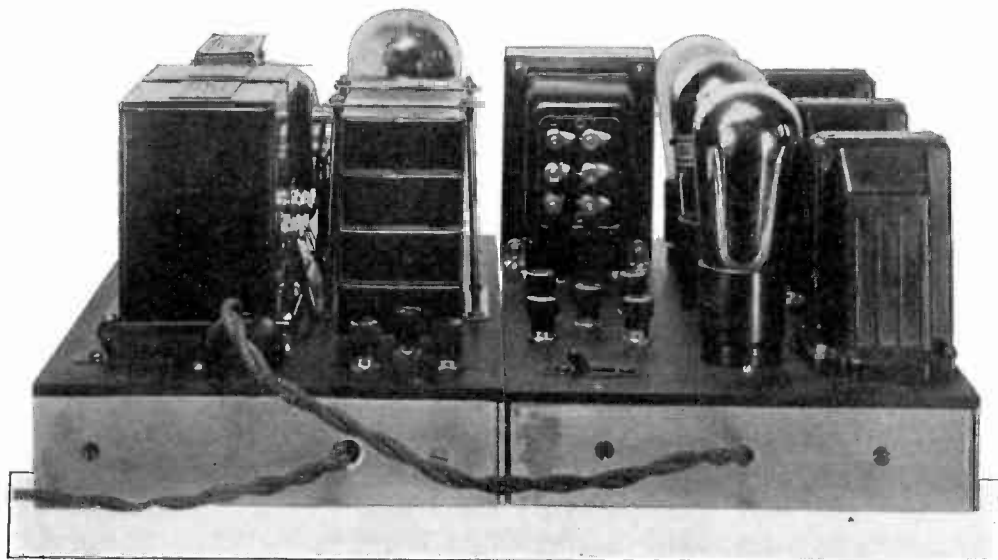

## Build This "One-Seventy-One" All Electric AMPLIFIER AND POWER SUPPLY Incorporating Push-Pull Amplification

By THE LABORATORY ENGINEERS

**N**EARLY every custom set builder knows by past profitable experience that a very desirable source of income is the "bringing-up-to-date" of radio receivers purchased by their customers in 1926 or 1925 or in the years previous.

Such receivers, of course, will not be operable from alternating current tubes nor will they include in their audio amplifier circuits the modern high quality transformers, that give, together with its correctly designed circuit a reasonably flat audio characteristic from about 100 to 4000 or 5000 cycles.

Many receivers of this vintage also are relatively inefficient as regards the radio frequency amplifier portion of the circuit and many regenerate over part of their frequency range. When a man or more particularly a woman who is using a receiver of this early date goes into the home of their friends and sees a modern day five or six tube receiver incorporating present day advantages and operating directly from the lighting circuit, they certainly become immediate prospects for either a completely new receiver or for the re-vamping of their old model.

Because the custom set builder is in a position to do this work or in the last analysis to provide such a desired result (by utilizing the old receiver and such new parts as need be purchased) he is in a position to obtain a great many profitable orders, pleasing to both himself and his customers.

We will assume that such a customer with a 1925 receiver has come into the shop and said, "Here is my "this-or-that" kind of a receiver. After hearing Dudley Brown's set last night, the wife rushed me down here to have this job fixed over, at least equal to Brown's receiver. You have my O K to go right to it, and if you don't do a good job, I'm afraid I'll be forced to spend \$350 of my hard earned money for a "this-or-those" receiver.

Now what is the custom set builder to do in such a case as this to keep everybody satisfied, and to make a good profit. It seems to me that there are two good practical common sense solutions.

First, the obsolete type audio transformers and sockets can be eliminated from the old receiver and new sockets for a. c. tubes and push-pull in-put and out-put transformers installed. Then by entirely rewiring the filament sockets of the complete receiver and connecting up the push-pull circuits, taking care to arrange proper grid bias voltages for all the tubes, the set can go back to the customer in a condition to compete with the to-day's receiver.

The second possibility is possibly a bit more expensive but is likewise more universal and usually can be proven to be a better investment for the customer, for it solves his immediate problem in a way that will allow him at a future time to discard the 1925 or 1926 obsolete receiver (which in the second method will be used only for its radio frequency circuit) and pur-



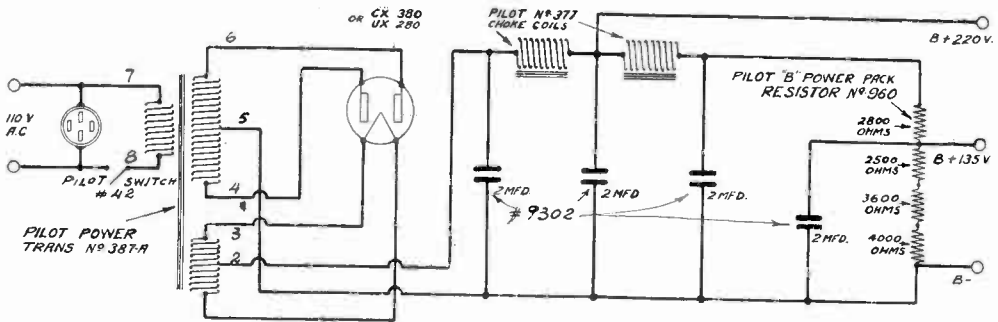

Fig. 2. Schematic circuit diagram of the power supply.

#### OFFICIAL LIST OF PARTS

The complete list of Pilot parts required for the construction of the amplifier and power supply unit are as follows:

##### POWER AMPLIFIER

- 1 No. 386 Filament Transformer
- 1 No. 390 Audio Transformer (2 to 1 ratio)
- 1 No. 399 Input Push-Pull Transformer (3½ to 1 ratio)
- 1 No. 401 Output Push-Pull Impedance
- 3 No. 216 Sockets
- 1 No. 42 Toggle Switch
- 5 Binding Posts (1 each Nos. 17-A, 15-A, 24, 19 and 32)
- 1 Bakelite Panel 12" x 7" x 3/16"
- 1 No. 956 1200 Ohm Fixed Resistor
- 2 No. 959 900 Ohm Fixed Resistor
- 1 No. 801 1 mfd. By-Pass Condenser
- 1 Piece Aluminum Strip 40" x 1½" x 3/32"
- 2 Wooden Blocks 6⅝" x 1½" x ½"
- 3 Ft. Twin Conductor
- 1 Attachment Plug
- 1 Package Assorted Screws, Terminals, etc.
- 6 Ft. Spagetti Insulating Tubing

##### POWER SUPPLY UNIT

- 1 No. 387 Power Transformer
- 2 No. 377 "B" Eliminator Choke Coils
- 4 No. 9302 2 mfd. Filter Condensers
- 1 No. 42 Toggle Switch
- 3 Binding Posts (One each Nos. 24, 15-A, and 17-A)
- 1 No. 277 Universal Receptacle
- 1 No. 216 Socket
- 1 Piece Aluminum Strip 40" x 1½" x 3/32"
- 2 Wooden Blocks 6⅝" x 1½" x ½"
- 3 Ft. Twin Conductor
- 1 Package Assorted Screws, Terminals, etc.
- 3 Ft. Spagetti In-

ulating Tubing

- 1 Attachment Plug
- 1 Bakelite Panel 12" x 7" x 3/16"
- 2 Pair Filter Condenser Supports Complete
- 1 No. 960 12,700 Ohm Fixed Resistor

#### CONSTRUCTIONAL NOTES

The base-board construction of these two units is a bit different from the usual "bread-board" type. The two bakelite panels are mounted on wooden strips on each end, and strips of aluminum 2" high and 3/32" thick are bent to shape to form a metal base for the entire panel. These aluminum strips can be obtained from practically every hardware store, cut to the desired width and bent exactly to shape, if you do not feel you can do it neatly yourself.

The mounting of all parts and their positions is very clear from the schematic diagrams and from the photographs. Care should be taken in wiring, to group the alternating current supply leads closely together to eliminate the possibility of picking up a. c. "hum" and all leads of course should be made as short as possible. The amplifier is provided with a short connecting cord of twisted pair having an attachment plug which should be inserted in

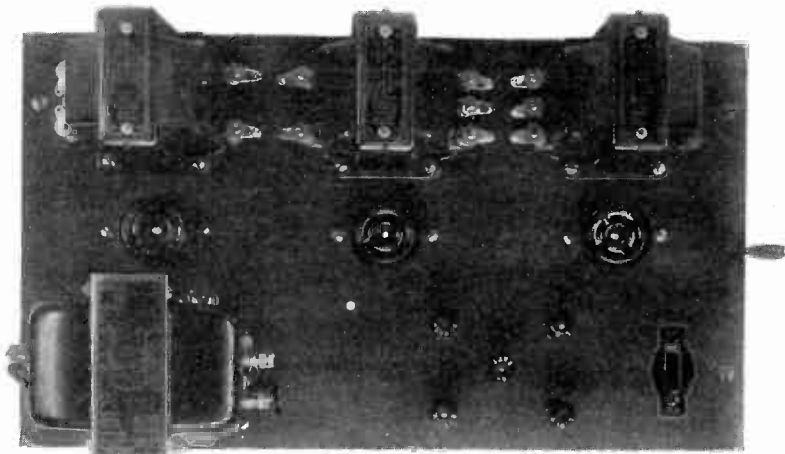

Fig. 3. Top view photograph of the amplifier.



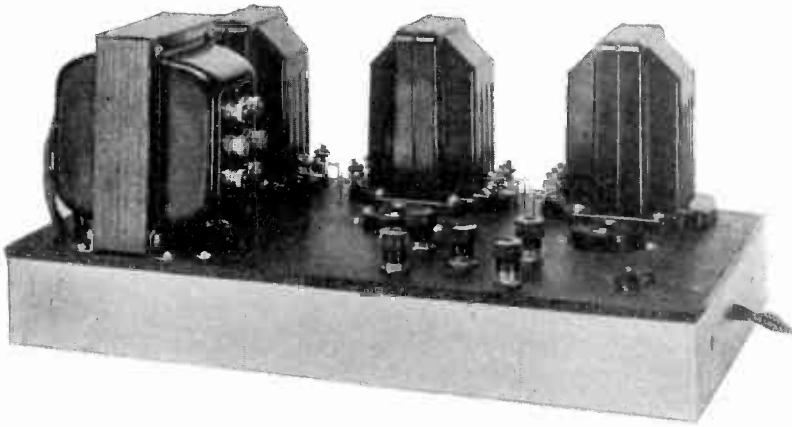

Fig. 4. Side view of the power amplifier unit.

the receptacle provided in the amplifier, thus supplying a. c. to the amplifier filament transformer. The high voltage plate supply to the amplifier is provided by making proper connections between the binding posts on the top of the panels of both the amplifier and power supply.

#### OPERATION

It will be noted that a UY-227 tube is used in the amplifier as the first audio frequency tube. This has been felt desirable in view of the fact that the type UX-226 tube is not a complete a. c. tube and as a consequence it generates within its associated circuits and alternating current, having the same frequency as the current supply. Although this parasitic hum is usually very small, still it is, of course, amplified through the successive stages, and usually reaches the loud speaker as an objectionable 60 cycle or 120 cycle disturbance. The amount of this hum is not altogether dependent on the amplifier circuit itself, for it will be usually found that different types and makes of loud speakers will show up the disturbance to varying degrees. In particular, using a UX-226

tube in connection with a moving coil loud speaker employing a large baffle board the hum may become extremely objectionable.

The UY-227 tube, however, does not have the objectionable hum of the UX-226 tube, because its electron emitting surface or cathode is not directly connected in the a. c. filament supply circuit, but is indirectly heated by the heated filament in that circuit. Accordingly the 60 cycle modulation of the alternating current supply cannot directly effect the cathode of the UY-227 tube, and any possibility of hum from this source is practically eliminated in the amplifier circuit described.

#### SUGGESTED ACCESSORIES

Never more so than today is it a fact that attention should be given to every item in a circuit if high quality radio or phonograph speech and music reproduction is to be achieved. Many thousands of radio writers, experimenters, and engineers have pointed out that no one portion or no one part of a radio receiver installation is more perfect than the most efficient part of that circuit.

To attempt to use such an amplifier and

Fig. 5. Side view photograph of the power supply unit illustrating the UX-280 full wave rectifier tube in its socket, the bank of filter condensers and the binding posts.

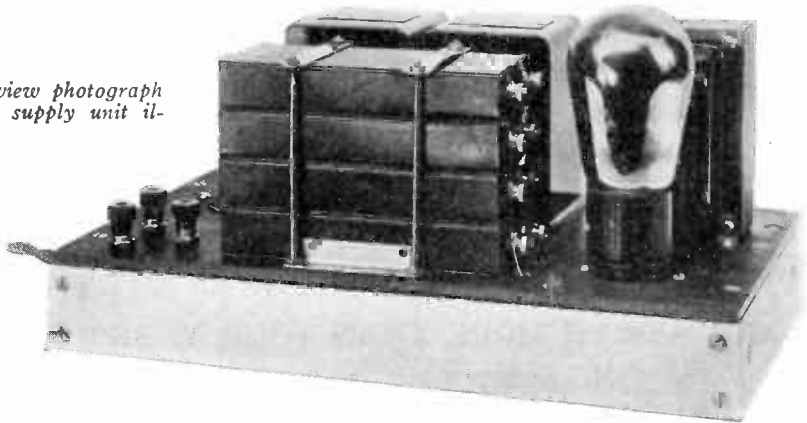

power pack as described with a radio receiver, which in the radio frequency portion alone has resonance characteristics such that several hundred cycles is cut off of the sides of each side band, or to use it with a phonograph and phonograph pick-up, the pick-up of which has peaked

the linen diaphragm construction together with a well designed unit is as good as can be obtained.

When using a moving coil speaker, of course, the lower frequencies will be reproduced with a greater degree of perfection if the speaker

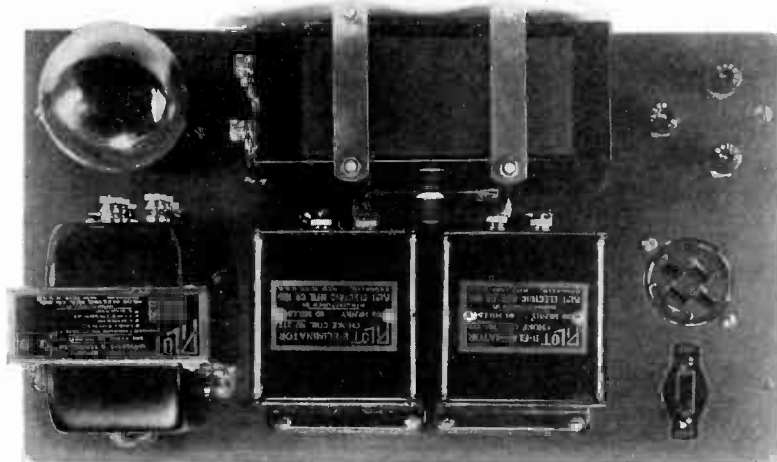

*Fig. 6. Top view photograph of the power supply unit.*

resonance characteristics, is immediately defeating the obtaining of high quality reproduction.

Again we must not forget the last link in the chain, the loud speaker. Assuming a near perfect radio receiver or phonograph pick-up is used, this amplifier with its excellent overall audio frequency characteristics cannot possibly reproduce the quality desired or expected, unless used with a high quality loud speaker either of the moving iron or moving coil type. Of the moving iron type of speakers, possibly

is used with a baffle or sounding board some three or four feet square.

The amplifier has a total over all output using UX-171 tubes and the push-pull circuit arrangement of some  $1\frac{1}{2}$  watts and this amount of energy will be found quite sufficient to drive a moving coil loud speaker, providing an extremely desirable over all fidelity comparable to the actual original phonograph recording or to the radio presentation given in the radio broadcasting station.

## PLANKS IN THE PLATFORM OF RADIO DESIGN

1. To supply prompt and accurate aid to every radio experimenter by answering his technical questions at no cost.
2. To design and publish in the magazine the very best of modern receivers, amplifiers, etc., and to look at radio construction and experimental work from the point of view of the radio builder who insists on results and economy.

**THESE ARE ONLY TWO OF THEM—BUT THESE TWO ARE WORTH MORE THAN YOUR YEAR'S SUBSCRIPTION—MAIL THE COUPON ON PAGE 138.**

# THE AIRPLANE RADIO BEACON

*Radio Waves Direct Plane to Field*

By ZEH BOUCK

**N**AVIGATION has always had a fascination for me—the fascination of the mysterious. Looking over the side of an ocean liner, glancing at the log swimming briskly along with us, I have been positively awed by the thought that here we were—with “water, water everywhere”—and speeding to our port with almost the inevitability of a solar eclipse.

Aerial navigation, as far as general cross country flying is concerned, is more obvious and less scientific than finding one's way at sea. But eliminate the constant checking of one's course by landmarks—let your pilot fly in fog or above a low ceiling, and the difficulties that make ocean travel interesting, are multiplied many fold.

As a matter of fact piloting a plane across country, even with good visibility is a tiresome undertaking, requiring constant vigilance of the man at the controls. Winds move much more rapidly than sluggish ocean currents, and the plane travels so fast that it requires but small errors in compass or judgment to throw the pilot far off his course.

## HOW THE PILOT FLIES

The pilot today flies by map. His course is generally laid out for him by government survey and he keeps his compass on the number of degrees indicated by the map — making consistent compensation for deviation. He must also check his drift, and fly the correct degree into the wind. On short trips, he makes his drift correction constantly — on longer trips he may use a drift indicator, which somewhat simplifies his calculations which are rapidly assuming vectorial proportions. In all cases he must check his position against land marks. With low hanging clouds, he must fly low—low enough to see the ground. If he flies above the clouds he is immediately lost and he prefers the hazard of ducking under them to grope his way through mountain passes.

## THE RADIO BEACON

Many of the haphazards of flying have been eliminated by the perfection of the radio beacon by the Bureau of Standards. The beacon indicator Fig. 1 in its perfected form is nothing more than an instrument, a little larger than a pack of cigarettes, that plugs into a mounting in the instrument board in front of

the pilot. Behind the glass face are two little squares of white that, when the plane is following its course, vibrate up and down tracing two vertical lines of equal length. If the plane moves off its course to the left, the left line shortens and the right hand line becomes longer—the reverse holding true for a right hand deviation. The reed indicator holds the true course, regardless of wind, drift, or magnetic deviation—whether the pilot is within sight of ground or at a safe altitude above the clouds, and when the plane is directly over the transmitting aerials, both reeds stop moving. If the transmitter is located at the flying field, the plane will be led to within one hundred feet of a safe landing.

## PILOT TESTS WITH BUREAU OF STANDARDS

It was the pleasure of the Pilot Electric Mfg. Co. to send their flying laboratory to Washington, D. C., in co-operation with the Bureau of Standards, to test a recently installed radio beacon system. The work on the development of the directive transmitter has been under the direction of Drs. Dellinger and Pratt. Receiver design has occupied the attention of Harry Diamond, while the visual recorder, the vibrating reed, is principally the work of F. W. Dunmore—all engineers and physicists connected with the Bureau of Standards.

In the photograph, Fig. 2, the personnel of the Washington tests, are standing alongside of the Pilot flying radio laboratory. From left to right they are F. W. Dunmore, holding the reed mechanism and its shock proof mounting, Harry Diamond, with the receiver, Louis Meier, pilot, the writer, and Mr. Himman, engineer with the Bureau.

The entire radio installations, including receiver, indicator, batteries and antenna weighs only about twenty-five pounds — a good example in portability.

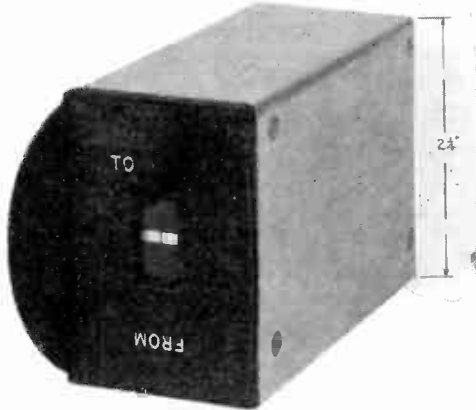

Fig. 1. The radio beacon indicator itself, is about the size of a pack of cigarettes.

## THE EQUIPMENT

The radio beacon equipment divides itself logically into three divisions, the transmitter, the receiver and the visual indicator. However, to grasp the idea of the way it operates, it is necessary to consider briefly the arrangement as a whole.

The theoretical aspects of the radio beacon are not difficult to understand. The transmitter is so designed that it transmits two audible frequencies on the same wavelength. The fre-



Fig. 2. The men who carried on the airplane radio beacon test, described by the author. From left to right, they are Mr. F. W. Dunmore, Mr. Harry Diamond, Mr. Louis Meier, Mr. Bouck and Mr. Hinman.

quencies employed at present are 65 and 85 cycles. The radiating system is, essentially, two loops mounted at right angles to each other (or approximately so). It is characteristic of a loop radiating system that the loudest signal, at any given distance from the loop, will be received in the plane of the loop. In other words, for the best results, the loop should be pointing at the receiver, just as, when receiving, the loop should be pointed at the transmitter. The locus of a point of constant field strength moving about the loop will trace a figure 8. If two loops are mounted on a common vertical axis, and at right angles to each other, we shall have the two figure 8's shown in Fig. 3. One loop transmits the 65 cycle and the other loop the 85 cycle wave. The two frequencies will be received most emphatically in areas where the two figure 8's overlap, the shaded portions indicating the zones of equal signal strength on the "course." In other words, a plane flying in this darkened area would receive equally strong 65 or 85 cycle impulses. Such a plane is suggested by the point P<sup>1</sup>. A plane at P<sup>11</sup> will receive more intense 85 cycle signals than 65 cycle signals, while a plane at P<sup>111</sup> will receive more intense 65 cycle signals than 85 cycle.

The reeds in the indicator are carefully tuned to these two frequencies, one reed to 65 cycles and the other to 85 cycles, and so connected

in the receiving system that they will respond to the incoming signals. If the 65 cycle signal is stronger than the 85 cycle signal, as at P<sup>111</sup>, the 65 cycle reed will vibrate more than the 85 cycle reed, tracing the longer line, and vice versa.

It is obvious that by revolving the transmitting loops, the radio beacon can be set for any desired course, just as, by revolving a receiving loop, it is possible to receive signals better from different directions.

#### THE TRANSMITTER

The transmitter consists of an oscillator, and two power amplifiers, each amplifier working into its own antenna system. By employing one oscillator, both waves are maintained constantly on the same wave length or radio frequency at 290 kilocycles. One of the power amplifiers is modulated by the 65 cycle current and the other by the 85 cycle current, in much the same manner that the carrier current of a broadcasting station is modulated by the voice. The power amplifiers, are coupled to the antennas by means of a goniometer, an instrument not dissimilar to the familiar variometer. The goniometer makes it possible to rotate the fields without actually moving the antennas, which are permanently erected, and shown in Fig. 4. The goniometer sets up "phantom loops" that turn as the goniometer is turned.

## THE REED INDICATOR

The indicator consists of two short reeds, tuned exactly to the correct frequencies, and mounted in a suitable electromagnet actuating arrangement. The reeds are so perfectly tuned to their respective frequencies, that a variation of plus or minus .05 cycle per second is sufficient to affect operation. They illustrate a beautiful example of mechanical resonance. During the tests in which the writer participated, it was impossible to pick up either frequency on the ear 'phones, due to the spark interference from the motor. However, the reeds had no trouble in discriminating between engine noise and their own particular transmitted frequencies. The reeds are therefore unaffected by static or any other form of interference that does not exactly duplicate the frequencies to which they are tuned. The operation of the beacon due to signal interference is limited only by the blocking of the receiver.

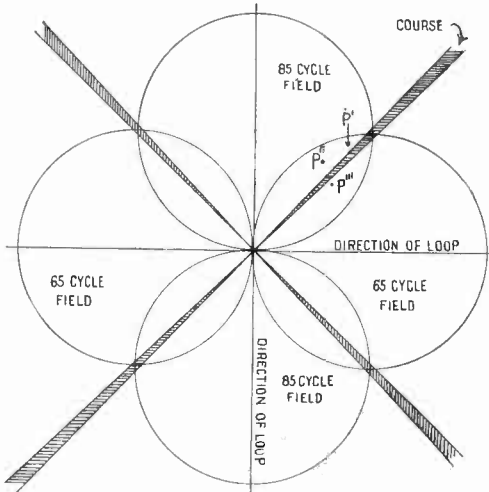

Fig. 3. Figure eight field characteristics of a radiating loop antenna system.

## THE RADIO RECEIVER

The receiver is a standard aircraft receiver, developed by the Bureau of Standards, designed for airplane frequency channels between 285 and 350 kilocycles. It is of uni-control design, with a trimming condenser to compensate antenna variations. A simple movement of the control handle tunes the receiver to any desired frequency within the aircraft band. While manual volume control was used in the tests made by the writer, future receivers will incorporate an automatic volume control, relieving the pilot of all concern and responsibility in this direction. The receiver can be used for telephone reception, as well as beacon indication, by plugging in head 'phones in place of the reed indicator. A short twenty foot trailing wire antenna, or a ten foot vertical rod antenna is used with the receiver-beacon combination. A short and comparatively straight antenna should be employed to eliminate directional effects on the receiving end. With the antenna system described, it is possible to locate the transmitting station within one hundred feet, from a altitude of one thousand feet. As an antenna of this description is not responsive to a horizontal field, and as no vertical field exists directly over the transmitting aerials, no signal is picked up and both reeds stop vibrating at this point!

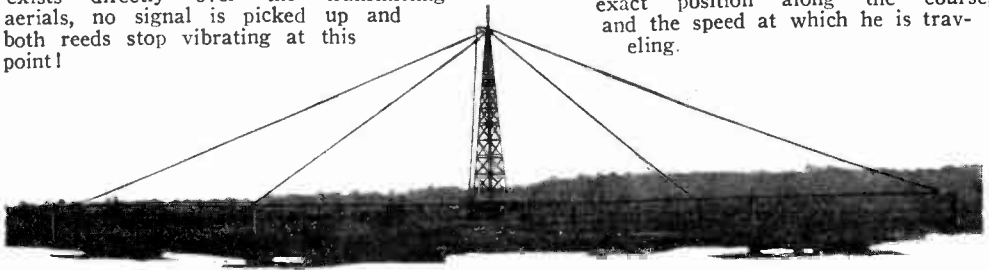

Fig. 4. The radio beacon transmitting antenna at the flying field, at College Park, Maryland. By the use of the goniometer the radiated signal can be rotated so that the visual radio indicating instrument installed on an aeroplane travelling away from, or toward the radio beacon station, will indicate when the plane is on its correct course, in any desired direction.

## THE WASHINGTON TESTS

The apparatus was installed in less than a half hour, using the trailing wire antenna with which the Pilot flying radio laboratory is equipped. Mr. Meier, our pilot, required less than a minute's instruction on the technique of beacon flying. The goniometer was set for Baltimore, and we took-off. Two minutes later we passed directly over the beacon transmitter, and in fifteen minutes we were over the city of Baltimore. We turned around, and with a bit of a head wind, passed over the beacon and flying field twenty-five minutes later—all without a single reference to compass or map.

The radio beacon indicates a deviation of two degrees off course. At a distance of sixty miles this amounts to a maximum of one mile on either side of the direct course. At a distance of two hundred miles from the beacon—about the practical limit using present day equipment—the indicator will show a drift of about three and a half miles. By noting the relative amplitudes of the two reeds, it is possible to ascertain, approximately, how much the plane is off the course.

It is planned to equip radio directive courses with marker beacons—low powered transmitters along the route having a maximum range of about two miles. Transmitting their own particular frequency, they will actuate a third reed, for a minute or so, with a null point directly over the marker, showing the pilot his exact position along the course, and the speed at which he is traveling.

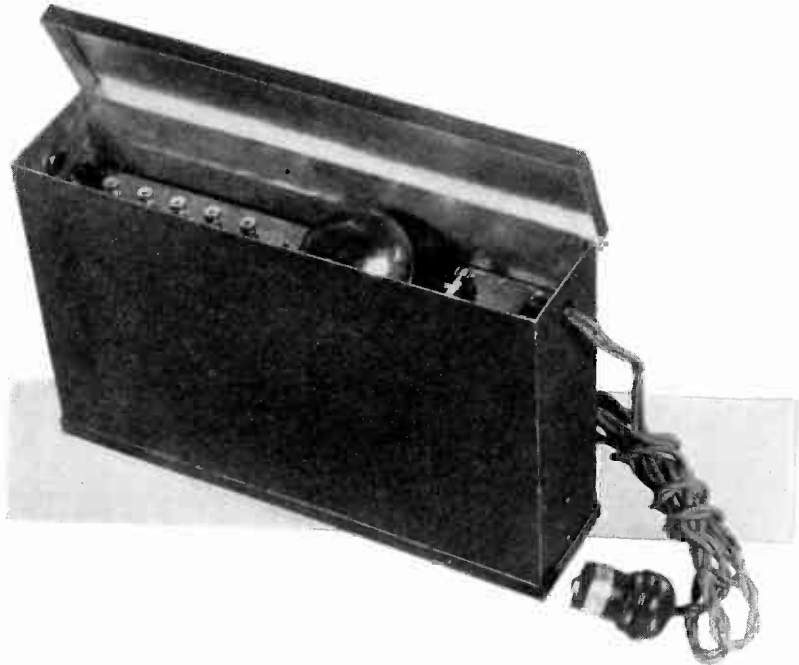

# THE PILOTONE "B" POWER SUPPLY

By THE LABORATORY ENGINEERS

This Pilotone "B" power supply was particularly designed to provide the required "B" power voltages of positive (+) 45, 90, 135 and 200 volts as required by the Pilotone Electric receiver.

The schematic circuit diagram of Fig. 1 shows the connections. The power supply is made up of a Pilot No. 405 power transformer, supplying the high voltage alternating current and also the alternating current to light the filament of the UX-280 rectifier tube. A one and one-half ampere (1.5) fuse has been provided in the primary supply circuit which is to be connected to the alternating current lighting circuit by the four foot attachment cord and plug provided.

The rectified current from the UX-280

tube is effectedly filtered by the use of two Pilot No. 3924 filter choke coils and the Pilot No. 934 filter condenser block incorporating a total of fourteen microfarads capacity.

Fig. 2 illustrates the interior view of the power supply and gives a general idea of the arrangement of the parts.

The entire unit is housed in a laquered metal case measuring approximately 11 $\frac{1}{8}$ " long, 7 $\frac{1}{2}$ " high and 2 $\frac{1}{2}$ " wide. The total weight is 7 $\frac{1}{2}$  lbs. The entire assembly of parts as shown in Fig. 2 is mounted on a metal chassis which slips into the case. The binding posts for connections are supported on a bakelite strip at the top, all terminals being marked.

Although this particular "B" power supply

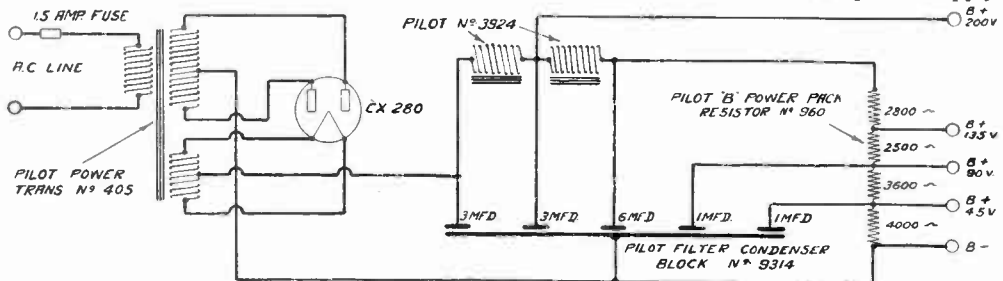

Fig. 1. Schematic circuit of the Pilotone "B" Power Supply Unit.

was designed for the Pilotone Electric receiver it is completely satisfactory for use with any radio receiver not requiring a total current consumption of greater than 40 milliamperes.

The convenient design and construction provides a power supply having dimensions that make it extremely convenient to use for nearly all receiving cabinets having adequate space to enclose the "B" power supply at the rear or at one end of the sub-panel of the receiver itself. If you have a battery model receiver and you live in a district that has 110 volt 60 cycle alternating current lighting circuits, it is very easy to "electrify" your receiver by having a Pilotone B power supply unit, a A. C. tube filament current transformer and new sockets for

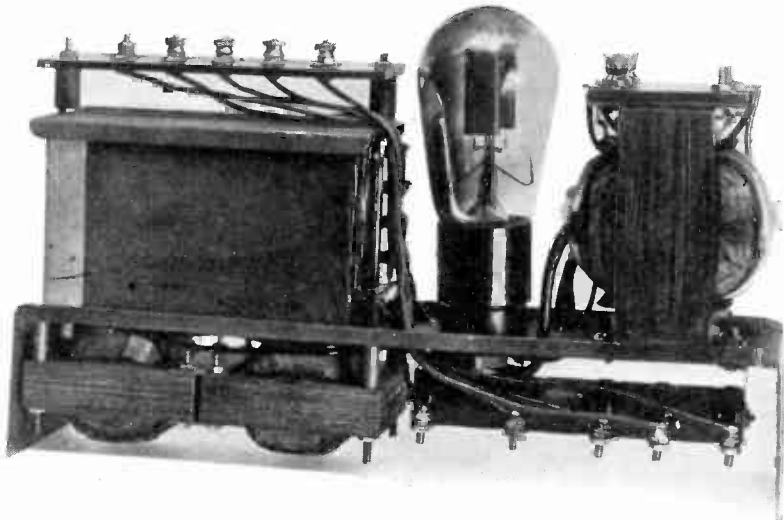

Fig. 2. The Pilotone "B" Power Supply Unit Chassis.

the A. C. tubes installed and wired in your receiver. If this is done care should be taken to use the proper resistances in the grid B minus (—) wiring to bias the amplifier tubes. Complete instructions for these resistance values and connections will be found on pages 116, 117, 118 and 119 of this issue.



are included in the Merriam Webster, such as *aerograph, broadtail, credit union, Bahaism, patrogenesis, etc.* New names and places are listed such as *Cather, Sandburg, Stalin, Latvia, etc.*

Constantly improved and kept up to date.

## WEBSTER'S NEW INTERNATIONAL DICTIONARY

Get The Best

The "Supreme Authority"

in courts, colleges, schools, and among Government officials both Federal and State.

452,000 entries including 408,000 vocabulary terms, 32,000 geographical subjects, 12,000 biographical entries. Over 6,000 illustrations, and 100 valuable tables.

Send for Free, new, richly illustrated pamphlet containing sample pages of the New International

G. & C. Merriam Company  
Springfield, Mass.

## TWIN COUPLER

Twin Coupler Coils are sold in KRESGE, KRESS, GRANT, and other stores thruout the U. S. A., Canada, and foreign countries



Largest Radio Coil Manufacturers in the United States

GENERAL OFFICES AND FACTORY  
TWIN COUPLER CO., Inc.  
POUGHKEEPSIE · NEW YORK

# HAIL TO THE GRAF ZEPPELIN

*The Pilot Flying Radio "Lab" Greet's the Ocean Flyer and Broadcasts the Epochal Event*

By ZEH BOUCK

**K**INGS, princes and Prelates have made entrances into this country noisy with sirens and bands. But if noise is any criterion of pre-eminence the Graf Zeppelin must be accorded first place among foreign visitors—a position, incidentally, it certainly deserves on other and more important considerations.

Half sheathed in a mist of gray fog and storm clouds, and surely vibrating with the artificial thunder of its own motors, those of two dozen circling planes and the echoing din of New York City below it, the Graf Zeppelin flew into history—and, a matter of little import, five hundred feet below the writer.

Before me, in the cabin of the plane, was a short wave transmitter, suspended by cushioned springs over a bank of high tension batteries, dimly lighted (it was growing dark) by the glow of the transmitting tubes.

But all of this was lost to me for the moment—and I thought of nothing but Tennyson's prophetic lines—

"Saw the heavens filled with commerce,  
argosies of magic sails!  
Pilots of the purple twilight."

But only for the moment. The motor of our plane roared its assuring drone—and above it, through the telephone receivers on my ears, came the voice of Louis A. Whitten, announcer over the Columbia chain, sitting by my side. Sitting by my side—yet his voice went a long way in reaching my ear . . . over the short wave transmitter down to a receiving station ten miles to the northwest . . . then over land wire to the WOR broadcast transmitter and out on the air again . . . and finally picked up on the super-hetrodyne receiver to which I was listening—back to its starting point again!

## THE PILOT FLYING RADIO LABORATORY

We had been preparing for this advent for a long while. As a matter of fact the months of experimentation with the "flying laboratory" had all contributed to the knowledge and experience essential to the suc-

cessful broadcast and rebroadcast from a flying station. The Stinson-Detroit airplane owned by the Pilot Electric Manufacturing Co., Inc., of Brooklyn, has spent several hundreds of hours in the air devoted to radio experimentation and research. Many transmitters and receivers have been developed and discarded in an effort to insure reliability of airplane radio communication—to make more safe and certain the inevitable system of future fast transportation.

The Graf Zeppelin was scheduled to arrive Sunday afternoon, October the 14th. Saturday afternoon, the Pilot organization made arrangements with the management of station WOR, of Newark, New Jersey, to broadcast a description of the arrival from the plane—a description that was to be rebroadcast on WOR's usual channel for the benefit of the world at large. The necessary apparatus was placed on a truck and rushed to the flying field at Garden City, Long Island. The writer and members of the WOR engineering staff arrived at Curtiss Field fifteen minutes later and the work of installing the special radiophone apparatus was commenced.

The transmitter employed two UX-210 tubes, one as an oscillator and the other as a modulator. While this arrangement permits of only about twenty-five per cent modulation, under distortionless conditions, it was considered adequate for short distance work, and simplified the problem of high voltage supply.

A special antenna system was rigged on the plane, using the frame of the fuselage as a

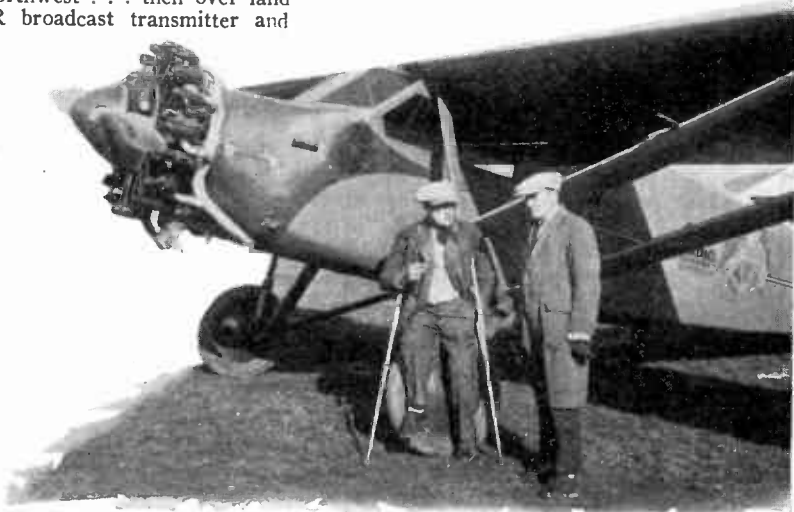

Fig. 1. The author, Mr. Bouck, and Mr. Meier, just previous to "hopping-off" in the Pilot flying radio laboratory to welcome the Graf Zeppelin.



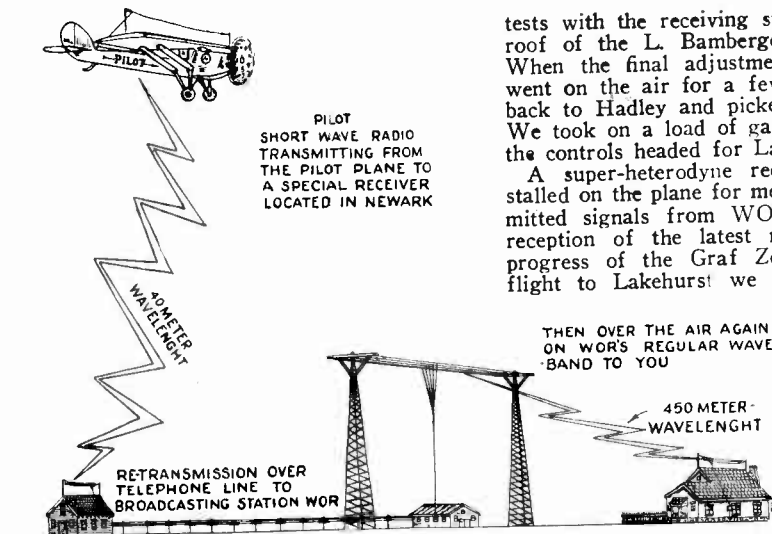

Fig. 2. Schematic diagram, showing how the description of the reception of the Graf Zeppelin by New York City was broadcast from the pilot flying laboratory to station WOR rebroadcasted on their regular wave channel.

counterpoise. Two four feet masts, fitting in sockets at the wing tips, supported a single wire almost the length of the span. Two additional wires, one from each end of the main antenna, were brought down and back to the braces on the horizontal stabilizer, and from there two lead-ins were led to the cabin, the form of the resulting antenna system approaching a triangle.

The installation and the final ground testing were completed just at dusk, and the preliminary flying test was made in the early evening. With Louis Meier at the controls we took off over the darkened field, making our final adjustments by the glow of the radiation indicating bulb, and the light of the transmitting tubes. Fifteen minutes later we came in for a landing. The lights of Garden City floated up to us we leveled off, and half a minute later taxied up to the ground station that had been set up simultaneously with the plane installation. The report was that everything was o. k.—a powerful distortionless signal, with practically no engine pick-up.

#### WE FLY TO NEWARK

The next morning we flew to the Newark airport, changing our base of operations to a location closer to both New York City and the receiving station at Newark, for final tests. However, the Newark airport was at this time only partially finished and the wind over the somewhat abbreviated runway was in a direction that made repeated taking-off with a heavily loaded plane a rather hazardous procedure.

So we again transferred our headquarters, this time to Hadley Field. This was chosen in preference to the Teterboro Airport because it was nearer to Lakehurst, where the dirigible would eventually come down, and was only ten minutes flight from Newark.

It was necessary now to make several air

tests with the receiving station located on the roof of the L. Bamberger store in Newark. When the final adjustment was effected, we went on the air for a few seconds, then flew back to Hadley and picked up the announcer. We took on a load of gas, and with Meier at the controls headed for Lakehurst.

A super-heterodyne receiver had been installed on the plane for monitoring our retransmitted signals from WOR and also for the reception of the latest news concerning the progress of the Graf Zeppelin. During the flight to Lakehurst we received several dispatches from WOR indicating definitely that the giant ocean flier would not arrive that evening. Delayed by the accident to her fin, she was approaching the coast slowly. Nevertheless we decided to look things over, and give the radio audience an eye description of just what preparations were being made

by the Navy Department, for her reception. Automobiles jammed the roads for miles around the Naval air station. From our altitude of two thousand feet the roads were black with these mechanical ants. The doors of the great hangar were hospitably open.

We returned to Newark, in the growing dusk. The sun had set as we went on the air for a ten minute period. The transmission went over beautifully as I could ascertain by monitoring on the super het. We returned to Curtiss Field, landing in the twilight.

#### THE GRAF ZEPPELIN ARRIVES

The next morning we made a few minor adjustments on the transmitting apparatus—tightening up here and there, improving the counterpoise connection and substituting a radiation meter for the bulb. Receiving a dispatch that the Zeppelin was over Philadelphia and heading for Lakehurst, we took off at two-thirty. We detoured briefly over Newark, for a final test with our receiver, and again went on the air for a minute or so, before turning the nose of the plane South for the Naval hangar. At the air station the scene of Sunday was duplicated, except for the fact that there were fewer automobiles in the roads and parked on the field. We circled Lakehurst for an hour, looking in vain for a trace of the Zeppelin. I had turned off the super-heterodyne receiver, because, due to the testing, the dry batteries were low, and I wanted to conserve them for the monitoring that would be essential when we transmitted. However, it was necessary that we get some word as to what had happened to the expected dirigible, and I turned on the receiver. Five minutes later, we learned that she had altered her course, and was over Bound Brook, New Jersey. However, as we had received so much conflicting information on the preceding day, we were doubt-

ful as to the authenticity of this position report. I decided to remain in the neighborhood of Lakehurst until we received a confirmation, reasoning that if we flew north and inland, and missed the Zeppelin, it would be too late to return to Lakehurst. On the other hand, if the airship were over Northern New Jersey, it would undoubtedly fly south along the coast and we couldn't miss it.

Ten minutes later we received a definite report that the Graf Zeppelin was over New York City! And we were in Lakehurst seventy-five miles away!

We had to move, and move quickly. Meier gave the plane the gun, and with a tail wind we made for New York at a clip around a hundred and thirty miles an hour. A Curtiss Falcon—Army observation plane—flew alongside of us for five minutes, before heading out over lower New York bay for Rockaway Point and Mitchel Field.

The air was very misty—and the ceiling steadily dropped. Over Staten Island we nosed down through an increasing fog. We strained our eyes through the smoke and mist for a sliver of silver. Finally we saw it—the Graf Zeppelin—over lower Manhattan. We certainly had made time!

Over Brooklyn, we were only a few hundred feet above this largest and greatest of trans-ocean fliers. A Junkers plane, carrying German relatives of several of the passengers aboard the Zeppelin flew under us. I turned on the transmitter, and looked at the announcer

alongside of me. I saw his lips move in front of the microphone. The radiation needle flickered on the transmitter, and I heard his voice through the 'phones on my ears—

"... the Graf Zeppelin is floating beneath us—a beautiful silver ship half lost in the mist and fog that seems to be its element. A dozen or more airplane are circling it. Down, beneath us and to the right, close by the Statue of Liberty, we can see a boat, with puffs of white steam coming from its funnel—whistling, undoubtedly its welcome to this commander of the skies..."

As the Graf Zeppelin faded into the mist toward Lakehurst, we flew over to Newark, and held the air for fifteen minutes. It was rapidly growing dark and our gas was low. Night had fallen as we turned our nose eastward. Jersey City sparkled below us—then, a few lights on the Hudson River. A minute later and Broadway glared up with garish twinkles. Over the East River and Queens, we could see ahead of us the flashing neon beacon at Curtiss Field. Five minutes later, Meier cut the gun, and we nosed down into a steep glide. Leveling out, the hangar lights were near but low. We swish-tailed into the field—the hangar lights were level with our eyes, the plane settled, the tail dropped and we were taxiing over to the hangar.

We felt—all of us in the plane—that this, indeed, was a day well done. We had seen history in the making and had played at least an infinitesimal part in it.

## ORDER PILOT PARTS FROM **SPEED**

For **SPEED** is the "FASTEST RADIO MAIL ORDER SERVICE IN THE WORLD"

SPEED, INC., was organized to supply you with PILOT parts (making shipments within eight hours after your order is received) provided that you cannot obtain instant service from your local radio dealer.

SPEED carries in stock all PILOT parts and kits, and desires to receive your order, whether it be for a binding post or for a complete kit for the SG-105 receiver, described in this issue of RADIO DESIGN. Enclose your check or money-order to receive "speedy" service.

**SPEED**  
A CORPORATION

FOR RADIO BUILDERS SUPPLIES

103-A Broadway, Brooklyn, N. Y.

All orders shipped by pre-paid parcel post. No orders are accepted or shipped C. O. D.

# THE PILOT ELECTRIC CO., INC. DEMONSTRATES TELEVISION AT THE 1928 ELECTRICAL EXPOSITION

By KIMBALL HOUTON STARK

**T**HE N. Y. Times, on Monday, Aug. 13, 1928, carried an editorial announcement to the effect that Station WRNY would start a regular schedule of television signal transmission over standard radio broadcast channels. This, to my knowledge, was the first attempt to inaugurate in America—for that matter, in the world—the transmission of radio television signals on a regular schedule.

That this was successfully inaugurated, and is being continued up to the present day, is largely due to the special apparatus designed by Mr. John Geloso, Chief Engineer of the Pilot Electric Mfg. Co., Inc., of Brooklyn, N. Y., under whose personal supervision the apparatus was constructed and installed.

Although the broadcasting studio of that station is in New York City, the television studio is located at the transmitter of the station at Coytesville, N. J. This condition presented many unique problems which were successfully overcome by the many ingenious devices incorporated in the apparatus and circuit design.

Since then, continual development work has been conducted in the Pilot laboratory and through the co-operation of the New York Edison Company, another public demonstra-

tion of television was held during the Electrical and Industrial Exposition, in the week of Oct. 20 to 28, 1928.

The success of this demonstration was amply proved by the fact that such a large number of people desired to see the demonstration, that it was at times necessary to employ more than a dozen policemen to keep the crowd moving and to eliminate constant confusion.

Credit is certainly due to Mr. Geloso and to the Pilot company in bringing practical television to the attention of the public and in technically accomplishing the very good results obtained.

The apparatus employed during the Electrical Exposition demonstration incorporated fundamental improvements over that previously used and the combination of apparatus and circuit arrangements used definitely proved that the six basic problems of television were at that time reasonably and successfully solved.

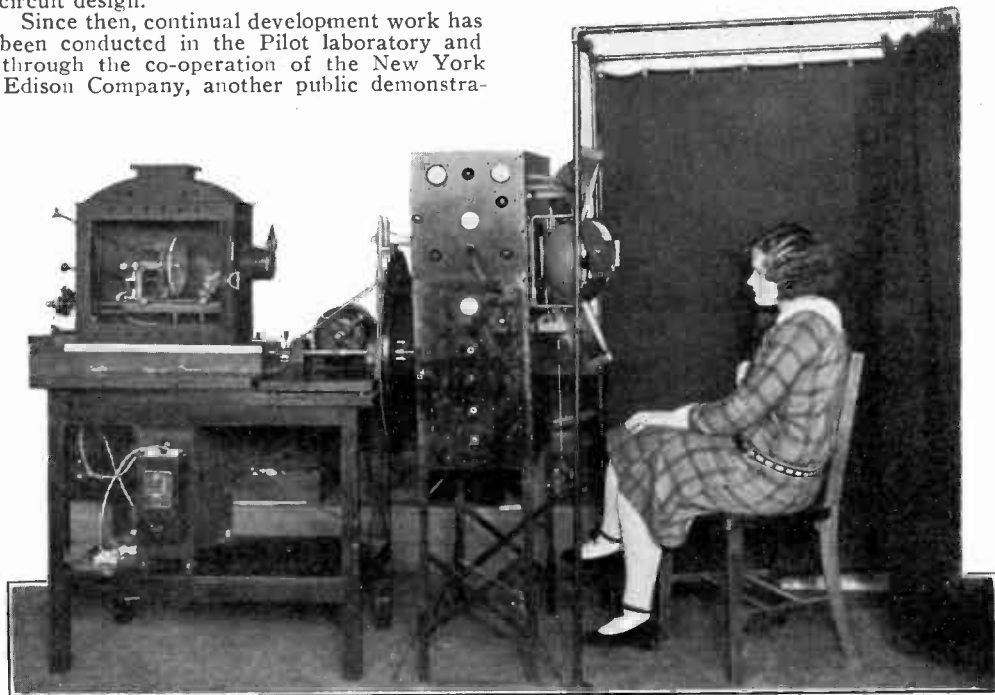

Fig. 2. Showing the television transmitter used during the demonstration at the 1928 Electrical and Industrial Exposition.

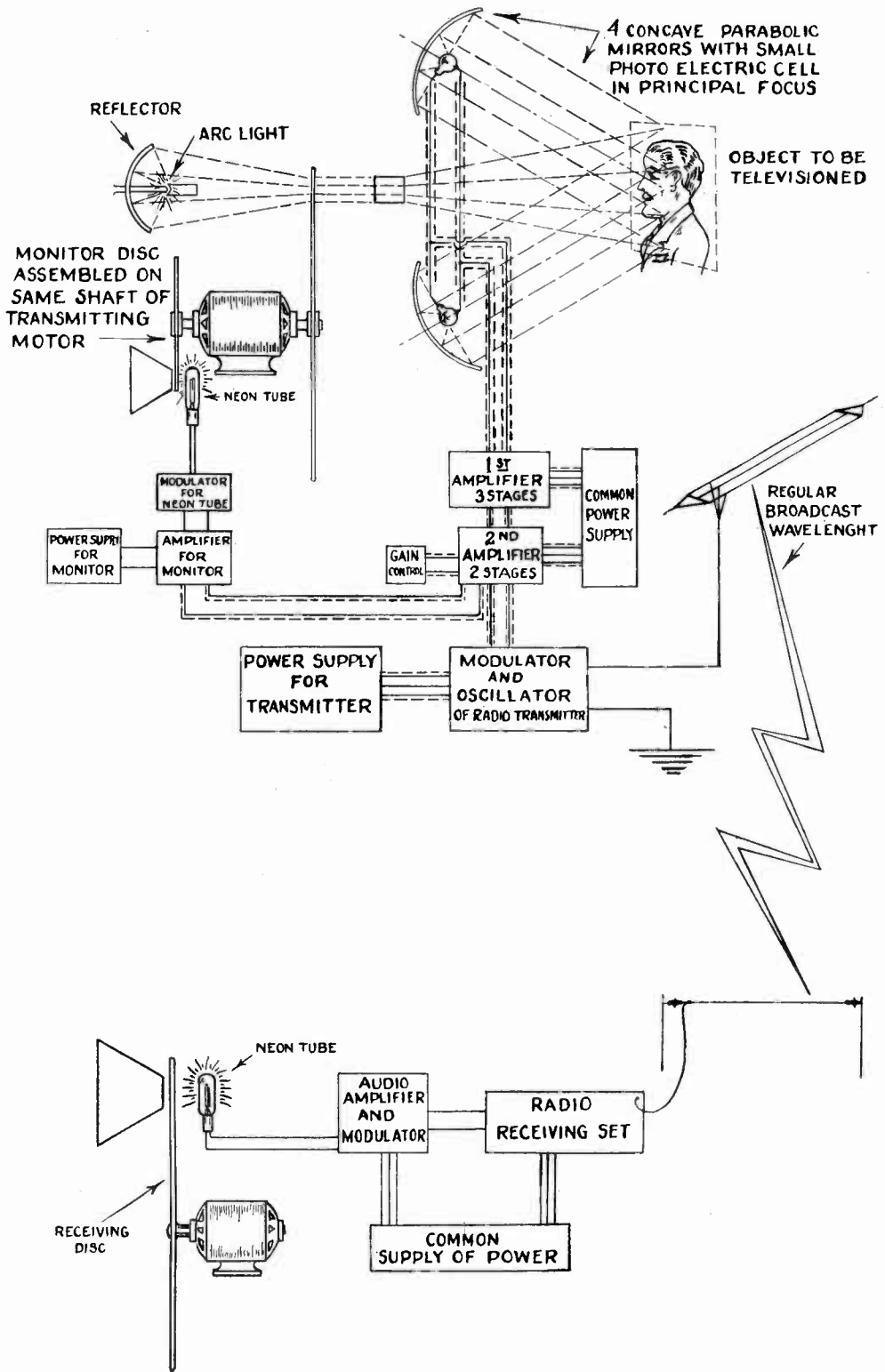
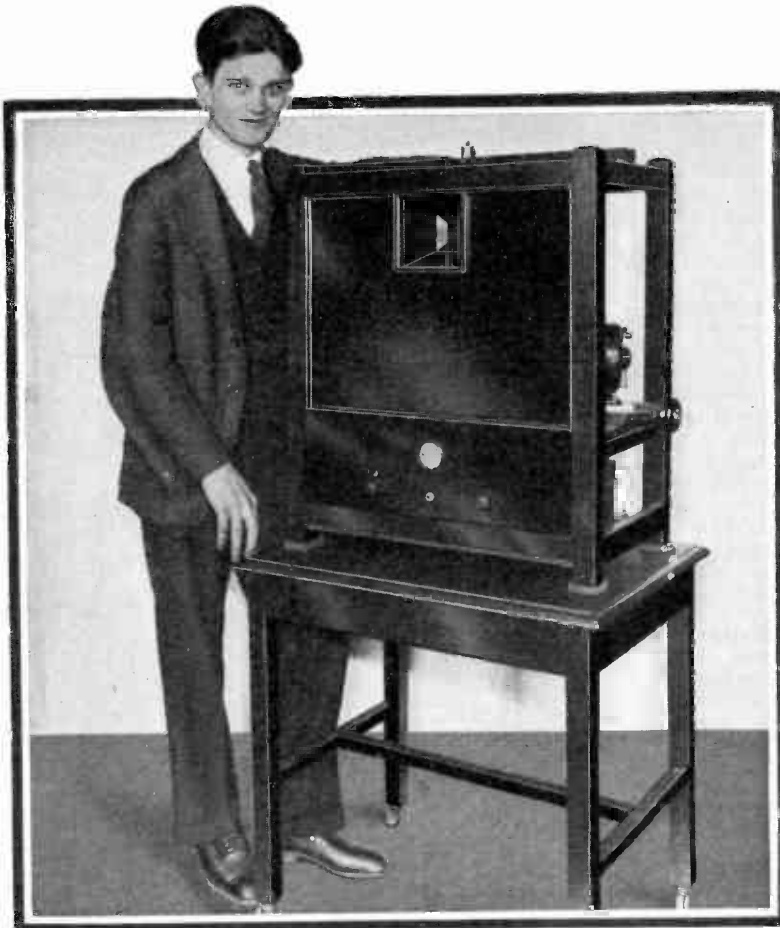

Fig. 1. Schematic diagram of the Pilot television transmitter and receiver.



*Fig. 3. Mr. John Geloso standing beside the television receiver scanning apparatus which he developed.*

#### THE SIX BASIC PROBLEMS OF TELEVISION

In a television system there are in general six basic problems. These are:

1. We may define television as the transmission of all details of a scene or picture (as seen by the human eye) in motion.

Science has not available devices or instruments capable of appreciating all details of light and shadow simultaneously. Therefore, we may consider the first fundamental problem of television to be the division of a scene or picture into a relatively large number of imaginary parts and to obtain the light and shadow effect from each part in regular sequence.

2. The second problem, is that in so far as it is essential to record motion, the whole moving scene or picture must be broken up into its component parts at the television transmitter, and reconstructed in reverse sequence at the television receiver, in an exceedingly short interval of time, this interval being a smaller period than the "time-lag" of the human eye.

This human eye "time-lag" may be taken as one-sixteenth of a second, which immediately necessitates that for any successful television system, the division of a scene and its reorganization must be done at an enormous speed.

3. Each separate light and shadow effect obtained from each individual part of the scene of picture to be televised must be transformed into an electrical effect. The photo-electric devices used for this purpose operate with no "time-lag," but the current available is so exceedingly small that it is necessary, in order to make this photo-electric current control a television transmitter, to amplify them enormously. The elimination of disturbances and distortion in the amplifier circuits is a serious problem.

4. The transmission by radio of the amplified photo-electric energy introduces difficulties, both as regards wire and radio channels of communication.

The frequencies necessary for the transmission of television signals, incorporating the necessary detail, occupy frequency channels having widths that present to engineers,

as well as to international statesmen the vital and world important problem of television frequency channel allocations.

5. At the television receiver, the problem is to transform the electrical energy back into images corresponding exactly to the original moving scene or picture. It is necessary to employ a source of variable illumination at the television receiver that will respond instantly and that has no appreciable "time-lag" to minute changes of electrical current. Here we have the problem of "thermionic-lag" and also the problem of eliminating of radiation of light for the infinitesimal interval of time between signal voltages; in other words, the radiation of light must not persist during the time period between signal voltage intervals.

6. The final problem is to arrange that all of the light and shadow effects produced at the television receiver follow each other in exactly the same sequence and position as did the original division of light and shadow at the television transmitting station, which involves the problem of synchronization of operation of both transmitter and receiver.

#### GENERAL ARRANGEMENT OF THE PILOT TELEVISION TRANSMITTER AND RECEIVER

The schematic drawing of the general circuit arrangements of the Pilot television transmitter and receiver system as used at the Electrical Exposition demonstration is shown in Fig. 1.

The photograph of Fig. 2 shows the television transmitter with a "subject" in position as if being televised.

Fig. 3 shows Mr. Geloso with his television receiver.

Referring to Fig. 1 we find illustrated the very ingenious photo-electric pick-up system using four concave parabolic mirrors with small photo-electric cells in the focus of these mirrors.

The light reflected from the object being televised is collected by the four concave mirrors and in turn reflected on the small photo-electric cells.

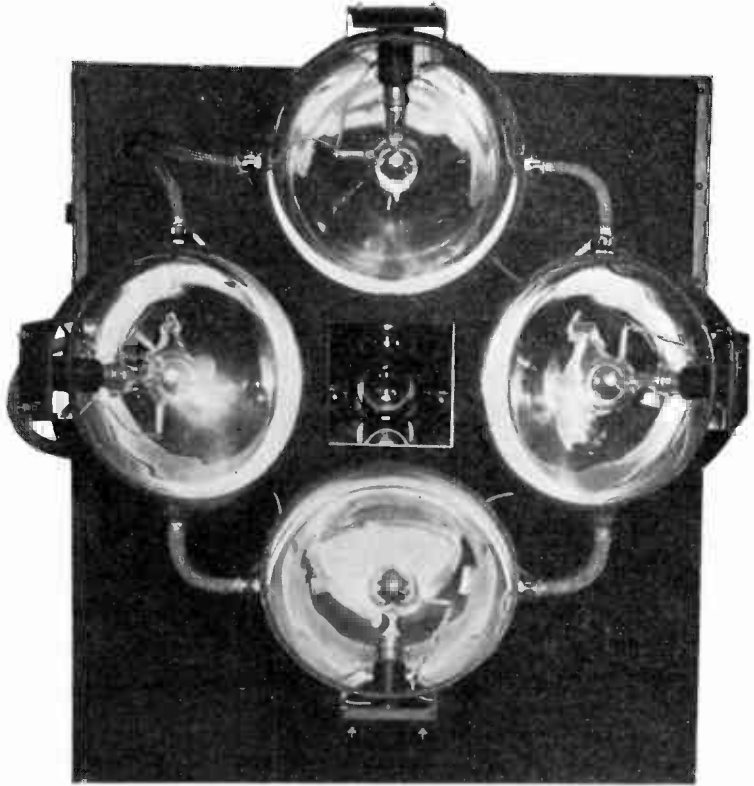

Fig. 4. Looking "straight-on" at the photo-electric cell "pick-up" end of the Pilot television transmitter.

The amount of light finally affecting the small photo-electric cells is of the same order as if four large photo-electric cells were used to pick up the reflected light directly from the image.

The advantages of the present system are the ease of obtaining standard photo-electric cells of the smaller size, being able to achieve satisfactory results at a cost of less than one hundred dollars compared to the fifteen hundred dollars necessary, using the large cells, and the securing of a more sharply modulated signal due to greater light and shadow photo-electric cell current variation.

The dotted lines in Fig. 1 indicate that all of the circuits so inclosed are most carefully shielded by inclosing them in metal conduits.

The photo-electric cell system is shown in detail in Fig. 4 which is a full front view of the top of the television transmitter panel exactly as it looks to a person being televised.

The photograph also shows the flexible copper cable shielding connecting the four photo-electric cells in circuit. The shielded circuits include of course in addition to the photo-electric pick-up circuits, the circuits between the first amplifier, the second amplifier, and the modulator and oscillator of the radio transmitter (assuming the tele-

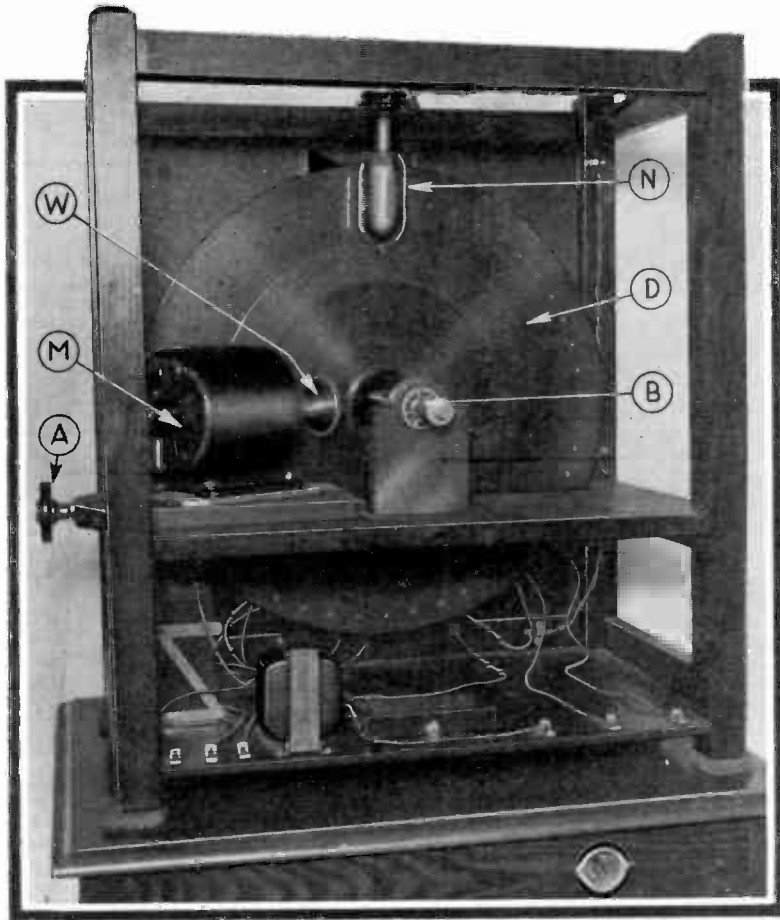

Fig. 5. Details of the television receiver scanning apparatus.

vision signals are to be broadcast) and likewise the circuits connecting all power supply units and to the separate amplifier used for the monitor scanning disc at the transmitter station.

The scanning disc of the transmitter is shown in Fig. 2 just to the left of the amplifier control panel, the disc being rotated by a synchronous electric motor.

The arc lamp and its housing is shown at the left of the illustration, the light from the lamp passing through the holes in the scanning disc, a lens system, and finally reaching the subject to be televised.

The design of the scanning disc itself is of extreme importance, for upon it depends the frequency of the transmitted signals as well as the definition or degree of perfection of the televised object or picture.

Fundamental improvements were incorporated in the scanning disc used in the circuit being described, particular attention being given to the size and shape of the holes in the disc.

It is to a large extent upon this detail that the success of television transmission de-

pends and months of careful design work, both experimental and mathematical, were necessary before the results desired were achieved.

The amplification of the original photoelectric energy at the transmitter as well as at the television receiver is a serious problem, particularly from the point of view of reducing the noise level, because five or six stages of audio frequency amplification must be used over a wide band of audio frequencies and at the same time the phase relationship of the final output current must be kept practically at zero with respect to the original input current, over the entire frequency band.

The scanning disc portion of the television receiver shown in Fig. 3 is illustrated in greater detail in Fig. 5—which is a close-up of the scanning disc.

In the photograph of Fig. 5, D designates the scanning disc rotating on a shaft mounted on ball-bearings as at B.

The scanning disc is driven by the electric motor M through the friction drive arrangement W, synchronization between the speed

# RADIO DESIGN

**MAGAZINE OF CONSTRUCTION FOR STUDENTS & SET BUILDERS**

**All New** kinds of radio equipment are described in RADIO DESIGN MAGAZINE, published for custom set builders, experimenters and students. The articles, accompanied by profuse photos, circuits and drawings, are written by such men as R. S. Kruse, Kimball Houton Stark, John Geloso, Zeh Bouck, A. A. Ghirardi, etc.

**Shield Grid** sets, showing the latest circuits before they are put into use by set manufacturers, will be found in RADIO DESIGN.

**Short Waves** All the newest short wave sets will be found in RADIO DESIGN, shown in full detail. Many RADIO DESIGN readers are hearing broadcasting from all over the world on these new sets.

**A. C. Sets** RADIO DESIGN leads in showing the newest A.C. broadcast receivers of all types. These articles are of the utmost importance to custom set builders.

**Push-Pull** Amplifiers, "B" Power Packs, "A" Packs, Power Amplifiers, everything that is newest and finest in the radio art.

*You can build sets that are a year ahead of the standard manufactured sets by following these designs.*

## RADIO DESIGN MAGAZINE

Issued Quarterly During the Year

**50c** PER YEAR IN U. S. A., CANADA AND ALL FOREIGN COUNTRIES

RADIO DESIGN PUBLISHING CO., INC.  
103-A Broadway, Brooklyn, N. Y., U. S. A.

Dear Sirs:

Please find enclosed 50c (cash or money order), for which send me four (4) issues of RADIO DESIGN MAGAZINE, starting with the current issue.

Name..... Street.....  
City..... State.....

MAIL THE COUPON TODAY  
↓



of the scanning disc at the transmitting station and the receiver scanning disc been obtained by the use of a synchronous motor at both transmitter and receiver and in addition by the arrangement of the radial friction drive between the motor and the disc, this adjustment being made by the hand wheel A at the left center of the picture.

The neon lamp is indicated at N and on the shelf beneath the motor shelf is shown some of the apparatus and circuits required for the modulating circuit of the lamp.

#### THE TELEVISION POLICY OF THE PILOT COMPANY

It has been my good fortune to discuss television with Mr. I. Goldberg, president of the Pilot Electric Mfg. Co., Inc. It has been through his courtesy that I am able to describe and illustrate the equipment used at the Electrical Exposition, and delighted as I was with what he was able to tell me and show me, I could not be content without asking him to tell me quite frankly the policy of the Pilot company with respect to television for the future. His answer, to my mind, indicates not only possibly good selfish business judgment, but also a policy that cannot but be of benefit to the radio industry and an aid to the advancement of the art of television in the United States.

Mr. Goldberg said:

"I have spent a great deal of money, possibly a hundred thousand dollars, in television experimental and development work and I am well satisfied with the technical and practical progress achieved to date by my engineers.

"I have seen the television demonstrations of other experimenters and I believe that the results which we have achieved are certainly equal if not superior.

"My engineers will continue with all energy and ability to develop television in an improved and practical way. I wish, how-

ever, to point out particularly that the Pilot Electric Mfg. Co., Inc., has not as yet made any announcement or carried any advertisement in the press offering apparatus specifically designed for television, for sale.

"This policy will be continued and I shall make no commercial announcement until such time as my engineers are able to prove to me and to my associates that I would be justified in recommending such equipment to the public. I am certain that television is not 'just around the corner.' Television is here with us today and I am sure that it will be of increasing importance to the future success of the radio industry. I am going to continue to spend my good money to aid in so far as I am able, the technical development of the art of television and I hope that my company may be among the first to offer to the public a practical and relatively inexpensive receiver capable of being used by the same millions of people that 'listen-in' every night with their regular broadcast radio receivers."

#### THE FUTURE

Certainly I can add nothing of equal importance to the statements made by Mr. Goldberg when speaking of the future of television transmission and reception, other than pointing out that the policy of technical development work now being carried on by the Pilot company will without question aid in placing future television in America in the position of leadership when compared to the countries of Europe, comparable to the position of supremacy now enjoyed by radio broadcasting in the United States. The maintenance of that leadership cannot fail, in my opinion, if all individuals and companies now working in the art of television hold for themselves the same ideal of achievement and possible future profit, as is the ideal of the Pilot Electric Mfg. Co., Inc.

## RADIO DESIGN IN TELEVISION

The engineers in the laboratory of Radio Design are doing a great deal of experimental work, using many different types of amplifiers and scanning disc arrangements—all leading to giving you a number of really practical television receiver, amplifier and scanning disc constructional and operation articles in early issue of the magazine  
—watch Radio Design for practical television data.

**Read what BIG money these fellows have made in the RADIO BUSINESS**

**\$375 One Month Spare Time**



"Recently I made \$375 in one month in my spare time installing, servicing, selling Radio sets. And, not so long ago, I earned enough in one week to pay for my course."  
**EARLE CUMMINGS,**  
 18 Webster St., Haverhill, Mass.

**\$1597 In Five Months**



"The N. R. I. is the best Radio school in the U. S. A. I have made \$1597 in five months. I shall always tell my friends that I owe my success to you."  
**HENRY J. NICKS, Jr.,**  
 302 Safford Ave.,  
 Tarpon Springs, Fla.

**\$1164 Spare Time Profits**



"Look at what I have made since I enrolled, \$1,164—money I would not have had otherwise. I am certainly glad I took up Radio with N. R. I. I am more than satisfied."  
**HENRY R. HEIKKINEN,**  
 123 W. Erie St., Chicago, Ill.

**Over \$1000 In Four Months**



"My opinion of the N. R. I. course is that it is the best to be had at any price. When I enrolled I didn't know a condenser from a transformer, but from December to April I made well over \$1000 and I only worked in the mornings."  
**AL JOHNSON,**  
 1109 Shelby St., Sandusky, Ohio.

# I will show you too how to start a spare time or full time Radio Business of Your Own without capital



J.E. SMITH Pres.

Radio's amazing growth is making many big jobs. The world-wide use of receiving sets and the lack of trained men to sell, install and service them has opened many splendid chances for spare time and full time businesses.

Ever so often a new business is started in this country. We have seen how the growth of the automobile industry, electricity and others made men rich. Now Radio is doing the same thing. Its growth has already made many men rich and will make more wealthy in the future. Surely you are not going to pass up this wonderful chance for success.

**More Trained Radio Men Needed**

A famous Radio expert says there are four good jobs for every man trained to hold them. Radio has grown so fast that it simply has not got the number of trained men it needs. Every year there are hundreds of fine jobs among its many branches such as broadcasting stations, Radio factories, jobbers, dealers, on board ship, commercial land stations, and many others. Many of the six to ten million receiving sets now in use are only 25% to 40% efficient. This has made your big chance for a spare time or full time business of your own selling, installing, repairing sets.

**So Many Opportunities You Can Make Extra Money While Learning**

Many of our students make \$10, \$20, \$30 a week extra while learning. I'll show you the

**I Will Train You At Home In Your Spare Time**

I bring my training to you. Hold your job. Give me only part of your spare time. You don't have to be a college or high school graduate. Many of my graduates now making big money in Radio didn't even finish the grades. Boys 14, 15 years old and men up to 60 have finished my course successfully.

**You Must Be Satisfied**

I will give you a written agreement the day you enroll to refund your money if you are not satisfied with the lessons and instruction service when you complete the course. You are the only judge. The resources of the N. R. I. Pioneer and Largest Home-Study Radio school in the world stand back of this agreement.

**Get My Book**

Find out what Radio offers you. My 64-page book, "Rich Rewards in Radio" points out the money making opportunities the growth of Radio has made for you. Clip the coupon. Send it to me. You won't be obligated in the least.

how to begin making extra money shortly after you enroll. G. W. Page, 1807-21st Ave., S., Nashville, Tenn., made \$935 in his spare time while taking my course.

**I Give You Practical Radio Experience With My Course**

My course is not just theory. My method gives you practical Radio experience—you learn the "how" and "why" of practically every type of Radio set made. This gives you confidence to tackle any Radio problems and shows up in your pay envelope too.

**You can build 100 circuits with the Six Big Outfits of Radio parts**

I give you. The pictures here show only three of them. My book explains my method of giving practical training at home. Get your copy!

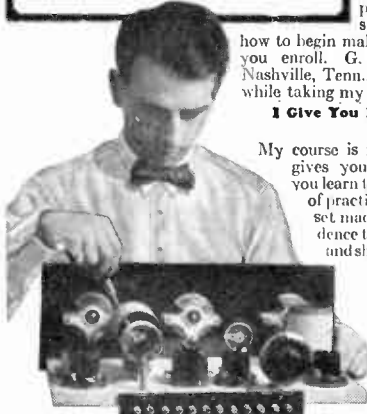

*This Book points out what Radio offers you Get a copy!*



**Address**

**J. E. Smith, Pres.**

**Dept. 9G3**

**National Radio Institute  
 Washington, D. C.**

**This coupon is good for a FREE copy of my Valuable Book. Mail it NOW!**

J. E. Smith,  
 President,  
 Dept., 9G3,  
 National Radio Institute, Washington, D. C.

Dear Mr. Smith: Send me your book. I want to know more about the opportunities in Radio and your practical method of teaching at home in spare time. This request does not obligate me to enroll and I understand no agent will call on me.

Name.....Age.....  
 Address.....  
 City.....State.....

# Hear Stations the World Over

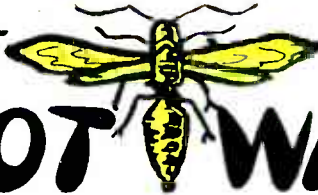
WITH **SHORT**  **THE WAVE**  
**PILOT WASP**

This New 3-Tube Short Wave Receiver brings  
 in Hundreds of Stations  
 You Never Heard Before!

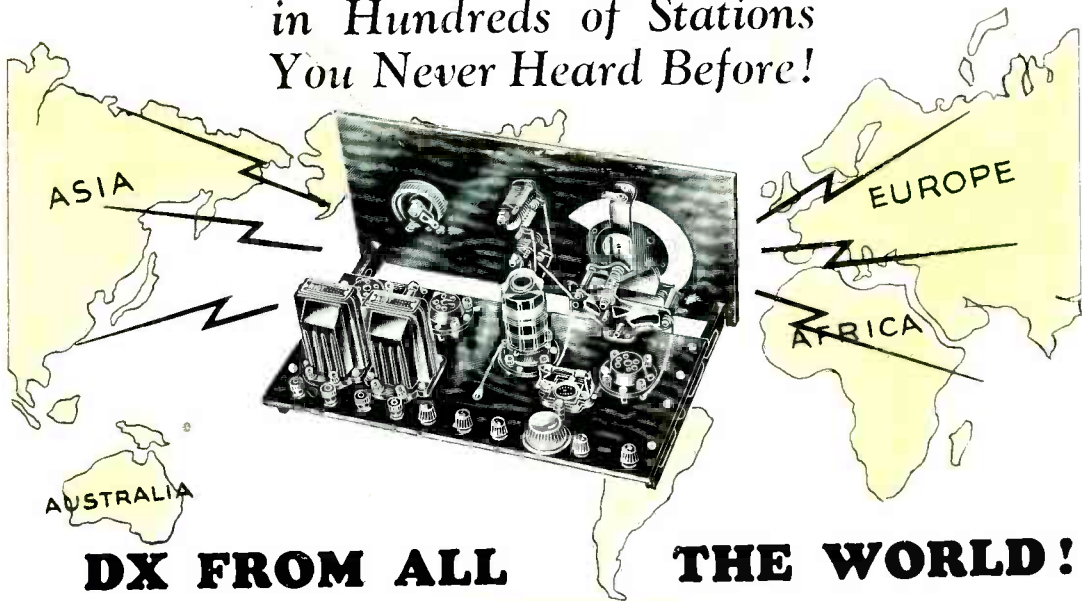

**DX FROM ALL THE WORLD!**

Listen to short wave broadcasts day and night from England, Italy, France, Germany and also American stations when static blankets the regular broadcast channels. The Pilot Wasp is ideal for receiving Television broadcasts soon to be transmitted on short wavelengths. For those who do their globe-trotting via radio, the Wasp is the receiver.

Can be assembled  
 for about  
**ONE-HALF**  
 the cost of any  
 similar receiver.

Ask your custom set-builder about the Pilot Wasp Short-Wave Receiver designed by Pilot engineers assisted by R. S. Kruse (of QST magazine fame). This set, with its 11,000 mile range, is simple to build and cheaper to assemble than any broadcast receiver. Panels drilled and engraved. The five Pilot Plug-in coils cover all wavelengths from 17 to 500 meters.

Get the Pilot Wasp Construction Blueprint from Your Local Store for 10c  
 or Send Direct to

Pilot  
 Precision  
 Radio  
 Parts



Sound  
 Engineering  
 Characterizes  
 PILOT PARTS

Radio Manufacturers Since 1908



TRADE MARK  
REG

## What **PILOT** Offers the Custom Set Builder

**First**, tried and tested circuits, designed and perfected by practical radio engineers. Full size blueprint layouts making assembly swift and results certain.

**Second**, a complete line of radio parts built to precision standards hitherto unachieved.

**Third**, prices that permit giving your customer the best, and while saving him money, making a reasonable profit for yourself.

Send 4c in Stamps for Catalog  
including Data Sheets.

**PILOT ELECTRIC MFG CO**  
323 BERRY ST.  **BROOKLYN, N.Y. INC.**  
TRADE MARK REGISTERED  
**"WORLD'S LARGEST RADIO PARTS PLANT"**

PILOT PRECISION  
RADIO PARTS