

RADIO CRAFT

RADIO — ELECTRONICS

ELECTRONIC KISSMETER

SEE ELECTRONICS SECTION



SEPT
1948

30c

RADIO-ELECTRONICS IN ALL ITS PHASES

All New! **Mallory** Revolutionary Midgetrol



Quietest and Smoothest . . . by Test!

THE SIZE IS NEW

Only 15/16" in diameter, it easily services the increasingly popular small sets where ordinary controls will not fit.

THE SWITCH IS NEW

No chance of failure—it's Mallory engineered and Mallory manufactured. Pushes on—stays on—and works.

THE DESIGN IS NEW

Brand new shaft style saves valuable time in installation—reduces inventory since one shaft fits all knobs.

THE ELEMENT IS NEW

More accurate over-all resistance, smoother tapers, ample power dissipation.

THE CONSTRUCTION IS NEW

Extra quiet—no metal-to-metal contact between shaft and cover or bushing. Special Mallory contact material.

THE CONTACT IS NEW

Laboratory tests prove that the Mallory Midgetrol is the quietest control on the market.

THE SHAFT IS NEW

Unique—two simple fittings—for all type knobs. No need for extra controls for different knobs.

THE TERMINAL IS NEW

Won't break—twist 'em all you want in close working space. Away from panel to avoid shorting.

THE EXTENSION IS NEW

Easy to apply with self-tapping screws. Supplementary shafts available for installations which require them.

THE SUSPENSION IS NEW

Two-point—insures even contact pressure at all points of rotation. Larger bushing area—added support—no wobble.

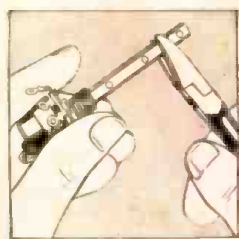

Side snips neatly cut shaft to length desired.



U-clip furnished to slide over end of shaft—holds set-screw knobs.

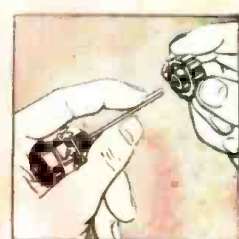

Use half the U-clip to hold push-on type knobs.

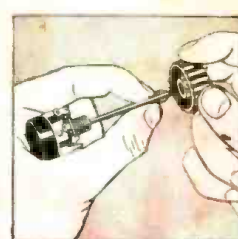

Spring steel clip included for use with knurled knobs.

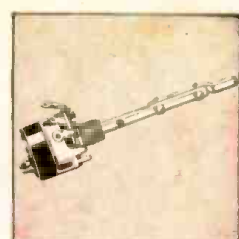

Extension shafts with two self-tapping screws available when needed.

It's the **NEW** Standard in Carbon Controls. See your Mallory distributor.

P. R. MALLORY & CO. Inc.
MALLORY
 CAPACITORS • CONTROLS • VIBRATORS • SWITCHES • RESISTORS
 • RECTIFIERS • VIBRAPACK* POWER SUPPLIES • FILTERS
*Reg. U. S. Pat. Off.
APPROVED PRECISION PRODUCTS
P. R. MALLORY & CO., Inc., INDIANAPOLIS 6, INDIANA

Be Your Own Boss



J. E. SMITH, President
National Radio Institute

**I WILL SHOW YOU HOW TO START
A RADIO SERVICE BUSINESS
Full Time or Spare Time WITHOUT CAPITAL**

LEARN RADIO

**BY PRACTICING
IN SPARE TIME**

As part of your training you build this complete, powerful Radio Receiver that brings in local and distant stations. N. R. I. gives you ALL the Radio parts... speaker, tubes, chassis, transformer, sockets, loop antenna, etc.



**You Build This
MODERN RADIO
and Many Other Circuits**

**with BIG KITS of
parts I SEND YOU**



YOU BUILD this Tester that soon helps you **EARN EXTRA MONEY** fixing neighbors' Radios, in spare time.

YOU PRACTICE with this A. M. Signal Generator. Provides amplitude-modulated signals for many tests.



YOU PRACTICE Radio soldering, mounting, connecting with equipment and Radio parts I send.



YOU BUILD this Super-Dynafone receiver circuit.

Let me show you how you can name your own days... your own hours... as your own boss in your own money-making Radio business. I've trained hundreds of men to earn good incomes in their own shops... men with no previous experience... and I can do the same for you. My unique train-at-home method makes learning easy. I send you **BIG KITS of Radio Parts**. You get practical Radio experience building, testing and experimenting with **Radio Circuits**. You keep these valuable kits to use in your own Radio business.

Radio, Broadcasting, Radio Manufacturing, Radio Repairing, Public Address Work, etc. And think of even greater opportunities in fast-growing Television, FM, Electronics.

Get Actual Lesson and Book Free

Act **NOW!** Send for my special **DOUBLE FREE OFFER**. Get actual lesson, "GETTING ACQUAINTED WITH RECEIVER SERVICING," absolutely free. Discloses short-cuts used by Radio repair men to check and repair Radios. Over 80 pictures and diagrams! Send now and also get my 64-page book, "HOW TO BE A SUCCESS IN RADIO - TELEVISION - ELECTRONICS." See how quickly, easily you can get started. But send **NOW!** J. E. SMITH, President, Dept. 81X, National Radio Institute, Pioneer Home Study Radio School, Washington 9, D. C.

Make EXTRA Money in Spare Time

The day you enroll, I send you **EXTRA MONEY** booklets. Use your *know-how* to make **EXTRA MONEY** fixing neighbors' Radios in spare time while learning. From here it's a short step to your own Radio shop or a good-pay job in Radio and Television industries.

N. R. I. Trained Men Face Bright Future

Think of money-making opportunities in Police, Aviation, Marine

I Trained These Men



GOOD JOB IN RADIO STATION

"Am Broadcast Engineer for Station **KROP**. Fundamentals of Radio learned in N. R. I. training invaluable." —**JEFFREY G. COLLETT**, Brawley, California.

HAS OWN RADIO BUSINESS

"After finishing course, opened my own Radio shop. Can't praise your training too high. It's the best!" —**ERNEST E. SLATE**, Corsicana, Texas.



EXTRA CASH IN SPARE TIME

"Earned enough spare time cash to pay for my course by time I graduated. N. R. I. training is tops!" —**ALEXANDER KISH**, Carteret, New Jersey.



ACTUAL LESSON FREE

Act **NOW!** Send for my special **DOUBLE FREE OFFER**. Get actual lesson, "GETTING ACQUAINTED WITH RECEIVER SERVICING," absolutely free. Discloses short-cuts used by Radio repair men to check and repair Radios. Over 80 pictures and diagrams. Send **NOW!**

**My Course Includes
TELEVISION
FM-ELECTRONICS**

Good for Both - FREE

MR. J. E. SMITH, President, Dept. 81X
NATIONAL RADIO INSTITUTE, Washington 9, D. C.
Mail me **FREE** Sample Lesson and 64-page book,
(No salesman will call. Please write plainly.)

Name.....
Address.....
City..... Zone..... State.....
 Check if Veteran. Approved For Training Under GI Bill.

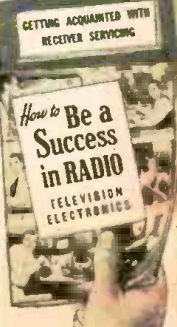

**VETERANS GET THIS TRAINING UNDER
G. I. BILL. MAIL COUPON**

RADIO CRAFT

RADIO —
ELECTRONICS

Incorporating
SHORT WAVE CRAFT • TELEVISION NEWS*
RADIO & TELEVISION
*Trademark registered U. S. Patent Office

Contents September 1948

Editorial (Page 21)			
Soviet Radio Land-Torpedo.....	by Hugo Gernsback 21		
Electronics (Pages 22-29)			
Kiss Meter—Electronic Osculation Indicator (Cover Feature) ..	by Lyman E. Greenlee 22		
Eclipse of the Radio Tube	24		
The Crystal Detector, Part III.....	by Jordan McQuay 26		
Electronics in Medicine.....	by Eugene J. Thompson 28		
Television (Pages 30-33)			
Video Alignment	by Robert N. Vendeland 30		
French Television Progress is Rapid.....	by P. Hemardinquer 33		
Servicing (Pages 34-38)			
Radio Set and Service Review (Ward's Airline Models 74BR-2003A and 84BR-1515A)	34		
Regulating Voltage with VR Tubes.....	by Richard L. Parmenter 36		
Pepping Up Midgets.....	by K. E. Stewart 38		
Foreign News (Page 39)			
European Report.....	Major Ralph W. Hallows 39		
Audio (Pages 40-43)			
Modern Phono Oscillators.....	by Richard L. Parmenter 40		
Two Channels for Hi-Fi.....	by P. Hemardinquer 40		
Instantaneous Intercom.....	by Harold R. Newell 41		
Three Bug-Free Amplifiers.....	by John W. Straede 42		
Test Instruments (Pages 45-52)			
The A.C. Ammeter Saves testing Time.....	by John Melicharek 45		
Versatile Tester Has New Features.....	by V. A. Jeannot 46		
Bridge Measures L-C-R.....	by Rutus P. Turner 50		
Amateur (Pages 54-63)			
Four-Band Converter Has Crystal Control.....	by Herbert S. Brier, W9EGQ 54		
Modifying the R-44/ARR-5.....	by L. W. May, Jr., W5AJG 58		
Relay-Controlled Ham Rig.....	by Richard H. Dorf, W2QMI 62		
Construction (Pages 78-81)			
Neon Lamp as Phototube.....	by Robert Jonquet 78		
Small-Space Metal Locator.....	by John Haynes 79		
Communications T.R.F.....	by T. W. Dresser 80		
FM (Pages 87-93)			
FM Station List.....	87		
Departments			
The Radio Month.....	10	Technotes.....	73
Radio Business.....	16	Try This One.....	74
People.....	64	Radio-Electronic Circuits.....	82
New Devices.....	66	Miscellany.....	85
New Patents.....	68	Book Reviews.....	94
Question Box.....	70	Communications.....	97

RADIO-CRAFT, September, 1948, Volume XIX, No. 12. Published monthly on the 25th of month preceding date of issue by Radercraft Publications, Inc., Erie Ave., P. O. Box 200, Philadelphia 32, Pa. Entered as second class matter at Post Office, Springfield, Mass., under Act of March 3, 1879. Application pending transfer to the Philadelphia, Pa., Post Office.

RADERCRAFT PUBLICATIONS, INC. Hugo Gernsback, Pres.; M. Harvey Gernsback, Vice-Pres.; G. Aliquo, Secy. Contents Copyright, 1948, by Radercraft Publications, Inc. Text and illustrations must not be reproduced without permission of Copyright owners.

EDITORIAL, ADVERTISING AND CIRCULATION OFFICES, 25 West Broadway, New York 7, N. Y. Tel. REctor 2-9691. BRANCH ADVERTISING OFFICES: Chicago: 308 W. Washington Street, Telephone Randolph 7363. Detroit: Frank Isolstein, Room 302 Lexington Bldg., 2970 West Grand Blvd. Telephone Madison 7020-7. Los Angeles: Ralph W. Harker, 606 South Hill St., Tel. Tucker 1708. San Francisco: Ralph W. Harker, 582 Market St., Tel. Garfield 1-2481.

SUBSCRIPTION RATES: In U. S. and Canada, in U. S. possessions, Mexico, South and Central American countries, \$3.50; \$6.00 for two years; \$8.00 for three years, single copies 20c. All other foreign countries \$4.50 a year, \$8.00 for two years, \$11.00 for three years. Allow one month for change of address. When ordering a change, please furnish an address stencil impression from a recent wrapper. All communications about subscriptions should be addressed to the circulation manager, RADIO-CRAFT, 25 West Broadway, New York 7, N. Y.

FOREIGN AGENTS: Great Britain: Atlas Publishing and Distributing Co., Ltd., 18 Bride Lane, Fleet St., London E.C.4. Australia: McGill's Agency, 179 Elizabeth Street, Melbourne. France: Brentano's, 37 Avenue de l'Opera, Paris 2e. Holland: Trilacton, Brunssteelsche, Dreef 124 Heemstede. Greece: International Book & News Agency, 17 Amerikis Street, Athens. So. Africa: Central News Agency, Ltd., Cor. Risak & Commissaries Bldg., Johannesburg. 112 Long Street, Capetown; 305 Smith Street, Durban, Natal. Universal Book Agency, 70 Harrison Street, Johannesburg. Middle East: Selmatsky Middle East Agency, Jaffa Road, Jerusalem. India: Susil Gupta (Distributors) Co., Armla Bazar Patilka Ln., 14 Ananda Chatterjee Lane, Calcutta.



MEMBER
AUDIT BUREAU
OF CIRCULATION

ABC PAID CIRCULATION 6 MONTHS TO
DEC. 31, 1947—102,688. (Publishers Statement)
PRINTED FOR SEPTEMBER ISSUE — 150,000



with
radio
men!

This year, as in every year since 1939, more radio men will buy more Sealdtite capacitors than any other molded paper capacitors.*

Molded paper tubulars are indisputably the best for moisture resistance and long life. All-Purpose Hi-Temp molded Sealdtites are the best molded tubulars. Once you try them, you'll always buy them!

Get your catalog without delay!

SOLAR CAPACITOR SALES CORP.
NORTH BERGEN, NEW JERSEY

SEALDTITE MEANS LONGER LIFE

★Trade Mar



SOLAR CAPACITORS

"Quality Above All"

RADIO-CRAFT for

**Radio Servicemen: Here is the Industry's
Newest, Practical Course in**

Television & FM Servicing

**Backed by the Famed
Facilities of CREI**
★
**Safeguard Your Future!
Earn more Money
in the Expanding
Servicing Field**

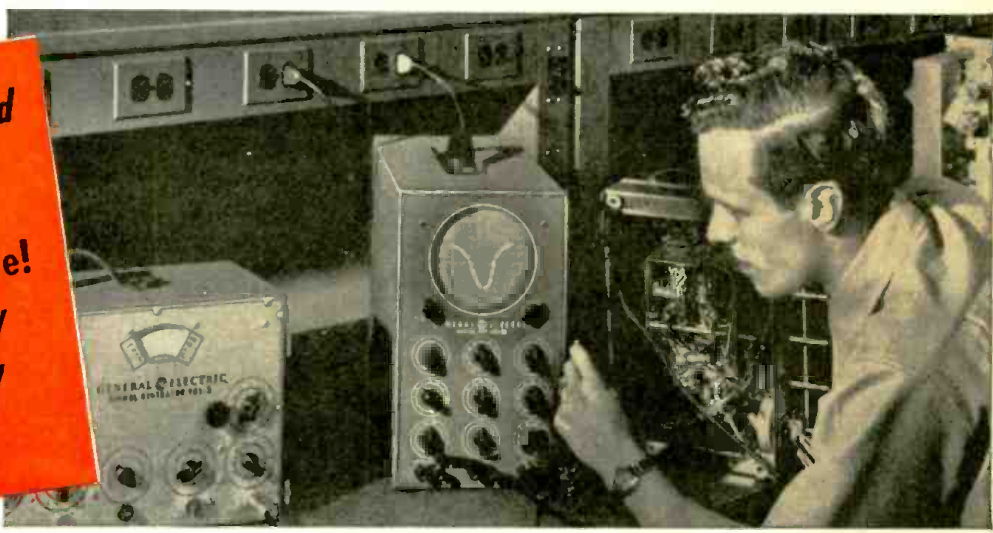

● CREI—long known as one of the nation's outstanding technical schools—now offers good radio servicemen a practical home study course in Television and FM Servicing. It is based on the assumption that you are a practicing radio repairman with sense enough to know that if you don't learn FM and Television, you might as well close up in a year or two. The shop without qualified FM and TV repairmen will soon be as obsolete as a blacksmith shop . . . because approximately 800,000 television sets will be produced in 1948 alone . . . because there will be 4,000,000 *more* radios with FM by the end of this year . . . because the repair business will go to the men with ability to do a scientific servicing job on *any* kind of set.

CREI developed this course at the request of several nationally known manufacturers and distributors who recognized the lack of qualified servicemen to handle TV and FM installations and servicing. After careful preparation CREI has created this special servicing course. It has been tested—and *proved* in the field. It is as practical as we can make it. It enables you to put the knowledge you gain from each lesson to work immediately. It *won't* make you rich overnight. It *won't* make a television engineer out of you in "ten easy lessons". You *don't* get a "free television set with your first lesson"—or your last. *But here's what you do get:* a systematic method method of FM and TV installation and maintenance,

knowledge of TV fundamentals, lessons in basic radio mathematics, meters, lenses and mirrors, inductive coupling and condensers at ultra-high frequencies, practical applications of resonant circuits, TV tubes, FM receiver alignment, TV antennas, picture synchronization, TV receivers, TV troubleshooting—and much more.

CREI is an accredited technical school with 21 years experience teaching radio engineers and technicians, both in home study and residence school work. Hundreds of practical engineers with key positions in industry, radio, and TV stations owe their successful training to CREI. More than two years of preparation have gone into this FM & TV servicing course. Backed by one of America's foremost technical institutes, it is designed for one purpose only: to help a good radioman become a good FM-TV serviceman. The course is *practical*; the cost is *popular*. Get complete details by filling in and mailing this coupon.

Radio Service Division of

CAPITOL RADIO ENGINEERING INSTITUTE

An Accredited Technical Institute

Dept. 598, 16th & Park Rd., N. W., Washington 10, D. C.
Branch Offices: New York (7) 170 Broadway • San Francisco (2) 760 Market St.

**MAIL
TODAY**

CAPITOL RADIO ENGINEERING INSTITUTE
16th & Park Road, N. W., Dept. 598, Washington 10, D. C.

Gentlemen:
Please send me complete details of your new home study course in Television and FM Servicing. I am attaching a brief resume of my experience, education and present position.

NAME _____

STREET _____

CITY _____ ZONE _____ STATE _____

I AM ENTITLED TO TRAINING UNDER G. I. BILL.

Only **AIR KING** Experience

could Build this Matchless

WIRE RECORDER

PHONO-COMBINATION



**AIR KING Portable
WIRE RECORDER
Model A-750-1**

\$139⁵⁰

*Includes federal excise tax
Slightly higher in Zone 2*

AIR KING has the "know-how"!

BUILDERS OF FINE RADIOS for 28 years, AIR KING likewise pioneered the Wire Recorder. From the time of its drawing-board inception, AIR KING engineers laboriously strived for that perfect, popular-priced Wire Recorder . . . the recorder that guarantees vivid reproduction . . . and versatility to meet all uses. As a result of these years of concentrated effort toward perfection and the thousands upon thousands of AIR KING Wire Recorders still giving matchless service, the AIR KING is your best Wire Recorder buy.

AIR KING has the experience!

AIR KING PRODUCTS CO., INC., 174 53rd ST., BROOKLYN 32, N. Y. • Export Address: Air King International, 75 West St., New York 6, N. Y.

Compare these exclusive

AIR KING features -

- RECORDS DIRECT FROM RADIO
- RECORD PLAYER. Plays 10" & 12" records
- RECORDS DIRECT FROM PHONOGRAPH
- 5-TUBE AMPLIFIER (including rectifier)
- Automatic shut-off at end of play or rewind of wire
- Crystal mike for hand, table or stand
- Rewind speed: 6 times forward speed
- Erases automatically when recording over used wire
- Safety lock prevents accidental erasure
- Covered in leatherette. Luggage-type carrying case
- Weighs 30 lbs. • 5" Alnico V P.M. speaker
- Complete with these extras: Two spools of 15-minute wire and cable for radio attachment

AIR KING RADIO

Division of HYTRON RADIO & ELECTRONICS CORP.

The Royalty of Radio Since 1920



RADIO-CRAFT for



Learn RADIO

TELEVISION, ELECTRONICS by SHOP METHOD HOME TRAINING

Let NATIONAL SCHOOLS, of Los Angeles, a practical Technical Resident Trade School for almost 50 years, train you for today's unlimited opportunities in Radio

You receive all parts, including tubes, for building this fine, modern Superheterodyne Receiver. This and other valuable standard equipment becomes your property.

these two FREE books will tell you how



Good Jobs Await the Trained Radio Technician

You are needed in the great, modern Radio, Television and Electronics industry! Trained Radio technicians are in constant and growing demand at excellent pay—in Broadcasting, Communications, Television, Radar, Research Laboratories, Home Radio Service, etc. National Schools Master Shop Method Home Study course, with newly added lessons and equipment, can train you in your spare time, *right in your own home*, for these exciting opportunities. Our method has been proved by the remarkable success of National Schools-trained men all over the world.

You Learn by Building Equipment with Standard Radio Parts We Send You

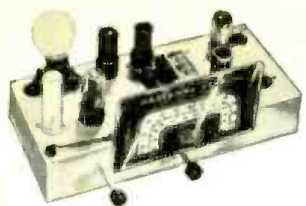

Your National Schools Course includes not only basic theory, but *practical* training as well—you learn *by doing*. We send you complete standard equipment of professional quality for building various experimental and test units. You advance step by step until you are able to build the modern superheterodyne receiver shown above, which is yours to keep and enjoy. You perform more than 100 experiments—build many types of circuits, signal generator, low power radio transmitter, audio oscillator, and other units. The Free books shown above tell you more about it—send for them today!

Now! NEW PROFESSIONAL MULTITESTER INCLUDED!



This versatile testing instrument is portable and complete with test leads and batteries. Simple to operate, accurate and dependable. You will be able to quickly locate trouble and adjust the most delicate circuits. You can use the Multitester at home or on service calls. It is designed to measure AC and DC volts, current, resistance and decibels. You will be proud to own and use this valuable professional instrument.

Lessons and Instruction Material Are Up-to-date, Practical, Interesting.

National Schools Master Shop Method Home Training gives you basic and advanced instruction in all phases of Radio, Television and Electronics. Each lesson is made easy to understand by numerous illustrations and diagrams. All instruction material has been developed and tested in our own shops and laboratories, under the supervision of our own engineers and instructors. A free sample lesson is yours upon request—use the coupon below.

Here's Just a Few of the Interesting Facts you Learn with the

FREE MANUAL

1. Routine for diagnosing Radio Troubles.
2. Preliminary inspection of Receivers.
3. How to Test and Measure Voltages.
4. How to Test Speaker in Audio Stages.
5. How to Trace the Circuit and Prepare Skeleton Diagram.
6. Complete Reference Table for Quickly Locating Receiver Troubles.

Both Home Study and Resident Training Offered

APPROVED FOR VETERANS

Check Coupon Below

NATIONAL SCHOOLS LOS ANGELES 37, CALIFORNIA EST. 1905 MAIL OPPORTUNITY COUPON FOR QUICK ACTION

National Schools, Dept. RC-9
4000 St. Flourens, Los Angeles 37, Calif. Paste on a postcard

Send me FREE the books mentioned in your ad including a sample lesson of your course. I understand no subscription will bill me.

NAME AGE

ADDRESS

CITY ZONE STATE

Check here if Veteran of World War II

GET THE DETAILS—SEND THE COUPON →

SEPTEMBER, 1948

ALPETH

NEW WORD ON TELEPHONE CABLES

Lead makes an excellent sheath for telephone cables—sixty years and thousands of miles in service have well proven that. But lead is useful in other ways—storage batteries and paint, to name only two. So the telephone industry shares the limited available supply with other claimants.

Before the war when there was no lead shortage, Bell Laboratories engineers sought to develop better and cheaper cable sheaths. An ideal sheath is strong, flexible, moisture-proof, durable and must meet specific electrical requirements. No single material had all those virtues, so thoughts turned to a composite sheath, each element of which should make a specific contribution to the whole.

Various materials and combinations were studied. Desirable combinations that satisfactorily met the laboratory tests were made up in experimental lengths, and spent the war years hung on pole lines and buried in the ground. After the war, with an unparalleled demand for cable and with lead in short supply, selection was made of a strong composite sheath of ALuminum and PolyETHylene. Now Western Electric is meeting a part of the Bell System's needs with "ALPETH" sheathed cable.

Meeting emergencies—whether they be storm, flood or shortage of materials—is a Bell System job in which the Laboratories are proud to take part.

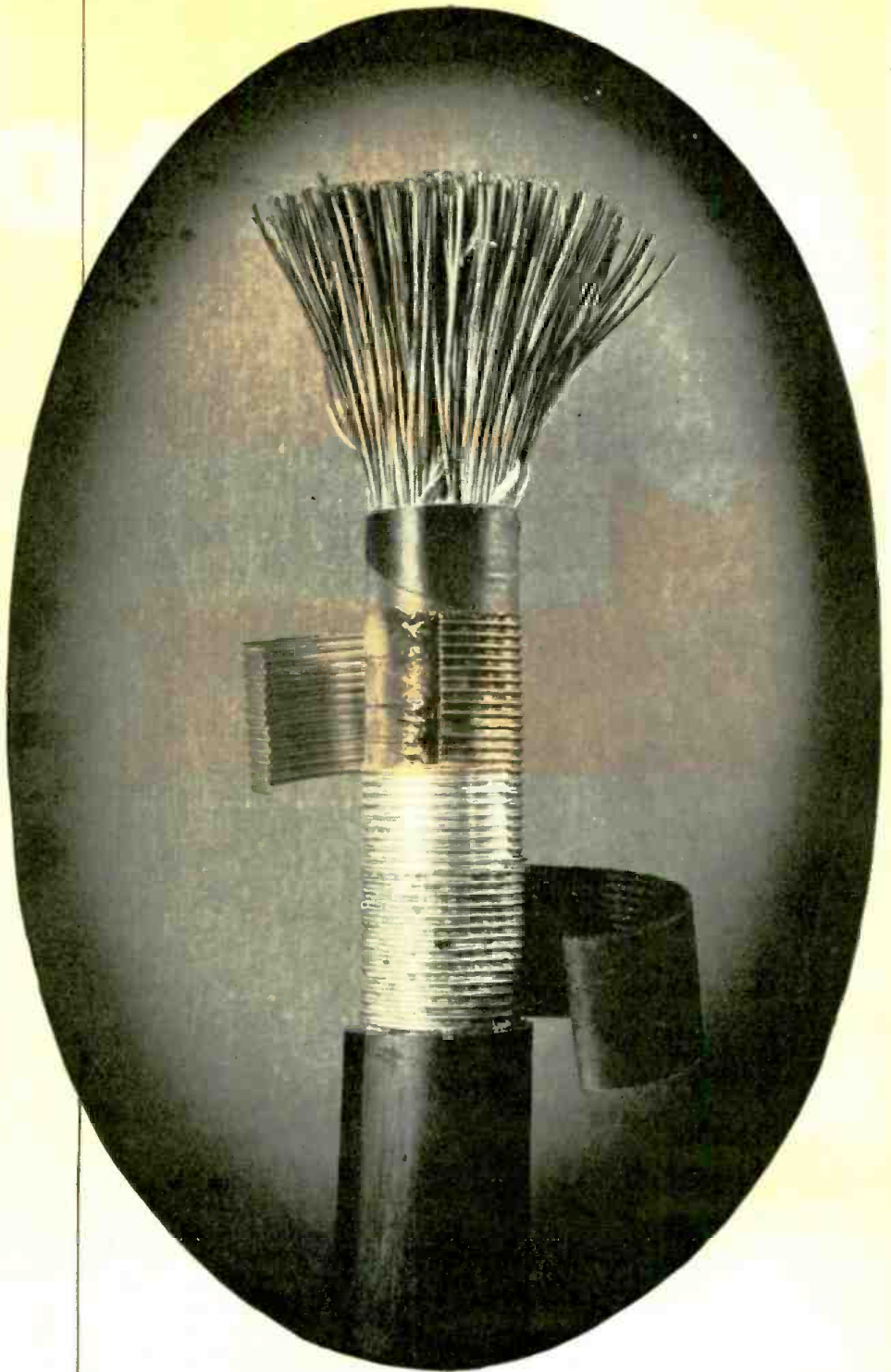

BELL TELEPHONE LABORATORIES



• EXPLORING AND INVENTING, DEVISING AND PERFECTING FOR
CONTINUED IMPROVEMENTS AND ECONOMIES IN TELEPHONE SERVICE.

RADIO-CRAFT for



FRANK L. SPRAYBERRY
famous Radio teacher of hundreds of successful Radio men.

GET THESE 2 BIG BOOKS FREE.

IF YOU WANT TO LEARN RADIO!

I TRAIN YOU RIGHT BY SENDING YOU 8 BIG KITS OF RADIO EQUIPMENT INCLUDING A POWERFUL 6 TUBE SUPERHET RECEIVER AND 16 RANGE TEST METER!

Radio job. Just mail the coupon for a FREE Sample Lesson and my big FREE book, "How To Make Money In Radio, Electronics, Television." It tells how I train you at home during spare hours by putting you to work building, testing, repairing Radio equipment. The Sprayberry Course teaches you Radio by working with 8 big kits of Radio parts I supply. You build a powerful 6 tube superhet Radio, a 16-range test meter, perform over 175 interesting, PRACTICAL experiments. My lessons are easy and interesting — you need no previous experience in Radio. I start you at the beginning... and give you valuable "bench" experience that sticks with you.

Soon after you start I send you my famous BUSINESS BUILDERS that help you earn EXTRA CASH getting and doing neighborhood Radio Service jobs while learning. You couldn't pick a better time to get into Radio. The Radio Repair Business is booming! Good Radio Service and Repair Shops are needed everywhere as millions of new sets are in use. Trained men are wanted for opportunities in Police, Aviation and Marine Radio, F.M. and Standard Broadcasting and Television. Manufacturers are looking for men who know Radio as production reaches new peaks. GET THE FACTS ABOUT YOUR FUTURE IN RADIO MAIL the COUPON TODAY for my FREE BOOKS

LEARN HOW TO BUILD-TEST-REPAIR RADIOS By Working with YOUR HANDS!

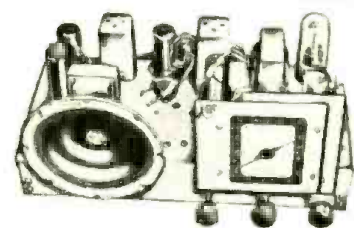

You really learn Radio the PRACTICAL way ... when you build this big, powerful 6-tube Superhet Radio from parts I send you.

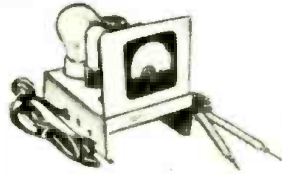

I give you a fine, moving coil type Meter — with parts for a complete analyzer and Circuit Continuity Tester. "Trouble-shoot" with professional accuracy.

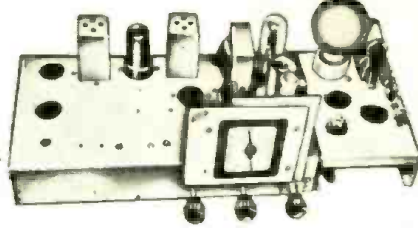

You don't have to buy expensive ready-made equipment. You get valuable experience building this Signal Generator and Multi-purpose Tester.

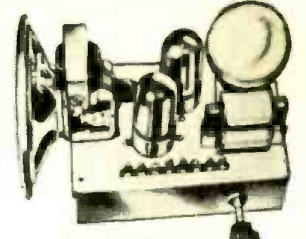

You construct this rectifier and filter, resistor and condenser tester, and really get on the Practical end of Radio.

LOW COST RADIO TRAINING STUDY AT HOME IN SPARE HOURS

Sprayberry Training costs surprisingly little! Easy monthly payments, if desired. Everything you need is furnished — nothing else to buy. With Sprayberry Training to back you up, you will be able to step into your own profitable Radio Service Business or go on to a big opportunity in Radio, Electronics or Television. The equipment I send you is yours "for keeps" — to use in your business or job. I have trained hundreds of successful Radio men — and I can help you too. Get the facts about Sprayberry Training — it's your first step to success, security and a bigger income in a field where you'll really enjoy your work. Fill out and mail coupon TODAY. I'll rush my two FREE books to you by return mail.

VETERANS: Approved for G. I. Training under Public Laws 16 and 346.

Sprayberry Academy of Radio
F. L. SPRAYBERRY, President
Room 2008, Sprayberry Bldg., Pueblo, Colorado

RUSH COUPON Today!

SPRAYBERRY ACADEMY OF RADIO
F. L. SPRAYBERRY, President
Room 2008, Sprayberry Bldg., Pueblo, Colorado

Please rush my FREE copies of "How To Make Money In Radio, Electronics and Television" and "How To Read Radio Diagrams and Symbols." No salesman will call.

Name _____ Age _____

Address _____

City and Zone _____ State _____

CHECK HERE IF A VETERAN
(Mail in an Envelope or Paste on Penny Postcard)



Trained Radio men can step into their own profitable Radio Service Shop — or —



New developments are constantly opening new big pay job opportunities in Radio.

2 out of 3 Need It!

ESPEY

The Custom-Built Chassis



According to a recent survey, over 18 million consoles were built before '44!

That's right! The newest are four years old, and there are more than 11 million of them that are ten years old. Of the 18 million owners, 51% or over 9 million LIKE their cabinets—in spite of the fact that the vast majority of receivers are hopelessly obsolete, lacking such present-day essentials as FM.

Furthermore, over 90% of the console owners WANT FM, but less than 6% HAVE it. What a replacement market!

It was to fill this tremendous need that ESPEY designed its line of top-quality custom-built chassis, supplied complete and ready to operate in your customers' cabinets.

For further details about the ESPEY replacement chassis, and the opportunities in the replacement industry, we urge you to write today to Dept. C-7.

ESPEY MANUFACTURING COMPANY INC.
625 EAST 72ND STREET—NEW YORK 21, N.Y.

"Established—1928"

SUPER-MITE RADIO

SUPER-MITE FEATURES! PACKS AMAZING POWER!

- World's most powerful miniature radio.
- Uses War-Born midget electronic tubes.
- Coast-wide reception obtained.
- Powered by midget hearing-aid battery.
- Picture diagram for radio beginners.



\$3.99

Brilliant red chassis, chrome and black dial, streamlined bakelite knobs. Complete kit ready to wire as shown. Only \$3.99 Post Paid. Tubes 95c each. This high quality set not available elsewhere at 10 times this price!

ELECTRONIC RESEARCH LABS.
1216 Park Row Bldg., Dept. RC, New York City 7

TELEVISION TECHNIQUES were used last month by Northwestern University to instruct doctors and medical students in operative methods. The broadcasts, described by the university as the largest medical classroom in the world, had an estimated audience of 7,000.

Four image orthicons were set up in the Passavant Memorial Hospital in Chicago, two above each of the two operating tables. Every detail of the operations was clearly picked up and reproduced on the screens of receivers on the Navy Pier and throughout the campus in classrooms. John K. West of RCA, which made the technical arrangements, said the setup was the largest temporary TV installation ever made.

During the operations, the surgeon in charge commented on each of the steps he took. Before the operations, he lectured on the case history.

The television technique has the same effect as the instructional operating theatre but it gives each student a much closer view and enables an almost infinite number of observers to watch at the same time.

A FACSIMILE machine designed to increase the speed of telegraph service was announced last month by Western Union. The machine, 10 x 11 x 7 inches, will be installed first in the offices of customers who handle five to twenty messages per day.

The sender of a message writes his text in longhand or by typewriter on a sheet of sensitized paper. The message is placed on a roller, in contact with which is a stylus. As the roller turns, current through the paper varies according to the written or typed marks.

The machine automatically becomes a receiver when the central office signals that a message is on hand. A blank sheet of sensitized paper is placed on

the roller and the stylus, transmitting current through the paper, causes the transmitted writing to appear.

The machine, developed less than a year ago by Garvice H. Ridings, is expected to cut time required for message transmission between New York and San Francisco to 10 minutes.

ULTRASONIC diagnosis and treatment of cancer was demonstrated last month by Drs. J. F. Herrick and E. J. Blades of the Mayo Foundation Institute of Experimental Medicine.

Supersonics, generated by crystals and transmitted to the body through paths of oil or water, travel in a sharply focused beam. The beam is reflected by any part of the body it hits, and where there is a cancer the character of the reflection or echo is abnormal.

After the cancer is detected it may be treated by the same type of ultrasonic beam, though with increased intensity. The beam, directed against the cancer, shakes it to pieces, destroying the tissues cell by cell.

The Mayo experiments have so far been only on animals. Other types of knifeless surgery using ultrasonics are also under investigation.

MINIMUM WAGES for radio technicians are established in a new order passed by the government of the Canadian province of British Columbia. The order, which went into effect June 1, defines the qualifications and the work of a radio technician and raises his minimum pay from the unskilled-labor rate of 54 cents per hour to 80 cents. The order also regulates the number of working hours and overtime pay.

The order was promulgated as a result of the work of the Associated Radio Technicians of British Columbia, an organization of radio repair, installation, and design technicians.

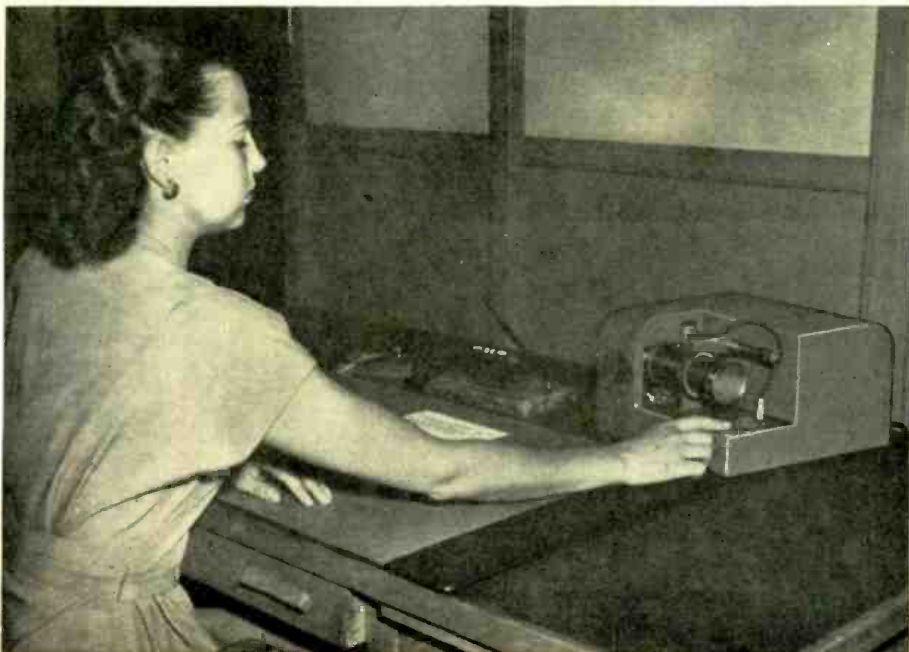

New Western Union facsimile machine brings the telegraph office to the executive's desk.

RADIO-CRAFT for

SPECIAL PERMITS for AM broadcast stations to operate beyond their regular daily sign-off times were abolished by the FCC last month. Limited-time stations have been applying for and receiving these "special temporary authorizations" for several years to permit them to broadcast programs which would not fit into their limited schedules.

The authorizations defeated the purpose for which the stations' broadcast time was limited—to prevent nighttime interference with others on the same frequency. The situation is particularly bad now that the number of AM stations on the air is so great.

THE IRON LUNG may be replaced by a new electronic instrument which was shown last month at the first international poliomyelitis conference in New York. The instrument, called an electronic stimulator, operates on batteries and is small enough to be carried anywhere. A motor and series of cams attached to a variable resistor vary the 2-millisecond, 40-per-second pulse out-

put of a standard nerve stimulator from zero to about three volts at the respiratory rate.

In using the device, the physician makes a small incision in the patient's chest and attaches a silver electrode to the phrenic nerve. The patient will then breathe at a rate which can be governed by adjusting the instrument. The stimulator is expected to be useful not only for polio victims but also for those suffering from poisoning and electric shock. It may also replace the respirator used to resuscitate drowning people.

FIRST 3-WAY TELECAST was made by NBC last July. The broadcast, held in connection with the Democratic convention, featured James W. Girard, former U. S. ambassador to Germany, who was in New York, Clinton Anderson, Secretary of Agriculture, in Philadelphia, and David A. Morse, acting Secretary of Labor, in Washington. The voices of all three were heard simultaneously and the picture of each appeared as he spoke during the informal conversation.

To make the broadcast possible, video signals from Philadelphia were sent to New York via the Philco microwave relay and the Washington signals were transmitted to New York on the north-bound co-axial cable. These, together with the signals originating in New York, were all available at the New York master switching panel. All that was necessary each time a new voice spoke was to throw the proper switch to send the speaker's picture to the New York transmitter (WNBT) and through the south-bound co-axial cable to the other stations of the network. An interesting point is that video originating in Philadelphia and Washington was sent to local receivers in those cities only after passing up to New York for switching and then back again via the regular network cable.

TO OUR READERS

YOU have now before you the first completely revamped and improved copy of the "new look" **RADIO-CRAFT**. The entire issue is now printed on a super-calendered paper stock; the magazine has been increased to 100 pages; color has been added throughout many pages; and the magazine has now been completely departmentalized, omitting all continuations. *This is only a start!* Further improvements will be made continuously.

We hope that you will be pleased with your magazine—your comments will be appreciated by

THE PUBLISHERS

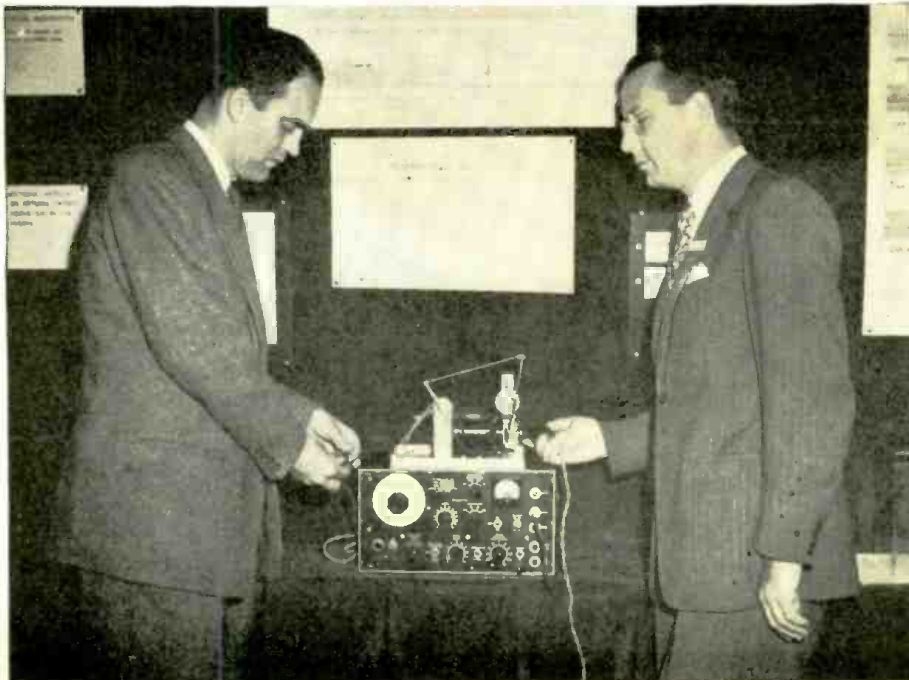

Dr. James L. Whittenberger and S. J. Sernoff with their electronic nerve stimulator.

SEPTEMBER, 1948

You Can't Match these MID-AMERICA Values!

Transformer Scoops!

Transformers listed are full-shell type, upright mounting. Color coded leads. Brand new! Quantities are limited—so order now!



MA-2510—Power Transformer 850 VCT, 200 MA; 5V, 3A; and 6.3V, 5A. 4 1/2" x 4" x 3 1/4". Regular list \$12.75. Now only, \$4.95 ea.

MA-2523—Driver Transformer 6F6 to 6L6. Class AB2. Rated 40 MA. Primary current. 3" x 2 1/4" x 3". A \$3.75 value. Mid-America's value price..... \$1.69 ea.

MA-2521—Filament Transformer 115 V, 6-cycle primary, 6.3V, 3A secondary, 3" x 2 1/4" x 2 1/4"..... \$1.49 ea.

Amazing FM Antenna

Model A-100 for use indoors—eliminates trouble of erecting outside antenna. Tunes 88-108 MC band with excellent signal gain. May be mounted on wall or out of sight under rug. Complete with twin lead-in cable; merely connect to receiver antenna posts. Brand new in original factory cartons. Shipping wt. 1 lb..... \$1.49 ea.

CONVERTERS!

These famous-make converters have never before been offered at these low prices! All are brand new, complete, ready for immediate installation and operation. Quantities are limited; get your order in NOW!

32-Volt DC to 115-Volt, 60-Cycle

Model 102, Rated 100 watts. Gray wrinkle-finish metal cabinet with ventilating louvres and bumper feet; measures 6 1/4" x 8 1/2" x 4". Has outlet receptacle, line cord and plug. Circuit is fused for overloads. On-off switch. A sturdy, dependable unit for many applications. Shipping weight 16 lbs..... \$17.95

Model 2115B. Dual output for operation of both radio and appliances; rated 100 watts. Streamlined metal case with smooth brown finish and chrome carrying handle. Complete with line cord, plug and overload fuse. On-off switch. Especially good for farm use. Measures 6" x 8 1/2" x 6 1/4"; shipping weight 15 lbs. Regular \$60 list..... \$22.95

Model 146. Heavy duty converter with wrinkle cable and clamps. Ventilated cabinet with wrinkle gray finish; bumper feet. On-off switch, two outlet receptacles. Rated 350 watts. Measures 9 1/4" x 15 1/2" x 7". Shipping weight 65 lbs..... \$59.50

115-Volt AC to 12-Volt DC

Model 2752. For operation of 12-volt DC equipment and for trickle charge of batteries. Rated 120 watts. Trim metal cabinet with ventilating louvres and bumper feet; smooth gray finish. Fused for overloads. Line cord, plug, on-off switch, 8 1/2" x 8 1/2" x 6 1/4"; shipping weight 22 lbs. Regular \$39.95 list..... \$15.95

115-Volt DC to 115-Volt, 60-Cycle

Model 267. Small unit for operation of clocks and other small motors. Rated 5 watts. Measures only 9" x 2" x 2"; shipping weight 3 lbs. Enclosed in smooth gray metal case. Has line cord and outlet receptacle. Regular \$16.95 list..... \$5.95

12-Volt DC to 115-Volt, 60-Cycle

Model 2774. Compact unit measures only 7 1/2" x 2 1/2". Rated 12 watts; fused for overloads. Smooth gray-finish metal case with mounting brackets. Regular \$49.95 list..... \$17.95

TERRIFIC SAVINGS ON CERAMIC GRID CAPS

3/4" clasp to fit 807, 2X2 and other popular tubes. Made by a famous manufacturer. Regular 21c. Get your share while they last at this sensational low price. MA-2234, 6 for 79c



Order from this Ad

Quantities on above-listed items are strictly limited! You must act fast to make sure you get what you want. Send 25% deposit. Pay balance plus postage on delivery. Get your name and address on Mid-America's select mailing list to receive monthly bargain bulletins that give you first crack at the latest, greatest, money-saving buys in radio parts, electronic equipment, tubes, etc. Send orders and mailing list data to Desk RC-98.

MID-AMERICA CO. Inc.

2412 S. Michigan Avenue
Chicago 16, Ill.

MORE and MORE TUBES and PARTS ARE BOUGHT FROM SENCO!

HERE'S WHY . . . Our policy of quantity buying, low overhead, cash sales, direct merchandising—eliminating all unnecessary expenses that add to your price—enables us to pass along large savings to you. Each and every item we advertise has been carefully priced and is offered to you at an absolute minimum cost. Take advantage of these savings now!

**THOUSANDS OF TUBES!
ALL BRAND NEW!
Individually Cartoned!**

R.M.A. Guarantee

Type	Each	Each	Type	Each	Each
0Z4	69c	59c	6V6GT/G	45c	39c
1A3	45	39	6X5GT/G	49	39
1A5GT/G	59	49	7A4	53	45
1A7GT/G	55	45	7A7	59	49
1H5GT/G	59	49	7B6	44	35
1L4	49	45	7F7	49	44
1L4A	49	39	7N7	49	44
1LH4	69	59	7X7		
1LN5	69	59	(KXFM)	44	35
1N5GT/G	59	49	7Y4	44	35
1R5	55	49	12A6	29	25
1S5	59	55	12A8GT	35	28
1T4	69	55	12AT6	50	45
1T5GT	59	49	12AT7	69	59
1U5	36	30	12BA6	50	45
1V7	45	39	12BE6	50	45
2A5	54	43	12F5GT	35	27
2A6	45	35	12H6	39	34
2A7	49	39	12J5GT	25	19
2X2/879	35	29	12J7GT	45	39

COMPARE OUR PRICES!

3A4	49	39	12K7GT	45	39
3Q5GT	55	49	12K8Y	35	25
3S4	55	45	12Q7GT	45	39
3V4	79	69	12SA7GT/G	40	32
5U4G	50	40	12SC7/1634	49	39
5W4GT/G	39	34	12SF7	35	32
5X4G	39	35	12SG7	43	37
5Y3G	42	37	12S17GT	55	49
5Y3GT/G	40	33	12SK7GT/G	45	35
5Y4G	39	32	12SL7	49	43
5Z3	49	39	12SQ7GT/G	40	32
5Z4	59	49	12SR7	35	32
6A7	59	45	14A7	65	55
6AB7	49	39	14B6	59	49
6AB7/1853	53	46	24A	49	39
6AC5	69	59	25A6	69	59
6AC7/1852	65	60	25L6GT/G	49	39
6AG7/6AK7	89	79	25Z5	49	45
6AK5	74	69			

IMMEDIATE DELIVERY!

6B7	55	49	25Z6GT/G	45	39
6BG6	79	69	26	45	32
6BJ6	69	59	27	49	44
6C4	29	25	32L7GT	52	48
6C5GT	40	35	35/51	45	32
6C5MG	89	79	35L6GT/G	45	39
6D5	45	32	35W4	43	40
6C8G	37	29	35Y4	43	40
6D6	49	45	35Z3	44	35
6F5	55	45	35Z5GT/G	43	39
6F6GT	45	39	36	35	29
6F7/VT70	45	39	39/44	25	19
6H6GT/G	45	39	41	49	45
6J5GT/G	45	39	42	47	41
6J6	59	49	43	54	47
6J7GT	42	38	45	49	39
6K6GT/G	45	39	45Z5GT	59	49
6K7G	50	41	47	49	39
6K7GT/G	45	39	47	49	39
6K8G	55	49	50A5	60	55

COMPARE OUR PRICES!

6L6G	79	69	50B5	42	32
6P5GT	59	49	50L6GT	50	45
6Q7GT	47	39	50Y6GT	50	45
6R7	55	45	56	45	39
6R7GT	59	49	57	45	39
6A4	49	39	58	45	39
6SA7GT/G	44	37	71A	39	29
6SB7	55	45	75	50	39
6SD7GT	39	34	76	49	45
6SF5	49	39	77	35	27
6SG7	44	39	78	49	39
6SH7GT	49	39	80	40	38
6S17GT	44	37	83V	79	69
6SK7GT/G	49	39	84/6Z4	49	39
6SL7GT	49	47	85	49	45
6SN7GT	49	47	99V	35	25
6SQ7GT/G	44	37	99X	35	25
6SD7	49	39	117Z6GT/G	89	76
6U6	49	39	182B	99	89
6U7G	35	25	1231	39	29
6V5G	59	49	1644	39	29

MINIMUM ORDER \$1.00
WHEN ORDERING —
Send 25% deposit for all
C.O.D. Shipments. In-
clude sufficient postage—
excess will be refunded.
Orders without postage
will be shipped express
collect. All prices F.O.B.
New York City.

**LOOK AT THESE ITEMS!
Heavy Duty SPEAKERS**

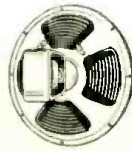

Top quality, precision-built speak-
ers at absolute minimum cost.

3" P.M.—.68 oz	Alnico V	ea. 99c
3" P.M.—1.47 oz	Alnico V	\$1.15
4" P.M.—1 oz	Alnico V	99c
4" P.M.—1.47 oz	Alnico V	1.89
5" P.M.—1 oz	Alnico V	99c
5" P.M.—1.47 oz	Alnico V	1.15
6" P.M.—2.15 oz	Alnico V	1.55
8" P.M.—6.8 oz	Alnico V	2.75
10" P.M.—6.8 oz	Alnico V	3.69
12" P.M.—3.2 oz	Alnico V	4.39
12" P.M.—6.8 oz	Alnico V	4.95
12" P.M.—21 oz	Alnico 3 with 6V6 P.P.	5.95
8" Output	Dynamic 680 ohms field with 6V6 P.P.	\$7.95 complete
12" Output	Dynamic 680 ohms field with 6V6 P.P.	3.95 complete
12" Output	Dynamic 1000 ohms field	6.95 complete
12" Output	Dynamic 1000 ohms field	5.95

Famous VOLUME CONTROLS



Nationally advertised brand.
An excellent buy!
All Brand New.

10,000 ohms V.C. with switch, 3" shaft	39
25,000 ohms V.C. with switch, 3" shaft	39
50,000 ohms V.C. with switch, 3" shaft	39
100,000 ohms V.C. with switch, 3" shaft	39
250,000 ohms V.C. with switch, 3" shaft—Tapped	49
500,000 ohms V.C. with switch, 3" shaft—Tapped	49
1 meg ohms V.C. with switch, 3" shaft—Tapped	49
2 meg ohms V.C. with switch, 3" shaft—Tapped	49

Only 44c Each

POWER TRANSFORMERS

All fully shielded, flush mount.
Quality construction at sensationally
low prices.



100 mll—6.3V @ 3 amps—5V @ 2 amps 750V C.T.	\$2.95
150 mll—6.3V @ 4 amps—5V @ 3 amps 750V C.T.	3.39
200 mll—6.3V @ 3.3 amps—5V @ 3 amps 812V C.T.	4.45

**Milwaukee AUTOMATIC
RECORD CHANGER**

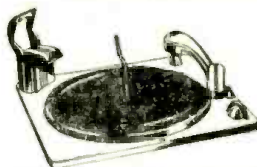

ONLY
\$13.95

Complete with
Astatic L-82
Crystal Cartridge,
Mounting Springs
and Full Instru-
ctions.

Amazing CARTRIDGE Value

Fresh stock of brand new
cartridges. Order now to
be sure you get all you
need.



L70 Astatic Crystal Cartridge	\$1.49
N7 Webster Crystal Cartridge	1.49
Astatic Nylon Cartridge	2.95

PLACE YOUR ORDER NOW!

TV REALLOCATIONS will have a profound effect on broadcasters and receiver owners, said John A. Willoughby, acting FCC chief engineer last month. Emphasizing the fact that he was speaking only for himself and not on behalf of the commission, Mr. Willoughby said the lower end of the present television band (channels 1-6) may be wiped out in two years, to make way for fixed and mobile services which require the space. Channels 7-13 will be used for TV for perhaps 10 years, in Mr. Willoughby's opinion, but only for "low-definition" transmission. The area above 500 mc will be used for high-definition black-and-white and color transmission, which may come in two years.

According to Mr. Willoughby, a television station starting operation on a low-frequency channel in the next two years is faced with possible loss of its transmitter and antenna investment. It follows that receiver owners would also take some loss, even if only that required to purchase conversion units.

FCC hearings on the TV allocation problem will begin September 20.

RAILROAD TELEPHONE service will be inaugurated soon on the 436-mile run between New York and Buffalo, Fred H. Baird, general passenger agent of the New York Central announced last month. This is the longest distance over which such a service has been planned to date. It is the first installation to be operated on the frequencies assigned for general highway mobile radio use in the 30-44-mc band.

Transmissions will be between the train, which will use a special type of antenna, and nine Bell System fixed stations spotted along the right of way. FM will be employed. Passengers will be able to make a telephone call from the train at any time during the journey.

Plans are made to extend the service over the remaining 525 miles between Buffalo and Chicago as soon as more fixed stations are ready.

ELECTROCUTION of Mrs. Harold E. Wiseman of Youngstown, Ohio, occurred last month when a radio she had placed on the edge of the bathtub fell into the bathtub. Death was swift and sure.

This is the third such death reported in RADIO-CRAFT in three months; many more have been unreported.

Every radio man realizes the great risk taken by any person who places a radio within reach of the bathtub or sink. It is up to radio men to warn their friends and customers that the mixture of radio and water may be even more dangerous than gasoline and alcohol.

WALKIE-TALKIES were used by 100 student surveyors of Rensselaer Polytechnic Institute in a 3-week field study concluded last month in the Poughkeepsie, N.Y., region. As the field men read their instruments they reported the findings by radio directly to the central office at Green Mountain Junior College. As a result, tabulation and mapping kept pace with field work.

SENCO RADIO INC
73 West Broadway, New York 7, N. Y.
TELEPHONE BEEKMAN 3-6498

Do you want to:

- ① Make Good Money?
- ② Have a Real Job?
- ③ Build for Future Security?
- ④ Have Your Own Business?

THEN get the facts about
OUR GREATEST OFFER
IN 17 YEARS . . . to help
 you learn **TELEVISION..**
RADIO..ELECTRONICS
IN YOUR OWN HOME

Here's good news...big news...our **BIGGEST NEWS** in 17 years. Now you get and keep many shipments of Radio-Electronic parts... work over 200 "Learn-By-Doing" Experiments... build and keep a quality 6-tube "Super" Receiver with Magic Tuning Eye... build and keep a commercial-type, jewel-bearing Multi-Meter... use fascinating, instructive **HOME MOVIES** to help you grasp important points faster easier... get real Employment Service.

Mail coupon below. Get the complete story. See how we do **BOTH**—(1) Prepare, then (2) Help you get started in America's thrilling Radio-Television-Electronic field.



Using the many shipments of parts and assemblies (left), you build and keep this 6-tube "Superhet" Receiver and jewel-bearing Multi-Meter (above) to give you practical experience **AT HOME in ASSEMBLY... WIRING . . . SOLDERING . . . TESTING . . . TROUBLE SHOOTING!**



You **KEEP** all of this equipment... **WORK OVER 200 "LEARN-BY-DOING" PROJECTS!**

TRAIN IN CHICAGO LABS
 If you prefer, you can get all of your training in our modern, well-equipped Chicago Laboratories. Write for all the details... there is no obligation.

LEARN FASTER . . . EASIER RIGHT: You receive the loan of a 16mm. Motion Picture Projector and many reels of "Learn-By-Seeing" film to speed your understanding of important points. You get this remarkably effective training aid **ONLY** from D.T.I.

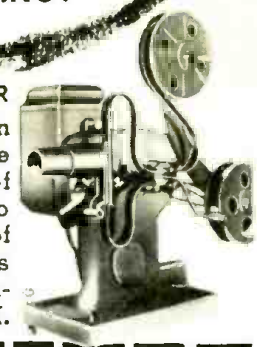

DeFOREST'S TRAINING, INC.
 CHICAGO, ILLINOIS
 Associated with DeVry Corporation,
 Builders of Electronic and Movie Equipment

DeForest's Training, Inc.
 2533 N. Ashland Ave., Dept. RC-E9
 Chicago 14, Illinois

MAIL TODAY

Send me complete details showing how I may make my start in Radio-Electronics-Television. No obligation.

Name _____ Age _____
 Address _____ Apt. _____
 City _____ Zone _____ State _____
 If under 16, check here for special information. If a discharged veteran of World War II, check here.

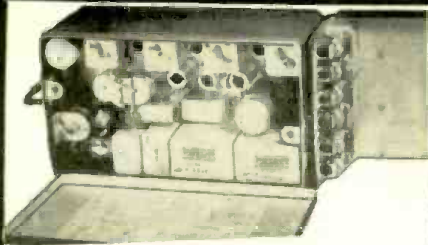

**GLIDE PATH RECEIVER
R 89/ARN 5 A**

Formerly used for blind landing but adaptable to many other uses such as receiver for new police or citizen's band. Band of operation 326-335 MC on any of three pre-determined crystal controlled frequencies. Contains eleven tubes, 6 relays and other valuable parts. For 24 V. DC operation. Size 13 3/4" x 5 1/2" x 6 3/4". Price, complete as shown **\$6.45**

MARKER-BEACON RECEIVER

Can be adapted to radio controlled devices. Was used by pilots to flash a signal lamp on aircraft instrument panel when in range of a beacon transmitter. Responds to modulated signals over a variable range of 62 to 80 Mc. Tube plates and filaments operate directly from 24 V. DC. Can be adapted for radio control of experimental apparatus opening garage doors, etc. Circuit diagram and parts list included on either model shown below:



BC-357—contains 12C8 and 12SQ7 tubes and sensitive relay (size 5 3/4" x 5 1/4" x 3 1/4"). **\$2.95**

BC-1033 — contains 6SN7, 6SL7 and 12SN7 tubes, sensitive relay (size 5 3/4" x 5 1/4" x 3 1/4"). **\$3.50**

OXYGEN TANKS



Aviators oxygen breathing bottles. Non-shatterable. Choice of two types.

(A) Withstands 2000 lbs. pressure.

(B) Withstands 500 lbs. pressure.

**CHOICE
\$4.95 ea.**

A B

APN-1 RADIO ALTIMETER

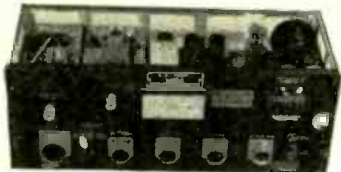

A complete 460 Mc. radio receiver and transmitter which can be converted for ham or commercial use. Tubes used and included: 4—12SH7, 3—12SJ7, 2—6H6, 1—VR150, 2—355, 2—9004. Other components such as relays, 24 V. dynamotor, transformers, pots, condensers, etc. make this a buy on which you can't go wrong. Complete as shown in aluminum case 18" x 7" x 7 1/4". **\$8.95**



C-1 GYRO

Part of the C-1 Auto Pilot which is sold separate and may be used to conduct many interesting and amusing experiments. Operates from 24 V. DC or may be operated for short periods on 110 V. AC. Gyro will run for approx. 15 minutes after actuating. Size—approx. 6" x 8 1/2" x 8 1/2". PRICE **\$8.50**

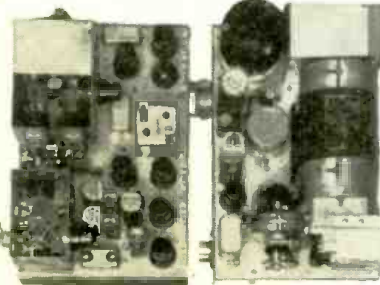

BC-966-A IFF

Approximately 2 meter frequency operation. 14 tubes. 350 V. DC dynamotor 12 V. DC input. Contains voltage regulators and many other fine parts. Worth more **\$4.75** for parts than price asked.



**BC-1155-A
SYNCHRONIZER**

Another invaluable unit for the Television and VHF experimenter. Contains 19 Mc. IF strip using 5—WE717A tubes. A total of 24 tubes included, consisting of 6—WE717A's, 2—6SL7GT's, 2—6AC7's, 5—6SN7GT's, 2—6NF7's, 2—6L6's, 1—6V6GT, 2—6AG7's, 1—6AG7, and 1—6H6GT. Other parts included are 6 pots, 10 Amphenol 831R chassis connectors and numerous condensers, resistors, and transformers. Weight **\$17.75** 22 lbs. Size 21" L x 11 1/2" W x 7 3/4" H.



SN-7C/APQ-13

Sensational offer for Television engineers. Contains 19 Mc. IF strip containing 5—WE717A tubes. Other HF strips containing 2—6AK5's, 3—6SL7GT's, 1—WE717A, 4—6SN7GT's, 2—6N7's, 2—6L6's, 1—6H6, 3—6AG7's, 2—6AG7's, 1—6V6. A total of 26 tubes. Other Parts such as DPDT relay, 7 pots, 12 Amphenol 831R chassis connectors, and numerous condensers, toggle switches, RF chokes, variable condensers, and transformers. Weight approx. 25 lbs. Size 20" L x 11 1/2" W x 7 3/4" H. PRICE **\$19.50**

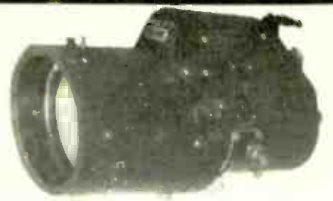

**INDICATOR SCOPE
ID-41/APQ-13**

About 6" diameter by 15" deep. Contains 1—5FP7, 1—6AK5 tube, 5 Grain of Wheat 3 V. pilot lights, magnetic deflection yoke, condensers, resistors, potentiometers, sockets. **\$6.95**

WILLARD LEAD ACID CELLS

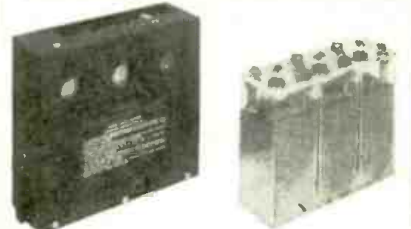

6 V. (New) (Dry-charged) **\$3.00**
6 V. (In metal carrying case) (Add electrolyte specific gravity 1.265) (Drugstore) **\$4.00**

**HRU (DC)
POWER SUPPLY**

24-28 V. at 70 amp. 2000 watts gasoline engine generator with electric starter. Power supply which can be used to operate 24-28 V. equipment, start airplane engines, charge batteries, as a welding machine, lighting system, or for amateur radio station. 21 1/2" x 24 1/2" x 11 1/2" lbs. **\$79.50**

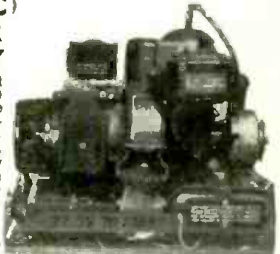

ARC-4 TRANSMITTER & REC.

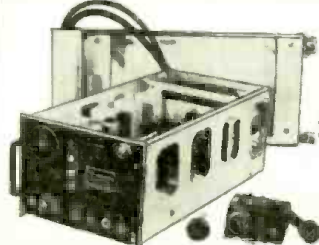

INCLUDING CASE
\$19.95

Operates on any of its 4 predetermined crystal controlled frequencies in the range of 140 MC. Complete with tubes, remote control, junction box, shock mounting base and connecting plugs. This unit is ideal for amateur UHF or mobile telephone. Operates from self-contained 24 V. DC dynamotor.

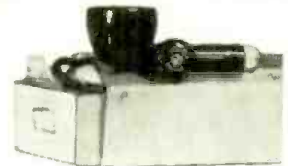

T-17-B CARBON MICROPHONES

(Handmade) (New) **\$1.35**



Radio Co
130 W. New York St.
Indianapolis 4, Ind.

Unless Otherwise Stated, All of This Equipment Is Sold As Used
CASH REQUIRED WITH ALL ORDERS
Orders Shipped F.O.B. Collect

Which Do You Want?



Better Pay



A Nice Home

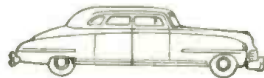

A New Car



Greater Security



Happy Vacations and Travel

Jobs worth \$3000 to \$7500 are opening up right now for FCC Licensed Radiomen

How to Pass FCC Commercial Radio Operator License Exams



GET YOUR FCC TICKET IN A FEW SHORT WEEKS

Get your license easily and quickly and be ready for the \$3000 to \$7500 jobs that are open to ticket holders. CIRE training is the only planned course of coaching and training that leads directly to an FCC license.

IT'S EASY WITH CIRE COACHING AND TRAINING

Your FCC ticket is recognized in all radio fields as proof of your technical ability. Employers often give preference to license holders, even though a license is not required for the job. Hold an FCC "ticket" and the job is yours!



I can train you to pass your FCC License Exams in a few short weeks if you've had any practical radio experience — amateur, Army, Navy, radio servicing or other. My time-proven training plan can help put you, too, on the road to success—

Let me send you FREE the entire story

Just fill out the coupon and mail it. I will send you, free of charge, a copy of "How to Pass FCC License Exams," plus a sample FCC-type Exam and Catalog A, describing opportunities for you in Radio-Electronics.

EDW. H. GUILFORD, Vice-President.

Get All 3 FREE Send Coupon Now!

Look what these students say:

"Thanks to this course, I now have a very good job in a local power plant's test department. I couldn't have obtained this job without the math and basic electrical theories in the first part of Section 1 of this course." Stud. No. 2893N12

"I have been working for Police Radio Station WPFS in Asheville for five months since getting my second-class ticket." Stud. No. 2858N12

"You may be interested to know that I am employed at the local broadcast station, where I am a transmitter operator. I took and passed the FCC examinations last February." Stud. No. 2754N12

CLEVELAND INSTITUTE OF RADIO ELECTRONICS
RC-9 Terminal Tower Cleveland 13, Ohio

Approved for Training under "G. I. Bill of Rights"

CLEVELAND INSTITUTE OF RADIO ELECTRONICS
RC-9 Terminal Tower, Cleveland 13, Ohio

I want to know how I can get my FCC ticket in a few short weeks. Send me your FREE booklet, "How to Pass FCC License Examinations" (does not cover exams for Amateur License), as well as a sample FCC-type exam and Catalog A, describing opportunities in Radio-Electronics.

NAME

ADDRESS

CITY ZONE STATE

Veterans check for enrollment information under G.I. Bill.

NO OBLIGATION—NO SALESMEN.

War Surplus Bargains

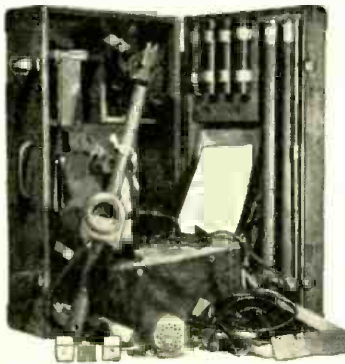

AN/PRS-1 MINE DETECTOR

The detector is designed to detect metals, non-uniformities (rocks, tree-roots) and may be used to detect metal buried in logs, to locate cables, pipes, sewer tile and etc. It is widely used by lumber camps, miners, prospectors, plumbers, treasure hunters and explorers.

A portable device used in the detection of both metallic and non-metallic by oral (ear) and visual (eye) means. These are brand new outfits, complete with instruction book and spare tubes. Shipped in original overseas moisture-proof container.

The set consists of the detector head with antenna and reflector meter, a meter housing and lower section of exploring rod, amplifier assembly, exploring rod extension, bag designated to carry equipment while operating, and wooden case for storing or transporting the complete unit when not in use.

Shipping weight, 125 lbs. Weight in operation only 22 lbs.

Batteries are not included but we can supply them for \$6.25 per set.

Price, brand new \$14.95

MG-149F INVERTER

(Holtzer-Cabot Elect. Co.)

Input 24 V. DC
36 amps.
Output 115 V. AC, 500 W. A.
Output at 90% P.F. . . .

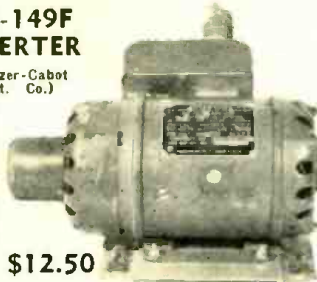

\$12.50

24V-L-3 50 AMP LEECE NEVILLE AIRCRAFT GENERATOR

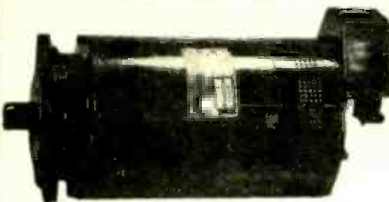

For Heavy Duty Work

24 V L-3-50 Amp—Leece Neville aircraft generator for heavy duty work. Can be used on automobile, etc., for that 24V rig. Weight 24 lbs—3" diameter—11" long—(3/4" diameter; 1" length shaft). Brand new \$17.50

BC-733D LOCALIZER RECEIVER

A part of aircraft blind landing equipment. Operates on any six of its predetermined crystal controlled frequencies in the range of 108-120 mc. Contains 10 tubes, three of which are WE-717-A's—and crystals. Ideal receiver for conversion to 144 mc. hom band or mobile telephone bands. For 24 V. D.C. operation. Size 14 1/2" x 7" x 4 1/2".

Price with dynamotor \$5.95

Price without dynamotor \$4.95

TERMS: CASH WITH ORDER

AMERICAN SURPLUS PRODUCTS CO.

537 N. CAPITOL AVE.
INDIANAPOLIS, IND.

VIDEO AUDIENCE SURVEYED

Stanley H. Manson, advertising manager of Stromberg-Carlson, revealed in a recent survey that 72% of the leisure time which television owners now spend viewing their television sets was formerly spent listening to radio. By way of comparison, a recent survey of Foote, Cone and Belding, advertising agency, shows that three-fourths of the television set owners interviewed are spending more evenings at home. Slightly more than half are going to the movies less often, although formerly they were confirmed and in most cases very heavy movie-goers.

Age of the television set did not appear to have any relationship to reported changes in movie-going habits, which tends to discount the theory that television's effect on evenings-out will diminish as the novelty of the new set wears off.

In the Stromberg-Carlson survey 60% were somewhat disappointed with their sets (mainly poor programming), 82% judged the video picture image "very good," 99% said they would buy a set again, 35% are interested in buying a second receiver, and 84% of all income groups expressed a desire to own a television set.

Although 73% now own table model sets and 27% consoles, 51% of those interviewed now want a console with all services, and while 86% of the owners had receivers with 10-inch tubes or smaller, 48% said they would insist on a larger tube in their next set, with the 12- and 15-inch most popular. Prices non-owners would be willing to pay is considerably lower than the price range satisfactory to owners. Thirty-five per cent of non-owners said \$400 or less, another 35% said \$400-\$600 and 30% over \$600. The study also indicated that in 75% of the cases the man of the house made the purchase decision, a high percentage compared to the sale of radio combinations.

Another interesting survey was made recently by Newell-Emmett Company, advertising agency. "Videotown-USA," a test television community has been selected to analyze the present television market and watch the growth of television over a period of time. Sets purchased in Videotown, located on the fringe of New York's television area, seem to be following the national average. The survey shows television ownership is in the middle-socio-economic group. Nearly two out of three sets are in the middle level. The actual breakdown shows that 60% of the sets are in the middle class; 26% in the upper and 14% in the lower. These figures compare closely with a survey made by television station WPIX in New York City recently.

The percentage of home sets is increasing rapidly. During the first half of 1947 41% were commercial installations. By the second half it dropped to 26%. The first three months of 1948 home percentage increased to 91% and the commercial installations dropped to 9%.

TELEVISION HELPS TAVERNS

Bell Television, Inc., which rents sets to tavern owners, recently made a survey in the New York Metropolitan area to measure results in this field.

To the question, "Do you believe all bars will eventually have television sets?" 64% said yes, 19% said no and 17% were undecided. Fifty-seven per cent stated that television increased business profit from 10% to 60%, averaging 16%; 34% reported no change in business; 9% noted a decrease.

Of all tavern owners interviewed, 67% had television receivers. Of that group 70% owned the sets while 30% rented them.

SPECIAL AUDIO-SOUND ISSUE

The October number will be a special Audio-Sound issue. Articles on public address systems, noise reduction, binocular audio systems, electronic organs, amplifiers, pickups and other audio-sound equipment and accessories will feature this issue. Reserve your copy at your newsstand NOW!

VIDEO TUBE PRODUCTION

Sylvania Electric Products, Inc., has entered a new financing program to aid in the expansion of cathode ray facilities. "The rate at which television is expanding makes it evident that more facilities will be urgently needed to meet the demand," said Don G. Mitchell, president.

At the present time, in excess of 95% of cathode ray tube production is for new television sets. Each set, however, constitutes a future replacement market. This is just beginning to develop and will grow as more sets come into use. Sylvania's expansion plans will be geared to both the new and the replacement markets."

BUYING OF TV SETS INCREASES

An increase of 37% in the ownership of television sets from May 1 to June 15 has been reported by Dr. George A. Gallup's Audience Research, Inc. This represents approximately 354,000 sets. From the same source it was learned that an additional 5,400,000 families would be in the market for sets priced around \$200, compared with a potential market of 2,000,000 for sets at \$400, the average current price. It was estimated that 1,000,000 additional families will purchase sets within the next year, and that the entire television area now covers more than 11,000,000 families.

RADIO FAMILIES INCREASE

The Broadcast Measurement Bureau reports 37,623,000 United States families now own one or more radio sets in good working order. This represents 94.2% of the total families and compares with 33,998,000 ownership, or 90.4%, in 1946.

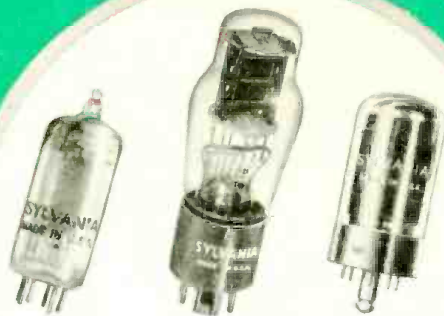

**SYLVANIA
RADIO TUBES ...**



**... MAKE THE SERVICE
DEALER HAPPY ...**



**... BECAUSE THEY KEEP
SET-OWNERS HAPPY!**

Whether a replacement job calls for miniatures, standard tubes or the famous Lock-Ins, you can install Sylvania Tubes with complete confidence. You know they'll give the kind of performance that builds good will among your customers!

And... don't fail to cash in on Sylvania's national advertising. Make full use of the Radio Serviceman's decal—your decal—featured in every single one of Sylvania's national ads!

DISPLAY THE DECAL THAT
BRINGS CUSTOMERS
TO YOU!



SYLVANIA ELECTRIC

Radio Tube Division, Emporium, Pa.

MAKERS OF RADIO TUBES; CATHODE RAY TUBES; ELECTRONIC DEVICES;
FLUORESCENT LAMPS, FIXTURES, WIRING DEVICES; ELECTRIC LIGHT BULBS

Sylvania Electric Products Inc.
Radio Tube Division
Advertising Dept., Room R-1309
Emporium, Pa.

Gentlemen:

Please send, FREE, the following quantities of the Sylvania Serviceman's decals:

..... 8-inch size 12-inch decals

Name

Company

Street Address

City Zone #

State

War Surplus Bargains Sold As Used Unless Otherwise Specified!

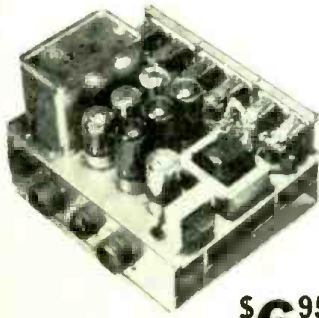

Complete **\$6.95**

C-1 AUTO PILOT AMPLIFIER

Used to control operation of servo unit in response to signals received from gyro unit and control unit. The complete amplifier includes one rect. 7Y4, 3-7F7's for amplification and control, 3-7N7's for signal discrimination, 1 power transformer, 6 relays, 4 control pots, chokes, condensers, etc. Convert for use on radio controlled models, doors, etc. Operates from 24 V. DC. Size, 9 1/4" x 6 1/4" x 7 7/8".



C-1 AUTO PILOT CONTROL BOX

Used for aligning control of C-1 Auto Pilot or use for parts, etc. Contains many useful pots., toggle switches, plugs, etc. Size, 11" x 6" x 4 1/2". PRICE

\$3.75



ROTATOR MOTOR FOR YOUR BEAM ANTENNA

\$14.95

As pictured on left

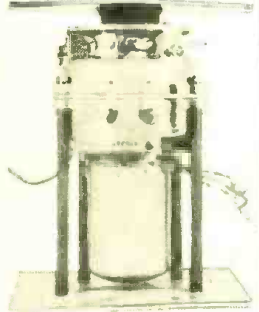

24-32 V. AC or DC operated. Reversible—only 3 wires required. Approximately 3/4 RPM. 7056 to 1 year reduction (no free swing). Powerful motor. Rugged precision gear train, and sturdy thrust bearing—will support and turn any ham beam. Weather-proof housing. Motors are easily converted into an FB beam rotator! Conversion data included.
 Motor with antenna mounting plates welded on.....\$6.00 extra
 Selsyn transformer for Selsyn indicators, 110 V. AC input, 25 V. AC output \$2.75
 Transformer for beam motor, 110 V. AC input, 2-12 v. Secondary windings, Rating 11 amps.\$4.95



AIR COMPRESSOR

Made by Cornelius Mfg. Co. Will pump pressure up to 1500 lbs. per sq. in. 3-stage type—air-cooled, powered by a 24 V. DC motor. Ideal in shop for use with airgun, small paint sprayer, and numerous other applications. Small, compact, precision - built. Only

\$12.95



2-METER BEAM ANTENNA

Portable or fixed, manually operated or can be used with beam motor, for use in 100-156 Mc. band. Easily adapted for ham or experimental use. Contains tuning unit which matches output of transmitter to antenna, 18' steel mast with brass tube containing co-ax cable and fittings inside steel mast (OD color), "H" frame for holding dipoles, 3 sets (4 per set) dipole rods, compensator or sense antenna for "H" frame, 2 steel truncated cones used as antenna support and feed-through, 360 degrees bearing indicator, and hand-wheel for rotating.
 Brand new backed in six boxes, total weight approx. 600 lbs. Limited quantity and in much demand. Place order now.

PRICE **\$79.50**

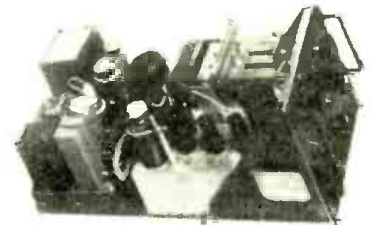

T-26/APT-2 RADAR TRANSMITTER

Contains tunable VHF circuit using 2-JAN CTL 7C3A's or 368AS tubes. Other tubes are: 2-5R4GY's, 1-2X2, 1-807, 1-6AG7, 2-6AC7's, and 1-931A. Other parts such as 24 V. DC motor and blower, MV. condensers and transformers, terminal strips and Amphenol connectors, knobs, fuse holders, etc., make this unit invaluable for parts alone. Weight approx. 45 lbs. Size 21" L x 10 1/2" W x 7 3/4" H. in metal case.\$9.75

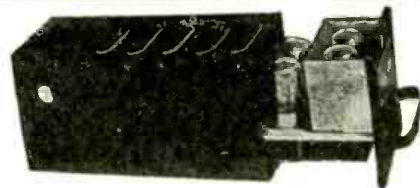

MICRO SWITCHES

R-RS, brand new in original box. Packed 10 per carton. SP type normally closed.
 Price per carton **\$2.35**

TURBO AMPLIFIER

Used for parts—shipped complete with the following tubes:

- 2.....7 C5's
- 1.....7 Y4
- 1.....7 F7

Price.....\$1.75 ea.
 Telephone LINCOLN 8328

TERMS: CASH WITH ORDER

AMERICAN SURPLUS PRODUCTS CO.

537 N. CAPITOL AVE.
 INDIANAPOLIS, IND.



PP-2/APQ-5 POWER UNIT

400 cycle, 115 V. Contains 10 tubes as follows: 2-5U4G's, 1-6X5GT, 4-6Y6G's, 1-6SL7GT, 2-VR150-30's and numerous condensers, transformers and resistors. Weight 17 lbs. Size 21" L x 5 1/2" W x 7 3/4" H. PRICE **\$5.75**

ARGON INCANDESCENT LAMP

2 watt pear shape with regular AC type screw base. New **25c each**

ALL PRICES F.O.B. INDIANAPOLIS

**LOW
FACTORY
PRICES!**

... on the Sensationally NEW 1949
MIDWEST RADIOS

**NEW
SERIES 16
SUPER DE LUXE
AM-FM
CHASSIS**

30 DAYS TRIAL

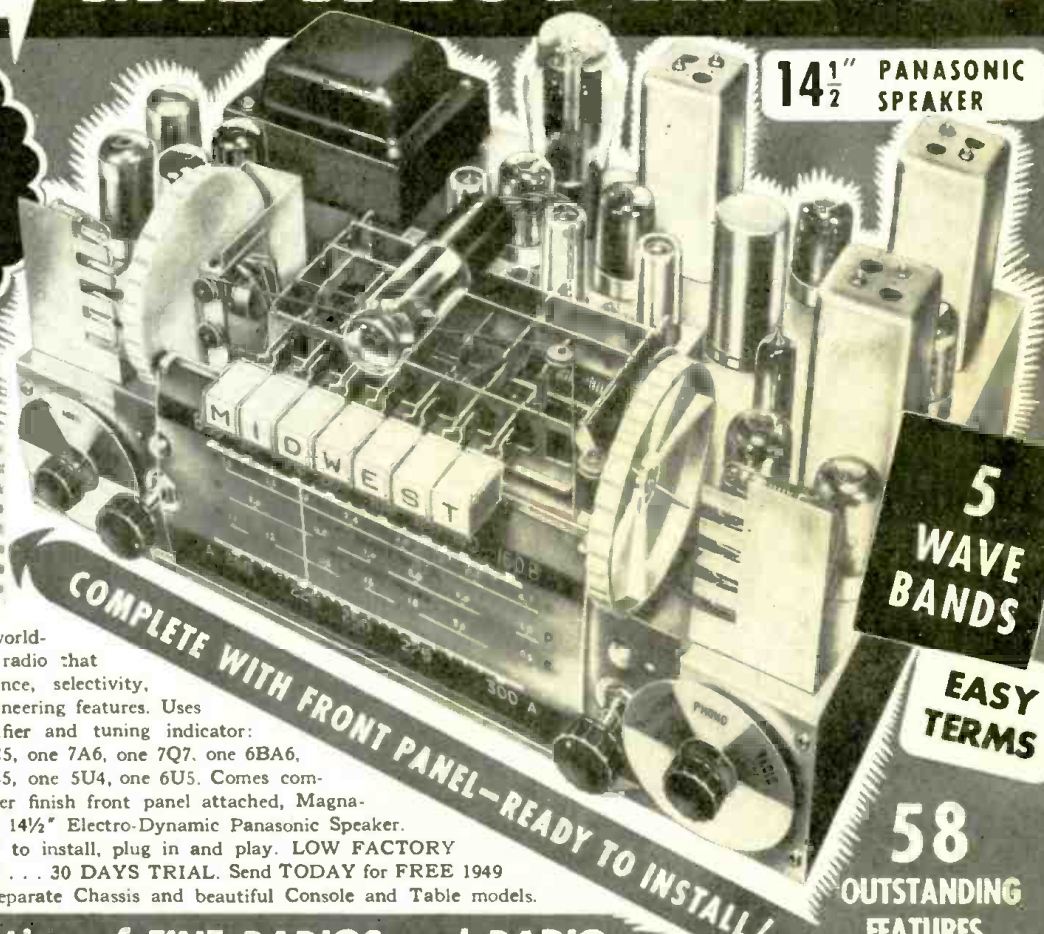

**14 1/2" PANASONIC
SPEAKER**

**5
WAVE
BANDS**

**EASY
TERMS**

**58
OUTSTANDING
FEATURES**

COMPLETE WITH FRONT PANEL—READY TO INSTALL!

Here is the last word in radio engineering . . . a powerful, world-ranging, magnificently-toned radio that is unsurpassed for performance, selectivity, sensitivity, and advanced engineering features. Uses these latest-type tubes, rectifier and tuning indicator: three 7A7, three 7A4, two 7C5, one 7A6, one 7Q7, one 6BA6, one 6BE6, one 6C4, one 6AL5, one 5U4, one 6U5. Comes complete with satin stripe copper finish front panel attached, Magna-Tenna Loop Aerial and giant 14 1/2" Electro-Dynamic Panasonic Speaker. Requires only a few minutes to install, plug in and play. **LOW FACTORY PRICES . . . EASY TERMS . . . 30 DAYS TRIAL.** Send TODAY for FREE 1949 Midwest Radio Catalog of separate Chassis and beautiful Console and Table models.

A Complete Line of FINE RADIOS and RADIO-PHONOGRAPHS . . . Available in SEPARATE CHASSIS Like the POWERFUL SERIES 16 AM-FM Model above or in COMPLETE CONSOLES like this...



**Beautiful
SYMPHONY GRAND
AM-FM Radio-Phonograph with
TELEVISION Audio Switch-Over
and NEW Intermix AUTOMATIC
RECORD CHANGER**

A Magnificent musical instrument and a masterpiece of cabinet design—the finest Midwest Radio in 29 years of manufacture. Offers world-ranging radio reception and newest automatic Intermix Record Changing Phonograph. Uses Series 16 Super De Luxe AM-FM Chassis. Giant 14 1/2" Panasonic Speaker; Tri-Magnadyne Coil System; Built-In Loop Antenna. Other luxurious console and table model cabinets available with Series 16, 12, and 8 chassis—on Easy Terms and 30 Days Free Trial.

- Including the Exclusive Midwest
- FLASH-O-MATIC**
Volume and Band Indication
- TELEVISION**
Audio Switch-Over
- FIDEL-A-STAT**
Color-Ray Tone Selection
- TRI-MAGNADYNE**
Coil System
- ...Plus **NO-DRIFT FM**
and many other features

Rush for Free Catalog!

**FILL IN COUPON AND MAIL TODAY OR JUST
SEND NAME AND ADDRESS ON 1c POSTCARD**

**MIDWEST RADIO & TELEVISION CORP.
Dept. 381, 909 Broadway, Cincinnati 2, Ohio**

Please send me your new FREE 1949 Catalog.

NAME _____
ADDRESS _____
CITY _____ ZONE _____ STATE _____

BUY DIRECT FROM FACTORY and SAVE!

MIDWEST RADIO & TELEVISION CORP.

Dept. 381 909 Broadway, CINCINNATI 2, OHIO

Buy WHERE YOU SEE THIS BANNER ... because IT'S BETTER FOR YOU!

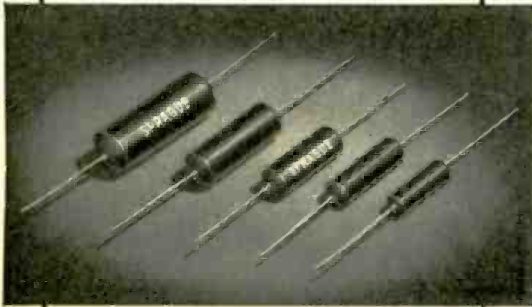

SPRAGUE TM TUBULARS

The first truly practical MOLDED Paper Tubulars! Now in stock—ready for your use—See your SPRAGUE Distributor.



SPRAGUE ATOMS—DRY ELECTROLYTICS

You can make up virtually any required capacity-voltage combination with a small stock. Keep a representative supply in your shop. **SAVE TIME—SAVE MONEY—SAVE SPACE!**



SPRAGUE EL SELF-MOUNTING MIDGET CAN CAPACITORS

No other Dry Electrolytic gives so much dependability in so small a space! Tinned, Twist-Prong Tabs for easy soldering; quick, universal self-mounting. **SAVES TIME—SPEEDS RELIABLE SERVICE!**



Yes, its better for you *and your business* to buy where this banner is displayed because the **SPRAGUE BANNER** identifies a Distributor who agrees that *"It's foolish to play penny-ante when your business is at stake!"*

Your Sprague Distributor is a successful business man. He knows the parts business intimately—and he knows that to really build a bigger, more successful service business, you should use only the best replacement parts. That's why he features Sprague Capacitors and *Koolohm Resistors. His business depends on your success and he wants you to remember that **YOUR REPUTATION AND YOUR CUSTOMERS ARE TOO VALUABLE TO RISK FOR THE FEW PENNIES "SAVED" BY BUYING INFERIOR OR UNKNOWN "BARGAINS"!**

*Reach for a SPRAGUE
and Know You're Right!*

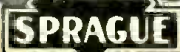

Yes! We're Listed in the **RED BOOK**

Looking for the correct Sprague replacement capacitors for any receiver manufactured from 1938 to 1948? It's easy—just refer to The Radio Industry **RED BOOK** . . .



CAPACITORS

SPRAGUE

*KOOLOHM RESISTORS

*T.M. Reg. U.S. Pat. Off.

SPRAGUE PRODUCTS CO., North Adams, Mass. • (JOBING AND DISTRIBUTING ORGANIZATION FOR THE PRODUCTS OF THE SPRAGUE ELECTRIC COMPANY)

RADIO-CRAFT for

SOVIET RADIO LAND-TORPEDO

A novel radio-telemechanic war means . . .

By HUGO GERNSBACH

DURING World War II the Russians employed a unique type of radio land mine which was used extensively against the Germans. Very little about it has been published up to now. We are indebted to the French periodical *La Nature*, from which the writer has abstracted the following highly informative account:

Up to a few years ago it was common practice to stop advancing enemy troops by blowing up buildings and fortifications by means of time bombs. The French population well remembers the terrible explosions which took place regularly several days after the Nazis evacuated French cities. No sooner did the city go back to its routine life than public buildings began to blow up, terrorizing the population. These explosions in most cases were set off by clockwork or by the well-known means of slow working acids which corrode metal diaphragms to activate the explosive charge.

A much more up-to-date means was used by the Russians beginning in 1942, with their radio mines, type F10.

F10 is a square metal housing which contains a radio receiver to which is attached an antenna 100 ft. long. Connected to the receiver are one or more mines.

A Russian model known as BIS could explode 36 mines simultaneously. These mines were electrically connected with each other. The various mines are placed about 50 yards distant from the *commandoreceiver* F10. By using an auxiliary amplifier type, BEREDO, it is possible to separate the mines a great deal farther.

The receiver is housed in a waterproof rubber sack to keep out moisture, rain, etc. The whole is buried to a depth of about 10 feet. The mines themselves can be placed in the ground or under walls, into foundations, etc.

The antenna is camouflaged carefully somewhere along the wall. F10 is equipped with an ingenious mechanical device. If technical trouble develops and the mines should not function, the entire radio receiver is destroyed so it cannot fall into enemy hands.

The installation uses a 12 volt storage battery for "A" current and a 90 volt "B" battery. Using a special clockwork, the receiver is put into operation every five minutes, but only for 10 to 15 seconds. This safeguards the installation in many ways and conserves batteries. Thus, it is possible to operate the F10 for as long as 40 days after it has been installed.

The distant transmitter sends out a series of precisely defined signals. At the receiver they are ampli-

fied and passed on to a system of three accurately tuned relays. Only when the three exactly registering pulses open a special cipher circuit is it possible to operate the detonator, which then explodes the mine or mines.

The transmitters used were standard Russian types. In order to explode the F10 mines, these transmitters had to send out special low-frequency impulses. The signals were sent four seconds apart.

The F10 wreaked tremendous havoc against the *Wehrmacht*. This continued for quite a while until by accident three installations were found intact. Now there began a technical war against the Russians. It was soon found that by using special amplifiers the clockwork could be heard up to about 20 feet, whereas without amplifiers it could only be heard about 1 foot away. Detection work, however, was exceedingly difficult and nerve-racking for the Germans, who knew that at any instant a Russian *commandotransmitter* might start transmitting and blow up F10 in their faces.

Even after F10 had been located, it was absolutely necessary to act with lightning rapidity, as in any given moment whole blocks could be blown up by the distant Russian commandoradio transmitters. The antenna had to be located quickly so it could be cut as close to the receiver as possible in order to reduce the sensitivity of the buried receiver. Then the batteries had to be disconnected, the clock mechanism put out of order, and the special mechanical delay detonator made harmless. Naturally, only specialists could do this tremendously difficult work.

The Germans evolved many countermeasures, but finally the following proved effective. Using 20 different receivers the Intelligence Service tried continuously to intercept the special signals. Using two special 100-watt transmitters operating continuously, the Nazis began sending out counter signals on exactly the same frequency. Two reserve transmitters also of 100 watts stood ready to take over in case the first two should be put out of commission. Further, a 1½ kw transmitter stood by in order to blank out the Russian signals with powerful counter transmitters. This *Störsignal* (counter signal) was transmitted as long as the Russian transmitter was on the air. The Russians countered the Nazi means by increasing *their* transmission power over 1½ kw to blank out the Germans in turn.

In practice, however, the Germans—usually being nearer to the buried receivers—were able to come out on top in this interesting radio battle.

COVER FEATURE

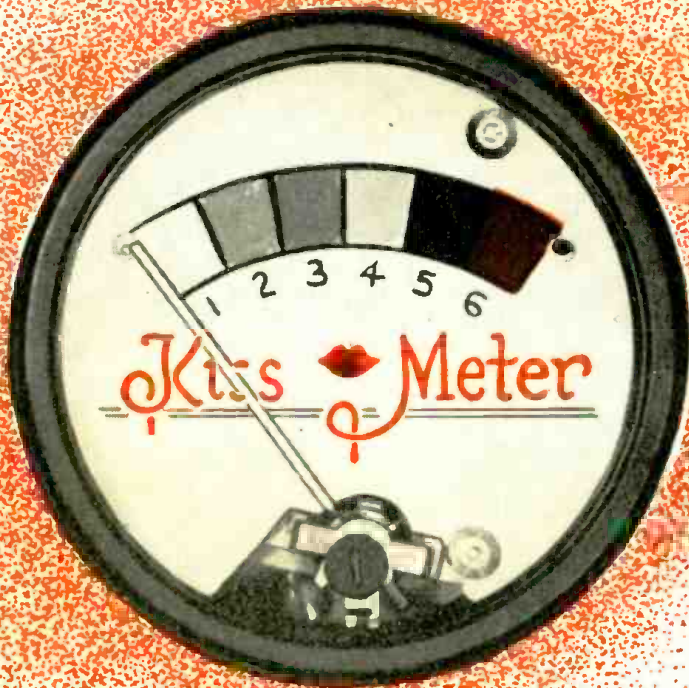

Electronic Osculation Indicator

By LYMAN E. GREENLEE

THE Kiss Meter is a scientific instrument designed to measure osculation reaction. With it you can tell whether blondes have more resistance than brunettes or redheads. An adept Lothario can probably find this out without the aids of science, but the meter gives us a good insight into biological electronics.

The meter measures the a.c. impedance of the human body at a frequency of about 400 cycles. Two electrodes formed of spring brass or copper are shaped to fit the wrists of the two persons undergoing the test. The electrodes are connected to the meter terminals. The applied a.c. voltage is very small, and this reduces the possibility of a disagreeable shock to the experimenters. Actually there is little or no sensation to be felt, although a very sensitive person will usually imagine that there is a slight tingling effect. A vacuum-tube voltmeter is required for adequate sensitivity. A balanced bridge circuit was chosen to insure stability.

A large cabinet happened to be on hand. Its use makes the instrument look impressive, but there would be plenty of room in a smaller case. As Fig. 2 indicates two 6J5's are used in a bridge circuit with a 0-200 or 0-500 microammeter to form a stable, highly sensitive vacuum-tube voltmeter. If a 0-500- μ a meter is used, the 1,500-ohm shunt will not be needed. A special scale (shown in Fig. 1) was drawn for the meter on white bristol board and colored to represent six degrees of osculatory intensity: 1 white, 2 blue, 3 green, 4 yellow, 5 orange, and 6 red. This covers the whole emotional range from "frigid" to "torrid."

A third 6J5 is used to generate the

400-cycle current for making the impedance measurements. A small push-pull output transformer was used, with the 6J5 cathode connected to the center tap of the secondary. No capacitor was necessary across the secondary winding with the particular transformer used, but some transformers may require about .005 μ f. The output is taken from the voice-coil winding. This keeps the voltage low enough so that little or no shock can be felt. Some transformers may not work successfully in this circuit. In case of difficulty try another transformer.

The power supply uses a 7Y4 connected as a half-wave rectifier and a small power transformer from a midget radio. If a center-tapped transformer is used, half the secondary winding may be disregarded. Since there was no separate filament winding for the rectifier on the power transformer used in the model, all the tubes were operated from the same 6.3-volt secondary; but, if a separate winding is available for the rectifier, it should be used to avoid excessive voltage between heaters and cathodes of the other tubes. Note that the output from the power supply is con-

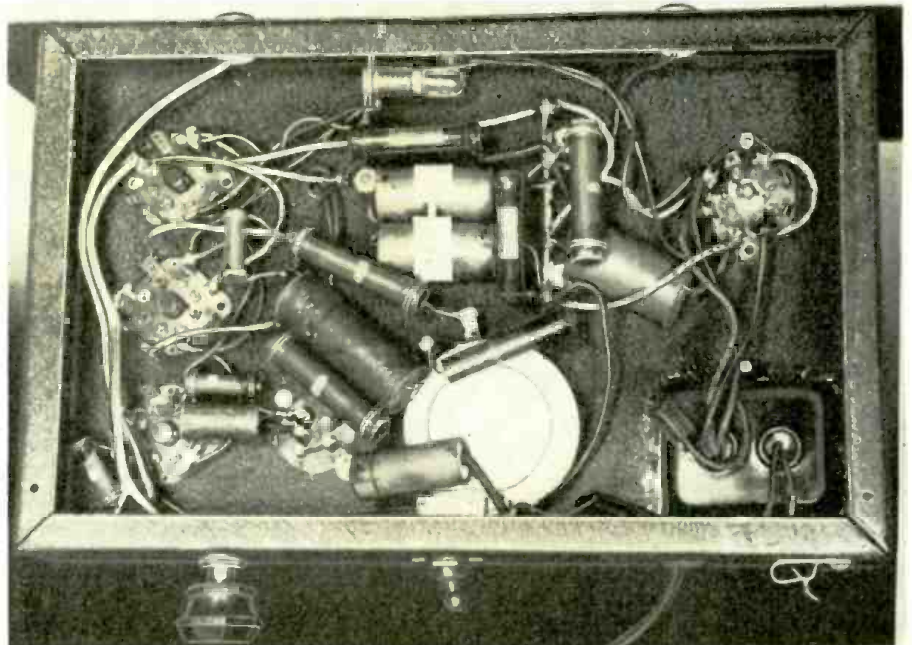

Under-chassis view of the Kiss Meter. Sensitivity control is at back, zero on chassis.

RADIO-CRAFT for

BIOLOGICAL ELECTRONICS — By HUGO GERNSBACH

WHEN the accompanying article by Mr. Greenlee was first received, it was thought that its publication might strike some individuals as too fanciful. But, biological electronics being something rather new, I believe it deserves a great deal more publicity. There is much to be learned about the effect of disease on the human anatomy, and it is quite possible that in the future we may investigate many diseases and illnesses by means of electronics.

Karl Friedrich Burdach, German physiologist and biologist, probably was the first scientist to investigate human osculation. He defined it as a "Galvanic contact between a positively and negatively electrified body: it increases sexual polarity and permeates the entire body."

Since this early pronouncement, nearly 100 years ago, other scientists have preoccupied themselves with the subject, particularly on the basis of sexual selection. The propagation of the human race depends upon many factors; and many of our senses are involved in this selection, be they visual, oral, or tactile. Osculation is one of these, and up to now it has

not been investigated too seriously.

Dr. G. W. Crile has demonstrated that the human life stream is continuously discharging electrical potential. It is a fact that many parts of the human animal are actively affected by *galvanotropism*—response of living things to electric stimuli.

It has been shown experimentally that during the act of kissing there is an actual exchange of electrical potential as well. Although only a weak current, it exists nevertheless.

Some years ago the writer did some research work along these lines and the following were noted:

To begin with, lips are covered with a mucoid membranous skin. This very sensitive skin is subject to many and varied influences. In different individuals and in different races, for instance, the thickness varies a great deal. Speaking generally, the male lip has somewhat thicker skin than the female. Age changes the thickness and consistency of this skin a great deal. Repeated measurements with an electrical potential have shown that the electrical response of the lip skin varies over a wide range. Thus, as might be ex-

pected, pressure affects the resistance. So does lipstick, which sometimes increases the electrical resistance, depending on the type used.

Moisture, of course, lowers the resistance a great deal, the degree depending upon the nature of the moisture. If the lips are moistened with the tongue, the resistance varies greatly with the state of health of the individual as well as with what foods had been ingested. Thus, for instance, the lip response of an individual was measured before and after drinking lemonade. After drinking this acidulous liquid, the resistance of the lip skin fell almost to the lowest point.

It was also found that emotions greatly affect electrical resistance of the human lip skin. Thus, fright—as is well known—dries up mucoid skin, and under this influence the resistance went up enormously. We all know from experience that during great emotional stress, such as fright, shock, etc., most individuals automatically lick their parched lips, which have become almost completely dry with an accompanying increase of electrical resistance.

nected to a voltage divider to supply about 150 volts positive plate potential, and 80 volts negative bias. No filter, other than the single 8- μ f electrolytic capacitor and the two 2- μ f electrolytics, is required. Larger capacitors can be used, but they are not necessary.

A 1-megohm potentiometer shunted with a 250,000-ohm resistor controls the input sensitivity, but a 200,000-ohm potentiometer may be used without the resistor. The 5,000-ohm zero-adjustment potentiometer should be wire-wound.

Fig. 2 shows two .005- μ f capacitors connected across the input of the power transformer and grounded to the chassis. A single .005- μ f capacitor connected directly across the line may also be tried. The meter is very sensitive and has a tendency to respond to any 60-cycle a.c. voltage introduced between the chassis and either side of the power line. In some cases it may be necessary to reverse the a.c. line plug or have the users stand on rubber matting.

The photographs show the wiring and placement of parts. The correct voltages at various points in the circuit are indicated in Fig. 2. These voltages were all measured from chassis using a 1,000-ohms-per-volt meter. If correct voltages do not appear, vary the resistors in the voltage-divider circuit until voltages are correct. It may be necessary to insert an additional resistor in series with the 20,000-ohm bleeder to cut the plate voltage at this point to 150.

The two controls that require adjustment are mounted, one at the rear and one on the top of the chassis, to prevent tampering with the calibration. The 5,000-ohm potentiometer is used to

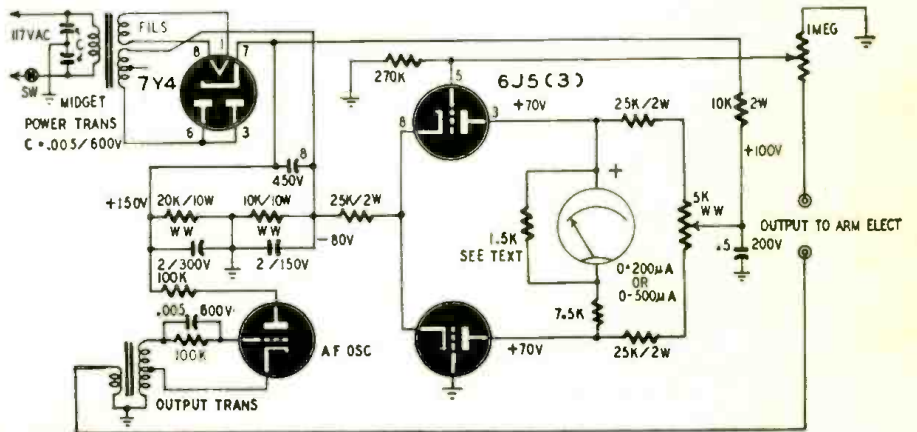

Fig. 2—Schematic. With some transformers, the oscillator plate may need bypassing to ground.

adjust the zero point of the meter with the arm electrodes disconnected. The 1-megohm potentiometer is used to set the sensitivity so that the meter reads full-scale with the arm electrodes shorted together. These are the only two adjustments required and they will rarely need to be altered, as the instrument is very stable in operation.

To insure adequate contact with the experimenter's wrist, it is a good idea to dampen the spring contactors with a little salt water. Small wads of cotton soaked with salt water or vinegar can be inserted between wrist and wristbands for better contact, if necessary.

The instrument was constructed for a specialized purpose, but the circuit might find much wider use. It is an a.c. impedance meter, which could easily be used to check inductors and capacitors,

resistors, etc. For such purposes a multi-scale instrument would perhaps be desirable. The author has not tried to adapt the instrument to the service bench, but the idea is attractive.

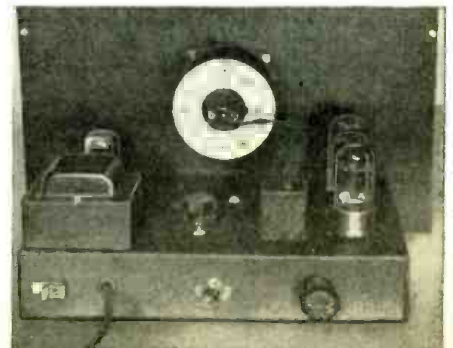

The chassis is much smaller than the cabinet.

Transistor—germanium crystal that oscillates and amplifies

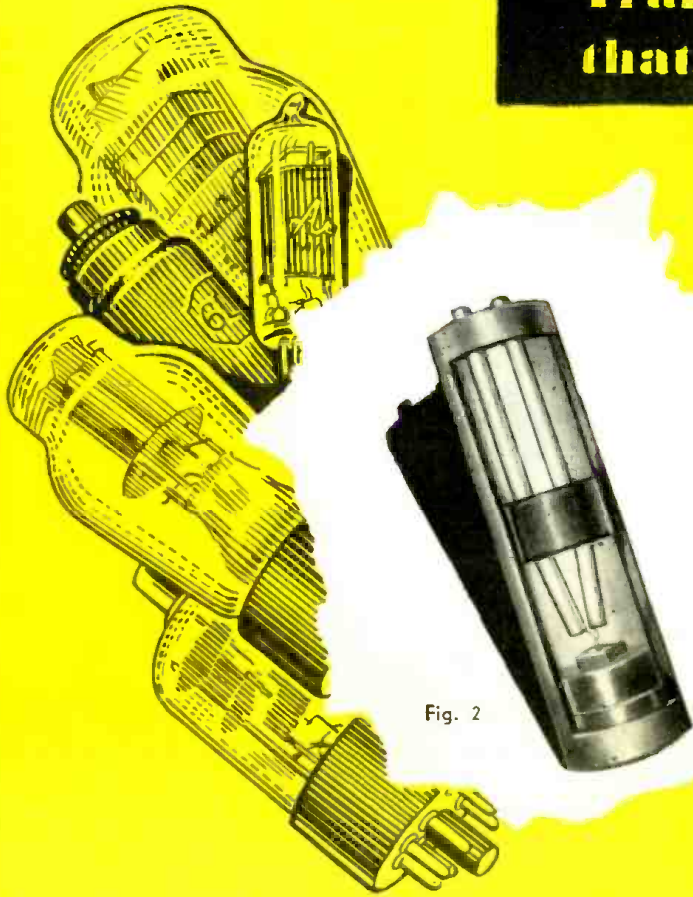

Fig. 2

Eclipse of the Radio Tube

THE beginning of the end of an era in radio—the era of the vacuum tube—was heralded on June 30 when the Bell Telephone Laboratories demonstrated a simple, revolutionary replacement for the vacuum tube.

Although still only a laboratory development, this device, known as a *transistor*, will do everything that the conventional vacuum tube can do, i.e.: amplify and oscillate. Yet, it consists of nothing more than a tiny piece of germanium crystal (similar to the 1N34) soldered to a metal base with two phosphor bronze or tungsten points spaced only .002 inch apart making contact with the top surface. The whole is inclosed in a metal cylinder less than an inch long (see Fig. 1). The device operates at normal room temperatures, and—unlike the vacuum tube—requires no cathode heating or vacuum.

A cross-sectional view of the device is shown in Fig. 2. The two hair-thin

contacts and the germanium crystal can be clearly seen.

The implications of this development, once it emerges from the laboratory and is placed in commercial channels, are staggering. No longer will it be necessary to supply power—whether it be by batteries or filament heating transformers—to heat an electron-emitting cathode to incandescence. The transistor requires only two low-voltage, low-current bias-voltage sources to operate as an amplifier or oscillator. Lighter and smaller pocket radio sets will be one of obvious results. Cheaper receivers will be possible because of the elimination of heater and filament circuits.

The first transistors have voltage gains of approximately 10, roughly the equivalent of a medium-mu triode.

There are two limitations on the use of the transistor at the present state of its development.

The first is the maximum frequency at which it will operate satisfactorily.

10 megacycles is the present upper limit.

The second limitation is the amount of power which can be developed in the units. This is 50 milliwatts. However, the maximum frequency and power limits of the transistor have not yet been explored and it is quite probable that with the knowledge gained from more experience in their use and manufacture, both figures will be raised.

A table model radio broadcast receiver using no vacuum tubes was demonstrated. This receiver was a modification of a commercial vacuum-tube receiver purchased in the open market.

Another tubeless set—the equivalent of a line-operated 10-tube conventional broadcast superheterodyne receiver—was also demonstrated.

In another demonstration a two-stage video amplifier incorporating two transistors was connected in series with the video line to a television receiver monitor to illustrate the low-distortion wide-range amplification of the device.

Fig. 3 shows a complete plug-in audio oscillator unit. The unit contains a transistor, a transformer, two condensers, and two resistors. The four-prong tube base of this unit connects to the necessary batteries and to a loudspeaker. This unit performed exactly the same as a vacuum-tube audio oscillator.

Transistor circuits

As far as circuit applications are concerned, the transistor may be compared to the conventional vacuum tube triode.



Fig. 1—This photograph shows how small the amplifying unit is. The crystal and the two contacts are enclosed within a tiny cylinder.

In fact, the transistor is defined as a semi-conductor triode.

Fig. 4 is a simplified schematic diagram of a typical amplifying circuit using a transistor.

The circuit looks very similar to a conventional triode circuit, if the emitter contact is considered as the control grid and the collector contact as the plate, with the semi-conductor base as the cathode.

Unlike the vacuum tube, however, the emitter contact is biased with a small positive voltage (1 volt) while the col-

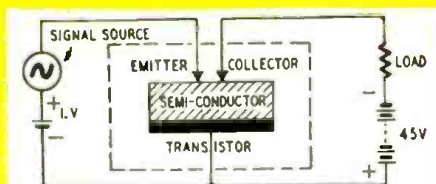

Fig. 4—This is basic transistor amplifier.

lector (or output) contact is supplied with a negative potential of approximately 45 volts.

Another fundamental difference is that the input impedance of the transistor is low, ranging from 200 to 1,000 ohms. Output impedance ranges from 10,000 to 100,000 ohms. Thus, the transistor can be matched to a high impedance load. Because of the low input impedance it will be necessary to use special input circuit arrangements.

Gain can be varied by varying the amount of bias applied to the emitter contact, much as gain in a triode can be varied by changing the grid bias.

The transistor can be used in any type of oscillator circuit where a vacuum tube triode can be used. Fig. 5 shows one oscillator circuit.

Transistor development

The transistor is the outgrowth of experiments and theoretical studies of semi-conductor phenomena by Dr. William Shockley of the Bell Telephone Laboratories, assisted by Drs. Walter Brattain and John Bardeen.

In critically examining the implications of the prevailing theory of electrical conduction in semi-conductors, Dr. Shockley was able to predict that it should be possible to control the meager supply of electrons inside a semi-conductor by influencing them with an electric field imposed from the outside without actually contacting the material. Realizing the practical implications of such a possibility he devised some experiments to test his hypothesis but was unable to secure positive results. The electrons seemed to get trapped in the surface of the material and did not behave just as anticipated.

This part of the problem was tackled on a theoretical basis by Dr. Bardeen. He developed a theory of what happened at the surface which was able to explain satisfactorily many of the observed facts and which led to further experiments carried out in collaboration with Dr. Brattain. In the course of these experiments they invented transistors.

Transistor action depends upon the



Fig. 3—Transistor plugs into a tube socket.

fact that electrons in a semi-conductor can carry current in two distinctly different ways. This is because most of the electrons in a semi-conductor do not contribute to carrying the current at all. Instead they are held in fixed positions and act as a rigid cement to bind together the atoms in a solid. Only if one of these electrons gets out of place, or if another electron is introduced in one

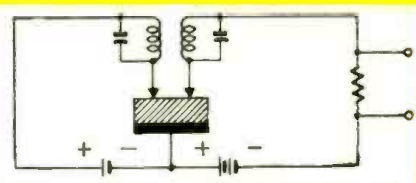

Fig. 5—Transistor replaces oscillator tube.

of a number of ways, can current be carried. If, on the other hand, one of the electrons normally present in the cement is removed, then the "hole" left behind it can move like a bubble in a liquid and thus carry current.

Fig. 6-a represents a cross-section of a germanium crystal with a positive voltage applied through a point contact (the emitter).

The current flow under this condition does not fan out from the emitter contact point through the body of the crystal material to the base, but instead spreads out widely over the surface of the crystal somewhat like water spreads out on top of a non-porous surface such as glass. This current flow across the surface is carried by the holes.

The amplification process can be understood in terms of the discovery that the emitter point is surrounded by an "area of interaction." Within this area the electronic structure of the semi-conductor is modified by the input current. Now, if the output point (the collector) is placed in this area and a negative bias applied to it the output current can be controlled by the input current. This control of output current by input current is the basic mechanism of amplification. The optimum spacing between

the emitter and the collector is about .002 inch. Increasing the spacing decreases amplification. The "area of interaction" extends out to a distance of about .01 inch from the emitter point.

If the negative collector bias is made large enough to make the collector current equal to, or larger than the emitter current, the polarity of the collector bias will attract the holes flowing from the emitter (Fig. 6-b). Then a large part of the emitter current flows to (and enters) the collector. While the collector has a high impedance to the flow of electrons into the crystal semi-conductor, there is little opposition to the flow of the holes into the collector point. If the emitter current is varied by feeding in an a.c. signal, the collector current varies correspondingly. The flow of holes from the emitter to the collector may alter the normal current flow from the crystal base to the collector in such a way that

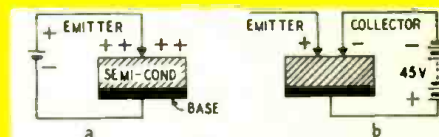

Fig. 6—This shows how transistor amplifies.

the change in collector current will actually be larger than the change in emitter current; in effect, amplification.

Historical background

In 1923 a Russian, O. V. Lossev, claimed to have successfully caused a crystal detector to oscillate and amplify. An account was published in the September, 1924, issue of one of Hugo Gernsback's former radio publications. Unlike the transistor, this arrangement (called the crystodyne) made use of a 2-contact crystal detector and relied on special circuits to get the desired results. Results were poor.

In the early part of this century Dr. Greenleaf W. Pickard produced oscillations with a crystal detector circuit. The circuit, however, was impractical. Pickard said:

"Any contact which doesn't obey Ohm's law can be used to produce oscillations. A crystal rectifier can also be made to amplify—although the simple contact must be changed to something more complex."

The Crystal Detector

Part III—Modern crystal cartridges

By JORDAN McQUAY

THE technique of high-frequency rectification with crystals or minerals is almost as old as radio itself. Beginning in 1902, Pickard and other pioneers developed the crystal detector which, until supplanted by the more efficient vacuum tube¹, was the chief means of radio reception. Decades later, modernized and improved crystal

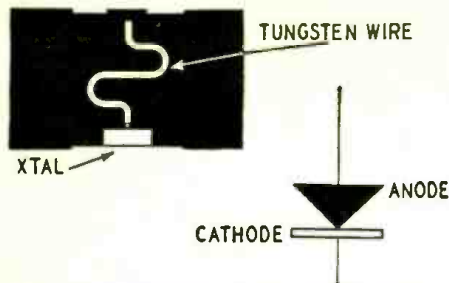

rectifiers returned to become the sole method of frequency conversion for microwave superheterodynes². So successful were these rectifier cartridges that other types were soon developed for other rectifying purposes at radio and audio frequencies as well as at power frequencies.

All modern crystal cartridges are essentially *point-contact rectifiers* (Fig. 1) having a small-area contact between a wire of tungsten or similar metal and a semiconductor of either silicon or germanium.

Semiconductors constitute a special class of materials between conducting and nonconducting solids. They have a high electrical resistance, between that of metals and insulators, and are much more sensitive to the presence of impurities than are metals.

If small amounts of certain impurities are added to either silicon or germanium, the resulting material can be made to function *nonlinearly* (not in accordance with Ohm's law) when placed in contact with a suitable conductor of fine wire. The nonlinear characteristic is decidedly polarized, as shown in Fig. 2. This curve reveals an important characteristic: the *back-to-front* ratio determined by the resistance of the rectifier in the front and back directions.

Rectification takes place across a *potential barrier* produced at the contact point of the semiconductor, due to the difference in functioning between the

metal conductor and the semiconductor. The barrier permits a flow of electrons from the semiconductor to the metal wire, but prevents electron flow in the opposite direction³.

This rectifying action is made possible by the inclusion of a small percentage of certain impurities, sometimes known as *doping ingredients*, in the basic, bulk material, silicon or germanium. Conduction depends upon impurities on the order of 0.1%. By rigid control of these impurities, the characteristics of a contact rectifier can be altered to satisfy any electrical requirement^{3, 4}. Besides bettering the performance of existing types of rectifier cartridges, im-

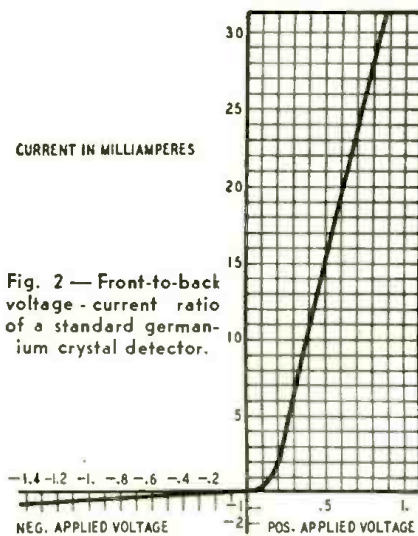

Fig. 2—Front-to-back voltage-current ratio of a standard germanium crystal detector.

proved methods of doping semiconductors have led to many different crystal types for various circuit applications. See Tables 1, 2, and 3.

Silicon rectifiers

A majority of the modern types of crystal cartridges (Fig. 3) developed during and since the war are for use as mixers or frequency converters in microwave superheterodyne receivers. (See Table 1.) Also, numerous types of rectifiers known as video detectors have been developed for direct demodulation of microwave signals, without the use of a superheterodyne circuit. (See Table 2.) And one type of crystal cartridge, the 1N22, is an instrument rectifier for microwave test and measuring equipment.

For all of these functions, where the operating frequencies are on the order of 1,000 to 25,000 mc, only silicon in crystalline form is a satisfactory semiconductor.

Silicon is a nonmetallic element, with a melting point of about 2,600 degrees F. Although it is one of the most abundant elements, it is never found free in nature. The pure crystalline form, obtained by chemical reduction, is a silvery, brittle substance in the form of globules or 6-sided pyramids. Pure silicon crystal, however, is not suitable as a semiconductor.

A crystalline form is first obtained at a high temperature from silicon tetrachloride. The silicon crystals are then melted in a vacuum, and to this melt small impurities are added, according to the intended use of the finished product. For microwave mixing or frequency conversion, aluminum, beryllium, and boron are added. For video detection, nickel and germanium, with extremely small amounts of bismuth, calcium, and cobalt, are mixed with the bulk silicon.

After the impurities have been added, the substance is cooled and sawed into sections about 1 mm thick. Both sides of each section are fairly well smoothed, but one side is finished and polished.

Next, the contact surface is given an oxidizing heat treatment⁵. Each slab is heated for several hours until a blue color appears, indicating the formation of a thin oxide layer. During this oxidizing period, various impurities in the silicon diffuse into the adhering silica



Fig. 3—Typical crystal for converter stage.

film, decreasing the amount of impurities on the surface of the silicon. The oxide layer is removed by a solution of

dilute hydrofluoric acid. The underlying layer of silicon is exposed and remains intact, as the acid does not readily attack the silicon. Any decrease in the impurity content of a semiconductor increases its resistance. Thus, the silicon surface has a higher resistance than before the oxidizing treatment. The characteristics of a silicon rectifier are governed by the resistance of the semiconductor, the area of contact, and the degree of surface oxidation.

In general, silicon rectifiers are confined to very-low-power circuits, usually on the order of 1 watt or less.

Although silicon could be treated for use at much lower frequencies, ger-

manium crystal cartridges are far more efficient for that purpose.

Germanium crystals

The need for crystal rectification at lower frequencies and at higher power led to the development of the germanium pigtail cartridges.

Existing types of germanium rectifiers can be operated at any frequency up to about 250 mc with a maximum back voltage of 200 and a safe maximum forward current of 150 ma. (See Table 3.) Improved types now under development will withstand inverse voltages up to 250.

The tiny cartridges are used as second detectors and d.c. restorers in television receivers, modulators and demodulators, voltage regulators, discriminators in FM circuits, volume limiters, varistors, meter rectifiers, noise silencers, and in other applications.

A matched unit, known as the 1N35 duo-diode, consists of two almost identical germanium rectifiers in a single mounting (Fig. 4). The two diodes are matched for values of forward and back resistance (within 10% at 1 volt), and are particularly desirable where full-wave rectification is required in a balanced circuit.

The highly polarized, nonlinear characteristics of all these crystal diodes are due essentially to the use of germanium (with certain impurities) as a semiconductor in contact with a sharp tungsten or platinum wire⁴.

Germanium is a rare metallic element which is silver-white, lustrous, hard, and brittle, with a melting point of about 1,755 degrees F. In the electrochemical series of elements, germanium (No. 28) is considerably more electropositive than silicon (No. 45); however, the properties of the two are very similar.

Never found free in nature, germanium occurs in many sulphide ores, usually in the form of germanium dioxide. The amorphous metal is obtained by chemical reduction. Impurities are then added to improve the quality of the germanium as a semiconductor.

For efficient low-frequency rectification with high inverse voltages, antimony and tin, with extremely small amounts of calcium, nickel, and strontium, are added to the bulk germanium. These combined impurities total less than 0.1% of the whole.

After melting and cooling, the substance forms diamond-shaped crystals. The ingot is sawed into wafers about 0.6 mm thick. Each wafer is polished on one surface, and then cut into four squares, 3 mm on a side. Next a crystal wafer is silver-soldered to one wire of the cartridge, and placed in contact with a tungsten or platinum point. The isolantite cartridge is wax-filled to maintain correct adjustment and make the unit moisture-proof and shock-proof.

It is reasonable to believe that within a few years there will be sufficient types of germanium rectifiers to supplant all vacuum-tube diodes, with a consequent saving in cost, weight, volume, and filament power consumption.

References

1. *The Crystal Detector* by Jordan McQuay, RADIO-CRAFT, July, 1948.
2. *The Return of Crystal Rectifiers* by Jordan McQuay, RADIO-CRAFT, Aug., 1948.
3. *Theory of VHF Rectification by Silicon Crystals* by H. A. Bethe, Rad. Lab. Report 43-11, MIT, 1943.
4. *The High-Voltage Germanium Rectifier* by S. Benzer, NDRC Report 14-342, Purdue, 1944.
5. *Development of Silicon Crystal Rectifiers for Receivers* by J. H. Scaff, R. S. Ohl, Bell Sys. Tech. Jour., Jan., 1947.
6. *The Germanium Crystal Diode* by E. C. Cornelius, privately publ., Sylva, 1946.

Other Bibliography

- Radar Engineering* by Fink, McGraw-Hill, 1947.
- Low Level Crystal Detectors* by Berlinger, Rad Lab Report, 61-15, MIT, 1943.
- Crystal Rectifiers* by Torrey, Whitmer, McGraw-Hill, 1948.

TABLE 1
SILICON RECTIFIER CARTRIDGES
(for frequency conversion in microwave superheterodynes)

Type	Optimum Freq. (mc)	Relative Sensitivity	Max. Conversion Loss (db)	Max. Output Noise Ratio	Av. Power Input (μ w)	Max. Power Input (μ w)
1N21	3,000	Low	8.5	4.0	0.4	1.0
1N21A	3,000	Medium-Low	7.5	3.0	0.4	1.0
1N21B	3,000	Medium	6.5	2.0	0.5	1.0
1N21C	3,000	Medium-High	5.5	1.5	0.5	1.0
1N23	10,000	Low	10.0	10.0	0.1	1.0
1N23A	10,000	Medium-Low	8.0	8.0	0.1	1.0
1N23B	10,000	Medium	6.5	6.5	0.1	1.0
1N24	25,000	Low	14	4.0	0.2	0.5
1N25	1,000	High	8.0	2.5	7.0	20.0
1N26	25,000	Medium	8.5	2.5	0.1	1.0
1N28	3,000	High	7.5	2.5	0.4	1.0

TABLE 2
SILICON RECTIFIER CARTRIDGES
(for video detection)

Type	Optimum Freq. (mc)	Minimum Video Freq. (cycles)	Minimum Video Impedance (ohms)	Maximum Video Impedance (ohms)	Maximum Power Input (μ w)
1N27	3,000	500	0	4,000	5
1N29	1,000	500	6,500	24,000	500
1N30	10,000	500	7,000	21,000	5
1N31	10,000	500	6,000	24,000	5
1N32	3,000	500	5,000	29,000	5
1N33	3,000	500	2,900	10,000	100

TABLE 3
GERMANIUM RECTIFIER CARTRIDGES
(for diode applications)

Type	Frequency Range (mc)	Maximum Inverse Voltage	Average Current (ma)	Maximum Peak Current (ma)	Maximum Surge Current (ma)
1N34	0 - 200 +	60	22.5	60	100
1N35	Consists of mounted pair of matched 1N34's for duo-diode applications.				
1N38	0 - 250 +	100	22.5	150	500
1N39	0 - 20	200	15.0	150	100

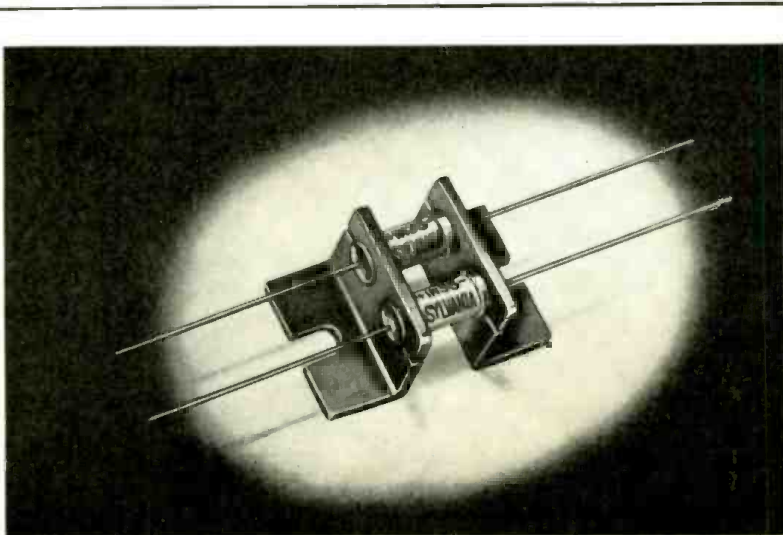

Fig. 4—These two matched detector cartridges are used in discriminator circuits.

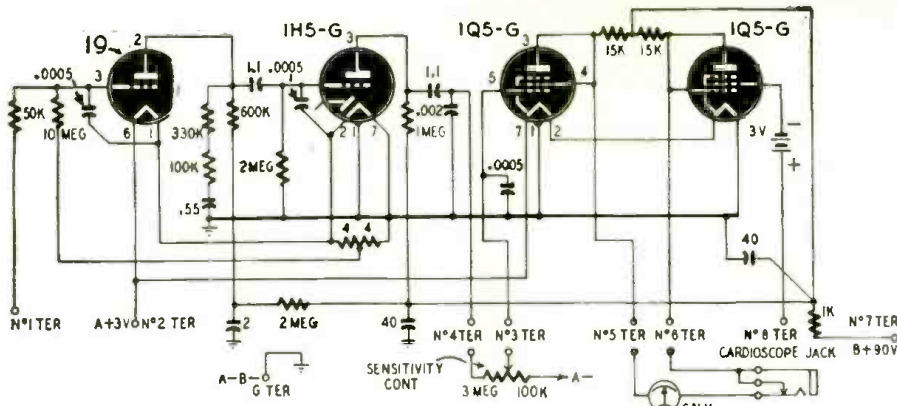

Fig. 3—Standard electrocardiograph amplifier uses very low frequency coupling components.

side noises are excluded so that the tape record is an accurate indication of heart sounds only. The size and shape of the bell affect the frequency response of the microphone. Increasing the size shifts emphasis to the lower frequencies; decreasing it gives a peak in the high range. High-frequency output can also be improved by stretching the patient's skin and increasing the pressure with which the microphone is held to the chest. A number of different-size bells is usually supplied with each instrument so the physician can select the one which accentuates the sounds he particularly wants to hear and record.

Microphones can be designed to respond to sound in two ways, linearly or logarithmically. If the response is linear, the output of the microphone for a sound which has an intensity (expressed, for example, in dynes/cm²) 100 times greater than another sound will be 100 times greater than the output for the lower sound. However, if the response is logarithmic, the microphone output for the louder sound will be equal to only twice the output for the weaker sound (log 10=1; log 100=2).

Each of these two types of response has its advantages and disadvantages. The linear type of response is useful for detecting sounds of low intensity and for distinguishing between sounds of relatively slight differences in intensity. Often a microphone of this type is of value in detecting very early valvular abnormalities which are below the thresh-

old of human hearing.

The logarithmic response offers the very important advantage of closely approximating human hearing, which is logarithmic. This is important in analyzing records, because an abnormal sound which has, say, twice the amplitude of a normal sound on the visual record, will actually sound twice as loud with a stethoscope.

When heart sounds are being recorded, the physician usually listens with a stethoscope at the same time. In some apparatus such as the instrument in Fig. 3, provision is made for plugging in a set of headphones which are acoustically compensated to permit the examiner to hear a true reproduction of the amplified sounds, as recorded.

Fig. 5 shows the special equipment used in recording pulse beats. The small cup A is held against the skin over an artery by suction created by the rubber bulb B or by manual pressure. The flat disc C, connected by a rubber tube to the cup, contains a pressure-operated piezoelectric crystal. With each pulse beat, the skin moves outward. This produces a small compression of the air in the rubber tube and in the crystal chamber. The distortion of the crystal caused by the air pressure produces a small voltage which is passed through the cable and cylinder D, which contains a small shunt time-constant capacitor, to an audio amplifier. A recorder connected to the amplifier output makes tape records of the pulse beats. An interesting fea-

ture of this method of recording pulse beats is that, not only their frequency and amplitude are registered, but also their wave form, which is of considerable diagnostic value.

Another method of recording pulse beats uses a photoelectric tube. The technique, which is used for many other purposes as well, is known as photoelectric plethysmography.

Fig. 6 shows how this method is used. A light source shining through a thin part of the body (an ear lobe is used here) illuminates a phototube. spurts of blood pass through the blood vessels each time the heart beats. The blood, coming between light source and phototube, makes the ear lobe more opaque. During the pauses between beats, blood does not flow and the lobe becomes more translucent. The light reaching the phototube depends on the translucency of the lobe, so it varies in step with the heart beats and blood spurts. The varying output of the photoelectric-tube circuit is fed to an amplifier and a wavy-line tape record is made. The amplifier used with this device must have very good low-fre-

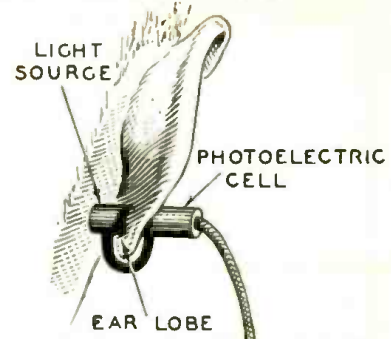

Fig. 6—Equipment for attachment to the ear.

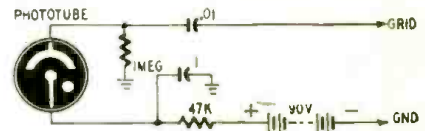
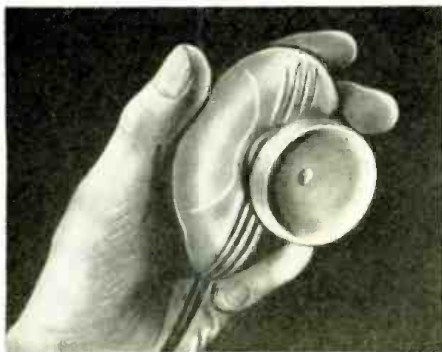

Fig. 7—Adapter for R-C coupled amplifier.

quency response, so direct-coupled circuits are often used. With R-C-coupled amplifiers an adapter circuit must be used, as shown in Fig. 7. Polarizing voltage is available in direct-coupled amplifiers, so no adapter is necessary.



Photographs Courtesy The Sanborn Co., Cambridge, Mass.

Fig. 4—Example of a heart-sound microphone. These are high-class crystal types and may have straight or logarithmic output curves.

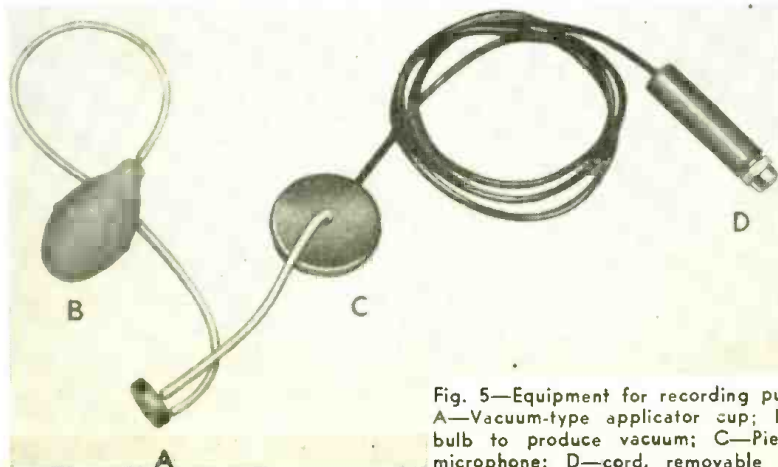

Fig. 5—Equipment for recording pulse beats. A—Vacuum-type applicator cup; B—Rubber bulb to produce vacuum; C—Piezo-electric microphone; D—cord, removable connector.



Instruments set up properly to align a television receiver.

VIDEO Alignment

By ROBERT N. VENDELAND*

NO wide-awake radio serviceman can deny that FM and television have caused a revolution in service techniques. Wide-band, high-frequency amplifiers necessary in television circuits are converting screw-turners into either well-equipped radio-men or ex-radio-men.

Correct alignment of a television or FM receiver is difficult and sometimes impossible without visual alignment equipment. If there is no real trouble in the set, and all it needs is trimming up, it may be possible to use an AM signal generator and a good indicator. But once

* Television Instructor
National Radio School, Cleveland

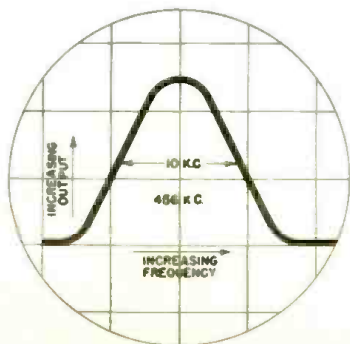

Fig. 1—A standard AM i.f. response curve.

the radio man has tried a visual alignment, he'll not consider any other method.

The television channel allotted to a single station is 6 mc wide, *almost six times as wide as the entire standard broadcast band*. As a result, all the tricks used to obtain high-gain, selective, broadcast-band amplifiers must be reversed to get video amplifiers to respond to the frequency range necessary for reproduction of a high-quality picture. The obvious solution to the problem of wide-band amplifier adjustment is visual alignment.

Fig. 1 shows a typical response curve for the i.f. amplifier of an AM broadcast set. As the unmodulated signal-generator output frequency rises toward 456 kc, the output of the stage increases. It reaches a maximum at 456 kc and then tapers off as the frequency increases still more. The curve shows just where the output of the stage is maximum. To line up the receiver, the signal generator is set at 456 kc and the trimmers are adjusted for maximum output-meter reading.

In a television receiver, a typical i.f. response curve might look like the one shown in Fig. 2. This is plotted in the same way as the curve in Fig. 1. As the signal-generator output increases in fre-

quency, the i.f.-stage output increases to a maximum at 23 mc and then drops off to a dip at 25 mc. At 27 mc there is another maximum and then a drop to zero at 30 mc.

In aligning a TV i.f., it might seem a simple matter to set the signal generator to 23 mc and tune for a given output, then turn to 27 mc and tune for the same output, with one check for a dip at 25 mc. This may work if the set is not out of alignment, but usually a video i.f. stage employs capacitive overcoupling and adjusting one peak for a maximum affects the frequency of the other peak. If you seesawed back and forth trying to get the proper response, you would soon lose patience.

The visual alignment technique seems to be the only solution. Most servicemen are familiar with oscilloscopes: they have had one on the bench for years and brag about not having had to use the blasted thing once. The 'scope is the business end of visual alignment, and you'll have to splice the line cord back where it was before you borrowed it for the electric fan.

In visual alignment, a sweep signal generator is necessary. This presents to the receiver a signal which varies in frequency from 20 to 30 mc at a 60-cycle rate. In other words, a 60-cycle sine

wave modulates the FM oscillator of the signal generator so that at one instant the frequency output is 20 mc and an instant later it is 21 mc, until finally the output increases in frequency to 30 mc. When 30 mc is reached, the signal frequency starts back toward 20 mc. Output at each frequency is maintained at the same amplitude level.

To use the generator and oscilloscope for aligning the video i.f. stages, the output of the sweep generator is first connected to the input of the last picture i.f. Fig. 3 is a block diagram of part of a typical television receiver. C is the point where the oscillator output is first connected.

The 60-cycle voltage which frequency modulates the FM oscillator in the generator is connected also to the horizontal plates of the oscilloscope. This causes the electron beam to pass back and forth horizontally 60 times per second. The vertical plates of the 'scope are connected to the output of the video detector.

Let us assume at first that the i.f. system of this particular receiver is properly adjusted so that Fig. 2 represents the response of the i.f. system at each frequency shown. At the beginning of the sweep, the oscillator frequency is 20 mc. Since the i.f. response at this frequency is very low, the rectified r.f. appearing at the detector will be low. When the oscillator frequency reaches 23 mc, which is one of the peaks in the i.f. response, rectified output of the detector will be high. At each remaining frequency, detector output will correspond to the i.f. response.

Since we have the 'scope connected across the load, the electron beam is moving up and down with the changes in load voltage; and if we can move the beam left and right in exact step with the changing sweep generator output, we'll have drawn our response curve. This is exactly what is done, since the sine-wave voltage that is used to change the FM oscillator frequency is introduced into the horizontal plates of the 'scope.

As the sine wave sweeps to increase the frequency, it also moves the electron beam in the 'scope to the right, and the response curve is drawn exactly as it looks in text books.

Fig. 4 gives a complete graphical picture of the whole operation.

Obviously, a good 'scope is necessary for successful visual alignment. The sweep signal generator should be designed for a sweep-width range that will show more than the entire response curve. For making a television alignment the sweep generator should have at least a 10-mc sweep, for all band widths extend somewhat beyond the 6 mc of a television channel and the trace must taper to a reference line. Fig. 2 shows the trace tapering off to zero at 20 and 30 mc, giving a good picture of the relative amplitudes on a 'scope pattern. If, for example, the generator sweeps a trace as shown in Fig. 2, but only extends from 22 to 28 mc, the curve would show only from A to B, and it

would be difficult to see the ratio between the peaks of the curve, point C, and the point of zero response at 20 and 30 mc. On the other hand, if the sweep width is too great—say 50 mc—the response curve would be only a small hill on a long line across the 'scope screen as shown in Fig. 5.

For an FM low-i.f. amplifier alignment, a generator with a sweep width of approximately 450 kc is sufficient. For television alignment, the sweep width must be at least 10 mc, and the center frequency of the sweep should be adjustable from about 5 mc to the top of the television channels (around 215 mc).

After the two basic pieces of equipment—'scope and sweep generator—are properly selected, a marker generator is necessary. When using the Hickok 610 sweep generator which will be discussed in this article, no marker generator is required since the instrument has a built-in marker. The function of the marker generator is to place a mark of some type on the sweep pattern so that you can tell the exact frequency represented by any point on the 'scope pattern.

The marker generator is usually an extremely accurate signal generator. It puts out an r.f. signal which mixes with the sweep signal and places a pip, as shown in Fig. 2, on the response curve. Reading the dial setting on the marker generator tells you the exact frequency of the pip.

Several precautions must be taken or false results may waste time. For visual alignment at high frequencies, the

grounding of all equipment is essential. A common ground in the form of a metal plate or a heavy grounding bus is absolutely necessary. If touching any piece of equipment changes the sweep pattern, the grounding is not adequate.

Manufacturer's directions for each receiver being aligned should be followed to the letter, since the correct order for alignment will differ from receiver to receiver.

The block diagram (Fig. 6) shows the Hickok 610 signal generator. Notice the FM generator in the upper left corner. The center frequency of this oscillator is variable from 75 to 115 mc. The 75-mc fixed oscillator shown below it is switched in and out of operation by the range selector on the instrument. The outputs of the two generators are combined in the mixer shown. By using the actual frequency, the sum and difference frequencies, and the first harmonic of

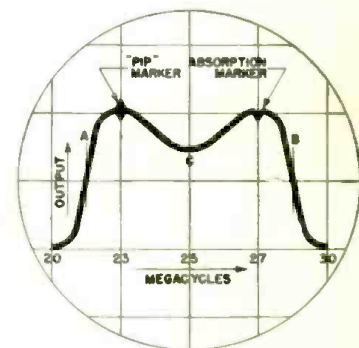

Fig. 2—i.f. response of television receiver.

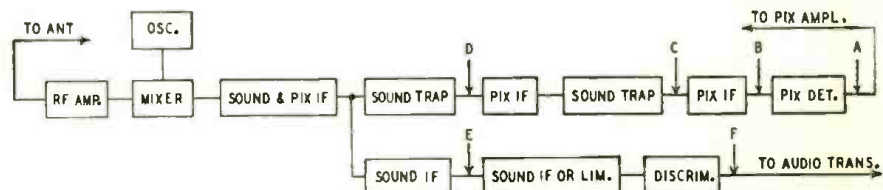

Fig. 3—Instruments are connected to the televiser at points lettered in the diagram.

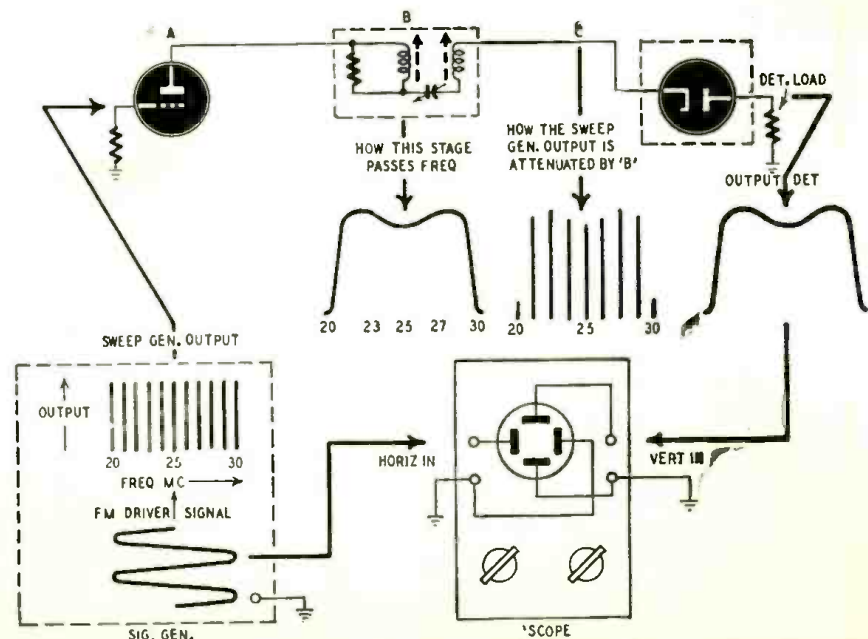

Fig. 4—Shows path of test and synchronizing signals through the set and oscilloscope.

each oscillator, the range of the generator can be extended from zero to 240 mc.

The mixer output is fed to a cathode follower and an attenuator. The other features of the generator shown on the block diagram will be discussed as they are used in the alignment of the typical television receiver of Fig. 3.

The oscilloscope is connected across

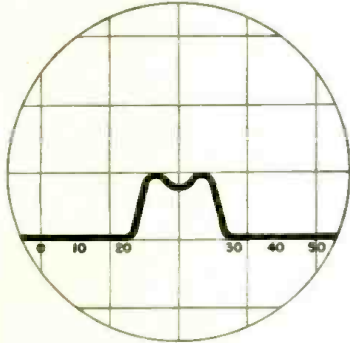

Fig. 5—Result of using too wide a sweep.

the detector load, point A in Fig. 3. Several features of the Hickok 505 'scope adapt it particularly to visual alignment. Its input amplifier has a response up to 1 mc. It is extremely sensitive, and its input can be fed through an internal demodulator for observing sweep patterns before the detector of the set—at point B, for example. The

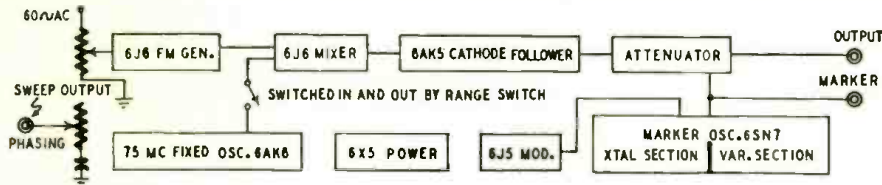

Fig. 6—Block diagram of Hickok 610 generator used in the alignment method described here.

'scope also has its own 60-cycle sweep with provisions for phasing the retrace or for blanking it out.

For the beginning of the alignment, the sweep generator is fed into the grid of the last picture i.f. amplifier, point C in Fig. 3. The center frequency is set for the middle of the picture i.f. channel, and the sweep is adjusted in width until the entire response is visible on the 'scope screen.

The set manufacturer's data will generally show a picture of the desired response at each stage. The slug adjustments in the cans are tuned until the 'scope picture looks like the manufacturer's response chart for that stage. At first it will probably appear like the one shown in Fig. 7, with the main trace and the retrace out of phase. When the 505 or 195 'scope is used as the indicator, the 60-cycle horizontal-sweep voltage need not be taken from the sweep generator. These 'scopes have internal 60-cycle sweeps with provisions for phasing the forward trace and the retrace so they will coincide to look like Fig. 2. The 505 'scope has a return-trace eliminator so that the retrace can be blanked out entirely, with no need for phasing. However, the 610 generator has a phasing network built into it so that the main trace and the retrace can be made to coincide on any 'scope. If this

is employed, the horizontal-sweep voltage from the generator must be used.

The internal marker of the model 610 will check the frequency of each point on the trace. This built-in, variable-frequency oscillator has a dial with extremely accurate calibration from 20 to 30 mc, the range of most television i.f. channels. The dial is calibrated in tenths of a megacycle to eliminate all guesswork. The amplitude of the marker signal is variable, but always use the minimum necessary output. Too large a marker amplitude will distort the response curve.

Occasionally, the i.f. amplifiers will pick up stray oscillation and several markers may appear on the trace. To aid in identifying the proper marker, the 610 has provision for stopping oscillation of the marker oscillator and using the tank circuit as a wave trap in the sweep output. This will put an absorption dip in the response pattern as shown in Fig. 2. Some servicemen prefer this to the pip and use it in all cases.

After the stage before the detector is aligned, manufacturer's directions usually specify connecting the sweep generator to point D of Fig. 3, the grid of the first picture i.f. amplifier. The 'scope lead is left at the detector grid. The trap just before point C is aligned. This usually is an adjacent-channel trap used

to eliminate the sound from a lower channel. Correct adjustment is made when the trap frequency shows a minimum on the indicator. Shut off the sweep and use the marker generator as a source for the trap frequency. For a better indication on the 'scope, the built-in, 400-cycle modulator shown in Fig. 6 can be turned on. Tune the trap for minimum amplitude.

Turning on the sweep causes the next response pattern to appear on the 'scope. This procedure is repeated stage by stage until the antenna input is reached. During the earlier part of the alignment, the manufacturer may have advised disabling the oscillator. When the signal is fed to the antenna terminals, the oscillator should be connected. The response curve of the whole set will appear on the 'scope screen.

Before the oscillator is tuned, the sound channel is usually aligned. Since the sound channel is an FM receiver, it can be adjusted just like any separate FM radio. The only difference is that in most cases the sound channel of a TV set has a 20- to 30-mc i.f., while an FM receiver i.f. is usually in the 10-mc range. For visual alignment of television FM circuits, the model 610 sweep generator is ideal; but for FM receivers, the lower-frequency sweeps of the Hickok model 288X FM-AM signal gen-

erator or similar units give better results. The 505 'scope has a built-in FM sweep that is excellent for lower-frequency work.

In aligning a sound channel visually, the discriminator or ratio detector is aligned first. The curve is adjusted to show a response like that in Fig. 8. Marker frequencies are injected in the same manner as for picture-channel alignment. If an extremely accurate marker is desired, the built-in Pierce crystal oscillator of the 610 generator may be employed. This oscillator may be modulated or unmodulated and is injected in the same manner as the variable oscillator.

To align for the pattern of Fig. 8, the sweep generator is inserted at the second sound i.f. or limiter grid (point E in Fig. 3), and the 'scope is connected to the discriminator load (point F). After the discriminator response curve is obtained with markers at the correct points, the generator output is moved back stage by stage, always giving a larger discriminator response curve on the 'scope. To bring the over-amplified picture back within the bounds of the 'scope screen, decrease generator output. This makes sure that no saturation of the stage under alignment is occurring.

Correct tuning for i.f. amplifiers is obtained when the discriminator response is at a maximum and shows no distortion.

After both picture and sound i.f. amplifiers have been adjusted, the oscillator for each channel may be tuned. This is of particular importance on push-button or turret-tuned sets where each channel has its private tuning arrangement. Crystals whose harmonics fall on the desired channel's sound frequency may be used to set up each television station. These crystals may be obtained for the sound carrier frequency of any of the 13 channels.

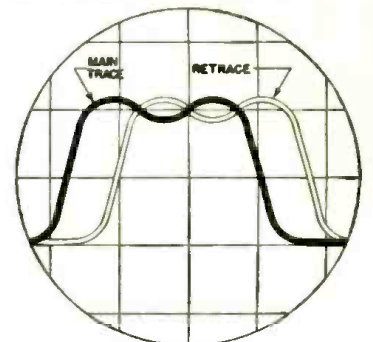

Fig. 7—Trace and retrace curves not phased.

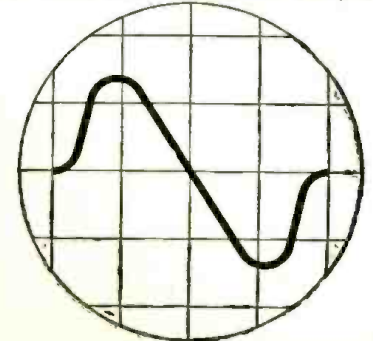

Fig. 8—Standard curve of FM discriminator.

French Television Progress is Rapid

By P. HEMARDINQUER*

THE number of television receivers in France is still very small—it does not exceed a few thousand.

This is so, first, because there is only one television broadcast station in France; and second, because of the very high price of television receivers. Programs are not particularly exciting, and the station is on the air not more than one hour daily.

This limited program schedule—due to budget economics of the French government—does not prevent the engineers of France from continuing their research, and some remarkable results have already been obtained. American technicians declared that the 1,000-line transmissions they saw were better than American television.

Projection television is also being studied, and in the near future a double television projector (analogous to the double motion-picture projector) will be installed in a Paris movie house to televise both films and news items.

The new projector consists of a television receiver, the projection equipment itself, a control panel, and a power supply.

To maintain uninterrupted projection under all circumstances, the installation is made in duplicate. Two complete sets of equipment are ready to operate at all times; if one should stop, the other can be swung into immediate action. (See Fig. 1.)

A special cathode-ray tube of high power is used for projection. It is shown with its optical system in Fig. 2. The accelerating voltage can be regulated between 60 and 80 kilovolts.

The electronic beam has an intensity of 2 ma maximum and an average of 0.5 ma. The tubes are very powerful—the dimensions of the primary image to be projected are 12 x 16 cm (about 4.7 x 6.3 inches) and the diameter of the luminous spot is only 0.25 mm.

The screen is of the directive type, having either a powdered-aluminum-covered flat surface, or a slightly concave surface covered with little plates of stamped aluminum to form a concave mirror. This assures a good concentration of reflected light along the vertical plane, while maintaining sufficient horizontal diffusion. The gain obtained, as compared with a white, perfectly-diffusing screen, is 4.25.

The objective lens used has an aperture of f1.9. The brilliance of the projected images is about equivalent to that of a standard motion picture.

As can be seen in Fig. 2, the electron

beam is at an angle to the perpendicular of the screen. This makes necessary a correction of the sweep to avoid distortion. A parabolic sweep of the same frequency as the original transmission is utilized for this correction.

The double high-frequency receiver is of the t.r.f. type. It transmits amplified signals at the carrier frequency of 46 mc to the detector and video amplifier stages in the sealed and insulated case through an insulated coupling system sealed in a vacuum tube, as illustrated in Fig. 3.

It is usually convenient to connect the fluorescent screen and an anode of a television tube to ground. The cathode and video amplifier are therefore at a high voltage, approximately 70,000 volts from ground. These elements are in a case mounted on insulators within the body of the projector. (See Fig. 4.)

In view of the great acceleration of the electron beam, and the consequent difficulty of deviating the electrons, the sweep amplifiers have to be particularly powerful.

The equipment will shortly be put into operation to demonstrate to the Parisian public the practical possibilities of large-screen projection in theaters. It is being developed by the *Compagnie pour la Fabrication des Compteurs*, under the direction of the great French television technician, Barthelemy.

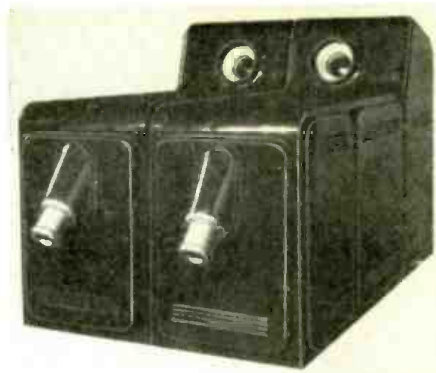

Fig. 1—Dual theater-type TV projectors.

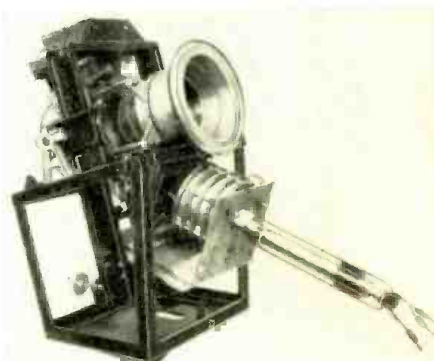

Fig. 2—Optical system of the projectors.



Fig. 3—The insulated r.f. coupling system.



Fig. 4—Side view of the projector with cover removed to show arrangement of the components.

*Consulting Engineer, Grenoble, France



Fig. 1—The dial pointer is on the ring in front of the speaker.



Fig. 2—Arrow points to plate containing four printed capacitors.

Radio Set and Service Review

Ward's Airline Models 74BR-2003A and 84BR-1515A

RESTRINGING receiver dial drive mechanisms quickly and correctly has meant headaches and loss in time and profits to radio service technicians for years. All too frequently, manufacturers fail to supply dial stringing data in their servicing information. Even when dial stringing guides are available, the average technician finds it almost impossible to replace the dial string without four hands, Scotch tape and an assortment of hooks, needles and other gadgets.

This problem has been eliminated in the Model 84BR-1515A and 74BR-2003A Airline receivers developed by the Belmont Radio Corporation for Montgomery Ward. The former model is shown in Figs. 1 and 2. This is a 4-tube-plus-rectifier a.c.-d.c. broadcast set with permeability tuning. The tuning control shaft, on the right in the photographs, has a small gear linking it to the 5-inch

dial gear mounted around the circumference of the speaker. A 1/4-inch metal pointer fastened to this ring or gear is visible through a slot under the calibrated scale on the front of the cabinet. Six and one quarter turns of the control shaft are required to tune across the band.

The end of the tuning shaft projecting under the chassis is threaded and moves the tuning slugs or cores in the antenna and oscillator coil forms as it turns. The back cover of the set is a sheet of metal-backed cardboard used as an antenna for local reception. A Fahnestock clip fastened to, but insulated from, the cover provides capacitive coupling to an outside antenna.

An interesting innovation in receiver construction is the use of printed circuits. The coupling and bypass capacitors enclosed in broken lines between the 12AT6 and 50B5, Fig. 3, are on a

thin ceramic plate 1 1/2-inch long and 1 inch wide. This unit is indicated by the arrow on Fig. 2.

The Model 74BR-2003A, Figs. 4, 5 and 6 uses a new type of slide-rule construction for dial drive. The pointer is fastened to a strip of spring brass with serrations on one edge (like a hacksaw blade) to engage the teeth of a small gear on the tuning control. The strip slides in the channel of a flat guide very much like the cross section of a flat curtain rod. The saw-tooth serrations are visible on the metal strip in the close up view at left of Fig. 4.

This set was designed as a radio-phonograph combination. Its circuit, Fig. 6 is similar to the circuit of the 84BR-1515A in Fig. 3. This set uses a loop antenna mounted in the cabinet and connected to the chassis through a socket and plug connector. Speaker and phono pickup connect to the chassis through co-axial type connectors.

When the chassis is in the set it is 3 inches high over-all. This makes it possible to install it in a cabinet just a few inches higher than the over-all depth of its record player or changer.

The electrical specifications of these sets are given below. Sensitivity measurements are based on 50 milliwatts output. This may be measured by disconnecting the voice coil and replacing it with a 3.2-ohm, 5-watt resistor. A level of 0.4 volts a.c. across the resistor is equivalent to 50 milliwatts.

Model 74BR-2003A
 Power supply—105 to 125 volts a.c. or d.c., 35 watts.
 Frequency range—535 to 1620 kc.
 Intermediate frequency—455 kc.
 Selectivity—At 1,000 kc., 50 kc. at 1,000 times down.
 Sensitivity—10 microvolts average for 50 milliwatts output.

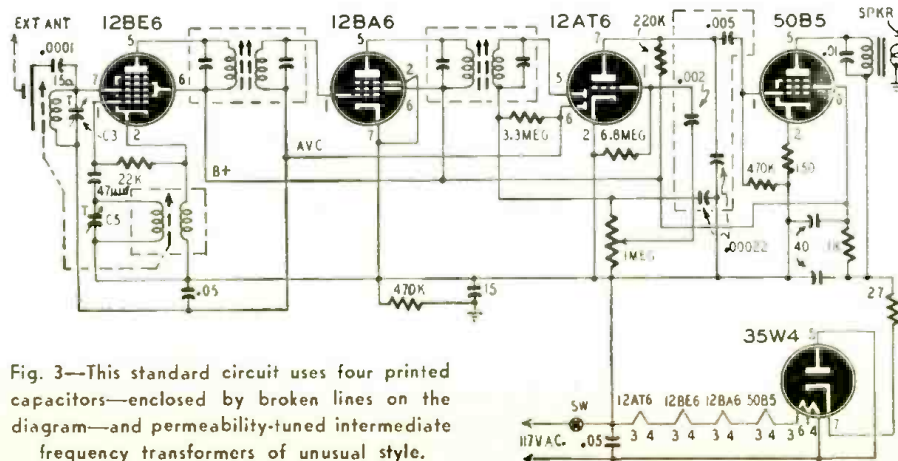

Fig. 3—This standard circuit uses four printed capacitors—enclosed by broken lines on the diagram—and permeability-tuned intermediate frequency transformers of unusual style.

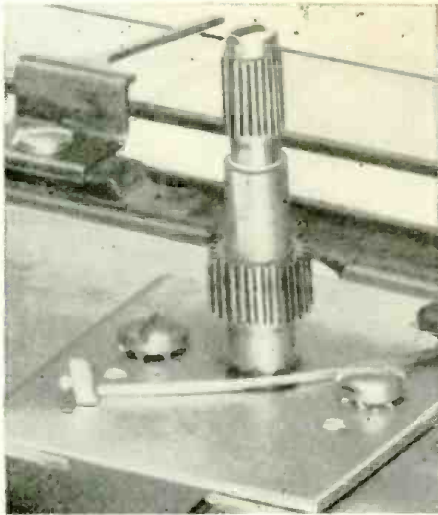
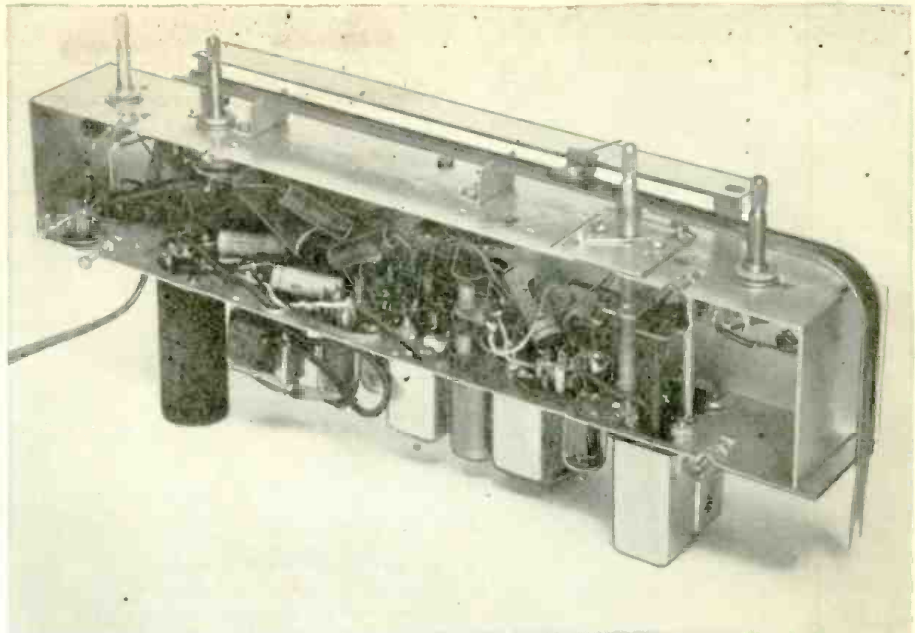

Fig. 4 (Right)—Bottom view of the 74BR-2003A shows the flexible-rule dial drive system. An enlarged view of the dial drive is shown above.



Power output—0.75 watt undistorted, 1 watt maximum.
 Loudspeaker—4 x 6-inch oval PM with 3.2-ohm voice-coil impedance.
 Tube complement—12BE6 converter, 12BA6 i.f. amplifier; 12AT6 detector; a.v.c.; and a.f. amplifier, 50B5 power amplifier and 35W4 rectifier.
 Automatic record changer.

Model 84BR-1515A

Power supply—105 to 125 volts a.c. or d.c., 35 watts.
 Frequency range—535 to 1620 kc.
 Intermediate frequency—455 kc.
 Selectivity—At 1,000 kc, 55 kc at 1,000 times down.
 Sensitivity—20 microvolts average for 50 milliwatts output.
 Power output—0.7 watt undistorted, 1 watt maximum.
 Loudspeaker—4-inch PM, 3.2-ohm voice coil impedance.
 Tube complement—12BE6 converter, 12BA6 i.f. amplifier, 12AT6 detector; a.v.c. and a.f. amplifier, 50B5 power amplifier and 35W4 rectifier.

Alignment procedure

The signal generator used for aligning these sets should be modulated 30 percent with a 400-cycle a.f. signal. The a.f. signal must be available for a.f. measurements. Alignment data for the 84BR-1515A and 74BR-2003A will be found in Tables I and II respectively. When checking tracking of either set at 1400 kc, screw the antenna core in or out for maximum volume. Retune the set to 1620 kc and check C3. If no appreciable change is needed the tracking is

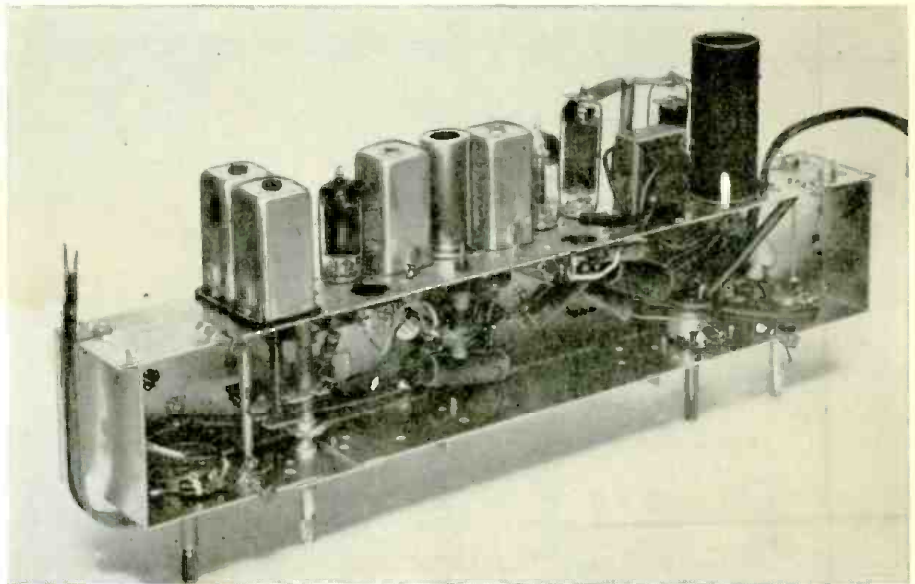

Fig. 5—This view shows the bottom and rear of the chassis used in the Model 74BR-2003A.

good. If C3 requires considerable adjustment, readjust the setting of the antenna core. Make these two adjustments several times until C3 does not have to be readjusted at 1620 kc.

If the tuning slugs of the 74BR-2003A

are badly out of alignment or the set fails to track properly, turn the tuning control until the bracket holding the slugs is against the front of the chassis. Adjust both tuning slugs so they protrude 1 9/32 inch out of the base of the

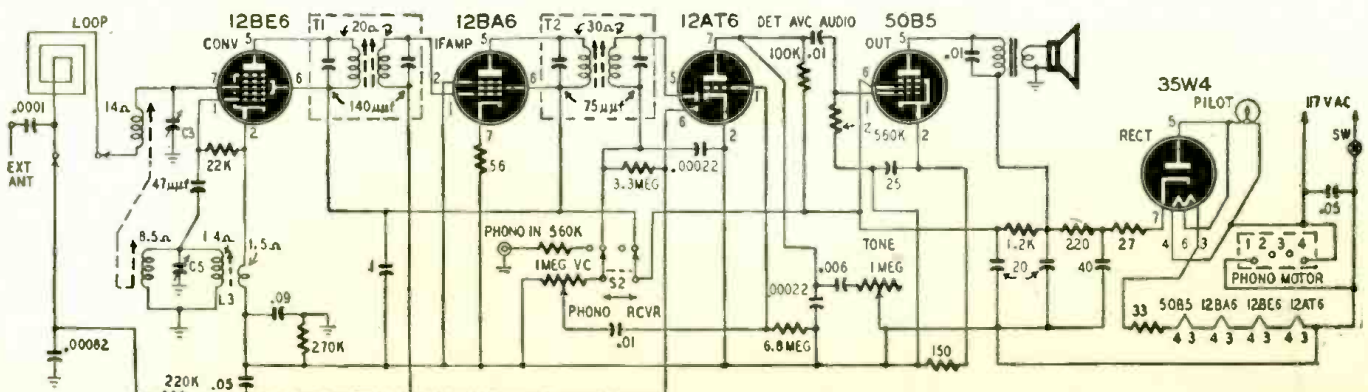

Fig. 6—Special oscillator coils simplify tracking in the 74BR-2003A. The chassis is 3 inches high, 15 3/8 inches long and 6 1/2 inches deep.

tuning assembly. If trouble is had with the 84BR-1515A, adjust the slugs to the positions shown in Fig. 7.

The i.f. transformers in these sets are

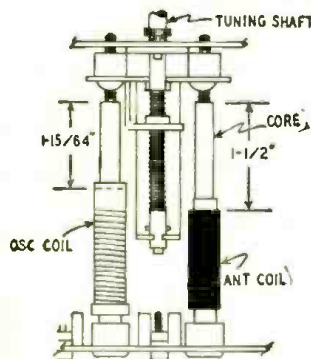

Fig. 7—Permeability tuner of the 84BR-1515A.

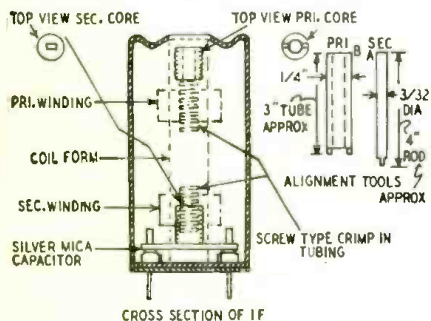

Fig. 8—Cross-section of the i.f. transformers.

of novel construction. The primary and secondary windings are on the same core with all tuning adjustments made from the top. A cross-section drawing of these transformers is shown in Fig. 8. The core of the primary winding has a hole through its center to allow a special tool

**TABLE I
84BR-1515A**

SIGNAL GENERATOR						
Frequency	Coupling Capacitor	Connection to Radio	Ground Connection	Tuner Setting	Adjust For Maximum Output	Input For 50-Milliwatt Output
455 kc	.1 μ f	12BE6, Pin 7	12AT6, Pin 2	Iron cores all the way out	Cores in output and input i.f. cans	45 microvolts
1620 kc	.1 μ f	12BE6, Pin 7	12AT6, Pin 2	Iron cores all the way out	Oscillator trimmer C5	—
1620 kc	2 μ f (max. capacity)	External antenna clip	12AT6, Pin 2	1620 kc	Antenna trimmer C3	20 microvolts
1400 kc	2 μ f (max. capacity)	External antenna clip	12AT6, Pin 2	1400 kc	Adjust position of ant. core by screwing in or out	20 microvolts
400 cycles	.1 μ f	12AT6, Pin 1	12AT6, Pin 2	—	—	.03 volt

**TABLE II
74BR-2003A**

SIGNAL GENERATOR						
Frequency	Coupling Capacitor	Connection to Radio	Ground Connection	Tuner Setting	Adjust For Maximum Output	Input For 50-Milliwatt Output
455 kc	.1 μ f	12BE6, Pin 7	12AT6, Pin 2	Iron cores all the way out	Trimmers on output and input i.f. cans	28 microvolts
1620 kc	.1 μ f	12BE6, Pin 7	12AT6, Pin 2	Iron cores all the way out	Oscillator trimmer C5	—
535 kc	200 μ f	External antenna clip	12AT6, Pin 2	Iron cores all the way in	Shunt osc. coil L3	11 microvolts
1620 kc	200 μ f	External antenna clip	12AT6, Pin 2	1620 kc	Antenna trimmer C3	8 microvolts
1400 kc	200 μ f	External antenna clip	12AT6, Pin 2	1400 kc	Adjust position of ant. core by screwing in or out	8 microvolts
400 cycles	.1 μ f	12AT6, Pin 1	12AT6, Pin 2	—	—	.03 v. lt

to pass through for adjusting the secondary core. The primary and secondary tuning tools are A and B shown at the upper right in Fig. 8. Both are made from fiber or other insulating material. In use, the secondary tool passes

through the center of the primary tool. Two resonant peaks will be noticed when adjusting the i.f. transformers. Be sure that the primary core is above its coil and the secondary core is below its coil.

Regulating Voltage With VR Tubes

Amateur and constructor will find them valuable in a number of applications

By RICHARD L. PARMENTER

IN the modern ham station the need for stabilized voltages in various electronic circuits is becoming more and more apparent. When the circuit requiring voltage regulation draws a relatively small current, gaseous type regulator tubes carry out this function very well. They are economical and simple to install, requiring only the tube and socket and one or two resistors. Since they present few difficulties to the user, these tubes should be used more than they have been in the past. This description of some of the uses for VR tubes is a reminder that such a useful little gadget is available to the radio builder.

The VR tube will be a big help to the beginner who has built a regenerative detector receiver and who has been disconcerted by the tendency of this type

receiver to be thrown "off-tune" by variations in plate voltage caused by line voltage fluctuations. They are practically indispensable to the more experienced builder who has need for stable voltages in frequency meters, variable-frequency oscillators, and local oscillators of v.h.f. receivers. Since these tubes maintain a relatively constant voltage across a varying load and stabilize a varying supply voltage across a constant load, their many uses are apparent.

When a voltage of correct potential is placed between two terminals in air or any other gas, the gas will break down suddenly and act as a reasonably good conductor of electric current. This breakdown is because a high enough voltage actually tears electrons from the molecules of the gas and under these

conditions a large number of positively charged ions and negatively charged electrons are produced. The breakdown point is determined by the amount of

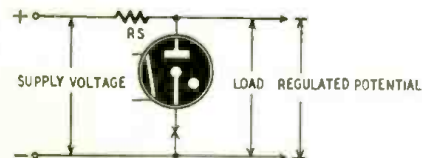

Fig. 1—This is the basic regulator circuit.

voltage together with the amount of gas in the tube and also its pressure. It is fairly easy to understand that the less dense the atmosphere inside the tube, the less difficulty the electrons will have in their progress from cathode to plate. Under reduced pressure the ionization

voltage—the voltage at which the tube will conduct—may be reduced. The operation of neon tubes, mercury vapor tubes and gaseous regulator tubes is based on this fact. The starting voltage of regulator tubes is about 30% higher than the rated voltage of the tube. Once the gas has become ionized voltage changes at the plate of the tube result in changes

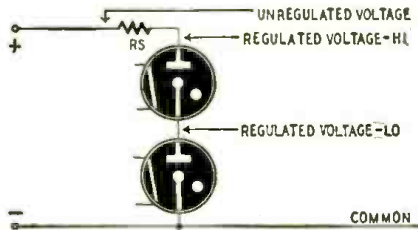

Fig. 2—Two tubes give two regulated outputs.

in the amount of current it passes. This condition exists until the potential at the plate is reduced to a certain critical value when the tube will revert to its original state of passing practically no current.

In the case of all VR tubes—when ionized—the change of current through the tube due to variations in potential results in a certain constant potential across the tube. In this respect the tube is acting like a constantly varying resistor which has a lower value if the potential is high and a higher value if the voltage is low. In this way, the effective IR drop across the tube is kept at a constant value. This constant IR drop is applied across the load, which thus receives a practically unvarying supply.

The basic circuit for the use of VR tubes is shown in Fig. 1. The supply voltage must be approximately 30% greater than the voltage that is desired.

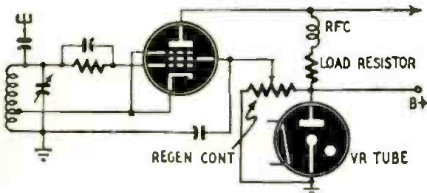

Fig. 3—A stabilized regenerative detector.

This is because a higher potential must be applied to the tube to ionize it. As soon as the tube is conducting the output voltage drops to the rated value of the tube. In the OD3/VR150 a starting potential of about 185 volts is desirable for good regulation. The series resistor RS is of correct value to hold the current through the tube to a value of somewhere between 15 to 20 milliamperes for normal operation, depending upon the application. If the total potential available from the power supply closely approaches the voltage rating of the tube, the regulation will be poor and will be effective only over a limited range. In other words it is desirable to have the tube conducting a considerable amount of current to start with so that a greater range may be covered by its variable resistor characteristics. If the resistor RS is less than 3,000 ohms to make the tube draw about 20 ma, then the supply voltage is too low for the particular VR

tube being used. Use Ohm's law to determine the value of resistor RS, after the supply voltage has been measured. In the following formula, the necessary series resistance RS is equal to the voltage to be dropped across the resistor divided by the current which is to pass through it. Thus

$$RS = \frac{Es - Er}{I}$$

where

RS is the value of limiting resistor
Es is the supply voltage
Er is the regulated voltage (tube rating)
I is the maximum rated current of the tube in amperes. Usually about .03 amp.

The voltage Es-Er is the amount that is lost by IR drop across resistor RS.

If two or more VR tubes are connected in series, then two regulated potentials may be obtained as shown in Fig. 2. The value of the limiting resistor in this case would be determined in the same manner as before but the total value of regulated voltage (add ratings of the

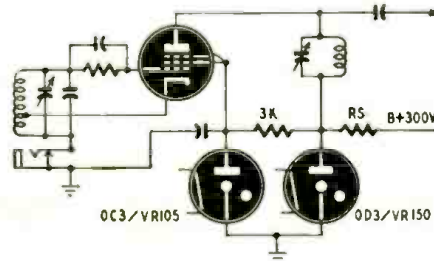

Fig. 4—VR tube adds to v.f.o.'s stability.

tubes used) would be used for Er. By connecting two or more tubes in series it is possible to obtain a wide range of voltages suitable for various uses. Remember, however, that the total amount of current that can be drawn from the bottom tube, Fig. 2, of the series string is limited because the upper tubes must carry all the current in the circuit. The upper tube or the one that is nearest the B-plus would have to carry its own current (10 to 30 ma) plus the current of the lower tubes, plus the current that is drawn off for the load. In other words, the current that is available for the load must necessarily be quite small, perhaps 10 ma or less, in order to leave enough for the voltage regulating function of the tubes. This is one of the limitations of VR tubes but this may be partially offset by designing the load so little current is required for it. Along the same line of thought of course, is the fact that quite often the circuit design may be such that 150 volts maximum is sufficient for the regulated section.

Typical VR-tube applications are shown in Figs. 3, 4 and 5. Since these are merely representative circuits, exact values for the various components are not given. Fig. 1 is the basic circuit and the general design procedure has been given for it. The same principles apply to any circuit using VR tubes. The resistor RS would be determined mathematically and checked for correct value

by noting if the tube "starts" when voltage is applied. If no glow appears around the electrodes of the tube, either the supply is not high enough or the value of resistor RS is too high. Insert a 0-50 ma d.c. millimeter at X in Fig. 1 and adjust RS until 20 to 25 ma flows in the circuit. Since this current will drop with increased load, it is better to set the no-load current somewhat higher than would normally be assumed. Even as high as 30 ma is desirable in some cases.

The regenerative detector circuit Fig. 3 uses an OD3/VR150 for regulating the d.c. voltage to compensate for variations in line voltage. An electron-coupled detector is shown but others could be used if preferable. To provide screen and plate voltage regulation, use the same setup as in the v.f.o. circuit, Fig. 4. In this diagram, both screen and plate voltages are regulated for variations in load. This is desirable in a variable-frequency oscillator since some variation in load and output will be noted when tuning across its frequency range. Regulated voltages are necessary in this type of oscillator to maintain good frequency stability and reset accuracy.

Fig. 5 shows a grid-dip oscillator used widely for determining frequency of resonant circuits in transmitters and receivers. It works on the principle that if power is absorbed from an oscillating circuit (by another resonant circuit in this case) the current flowing in the grid circuit will decrease sharply. In other words if a tuned circuit of the same frequency as the tuned circuit of the oscillator is brought near it, the point of resonance of the unknown circuit will be indicated by a sharp dip in the rectified grid current. Unknown L-C combinations may be calibrated by this means. Since grid-dip oscillators are calibrated with the best standards available, good plate voltage regulation is desirable to maintain their accuracy to the highest degree. The VR tube fits into the requirements very nicely. In fact, the only other way to obtain satisfactory operation is to use a battery supply.

These few illustrations of the various uses of VR tubes should indicate to the radio builder or experimenter many other possibilities for their effective use. In almost all radio or electronic equipment there is often a compromise between accuracy and cost of equipment. The performance of many pieces of equipment can be improved through good voltage regulation. Since the cost of voltage regulation is low, this is an excellent means of improving the accuracy of test equipment.

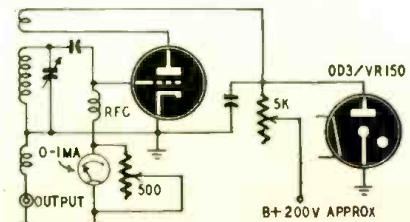

Fig. 5—Grid-dip meter accuracy is improved.

Pepping Up

Midgets

By K. E. STEWART

A.c.-d.c. midgets often offer many opportunities for improvement.

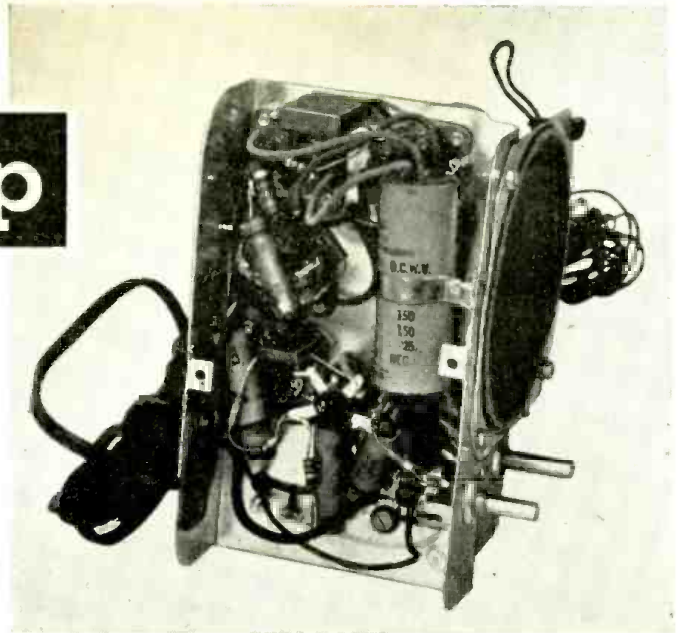

SOME midget a.c.-d.c. receivers do not have sufficient sensitivity for use in remote areas where signals are weak. Often a repairman in a vicinity where there are fairly good signals will find a midget receiver which seems to test o.k. in every respect except that it doesn't have enough volume. Although installing an outside antenna will usually improve reception in both these cases, such an antenna is not always convenient.

One common fault in midget receivers is too many turns of wire in the tuned loop antenna. The technician may find, in trying to peak the antenna trimmer around 1500 kc, that the output increases as the trimmer capacitance is reduced. Often the capacitance cannot be reduced enough to hit the resonance peak. Removing 1 to 3 turns of wire from the loop will correct this condition. The turns should be removed from the inside of the loop. Only one turn should be removed at a time. Check with the antenna trimmer after removing each turn. The removal of more wire than necessary to provide peaking will reduce the sensitivity of the set.

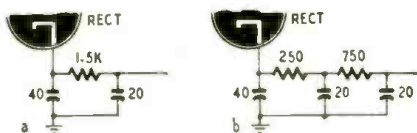

Fig. 1—How to decrease filter resistance.

Another common fault among midgets is the tendency to go into oscillation when tuned to the low-frequency end of the dial if the i.f. trimmers are peaked. On checking the alignment of these receivers it is sometimes found that the i.f. transformers have been slightly stagger-tuned to prevent oscillation, with, of course, a resultant loss of sensitivity. If the feedback producing oscillations is removed, the i.f. transformers can be peaked, giving a marked increase in selectivity as well as sensitivity.

Feed-back can often be eliminated by properly dressing the i.f. transformer leads or by removing some of the excess wire. Substituting metal tubes for glass ones will sometimes eliminate the trouble when tube shields fail.

The output stage in many modern midgets does not have a cathode bypass capacitor. The omission of this capacitor introduces some negative feedback into the stage, reducing hum and increasing stability. The bass response and the general output can be increased by the installation of a 10- to 25- μ f bypass.

Usually receiver output can be substantially increased by a comparatively small addition to the B-supply voltage.

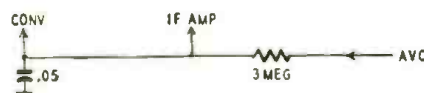

Fig. 2—Typical a.v.c. circuit in midget set.

A typical filter circuit used in these receivers is shown in Fig. 1-a. The filter resistor has a value of 1,500 ohms. If the value of this resistor can be reduced, the IR drop will also be reduced, resulting in a higher voltage output. Fig. 1-b shows how this resistance can be decreased to 1,000 ohms without impairing filtering. (See also "We Learn the Hard Way," RADIO-CRAFT, Jan., 1944.) The 1,500-ohm resistor is replaced with two resistors, one of 250 ohms and the other of 750 ohms. A 20- μ f, 150-volt capacitor is also added. The ripple voltage with this circuit is usually lower than it was originally, and output goes up considerably.

In most midgets the a.v.c. filtering circuit consists merely of one resistor and one capacitor, with no isolating networks for the various controlled stages. Fig. 2 shows a typical circuit. Sometimes a noticeable increase in volume will result from replacing the .05- μ f capacitor with 0.1 μ f unit.

The 3-megohm isolating resistor

shown in the figure should be reduced to prevent too great an increase in the a.v.c. time constant. The time constant in seconds is the product of C in μ f and R in megohms. The time constant in Fig. 2 is 0.15 second. Therefore, if the capacitor becomes 0.1 μ f, the resistor must be 1.5 megohms to hold the time constant to 0.15 second. However, in most cases, a 2.2-megohm resistor will give more output, and the increase in the time constant will not be noticed.

It is important in changing the filter circuit of the a.v.c. to avoid loading the audio output of the detector to any appreciable degree. Effectively, the resistor and the capacitor are in series across the audio load. The 0.1- μ f capacitor, if placed across the audio load, would constitute practically a short circuit. The series resistor prevents this and therefore must be kept fairly high in value.

In a few stubborn cases it is worth while to reduce the a.v.c. voltage to get more gain in the receiver. A practical way to do this is shown in Fig. 3. A 470,000-ohm resistor is connected between the load end of the a.v.c. line and ground. This value is usually best for the proper compromise between added gain and reduced a.v.c. action.

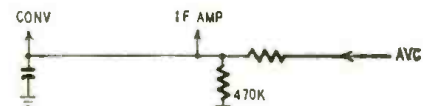

Fig. 3—How the a.v.c. voltage can be reduced.

Most of these methods are of course contrary to the manufacturer's design of the receiver. They are recommended only as a last resort after the set has been thoroughly checked for ordinary faults. The manufacturer generally expends more time and labor in engineering his receiver than you will be able to, and it is bad business to redesign a circuit while overlooking faults which may continue to get worse.

European Report

By Major Ralph W. Hallows

RADIO-CRAFT LONDON CORRESPONDENT



TELEVISION is now going ahead rapidly in France. At the moment the only transmitter

is installed in the Eiffel Tower in Paris; but relays at Lille and Lyons are now under construction and are expected to be in operation before long. Other relaying stations are to be built at Bordeaux, Toulouse and Marseilles. It has been decided that the present 455-line system shall be maintained for at least 10 years to insure purchasers of televisers against having their sets made obsolete overnight by changes in television standards. At the same time an 819-line service is being developed to work side by side with the other. The Eiffel Tower station already has two 819-line outfits, including orthicon-type cameras, which are being used for experimental transmissions. Several important demonstrations have been given with complete success. The same program was sent simultaneously by 455-line and 819-line transmitters. At the receiving end corresponding televisers were arranged side by side so the audience could make direct comparisons between the high-standard and definition systems. During these demonstrations a series of linens, cretonnes and other cloths in a variety of intricate designs and colors were placed in front of the cameras. A friend who saw one of the shows tells me that reception of patterns such as fine black and white checks was startlingly good. "I hadn't a notion that television could do such things," said he! Another interesting item was the projection on to a 12 x 10 feet screen of a film made from 819-line television images.

You must know about the system invented a good many years ago, which allows movie film to be exposed, developed, fixed and passed through a projector in well under 30 seconds. It may be that a combination of this system with 819-line (or, perhaps, one thousand-and-something-else line) television will provide the quickest short-cut to big-screen television—though I can't and won't believe that it's anything like a final solution of the problem.

AM versus FM

In Britain the experts are getting heated up almost to the assault-and-

battery point over the relative merits of AM and FM for v.h.f. high-fidelity broadcasting. Almost any place where radio hams gather you will find such heated arguments that you begin to wonder when the shooting will start. The AM fans maintain that the method of their choice can do anything that can be done by FM. They protest that FM means receivers of a more elaborate and expensive type and that cheap FM sets can never do justice to this type of broadcasting. Frequency drift, they say, would damn the cheap receiver and the difficulty of tuning such a set would result in further damning on the part of its owner.

On the other hand the FM supporters (of whom I am most emphatically one, provided that no one with more than about my 190 pounds of weight looks like getting nasty) hold that FM gives by far the better all-around results; that it is much superior in eliminating man-made static (the only kind that matters much at such frequencies); that it is a disgrace to designers in these days for even a cheap set to suffer from frequency drift; and that both alignment and tuning can be made perfectly simple. Who will win the battle? Clothing is strictly rationed and laundries play havoc with what we have; but I'd bet my shirt—even if it was the last one I had—on FM.

Stable discriminator

Talking of FM alignment leads me to mention a remarkably stable discriminator circuit (shown below) described recently by Thomas Roddam in *Wireless World*. Roddam is one of our most brilliant young radiomen, and anything

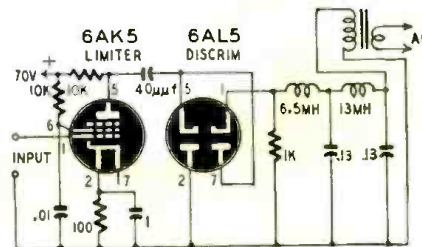

he writes about is worth studying. His discriminator circuit is shown in the accompanying diagram. It is not, as he says, very efficient; it needs a high input and delivers a low output; but it *does* stay put. It requires a 150 kc intermediate frequency, though that raises no great difficulty. The point about it, as the author says, is that it goes on working indefinitely and just can't go wrong. All the constants are given in the diagram so that readers who care to experiment with the circuit can make it up and see for themselves what sort of goods it delivers.

French televisers

At the recent *Foire de Paris* (Paris Fair) an unexpectedly large number of French-made televisers was on display. No less than 23 makers exhibited them and the number of different types was considerable. Till recently few televisers have been available in France with cathode-ray tubes of larger than 7 to 9 inches—and there weren't very many of those. At the Fair there were 11 different sets with 12-inch tubes and three of the projection type, with screens ranging from 16 x 12 to 22 x 16 inches. None of the projection types were priced, so they can't be regarded as production models. Of the others, prices ranged from \$260 for a 10-tube table-model giving vision only and with a 9-inch screen to \$920 for a 25-tube console with a 12-inch screen and incorporating a radio receiver. French designers as a whole seem to favor four main control knobs, though there was one model with only two. Others had from five to eight. It didn't seem as if would-be buyers would have long to wait for delivery. Seven manufacturers guaranteed to supply at once; others mainly offered delivery in one to three weeks. And, believe it or not, that's pretty good going in Europe nowadays. If my tailor doesn't soon let me have the suit of clothes I ordered six months ago, I'll be going about in a blanket!

Wired wireless

I'm not sure whether there are radio program relay services in American towns and villages. By program relay services, I mean systems in which a company runs an elaborate receiving station in or just outside a built-up area and supplies subscribers, connected by wires to a central exchange, with a choice of two or more programs. Wired wireless is used a great deal here. Subscribers pay 35 to 40 cents a week and the relay company provides and maintains the simple gear needed in their homes. The advantages are that the subscriber gets trouble-free and interference-free reception of good quality at all times and in all conditions. The British Post Office, which also runs the country's telephone system, has been engaged for some time in developing a system of relaying radio programs to telephone subscribers. When he wants radio the subscriber calls the exchange and asks for the program of his choice. He then turns a switch which cuts out his telephone and brings in an amplifier and loudspeaker. Should there be a telephone call for him, he receives a warning from the loudspeaker. He then turns the switch to the telephone position and takes the call.

Instantaneous Intercom

By HAROLD R. NEWELL

Selenium rectifier and battery tubes eliminate the warm-up time

THIS intercom is suitable for home, office or any location where the noise level is not too high. The circuit provides for one master and one remote but can be adapted for several remotes. Each station can call the other.

The power is normally turned off. Instant starting is possible because of the selenium rectifier and miniature instant-heating battery-type tubes. There is no standby current and the tubes are being used only when actually needed.

The tube lineup includes a 1S5 as first audio amplifier driving a push-pull output stage using a 3S4 and 3Q4. These two different tubes are used because they match the bias obtainable from the filament circuit. Although they have somewhat different load ratings, they work very well together and provide ample output.

The method of obtaining the phase-inverted signal for the 3S4 is the same as used in several commercial receivers. A resistor is inserted in series with the screen of the 3Q4 and the signal developed across it is passed to the 3S4 through a blocking condenser.

An aluminum chassis $4\frac{1}{2} \times 4\frac{1}{4} \times 1\frac{1}{2}$ inches is used for the master station. On this are mounted a 4-inch speaker, the three tube sockets, two transformers, volume control, switch, and filter-capacitor can. The volume control and the switch are mounted on a bracket at the side of the chassis. The selenium rectifier is mounted below the chassis.

A 2,500-ohm 10-watt resistor is used to drop the voltage for the tube fila-

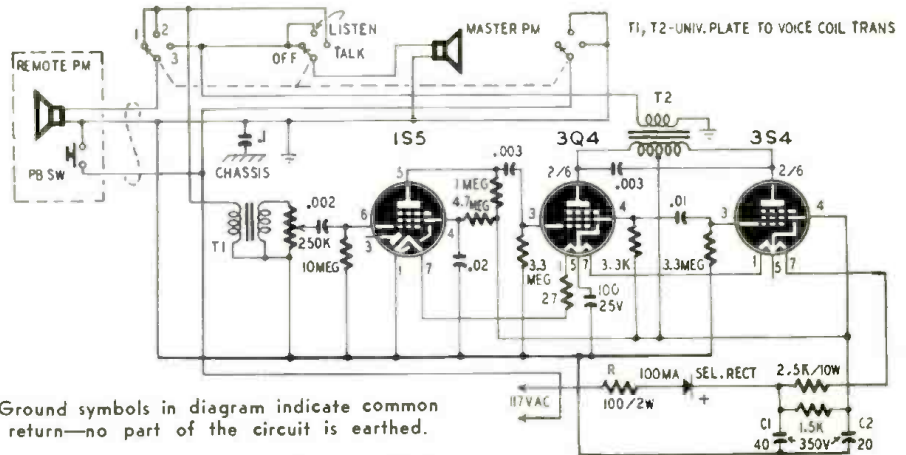

Ground symbols in diagram indicate common return—no part of the circuit is earthed.

ments. It is bypassed with the 100- μ f section of the condenser block, which includes C1, C2, and C3.

The talk-listen switch is a 3-pole, 3-position positive-acting rotary. The first position of the switch is OFF. The remote speaker is connected as a microphone. When the remote power button is pressed, the amplifier is turned on and the remote can call the master. In the second position the master may listen. In the third, the master may talk.

The master and remote units are connected with a three-wire cable. One wire is the circuit ground, the second for the voice coil and the third for the power button. When the power button is pressed to call the master, some hum is produced because the ground wire is common to both the audio and a.c. power circuits.

Although useful in getting the master's attention this hum may be eliminated by using a four-wire cable, with a separate power-return lead.

Note that the circuit ground is separated from the chassis by a 0.1- μ f capacitor. Though not necessary electrically, this helps prevent shock and is common practice with transformerless power supplies. To make the unit absolutely safe, the amplifier should be enclosed in a wooden cabinet and all external cables and leads should be well insulated.

The author has not found much use for the volume control; the gain is about right as is. If desired, it may be eliminated.

Some adjustment of R may be necessary to obtain correct voltages at the tube filaments.

UNOBTRUSIVE HEARING AID

One of the reasons many hard-of-hearing people refuse to wear hearing aids is an objection to their conspicuousness. This problem has been largely overcome in recent years by placing the amplifier, microphone, and batteries in one small case which can be hidden in a pocket. However, the earphone is usually quite visible.

A new type of receiver developed by the Maico Company reduces the visibility of the earphone almost to zero. Instead of plugging the phone directly into the ear, it is pinned to the inside of a man's collar or concealed in some part of a woman's clothing or hair. A small chain is attached to it for this purpose. (See photograph.)

A thin lucite tube fastened to the receiver conducts the sound to a moulded plastic insert shaped to fit inside the ear. The insert is almost invisible when it is in place, not only because it is made



Secretear compared in size with finger ring.

of flesh-colored plastic but also because it is exactly shaped to the contours of the ear.

Despite the acoustical transmission

through the lucite tube the quality of the sound appears to be unaffected. Listening tests on the Secretear have proved it very satisfactory.

The amplifier measures about $4\frac{3}{4} \times 2\frac{1}{2}$ inches. The batteries and microphone are in the same white plastic case.

Three Bug-Free Amplifiers

The author presents circuits and data for three straightforward amplifiers

By JOHN W. STRAEDE*

IN this article descriptions of three straightforward bug-free amplifiers are given. Their circuits are comparatively simple and do not include unnecessary parts. They deliver 9, 13 and 20 watts respectively.

The tubes used in the amplifier of Figs. 1 and 2 are a couple of voltage-amplifying pentodes in cascade followed by a 6L6-G developing 9 watts. The rectifier is either a 5Y3-G or 5V4-G depending upon the voltage of the transformer secondary. If the high-voltage winding gives about 375 volts per side a 5Y3-G (or an 80) can be used. If the voltage is lower, around 300 per side, the more efficient 5V4-G must be used to provide a sufficiently high d.c. output. As an alternative to the 5V4-G, a metal 5Z4 can be employed.

Parallel mixers are used with 270,000-ohm isolating resistors between the volume controls and the control grid of the second tube.

Unusual points in the circuit are the use of grid leak bias on the first 6J7, lack of a filter choke, use of a volume-expander lamp and a lamp as fuse.

Advantages of grid leak bias are the saving of a cathode resistor and a bypass condenser and lower hum level (because cathode is grounded.)

No filter choke is necessary for ordinary PA use, because a beam tetrode or pentode output valve has a high plate resistance and the plate current is al-

*Lecturer in electronics and electro-acoustics, Melbourne Technical College, Australia.

Fig. 1 (right)—Schematic of the 9-watt unit.
Fig. 2 (below)—Sockets are for speaker plugs.

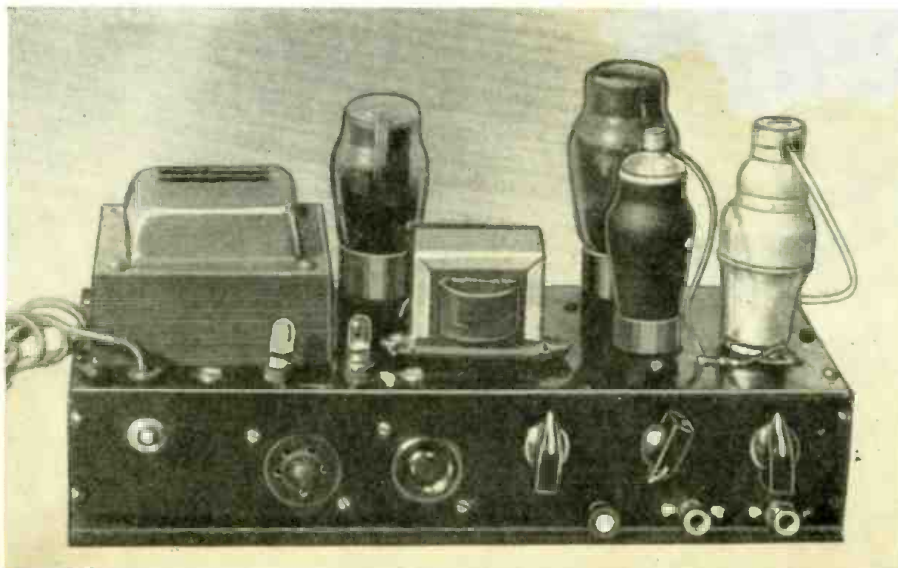

most entirely unaffected by changes in plate voltage.

The pilot lamp connected across the voice coil winding of the speaker transformer gives a small amount of automatic volume expansion but its real use is to act as an output-level indicator.

Another 6-volt 0.3-amp lamp is connected in the negative side of the high-voltage supply to prevent damage to the power transformer if an electrolytic condenser should break down. The pilot light may have to be omitted if a 5V4-G or other low-impedance rectifier is used, because switching the set on and off when hot may cause the lamp to blow out.

One feature not at first noticeable is the way in which the circuit is designed to give a good frequency response. Although there are small plate bypass condensers to remove any r.f. that may be picked up, the plate load resistors are smaller than usual, resulting in an excellent high-frequency response. Bass response is also good because the decoupling network for the 6L6-G bias supply

acts to a certain extent as a bass-booster.

A conventional high-cut tone control is connected between the plate of the second tube and ground.

A 47,000-ohm suppressor resistor is connected directly in series with the 6L6-G control grid to make the sound more tolerable when momentary overloads occur.

To eliminate the bass boost, reduce C to .01- μ f and increase the suppressor resistor R to 270,000 ohms.

The sixth pin of each tube socket (except the rectifier) is used as a tie point. It is definitely not advisable to have parts rigidly mounted—a little slack in the wiring gives elasticity and minimizes the chances for resistors and condensers to break down.

Six tubes, thirteen watts

The second amplifier (Figs. 3 and 4) is quite orthodox, bearing some similarity to the smaller job in the use of shorting jacks, high-cut tone control and lack of a filter choke.

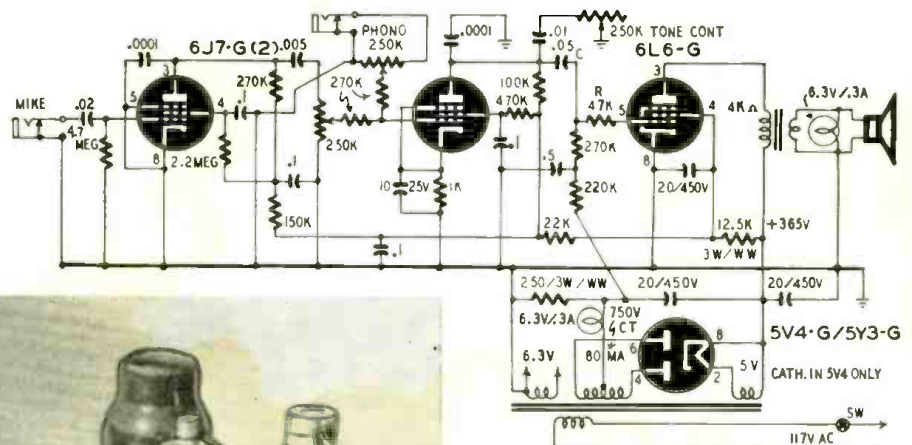

A pair of 6V6-G beam tetrodes is used in class AB1. The operating conditions are such as to provide negative regulation (the total current drawn decreases at full volume).

Floating paraphase phase inversion is used—a system which gives an automatic near-balance. This system cannot give perfect balance, for if each 6V6-G grid had an equal signal, there would be no signal to drive the phase-inverter grid.

The common cathode resistor helps to bring the system nearer to perfect balance—these resistors have such an effect that if the 150,000-ohm resistor is shorted the drop in volume is negligible.

A 20 percent change in value has no perceptible effect. Most critical value is that of the 6,500-ohm dropping resistor for the 6V6-G screens. If no wire-wound resistor is available three 20,000-ohm, 1-watt carbon resistors can be connected in parallel.

Although a 3.9-megohm resistor is shown as an inverse feedback device, this is seldom used, as the presence of inverse feedback is apt to cause a rise in hum level when the output tubes do not have a well-filtered supply. (Feedback from the voice coil is less likely to produce a higher hum level but it is not easily applied in this circuit).

Decoupling is used for every stage. The filtering is comparatively poor for the output stage but is better for each preceding stage. The very best of filtering is necessary for the first tube because it is followed by a gain of something like 2,000.

Five tubes, twenty watts

This five-tube amplifier has a peculiar layout as Fig. 5 indicates. The power-pack section is spaced well away from the four amplifying tubes. This is to allow it to fit in a case with plenty of room in the center for a heavy-duty PM speaker. As in the previous amplifiers, grid-leak bias is used for the microphone preamplifier, but unlike the others, a filter choke is included so plenty of negative feedback can be used without excessive hum. The schematic appears in Fig. 6.

There are two negative feedback circuits. One is from an output tube plate to a 6SC7 plate. The other comes from the other 6L6-G plate to the 6SC7 input grid, helping to compensate for lack of coupling between halves of the output transformer primary.

Paraphase inversion is used and the 6SC7 works very well. Formerly a 6N7 was used, resulting in lower gain.

The cathode of the phase inverter is bypassed for high frequencies with a .05- μ f condenser so that there is no com-

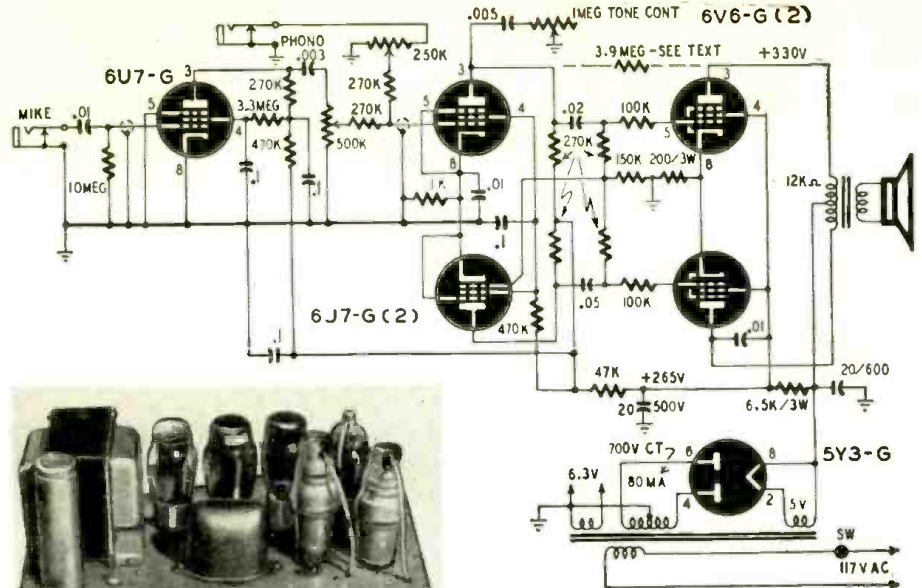

Fig. 3 (above)—The 6-tube, 13-watt amplifier. Fig. 4 (left)—Chassis layout of this unit.

mon coupling at high frequencies. This allows more effective operation of the high-frequency tone control. The plate-to-plate feedback circuit is connected as a low-frequency tone control.

In the other feedback circuit there are two condensers. One of 500 μ f shunts some signal to ground to reduce the feedback at high frequencies and thus provide a high-frequency boost. The .001-

μ f condenser in series, provides a bass boost by reducing the feedback at low frequencies.

The gain from 6SC7 grid to 6L6-G anode is about 800 so the feedback voltage is reduced by two voltage dividers—one consisting of 3.9-megohm and 47,000-ohm resistors, and the other consisting of a 1-megohm resistor and the 270,000-ohm isolating resistors of the two volume controls.

If the amplifier is unstable because of

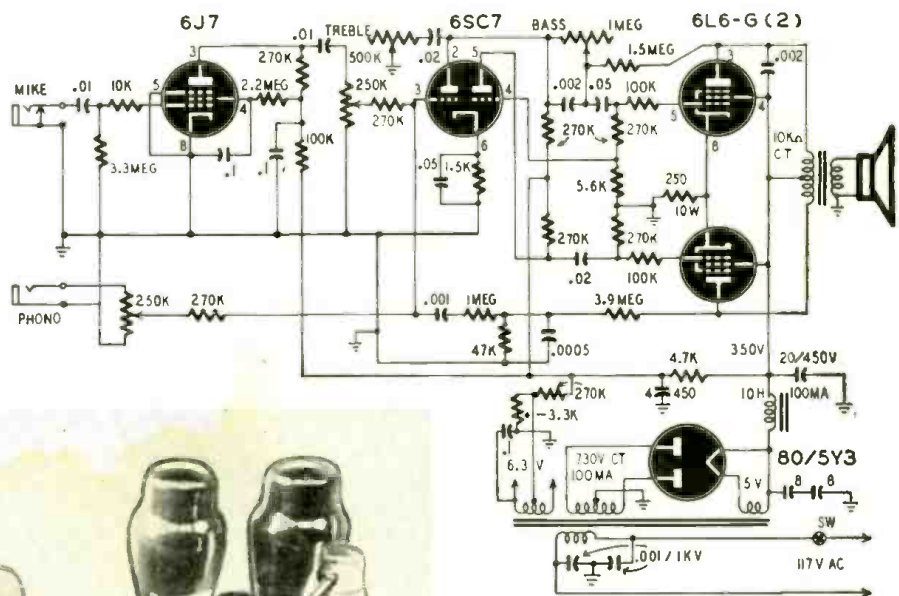
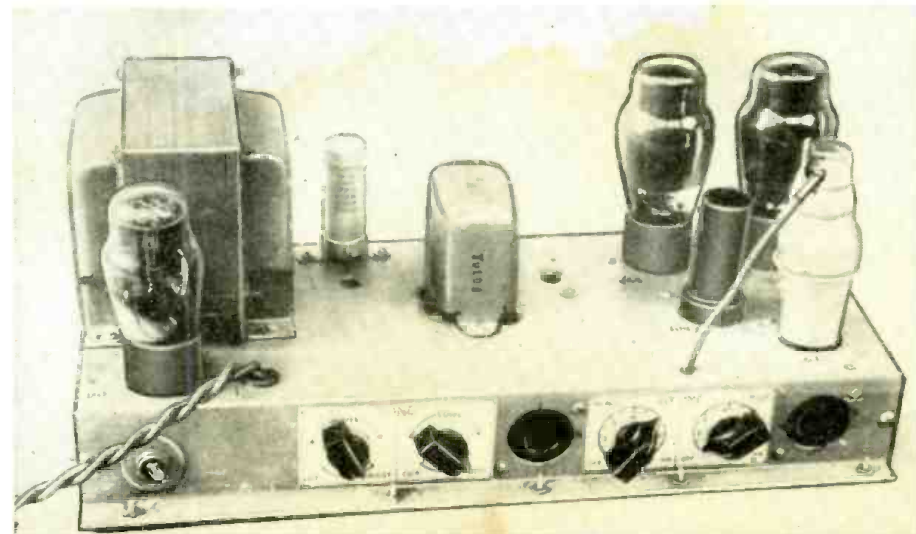

Fig. 5 (below)—Parts placement reduces hum. Fig. 6 (right)—Amplifier output is 20 watts.



too much gain or due to phase changes in the feedback circuit, it may be necessary to reduce the size of the 47,000-ohm resistor or to increase the 1-megohm resistor to around 4 megohms.

Two features not found in either of the other amplifiers are the use of an r.f. suppressor, a 10,000 ohm resistor in series with the grid of the 6J7-G, and the application of a positive voltage to the heaters of the tubes to reduce heater emission, a common cause of hum.

This amplifier is very suitable for recording.



The next time you hear voices -LISTEN!

IT MAY BE your conscience speaking.

It may be saying: "Save some of that money, mister. Your future depends on it!"

Listen closely next time. Those are words of wisdom. Your future—and that of your family—*does* depend on the money you put aside in savings.

If you can hear that voice speaking clearly, do this:

Start *now* on the road to *automatic* saving by signing up on your company's Payroll Savings Plan for the purchase of U.S. Savings Bonds.

There's no better, no surer way to save money. Surer because it's automatic . . . better because it pays you back four dollars for every three you invest.

Do it now. If you can't join the Payroll Savings Plan, tell your banker to enroll you in the Bond-A-Month Plan that enables you to purchase a bond a month through your checking account.

Remember—better save than sorry!

Automatic saving is sure saving— U.S. Savings Bonds



Contributed by this magazine in co-operation with the Magazine Publishers of America as a public service

RADIO-CRAFT for

The A. C. Ammeter Saves Testing Time

By JOHN MELICHAREK

FEW radio technicians realize the amount of time and labor that can be saved by using an a.c. ammeter in radio servicing. A.c. ammeter ranges are seldom included in multi-testers; however, it will be worth your while to purchase a 0-1-ampere a.c. meter for your shop. If you use it intelligently, you can often save hours that would otherwise be spent in tracking down false clues. I use one to check every set that comes into my shop.

I have a 7-inch 1-ampere meter in series with one side of the power receptacle to which I connect all sets for their initial testing. Most sets have the normal power consumption, in watts, marked on a plate or tag on the chassis or cabinet. I convert this wattage rating to amperes ($I = W/E$) and compare it with the reading on the meter. When the reading is higher or lower than normal, it can be used as an indication of possible sources of trouble.

Two troubles are common in radio receivers. A component burns out or opens or develops a short. Your servicing job becomes much simpler when you know which of these conditions exists. The facts are clearly defined for you by the a.c. ammeter. Just plug in the receiver, turn on the power and read the trouble on the meter.

To clarify this, consider a 75-watt re-

ceiver that is working properly. Removing the rectifier tube drops the reading to 45 watts (.38 amperes). Pull out the power amplifier tube and the reading drops to 55 watts. A burned-out output transformer or burned-out field coil drops the consumption to 60 or 50 watts. Five-watt drops are easily seen on the meter. Drops of 15, 20 and 30 watts can easily be diagnosed with just a little experience. If the drop were only 5 or 6 watts, you would not need to check or suspect the speaker field, choke coil or rectifier tube.

Like other test instruments, the meter will not show you everything. A 6K7 tube with an open heater will cause about a 5-watt drop; but an open plate or screen supply will not show on the meter. It takes at least 20 ma at 100 volts to give a good indication.

If the radio has a high-current short the meter immediately shows it. Shorted filters and bypass condensers are the two main offenders. Readings will be from 80 to 200 watts. Shorted filter condensers show up almost instantly, while shorted plate and screen bypass condensers do not show up until the filters are charged.

When servicing a.c.-d.c. receivers, the ammeter shows the continuity of the filament string and the current drawn while the set is heating up. An a.c. re-

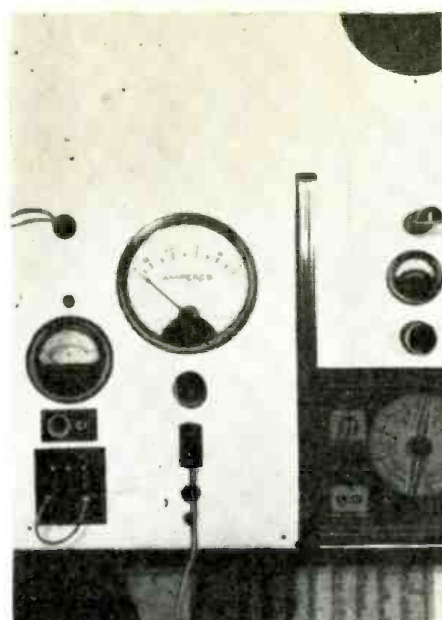

The ammeter mounted in the back of the bench.

ceiver, when first turned on, draws only about one half of its rated current; the current begins to increase as the tubes reach operating temperature.

A 40-watt a.c.-d.c. receiver draws only 22 watts when it is first turned on. The current begins to rise as the tubes heat up, and if nothing is shorted, the needle will stop around the 40-watt mark. If it should continue beyond the 40-watt mark a short is indicated and the power should be cut off immediately. Almost any short in the filter section will cause the 40-watt receiver to draw 100 watts. This shows why a rectifier tube can burn out or go bad in a few minutes.

The important point is to watch the meter needle with one hand on the power switch. Be ready to cut off the power if the needle goes beyond its mark for a normal set. The needle may take from 10 to 30 seconds to come to rest. A longer period may be caused by high resistance in the filament string or poor rectifier tubes. If the rectifier is bad (not burned out) the needle will not move off its starting point—a sure indication of what is wrong.

The meter shown in the picture is a G.I. souvenir that I brought back from Germany. It is a French 1-ampere meter, with a 7-inch scale. A meter this size is preferred because the divisions will be around 3 times larger than for a 4-inch meter. It can easily be read from a distance. Still, I would settle for a 2-inch meter rather than none at all.

The most important feature of the meter is its range. 1 ampere is about equal to 115 watts. This will take care of most receivers up to 12 tubes (less phono motor). A 2- or 3-ampere meter will not be sensitive enough, unless you are servicing electronic equipment which draws 1.5 amperes or more.

Many radios develop serious shorts which will cause 2 or 3 amperes to be drawn in some cases even more. Always protect your instrument with the proper fuse; for a 1-ampere meter, use a 1-ampere fuse.

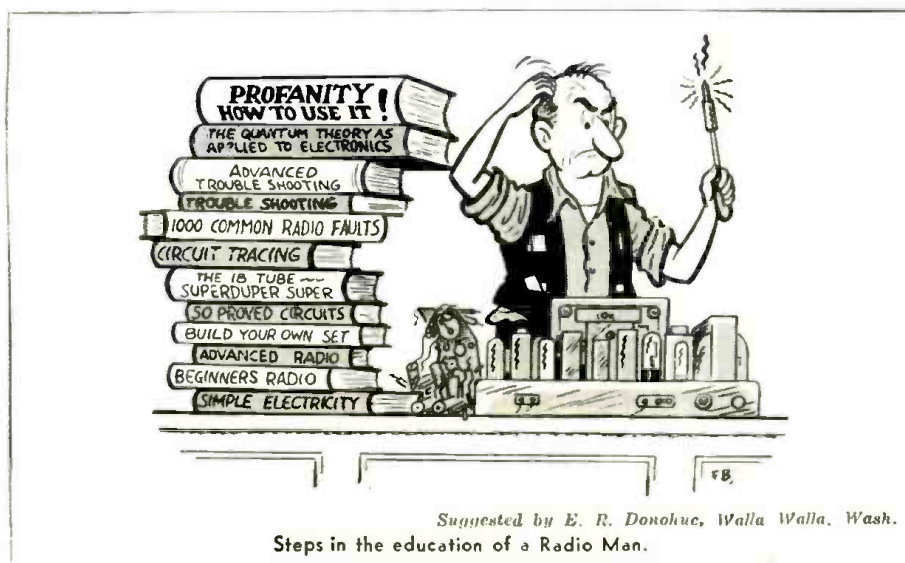

Suggested by E. R. Donohue, Walla Walla, Wash.
Steps in the education of a Radio Man.

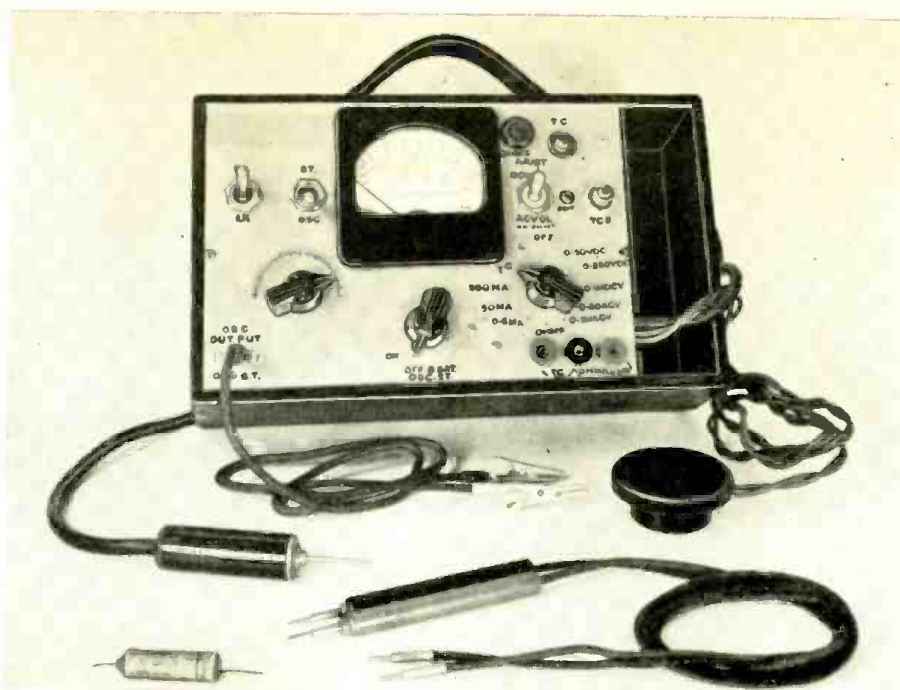

This small test instrument is ideal for outside service calls. All parts fit into the case.

Versatile Tester Has New Features

**This instrument
has a novel con-
denser checker
plus signal gen-
erator-tracer &
multimeter**

By V. A. JEANNOT

THIS is an ideal test instrument for experimenters and for radio servicemen to use on outside servicing calls. It is a combination test oscillator, signal tracer, condenser tester, multimeter and continuity and polarity tester. It is inexpensive and can be built into a case $7\frac{1}{2} \times 5 \times 3$ inches. A case this size includes ample space for a few replacement condensers, resistors, fuses and other essential accessories.

The condenser tester (for testing paper and mica condensers for shorts) is novel. The basic circuit is shown in Fig. 1. The condenser is placed in a high-frequency high-voltage circuit in series with a neon lamp. One electrode of the lamp glows as the condenser charges and the other glows as it discharges. This action is so rapid that both elements appear to glow at the same time. If the condenser is shorted, only one plate will glow. (Carry several good condensers in the spare parts compartment and shunt them across condensers suspected to be open.)

The high-frequency voltage for the test is developed in a vibrator transformer made from a small relay. The original coil is removed and replaced

with a 150-turn primary of No. 24 enamel wire. This is covered with a layer of Scotch tape and the remaining space filled with as many turns as possible of No. 30 enamel wire. The relay contacts are wired so the unit will work as a vibrator or buzzer. When the push-button switch S4 (marked TCS on the front panel) is pressed, a high-voltage high-frequency current is developed in the secondary of the vibrator-transformer. The secondary is connected to pin jacks marked T-C through S5B when it is in position 11.

Test Oscillator

The test oscillator or signal generator is a Hartley oscillator using the pentode section of a 1S5. This is shown on the complete diagram, Fig. 2. Two coils are

used to cover the i.f. and broadcast ranges with a small 365- μ fd variable condenser. The low-frequency coil has 500 turns of No. 30 enamel wire scramble-wound on a $\frac{3}{8}$ -inch form and the broadcast coil 60 turns of No. 28 enamel wire on a $\frac{1}{4}$ -inch form. Both coils are center-tapped. The low-frequency coil may be the secondary of an i.f. transformer designed to work into a full-wave detector. This coil is mounted inside one end of the large coil form. Coils are selected by a d.p.d.t. switch, S3. The 1S5 is also used in the signal tracer circuit; when using the oscillator S2, a d.p.d.t. switch, should be in the Osc position. Filament voltage is turned on with S1 in the A.C. VOL position. B-voltage, from a hearing-aid-type B-battery, is applied through a switch on the r.f. output control. Output is obtained through an open-circuit jack on the panel. A shielded output cable carries the signal to external circuits. The shield is used as a common return. No modulator is used. The values of the grid leak and condenser—1 megohm and .001 μ f—are selected to cause audio blocking or squegging at an audio rate

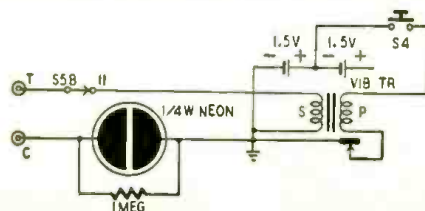

Fig. 1—The condenser checker is unusual.

(Continued on page 48)

AN ACCURATE POCKET SIZE VOLT-OHM MILLIAMETER

(SENSITIVITY: 1000 OHMS PER VOLT)



The Model 770 comes complete with self-contained batteries, test leads and all operating instructions.

FEATURES

- ★ Compact-measures 3 1/4" x 5 7/8" x 2 1/4".
- ★ Uses latest design 2% accurate 1 Mil. D'Arsonval type meter.
- ★ Same zero adjustment holds for both resistance ranges. It is not necessary to readjust when switching from one resistance range to another. This is an important time-saving feature never before included in a V.O.M. in this price range.
- ★ Housed in round-cornered, molded case.
- ★ Beautiful black etched panel. Depressed letters filled with permanent white, insures long-life even with constant use.

SPECIFICATIONS

- 6 A.C. VOLTAGE RANGES:
0-15/30/150/300/1500/3000 VOLTS
- 6 D.C. VOLTAGE RANGES:
0-7.5/15/75/150/750/1500 VOLTS
- 4 D.C. CURRENT RANGES:
0-1.5/15/150 MA 0-1.5 AMPS.
- 2 RESISTANCE RANGES:
0-500 OHMS 0-1 MEGOHM

\$13.90
NET

GUARANTEED QUALITY TUBULAR CONDENSERS

An example of the value we offer, the 20/20 150 V condenser listed below (made for us by a nationally famous manufacturer) lists at \$1.30, our selling price is only 26c.

		PER HUNDRED	
.001	— 600V	\$3.95
.002	— 600V	3.95
.003	— 600V	4.40
.005	— 600V	4.40
.006	— 600V	4.40
.01	— 600V	4.40
.02	— 600V	4.95
.03	— 600V	4.95
.05	— 600V	4.95
.1	— 600V	7.20
			EACH
.25	— 600V12
.5	— 600V17
5	— 25V14
10	— 25V16
25	— 25V18
10	— 50V22
100	— 25V29
16	— 150V18
20	— 150V24
20/20	— 150V26
30	— 150V28
40/20/20	— 150V-25V44
40/40/20	— 150V-25V44
50/30	— 150V44
4	— 450V24
8	— 450V27
16	— 450V36
16/16	— 450V59
20	— 450V39
30	— 450V47
40	— 450V59
80	— 450V97
.005	— 1700V13
.008	— 1700V15
.01	— 1700V17
.02	— 1700V19
.05	— 1700V21
.05	— 2500V58
.1	— 2500V64
.25	— 2500V86
.05	— 3000V69
.003	— 5000V57
.005	— 5000V62
.01	— 5000V74
.0005	— 7500V58
.003	— 7500V67
.0005	— 10000V64

RADIO TUBES - STANDARD BRANDS - BULK

All brand new, cart. supplied free with each tube

OZ4 \$.65	6H6GT 49	12SF5GT 49	24A54
1A5GT 59	6J5GT 49	12SF7GT 69	2649
1A7GT 59	6J685	12SJ7GT 49	2751
1H5GT 59	6J7GT 55	12SK7GT 49	35/51 59
1N5GT 59	6K6GT 49	12SQ7GT 49	3674
1LA4 95	6K7GT 55	12SR7GT 49	3749
1LA6 95	6L6G 95	14A769	3859
1LB4 95	6Q7GT 55	14B669	39/44 54
1LC6 95	6SA7GT 49	14Q769	4159
1LD5 95	6SC7 55	25A6G 1.15	4269
1LE3 95	6SF5GT 59	25L6GT 59	4359
1LH4 95	6SH7 55	25Z555	4559
1LN5 95	6SJ7GT 49	25Z6GT 47	4674
1Q5GT 95	6SK7GT 49	32L7GT 95	4774
1R579	6SL7GT 74	35A565	4995
1S469	6SN7GT 59	35B565	5095
1S565	6SQ7GT 49	35L6GT 55	5374
1T465	6V6GT 69	35W445	5571
3Q469	6X5GT 65	35Y469	5659
3Q569	7A8GT 79	35Z384	5765
3S469	7B7GT 79	35Z5GT 45	5874
5U4G 59	7C579	50A585	7795
5V4G 85	7C679	50B555	71A74
5Y3GT 42	7F779	50L6GT 55	7559
5Y4GT 55	7Y479	50Y6GT 74	7649
6A759	12A8GT 75	70L7GT 95	7749
6A8GT 59	12AT6 49	117L7GT 1.15	7849
6AC7 85	12AU6 75	117P7GT 1.15	7985
6AK5 75	12BA6 49	117Z395	8042
6AL5 85	12BE6 49	117Z6GT 95	81 1.55
6C4 42	12J5GT 49		82 1.15
6C6 49	12J7GT 69	TELEVISION	8364
6D6 49	12K7GT 74	Kinescopes	8469
6F5GT 49	12Q7GT 74	7EP4 17.40	8559
6F6GT 49	12SA7GT 49	10BP4 34.50	8969

BROOKS RADIO DIST. CORP., 80 VESEY ST., (Dept. A) NEW YORK 7, N. Y.

MONEY BACK GUARANTEE — We believe units offered for sale by mail order should be sold only on a "Money-Back-If-Not-Satisfied" basis. We carefully check the design, calibration and value of all items advertised by us and unhesitatingly offer all merchandise subject to a return for credit or refund. You, the customer, are the sole judge as to value of the item or items you have purchased.

THE NEW MODEL 670

SUPER METER



SUPER METER. A Combination VOLT - OHM - MILLIAMMETER plus CAPACITY REACTANCE, INDUCTANCE and DECIBEL MEASUREMENTS.

D.C. VOLTS: 0 to 7.5/15/75/150/750/1500/7500. A.C. VOLTS: 0 to 15/30/150/300/1500/3000 Volts. OUTPUT VOLTS: 0 to 15/30/150/300/1500/3000. D.C. CURRENT: 0 to 1.5/15/150 ma.; 0 to 1.5 Amps. RESISTANCE: 0 to 500/100,000 ohms. 0 to 10 Megohms. CAPACITY: .001 to 2 Mfd. .1 to 4 Mfd. (Quality test for electrolytics.) REACTANCE: 700 to 27,000 Ohms; 13,000 Ohms to 3 Megohms.

INDUCTANCE: 1.75 to 70 Henries; 35 to 8,000 Henries.

DECIBELS: -10 to +18, +10 to +38, -30 to +58.

The model 670 comes housed in a rugged, crackle-finished steel cabinet complete with test leads and operating instructions. Size 5 1/2" x 7 1/2" x 3".

\$2840
NET

The New Model 606

TUBE & SET TESTER

A COMPLETE TUBE TESTER

Tests all tubes including the new post-war miniature sockets such as the 12AT6, 12AU6, 35W4, 50B5, 11723, etc. Tests by the well-established emission method for tube quality. Directly read on the scale of the meter. Tests shorts and leakages up to 3 megohms in all tubes. Tests leakages and shorts of any one element against all elements in all tubes. Tests both plates in rectifiers. Tests individual sections such as diodes, triodes, pentodes, etc., in multi-purpose tubes.

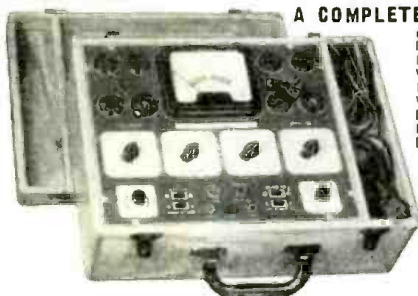

A COMPLETE MULTI-METER

6 D.C. VOLTAGE RANGES: 0 to 7.5/15/75/150/750/1500 Volts • 6 A.C. VOLTAGE RANGES: 0 to 15/30/150/300/1500/3000 Volts • 4 D.C. CURRENT RANGES: 0 to 1.5/15/150 Ma. 0 to 1.5 Amps • LOW RESISTANCE RANGE: 0 to 2,000 Ohms (1st division is 1/10th of an ohm.) • 2 MEDIUM RESISTANCE RANGES: 0 to 20,000/200,000 Ohms • HIGH RESISTANCE RANGE: 0 to 20 Megohms • 3 DECIBEL RANGES: -10 to +38 +10 to +38 +30 to +58 D.B.

\$4785
NET

Model 606 comes housed in a beautiful hand rubbed oak cabinet complete with portable cover, test leads, tube charts, and detailed operating instructions

The Model S-35 — a POWERFUL

REFLEX PROJECTOR

COMPLETE WITH BUILT-IN DRIVER UNIT CONSERVATIVELY RATED AT 35 WATTS—HANDLES UP TO 55 WATTS WITHOUT BLASTING. DRIVER UNIT MFG. BY WESTERN ELECTRIC.

Heavy gauge aluminum in the main trumpet section completely eliminates blasting and blaring. New plastic diaphragm overcomes the resonant peaks of the old type; also it is absolutely impervious to atmospheric changes whereas the old type was subject to atmospheric corrosion. Complete unit unconditionally guaranteed for one year.



Specifications
POWER (CONSERVATIVE) — 35 WATTS; AIR COLUMN—3 1/2 FT.; DISPERSION—80°; POWER (PEAK) —55 WATTS; BELL DIAMETER—15"; IMPEDANCE—8 ohms; FREQUENCY RANGE—130 to 5000 C.P.S. PROJECTION — 1/2 mile; FINISH — Attractive two tone crystalline. The Model S-35 Comes Complete with Built-in Driver Unit. ONLY

\$2850
NET

The New Model 770 — An Accurate Pocket-Size

VOLT-OHM MILLIAMMETER



(Sensitivity: 1000 ohms per volt)

Features: Compact—measures 3 1/4" x 5 7/8" x 2 1/4". Uses latest design 2% accurate 1 Mil. D'Arsonval type meter. Same zero adjustment holds for both resistance ranges. It is not necessary to readjust when switching from one resistance range to another. This is an important time-saving feature never before included in a V.O.M. in this price range. Housed in round-cornered, molded case. Beautiful black etched panel. Depressed letters filled with permanent white, insures long-life even with constant use.

Specifications: 6 A.C. VOLTAGE RANGES: 0-15/30/150/300/1500/3000 volts.

6 D.C. VOLTAGE RANGES: 0-7 1/2/15/75/150/750/1500 volts.

4 D.C. CURRENT RANGES: 0-1 1/2/15/150 Ma. 0-1 1/2 Amps.

2 RESISTANCE RANGES: 0-500 ohms. 0-1 Megohm. The Model 770 comes complete with self-contained batteries, test leads and all operating instructions.

\$1390
NET

THE NEW MODEL 777

20,000 OHMS PER VOLT!!

TUBE & SET TESTER

Tube Tester Specifications:

★ Tests all tubes including New Miniatures, etc. Also Pilot Lights.
★ Tests by the well-established emission method for tube quality, directly read on the scale of the meter. ★ New type line voltage.

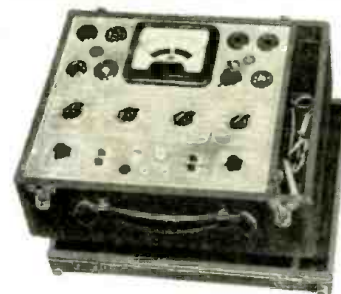

V.O.M. Specifications:
* D.C. VOLTS: (at 20,000 Ohms Per Volt), 0 to 7.5/15/75/150/750/1,500 Volts.

* A.C. VOLTS: (at 10,000 Ohms Per Volt), 0 to 15/30/150/300/1,500/3,000 Volts.

* D.C. CURRENT: 0 to 1.5/15/150 Ma. 0 to 1.5 Amperes.

* RESISTANCE: 0 to 5,000/50,000/500,000 Ohms. 0 to 50 Megohms.

Model 777 operates on 90-120 volts 60 cycles A.C. Housed in beautiful hand-rubbed cabinet. Complete with test leads, tubes, charts and detailed operating instructions. Size 13" x 12 1/2" x 6".

\$5995
NET

The Model 88 — A COMBINATION

SIGNAL GENERATOR AND SIGNAL TRACER

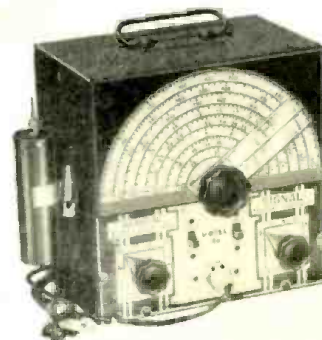

Signal Generator Specifications:

*Frequency Range: 150 Kilocycles to 50 Megacycles. *The R.F. Signal Frequency is kept completely constant at all output levels. *Modulation is accomplished by Grid-blocking action which is equally effective for alignment of amplitude and frequency modulation as well as for television receivers. *R.F. obtainable separately or modulated by the Audio Frequency.

Signal Tracer Specifications:

*Uses the new Sylvania 1N34 Germanium Crystal Diode which combined with a resistance-capacity network provides a frequency range of 300 cycles to 50 Megacycles.

\$2885
NET

The Model 88 comes complete with all test leads and operating instructions. ONLY

20% DEPOSIT REQUIRED ON ALL C.O.D. ORDERS

GENERAL ELECTRONIC DISTRIBUTING CO. DEPT. RC-9 98 PARK PLACE, NEW YORK 7, N. Y.

Bridge Measures L-C-R

Building an accurate instrument for measuring radio parts values

By RUFUS P. TURNER

FOR good all-around flexibility and dependability, the skeleton-type impedance bridge is unequalled for reliable resistance, capacitance, and inductance measurements. It is distinguished from other L-C-R bridges in that it employs plug-in standards that reduce the errors caused by stray capacitances in the range-switch circuits ordinarily employed in home-made L-C-R bridges.

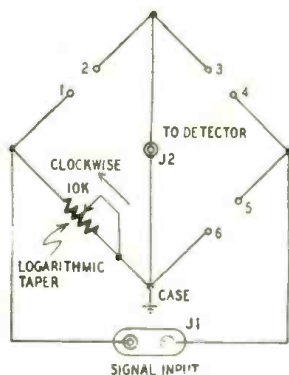

Fig. 1—Schematic shows simplicity of bridge.

The bridge has plug-in terminals in three of its four arms. By simply shifting the standards and the unknown component among these terminals, the bridge may be converted from the Wheatstone type (for resistance measurements) to the Wien type (capacitance) or to the Maxwell type (inductance).

Any convenient signal source, such as an audio oscillator or the low-voltage output of a 60-cycle filament transformer, will supply a.c. input to the bridge. Any convenient null detector may be employed. Satisfactory null detectors include headphones, audio amplifiers with electron-ray indicator tubes, oscilloscopes, and a.c. vacuum-tube voltmeters. In some instances non-electronic a.c. voltmeters have been used with some success. When making resistance measurements, the a.c. signal source and detector may be dispensed with and a battery connected to the bridge input terminals; a center-zero d.c. microammeter or bridge galvanometer may be connected to the bridge output.

The skeleton-type bridge is easy to build and calibrate. The circuit is shown in Fig. 1. The only adjustable element is the rheostat, which carries a direct-reading dial. The terminals, 1-2, 3-4, and 5-6, are provided for plug-in standards and the resistor, capacitor, or coil

under test. Signal voltage is injected into the bridge through jack J1, and the null detector is plugged into jack J2.

While any 10,000-ohm wire-wound rheostat or potentiometer might be used, a rheostat having a logarithmic taper affords an open, easily readable dial. Ordinarily, logarithmic rheostats are rather costly, but an excellent component of this type recently has appeared in the surplus market at a very low price.

The skeleton bridge described in this article is patterned after the discontinued General Radio type 625-A and is a simplification of a similar bridge previously developed by the author.* It has the following ranges: resistance, .01 ohm to 1 megohm in 7 steps; capacitance, 1 μ f to 100 μ f in 7 steps; inductance, 1 μ h to 100 h in 7 steps.

The bridge ranges may be changed by plugging in standard resistors and capacitors of appropriate value (see Tables 1, 2, and 3). The dial of the rheostat (Fig. 2) can be read directly in ohms, micromicrofarads, microfarads, millihenries, millihenries, or henries.

The following standards are required for complete coverage of the resistance, capacitance, and inductance ranges:

- 1 1-ohm resistor
- 1 10-ohm resistor

*See *Radio Test Instruments* by Rufus P. Turner

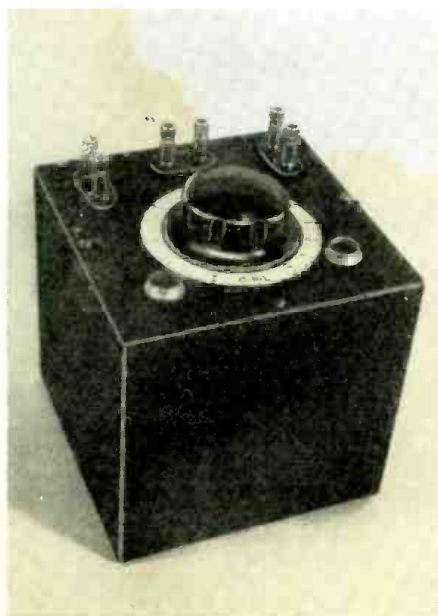

Fig. 2—Bridge is built in square steel box.

- 2 100-ohm resistors
- 2 1000-ohm resistors
- 2 10,000-ohm resistors
- 1 0.0001- μ f capacitor
- 1 0.001- μ f capacitor
- 1 0.01- μ f capacitor
- 1 1.0- μ f capacitor

The accuracy of the bridge depends upon the accuracy of these standards. Precision, non-inductive wire-wound resistors should be employed (they are not expensive) and the capacitors should have at least a 1% accuracy rating.

Construction

The author's bridge (See Figure 2) is built in a standard 6 x 6 x 6-inch steel box. The terminal posts take wire leads and banana jacks.

Signal input jack J1 is a female 2-terminal connector. Bridge output jack J2 is a female co-axial connector. Different types of jacks are used because the input and output terminals of the bridge cannot both be at ground potential without short-circuiting the rheostat, which would be the case if co-axial jacks were used in both positions.

The dial is 3 1/2 inches in diameter and has a metal skirt. A disc of thick white drawing paper is cemented to the metal disc and the graduations from zero to 10 (see Fig. 2) are drawn on this paper.

The standard resistors and capacitors should be mounted inside small boxes or cans provided with banana plugs that fit into the terminal posts of the bridge.

Wiring must be done with stiff bus wire run by the shortest route between circuit points. Fig. 3 gives a clear view of the simple wiring. Be sure to connect the rheostat so that resistance increases with counter-clockwise rotation.

Calibrating the bridge

The skeleton bridge is calibrated by marking the rheostat dial in resistance units. Connect to terminals 1 and 2 a well-calibrated ohmmeter or a resistance bridge of good quality. Temporarily connect wire jumpers between terminals 3 and 4 and between terminals 5 and 6.

Rotate the knob until the ohmmeter or external bridge reads 100 ohms. Mark this point on the scale. Repeat at as many points as possible between zero and 10,000 ohms. Remove the jumpers from the bridge terminals. Remove the dial from the rheostat shaft and ink in the lines permanently. Mark the 1,000-

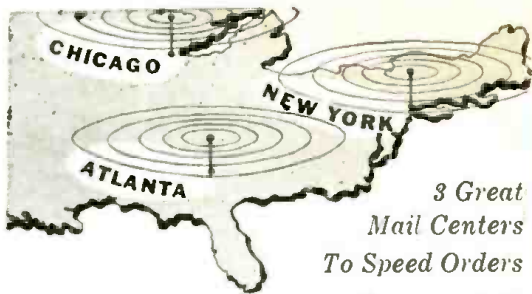

3 Great
Mail Centers
To Speed Orders

LAFAYETTE-CONCORD

ELECTRO NEWS

29 Years of Service—500,000 Satisfied Customers

Great New Radio Merger Announced!

Below are shown 3 typical Lafayette-Concord values. Our shopping scouts will comb the country to bring you best buys like these every month. So keep your bargain-hunting eye on Lafayette-Concord. You'll be missing plenty if you don't.

LAFAYETTE-CONCORD unite. Form largest organization... offer biggest values... most complete stocks, fastest delivery.

3-TUBE PHONO AMPLIFIER,

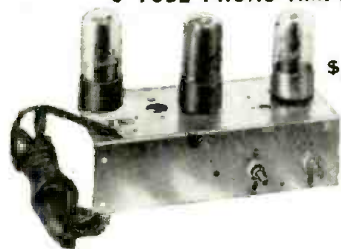

\$424

A compact, useful phono amplifier, ready for installation. Will work fine in hookup to record player. Uses 35Z5, 12SQ7 and 50L6 tubes. Audio stages are capacity coupled. Tone and vol. controls with 1/4" shafts. Plated chassis. 7 x 3 1/4 x 2". Including tubes, at a slam-bang low.....

5" PM SPEAKER

WITH OUTPUT TRANSFORMER



Ideal to use with amplifier above or for replacement in radio receivers, call, paging and inter-communication systems. High quality, high permeability magnet. Formed one piece seamless cone. Dustproof spider and voice coil construction. 2-watt capacity. Voice coil impedance 3.2 ohms. Includes output transformer which matches 50L6 or 50B5 tubes. Only Lafayette has it for

\$424

\$139

EXTRA SPECIAL!

2 STATION INTERCOM BUY



HOME • NURSERY • OFFICE
GARAGE • STORE • FACTORY

Complete 2 way system. Ideal for a dozen uses right in your home or place of business. Install in 5 minutes with screw driver. Calls can originate from either end. A baby's whimper will pick up at 15 feet. So powerful remote will operate over 2,000' from master station. Plastic cabinets, tubes, 50' connecting wire, etc., included. Supply will be limited to readers of this magazine, so send coupon with order.....

\$1295

It's special news — for you — this exciting combine of Lafayette and Concord. Special, because now you can get from the largest organization in the industry...

1. GREATEST VALUES

Tremendous purchasing power makes possible the lowest prices in the industry. Lafayette buys in huge quantities... savings are passed along. Just look through our new catalog and see what we mean. Compare Lafayette parts, radios, equipment... dollar for dollar. See if you can match the value anywhere!

2. BIGGER STOCKS

Lafayette's huge stocks are complete to the tiniest accessory. Thousands upon thousands of items including many hard-to-get today. Full assortments, of course, in ham and hi-fi gear. Sound Systems? You bet! Lafayette P. A. is years ahead in engineering, styling, matchless performance.

TELEVISION'S BIG NEWS — you can find the latest TV gear at Lafayette-Concord. Add dozens of AM and FM models, and kits of every size and type. Pages and pages of 'em in the catalog. And don't forget Lafayette's reputation as Test Equipment headquarters. Every known name is represented. Stocks are always complete and up-to-the-minute.

3. FASTER DELIVERY

Pahokee, Fla., Paducah, Ky., or Painted Post, Wyo., no matter where you are — you save time when you buy at Lafayette-Concord. Three Big Shipping Centers, located in focal spots in the South, East, and West, speed your order the same day it's received. Yes sir, faster than you can say super-sonic, your order is being processed through the world's largest radio house — marked special all the way.

4. ENGINEERING SERVICE

Stumped on a P.A. puzzler? Shoot the problem to our engineers — we hate to brag, but they're smart. And that goes for our entire staff of answer-men. Hi-Fi, Television (you'll run into lulus in TV), you think them up, we'll answer them promptly.

5. OLD TIME RELIABILITY

For 29 years, Lafayette-Concord has been giving folks "the best at the fairest prices". This reliability is an old story to 500,000 satisfied customers... So why take chances on unknowns? Trade with good old reliable Lafayette-Concord — you'll be sure of a square deal.

There you have 5 good reasons, and you'll probably think of a few new ones yourself, once you start doing business with Lafayette-Concord. Don't forget, too, the convenient L-C outlets. Check the addresses below. When you're in the neighborhood, drop in. Whether you buy or chat, we think you'll like the way we do business.



FREE

BRAND NEW CATALOG!

Don't confuse this big book with any catalog you've ever seen before! When you get your copy, you'll see why. It's complete! What a book to have! Page after page on television, hi-fi, radios, P.A., parts, tools, test equipment, etc., etc. Everything in radio is here. But that's only the start of the story. Lafayette-Concord prices are lowest — get this FREE book now and see for yourself!

JUST OFF THE PRESS!

Whatever your interest in radio — service work, engineer, hobbyist, experimenter, beginner — there's more in this book for you than in any ever before published. Don't delay. Mail the coupon on penny postcard.

RUSH THIS COUPON FOR FREE CATALOG AND FOR ORDERING:

LAFAYETTE-CONCORD, DEPT. JER
100 Sixth Ave., New York 13, or
901 W. Jackson Blvd., Chicago 7

MAIL NOW

Please rush FREE catalog No. 89

I enclose \$..... Please fill attached order.

NAME.....

ADDRESS.....

CITY.....ZONE.....STATE.....

Lafayette Concord

100 SIXTH AVENUE, NEW YORK 13
265 PEACHTREE STREET, ATLANTA 3
24 CENTRAL AVENUE, NEWARK 2

229 W. MADISON STREET, CHICAGO 6
110 FEDERAL STREET, BOSTON 10
542 EAST FORDHAM ROAD, BRONX 58

ohm point 1, the 2,000-ohm point 2, and so on up to 10. Then carefully replace the dial.

The accuracy of the calibration will depend upon the precision of the external meter or bridge used, the care with which the dial points are inscribed, as well as the care with which the dial is replaced on the rheostat shaft after inking.

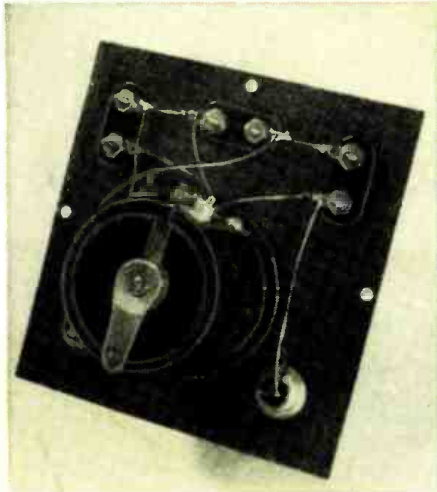

Fig. 3—Wiring is rigid and leads are short.

Operating the bridge

An a.c. signal is used for most measurements. This is supplied in most cases by an audio oscillator. Connect the oscillator and the null detector to the bridge with short lengths of flexible shielded cable. Fig. 4 shows the bridge supplied by an audio oscillator and connected to an oscilloscope used as the null detector. This is a very sensitive arrangement.

Plug in the standards and connect the unknown resistor, capacitor, or inductor as indicated in Tables 1, 2, and 3. Adjust the rheostat for a sharp null. Read the resistance, capacitance, or inductance of the unknown from the dial, according to the range given in the table. If no null is obtained with a given set of standards, change the standards to the next range.

Very often, a sharp null is not obtained during capacitance checks. This is due to capacitor power factor. For sharpening the null and for measuring the power factor, the scheme shown in Fig. 5 is recommended. A calibrated

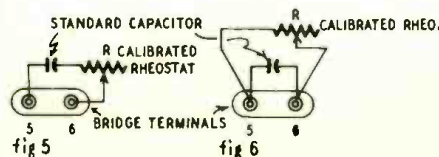

Fig. 5—Extra rheostat measures power factor. Fig. 6—Adjust R for the sharpest indication.

rheostat, R, is connected in series with the standard capacitor and bridge terminals 5 and 6. The rheostat must be connected by the shortest possible leads. R is adjusted along with the bridge dial until the sharpest null is obtained. At this point, the power factor of the capacitor under measurement may be deter-

Range (ohms)	Terms. 1-2 (ohms)	Terms. 3-4 (ohms)
.1-1	10,000	1
0.1-10	10,000	10
1-100	10,000	100
10-1,000	10,000	1,000
100-10,000	10,000	10,000
1,000-100,000	1,000	10,000
10,000-1,000,000	100	10,000

Connect unknown resistor to terminals 5-6.

mined by means of the formula, Power Factor (%) = .000628 fR_c, where f is the bridge signal frequency in cycles, R is the resistance of the auxiliary rheostat at its null, and R_c is the value of the unknown capacitor in microfarads.

A sharp null often cannot be obtained in inductance measurements because of the resistance of the coil under test. To improve this situation, a calibrated rheostat, R, is connected in parallel with the standard capacitor and bridge terminals 5 and 6, Fig. 6. R then is adjusted along

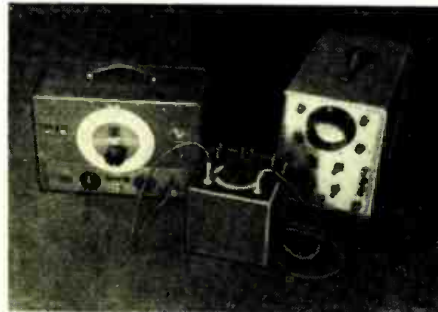

Fig. 4—Bridge used with generator and 'scope.

with the bridge dial to give the sharpest null. At this point, the equivalent series resistance of the coil may be determined by the formula, Equivalent Series Resistance (ohms) = $\frac{R \cdot R_p}{R}$ where R_p is the standard resistor connected to terminals

Range	Terms. 1-2 (ohms)	Terms. 5-6 (μf)
1-100 μμf	10,000	.0001
10-1,000 μμf	10,000	.001
100 μμf-.01 μf	10,000	.01
.001-.01 μf	1,000	.01
.01-1 μf	10,000	1
0.1-10 μf	1,000	1
1-100 μf	100	1

Connect unknown capacitor to terminals 3 and 4.

3 and 4, R_p is the resistance of the main bridge rheostat at its null, and R is the resistance of the auxiliary rheostat at its null. Use the shortest possible leads between the rheostat and the bridge terminals.

To check resistance by the d.c.-bridge method, connect a 1½- to 4½-volt battery to jack J1, and a zero-center d.c. microammeter (100-0-100, 50-0-50 or lower) to jack J2. Connect a pushbutton switch in series with the battery and J1. Set up the bridge for resistance according to Table 1. As the bridge dial is rotated, depress the pushbutton intermittently, noting whether null is approached. As the meter deflection approaches null, the pushbutton may be held down safely. Exact null, of course, is indicated by zero meter deflection.

Range	Terms. 3-4 (ohms)	Terms. 5-6 (μf)
1-100 μh	1	.01
10-1,000 μh	10	.01
100 μh-10 mh	100	.01
1-100 mh	1,000	.01
10-1,000 mh	10,000	.01
0.1-10 h	1,000	1
1-100 h	10,000	1

Connect unknown coil to terminals 1 and 2.

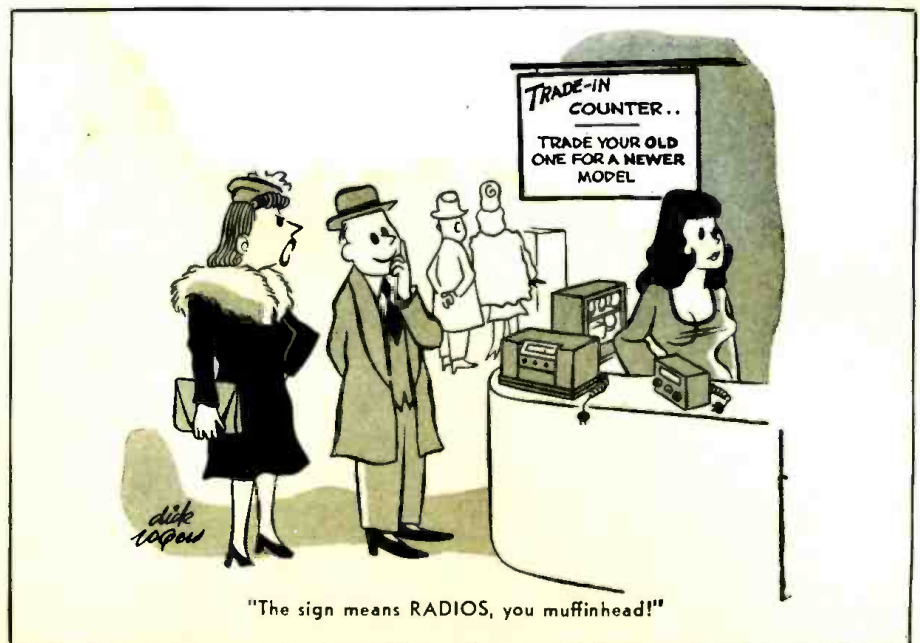

CREI Training is Your
DOWN PAYMENT
 ON PROMOTION, MORE MONEY,
 SECURITY



Train With One of America's
 Foremost Technical Institutes

**RADIO-
 ELECTRONICS!
 TELEVISION!**

**CREI Training Can
 Help You to a
 Better-Paying Job!**

EVERY WEEK letters from students and graduates tell us of new pay increases and promotions that are made possible through the help of modern technical training with CREI.

Said one man recently: "... I am happy to report that in the past seven months with Station K - - , I have received three increases in salary and a promotion which can be partly credited to CREI."

Hundreds of engineers and technicians with key positions in the radio industry, broadcasting, FM and Television owe their successful training to CREI. We are ready to help you in the same way we have been helping others for over 20 years.

Even if your radio experience is limited, there is a CREI course for you. CREI takes you all the way to a practical engineering level. CREI does

not drop you off at the elementary job training phase. You quickly advance lesson-by-lesson to the more advanced study of engineering principles and practice. The courses are practical, authoritative and easy to follow.

Your future success can be assured by the plans you make today. Just figure out for yourself how many good jobs are waiting for good men to fill them. These men must have modern training to handle intricate present day equipment. You can't say, "I don't need more training." Every radio man needs more training to increase his technical knowledge, no matter how limited or how great his experience.

Send for and read our 24-page booklet that explains our self-improvement program—our courses—and what we can do for you and your future. CREI courses are still available at pre-inflation prices and today give you more thorough instruction service per dollar than ever before—on convenient terms. It costs you nothing to read the facts. Please write today.



**Capitol Radio
 Engineering Institute**

An Accredited Technical Institute

Dept. RC-9, 16th & Park Rd., N. W., Wash. 10, D. C.
 Branch Offices: New York (7) 170 Broadway • San Francisco (2) 760 Market St.

SEPTEMBER, 1948

MAIL COUPON FOR FREE BOOKLET

CAPITOL RADIO ENGINEERING INSTITUTE
 16th and Park Road, N. W., Dept. RC-9, Washington 10, D. C.

Gentlemen: Please send your free booklet, "CREI training for your better job in Radio-Electronics," together with full details of your home-study training. I am attaching a brief resume of my experience, education and present position.

- Check field of greatest interest:
- PRACTICAL RADIO-ELECTRONICS PRACTICAL TELEVISION
 - BROADCASTING AERONAUTICAL RADIO ENGINEERING
 - RECEIVER SERVICING INDUSTRIAL ELECTRONICS

NAME _____

STREET _____

CITY _____ ZONE _____ STATE _____

I AM ENTITLED TO TRAINING UNDER G. I. BILL.

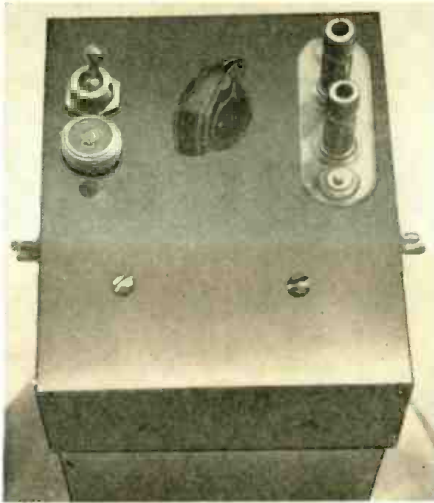

The converter is mounted in a steel cabinet.

Four-Band Converter Has Crystal Control

By HERBERT S. BRIER, W9EGQ

THE big problems in designing high-frequency receiving equipment are instability, drift (have you ever tried to use the crystal filter of your receiver on 6 or 10 meters?), and a high signal-to-noise ratio. The first two cease to be problems with crystal-controlled equipment.

The pictures and diagram show the simplicity of this crystal-controlled converter. With it, any well-shielded receiver, capable of covering a frequency range equal to the width of the desired band, becomes a sensitive receiver for that band. All receiver controls are used in the normal manner. Even the dial calibration can be used if a judicious choice of crystals is made. With the converter oscillator producing a 20-mc output, for instance, a 28.5-mc signal will beat with it to give an 8.5-mc input to the receiver; a 29-mc signal will give a 9-mc input to the receiver; and so on. The same relationship can be had in other bands. The crystal table lists a few of the crystal frequencies which may be used.

The extreme stability of the converter is especially noticeable when receiving weak DX signals through interference.

Below is a schematic diagram of the converter. Assuming that 10- and 11-meter signals are to be received, the slug-tuned r.f. and mixer coils L2 and L4 are resonated to 28.5 mc. Being heavily loaded, L4 allows approximately equal amplification of all signals between 27 and 30 mc. The 27- to 30-mc

signals beat with the 20-mc oscillator to produce 7- to 10-mc difference frequencies at the plate of the mixer tube. The difference frequencies are fed into the receiver, the tuning of which determines which signal will be further amplified and detected.

Tight antenna coupling broadens the response of L2 sufficiently to cover the desired frequency range, and it puts the greatest possible signal on the grid of the r.f. amplifier—necessary for the best signal-to-noise ratio. L4 is loaded by a 6,200-ohm resistor and by being closely coupled to L3.

The receiver to be used with the converter must be practically dead without an antenna; otherwise unwanted signals at the converter output frequency will leak through and interfere with the desired signals. Make the test at night when the signals are loudest. Disconnect the antenna, temporarily shielding the terminals, if necessary. One or two weak signals can be tolerated, because the noise contributed by the converter will cover them up; but strong signals will cause annoying interference.

With a "souped-up" BC-348 there was enough pickup from the antenna terminal for some commercial c. w. signals to push the S meter well up the scale. Use of crystal microphone connectors and a shielded lead between the converter and the receiver eliminated the unwanted signals when the converter's antenna switch was not used. However, with the switch and with an antenna having considerable pickup at the undesired frequencies, weak signals would feed through the small capacitances between the switch contacts.

This does not occur with antennas using half-wave elements fed with low-impedance feeders (300 ohms or less), and the switch does provide a convenient method of switching the converter in and out of the circuit; but with long-wire antennas or high-impedance feed lines, some spurious signals may leak through.

All coils, except the oscillator cathode coil, are wound on Millen type 74001, slug-tuned, shielded, plug-in forms.

In construction, the parts layout closely follows the electrical sequence. The box used was 4 3/8 x 7 x 3 3/8 inches, but a larger box with a hinged top is recommended.

Crystal Freq. (Mc)	Crystal Harmonic	Signal Frequency (Mc)	Receiver Dial
4	4th	21-21.5	5-5.5
5	3rd	21-21.5	6-6.5
	4th	27-30	7-10
6.667	2nd	21-21.5	7.666-8.156
	3rd	27-30	7-10
10	Fund.	21-21.5	11-11.5
	2nd	27-30	7-10
14.667	Fund.	21-21.5	6.333-6.833
	3rd	50-54	6-10
20	Fund.	27-30	7-10
	2nd	50-54	10-14

To obtain short leads the coil and tube sockets in the r.f. and mixer stages are turned so that pin 3 (the grid connection of each coil socket) is adjacent to pin 1 (control grid) of the tube sockets, and in the oscillator so that pin 3 (the plate connection) of the coil socket is adjacent to tube socket pin 5 (plate). Pin 3 is the hot one on all coils, and the numbers on the diagram indicate the pins used for the remaining connections.

Winding data for all coils is given in the coil table.

All components below the chassis are hung in place wherever convenient, aided by tie lugs. All grounds are made directly to the chassis, and the only shielding required, in addition to that

(Continued on page 56)

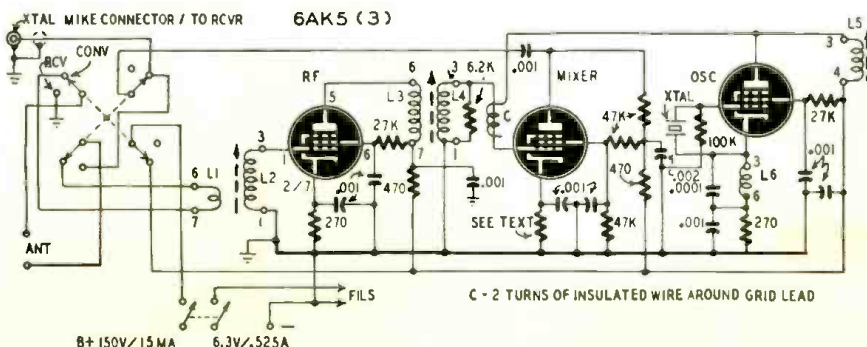

The schematic diagram shows how simple the converter is. Three miniature tubes are used.

ALLIED has Everything New in Radio!



**NEW hallicrafters
SX-62 RECEIVER**
Designed for Short Wave
Listeners and DX Fans

Television by hallicrafters



505 TELEVISION TABLE MODEL

The immensely popular direct-viewing Hallicrafters TV receiver in a distinctively styled wood table model cabinet. Here's perfected, clear, sharp, bright Television at amazingly low cost. Provides a brilliant picture 5 3/4" long by 4" high—a full 23 sq. inch picture area. Easy to operate: push-button station selection, simplified contrast control, easy horizontal and vertical framing. Has built-in 6" x 4" oval PM speaker; excellent sound. Overall size: 20 1/2" long, 11" high, 17" deep. For 105-125 volts, 50-60 cycles AC. Complete with tubes. Shpg. wt., 45 lbs. **97-803. NET, f.o.b. Chicago \$179.50**
Terms: \$35.90 down, \$12.68 monthly for 12 months.
Famous Model T-54. Same as above, but in furniture steel cabinet, finished in rich silver-gray.
97-800. NET, f.o.b. Chicago \$169.50
Terms: \$33.90 down, \$11.98 monthly for 12 months.

Developed and built especially for the SWL. Total tuning range is 540 kc to 110 mc, continuously, covering world-wide Short-Wave and special services, broadcast, and all FM channels between 27 mc and 110 mc. Features: professional slide-rule dial with foreign Short-Wave stations and all services (marine, aviation, etc.) located on the dial; 500 kc crystal calibrator; pointer adjustment to set receiver on exact frequency; single knob tuning, 60 to 1 tuning ratio; each band separately illuminated; series type ANL; 4-position tone control; high-fidelity audio system; 8 watts output; dual IF channels; six-step selectivity; crystal filter; record-player input—plus a host of other desirable features. In handsome steel cabinet, 20" x 10 1/4" x 16". For 105-125 volts, 50-60 cycle AC. Complete with tubes. Shpg. wt., 65 lbs. **97-585. SX-62. NET, f.o.b. Chicago \$249.50**
Terms: \$49.90 down, \$17.63 monthly for 12 months.
97-780. R-42 Speaker. Bass-reflex type, in matching metal cabinet. Shpg. wt., 20 lbs. **NET \$34.50**
97-568. B-42 Tilt-Base. Chrome finished. Shpg. wt., 6 lbs. **NET \$7.50**

There's Only ONE COMPLETE Radio Buying Guide—It's ALLIED'S CATALOG!

Get the Radio Buying Guide that's used by thousands of expert servicemen, engineers, soundmen, Amateurs, builders and experimenters! Radio's biggest catalog brings you the widest selections of the newest and finest equipment, at money-saving low prices. Get every buying advantage at ALLIED—speedy, expert shipment, the personal attention of seasoned radio experts—complete satisfaction on every order. Get your ALLIED Catalog today!



**172 VALUE-PACKED
PAGES. SEND FOR IT!**



**THE WORLD'S
LARGEST
RADIO
SUPPLY
HOUSE . . .**

**★ ALLIED
RADIO**
*Everything in Radio
and Electronics*

ALLIED RADIO CORP.
833 W. Jackson Blvd., Dept. 2-J-8
Chicago 7, Illinois

- Send FREE 172-Page ALLIED Catalog.
- Enter order for Hallicrafters Model.....
- Enclosed \$..... Full Payment
- Part Payment (Balance C.O.D.)
- Send ALLIED Easy Payment Plan details and order blank.

Name.....
Address.....
City..... Zone..... State.....

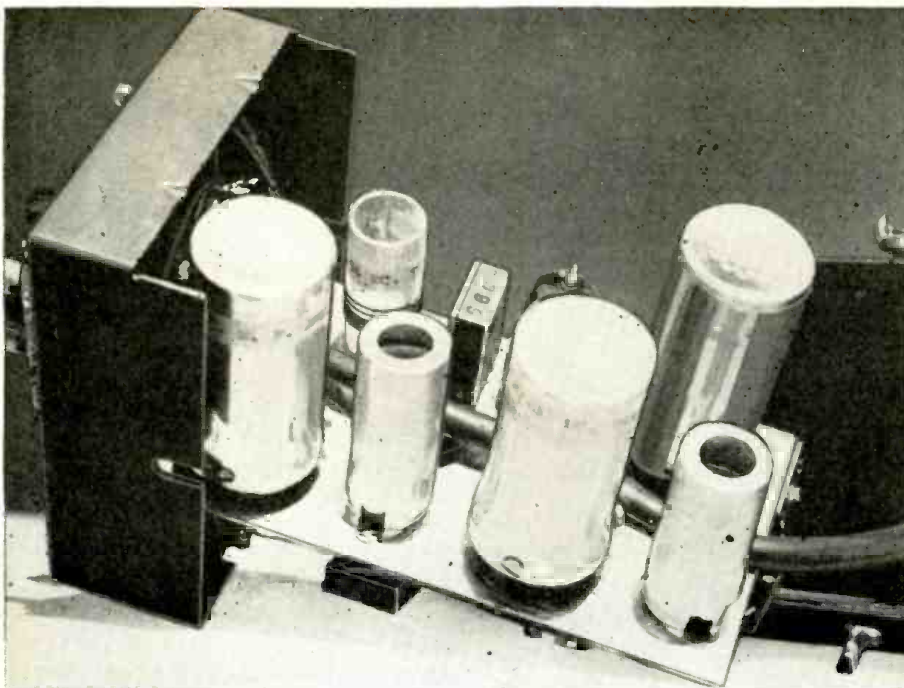

R.f. and mixer tubes are covered with shields. Wind all coils except L6 on shielded forms.

supplied by the coil and tube shields, is the shielded output lead.

Preliminary adjustment

To put the converter in operation, insert the 28-mc coils, tubes, and crystal; connect the converter output to the receiver antenna terminal through a shielded line; and apply the proper voltages. Connect a low-range voltmeter across the oscillator cathode resistor and adjust the slug in L4 for minimum reading on the meter. The crystal oscillator signal should be clearly received when the receiver is tuned to the crystal frequency or a harmonic thereof; removing the crystal will cause the signal to disappear and will increase the meter reading slightly.

If a signal generator is available, set it to 28.5 mc and couple it loosely to the converter input. Tune the receiver dial around 8.5 mc until the signal generator is heard, and adjust the slugs in L2 and L4 for maximum output. If a signal generator is not available, simply set the receiver dial to 8.5 megacycles and adjust the slugs for maximum noise output with no antenna connected to the converter. When the antenna is connected, there will be a great increase in background noise; and if the band is open, signals can be tuned in by moving the receiver dial between 7.16 and 9.7 mc. The antenna will detune the input circuit somewhat, and the slug in L2 should be readjusted with the receiver dial set at 8.5 mc. Its setting will be much less critical than before.

The same procedure is followed with the 50-54-mc coils; however, if it is necessary to triple or quadruple the fundamental crystal frequency to reach 40 mc in the oscillator, it is quite difficult to tune the oscillator plate circuit to resonance by observing the variation in voltage across the cathode resistor be-

cause the voltage is so small. A receiver tuned to 40 mc can be used, by tuning the slug for maximum signal strength; but the easiest method is to leave the 28-mc coils in the r.f. and mixer stages and, with the receiver dial set to 11.5 mc, to adjust the slug in the 40-mc oscillator coil for maximum signal. Output of the mixer will still be at the difference frequency between r.f. and oscillator signals, but the oscillator will be operating above the r.f. The converter will work as well on 27 to 30 mc as before, but the receiver dial calibration will be backwards.

Once the oscillator is peaked, insert the remaining 50-54-mc coils and adjust as outlined for the 28-mc band. The receiver dial should be set near 12 mc and the signal generator to 52 mc. 50 to 54 mc will correspond to 10 to 14 mc on the receiver. Coils for the 21-mc band are similarly adjusted.

L1, as specified, is approximately correct for 300-ohm feeders. For feeders of different impedance, the number of turns must be changed for best results. Three turns should be correct for 75 ohms, and 10 turns for 600 ohms, on 28 megacycles. On 50 megacycles two to six

turns are recommended. The more turns used, the more L2 is loaded. Up to a point the signal-to-noise ratio also improves. The antenna itself has some bearing on how heavily the input circuit may be loaded. An antenna having considerable pickup at the converter output frequency will cross modulate the 6AK5 grid when coupled too tightly, and signals will ride through without regard to the position of the slugs in the coils. When this effect is present, the antenna is overcoupled; and reducing the number of turns in L1 not only eliminates the trouble, but also increases the strength of the desired signals.

An improvement in signal-to-tube-hiss ratio may be obtained by adjusting the mixer bias. Temporarily replace the mixer cathode resistor with a 10,000-ohm potentiometer. Replace the antenna with a resistance of the same value as the feeder impedance to eliminate outside signals. Pick up a weak, locally generated signal, and adjust the mixer bias to the value that gives the greatest signal-to-noise ratio. Before adjustment, the S meter may read S6 with signal and drop to S4 without signal. Increasing the bias may drop the meter reading to S5 with signal, and at the same time drop the no-signal reading to S1, obviously a tremendous improvement in signal-to-noise ratio. After the optimum value is found, the actual resistance in the circuit is read with an ohmmeter, and the process repeated for another band. The optimum value will be different on each band, because it depends on the amount of oscillator voltage being injected into the mixer grid. Use the lowest resistance, because—within limits—higher resistance merely reduces mixer sensitivity slightly without affecting the over-all signal-to-noise ratio. However, if the resistance is less than 1,000 ohms on any band, it indicates that insufficient oscillator voltage is being injected into the mixer grid. Wrap another turn of the wire forming capacitor C around the mixer grid lead and repeat the procedure.

When the converter is used with a BC-348 receiver, bands 4 and 5 cover only 6-9.5 and 9.5-13.5 mc, according to the dial calibration. Nevertheless, without turning the band switch, the entire 6- and 10-11-meter bands can be covered by turning the dial beyond the calibrated portion of the scale for the high-frequency ends of these bands.

COIL TABLE
Turns

	Signal Frequency (Mc)			REMARKS
	21-21.5	27-30	50-54	
L1	10	7	4	Over grounded end of L2.
L2, L3, L4	22	15	6	Closewound. L3 near top of form; L4 separated from L3 by 1-16 inch.
L5	43	22	11	Closewound

	Crystal Frequency (Mc)						
	4	5	6.667	10	14.667	20	
L6	20	18	15	10	7	4½	5-10-mc, closewound. 10-mc, spaced wire diameter. 14-20-mc, spaced to ½-inch.

All coils wound with No. 24 enamelled wire, except L5 for 21-21.5 mc and L1 for all bands, which are wound with No. 28. L1 to L5 are made on Millen 74001 x ½-inch-diameter shielded slug-tuned forms, L6 on ¾-inch plain forms.



BEAM MECHANISM
The most powerful, compact assembly offered on surplus for beam rotation. 50:1 gear ratio turned by 24 vdc motor that will run on 12 vac. Bicycle type sprocket for easy coupling to any shaft. 9/4" L x 6 1/2" W x 4" H with mounting facility. New, guaranteed, complete with 110 vdc to 12 vac step-down transformer. \$16.50

DYNAMOTORS

Type	Input Volts	Input Amps	Output Volts	Output Amps	Radio Set	Price
BD 77KM	14	40	1000	.350	BC 191	\$12.00N
PE 73	28	19	1000	.350	BC 375	7.95LN
DM 21	14	3.3	235	.090	BC 312	3.45LN
DM 21CX	28	1.6	235	.090	BC 312	3.45N
DM 25	12	2.3	270	.050	BC 367	2.49LN
DM 26R	28	1.25	275	.070	BC 318	5.75
DM 33	28	1.6	540	.250	BC 436	6.50N
DM 42	14	4.6	515	.110	SCR 506	6.50LN
PE 55	12	55	500	.400	SCR 245	5.25LN
PE 86 N	28	1.25	250	.060	BC 306	3.95N
PE 101 C	13/20	12.6/6.3	400	.135	SCR 512	6.25N
BD AR 93	28	3.25	375	.150		4.95N
23550	27	1.75	285	.075	AFN-1	3.50N
33X045B	28	1.2	250	.060		3.50N
ZA 6515	12/24	4/2	500	.040		3.95N
ZA 6516	12/24	4/4	275	.110		4.25N
B-19 pack	12	9.4	275	.110	Mark II	9.95N

*N—New. LN—Like New

ARC-5 ACCESSORIES

CONVERSION COILS FOR ARC-5 TRANSMITTERS

M.O. Coils	P.A. Coils	Antenna Loading Coils	Freq. Range
\$1.00 each	\$1.00 each	\$1.50 each	
6029	7247	6033	3-4 Mc.
6030	9293	6034	4-5.3 Mc.
6032		6035	7-9.1 Mc.

CONVERSION KIT, consisting of 1-4 coil, 1-P.A. coil, 1-ANTENNA COIL, in any one particular frequency range \$2.00

ARC No. 6558 variable receiving capacitor, 62 mm section, 3 sections, .037 spacing, 8 rotors, worm drive ratio 33:1 \$1.75

ARC No. 4990, variable NMT capacitor, 22.4-145 mmf, .034 spacing, 11 rotors, each \$1.00

ARC 5632 Var. Xmtg. capacitor, 29.2-117 mmf, .047 spacing, 16 rotors, worm drive \$0.81

Single revr. mtr. racks \$1.00

Shrink-shock motors for rack 5.50; dual \$1.00

DUAL CONTROL BOXES FOR CVRS \$1.00

TRANSMITTER TUNING UNITS

From BC 375 TU 10 17-7.50 mc; TU 10 10-12.5 mc; TU 22 (350-650 kc); TU 26 (200-500 kc) \$2.25 Each

For BC 610; TU 18 (2.5-3 mc); TU 52 (6.35-8 mc); TU 53 (8-12 mc) \$1.00

RC 223 AX; TU 17 (2-3 mc); TU 18 (3-4.5 mc) \$1.95 Each

POWER EQUIPMENT

STEP-DOWN TRANSFORMER, Pri. 110-220/110 volts ac, 60 cycles, 3 KVA, Sec. 115 v, 2500 volt insulation, Size 12"x12"x17" \$40.00

PLATE TRANSFORMER, Pri: 117 v, 60 cy. Sec: 17,000 v, @ 114 ma. with choke. Oil immersed. Size 26"x29"x13". Amertran \$65.00

Fil. Transformer, Pri: 220 vac., 60 cy.; 65KVA, Sec: 2 v, 34,000 test \$24.50

FH. Trans. UG-6899, Pri: 115 V, 60 cy. Sec: Two 5V, 5.5 Amp Wds. 29KV Test \$24.50

Plate Transformer, Pri: 115/210 vac., 50-60 cy. Sec: 21,000 v, 100 ma. \$145.00

LINE VOLTAGE REG. Pri 92-138v 57/63 cy. 1ph1.5A Sec 115v 1.5A .82 Kw 96% PF \$99.50

VOLTAGE REG. "Transat" Amertran Type "RH" 2 Kva Load, Input: 90-120 v 50/60 cy. Output 115v \$40.00

TRANSTAT VOLTAGE REG. 11.5 KVA, 0-115 vac, 60 cy 100 amp \$75.00

ITE Circuit Breaker, 115 amps, 600v \$15.00

400 CYCLE TRANSFORMERS

KS 9584: Pri: 115 v, 400 cy. Sec: 5000 v, 290 ma. 5v, 10 amp \$12.50

2-12033: Pri: 115 v, 800 cy. Sec: 5100 v, 250 ma \$9.95

Plate Xfmr: Pri: 115 v, 380-2800 cy. Sec: 2200 v, 250 volt amps \$5.45

KS 9273: Pri: 115 v, 400-2400 cy. Sec: 50-111 v, 247 in 622 V.A. \$1.35

KS 9435: Pri: 115 v, 400-2400 cy. Sec: 592 v, 120 ma, 6.3 v, 8 amp, 5v, 2 amp \$3.50

Plate Xfmr: Pri: 115 v, 400 cy. Sec: 9800 or 6800 v, 32 ma. \$12.50

Plate Xfmr: Pri: 115 v, 400 cy. Sec: 1150-0-1150 v, 40 ma. \$1.75

Plate Xfmr: Pri: 115 v, 400 cy. Sec: 600 v, 36 ma \$1.15

POWER CHOKES

SWINGING CHOKE: 4.5 to 8 by, 2 to 1 amp 12 OHMS \$10.95

.03 by, 2 amp \$1.45

1.50 Ohm, 120 by, 17 ma \$2.45

8.5 by, 125 ma \$1.50

.01 by, 2.5 amp \$1.50

25 by, 150 ma \$1.40

.03 by, 35 amp \$7.50

6 by, 150 ma \$1.50

Dual 2.5 by, 130 ma \$1.25

Dual 7 by, 75 ma, 11 \$1.10

1 by, 12 amp, 46 ohms 16.20

by, 65 ma \$1.65

Dual .5 by, 380 ma .95

Dual 2 by, 100 ma .75

.5 by, 34 ma, 312 ohms .65

.116 by, 150 ma \$1.40

2 by, 200 ma .75

INVERTERS

PE 206-A, Input: 28 Vd., @ 38 amp. Output: 80 volts @ 300 volt-amps, 800 cycles. Latest! New, complete with enclosed relay, filter, instruction book \$12.50

PE 218: Input: 25-28 VDC @ 92 amps. Output: 115 volts @ 1500 volt-amps, 380-500 cycles. Poor physical but good running condition \$12.50

CROSS POINTER INDICATOR

Two 0-200 microamp. movements in 3" case. Each movement brought out to 6-term. receptacle at rear. Originally used in ILS equip-ment. New \$2.50



BIG TUBE VALUES

01-A	\$.45	562	\$90.00
1A3	.70	615	.89
2021	.69	703-A	7.00
2022	.69	704-A	.75
2121-A	25.00	705-A	2.85
2122	15.00	707-B	20.00
2126	15.00	714AY	15.00
2127	15.00	715-B	12.00
2131	25.00	720CY	25.00
2132	15.00	721-A	3.60
2138	25.00	723-A/B	7.75
2139	25.00	724B	1.75
2155	25.00	724-D	25.00
3131	25.00	725-A	25.00
2K2-879	.69	726-A	9.50
3A4	.65	800	2.25
3BP1	2.25	801-A	1.10
3C24	.60	804	9.95
3C30	.70	811	1.95
3D6	.79	814	5.95
3CP1 SI	3.50	815	3.95
3D21-A	1.50	836	1.15
3DP1	2.25	837	1.95
3EP1	2.95	843	.59
3FP7	1.20	860	15.00
3GP1	3.50	861	40.00
3GP1	.79	874	1.95
5BP1	1.20	876	4.95
5BP4	4.95	889	78.5
5CP1	3.75	1005	.35
5FP7	1.35	1613	.95
5JP2	8.00	1619	.21
5I30	39.50	1624	.85
6A27	1.00	1629	.35
6A45	.69	8012	3.95
6G	2.00	9004	.47
6SC7	.70	5006	.47
6SL7	1.00	CEQ 72	1.95
704	1.00	EF 50	.79
7E5	1.00	1148	.75
7E6	.72	F 127	20.00
10Y	.60	FC 258A	165.00
12A6	.35	CT 271	40.00
12GP7	14.95	GL 562	75.00
12K8Y	.65	GL 623	75.00
12SF7	.44	GL 697	75.00
12SR7	.72	NL 100	60.00
15R	1.40	QK 59	45.00
28D7	.75	QK 60	45.00
30 (Spec)	.70	QK 61	55.00
33L6	.69	QK 62	55.00
35Z5	.66	RCA 937	1.00
50L6 (Spec)	.79	VR 130	1.25
39 44	.49	VR 135	1.25
35 51	.72	VR 137	1.25
227A	4.95	VR 150-30	.75
225	8.80	VO 120	1.00
21R	7.95	WU 134	1.00
267-A	20.00	WN 150	3.00
355-A	19.50	WT 260	5.00
530	90.00		
531	45.00		
532	2.00		
539	4.00		

5130 THE NEWEST THING IN UHF. 10-350 MC. MAGNETRON IN GLASS ENVELOPE. NEW, COMPLETE WITH DATA SHEET \$39.50

TUBE	FREQ. RANGE	PK. PWR. OUT.	PRICE
2431	2820-2860 mc.	265 K.W.	\$15.00
2421A	9375-9415 mc.	50 K.W.	25.00
2422	2967-3003 mc.	265 K.W.	15.00
2426	2992-3019 mc.	275 K.W.	15.00
2427	2965-2992 mc.	275 K.W.	15.00
2432	2780-2820 mc.	285 K.W.	15.00
2438	3249-3263 mc.	5 K.W.	25.00
2439	3267-3333 mc.	8.7 K.W.	25.00
2455	9545-9615 mc.	40 K.W.	25.00
2461	24,000 mc.	35 K.W.	25.00
711AY			
720BY	2800 mc.	1000 K.W.	25.00
KLYSTRONS: 725A B	\$7.75	767B	\$20.00

MAGNETS
For 2121 725-A, 2122, 2126, 2127, 2431, 2432, and 3431
480 Gauss, 5/8" bet. pole faces, 1/2" pole diam. Each \$8.00
1500 Gauss, 1 1/2" bet. pole faces, 1 1/2" pole diam. 8.00
1000 Gauss, electronagnet, adjustable 2 1/2" to 3" bet. pole faces, 2 1/2" pole diam. 12.00

TUNABLE PKG'D "CW" MAGNETRONS
QK50 2075-2000 Mcs. QK60 2075-3200 Mcs
QK50 2075-2000 Mcs. QK62 2150-3275 Mcs
NEW—\$45 each NEW—\$55 each

SPECIALS

Antenna Tuning Unit BC 729-C. Includes variable, loading coil, controlled from front panel turns inductor, vacuum capacitor, (which may be switched in and out of circuit). For coupling to whip antenna from transmitter, BC 610. \$20.00

QBG-1, ECHO RANGING DRIVER-RECEIVER. Complete underwater sound signal transmission and reception unit with range of 200 to 600 yds. and freq. range of 16 to 27 kc. New, complete with battery box in leather chest, less pro- \$85.00

MINE DETECTOR
AN/PRS-1. Can be used to detect buried objects, such as rocks, tree stumps, water pockets, etc. Every home-owner, camper, prospector needs one. Complete unit, consisting of detector unit, amplifier, headphones, meters, resonator, with all necessary cables and tubes, now \$12.75
With Batteries \$21.65

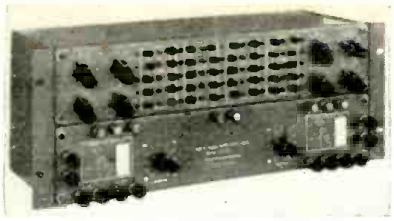

FEDERAL F.T.&R 101-A TWO WIRE APPLIQUE

Provides necessary balancing facilities for four-wire repeater when used on two-wire lines which may be voice-frequency telephone lines of open wire, or non-loaded or loaded cable, Std. 19" channel iron rack mnt. Price, new, as shown, complete with tech. \$54.00

EE-89 REPEATER: Extends range of field telephone apparatus, such as EE-8 up to 25 miles, when inserted in a line. New, with spare tube and instruction manual, less standard type batteries \$21.50

MICRO WAVE GENERATORS

AN/APS-15A "X" Band compl. RF head and modulator, incl. 725-A magnetron and magnet, two 723-A B klystrons (local osc & beam), 1124 TH, revr-ampl, duplexer, HV supply, blower, pulse xfmr, PK. Pwr Out: 45 KW app. Input: 115 v, 400 cy. Modulator pulse duration 5 to 2 microsec. Amp. 15 KV Pk Pulse. Compl. with all tubes incl. 715-B, 829 B, RKH 73, two 72's \$210.00
Compl. pkg new

APS-15B, Compl. pkg as above, less modulator \$150.00

"S" BAND AN/APS-2, Compl. RF head and modulator, including magnetron and magnet, 417-A magnet, TRK receiver, duplexer, blower, etc. and complete \$75.00
pulsr. With tubes... used, fair cond.

10 cm. RF Package, Consists of: 80 Xmtg. receiver using 2427 magnetron oscillator, 250 KW peak input, 707-B receiver-mixer \$150.00
Modulator-motor alternator unit for above \$75.00
Receiver rectifier power unit for above \$25.00
Rotating antenna with parabolic reflector, New \$45.00

RT 39/APG-15 Transmitter-receiver, 2C43 Lighthouse tube oscillator, 5 KW, App. 2700 Mc operation \$100.00

MICROWAVE TEST EQUIPMENT

W. E. I. 138 A, Signal generator, 2700 to 2900 mc range. Lighthouse tube oscillator with attenuator & output meter 115 VAC input, rec. Pwr. supply. With circuit diagram \$50.00

TS-238 GP, 10 cm. Echo box with resonance inductor and micrometer adjust cavity \$85.00

3 cm wavemeter, 9200 to 11,000 mc transmission type with square flanges \$15.00

3 cm stabilizer cavity transmission type \$20.00



Measures frequency between 150 & 200 mc. by heterodyne method. Power of Xmtg can be directly measured. Measures DC voltages up to 500 Volts. Original operation on 110 V, 400 cy. but conversion kit makes it operable on 110 v, 60 cy. new, complete with tubes, crystal, cal. chart, antenna, meter & conversion kit and diagram \$29.95

A COMPLETE LINE OF MICROWAVE EQUIPMENT IN STOCK: 10CM, 3CM, 1.25CM. SEND FOR MICROWAVE FLYER.

HEADSETS

Dynamic mike and headset combination. A high quality, efficient unit, used in B-19 tank Xmtg. Mike & phones complete, new \$2.75

HS 30 HEADSET: A featherweight headset with insert type phones that cut background noises to a minimum. Low impedance (500 ohms) assures efficiency & high fidelity \$85c

Matching transformer to match 500 ohms to 8000 ohms output \$35c

R-15 headset, 8000 ohm impedance, rubber cushions. Comes with 8' cord & plug PL 55, New \$1.95

BAND PASS FILTER, #70473. Sharp band pass peaked at 700 cps (variable). High-to-high impedance. Can be plugged into phone output of receiver. Cuts out \$2.25

INSTRUCTION MANUALS

BC112, BC 342 \$1.25
SCR 281 \$1.25
ZA 6501 \$.75
MARK II \$.75
SCR 508 \$1.00

CONDENSER DRIVE ASSEMBLY

Rotates any coupled shaft by means of motor thru 90 deg. at rate of 5 deg. per min. Operates on 55-110 vac, 60 cy. Manual knob permits rough adjustment. W.W. # B 4010209. New, complete with cover and 0-90 deg. indicator seal \$12.50



131-C. Liberty St. New York 7, N.Y. All merchandise guaranteed. Mail orders promptly filled. All prices, F.O.B. New York City. Send Money Order or Check. Shipping charges sent C.O.D. **PHONE DIGBY 9-4124**

COMMUNICATIONS EQUIPMENT CO.

Modifying the R-44 / ARR-5

This set makes a top-notch FM receiver

By L. W. MAY, JR., W5AJG

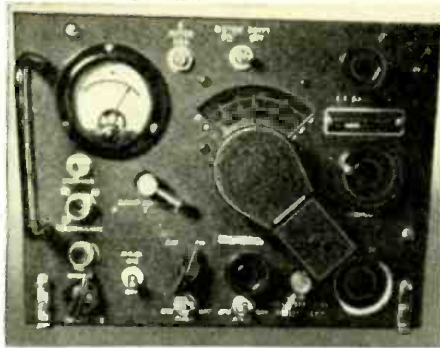

Front view of the set after conversion.

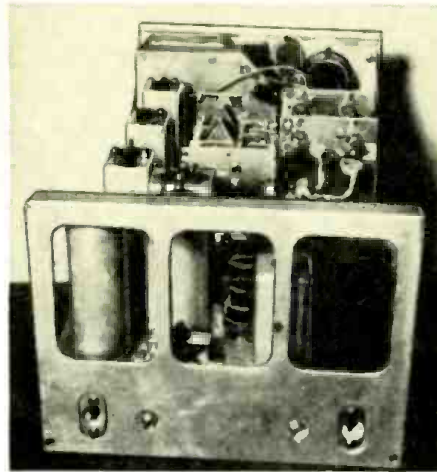

Rear of the R-44/ARR-5 v.h.f. receiver.

THE type R-44/ARR-5 v.h.f. receiver is one of the better pieces of military radio equipment to appear on the surplus market. It is the military version of the Hallicrafters' S-36A v.h.f. FM-AM-C.W. receiver used in the services as an airborne search receiver for locating enemy radar and communication channels between 27 and 143 mc. The old and new FM broadcast bands and the 11-, 10-, and 6-meter amateur bands are included in this range; therefore this set will prove equally useful as an FM broadcast receiver or a v.h.f. receiver for the amateur bands.

This set can be used as is by adding a suitable power supply and loudspeaker; however, some changes and modifications improve its over-all performance and adaptability for civilian use.

The R-44/ARR-5 was used with the AN/APA-10 panoramic adapter or AN/APA-6 radar indicator to provide visual indications. These units were connected to the receiver through co-axial connectors on the front panel. A motor-driven scanning device was provided for continually tuning back and forth over any predetermined section of the tuning range.

After carefully checking the circuits of the ARR-5 and the commercial counterpart, the S-36A, we found that the major circuit differences are in the audio circuit. The S-36A has a push-pull output stage capable of several watts undistorted audio output, while the ARR-5 has a single output stage delivering only 50 milliwatts of audio. A video output connection for feeding the AN/APA-6 radar indicator was made in the cathode circuit of the 6V6 a.f. amplifier. The r.f. and i.f. channels are practically identical and with a few changes in both the a.f. and r.f. sections, the ARR-5's performance can be made to approach that of the S-36A.

R.f. circuit alterations

The modifications are not at all difficult and can be made by anyone familiar with v.h.f. receiver construction. To start with, the ARR-5 has an extra r.f. amplifier stage using a 956 tube in a reradiation suppressor stage. This is an untuned r.f. stage (Fig. 1) in a separate shielded box between the antenna terminals and the standard r.f. section

(Continued on page 60)

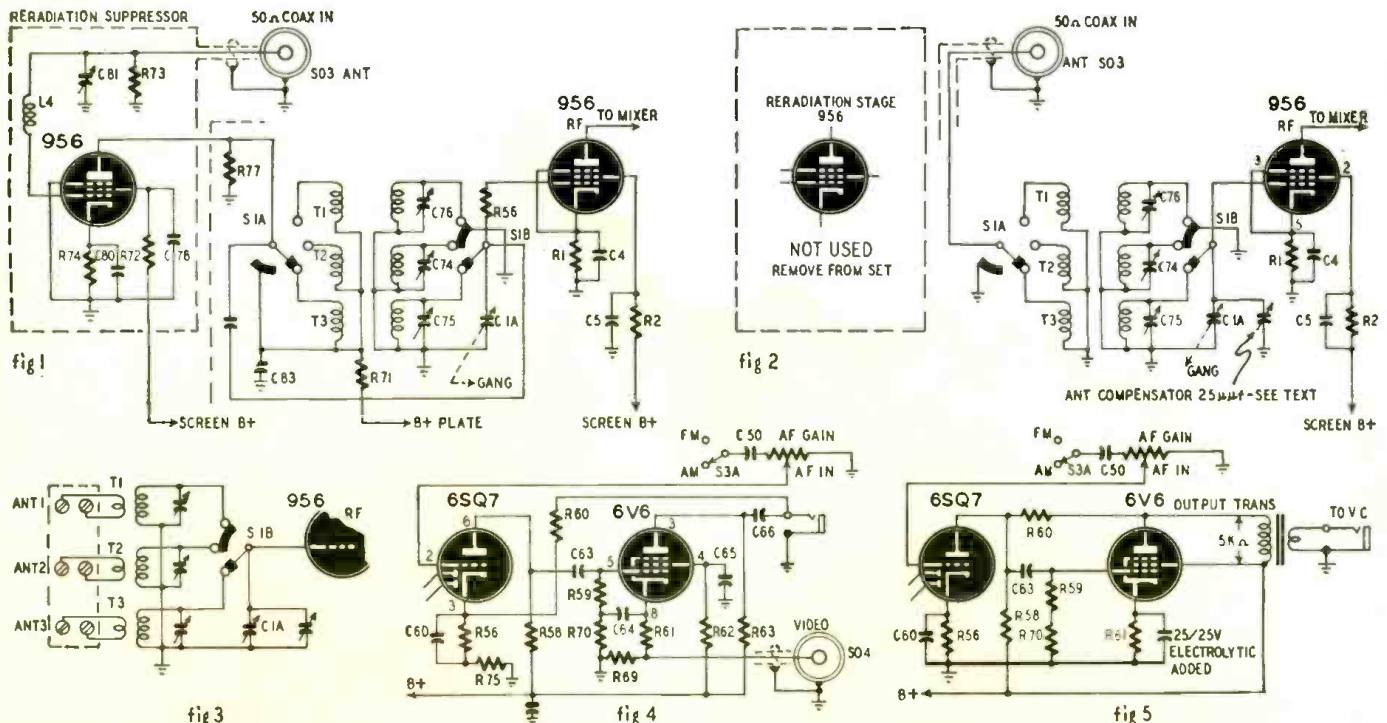

Fig. 1—R.f. circuit of the R-44/ARR-5 before conversion. Fig. 2—The r.f. circuit of the receiver after conversion. The reradiation stage is removed bodily from the chassis. Fig. 3—An optional connection permitting separate antennas for each tuning range. Fig. 4—Note the circuit of the combination audio-video output stage before conversion. Fig. 5—The output stage after conversion is completed.



Machines in RCA's Lancaster Tube Plant are designed for mass production of Kinescopes—television picture tubes—at lowest possible cost.

Behind the magic of a Television Tube

Every morning, 14 tons of glass "bulbs" go down to the production lines at the RCA Tube Plant in Lancaster, Pa.

By evening, the bulbs are television picture tubes, their luminescent faces ready to glow—in television homes everywhere—with news, sports, entertainment, education, politics.

Born of glass, metals, chemicals, the picture tube comes to life through flame and heat. Its face is

coated with fluorescent material—forming a screen on which an electron gun "paints" moving images.

Each step is so delicately handled that, although RCA craftsmen are working with fragile glass, breakage is less than 1%.

Water, twice-distilled, floats the fluorescent material into place on the face of the tube, where it clings by molecular attraction—as a uniform and perfect coating.

Every phase of manufacture conforms to scientific specifications established by RCA Laboratories. **Result:** Television tubes of highest perfection—assuring sharp, clear pictures on the screens of RCA Victor home television receivers.

• • •

When in Radio City, New York, be sure to see the radio, television and electronic wonders at RCA Exhibition Hall, 36 West 49th Street. Free admission. Radio Corporation of America, RCA Building, Radio City, New York 20.



RADIO CORPORATION of AMERICA

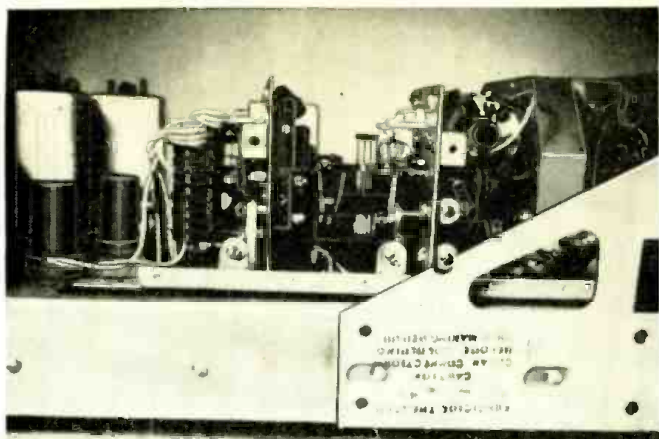

The reradiation stage was originally located on the rear of the sub-chassis supporting the r.f. and oscillator assemblies. The original antenna coils were replaced with coils wound from thin copper strips. This change resulted in an overall gain increase of 6 to 10 db. The antenna primaries were wound with rather heavy bus bar covered with suitable insulating material.

of the receiver. Its purpose is to suppress any radiation from the receiver itself, thereby preventing the enemy from employing direction-finding techniques to spot its location. Its efficiency in suppressing any signal leaking out of the receiver is remarkable. Unfortunately, it also does a fair job of suppressing any incoming signal as well, making the ARR-5 receiver relatively insensitive and leaving much to be desired in the way of a good v.h.f. job. This situation is easily corrected by eliminating the reradiation suppressor stage and rerouting the antenna input directly into the first 956 r.f. amplifier stage (Fig. 2).

Balanced 400-ohm antenna feeder systems are employed exclusively on the v.h.f.'s at W5AJG/W5JKM. Since the ARR-5 is set up for a co-axial input of 50 ohms impedance, changes were made in the mechanical construction of the set to accommodate balanced inputs.

Referring to Figs. 1 and 2, the before-and-after circuits of the r.f. section, and to the photographs taken after modification, it is seen that the suppressor stage has been removed bodily and an opening provided in the side of the first r.f. stage compartment for the new balanced leads to emerge. The primaries of transformers T1, T2, and T3 were used for the plate-coupling windings of the suppressor tube, so they have a relatively high impedance. We use 400-ohm lines, so these windings are removed entirely and lower-impedance links of a few turns substituted to serve as the antenna pickup coils. It is possible, by reducing the number of turns to fit the particular antenna in use, even to use the windings without removing them. After doing this, the coupling is still rather loose. This may result in insufficient antenna pickup and transfer. At this particular installation, the coupling proved to be insufficient with the original cut-down primaries. Hence the new windings and closer coupling.

Coupling capacitor C83 is also removed, and the antenna is connected in on the arm of S1A. If a 50-ohm co-axial input is employed, the original front panel receptacle labelled ANT can be used and one side of the antenna coils returned to ground. If separate antennas are used, say one for 10 meters, one for 6 meters and one for the new 88-108 mc FM broadcast band, three

separate inputs could be provided on the terminal plate on the side of the r.f. compartment and switch section S1A neglected altogether. This connection is shown in Fig. 3.

With these changes in the r.f. section, and after routine alignment of the trimmers C74, C75, and C76, performance is better than with the reradiation suppressor stage in the circuit. Signals should average about 20 to 30 db stronger. This is quite an improvement, and some users may find the increase in gain sufficient for their needs. However, this arrangement did not satisfy us for long and additional changes were made.

In tracking the front end it was noted that the receiver's wide frequency range makes it practically impossible to get one antenna to look entirely resistive over the whole range. An antenna compensator was added across C1A to peak the received signal. This is a small 25- μ f variable condenser conveniently mounted on the underside of the chassis, in the present location of the a.f. gain control. Remove this control and push it aside, leaving the wiring intact. Install the antenna compensator and drill a $\frac{3}{8}$ -inch hole through the chassis. This will come out directly under the first section of the main tuning condenser. Use a piece of strap copper about 1/32 inch thick and $\frac{1}{4}$ inch wide to connect the two stators together, and another piece to ground securely the bracket which carries the antenna compensator. The a.f. gain control may be mounted on a small piece of bracket material soldered to the chassis or screwed to anything convenient and controlled from the front panel by an extension shaft. The co-axial antenna input receptacle was removed, and the audio volume control shaft extends out through this opening.

The panoramic adapter outlet was left connected as it is convenient for working out of the r.f. section into a regular communications receiver set at 5.25 mc. This affords greater selectivity than the ARR-5 is capable of providing because FM i.f. transformers are used. Be sure to use a blocking condenser, as the mixer plate voltage appears on the outlet.

A.f. circuit alterations

The 6V6 video output stage has an audio output of only 50 milliwatts (see

Fig. 4). The circuit was altered as in Fig. 5. The output transformer should be of fair quality for best FM reception, and may be mounted in place of the filter choke L3 which isn't needed since sufficient filter may be included in the power supply. All necessary changes are shown on the before-and-after audio-section schematic and all are of minor importance. Only one component is added, a cathode bypass condenser for the output tube.

No power supply is included. Any normally well filtered supply providing 250 to 275 volts d.c. at about 100 ma and 6.3 v a.c. at approximately 2 amperes may be used. The scanning motor requires 24 volts d.c. at less than $\frac{1}{2}$ ampere, if this feature is utilized. The power input receptacle is replaced by a 5-prong socket.

Optional modifications

After the set had been working for a few days, we decided that there was a chance that we were losing some signal in the r.f. coils, which were wound on bakelite forms. Consequently, T1, T2, and T3 were all removed, the recently wound antenna primaries being included and carefully laid aside so that they could be reinstalled should the coming experiment prove disastrous.

First, a length of common copper strip about 1/32-inch thick and $\frac{1}{4}$ -inch wide was connected from the ground point of the rotor on the main tuning to the ground side of the r.f. grid coils. Another piece of this material was used for winding the coils themselves, in a spiral fashion, making a very rigid air-supporting structure. The new low-impedance antenna coils were then wound from rather heavy bus wire. On the first try, nothing would resonate—it seems that when using this flat copper ribbon or strip material for coils, approximately *twice as many turns* are required as when using ordinary wire coils.

After increasing the number of turns on the copper-ribbon coils, the r.f. stage performed beautifully. By tuning in a known station and watching the S-meter, it appeared that a worth-while improvement resulted.

With these changes the ARR-5 becomes a very desirable piece of v.h.f. receiving gear, versatile and very usable. It is suspected that lots of v.h.f. men grabbed this set for the same purpose for which the writer uses it primarily—that is, checking the muf (*maximum usable frequency*) between 30 and 50 mc. Intelligently used in this manner, it will save many fruitless hours of listening to dead 50-mc air. One v.h.f. enthusiast contacted, who used an ARR-5 for this purpose, avowed he would set up the sector automatic tuning and insert a relay in the a.v.c. system, so when a signal was scanned by the automatic mechanism, the set would stop on the signal and ring a warning bell, indicating that 50 mc was in business. Could be—anyway, it's food for thought.

LARGEST STOCK OF TUBES IN THE COUNTRY

ALL BRAND NEW — STANDARD BRANDS — QUANTITY PRICES ON REQUEST — Minimum Order \$5.00

1B24	4.95	9MP7	14.95	806	17.50	C58	12.95	1C6	1.06	6AQ7GT	.88	6Y6G	.88	14H7	.88
1H25A	1.95	10BP4	34.95	807	1.25	C6A	9.95	1C7G	1.06	6AR5	.66	6Z7G	1.28	14J7	1.06
1B26	15.95	10CP4A	42.20	808	2.95	C6J	12.95	1C8	.88	6AT6	.51	6ZY5G	.72	14N7	1.06
1H27	4.95	10FP4	54.50	809	2.50	CEQ72	1.95	1D5G	1.28	6AU6	.72	7A4/XXL	.72	14Q7	.88
1H29	4.95	10HP4	49.50	810	7.95	CK1005	.39	1D5GP	1.28	6AV6	.54	7A5	.72	14R7	.88
1H32	4.95	10Y	.69	811	2.25	CK1006	.69	1D7G	1.06	6B4G	1.06	7A6	.72	14S7	1.06
1B56	8.00	10 spec.	.69	812	2.95	EF50	.79	1D8GT	1.28	6B5	1.56	7A7	.72	14W7	1.06
1N21	.59	12DP7	14.95	812H	6.90	EL3C	4.95	1E5GT	1.56	6B6G	.72	7A8	.72	14X7	1.06
1N23	.59	12GP7	14.95	813	7.95	FL225	1.95	1E7GT	1.56	6B7	1.06	7AD7	1.06	14X4	.88
1P22	11.50	12JP4	60.00	814	4.95	FL23A	12.95	1F1	.88	6B8	1.06	7AF7	.72	19	1.06
1P24	2.00	15AP4	125.00	815	2.50	FL27A	22.50	1F5G	.88	6B8G	1.06	7AG7	.88	19T8	1.06
1S21	1.95	15E	1.50	816	1.19	F660	150.00	1F6	1.28	6BA6	.66	7AH7	.88	20	1.56
2A P1	2.95	15R	1.50	822	11.95	FG81A	6.95	1F7G	1.28	6BE6	.66	7B1	.72	22	1.28
2H22	5.35	20AP4	270.00	826	.79	FG105	19.95	1G1GT	.88	6BG6G	1.92	7B5	.72	24A	.72
2C21	.98	23D4	.49	827R	99.50	FG172A	32.50	1G6GT	.88	6BH6	.93	7B6	.72	25A6	1.06
2C22	.39	45 spec.	.49	828	6.95	FG238B	160.00	1H4G	.72	6BJ6	.72	7B7	.72	25AG6	1.06
2C26A	.75	75TL	3.95	829A/B	7.95	GL146	11.00	1H5GT	.60	6C1	.60	7B8	.72	25AC5GT	1.06
2C34	.59	100TH	12.95	829B/3E29	4.95	GL605	250.00	1H6G	1.06	6C5	.60	7C4/1203A	1.06	25CG6	1.06
2C40	1.98	100TS	3.00	830B	5.25	GL697	150.00	1H8GT	1.06	6C5GT	.60	7C5	.72	25L6GT	.60
2C43	1.50	102F	4.00	832/A	3.95	HF100	3.95	1H6GT	1.06	6C6	.72	7C6	.72	25Y5	1.06
2C44	1.75	111A	.69	833A	39.50	HF200	17.50	1L1	.72	6C8G	1.06	7C7	.72	25Z5	.54
2C46	7.50	114B	1.25	836	1.15	HY21	1.95	1LA4	1.06	6D6	.60	7E5/1201	1.06	25Z6	.72
2D21	1.69	120	5.95	837	2.50	HY31Z	5.50	1LA6	1.06	6D8G	.60	7E6	.72	25Z6GT	.54
2D29	1.39	121A	2.65	838	3.95	HY69	2.49	1LB4	1.06	6E5	.72	7E7	.88	25Z6GT	.60
2E22	1.50	203B	10.95	841	.69	HY75	1.25	1LC5	1.06	6F5	.60	7F7	.88	26	.54
2E24	4.37	203R	5.95	843	.69	HY1148	1.25	1LC6	1.06	6F6GT	.60	7F8	1.06	28D7	.98
2E25	3.95	204A	49.95	845	4.95	HY115	1.25	1LD5	1.06	6F6	.72	7G7/1232	1.06	30	.72
2E26	3.29	205B	4.50	845W	5.95	HY615	1.25	1LE3	1.06	6F6GT	.60	7A7	.80	30	.72
2E30	2.25	211	.98	851	98.00	HYE1148	.48	1LG5	1.06	6F7	.60	7J7	1.06	31	.88
2J21A	14.95	215A	3.00	852	14.95	HY1231Z	5.50	1LH4	1.06	6F8G	1.06	7K7	1.06	32L7GT	1.28
2J22	24.95	217C	7.50	860	3.00	HY1269	5.50	1LH5	1.06	6G6G	1.06	7L7	.88	32	1.06
2J26	14.95	221A	2.95	861	49.95	KC1	105.00	1NSGT	.72	6G6G	.88	7N7	.88	33	1.06
2J31	24.95	222A	120.00	864	.69	KU676	22.00	1PSGT	.88	6H6	.60	7Q7	.72	34/51	.72
2J32	21.95	227A	3.95	865	.98	ML100	105.00	1QSGT	.88	6H6GT	.60	7R7	.88	35A5	.72
2J34	24.95	241C	90.00	866A	.89	ML101	150.00	1R1	.88	6J5	.54	7S7	1.06	35B5	.72
2J38	37.50	242C	5.95	868	1.95	ML502	300.00	1R5	.72	6J6GT	.54	7V7	1.06	35L6GT	.60
2J39	34.95	249C	3.49	869B	75.00	MR1	90.00	1S4	.88	6K16	1.06	7W7	1.06	35W4	.46
2J40	34.95	250R	7.95	872A	2.50	QK59	45.00	1S5	.66	6J7	.72	7X7/XXFM	1.06	35Z4	.60
2J42	34.95	250TH	19.50	874	2.49	QK60	45.00	1T1	.72	6J7GT	.72	7Y4	.72	35Z4	.72
2J49	34.95	250TL	19.50	876	2.49	QK61	55.00	1T5GT	.88	6J7GT	.72	7Z4	.72	35Z4	.72
2J51	34.95	252A	4.95	878	2.49	QK62	55.00	1U1	.72	6J8G	1.06	10	1.56	35Z4GT	.50
2JH51	4.95	259A	4.95	879	.89	REL21	4.25	1U5	.66	6K5GT	.88	12A6	.89	35Z5GT	.46
2J53	25.00	274A	1.25	884	.98	RK12	1.95	1V1	.72	6K6GT	.54	12A6GT	1.06	35Z6G	.88
2J54	25.00	274B	1.25	889	.98	RK21	3.95	1V5	.88	6K7	.60	12A7	1.06	36	.88
2K25	24.95	301A	4.95	891	110.00	RK22	4.95	1W5	.88	6K7G	.60	12A8GT	.72	37	.72
2K28	24.95	304TH	7.95	892R	200.00	RK25	2.95	2A3	1.06	6K7GT	.60	12A8GT	.88	38	.60
3A P1	2.95	304TL	1.98	902P1	7.95	RK33	.98	2A4G	1.28	6K8	1.06	12A5	.72	39/44	.59
3B22	4.95	305A	12.95	905	11.95	RK34	.59	2A5	.72	6K8G	.88	12A6	.54	41	.60
3H23	4.95	307A	6.25	920	2.95	RK59	3.95	2A6	.88	6K8GT	.88	12A7	1.06	42	.60
3H24	1.95	310	4.95	923	.98	RK60	.79	2A7	2.20	6L5G	.88	12A7G	.72	43	.60
3B25	.98	311A	1.98	931A	4.95	RK65	24.95	2B7	.88	6L6	1.28	12A7	.88	45	.60
3B26	5.95	316A	.89	950	1.06	RK69	49.50	2E5	.88	6L6G	1.06	12A7G	.96	45Z5GT	.60
3HP1	2.95	322A	120.00	953B	4.95	RK72	3.95	2V3G	1.10	6L6GA	1.06	12BA6	.66	46	.88
3C21	5.95	327A	4.95	954	.75	RK73	1.95	2X2A	.69	6L7	.88	12BE6	.66	47	.88
3C22	2.95	331A	4.95	955	.75	RK75	6.25	3A4	.72	6L7G	1.06	12C8	.89	49	.88
3C23	4.95	350A/B	2.95	956	.75	RX120	10.00	3A5	1.29	6N6G	1.28	12FGT	.60	50	1.56
3C24	.69	353A	4.95	957	.75	T20	1.95	3ARGT	1.92	6N7	.88	12H6	.60	50A5	.88
3C30	1.50	368AS	9.95	958A	.75	TZ40	2.95	3B7	1.06	6N7GT	.88	12J5GT	.54	50B5	.72
3CP1	3.00	371A	2.95	959	.75	UX6653	3.95	3C6/XXB	1.28	6P5GT	.88	12J7G	.72	50C6G	1.06
3HP1	3.95	371B	2.95	991	.69	V700	6.95	3D6	.89	6Q6G/6T7G	1.06	12J7GT	.72	50L6GT	.60
3EP1	3.95	388A	7.95	1000 spec.	24.95	VR75	.98	3E6	1.06	6Q7	.72	12K7G	.72	50X6	.88
3D21A	3.00	393A	7.95	1000T	75.00	VR78	.75	3F4	1.06	6Q7G	.60	12K7GT	.60	50Y6GT	.60
3E29	4.95	394A	4.50	1611	.99	VR90	.75	3Q1	.72	6Q7GT	.60	12K8	.88	53	.72
3GP1	4.95	417A	24.95	1613	.75	VR91	1.49	3Q5GT	.88	6R7	.88	12K8GT	.88	55	.88
4-65A	14.50	434A	3.95	1614	1.75	VR92	.75	3S4	.72	6R7GT	.88	12Q7GT	.60	56	.60
4-125A	27.50	446A	1.95	1616	1.39	VR105	.75	3V4	.72	6S7	.88	12SA7	.60	57	.72
4-250A	37.50	450TH	24.95	1619	.75	VR150	.98	5AZ4	.42	6S7G	.88	12SA7GT	.60	58	.72
4A1	1.98	503	195.00	1621	1.75	VT127A	3.00	5R4GY	1.63	6S8GT	.96	12SC7	.72	59	1.06
4AP10	6.95	527	12.95	1622	1.75	VU111	1.19	5T1	1.28	6SA7	.60	12SF5	.60	70L7GT	1.42
4B24	4.95	531	49.50	1624	1.75	WL160	14.95	5U4G	1.28	6SA7GT	.60	12SF5T	.66	71A	.72
4C35	19.95	575A	14.95	1625	.49	WL168	14.95	5V4G	.88	6SB7	.88	12SF7	.72	75	.60
4E27	8.95	632A	9.95	1626	.49	WL532A	4.95	5W4	.88	6SC7	.72	12SF7GT	.88	76	.60
4J28	34.95	701A	4.95	1627	7.95	WL562	150.00	5W4GT	.60	6SD7GT	.96	12SG7	.72	77	.60
4J29	34.95	702A	3.95	1629	.69	WL616	105.00	5X4G	.60	6SE5	.60	12SH7	.72	78	.60
5AP1	4.95	703A	4.95	1630	7.50	WL619	49.50	5Y5G	.60	6SG5GT	.72	12SJ7	.60	79	.88
5AP4	5.95	704A	1.98	1636	5.95	Z225	1.95	5Y3GT	.38	6SF7	.72	12SJ7GT	.60	80	.42
5HP1	1.95	705A	2.95	1638	.98	OA2	1.69	5Y4G	.50	6SG7	.72	12SK7	.60	81	1.28
5BP4	4.95	706BY	24.95	1641	.79	OA3/VR75	1.06	5Z3	.88	6SH7	.72	12SK7GT	.88	82	.88
5CP1	3.95	706CY	24.95	1642	.98	OA4G	1.06	5Z4	.88	6SJ7	.60	12SL7GT	.88	83	.88
5CP7	11.95	707A/B	24.95	1654	1.98	OB2	2.05	6A3	1.06	6SJ7GT	.60	12SN7GT	.80	83V	1.06
5D21	29.95	708A	7.95	1655	.98	OB3/VR90	.75	6A6	.88	6SK7	.60	12SQ7	.54	84/6Z4	.60
5FP7	3.95	709A	9.95	1851	1.25	OC3/VR105	.75	6A7	.72	6SK7GT	.60	12SQ7GT	.54	85	.72
5GP1	9.95	713A	1.65	1852	1.06	OC3/VR150	.75	6A8	.72	6SL7GT	.88	12SR7	.72	89	.72
5JP1	11.95	714Y	14.95	1853	1.06	OO	.50	6A8G	.72	6SN7GT	.80	12SR7GT	.72	99V	1.28
5J29	29.50	715A/B	19.95	1963	.95	OY1	.88	6A8GT	.72	6SQ7	.54	12X3	.98	98X	1

Relay-Controlled Ham Rig

The c.w. key controls the whole station

By RICHARD H. DORF, W2QMI

THE control system of this 60-watt c.w. transmitter was designed after the writer saw a number of ham stations where changing over from receive to transmit involved throwing three or four switches, unplugging a pair of phones and going through a moderate acrobatic routine.

Pressing the key puts the station on the air, switches the antenna to the transmitter, and silences the receiver. When keying is finished the receiver automatically comes on again, the antenna swings over to it, and the transmitter goes off. A self-contained audio keying monitor operates a small loudspeaker on the transmitter panel. This control system was designed for this rig but can be readily applied to any size c.w. transmitter.

The rig is a standard oscillator-amplifier combination. As the schematic, Fig. 1 shows, a 6V6 Pierce oscillator drives an 807 power amplifier. Depending on the power-supply voltage, outputs up to 50 watts are possible.

Five crystal sockets and a selector switch are provided for quick frequency change. 80- and 40-meter crystals can be used for the 80- and 40-meter bands or 80-meter crystals can be used for 40 meters by using the final stage as a doubler. This, however, impairs effi-

ciency and reduces the power output.

The oscillator cathode is keyed so that the transmitter can be used for break-in work, if desired. The OD3/VR150 voltage regulator keeps the oscillator plate and screen voltages almost constant, so there is no perceptible chirp. The click filter (RFC1, RFC2, C1, C2, and R1) is so effective that no clicks can be heard even when the receiver is placed right next to the transmitter.

The oscillator is capacitively coupled to the 807. Try different values for C3 if the 807 grid current is less than 3.5 ma with the key down.

Grid-leak bias is used on the 807 to avoid the loss of plate voltage that would be caused by a cathode resistor. A 6V6 is connected between screen and ground to prevent the 807 from burning up when there is no signal (key up) and no bias. When the key is up there is no bias on the 6V6 and it draws maximum plate current. This large current, passing through the 807 screen resistor, R2, causes a large voltage drop across it. The voltage on the screen is, therefore, very small. This prevents 807 plate current from rising to more than about 40 ma.

When the oscillator is keyed the grid-leak bias on the 807 is applied through the 100K isolating resistor to the grid of

the 6V6. This cuts off the 6V6 and restores the 807 screen voltage to its normal value.

A Collins pi-network is used in the output. Two coils, one for each band, are switched in and out. Any single-wire antenna can be used. The pi will load anything from a lead pencil to a steel tower. The commercial coils used have end links, so a balanced feeder can be used in place of the single wire. Usually, a separate antenna-tuning network will be required for that.

The power supply shown uses a combination-type power transformer, though separate plate and filament transformers can be substituted. The condenser-input filter gives poor regulation but a high output voltage, 600 volts in this case. Since the OD3/VR150 takes care of the oscillator, the poor regulation in the final does not matter.

The control system

Three single-pole keying relays are used because a 3-pole keying relay seems to be hard to find. Any fast-acting low-voltage relays are usable; the ones here are 5,000-ohm, 4-ma sensitive units. They operate nicely on about 20 volts.

The first relay, RY1, keys the oscillator cathode. RY2 keys the voice coil of the audio monitor oscillator speaker. RY3 operates the control circuits which take care of antenna changeover and receiver disabling.

The control circuit uses one half of the 6N7. R4 and C6 are a series RC time-constant circuit. When the key is up and the contacts of RY3 are open, 22.5 volts from the battery are applied to the grid through R4 and C6. There is no drop across R4 because there is no current flowing through it—C6 acts as a blocking capacitor. With 22.5 volts on the grid, no plate current flows and RY4 is open.

When the key is pressed the contacts of RY3 close and short the grid to ground. This reduces the bias to zero, plate current flows and RY4 closes. This energizes RY5, which switches the antenna over to the transmitter and opens the receiver disabling circuit.

When the key is opened after making each dot and dash the short across C6 is removed. However, the capacitor takes time to charge up and the full 22.5 volts do not appear between grid and ground until it does charge. If the key is pressed again, for the next character, before the grid voltage has time to reach a value that would cause RY4 to open, RY4 stays shut and the station stays on the air. If, however, keying is finished, and the key is not pressed again the grid

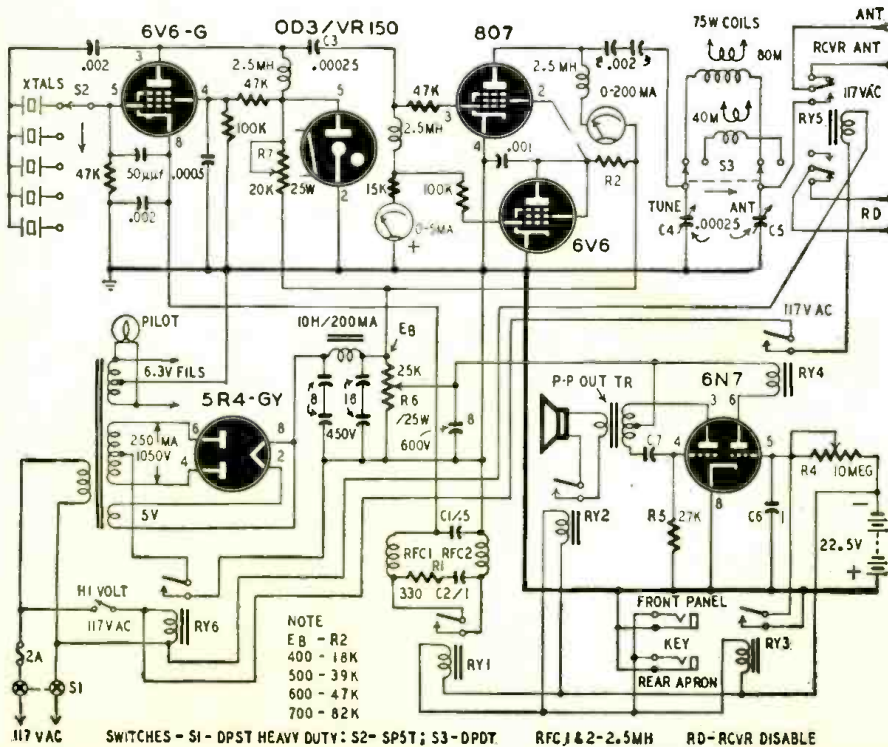

Fig. 1—Six relays are used in the transmitter. The antenna may be a random length of wire.

voltage will reach cutoff and RY4 will open, turning on the receiver and switching the antenna.

The time taken for C6 to charge depends on the values of C6 and of R4 and the battery voltage. The time in which the capacitor will charge to about 67 percent of the battery voltage is equal to C in microfarads times R in megohms. With the 10-megohm resistor and 1- μ f capacitor, the maximum time is about 10 seconds. However, the 10-megohm resistor is variable, so the operator can set time according to his own average keying speed. If he is a speed demon, the time can be short; if he is an average or slow-speed operator the time and the resistor setting will have to be larger so RY4 will not open between characters.

The other half of the 6N7 is an audio oscillator. The transformer may be any push-pull output unit. The grid leak, R5, and C7 may be changed to give a different tone. If necessary, a small capacitor can be shunted across the transformer primary. A 3-inch speaker was used since compactness, not fidelity, was the important point. The audio oscillator is keyed by RY2 and gives a good indication of the operator's keying, though transmitter output signal should be checked occasionally for roughness.

Construction

A 13 x 17 x 3-inch chassis was big enough for all the components, but not too big, so don't try to economize on a chassis. Fig. 2 shows how the parts are mounted. The oscillator tube is at the upper right in the photo with the 807 next to it. The 6V6 screen-control tube and the OD3/VR150 are below these two. A standard 807 shield is included to minimize spurious oscillation. The battery is fastened to the chassis with a yoke of stiff bus bar. The small black pointer knob controls the resistance of R4.

The two coils are mounted at right angles to each other so the field of one will not cut the turns of the other.

Underneath the chassis (Fig. 3) the coil switch is fastened down with an angle bracket and an extension shaft is used to avoid long leads. The audio transformer is on the right. At bottom is RY6, which is controlled by a panel switch and breaks the center tap of the high-voltage transformer winding for long standby periods.

Fig. 4 shows the front panel with the transmitter mounted in a metal cabinet. Height of the panel is 8 $\frac{3}{4}$ inches and width is 19 inches. In addition to the key jack on the front panel there is one on the rear apron so that a key can be plugged into either place.

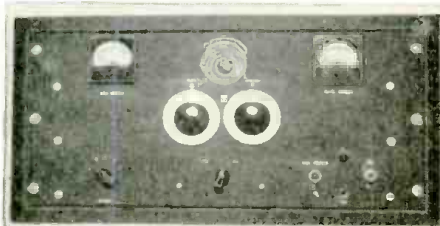

Fig. 4—The front-panel layout is symmetrical.



Fig. 2—The power supply is shown at the lower right in the picture. Coils are at center.

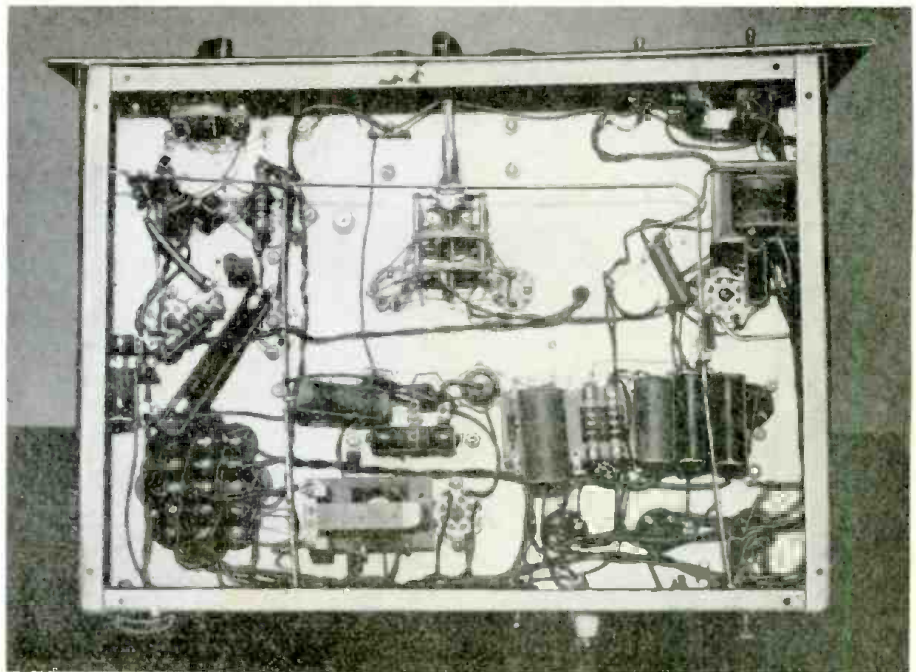

Fig. 3—The high-voltage relay is under the chassis. There is little crowding of parts.

Transmitter adjustment

Place the tap on the bleeder (R6) at the ground end, remove the 6N7, and adjust R7 for maximum resistance.

Now turn on the HIGH-VOLTAGE switch. See that the 807 plate current does not go above about 40 ma.

Insert a milliammeter between the cathode (pin 2) of the OD3/VR150 and ground and adjust the tap on R7 for 25-ma. Replace the cathode connection.

Connect an antenna to the transmitter and clamp RY5 shut with a paper clip. Turn on the high voltage, press the key, and, with C5 at maximum capacity, tune

C4 for a plate-current dip. Now, rotating C5 will load the antenna. Advance it in small steps, retuning C4 each time for a dip, until 807 current is 100 ma.

Replace the 6N7 and advance the tap on R6 until RY4 closes when the key is pressed. Remove the paper clip from RY5. Now pressing the key should put the transmitter on the air and operate all the control circuits: Adjust R4 until the time delay is satisfactory.

If the monitoring tone in the loudspeaker is too loud, a series resistor can be inserted in series with the transformer secondary and the voice coil.

E.M.C. Gives More Measurement Value per Dollar

E.M.C. MODEL 300

Vacuum Tube Volt-Ohm Capacity Meter

- DC VOLTS—6 ranges to 1000 volts.
- AC VOLTS—5 ranges to 1000 volts.
- RESISTANCE—6 ranges to 1000 meg-ohms.
- CAPACITY—4 ranges (.000025 mfd to 20 mfd)
- HAS ZERO CENTER POSITION

Model 300, as illustrated with leads... **\$39.50**

(other models also available)

See the Model 300 at your Jobber

WRITE TODAY to Dept. 8-9, for NEW, FREE CATALOG

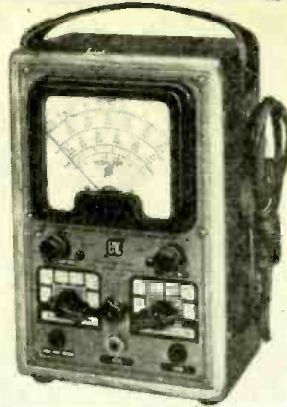

ELECTRONIC MEASUREMENTS CORPORATION

423 Broome St., New York 13, N. Y.



SEPTEMBER SPECIALS

FREE!! New "HEARING AID AND MINIATURE PARTS" Supplement

GE D. P. D. T. RELAYS—3/16" silver contacts, protective plastic housing. 18-25V. DC. 180 ohm coil. BRAND NEW. ONLY 39 15 for 5.00

1/2" PILOT JEWEL ASSEMBLY with faceted Red, Green, Amber or Clear Jewel. Min. screw base. 1.39 6 for 1.00

R3-1AP CO-AXIAL CONNECTOR. Rt. angle. Ea. 29 10 for 2.50

TUBES! TUBES! TUBES! BUY NOW—SAVE UP TO 80% with a 90 DAY GUARANTEE!!

Most types in stock: unsealed cartons.

27, 35, 36, 37, 39, 77, 84, 85, 89, 5W4, 5Z3, 6H6, 6K7, 6L7, or 6X5 39¢

41, 75, 76, 78, 5U4, 5Y3, 5Y4, 1A7, 1L6S, 6A1, 6A7, 6B7, 6C5, 6Y5, 6G5, 6J5, 6K6, 6L6, 6SA7, 6SD7, 6SH7, 6SK7, 6R7, 7A7, 7H6, 7Y4, 12SK7 or 50B5 49¢

TUBE CARTONS—Plain White

Miniature (1" sq. x 2 1/4"). Per 100... .98

GT (1 1/4" sq. x 3 1/4"). Per 100... 1.25

Medium (1 1/2" sq. x 4 1/4"). Per 100... 1.49

Lance (2" sq. x 5"). Per 100... 1.79

HEARING AID AMPLIFIER ASSEMBLY. Vacuum tube type. Make a REAL VEST POCKET RADIO or AMPLIFIER adding only small tuner sect. and speaker or phone. Ready-wired miniature components include: 2 controls (1 & 4 meg), output trans., dbie. choke, switch, resistors, condensers, etc. Complete with UNIT SCHEMATIC. Less tubes and case. 2"x5"x1/2" deep. Weighs only 3 1/2 ozs. 2.49



ALNICO MAGNETS—NEW EXPERIMENTAL KIT of 10 assorted. Bar, "C", Circular, Block, etc. Kit of 10... 1.98

WRITE TODAY FOR LATEST ILLUSTRATED "ALNICO MAGNET" SUPPLEMENT.

BLANK CHASSIS for small receiver or amplifier. 6 3/4"x4 1/2"x1 1/4". Rustproofed steel. .29

3AG FUSES—Farnum make—2. 1 1/4, 2. 2 1/2, 4 or 5 amps. ea. .03 Box of 25... .69

"17" IS YOUR LUCKY NUMBER!!!

Yes, Leotone's value-packed new JUMBO RADIO PARTS ASSORTMENT is the YEAR'S BEST BUY! 17 FULL POUNDS of new & dismantled radio and electronic parts—COILS, TRANSFORMERS, WIRE, SPEAKER REPAIR PARTS, HARDWARE, RESISTORS, CONDENSERS, etc., etc. All these and much more for only 2.95

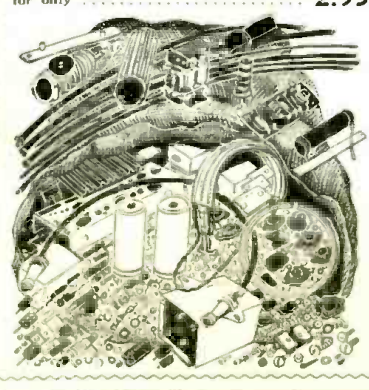

PE-157 POWER SUPPLY. Incomplete unit, but a "gold mine" of relays, switches, jacks, selenium rect. etc. Portable hinged lid metal case (6"x6"x12"). OD erackle finish. ILLUS descriptive 173p. Tech. Manual. Shpg. wt. 20 lbs. 2.49

TELEVISION FOCUS COIL—for use with 10", 12" or 15" tubes. 275 ohms DC @ 125MA. Fully shielded. Triangular 4 1/4" mtg. 1-9/16" hole. Shpg. wt. 4 lbs. 4.25

W-110 FIELD WIRE—Made to rigid Govt. specs. Twisted rubber insul. pair, outside cotton. All-purpose for indoor or outdoor radio. Telephone or P.A. use. Sold in rolls of approx. 3000 ft. only (several lbs. per roll). Shpg. wt. 75 lbs. shipped express collect. 5.95

Get on our mailing list. Always something new.

FACTORY SPEAKER REPAIR SERVICE

Min. Order \$2.00—20% Deposit Required on COD's

Please add sufficient Postage

LEOTONE RADIO CO.

MAKERS OF CONES AND FIELD COILS

65-67 DEY STREET, NEW YORK 7, N.Y.

WORTH 2-0284-5

12,000 SQ FT OF RADIO PARTS

TELEVISION RECEIVER—\$1.00

Complete Instructions for building your own television receiver. 16 pages—11"x17" of pictures, pictorial diagrams, clarified schematics. 17"x22" complete schematic diagram and chassis layout. Also booklet of alignment instructions, voltage & resistance tables and troubleshooting hints. All for \$1.00.

CERTIFIED TELEVISION LABORATORIES
Dept. C, 5507-13th Ave., Brooklyn 19, N. Y.

NEW INSIDE DOPE ON IDEAL AMPLIFICATION

SEND 3c STAMP FOR POSTAGE

AMPLIFIER CORP. OF AMERICA

398-10 Broadway New York 13, N. Y.

HARRY DIAMOND DIES

Harry Diamond, Chief of the Electronics Division of the National Bureau of Standards, died suddenly June 21.

One of the inventors of the radio proximity fuze (No. 2 secret weapon of World War II). Mr. Diamond was widely honored for his work. Among the acknowledgments he had received were the 1940 Award for Engineering Achievement of the Washington Academy of Sciences; the Naval Ordnance Development Award for Exceptional Service, 1945, and the War Department Certificate for Outstanding Service.



Mr. Diamond played a large part in the development of the Instrument Landing System (ILS) and participated in the first completely blind flight and landing of an aircraft, which took place in March 1933.

Another development of world importance in which he had a major role is the radiosonde. His other contributions to the radio art include visual beacons for air-craft guidance, antenna systems, range-beacon course-alignment procedures, a simultaneous phone and beacon-range system, aircraft-engine ignition shielding, automatic weather stations, upper-air wind velocity determination by radio, a method for measuring direction-finder polarization errors, and director for electronic bombs.

PHILCO'S NEW VICE-PRESIDENT

Radcliffe L. Romeyn has been appointed Vice-President and Factory Export Manager of the International Division of Philco Corporation. For the past two years Mr. Romeyn has served as Factory Export Manager. He will continue the same duties with added responsibilities in his new position as Vice-President.

RCA APPOINTS NEW OFFICIALS

Glen McDaniel has been elected a vice-president of the Radio Corporation of America to serve on the president's staff.

David C. Adams, assistant general counsel of the National Broadcasting Company, has been elected vice-president and general attorney of RCA Communications, Inc.

FARNSWORTH ENGINEER DIES

Charles J. Lemieux, senior engineer in charge of the Capehart laboratory of Farnsworth Television & Radio Corporation died June 26 at the age of 44. Mr. Lemieux was with the Farnsworth Corporation eight years and was in charge of the Materials Testing Division seven years.

Prior to joining Farnsworth he was with the International Detrola Corporation. He was widely known in the radio components industry and was a member of the RMA Safety Committee.

HERSHEL RADIO CO.

5249 GRAND RIVER • DETROIT 8, MICHIGAN

IMPORTANT NOTE

All orders F.O.B. Detroit—Minimum order \$2.00—Michigan customers add 3% sales tax—20% payment must accompany all orders.



NEW BC 223 AX TRANSMITTER

MY 109

\$29⁹⁵

801 Oscillators and 801 power amplifiers, 2-46 modulators and 1-46 speech amplifier 4 Xtal. frequencies and master oscillator on selector switch. 10 to 30 Watts output. Tone voice or C.W. Mod. Ideal for 80 meter band. Comes with 3 coils TU 17A 2000-3000 Kc. TU 25 3500-5250 Kc. Black crackle case. Includes two separate cases to store extra coils. Frequencies chart and tubes included, packed in original cases, less crystals at this low price.

PYRANOL CAPACITOR

1 MFD, 5000 VDC,
Size: 4x4½x3¾"

MY 132
\$2⁹⁵



\$1⁹⁵
MY 150

Containing: 6V. AC relay, 3 miniature sockets with tube shields, 5 condensers and 6 res. Size: 3x5x1".



BK 22 K RELAY

MY 110

\$2⁹⁵

Used in conjunction with SCR269F, change-over contains 28V. step relay 5 deck, 6 position switch. 12V. DPST.



DETROLA RECORD CHANGER

MY 311

\$12⁴⁵

Handles 12—10" records or 10—12" records. Automatic changer.

ANTENNA DUPLEXER

Originally used on BNIFF equipment to allow the use of a common antenna for receiver and transmitter. 156 to 187 MC. \$5.95



ANTENNA

BOTH UNITS
ONLY

\$9⁹⁵

2 meter antenna: 157. 1.87 MC. Originally used with BNIFF equipment—successfully used on 144 MC as a non-directional antenna. \$5.95



MODULATION TRANSFORMER AND DRIVER TRANSFORMER

BOTH UNITS ONLY
\$4⁹⁵ MY 302



RC 1206 modulation transformer. 815 Class A82, 56W. audio. RC 1205 driver transformer, 6SN7 to 815, Class A82—Companion to RC 1206.

No. MX16 Cross pointer 3½" Meter. Two 200 microamp movements. Brand new. \$2.95
500 ohm to grid matching transformer #81749. 69c
Ceramic Silver Padders Dual 3 to 12 MMFD or 5 to 20 MMFD. 19c
Ceramic mica Padder single 5 to 20 MMFD. per doz. 50c
Choke—300MA 20HY. Insulated for 5000V. Heavy Porcelain Insulators. Very conservatively rated. Idle for KW rig. \$8.95



TRANSFORMER

Audio oscillating transformer with output and feedback winding.

95c

MY 148



STANDARD TYPE HE

49c

100W. Bleeder consisting of 5 sections; 750 ohms, 23 ohms, 23 ohms, 7500 ohms, 3000 ohms, Total—11,296 ohms.

MY 147



IF TRANSFORMER

95c

Mounted in aluminum shield can. 5 MC with air trimmer, impedance coupled type. DISCRIMINATOR TRANSFORMER TO MATCH. 95c

MY 115

TOGGLE SWITCH

DPST. 30
amps, in
Bake-a-lite
case.

39c
MY 151



COAXIAL FITTINGS



5c

25c

35c

20c

HOOD

SOCKET

PLUG

ANGLE-ADAPTER

SO-239

83-IR

PL-259

M-359

83-IR

83-ISP

83-IAD

83-IAD

SELSYN MOTORS MODEL 2JIGI

TWO
FOR
\$3⁹⁵

MY 402

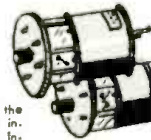

The ideal way of indicating the position of Rotary beams, wind indicator, etc. Line chord and instructions for 110 AC operation furnished on request.



POTTER & BRUMFIELD OVERLOAD RELAYS

\$1⁹⁵

MY 161

Potter and Brumfield. Relay #1—5000 ohms, coil current 10 MA. Relay #2—110V. 60 Cy., AC coil. SPDT.



30 MC-1F
SILVER-SLUGGED

MY 412

29⁹⁵



MICA CAPACITOR MY 166
002. MFD.—3000 W.V.D.C. **69c**



FILAMENT TRANSFORMER

110V., 60 Cy. Sec. 1; 4V. at 16 amps, Sec.2; 2.5V. at 1.75 amps, insulated for 5000V. Ideal for 2X2 and 826 tubes. MY 145 Hermetically sealed. **\$1⁹⁵**
Size: 6x3½x4½L.

304TL
TUBE

89c

Just the tube for that 1KW final—typical operation 2500 volts at 400 MA. An ideal tube for that induction heater or dielectric heater. Efficient operation at 1500V. to 3000V.



DON'T MISS THESE SPECIAL SAVINGS!

Powdered iron, ¾ slug. my118. 10c
Jacks for PL55, or PL68. my119. 10c
Ass't mica condensers—per 100. my120. \$ 1.95
Pin straightener for miniature tubes. my122. 25c
Ear phones, 2000 ohms, used. my124. 95c
SCR625 Mine detector, used. my127. \$39.50
75,000-ohm 200 watt Bleeder Res. my413. 95c

SILVER CERAMIC CONDENSERS 500 W.V.D.C. 12c ea. 10 for \$1.00

Available capacity (MMFD's). 2, 3, 4, 5, 7, 8, 8½, 10, 11, 12, 15, 24, 25, 40, 45, 50, 51, dual 60, 70, 72, 75, 80, 81, 95, 100, 120, 470, 500, and 1000.



SCOPE TRANSFORMER

MY 104 Primary 110V. 60 Cy. Sec; **\$3⁹⁵** 4000V. at 10 MA. Size 6x4x3½".

FM-AM TUNER

Browning Laboratories, Inc.
Winchester, Mass.

The RJ-12A tuner has separate AM and FM circuits. Both sections include an i.f. amplifier.

Sensitivity of the FM section is less than 10 μ v for 30-db noise reduction. Two limiters are used in the Armstrong circuit. FM audio response is flat from 10 to 15,000 cycles. A compensation network eliminates frequency drift after a 2-minute warmup period.



Audio response of the AM section is flat from 20 to 6,600 cycles ± 3 db. Rectifier developed triple-tuned i.f. transformers are employed. AM sensitivity is 5 μ v.

A connector on the rear of the chassis allows use of a phonograph pickup. A standard 300-ohm antenna feed line is provided for in the FM section; the line is used as an AM antenna.—RADIO-CRAFT

POWER INVERTERS

American Television & Radio Co.
St. Paul, Minn.

The new ATR d.c.-a.c. inverters include units operating on d.c. input voltages ranging from 6 to 220, delivering an output of 110 volts, 60 cycles, with capacitances ranging from 75 to 500 watts. These inverters are specially designed for operating a.c. radios, PA



systems, television sets, amplifiers, small a.c. motors and electrical appliances from a.c. sources. Featured is an automatic switching unit for use with 32- and 110-volt d.c. inverters, permitting automatic starting and stopping of these units as the load is turned on and off. More than 33 different standard inverter types are offered.—RADIO-CRAFT

WINDOW-MOUNT ANTENNAS

Vertrod Corp.
New York, N. Y.

New window-mounting FM and TV antennas are offered for those who cannot or may not install standard antennas on their roofs. The units mount outside the window and project outward to a maximum of 45 inches.



The cylindrical ceramic base houses an electrical network which permits the use of 300-ohm balanced line for the load. Three models are offered. They appear to be similar, but they differ in the network contained in the ceramic housing. They are for TV and FM, FM and AM, and TV, AM, and FM.—RADIO-CRAFT

V.T.V.M.

Triplett Electrical Instrument Co.
Bluffton, Ohio

Model 2451 electronic volt-ohm-milliammeter measures up to 1,000 volts

a.c. or d.c. and 50 volts r.f., 1 ampere d.c., and 100 megohms resistance. An important feature is that the meter may be zeroed on the range to be used rather than having to be switched to the basic range for adjustment.

A detachable crystal-diode r.f. probe may be plugged into the instrument for measuring frequencies as high as 100 mc. An additional probe can be purchased to extend the range to 400 mc. Input resistance on the d.c. ranges is 11 megohms.—RADIO-CRAFT

MULTIMETER

Radio City Products Co.
New York, N. Y.

Model 450 series Hi-Meg meters include a resistance range for measur-



ing up to 1,000 megohms without an external battery. Other ohms ranges extend to 5 megohms.

The meters are available with sensitivities of 1,000, 5,000 and 20,000 ohms per volt. All models have ranges up to 2,500 volts d.c. and 1,000 volts a.c. 1 ampere, and -9 to $+55$ db.—RADIO-CRAFT

POCKET-SIZE TESTER

Precision Apparatus Co.,
Elmhurst, N. Y.

The Series 40 circuit tester is contained in a Bakelite case 3 3/4 x 6 1/4 x 2 1/2 inches. It includes 31 a.c. and d.c. ranges to 6,000 volts, 600 ma, 70 db and 5 megohms.

The meter is a 3-inch, 400 μ a instrument. Two pin jacks are used for all ranges, except the 6,000 volt one for which a recessed safety jack is provided. A rotary switch selects the desired functions.—RADIO-CRAFT

HAM INDUCTORS

E. F. Johnson Co.
Waseca, Minn.

Air-wound inductors for the final stages of amateur transmitters are offered in several types. Two models for each band provide for matching high-current, low-voltage or low-current, high-voltage tubes. Various links to match transmission-line impedances may be plugged into the swiveling link arm.



The inductors are supported on polystyrene. Each part of the assembly is available separately.—RADIO-CRAFT

WIDE RANGE METER

Triplett Electrical Instrument Co.
Bluffton, Ohio

Model 625-NA is a wide-range volt-ohm-milliammeter with a 6-inch mirror-scale meter for better reading accuracy. Ten d.c. voltage ranges extend up to 5,000 at 10,000 and 20,000 ohms per volt. A.c. voltages up to 5,000 volts at 10,000 ohms per volt are in five ranges. There are three resistance ranges up to 40 megohms, and six direct-current ranges from 50 μ a to 10 amps. A decibel scale on the meter is calibrated from -30 to 69 db. The instrument is housed in a black molded-bakelite case with a removable strap handle.—RADIO-CRAFT

MULTIMETER

Bradshaw Instruments Co.,
Brooklyn, N. Y.

Model 10 F covers 25 ranges, including capacitance to 10 μ f, a.c. to 15 amperes, a.c. and d.c. volts to 1,000,



direct currents to 1 ampere, and resistance to 2 megohms.

The tester which is offered in both bench and portable models, contains a fuse to protect the meter movement. A 3 inch meter is used.—RADIO-CRAFT

V.H.F. GENERATOR

Rollin Co.
Pasadena, Calif.

The Model 30 power-type standard signal generator tunes from 40 to 400 mc. Maximum output is 5 watts (15 volts). An attenuation network brings output down to a minimum of 0.1 μ v.

The signal scale has an effective length of nearly 4 feet and calibration marks are inserted at 1% frequency intervals. Leakage fields are less than 0.1 μ v per meter.—RADIO-CRAFT

FM TUNER

Collins Audio Products Co.
Westfield, N. J.

This tuner covers the 88-108-mc FM band. It is permeability-tuned and, according to the maker, has no frequency drift.

The Armstrong circuits used include two cascaded limiters. Included in the 11 tubes is a 6AL7 GT tuning indicator. Sensitivity is 10 μ v assuring good reception at some distance from the transmitter.—RADIO-CRAFT

**TUBE TESTER**

General Electric Co.,
Syracuse, N. Y.

The Type YTW-1 facilitates rapid checking of receiving tubes. A large degree of flexibility is attained through the use of individual circuit switches for each tube element.

Tubes accommodated include 4-, 5-, 6-, 7-, and 8-pin standard types, 5-pin small, 7- and 9-pin miniatures, and lock-in types. Batteries and pilot lights can also be tested.

The YTW-1 is an emission-type tester. It also checks for filament continuity (without waiting for warmup) and open and shorted elements. Weight of the unit is 15 pounds.—RADIO-CRAFT

RADIO CABINETS

Nemes
Chicago, Ill.

One of the great problems in putting together radiophonographs from component parts is finding a cabinet.



These cabinets are constructed to order. Size, style, and type of wood may be specified by the purchaser.—RADIO-CRAFT

SOLDERING IRON

Jett Thermal Device Co.
Brooklyn, N. Y.

The Slim Jim soldering iron weighs only 3 1/2 ounces. By what the manufacturer calls the "wattage expanding principle," the thermal cartridge concentrates all its heat in the tip instead of wasting a large amount in useless radiation. This allows a 30-watt car-



tridge to furnish as much useful heat as the normal 100 watt iron.

With the transformer, which also acts as a holder, the iron works on 117 volts a.c. Without the transformer, a 6-volt car battery furnishes suitable power.

Tips made of a nonoxidizing material, are replaceable. Cartridges of different wattages may be inserted.—RADIO-CRAFT

RADIO SILENCER

Kenworth Mfg. Co.
Milwaukee, Wis.

Radi-Off automatically turns off the radio when the telephone receiver is lifted off the cradle, and turns it on again when the receiver is replaced. No electrical connection need be made to the telephone.

A shallow metal box is placed under the telephone instrument. The top of the box is spring-mounted so that as the telephone's weight decreases (when the receiver is removed), the box rises slightly and opens an internal switch contact, turning off the radio.



Connector to the radio is made by plugging the radio's line cord into a receptacle wired to the Radi-Off and plugging the latter into the wall socket.

The device is adjustable for the weights of different telephones.—RADIO-CRAFT

SMALL CAPACITORS

Solar Mfg. Corp.
North Bergen, N. J.

Type TST Tiny, Sealdites are tubular moulded paper capacitors, 3/16 inches in diameter x 1/8 inch long.

They are molded in Hi-Temp plastic compound for satisfactory operation under the high operating temperatures found in miniaturized electronic equipment and personal radios. Unlike conventional thermosetting molding materials the Hi-Temp plastic compound housing withstands extremes of humidity.—RADIO-CRAFT

MOBILE TRANSMITTER

Standard Transformer Corp.
Chicago, Ill.

The ST-203-A amateur transmitter is designed for operation in an automobile but can be used also at a fixed station. Operating in the 10-meter band its maximum plate power input is 27.5 watts. Power requirements are 400-500 volts d.c. at 200 ma, and 6 volts a.c. or d.c. at 2.8 amperes.

Five tubes are used. They are: 6V6 r.f. oscillator, 2E26 power amplifier, 6J5 speech amplifier, and two push-pull 6V6 modulators. The transmitter may be controlled from the driver's seat by the push-to-talk button on the microphone.

The unit is provided with a base mounting plate for installation in an automobile trunk. The transmitter fastens to the base plate with two spring-loaded catch fasteners. Dimensions are 8 3/4 x 7 3/4 x 6 1/4 inches.—RADIO-CRAFT

THE COMPLETE TELEVISION MANUAL THE VIDEO HANDBOOK

768 pages . . . 14 sections, covering every phase in television . . . over 800 illustrations . . . handsomely bound in black with red and silver stamping.

How Television Works.
Basic . . . though advanced.

How to Troubleshoot and Repair Television. Safety procedures.

How to Select and Install a Television Antenna.

The vast amount of information contained in this book can only be briefly outlined here . . . The VIDEO HANDBOOK contains thousands of vital facts—covering everything you need for working in television. All this information is designed for easy reading, quick reference—all in non-mathematical language, every point of discussion pictured in diagrams or photographs. The VIDEO HANDBOOK is divided into 14 sections—each a complete, authoritative coverage on its subject—arranged in a practical, easy-to-follow handbook of solutions to every television problem.

READ BY:

Engineers, Experimenters,
Servicemen, Production men,
Designers, Laboratory technicians,

How to Design and Engineer Television.

How to Create a Television Show.

How to Build an Operating Television Receiver. Complete Instructions.

How to Select a Television Receiver.

Maintenance men, Broadcast technicians,
Program directors, Manufacturers,
Studio personnel, Laymen.

Section 1. Television, Past, Present and Future.

The first section of the VIDEO HANDBOOK is an introduction to television. In it you will find an account of the inventions, discoveries and developments that led to the present system of television. The television industry today is covered in a complete description of its organization, operation and characteristics. And—you will find an invaluable outline of television in the future.

In addition, there are statistics on present day television—how many transmitters there are and where—the standards required for satisfactory operation—and mentioned last, but not least, the status of color television.

This section is the most complete explanation and resume of television to date. It will introduce a beginner into the field—and it will give an expert much he did not know!

Section 2. Fundamentals of Electronic Television.

In this chapter, a simplified explanation of the complete electronic television system is given. The entire process, equipment used and its operation are covered in a thorough discussion—designed to give anyone and everyone a complete basic understanding of television.

Today's television system is based on the cathode ray tube. Its development made electronic television possible. Therefore, a detailed account of the construction, function, and characteristics of the cathode ray tube is presented. This and all the things that are television are presented here in a carefully planned introduction to the more detailed and specialized sections that follow. Everything is written and illustrated so that the beginner may see and read how television works . . . without weighty mathematical language.

Section 3. The Television Station Pick-up—Control—Transmission.

Now, in the third section, the mechanical and electrical details of transmitting a television program are given. From the camera to the transmission of the television signal, every piece of equipment is described and illustrated. All technical functions of the television station are covered. The power supplies, video amplifiers, microwave lengths, sync generators, video and audio transmitters and all the other elements of a complete station are discussed in detail. Pick-up equipment, both studio and remote is covered in detail, including cameras, camera tubes, such as orthicons, iconoscopes and signal orthicons, plus all the other components used.

Section 4. The Television Receiver.

This is the section of the VIDEO HANDBOOK that will be the most frequently used by most readers.

The signal is followed from the antenna through every stage of the receiver—step by step—each stage is individually studied and its function completely described as a unit and in relation to all the other stages. These are then separated into the receivers six basic sections—the RF section, the video channel, the sweep circuits, the low and High Voltage Power Supplies, the Picture tube with its associated circuits, and the sound channel. Each section is then discussed as an operating unit, completely explained and illustrated. For example, in the sweep circuits, the video signal is traced with photographs of oscillograms showing all orienting wave forms . . . the advantages and techniques of design of flying synchronization circuits, and triggered synchronization circuits are individually illustrated and explained . . . sweep generators and their basic circuits are discussed as are sweep amplifiers and methods of damping. The picture tube and its functions in the receiver are illustrated by means of circuit diagrams, cutaway drawings, etc. Staggered tuned video amplifiers, the intercarrier sound system, and all the other circuit arrangements. Every component that goes into the modern television receiver is analyzed.

Section 5. Television Antenna Systems.

In television the antenna assumes tremendous importance. In section 5 this importance is thoroughly explained and analyzed. The proper antennas for the various receivers and locales are explained. The effects of different locales on antenna efficiency are presented. The twenty or so different types of antenna now on the market are illustrated and discussed. Wave patterns are illustrated. Propagation of television waves and how they resemble to light waves in some ways. Loading, impedance, polarization, directivity, etc., are explained and diagrammatically illustrated. Feed systems and transmission lines are illustrated and illustrated. Section 5 of the VIDEO HANDBOOK is designed to clarify the present confusion over television antennas. It will provide valuable and interesting reading—it provides more and better information on the subject than heretofore available.

Section 6. Creating a Television Show. Programming and Production.

The problems of producing a television show are related to the limitations and characteristics of television equipment. They are problems that must be handled by coordinated action on the part of program directors and television technicians. Every man in the broadcast studio

must know the limitations—and the amazing advantages of television as a medium of entertainment and education.

This section presents these problems and their solutions—illustrates the similarity to motion picture and stage production and where this similarity ends. It thoroughly explains all the special requirements and possibilities of television as a separate form of expression. The sensitivity of television cameras to color and lighting. Special requirements of set design and actors' make-ups. The versatility of different lenses for creating special effects. Network control and the use of remote equipment in combination with studio personnel. How the various duties of studio personnel can be applied to the best advantage. Timing of action for top efficiency in the show and in relation to other shows preceding and following. Trends in audience reaction. The phenomenal possibilities of electronics for special effects.

Section 7. Descriptions of Modern Television Receivers, Circuit Variations—Design—Mechanical Features.

This section includes a circuit diagram of every type of receiver on the market today.

The man who is going to sell, work with, design, service, install or engineer television receivers, must know about the sets now in use. Section 7 of the VIDEO HANDBOOK provides complete information on the various types of receivers . . . their complete circuits, their components, the differences between them and complete descriptions of how each type operates. Outstanding features of each receiver are noted, as are different manners of construction of the same components. For example continuous tuning, current type tuners, and push button tuners in the RF section . . . differences in oscillator circuits, types, antenna coupling variations, etc. The various peculiarities in design of the other five sections of the types of receivers are discussed . . . single-tuned grid amplifiers, push-pull oscillators, single-tuned oscillators, triode mixers, cathode followers, AFC oscillators, etc. This information provides the knowledge and experience otherwise obtainable only through months of painstaking research.

Section 8. Installing Television Receivers.

This is a highly specialized operation, but it can be done by following very carefully the instructions in this section. It was prepared as a guide and reference for installation technicians and servicemen and gives complete information on everything from the all important safety precautions to an instruction outline on how to operate the receiver after it's installed.

Every step is covered . . . pre-installation surveys, equipment required, locating and erecting the antenna, laying transmission lines to the receiver in the building. All these procedures are illustrated in step by step, working photographs covering all details including proper ways to climb roofs, fastening lines, securing antenna mounts, etc. In addition there's a complete set of photographs of test patterns, illustrating maladjustments and common interferences (auto, diathermy, FM), weak signals, too-strong signals, mis-match in the antenna system, etc. There are recommendations as to customer-relations: how to insure legality of certain installations in respect to house rules, leases, etc. This section is a practical, how-to-do-it guide that will save a lot of money!

Section 9. Servicing Television Receivers. Troubleshooting—Interpreting Test Patterns—Alignment—Repair.

This is another section devoted to detailed, how-to-do-it procedure. This time on servicing the receiver. Here you will find the most complete account yet published on every step in repair or maintenance. There are detailed block diagrams illustrating every test equipment set-up. There are circuit diagrams illustrating every stage discussed, every component. You will find a complete description of alignment procedure, signal tracing for troubleshooting and over 100 photographs of oscillograms showing wave forms encountered. There are 30 pages of trouble-shooting charts, short-cuts that are money-saving and time-saving.

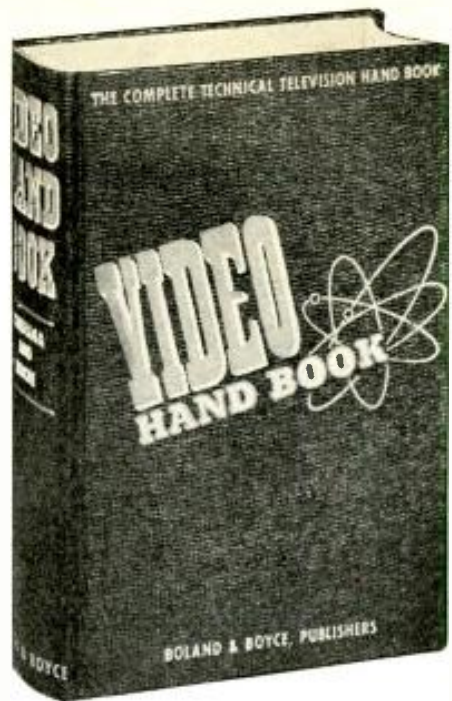

Section 10. Television Test Equipment. How To Use It—How To Buy It.

This chapter gives information on how to select the proper instruments and how to use these items for best results. Complete descriptions of all meters, tracers, generators and testers are found here. These descriptions are illustrated with photographs and diagrams. Detailed instructions for connecting and using every type of instrument are presented and illustrated. Complete information on how the oscillograph works and how to use it are included and illustrated. Every separate current, voltage, and resistance measurement is given as are impedance, capacitance, etc., as applied to all sections and stages of the television receiver.

Testing and measuring are simple quick operations when done with the proper equipment, but the knowledge of which is the proper instrument to use is all important. Section 10 of the VIDEO HANDBOOK was expressly designed to give you this information—it can save you as much as \$1000.00 in purchasing test equipment.

Section 11. Building a Television Receiver.

The quickest, most thorough method of learning television is to build a receiver. This project can rapidly give a beginner the practical experience he needs, and can augment an experienced man's understanding and knowledge. In each case, the result of this project will be a valuable television receiver that can be used for pre-installation surveys, laboratory experiments and demonstration. It is a complete receiver in every respect with the added advantage of being profitable. Included here are complete plans, diagrams, photographs of components needed and step-by-step assembly instructions. Every part is listed and information as to where you can obtain it, whether you can construct the part yourself or not and approximate cost of each item. Every operation and section in constructing this receiver are separately described in an easy-to-follow style. This project, in addition to being a highly interesting and enjoyable one for anyone interested in television, is a very valuable education in itself.

Section 12. Data Section.

Here are compiled all the graphs, charts, curves, nomographs, symbols, formulas and rules used in television. Designed for quick reference, this section presents all the figures and data needed for any type of work on television. This information is found completely only in the VIDEO HANDBOOK. There is no further need for wading through several books to find the standard formula or chart you need. This is a time-saving feature of the VIDEO HANDBOOK that will spare you much aggravating research. It will save money, because it saves time.

Section 13. Television Terms.

A complete dictionary of words, terms, phrases and titles used in television.

Section 14. Bibliography.

This is the most complete list of literature on television issued to date. For anyone wanting another book or periodical on the subject, this section has it in its complete listing and a descriptive paragraph of that literature's contents. No time wasted on getting the wrong periodical or book . . . no guesswork on titles, wondering if they represent the material you want. Should the user of the VIDEO HANDBOOK desire other literature on the subject of television he will find this complete library-type index right in the back. Another time-saver!

768 PAGES — 14 BIG SECTIONS — ONLY \$5.00. OUT IN DECEMBER. MAKE SURE YOU GET YOUR COPY — ORDER NOW!

MAIL THIS COUPON TO YOUR JOBBER, OR DIRECT TO:		RC-9
BOLAND & BOYCE Inc., PUBLISHERS 460 BLOOMFIELD AVE., MONTCLAIR, N. J.		
Here's my order for one VIDEO HANDBOOK		<input type="checkbox"/> ENCLOSED IS \$5.00 (\$5.50 FOREIGN)
		<input type="checkbox"/> ENCLOSED IS \$1.00, I WILL PAY POSTMAN \$4.00 (IN U.S. ONLY)
NAME		
ADDRESS		
CITY	ZONE	
STATE		
BOLAND & BOYCE INC., PUBLISHERS		

WANTED

Your Name

on our mailing list to receive our **FREE MONTHLY BULLETIN** listing hundreds of outstanding radio bargains.

To get your name, your address, RSE offers

MIDGET I.F. TRANSFORMERS

Back again—by popular demand!



RSE scores again with a new and better I. F. 400-500 KC range—1 1/4" square x 3" high—ceramic based mica trimmers—high gain iron cores—pep up old receivers, ideal for new construction—and now available in either input or output types—for peak performance! Individually boxed in the colorful RSE carton. List price \$2.10. LRI—input; LR2—output;

Specify Type.

Each	Matched Pair	Dozen	Egg Crate of 100
36c	69c	\$3.95	\$29.00



VOLUME CONTROLS

• Our own private brand—made by a nationally known manufacturer. • The same kind that net for \$1.09. • Noise-free carbon construction, standard shaft and bushing. • Individually boxed in our colorful carton carrying the RSE equal quality seal of approval. • Complete with switch, full range of sizes.

10 M ohms	100 M ohms	each	59c
15 M ohms	250 M ohms		
25 M ohms	500 M ohms	per 10	\$5.50
50 M ohms	1 Meg ohms		
2 Meg ohms	500 M Knurled Shaft	assid.	\$5.50
500 M ohms less switch, 39c each, 100 for \$35.00			

PHONO CABINET



Used in the Zenith "Cobra Tone Arm" record demonstrators. Solidly built of 3/4" plywood covered with maroon luggage cloth. 14" x 16" square, 11" high. Flocked grill for B" speaker. Rubber mounting feet, ventilated rear cover. Brand new in factory cartons. Every record and radio shop can use these at

\$2.99

PHONO AMPLIFIER

A high quality AC-DC phono amplifier featuring the latest circuits and tubes. The chassis is only 2" x 2 1/4" x 5 1/2" and includes volume and tone controls, built-in output transformer, and 5' rubber line cord. Complete with 35W4 and 50B5 tubes. Operates on 110 to 120 volts AC or DC. Supply is limited—first come first served



\$4.19

OZ4'S at 73% OFF!

Until sold out—RSE offers 15000 new guaranteed OZ4 tubes. You know who made them—You can't go wrong at



ORDER INSTRUCTIONS

Minimum order—\$2.00. 25% deposit with order required for all C.O.D. shipments. Be sure to include sufficient postage—excess will be refunded. Orders received without postage will be shipped express collect. All prices F.O.B. Detroit.

DEMAND THIS SEAL OF QUALITY

RADIO SUPPLY & ENGINEERING CO., Inc.
125 SELDON AVE. DETROIT 1, MICH.

DIFFERENTIATION CIRCUIT

Patent No. 2,436,891

Wm. A. Higinbotham, Santa Fe, N. M. (assigned to United States of America as represented by the Secretary of War)

Differentiating circuits are important in television and electronic counters (see page 26, July RADIO-CRAFT). To differentiate a voltage, it is connected across a series condenser and resistor. The output appears across the resistor. For an accurate differentiated output R must be negligible compared with C. Unfortunately, this results in practically no output.



This new circuit combines accurate differentiation with high output. It is shown below. The input passes through a cathode follower for isolation from the differentiating circuit C, R, S. The voltage drop across the two resistors is amplified and then transmitted to the beam power cathode follower. The cathode current of this tube flows through S.

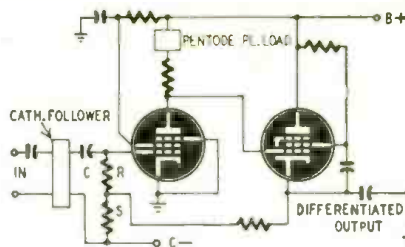

The voltage drop across S is made up of two parts. One is due to the original differentiated current. The other is produced by a reverse current similar to the first but greatly amplified. These voltages can be made to almost cancel. Therefore the combined effect of R and S is negligible as required.

The accurately differentiated voltage appears at the cathode load of the beam power tube.

VOLTAGE REGULATOR

Patent No. 2,434,069

Harold Goldberg, Irondequoit, N. Y. (assigned to Stromberg-Carlson Co.)

Regulated power supplies which provide high voltages at fairly heavy loads use at least the following tubes: rectifier, voltage regulator, pentode, and triode. In the figure these are illustrated, respectively, as A, B, C, and D. To describe briefly the operation, assume that the output voltage (across the bleeder) undergoes an increase for any reason. The control grid of the pentode then assumes a more positive potential and causes greater plate current to flow through R. There is an increased voltage drop across this resistor and therefore the triode grid becomes more negative. The higher tube resistance is in series with the power supply, consequently the output drops and compensates for the original rise. When properly adjusted, such a circuit can maintain an output voltage constant to within a small percentage.

In the circuit illustrated, the voltage regulator tube B is used simultaneously to regulate a second voltage, for example, for bias purposes. To do this it is necessary only to add a half-wave

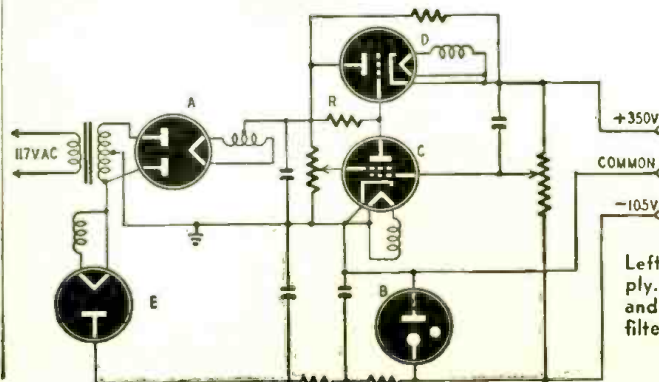

rectifier tube E and a filter system. The filter may be a simple R-C combination because of the low drain of the C supply. The regulator tube not only standardizes the grid potential of the pentode tube but also the negative voltage output.

This circuit is especially useful in connection with class C amplifier power supplies.

TRIGGER CIRCUIT

Patent No. 2,441,006

Arthur E. Canfora, Brooklyn, N. Y. (assigned to Radio Corp. of America)

This circuit is controlled by a neon lamp. The two triodes are connected so that when one conducts the other is cut off. Change-over takes place when a pulse of correct polarity operates the first tube.

If the input is positive V1 conducts. Its plate voltage drops to a low value due to heavy current through R and the neon lamp cannot light. The grid resistor of V2 is connected through the lamp and R to the positive terminal of the power supply. If this path is interrupted (when the neon lamp is not lighted) V2 is cut off because

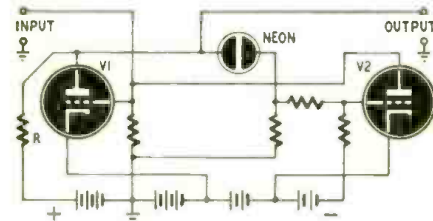

its grid is also connected to the negative end of the supply. If the input pulse is negative V1 is reduced to cutoff. The high plate voltage lights the neon lamp and provides the second tube with a positive grid voltage. Therefore this tube conducts.

The change-over from conduction to cutoff is abrupt because the neon lamp strikes at a definite potential. The other parts of the circuit are not critical. It is only necessary that the input pulse exceed a certain minimum value.

This circuit can be used as an improved pulse counter or as an electronic switch.

AUTOMATIC FIRE ALARM

Patent No. 2,439,502

Thomas J. Tate, Talladega, Ala.

A thermostat is used in this invention to automatically sound a fire alarm and summon aid. The alarm may be sent over telephone wires to the central office or may be sounded at the switchboard of a hotel or apartment house. There is no interference with normal use of the telephone lines.

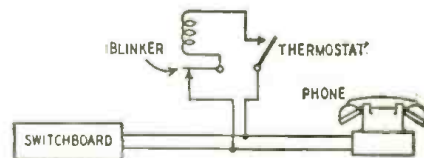

The only parts needed are a thermostat and a blinker. The thermostat is adjusted to close the circuit at about 135° F. When a fire breaks out its contacts close and the blinker sends

periodic signals over the wires. At the other end of the line a light goes on and off or a gong sounds to indicate where the fire has broken out.

For greater safety two thermostat circuits may be connected to the lines.

Left—A regulated power supply. Addition of an extra tube and a simple resistance-capacity filter provides a source of bias.

VIDEO AMPLIFIER

Patent No. 2,441,880

Elmer Dudley Goodale, Bayside, L. I. and Vernon J. Duke, Rockville Centre, N. Y. (assigned to Radio Corp. of America)

A video channel amplifies only the a.c. component of picture signals. The d.c. must be reinserted in the output. A diode tube rectifies the

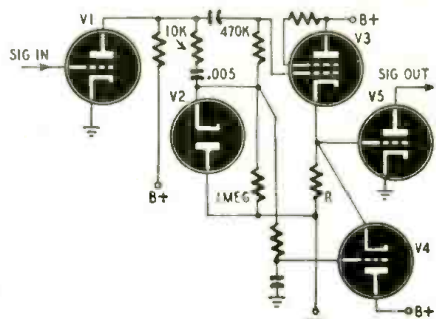

pulses and provides the d.c. for correct background brilliance.

The d.c. component must be kept fairly constant, especially at the transmitter end. If the video amplifier feeds into a grid-modulated power amplifier this may be difficult. As the grid bias varies it causes change in the picture background. This change can be avoided by adding a compensating tube.

Only the a.c. component is amplified by V1. This voltage is rectified by V2. The cathode condenser of V2 becomes charged to the peak voltage and gradually discharges through the resistor network. This d.c. voltage is applied to the grid of V3, a cathode follower. From here it goes to the grid of the power amplifier V5.

The grid current of V5 may change with different values of excitation. This tends to vary grid bias on the tube. Compensating tube V4 is connected across the cathode load of V3 to prevent this. When V5 grid current increases (through R) it results in greater negative voltage across R. This makes the cathode of V4 more negative and therefore increases plate current of the tube. Note that this current also flows through R but in the opposite direction. The mutual conductance of V4 may be adjusted to make the two opposite currents equal. Then the average drop across R remains constant and cannot affect the average brilliance of the picture background.

VOLTAGE REGULATOR

Patent No. 2,439,938

Reuben Lee, Catonsville, and Charles K. Hooper, Shipley Heights, Md. (assigned to Westinghouse Elec. Corp.)

Even in a well-designed power supply the regulation tends to become poor at low current drains. These inventors find that the sharp change in voltage occurs when the harmonic components become larger than the average or d.c. output.

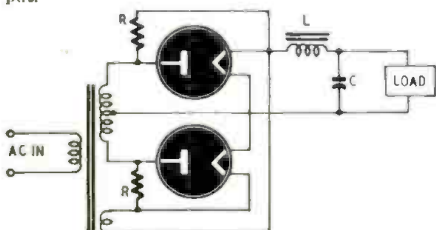

The characteristic curve becomes more nearly straight if the d.c. through the load always remains larger than the harmonics. This may be assured by adding a conventional bleeder across the load. Chokes large enough to pass the combined load and bleeder currents are required. A more efficient solution is to add resistors before the chokes.

A full-wave power supply requires two resistors. For highest efficiency each should be equal to $27.6fL - 0.239/C$, with f in cycles, L in henries, and C in farads.

Dry rectifiers such as selenium permit current flow in both directions to some extent. In many cases the leakage may be equal to or larger than the above value. Therefore there is no need for the added resistors.

TRANSVISION



BIGGEST VALUES in TELEVISION!

Large-Image, Direct-View TV Kits at Low Cost!

Kits Engineered for EASE of ASSEMBLY and Top Performance. Cabinets designed and built for Beauty, Utility, Durability.

NO TECHNICAL KNOWLEDGE REQUIRED FOR ASSEMBLY.



Console Model 7CL



MODEL 10BL Gives 115 Sq. In. Picture

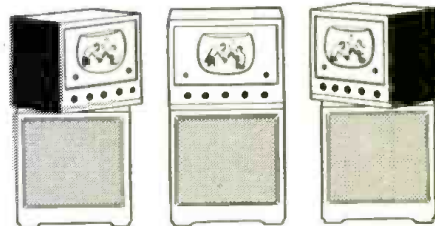

Roto-Table for full 180° Visibility

TRANSVISION manufactures the most extensive line of high quality Television Kits, Cabinets, and Components. Models illustrated and listed here are only representative of Transvision's leading values. See your distributor.



MODEL 10BL, TV/FM Kit, gives 115 sq. in. picture; complete FM Radio; receives all channels; streamlined cabinetNET \$299.00
Roto-Table for Model 10BL, gives full 180° visibility.NET \$ 24.95
MODEL 7CL, TV Kit, gives 60 sq. in. picture; console cabinet with Roto-Table; streamlined designNET \$199.00
MODEL 7BL, same as 7CL except that it is a table model NET \$189.00
All prices include cabinets, tubes, antenna, and 60 ft. of lead-in wire. (Models 7CL and 7BL can be supplied with complete FM Radio for small additional cost.)

**—FREE—
Fascinating
BOOKLET
On Television**

Illustrated 20-page 2-color booklet gives you excellent basic information on television. Call at your distributor's for a FREE COPY; or write to us for names of distributors.

"SERVICE NOTES"

by TRANSVISION

the Key to Successful Television Servicing . . . Confidential Television Notes and Information, product of experience with over 20,000 television sets. Complete with photos, diagrams. Worth a small fortune. Cost is only \$1.95 NET



All prices 5% higher west of Mississippi; all prices fair traded. For further information see your distributor, or write to:

TRANSVISION, INC. Dept. R.C. NEW ROCHELLE, N. Y.
In Calif.: Transvision of California, 8572 Santa Monica Blvd., Hollywood 46

For TELEVISION, it's TRANSVISION—the complete line of High Quality Kits, Cabinets, Antennas, Lenses, Filters, Boosters, Components—Ask your distributor!

CONVERTING THE SCR-178 AND -179

30,000 SUCCESSFUL RADIO SERVICE- TECHNICIANS READ



EVERY MONTH

RADIO MAINTENANCE today fills a breach that has existed in the radio field for a long time. Already 30,000 technicians read RADIO MAINTENANCE every month because it is devoted entirely to the Radio Serviceman.

The RADIO MAINTENANCE staff specializes in the preparation of articles on every phase of Radio Maintenance in series form which may be filed and used for reference. The leading articles cover everything for the radio serviceman on Television, FM and AM; Test Equipment; Electronic Appliances; Tools; Antennas; Alignment; Troubleshooting; Repair; Construction; Pick-ups and Sound Amplification and Reproduction Equipment. Also, in RADIO MAINTENANCE each month there are departments on hints and kinks, the latest news of the trade, review of trade literature, radiomen's opinions, new products and news from the organizations. All articles are presented in a step-by-step precision style, clearly illustrated, with schematics, accurate photographs, specially prepared drawings, white on black charts, color diagrams, isometric projections and exploded views.

Binders in beautiful green simulated leather are now available for your RADIO MAINTENANCE magazines—see the current issue for details.

RADIO MAINTENANCE MAGAZINE RC-9
460 Bloomfield Avenue,
Montclair 6, N. J.

Please send me RADIO MAINTENANCE for
 2 years, \$5 1 year, \$3
 Payment enclosed Bill me later

Name

Address

City—State

•Occupation

Title

Employed by

•Independent Serviceman — Dealer Serviceman—
Service Manager—Dealer—Distributor—Jobber.

BOLAND & BOYCE INC., PUBLISHERS

? I have an SCR-178 radio set consisting of a BC-186 receiver, BC-187 transmitter, and BC-188 modulator. Please modify the transmitter diagram for use with a.c. on the filaments and crystals in the oscillator circuit. I also want a diagram of an a.c. power supply for the entire set. Can I alter the tuning range (2.4-3.7 mc) to 3.5-4 and 7-7.3 mc?—B. M. McN., Sydney, Nova Scotia.

▲. The transmitter circuit has been revised, and a power supply is shown.

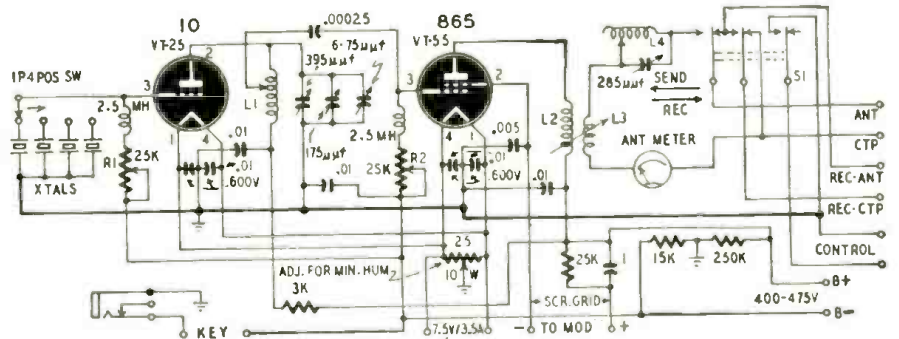

Separate d.c. supplies provide bias and filament voltages for modulator and receiver. Rect. 1, Rect. 2, and Rect. 3 are fullwave rectifiers that deliver about 6 volts d.c. at 300 ma or more. They may be

ma, and their d.c. resistance should be 4 ohms or less. The inductance should be .02 henry or more. C1, C2, C3, C4, and C5 are 6-volt electrolytics with capacitances of 500 μ f or more.

You may raise the tuning range of the transmitter to 4 mc by removing a few turns from L1 and L2. For 40 meters, remove about half the turns from L1 and L2. Vary the position of the grid tap on L1 and the number of turns on L3 and L4 for best results. Adjust R1 and R2 for correct bias on

the VT-25 and the VT-55. Do not attempt to double in the final or oscillator.

Ready-made plug-in coils can be used in the receiver if they can be made to fit the coil sockets. If not, you can wind

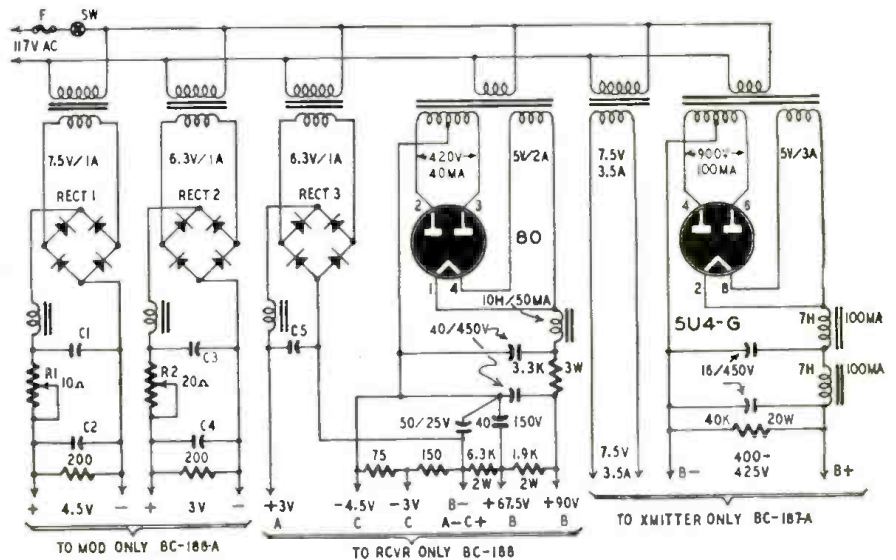

Mallory type 1B12R or equivalent. The chokes in these circuits should carry 300

them, using standard data for 140- μ f tuning condensers.

PREAMPLIFIER WITH A.G.C.

? Please print a circuit of a battery-powered microphone preamplifier and include automatic gain control. I would like to use 1S5's throughout, if possible.—N.F.W., East Alton, Ill.

▲. Here is a circuit of a microphone preamplifier with a.g.c. Remote-cutoff tubes work best in a.g.c. circuits so 1T4's or equivalents are desirable. A 1S5 is the a.g.c. amplifier and rectifier. Adjust

the control in the plate circuit of the first 1T4 for satisfactory operation.

If the preamplifier is some distance from the main amplifier, use a plate-to-line transformer as shown in the circuit. If the two units are close together, you can use capacitive coupling as shown by broken lines. Replace the transformer with a 1-megohm resistor in the plate circuit and change R1 to 2 megohms. Connect the plate of the 1T4 to the high-

this valuable book
FREE with your
 Subscription
 to **RADIO-CRAFT**

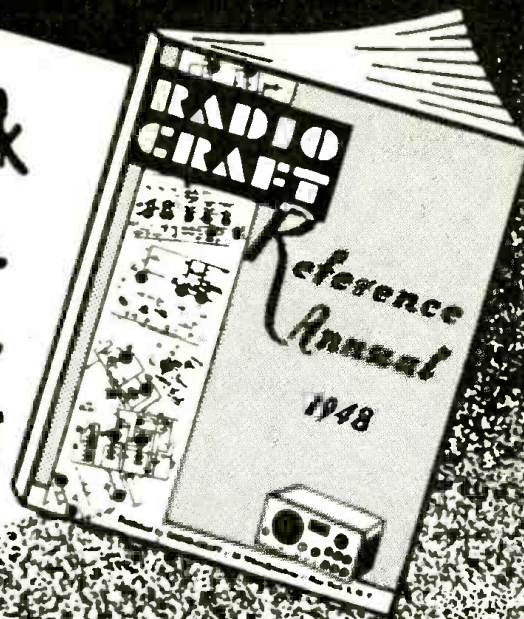

Provides Practical Construction and Servicing Articles from Many Parts of the Globe

Now we can offer you, for the first time, the cream of articles on construction and servicing prepared by foreign technicians.

The 1948 RADIO-CRAFT REFERENCE ANNUAL brings this world-wide information, along with some of the best of our own country, in one volume. Just run your eyes down the contents listed on the right and see for yourself what a wealth of new and important material it contains. *Each article has been selected with a view to presenting information not appearing elsewhere in textbooks, manuals, or periodicals printed in the United States.* Each has accurate schematics and detailed data enabling you to get at constructional and operational features easily, and—if you so desire—to duplicate similar models.

Another feature of the Annual is the RADIO-CRAFT Index, covering issues between Oct. 1946 and Sept. 1947. This Index enables you to locate the important articles appearing during the year on such special subjects as come up in the course of your work or studies. Taking all in all - - the worldwide construction and servicing articles - - the handy kinks and short cuts, and the RADIO-CRAFT Index you have a well rounded reference book of inestimable value. Get this valuable 1948 reference book by subscribing to RADIO-CRAFT at once.

CONTENTS

TRANSITRON OSCILLATOR—ITS USES
 MAKE A V.H.F SUPERREGENERATOR
 CHECK YOUR FREQUENCY
 IDENTIFY THAT STATION
 CONSTRUCTING A B. F. O.
 TODAY'S D.-C. AUDIO AMP.
 METAL LOCATOR
 LOW-LEVEL TONE CONTROL
 PHOTO-PRINT TIMER
 SUPERSONIC DOOR OPENER
 POWER SUPPLY STABILIZER
 NEW CIRCUITS FOR OLD
 SIMPLE TUBE VOLTMETER
 2-TUBE PORTABLE
 SIGNAL TRACER FROM OLD RECEIVER
 HI-FI TRF TUNER
 4-TUBE REFLEX SET
 LOUDSPEAKER FIDELITY
 PHONO AMPLIFIER WITH ADJUST-
 ABLE FEEDBACK
 MULTI-CIRCUIT CLIP SET
 A. F. EQUALIZER STAGE DESIGN
 FM RECEIVER
 NOVEL GLASS A AND B AMPLIFIER
 V.O.M.-COND. TESTER
 RADIO-CRAFT INDEX OCT. 46-SEPT. 47

**Mail Coupon
 with Your
 Remittance
 Today** →

RADIO-CRAFT

25 West Broadway, Dept. 9, New York 7, N. Y.

Gentlemen: Enter my subscription to RADIO-CRAFT for the period indicated below, and send me a free copy of the new 1948 RADIO-CRAFT REFERENCE ANNUAL. I enclose my remittance.

- | | | |
|--|---|---|
| <input type="checkbox"/> 1 Year \$3.50 | <input type="checkbox"/> 2 Years \$6.00 | <input type="checkbox"/> 3 Years \$8.00 |
| <input type="checkbox"/> This is a new order | <input type="checkbox"/> Renewal | <input type="checkbox"/> Extension |

Name

(Please print clearly)

Address

City Zone State

(Canada, Mexico, South and Central America same as U.S.A. All other foreign \$1.00 extra for each year.)

ALMO PRESENTS THE NEW HALLICRAFTERS T-54

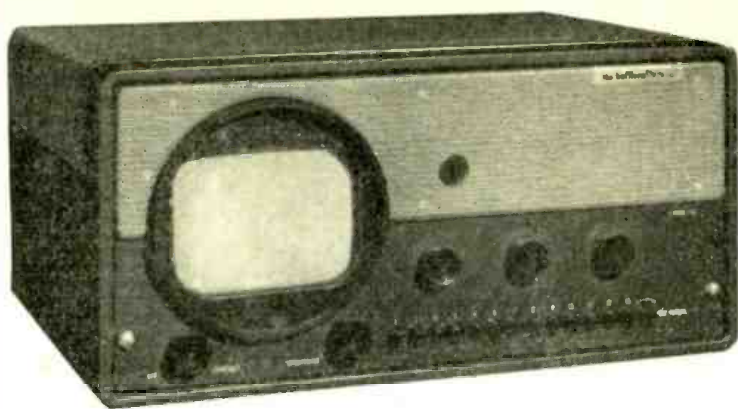

Here's the Finest in TV at a Price You Can Afford

YOUR COST \$169.50

Only Hallicrafters can offer you such a fine TV receiver for so low a price. You are assured of constant reception with this new receiver because of a special automatic gain control circuit. Both sensitivity and distance reception are comparable to TV receivers in much higher price brackets.

An attractively styled cabinet finished in rich silver grey has an airodized top on a full length piano hinge. The control panel is deep grey. The T-54 is also available in a walnut and blonde finish cabinet at \$179.50.

The same excellent engineering that you recognize in other Hallicrafters products makes this exciting new T-54 a prized possession for the man who understands radio.

We will send your new T-54 the same day that your order is received. Send check, Money Order or C.O.D.

New Hallicrafters T-54 has 7 inch electrostatic tube, push button tuning on all 13 channels, operates 105 to 120 volts, 50-60 cycle A.C. three stage I.F., iron core I.F. transformers, eighteen tubes plus 3 rectifiers, automatic gain control circuit, inter-carrier modulation type FM, and a built-in 4" by 6" PM dynamic speaker.

ALMO RADIO COMPANY, 509 Arch Street, Phila., Penna.

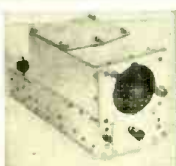

COMMAND RECEIVERS

BC-454 3 to 6 Mc. with Schematic. New \$5.95
 BC-455 6 to 9.1 Mc with Schematic. New \$7.95

TUNING CONTROL CRANKS 50c

TRANSFORMER FOR RECEIVERS—115 Volt, 60 cycle Primary; Sec. 250-0-250 Volt 50 MA; \$2.95
 6.3 Volt and 24 Volt, with AC Schematic.



INTERPHONE AMPLIFIER BC-347

Army Aircraft Type; Uses 6F8 Tube. Contains two (2) Midget High Fidelity UTC output transformers (1/2" x 1/2"). Input—200 ohm to single or push-pull Grid; Output 200 ohm from single or push-pull plate, plus resistors, cond., etc. Completely enclosed. With Schematic. Size: 2 1/2" x 4" x 6". Less Tube. price—each New 79c
 Or three (3) for \$2.00

DYNAMOTORS

MOBILE USE—9 Volt input; output 405 volts 95 MA. Also will operate from 6 Volt input; output 280 Volts 65 MA. Size: 3" x 7". DM 635x \$3.95



MINIMUM ORDER—\$2.00



LOOP LP-21 RADIO COMPASS INDICATOR ANTENNA

Can be used for small beam indicator. Loop rotated by selsyn motor, also has selsyn indicator trans. for remote indication, & slip ring assy. Wiring diagram for AC operation is included. Used but Tested \$3.95

SELSYN INDICATOR AND MOTOR

Part of LP-21 Loop. 0-300 calibration on selsyn. Wiring Schematic included. Used (Tested) \$2.95



1-82 5" INDICATOR
 Radio Compass Indicator used with selsyns for remote indication (Used and Tested) at New \$4.95

SELSYN 2JIG1

Suggested wiring for 110 volt, 60 cycle included. Normally operates from 57 1/2 volts 300 cycle. Used (Tested) Per Pair— \$3.50

impedance input terminal of the amplifier through shielded cable.

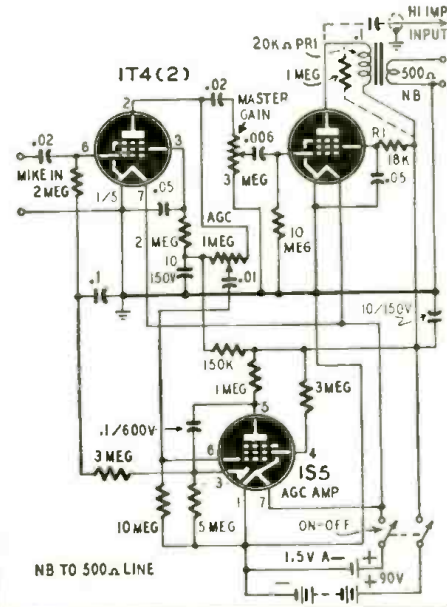

Question Box queries will be answered by mail and those of general interest will be printed in the magazine. A fee of \$1.00 will be charged for questions requiring no research or schematics. Write for estimates on questions requiring diagrams or considerable research. Be sure to give full specifications and details on the application. Six to 8 weeks is required to draw up answers involving large schematics or research.

FAIR RADIO SALES 132 SOUTH MAIN ST. LIMA, OHIO

ELEMENTS OF MAGNETIC TAPE RECORDING AND 999 APPLICATIONS
 by A. C. SHANEY
 Only 25c
AMPLIFIER CORP. of AMERICA
 398-10 Broadway, New York 13, N. Y.

SMOOTH FM TV VHF SERVICING
 This VHF ALIGNMENT WAND gives a constant check on the alignment of FM, TV & other 5-300 mc equipment during servicing. Its blending of setup and alignment makes servicing smooth and fast. Solves your TRACKING, SENSITIVITY & S:N problems. Tells which adjustment to make, which way and how much. A modern shop MUST!
HAWKINS RADIO COMPANY
 621 East 31st Street Kansas City 3, Mo.

CONDENSER SHORTS

If a small set with a loop antenna lacks sensitivity and image rejection even after being properly aligned, check the variable condenser for a high-resistance short which may be loading the antenna. Remove the condenser, clean it with carbon tetrachloride, and bake it in an oven to remove moisture. Don't heat it too much.

JOE FIEDERER,
Worcester, N. Y.

OLDSMOBILE 982375

When installed in the automobile this set would cut out after about a half hour. On the bench it would sometimes play for a whole day without the slightest difficulty.

The trouble was in the oscillator grid coil. Loose turns on the ground end were rubbing against each other and shorting out. The winding cannot be seen but the trouble was detected with an ohmmeter.

I removed the winding, rewound the loose turns, and heated the coil to drive out moisture. Then I gave it a coat of speaker cement. The set then worked perfectly.

C. W. TEWS,
Milwaukee, Wis.

RADIO-CRAFT offers a 1-year subscription or \$3.50 for television Technotes describing troubles in popular TV receivers and telling how the problems were solved.

ARLINGTON MODEL 7J7

The set played intermittently and distorted badly. The distortion remained after the defective a.v.c. filter and audio coupling capacitors were replaced. Disconnecting and resoldering the leads from the output transformer to the speaker voice coil cured the trouble. Evidently the original connection was faulty.

C. W. TEWS,
Milwaukee, Wis.

TUNING CAPACITORS

A dirty tuning capacitor is a frequent cause of noise and erratic operation. An oil can filled with carbon tetrachloride helps clean high-resistance bearings.

To clean dirt from between the plates, blow it out and use pipe cleaners or a visiting card moistened in carbon tetrachloride. Look through the plates with a light behind them to find metal filings or steel wool. If plates are touching, place a calling card or a plastic speaker shim between each set of plates until the set operates.

Small metal chips can usually be removed by burning them out. Connect the high voltage momentarily across the plates. Do not do this if the plates themselves are touching each other.

H. A. NICKERSON,
Dorchester, Mass.

(Better disconnect the coil first.—Ed)

ACORN

GIVES YOU WHAT YOU NEED!
LOW PRICES • IMMEDIATE DELIVERY

APPROVED FM FRONT-END

\$18.95



CIRCUIT: Superheterodyne
TUNING RANGE: 88-108 MC
INTERMEDIATE FREQUENCY: 10.7 MC
AVAILABLE FOR: 21.6 MC (Television I F)
FREQUENCY DRIFT: Negligible after 5 minutes
3 TUBES: 6AK5 Amplifier, 6X6 Oscillator, mixer, detector
6U5 Indicator (Tuning Eye)
ANTENNA: 300 Ohm line (DIPOLAR)
COMPLETELY ALIGNED
NO POWER SUPPLY INCLUDED
TERMINAL STRIP CONNECTION

TUNING RATIO: 10:1
TUNED LINES: Brass, silver overlay .0005 thick

PP 6L6 OUTPUT TRANSFORMER

Fully shielded, upright mtg., output transformer. Will handle 25 watts from push-pull 6L6's. Mtg. centers 3 3/4", 3" H. x 2 1/2" W. x 3" D. Primary 6600 ohm to 4-8-12 ohm voice coil. Shipping weight 4 lbs. Channel mtg.

\$2.45 each
3 for \$7

FM TUNING CONDENSER



3 rang 3-30 mfd. with trimmers. 88-108 mhz. A perfect condenser to cover FM band. 3/4" shaft, w. 1 1/2" h. 2 3/4" d. 3/4" Shipping weight 1 lb.

\$1.10 each
3 for \$3

ELECTROLYTIC CONDENSERS

PP TYPE IN CANS	PRICE
10 @ 350v	...
30 @ 300v	... \$.39
20-20 @ 25v	...
30 @ 450v	...
20 @ 450v	...
10 @ 450v99
20 @ 25v	...
20-20 @ 450v74
20-20-20-20 @ 450v	... 1.29
20-20 @ 400v-250v44
10-10 @ 350v59
20 @ 25v	...
30-30 @ 450v79
100 @ 50v49
100 @ 25v89
10-10-10-10 @ 400v59

OIL CONDENSERS

2 x .02 mfd 1500v	... \$.69
.1 mfd 3500v79
.1 mfd 7500v	... 1.79
.25 mfd 3000v	... 1.19
.15 mfd 4000v	... 1.39
.5 mfd 5000v	... 1.89
1.0 mfd 2000v	... 1.29
1.0 mfd 1200v99
4.0 mfd 1000v89
4.0 mfd 600v45
3-3 mfd 600v79
6.0 mfd 600v79
8-1 mfd 1000v	... 1.39
10 mfd 600v89
15 mfd 1000v	... 1.89
1.0 mfd 330VAC39
1000DC39
1.5 mfd 333VAC39
1000DC39

BATHUB CONDENSERS

2.0 Mfd 600v with slide terminals .44c ea.
10 for \$3.90

TLA OIL FILLED

4.0 mfd 600v ... 1.49
2.0 mfd 1000v ... 1.39

APPROVED FM AND TELEVISION SWEEP SIGNAL GENERATOR MODEL A-300

\$43.50

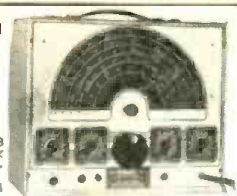

A—FREQUENCY RANGE 3 Bands No handswitching necessary) 12 to 227 Mc. (cycles)
A—2-77 MC; B—40-154 MC; C—151-227 MC; D—Calibration and reference scale; E—Dial scale length
B—FRONT PANEL CONTROLS
A—Sweep width 500 KC to approximately 10 MC;
B—Phase-locked control;
C—Tuning vernier control 10 to 1 ratio;
D—Selector switch FM-IF-CAL;
E—RF Output control;
F—Horizontal sweep output;
G—RF output;
C—TUNE LINEUP
A—6C4—Reactance tube modulator; B—6C4—Fixed frequency modulated oscillator; C—6C4—Continuously variable beat frequency oscillator; D—6C4—Mixer—Cathode follower output tube; E—7Y4—Rectifier tube.
D—GENERAL INFORMATION
A—High frequency insulation throughout; B—Maximum output 500,000 U/V; C—Power required 105-125 Volt 60-60 cycle AC; 35 watts; D—Power line filter built-in; E—Special Midline capacity tuning condenser; F—Pilot light indicator; G—Generator output can be used either frequency modulated or pure RF.

POWER TRANSFORMER

Primary 115 AC-60 Cycle Secondary 350-0-350-CT at 145 mls. 0.3 @ 4.5 amps. 5.0 @ 3 amps. Upright mount, mtg. centers 2 3/4" x 2 3/4". Made by Thorndarson. (Same as 70-11-62) Weight 6 lbs.

\$3.79 3 for \$10.75



FILTER CHOKES



10 henry at 85 mls. 250 ohms DC. Channel mount. Mounting centers 2 3/4". Made by Thorndarson. Shipping wt. 2 lbs.
10 henry at 55 mls. 350 ohms DC. Channel mount. Mounting centers 2 3/4" inches. Shipping wt. 1 lb. 79c ea. 3 for \$2.75
8 henry at 160 mls. 135 ohms DC. Channel mount. Mounting centers 3 1/4". Shipping wt. 4 lbs. \$1.19 ea. 5 for \$5

TERMS: 20% cash with order. Balance C.O.D. All prices F.O.B. our warehouse N.Y.C. No orders under \$2.50.

Write for FREE BARGAIN CATALOG
ACORN ELECTRONICS CORP.
80 VESEY ST., DEPT. C9 NEW YORK 7, N. Y.

CHECKING OSCILLATORS

Another receiver can be used to find out whether the local oscillator in an apparently dead receiver is operating or not.

Tune the good receiver to a frequency equal to the dead receiver's i.f. plus 500 kc and the dead receiver to about 500 kc. A beat note should be heard in the good receiver.

The two sets may have to be coupled fairly closely if the dead one is well shielded. It may be necessary to use capacitive coupling between the oscillator and the antenna of the good set. A 2-turn gimick around the oscillator grid or anode may be used to couple to the antenna.

THOS. P. MOTTLEY,
Ocean Grove, N. J.

4 CONTINUOUS HOURS of PLAY

with the MAGNETAPE

TWIN-TRAX RECORDER

\$495 including microphone

NO OTHER RECORDER OFFERS THESE SPECIAL FEATURES

4 hours continuous play... Frequency response 40 to 10,000 cycles ± 2 db... Individual bass and treble controls... Simplified tape threading... Heavy-duty non-overheating motor... No tape rewinding necessary... Phono pickup and turntable facilities available... Low hum level (DC on heaters)... Automatic tape reversal at end of reel... Sockets for VU meter and foot switch... Major components easily accessible... Instantaneous reverse control — without unthreading... Instantaneous stop — rapid start... High speed forward and reverse without unthreading... No tape spillage possible during high speed shuttle... Plays single track recordings made on other recorders... Separate recording and playback amplifiers on single chassis... Rubber-rimmed drive cannot develop flats... Complete elimination of capstan tape slippage... 3.2 and 500/600 ohm balanced line outputs... Jack for external speaker or carphone monitoring... Twin electronic erase heads... Flutter and wow — 0.1%... No belts to loosen or pulleys to slip... Dimensions 20 1/2" x 17" x 15 1/2". Wt 55 lbs.

Complete symphonies and operas — or any musical or variety program up to 4 hours in duration can now be recorded and played back on a single 1 1/2 inch reel of magnetic tape with the newly-developed Model 910-B Magnetape Twin-Trax Recorder. Incorporating new mechanical design features and the finest magnetic recording amplifier ever constructed, this exceptional instrument is the only answer to prolonged, uninterrupted high-fidelity recording of music or voice. Built-in reverse control and instantaneous stop feature makes this recorder ideal, also, for dictation and conference recording. Tape costs are actually cut in half through the revolutionary use of two independent and isolated sound tracks on standard 1/4 inch reels of tape. The cabinet, ingeniously designed for compactness and beauty, covers and protects the reels during operation of the recorder.

Its many exclusive features make this recorder unmistakably the perfect unit for the home, laboratory, industry, recording studio, and broadcast station. Also available is Model 810-B Twin-Trax Recorder, which plays for one hour at high fidelity on standard 1/2-hour reels of magnetic tape. Priced at \$285.00, less microphone.



Unit operates with cover and sides closed.

AMPLIFIER CORP. OF AMERICA
398-10 Broadway New York 13, N. Y.

TECHNICAL KO₅

OIL-FILLED CONDENSERS

.05	MFD 1000V	\$0.35
.05	500V	.14
.1	2500V	.75
.1	7500V	1.65
2x.1	7000V	4.10
.12	15000V	7.95
.25	1000V	.35
.25	4000V	2.15
.25	6000V	3.75
10x.25	600V	1.05
.5	600V	.28
.5	1000V	.40
.5	2000V	.75
.75	400V	.30
.85	600V	.35
1.0	1000V	.45
2.0	200V	.20
2.0	600V	.40
2.0	1000V	.60
4.0	600V	.60
4.0	1000V	1.00
5.0	220VAC	.55
6.0	600V	.70
6.0	1000V	1.45
8.0	600V	.85
8.0	1000V	1.75
10.0	600V	1.00
30.0	90VAC	1.40
30.0	330VAC	3.75
25.0	25V	.40
100.0	25V	.50

TRANSMITTING MICAS

.000025	2500V	\$0.15
.00005	2500V	.15
.00005	3000V	.35
.00005	5000V	.85
.00007	2500V	.20
.00007	2500V	.20
.00025	2500V	.25
.00025	5000V	.85
.0005	2500V	.25
.00072	5000V	.85
.0008	5000V	.85
.001	2500V	.25
.0011	5000V	.85
.002	1200V	.20
.002	3000V	.65
.00275	2000V	.25
.003	2500V	.30
.003	3000V	.65
.004	2500V	.35
.005	1000V	.15
.005	3000V	.65
.006	2000V	.35
.008	1200V	.15
.01	1200V	.15

TUBES-CHOKES-POTS

Tubes—6X6 Metal	\$0.99
Tubes—12X3 Metal	.29
Choke—100MA-10H.	
250 Ohm	1.59
Pots: 20K-50K-100K	.19
Dual. 1/2 Meg	
"250K-50K"	.30

SHIELDED WIRE #2250 Ft. for .65
 RESISTOR KIT Assorted 1/2 & 1W 100 for 1.49
 BATHTUB KIT 3x.1, .5, .05, ETC. 10 for .58
 CONDENSER KIT .01-.00001...100 for 2.99
 MICAS .01, .002, .005, ETC. All Values .08
 .01 150V PAPER (MIDGET) ...60 for 1.00
 0.1 600V PAPER 8 for 1.00

\$2.00 min. order F.O.B. N.Y.C. Add postage
 50% deposit, balance C.O.D. with all orders.
 Manufacturers inquiries invited. Send for Flyer.
 Prices are subject to change without notice.

TECHNICAL RADIO PARTS CO.

265 Greenwich St. Dept. RC-4 N.Y. 7, N.Y.

1949 MODEL MUTUAL CONDUCTANCE TUBE TESTER

with new 9 pin socket to handle all future tube developments... **\$49.95**

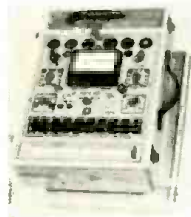

No possibility of good tubes reading "Bad" or bad tubes reading "Good" as on dynamic conductance testers or other ordinary emission testers. "Attractive panel and case equal to any on the market in appearance... Large 4 1/2" meter... Calibrated microhmo scale as well as a Bad-Good scale... Front panel fuse... Individual sockets for all tube base types—voltages from .75 volts to 117 volts and complete switching flexibility allow all present and future tubes to be tested regardless of location of elements on tube base... Indicates gas content and detects shorts or opens on each individual section of all local, octal and miniature tubes including cold cathode, magic eye and voltage regulator tubes as well as all ballast resistors. Name of the nationally known manufacturer withheld because of special price offer.

Model "C"—Sloping front counter case \$49.95
 Model "P"—Handsome hand-rubbed portable case \$4.95
 Built-in-roll chart with either of above \$5.00 extra.

BUFFALO RADIO SUPPLY
 219-221 GENESEE STREET BUFFALO 3, N. Y.
 DEPT. 9C

FREE Catalog

- Radio, Television, Electronic Kits, Parts, etc. **LOWEST PRICES.** Also War Surplus Bargains. Get Your Copy Now.

OFFENBACH & REIMUS
 372 ELLIS ST., SAN FRANCISCO 2, CAL.

TUBE BASE CONNECTOR

Flat cable connectors can be made easily from old tubes. Cut off the base leaving about 1/4-inch inside clearance.

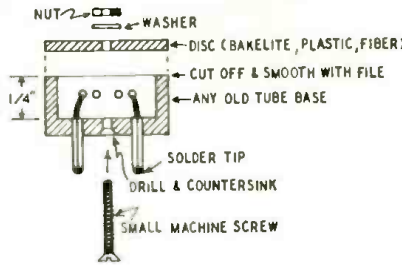

Cut out a plastic disc of about the same diameter as the tube base.

Drill holes for the cable in the side of the base. Connect the wires to the tube prongs, then place the plastic disc over the tube base, as the drawing shows, and fasten it in place with a flat-headed screw run through a hole drilled in the bottom of the base. After the nut is tightened, file the edges of the disc flush with the tube base.

WILLIAM F. WENDT,
 Napc Calif.

MEASURING OUTPUT

When aligning a receiver, the voice coil is the logical place to connect the output meter because of accessibility. The voltage at this point, however, is

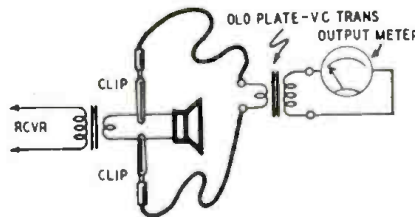

usually too low for a satisfactory reading.

Any old output transformer will make a useful shop tool to obtain a higher voltage. Equip the secondary (4-8 ohms impedance) with a pair of leads ending in alligator clips. To make output measurements, connect these clip leads across the set's voice coil and clip the voltmeter leads to the plate winding of the old output transformer. The transformer will step up the set's output voltage and a very good meter reading will be obtained.

ALBERT LOISCH,
 Darby, Pa.

TV INSTALLATION

For installing television antennas, it is essential to have communication between the man on the roof and the man watching the screen to determine when the image is satisfactory. A very simple system requires only two pairs of magnetic headsets two carbon microphones, and a 4 1/2-volt battery.

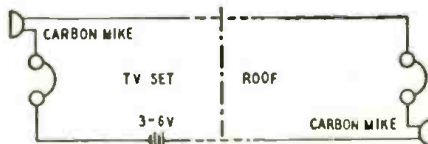

Connect one microphone, one headset, and the battery in series at the receiver location. Run a 2-wire line (anything will do, even lamp cord) to the roof. Across the roof end of the line connect the other headset and microphone in series.

Depending on the components at hand, a smaller or slightly larger battery may be desirable. With ordinary 2,000-ohm headsets and surplus oxygen-mask microphones, four and one-half volts worked well.

RICHARD HENRY,
 New York, N. Y.

INTERMITTENT CHECKER

Many intermittents are caused by capacitors which open when normal voltages are applied to them, but which check O.K. on a condenser tester. To locate one of these, it is usual to wait

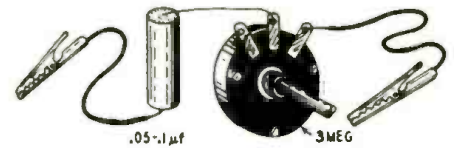

until the receiver stops working, then shunt a good capacitor across the suspected one. Often the sudden charging of the good capacitor is enough to start the set going again.

To reduce the suddenness of the charging, place a 3-megohm potentiometer in series with the good capacitor. Set the potentiometer for maximum resistance, then shunt the combination across the suspected capacitor. Slowly rotate the potentiometer shaft to minimum resistance. If, somewhere along the line, the set starts to operate, the chances are good that the suspected capacitor was the bad one.

RUSSELL SWANFELT,
 Fort Wayne, Ind.

(No gadget can be depended on for consistent results with intermittents, but this one is simple to make and should repay the effort required—Editor)

SIG-TRACER RECEIVER

Some of the surplus receivers, especially the low-frequency models, can be used as signal tracers. The receiver should cover the r.f., i.f., and local os-

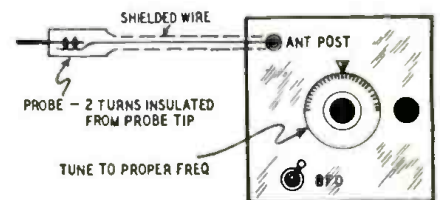

cillator frequencies of the receiver under test and should have a c.w. oscillator. It should be one of the well-shielded varieties.

Shield the antenna post and attach a probe to it with a short shielded cable, as shown in the drawing. It may be necessary to replace the antenna terminal with a jack for better shielding.

GEORGE H. HAGUE,
 Fall River, Mass.

TIP JACKS

When tip jacks are needed try the base pins of old tubes. Break up the tube bases with a hammer, being careful not to crush the pins. Heat each and blow the solder from inside it. Several different-sized jacks can be made from different base pins.

L. E. KLINGBERG,
Inglewood, Calif.

FM ALIGNMENT

FM ratio detectors sometimes are jarred slightly out of alignment by a rough trip from the factory. To align them I turn on the motor of my car, which is less than 50 feet from the antenna, tune in a weak station, then adjust the ratio-detector trimmers to cancel out the ignition-noise interference.

This method will not work with sets that have limiters.

ROBERT C. GREEN,
Hyattsville, Md.

PILOT LIGHT LONGEVITY

To avoid the bother and expense of changing pilot lights in a.c. receivers and amplifiers, unsolder the leads of the light socket from the 6.3-volt power transformer winding and hook them across the 5-volt rectifier winding. Reducing the voltage applied to the bulb to 5 volts will about triple its life.

Be sure that the socket is thoroughly insulated (both contacts) since the light will be at high voltage to ground. Lack of care in this respect may cause shorting of the high-voltage supply or severe shock.

If no 5-volt winding is available, a resistor of about 10 ohms in series with the lamp will accomplish the same purpose. The brightness of the light does not decrease noticeably with either method.

ROBERT D. CARLEN,
Brooklyn, N. Y.

ANTENNA COUPLING

The performance of some receivers, both t.r.f. and superheterodyne, can be improved by winding the insulated antenna lead around the grid lead of the input tube several times before connecting it to the antenna post. This adds capacitive coupling to the inductive coupling. Capacitive coupling is built into many sets. Those that don't have it are improved by this trick.

FRANK BODINE, W4JVZ,
Ft. Wayne, Ind.

RADIO-CONTROLLED BEAM

The BC-357, a surplus marker-beacon receiver, has a relay in the output circuit. It was originally designed so that an incoming signal would close the relay and light a lamp.

The receiver can be used to control the rotation of a beam antenna located at some distance from the shack. Shunt the two tuned circuits with capacitors made of twisted wire to lower the frequency from the original 75 mc to the upper portion of the 6-meter band. Place

PHOTOFACT Publications
HELP YOU TO SUCCESS!
These are the indispensable service data books you'll use profitably every single working day...



Your Price Each Volume, In Deluxe Binder **\$18³⁹**

NOW! PHOTOFACT VOLUME 4
Includes First Three TV Course Installments

Bring your file of post-war receiver Service Data right up to July, 1948! Here's the most accurate and complete radio data ever compiled—preferred and used daily by thousands of Radio Service Technicians. Includes: Exclusive Standard Notation Schematics; photo views keyed to parts lists and alignment data; complete parts listings and proper replacements; alignment, stage gain, circuit voltage and resistance analysis; coil resistances; record changer service data, etc. Order Volume 4 today—keep your Photofact library up-to-date—it's the only Radio Service Data that meets your actual needs!

- Vol. 4. Covers models from Jan. 1, 1948 to July 1, 1948
- Vol. 3. Covers models from July 1, 1947 to Jan. 1, 1948
- Vol. 2. Covers models from Jan. 1, 1947 to July 1, 1947
- Vol. 1. Covers all post-war models up to Jan. 1, 1947



1947 Record Changer Manual

Nothing like it! Complete, accurate data on over 40 post-war models. Exclusive exploded views, photos from all angles. Gives full change cycle data, information on adjustments, service hints and kinks, complete parts lists. PLUS—for the first time—complete data on leading Wire, Ribbon, Tape and Paper Disc Recorders! 400 pages; hard cover; opens flat. Order now! **\$4⁹⁵ ONLY**



Receiver Tube Placement Guide

Shows you exactly where to replace each tube in \$500 radio models, covering 1938 to 1947 receivers. Each tube layout is illustrated by a clear, accurate diagram. Saves time—eliminates risky hit-and-miss methods. 192 pages, completely indexed. **\$1²⁵ ONLY**



Dial Cord Stringing Guide

The book that shows you the one right way to string a dial cord. Here, in one handy pocket-sized book, are all available dial cord diagrams covering over 2300 receivers, 1938 through 1946. Makes dial cord restringing **\$1⁰⁰** jobs quick and simple. **ONLY**

THE FIRST TELEVISION FOLDER
APPEARS IN
PHOTOFACT SET NO. 46
DON'T MISS IT!

Now—PHOTOFACT brings you a new kind of Television Service Data—a complete, accurate analysis of a popular Television receiver—based on actual examination of the set in the Sams' laboratories. This is the beginning of a series of uniform, accurate, authoritative Television Folders, exclusively PHOTOFACT—plus the \$500 Television Course—at no extra cost to you! Don't miss Set No. 46—at your local jobber now!

STAY AHEAD OF THE GAME —
SUBSCRIBE REGULARLY TO
PHOTOFACT FOLDER SETS

HOWARD W. SAMS & CO., INC.
INDIANAPOLIS 7, INDIANA

the receiver at the antenna location with the relay contacts in series with the beam-rotator motor.

To rotate the beam, switch the transmitter to the receiver's frequency and key it until the beam is pointing in the right direction. Then switch the transmitter back to the operating frequency and go on the air as usual.

This receiver can, of course, be used for other types of radio-controlled devices.

A. R. GREEN,
Fort Worth, Tex.

(A 1-tube 6-meter control transmitter might be built especially for operating the antenna. This would save the trouble of retuning the main transmitter and

EASY TO LEARN CODE

It is easy to learn or increase speed with an Instructograph Code Teacher. Affords the quickest and most practical method yet developed. For beginners or advanced students. Available tapes from beginner's alphabet to typical messages on all subjects. Speed range 5 to 40 WPM. Always ready—no QRM.

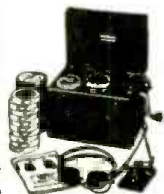

ENDORSED BY THOUSANDS!

The Instructograph Code Teacher literally takes the place of an operator-instructor and enables anyone to learn and master code without further assistance. Thousands of successful operators have "acquired the code" with the Instructograph System. Write today for convenient rental and purchase plans.

INSTRUCTOGRAPH COMPANY

4701 Sheridan Rd., Dept. RC, Chicago 40, Ill.

would permit operation of 10- and 20-meter beams.—Editor)

*It's Only
Natural*

**FOR RADIO MEN TO
ASSEMBLE THEIR OWN**

**Heathkit ELECTRONIC SWITCH KIT
DOUBLES THE UTILITY OF ANY SCOPE**



\$34.50

Gives two separately controllable traces with individual inputs on any scope.
See both the input and output traces, locate distortion, phase shift, etc., immediately.
Individual gain controls and positioning control. Coarse and fine sweeping rate controls. Complete Heathkit matches others, with 5 tubes. All metal parts are punched, formed and cadmium plated. Complete with tubes, all parts, detailed blueprints and instructions. Shipping Wt. 13 lbs.
Nothing ELSE TO BUY

- ★ Save ⅓ the cost.
- ★ Gain valuable knowledge.
- ★ Achieve better workmanship.
- ★ Learn many new applications.
- ★ Ideal training for use.

Heathkits are regular factory quality test equipment unassembled but with all forming, punching, calibrating and printing already completed.

**HEATHKIT
CONDENSER CHECKER KIT**

A condenser checker anyone can afford to own. Measures capacity and leakage from .00001 to 1000 MFD on calibrated scales with test voltage up to 500 volts. No need for tables or multipliers. Reads resistance 500 ohms to 2 megohms. 110V 60 cycle transformer operated complete with rectifier and magic eye indicator tubes.
Easy quick assembly with clear detailed blueprints and instructions. Small convenient size 9" x 6" x 4 3/4". Weight 4 pounds. This is one of the handiest instruments in any service shop.

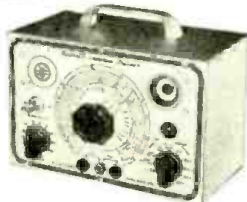

\$19.50
*Nothing
ELSE TO BUY*

**THE NEW HEATHKIT VACUUM TUBE
VOLTMETER KIT**

The most essential tool a radio man can have, now within the reach of his pocketbook. The Heathkit VTVM is equal in quality to instruments selling for \$75.00 or more. Features 500 microamp meter, transformer power supply, 1% glass enclosed divider resistors, ceramic selector switches, 11 megohms input resistance, linear AC and DC scale, electronic AC reading RMS. Circuit uses 6SN7 in balanced bridge circuit, a 6H6 as AC rectifier and 6 x 5 as transformer power supply rectifier. Included is means of calibrating without standards. Average assembly time less than four pleasant hours and you have the most useful test instrument you will ever own. Ranges 0-3, 30, 100, 300, 1000 volts AC and DC. Ohmmeter has ranges of scale times 1, 100, 1000, 10M and 1 megohm, giving range .1 ohm to 1000 megohms. Complete with detailed instructions. Add postage for 8 lbs.



\$24.50
*Nothing
ELSE TO BUY*

**HEATHKIT
SIGNAL GENERATOR KIT**



\$19.50
**NOTHING ELSE
TO BUY**

Every shop needs a good signal generator. The Heathkit fulfills every servicing need, fundamentals from 150 Kc. to 30 megacycles with strong harmonics over 100 megacycles covering the new television and FM bands. 110V 60 cycle transformer operated power supply.

400 cycle audio available for 30% modulation or audio testing. Uses 6SN7 as RF oscillator and audio amplifier. Complete kit has every part necessary and detailed blueprints and instructions enable the builder to assemble it in a few hours. Large easy to read calibration. Convenient size 9" x 6" x 4 3/4". Weight 4 1/2 pounds.

**HEATHKIT
SIGNAL TRACER KIT**

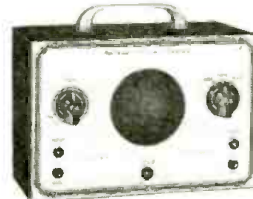

\$19.50
Nothing ELSE TO BUY

Reduces service time and greatly increases profits of any service shop. Uses crystal diode to follow signal from antenna to speaker. Locates faults immediately. Internal amplifier available for speaker testing and internal speaker available for amplifier testing. Connection for VTVM on panel allows visual tracing and gain measurements. Also tests phonograph pickups, microphones, PA systems, etc. Frequency range to 200 Mc. Complete ready to assemble. 110V 60 cycle transformer operated. Supplied with 3 tubes, diode probe, 2 color panel, all other parts. Easy to assemble, detailed blueprints and instructions.
Small portable 9" x 6" x 4 3/4". Wt. 6 pounds. Ideal for taking on service calls. Complete your service shop with this instrument.

**HEATHKIT SINE AND SQUARE WAVE
AUDIO GENERATOR KIT**

The ideal companion instrument to the Heathkit Oscilloscope. An Audio Generator with less than 1% distortion, high calibration accuracy, covering 20 to 20,000 cycles. Circuit is highly stable resistance capacity tuned circuit. Five tubes are used, a 6SJ7 and 6K6 in the oscillator circuit, a 6SL7 square wave clipper, a 6SN7 as a cathode follower output and 5Y3 as transformer power supply rectifier.

The square wave is of excellent shape between 100 and 5,000 cycles giving adequate range for all studio, FM and television amplifier testing.

Either sine or square wave available instantly at a toggle switch. Approximately 25V of sine AC available at 50,000 ohm output impedance. Output \pm 1 db. from 20 to 20,000 cycles. Nothing else to buy. All metal parts are punched, formed and cadmium plated. Complete with tubes, all parts, detailed blueprints and instructions.

\$34.50

Shipping Wt., 13 lbs.



The **HEATH COMPANY**

DEPT. C . . . BENTON HARBOR, MICHIGAN

RADIO-CRAFT for

TEST EQUIPMENT

NEW 1948 HEATHKIT 5" OSCILLOSCOPE KIT

\$39.50

Nothing ELSE TO BUY

Necessity for the newer servicing technique in FM and television at a price you can afford. The Heathkit is complete, beautiful two color panel, all metal parts punched, formed and plated and every color supplied. A pleasant evening's work and you have the most interesting piece of laboratory equipment available.

Check the features — large 5" 5BP1 tube, compensated vertical and horizontal amplifiers using 6SJ7's, 15 cycle to 30 M cycle sweep generator using 884 gas triode, 110V 60 cycle power transformer gives 1100 volts negative and 350 volts positive.

Convenient size 8 1/2" x 13" high, 17" deep, weight only 26 pounds.

All controls on front panel with test voltage and ext. syn post. Complete with all tubes and detailed instructions. Shipping weight 33 pounds. Order today while surplus tubes make the price possible.



HEATHKIT HIGH FIDELITY AMPLIFIER KIT

\$14.95

Build this high fidelity amplifier and save two-thirds of the cost. Push pull output using 1619 tubes (military type 6L6's), two amplifier stages using a dual triode (6SN7), and a phase inverter give this amplifier a linear reproduction equal to amplifiers selling for ten times this price. Every part supplied; punched and formed chassis, transformers (including quality output to 3-8 ohm voice coil), tubes, controls, and complete instructions. Add postage for 20 lbs.

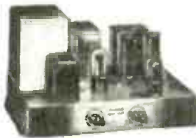

12" PM speakers for above.....\$6.95

HEATHKIT 3-TUBE ALL-WAVE RADIO

110-volt AC operation

\$8.75

An ideal way to learn radio. This kit is complete ready to assemble, with tubes and all other parts. Operates from AC. Simple, clear detailed instructions make this a good radio training course. Covers regular broadcasts and short wave bands. Plug-in coils. Regenerative circuit. Operates loud speaker. Add postage for 3 lbs.



HS 30 Headphones per set.....\$1.00
2 1/2" permanent magnet loudspeaker.....\$1.95

INTERPHONE 2-WAY CALL SYSTEM KIT

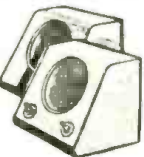

\$14.50

Ideal call and communication system for homes, offices, factories, stores, etc. Makes excellent electronic baby watcher, easy to assemble with every part supplied including simple instructions. Distance up to 1/5 mile. Operates from 110 V.A.C. 3 tubes, one master and one remote speaker. Shipping Weight 5 pounds.



HEARING AID HEADPHONES

The Army's best — eliminate flat ears and outside noise. Complete with transformer for conversion from low to high impedance. With cord and plug complete. Add postage for 1 lb.

\$1.00

COMMAND SET ACCESSORIES



5" PM SPEAKER
With output transformer, matching headphone output.....**\$2.80**

Dual receiver rack FT277A with connecting plugs.....**\$1.00**

Single transmitter rack FT234A.....**\$1.00**

SPLINE SHAFT FOR TUNING COMMAND RECEIVERS
Allows use of regular tuning knob on BC 453-4-5 receivers.....**39c**

POWER TRANSFORMER Specials



Primary 117V 60 cycle. Secondaries supply 746 V.C.T. at 220 MA, 6.3V at 4.5 A., and 5V. at 4 A. Will handle 13 tube radio receivers. Supply is limited, order early. Shipping Wt. 11 lbs. each.

\$3.95 3 FOR **\$9.95**

OUTPUT TRANSFORMER

Push pull 6V6's to 6-8 ohm voice coil excellent characteristics. No. 800.....**3 FOR \$1.95**



TRANSFORMER TRANSFORMER
The transformer from Transmitter Power Supply listed below, 600 Volt at 200 MA and 4 Amp. filaments of 3 to 24 Volts. Also 5 Volts at 4 Amperes for rectifier. Shipping Wt. 12 lbs.....**\$9.50**

MILITARY POWER TRANSFORMERS
Convert your military receivers without rewiring the filament. "A" type supplies 500 VCT at 50 MA, 5V at 2A and 24V at 1/2 A. "B" type supplies 500 VCT at 50 MA, 5V at 2A and 12V at 1 Amp. State whether A or B type desired. Ship. Wt., 4 lbs.....**\$2.95**

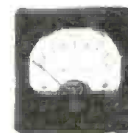

METER Special

Brand new DeJur Model 312 0-800 M.A. D.C. Square 3" 0-10 M.A. basic meter with built in shunt. Probably the best buy ever offered in a surplus meter. Shipping Wt., 1 lb.....**\$2.95**

BALLENTINE 6 VOLT

DYNAMOTOR

Dynamotor only from PE 103 power supply. Input 6 or 12 Volts, output 500 Volts at 160 MA. Brand new original cartons. Shipping Wt. 29 lbs.....**\$5.95**



T32 TABLE MICROPHONE

One of the Army's best. Built by Kellogg, ideal for factory call system, public address, amateur use. Brand new in original cartons, add postage for 5 lbs.....**\$2.95**



110 V. A.C. MILITARY RECEIVER POWER SUPPLY KIT



Ideal way to convert military sets. Supplies 24 Volts for filament — no wiring changes inside radio. Also supplies 250 V. D.C. plate voltage at 50-60 MA. Connections direct to dynamotor input. Complete with all parts and detailed instructions. Ship. Wt., 6 lbs. **\$ 5.95**

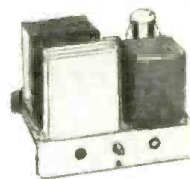

\$14.50

110 V. A.C. TRANSMITTER POWER SUPPLY KIT

For BC-645, 223, 522, 274N's, etc. Ideal for powering military transmitters. Supplies 500 to 600 Volts at 150 to 200 MA plate, 6.3 C.T. at 4 Amps, 6.3 at 4 Amps and 12V at 4 Amps. Can be combined to supply 3-6-9-12 or 24 Volts at 4 Amperes. Kit supplied complete with husky 110V 60 cycle power transformer, 5U4 rectifier, oil filled condensers, cased choke, punched chassis, and all other parts, including detailed instructions. Complete — nothing else to buy.

The HEATH COMPANY
 DEPT. C . . . BENTON HARBOR, MICHIGAN

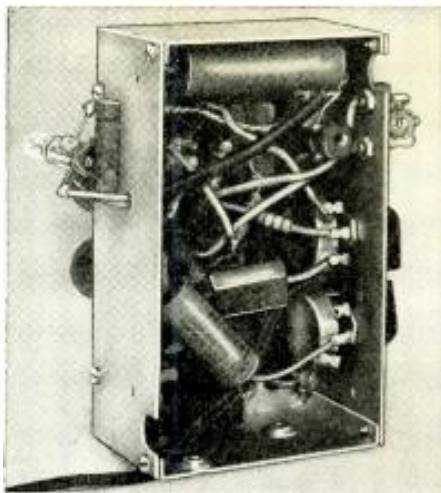

The wiring below the chassis is noncritical.

to cause Neon 1 to oscillate at between 500 and 700 cycles. Try values between .0007- μ f and .003- μ f. Almost any neon glow lamp may be used for Neon 1. Neon 2 may be a type NE3, NE51, or any other 1/25-watt glow lamp *without* a resistor in its base.

This unit is simple to operate. Make sure Neon 1 is oscillating by connecting a pair of phones across Neon 2 through blocking condensers or by noting a

slight glow on one electrode of Neon 2. When you are sure of proper operation this far disconnect the phones, turn the gain control all the way up, and adjust the sensitivity control for full resistance. This should make both electrodes of Neon 2 glow brightly. Back off the sensitivity control about three-quarters and decrease the gain until one electrode goes out completely.

Now adjust the sensitivity control until the lamp begins to flash slowly. Decrease the gain until the lamp just goes out. At this point, Neon 2 is most sensitive to light changes. Focus light rays on the lamp, and it will begin to flash again. If it fails to do so, a slight adjustment of the gain or sensitivity controls, or of both, should produce the desired results.

Placing phones across the lamp, you will be able to hear the frequency of the pulses increase or decrease as the light source is brought nearer or moved away from the lamp. When phones are connected across the lamp, it may be necessary to readjust the controls slightly.

In its present state, this device is simply an interesting experiment. However, it offers a challenge to experimenters who may be able to put the circuit to practical use. The writer is interested in hearing of any progress that you may make toward this goal.

Small-Space Metal Locator

HERE is an efficient metal locator which can be made very small, especially if hearing-aid batteries are used. No cabinet dimensions are given, since each constructor will use his ingenuity to put the electronic parts in as small a box as possible.

As the diagram (Fig. 1) shows, 3A5's are used in both transmitting and receiving sections. The transmitter uses a Hartley oscillator. The transmitting coil L1 is the exploring device and is located at the lower end of the handle, Fig. 2. It is wound around the edges of a 3-inch thick piece of wood 18 inches square. Use 20 turns of No. 18 bell wire or any other wire larger than No. 24. Experiment for the best place for the tap.

The long handle (see Fig. 2) is a 4 1/2-foot of length of 2 x 2. The cabinet containing the tubes and electronic components other than L1 is mounted at the top.

The two sections of the transmitting 3A5 are paralleled. The plates of the receiving tube are paralleled but the grids are not. The antenna may be a 1-or

2-foot length of wire wrapped around the cabinet.

The tuning capacitors C1 and C2 are 100- μ f air padders. They are screw-driver adjusted and are less affected by vibration than standard mica padders.

The receiving coil L2 is a standard broadcast-band r.f. coil with a tickler winding added. Vary the number of turns for best results. If several coils are in the junk box, experiment to find the best one.



Fig. 2—Place handle at the point of balance.

To adjust the metal locator, open the antenna trimmer about half way, then adjust both tuning capacitors until the loudest signal is heard in the phones. The 50,000-ohm potentiometer will provide some volume control. Tune the antenna trimmer until a clicking sound appears in the headphones. In exploring, a change in sound usually indicates the presence of metal.—JOHN HAYNES

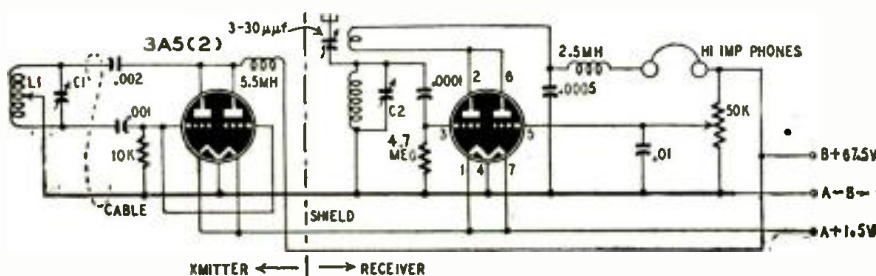

Fig. 1—Schematic. Note the special regenerative system used in the receiving section.

FALL SPECIALS

TUBE SPECIALS

GUARANTEED — STANDARD BRANDS			
1LH4	.59	12A6	.30
1LN4	.59	12SA7GT	.45
3B7	.89	12SG7	.62
3D6	.69	12SK7GT	.40
3D4	.49	12SH7	.65
	.39	12SQ7	.50
5R4GY	.89	25L6GT	.50
5U4G	.45	50L6GT	.50
6AB7	.89	117Z6	.80
6AC7	.59	30	.80
6AG7	.79	34	.80
6D6	.40	49	.80
6J5	.39	76	.45
6L6	.70	956	.65
6SJ7	.39	958-A	.60
6SK7	.40	959	.45
6SL7	.40	1625	.35
6SN7	.40	2050	.69
6V6GT/G	.45	603	6.00
6X5GT/G	.45	807	.95

SWITCHES

SPDT AN-3022-6B, 1 slide Mom. center off Lum. Tip	.25
SPST AN-3022-2B, Bat Handle, Lum. Tip	.25
DPDT Slide Sw. Stackpole 5 A. 125V	.15
SPDT Momentary, center off, 6A 125V, Long Bat Handle	.30
DPDT Bat Handle 10A 125V	.50
SPDT Center off, AN-3022-1B Lum. Tip, 6A 125V	.30
SPST Bat Handle, 6A 125V	.25
SPDT Bat Handle, 6A 125V	.30
DPDT Momentary, center off, 10A 125V	.50
DPST AN-3023-2, 10A 125V	.45
DPST Momentary, Push Type, 6A 125V	.35
SPST Rotary (enclosed) 6A 125V, 1/2" shaft	.25
SPST Phone Switch 1/2" shaft	.20

G. E. SWITCHETTES

CR-1070C103-B3 normally open	.35
CR-1070C123-C3 normally open or norm. closed	.35
CR-1070C103-K2 normally closed	.35

SURPLUS SPECIALS

Small 110V AC 60 cycles open frame motor 1/2" shaft, 2700 RPM, 1/70 HP mfg. by Barber Colmann Co.	2.00
Synchronous Motors: 1/2" shaft 110V AC 60 cycle, 4/7, 1, 1-1/2 & 1 3/4 RPM 2.2 Watts, mfg. by Haylen Mfg. Co.	2.00

(Specify speed desired)

AMAZING BLACK LIGHT

Complete with resistance line cord and Ultra Violet ray filter. Ready to use from 110V AC line.	
Rigid Mount Type	\$3.95
Gosswick Mount Type	4.49
Replacement Bulbs	.35
Luminous Paint kit consisting of two colors. Blue and Violet. Can be used in conjunction with Black Light	.89

MISCELLANEOUS

PL-259A Coax Connector & Socket, silver plated, for RG81 & RG11U	.60
Variable ceramics 1-30 mmf 7-45 mmf	.25
Telescoping Antenna 7 feet	1.00
Rectifier, Copper oxide, full wave, 110V AC input, 100V DC output 1A	3.50
Solenoid, 6V DC complete with plunger and mtg. bracket	1.25
Hot Light Assy. complete with 1/2" jewel, white or red, & miniature bayonet base	.25
Flexible Shaft 8 3/4" long with spline ends	.25
PL-55 Phone plug with 4' cord	.30
Di-Heptal sockets (less mtg. ring)	.50
2N2 socket	.35
Oetal Steatite socket	.15
1 Phone socket	.15
Shock Mounts (Lorr) cap 75 lbs.	.60
Stepdown Transformer UTC Type 63823 220V to 110V, 100 Watts, 60 cycles	4.00
Oetal plug	.20
Dynaflex Microphone ELECTRO VOICE Model 600C (press to talk switch) cord & plug	4.50
High Impedance	1.2
T-17 Microphone with press to talk switch, cord & plug	.79

WIRE WOUND RHEOSTATS

1.1 ohm 50 Watt with switch	1.25
6 ohm 25 Watt	.65
8 ohm 50 Watt	1.00
250 ohm 50 Watt	1.00
2500 ohm 25 Watt	.65

CONDENSERS & CAPACITORS

STANDARD BRANDS	
Capacitor 500 mfd. 200 V DC	1.75
4 mfd. 2000 V DC Oil Filled Cond.	3.75
10 mfd. 1500 V DC Oil Filled Cond.	2.95
10 mfd. 600 V DC Oil Filled Cond.	.90
1 mfd. 2500 V DC Oil Filled Cond.	1.25

No sale less than \$2.00. All prices FOB N.Y.C. Add 25¢ to cover Postage. 20% deposit required with all orders.

A. M. RADIO SALES CO.

345 Canal St. N. Y. C. 13, N.Y.

Communications T.R.F.

By T. W. DRESSER



Featuring • Better Response
• More Power • Smaller Size
and 5-YEAR GUARANTEE

"Shaney-Designed" has long been accepted as the standard of quality in amplification equipment. But never has so much quality been incorporated into popular-priced amplifiers as in this exceptional trio of public address units. They are specifically designed to provide amazing fidelity and trouble-free operation for all indoor and outdoor public address requirements, including electioneering, and auditorium and stadium operation.

SPECIFICATIONS

(Note) Frequency response for all models: 30 to 15000 cycles ±1 db. All models have following output impedances: 4, 8, 16, 250, and 500 ohms.)

Model	Inputs	Rated Output	Overall Gain	Dimensions	Price
32C	(2) 1 high; 1 low	24 Watts	High—123 db Low — 80 db	14.7x8 1/2"	\$61.00
38D	(3) 1 high; 1 med.; 1 low	27 Watts	High—123 db Med—110 db Low — 80 db	17x10x10"	\$66.00
58D	(5) 3 high gain mkt; 1 med. gain mkt; 1 low gain phone.	52 Watts	3 High Gain Mkt—124 db; Med. Gain Mkt—107 db; Phone—79 db.	17x10x10"	\$147.00

All amplifiers supplied with matched set of tubes. If not available at your dealer, order direct.

AMPLIFIER CORP. OF AMERICA

398-10 Broadway, New York 13, N. Y.

EVERYTHING IN TELEVISION



MODEL EL-1

Latest design • Features High Definition, Brilliance and Stability • New Synchro-Lock and Contrast Emphasis Circuits • 55 sq. in. Screen • Beautiful Cabinets

RECEIVERS, FM STRIPS, TEST EQUIPMENT, KITS, FILTERS, LENSES, DECALS, TUNERS, ACCESSORIES, COMPONENTS, ASSEMBLIES, ANTENNAS, CABINETS



SURPLUS RADIO, INC.
44-31 Douglaston P'kwy
Douglaston, L. I., N. Y.

Please send me your FREE Catalog

Name

Address

Town State

SINCE short waves were first used for communication, controversy has raged over the relative merits of the t.r.f. set and the superheterodyne. The prime bone of contention has been the signal-to-noise ratio. The t.r.f. enthusiast swears that he gets a signal as strong as, but considerably clearer than, the superheterodyne user; while the latter is equally emphatic that he can pick up signals the other fellow can't even hear.

Manufacturers of receivers for the amateur have, with few exceptions, adhered religiously to superhets; and it must be admitted they have turned out excellent jobs. But one point about their products makes the t.r.f. user wrinkle his nose—they have all had to use noise-limiting circuits.

The suggestion put forth by some that the t.r.f. as a short-wave receiver is finished is difficult to justify. On the whole, its advantages far outweigh its disadvantages. Its simplicity in construction and operation lends itself to sturdiness; it is not prone to alignment troubles, and—perhaps its outstanding point—it has very low noise level. Its principal fault is poor selectivity, inability to separate stations 10 kc apart. But there is no reason why such separation should not be achieved in a t.r.f.

The advocates of the superhet claim that it is both selective and sensitive if the design is good; and, of course, they are correct. But a great deal depends upon the design, particularly upon the choice of the intermediate frequency. If the latter is low, in the 450-kc region, image suppression is poor. If it is high, 1600 kc to 3 mc, there is a strong risk that the i.f.'s will pick up signals at or close to the fundamental frequency. Moreover the gain at these higher frequencies is relatively poor, and i.f.

stages may have to be added to compensate for the loss of gain. This further increases the cost and the noise level. It is another vicious cycle.

The superregenerative receiver is hardly worth mentioning. It is extremely noisy and decidedly unselective.

The t.r.f. set shown in the diagram uses the best of the modern high-gain r.f. tubes to improve the sensitivity. It incorporates all good qualities of the t.r.f. Its performance was judged against that of a superhet built some time ago, on which performance figures were available.

In designing the circuit selectivity was a first requirement, so a minimum of two (preferably three or four) tuned circuits was desirable. Shielding had to be adequate, and there had to be ample decoupling. The detector had to be capable of handling a large signal without distortion as no a.v.c. was to be used.

The circuit, although not highly original, makes full use of the high gain available from modern 1852 tubes. Three of them are used in the r.f. stages with somewhat unorthodox decoupling. A 6C5 acts as a grid-leak detector and a 6V6 is the output tube. Plate and heater circuits are well filtered, making for low hum and stability. Each stage is unusually well shielded from its neighbors both above and below the chassis deck. The r.f. gain control is in the cathode of the second stage.

Tuned grid circuits are used throughout and the coupling capacitors are variable. Alignment, therefore, resolves itself into adjusting for maximum signal these coupling capacitors and the trimmers on the 4-gang tuning capacitor. The antenna capacitor is used with single wire antennas. In the first model plug-in coils were used, but switched coils are more convenient if there is really effective shielding between stages.

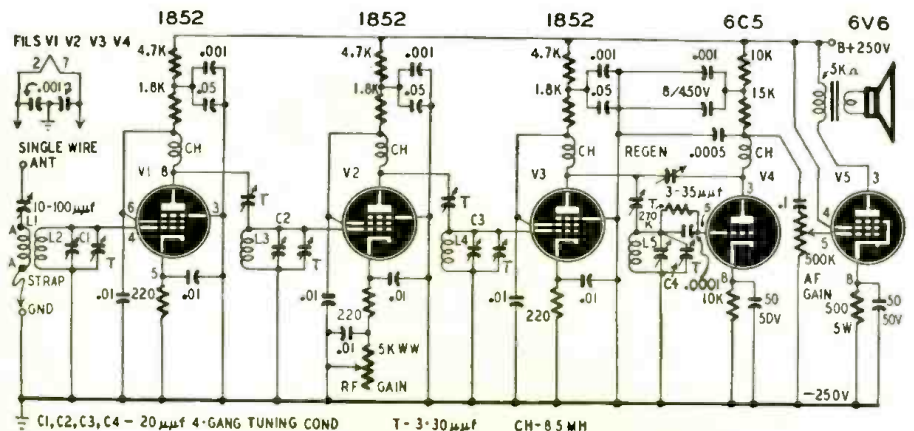

Capacitive coupling between r.f. stages is used in this t.r.f. communications receiver.

RADIO-CRAFT for

Assembled on a 12 x 8 x 2½-inch aluminum chassis, the receiver is good looking, and it has exceptional sensitivity, a noise level that is negligible, and selectivity that is outstanding for a t.r.f. Given a good layout with regard to the high gain involved, short wiring, and good solid ground connections, it will provide excellent performance. Here in Britain, with 10 feet of uninsulated wire hanging 6 inches from a brick wall and surrounded by high hills, it has received Australia and Argentine consistently at R8. As for the c.w. hound, use of the regeneration control will give him all the code he wants, with the r.f. stages effectively preventing any radiation from the antenna.

COIL TABLE

Wave length (meters)	L1 (turns)	L2 (turns)	Wire size
7-18	2¼	5½	21
17-36	3¼	13	21
34-78	7	24½	21
75-150	11	52	23
145-250	13	111	28
240-575	20	230	30

All forms 1 inch in diameter. All coils close-wound.

ELECTRON-RAY TESTER

The diagram shows a tester using a 6E5 indicator for measuring a.c. and d.c. voltages and detecting bad capacitors and resistors.

To check d.c. volts, connect the voltage to the d.c. terminals, set S1 to position 2, and adjust the potentiometer for zero shadow. If the potentiometer dial has previously been calibrated with various voltages, it will read the value applied. The same holds true for a.c., which is rectified by one of the 25Z5 diodes.

To check resistors open S2. Bias for the 6E5 is developed by the 8,000-ohm cathode resistor. Switch S1 to position 1 and connect the resistor across the terminals. If it is good, it will act as a grid leak and the eye will close. If it is open, the grid will float and shadow angle will be maximum.

To check capacitors open S2, switch to position 4, and place the capacitor across the terminals. The 1-megohm terminal resistor and the potentiometer act as a voltage-divider across the cathode-resistor voltage, with the grid connected to the center. Now switch to position 3. If the capacitor is good, its charge will tend to hold the shadow angle small. If it is open or shorted, the shadow angle will enlarge to maximum.

RUSSELL BEANE,
Tionesta, Pa.

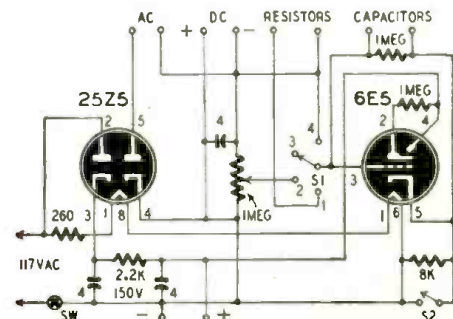

REVOLUTIONARY SOLDERING IRON

TRANSVISION Soldetron

Tr. Mark Reg., Pat. Pend.

For Easier, Better Soldering—on Any Job!

- Weighs only 3 ozs., yet can do the job of a 200 watt iron.
- Heats up in twenty seconds from a cold start; saves time.
- Fingertip control; permits soldering without fatigue.



Ready for attachment and operation on 110 V A.C., 50-60 cycles, through transformer supplied with iron, or 6-8 volt A.C. or D.C. without transformer (from an automobile battery). Overall size 9¼" x 15/16"; ship. wt. approx. 4 lbs.

- Ideal for fine precision work in "hard-to-reach" places.
- Readily interchangeable tip-heads; no cleaning or filing.
- Retains heat with switch off up to 1 minute; efficient.
- Bakelite handle, cork covering, for comfortable cool grip.

PRICE, including transformer and Tip-Head "A," \$13.95
5% higher west of Mississippi; fair traded.

Ask your distributor, or for further information write to:
TRANSVISION, INC., Dept. RC, NEW ROCHELLE, N. Y.
In Calif.: Transvision of Cal., 8572 Santa Monica Blvd., Hollywood 46

WAR SURPLUS BARGAINS ORDER BY MAIL FROM ABELL!

LINEMAN'S SAFETY BELT
and strap. State belt size.
\$5.75

LINEMAN'S POLE CLIMBERS and straps.
\$4.50

ROPE
¾" SIGNAL
6½ ft.
Minimum order
—15'
Maximum
length—150'

LEATHER TOOL POUCH
Straps on belt 4pc

50 Spark Plug Suppressors **\$2.25**

Canvas straps —
ST-19 2" wide—
adjustable 4-7 ft. **2pc**

100 WATT XMITTER
RC 375.0-350 MA. 0-8 amp
RF and 0-15 V meters. Lots
of fine top quality parts
for your medium **\$10.95**
power rig

EE-8 FIELD PHONES
Small portable 2 wire
telephone. Generator,
bell handset, etc. Ex-
cellent for farms, con-
tractors, mines, etc.
Requires only 2 flash
line batteries. Tested
before shipment. Each
\$9.75. Pair **\$17.95**

7 CONDUCTOR CABLE
#14
STRANDED
600 V Insulation.
Heavy duty rubber
covered. 65
feet. Tank,
Russell Steel
plug #3881
at each end.
¾" OD **\$4.95**

DESK STAND MICROPHONE
With switch, 5
ft. cord and plug,
200 ohm carbon
button.
\$2.95

WIRE GRIPS (COMALONGS)
SMALL **\$1.50**
MEDIUM **\$2.50**
LARGE **\$3.50**

INSULATED ANTENNA TRIPOD
Constructed of 2" phenolic tubing,
stands 13 ft. high
when assembled.
Rotating ball joint,
ing head, with clamp
2" tube or shaft.
Light weight, strong,
does not need RF in-
sulation. Good for ro-
tating beams, TV, etc.
Easy to assemble and
install. Brand New.
\$14.95

MINE DETECTOR SCR 625

Ideal for locating buried metal, pipes, treasure, metallic fragments in lumber. Approximate depth of detection 6 feet depending on soil conditions. Supplied with batteries and tubes. Schematic. Tested before shipment.
Shipping weight, 70 lbs.
\$49.50

GIBSON GIRL 500 KC SOS XMITTER

Operates from life raft, boat or vehicles. Provides 20 seconds automatic SOS or alarm signals, then 20 seconds 1000 cycle tone. Can be keyed manually. No batteries. Has speed indicating and tuning control lamps. Tubes—12SC7 (Audio osc. and amp.), 12AB (RF Osc.) Radio and signal light keyed by hand powered generator. 300' antenna wire furnished. Spare, 2 balloons, 2 hydrogen generators, box kite, parachute, signal lamp, spare antenna wire and instructions. In shockproof, scuff-proof bag. Easy to operate (no experience needed). Weight 40 lbs. New mine. Original price... **\$24.95**

SEND FOR SPECIAL VALUE BULLETINS

On our large stock of Radio and Photo Supplies. Tell us your wants. Above Prices Do Not Include Postage.

ABELL
Distributing Company
15 E. BIDDLE ST.—BALTIMORE 2, MD.
DEPT. No. 15

Satisfaction guaranteed. Order by Mail. We ship C.O.D. Order today. Prices subject to change without notice.

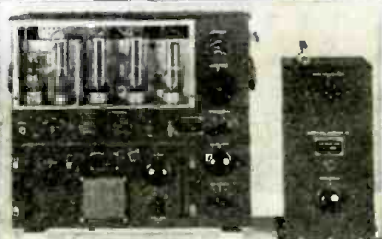

GENERAL ELECTRIC 150 WATT TRANSMITTER

Cost the Government \$1800.00
Cost to you \$44.50!!!!

This is the famous transmitter used in U.S. Army bombers and ground stations, during the war. Its design and construction have been proved in service, under all kinds of conditions, all over the world. The entire frequency range is covered by means of plug-in tuning units which are included. Each tuning unit has its own oscillator and power amplifier frequency range. Transmitter and accessories are finished in black crackle, and the milliammeter, voltmeter, and RF ammeter are mounted on the front panel. Originally designed to cover the frequency range from 200 to 500 KC and 1500 to 12,500 KC. Will operate on 10 and 20 Meter Bands with slight modification. Here are the specifications: OSCILLATOR: Self-excited, thermo compensated, and hand calibrated. POWER AMPLIFIER: Neutralized class "C" stage, using 211 tube, and equipped with antenna coupling circuit which matches practically any length antenna. MODULATOR: Class "B"—uses two 211 tubes. POWER SUPPLY: Supplied complete with either 12 or 24V dynamotor (SPECIALLY) which furnishes 1000V at 350 MA. Complete conversion instructions for 10 and 20 Meter bands, with the tuning units supplied, as well as 110V AC modifications are furnished. SIZE: 21½ x 23 x 9½ inches. Total shipping weight 200 lbs., complete with all tubes, dynamotor power supply, five tuning units, antenna tuning unit and the essential plugs. These units have been removed from unused aircraft but are guaranteed to be in perfect condition.

BUFFALO RADIO SUPPLY 219-221 GENESEE STREET
BUFFALO 3, N. Y. DEPT. 9C

SHOOT TROUBLE FASTER!
MAKES MORE MONEY FOR YOU ON THE JOB OR AT SERVICE BENCH



PRICE \$9.95

at distribu. for or post-paid, direct.

Sorry, no COD's. Ohioans add 3% State Sales Tax.

Signalette

MULTI-FREQUENCY GENERATOR

In radio service work, time means money. Locate trouble faster, handle a much greater volume of work with the SIGNALETTE. As a trouble shooting tool, SIGNALETTE has no equal. Merely plug 110 V. AC-DC line, start at speaker end of circuit and trace back, stage by stage. Listening in set's speaker. Generates RF, IF and AUDIO Frequencies, 2500 cycles to 20 Mc/sec. Also used for checks on Sensitivity, Gain, Peaking, Shielding, Tube testing. Wt. 13 oz. Fits pocket or tool kit. See at your dist. or order direct.

Clippard INSTRUMENT LABORATORY, INC.

DEPT. C. 1125 BANK STREET CINCINNATI 14, OHIO

Qualified Jobbers write, wire for details.

FREE RADIONIC CATALOG

RADIONIC VALUES!

CERAMICONS
 Variable 3-15, 5-20, 4-30, 7-45 mmf.
 18c each; 6 for \$1.00.
 Fixed 3, 5, 10, 50, 100, 150, 200, 500 mmf.
 6c each; 20 for \$1.00

CHECK FULL OF BUYS!

RADIO RECEIVERS
 PARTS KITS
 ADDRESS INTER COMMUNICATIONS
 RECORDERS
 RECORD CHANGERS
 TEST INSTRUMENTS
 AMATEUR EQUIPMENT
 RADIO HARDWARE
 TECHNICAL BOOKS

A MUST for all
 Service Dealers
 Amateurs
 Experimenters
 Industrials
 Institutions
 Government Agencies

RADIONIC EQUIPMENT COMPANY

170 NASSAU ST., NEW YORK 7, N. Y.

Tribune Theatre Entrance
 Tel. WOrth 2-0421 • Cable "CHANSLOR"

RADIONIC EQUIPMENT CO., Dept. 108
 170 Nassau Street, New York 7, N. Y.

Send at once your free catalogs, supplements and bargain lists as published—listing products of leading manufacturers of radio-electronic parts and equipment.

NAME

P.O. BOX or STREET

TOWN STATE

CODE OSCILLATOR

Here is a multivibrator oscillator which can be used for code practice and as a signal source for testing amplifiers. The key is connected in series with the 6SC7 cathode. A phone jack is provided for headphone output and a pin jack takes a test lead.

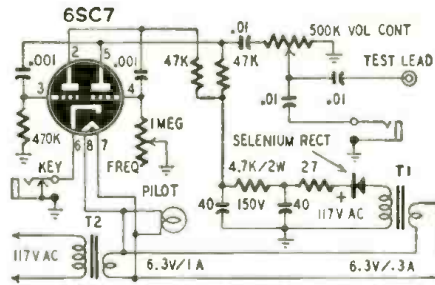

A selenium rectifier is used. T2 furnishes 6.3 volts for the 6SC7 filament and the pilot light. It is also connected to T1, another filament transformer, which is operated in reverse to produce 117 volts for the rectifier. This isolates the power supply from the a.c. line, a good idea in view of the fact that the exposed metal of the key would otherwise be connected directly to one side of the line.

The frequency can be controlled within limits by the 1-megohm potentiometer. The oscillator will not chirp, even with very fast keying.

W. A. M. Wood, VE4MW,
 Winnipeg, Canada

CODE OSCILLATOR

This 1-tube code oscillator gives loud-speaker output. T may be almost any center-tapped output transformer. Ch can be any filter choke or it may be replaced by a resistor (experiment for value).

Since the key contacts are connected to the high voltage use insulation or one of the surplus keys which are entirely enclosed.

The potentiometer will vary the tone as well as the volume.

WOODROW V. RYDER,
 Red Hook, N. Y.

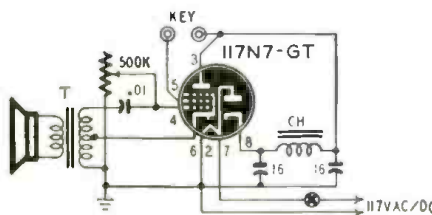

SET ALIGNMENT

A 6E5 electron-ray tube can be used as an indicator for aligning sets with a.v.c.

A unit like the one shown in the diagram can be built in a small metal box. Use a toggle switch in the transformer primary circuit. The grid switch is on the 3-megohm volume control. Adjust the tap on the 50,000-ohm bleeder until the power-supply output is 250 volts.

To align a receiver, supply it with an unmodulated signal and connect the in-

RADIO-CRAFT welcomes new and original radio or electronic circuits. Hookups which show no advance on or advantages over previously published circuits are not interesting to our readers. Send in your latest hookups and receive a 1-year subscription to RADIO-CRAFT or \$3.50 for each contribution accepted. Pencil diagrams—with short descriptions of the circuit—are acceptable if clearly drawn on a good-sized sheet of paper.

indicator leads to the a.v.c. line and the set's ground. Adjust the trimmers for maximum closure of the shadow on the 6E5 screen.

If the eye closes too soon, turn the potentiometer to close the grid switch and adjust it for the desired shadow angle.

TED R. PARKS,
 Salem, Ore.

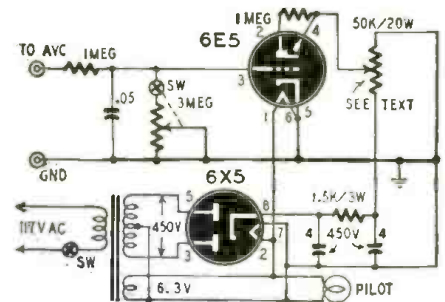

T.R.F. TUNER

The diagram shows a high fidelity t.r.f. tuner described originally in *Radio and Hobbies*, an Australian magazine.

Standard coils are used with a 3-gang 365-µmf tuning capacitor.

To align the tuner, tune in a station toward the high end of the band (or a signal from a test oscillator) and adjust trimmers for maximum output. If a commercial calibrated dial is being used, peak the trimmers and note the dial calibration. If it is off, move the dial slightly toward the correct mark and realign. Keep this up until peak output occurs at the proper marking. As a check on the trimmer settings tune to one side of the carrier and peak them on the noise. If iron-core coils are used, they can be peaked on a low-frequency station, then the trimmers rechecked on

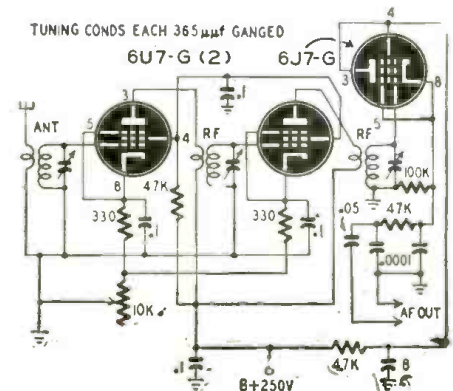

RADIO-CRAFT for

a high-frequency station. Very little tracking trouble will be had.

The 6J7 is an infinite-impedance detector. The tube operates on a non-linear portion of its E_c-I_p curve, as in a plate detector, but output is taken from the cathode circuit. This gives negative feedback reducing distortion.

RADIO-CONTROL UNIT

The transmitter for this radio-control unit uses the spark-gap discharge principle. It is shown in Fig. 1. An old Ford spark coil steps up the voltage from a 6-volt battery to a high value; the high voltage discharges as a spark across the gap between the two 1-inch-diameter brass balls. These can be salvaged from an old brass bedstead or curtain-rod assemblies.

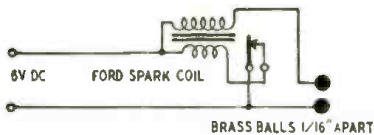

Fig. 1—Activator of the radio control tube.

Fig. 2 is the receiver diagram. The antenna is a length of copper tubing bent to form almost a complete circle 12 inches in diameter. A 1.5-volt flashlight battery biases the 2051 gas tetrode. When the signal is picked up, the tube is triggered and the relay is energized.

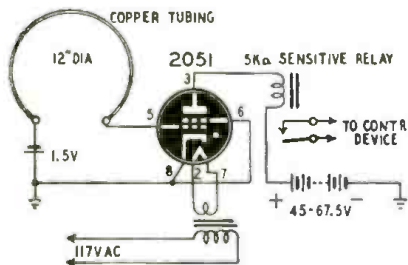

Fig. 2—Control tube is a small thyratron.

Anything can be controlled if it is connected to the relay contacts. Control is reliable, however, only if the transmitter and receiver are no more than 12 feet apart. I use the gadget to open my garage doors without getting out of the car. The transmitter creates radio interference for a greater distance so should be operated as little as possible.

MELVIN YOUNGMAN,
Oak Park, Ill.

NOVEL REFLEX CIRCUIT

In the conventional reflex amplifier a resistor is connected between B-plus and the plate as an audio load. This causes a loss of plate voltage and a reduction in r.f. amplification.

The reflex circuit shown in the diagram avoids this by taking the audio

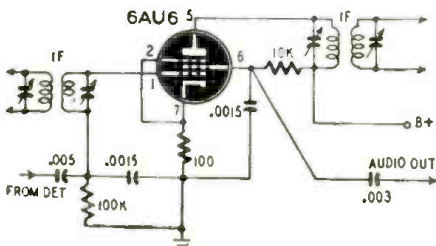

JUST OUT! All the "Know How" of **AUTO RADIO REPAIR** in one handy training book... for only \$7.50



MAKES THE WORK TWICE AS EASY

Covers all auto radio types from mid-1930's to the present, including mobile FM receivers

Here—written by a practical auto radio expert of 20 years' standing—is just the data you need to repair car radios faster, easier, and a lot more profitably! A. L. Hurlbut's **SERVICING THE MODERN CAR RADIO** is the only book devoted solely to this fast-growing service field. Explains every detail of the work clearly—and tops this off with 222 illustrations and over 500 circuit diagrams covering specific service details on every type of automotive radio in use!

COMPLETE THEORY—TEST—INSTALLATION—ANTENNA—AND SERVICE DATA

It is the only single book that includes needed data to transform a good home-radio serviceman into a car-radio expert. Describes circuits. Explains automotive electrical units their function and effect on radio performance. Tells how to install car radios properly and why they should be installed that way. Provides circuit diagrams on hundreds of popular models and contains ample data to help you do a good job on sets for which diagrams are not readily available. Gives full details on proper antenna mounting; contains pertinent information on FM receivers; tells how to get business, how to deal with auto radio service customers, and how to set up your shop, test bench, etc., for maximum efficiency in this specialized, fast-growing field. In short, **SERVICING THE MODERN CAR RADIO** provides at your fingertips a complete, easily understood encyclopedia of facts, methods and data for operating a complete auto radio service station. Use **FREE EXAMINATION** coupon today!

SERVICING THE MODERN CAR RADIO

BY A. L. HURLBUT
Auto Radio Service
Manager and Design
Consultant

Second Edition. 702 pages, 8½ x 11. 222 illustrations, over 500 diagrams, \$7.50.

Practical, easily understood data on

- Entering the Car Radio Field
- Principal Differences between Mobile and Home Radios
- Automobile Antennas
- Antenna Input Circuits
- The Power Supply
- Typical Circuit Features
- The Automotive Electrical System
- Setting Up the Car Radio Service Station
- Installing the Car Set
- Installing the Antenna
- Loudspeaker Installation
- Interference
- Servicing Procedure
- Vibrator Maintenance
- Servicing the Loud speaker
- Car Radio Alignment
- Push-button Tuning

and over 500 specific car radio circuit diagrams!

OPPORTUNITY OF A LIFETIME

for alert servicemen, says A. A. Ghirardi

Take this advice from A. A. Ghirardi, author of famous radio service books and articles! "I have read Hurlbut's **SERVICING THE MODERN CAR RADIO** from cover to cover. I sincerely believe it represents an opportunity no wide awake serviceman can afford to miss. For nowhere in radio today is there a better chance to build business, increase profits, step ahead of competition!



OVER 9,000,000 CAR RADIOS!

"Just think of it! Approximately 16 out of every 100 radio receivers in use today are car radios—and this percentage is increasing every day. Good automotive radio servicemen are scarce—and Mr. Hurlbut gives a gold mine of information you need to cash in on this profitable business!"

Read it 10 Days at our Risk!

10 DAYS' FREE EXAMINATION

Murray Hill Books, Inc. (Division of Rinehart & Co.)
Dept. RC-98, 232 Madison Ave., New York 16, N. Y.

Send me the new Second Edition of Hurlbut's **Servicing the Modern Car Radio** for 10 days' examination on approval. In 10 days I will send \$7.50, plus few cents postage, or return book postpaid. Postage paid on cash orders; same return privilege. (Books sent on approval in U.S. only. Price outside U.S., \$8.00, postpaid.)

Name

Address

City (Zone) & State

Occupation

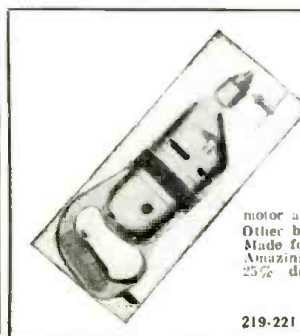

TERRIFIC VALUE—PORTABLE ELECTRIC DRILL

(Sold at less than established factory price so we cannot mention brand name)

- Only \$19.95 equipped with ¼" Jacobs Gears Chuck and Key.
- Not an intermittent duty drill, but a full size rugged tool.
- Most convenient type switch, natural grip handle, and balance like a six-shooter.
- Precision cut gears—turbine type cooling blower—extra long brushes.
- No stalling under heaviest pressure because of powerful 110 Volt AC-DC motor and multiple ball thrust bearings.
- Other bearings self-aligning lifetime lubricating Chrysler Oilite type.
- Made for toughest year-in and year-out service in Plant or on construction jobs.
- Amazing perpetual factory guarantee assures you of a lifetime of trouble-free use.
- 25% deposit on C.O.D.'s. Full refund if returned prepaid within five days.

BUFFALO RADIO SUPPLY

219-221 GENESEE STREET BUFFALO 3, N. Y. DEPT. 9C

SMALLEST B-BATTERY

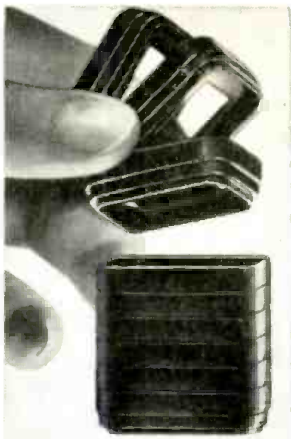

Courtesy Olin Industries Ltd.

Individual cells of new B-battery interlock automatically to make electrical connections, eliminating 91% of soldering. Electrodes are thin carbon-coated zinc plates which fit the square windows seen in center of sections.

Mobile communication needs have grown so much that the FCC last month proposed to separate the present automobile and truck telephone service into three new classes, each with its own frequency band.

The three classes would be: land transportation—busses, trucks, trains, and taxicabs; domestic public service—common-carrier service for the general public; and industrial service—delivery and pickup trucks, doctors' cars, and ambulances.

The proposed new services consolidate a number of present services, reduce overlap between them, and increase the number of businesses eligible to use radio.

Radio Thirty-Five Years Ago

In Gernsback Publications

HUGO GERNSBACK

Founder

Modern Electrics	1908
Electrical Experimenter	1913
Radio News	1919
Science & Invention	1920
Radio-Craft	1929
Short-Wave Craft	1930
Wireless Association of America	1908

Some of the larger libraries in the country still have copies of ELECTRICAL EXPERIMENTER on file for interested readers.

In September 1914
ELECTRICAL EXPERIMENTER

How to use the "Electro" Loose Coupler

Improved Buzzer Transmitter by Frank H. Broome

Aerial Mast Construction by Charles Fitzgerald

The Sayville, L. I. Wireless Station Adjustable Condenser and 'Phone Switch by Frank H. Broome

A good Mineral Detector by Ralph Humphrey

Portable Wireless Station Tower Automatic Tikker Receiver New Pickard Crystal Detector Stand Firing a Revolver by Radio Waves 200 Volt Radio Transformer

THE NEW MODEL 247

TUBE TESTER



Checks octals, loctals, bantam jr. peanuts, television miniatures, magic eye, hearing aids, thyratrons, the new type H.F. miniatures, etc.

FEATURES:

- ★ A newly designed element selector switch reduces the possibility of obsolescence to an absolute minimum.
- ★ When checking Diode, Triode and Pentode sections of multi-purpose tubes, sections can be tested individually. A special isolating circuit allows each section to be tested as if it were in a separate envelope.
- ★ The Model 247 provides a super sensitive method of checking for shorts and leakages up to 5 Megohms between any and all of the terminals.
- ★ One of the most important improvements, we believe, is the fact that the 4 position fast-action snap switches are all numbered in exact accordance with the standard R. M. A. numbering system. Thus, if the element terminating in pin No. 7 of a tube is under test, button No. 7 is used for that test.

Model 247 comes complete with new speed-read chart. Comes housed in handsome, hand-rubbed oak cabinet slinged for bench use. A slip-on portable hinged cover is included for outside use. Size 10 3/4" x 8 3/4" x 5 3/4". **ONLY \$29.90 NET**

THE NEW MODEL 257

ELECTRONIC ANALYZER

THE MOST COMPLETE MULTI-RANGE, MULTI-SERVICE UNIT EVER DESIGNED!!

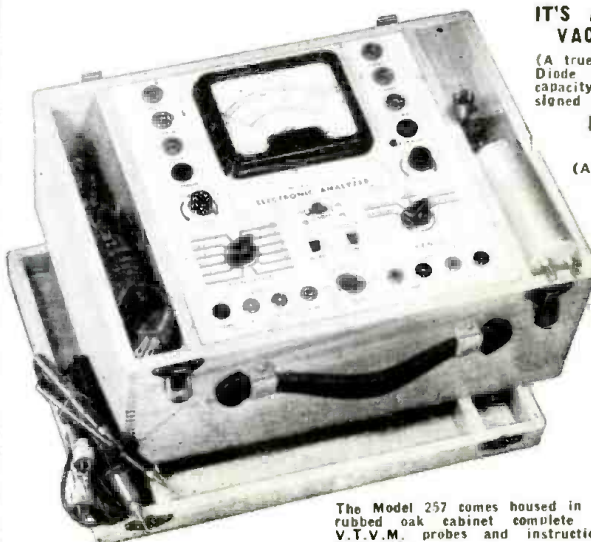

IT'S A HIGH FREQUENCY A.C. VACUUM TUBE VOLTMETER

(A true A.C.-V.T.V.M. employing a 1-A3 Diode which together with a resistance capacity network is built into a specially designed Polystyrene High Frequency Probe.)

IT'S A D.C. VACUUM TUBE VOLTMETER

(At 11 megohms input resistance.)

IT'S A CAPACITY METER

IT'S A REACTANCE METER

IT'S AN INDUCTANCE METER

IT'S A DECIBEL METER

IT'S A 1000 OHMS PER VOLT V.O.M.

Measures D.C. Voltages (at 1,000 ohms per volt) up to 3,000 volts. A.C. Voltages (at 1,000 ohms per volt) up to 3,000 Volts. D.C. current up to 15 amperes. Resistance up to 1,000 megohms.

The Model 257 comes housed in a beautiful hand-rubbed oak cabinet complete with test leads. V.T.V.M. probes and instructions. Size: 6 1/2" x 10 1/4" x 14". **\$57.50 NET**

Sixty, yes Sixty—separate ranges are provided by this most versatile unit ever designed.

Specifications

A.C. V.T.V.M. VOLTS: (Input resistance—10 megohms shunted by 8 micromicrofarads. Freq. Range—50 cycles to 500 Megacycles.) 0 to 3/15/30/75/150/300 Volts. D.C. V.T.V.M. VOLTS: (At 11 Megohms Input Resistance) 0 to 3/15/30/75/150/300/750/1500/3000 Volts. D.C. VOLTS: (At 1,000 Ohms Per Volt) 0 to 3/15/30/75/150/300/750/1500/3000 Volts. A.C. VOLTS: (At 1,000 Ohms Per Volt) 0 to 3/15/30/75/150/300/750/1500/3000 Volts. D.C. CURRENT: 0 to 3/15/30/75/150/300/750 Ma. 0 to 3/15 Amperes. RESISTANCE: 0 to 1,000 10,000/100,000 Ohms; 0 to 1/10/1,000 Megohms. CAPACITY: (In MFD) .0005—.2 .05—.20. REACTANCE: 10 to 5M (Ohms) 100—50M (Ohms); .01—5 (Megohms). INDUCTANCE: (In Henries) .035—14 .35—140 35—14,000. DECIBELS: —10 to +18 +10 to +38 +30 to +58.

20% Deposit Required On All C.O.D. Orders

MOSS ELECTRONIC DISTRIBUTING CO.

DEPT. RC 9

229 FULTON STREET

NEW YORK 7, N. Y.

RADIO TUBES

For immediate shipment

R.M.A. Guaranteed

Individually Sealed Cartons

GT Types		Miniature Types	
6K6GT	.40	1S5	.50
6K5GT	.46	1T4	.55
6V6GT	.46	1R5	.55
6SA7GT	.46	3S4	.55
6SJ7GT	.46	6BA6	.50
6SK7GT	.46	6BE6	.50
6SQ7GT	.46	6AT6	.42
6X5GT	.40	12BA6	.50
12SA7GT	.46	12BE6	.50
12SQ7GT	.46	12AT6	.42
12SK7GT	.46	35W4	.42
12SJ7GT	.46	50B5	.55
35L6GT	.40		
35Z5GT	.32		
50L6GT	.46		

25% DEPOSIT REQUIRED ON C.O.D.—2% C.O.D.

10% DISCOUNT ON LOTS OF 50 OR MORE

RAVAC ELECTRONICS CORP.

432 Fourth Avenue
New York 16, N. Y.

AMSCO SERVICE KIT

Kit includes assortment of:
 1 pr. head-phones or lip mike.
 100 Resistors, 1/2 and 1-watt.
 100 Condensers, paper, mica, electrolytic & can.
 10 Switches, Toggle, Gang & Rotary.
 100 ft. Spaghetti, various sizes.
 12 Knobs, round and bar.
 2 lbs. Hookup wire.
 20 Fuses.
 10 Tube Sockets.
 1 lb. Hardware (screws, nuts, fugs, etc.).

\$9.95 complete

PHOTO-CELL AMPLIFIER

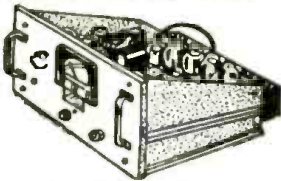

\$9.95

PARABOLIC REFLECTORS

15" spun aluminum, Alzak fin. for 1200 Mc. Up. 2 for **\$3.00**
 Vibrator—Syn. 2 Volt 7 prong for G.E. Portables. Replaces LB-530. 2 for **\$2.49**
 Microphone—T-24 Carbon with Push Switch and Cable. New **.79**
 Scope Tubes 5BP1 and 5CP1 new in cartons. Each **\$2.29**

Available **1948 CATALOG** Write Today

AMERICAN SALES CO.

1811 W. 47th St. Chicago 9, Ill.

FREE!

New 1949
Walter Ashe
CATALOG

It's nearly ready... the new, bigger, better-than-ever Walter Ashe Catalog of Radio and Electronics for 1949!

For "priority" delivery, reserve your free copy of this helpful, informative buying guide now. Simply write: "1949 Catalog on a penny post card. Sign your name and address. Mail to--"

WALTER ASHE RADIO CO.
1125 PINE ST. ST. LOUIS 1, MO.

Send for this catalog TODAY!

Scale models of television studios simplify planning. Transmitter is at rear, control console in foreground, and cameras at right in this picture. General Electric employees Jean Thater and Jane Reid inspect the model.



SPARK PLUG REDUCES INTERFERENCE

NOW that FM and television are gaining wide acceptance, high-frequency noise from automobile engines is becoming an important source of interference. A new spark plug developed by the Electric Auto-Lite Company contains a built-in resistor which is said to reduce noise radiation considerably.

The discharge at the gap of a spark plug consists of high-voltage, high-ampere damped oscillations of short duration followed by a non-oscillating discharge of much greater duration. The oscillatory discharge generates high frequencies of large amplitude. These cause serious radio interference.

As the cutaway photograph shows, the new plug has a built-in 10,000-ohm ceramic bonded carbon resistor between the "hot" terminal and one side of the spark gap.

The resistor has a damping effect.

The damping reduces the duration of the oscillations and also restricts the oscillation to lower frequencies. The oscillation peaks are damped so effectively that radiation is kept below 35 millivolts per meter from 540 kc to 150 mc at 50 feet from the engine.

In addition to suppressing interference the new plug is said to reduce engine misfiring, help lubrication, and lengthen the life of pistons, rings, and cylinder walls.

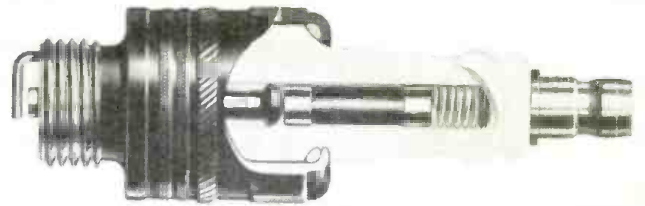

BETATRONS IN FIGHT AGAINST CANCER

Betatrons will be used next year for cancer treatment for the first time, *Science Service* reported recently. The betatrons will produce 20-million-volt X-rays 20 times more powerful than those used heretofore. These X-rays can be concentrated on a point deep inside the patient's body with reduced danger of damage at the point where the rays enter the body. Lower-voltage rays have

their maximum effect at the surface. The betatron produces its X-rays by bombarding a platinum target with high-energy electrons.

When it was invented, its originator, Prof. Donald W. Kerst of the University of Illinois, pointed out its cancer-fighting possibilities. Research in this direction was delayed, however, by the war.

HOW TO GET THE MOST
from only
BASIC TEST EQUIPMENT

Servicing by Signal Substitution

The Simple, Modern, Dynamic Speed approach to receiver alignment and adjustment problems, FM-AM-TV.

- Nothing complex to learn
- No extra equipment to purchase
- Universal — non-obsolete
- Employs only Basic Test Equipment

S-S-S tells HOW — in simple, direct language.
New 9th edition now off the press. 100 pages of valuable information.

Available from all leading radio parts and equipment distributors or directly from factory at only 40¢ per copy.

PRECISION APPARATUS COMPANY, Inc. • 92-27 Horace Harding Blvd., Elmhurst 4, N. Y.

FM STATION LIST

THE response to our call for FM scouts has been extremely good. Mail has been arriving in large quantities and the letters have all been interesting. We expect that the reports from RADIO-CRAFT readers will be of definite importance to those who are gathering information about FM propagation on the 100-mc band because they upset any theories which might still exist about line-of-sight reception.

Sidney Padrick, of Avenal, California, for example, reports reception of KIMV, Hutchinson, Kansas; WKY-FM and KOCY-FM, Oklahoma City, Oklahoma; and KCMC-FM, Texarkana, Texas, among others. Signals were strong—and all the stations were from 1,200 to 1,400 miles away! This was no laboratory experiment; a Meissner tuner was used with a Ward antenna. Although the antenna array included a reflector, rotating it had no effect.

Hayes Lyon, located in Austin, Texas, reports hearing KNX-FM, Hollywood, California, and WNDB. Daytona Beach, Florida, 1,200 and 1,000 miles away respectively. He used a Scott receiver with the antenna built into the cabinet. The signals faded in and out, being absolutely clear and noiseless at their best.

Another Scott owner, R. J. Marks of Norfolk, Virginia, reports reception of KOCY-FM, Oklahoma City, a distance of about 1,175 miles.

John A. Beckman of Jacksonville, Florida, reports frequent reception of WMIN-FM, St. Paul, Minnesota. He uses a Hallicrafters SX-43 with a half-wave doublet antenna cut for the 40-meter amateur band. Reception over this 1,190-mile path is best after 6 pm. The signal fades in and out at 5- to 10-minute intervals.

Several 1,000-mile reports came in. Roger E. Hammer of Elkton, Virginia, received WFAA and KIXL in Dallas, Texas, with a Westinghouse receiver and a folded dipole and reflector 30 feet above ground. Charles E. Brown in West Palm Beach, Florida, heard WFUV in New York City on a home-built receiver with an r.f. stage and three i.f. amplifiers.

Reception of WMIN-FM, St. Paul, Minnesota, was reported by S. B. Knapp of Baton Rouge, Louisiana. Mr. Knapp made a wire recording of the programs to prove his DX report.

Harold R. Vogt of Mountain Lake, Minnesota, writes that he heard WTPS-FM in New Orleans, Louisiana, with plenty of volume for a few minutes, after which the station faded out. The owner of Schmitz Radio in Staples, Minnesota, reports reception of WMAS-FM in Springfield, Massachusetts.

There were several long-distance reports on old-band (42-50-mc) FM. The ordinary skip-effect is known to be present on this band, which was one of the reasons for going over to the high band after the war. These reports were, therefore, excluded from our discussion.

We hope that all RADIO-CRAFT readers who own FM sets will continue to act as FM scouts and send in their reports on

★ For over 35 years—the finest in electrical and electronic instruments.



TUBE TESTERS

Choice of the experts!

Television receivers MUST have good tubes. You can depend on HICKOK Tube Testers to reject all weak tubes quickly and accurately.

Exclusive features that have put HICKOK Tube Testers far in the lead are:

1. Tests FUTURE life of tubes!
2. Tests all tubes ACCURATELY!
3. Reads micromhos DIRECTLY—the only true test of a tube!
4. Tests tubes for gas content—more important now than ever before!

The HICKOK line of Tube Testers is COMPLETE. They are available in portable, counter and display cases. Also with self-contained, high sensitivity multimeters and with specially designed professional features.

HICKOK has long been the choice of leading technicians and electronic manufacturers the world over.

See your jobber or write for free catalog.

533 DM (illustrated above)
Dynamic Mutual Conductance Tube Tester

The popular and effective selling-aid model, designed for quick customer-convincing, counter demonstration and test. Incorporates the new HICKOK test feature that foretells future tube life. Large 9" scale, reading directly in micromhos, also indicates "GOOD", "2" and "REPLACE". 17" x 26 3/4" x 11". 110-130 VAC.



ELECTRICAL INSTRUMENT COMPANY

10531 DUPONT AVENUE • CLEVELAND 8, OHIO

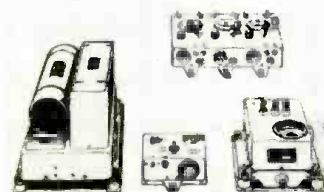
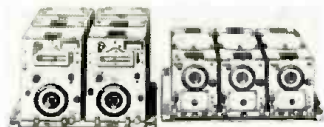

SCR-274N COMMAND SET

The greatest radio equipment value in history

A mountain of valuable equipment that includes 3 receivers that use plug-in coils, and consequently can be changed to any frequencies desired without conversion. Also included are two Tuning Control Boxes; 1 Antenna Coupling Box; four 28V. Dynamotors (easily converted to 110V. operation); two 40-Watt Transmitters including crystals, and Preamplifier and Modulator. 29 tubes supplied in all. Only a limited quantity available, so get your order in fast. Removed from unused aircraft and in guaranteed electrical condition. A super value at \$34.95, including crank type tuning knobs for receivers.

BUFFALO RADIO SUPPLY

219-221 GENESEE STREET
BUFFALO 3, N. Y. DEPT. 9C

Aluminum gear box 18x357 that contains two powerful electric motors and two matched gear trains. 2 1/2 gears in all varying in size from 3/4 to 4 inches in diameter. This unit is readily converted to rotate a beam antenna or any other similar use \$3.00

TUBES—All types in stock. 60% off on all tubes if ordered in lots of 10 or more.

AUTO-TRANSFORMERS—Steps up 110v. or steps down 220v to 110v—\$1.95.

FIL. TRANSF.: 6.3v. 20 Amps.—\$1.98; Universal Output Trans. 8 Volt—89c; 15 Volt—\$1.29; 30 Volt—\$1.69. **AUDIO TRANSFORMERS**: 8" Plate to 8" Grid—\$1.79c; 8" Plate to 11" Grid—79c; Heavy Duty Class AB or R. I. P. inputs—\$1.49; Midget Output for AC-DC sets—69c; **MIKE TRANSFORMER** for T-17 Shure microphone, similar to UTC voice type—\$2.00. Stancor 8B or 11B mike to line or grid—\$1.95.

POWER TRANSFORMERS—Half shell type 110V. 60 cy. Centertapped HV winding. Specify either 2.5 or 6.3V filament when ordering.
 For 4-5 tube sets—650V. 40MA. 5V & 2.5 or 6.3V \$1.49
 For 5-6 tube sets—650V. 45MA. 5V & 2.5 or 6.3V 1.75
 For 6-7 tube sets—675V. 50MA. 5V & 2.5 or 6.3V 1.90
 For 7-8 tube sets—700V. 70MA. 5V & 6.3 or 2.5V 2.35
 For 7-8 tube sets—700V. 70MA. 5V & 6.3 (2.5 Cycle) 3.60
 For 8-9 tube sets—700V. 90MA. 5V-3A. 2.5V 2.85
 For 9-11 tube sets—700V. 5V & 6.3V-4A 2.85
 For 9-15 tube sets—600V. 150MA. 5V & 6.3V 2.95

CONDENSERS—PAPER TUBULAR 600 WV.—.001, .002, .005—8c; .01, .05—9c; 1—10c; 25—23c; 5—35c; ELECTROLYTICS: Rmfd 200v—20c; 10mfd 35v—20c; 30mfd 150v—23c; 20/20mfd 150v 35c; 30/20 150v 46c; 50mfd 150v—43c; Rmfd 475v—34c; 10mfd 350v—65c; **OIL CONDENSERS:** 4mfd 600v—49c; 2mfd 600v—29c; 3X 1mfd 600v—29c.

SPEAKERS—These FM speakers are the finest that are available. All have heavy overdrive Alnico V magnets.

- 3 1/2" \$1.15 6 for \$6.60
- 4" \$1.15 6 for \$6.60
- 4x6 (oval) \$1.95 6 for \$11.40
- 5" \$1.10 10 for \$9.50
- 6" \$1.50 6 for \$8.70
- 7" (Car Radio Size) \$4.50 6 for \$21.50
- 8" 10 oz. \$3.95 6 for \$20.50
- 8" 21 oz. \$4.95 6 for \$26.50
- 10" 21 oz. \$5.50 6 for \$30.00
- 12" 21 oz. \$7.95 6 for \$42.00

FILTER CHOKES: 200, 300, 400, 500 ohm light duty—59c; 200 or 300 ohm heavy duty—89c; 250 ma 35 ohm, made for U.S. Navy, fully shielded—\$1.95; 75 ohm 125ma—25c; or 25 for \$4.25; "Meissner type" tapped after chokes—25c; Choke-condenser combination, ideal to replace any size speaker field when installing FM speaker—79c.

LINE FILTERS—110V—each unit contains two 2 mfd. oil filled condensers and a 15 amp. iron core choke. This filter has innumerable uses such as oil burner line filter, etc. A ten dollar value for 98c.

SELENIUM RECTIFIERS—Dry disc type 1 1/2", 1", 1.2 Amp. maximum, suitable for converting DC relays to AC, for simplifying filament source in portable radios, converting DC meter to AC applications, and also may be used in low current chargers—90c.

30 MC IF TRANSFORMERS, double slug tuned—25c.
30 MC VIDEO AMPLIFIER PLATE COILS—Slug tuned—25c.

BUFFALO RADIO SUPPLY

219-221 GENESEE STREET, BUFFALO 3, N. Y. DEPT. 9C

Come to the Great

SHOPS OF
COYNE

where you learn by doing



RADIO
 ELECTRONICS—TELEVISION
Quickly

To Succeed in Television, You Need All-Around Radio Training!

Trained Radio men needed now. Get Radio training and be ready for a real future. Learn on actual equipment at Coyne. 49 years of training experience Not "Home Study". Free employment service to graduates. Many earn while learning. If you are short of money, ask about Student Finance Plan. Now added Training in Electric Refrigeration. G.I. Approved.

SEND COUPON FOR FREE BOOK

B. W. COOKE, President
 COYNE ELECTRICAL & RADIO SCHOOL
 500 S. Paulina St., Dept. D8-8H, Chicago 12, Ill.
 Send Big Free Book; also details about Coyne Part-Time Employment and Student Finance Plan.

NAME.....AGE.....

ADDRESS.....

CITY.....STATE.....

any record long-distance FM reception.

When you write please include all the information you can think of. Especially important are: type of set; description of antenna; the type of country sur-

rounding the receiving location—hilly, flat, etc.; signal strength of stations received, time of day, and giving us air-line distance between your location and the transmitter.

FREQUENCY (MC)	CALL	LOCATION
44.1	W2XMN	Alpine, N. J.
89.1	WH5F	Wausau Wis.
89.5	WSOU	So. Orange, N. J.
89.9	KCRW	Santa Monica Calif.
89.9	WCTF	Chicago, Ill.
89.9	WHKW	Chilton Wis.
90.1	KOKH	Oklahoma City, Okla.
90.1	KRVM	Eugene, Ore.
90.1	WABE	Atlanta, Ga.
90.3	WBOE	Cleveland Ohio
90.3	WSHS	Floral Park, N. Y.
90.5	KWGS-FM	Tulsa, Okla.
90.5	WKAR-FM	E. Lansing, Mich.
90.7	WUVU	New York N. Y.
90.7	WHAD	Delafield Wis.
90.9	KOKU	Norman Okla.
90.9	WDTR	Detroit, Mich.
90.9	WEHR	State College, Pa.
90.9	WFIU	Bloomington, Ind.
91.1	WBG0	Newark, N. J.
91.3	KCVN	Stockton, Calif.
91.3	WBKY	Lexington, Ky.
91.3	W01-FM	Ames, Iowa
91.3	WTDS	Toledo, Ohio
91.3	WWCH	W. Chester, Pa.
91.5	KSLS	St. Louis, Mo.
91.5	KUSC	Los Angeles, Calif.
91.5	WBZE	Chicago, Ill.
91.5	WHA-FM	Madison, Wis.
91.5	WNYE	New York, N. Y.
91.5	WPFL	Providence, R. I.
91.7	KALW	San Francisco, Calif.
91.7	KOAG-FM	Stillwater, Okla.
91.7	KSDS	San Diego, Calif.
91.7	KSUI	Iowa City, Iowa
91.7	KUHF	Houston, Tex.
91.7	WIUC	Urbana, Ill.
91.7	WJUN	Philadelphia, Pa.
91.7	WLSU	Baton Rouge, La.
91.7	WTHS	Miami, Fla.
91.7	WUOA	Tuscaloosa, Ala.
91.7	WUOM	Ann Arbor, Mich.
92.1	W2XEA	Alpine, N. J.
92.1	WNAE-FM	Warren, Pa.
92.3	KFEQ-FM	St. Joseph, Mo.
92.3	KRPO	San Jose, Calif.
92.3	KVNJ-FM	Fargo, N. D.
92.3	WBCE-FM	Superior, Wis.
92.3	WCOH-FM	Newnan, Ga.
92.3	WCOL-FM	Columbus, Ohio
92.3	WJOB-FM	Hammond, Ind.
92.3	WPRO-FM	Providence, R. I.
92.5	KCMC-FM	Texarkana, Tex.
92.5	KRLD-FM	Dallas, Tex.
92.5	KYWF-FM	Philadelphia, Pa.
92.5	WFRS	Grand Rapids, Mich
92.5	WGOV-FM	Valdosta, Ga.
92.5	WHAV-FM	Haverhill, Mass.
92.5	WING-FM	Winchester, Va.
92.5	WMBD-FM	Peoria, Ill.
92.9	KBUR-FM	Burlington, Iowa
92.9	KDKA-FM	Pittsburgh, Pa.
92.9	KGDM-FM	Stockton, Calif.
92.9	KONO-FM	San Antonio, Texas
92.9	KOAO-FM	Omaha, Nebraska
92.9	WBNY-FM	Buffalo, N. Y.
92.9	WBZF-FM	Buffalo, N. Y.
92.9	WEEU-FM	Boston, Mass.
92.9	WOSH-FM	Reading, Pa.
92.9	W0SH-FM	Oshkosh, Wis.
93.1	KNX-FM	Hollywood, Calif.
93.1	KWBW-FM	Hutchinson, Kans.
93.1	WAIR-FM	Winston-Salem, N. C.
93.1	WFBL-FM	Syracuse, N. Y.
93.1	WGUY-FM	Bangor, Me.
93.1	WHYN-FM	Bangor, Me.
93.1	WJBK-FM	Holyoke, Mass.
93.1	WKAT-FM	Detroit, Mich.
93.1	WKBT-FM	Miami Beach, Fla.
93.1	WKBH-FM	La Crosse, Wis.
93.3	WFLA-FM	Tampa, Fla.
93.3	WGBR-FM	Goldsboro, N. C.
93.3	WIP-FM	Philadelphia, Pa.
93.3	WJTN-FM	Jamestown, N. Y.
93.3	WKPB	Knoxville, Tenn.
93.3	WKYC	Paducah, Ky.
93.3	WRBL-FM	Columbus, Ga.
93.3	WTMJ-FM	Milwaukee, Wis.
93.5	KOCS-FM	Ontario, Calif.
93.5	WDHN	New Brunswick, N. J.
93.7	KRFM	Fresno, Calif.
93.7	KVSO-FM	Ardmore Okla.
93.7	KXOK-FM	St. Louis, Mo.

FREQUENCY (MC)	CALL	LOCATION
93.7	WCSI	Columbus, Ind.
93.7	WCSI	Franklin, Ind.
93.7	WDRC-FM	Hartford, Conn.
93.7	WFBC-FM	Greenville, S. C.
93.7	WKJF	Pittsburgh, Pa.
93.7	WLAW-FM	Lawrence, Mass.
93.7	WSGN-FM	Birmingham, Ala.
93.9	KSPI-FM	Stillwater, Okla.
93.9	WCOU-FM	Lewiston, Me.
93.9	WNYC-FM	New York N. Y.
93.9	WRC-FM	Washington, D. C.
93.9	WROW-FM	Albany, N. Y.
94.1	KERN-FM	Bakersfield Calif.
94.1	KLZ-FM	Denver, Colo.
94.1	WEAU-FM	Eau Claire, Wis.
94.1	WEMP-FM	Milwaukee, Wis.
94.1	WGST-FM	Atlanta, Ga.
94.1	WHBC-FM	Canton Ohio
94.1	WIBG-FM	Philadelphia, Pa.
94.1	WKOK-FM	Sunbury, Pa.
94.1	WMIX-FM	Mt. Vernon, Ill.
94.1	WREN-FM	Topeka, Kans.
94.3	WBEC-FM	Pittsfield, Mass.
94.3	WJLK-FM	Asbury Park, N. J.
94.3	WOCB-FM	West Yarmouth, Mass.
94.5	KGKL-FM	San Angelo, Texas
94.5	KWOC-FM	Poplar Bluff, Mo.
94.5	WHDM-FM	Boston, Mass.
94.5	WIS-FM	Columbia, S. C.
94.5	WMLL	Evansville, Ind.
94.5	WMOT-FM	Pittsburgh, Pa.
94.5	WNBZ-FM	Daytona Beach, Fla.
94.5	WYSR-FM	Syracuse, N. Y.
94.7	KOCY-FM	Oklahoma City, Okla.
94.7	KROC-FM	Rochester, Minn.
94.7	WAAT-FM	Newark, N. J.
94.7	WAPR-FM	Chattanooga, Tenn.
94.7	WENR-FM	Chicago, Ill.
94.7	WMAA-FM	Springfield, Mass.
94.7	WMCP	Baltimore, Md.
94.9	KAKC-FM	Tulsa, Okla.
94.9	KCFM	Kansas City, Mo.
94.9	KFPW-FM	Fort Smith, Ark.
94.9	KING-FM	Seattle, Wash.
94.9	KSCJ-FM	Sioux City, Iowa
94.9	KSFH	San Francisco, Calif.
94.9	WCMW-FM	Canton, Ohio
94.9	WDBJ-FM	Roanoke, Va.
94.9	WMRC-FM	Greenville, S. C.
94.9	WQAM-FM	Miami, Fla.
94.9	WWCF	Greenfield, Wis.
94.9	WXLW-FM	Indianapolis, Ind.
95.1	KFXM-FM	San Bernardino, Calif.
95.1	WEM-FM	St. Louis, Mo.
95.1	WGBA-FM	Columbus, Ga.
95.1	WGPA-FM	Bethlehem, Pa.
95.1	WHBS-FM	Huntsville, Ala.
95.1	WPDZ-FM	Clarksburg, W. Va.
95.1	WRXW	Louisville, Ky.
95.1	WTMA-FM	Charleston, S. C.
95.1	WTRF-FM	Bellaire, Ohio
95.1	WVFC	Ithaca, N. Y.
95.3	KGBS-FM	Harlingen, Texas
95.3	KSJO-FM	San Jose, Calif.
95.3	WSRS-FM	Cleveland Heights, Ohio
95.5	KECA-FM	Los Angeles, Calif.
95.5	KPRA	Portland, Ore.
95.5	KRBA-FM	Lufkin, Texas
95.5	WBGE-FM	Atlanta, Ga.
95.5	WCHA-FM	Chambersburg, Pa.
95.5	WHPE-FM	High Point, N. C.
95.5	WJAC-FM	Johnstown, Pa.
95.5	WJAR-FM	Providence, R. I.
95.5	WJZ-FM	New York, N. Y.
95.5	WMBI-FM	Chicago, Ill.
95.5	WPAM-FM	Pottsville, Pa.
95.5	WRWR	Albany, N. Y.
95.7	KOA-FM	Denver, Colo.
95.7	WCRS-FM	Greenwood, S. C.
95.7	WMMW-FM	Meriden, Conn.
95.7	WMUR-FM	Manchester, N. H.
95.7	WTPS-FM	New Orleans, La.
95.9	WFMZ	Allentown, Pa.
96.1	KCRA-FM	Sacramento, Calif.
96.1	KFMX	Council Bluffs, Iowa
96.1	KLCN-FM	Blytheville, Ark.
96.1	WAMS-FM	Wilmington, Del.
96.1	WBCM-FM	Bay City, Mich.
96.1	WCAE-FM	Pittsburgh, Pa.

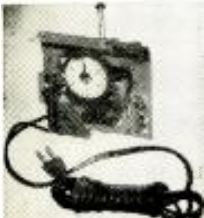

NEW BUSINESS

Multiple coin mechanism, timer clocks for power or utility outlets, convert, revamp any new or old A.C. radio, washing-machine, iron, fans, air-conditioning, Refrigerators, Heaters, ice-makers, etc., for coin machine operation.

TIMER MECHANISM, LIGHT-CORD AND FITTINGS
 5c for 10 minutes \$4.95
TIMER MECHANISM, LIGHT-CORD AND FITTINGS
 25c for 1 hour or 2 hours each \$4.95

Quantity Lots Write **F.O.B. Los Angeles**

RADIO-COIN-MATIC 1110 S. Normandie, Los Angeles 6, Cal.

Wonderful
NEW $\frac{3}{4}$ RPM
Motor
\$2.95



Ideal for a beam rotor, plenty of power. Originally designed for 24 volt operation, but easily converted, 110 volts AC. Complete instructions included. Excellent for other uses too. Brand new, surplus, guaranteed. (Add 40c each to cover postage and handling)

RG-8/U
COAX CABLE
100 FT. Only \$3.95

RG-8/U is the ideal cable for feeding, receiving and transmitting antennas for all frequencies up to 250 MC and can be used up to 3000 MC and DOWN to DC. New in 100 foot lengths. Less than ever before.

Only \$3.95

Shipped express collect

500' \$2.95
3 CONDUCTOR
TELEPHONE WIRE

3 conductor Braided insulated copper & steel telephone wire. It is made of copper for conductivity, and steel for strength. Worth at least 3c per ft. Yet due to an exceptional buy, we can now offer it at less than 1c a ft.

Shipped Express Collect



PHANTOM
ANTENNA
85¢

A transmitting antenna, for use on approximately 450 MC. Complete with standard coax connector. A weather-proof unit. (Add 25c to cover handling and postage.)

IMPORTANT!

All merchandise subject to prior sale, minimum order \$2.00. No C.O.D. orders accepted. Michigan residents must add 3% State sales tax.

"Meter Specials"
77¢



Brand new Bowers D.C. Voltmeter 2" round case. Meter has 450 ohms resistance (150 ohms per volt). (Add 15c each to cover postage and handling.)

Brand new Bowers D.C. Ammeter 0 to 100 amp scales (600 ma. movement with 100 amp shunt) same case as volt meter each .99c

Add 20c each to cover postage and handling



N. SILVERSTINE CO.
6532 EAST McNICHOLS ROAD DETROIT 12, MICHIGAN
Seven Acres of Surplus

FREQUENCY (MC)	CALL	LOCATION
96.1	WGAA-FM	Cedarstown, Ga.
96.1	WMBH-FM	Joplin, Mo.
96.1	WNAO-FM	Raleigh, N. C.
96.1	WOHS-FM	Shelby, N. C.
96.1	WOWO-FM	Fr. Wayne, Ind.
96.1	WTAG-FM	Worcester, Mass.
96.1	WVJS-FM	Owenboro, Ky.
96.3	KRED	Eureka, Calif.
96.3	KRKD-FM	Los Angeles, Calif.
96.3	WBIK	Chicago, Ill.
96.3	WINX-FM	Washington, D. C.
96.3	WJMC-FM	Rice Lake, Wis.
96.3	WJR-FM	Detroit, Mich.
96.3	WQXR-FM	New York, N. Y.
96.5	KRON	San Francisco, Calif.
96.5	KSDO	San Diego, Calif.
96.5	KSEI-FM	Pocatello, Idaho
96.5	KXYZ-FM	Houston, Texas
96.5	WAPJ	Altoona, Pa.
96.5	WGH-FM	Norfolk, Va.
96.5	WHEC-FM	Rochester, N. Y.
96.5	WHOO-FM	Orlando, Fla.
96.5	WTIC-FM	Hartford, Conn.
96.7	WBUZ	Bradbury Heights, Md.
96.7	WEAW	Evanston, Ill.
96.7	WSTC-FM	Stamford, Conn.
96.7	WVAW-FM	Cheviot, Ohio.
96.9	KALB-FM	Alexandria, La.
96.9	KCRK	Cedar Rapids, Iowa
96.9	KFBK-FM	Sacramento, Calif.
96.9	KRBC-FM	Abilene, Texas
96.9	WCSC-FM	Charleston, S. C.
96.9	WEBR-FM	Buffalo, N. Y.
96.9	WIBX-FM	Utica, N. Y.
96.9	WJHP-FM	Jacksonville, Fla.
96.9	WLAN-FM	Lancaster, Pa.
96.9	WLAV-FM	Grand Rapids, Mich.
96.9	WOPJ-FM	Bristol, Tenn.
96.9	WPAD-FM	Paducah, Ky.
96.9	WXHR-FM	Cambridge, Mass.
97.1	KKLA	Los Angeles, Calif.
97.1	KMHB	Belton, Tex.
97.1	KPFM-FM	Portland, Ore.
97.1	KTUL-FM	Tulsa, Okla.
97.1	WASH	Washington, D. C.
97.1	WBBM-FM	Chicago, Ill.
97.1	WBZA-FM	Springfield, Mass.
97.1	WELD-FM	Columbus, Ohio
97.1	WMHC	Indianapolis, Ind.
97.1	WNBC-FM	New York, N. Y.
97.1	WRCM	New Orleans, La.
97.1	WTCN-FM	Minneapolis, Minn.
97.1	WWJ-FM	Detroit, Mich.
97.3	KSO-FM	Des Moines, Iowa

GASOLINE HEATER **MOTOROLA**
MODEL GN-3-24

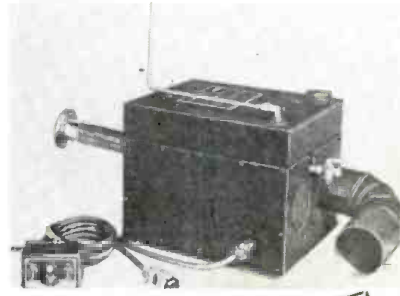

An internal combustion type heater which will give 15,000 B.T.U. of heat per hour. Ideally suited for use with equipment, farms, boats, bungalows, cabins, trailers, work sheds, dark-rooms, mobile equipment, transmitter stations etc., and any place where a quick heat is required in volume.

Very economical in operation—tank holds one gallon of gasoline which is sufficient for 6 hours operation. Uses any grade gasoline.

This unit is designed primarily for aircraft installation, 24-28 volts d.c., but it can be readily adapted for a 115 or 230 volt 60 cycle power supply by use of a transformer and rectifier. Simple circuit diagram for adaption to 115 or 230 volts 60 cycle use supplied with each unit. Can be used on 32 volt farm or boat systems as is without the installation of additional transformers, etc. Power consumption approximately 75 to 100 watts.

Approximately 12" long x 9 1/4" high x 9 1/4" wide. Complete with technical manual and parts list.

@ \$22.50 F.O.B. N. Y.

Send for Free Circular

MARITIME SWITCHBOARD

338 CANAL STREET NEW YORK 13, N. Y. Worth 4-8216-7-8-9

We carry a complete line of surplus new meters suitable for every requirement, such as portable, panel, switchboard, laboratory stands, etc.
OVER 50,000 METERS IN STOCK
We also have in stock various surplus components, tubes, code keying and recording units, tube testers, tachometers, analyzers, current transformers, precision resistors, condensers, and other electronic units, parts and accessories.

RADIO-CRAFT will pay full space rates for construction articles on modern standard and shortwave receivers. Sets should be preferably small—six tubes or less—and built with new efficient postwar tubes and components. Similar articles on other radio and electronic equipment will also be welcomed.

RISCO HAS IT

DO YOU HAVE IN YOUR TELE-SET GHOSTS

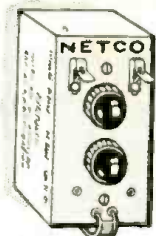

Trap it out with a NETCO Television Eliminator

Guaranteed to eliminate FM. Amateur and all external interference in entire television spectrum (by absorbing the signal). Complete! Ready to install. No soldering. Knob adjustment. From 30-120 Kc range. Instructions incl. Lists for \$4.00. your price \$6. Sent prepaid anywhere in U. S. A. Order yours today.

\$6.00

SERVICEMEN'S SPECIALS

- 100-INSUL. RES. KIT 1/2, 1, 2W\$1.45
- 15-ASSP. BY-PASS COND.89
- ALLIANCE PHONO MOTORS 2.50
- ASTATIC L-70 PICKUPS 1.79
- ASTATIC L-70 CARTRIDGES 1.45
- ASTATIC NYLON I.F. 3.45: WLP 1.95
- 50L6 OUTPUT TRANS.35
- 6V6 P.P. OUTPUTS55
- 1F TRANS. 456 KC SHIELDED INPUT OR OUTPUTea. .35
- MEISSNER OSC. COIL 12SA712
- VOLUME CONTROLS 500 M 19-W.S. (switch)29
- ANTENNA LOOPS, PRIM & SEC23
- 2 TUBE PHONO AMP. WIRED 1.95
- 2 TUBES 1.00
- 100 MA SELENIUM RECTIFIERS59
- GE PREAMPLIFIER WITH TUBE 4.25
- 6 FT. RUBBER LINE CORDS12
- TELEVISION TUBES new 14.95
- 300 FT. 300 OHM LEAD IN 1.85
- SP. PHOENIX VARIABLE COND. 300 MFD.59
- 100 FT. PHOSPHOR BRONZE DIAL CABLE59
- 8 PUSH BUTTON SWITCH39
- SIAGHETTI-36" LENGTH65

V. M.

VELVET MIXER RECORD CHANGER

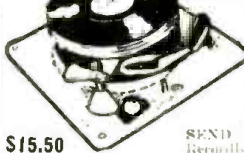

PLAYS 10" and 12" records at the same time \$15.50
 2 for \$28
 DETROIT \$13.75
 V.M. 100 \$28—unrepaid
 Astatic JT-30 Crystal Mikes \$8.95

\$15.50

SEND for Latest Prices on Recordist Recording Blanks.

Above Easily Attached to Any Radio or CAN BE USED WITH AMPLIFIER BELOW

Condenser Specials—New Stock

- 20-20-150\$.29
- 20-20-150 CD49
- 8-450V29
- 8x8-450V45
- UP TO .02-10A-PAER 4-600V 10 for .42
- UP TO .25 10 for .52
- 25x25V CAN \$.16
- 8x500 PP (CAN)39
- 10x30x10x10-400 V49
- 10x150V45
- 50x30x150V49



PHONO AMPLIFIER 3-TUBE AC-DC

Wired and Tested \$2.75
 Volume and Tone Controls Set of 3 Tubes \$1.75
 Output Trans.35
 5" Astatic SDB 1.19

PHONO OSC-2-TUBE

Wired & Tested 2 Tubes—\$1.20 \$2.75

25% on C.O.D. orders. Orders Filled as Received
 VISIT OUR NEW SHOW ROOM
 Free Catalog "C" Just Out
 We Specialize in Mail Orders

RISCO ELECTRONICS
 WHOLESALE DISTRIBUTORS
 25 West Broadway, N. Y. 7, N. Y.

GREYLOCK

A Dependable Name in RADIO TUBES

GT, Glass, and Miniature Types. All Tubes Individually Boxed.
 12SA7, 12SK7, 12SQ7, 50L6, 12AT6 each 39c
 12BA6, 12BE6, 35W4, 500S each 39c
 1R5, 1S5, 1T4, 354, 3Q4, 6AK5, 6AC5, 6AQ5, 6BE6, 6BA6, 6AU6, 6BJ6, 6X4, 11Z73 each 49c
 32L7, 70L7, 11ZL7 each 59c
 All Tubes carry RMA 90-Day Guarantee

PM SPEAKERS

- 4" Alnico No. 5each \$1.19
- 5" Alnico No. 5each 1.29

TERMS: Net COD. No order accepted for less than \$5.00

WRITE FOR BARGAIN CATALOG C-8

GREYLOCK ELECTRONIC SUPPLY CO.
 30 Church Street New York 7, N. Y.

FREQUENCY (MC)	CALL	LOCATION
97.3	KTRN	Wichita Falls, Texas
97.3	KWBR-FM	Oakland, Calif.
97.3	KWBR-FM	San Francisco, Calif.
97.3	WFMY	Greensboro, N. C.
97.3	WHCU-FM	Ithaca, N. Y.
97.3	WHP-FM	Harrisburg, Pa.
97.3	WIL-FM	St. Louis, Mo.
97.3	WIOD-FM	Miami, Fla.
97.3	WKWK-FM	Wheeling, W. Va.
97.3	WROL-FM	Knoxville, Tenn.
97.3	WTAR-FM	Norfolk, Va.
97.3	WTQC-FM	Savannah, Ga.
97.5	KPOR	Riverside, Calif.
97.5	KNWO-FM	Winona, Minn.
97.5	WAKR-FM	Akron, Ohio
97.5	WATL-FM	Atlanta, Ga.
97.5	WBOC-FM	Salisbury, Md.
97.5	WESB-FM	Bradford, Pa.
97.5	WLVA-FM	Lynchburg, Va.
97.5	WSIX-FM	Nashville, Tenn.
97.7	WISR-FM	Butler, Pa.
97.9	KFAB-FM	Lincoln, Nebr.
97.9	WBTM-FM	Danville, Va.
97.9	WEHS	Chicago, Ill.
97.9	WFAA-FM	Dallas, Texas
97.9	WGYN-FM	New York, N. Y.
97.9	WJLB-FM	Detroit, Mich.
97.9	WLEU-FM	Eric, Pa.
97.9	WLPN-FM	Suffolk, Va.
97.9	WLTN	Lewislow, Pa.
97.9	WMAR-FM	Baltimore, Md.
97.9	WMRF-FM	Lewiston, Pa.
97.9	WRNY-FM	Rochester, N. Y.
97.9	WWPG-FM	Palm Beach, Fla.
98.1	KOZY	Kansas City, Mo.
98.1	KQV-FM	Pittsburgh, Pa.
98.1	KRSC-FM	Seattle, Wash.
98.1	WCOD-FM	Richmond, Va.
98.1	WLAU-FM	Philadelphia, Pa.
98.1	WBRL	Baton Rouge, La.
98.1	WFMR	New Bedford, Mass.
98.1	WFNC-FM	Fayetteville, N. C.
98.1	WSAL	Saginaw, Mich.
98.1	WVUN	Chattanooga, Tenn.
98.3	KAGH	Pasadena, Calif.
98.3	WEEX	Easton, Pa.
98.3	WHAI-FM	Greenfield, Mass.
98.3	WHNY-FM	Hempstead, N. Y.
98.3	WLAD-FM	Danbury, Conn.
98.3	WOAK	Oak Park, Ill.
98.3	WPIK	Alexandria, Va.
98.3	WTFM-FM	Tiffin, Ohio
98.5	KBIX-FM	Muskogee, Okla.
98.5	KBTR	Minneapolis, Minn.
98.5	KOPY	Houston, Texas
98.5	KWOS-FM	Jefferson City, Mo.
98.5	WAGE-FM	Syracuse, N. Y.
98.5	WBRE-FM	Wilkes-Barre, Pa.
98.5	WCBL-FM	Roanoke Rapids, N. C.
98.5	WHLD-FM	Niagara Falls, N. Y.
98.5	WJPF-FM	Herrin, Ill.
98.5	WKPT-FM	Kingsport, Tenn.
98.5	WMOX-FM	Meridian, Miss.
98.5	WNAM-FM	Neenah, Wis.
98.7	KDYL-FM	Salt Lake City, Utah
98.7	KMGM	Los Angeles, Calif.
98.7	KPOJ-FM	Portland, Ore.
98.7	KVWC-FM	Vernon, Texas
98.7	WCTP	Greensboro, N. C.

FREQUENCY (MC)	CALL	LOCATION
98.7	WGNB	Chicago, Ill.
98.7	WHKB	Columbus, Ohio
98.7	WHOP-FM	Hopkinsville, Ky.
98.7	WJNO-FM	West Palm Beach, Fla.
98.7	WPAG-FM	Ann Arbor, Mich.
98.7	WOR-FM	New York, N. Y.
98.7	WSOY-FM	Decatur, Ill.
98.7	WWVA-FM	Wheeling, W. Va.
98.9	KBOA	Kennett, Mo.
98.9	KJBS-FM	San Francisco, Calif.
98.9	WCOA-FM	Pensacola, Fla.
98.9	WHBF-FM	Rock Island, Ill.
98.9	WHFM	Rochester, N. Y.
98.9	WKBN-FM	Youngstown, Ohio
98.9	WKY-FM	Oklahoma City, Okla.
98.9	WSNJ-FM	Bridgeton, N. J.
98.9	WSPA-FM	Spartanburg, S. C.
99.1	WNHC-FM	New Haven, Conn.
99.1	KUGN-FM	Eugene, Ore.
99.1	KWK-FM	St. Louis, Mo.
99.1	WDOF-FM	Oneonta, N. Y.
99.1	WGTR	Boston, Mass.
99.1	WHIO-FM	Dayton, Ohio
99.1	WMAZ-FM	Macon, Ga.
99.1	WNAV-FM	Annapolis, Md.
99.1	WLSL-FM	Roanoke, Va.
99.1	WTFH-FM	Port Huron, Mich.
99.1	WYMH	Hillsdale, Mich.
99.3	KGAR-FM	Garden City, Kans.
99.3	WAJR-FM	Morgantown, W. Va.
99.3	WFRO-FM	Fremont, Ohio
99.5	KFYO-FM	Lubbock, Tex.
99.5	KISS	San Antonio, Tex.
99.5	KRIC-FM	Beaumont, Tex.
99.5	WABF	New York, N. Y.
99.5	WAFM-FM	Birmingham, Ala.
99.5	WEFM	Chicago, Ill.
99.5	WGFH	Schenectady, N. Y.
99.5	WJLS-FM	Beckley, W. Va.
99.5	WMFR-FM	High Point, N. C.
99.5	WMIN-FM	St. Paul, Minn.
99.5	WNLC-FM	New London, Conn.
99.5	WSON-FM	Henderson, Ky.
99.5	WTAD-FM	Quincy, Ill.
99.7	KNBC-FM	San Francisco, Calif.
99.7	KPDR-FM	Alexandria, La.
99.7	KTFI-FM	Twin Falls, Idaho
99.7	WHAS-FM	Louisville, Ky.
99.7	WJAS-FM	Pittsburgh, Pa.
99.7	WMC-FM	Memphis, Tenn.
99.7	WSAP-FM	Portsmouth, Va.
99.9	K8MT	San Bernardino, Calif.
99.9	KMYC-FM	Marysville, Calif.
99.9	KVEC-FM	San Luis Obispo, Calif.
99.9	KWFT-FM	Wichita Falls, Tex.
99.9	WBT-FM	Charlotte, N. C.
99.9	WCLO-FM	Janesville, Wis.
99.9	WEBO-FM	Harrisburg, Ill.
99.9	WERC-FM	Erie, Pa.
99.9	WFNS-FM	Burlington, N. C.
99.9	WHFB-FM	Benton Harbor, Mich.
99.9	WKMO-FM	Kokomo, Ind.
99.9	WKRG-FM	Mobile, Ala.
99.9	WKRT-FM	Cortland, N. Y.
99.9	WSAN-FM	Allentown, Pa.
99.9	WTRT-FM	Toledo, Ohio.
100.1	WKBR-FM	Manchester, N. H.
100.1	WLBR-FM	Lebanon, Pa.
100.1	WMUS-FM	Muskegon, Mich.

BUFRAD CAR RADIO ANTENNAS

All of our car radio antennas are made of triple plated Admiralty Brass Tubing, complete with low loss shielded antenna leads and high quality fittings.

SIDE COWL—BR-1, 3 sections extend to 66". Your price—single units—\$1.50; in lots of 12—\$1.35 ea.

SKYSCRAPER—BR-2 has 4 heavy duty sections that extend 98". This super-aerial must be seen to be fully appreciated. Your price—single units—\$2.45; in lots of 12—\$2.25 ea.

TILT ANGLE—BR-3, may be adjusted to all body contours, 3 sections extend to 66". Single unit price—\$1.50; 12 lot price—\$1.25 ea.

VERSATILE—BR-4, single hole fender or top cowl mounting may be adjusted to conform with all body contours, 4 sections extend to 56". Single unit price—\$2.90; 12 lot price—\$2.75 ea.

THE MONARCH—BR-5, single hole top cowl mounting, 3 sections extend to 56". Single unit price—\$1.90; 12 lot price—\$1.75 ea.

AFTER SEEING OUR ANTENNAS AND COMPARING, YOU WILL NEVER BUY ANY OTHER MAKE!

BENDIX SCR 522—Very high Frequency Voice Transmitter-Receiver—100 to 156 MC. This job was good enough for the Joint Command to make it standard equipment in everything that flew, even though each set cost the Gov't \$2500.00. Crystal Controlled and Amplitude Modulated—HIGH TRANSMITTER OUTPUT and 3 Microvolt Receiver Sensitivity gave good communication up to 180 miles at high altitudes. Receiver has ten tubes and transmitter has seven tubes, including two 832's. Furnished complete with 17 tubes, remote control unit, 4 crystals, and the special wide band VHF antenna that was designed for this set. These sets have been removed from unused aircraft and are guaranteed to be in perfect condition. We include free parts and diagrams for the conversion to "continuously variable frequency coverage" in the receiver.

The SCR 522 complete with 24 volt dynamotor sells for only \$37.95. The SCR 522 is also available with a brand new 12 volt dynamotor for only \$42.95.



BR1 BR2 BR3 BR4 BR5

BUFFALO RADIO SUPPLY

219-221 GENESEE STREET, BUFFALO 3, N. Y. DEPT. 9C

FREQUENCY (MC)	CALL	LOCATION
100.3	KGW-FM	Portland, Ore.
100.3	KMPC-FM	Hollywood, Calif.
100.3	KSL-FM	Salt Lake City, Utah.
100.3	WACE-FM	Chicopee, Mass.
100.3	WCLT	Newark, Ohio.
100.3	WCNB	Connersville, Ind.
100.3	WFMF	Chicago, Ill.
100.3	WG8G-FM	Greensboro, N. C.
100.3	WHO-FM	Des Moines, Iowa
100.3	WMGM	New York, N. Y.
100.3	WRAK-FM	Williamsport, Pa.
100.3	WSAV-FM	Savannah, Ga.
100.3	WWLH	New Orleans, La.
100.5	KMBC-FM	Kansas City, Mo.
100.5	KSBR	San Bruno, Calif.
100.5	WDXY	Spieringburg, S. C.
100.5	WFIN-FM	Findlay, Ohio
100.5	WHMA-FM	Anniston, Ala.
100.5	WHTN-FM	Huntington, W. Va.
100.5	WLDS-FM	Jacksonville, Ill.
100.5	WNNE	Mt. Washington, N. H.
100.5	WMUS-FM	Muskegon, Mich.
100.5	WNB-FM	Binghamton, N. Y.
100.5	WVNY-FM	Watertown, N. Y.
100.7	KIRO-FM	Seattle, Wash.
100.7	WBAB-FM	Atlantic City, N. J.
100.7	WBIB	New Haven, Conn.
100.7	WBML-FM	Macon, Ga.
100.7	WBOX-FM	Louisville, Ky.
100.7	WCEC-FM	Rocky Mount, N. C.
100.7	WCIL-FM	Carbondale, Ill.
100.7	WHKX	Cleveland, Ohio
100.7	WKAP-FM	Allentown, Pa.
100.7	WKIL	Kankakee, Ill.
100.7	WRJN-FM	Racine, Wis.
100.7	WSVA-FM	Harrisonburg, Va.
100.7	WTJS-FM	Jackson, Tenn.
100.7	WTRC-FM	Elkhart, Ind.
100.9	WABX-FM	Harrisburg, Pa.
100.9	WBYS-FM	Canton, Ill.
100.9	WCFR	Fall River, Mass.
101.1	KGLO-FM	Mason City, Iowa
101.1	KHJ-FM	Hollywood, Calif.
101.1	KTRH-FM	Houston, Texas
101.1	KVCI-FM	Chico, Calif.
101.1	KXLW-FM	Clayton, Mo.
101.1	WB8B-FM	Burlington, N. C.
101.1	WB8A-FM	Schenectady, N. Y.
101.1	WBOW-FM	Terre Haute, Ind.
101.1	WCAC-FM	Anderson, S. C.
101.1	WCBS-FM	New York, N. Y.
101.1	WJPG-FM	Green Bay, Wis.
101.1	WKST-FM	New Castle, Pa.
101.1	WLCS-FM	Baton Rouge, La.
101.1	WLWA-FM	Cincinnati, Ohio
101.1	WWDC-FM	Washington, D. C.
101.1	WXYZ-FM	Detroit, Mich.
101.3	KLX-FM	Oakland, Calif.
101.3	WATG-FM	Ashland, Ohio
101.3	WCFC	Bekley, W. Va.
101.3	WGAL-FM	Lancaster, Pa.
101.3	WSBF	South Bend, Ind.
101.3	WSRK	Shelbyville, Ind.
101.5	KFMB-FM	San Diego, Calif.
101.5	KGKB-FM	Tyler, Tex.
101.5	KMUS	Muskogee, Okla.
101.5	KYFM-FM	San Antonio, Tex.
101.5	WFMD-FM	Frederick, Md.
101.5	WGCM-FM	Gulfport, Miss.
101.5	WIBA-FM	Madison, Wis.
101.5	WJBC-FM	Bloomington, Ill.
101.5	WRAL-FM	Raleigh, N. C.
101.5	WSPD-FM	Toledo, Ohio
101.5	WWPB-FM	Miami, Fla.
101.7	KWIL-FM	Albany, Ore.
101.7	WFAH-FM	Alliance, Ohio
101.7	WLIN-FM	Merrill, Wis.
101.9	KARM-FM	Fresno, Calif.
101.9	KFXD-FM	Nampa, Idaho
101.9	WCTS	Cincinnati, Ohio
101.9	WGAN-FM	Portland, Me.
101.9	WGHF	New York, N. Y.
101.9	WGNC-FM	Gastonia, N. C.
101.9	WSFL	Springfield, Mass.
101.9	WSYO	Sylacauga, Ala.
101.9	WYBT	South Bristol, N. Y.

GREAT NEWS!
a new kind of instrument
for testing all
electrical circuits
and appliances

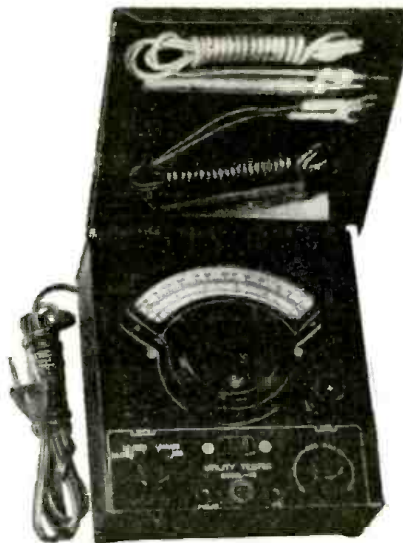

THE NEW MODEL 40

**UTILITY
TESTER**

ACCURATELY TESTS

RANGES • SHAVERS • HEATERS • IRONERS
WASHERS • FANS • VACUUM CLEANERS
AIR CONDITIONERS • REFRIGERATORS
SUN LAMPS • TOASTERS • WASHING
MACHINES and MOTORS

ALL MOTORS—single phase, multi-phase, universal, squirrel cage, induction, in fact every type of motor from fractional H.P. to 2 H.P.

THE MODEL 40 UTILITY TESTER

Will indicate whether voltage is 110 Volts or 220 Volts, if current is A.C. or D.C. and if frequency is 25 cycles or 60 cycles. Will test Thermostats under actual working conditions. Will measure the actual current consumption of any appliance either A.C. or D.C. while the unit is in operation—reading will be direct in amperes—the appliance or utility may be plugged directly into front panel receptacle—a special pair of insulated clip-end leads is provided for motors. Incorporates an ultra-sensitive direct reading resistance range which will accurately measure all appliance and utility resistances down to a fraction of an ohm. Will test bulbs, fuses, condensers, field coils, etc. Is ideal trouble shooter as it will instantly locate opens, shorts and grounds. Will locate cause of failure in three-way heat control switches. Will indicate when one side of an appliance or motor connected to line under test is "grounded." Will indicate excessive leakage between a motor and a line. Will indicate when a three-phase motor is running erratically due to a "blown" fuse.

Model 40 Utility Tester comes housed in a rugged crackle finished steel cabinet with portable cover.

\$15⁷⁵

Complete with all test leads and operating instructions

20% DEPOSIT REQUIRED ON ALL C.O.D. ORDERS

GENERAL ELECTRONIC DISTRIBUTING CO.
DEPT. RC-9, 98 PARK PLACE, NEW YORK 7, N. Y.



Suggested by W. J. Corbett, Springfield, Mass.
"Look Ma! We're playing television."



Better Products for the Radio Industry

NEW G-C
STATIC CHASER INJECTOR
AND POWDER

Tire static powder kits—improve auto radio reception. Eliminates wheel static interference. New powder is blown into all inner tubes—easy to use. For every car owner.



- No. 5604—Injector for G-C Static Powder.....List \$1.50
- No. 5605—G-C Static Powder Packet for 5 tires.....List \$1.00
- No. 5606—Kit—One Powder packet and injector.....List \$2.50

G-C FELT KOAT FLOCK
FINISH SPRAY KITS

Now it's easy to supply flock for refinishing turntables, cabinets, grilles, etc. Kit contains specially designed spray gun, 2 colors flock, undercoats, thinner, brush, instructions, etc.



- No. 180-2List \$9.50

NEW G-C
TUBE PULLER

Makes it easy to remove or insert miniature tubes—simple to operate. Inserts or extracts tubes where fingers will not reach—into hard-to-reach places. Saves time and money. Ends tube breakage, prevents burnt fingers.



- No. 5093—Miniature Puller.....List \$1.65
- No. 5093-D Display of 12.....List \$19.80

G-C "Speedex"
WIRE STRIPPER

Strips insulation from wire sizes No. 8 to No. 30. Ideal tool for manufacturers, electricians, maintenance men, etc. Strips 750 to 1000 wires per hour. For the new 300 ohm Television and FM twin transmission line:



- No. 733-H Standard ModelList \$6.00
- No. 744-H Automatic ModelList 8.00



Have you seen the new G-C "Speedex" Wire Strippers... write for illustrated literature.
RADIO DIVISION DEPT. D

G-C Products are available at leading distributors. Write for your copy of our new illustrated catalog.

GENERAL CEMENT Mfg. Co., Rockford, Ill., U. S. A.
Manufacturers of over 3,000 products • Sales offices in principal cities

SEPTEMBER SPECIAL

3 TUBE PHONO AMPLIFIER

\$1.95

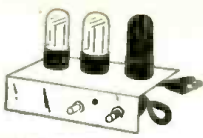

COMPLETELY WIRED, VOLUME AND TONE CONTROLS

Set of 3 tubes: 50L6, 35Z5, 12A6	\$1.10
Output trans. 50L6	.35
1/2 Meg. vol. control with sw.	.35
4" pm speaker	.95
5" pm speaker	1.15
6" pm speaker	1.55
8" pm speaker	2.75
12" pm speaker	4.89
4 x 6" pm speaker	1.89
Astatic pickups	1.89
Astatic crystals	1.59
Alliance motor & turntable	2.50
Vm #400 intermix changer	26.95

FAMOUS MAKE CONDENSERS

50 x 30... 150v... .45	16... 450v... .39
20 x 20... 150v... .35	400v or 600v... Per 10
20x20 (10) 150v (25) .39	.01, .02, .05... .49
8 x 8... 450v... .49	.001, .002, .005... .49
25... 25v... .29	.1, .3, .4, .5... .59
25... 50v... .29	

All prices F.O.B. N.Y.C.—on C.O.D. 25% Deposit. Write for free catalog.

THE ROSE COMPANY

88 West Broadway, Dept. C, New York 7, N. Y.

DUE TO POPULAR DEMAND WE REPEAT THESE

TERRIFIC BARGAINS

- Three assorted new MICROPHONES, including push-to-talk type... \$1.99
- Ten assorted R. F. Chokes including high frequency types... \$.35
- Five assorted AUDIO or FILTER CHOKES... \$.99
- One Hundred assorted RESISTORS... \$1.95
- Ten assorted JAN CABLE CONNECTORS, including SCR274,522 and BC375 types... \$.99
- Six assorted OIL FILLED CAN TYPE CONDENSERS, all with mounting brackets... \$1.19
- Ten assorted METAL & BAKELITE KNOBS—(no wooden knobs)... \$.39
- Six assorted VARIABLE CONDENSERS, including butterfly types... \$1.49
- Six assorted POWER and AUDIO TRANSFORMERS, all new... \$1.98
- Six assorted isolantite and bakelite R. F. COILS, shielded and unshielded... \$.99

The above ten assortments totaling over \$12.00 at the unbelievable bargain prices listed can be purchased together as one lot at a super-special total price of only \$10.00. All merchandise guaranteed to be as advertised.

BUFFALO RADIO SUPPLY

219-221 GENESEE STREET BUFFALO 3, N. Y. DEPT. 9C

12B8 and 25B8 TUBES

Adapter unit using 2 miniature tubes (6AT6 and 6BA6) or (12BA6 and 12AT6). Takes less space than original tube—nothing else to buy—just plug in and it works. Money-back guarantee. 12B8 or 25B8 unit complete: \$2.49 each. 10 units for \$22.50.

Send 25% deposit, balance C.O.D. Write for free parts catalog.

COMMERCIAL RADIO

36 BRATTLE STREET BOSTON 8, MASSACHUSETTS

HARD-TO-GET PARTS

POWERFUL ALL-PURPOSE INDUCTION MOTOR

IDEAL FOR EXPERIMENTERS—101 USES



Sturdily constructed to precision standards, this self-starting shaded pole A.C. induction motor is powerful enough for a number of uses. Some of these are: Automatic Timing Devices, Current Interrupters, Electric Fans, Electric Chimes, Window Displays, Photocell Control Devices, Electric Vibrators, Small Grinders, Buffers and Polishers, Miniature Pumps, Mechanical Modells, Sirens, and other applications.

Consumes about 15 watts of power and has a speed of 3,000 r.p.m. When geared down, this sturdy unit will constantly operate an 18-inch turntable loaded with 200 lbs. dead weight—THAT'S POWER!

Dimensions 3" high by 2" wide by 1 1/4" deep; has a convenient mounting lug; shaft is 1/8" long by 3/16" diameter, and runs in self-aligning oil-retaining bearings. Designed for 110-20 volts, 50-60 cycles, A.C. only. Snp. Wt. 2 lbs.

ITEM NO. 147 YOUR PRICE **\$2.95**

ULTRA MAGNET

LIFTS MORE THAN 20 TIMES ITS OWN WEIGHT

LITTLE GIANT MAGNET

Lifts 5 lbs. easily. Weighs 4 oz. Made of ALNICO new high-magnetic steel. Complete with keeper. World's most powerful magnet ever made. The experimenter and hobbyist will find hundreds of excellent uses for this high quality permanent magnet. Measures 1 3/4" x 1 1/4". Ship. Wt. 3 1/2 lbs.

ITEM NO. 159 YOUR PRICE **\$1.50**



GENUINE MICROPHONE TRANSMITTERS

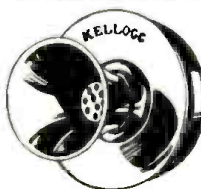

Regular telephone transmitters taken from a large telephone supply company's overstock. Work perfectly on 2 dry cells. Can be used on P.A. systems, coil systems, intercommunications, a e t s, short-line telephone circuits, house-to-house, or farm-to-farm phone lines, also to talk through your own radio or an connected telephone pick-up. Useful replacements on battery-operated rural telephone lines.

THESE ARE GENUINE TRANSMITTERS, MADE BY KELLLOGG, WESTERN ELECTRIC AND STROMBERG-CARLSON, excellent in appearance and operation. A remarkable value and one seldom offered in these times. Ship. Wt. 1 lb.

ITEM NO. 160 YOUR PRICE **\$1.95**

WATTHOUR METER



Completely overhauled and ready for immediate service. Designed for regular 110-volt, 60 cycle, 2-wire A.C. circuit. Simple to install: 2 wires from the line and 2 wires to the load. Sturdily constructed in heavy metal case, 8 1/2" high, 6 1/2" wide, 5" deep. Westinghouse, G. E. Ft. Wayne, Sanyo or other available make. Snp. Wt. 1 1/2 lbs.

ITEM NO. 33 YOUR PRICE **\$6.50**

AMAZING BLACK LIGHT!

Powerful 250 Watt Ultra-Violet Source



The best and most practical source of ultra-violet light for general experimental and entertainment use. Makes all fluorescent substances brilliantly luminescent. No transformers of any kind needed. Fits any standard amateur particle trays, etc., to obtain unique lighting effects. Sub only. Snp. Wt. 2 lbs.

ITEM NO. 87 YOUR PRICE **\$2.50**

WESTERN ELECTRIC BREAST MIKE

This is a fine light-weight aircraft carbon microphone. It weighs only 1 lb.

Mike comes with breastplate mounting and has 2-way swivel-tilt adjustment so that it can be adjusted to any desired position. There are 2 woven straps; one goes around neck, the other around chest. Straps can be snatched on and off quickly by an ingenious arrangement.

This excellent mike can be adapted for home broadcasting or private communication systems. By dismounting breastplate, it can be used as desk mike.

Comes complete with G-Root cart and hard rubber plug. Finished in spherulized plate, non-rustable. Shipping weight, 2 lbs.

ITEM 152 YOUR PRICE **\$1.49**

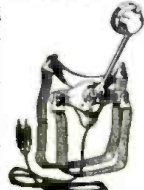

HUDSON SPECIALTIES CO.

40 West Broadway, Dept. RC-9-48, New York 7, N. Y.

I have creted below the numbers of the items I'm ordering. My full remittance of \$... is enclosed (NO C.O.D. ORDERS UNLESS ACCOMPANIED WITH A DEPOSIT.) OR my deposit of \$... is enclosed (20% remitted, ship order, balance, NO C.O.D. ORDER FOR LESS THAN \$5.00. BE SURE TO INCLUDE SHIPPING CHARGES. Circle item No. wanted.

147 159 160 87 152 33

Name _____
Address _____ Please Print Clearly
City _____ State _____

FREQUENCY (MC)	CALL	LOCATION
101.9	WVCV	Cherry Valley, N. Y.
102.1	KSTP-FM	St. Paul, Minn.
102.1	KRKN-FM	Fort Smith, Ark.
102.1	WELL-FM	Battle Creek, Mich.
102.1	WEWS-FM	Cleveland, Ohio
102.1	WFIL-FM	Philadelphia, Pa.
102.1	WIMA-FM	Lima, Ohio
102.1	WRNL-FM	Richmond, Va.
102.3	WGAY-FM	Silver Spring, Md.
102.5	WFJS	Freeport, Ill.
102.5	WBWF-FM	Topeka, Kans.
102.5	WNDR-FM	Syracuse, N. Y.
102.5	WISE-FM	Asheville, N. C.
102.5	WOAI-FM	San Antonio, Texas
102.5	WPLH-FM	Huntington, W. Va.
102.5	WRVC	Norfolk, Va.
102.5	WTSP-FM	St. Petersburg, Fla.
102.7	KCRG-FM	Enid, Okla.
102.7	KOKK-FM	Keokuk, Iowa
102.7	KFMY	Fort Dodge, Iowa
102.7	WCAO-FM	Baltimore, Md.
102.7	WSMB-FM	New Orleans, La.
102.7	WTRI-FM	Troy, N. Y.
102.9	KFOR-FM	Lincoln, Nebr.
102.9	KPRC-FM	Houston, Tex.
102.9	WCVS-FM	Springfield, Ill.
102.9	WFMU	Crawfordsville, Ind.
102.9	WHKY-FM	Hickory, N. C.
102.9	WJDX-FM	Jackson, Miss.
102.9	WLET	Toccoa, Ga.
102.9	WPEN-FM	Philadelphia, Pa.
102.9	WPIC-FM	Sharon, Pa.
102.9	WRLD-FM	Lanett, Ala.
103.1	KRJM	Santa Maria, Calif.
103.1	WCTW	New Castle, Ind.
103.1	WFMO-FM	Jersey City, N. J.
103.1	WJWJ	Wyandotte, Mich.
103.1	WOAP-FM	Owosso, Mich.
103.1	WRGK	La Grange, Ill.
103.3	KBEE	Modesto, Calif.
103.3	WAGA-FM	Atlanta, Ga.
103.3	WBQB	Dubuque, Iowa
103.3	WEEI-FM	Boston, Mass.
103.3	WZZI	Wilkes-Barre, Pa.
103.3	WLOG-FM	Logan, W. Va.
103.3	WSBA-FM	York, Pa.
103.3	WSFA-FM	Montgomery, Ala.
103.3	WSPA-FM	Nashville, Tenn.
103.5	KYSM-FM	Manitow, Minn.
103.5	WMOH-FM	Hamilton, Ohio
103.5	WSOC-FM	Charlotte, N. C.
103.5	WSTV-FM	Steubenville, Ohio
103.7	KOW-FM	San Francisco, Calif.
103.7	WFBB-FM	Altoona, Pa.
103.7	WJBY-FM	Gadsden, Ala.
103.7	WKNB-FM	New Britain, Conn.
103.7	WROV-FM	Roanoke, Va.
103.7	WSAR-FM	Fall River, Mass.
103.7	WTAX-FM	Springfield, Ill.
103.9	KENO-FM	Las Vegas, Nev.
103.9	KOPP-FM	Ogden, Utah
103.9	WBNU	Aurora, Ill.
103.9	WDLB-FM	Marshfield, Wis.
103.9	WFAS-FM	White Plains, N. Y.
103.9	WJEM	Springfield, Ohio
103.9	WTAL-FM	Tallahassee, Fla.
103.9	WXNJ	Green Brook Twp., N. J.
104.1	KFUO-FM	St. Louis, Mo.
104.1	KMFM	Monroe, La.
104.1	WBMS-FM	Boston, Mass.
104.1	WJWF-FM	Cleveland, Ohio
104.1	WLAB	Lebanon, Ind.
104.1	WMUN	Muncie, Ind.
104.1	WPAY-FM	Portsmouth, Ohio
104.1	WRUF-FM	Gainesville, Fla.
104.1	WSJS-FM	Winston-Salem, N. C.
104.3	KGNC-FM	Amarillo, Texas
104.3	KTOK-FM	Oklahoma City, Okla.
104.3	KWLK-FM	Longview, Wash.
104.3	WAFB-FM	Baton Rouge, La.
104.3	WEXL-FM	Royal Oak, Mich.
104.3	WITM-FM	Baltimore, Md.
104.3	WLOS-FM	Asheville, N. C.
104.5	KIXL-FM	Dallas, Tex.
104.5	KRCC	Richmond, Calif.
104.5	WHIS-FM	Bluefield, W. Va.
104.5	WWST-FM	Wooster, Ohio
104.7	KWFM	San Diego, Calif.
104.7	WEIM-FM	Fitchburg, Mass.
104.7	WHVA	Chargokeepsie, N. Y.
104.7	WIST	Charlotte, N. C.
104.7	WJEF-FM	Hagerstown, Md.
104.7	WJD-FM	Birmingham, Ala.
104.7	WOPT-FM	Oswego, N. Y.
104.9	KONG	Alameda, Calif.
104.9	KURV-FM	Edinburg, Tex.
104.9	WLAL	Lakewood, Ohio
104.9	WMCK-FM	McKeesport, Pa.
105.1	KCLI	Los Angeles, Calif.
105.1	WDNC-FM	Durham, N. C.
105.1	WFJM-FM	Youngstown, Ohio
105.1	WODI	Quincy, Ill.
105.1	WDCI	De Ruyter, N. Y.
105.3	WARY	Norfolk, Va.
105.3	WWHG	Hornell, N. Y.
105.5	WFOB	Fostoria, Ohio
105.7	KIMV	Hutchinson, Kans.
105.7	KUOA-FM	Siloam Springs, Ark.
105.7	WEXL-FM	Waterloo, Iowa
105.7	WARM-FM	Scranton, Pa.
105.7	WDAE-FM	Tampa, Fla.
105.7	WMBS-FM	Uniontown, Pa.
105.7	WRUN-FM	Rome, N. Y.
105.7	WSIC-FM	Statesville, N. C.
105.9	KFI-FM	Los Angeles, Calif.

BIG MONEY IN RADIO

SEE THESE BRAND NEW RADIO BOOKS FREE

COYNE'S *New 5 Volume Set* "APPLIED PRACTICAL RADIO"

You men who want to go places in Radio, and who know how much a solid working knowledge of the field helps to get the big money—this is IT! Over 1500 pages of down-to-earth Radio, from simplest principles to newest Television! It's all there easy to understand—how and why it works . . . how to construct, install, service. PA, short-wave, auto-radio, aviation, radio-phonographs, FM, testing instruments and trouble-shooting short-cuts, phototubes—you name it, COYNE'S got it, in "Applied Practical Radio"!

GET THIS BOOK FREE for LOOKING AT SET



Brand New! Explains circuits of latest sets.

PRACTICAL! CLEAR! COMPLETE!

5 big volumes—1000 illustrations and diagrams, with step-by-step photographs which "break down" the equipment for you to show what makes it "tick". Up-to-the-minute, complete, easy to follow . . . written as only COYNE books are written!

SEE IT FREE FOR 7 DAYS

JUST OFF THE PRESS!

VALUABLE BOOK FREE for Looking at 5-Volume Set

Send This Coupon NOW

You must SEE these books to know how easy it is to prepare for the big jobs in radio. Here's our special offer:—we'll send the complete 5-volume set for your 7-Day FREE Examination. And with it, we'll include our valuable, new guide for all radiomen, "150 New Radio Diagrams Explained", absolutely FREE! If you keep the 5-volume Set all you pay is \$3.00 within 7 days after the books arrive and \$3.00 per month until \$16.75 is paid—or you can pay \$15.00 cash price. If you don't want the set, return it and you OWE NOTHING. But either way you keep the "150 Radio Diagrams Book" as a gift. That book is ABSOLUTELY FREE.

EDUCATIONAL BOOK PUBLISHING DIVISION
COYNE ELECTRICAL & RADIO SCHOOL
Dept. 68-T1, 500 S. Paulina St., Chicago 12, Ill.

O. K., send me postpaid your new 5-volume set, "Applied Practical Radio" on 7 days "free trial" per your offer in Radio Craft. Be sure to include the book of 150 New Radio Diagrams Explained, absolutely FREE.

NAME _____ AGE _____
ADDRESS _____
TOWN _____ ZONE _____ STATE _____

SEND NO MONEY REMEMBER—Coupon is not an order, just a request to see set free and get the FREE BOOK. But offer is limited, so act at once!

COYNE ELECTRICAL & RADIO SCHOOL (Founded 1899)
500 S. Paulina St., Dept. 68-T1, Chicago 12, Ill.

• TEST-AID • FIRST-AID FOR RADIO-TELE SETS



ONLY \$15.95

COMPLETE
•
WRITE FOR CATALOG SHEET

- QUICKLY LOCATES FAULTY CONDENSERS AND RESISTORS FOR FAST SERVICING
 - SUBSTITUTES 11 DIFFERENT VALUES OF CAP. OR RES. WITH SET IN OPERATION 50mmf to 40mf 450-600 WVDC—27 ohms to 5 meg.
 - CHECKS CONDENSER LEAKAGE ON DIRECT CURRENT SUPPLIED FROM OWN PWR SUP.
 - OUTPUT INDICATOR FOR ALIGNMENT—CONTINUITY CHECKS
 - PROVIDES 100 VOLTS AT 100 MA FOR EXPERIMENTS.
- These are only a few of the many uses of the TEST-AID. See them at your dealer or write us direct.

Custom Craft MANUFACTURING CO.

256 E. 98th STREET, BKLYN, N. Y.

GENERAL ELECTRIC RT-1248 15-TUBE TRANSMITTER-RECEIVER

TERRIFIC POWER—(26 watts) on any two instantly selected, easily pre-adjusted frequencies from 435 to 500 mc. Transmitter uses 5 tubes including a Western Electric 316 A as final. Receiver uses 10 tubes including 155's as first detector and oscillator, and 7H7's as IF's, with 4 slug-tuned 40 Mc. IF transformers, plus a 7H7, 7E6's and 7E7's. In addition unit contains 8 relays designed to operate any sort of external equipment when actuated by a received signal from a similar set elsewhere. Originally designed for 12 volt operation, power supply is not included, as it is a cinch for any amateur to connect this unit for 110V AC, using any supply capable of 400V DC at 135MA. The ideal unit for use in mobile or stationary service in the Citizen's Radio Telephone Band where no license is necessary. Instructions and diagrams supplied for running the RT-1248 transmitter on either code or voice in AM or FM transmission or reception, for use as a mobile public address system, as an 80 to 110 Mc. FM broadcast receiver, as a Piesimile transmitter or receiver, as an amateur television transmitter or receiver, for remote control relay hookups, for Geiger-Mueller counter applications. It sells for only \$29.95 or two for \$53.90. If desired for marine or mobile use, the dynamotor which will work on either 12 or 24V DC and supply all power for the set is only \$15.00 additional.

BUFFALO RADIO SUPPLY
219-221 Genesee Street, Buffalo 3, N. Y. Dept. 9C

FREQUENCY (MC) CALL LOCATION

105.9	KOMA-FM	Oklahoma City, Okla.
105.9	KSBS	Kansas City, Kans.
106.1	KDNT-FM	Denton, Tex.
106.1	KGO-FM	San Francisco, Calif.
106.1	KIDO-FM	Boise, Idaho
106.1	WKJG-FM	Ft. Wayne, Ind.
106.1	WKNP-FM	Corning, N. Y.
106.1	WLOB-FM	Claremont, N. H.
106.1	WHTT-FM	Hartford, Conn.
106.3	WMLN	Mt. Clemens, Mich.
106.3	WOTW-FM	Nashua, N. H.
106.5	WBEN-FM	Buffalo, N. Y.
106.5	WFML	Washington, Ind.
106.5	WGOR	Ft. Lauderdale, Fla.
106.5	WRGA-FM	Rome, Ga.
106.5	WSTP-FM	Salisbury, N. C.
106.7	WCLC	Clarksville, Tenn.
106.7	WGTM-FM	Wilson, N. C.
106.9	WHHM-FM	Memphis, Tenn.
106.9	WMIT	Winston-Salem, N. C.
107.1	WAJL	Flint, Mich.
107.1	WCAF-FM	Asbury Park, N. J.
107.1	WLEY	Elmwood Park, Ill.
107.1	WWDX-FM	Paterson, N. J.
107.3	KSEO-FM	Durant, Okla.
107.3	WBNB	Beloit, Wis.
107.3	WFMI	Portsmouth, N. H.
107.3	WMAL-FM	Washington, D. C.
107.5	KTEM-FM	Temple, Texas
107.7	KESA	Fort Smith, Ark.
107.7	WAYS-FM	Charlotte, N. C.
107.9	XKOA-FM	Sacramento, Calif.
107.9	WAB8	Mobile, Ala.
107.9	WDAK-FM	Columbus, Ga.
107.9	WEMI	New Haven, Conn.
107.7	WFNF	Wethersfield, N. Y.
107.7	WLIV	Providence, R. I.
107.7	WVBN	Turin, N. Y.
107.9	WEST-FM	Bethlehem, Pa.
107.9	WRRN-FM	Warren, Ohio
107.9	WWOD-FM	Lynchburg, Va.

The stations are listed this month by frequency and the list was checked against the latest information available. We'll have another list for you, probably in December, giving the latest information. This month's list gives 121 stations more than our June list, indicating the rapid growth of FM.

WAR SURPLUS BARGAIN SPECIAL!

Brand New BEAM ANTENNA ROTATOR MOTOR

\$5.95

Postpaid in Continental U.S.A.

- OPERATES DIRECTLY ON 110V AC, 60 CYCLES (Requires only 12 MFD Condenser)
- NO STEP-DOWN TRANS. NEEDED
- NO LINE RESISTOR NEEDED
- HIGH TORQUE — NO FREE SWING
- APPROX. 3/4 R.P.M.
- REVERSIBLE — ONLY THREE WIRES NEEDED
- ELECTRICALLY & MECHANICALLY QUIET
- LIGHTWEIGHT, RUGGED, QUIET
- MOTOR & GEARS OIL SEALED
- NO EXPENSIVE CONVERSIONS
- FLAT MOUNTING SURFACE — FOUR TAPPED HOLES
- FB. FOR 2-6-10-LITE 20 BEAMS
- FREE COMPLETE INSTRUCTIONS & DIAGRAMS

ALVARADIO SUPPLY CO.
DEPT. RC3, 903 SO. ALVARADO
LOS ANGELES 6, CALIFORNIA

PEN-OSCIL-LITE

Extremely convenient test oscillator for all radio servicing; alignment • Small as a pen • Self powered • Range from 700 cycles audio to over 600 megacycles u.h.f. • Output from zero to 125 v. • Low in cost • Used by Signal Corps • Write for information.

GENERAL TEST EQUIPMENT

38 Argyle Ave. Buffalo 9, N. Y.

• TUBE SPECIALS •

AC-DC five—50L6GT, 35Z5GT, 12SA7, K7, Q7GT...\$1.90
Miniature five—50B5, 35W4, 12AT6, BA6, BE6... 1.90
★ TWO JUMBO ASSORTMENTS ★
40-35Z5, 20-50L6, 10 ea. 35L6, 12SA7, K7, Q7, 100 tubes.
40-33W4, 30-50B5, 10 ea. 12AT6, BA6, BE6, 100 tubes.
Either of the above specials at only \$34.00.

Every tube new and perfect. Guaranteed 100%.
Selenium rectifiers 100MA—ten for \$7.20
Postage extra. 20% deposit on C.O.D. orders.
Send for our new bargain list.

HALLMARK ELECTRONIC CORPORATION
592 Communipaw Ave. Jersey City 4, New Jersey



Answers
Your
Questions

**GERNSBACK
LIBRARY**

PRACTICAL INFORMATION

Here is the book that thousands of radio enthusiasts have been waiting for. Whether you're interested in amateur or professional recording, you'll find **PRACTICAL DISC RECORDING** by Richard H. Dorf invaluable. It not only tells you how to make successful records, but in addition each important recording component is given a full chapter, explaining its purpose, and what features to look for when buying. You'll like this book for many reasons. Without waste of words, it gets right down to business on the first page. It tells you what you need to make good records and how to do it by using any type equipment—from the simplest to the most expensive—depending on your purpose and pocketbook. You will find all the practical phases of recording covered as well as the underlying principles.

FILLED WITH FACTS

Chapter 1 discusses the various components which make up the complete system. Chapters 2 to 5 go into the practical details of the selection and use of discs, motors and turntables, feed mechanisms and cutters. Chapter 6 is a comprehensive explanation of constant amplitude and constant velocity recording, the two fundamental recording characteristics on which all recording is based. Chapter 7 covers stylus selection. In Chapter 8 the various sound sources (microphone, radio-tuner, etc.) are discussed. A feature is the handy chart of characteristics of different types of microphones. Chapter 9 discusses the all important amplifier. Circuits of several practical amplifiers are given. In Chapters 10 thru 13, you'll find explained the detailed techniques of making good records. All the fine points of adjustment, equalization, microphone placement and microphone technique, and a whole chapter on dubbing. Chapter 14 is a concise summary of common troubles in recording, and how to overcome them. The book ends with a comprehensive glossary of recording terms.

96 PAGES 82 ILLUSTRATIONS

Only 75c

See your jobber today or send for **PRACTICAL DISC RECORDING** along with other titles in the **GERNSBACK LIBRARY**.

MAIL THIS COUPON NOW

RADCRAFT PUBLICATIONS, Dept. 117
25 West Broadway, New York 7, N. Y.

Send me the books (postpaid) checked.

NO. 39—PRACTICAL DISC RECORDING 75c

I enclose \$.....

Your Name
(Print clearly)

Address

Jobber's Name

Address

10 OTHER BOOKS—50c EACH

- No. 29—Handy Kinks and Short Cuts
- No. 30—Unusual Patented Circuits
- No. 31—Radio Questions and Answers
- No. 32—Advanced Service Technique
- No. 33—Amplifier Builder's Guide
- No. 34—Radio-Electronic Circuits
- No. 35—Amateur Radio Builder's Guide
- No. 36—Radio Test Instruments
- No. 37—Elementary Radio Servicing
- No. 38—How to Build Radio Receivers

TECHNIQUE OF MICROWAVE MEASUREMENTS (Volume XI of the M.I.T. Radiation Laboratory Series), edited by Carol G. Montgomery. Published by McGraw-Hill Book Co., Inc. 6 1/4 x 9 1/4 inches, 939 pages. Price \$10.

Like the other volumes of the MIT Radiation Laboratory series, Volume XI is a compilation, written by several authors, of knowledge gained during the war in many laboratories.

There are four main measurement techniques covered by the book. These are power, frequency and wavelength, impedance and standing waves, and attenuation and radiation. Each technique differs radically from its counterpart in low-frequency work. Not only must standard procedures be revised, but many new factors must be taken into account. The dielectric constants of all the media and materials concerned must be accurately known, for example, and such properties as the capacitance and inductance of the shortest wire connections assume great importance. Electron transit time makes normal tubes useless in microwave work and special klystrons have been developed.

This volume is a comprehensive and authoritative compilation of all the available information on microwave measurement. But in describing measurements, a good deal of information on the basic methods of generation, propagation, and reception is given. The calculation of waveguide dimensions and the conformation of the guides is treated in great detail, as are many other subjects, such as klystrons, oscillators, and attenuators.—R.H.D.

TELEVISION—HOW IT WORKS, by Wm. Bouie, S. D. Usian, H. Chanes and R. F. Knech. Published by John F. Rider Publisher, Inc. Paper covers, 8 1/2 x 11 inches, 203 pages. Price \$2.70.

The works of four authors have been combined in this latest edition to the Rider's "How it Works" series. These authors present television theory so it is easily understood by anyone with a knowledge of basic radio.

There are 12 chapters covering television systems, television signals, antennas, r.f. circuits, audio and video channels, sync and sweep circuits, picture tubes, power supplies, and TV receiver servicing. The book is well illustrated with drawings and partial schematics showing various types of circuits found in the more common TV receivers.—RFS.

TELEVISION AND FM RECEIVER SERVICING, by Milton S. Kiver. Published by D. Van Nostrand Co., Inc. Paper covers, 8 1/2 x 11 inches, 212 pages. Price \$2.95.

This is a practical treatment of television and FM receiver servicing theory and practice prepared by the author of *Television Simplified* and *FM Simplified*. The first chapter covers v.h.f. antenna systems, their characteristics and installation methods. Design data is given on several types of FM and TV antennas and a number of commercial systems are illustrated and described. The next eight chapters are devoted entirely to television receiver servicing. Equipment required for servicing is described and illustrated with block diagrams and simplified schematics. Pictures of test patterns show the effects

of various types of interference and maladjustment within the set.

The last four chapters cover FM fundamentals, typical commercial FM receiver circuits, and aligning and servicing FM receivers.

This book will prove useful to TV and FM service technicians, particularly when manufacturer's servicing data is not available.—R.F.S.

ELEMENTARY INDUSTRIAL ELECTRONICS. by William R. Wellman. Published by D. Van Nostrand Co., Inc. 6 1/4 x 9 1/4 inches, 372 pages. Price \$3.20.

Those persons interested in electronic tubes and their industrial applications, will find this book informative and easy to read. It has been prepared for students, maintenance engineers and workers in allied fields who desire a basic knowledge of electronics.

Among the devices and theories described are: a.c. fundamentals, basic principles of vacuum tubes, gas-filled tubes, industrial applications of kenotrons, applications of hot-cathode gas-type rectifiers, mercury-pool rectifiers, vacuum-tube amplifiers, industrial high frequency heating, electronic control of motors and generators, electronic control of resistance welding, photoelectric devices, and electronic lamps.

The reader will appreciate the carefully worded descriptions of the actions occurring in various types of tubes, together with the clear diagrams. A chapter is devoted to electronic symbols and terms, suitably illustrated. The section on kenotrons and hot-cathode gas-filled rectifiers includes diagrams of thyatron battery chargers and a thyatron inverter. All types of v.t. amplifiers are described, with circuit diagrams. The growing use of high frequency heating for industrial purposes makes this section particularly useful.

The chapter on electronic lamps covers many details scarcely ever mentioned in the average book on electronics. Different types of electronic lamps discussed are glow lamps of the argon and neon types, neon lighting tubes, sodium vapor lamps, high-intensity mercury vapor lamps, fluorescent lamps and their characteristics, and the high-intensity photoflash lamp. A series of questions and references are given at the end of each chapter. A suitable index completes the work.—H.W.S.

RADAR. What Radar Is and How It Works (Revised Edition). by Orrin E. Dunlap, Jr. Published by Harper & Brothers. 5 1/2 x 8 1/4 inches, 268 pages. Price \$3.00.

This is a book for the layman who has no technical background but still would like to know how radar works.

The author writes in a clear and interesting style and begins with the early inventions that led to the final development of radar as we know it today. Photos of radar apparatus and the inventors who helped to perfect it are included in the work. Many of the amazing feats performed by radar during the war are described. The later chapters deal with post-war applications of radar, the development of Teleran, Shoran, G.C.A. radar, and other systems.

The simple method of sending out pulses of radio energy and measuring

BOTH BOOKS FREE

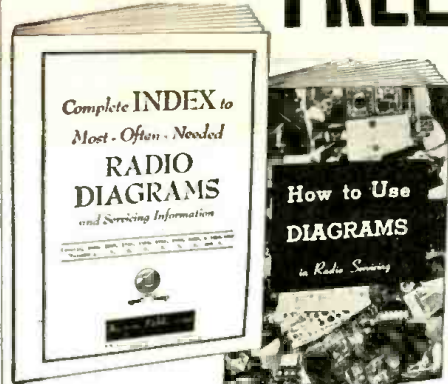

FREE to every reader of Radio-Craft. No strings, nothing to buy. "How to Use Diagrams" gives hints, suggestions, short cuts on the use of diagrams in radio servicing. The 26-page INDEX will tell you just what models are included in "SUPREME" "Most-Often-Needed Radio Diagrams" manuals. If you need a circuit at any time, the INDEX will tell you where to get it. Get both books in 2-40-1 volume FREE, just send 2c stamp for postage.

SUPREME PUBLICATIONS 9 S. Kedzie Ave. Chicago 12, ILL.

**NOW—A REALLY HIGH-POWERED—
Radio Engineering
Library**



NOTE:
The Library comprises a selection of books culled from leading McGraw-Hill publications in the radio field.

- especially selected by radio specialists of McGraw-Hill publications
- to give most complete, dependable coverage of facts needed by all whose fields are grounded on radio fundamentals
- available at a special price and terms

THESE books cover circuit phenomena, tube theory, networks, measurements, and other subjects—give specialized treatments of all fields of practical design and application. They are books of recognized position in the literature—books you will refer to and be referred to often. If you are a practical designer, researcher or engineer in any field based on radio, you want these books for the help they give in hundreds of problems throughout the whole field of radio engineering.

- 5 VOLUMES, 3319 PAGES, 2289 ILLUSTRATIONS**
1. Eastman's FUNDAMENTALS OF VACUUM TUBES
 2. Terman's RADIO ENGINEERING
 3. Everitt's COMMUNICATION ENGINEERING
 4. Hund's HIGH FREQUENCY MEASUREMENTS
 5. Henney's RADIO ENGINEERING HANDBOOK

10 days' examination. Easy terms. Special price under this offer less than books bought separately. Add these standard works in your library now; pay small monthly installments, while you use the books.

10 DAYS' FREE EXAMINATION—SEND COUPON
McGraw-Hill Book Co., Inc. 330 W. 42nd St., N.Y.C. 18

Send me Radio Engineering Library, 5 vols., for 10 days' examination on approval. In 10 days I will send \$2.50, plus few cents postage, and \$5.00 monthly till \$27.50 is paid, or return books postpaid. (We pay postage on orders accompanied by remittance of the first installment.)

Name

Address

City and State

Company

Position

the time required for the echo to be received when the wave is reflected by a ship, plane or other object, is clearly explained. If you have not kept up to date on the many applications and improved forms of radar, this book will acquaint you with them.—H.W.S.

PLEASE TEAR OUT THIS ADV. AS REMINDER

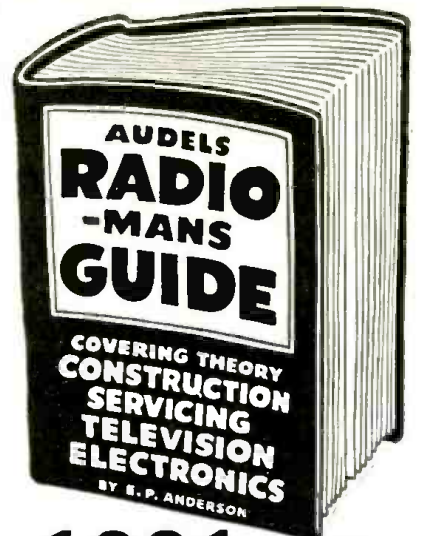

1001 RADIO FACTS AND FIGURES

AUDELS RADIOMANS GUIDE—914 Pages, 633 Illustrations, Photos, Wiring Diagrams, 38 Big Chapters, covering Radio Theory, Construction, Servicing, including Important Data on Developments in Television, Electronics and Frequency Modulation, Review, Questions and Answers, Calculations & Testing, Highly Endorsed—Indispensable for Ready Reference and Home Study.

\$4 COMPLETE • PAY ONLY \$1 A MONTH
Step up your own skill with the facts and figures of your trade. Audels Mechanics Guides contain Practical Inside Trade Information in a handy form. Fully Illustrated and Easy to Understand. Highly Endorsed. Check the book you want for 7 days' Free Examination.

Send No Money. Nothing to pay postman.

CUT HERE MAIL ORDER

AUDEL, Publishers, 49 W. 23 St., NEW YORK 10, N. Y.

Please send me postpaid for FREE EXAMINATION books marked (x) below. If I decide to keep them I agree to mail \$1 in 7 Days on each book ordered and further mail \$1 monthly on each book until I have paid price—otherwise, I will return them.

- RADIOMANS GUIDE, 914 Pages . . . \$4
- ELECTRICIANS EXAMINATIONS, 250 Pages . . . 1
- WIRING DIAGRAMS, 210 Pages . . . 1
- ELECTRIC MOTOR GUIDE, 1000 Pages . . . 4
- ELECTRICAL DICTIONARY, 9000 Terms . . . 2
- ELECTRICAL POWER CALCULATIONS, 425 Pgs. . . 2
- HANDY BOOK OF ELECTRICITY, 1440 Pages . . . 4
- ELECTRONIC DEVICES, 216 Pages . . . 2
- ELECTRIC LIBRARY, 12 vol., 7000 Pgs., \$1.50 vol. . . 1
- OIL BURNER GUIDE, 384 Pages . . . 1
- REFRIGERATION & Air Conditioning, 1280 Pgs. . . 4
- POWER PLANT ENGINEERS Guide, 1500 Pages . . . 4
- PUMPS, Hydraulics & Air Compressors, 1658 Pgs. . . 4
- WELDERS GUIDE, 400 Pages . . . 1
- BLUE PRINT READING, 416 Pages . . . 2
- SHEET METAL WORKERS Handy Book, 388 Pgs. . . 1
- SHEET METAL PATTERN LAYOUTS, 1100 Pgs. . . 4
- AIRCRAFT WORKER, 240 Pages . . . 1
- MATHEMATICS & CALCULATIONS, 700 Pgs. . . 2
- MACHINISTS Handy Book, 1600 Pages . . . 4
- MECHANICAL Dictionary, 968 Pages . . . 4
- AUTOMOBILE GUIDE, 1700 Pages . . . 4
- DIESEL ENGINE MANUAL, 400 Pages . . . 2
- MARINE ENGINEERS Handy Book, 1280 Pages . . . 4
- MECHANICAL DRAWING GUIDE, 160 Pages . . . 1
- MECHANICAL DRAWING & DESIGN, 480 Pgs. . . 2
- MILLWRIGHTS & Mechanics Guide, 1200 Pgs. . . 4
- CARPENTERS & Builders Guides (4 vols.) . . . 6
- PLUMBERS & Steamfitters Guides (4 vols.) . . . 6
- MASONS & Builders Guides (4 vols.) . . . 6
- MASTER PAINTER & DECORATOR, 320 Pgs. . . 2
- GARDENERS & GROWERS GUIDES (4 vols.) . . . 6
- ENGINEERS and Mechanics Guides . . . 12
- Nos. 1, 2, 3, 4, 5, 6, 7 and 8 complete . . . 1
- Answers on Practical ENGINEERING . . . 1
- ENGINEERS & FIREMANS EXAMINATIONS . . . 1

Name

Address

Occupation

Employed by

RADIO SCHOOL DIRECTORY

PRACTICAL TECHNICAL TRAINING

Specialize IN RADIO, ELECTRONICS
ELECTRICAL ENGINEERING

Prepare for a successful career in industry or a business of your own in 6 months to 3 years. More than 35,000 former students in industry the world over. 1,538 students now enrolled from 48 states and 13 overseas countries. Faculty of 72 specialists. Write for Catalog and Personal Guidance Questionnaire.

Terms start *September, January, April, July.*



B.S. Degree
in Electrical
Engineering
with Major in
Electronics
in 3 Years.

MILWAUKEE
SCHOOL of ENGINEERING
A Technical Institute Founded 1903

Dept. RC-948 North Broadway, Milwaukee, Wisconsin

COURSES

SERVICE

- 6 to 12 Months
- Electricity
- Welding
- Refrigeration
- Heating

TECHNICIAN

- 1 to 2 Years
- Electricity
- Radio
- Electronics
- Refrigeration, Heating and Air Conditioning

PROFESSIONAL

- 3 Years
- Electrical Engineering
- Bachelor of Science Degree
- Major in Machinery or Electronics

WANTED:

Men and Women to Fill
TOP RADIO JOBS
in AM—FM—Television

If you are looking for a career with a future, why not join the hundreds of graduates from the Don Martin School of Radio Arts now successfully employed in the radio industry. The demand is great for qualified radio personnel in AM-FM-Television. Train now to be an announcer, script writer, disk jockey, news-caster, or radio technician. Complete day and night classes... the latest equipment. Free placement service. Approved for veterans. Write for free booklet.

Don Martin School of Radio Arts

1655 North Cherokee St. Hollywood 28, Calif.

LEARN RADIO!

IN ONLY 10 MONTHS
PREPARE FOR A GOOD JOB!
COMMERCIAL OPERATOR (CODE)
BROADCAST ENGINEER
RADIO SERVICEMAN

Television Servicing—15 Months

Veterans get \$130.00 Equipment
SEND FOR FREE LITERATURE
BALTIMORE TECHNICAL INSTITUTE
1425 Eutaw Place, Dept. C, Baltimore 17, Md.

FM-RADIO-TV PRACTICAL TRAINING

Four fully-equipped laboratories provide the PRACTICAL training essential for successful careers in Radio Communications (FCC licenses) and in Radio-Television Servicing (Technician). Train under the supervision of technical specialists — with commercial-type equipment. Investigate why WRCI SPECIALIZED TRAINING methods are outstanding: why WRCI laboratory-trained specialists are in demand. Read our illustrated bulletin before enrolling in any school. Approved for veteran training—non-veterans accepted. Send for free copy of Bulletin-M today.

Western Radio Communications Institute

Specialists in Radio-Electronics Training
341 West 18th Street, Los Angeles 15, Calif.

RADIO ENGINEERING

FM—Television—Broadcast

Police Radio, Marine Radio, Radio Servicing, Aviation Radio and Ultra High mobile applications. Thorough training in all branches of Radio and Electronics. Modern laboratories and equipment. Old established school. Ample housing facilities. 7 acre campus. Small classes, enrollments limited. Our graduates are in demand. Write for catalog.

Approved for Veterans

VALPARAISO TECHNICAL INSTITUTE
Dept. C VALPARAISO, INDIANA

RADIO ENGINEERING!

Complete Radio Engineering Course. Bachelor of Science Degree. Courses also in Civil, Electrical, Mechanical, Chemical, Aeronautical Engineering; Business Administration, Accounting, Secretarial Science. Graduates successful. 65th year. Enter Sept., Jan., March, June. Write for catalog.

TRI-STATE COLLEGE 2498 College Ave. ANGOLA INDIANA

CORRESPONDENCE COURSES IN RADIO and ELECTRICAL ENGINEERING

ELECTRICAL ENGINEERING Get good grasp of wide electrical field. Prepare yourself at Low Cost, for secure future. Modern course. So simplified anyone can understand quickly.
RADIO ENGINEERING Extra fine course in radio. public address, photo-electric work. Trains you to be super-service man, real vacuum-tube technician. Servicemen needed badly. Diploma on completion. Many graduates earning big pay.
WRITE Send postcard for Free Copies of school catalog, full details, all about deferred payment plan. \$25 Course experimental kits, etc.
Lincoln Engineering School, Box 931-C-125, Lincoln 2, Nebr.



RADIO COURSES

Preparatory, Service, Broadcast, Television, Marine Operating, Aeronautical, Frequency Modulation, Radar.

Classes forming for fall term Oct. 1.
Entrance exam Sept. 20.
Veterans. Literature.

COMMERCIAL RADIO INSTITUTE
(Founded 1920)
38 West Bliddle Street, Baltimore 1, Md.



RCA INSTITUTES, Inc.

Offer thorough training courses in all technical phases of
Radio and Television

DAYS—EVENINGS WEEKLY RATES
VETERANS: RCA Institutes is approved under G. I. Bill of Rights
For Free Catalog Write Dept. RC-48
RCA INSTITUTES, Inc.
A Service of Radio Corporation of America
350 WEST 4TH STREET NEW YORK 14, N. Y.

A CAREER WITH A FUTURE! TELEVISION

SHOP WORK • SHOP TECHNIQUES • THEORY • FULLY EQUIPPED LABORATORIES

- RADIO SERVICE & REPAIR
- F. M. & TELEVISION
- TRANSMITTER COURSES

Preparing for F.C.C. LICENSES

- RADIO TECHNOLOGY

MORNING • AFTERNOON • EVENING CLASSES • MODERATE RATES • INSTALLMENTS AVAILABLE UNDER G. I. BILL

DELEHANTY SCHOOL OF RADIO • ELECTRONICS • TELEVISION
105 EAST 13th STREET, NEW YORK 3, N. Y. • DEPT. R
LICENSED BY STATE OF NEW YORK

RADIO

TECHNICIAN and RADIO SERVICE COURSES
FM and TELEVISION

AMERICAN RADIO INSTITUTE
101 West 63rd St., New York 23, New York
Approved Under GI Bill of Rights
Licensed by New York State

RADIO COURSES

- RADIO OPERATING
- RADIO SERVICING
- CODE
- ELECTRONICS
- F.M. TELEVISION

- REFRIGERATION SERVICING

Write for Catalog and Picture Brochure

Y.M.C.A. TRADE & TECHNICAL SCHOOLS
15 W. 63rd St. (N'r B'way) New York City



SHORT CUT **CODE SPEED**
Be an Expert

Learn to be a Telegrapher or Radio Operator. Thousands of men needed. Intensely interesting work—good pay. Learn at home or wherever you are, quickly, easily, with the famous Candler Code Speed System. Quality for amateur or commercial license. Book of particulars free.

CANDLER SYSTEM CO.
Dept. 3-K, Box 928, Denver 1, Colo.

THIS COUPON MAY PROVE TO BE THE KEY TO YOUR SUCCESS IN ELECTRONICS

MELVILLE RADIO INSTITUTE
The Progressive Radio School
Managed by Radio Men

Licensed by the N. Y. State Board of Education
RECOGNIZED BY INDUSTRY
APPROVED FOR VETERANS

CUT IT OUT! FILL IT OUT! MAIL IT OUT! — NOW!

MELVILLE RADIO INSTITUTE RC
Melville Bldg., 15 W. 46th St., N. Y. 19, N. Y.

Send me without obligation information about your intensive courses:

- Radio Technician
- Radio & Television Servicing
- Radio Communications
- Fundamental Radio Mathematics

My Name.....
Address.....

THE TABLE OF CONTENTS

Dear Editor:

The Table of Contents in RADIO-CRAFT is almost invariably on page 10. That is inconvenient for the newsstand buyer, who may want to see what's in the magazine before he buys it. It's also a nuisance to the owner of back issues when he tries to find an article and has to thumb through 9 pages of advertising before finding the contents page.

How about putting the Table of Contents on page 2? That will save much wear and tear on the fingertips and the temper!

NATE SILVERMAN,
Los Angeles, Calif.

(Turn to the second page of this issue and take a look. You'll find the Table of Contents there! Mechanical printing difficulties have long prevented our putting it on the second page but from this month on, readers will be able to find out what's in RADIO-CRAFT without any trouble.—Editor)

MORE SERVICE ARTICLES

Dear Editor:

I have followed RADIO-CRAFT for about as long as it has been published. I enjoy the April Fool stories such as Fips' *Tubeless Homo-Heteradio* (RADIO-CRAFT, April, 1948) as well as the technical items.

There has been a lot of talk about a paper shortage which is forcing magazines to limit their size. In common, I think, with most readers, I approve of light material like the Fips article occasionally, but my interest in radio makes me wish that instead of printing letters from readers who try to tell taller and taller stories, you would use the space for radio articles.

I think, too, that you give too much space in the *Technotes* department to reports on very familiar troubles and very rare cases that are not likely to happen again. I would like to see that space used for more good articles on modern servicing methods.

ROBERT F. STONES,
Daytona Beach, Fla.

BEST CRYSTAL CIRCUIT

Dear Editor:

Spain, in the December, 1946, RADIO-CRAFT, gave crystal enthusiasts about as good a receiver as can be put together without using expensive parts. After I tried it for three months in competition with the "Loud" *Crystal Radio* (RADIO-CRAFT, September, 1945) and the *Modern Midget Set* (RADIO-CRAFT, January, 1948) I give it my medal for superiority.

All the sets were compared using the same components except for the capacitors. The coils were carefully trimmed for best results.

By the way, I am using the same galenas as when I started making crystal receivers in 1920!

G. S. ROBERTSON,
Montreal, Canada



NOW!
BUILD 15 RADIOS \$14⁷⁵
COMPLETE KIT ONLY...

ABSOLUTELY NO KNOWLEDGE OF RADIO NECESSARY
YOU NEED NO ADDITIONAL PARTS!

THE PROGRESSIVE RADIO KIT is the ONLY COMPLETE KIT

Operates on 110-120 volts AC/DC. Contains everything you need. Instruction Book, Metal Chassis, Tubes, Condensers, Resistors and all other necessary radio parts. The 36-page Instruction Book written by expert radio instructors and engineers teaches you to build radios in a professional manner. The first circuit built is a simple one-tube detector receiver. Each succeeding circuit incorporates new arrangements of detectors, RF and AF amplifiers. This kit is excellent for learning the principles of receiver, transmitter and amplifier design. It is used in many radio schools and colleges. All of the commonly-used detectors are used, including diode, grid leak, plate and infinite-impedance. The transmitters are designed with Hartley and Armstrong oscillators, using screen-grid and con-

trol-grid modulation. Both vacuum tube and selenium rectification are employed in these circuits. The circuits are designed to provide excellent performance. Altogether, fifteen circuits are constructed, including 11 receivers, 1 audio amplifier, and 3 transmitters. The sets start with simple circuits of 1 tube plus rectifier, gradually grow more complex, and finish with several examples of radio sets using three tubes plus rectifier.

PROGRESSIVE RADIO KIT—ONLY \$14.75

SPECIAL FREE OFFER

Electrical and Radio Tester sent absolutely FREE with each Progressive Radio Kit. PLUS FREE membership in Progressive Radio Club. Entitles you to free expert advice and consultation service with licensed radio technicians. Write for further information or order your KIT NOW!

WE PAY POSTAGE ON PREPAID ORDERS
C.O.D. ORDERS SHIPPED COLLECT

ATTENTION RADIOMEN!!

Progressive's new DEALER'S CATALOGUE is just off the press

● RADIO KITS	● PORTABLE RADIOS
● AMPLIFIER KITS	● CAMERA-RADIOS
● FM COIL & CONDENSER KITS	● TUBES
● RESISTOR KITS	● AUTO RADIOS
● CONDENSER KITS	● HOME RADIOS
● RADIO TOOL KITS	● TELEVISION SETS
● FM-AM CHASSIS	● TELEVISION CABINETS
● SPEAKERS	● TEST EQUIPMENT
● RADIO PARTS	● FM TUNERS

SEND FOR YOUR FREE DEALER'S CATALOG AND PRICE LIST TODAY!

PROGRESSIVE ELECTRONICS CO.
DEPT. RC-17 497 UNION AVE BROOKLN 11, N. Y.

TELEVISION 1948!!

Train at an Institute that pioneered in TELEVISION TRAINING since 1938. Morning, Afternoon or Evening Sessions in laboratory and theoretical instruction, under guidance of experts, covering all phases of Radio, Frequency Modulation, Television, lead to opportunities in Industry, Broadcasting or own Business. Licensed by N. Y. State. Approved for Veterans.

ENROLL NOW FOR NEW CLASSES

Visit, Write or Phone

RADIO-TELEVISION INSTITUTE

480 Lexington Ave., N. Y. 17 (46th St.)
PLaza 3-4585 2 blocks from Grand Central

Hollywood Experts Help You Make Good in RADIO-TELEVISION at Home

Direct from Hollywood, nerve-center of broadcasting, Television, Radio and Sound activities, comes R.T.A.'s time-proven and tested home training. Here at last—easy to learn, home instruction that quickly qualifies you for steady, good-pay jobs or your own Radio business. 10 big kits of radio parts given at no extra charge. Get full details at once! Send postal for FREE BOOK "How to Make Good in Radio-Television."

RADIO TRAINING ASS'N OF AMERICA, Dept. RCN
5620 Hollywood Blvd. Hollywood 28, Calif.

SOUND RECORDING SCHOOL

A practical engineering course in Sound Fundamentals, Recording, and Sound Transmission measurements; in a laboratory containing transmission sets, oscillators, square wave generator and intermodulation analyzer, and other equipment.

Complete recording studio assimilating broadcast, motion picture and commercial sound recording, under the direction of H. M. Tremaine.

HOLLYWOOD SOUND INSTITUTE, Inc.

1040-C No. Kenmore Hollywood 27, Calif.



Combination Broadcast Receiver & Intercom System

Price includes radio-master station, 1 remote, & 50 ft. of wire

BRAND NEW
\$29.95
LIMITED QUANTITY

Standard broadcast (6 tube superhet) receiver, plus home or office intercommunication system, walnut finish, modern design table model; high quality components; uses one to four remote stations. Any station can call the master while radio is playing; call can be returned to any remote. 115 v. AC; original list was \$84.50 (with 4 remotes). Additional remote stations, \$3.95 each.

R & M RADIO COMPANY

1426 N. QUINCY ST. Dept. RC-98
ARLINGTON, VIRGINIA



EXCITING! EXCITER BARGAIN

25 to 40 WATTS
10 to 80 METERS FOUNDATION KIT

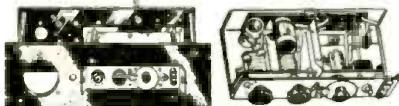

Engineered around the BC-610 series of plug-in tuning units. Described in the 11th edition Radio Handbook. Completed exciter uses 6AG7 crystal or electron coupled oscillator, 6L6 buffer-doubler and 807 amplifier. Kit includes four tuning units (illustrated at right above with cover removed), special 5/4" aluminum relay rack panel, socket for plug-in units and special hardware, together with full instructions and diagrams for assembling complete exciter.

No. 31A28, FU-40 Foundation, Spec. **\$9.95**

PARTS KIT. Everything needed to complete exciter except tubes and power supply. Includes all mica condensers, resistors, RF chokes, sockets, meter switch, 0-200 ma meter, key jack, and miscellaneous parts.
No. 31A28A, Special Per Kit, Each. **\$9.31**

DID YOU GET IT?

THE BIG B-A 1948 Catalog No. 481 — Everything in Radio and Electronics. Write if you have not received it. **FREE** on request.



RADIO-CRAFT needs more photos of service shops and service benches. We will pay \$6.00 for each 6x8- or 8x10-inch glossy photo accepted. Do not "dress up" your bench, but take a bona-fide photo, preferably with men working.

OPPORTUNITY AD-LETS

Advertisements in this section cost 25c a word for each insertion. Name, address and initials must be included at the above rate. Cash should accompany all classified advertisements unless placed by an accredited advertising agency. No advertisement for less than ten words accepted. Ten Percent discount six issues, twenty percent for twelve issues. Objectionable or misleading advertisements not accepted. Advertisements for October, 1948, issue must reach us not later than August 24, 1948.
Radio-Craft • 25 W. B'way • New York 7, N. Y.

SELECTED GROUP OF MEN, GRADUATES OF WELL-KNOWN trade school, desire employment in Radio Field. Will travel anywhere. Qualified in radio servicing, installation, test instruments, circuit operation, etc. Contact Placement Dept., Eastern Technical School, 888 Purchase Street, New Bedford, Mass.

MAGAZINES (BACK DATED)—FOREIGN, DOMESTIC, arts, books, booklets, subscription, pin-ups, etc. Catalog 10c (refund), Clecron's, 863 First Ave., New York 17, N. Y.

YOU CAN ACCURATELY ALIGN SUPERHETERODYNE receivers without signal generator. Complete Instructions \$1. Moneyback guarantee. Chas. Gates, Pecos 2, Texas.

LANCASTER, ALLWINE & ROMMEL, 436 ROWEN Building, Washington 5, D.C. Registered Patent Attorneys. Practice before United States Patent Office. Validity and Infringement Investigations and Opinions. Rooklet and form "Evidence of Concealment" forwarded upon request.

AMATEUR RADIO LICENSES. COMPLETE THEORY Preparation for passing amateur radio examinations. Home study and resident courses. American Radio Institute, 101 West 63rd St., New York City. See our ad on Page 96.

NEW CATERED RADIO TUBES 39c. WHITE FOR bargain catalog. Henshaw Radio, 3313 Delavan, Kansas City, Kansas.

WE REPAIR ALL TYPES OF ELECTRICAL INSTRUMENTS, tube checkers and analyzers. Hazleton Instrument Co. (Electric Meter Laboratory), 140 Liberty Street, New York, N. Y. Telephone—Barelay 7-4239.

RADIOMEN, SERVICEMEN, BEGINNERS — MAKE more money, easily, quickly. \$250 weekly possible. We show you how. Information free. Merit Products, 216-32L 132nd Avenue, Springfield Gardens 13, New York.

BRITAIN'S FOREMOST RADIO MONTHLY, PRACTICAL WIRELESS, sent all over world to "hamis" interested European radio developments. Leading technicians describe the new British ideas and much valuable advice published for both amateur and expert. Indispensable to the keen serviceman enthusiast who wants to "keep ahead" and for all DX "hamis" who listen out across Atlantic. For annual subscription mailed direct from London, send only \$2.00 to George Newnes Ltd. (P.W. 13), 312 Madisson Avenue, New York 17.

SUITCASE SIZE RADIO SHOP-BUILD IT AND reap huge profits. Free literature. Write: Grand Federal, 3516 Woodend, Kansas City 3, Kansas.



MASTERPIECES in CABINETRY

Television cabinets specially engineered for 12" and 15" Standard and De Luxe "Transvision" models. Also available for 12" and 15" Standard and Champion "Television Assembly" models. Exclusively designed tables to match. Various finishes. Write for particulars, Dept. B.

TEL-CRAFT COMPANY
108 Havemeyer St., Brooklyn 11, N. Y.

MAKE MORE MONEY



\$1.00 VALUE
25c
40,000 WORDS IN TEXT
NO ADS ALL "MEAT!"
Money Back Guarantee

In "CASH IN" you now get THE real money-makers — dozens of profitable tested mail order plans, confidential business secrets, dozens of practical tested formulas, successful tested schemes — actual experiences of men who have started on a shoe-string — with less than \$10 capital. 25c a copy postpaid. Send U. S. stamps, money order, or coin.

NATIONAL PLANS COMPANY
Box 26RA, Ansonia Station New York 23, N. Y.

Index To Advertisers

Abell Dist. Co.	81
Acorn Electronics Corp.	73
Air King	6
Allied Radio Corporation	55
Almo Radio Co.	72
Alvaradio Supply Co.	93
American Sales Company	86
American Surplus Products Co.	16, 18
Amplifier Corp. of America	64, 72, 73, 80
A. M. Radio Sales Company	79
Walter Ashe Radio Co.	86
Audel Publishers	95
Bell Telephone Labs.	8
Boland and Boyce Publishers, Inc.	67, 70
Brooks Radio Distributing Co.	47
Buffalo Radio Supply	74, 81, 83, 87, 88, 90, 92, 93
Burstein-Applebee Co.	98
Capitol Radio Eng. Inst.	5
Certified Television Laboratories	64
Cleveland Inst. of Radio	15
Clippard Instrument Laboratory, Inc.	82
Commercial Radio	92
Communications Equipment Co.	57
Coyne Electrical School	88
Coyne Electrical School	93
Custom-Craft Mfg. Co.	93
DeForest's Training Institute	13
Electronic Measurements Corp.	Home
Electronic Research Labs.	10
Espey Mfg. Co., Inc.	10
Esse Radio Co.	14
Fair Radio	72
General Cement Mfg. Co.	91
General Electronic Dist. Co.	49, 91
General Test Equipment	93
Greylock Electronic Supply Co.	90
Hallmark Electronic Corp.	92
Hawkins Radio	73
The Heath Company	76, 77
Hershel Radio Co.	65
Hickok Electrical Instrument Co.	87
Hudson Specialties	92
Instructograph Co.	75
Lafayette Radio	51
Leotone Radio Corp.	64
McGraw-Hill Book Co., Inc.	95
P. R. Mallory & Co., Inc.	Inside Front Cover
Maritime Switchboard	89
Metropolitan Elec. & Inst. Co.	84
Mid-America Co.	11
Midwest Radio and Television Corp.	19
Moss Electronic Distributing Co.	85
Murray Hill Books, Inc.	83
National Radio Inst.	3
National Schools	7
Niagara Radio Supply Co.	61
Offenbach & Reimus Co.	74
Opportunity Adlets	98
Precision Apparatus Co.	86
Progressive Electronics Co.	97
Radio-Coin-Matic	88
Radio Corporation of America	59
Radio-Craft	71, 94
Radio Dealers Supply Co.	78
Radio Kits Co.	84
Radionic Equipment Co.	82

RADIO SCHOOL DIRECTORY (Pages 96-97)

American Radio Institute	
Baltimore Technical Institute	
Candler System Co.	
Commercial Radio Institute	
Delehanty Institute	
Don Martin School of Radio Arts	
Hollywood Sound Inst., Inc.	
Lincoln Engineering School	
Melville Radio Institute	
Milwaukee School of Engineering	
Radio Television Institute	
Radio Training Assoc. of America	
RCA Institutes	
Tri-State College	
Valparaiso Technical Institute	
Western Radio Communications Inst.	
YMCA Trade and Technical Schools	

Radio Supply & Engineering Co.	68
Ravac Electronics Corp.	86
Risco Electronics	90
The Rose Co.	92
R. & M. Radio Co.	98
Howard W. Sams & Co., Inc.	75, Inside Back Cover
Senco Radio, Inc.	12
N. Silverstine	89
Simpson Electric Co.	Back Cover
Solar Capacitor Sales Corp.	4
Sprague Products Company	20
Sprayberry Academy of Radio	9
Supreme Publications	95
Surplus Radio, Inc.	80
Sylvania Electric Products, Inc.	17
Technical Radio Parts Co.	74
Tel-Craft Co.	98
Transvision	69, 81

Howard W. Sams

presents the amazing

RADIO INDUSTRY

RED BOOK

REPLACEMENT PARTS

BUYER'S GUIDE

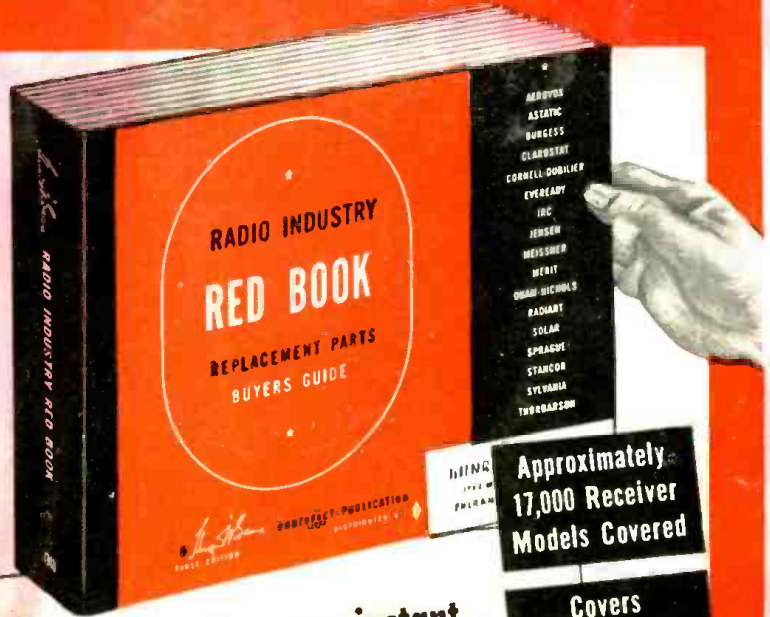

Approximately
17,000 Receiver
Models Covered

Covers
Ten Years:
1938 to 1948

Easy to Use:
All Data
Quick to Find

440 Pages
Smythe-bound
Opens Flat

NOW — a SINGLE authoritative volume that gives you instant reliable data on ALL replacement parts for thousands of popular radio receivers... more useful data than in all other replacement parts guides and manuals COMBINED...

COMPLETE!

The First Cooperative Industry Effort in Behalf of the Radio Service Technician

FOR THE FIRST TIME IN RADIO HISTORY!

All 9 Major Replacement Components Listed

(not just 1 or 2 components)

17 Leading Parts Manufacturers Represented

(not just 1 manufacturer)

COMPLETE DATA ON ALL RECEIVER REPLACEMENT PARTS — ALL IN THIS ONE GREAT BOOK!

Save time! Stop wasteful hunting! Get All the parts data you need—quickly—from this single book. NOW—for the first time—have all the replacement parts data you need—ALL in one single, authoritative volume. No more waste of valuable time searching through dozens of incomplete manuals and catalogs. The RED BOOK, first and only complete parts guide ever produced, covers approximately 17,000 radio models made from 1938 through 1947—10 full years. Lists parts made by 17 leading manufacturers—not just one! Gives you complete, accurate data on all 9 major replacement components—not just one or two! Clear, concise, easy-to-use—over 440 pages (8 1/2" x 11") bound in a sturdy sewed cover, arranged alphabetically by manufacturer and model number for quick reference. Does away with confused collections of separate books and manuals—gives you complete information—PLUS data that cannot be found in any other source—at a fraction of the price you'd pay for the books it replaces. There's never been anything like it—absolutely indispensable for every service shop!

Only the RED BOOK gives you ALL this invaluable data. Here's everything you need to know about the replacement parts for the receivers you service daily. The RED BOOK gives you original manufacturers' parts numbers, proper replacement parts numbers and valuable installation notes on *Capacitors, Transformers, Controls, IF Coils* (including Peak Frequencies), *Speakers, Vibrators* and *Phono Cartridges, Tube and Dial Light* data includes number of tubes in each chassis, with type number for each tube, plus dial light numbers. *Battery* data includes replacement numbers on A, B, and AB packs. The following leading replacement parts manufacturers are represented in the RED BOOK:

- | | |
|------------------|-----------|
| AERVOX | ASTATIC |
| BURGESS | CLAROSTAT |
| CORNELL DUBILIER | IRC |
| EVEREADY | JENSEN |
| MEISSNER | MERIT |
| QUAM-NICHOLS | RADIART |
| SOLAR | SPRAGUE |
| STANCOR | SYLVANIA |
| THORDARSON | |

18 months in preparation—over \$90,000 to produce. The RED BOOK is the product of thousands of man-hours spent in laboratory research and in cooperation with 17 participating manufacturers to produce the most complete, accurate, authoritative parts replacement guide ever published. Every bit of information in this amazing book has been painstakingly checked to insure maximum accuracy and usefulness. Over \$90,000 was spent to prepare the RED BOOK—the only book that brings you everything you need to know—every bit of replacement parts data you want to make your work easier and more profitable. You can't afford to be without the RED BOOK. It's the indispensable guide you'll use profitably every single day. Stop hunting for the right answers now—order your copy today.

THE INDISPENSABLE
RED BOOK... ONLY... **\$3.95**

BE SURE TO ORDER YOUR RED BOOK TODAY



HOWARD W. SAMS & CO., INC.
INDIANAPOLIS 7, INDIANA

Mail This Order Form to Your Parts Jobber Today or send directly to HOWARD W. SAMS & CO., INC., 2924 E. Washington St., Indianapolis 7, Ind.

My (check) (money order) for \$..... enclosed.
 Send.....RED BOOK(S) at \$3.95 per copy. (I understand that delivery will be made to me in September.)

Name.....
 Address.....
 City..... State.....

ONE Button

... clears every switch setting
 ... ready for the next tube test

Model 335 Plate Conductance Tube Tester

The Simpson Automatic Reset is just another of the practical refinements that make Simpson tube testers serve you better than other testers. When you finish a test, just press the Automatic Reset button and instantly all switches, both push button and rotary, return to normal. This not only saves time but prevents error due to previous settings being left in position at the beginning of the new test. The Reset mechanism, in whose design and tooling many thousands of dollars have been invested, is Simpson patented. No other switch control mechanism is so completely automatic.

Simpson Model 335 adds the Automatic Reset to its many other features. It tests tubes in percentages of rated plate conductance, also indicating that tube is good, fair, doubtful, or definitely bad. Only a few settings are necessary for the most complicated tube. Sockets for all types of tubes are provided, including the new 9-pin miniature; also the sub-miniature as used in hearing aids, etc.

For 105-130 volts, 50-60 cycle. Size: 15 1/2" x 9 1/2" x 6 1/4"
 Dealer's Net Price, complete with 12-page Operator's Manual\$98.50



Model 340 SIGNAL GENERATOR— 75 Kilocycles to 120 Megacycles Fundamentals to 30 MC.

Electron coupled circuit assures extreme stability and output uniformity, throughout the band. Standard 30% modulation at 400 cycles. Coil, attenuator and signal selector individually shielded. Effective shielding throughout. Each coil individually calibrated to close tolerances against crystal standards by means of variable inductance and variable minimum capacitance. For 105-130 volts, 50-60 cycle. Size: 16" x 10" x 6"

Dealer's Net Price, complete with 44-page Operator's Manual\$69.85

Simpson

INSTRUMENTS THAT TEST AND MEASURE

SIMPSON ELECTRIC COMPANY
 5200-5218 W. Kinzie St., Chicago 44, Ill.

