

HUGO GERNSBACH
Editor

IN THIS ISSUE
Tele Camera Preamplifiers
Double-Bridge Voltmeter

RADIO CRAFT

RADIO-ELECTRONICS

THE ELECTRONIC NOSE

SEE ELECTRONICS SECTION



JULY

1948

30¢

CANADA 35¢

RADIO-ELECTRONICS IN ALL ITS PHASES

TV and FM adapter for your A.M. Signal Generator



**Convert your
present A.M. Signal
Generator into a
Modern Wide Sweep
TV and FM
Signal Generator**

Triplet Model 2435

Features

- Readily connected to any A.M. Signal Generator.
- Sweeps 100 K.C. to 10 M.C.
- Calibrated marker frequencies provide for marking I. F. oscilloscope trace... 20 to 40 m.c. attenuated output... Marker Signal attenuated.
- Horizontal synchronized voltage available on panel jack.
- Shielded R.F. input and output jacks.
- Supplied with two co-axial cables 2 ft. long.

How Adapter Functions

When used as an adapter the 20—40 m.c. variable frequency oscillator can be used as a marker source. Also as an adapter the r.f.

voltage supplied by the external AM generator is mixed with the frequency modulated signal. The output frequency will be determined by adding or subtracting the frequencies of the external AM generator to or from the 110 m.c. signal produced by the reactance modulated oscillator.

A Must for Every Radio Service Shop

Radio service engineers everywhere have been waiting for this... an economical test oscillator for FM and TV... Triplet engineers have found a way to do it using your AM signal generator as a base thus keeping cost to a minimum. Furthermore this adapter unit has been designed with all the refinements necessary for quick and first class service repair work. Note particularly all the precision features built into this fine adapter-tester. Every shop can use one.

Full instructions are packed with each adapter showing how to hook up and use with your present AM signal Generator.

Place your order with your distributor for delivery when available. Worth waiting for.

Precision first... to Last

TRIPLET ELECTRICAL INSTRUMENT COMPANY • BLUFFTON, OHIO, U.S.A.

In Canada: Triplet Instruments of Canada, Georgetown, Ontario



LEARN RADIO

BY PRACTICING IN SPARE TIME

As part of my Course I send you the speaker, tubes, chassis, transformer, loop antenna, etc. . . . EVERYTHING you need to build this modern, powerful Radio Receiver! In addition, I send you parts to build many other real Radio circuits, like the Radio Tester, Frequency Modulation (FM) Signal Generator, and Superheterodyne Receiver pictured below. You use this material to get practical Radio experience and to make EXTRA money fixing neighbors' Radios in spare time. Mail coupon below for complete information!

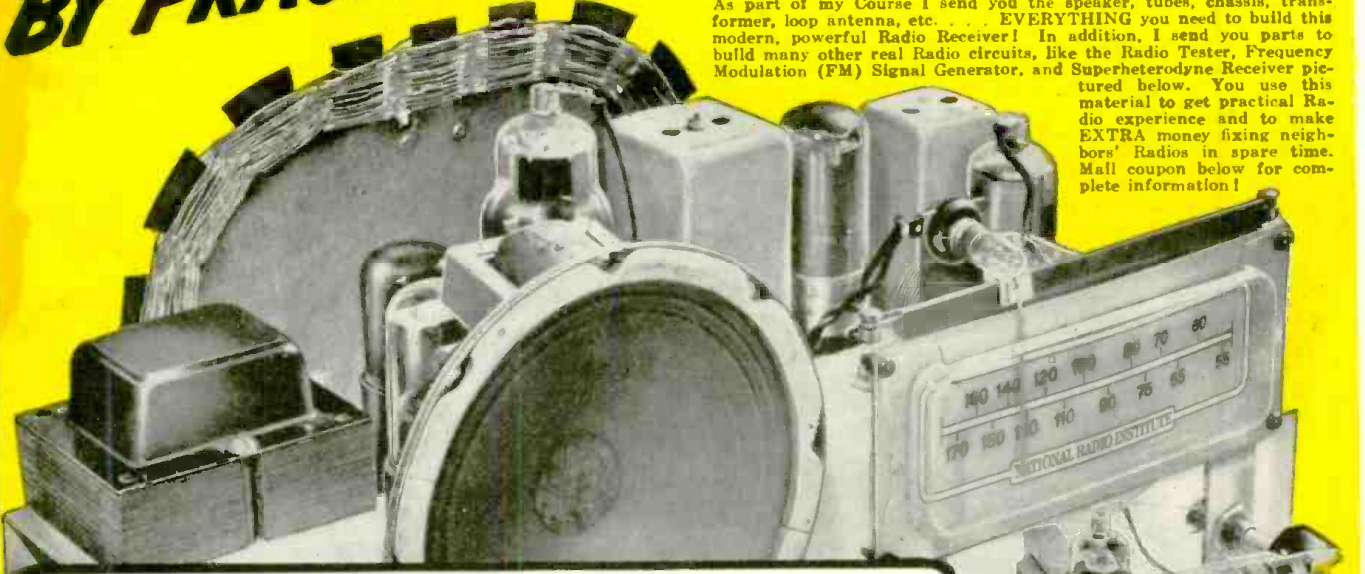

I SEND YOU BIG KITS OF PARTS
You Build and Experiment
With this MODERN RADIO
AND MANY OTHER CIRCUITS



J. E. SMITH, President
National Radio Institute

Do you want a good-pay job in the fast-growing Radio Industry—or your own money-making Radio Shop? My train-at-home method has helped hundreds of men with *no previous experience* become qualified Radio Technicians. Mail the Coupon and you'll get a Sample Lesson and my 64-page book, "How to Be a Success in RADIO-Television-Electronics," both FREE. See how you get practical Radio experience at home, building, testing Radio circuits with BIG KITS OF PARTS I send!

Future for Trained Men is Bright in Radio, Television, Electronics
 It's probably easier to get started in Radio now than ever before, because the Radio Repair Business is booming. Trained Radio Technicians also find profitable opportunities in Police, Aviation, Marine Radio, Broadcasting, Radio Manufacturing, Public Address work. Think of even greater opportunities as public demand for Television, FM Electronic devices continues to grow. Get the facts on all these opportunities. Send for FREE books now!

I TRAINED THESE MEN

Makes \$60 A Week Plus Bonus
 "I am Radio Serviceman for The Adams Appliance Co. Am now getting \$60 a week, plus bonus and overtime."—W. A. ANGEL, Blytheville, Arkansas.

Knew Nothing About Radio
 "I knew nothing about Radio when I enrolled. I am doing spare time work. I have more than paid for my Course and about \$200 worth of equipment."—RAYMOND HOLT CAMP, Vandalia, Illinois.

Many Beginners Soon Make EXTRA Money in Spare Time While Learning
 The day you enroll I start sending EXTRA MONEY manuals. You learn Radio principles from my easy-to-understand, illustrated lessons—PRACTICE what you learn with parts I send—USE your knowledge to make EXTRA money fixing neighbors' Radios in spare time while still learning! From here it's a short step to your own (full-time) Radio Shop or a good Radio job!

Find Out What NRI Can Do For You
 Mail Coupon for Sample Lesson, "Getting Acquainted With Receiver Servicing," and my FREE 64-page book. It's packed with facts about Radio's opportunities for you. Read the details about my Course. Read letters from men I trained, telling what they are doing, earning. See how quickly, easily you can get started. No obligation. Just MAIL COUPON NOW in an envelope or paste it on a penny postal.
 J. E. SMITH, Pres., Dept. 8GX
 National Radio Institute, Pioneer Home
 Study Radio School, Washington 9, D. C.

VETERANS
 You can get this training under G. I. Bill. Mail coupon.

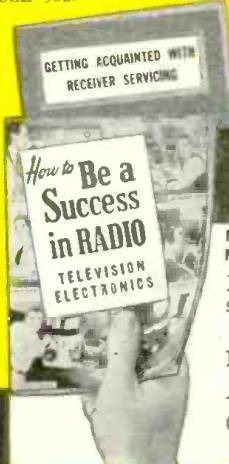

Good for Both—FREE

MR. J. E. SMITH, President, Dept. 8GX
 National Radio Institute, Washington 9, D. C.

Mail me FREE Sample Lesson and 64-page book. (No salesman will call. Please write plainly.)

Age.....
 Name.....
 Address.....
 City..... Zone..... State.....
 Check if Veteran

**Don't let others
put you out of
the picture!**

Here's how CREI
Home Study Training
prepares you NOW
for a BETTER Job
and a Secure Career
in Radio-Electronics

**CREI plus Your Present
Experience keeps you ahead
of Competition—Earns you more money!**

Never before have so many men like you had the opportunity to step ahead into better-paying jobs and enjoy lasting success. Why? Just look at the more than 3000 FM and standard broadcast stations predicted by the FCC by the end of the year—the scores of applications and permits for Television stations—the new applications radio-electronics is finding daily in every type of industry—the mobile communications systems now being utilized everywhere from backwoods logging operations to metropolitan taxicabs—the new high in overall radio-electronics manufacturing.

No wonder men with modern, technical training are needed in every branch of radio-electronics. Don't let others put you out of this picture. NOW is the time for you to take the time to prepare yourself for the important career jobs this great industry expansion is making possible. CREI home study training can show you the way by providing you with the "tools" with which to build a firm foundation of ability based on a planned program of modern technical training.

In our proved method of instruction you learn not only *how*, but *why*! This is real, honest-to-goodness practical training that leads to better jobs and more rapid promotions . . . the type of training for which many thousands of radio technicians have enrolled during the past 21 years.

It costs you nothing to read the interesting facts. There is no obligation. Send the coupon now.

VETERANS! CREI TRAINING AVAILABLE UNDER G. I. BILL

CAPITOL RADIO ENGINEERING INSTITUTE

An Accredited Technical Institute

Dept. RC-7, 16th and Park Road, N. W., Washington 10, D. C.
Branch Offices: New York (7) 170 Broadway • San Francisco (2) 760 Market St.



Mail Coupon for
FREE Booklet



CAPITOL RADIO ENGINEERING INSTITUTE

16th & Park Road, N.W., Dept. RC-7, Washington 10, D.C.

Gentlemen: Please send your free booklet, "CREI training for your better job in Radio-Electronics," together with full details of your home-study training. I am attaching a brief resume of my experience, education and present position.

- PRACTICAL RADIO-ELECTRONICS Practical Television
 Broadcasting Aeronautical Radio Engineering
 Receiver Servicing Industrial Electronics

NAME _____

STREET _____

CITY _____ ZONE _____ STATE _____

I am entitled to training under G. I. Bill.



Learn RADIO TELEVISION, ELECTRONICS by SHOP METHOD HOME TRAINING

Let NATIONAL SCHOOLS, of Los Angeles, a practical Technical Resident Trade School for almost 50 years, train you for today's unlimited opportunities in Radio

You receive all parts, including tubes, for building this fine, modern superheterodyne Receiver. This and other valuable standard equipment becomes your property.

these two FREE books will tell you how



Good Jobs Await the Trained Radio Technician

You are needed in the great, modern Radio, Television and Electronics industry! Trained Radio technicians are in constant and growing demand at excellent pay—in Broadcasting, Communications, Television, Radar, Research Laboratories, Home Radio Service, etc. National Schools Master Shop Method Home Training course, with newly added lessons and equipment, can train you in your spare time, right in your own home, for these exciting opportunities. Our method has been proved by the remarkable success of National Schools-trained men all over the world.

You Learn by Building Equipment with Standard Radio Parts We Send You

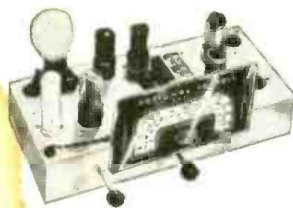

Your National Schools Course includes not only basic theory, but practical training as well—you learn by doing. We send you complete standard equipment of professional quality for building various experimental and test units. You advance step by step until you are able to build the modern superheterodyne receiver shown above, which is yours to keep and enjoy. You perform more than 100 experiments—build many types of circuits, signal generator, low power radio transmitter, audio oscillator, and other units. The Free Books shown above tell you more about it—send for them today!

Now! NEW PROFESSIONAL MULTITESTER INCLUDED!



This versatile testing instrument is portable and complete with test leads and batteries. Simple to operate, accurate and dependable. You will be able to quickly locate trouble and adjust the most delicate circuits. You can use the Multitester at home or on service calls. It is designed to measure AC and DC volts, current, resistance and decibels. You will be proud to own and use this valuable professional instrument.

Lessons and Instruction Material Are Up-to-date, Practical, Interesting.

National Schools Master Shop Method Home Training gives you basic and advanced instruction in all phases of Radio, Television and Electronics. Each lesson is made easy to understand by numerous illustrations and diagrams. All instruction material has been developed and tested in our own shops and laboratories, under the supervision of our own engineers and instructors. A free sample lesson is yours upon request—use the coupon below.

Here's Just a Few of the Interesting Facts you Learn with the

FREE MANUAL

1. Routine for diagnosing Radio Troubles.
2. Preliminary inspection of Receivers.
3. How to Test and Measure Voltages.
4. How to Test Speaker in Audio Stages.
5. How to Trace the Circuit and Prepare Skeleton Diagram.
6. Complete Reference Table for Quickly Locating Receiver Troubles.

Both Home Study and Resident Training Offered

APPROVED FOR VETERANS

Check Coupon Below

NATIONAL SCHOOLS

LOS ANGELES 37, CALIFORNIA EST. 1905



MAIL OPPORTUNITY COUPON FOR QUICK ACTION

National Schools, Dept RC-7
4000 S. Figueroa, Los Angeles 37, Calif.

Paste on a postcard

Mail me FREE the books mentioned in your ad including a sample lesson of your course. I understand no salesman will call on me.

NAME AGE

ADDRESS

CITY ZONE STATE

Check here if Veteran of World War II

GET THE DETAILS—SEND THE COUPON. →

HERE'S YOUR

Big Chance

**Profit Through Training in
RADIO-ELECTRONICS
TELEVISION**

Prepare at HOME or in our CHICAGO LAB-ORATORY to get REAL MONEY, a BETTER JOB, or a BUSINESS OF YOUR OWN . . .

Our business is helping men . . . and young men . . . get into a well-paying future in the highly profitable fields of RADIO-ELECTRONICS. During the past sixteen years we have trained many men who desired better jobs or businesses of their own. We can effectively provide you with this same opportunity either in our new, modern Chicago laboratories or in the privacy of your own home.

TAKE YOUR CHOICE

If you choose to come to Chicago, we shall find comfortable living quarters for you. If you train at home, we shall send you modern, practical equipment. In either of these two methods, you will have the supervision of some of the finest instructors in the country. Fill in coupon below and we shall send you, absolutely FREE, full information about our program of building men for better opportunities in RADIO-ELECTRONICS—which includes Television, F. M. Radio Broadcasting, Industrial Electronics, 2-Way Mobile Radio, etc.

If you prefer to remain at home, you receive many shipments of radio parts and assemblies from which you can work out dozens of fascinating radio circuits to gain practical experience in your own home. In addition, you receive a 16 mm. motion picture projector and 12 information-packed reels of film which help you learn faster, easier. You also get modern looseleaf lessons with handy fold-out diagrams.

EMPLOYMENT SERVICE

When you complete your training, our effective Employment Service helps you get started toward a real future. Mail coupon below today . . . do not delay.

YOU USE ALL of the equipment shown on this page to work out scores of Learn-By-Doing projects and experiments at home.

DeForest's Training, Inc.

Chicago, Illinois

Associated with the DeVry Corporation, Builders of Electronic and Movie Equipment

MAIL THIS OPPORTUNITY COUPON NOW

DeForest's Training, Inc.
2533 N. Ashland Ave., Dept. RC-67
Chicago 14, Illinois

Send me complete details showing how I may make my start in Radio-Electronics-Television. No obligation.

Name _____ Age _____
 Address _____ Apt. _____
 City _____ Zone _____ State _____
 If under 16, check here for special information.
 If a discharged veteran of World War II check here.

HOW TO MAKE MONEY
in
RADIO
ELECTRONICS
TELEVISION

HOW TO READ
RADIO DIAGRAMS
AND SYMBOLS

SPRAYBERRY
ACADEMY
of RADIO

GET THESE 2 BIG BOOKS
FREE.

IF YOU
WANT TO LEARN

RADIO!



FRANK L. SPRAYBERRY
famous Radio teacher of hundreds
of successful Radio men.

I TRAIN YOU RIGHT BY SENDING YOU 8 BIG KITS OF
RADIO EQUIPMENT INCLUDING A POWERFUL 6 TUBE
SUPERHET RECEIVER AND 16 RANGE TEST METER!

Find out NOW how Sprayberry Training prepares you for a Radio Service Business of your own — or a good pay Radio job. Just mail the coupon for a FREE Sample Lesson and my big FREE book, "How To Make Money In Radio, Electronics, Television." It tells how I train you at home during spare hours by putting you to work building, testing, repairing Radio equipment. The Sprayberry Course teaches you Radio by working with 8 big kits of Radio parts I supply. You build a powerful 6 tube superhet Radio, a 16-range test meter, perform over 175 interesting, PRACTICAL experiments. My lessons are easy and interesting — you need no previous experience in Radio. I start you at the beginning... and give you valuable "bench" experience that sticks with you.

Soon after you start I send you my famous BUSINESS BUILDERS that help you earn EXTRA CASH getting and doing neighborhood Radio Service jobs while learning. You couldn't pick a better time to get into Radio. The Radio Repair Business is booming! Good Radio Service and Repair Shops are needed everywhere as millions of new sets are in use. Trained men are wanted for opportunities in Police, Aviation and Marine Radio, F. M. and Standard Broadcasting and Television. Manufacturers are looking for men who know Radio as production reaches new peaks. GET THE FACTS ABOUT YOUR FUTURE IN RADIO MAIL the COUPON TODAY for my FREE BOOKS

LEARN HOW TO BUILD-TEST-REPAIR RADIOS By Working with YOUR HANDS!

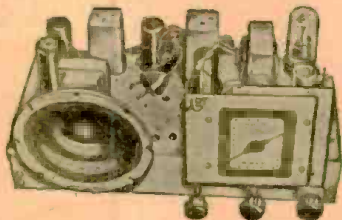

You really learn Radio the PRACTICAL way... when you build this big, powerful 6-tube Superhet Radio from parts I send you.

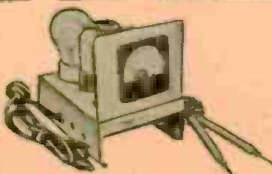

I give you a fine, moving coil type Meter — with parts for a complete analyzer and Circuit Continuity Tester. "Trouble-shoot" with professional accuracy.

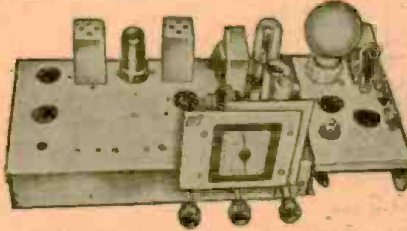

You don't have to buy expensive ready-made equipment. You get valuable experience building this Signal Generator and Multi-purpose Tester.

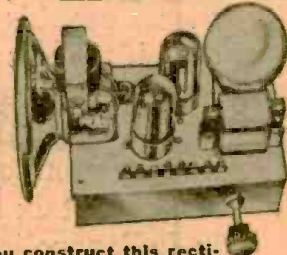

You construct this rectifier and filter, resistor and condenser tester, and really get on the Practical end of Radio.

LOW COST RADIO TRAINING STUDY AT HOME IN SPARE HOURS

Sprayberry Training costs surprisingly little! Easy monthly payments, if desired. Everything you need is furnished — nothing else to buy. With Sprayberry Training to back you up, you will be able to step into your own profitable Radio Service Business or go on to a big opportunity in Radio, Electronics or Television. The equipment I send you is yours "for keeps" — to use in your business or job. I have trained hundreds of successful Radio men — and I can help you too. Get the facts about Sprayberry Training — it's your first step to success, security and a bigger income in a field where you'll really enjoy your work. Fill out and mail coupon TODAY. I'll rush my two FREE books to you by return mail.

VETERANS: Approved for G. I. Training under Public Laws 16 and 346.

Sprayberry Academy of Radio
F. L. SPRAYBERRY, President
Room 2078, Sprayberry Bldg., Pueblo, Colorado

RUSH COUPON Today!

SPRAYBERRY ACADEMY OF RADIO
F. L. SPRAYBERRY, President
Room 2078, Sprayberry Bldg., Pueblo, Colorado
Please rush my FREE copies of "How To Make Money In Radio, Electronics and Television" and "How To Read Radio Diagrams and Symbols." No salesman will call.

Name _____ Age _____

Address _____

City and Zone _____ State _____

CHECK HERE IF A VETERAN
(Mail in an Envelope or Paste on Penny Postcard)



Trained Radio men can step into their own profitable Radio Service Shop — or —



New developments are constantly opening new big pay job opportunities in Radio.



ESSE Specials!

In this July issue of Radio Craft magazine, we are omitting our ads except for this page. Esse Radio Company, having been one of the first companies to enter the surplus sales field, has accumulated, over the past few years, odds and ends of all different kinds of electronic surplus gear and now, during the month of July, is going to hold its retail store open Monday through Friday from 9 AM to 5 PM and on Saturday from 9 AM to 3 PM and we cordially invite anyone to our store and will promise that, if you do come, you will see the most sensational bargains ever offered anywhere. We suggest that, if you have never been in our store, that you should come alone or invite your friends and all of you come as a group. Esse will go through all of its warehouses and bring to the sales floor, the largest assortment of electronic gear that has ever been assembled in one sales room. We want to clear our shelves of small quantity lots, obsolete equipment, too large a stock of items and we want to become personally acquainted with our mail order customers so we are putting prices "Down", "Down", "Down" until our customers will hardly be able to believe what they see when they enter our door.

On this sale, you will find radio hardware, parts, receivers, transmitters, modulators, power supplies, and all the vast array of things that are yet unsold that you have seen in previous Esse ads. You will find hundreds of aircraft parts, controls, and instruments. There will be radar gear galore. We are going to cram into every shelf, corner and nook of this sales floor, all the way to the ceiling, tens of thousands of items.

Please use this as an open invitation to visit our store and believe us when we state that, if there is an item that you desire that's on the surplus electronic market, that we probably have it and that the prices that we quote you will amaze you. Even if you have no intentions of buying and don't buy while visiting our store, it's almost an education to come here and examine the vast array of war devices that we have. Meet and talk to some of your friends, whom you have talked to over the air here in Indianapolis, and get together and exchange ideas on radio.

We want to meet and become better acquainted with customers from all over the United States and Canada and from anywhere else, so please take our word for it—"It will be interesting"—Come in!

ESSE RADIO COMPANY
140 W. New York Street, Indianapolis, Indiana

ESSE Radio Co
130 W. New York St.
Indianapolis 4, Ind.

Unless Otherwise Stated, All of
This Equipment Is Sold As Used
CASH REQUIRED
WITH ALL ORDERS
Orders Shipped F.O.B. Collect

12 BOOKS IN 1

IN THE
RADIO DATA BOOK

The only Radio Handbook of its kind! . . .
1148 pages, 12 sections, each a complete
coverage of one radio subject.

Together, the 12 sections form the most
complete Radio Handbook you can BUY!
Easy to read . . . A quick reference!

Plan every operation in radio and electronics with
the Radio Data Book. This new radio bible will be
your lifelong tool . . . you will use it every day, on the
board, at the bench, in the field! Use it for engineer-
ing, construction, trouble-shooting and testing. The
RADIO DATA BOOK will be your invaluable aid in
design, experiment and in layout. It will help make
your production better, faster and easier. In any and
every operation in radio and electronics, you will use
the RADIO DATA BOOK!

The RADIO DATA BOOK is a work of complete authority,
prepared by engineers with many years of practical experi-
ence. They have been assisted by the Boland & Boyce staff of
editors skilled in preparing electronics manuals for the U. S.
Signal Corps for many years. These men have worked for
several years gathering material for this book . . . all the
knowledge of radio principles and operation . . . all the statis-
tics . . . all the newest developments in electronics . . .
every possible angle and detail. Eighteen months were spent di-
gesting this material into the most concise, the clearest, and
the most readable form. The result is this invaluable manual
. . . The RADIO DATA BOOK. Whether you use this book
for general reference, for scientific instruction, or for edu-
cation, one thing is certain—the practical help, the daily use-
fulness you will derive from it will prove to be worth many,
many times its astonishingly low price!

Here's a description of just ONE section—Section 5, Sound
Systems:

This section covers the planning, selection of components,
and assembly of complete P.A. installations. Every type of
unit and material used in a sound system is described and
analyzed. Components are classed as to size and type of P.A.
installations in which they should be used. Tables and charts
are given from which to determine power and ratings. Micro-
phone and speaker construction are described and illustrated
in detail . . . placement in auditoriums, etc., for proper
acoustical results is explained and illustrated. Patterns of
the different types of microphones are illustrated as are the
proper methods of wiring up the various units, etc.

The above is just one of the twelve big sections in the
RADIO DATA BOOK. We wish we had room here to describe
all twelve in detail, but just look over the list of sections, and
you will see why this is the best radio handbook money can
buy. Send in your order for the RADIO DATA BOOK today.

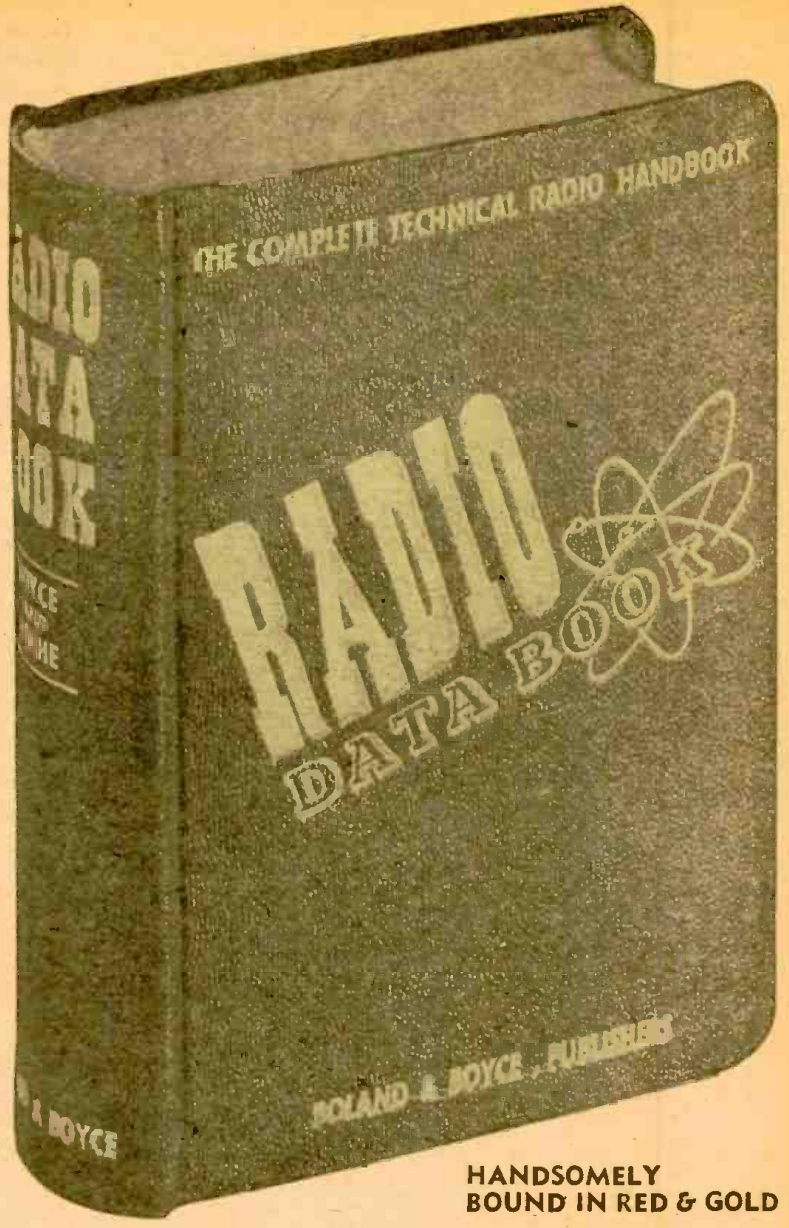

**HANDSOMELY
BOUND IN RED & GOLD**

12 sections . . . 1148 pages . . . Completely Illustrated

- SECTION 1. THE 150 BASIC CIRCUITS IN RADIO.
- SECTION 2. COMPLETE TEST EQUIPMENT DATA.
- SECTION 3. TESTING, MEASURING AND ALIGNMENT.
- SECTION 4. ALL ABOUT ANTENNAS.
- SECTION 5. SOUND SYSTEMS.
- SECTION 6. RECORDING.
- SECTION 7. COMPLETE TUBE MANUAL.
- SECTION 8. CHARTS, GRAPHS AND CURVES.
- SECTION 9. CODES, SYMBOLS AND STANDARDS.
- SECTION 10. 50 TESTED CIRCUITS DESIGNED FOR OPTIMUM PERFORMANCE.
- SECTION 11. DICTIONARY OF RADIO AND ELECTRONIC TERMS.
- SECTION 12. RADIO BOOK BIBLIOGRAPHY.

12 complete books in one only \$5.00
Less than 42c per book!

Coming Soon!

The VIDEO HANDBOOK

Everything in Television in one Complete Text-
book. Over 500 pages completely illustrated.

This new handbook will be invaluable to everyone concerned with
the technical aspect of Television. Everything from the basic theory of
television through the design and characteristics of receivers to final
installation, operation, and maintenance is covered. This is a com-
pletely new book that includes all of the latest developments in the
field—the components discussed are of the newest design—the practical
maintenance described is a result of intensive study of the equip-
ment placed in operation during the past few months.

There are five completely illustrated sections in the VIDEO HANDBOOK,
each over a hundred pages long. Each section completely covered.

The VIDEO HANDBOOK will be out October 15th, but we have
received a flood of orders already. To insure your getting a copy in
the first printing—mail your order now.

The VIDEO HANDBOOK is \$5.00 alone, or you can order it with
the RADIO DATA BOOK and get both books at the special price of
\$9.00. Send in the coupon today!

Mail this coupon to your jobber—or direct to: RC-7

BOLAND & BOYCE, INC., PUBLISHERS
460 Bloomfield Ave., Montclair, N. J.

- Please send me:
- The Radio Data Book at \$5.00. (Foreign \$5.50)
 - The Video Handbook at \$5.00. (Foreign \$5.50)
 - Both Books at the Special price of \$9.00. (Foreign \$10.00)

- I enclose full payment.
- I enclose \$1.00 and will pay balance to postman on delivery. (In U. S. only)

NAME
ADDRESS
CITY ZONE
STATE

BOLAND & BOYCE INC., PUBLISHERS

McMurdo
SILVER



Laboratory Caliber Electronic Test Instruments

McMurdo Silver Co., Inc.
1240 MAIN STREET HARTFORD, CONNECTICUT
CABLE ADDRESS SILVERADIO, U.S.A.

New "VOMAX", new "SPARX" signal tracer, universal test speaker, AM, FM and TV sweep and signal generators, laboratory C/R bridge, multi-frequency standard, wavemeter, universal test speaker, sine/square wave audio oscillator. Buy them from your favorite jobber.

IN OUR NEW CATALOG you will find completely described ten instruments, each of which is in a special class . . . *Laboratory Caliber Electronic Test Instruments* at prices every technician can afford. Each is the product of the exclusive McMurdo Silver LCETI plan . . . the modern plan which makes available to every service technician the same instruments used by the big manufacturers who design and test the very radios you must service.

Instruments of advanced design . . . practical application "know-how" translated into simple *pictorial instruction manuals* . . . backed by over 37 years of world-famous radio engineering leadership . . . have increased LCETI production over

500% in 3 years and continue its growth.

We are proud that our efforts to bring fine instruments to the service professional and the research engineer have earned such overwhelming acceptance. Without our tens of thousands of customers we could never keep prices down while continuously increasing quality, accuracy and all-around "usability".

We are ever ready to help you turn your shop into a modern, efficiently-equipped service laboratory with *Laboratory Caliber Electronic Test Instruments*. Our new catalog will show you how easy this is . . . how each of these new instruments can amazingly increase your earning-power and efficiency. Send for 1948-49 LCETI catalog.

LABORATORY
CALIBER
ELECTRONIC
TEST
INSTRUMENTS

OVER 37 YEARS OF RADIO ENGINEERING ACHIEVEMENT

McMurdo Silver Co., Inc.

EXECUTIVE OFFICES: 1240 MAIN ST., HARTFORD 3, CONN.
FACTORY OFFICE: 1249 MAIN ST., HARTFORD 3, CONN.

CATALOG
OF NEW
LCETI

RADIO-CRAFT for

NEW! hallicrafters Projection Television!

16" x 12" PICTURE—192 SQ. INCHES

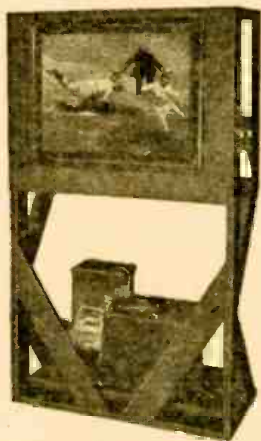

MODEL T-60 RACK TYPE PROJECTION UNIT FOR CUSTOM INSTALLATIONS

A brilliant new Hallicrafters development! A Television Projection System which consists of: an optical unit which magnifies, projects, and reflects a beautiful 16" x 12" picture; the receiver chassis; a high voltage unit which sustains brilliance and stability, and the viewing screen. Complete for custom installation in any desired location. Delivers a brilliant, sharp, flat-faced 192 square-inch picture, comfortable at close range, perfect for distant viewing. Optically correct picture provides excellent day or night viewing. Rack arrangement provides proper throw; stable optical system stays in adjustment. Ideal for custom installations in homes; in wide demand for taverns, clubs, halls, schools and for similar applications.

97-801. Hallicrafters T-60 TV Projection System. NET, f.o.b. Chicago **\$595.00**



hallicrafters' FAMOUS T-54 TELEVISION TABLE MODEL

The immensely popular direct-viewing TV Receiver at low cost! Provides a brilliant picture 5 3/4" long, 4" high—full 23 square-inch area. Easy to operate. Clear, sharp, bright image. Excellent sound.

97-800. Hallicrafters' T-54 Receiver. NET, f.o.b. Chicago **\$169.50**
Terms: \$33.90 down, \$11.98 monthly for 12 months

ALLIED has Everything NEW IN RADIO!

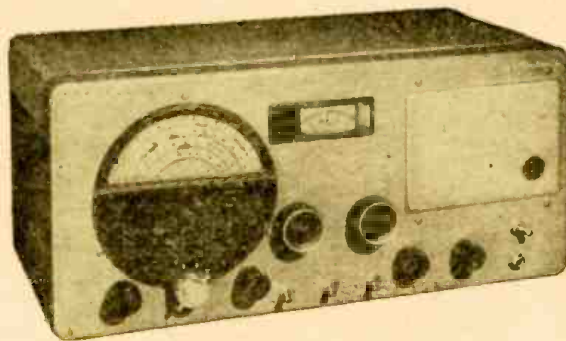

NEW! hallicrafters S-52 Receiver!

A popularly-priced new Hallicrafters communications receiver, packed with exceptionally fine features. Designed for AC-DC operation. Tunes 550 kc to 43 mc in 4 bands. Highlights include: full electrical bandspread; inertia flywheel tuning; calibrated main dial; automatic noise limiter; adjustable pitch BFO; standby switch; code-phone switch; headphone jack; shock-mounted speaker; separate sensitivity and volume controls; 3-position tone control. Includes 7 tubes, plus rectifier and ballast; for 117 volts AC/DC operation. In handsome all-steel cabinet, 18 1/2" x 9 3/4" x 8 1/2". Shipping weight, 25 lbs.

97-588. S-52 Receiver. NET, f.o.b. Chicago **\$99.50**
\$19.90 down, \$7.03 monthly for 12 months

There's Only ONE COMPLETE Radio Buying Guide—It's ALLIED'S CATALOG!

Get the Radio Buying Guide that's used by thousands of expert servicemen, engineers, soundmen, Amateurs, builders and experimenters! Radio's biggest catalog brings you the widest selections of the newest and finest equipment, at money-saving low prices. Get every buying advantage at ALLIED—speedy, expert shipment, the personal attention of seasoned radio experts—complete satisfaction on every order. Get your ALLIED Catalog today!



**172 VALUE-PACKED
PAGES. SEND FOR IT!**

FREE

THE WORLD'S
LARGEST
RADIO
SUPPLY
HOUSE . . .

★ **ALLIED
RADIO**
*Everything in Radio
and Electronics*

ALLIED RADIO CORP.
833 W. Jackson Blvd., Dept. 2-G-8
Chicago 7, Illinois

- Send FREE 172-Page ALLIED Catalog.
- Enter order for Hallicrafters Model.....
- Enclosed \$..... Full Payment
- Part Payment (Balance C.O.D.)
- Send ALLIED Easy Payment Plan details and order blank.

Name.....

Address.....

City..... Zone..... State.....

JULY • 1948

Editorial

Radiovision by Hugo Gernsback 17

Electronics (pages 20-23)

The Crystal Detector by Jordan McQuay 20
 Photoelectric Eye Protects Sunbathers 22
 The Electronic Nose 23

Television (pages 24-26; 76-77)

Television Camera Preamplifiers by Edward M. Noll 24
 Television Counters by Robert W. Ehrlich 26
 New Television Projector 76

Test Instruments (pages 27-30)

Tiny Signal Tracer by Rufus P. Turner 27
 Double-Bridge V.T. Voltmeter by I. Queen 28
 Audio Generator by James C. McGuire 30

Construction (pages 31-33)

A 4-Tube Reflex Superhet by T. W. Dresser 31
 Circuits Needed Most 32
 German Ionospheric Experiments on 3.6 mc. by Dr. Wilhelm Oburger 33

Audio (pages 34-36)

Phase Inversion Circuits by John W. Straede 34
 Magnetic Recorders 35
 Vacuum Tube Is Phono Pickup 36

FM (page 37)

Crystal FM Deviation Circuits 37

Amateur (pages 38-39)

Vacationer's 35-Wattter by Clinton Clark, WIKLS 38
 AM and FM Share Same Carrier 39

Servicing (pages 40-55)

Understanding Tube Checkers by Sol D. Prensky 40
 Radio Set and Service Review (Langevin Model 122 Amplifier) by Richard H. Dorf 42
 War on Radio Repairmen by Fred Shunaman 44
 Time-Saving Repair Tips by W. G. Eslick 49
 Servicing Farm Radios by Harry Leeper 50
 Pedro's Inductant Reasoning by Guy Slaughter 52

Foreign News (pages 64-66)

Report From Britain by Major Ralph W. Hallows 64
 Radio School in Greece 66

Radio-Science (page 71)

Radio vs. Raindrops 71

Departments

The Radio Month 18
 Try This One 48
 Radio-Electronic Circuits 56
 New Devices 60
 Question Box 62
 New Patents 68
 Technotes 72
 World-Wide Station List Edited by Elmer R. Fuller 78
 Communications 80
 Book Reviews 84



RADIO-ELECTRONICS

Incorporating

SHORT WAVE CRAFT* TELEVISION NEWS*
RADIO & TELEVISION
 *Trademark registered U. S. Patent Office

HUGO GERNSBACK

Editor-in-Chief

FRED SHUNAMAN, Managing Editor

M. HARVEY GERNSBACK,
Consulting Editor

ROBERT F. SCOTT, W2PWG,
Technical Editor

ANGIE PASCALE,
Production Manager

I. QUEEN, W2OUX, Editorial Associate

ELMER FULLER, Shortwave Editor

G. ALIQUO, Circulation Manager

JOHN J. LAMSON,
Advertising Director

ALFRED STERN, Promotion Manager

In Our Next Issue

TELEVISION POWER SUPPLIES
 HANDI-DANDY TRANSCEIVER
 "HIGH-FIDELITY" HUM

On the Cover:



The "electronic nose" is a device which detects gases in the air. It is operated by Jane Barstow, of the General Electric Co., Schenectady, New York.

Chromatone by Alex Schomburg from G-E photo by James O. Burns.



ABC PAID CIRCULATION 6 MONTHS TO DEC. 31, 1947—102,688. (Publishers Statement)

PRINTED FOR JULY ISSUE—149,000

RADCRAFT PUBLICATIONS, INC. Hugo Gernsback, President; M. Harvey Gernsback, Vice President; G. Aliquo, Secretary

Contents Copyright, 1948, by Radcraft Publications, Inc. Text and illustrations must not be reproduced without permission of Copyright owners.

RADCRAFT PUBLICATIONS INC. • PUBLICATION OFFICE 29 Worthington Street, Springfield 3, Mass. Address all correspondence to N. Y. office. EDITORIAL AND ADVERTISING OFFICES 25 West Broadway, New York 7, N. Y. Telephone RECTOR 2-9690. BRANCH ADVERTISING OFFICES: Chicago: 308 W. Washington Street, Chicago 6, Ill. Tel. Randolph 7363. Detroit: Frank Holstein, Manager, Room 402 Lexington Bldg., 2970 West Grand Blvd., Detroit 2, Mich. Telephone Madison 7026-7. Los Angeles: Ralph W. Harker, Manager, 606 South Hill St., Los Angeles 14, Calif. Tel. Tucker 1793. San Francisco: Ralph W. Harker, Manager, 582 Market St., San Francisco 4, Calif. Tel. Garfield 1-2481.

RADIO-CRAFT, July, 1948, Volume XIX, No. 10. Published monthly on 25th of month preceding date of issue. Allow one month for change of address. When ordering a change, please furnish an address stencil impression from a recent wrapper. All communications about subscriptions should be addressed to the Circulation Manager, Radio-Craft, 29 Worthington St., Springfield 3, Mass., or 25 West Broadway, New York 7, N. Y.

SUBSCRIPTION RATES: United States and possessions, Mexico, Central and South American countries, \$3.50 a year; \$6.00 for two years; \$8.00 for three years. Canada, \$4.00 a year; \$7.00 for two years; \$9.50 for three years. All other foreign countries, \$4.25 a year, \$7.50 for two years; \$10.25 for three years.

FOREIGN AGENTS: Great Britain: Atlas Publishing and Distributing Co., Ltd., 18 Bride Lane, Fleet St., London E.C.4. Australia: McGill's Agency, 179 Elizabeth Street, Melbourne. France: Brentano's, 37 Avenue de l'Opera, Paris 2e. Holland: Trilectron, Heemsteedsche, Dreef 124 Heemstede. Greece: International Book & News Agency, 17 Amerikis Street, Athens. So. Africa: Central News Agency, Ltd., Cor. Rissik & Commissioner Sts. Johannesburg; 112 Long Street, Capetown; 369 Smith Street, Durban, Natal. Universal Book Agency, 70 Harrison Street, Johannesburg. Middle East: Steimatzy Middle East Agency, Jaffa Road, Jerusalem. India: Susil Gupta (Distributors) Co., Amrita Bazar Patrika Lt., 14 Ananda Chatterjee Lane, Calcutta.

RADIO-CRAFT for

Which Do You Want?

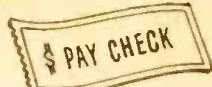

Better Pay



A Nice Home



A New Car



Greater Security



Happy Vacations and Travel

Jobs worth \$3000 to \$7500 are opening up right now for FCC Licensed Radiomen

How to Pass FCC Commercial Radio Operator License Exams

GET YOUR FCC TICKET IN A FEW SHORT WEEKS

Get your license easily and quickly and be ready for the \$3000 to \$7500 jobs that are open to ticket holders. CIRE training is the only planned course of coaching and training that leads directly to an FCC license.

IT'S EASY WITH CIRE COACHING AND TRAINING

Your FCC ticket is recognized in all radio fields as proof of your technical ability. Employers often give preference to license holders, even though a license is not required for the job. Hold an FCC "ticket" and the job is yours!

Look what these students say:

"Thanks to this course, I now have a very good job in a local power plant's test department. I couldn't have obtained this job without the math and basic electrical theories in the first part of Section 1 of this course." Stud. No. 2893N12

"I have been working for Police Radio Station WPFBS in Asheville for five months since getting my second-class ticket." Stud. No. 2858N12

"You may be interested to know that I am employed at the local broadcast station, where I am a transmitter operator. I took and passed the FCC examinations last February." Stud. No. 2754N12

CLEVELAND INSTITUTE OF RADIO ELECTRONICS
 RC-7 Terminal Tower Cleveland 13, Ohio

Approved for Training under "G. I. Bill of Rights"

JULY, 1948



I can train you to pass your FCC License Exams in a few short weeks if you've had any practical radio experience—amateur, Army, Navy, radio servicing or other. My time-proven training plan can help put you, too, on the road to success—
 EDW. H. GUILFORD, Vice-President.
Let me send you FREE the entire story Just fill out the coupon and mail it. I will send you, free of charge, a copy of "How to Pass FCC License Exams," plus a sample FCC-type Exam and Catalog A, describing opportunities for you in Radio-Electronics.

Get All 3 FREE Send Coupon Now!

CLEVELAND INSTITUTE OF RADIO ELECTRONICS
 RC-7 Terminal Tower, Cleveland 13, Ohio

I want to know how I can get my FCC ticket in a few short weeks. Send me your FREE booklet, "How to Pass FCC License Examinations" (does not cover exams for Amateur License), as well as a sample FCC-type exam and Catalog A, describing opportunities in Radio-Electronics.

NAME

ADDRESS

CITY ZONE STATE

Veterans check for enrollment information under G.I. Bill.

NO OBLIGATION—NO SALESMEN.

COMMAND SET ACCESSORIES

TRANSMITTER POWER SUPPLY KIT

For BC-645, 223, 522, 274N's, etc. Ideal for powering military transmitters. Supplies 500 to 600 Volts at 150 to 200 MA plate, 6.3 C.T. at 4 Amps, 6.3 at 4 Amps and 12V at 4 Amps. Can be combined to supply 3-6-9-12 or 24 Volts at 4 Amperes. Kit supplied complete with husky 110V 60 cycle power transformer, 5U4 rectifier, oil filled condensers, cased choke, punched chassis, and all other parts, including detailed instructions. Complete — nothing else to buy.

TRANSFORMER ONLY \$9.50

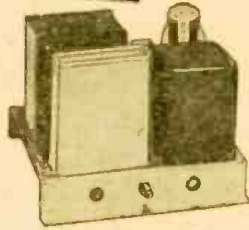

\$14.50



110V RECEIVER POWER SUPPLY KIT

With 24 volt filament, no wiring changes inside set, punched chassis and volume control

\$5.95

5" PM SPEAKER

With output transformer, matching Headphone output

\$2.80

Dual receiver rack FT277A with connecting plugs

\$1.00

Single transmitter rack FT234A

\$1.00

MILITARY CONVERSION POWER TRANSFORMERS

Convert your military receivers without rewiring the filament. "A" type supplies 500 VCT at 50 MA, 5V at 2A and 24V at 1/2A. "B" type supplies 500 VCT at 50 MA, 5V at 2A and 12V at 1 amp.

State whether A or B type desired..... **\$2.95**

BEST OF KITS

POWER TRANSFORMER *Specials*

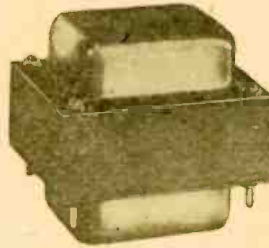

A wonderful buy in a new production heavy duty power transformer. Primary 117V 60 cycle. Secondaries supply 746 V.C.T at 220 MA, 6.3V, at 4.5 A., and 5V at 4 A. An ideal transformer for high quality amplifier modulator, small transmitter or quality radio. Will handle 13 tube radio receivers. Supply is limited, order early.

\$3.95 ... 3 FOR \$9.95

INPUT AND OUTPUT TRANSFORMER

Two units in one case carbon microphone input and output from 155 to 150 ohm load used in Handie Talkie No. 744 special

4 for..... **\$1.00**

Filter Choke 15 henries at 60 MA cased type hermetically sealed No. 643, each..... **\$1.00**



OUTPUT TRANSFORMER Push pull 6V6's to 6-8 ohm voice coil excellent characteristics No. 800. 3 for..... **\$1.95**



OUTPUT TRANSFORMER Couples, 6C4, 6J5, etc. to 500 or 5,000 ohm line No. 716. 2 for **\$1.00**

MIDGET AMATEUR TRANSMITTER KIT

Complete kit to assemble a 1 Watt battery operated amateur 80 meter transmitter, including tube and crystal. Range up to 500 miles. Only accessories needed are sending key and batteries. Complete instructions supplied. Add postage for 2 lbs.

ACCESSORIES

Key (add postage for 2 lbs.)..... **\$1.00**
Kit of batteries (add postage for 4 lbs.)..... **3.25**

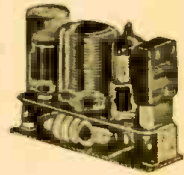

\$3.95

AN/APNT RADIO ALTIMETERS

Brand new, complete with tubes, dynamotor, antennae, indicator, switch, plugs and instruction manual. Consists of 420 MC transmitter and receiver. Converts into excellent boat radar indicating in feet, or amateur 420 MC rig. In original crate.



\$34.95



T32 TABLE MICROPHONE

One of the Army's best. Built by Kellogg, ideal for factory call system, public address, amateur use. Brand new in original cartons, add postage for 5 lbs..... **\$2.95**

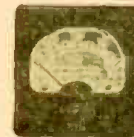

METER *Special*

Brand new DeJur Model 312 0-800 M.A. D.C. Square 3" 0-10 M.A. basic meter with built in shunt. Probably the best buy ever offered in a surplus meter. Shipping weight 1 lb. **\$2.95**

HEARING AID HEADPHONES

The Army's best — eliminate flat ears and outside noise. Complete with transformer for conversion from low to high impedance. With card and plug complete. Add postage for 1 lb. **\$1.00**



DYNAMOTORS

Consists of electric motor operating generator on same shaft. Many applications—operating radios from storage battery—using as motor.

Dynamotor C—Input 28 volts, output 220 volts at 60 MA. Shipping Weight 6 pounds..... **\$1.50**

Dynamotor A—Input 12 volts, output 1000 volts at 350 MA. Shipping Weight 72 pounds..... **\$5.95**

Dynamotor B—Input 6 or 12 volts, output 500 volts, 160 MA. Shipping Weight 30 pounds..... **\$5.95**

HEATHKIT 3-TUBE ALL-WAVE RADIO

110-volt AC operation

\$8.75

An ideal way to learn radio. This kit is complete ready to assemble, with tubes and all other parts. Operates from AC. Simple, clear detailed instructions make this a good radio training course. Covers regular broadcasts and short wave bands. Plug-in coils. Regenerative circuit. Operates loud speaker. Battery model for use where no AC house current is available. Add postage for 3 lbs.

Heathkit Beginners' Radio 110-volt type..... **\$8.75**

Heathkit Beginners' Radio, battery type (2 tubes, no rectifiers)..... **\$8.75**

Headphones for either type HS 30 per set..... **\$1.00**

2 1/2" permanent magnet loudspeaker for either type..... **\$1.95**

Batteries, complete kit for battery type set... **\$3.25**



INTERPHONE 2-WAY CALL SYSTEM KIT

Ideal call and communication system for homes, offices, factories, stores, etc. Makes excellent electronic baby watcher, easy to assemble with every part supplied including simple instructions. Distance up to 1/5 mile. Operates from 110 V.A.C. 3 tubes, one master and one remote speaker. Shipping Weight 5 pounds. **\$14.50**



LOOK AT THE PARTS IN A GENERAL ELECTRIC BC-375 TUNING KIT

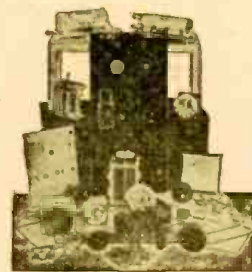

FOR *Only* **\$2.49**

A beautiful aluminum case ideal for building a receiver or transmitter. Three variable condensers, transmitting coils, transmitting mica condensers, ceramic switches, National Velvet Vernier dial, ceramic insulated couplings, 10 banana jacks, RF chokes, etc. The parts in this unit will be useful for years.

This is truly the greatest buy in surplus — better order one while still available. We include plans for converting to an 80 meter transmitter receiver all for \$2.49. Specify TU26B (200-500 KC.) or TU10B (10 to 12.5 MC.) Shipping weight 20 lbs.

The HEATH COMPANY
DEPT. C ... BENTON HARBOR, MICHIGAN

Build YOUR OWN TEST EQUIPMENT

\$39.50

Nothing ELSE TO BUY

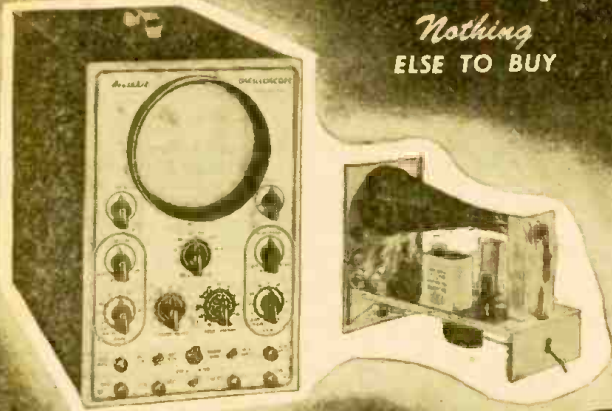

NEW 1948 HEATHKIT 5" OSCILLOSCOPE KIT

A necessity for the newer servicing technique in FM and television at a price you can afford. The Heathkit is complete, beautiful two color panel, all metal parts punched, formed and plated and every part supplied. A pleasant evening's work and you have the most interesting piece of laboratory equipment available.

Check the features — large 5" 5B1 tube, compensated vertical and horizontal amplifiers using 6SJ7's, 15 cycle to 30 M cycle sweep generator using 8B4 gas triode, 110V 60 cycle power transformer gives 1100 volts negative and 350 volts positive.

Convenient size 8½" x 13" high, 17" deep, weight only 26 pounds.

All controls on front panel with test voltage and ext. syn post. Complete with all tubes and detailed instructions. Shipping weight 35 pounds.

Order today while surplus tubes make the price possible.

HEATHKIT SINE AND SQUARE WAVE AUDIO GENERATOR KIT

The ideal companion instrument to the Heathkit Oscilloscope. An Audio Generator with less than 1% distortion, high calibration accuracy, covering 20 to 20,000 cycles. Circuit is highly stable resistance capacity tuned circuit. Five tubes are used, a 6SJ7 and 6K6 in the oscillator circuit, a 6SL7 square wave clipper, a 6SN7 as a cathode follower output and 5Y3 as transformer power supply rectifier.

The square wave is of excellent shape between 100 and 5,000 cycles giving adequate range for all audio, FM and television amplifier testing.

Either sine or square waves available instantly at a toggle switch. Approximately 25V of sine AC available at 50,000 ohm output impedance. Output -1 db. from 20 to 20,000 cycles. Nothing else to buy. All metal parts are punched, formed and cadmium plated. Complete with tubes, all parts, detailed blueprints and instructions.

HEATHKIT SIGNAL TRACER KIT

Reduces service time and greatly increases profits of any service shop. Uses crystal diode to follow signal from antenna to speaker. Locates faults immediately. Internal amplifier available for speaker testing and internal speaker available for amplifier testing. Connection for VTVM on panel allows visual tracing and gain measurements. Also tests phonograph pickups, microphones, PA systems, etc. Frequency range to 200 Mc. Complete ready to assemble. 110V 60 cycle transformer operated. Supplied with 3 tubes, diode probe, 2 color panel, all other parts. Easy to assemble, detailed blueprints and instructions.

Small portable 9" x 6" x 4¾". Wt. 6 pounds. Ideal for taking on service calls. Complete your service shop with this instrument.

HEATHKIT SIGNAL GENERATOR KIT

Every shop needs a good signal generator. The Heathkit fulfills every servicing need, fundamentals from 150 Kc. to 30 megacycles with strong harmonics over 100 megacycles covering the new television and FM bands. 110V 60 cycle transformer operated power supply.

400 cycle audio available for 30% modulation or audio testing. Uses 6SN7 as RF oscillator and audio amplifier. Complete kit has every part necessary and detailed blueprints and instructions enable the builder to assemble it in a few hours. Large easy to read calibration. Convenient size 9" x 6" x 4¾". Weight 4½ pounds.

THE NEW HEATHKIT VACUUM TUBE VOLTMETER KIT

The most essential tool a radio man can have, now within the reach of his pocketbook. The Heathkit VTVM is equal in quality to instruments selling for \$75.00 or more. Features 500 microamp meter, transformer power supply, 1% glass enclosed divider resistors, ceramic selector switches, 11 megohms input resistance, linear AC and DC scale, electronic AC reading RMS. Circuit uses 6SN7 in balanced bridge circuit, a 6H6 as AC rectifier and 6 x 5 as transformer power supply rectifier. Included is means of calibrating without standards. Average assembly time less than four pleasant hours and you have the most useful test instrument you will ever own. Ranges 0-3, 30, 100, 300, 1000 volts AC and DC. Ohmmeter has ranges of scale times 1, 100, 1000, 10M and 1 megohm, giving range .1 ohm to 1000 megohms. Weight 8 lbs.



\$24.50

Nothing ELSE TO BUY

\$19.50

Nothing ELSE TO BUY

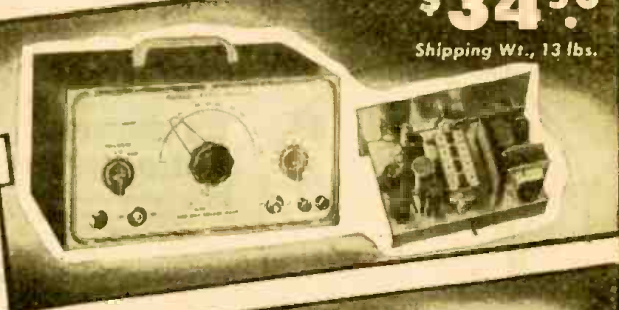

\$34.50

Shipping Wt., 13 lbs.

\$19.50

Nothing ELSE TO BUY



\$19.50

Nothing ELSE TO BUY



\$19.50

HEATHKIT CONDENSER CHECKER KIT

A condenser checker anyone can afford to own. Measures capacity and leakage from .0001 to 100 MFD an calibrated scales with test voltage up to 500 volts. No need for tables or multipliers. Reads resistance 500 ohms to 2 megohms. 110V 60 cycle transformer operated complete with rectifier and magic eye indicator tubes.

Easy quick assembly with clear detailed blueprints and instructions. Small convenient size 9" x 6" x 4¾". Weight 4 pounds. This is one of the handiest instruments in any service shop.



The HEATH COMPANY

DEPT. C . . . BENTON HARBOR, MICHIGAN

Wonderful
NEW 3/4 RPM
Motor
\$2.95



Ideal for a beam rotor, plenty of power. Originally designed for 24 volt DC operation, but easily converted, 110 volts AC. Complete instructions included. Excellent for other uses too. Brand new, surplus, guaranteed. (Add 40c each to cover postage and handling)

PLUS

24 Other Bargains!!!



Brand new 3-0-3, DC voltmeter 2" round case. Meter has 450 ohms resistance (150 ohms per volt). (Add 15c each to cover postage and handling.)

"Meter Specials"
77¢

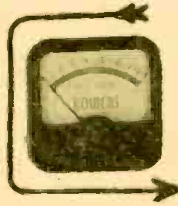

Brand new Bowers D.C. Volt meter 0 to 9 volts in 2" case with 2 3/4" Flange ----- each .99c

Brand new Bowers D.C. Ammeter 0 to 100 amp scales (600 ma. movement with 100 amp shunt) same case as volt meter each .99c

Add 20c each to cover postage and handling

Stock Up



WILLARD 2-VOLT BATTERIES ONLY \$1.25 each

Brand new, Compact spill proof, Built-in Hydrometer Group several together for higher voltages. Uses Standard Electrolyte Guaranteed. Add 35c to cover postage and handling

500' \$2.95
3 CONDUCTOR TELEPHONE WIRE

3 conductor Braided insulated copper & steel telephone wire. It is made of copper for conductivity, and steel for strength. Worth at least 3c per ft. Yet due to an exceptional buy, we can now offer it at less than 1c a ft.

Shipped Express Collect



Radio Compass

RS/ARN7 or 433G, either of these Radio Compass Receivers complete with tubes. Ideal for conversion for home reception. Used but good. A real buy at only \$14.95

Now \$14.95

(Shipped express collect)

Tubes!

3 CP 1 (Ind. Screen) .95
3 DP 1-A (Ind. Screen) .95
3 FP 7-A ----- 1.35
3 HP 7 ----- 1.45

(add 25c each to cover postage and handling)

5 FP 7 ----- 1.75
5 CP 1 ----- 1.95
5 BP 1 ----- 2.45
5 MP 1 ----- 2.45

(add 35c each to cover postage and handling)

7 BP 7 ----- 2.65
7 CP 1 ----- 3.25

(add 40c each to cover postage and handling)

9 GP 7 ----- 3.50

(Shipped express, charges collect)

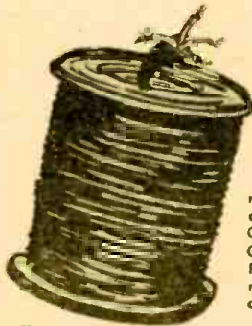

1300' Rubber Covered Wire

ONLY \$18.00

New 4 conductor 16 gauge rubber covered cable. Color coded. Used by United States Government as Field Telephone Cable. 1300 feet on steel reel. F.O.B. Our warehouse Shipped motor freight or express shipping charges collect.

LOOP ANTENNA
A NEVER AGAIN BUY \$3.95

Used primarily on aircraft & Marine ADF Systems, Loop LP-21-A contains an electric motor and selsyn. These loops have been removed from salvage aircraft, but are guaranteed to be in excellent working condition.

Shipped Express Collect

BC 450 CONTROL BOX

Triple remote control box for Command Receivers 1SCR 274 N Series. Equipped with 3 tuning dials, 3 volume controls, and 6 selector switches. Used, but in excellent condition, a steal at only \$1.50 ea. Add 25c to cover postage and handling.



PHANTOM ANTENNA

85¢

A transmitting antenna, for use on approximately 450 MC. Complete with standard coax connector. A weather-proof unit. (Add 25c to cover handling and postage).

ZA-1 LOCALIZER SIGNAL CONVERTER



CDE-20109 \$1.95 ONLY

Contains 2 tubes 6F8G and 6C8G, several carbon resistors, 2 wire wound resistors, 2 precision resistors, 3 transformers, 3 set volume controls and other valuable parts. Add 40c to cover handling and postage.

NOTE

Due to customs regulations which require excessive paperwork and packaging complications, we cannot accept orders for shipment outside the United States or its possessions.

IMPORTANT!

CHECK THESE VALUES

Continuity Tester with 12 extra penn light cells..... \$1.95
Add 15c to cover handling & postage

Throat Mike, complete with cord and switch..... \$.95
Add 15c to cover handling & postage

All merchandise subject to prior sale, minimum order \$2.00, No C.O.D. orders accepted, Michigan residents must add 3% State sales tax.



N. SILVERSTINE CO.

6532 EAST McNICHOLS ROAD DETROIT 12, MICHIGAN

"Seven Acres of Surplus"

RADIO-CRAFT for

SLASHED PRICES DOWN

TUBES

GREATEST SELECTION IN COUNTRY
 LOWEST PRICES
 NEW—STANDARD BRAND—Min. Order \$5.00
 QUANTITY PRICES ON REQUEST

KITS!

0A4G	\$.10	3C6	1.28	6N7	.88	12DP7	14.95	50	1.56	832A	2.95
0D	.50	3C24	.89	6N7GT	.88	12F5GT	.59	50A5	.72	833A	39.50
0Y4	.80	2D6	.89	6P5GT	.88	12H6	.59	50B5	.59	836	1.15
0Z4	.80	3E29	2.95	6Q5G	.98	12J5GT	.59	50L6GT	.59	837	2.50
1A3	.72	3Q4	.72	6Q6G/6T7G	1.06	12K7GT	.72	50X6	.88	838	4.95
1A4	1.28	3Q5GT	.88	6Q7	.88	12K8	.88	50Y6GT	.59	841	.69
1A4P	1.28	3S4	.72	6S7	.88	12K9GT	.59	53	.72	843	.69
1A4T	1.28	4-65A	14.50	6S8GT	.88	12Q7GT	.59	55	.88	845	.69
1A5G	1.28	4-125A	14.50	6SA7GT	.59	12SA7	.59	57	.59	860	4.95
1A5	1.06	4-250A	37.50	6SC7	.72	12SC7	.59	59	.59	861	50.00
1B5	1.06	5BP1	1.49	6SD7GT	.59	12SF5	.72	58	.72	864	.69
1B4	1.28	5BP4	4.95	6SF5	.72	12SG7	.72	71-A	.72	866A	.89
1B5/25S	1.06	5CP1	3.95	6SF7	.72	12SH7	.72	75	2.95	868	1.95
1B7	.72	5FP7	3.95	6SH7	.72	12SJ7	.72	75TL	.59	868A	1.95
1B7	.88	5R4GY	1.29	6SJ7	.59	12SK7	.59	76	.59	868	1.95
1B38	4.95	5T4	1.29	6SK7	.59	12SL7GT	.88	77	.88	869	4.95
1C5G	.88	5U4G	.54	6SN7GT	.88	12SN7GT	.88	78	.59	870	2.95
1C6	1.06	5V4G	.88	6S7	.59	12X3	.88	81	1.28	875	1.06
1C7G	1.06	5W4	.60	6S7	.72	12Z3	.88	82	1.06	883	.49
1D5GT	1.06	5X4G	.88	6S7	.88	12A3	1.56	83V	.88	884	.69
1D7G	1.06	5Y3GT	.38	6S7	.72	12A7	.88	84/8Z4	.59	885A	.49
1D8GT	1.28	5Y4G	.50	6T7	.72	14A7	1.10	85	.88	886	.49
1E5GP	1.56	5Z3	.60	6U5	1.06	14B7	.88	89	1.56	887	1.75
1E7G	1.28	5Z4	.88	6U5GT	.59	14C6	.88	89V	1.56	888	1.39
1F4	.88	6A3	1.56	6U7B	1.06	14B5	.88	90X	1.56	889	.29
1F5G	1.28	6A5G	.88	6V6GT	.72	14C7	.88	100TH	12.95	891	1.75
1G4GT	.88	6A7	.72	6V7G	.88	14E6	.72	114A	.69	892	.49
1G6GT	.88	6A8	.72	6W7G	.55	14F7	.88	117L7GT	1.28	893	.49
1H4G	.72	6AB5/6N5	.88	6X4	.54	14H7	1.06	117M7GT	1.28	894	7.95
1H5GT	.60	6AB7	1.06	6Y6G	.88	14J7	1.06	117N7GT	1.28	895	4.95
1H6G	1.06	6AC5GT	1.06	6Z7G	1.28	14K7	.88	117P7GT	1.28	896	1.75
1J6G	.72	6AD7G	1.06	6ZY5G	.72	14S7	1.06	117Q7GT	.88	897	4.95
1L4	1.06	6AF6G	.88	7A4	.72	14R7	.88	120A	12.95	898	.89
1L4A	1.06	6AF8	.88	7A5	.72	14W7	1.06	121A	2.65	899	.49
1L4B	1.06	6AG5	1.06	7A6	.72	14X7	1.06	205B	4.50	900	3.95
1L4C	1.06	6AG7	.99	7A7	.72	14Y4	1.06	215A	3.00	901	5.95
1L4D	1.06	6AK5	.99	7A8	.72	15A4	1.06	217C	7.50	902	10.00
1L4E	1.06	6AK6	.88	7A7F	.72	15E	1.50	217C	7.50	903	3.95
1L4F	1.06	6AL5	.72	7B3	.72	19	1.06	250R	7.95	904	4.95
1L4G	1.06	6AL7GT	1.06	7B4	.72	20	1.56	250TH	19.95	905	2.95
1L5	1.06	6AL7GT	1.06	7B7	.72	20A4	27.00	252A	4.95	906	1.95
1L5G	.88	6AQ5	.72	7B8	.72	22	.49	304TL	1.98	907	3.95
1P22	11.50	6AQ6	.60	7B9	2.95	23D4	.98	310	4.95	908	5.95
1P5GT	.88	6AT6	.60	7BP7	1.06	23D6	.98	307A	6.25	909	.89
1Q5GT	1.06	6B4G	1.06	7C4	.72	24A	.69	316A	.89	910	.69
1R4	.72	6BBG	.72	7C5	.72	24G	1.06	316A	4.95	911	1.56
1T4	.72	6BBG	.72	7C6	.72	25A6	1.06	350B	4.95	912	.69
1T5GT	.88	6B7	1.06	7E5/1201	1.06	25A7GT	1.06	350B	4.95	913	.69
1U4	.72	6B8	.72	7E6	.72	25C6G	1.06	350B	4.95	914	.69
1U5	.88	6B9AG	.72	7E7	.72	25C6G	1.06	350B	4.95	915	.69
1-V	1.06	6BG6	2.40	7EP4	17.95	25Y5	1.28	450TL	24.95	916	1.95
2A3	.72	6C4	.60	7F7	.88	25Z5	.54	531	49.50	917	.39
2A6	.88	6C5	.60	7F8	1.06	25Z6	.59	701A	7.50	918	.69
2A7	.88	6C6	.60	7G7	1.06	26	.72	703A	2.95	919	.79
2API	2.95	6C8G	1.06	7G7	1.06	27	.72	705A	2.95	920	1.95
2B7	.88	6D4	1.95	7H7	1.06	28D7	.72	707A	24.95	921	1.95
2C22	.88	6D5	.60	7I7	1.06	31	.88	709A	9.95	922	4.95
2C25A	.75	6E5	.72	7K7	.88	32	1.06	713A	1.65	923	2.60
2C34	.98	6F5	.72	7L7	.88	33	1.06	715B	19.95	924	3.95
2C40	2.60	6F6G	.72	7M7	.88	32L7GT	1.28	717A	3.95	925	2.95
2C43	2.80	6F8	1.06	7N7	.88	34	1.06	721A	3.95	926	1.25
2C44	1.75	6F7	1.06	7O7	.88	35	1.06	723AB	5.95	927	1.25
2E5	1.59	6F8G	1.06	7R7	1.06	35/51	.72	725A	12.50	928	1.25
2D21	.88	6G6G	.88	7S7	1.06	35A5	.72	750TL	49.50	929	1.95
2E22	1.59	6H6	.60	7T7	1.06	35W4	.59	800	2.25	930	4.95
2E24	4.37	6H6GT	3.95	7Y4	.72	35Y4	.88	801A	1.10	931	.79
2E25	3.95	6J5	.54	7Z4	.72	35Z4GT	.59	802	2.95	932	3.50
2E30	2.25	6J5GT	1.06	10BP4	34.95	35Z4GT	.59	805	4.95	933	3.95
2I B51	4.95	6J6	49.50	10CP4	42.20	35Z5GT	.46	807	1.25	934	2.95
2V3G	1.10	6J7	.60	10Y	.69	37	.88	808	2.95	935	6.95
2X2	.72	6J7GT	1.06	12A6	.89	38	.88	810	7.95	936	.98
3A4	1.92	6K6G	.88	12A7	1.06	39/44	.59	811	1.95	937	.75
3A3GT	2.95	6K5GT	.54	12A8GT	.72	41	.59	812	2.95	938	.75
3A3P1	1.06	6K6GT	.54	12AH7GT	.88	42	.59	812H	6.50	939	.75
3B7	1.06	6K7	.60	12AT6	.59	43	.59	813	7.95	940	.75
3B22	4.95	6K8	.88	12AUG	.72	45	.59	814	2.50	941	3.00
3B23	4.95	6L5G	.88	12AU7	.88	45Z5GT	.59	815	1.25	942	1.50
3B24	1.95	6L6	1.29	12BA6	.72	46	.88	826	4.95	943	4.95
3B25	.98	6L6G	1.06	12BEG	.72	47	.88	829B	4.95	944	1.95
3BP1	2.95	6L7	.88	12C8	.89	49	.88	830B	5.25	945	1.95

TUBE KITS

Complete Set of Tubes for SCR-522 **\$17.95**

Complete Set of Tubes for BC-348 **\$7.95**

Complete Set of Tubes for BC-312 **\$7.95**

Specify Model Numbers

BC-348 Owners

CONVERTER for BROADCAST BAND

Convert that BC-348 without any alteration in your circuit. Our special converter takes power from receiver. Just tune your set to 450 kc. and forget it. All tuning is done on a converted panel covering 550 to 1600 kc.—double conversion means High Sensitivity. Excellent Fidelity and Higher Selectivity—complete basic kit with schematic and full instructions—less chassis dial and tuning knobs. Terrific Buy at..... **\$6.50**

Do You Own an SCR-522

We have a complete power supply containing all the necessary parts down to the line cord, pilot light switch & terminal blocks & delivers the following voltage—300 v. DC @ 250 milli. 150 v. of regulated bias and sufficient 12 v. to operate the tubes of both receiver and transmitter. Complete at the amazingly low **\$14.95** price of

Model 200-EA. 5-ELEMENT 2 METER BEAM KIT. Folded di-pole driven element. All-aluminum construction. Feed with low impedance coaxial cable. Amateur net price..... **\$8.40**

HOTTEST ITEM OUT!! Make your SCR-522 Receiver operate on 144 to 148 Mc. with ONE DIAL control. In less than 1 hour! Parts and instructions **\$3.00**

DESIGNED FOR THE 522 TRANSMITTER

A Four Band Selector Unit which replaces the selector motor allowing you to change frequency from the front panel quickly. Can be installed in 10 minutes. **\$3.00 each**

No. T-4640 TRANSFORMER

Here is a rugged transformer Hermetically sealed to Army specs. Hermetically sealed for easy soldering terminals for easy franking. Primary 115 v. 60 cys. Sec. No. 1 8.5 v. @ 58 ma. Sec. No. 2 5.4 v. @ 3 a. Sec. No. 3 6.4 v. @ 6 a.

Weight 10 lbs. Your cost **\$2.49**

No. H-3040 Here is a Buy—Dual Grinder HEAVY DUTY

Using 1/3 horse-power motor — If you do any work around the house this will save you endless hours of labor. **\$36.50**



NEW BEE-BEE NB-FM MODULATOR UNIT NO. 500

Here's the answer! This new reactance type modulator is designed for direct coupling to the VFO or crystal socket of a conventional crystal controlled pentode or triode oscillator. It means that you can get NB-FM operation with your PF100 without expensive speech equipment; you can run your phone rig on CW ratings. Phone quality depends solely upon your mike. Clears up most BC troubles. The Bee-Bee unit is not an exciter and does not eliminate or duplicate any of your present equipment. Amateur net, complete with tubes and instructions: **\$18.95**

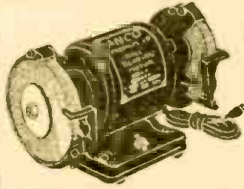

20% DEPOSIT WITH ORDERS UNLESS RATED

NIAGARA RADIO SUPPLY CORP.

160 GREENWICH STREET

NEW YORK 6, N. Y.

ALL PRICES F. O. B. N. Y. C.

RUBBER RECIPE

Rubber compounds to the tune of some 35 million pounds a year go into Bell System plant. Each compound must meet many requirements for resistance to humidity, oxygen, ozone, light and abrasion. The right properties depend on skillful selection and compounding of ingredients; this is one of the jobs of Bell Laboratories.

Sulphur, one essential ingredient of rubber, can also be corrosive. That seemed to rule out rubber on telephone cords. But Bell chemists found that if they held sulphur to the bare minimum, corrosion ceased. Now your handset cord has long life, is less susceptible to moisture as, for example, from a wet umbrella.

Connecting your home to the telephone wire on the street is a "drop" — one hundred feet or more of rubber-insulated wire. Once this wire was protected from ozone, light and abrasion by an impregnated cotton braid; but water leached the impregnant, and the braid rotted. Bell chemists tested scores of synthetics, and selected neoprene as an exterior covering with many times the life of braid.

Rubber is only one of many types of insulation developed by the Laboratories for the Bell System; insulation is only one of the Laboratories' problems in providing a quick, economical path for your voice.



BELL TELEPHONE LABORATORIES

EXPLORING AND INVENTING, DEVISING AND PERFECTING FOR CONTINUED IMPROVEMENTS AND ECONOMIES IN TELEPHONE SERVICE.



RADIO-CRAFT for

RADIOVISION

Radiovision instead of Television expresses the new art more logically . . .

By HUGO GERNSBACK

"TELEVISION and the Telephot" was the title of an article which I wrote in the December, 1909, issue of my former magazine, MODERN ELECTRICS. This, to the best of my knowledge, was the first technical article to appear in print which used the term "television."

The word "television"—a mongrel word—is composed of the Greek "tele," which means far, and the English word "vision." "Telephot"—a purer term—uses two Greek words: "tele" (far), "photos" (light). In other words: far light.

The 1909 article in MODERN ELECTRICS discussed the German inventor Ruhmer's selenium-cell television experiments, in which a number of light-sensitive cells were arranged into a transmitter of 25 squares. Each of the 25 cells operated a sensitive relay when exposed to light. This sent an alternating current over a wire line. At the receiving end were 25 similar relays which operated incandescent lamps made into a square like that at the transmitter. This, of course, was a very crude type of television, but nevertheless a beginning that actually gave some, if crude, results.

At that time we still used the word "wireless"—the termination "radio" had not as yet appeared on the scene. Moreover, the article concerned only wire transmission and reception of television, when and if it came about. No progress to speak of had been made at that time in translating light impulses into electrical ones, while all inventors would have been very happy indeed to transmit television *via* wire.

Later on when crude television made its debut it was still by wire. It was many years later that television impulses finally were sent through space *via* radio.

Now that sending images by radio is more common than sending them over wire, the term "television" (cognate with "telegraphy" and "telephony") is no longer entirely appropriate.

In one of my former radio magazines I suggested (in July, 1928) the term "radiovision," a word which exactly describes the present video transmission through space. I am of the opinion that this more modern expression should be applied to the new and rapidly growing art now called "television," for a number of reasons:

We must always be conscious of the fact that seeing over a distance will be done in the future in a twofold manner: one way by wire, cable, etc., the other by radio.

The Bell Telephone Laboratories—always in the vanguard of television research—have been prominent in

this endeavor for one important reason. That is primarily to link television with the telephone. When and if the problem shall have been solved—and it won't be in a too distant future—we will have *true* television applied and integrated with the telephone. Then when you pick up your phone it will be possible for the distant subscriber to see and be seen over the telephone wire.

In the future, also, we will have a good deal of commercial nonbroadcast television over wires, such as in department stores, in manufacturing plants, in atomic plants, for controlling distant gauges, in banks for verifying checks, etc. Indeed, the two latter applications now are already in use. *The field of wire television will be a vast one.*

But, what concerns us at the present is the far greater application of video: broadcasting through space, which is, of course, radiovision. This term is far more logical, because radio broadcasting should logically remain in its own domain whether it is audio or video. I can easily see many complications and much confusion in the future if the new terminology is not adopted soon.

There is no reason why the word *radiovision* cannot be sold immediately to the public, *before* the video art has become established throughout the land and has become more firmly imbedded in our consciousness.

The regular terminology now used in television can be used with equal facility in radiovision. For instance, we now use the word "telecast." Its counterpart in radiovision, of course, would be "radiocast." A term such as "televise" would have for its counterpart "radiovisive." While such words may sound strange at first, they are no stranger than the old terms were when they first came into use.

To us it seems that the radio industry should adopt the term *radiovision* immediately. Once the country has been thoroughly equipped with video stations and when tens of millions of video receivers have been installed, it will then be too late to make a change. Today it can be effected without great difficulty, if and when the radio industry gets behind it. It would appear that the *radio* terminology, as applied to video for this reason, would be most advantageous.

Let us never lose sight of the fact that in the not too distant future we probably will no longer have sound broadcasting alone. Most far-seeing radio engineers today foresee the time when there will be only one kind of radio in this country, namely: sound plus sight. In this coming development the word *Radiovision* will uphold the radio tradition.

DR. J. HOWARD DELLINGER, chief of the Central Radio Propagation Laboratory of the National Bureau of Standards, retired on April 30 after 40 years of government service.

He is the discoverer of the simultaneous occurrence of solar eruptions and radio fadeouts, known as the Dellinger Effect.

Dr. Dellinger joined the Bureau of Standards in 1907, working first on



standards of conductivity for copper. National and international standards were later based on his work. The scientist initiated radio research in the Bureau and was made chief of the Radio Section at its start in 1919. In the early 1920's he began the standard radio frequency broadcasts of WWV.

Author of over 200 technical papers, Dr. Dellinger is the radio editor of Webster's Dictionary and holds many posts of importance in American and foreign technical organizations.

DISABLED VETERANS in New York City were aided by television last month in obtaining jobs. Representing the first major public service program presented by a TV station, WNBT's "Operation Success" offered two veterans an opportunity to demonstrate their skills to the home viewers. One, victim of a foot injury, and trained by the Veterans' Administration as a draftsman, demonstrated his ability by completing before the camera, a working drawing of a house. The other veteran showed his capabilities as an automobile mechanic by repairing part of a racing car.

Immediately after the broadcast, station telephone lines were jammed with calls. 35 positive offers of jobs were made and the Veterans' Administration expects many additional inquiries.

Further broadcasts are planned along the same lines.

FM SETS IN BUSES will furnish riders in Scranton and Wilkes-Barre, Pa., with music and news from station WIZZ. Installation of the receivers has already been started. The arrangement is a commercial tieup between the station and the bus company.

STEREOPHONIC SOUND, produced by multiple recording on magnetized tape, was announced last month by Armour Research Foundation. It is produced by recording three sound tracks from microphones placed at different points.

The three tracks are then amplified through individual amplifiers whose speakers are so located as to give the sought-for two-dimensional effect. Music from such a system seems to "surround" the listener, according to the Foundation.

SMALLER TV STATIONS will be furnished with the best in program fare by a new system of "networking" demonstrated for the first time last month by the Allen B. Dumont Laboratories. In somewhat the same manner as transcriptions are made of sound broadcasts, a film record, known as a tele-transcription, is made of the TV program as it is broadcast, and prints of the film are sent out to other stations.

The process involves receiving the program on a standard kinescope and photographing the image from the face of the tube. It was necessary to develop a special shutter for cameras used in preparing teletranscriptions.

Although the demonstration indicated that very little picture quality is lost in the teletranscription process, its chief advantage is said to be financial. Programs of large city stations, whose expenses are already underwritten, may be syndicated with no extra talent cost. Filming them from a C-R tube saves the expense and trouble of keeping motion picture cameras on hand in the television studios.

ELECTRON TRACKS have been reported seen for the first time with the aid of a new photographic emulsion, Eastman Kodak Laboratories announced last month.

Electron tracks in emulsions were reported from the University of Montreal in 1946, but the new Eastman tracks, first obtained in the company's laboratory at Harrow, England, and later in Rochester, N. Y., are long enough to remove all doubt as to their identity. The number of developed silver grains in a track on the emulsion ranges from six to a maximum of twenty-eight. The length of the path in an emulsion is about two thousandths of an inch, so that a microscope must be used to see it.

MAGNETIC STORMS which blanket out radio communications may now be predicted dependably to within 15 minutes, research engineers of the Radio Corporation of America announced last month.

The new accurate predictions are due to the discovery of a "critical zone" on the face of the sun. Sunspots in this area are the ones responsible for radio "black-outs." Composition and polarity of these spots are also factors that determine their effect on radio communications.

150-KILOWATT broadcast station will be operating by December 1 at San Luis Potosi, Mexico, near the American border. The decision made recently by the Mexican government to license the station on the new 540-kc channel was protested by the National Association of Broadcasters, which contends the authorization contravenes the regulations made at last summer's international conference in Atlantic City. The regulations widened the broadcast band to include 540 kc but forbade use of the channel without a regional agreement.

Though no decision has been made in the U. S., there has been much discussion of reserving the frequency for regional use. The Mexican grant would make this impossible in a large area of the United States.

MILITARY TV can be a substantial aid to victory in any future war, according to David Sarnoff, president and chairman of the board of RCA. Mr. Sarnoff, who is also president of the Armed Forces Communications Association, cited a demonstration of airborne television by the Navy two years ago. He also listed remote control and direction of pilotless bombers and crash boats, military spotting, gun control, and the guidance of bombs, flying torpedoes, and other guided missiles.

"The day may come," predicted Mr. Sarnoff, "when the Commander-In-Chief in Washington will be able to watch distant military activities, even overseas."

NEW RECTIFIER TUBE greatly increases the power-carrying capacity of electrical transmission lines by making possible the use of d.c. on long-distance lines. The new tube, a multi-grid thyatron, has a theoretically infinite power-handling capacity, according to a recent statement by Dr. A. W. Hull of the General Electric Laboratories.

The maximum a.c. which can be carried on a line is limited by the insulation required to handle the peak voltage. It is, however, the r.m.s. voltage—which amounts to only 70.7% of the peak value—which determines the useful energy available. Thus, a line insulated sets for 100,000 volts can do only 70,700 volts worth of work.

Since d.c. voltage does not fluctuate, the same line could handle 100,000 volts of d.c., and 100,000 volts worth of energy would be carried.

Tubes capable of handling the transmission of current generated at Boulder Dam to the west coast at almost 300,000 volts can be built. If the power industry needs them, even larger tubes are possible.

DR. WILLIAM WILSON, former assistant vice-president of the Bell Telephone Laboratories in New York, died last month at his home in Raleigh, N. C. He was an important contributor to the development of the vacuum tube. At the time of his death he was professor of physics at the University of North Carolina.

NEW TELEVISION STUDIOS were leased last month by the National Broadcasting Company in New York City. Three of the RKO-Pathe motion picture sound studios on upper Park Avenue will be used for TV originations. The main studio, measuring 97 x 54 feet, will be the world's largest television studio; according to NBC.

When the new center goes into operation on July 1, the network will have a total of five New York studios. The other two are located at NBC headquarters in Rockefeller Center.

STUDY OF THE 216-500-MC band to determine its usefulness for television will be conducted by a joint committee of the RMA and the IRE, it was announced recently. The project follows a suggestion made by Chairman Wayne Coy of the FCC to the IRE. The study will be of a general nature, to enable the committee to advise the FCC on the practicability of extending commercial television to 500 mc. The present band, according to Mr. Coy, is likely to prove inadequate.

TRAVEL RESERVATIONS may be made automatically by Intelix, an amazing electrical brain which continually keeps track of available airplane or railroad accommodations, granting space to travellers if it can be had or denying requests when facilities are sold out.

The new machine, demonstrated last month by the International Telephone and Telegraph Corporation, can be compared to a dial telephone system, but it is much more complex. Clerks at transportation offices send a coded teleprinter message to the Intelix asking for a reservation. The machine determines whether one is available for the particular journey desired, then automatically sends a message of confirmation or denial to the clerk. Only one Intelix is needed for a transit system; it will deal with offices from coast to coast.

One-way or round-trip journeys may be scheduled, as well as more complicated routings. If the desired reservation cannot be had, the mechanism suggests alternative ones. A "broadcast circuit" will inform all offices as soon as space is sold out.

The device is also applicable to inventory control and bookkeeping.

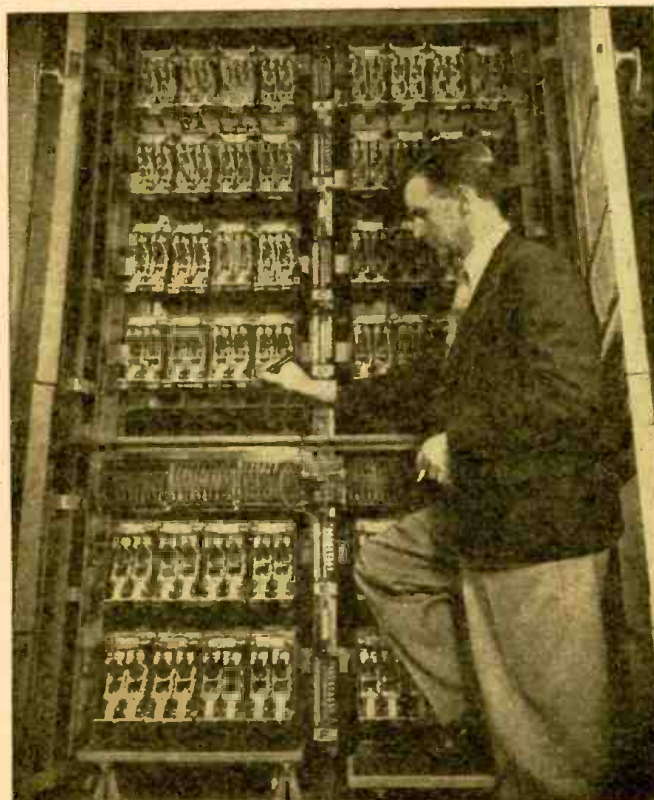

The Intelix, a new electronic device for making train reservations.

DELETION OF CHANNEL 1 from the band assigned to television transmission was announced last month by the FCC. At the same time, the commission ruled all sharing services off the other 12 video channels and called for a public hearing on the whole television allocation problem. Both black and white and color TV will be studied at the hearing, which will be held in September.

Repeating its statement of 1945 that "there is insufficient spectrum space below 300 mc to make possible a truly nationwide and competitive television system," and that such a system must "find its lodging higher in the spectrum where more space exists," the FCC proposed to look into the status of transmitting and receiving equipment for the 475 to 890-mc band.

UN AMATEUR STATION began operation last month from United Nations headquarters at Lake Success. Using the call K2UN, two 1,000-watt transmitters will operate in the 10-, 20-, 40-, and 80-meter bands. Complex beam antennas will assure maximum range of transmission and reception.

The station will make it possible for more information to be spread throughout the world on UN activities, and will afford contact with individuals, to answer queries and to carry messages to and from delegates' families.

Housed in a glass-enclosed booth at one side of the main public lobby, the equipment and the semi-circular control table will be in plain view of UN visitors. Operation will be handled by members of the UN Amateur Radio Club.



A MICROWAVE TOWER "to bring into the laboratory the facilities of the field" was dedicated by Federal Telecommunications Laboratories last month at Nutley, New Jersey. Rising 300 feet from its base and 358 feet above sea level, it will make possible the carrying on of many experiments right at the best point for a radiator.

The tower, made of steel and aluminum, has three main floors which can be used for research purposes. These are directly under the top. There are also several interior platforms for the installation of experimental microwave equipment. At present work with search radar is being carried on in the top section (the parabolic antenna may be seen above the tower) and the one below is being used for experimental television transmission on the high-frequency television band.

One of the new developments shown was a two-color radar. Planes equipped with responders reply to radar challenge with strong signals, which are shown in green on one C-R indicator, while another indicator shows the weaker standard radar reflections from all planes in the area in yellow.

The two indicators are suspended above a mirror so that their images are superimposed and the viewer sees what appears to be a single indicator. Advantages are that the much stronger signals from responder-equipped planes appear plainly in many cases where the natural radar reflection is obscured entirely by ground clutter, yet the duplex indicator can be watched as easily by the operator as a single screen.

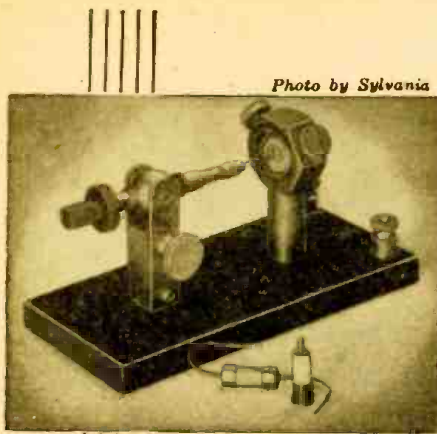

Fig. 1—Crystal detectors, the old and new.

MODERN development of crystal cartridges has led to countless new uses of crystals for detecting, mixing, and rectifying. With improved manufacturing processes and the use of germanium, these tiny crystal rectifiers may ultimately replace practically all diode vacuum tubes.

The origin of modern crystal cartridges lies in the familiar and historic crystal radio detectors (Fig. 1) of nearly a half century ago.

Not so familiar, however, is the true story of the discovery and development of the first crystal detectors. The supposed date of the discovery of the original crystal or mineral detector has long been generally accepted as 1906, when the first patent was issued. Actually, discovery of the first crystal detector occurred four years earlier in 1902 when Dr. Greenleaf W. Pickard quietly began his initial experiments in wireless detection. There was no publicity, and no patent was applied for; but sufficient evidence has been found to substantiate this early research.

Early detectors

A suggestion that certain minerals possessed unilateral characteristics was advanced as early as 1874 by Braun¹ of Germany, but his experiments dealt only with the conduction—not detection—of electric waves. Beginning about 1891, Branly² used combinations of two dissimilar metals as contact rectifiers of very low-frequency waves, with only fair results. Except for occasional speculation in the technical press of the period, the vast possibilities of crystal and mineral detectors remained virtually unexplored.

At the turn of the century there were five principal methods of detecting wireless signals: (1) the metal- filings coherer, (2) the liquid barretter or electrolytic detector, (3) the de Forest responder or antioherer, (4) the delicate carbon-steel microphonic detector, and (5) the intricate magnetic detector. Although sometimes suitable for low-speed code reception, these detectors were usually unstable and inefficient; they required a battery and were critical to adjust.

During the summer of 1902, a young American radio engineer became keenly interested in the need for a simpler and more efficient means of detection. On May 29, while conducting experiments at Cape May, New Jersey, with a carbon-steel detector and a telephone receiver, he discovered accidentally that messages could be received extremely well when the battery was switched out of the de-



Fig. 2—Dr. G. W. Pickard, still active at 70.

tor circuit. This was contrary to the accepted theory of the time, and indicated that the telephone diaphragm was being operated entirely by radio energy. Determined to investigate and develop solid-contact detectors which embodied this new principle, from that day in 1902 on, Greenleaf W. Pickard—then a young man of 25—turned his attention to studies of mineralogy and chemistry.

While leading radio engineers and experimenters (such as Marconi, Fessenden, de Forest, Lodge, Stone, King, Collins, Pierce, Vreeland, Taylor, and others) were concerned with the relative merits of the barretter and coherer, young Pickard returned to Boston and quietly began his experiments in search of suitable rectifying substances. These experiments continued without substantial interruption for well over a decade.

The first mineral detector

"At first it was a case of trial and er-

ror," relates Dr. Pickard, now 70 years old and still active as a consulting radio engineer (Fig. 2).

"After building my own test instruments, I began experiments in the summer of 1902. I started with a typical carbon-steel detector using a focal battery, and tried all possible variations to improve reception. One day, I obtained the best results," recalls Dr. Pickard, "when I used an oxidized steel surface, instead of carbon, in contact with a steel needle." This occurred on July 25, 1902.

After exhausting the possibilities of the carbon-steel device as an efficient rectifier, Pickard was ready to explore further the field of minerals.

Recalling his fair results with an oxidized steel surface (essentially an oxide of iron, or layer of magnetite), Pickard obtained a small quantity of lodestone or natural magnetite. "For my experiment," states Dr. Pickard, "I used a fragment of lodestone about 1/10 inch thick, placed on a piece of tinfoil to provide a large contact area. A copper wire served as the second member of the contact."

On October 16, 1902, this combination was used successfully for the first time as a detector without a battery in a simple receiving circuit. Despite only fair results, this was actually the first use of a mineral-type contact detector for the reception of radio waves. Although Pickard made no attempt to patent his discovery of the magnetite detector, the date of this experiment precedes by four years the issuance of the first detector patent³ and by at least three years the activities of any other

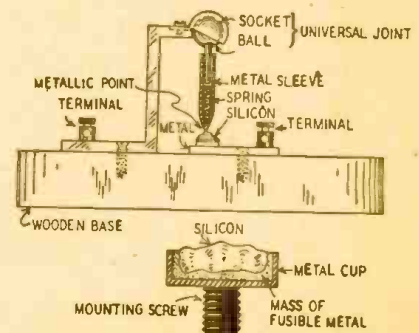

Fig. 3—The first patented mineral detector.

RADIO-CRAFT for

experimenter engaged in similar work. This is substantiated by Pickard's notes and other data³ on file in the U.S. Patent Office. Subsequent experiments with magnetite proved it to be fairly efficient and capable of withstanding sub-

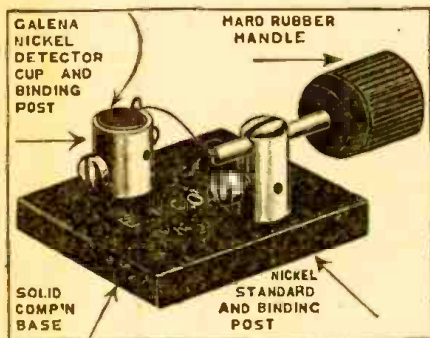

Fig. 4—E. I. Co. crystal detector, designed by H. Gernsback in 1912, originally sold for 10c for the complete detector. Probably the most widely sold detector at any time. Over 250,000 of these detectors were sold.

stantial electrical overloads, but not very sensitive⁴.

In September 1903, the first intelligible speech was received with a carbon-steel rectifier, and the experiments were repeated shortly after with the magnetite detector⁵. (Transmission was by high-frequency spark, incidentally!) Using a modified form of the device, Pickard found that the presence of a local battery did not affect the rectifying action of the detector. However, the use of another substance was required for more sensitive and efficient detection.

Early investigations

Beginning in 1903 and continuing for over seven years, Pickard conducted an exhaustive investigation of all known minerals and crystals to determine those most suitable for the detection of radio waves. The experiments consisted of practical listening tests of code stations in the vicinity, which included the Marconi station at South Wellfleet, Cape Cod (about 80 miles distant), the Navy Yard station at Boston (about 40 miles), and the Fessenden station at Brant Rock, Mass. (about 70 miles).

Minerals were graded on their relative sensitivity when in contact with a nonrectifying conductor and with various other rectifying materials. After testing all minerals available locally and regionally, in 1905 Pickard began tests of new and rarer types from chemical supply companies.

Much of his early work was concentrated on metallic oxides. Of the thousands tested, zinc oxide and lead oxide were identified as highly sensitive materials early in 1905. Also in that year, the merits of galena and iron pyrites were recorded by Pickard. Thereafter, his work was largely concentrated in the study of crystalline materials.

The enormous scope of Pickard's experiments during these years included not only solid chemical elements, but chemical compounds of the various classes—such as oxides and sulphides. During the course of these experiments,

Dr. Pickard discovered more than 250 distinct types of material which exhibited pronounced properties of rectification. Since these materials were tested in contact with a nonrectifying conductor and then in contact with other materials, actually more than 30,000 different combinations of rectifying materials were tested and classified. This spectacular accomplishment represents one of the most detailed technical investigations in the history of radio.

During the latter part of 1905, occasional references to Pickard's experiments began to appear in the technical press. Then, for perhaps the first time, many engineers and experimenters realized the potential importance of mineral rectifiers and detectors. Austin, Pierce, Round, Fleming, and others began independent experiments.

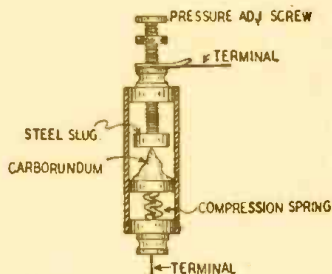

Fig. 5—Dr. Pickard's holder for carborundum.

The silicon detector

Although he had found no detector with extreme sensitivity by the fall of 1905, Pickard continued his investigations, knowing the characteristics of materials most likely to provide efficient and satisfactory rectification. He knew

a mineral with a high specific electrical resistance was required.

In November, 1905, Pickard read⁶ of a new electric-furnace product known as silicon, which had not only a high specific resistance but a considerable degree of hardness and a high melting point. A sample of silicon was received and tested by Pickard on Aug. 13, 1906. When suitably mounted, with a flat surface of the silicon in contact with a steel hair wire (later known as a catwhisker), the detector proved extremely sensitive despite critical adjustment.

Satisfied with his results, Pickard applied for a patent covering his use of silicon in a special holder. This was finally granted⁶ on Nov. 20, 1906. It was the first patent⁷ issued for a contact-type mineral detector; it is shown in Fig. 3.

Other types of crystals

During 1906, another contact detector using carborundum was devised by H. H. C. Dunwoody, a retired Signal Corps general.

Carborundum, an electric furnace product, was somewhat of a novelty at that time, and Dunwoody conceived the idea of using it as a detector in a large number of wireless applications. He applied for a broad patent for his device, but before the patent was granted⁸ Dunwoody sold his idea of a carborundum detector to the American de Forest Wireless Telegraph Company.

Convinced of the possibilities of carborundum but unable to operate the detectors properly, the de Forest Company employed G. W. Pickard—by then a recognized authority on mineral detectors

The "Electro" Universal Detector Stand.

During the last months we have had a great many inquiries for Carborundum, Molybdenite and Silicon Detectors.

We felt that it would be unwise to manufacture any of these Detectors, as almost every month a new substance is discovered, proving better than those invented before.

We therefore decided to manufacture a universal Detector stand which could be used in connection with any substance—old, new, and as yet to be discovered.

Our customers will agree with us that this is a sensible method, as it will then not be necessary to buy a new detector every time a new substance is found.

In ALL Detectors of this type the substance is clamped between two metal parts and this feature is found in our new Universal Stand.

The two uprights hold a movable horizontal bar, at the end of which a heavy brass disc is provided. At the other end a knurled rubber handle is attached, making adjusting easy, and also preventing current leakage through the body while adjusting. One horizontal bar and disc is nickel plated, the other bar and disc silver plated. We find this combination gives the best results.

A spiral spring is provided between each disc and upright, making it possible to adjust the detector very accurately and sensitively.

When detector is adjusted screw down the two upper thumb-screws and the detector cannot possibly get out of adjustment.

We also furnish a pair of finely nickel plated steel pinchers, as they facilitate the handling of small pieces of the various substances a great deal. Without these pinchers adjusting and placing small pieces correctly is very tiresome.

We guarantee that our Universal Detector Stand will do all and just as good work as expensive stands in which you pay for fancy trimmings, etc. You want to get results. Our instrument furnishes them and don't tax your pocket-book. Size of base, 3 inches in diameter.

9230 Electro Universal Detector Stand \$1.00
By mail, extra 0.10

NOTE.—Parts to this Stand are NOT sold, nor do we equip same with Carborundum, Silicon, Molybdenite or any other patented substance.

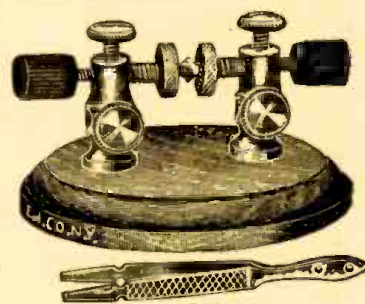

Fig. 6—The first crystal holders were offered in 1908 by the Electro Importing Company.

—to explain the proper adjustment and operation of the detectors to de Forest engineers and technicians. Pickard soon introduced new crystal holders (Fig. 5) for the carborundum, and later designed holders for carborundum detectors used with the de Forest Type 8 receiver.

The carborundum detector was rugged and stable, and it became fairly popular with commercial operators. Considerable contact pressure was required for efficient operation, and a local battery and potentiometer were necessary for varying the sensitivity. However, the detector did not require frequent adjustment.

In May of 1906, L. W. Austin proposed that contact detectors could be made of any material or combination of materials, so long as the two contact elements were brought together with sufficient pressure. However, his attempt to patent a holder¹⁰ met with failure. Continuing his activities, Austin developed a unique detector consisting of tellurium and silicon arranged in a thermocouple. Although patented¹¹, the device had little practical application.

Later developments

Continued popularity of the silicon detector was assured by the middle of 1907, but Pickard did not abandon his search for more sensitive rectifying materials.

He developed an improved silicon detector¹², more rugged and with higher sensitivity, which was subsequently adopted as standard by the Army Signal Corps.

Expanding his earlier experiments with zinc oxide, Pickard perfected a sensitive contact rectifier known commercially as the "perikon" detector¹³. The unilateral element of this device consisted of a combination of zinc oxide and copper pyrites.

By this time, many experimenters had become interested in contact detectors, and the majority believed that the action was entirely thermoelectric in nature. Despite the firm beliefs of engineers and experimenters such as de Forest¹⁴, Acheson¹⁵, Pierce¹⁶, Tissot¹⁷, and Fleming¹⁸, Pickard proved conclusively that the action was not thermoelectric but a true rectifying action.

Subsequently, Pickard was successful in producing oscillations with a crystal detector circuit, so that the circuit could be operated as a beat receiver.

Later, Pickard developed and patented a molybdenite detector¹⁹, an improved zincite-chalcocopyrite detector²⁰, and the "pyron" detector composed of iron sulphide.

During this period, a number of other materials such as galena, iron pyrites, and pyrolusite, were perfected for use as contact rectifiers. In particular, the galena detector (Fig. 4) proved extremely popular because of its high sensitivity.

Heyday of crystal detectors

Public interest in crystal detectors, beginning in 1909, had a profound effect

on the popularization of radio and, eventually, broadcasting.

The first commercial crystal holder (Fig. 6) was advertised by Hugo Gernsback's Electro Importing Company of New York in its *Catalogue 5* and in the technical press²¹ in the fall of 1908.

There was no vast radio industry at that time; but to meet the increasing demands of amateurs, and later, the general public, more and more firms turned to the manufacture and sale of crystal detectors and receivers from 1910 to about 1920.

All this came to an end with the development of the vacuum tube which, at that time, proved a far more efficient detector and rectifier than any mineral substance. Today, only memory serves as a reminder of the heyday of crystal detectors, but the early work of Dr. G. W. Pickard remains a monumental achievement of historical importance.

Dr. Pickard believes today that many of the useful radio and electrical possibilities of minerals and crystals have yet to be explored and developed.

"Any contact which doesn't obey Ohm's law can be used to produce oscillations," states Dr. Pickard. "If it can be made to oscillate, a crystal rectifier can also be made to amplify—although the simple contact must be changed to something more complex."

And in the light of highly successful experiments which are now in progress at the laboratories of several universities, the eventual use of certain minerals and crystals for amplification is a distinct probability.

References

1. *Poggendorff's Annalen*, Vol. 152, 1874.

PHOTOELECTRIC EYE PROTECTS SUNBATHERS

THE science of electronics, in addition to performing such varied chores as arousing sleepwalkers and opening garage doors, has invaded still another sphere of activity. Bathing beaches, formerly associated with bathing beauties, playboys, and escapists from the oppressive heat of cities, may now be the proving grounds of science. The all-seeing photoelectric eye will scan sun bathers and ration the amounts of suntan.

Tourists to Florida beaches next winter may be seen carrying, in addition to their usual luggage, a device resembling an overgrown portable radio, with a knob on top. Inside the wooden container is a photoelectric tube which controls a flow of current in direct proportion to the intensity of the light entering the box. The unit uses standard equipment for correlating light intensity and exposure time, as is done in making exposures for photo engravings. In measuring sun-tan, the device automatically fixes the period of time in relation to the amount of light—thus preventing undesirable sunburn.

Where breathes there a man with skin so immune that he has not at some time lain overlong under a deceptively hazy sky and gone home with a burning, itching, tortured hide? Some light-com-

2. *Comptes Rendus*, July, 1908.
3. Record of Interference 29,003 and 31,649 in U. S. Patent Office, 1911.
4. Personal communication: Dr. Pickard to author.
5. London, *Science Abstracts*, Nov. 1905.
6. Patent 836,531, Silicon Detector, by G. W. Pickard, Nov., 1906.
7. *Electrical World*, Nov. 24 and Dec. 8, 1906.
8. Patent 837,616, Carborundum Detector, by H. H. C. Dunwoody, Dec., 1906.
9. *Electrical World*, Aug. 25 and Nov. 24, 1906.
10. Patent Application 319,241, by L. W. Austin, May, 1906.
11. Patent 846,081, Tellurium Detector, by L. W. Austin, Mar., 1907.
12. Patent 888,191, Silicon Detector, by G. W. Pickard, May, 1908.
13. Patent 886,154, Perikon Detector, by G. W. Pickard, April, 1908.
14. *Electrical World*, Sept. 8, 1906.
15. *Electrical Journal*, 1906.
16. *Physical Review*, June, 1907.
17. *Electrical Engineering*, July, 1908.
18. *Cassier's Magazine*, Vol. 34, Sept., 1908.
19. Patent 904,222, Molybdenum Detector, by G. W. Pickard, Nov., 1908.
20. Patent 912,726, Zincite-Chalcocopyrite Detector, by G. W. Pickard, Feb., 1909.
21. *Modern Electrics*, Vol. 1, No. 8, Nov., 1908.

Other Bibliography

- History of Radio to 1926* by Gleason L. Archer, Stratford Press, 1938.
The Electric Word by Paul Schubert, MacMillan, 1928.
Radio's Conquest of Space by Donald McNicol, Murray Hill, 1947.

plexioned individuals even refuse to go to a beach at all because they know that no matter how much they may enjoy their revels in the surf and their gambols on the sand, the next week's agony may be small recompense. For these unfortunates, electronics come to the rescue.

Fair, sensitive skins of blondes, for instance, cannot tolerate more than twenty minutes of bright sunlight, without inviting a painful lobster red. Hazy days with intervals of cloudiness and brightness, are even more problematical to sensitive skins. On such days, the all-seeing and scientifically accurate photoelectric eye can dole out proper doses of sunshine to sun bathers. The indicator on the dial of the General Electric gadget is set on the desired duration of time, assuming bright sunlight, say 20 minutes. A switch is flipped, and the electronic tube passes electric current in proportion to the intensity of the light actually present. An indicator on the dial slowly moves back to zero at a speed depending on tube current. When the dial registers zero, the desired amount of suntan has been obtained, and either a bell rings or a light flashes a visual warning. Net results—scientific sun bathing!

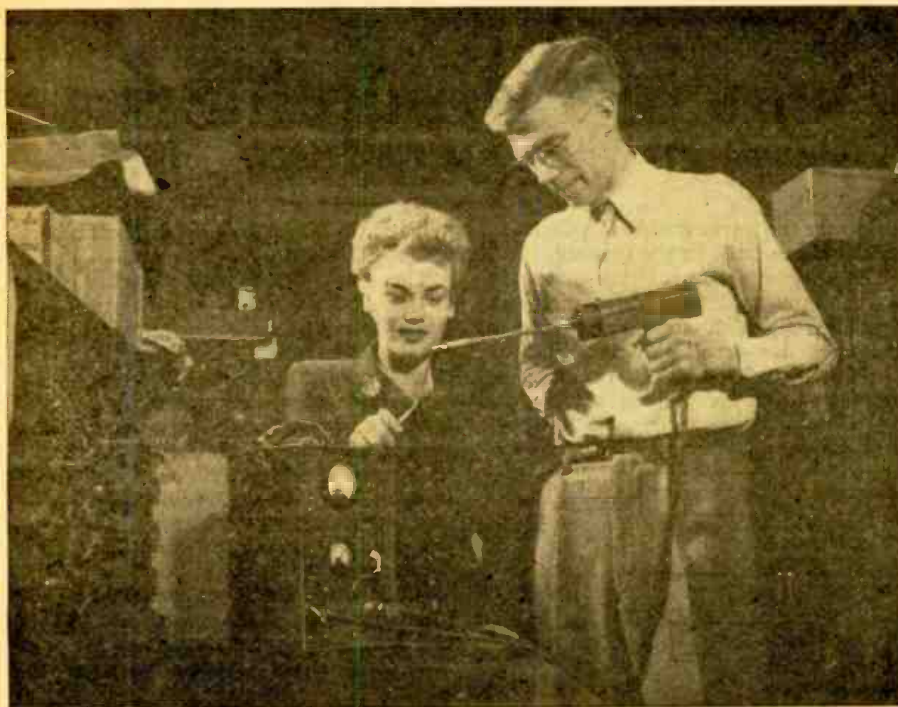

Above—The halogen-sensitive element used in the electronic nose. Left—The burning driftwood splinter releases halogen smokes which are drawn through the "pistol barrel" to the sensitive element. Upper meter shows presence and concentration of vapor or gas.

The Electronic Nose

ONE of the latest developments in the application of electronics to industry is an "electronic nose" capable of indicating the presence and the strength of an odor. The instrument adds the sense of smell to the other human functions which can be duplicated by science—

made negative and the heated cathode positive. Ion emission can take place in air, unlike electron emission, which requires a near-vacuum.

This device makes use of the ion emission, which increases when the cathode is struck by vapors of the halogen family. This includes bromine, iodine, fluorine, chlorine, and their compounds. It is especially sensitive to chlorine compounds such as carbon tetrachloride, chloroform, and Freon.

Fig. 1 shows the structure of the "electronic nose." The platinum wire heater heats the inner cylinder or cathode. D.c. is applied between the outer cylinder and the cathode. The negative charge on the outer cylinder attracts positive ions emitted by the cathode, and a current flows through the meter.

A flow of air is maintained through the spaces between anode and cathode. When the air contains chlorine vapors, the stream of ions flowing from cathode to anode increases. The resulting increased meter reading indicates the presence and relative concentration of these vapors in the air.

Increased ion-flow also takes place when certain types of solid particles are added to the air. The nose will "smell" smoke produced by burning of any substance containing iodides, chlorides, bromides, and fluorides.

In its present form, the elements become corroded after too much exposure to vapors, and they must be replaced; there is promise, however, that more research will enable the "electronic nose" to maintain its sensitivity for longer periods.

Practical uses for the device are manifold. It can be used, for instance, to detect gas leakages. In one refrigerating system using Freon gas, the air intake nozzle is moved around near places where the Freon is suspected to be leaking. If it is actually leaking some of it will get into the spaces between cathode and anode of the detector and the rising meter reading will indicate the leak.

Fig. 2 shows another interesting method for making the unit indicate the presence of vapors. The speaker transformer, condenser, and glow-discharge tube form a relaxation oscillator. The current through the d.c. circuit (controlled by the emission of the cathode) builds up a charge across the condenser. When the charge is high enough the glow tube breaks down and shorts the condenser, which then starts charging again. Each time the glow tube breaks down a click is heard in the speaker. As the amount of vapor in the air increases, ion emission increases, the condenser charges more quickly and the clicks in the speaker speed up.

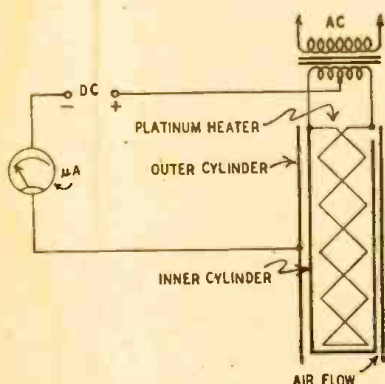

Fig. 1—Gas leaks are found with this circuit.

hearing (the microphone), speaking (the loudspeaker), sight (the photoelectric tube), and touch (simulated by special instruments).

The new device, born recently in the General Electric Laboratories, is expected to be most valuable in detecting the presence of harmful smokes and gases.

Emission of electrons is a commonplace in radio. Vacuum tubes are based on this. That positive ions can also be emitted by the action of heat is not so well known. The polarities of the vacuum tube must be reversed: the cold anode is

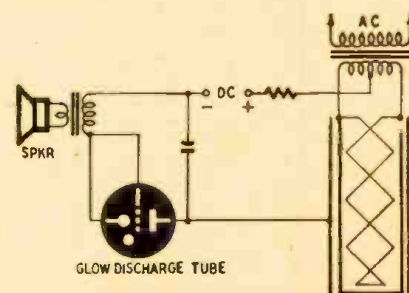

Fig. 2—A gas leak sounds audible alarm.

Television Camera Preamplifiers

By EDWARD M. NOLL

CAMERA preamplifiers are used to bring up the very weak output of the camera tube to a level suitable for transfer through a co-axial cable to the main video amplifiers. Generally, four or five stages are necessary.

Only the parts within the dash-line rectangle are built in the camera.

The three major problems in the design of a preamplifier are: maintenance of a high signal-to-noise ratio with an extremely low-level signal; obtaining the proper band width to amplify all components of the picture signal; and

noise ratio is obtained with the highest value of resistance.

There is a limit to the possible value of the output resistor. While output and signal-to-noise ratio do improve with greater resistances, the distributed capacitance of the camera and tube circuits does not allow the high-frequency output to increase at the same rate as output at middle and low frequencies. The maximum permissible resistor value is limited by the allowable amount of high-frequency loss, which must be compensated for in a later stage (the high peaker) of the preamplifier. Located at a point where the signal reaches an appreciable level, it attenuates the middle and low frequencies until they reach a level comparable to that of the highs.

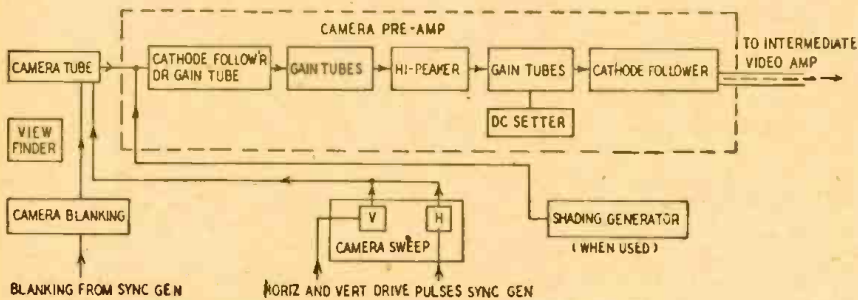

Fig. 1—Blanking and sync voltages are usually generated at the master control.

To keep the signal above the noise level, the preamplifier is placed near the camera tube. Even with the preamp mounted close to the camera a number of unusual precautions must be taken to keep the signal-to-noise ratio high and to amplify linearly a band of frequencies extending from 30 cycles to 4 or 5 mc.

A block diagram showing the main components of the camera circuit appears in Fig. 1. Not all of these components are a part of the camera proper, but they are essential for proper opera-

tion. Thermal agitation in the output resistor of the camera tube contributes a considerable amount of noise. The amplitude of this noise rises as the square root of the resistor value, while signal output rises directly as the resistance value. Consequently, the best signal-to-

proper shielding to prevent hum and the introduction of spurious signals. Since output from the camera tube is so small, noises which are considered insignificant in other work, such as thermal and tube shot noises, seriously affect a camera circuit.

Thermal agitation in the output resistor of the camera tube contributes a considerable amount of noise. The amplitude of this noise rises as the square root of the resistor value, while signal output rises directly as the resistance value. Consequently, the best signal-to-

Frequency response

The over-all frequency response of the camera preamp must be linear over a wide range. To follow an abrupt change in brightness along one line of the picture requires a very fast change in voltage, or good high-frequency response; to follow a very slow change requires good low-frequency response.

The high-frequency response is restored by special series or shunt peaking systems. Every possible precaution is taken to keep distributed capacitance at a minimum, particularly in the camera-tube output circuit. If the circuit capacitance is held at a minimum, the output load resistor can be made higher, and more gain can be obtained. Miniature tubes, with their low input and output capacitances and high gain, have greatly improved and simplified camera preamplifiers.

A cathode follower is often used in the input stage because of its lower input capacitance. Cathode followers are used in output circuits as impedance transformers, to obtain the low-impedance signal necessary to match the co-axial transmission line without high-frequency loss.

The good low-frequency characteristic and the high gain of the preamplifier make microphonics and hum pickup important. The preamp must be properly shielded, very carefully decoupled at the power supply point, and must use non-microphonic tubes. Wiring must be done carefully to prevent hum and low-frequency oscillation (motorboating). In most units, d.c. is applied to the heaters.

In some cameras, special clamping circuits are used to sustain low-frequency response. When this system is used, the earliest stages have relatively poor low-frequency response, and, therefore, are not susceptible to microphonics and hum. In a later stage the low-frequency components and the d.c. black-level signals are re-inserted by means of the clamping circuits.

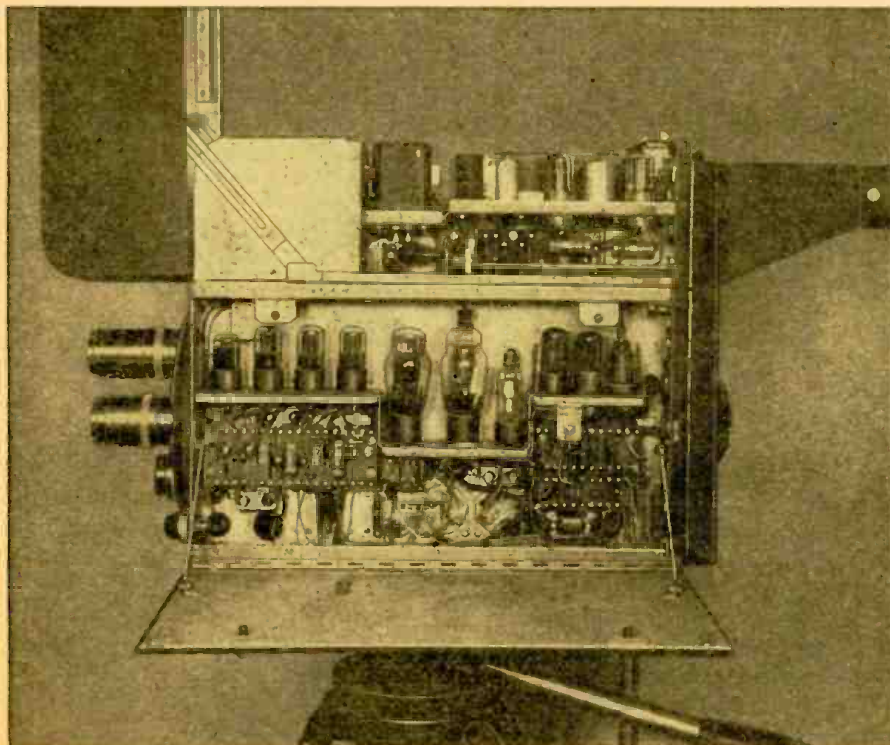

The preamplifier is in the lower section of this RCA image orthicon camera unit.

The camera tube is well shielded. This prevents hum pickup from motor-driven focusing and view-finder systems.

Special compensating circuits must be used to remove spurious signals inserted into the camera output during the beam retrace period, when relatively high-voltage transients are generated in the deflection coils.

High-frequency peaking

The equivalent output circuit of the camera tube is shown in Fig. 2-a. Resistor R1 represents the output resistance, and capacitor C1 represents the

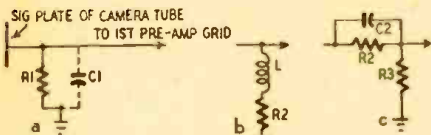

Fig. 2—H.f. compensation for camera tube.

total distributed capacitance in shunt with the resistor. As in all amplifiers, the capacitance shunting the output resistance reduces the net impedance at high frequencies. In the case of camera tubes, where the signal passing through the resistance is extremely weak, the resistance must be kept as high as possible to develop an appreciable voltage. But, as the value of the resistor increases, the high-frequency loss becomes more serious. To obtain appreciable output voltage from an iconoscope circuit, the output resistor must be approximately 300,000 ohms. Obviously, high-frequency loss is great. In a typical example, the output impedance consists of 300,000 ohms shunted by an effective 8- μ f capacitor. With this combination the output is reduced to 70.7% of the mid-frequency level at 67,000 cycles. A good deal of compensation is necessary to obtain linear response up to 5 mc at the preamplifier output.

Two basic compensating circuits are shown in Figs. 2-b and 2-c. In Fig. 2-b a simple inductor-resistor combination is used. Its rising impedance with frequency compensates for the decreasing impedance of the camera-tube output circuit. If the time constants of these two networks are made equal, the high-frequency loss and phase shift will be compensated for.

With the capacitor-resistor combination of Fig. 2-c a similar relationship exists, where the time constant of R1-C1 and R2-C2 must be equal for proper compensation. With this method, C2 prevents the transfer of the low and middle

frequencies to R3, while it readily passes the high frequencies.

Amplifiers following the high-peaker network must have a linear response over the entire range. The combination of the output impedance of the camera tube, the high-peaker stage, and the following linear amplifiers, produces a camera preamplifier with a linear response over the entire video range.

Typical preamplifiers

A typical iconoscope preamplifier is shown in Fig. 3. It uses the R-L method of high peaking, as in Fig. 2-b. The peaking circuits are adjustable and are set when aligning the camera. In practice, the high peaker is set to give the best horizontal resolution without the appearance of transients in the picture.

The preamp of Fig. 3 uses a cathode-follower input stage, followed by a linear amplifier and the high peaker. Another amplifier follows the high peaker and feeds the output tube.

The normal input capacitance of the 1851 is 16 μ f; by connecting the tube as a cathode follower, the effective input capacitance becomes only 2 μ f. This

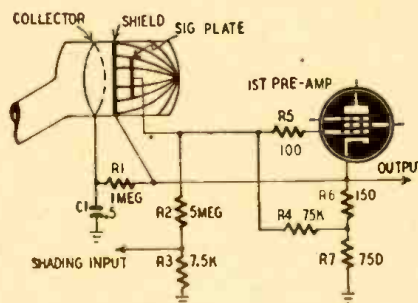

Fig. 4—Detail of first amplifier stage, Fig. 3.

permits the use of a higher-value load resistance with an attendant increase in camera output voltage and signal-to-noise ratio.

The iconoscope output circuit and video input stage are shown in detail in Fig. 4. The actual resistive load on the iconoscope consists of R4 in series with R7. Although these are only 75,000 and 750 ohms, respectively, the resistive load on the iconoscope is actually 300,000 ohms because of the effective increase in input resistance when the tube is used as a cathode follower.

R6 and R7 in series form the cathode output resistance. The grid return is at the junction of these two resistors to obtain the proper bias. R5 is a parasitic suppressor.

Since the average emission from the iconoscope increases when the collector ring is operated at a slightly positive potential with respect to the signal plate, a positive voltage is taken from the cathode of the input stage and passed through R1 to the collector. The a.c. variations are effectively filtered to produce a d.c. voltage across C1, which makes the collector ring slightly positive with respect to the signal plate, which is at the d.c. ground potential. This circuit does not affect the a.c. output variations across R6 and R7.

The shading signal is introduced through a voltage-divider network to keep it at the same low level as the camera-tube output signal. R3 serves as a termination for the shading generator. R2 is very large and effectively isolates the capacitance of the shading generator circuit from the iconoscope output.

The wire screen often placed around the iconoscope near the mosaic and signal plate keeps the capacitance of the signal plate to ground constant.

Bifilar winding

The third stage of the camera preamp in Fig. 3 uses a high-peaker network with an electrical equivalent of the series R-L combination of Fig. 2-b. In the high peaker, the requirement is that the quotient of L/R be equal to the time constant of the iconoscope output circuit. However, the value of L is limited by the distributed shunt capacitance of the high peaker stage itself. For example, assuming a certain shunt capacitance value, the value of L must be chosen to produce a linear frequency response up to about 5 mc. The variable quantity is the resistance. If, as is usually true, there must be substantial compensation, the resistor value becomes extremely low. In the preamp of Fig. 3,

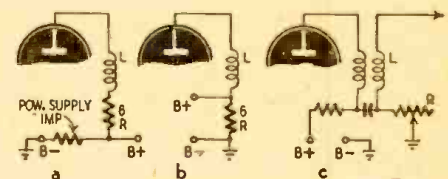
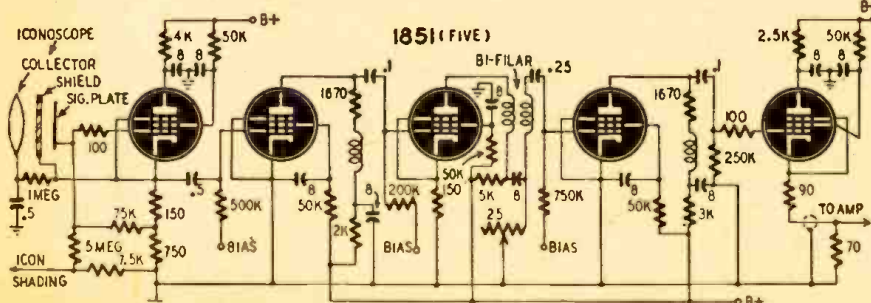

Fig. 5—High-peaking for plate circuits.

it is about 6 ohms. If a conventional video amplifier output circuit is used, as shown in Fig. 5-a, the 6-ohm value of R is much lower than the power supply impedance. The load on the high peaker stage is not, therefore, really 6 ohms.

An effective 6-ohm load can be placed on the high peaker by placing the resistor across the power supply, as in Fig. 5-b, but this would call for a mammoth B supply to furnish the tremendous current the resistor would draw. The solution to the problem is the bifilar winding (Fig. 5-c).

A bifilar winding consists of two very closely spaced windings with unity coupling and a uniform transfer over a very broad band. The 6-ohm load is placed between the low side of the secondary winding and ground. For the a.c. signal, the load is the series impedance of L and R; the d.c. power supply has been effectively isolated.



TELEVISION COUNTERS

Television pictures are stabilized with differentiators and integrators.

By ROBERT W. EHRlich

INTEGRATING and differentiating circuits are among the most useful of those employed in present-day electronic developments. It would have been almost impossible to develop telemetering systems, radar, high-speed counters and television to their present state of perfection without them.

The differentiator or "peaker" is a high-pass filter designed to produce sharp pips of short duration when rectangular voltage waves are applied to its input terminals. It consists of a capacitance and resistance in series across the voltage source. The leading edge of the wave causes the voltage across the resistor to rise sharply to maximum and then decay as the charge builds up on the capacitor. When the capacitor is fully charged, the voltage across the resistor drops to zero and remains there until the lagging edge of the input pulse comes along. Then the condenser discharges through the resistor to produce a voltage pip in a negative direction. The pips are sharpest when the time constant ($R \times C$) of the resistance-capacitance combination is shortest.

The integrator circuit is physically the same as that of a differentiator. But it is designed as a low-pass filter and the output voltage appears across the capacitance. The output voltage wave-shape follows the gradual rise and fall of the capacitor charge. This circuit is often used ahead of triggered oscillators and gating circuits when they must respond only to input pulses of comparatively long duration. The time constant of the circuit should approach or equal the duration of the operating pulse.

In the television receiver, there are two sweep circuits that must be synchronized with those of the transmitter. One sweeps the beam horizontally at the rate of 15,750 times per second; the other sweeps it vertically at the much slower rate of 60 times per second. Synchronization is accomplished by superimposing a number of rectangular pulses on the picture signal as it is sent out from the transmitter. The receiver must interpret these pulses, feeding one pulse every $1/15750$ second to the horizontal sweep circuit and one every $1/60$ second to the vertical sweep circuit. The trick is that the $1/15750$ second pulses must continue all the time, even during the relatively long period each $1/60$ second when vertical synchronization is to be applied.

A portion of the series of synchroniz-

ing pulses as they are included in the video signal is shown at *a* in Fig. 1. During most of the $1/60$ second "field" period, narrow pulses are sent out at such rates as to synchronize the 15,750-cycle horizontal sweep oscillator frequency. During the interval when the vertical synchronization is to take place, high-rate pulses are still sent out but they are made very much wider.

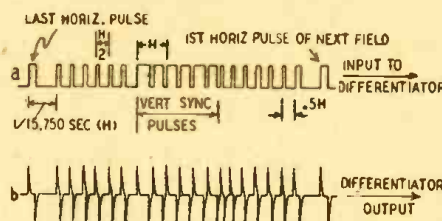

Fig. 1—The leading and trailing edges of the rectangular pulses produce sharp pips.

When the synchronizing signal of *a* is applied to the differentiation circuit, Fig. 2, the output of the latter is a number of extremely sharp positive pulses which correspond to each sudden rise in synchronizing voltage, as well as sharp negative pulses corresponding to each drop in synchronizing voltage. These pulses are shown at *b* in Fig. 1. The polarities in the circuit are such that the sharp positive pulses will cause synchronization of the local sweep oscilla-

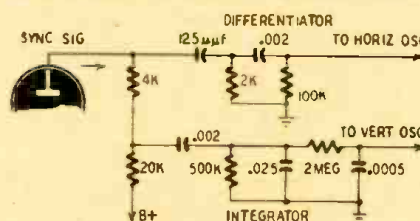

Fig. 2—A typical synchronizing separator designed for use in a television receiver.

tor, whereas the negative ones are clipped off in the grid circuit of the following tube and so have no effect. It will be noted that the positive pulses appear at the differentiator output at a constant rate during this period, irrespective of the width of the corresponding synchronizing impulse from the transmitter. The horizontal sweep circuit is then locked in with the transmitter at all times, even while the wide pulses are being transmitted.

The same sync signal is applied to an integration circuit, Fig. 2. Here the narrow horizontal pulses cause only a small integrator output, which is too

small to affect the vertical oscillator circuit. However, shortly after the end of the field, the wider vertical impulses allow a greater charge to accumulate on the integrating capacitor, and the output of the integrator is then the broad pulse shown in Fig. 3-b.

You may feel that this broad pulse is not sufficiently sharp to accurately synchronize the vertical sweep oscillator. Remember that the period of this oscillator is relatively long, $1/60$ second. When Fig. 3-b is redrawn to show a complete vertical cycle, these pulses are seen to be relatively short compared to the entire cycle.

Separation of horizontal and vertical synchronizing pulses is only one of many applications for these versatile circuits. Even in the same television receiver, integration is often used again for another purpose. In many of the low-cost television receivers, the pulses of Fig. 1-b are rectified to cut off the negative pulses and clipped to flatten the tops of the positive pulses. The resulting series of short, flat-topped pulses is then integrated to produce a sawtooth waveform. The sawtooth wave is amplified directly and used to drive the scanning spot horizontally across the face of the cathode-ray tube.

Both the designer and the serviceman must be familiar with the principles of integration and differentiation circuits. This necessity for the designer is obvious, but the serviceman must also recognize these functions when they appear in the circuit diagram of some equipment. On a diagram the R-C type of differentiator looks like a standard audio coupling circuit in which the capacitor need only be large enough to pass the lowest audio frequency concerned. On the other hand, the time constant of a differentiator circuit must be set at an exact value. Replacement with

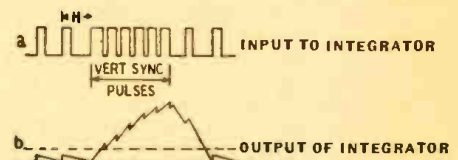

Fig. 3—The broad vertical pulses build up a charge on the integrating condenser.

an incorrect component or failure to replace a capacitor or resistor that has changed value will completely destroy the effectiveness of the circuit and of the apparatus in which it is employed.

Tiny Signal Tracer

By RUFUS P. TURNER

A PRACTICAL signal tracer that takes no more room in the serviceman's pocket than a book of safety matches is almost a believe-it-or-not item. Yet, here is one that actually is built inside a book-match cover. We believe this is the ultimate in compact signal tracers.

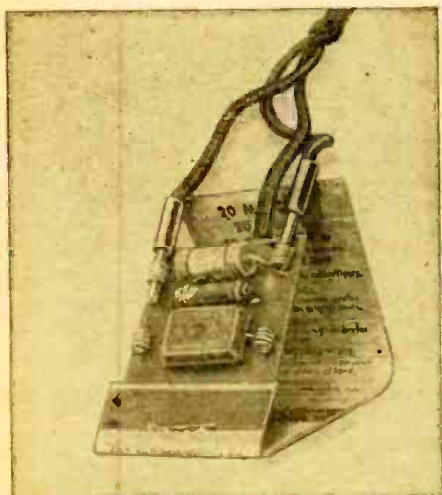

Fig. 2—Parts are mounted on thin fiber card.

The vest-pocket signal tracer described in this article definitely is not a toy. Its essential components are a crystal diode, coupling capacitor, and load resistor—the same parts used in all modern, batteryless probes. Its small size makes it exceptionally easy to carry.

In spite of its tubeless design, this signal tracer has sufficient sensitivity to give a good headphone signal right down to the antenna and ground terminals of a receiver. It may be used on both a.f. and r.f. signals. And it can be used as an a.f.-r.f. probe for a d.c. vacuum-tube voltmeter. It cannot be damaged by d.c. voltages in the set under test.

Circuit details

The circuit schematic of the signal tracer given in Fig. 4 will be recognized as the standard shunt diode rectifier circuit employing a 1N34 crystal. The coupling capacitor C serves also to isolate the tracer circuit from d.c. voltages. R is a 1-megohm load resistor across which the output voltage is developed.

Signals as high as 30 volts r.m.s. may be applied continuously to the input terminals without damaging the crystal. Somewhat higher voltages may be applied momentarily. This will be satisfactory in most signal-tracing operations. If a 1N38 crystal is employed, much higher signal voltages may be handled.

Figs. 2, 5, and 6 show constructional details of the signal tracer. All parts are visible in the photographs (Figs. 2 and 3) and in the layout drawing (Fig. 5).

The parts are mounted on a thin card of fiber or stiff cardboard measuring $1\frac{3}{4} \times 1\frac{7}{16}$ inches. The pigtail leads of the crystal, resistor, and capacitor are pushed through pinholes in this card so that all connections may be made on the reverse side of the card. After the parts are mounted and the wiring completed, the card is stapled into the match folder in place of the matches. A regular desk stapler may be used.

Small-sized components are employed throughout. R, for example, is the smallest $\frac{1}{2}$ -watt carbon resistor, and C is an Aerovox type 1469 miniature mica capacitor.

The input and output terminals are small coil springs wound with No. 20 bare solid hookup wire. These springs may be made by close-winding 4 or 5 turns of the wire around the thin end of a standard phone tip, then slipping off. The two ends of each coil are passed through pinholes in the mounting card and soldered together, for support, behind the card, as shown in Fig. 6. Headphone cord tips may be inserted directly into the two output spring terminals



Fig. 3—A straight pin is used as test prod.

(see Fig. 2). Wire leads may be pinched between turns of the two input spring terminals. In Fig. 3, a straight pin is shown pinched into the input spring terminal A to be used as a simple test prod. Input terminal spring B must be connected to the chassis or B-minus terminal of the radio or amplifier under test.

The folder may be closed as easily as



Fig. 1—Signal tracer in a matchbook

any ordinary book of matches (see Fig. 1), and the closed signal tracer fits comfortably into a vest or shirt pocket. A miniature hearing-aid phone may be tucked away in the vest pocket along with the tracer.

Using the tracer

When tracing signals through a radio receiver, a modulated r.f. signal must be fed into the receiver. Headphones then may be employed with the tracer, and tests may be made in any stage in the set.



Fig. 4—Schematic diagram of the tiny tracer.

Clip the exploring prod into input spring terminal A, as shown in Fig. 3. Connect input spring terminal B to the chassis of the receiver by means of a short, flexible lead.

The tracer may be used also as an a.f.-r.f. probe for a d.c. vacuum-tube voltmeter. Connect the negative meter

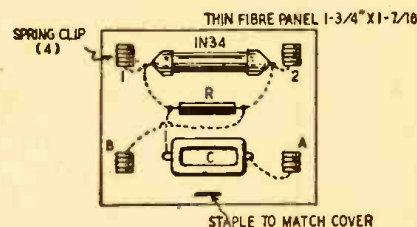

Fig. 5—Dotted lines show wiring under card.

terminal to tracer output terminal 1, and the positive meter terminal to terminal 2. The meter reading will indicate the peak value of the voltage being measured, that is, 1.414 times the r.m.s. value, except on the 0-3 volt scale of the meter where the reading will be somewhat lower than the peak value.

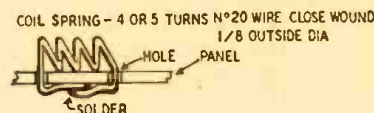

Fig. 6—Attachment of the spring terminals.

As a probe, the tracer also may be employed with an audio amplifier when loudspeaker operation is desired. In this application, connect the input terminals of the audio amplifier to the two output terminals of the tracer, and use the tracer in the usual manner.

rotated to the "200" range. The instrument is then plugged in and the power switch S4 (at rear) turned on. Allow about 3 to 4 minutes warm-up time.

The d.c. leads are inserted into the banana jacks at the bottom center of the panel. It is necessary to watch their polarization only on higher voltage ranges. S5 is used to reverse polarity on the lower ranges without reversing the leads themselves.

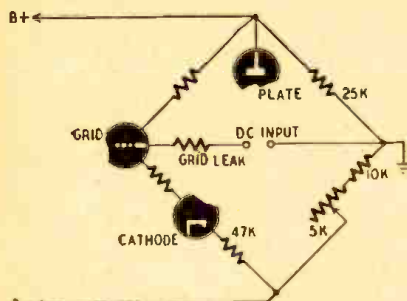

Fig. 2—Fundamental circuit of the voltmeter.

After several minutes for complete warm up, the prods are shorted together. The range switch is rotated to the lowest range and the d.c. zero is set. This setting will need very little attention after the first few minutes.

The grid current control is now adjusted. Separate the d.c. leads and watch the meter. There will probably be a gradual drift away from zero in one direction or the other. Allow about 5 or 10 seconds since the drift is very slow. Keep adjusting the grid current control until the meter remains at zero whether the d.c. leads are shorted or separated.

Don't shake the leads or move them about during the calibration since this induces a very small voltage and causes an incorrect meter reading.

A drift of about one or two small divisions on the lowest range can be tolerated. This reading is equivalent to about .02 volt and will be negligible on higher ranges. It becomes zero when the prods are shorted or when a measurement is made across a reasonably low resistance (like 25 megohms!).

The three low-voltage d.c. ranges are individually calibrated by comparison with a standard meter and are checked for linearity at several points on each scale. A dry cell or other d.c. power supply with a potentiometer across it will provide a convenient calibrating voltage.

The accuracy of calibration will depend primarily upon the accuracy of the standard meter.

The 200-volt range has no separate calibrating potentiometer, but is adjusted after the a.c. voltage ranges are calibrated.

If the calibration points are not near the centers of the potentiometers, try other resistors of nearly the same values until satisfactory ones are found.

A.c. voltages are measured by using a tube rectifier to feed the d.c. voltmeter. The type 9006 diode used is effective to well beyond FM frequencies. The tube is within an aluminum probe 1 inch in diameter and 3 1/16 inches

long (Fig. 3). A circular piece of bakelite drilled to accommodate the 9006 socket is wedged in the probe with the socket pins toward the front end. The front is closed by a circular piece of 1/4-inch thick polystyrene with a banana jack mounted in the center.

The other end of the probe is fitted with a 4-prong socket. Two leads are for the 9006 filament, one for ground (shell of the probe), and one comes from the 9006 plate (through a high resistance). A 4-conductor cable of convenient length connects the removable probe with the instrument.

Calibration is carried out at 60 cycles. A variable-tap toy transformer is good for low voltages. For highest accuracy use a reliable a.c. standard voltmeter to monitor the voltage at the terminals. The a.c. adjustment is governed by the 50-megohm fixed resistor. Too much resistance causes a high reading. The a.c. scales will correspond to the d.c. scales with the correct value of resistance.

The a.c. zero control is a potentiometer in the plate circuit of a second 9006. This tube is used only to cancel the initial velocity reading of the other 9006. Without it there would be an a.c. reading even before the application of input voltage. It may be necessary to transpose these diodes to get proper zero control.

Voltage range adjustment

Adjustment of the voltage ranges should be made in order according to Table 1.

Step	Range	Adjustment
1	0.4 v d.c.	basic circuit design, especially the cathode feedback resistors and the plate voltage
2	2 v d.c.	2,000-ohm potentiometer
3	20 v d.c.	15,000-ohm potentiometer
4	2 v and 20v a.c.	20-megohm resistor (actual value is correct when it makes a.c. scales read correctly with previous d.c. calibrations)
5	200 v a.c.	2.2-megohm grid leak (actual value is correct when this range reads correctly)
6	200 v d.c.	20-megohm resistor in neg. probe (choose value which makes this range read correctly)

It is usually convenient to measure low-frequency voltages at a panel jack. In this case, the probe is plugged into a connector at the rear of the panel. A fixed condenser connects this rear-panel plug with the a.c. jack at the left of the front panel. This plug is in the upper right-hand corner behind the panel. A short screw through the side of the cabinet fits into the probe to hold it in the cabinet.

For intermediate- and high-frequency measurements the probe is taken out of the cabinet and applied right at the point of measurement. An isolating condenser is soldered to a banana plug which can be plugged into the probe. The free end of the condenser is the lead actually applied to the r.f. circuit. For frequencies of 100 mc or higher, use a 100- μ f ceramic or silver mica condenser. A .01- μ f condenser is suitable for lower frequencies.

D.c. milliamperes

The values indicated for the current shunts shown apply only to the par-

ticular meter used here—200 μ a full scale, and 500 ohms internal resistance. (Other meters may require different values.) The shunts are individually wire-wound on a form which is later mounted above the chassis near the 6SL7. Taps from the shunts lead to the range switch. For high accuracy the shunts should be measured on a reliable bridge.

To eliminate the possibility of damage to the meter, the milliamperage jacks are of the phone type (banana plugs are used for the voltage jacks).

This instrument will be found as easy to build as it is to use. The meter is a 200- μ a instrument with four main scale divisions and 40 subdivisions. Therefore the ranges 2, 20, 200 volts or milliamperes are direct-reading except for the decimal point, which is supplied mentally almost at once. The very low range is also practically direct-reading. Each small division represents .01 and each main division is 0.1 volt or ma. A mental multiplication by 2 is required on any scale when the range-doubling switch S1 is thrown.

The meter deflection is very sluggish on the lower-range voltage measurements. This is due to the open grid, high capacitance across the grid, and the large isolating resistor. The slow downward travel can be used to advantage. After the two prods are removed from the circuit, there is still plenty of time to note the reading. The grid is discharged more rapidly to zero when the prods are shorted or connected across a resistor.

Other adjustments

The only adjustments which may occasionally have to be made are to the grid current control and the two d.c. range potentiometers. These three are mounted on an aluminum strip at the right side of the instrument and their screw-driver adjustments can be reached through holes in the cabinet.

The high resistance of this voltmeter can be shown by a simple experiment. Switch it to the 2-volt range and connect it across a dry cell. Use the a.c. lead (without isolating resistor) instead of the negative d.c. lead and note the

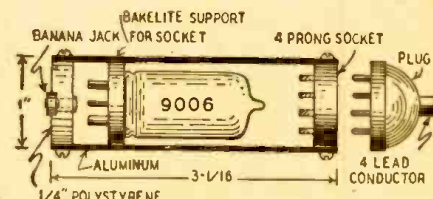

Fig. 3—Mounting details of the r.f. probe.

reading. Now take the measurement with the regular d.c. negative lead. This value will be only about .01 volt lower than the previous one. The addition of 20 megohms in series with the voltmeter resistance has produced an added drop of little more than .01 volt. A simple Ohm's law calculation shows an input resistance of approximately 2,500 megohms.

Audio Generator

A sine- and square-wave source

By JAMES C. MCGUIRE

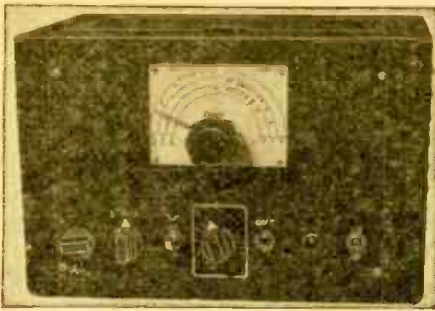

Front panel shows the home-made tuning dial.

VARIABLE-FREQUENCY a.f. oscillators and square-wave generators have innumerable applications which make them useful to the serviceman or experimenter. This combination sine- and square-wave generator is simple and can be duplicated with little effort. Its parts are not critical and most of them can be taken from the spare-parts box.

The sine-wave output from this device (20 to 20,000 cycles in three ranges) is useful in running a.f. response curves, checking speaker resonance points, and a.f. signal tracing. The high harmonic content of square waves makes them useful for visual checking of frequency response and for r.f. signal tracing.

The output of V2 is fed back to the grid of V1 through C3, C1, and P1, producing an oscillatory circuit which without P2 would be a free-running multivibrator. If S1 is closed and P2 inserted, the strength of oscillation and the output wave shape can be controlled by adjusting P2. Decreasing its resistance reduces the feedback to the No. 1 grid of V1 and increases the degenerative feedback current through the lamp in the cathode circuit, automatically controlling the output of the oscillator. The output approaches a perfect sine wave when P2 is adjusted correctly. When the resistance of P2 is too low, oscillations are erratic or stop altogether. Once the correct adjustment is found, it

need not be changed unless the lamp burns out. To produce a square wave, open S1 and adjust P3 till the output approximates the desired wave shape. The square wave will not be perfect, but P3 can be adjusted to produce a wave form which is usable for checking

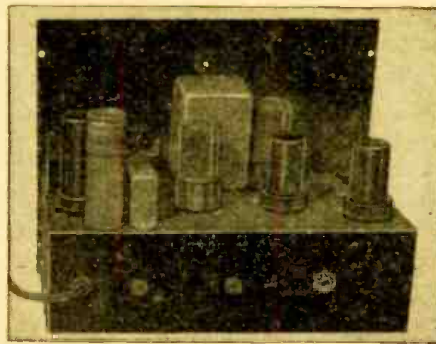

P1 is mounted in the metal box at the center.

amplifiers or speakers. The unit delivers about 1 watt and can be matched to a speaker through an 8,000- or 10,000-ohm output transformer.

Calibration is easy

An oscilloscope and calibrated oscillator are needed for calibration. Connect your uncalibrated oscillator to the vertical input of the scope and the calibrated oscillator to the horizontal input posts. Lissajou's figures can be used to determine the ratio between known and

unknown frequencies. It is simpler and easier to adjust the oscillators to zero beat for each calibration point. This condition is indicated by a stationary circle, ellipse, or diagonal line, depending on the phase and amplitude of the known and unknown signals.

Connect the output of the new oscillator to one input of the oscilloscope, and the output of the standard generator to the other. Set the standard to the desired frequency, then rotate the dial of the new unit until the oscilloscope shows one of the given patterns. Usually the circle or ellipse will be seen, the diagonal line less often. When the pattern is stationary, mark the dial.

Calibration on the author's unit was not correct for square waves; but the difference was equal for all bands, so square-wave calibration was marked with red dots on each band.

Construction

The complete unit was built on a $9\frac{1}{2} \times 5 \times 3$ -inch chassis and placed in a small metal cabinet. The tuning dial is home-made and hand-calibrated. The pointer is made by drilling a small hole in a fluted knob and cementing a piece of steel wire in it. The dial scales were drawn on a piece of white cardboard and protected with a sheet of 1/16-inch Plexiglas. Each band was calibrated from 2 to 20 and the multipliers inked in below.

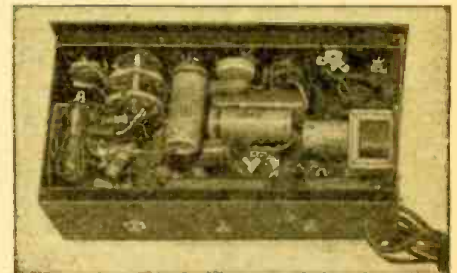

The stabilizing lamp is under chassis at left.

Two insulated pin jacks, J2 and J3, on the back of the chassis, provide plate voltages for other purposes. The closed-circuit jack J1 is also on the rear of the chassis. It is used for keying the oscillator when necessary. Keep all grid leads out of a.c. fields. Shield the leads if they are long. Mount the control potentiometers P1 (IRC Type No. 33-3939) in a metal shield box to prevent unwanted feedback and hum pickup.

RADIO-CRAFT for

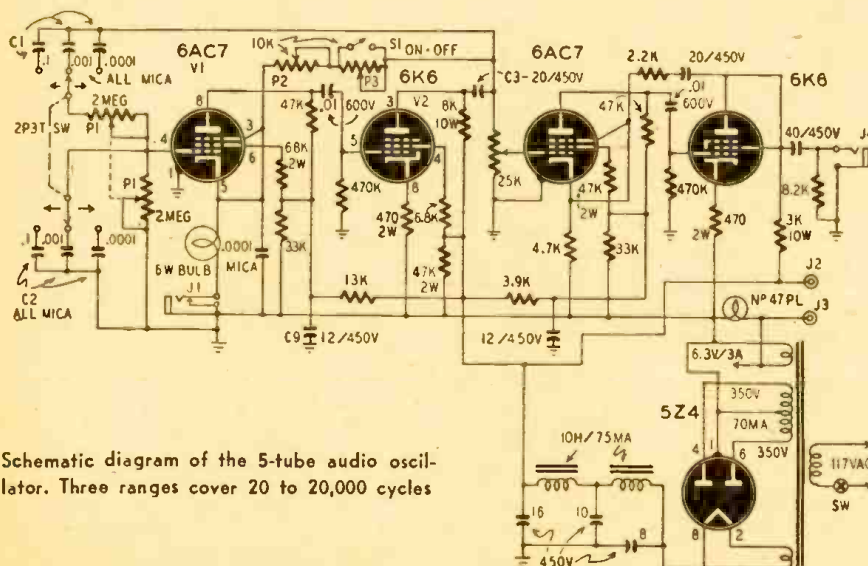

Schematic diagram of the 5-tube audio oscillator. Three ranges cover 20 to 20,000 cycles

Phase Inversion Circuits

Part II — The R-C coupled phase inverter

By JOHN W. STRAEDE*

ONE of the earliest types of resistance-capacitance-coupled phase inverters is the *paraphase*. The signal from an amplifier tube is taken from a tap on either its plate resistor or the grid resistor of the output tube it feeds (usually the latter), and applied to a phase-inverter tube. This tube reverses the polarity of the signal.

Because the phase-inverter tube also amplifies, only a portion of the first tube's signal is applied to it, and its output goes to the grid of the other output tube. The modern version of the paraphase circuit is shown in Fig. 1.

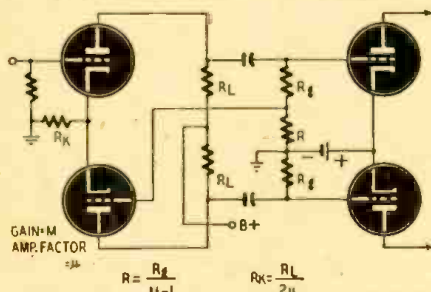

Fig. 1—A modern paraphase phase inverter.

The voltage-divider constants R_g and R are critical, and resistors with closer than 10% tolerance are required. Aging of the phase-inverter tube reduces its output and results in unbalance.

Automatic near-balance is obtained in the floating paraphase circuit (Fig. 2).

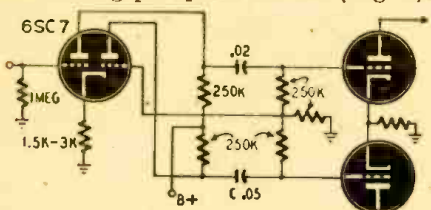

Fig. 2—The driver tube must have high gain. The signal for the inverter section depends upon the lack of circuit balance. The greater the gain of this tube, the nearer is true balance approached; therefore, a high-gain tube such as a 6SC7 is commonly used.

A still closer approach to true balance can be obtained by making the plate and grid resistors in the inverter section just a trifle larger than those in the voltage amplifier.

Unbalance at low frequencies is due to extra phase shift caused by the lower coupling condenser C . This condenser should be much larger than the top one.

If a large amount of negative feedback is to be used over the phase-inverter stage, the straight paraphase circuit is preferable, since accurate balancing is important.

In the split-load inverter (Fig. 3), output voltage from a tube is divided by placing half the load impedance be-

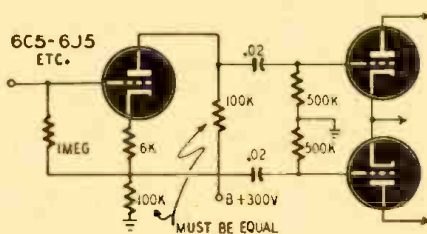

Fig. 3—Stage gain is low with this circuit.

tween cathode and ground. The voltage at the cathode is then out of phase with the voltage at the plate. Half the load in the cathode circuit also results in half the load being in the grid-to-cathode circuit and gives a negative feedback factor of one-half. Stage gain is therefore very low; in practice it is usually about 0.9 (from grid of phase inverter to grid of one output tube).

This circuit, popular in Australia, is sometimes known as the *kangaroo* phase inverter.

Accuracy of balance depends solely upon the equality of the load resistors and the following grid resistors. Because of degeneration, the cathode resistor does not require bypassing (unless a low-gain tube is used), and the coupling condenser to the grid of the phase inverter can be smaller than usual.

Cathode-Drive Inverters

If push-pull tubes share a common unbypassed cathode bias resistor, an interesting phenomenon occurs if the signal is removed from one tube. Instead of the output dropping considerably, there is only a slight lessening of volume and the output continues to come from both tubes, though there is a distinct lack of balance. The undriven tube is actually being driven by the other one through

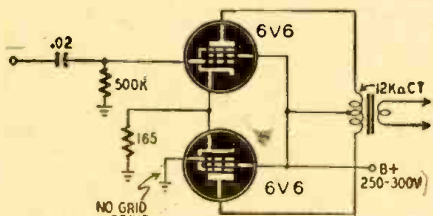

Fig. 4—The upper tube drives the lower one.

the common cathode impedance. One example of this is the Barnes "mystery" circuit of Fig. 4.

The greater this common cathode impedance in comparison to the load impedance, and the greater the stage gain, the more nearly perfect is the balance. If two push-pull voltage amplifier stages are used with no signal on one

tube of the first stage, very good balance is obtained at the output of the second stage. This amplifier (Fig. 5) is sometimes known as the "long-tailed" amplifier.

If very good balance is desired, the size of the common cathode resistor is increased and tapped to give the correct grid bias, as in Fig. 6.

Accuracy of balance depends on the similarity of the tubes and the equality of the plate load resistors.

Fig. 7 shows a 2-stage direct-coupled amplifier with cathode-drive phase inversion. It responds to d.c. voltages as well as to a.c. Balance is not as good as in resistance-coupled amplifiers, but the unbalance is limited to a difference in

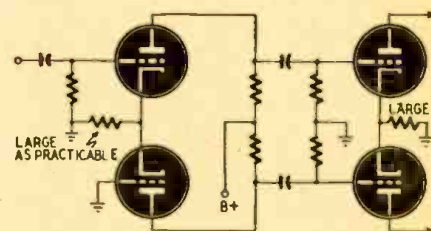

Fig. 5—The long-tailed push-pull amplifier.

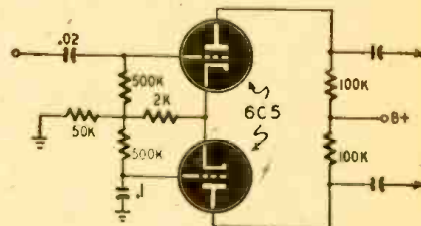

Fig. 6—Similar driver tubes improve balance.

amplitude. There is no unbalance due to phase shift at different frequencies.

Unusual phase inverters

Besides the more commonly used circuits, there are some unique variations of the split-load and paraphase circuits.

Fig. 8 is a simplified split-load inverter in which the inverter tube is directly coupled to the preceding tube. Gain is higher than might be expected, since part of the load for the first tube is actually amplified by the inverter. There is noticeable reduction in the number of

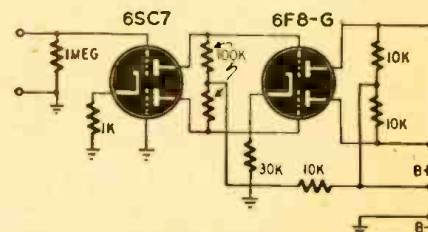

Fig. 7—A two-tube direct-coupled amplifier.

*Lecturer in electronics and electro-acoustics, Melbourne Technical College, Australia.

parts, and the output voltages are sufficient to drive 6V6's.

To obtain gain from the actual phase-inverter stage, the preceding tube must be a pentode and the load is amplified by a split-load inverter. The extra gain is due to load amplification and practi-

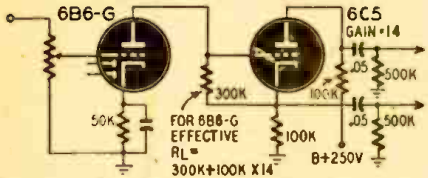

Fig. 8—Split-load direct-coupled inverter.

cally disappears if the preceding tube is a triode.

A version of this circuit is shown in Fig. 9. Over-all gain from the 6J7 input

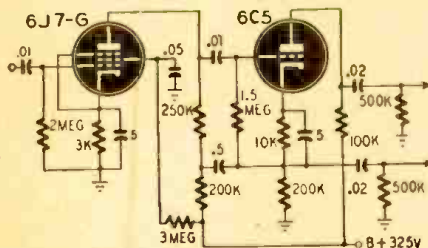

Fig. 9—This inverter provides high gain.

to one output tube grid is about 700, and each output is about 40 volts peak.

To economize in the use of tubes, attempts have been made to use one of the output tubes as a paraphase-type phase inverter. Part of the output voltage is applied to the grid of the other output tube. The output load impedance

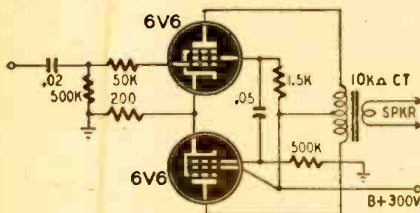

Fig. 10—One 6V6 is a paraphase inverter.

varies with frequency, so perfect balance is obtained over only a narrow band.

When pentode or beam tubes are used, the signal is usually obtained from the screen grid across a 1,000- or 2,000-ohm load resistor. The results are disappointing—in practice the circuit does not seem to function better than a pair of tubes in parallel or the Barnes mystery circuit of Fig. 4. One of the better circuits is shown in Fig. 10.

Note that the control grid of one 6V6 is coupled to the screen grid of the other through a .05- μ f condenser. When a signal is applied to the upper tube, its screen current varies and develops a voltage across the 1,500-ohm resistor. This voltage has the correct magnitude and polarity to excite the lower tube.

References

- RADIO-CRAFT, April 1946 (Amplifiers with Paraphase and with Split-load Inversion).
- RADIO-CRAFT, November, 1944 (Amplifier with Paraphase Inverter).
- RADIOTRON TUBE MANUAL RC 15 (Pages 222 and 223).
- RADIOTRON DESIGNER'S HANDBOOK.

MAGNETIC RECORDERS

The impetus given during the war to magnetic recording has resulted in a number of consumer models using both tape and wire. The table below lists the important data on most currently available models. It was originally published

in the *Saturday Review of Literature* as part of an article by James E. Jump.

All statements in the table are factual, except for the fidelity ratings, which are the author's personal opinions.

COMPARATIVE TABULATION OF AVAILABLE MAGNETIC RECORDERS

Manufacturer	List Price*	Cost Per Hour**	Fidelity	Appearance	Recording Time	Portability	Indexing Feature	Rewind Time	Modulation Indicator
WIRE:									
Brush									
Model BK-303	\$795.00	\$8.25	excellent	suitcase	30, 60, 120 180 min.	yes 50 lbs.	yes	2, 4, 8, 12 min.	eye
National Polytronics									
	\$79.50	\$4.50	fair	table model	10 min.	yes 20 lbs.	no	5 min.	ear
Pierce									
	\$424.00 (3)	\$9.00	good	professional	66 min.	yes 40 lbs.	yes	15 min.	eye
Powell									
	\$225.00 (3)	\$7.50	good	suitcase	60 min.	yes 26 lbs.	yes	7½ min.	lamp
Webster									
	\$149.50	\$5.00	fair	suitcase	15, 30, 60 min.	yes 28 lbs.	no	2, 4, 8 min.	lamp
Air King									
Model A-750	\$129.50	\$4.95	fair	suitcase	to 60 min.	yes 33 lbs.	no	10 min.	lamp
Model 4700	\$239.50	\$4.95	fair	walnut-finish console	to 60 min.	no	no	10 min.	lamp
Precision-Audio Products (Wire Master)									
	\$295.50 (7)	\$5.00	excellent	suitcase	15, 30, 60 min.	yes 45 lbs.	no (8)	2, 4, 9 min.	2 lamps
TAPE:									
Amplifier Corp. of America									
Model 800-A	\$239 net	\$5.00	good	table model (4)	30 min.	yes (4) 40 lbs.	optional (4)	½ min.	eye
Model 800-B	\$263 net	\$5.00	good	table model (4)	30 min.	yes (4) 40 lbs.	optional (4)	½ min.	eye
Model 800-E	\$312 net	\$2.50	fair	table model (4)	60 min.	yes (4) 40 lbs.	optional (4)	½ min.	eye
Model 800-F	\$322 net	\$10.00	excellent	table model (4)	15 min.	yes (4) 40 lbs.	optional (4)	½ min.	eye
Model 800-G	\$401 net (5)	\$10.00 (5)	excellent	table model (4)	15, 30, 60 min. (6)	yes (4) 40 lbs.	optional (4)	½ min.	eye
Brush									
Model BK-401	\$229.50	\$5.00	excellent	table model	30 min.	yes 40 lbs. (1)	yes	1 min.	eye
Model BK-403	\$375.00	\$2.50	excellent	suitcase	30, or 60 min. (2)	yes 50 lbs.	yes	¾ min.	eye

*Includes microphone, amplifier, speaker and recording mechanism unless otherwise noted.
**Cost per hour of wire or tape at nominal speed, whether 60-minute reels available or not.

- (1) Carrying case with handle supplied for \$16.50 extra.
- (2) At 4½ inches per second. At 7½ inches per second for maximum fidelity the running time is proportionately less.
- (3) Recorder and playback mechanism only—no microphone, speaker or playback amplifier provided. Faster rewind device available at \$40 extra.

(4) Similar portable models available for \$42.00 extra. Other optional features include indexing device at \$11.90 extra and automatic program timer at \$28.80.

- (5) Includes 3 capstans (\$25.00 each) but may be purchased with only 1 or 2 capstans. Tape cost \$2.50, \$5.00, \$10.00, depending upon fidelity desired.
- (6) Based on 3 capstans.
- (7) Microphone not included — suitable ones recommended on request. (Price range from \$24.00 to \$62.00.)
- (8) Automatic timer may be used.

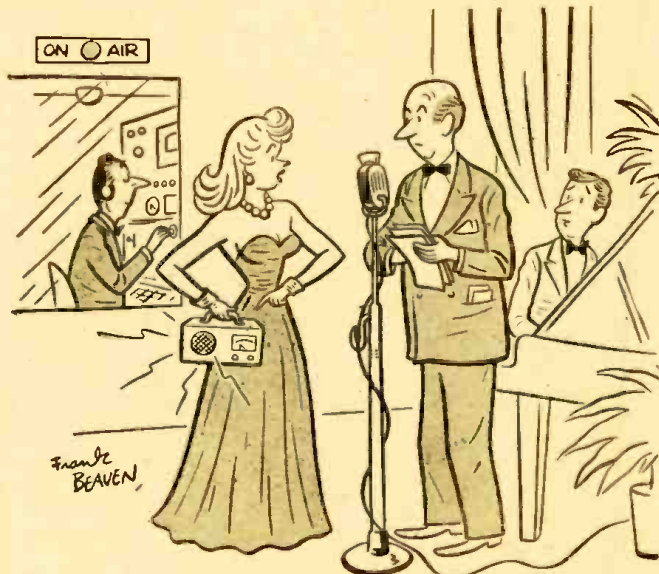

Idea by Merrylen Townsend, New York City
"I bought it so I could listen to myself when I sing over the air."

Vacuum Tube Is Phono Pickup

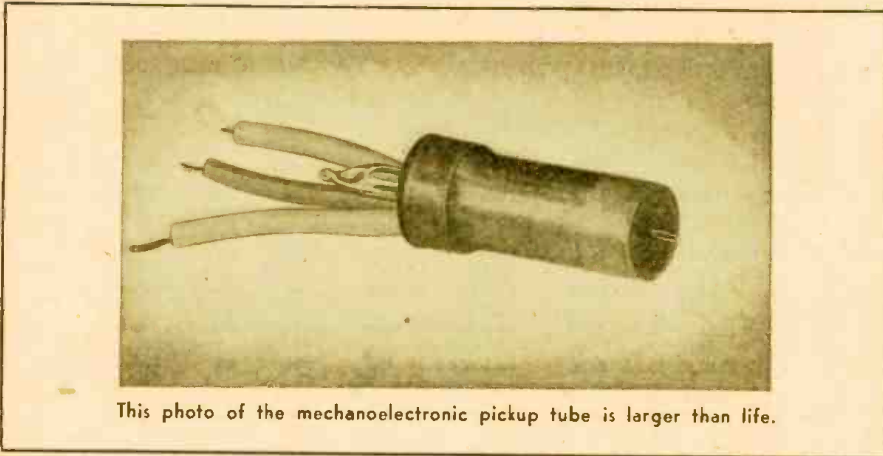

This photo of the mechano-electronic pickup tube is larger than life.

THE Radio Corporation of America has developed an electronic phono pickup and a microphone which operate on a principle entirely different from conventional types. Its operation, as described recently to the Audio Engineering Society by its designer, Dr. Harry F. Olson, is based upon the use of a mechano-electronic transducer. In this new system, voltage is developed by the motion of one or more elements inside an electron tube. Advantages are: (1) the transducer can be made very small to have a low mechanical impedance; (2) electrical power output is not obtained from the actuating source.

The fundamental problem involved in design of such transducers is transfer of controlled vibrations to the tube elements through a vacuum-tight shell. The specific problem was to design a vacuum-tight link that would operate with forces of less than one-millionth of a pound and yet withstand a static air pressure of 15 pounds per square inch.

One type of transducer tube, shown

in Fig. 1 and the photo above, is a metal triode about 1 inch long and 1/4 inch in

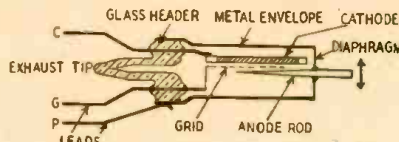

Fig. 1—The transducer tube's plate moves. diameter. Leads from the elements are brought out through a glass seal at one end. The flexible metal diaphragm at the other end permits transfer of external motion to the movable anode.

Fig. 2 is a cross section of an electronic phonograph pickup. The needle is at-

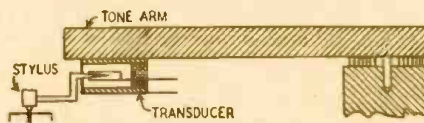

Fig. 2—How the tube is used in a pickup. tached to the transducer tube's actuating rod.

The electronic microphone (Fig. 3) has its diaphragm attached to the flexible metal diaphragm on the transducer tube. A microphone of this type has the high sensitivity of a carbon microphone, but without its accompanying high distortion, carbon packing, and variation in response with orientation.

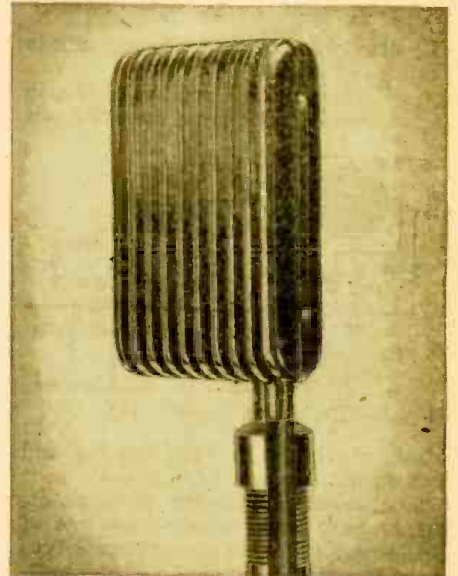
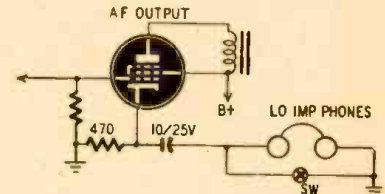

Fig. 3—A tube transducer type microphone.

The model in the photograph is a general-purpose microphone, suitable for public address and paging systems and outside broadcast pickups. The diaphragm is a molded paper cone 2 inches in diameter.

Low-impedance Phones

I recently bought a pair of surplus headphones and found they were low impedance instead of high. By using the hookup shown in the diagram I was able to avoid buying a transformer to convert the phones to high impedance.



The switch across the phones cuts them out and restores normal operating conditions to the tube when the phones are not used.

R. P. BALIN,
Miami, Fla.

Amplifier Makes Telephone "Speak Up"

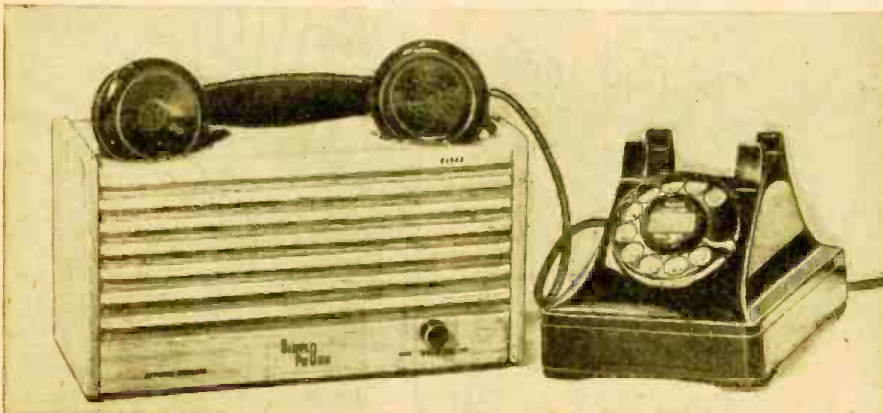

Courtesy Intercontinental Inventions Management Corp.

This amplifier allows the user to telephone without having to hold the instrument, leaving hands free for writing or typing. The telephone handset is placed atop the cabinet, as the photo shows, with the microphone and receiver resting in small depressions. Amplification is sufficient to allow the listener to hear perfectly at distances of a few feet and to permit several other people to listen to the call or take part in the conversation.

(The same result might have been obtained by connecting the phones across the speaker voice coil. Most of the surplus 300-ohm phones are recognizable by the red plug at the end of the cable. —Editor)

Crystal FM Deviation Circuits

BECAUSE of the difficulty of modulating crystals, wide-band FM transmitters generally rely on self-excited master oscillators, but, to maintain a constant center frequency, elaborate stabilizing networks must be added (see RADIO-CRAFT, May-June, 1946).

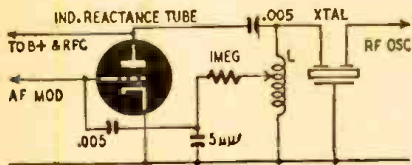

Fig. 1—Simple, stable FM deviation circuit.

However, many laboratories are currently working on this problem, and several new types of crystal oscillators have been developed recently that can be modulated over a relatively wide band without loss of control and with good linearity. The frequency is varied by changing the total reactance in the crystal circuit.

The simplest frequency change is made by adding a small capacitance across the crystal, but the effect is limited since shunt capacitance already exists due to the holder or plated surfaces

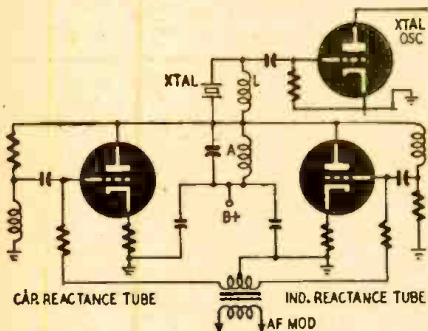

Fig. 2—Improved circuit for more deviation.

of the crystal. Adding a coil is a better method because it balances out the holder capacitance. Then the circuit operates with low reactance, and deviation is more easily produced. In addition, inductance produces better linearity over a wider frequency range.

A circuit invented by Warren P. Mason (Bell Telephone Labs, U.S. patent 2,424,246) is shown in Fig. 1. The modulator and oscillator stages are coupled only through the crystal which is mounted in a split holder. This reduces shunt capacitance and reduces amplitude modulation of the oscillator by the modulator. As a matter of fact, the oscillations continue even when the modulator end of the crystal is short-circuited.

A low-impedance triode is used as an inductive reactance tube across coil L. The combination of tube, coil and crystal is designed for low inductive reactance over the oscillator band. The tube reactance varies with the a.f. voltage im-

pressed upon its grid and with the change in oscillator frequency. A total frequency change of 0.7% can be attained. For best stability and linearity, it should be limited to about .07%, however.

The more complicated circuit illustrated in Fig. 2 was invented by Paul D. Gerber (RCA, U.S. patent 2,438,392). In the unmodulated condition the two reactance tubes are biased to cut-off. When a.f. modulation is applied to their grids in push-pull, the tubes conduct alternately. During half of each a.f. cycle, one tube introduces inductance.

During the other half, the other tube introduces capacitance. If the reactance of the parallel circuit A is approximately equal to that of the crystal element, the oscillator frequency will deviate widely as the reactance tubes become effective. The coil L is added across the crystal for greater deviation with low distortion.

The connection of reactance tubes in push-pull provides greater frequency deviation. A total change of about 1.5% can be accomplished with good linearity. Each reactance tube is responsible for half of this change.

ROLLING RADIO STUDIO COVERS OKLAHOMA

The photograph shows WKY's new bus for relaying outside broadcasts to the main studios. It is in reality a broadcasting station on wheels. The inset reveals the equipment. A 200-watt AM transmitter, monitor speakers, studio speech console, transcription tables and recording equipment, and 3 receivers, for AM and FM, are just behind the driver's compartment.

Since runs of 150 miles or more to cover an important event are commonplace, the design of this bus considers comfort of personnel more than many such installations. Seating space is provided for carrying the driver, two or three engineers and any other persons who may be needed for special events.

Transmitting facilities include an RCA ACT-150 relay transmitter (1600 to 2800 kc) and a pack transmitter (30

to 40 mc). Space has been reserved for a 150-mc FM relay transmitter.

The studio, behind the control room, is entered through a glass-paneled door. Tables, with microphones on them, are fastened to the floor.

The rear compartment includes a Bell System radio telephone for calling the studio, a PA amplifier (note the speakers on the roof of the bus), an antenna tuning unit, police receiver, and 2-kw 60-cycle Onan gasoline generator. This power unit has proved to be extremely dependable under all extremes of temperature.

Three whip-type receiving antennas are visible in the photo. A 35-foot transmitting antenna and a 25-foot receiving antenna are used for stationary operation. The railed-in announcer's stand enables him to work above large crowds.



connected to a 550-volt power supply, tune up as follows: Open the meter switch and apply plate voltage. Tune immediately for greatest dip of the milliammeter. At this point a pickup loop and bulb will be found helpful as an r.f. indicator. Placed over the tank coil, it indicates resonance by the brightest glow of the bulb. With antenna attached, tune the antenna tuner to resonance. This will be shown by a noticeable decrease in the brilliance of the bulb in the pickup loop. Remove the loop and place it over the antenna coil. Tune here for *maximum* brilliance. For stable operation avoid trying to draw all of the r.f. energy from the plate circuit—loosen the coupling a little!

With the alternate method, antenna tuning is a matter of tuning the two condensers to the proper ratio. A small bulb in series with the antenna makes an excellent and sensitive r.f. indicator. This bulb may be shorted out of the circuit when the point of maximum output is reached.

If the builder wants to vary this design or does not wish to purchase a BC-375 tuning unit, it will be helpful to know that the condensers (C1 and C2) are approximately 100-150 μf . Old broadcast condensers may be cut down and double-spaced to approximate this value, or commercially manufactured coil and condenser combinations may be used.

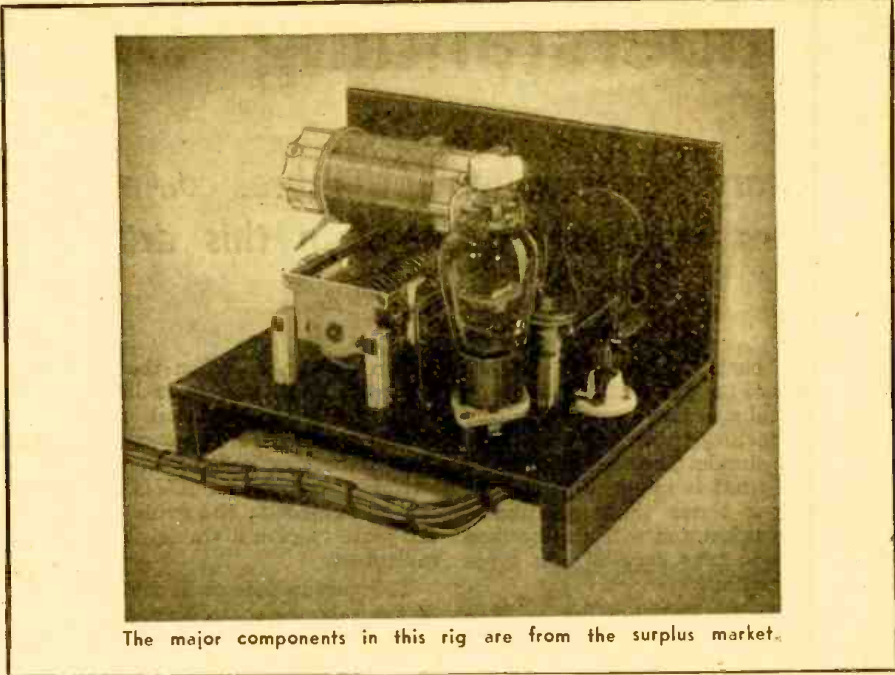

The major components in this rig are from the surplus market.

The meter is a 150-ma d.c. unit with a shorting switch across its terminals. It may be placed in the 500-volt B-plus lead or in the cathode circuit between the frame of the jack and ground. In the latter position, it reads the sum of the plate, screen and control grid currents.

Be sure that the meter you use has adequate insulation between its movement and case.

Adjust the tuning and antenna loading so the plate current is about 65 ma at resonance when loaded for 35 watts input.

AM and FM Share Same Carrier

SIMULTANEOUS transmission of FM and AM over the same carrier is entirely practical and not difficult, John J. O'Brien told the IRE convention last March. There is no saving in spectrum space, since the resulting channel is as wide as the sum of a standard FM plus a standard AM channel, but the advantages of having an additional signal channel on a given carrier may be great. For example, AM speech might be used for control purposes on an FM relay channel.

Reception is not as simple, but is also entirely practical, and some interesting circuits were developed to separate the two types of signals.

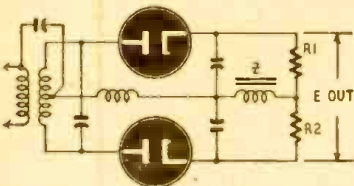

Fig. 1—The simplest discriminator-detector.

No particular problem is presented in transmitting AM and FM simultaneously, Mr. O'Brien stated. Any reasonably constant-amplitude FM signal can be made to drive a class-C final amplifier, which can be plate-modulated by the AM signal at the same time. The class-C final stage must be broad enough to have a practically flat response over the frequency-deviation range, and powerful enough to handle the AM peaks.

There are several ways to solve the

more complex problem of separating FM and AM signals in the receiver. Simplest of these is to use a Foster-Seeley discriminator with a high impedance in the center connection (Fig. 1). This amplitude-modulation output impedance Z should be high at all audio frequencies, as compared with R1 and R2. Other constants in the circuit may be kept to standard values, unless it is desirable to reduce R1 and R2 for better ratio with Z. The impedance may be a large inductance or a "constant-current" pentode.

Fig. 2 is a pentode discriminator. Triodes can be used in a similar circuit. This is an improvement over the diode circuit because of its higher input impedance. Cathode resistors should be high enough to make the tubes work as plate detectors.

Self-balance and correction for discriminator misalignment—characteristic of the triode or pentode discriminator—are increased by placing the impedance Z in a common cathode degenerative return circuit, as in Fig. 3. With this circuit it is possible to substitute a large resistor (compared to R1 and R2) for the constant-current impedance Z. Any remaining frequency modulation in the output voltage across the cathode resistor may be eliminated by connecting a bypass capacitor of large capacitance between the two plates.

These discriminators, with their advantages of high input impedance and appreciable amplification might be well

worth study by the straight FM constructor as well as the experimenter with hybrid circuits. Circuit constants will have to be determined experimen-

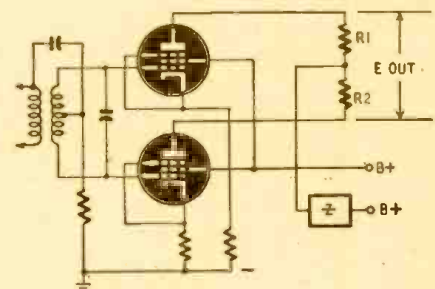

Fig. 2—This discriminator uses pentodes.

tally, but in general will follow standard practice. Modifications may be desirable in some cases. For example, if a large resistor is used as cathode impedance in Fig. 3, the idea of tapping it and

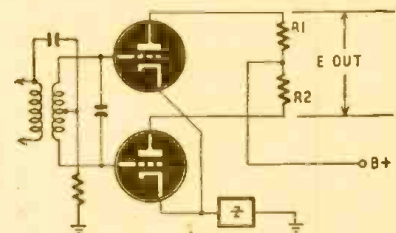

Fig. 3—Triode type; AM output from cathode.

bringing the grid return back to a point of correct bias arises immediately. The possible variations—and varied possibilities—of these circuits are many.

Understanding Tube Checkers

Theory and operation of the three common types are fully described in this article

By SOL D. PRENSKY*

IN THE past few years, new tube types have poured forth by the hundreds, and still they come. The problem of testing this wide variety of tubes is not simple. The technician must understand what is required so that he can choose a tester that will handle present-day tubes and will also be flexible enough to take care of new types as they come along.

There are three main classifications of tube tester in wide use. (a) the *emission* type, (b) the *direct-reading mutual-conductance* type, and (c) the *relative-reading mutual-conductance* or *dynamic* type.

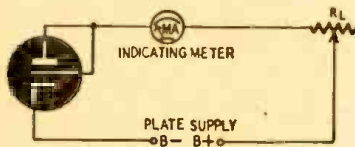

Fig. 1—How the emission-type tester works.

Any of these types can be satisfactory to the serviceman. None of them will predict tube performance infallibly in every possible application. In most cases the emission-type tester is reasonably effective in spotting bad or doubtful tubes; but there are many cases where the circuit requirements of particular tubes require a more demanding test. An emission test might indicate GOOD, and yet the tube might not give satisfactory performance in some particular circuit.

In these cases, the tester should be able to test the tube under conditions as close as possible to actual operating conditions. For this more demanding test, the mutual-conductance tester—either the direct-reading or the relative-reading type—is more desirable.

There are, of course, special cases, where nothing but an actual performance test will do. Then a new tube must be substituted in the actual circuit. As simple and effective as this test is, it would be impractical to use it at all times, considering the many tube types likely to be encountered, to say nothing of the possibility of more than one tube being bad in the equipment under test.

Emission testers

The circuit required for measuring the amount of electron emission from a heated cathode is quite simple. It is

*Instructor, Brooklyn Technical High School. Some of the material here is taken from the forthcoming book "Electronic Maintenance and Test Equipment."

shown in Fig. 1. When the cathode is heated to its normal operating temperature, the normal amount of emission should give a certain meter reading. To adjust the circuit for various tubes, a variable load resistor R_L is included in the plate circuit; the grids are tied to the plate to give a stable plate current indication.

To show up defects in the positioning of the tube elements, the emission test is supplemented by other tests designed to indicate shorted elements or leakage between elements. Usually, a sensitive neon-tube indicator is used.

Although the emission tester does not test the normal functioning of the grids, it is practical within its limits, since most tube failures result from reduced emission or shorted elements. It is effective in most cases where a tube should be replaced in an ordinary receiver, but it does not give a complete picture of the worth of the tube. The emission tester is most desirable where low cost and simple operation are important. A typical emission tester is pictured in Fig. 2.

Direct-reading gm testers

In the direct-reading mutual-conductance tester, the tube is placed in a circuit which allows measurement, not only of the plate current, caused by cathode emission, but also of the *change* in plate current caused by application of a signal to the tube's control grid. The amount of change in plate current is an indication of the mutual con-

ductance of the tube, according to the formula:

$$g_m = \frac{\text{change in plate current}}{\text{change in grid voltage}}$$

If plate current is in milliamperes and grid voltage in volts, the g_m (mutual conductance or transconductance) will be in micromhos.

To make this measurement, it is necessary to supply the tube with normal heater, plate, and screen voltages, and then to apply a constant a.c. signal to the control grid. By arranging the plate meter to read zero for the resting value of plate current and to deflect upward in proportion to the change in plate current caused by application of the grid signal, it is possible to calibrate the meter scale to read directly in micromhos.

For analysis of this type of circuit, the Hickok model 532-P is selected as an example. A simplified circuit diagram is given in Fig. 3.

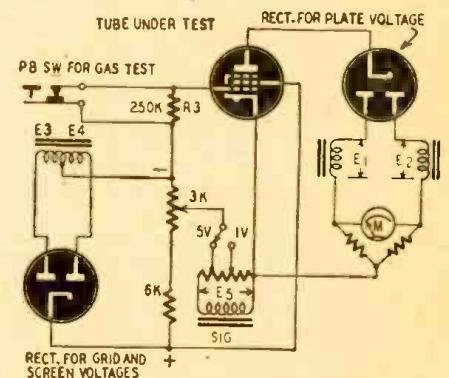

Fig. 3—Fundamental circuit of gm checker.

Two rectifier tubes are used: an 83 mercury-vapor tube for the plate voltage, and a 5W4 for grid and screen potentials. The voltages supplied to the tube all come from secondary windings of the same transformer. They are marked in the diagram as follows: E1 and E2 for the plate supply, E3 and E4 for the screen and fixed bias supply, and E5 for the a.c. grid signal voltage. Since these voltages are all derived from the same transformer, they are all in phase.

When no signal voltage is applied to the grid of the tube, the unfiltered pulsating d.c. plate voltage from the 83 rectifier causes plate current to flow on each half cycle. Equal amounts of this plate current, of opposite polarity, are alternate-



Fig. 2—Standard emission-type tube checker.

Courtesy Superior Instruments Co.

ly shunted through the meter; as a result of the inertia of the meter movement, which prevents it from swinging 120 times per second, the needle remains motionless.

With the proper amount of a.c. signal E5 applied to the tube grid, the grid becomes more negative on one-half of the a.c. cycle and less negative on the other half. The current tending to push the meter to the right is then greater than that tending to push it to left because, during the positive pulse of plate current, the grid becomes positive, allowing the tube to conduct, while, during the negative plate current pulse,



Courtesy Precision Apparatus Co.

Fig. 4—Relative-reading, or dynamic tester.

the grid is negative, reducing its conductance. The average current through the meter now being positive, the meter pointer will deflect upward. This deflection represents the gm of the tube, and the meter can be calibrated directly in micromhos. In accordance with the gm formula, a plate current change of 1 ma for a grid signal of 1 volt represents a transconductance of 1,000 micromhos, and a plate current change of 2 ma for the same grid signal would mean a gm of 2,000 micromhos. By allowing for sufficient variation of the supply and signal voltages, the manufacturer usually provides direct-reading ranges of 3,000, 6,000, and 15,000 micromhos. A GOOD—?—BAD scale is often included for quick checking, and tests for shorted elements, noise, and gas are usually added.

Modified gm testers

Between the two extremes of the simple emission tester and the fairly complex direct-reading gm instrument there is another tester, usually known as the

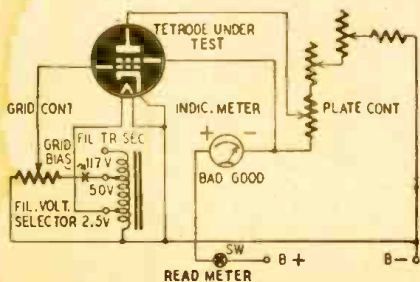

Fig. 5—Working principle of dynamic tester.

dynamic type, which uses a modified gm-testing circuit. Its purpose is to indicate tube condition by a relative gm reading, without using a direct-reading scale to give the absolute value. Its price range falls between those of the other two instruments. It has won wide acceptance because it is relatively easy to use and quite reliable.

The dynamic tester, like the last type described, makes a grid voltage change indicate merit in terms of the resulting plate current change. The a.c. grid voltage causes plate current to vary symmetrically above and below its resting value. Due to meter inertia, this would cause no change in the reading. One method employed to cause the meter to indicate is to use an a.c. meter of the type which responds to both steady d.c. value and the a.c. component. Where the more sensitive d.c. meter is to be retained, the tube can be operated as a plate detector, rather than a class-A amplifier. Partial rectification takes place, causing d.c. plate current to increase as the grid voltage increases.

The photograph of Fig. 4 shows a dynamic tester. The meter gives an indication of relative gm, an indication that is dependent upon gm without reading directly in micromhos.

The functional diagram of this tester (Fig. 5) shows how an a.c. signal is applied to the grid, causing a plate meter indication which varies with values of grid voltage. Note that the tube, in this circuit, is being operated under conditions quite similar to those encountered in actual use. Element potentials are adjusted so that the meter reading, for a good tube, will fall on the good portion of the scale. This instrument also tests cathode leakage, inter-element shorts, filament continuity, and noise.

Combination testers

Figs. 6 & 7 show two of the latest types of testers, in which the tube tester is combined with a multimeter to produce a combination instrument usually called a set-tester. Note that, in both of the units

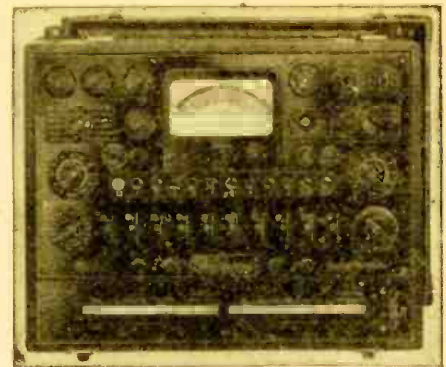

Courtesy Simpson Electric Co.

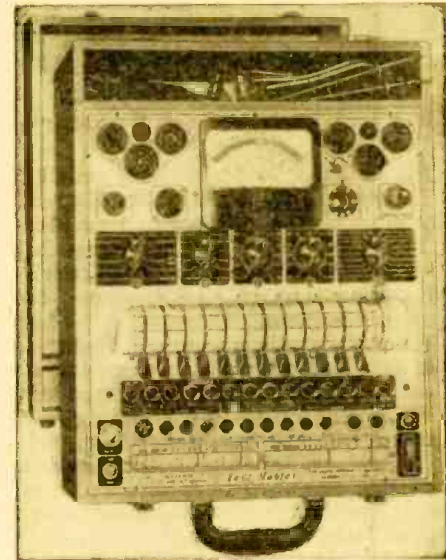

Courtesy Precision Apparatus Co.

Figs. 6 and 7—Two tube tester-multimeters.

pictured, the multimeter functions occupy very little extra space, though they provide many ranges. It is also interesting to note the trend toward multiple lever selector systems to provide for circuit elements beyond the capacity of the common 4- to 8-pin socket. With such a system it is possible to accommodate the newer-type tubes, such as the 9-pin miniatures and others coming into wide use as v.h.f. amplifiers.

X-RAY INSTRUMENT MEASURES STEEL THICKNESS

Better quality sheet metal is being made with an X-ray thickness gauge now in operation. The gauge consists of two X-ray sources and a phototube pick-up device. Radiation from one X-ray source is directed up through the sheet being gauged so that the transmitted rays will strike the pick-up. X-ray from the upper source is directed through a standard sample of correct thickness; to strike the same pick-up tube. The two sources emit radiation 180 degrees out of phase so that their rays strike the pick-up alternately.

The pick-up device consists of a photomultiplier tube surrounded by a fluorescent screen and enclosed in a light-proof cover. Absorption of X-radiation by the fluorescent screen causes visible luminescence which is picked up by the photoelectric cell and converted into current pulses, which vary in amplitude according to the thickness of the mate-

rial. The pulses are amplified and the differences checked by a comparator.

Any disparity in the intensities of X-rays from the two sources hitting the pick-up is registered on the indicator instrument. When the thickness of the material is out of gauge, the indicator needle is fully deflected.

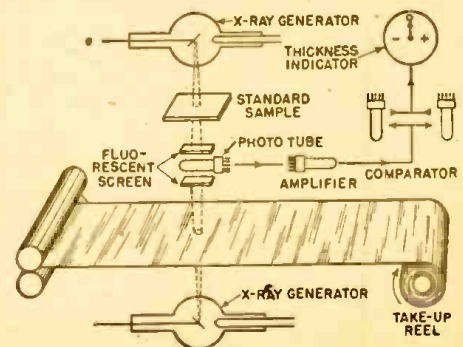

Radio Set and Service Review



Only two controls appear on the front panel.

INTEREST in high-fidelity sound reproduction has heightened greatly since the end of the war. New phonograph pickups and cartridges have been developed and records—particularly some foreign makes—have been greatly improved. Increase in the number of FM stations and their duplication of standard programs have contributed much to high-quality radio transmission. FM tuners are being offered to give listeners optimum reception. Adding to the development of high-fidelity systems, speaker manufacturers have added several excellent dual and co-axial units to their lines.

Probably the least attention has been paid to amplifiers. Usually, audio sections of standard receivers are used with phonographs and tuners. The results are often far from ideal because

the a.f. system of the average receiver is not particularly good.

The Langevin Model 122 Amplifier was developed especially for home use. Basically, it is simply an 8-watt amplifier. But, unlike most commercial units with living-room-size power outputs, its frequency characteristic is flat within 1 db from 30 to 15,000 cycles and harmonic distortion is kept down to 3% over the entire range. A laboratory check confirms the manufacturer's rating on the frequency response; although no harmonic distortion measurements were made, the amplifier sounded exceptionally clean when used for records and live FM programs.

The amplifier is interesting because of its flexibility. There are two input channels with separate gain controls. Microphones, pickups, tuners, and lines with impedances of 30, 150, 250, or 600 ohms may be used. High-impedance devices may be worked into a 1-megohm load.

The tube lineup includes a 6SL7 pre-amplifier in channel 1 and a 6SJ7 pre-amplifier in channel 2. Use of either is optional, depending on the gain re-

quired. A 6SJ7 voltage amplifier drives a 6V6-GT (triode connected) phase-inverter. The output stage consists of a pair of 6V6-GT's in push-pull (Fig. 1).

The basic gain of the amplifier is set by either including a preamplifier in one or both of the input channels or leaving it out of the circuit. For tuners, crystal pickups, and lines, about 69 db is the overall gain. Using the built-in preamplifiers, 107 db is available for microphones and modern magnetic-type pickups.

Variable low-frequency equalization can be inserted for use with crystal pickups; a fixed equalizer (plus the necessary extra gain) is added for such pickups as the Pickering, GE, and others.

Output impedances of 3.2 to 16 ohms are provided for voice coils; 150- and 600-ohm taps are also available on the output transformer.

No line cord is provided. A.c. must be connected to the power supply through a small plastic knockout to terminals on the right rear of the chassis. A convenience outlet is provided at the side of the case. Fig. 2 shows a rear view of the amplifier with the hinged cover swung down. Mounting the chassis on its side, rather than on its bottom allows easy access to the circuit components. "Dish-mounting," as this is called, is very common in broadcast equipment, where testing and maintenance must be done without wasting time.

Four keyhole slots are provided for wall-mounting the amplifier. To do this, the terminal board on the hinged rear cover is removed and remounted with spacers, so that the terminals will not hit the wall. Small knockouts are built into the bottom of the case, so that leads may be brought in.

The way in which the amplifier is adapted for the various uses to which it can be put is interesting. Rather than including the required number of variable controls to change impedances, gain, and equalization, the designer has furnished only two controls for ordinary use. These are the gain controls for the two input channels. They appear on the front panel in the photo above. If a permanent gain setting is desired, the knobs and extension shafts can be taken off and the knobs placed directly on the potentiometers, within the cabinet.

Fig. 3 shows the front of the amplifier with the cover removed. Note the two empty octal tube sockets at bottom of the chassis on each side. One or more

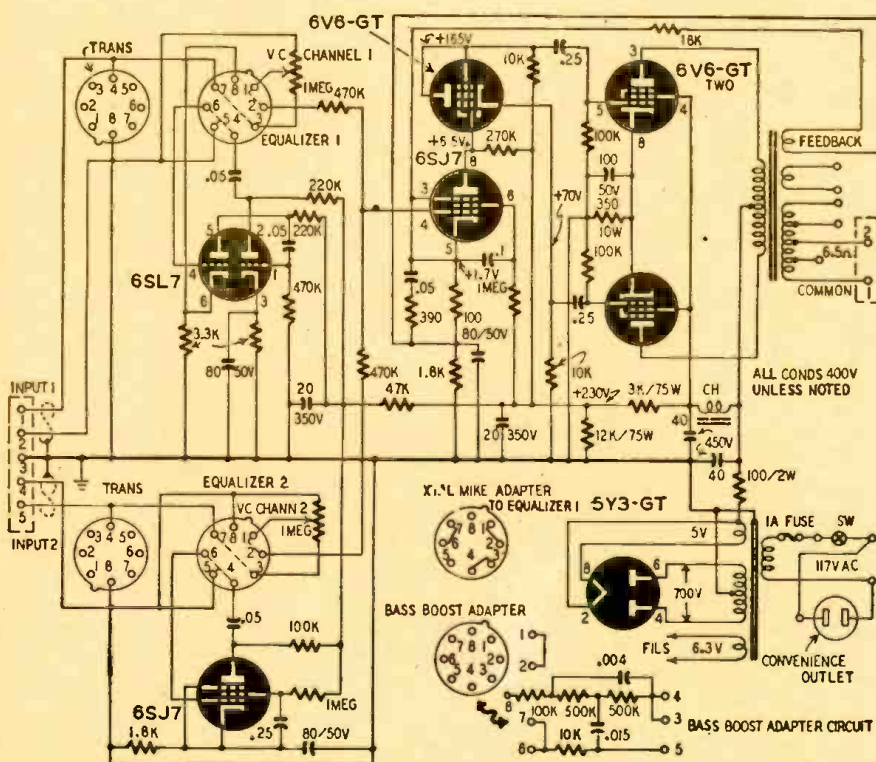

Fig. 1—The schematic. Dotted lines in the equalizer sockets indicate red-covered jumpers.

of the plugs which appear in front of the amplifier in the picture may be inserted into these sockets to give the desired amplifier characteristics. Some of the plugs are connected as jumpers and others are equalizer circuits. One impedance-changing transformer is furnished. This appears at the left in the photo.

The second and third adapters from the left in the photo are variable bass boosters. Using them, maximum bass boost in channel 1 is about 18 db at 20 cycles, in channel 2, about 10 db at 50 cycles. The next adapter provides fixed bass boost for use with magnetic pickups.

One of the small plugs at the right is strapped in the same manner as the original strapping on the equalizer sockets (shown in dotted lines in Fig. 1). It is inserted in the socket to reconnect the strapping, if that should be desired, after the original red-covered wires have been cut by the user. Two more are adapters for crystal microphones, cutting the appropriate preamplifier tube into the circuit for extra gain. The last is a voice filter.

All the adapters are to be plugged into the equalizer socket of the channel to be used. The transformer plugs into one of the transformer sockets.

The schematic diagram, Fig. 1, shows the amplifier as furnished, with all tubes in place, but without plugs in the equalizer or transformer sockets. The dotted connections in the equalizer sockets indicate jumper connections which must be clipped off if plugs are to be used. Jumpers are covered with red spaghetti for easy identification.

For channel No. 1, terminal 2 at the input board on the left is grounded, and terminal 1 is the "high" side of the line. This lead goes to pin 7 of the equalizer socket, through the dotted jumper and pin 3, to one end of the channel 1 gain control. The other end of the control is grounded. The variable arm leads through pins 1 and 2 and a 470,000-ohm isolating resistor to the grid of the 6SJ7. Notice that the 6SL7 is bypassed.

The 6SJ7 is direct-coupled to the 6V6-GT triode phase inverter, which uses its cathode circuit to obtain an out-of-phase voltage for the grid of the bottom power-output tube. The voltage markings show how the proper polarities are maintained with the direct coupling. Though the 6V6-GT grid operates at +64 volts, the cathode is at +70; since the cathode is more positive than the grid, the net grid-to-cathode potential is negative.

The output transformer is tapped for the required impedances; as furnished, the 6.5-ohm taps are brought out to the terminals, but the user can change this by soldering the proper leads to the terminal board. Taps are also provided at the transformer secondary for 13 db negative feedback. The feedback voltage is returned to the cathode of the 6SJ7.

As shown, the amplifier is suitable for high-level devices, such as tuners or crystal pickups. Its frequency response is flat and neither of the two preamplifier tubes is in the circuit. To adapt the unit for other uses, the dotted jump-

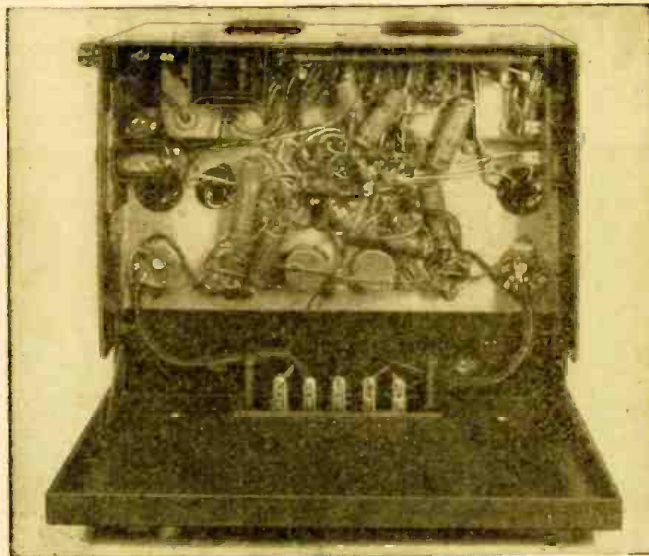

Fig. 2—Opening the hinged rear cover gives access to the parts.

er connections must first be cut away from the equalizer sockets. Plugs are provided, as mentioned previously, to re-make these connections.

The extra gain of a preamplifier tube is needed if a crystal microphone is to be used. For channel 1 the adapter shown in lower center of the diagram is furnished. It makes the proper connections for adding the 6SL7 to the circuit when inserted into the equalizer socket. Tracing the channel 1 input with this adapter in the top equalizer socket, terminal 1 (the "high" side) leads to pin 7, through the adapter jumper to pin 6, and thence to the left grid of the 6SL7. The left plate is coupled to the right grid, and the signal from right plate passes through its .05- μ f blocking condenser to pin 4 on the equalizer socket. The adapter jumper carries it to pin 3, one end of the volume control. The arm of the control is connected to pin 1, and the adapter jumper carries the signal through pin 2 to the 6SJ7 grid. The 6SL7 is thus connected into the circuit

as a preamplifier. Similar operation is obtained in channel 2 if the crystal microphone adapter is placed in the other equalizer socket.

The bass-boost adapter used with magnetic-type pickups contains, in addition to necessary jumpers, an R-C equalizer circuit which gives a 6 db-per-octave bass rise. The adapter circuit is shown in Fig. 1. The original design for this adapter left the high-frequency end of the range flat, but a roll-off will probably be added in future production to compensate for the pre-emphasis existing on most records.

Adding to the amplifier's versatility, a voice filter is furnished. When plugged into an equalizer socket, it emphasizes frequencies in the 2,000-cycle region.

A multi-tap input transformer with an octal plug base can be inserted into a transformer socket to accommodate low-impedance microphones, pickups, or lines. Jumpers must be soldered to the transformer socket to give the desired impedances.

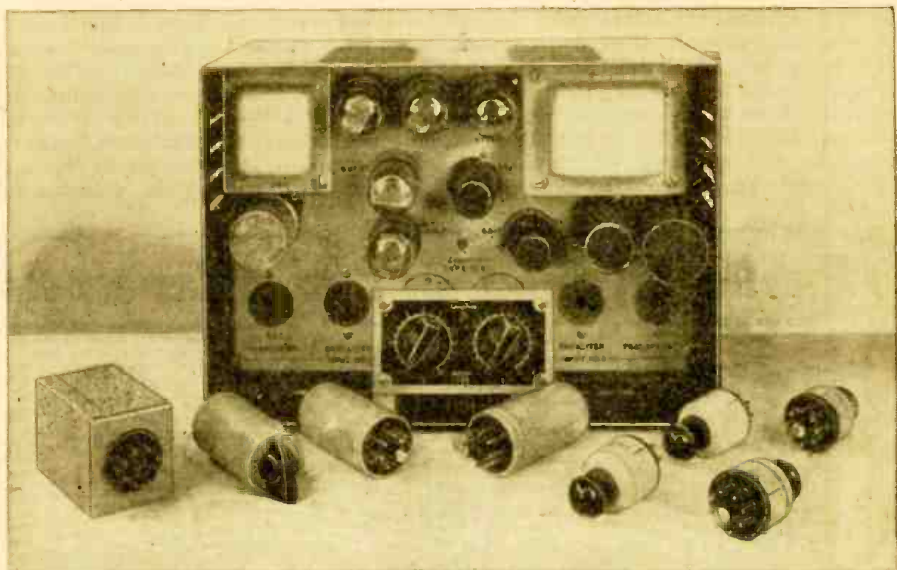

Fig. 3—The adapters shown in front of the amplifier may be plugged into the empty sockets.

War On Radio Repairmen



Members of Pittsburgh's Better Business Bureau show racketeering with prepared chart.

Servicemen organize to fight gyps and unfair surveys

By FRED SHUNAMAN

faults a 13-year-old boy might have an advantage over the skilled repairman. He might conceivably have an advantage over a Better Business Bureau in a parallel case—say one in which a company is not answering complaints because of a crack in its mail chute. Better Business Bureaus are not geared to look for such faults as leaky mail chutes—nor do radiomen look for short circuits as an initial procedure.

The very real abuses of the Pittsburgh situation must not be obscured by any shortcomings of the investigation. Each of the 51 complaints represented either dishonesty on the part of some radio technician, or ineptness in selling his services. The question is not: "How could the survey have been improved," but "What are we going to do about it?" What can be learned from the Pittsburgh investigation?

First and most unhappy lesson is: *Look out for gimmicks!* More and more agencies, newspapers and independent investigators are being stirred up by the various exposés to check up on their local repairman. Look over all radios for something out of the ordinary—especially if standard tests do not show up the fault immediately! A dead audio circuit may mean that phono jack contacts are squeezed together. No i.f. may be caused by a nonfunctioning oscillator—or by a cut wire. Use your eyes—remember the old slogan "The Customer Will Gyp You If You Don't Watch Out" (RADIO-CRAFT, April 1942, Page 477).

Stop the abuses!

The second and harder lesson is—the abuses must be stopped. And nobody is (Continued on page 49)

THE War on Servicemen" is on again, with Pittsburgh its latest battleground, as witness the photo on this page. The same "investigation" and "gimmick" weapons have been brought into play, and the same eager press has hurried to join the manhunt: "Radio Racketeers Dupe Public," screams the *Pittsburgh Press*, while the *Sun-Telegraph* informs: "Two out of three radio repair shops in Pittsburgh are gypping the public . . ." The attacking forces, incidentally, have a new ally—the serious and cautious Better Business Bureaus.

The Pittsburgh attack was by no means unprovoked. George Dennison, secretary of the Better Business Bureau, reports that no less than 51 complaints from radio owners were received. Attempts made to contact 41 of the shops complained of resulted in such negative co-operation that an in-

vestigation and exposé was deemed the only way to correct the situation.

Unhappily, the discredited "gimmick" was again pressed into service. Artificial faults of a type not found in a genuinely defective radio were introduced — an open connection, two wires pressed together, an open audio circuit—and the "gimmicked" set shopped around various radio shops. Not only were the faults atypical; they were trivial. After spending his time locating the trouble, the radioman did not find a genuine repair job for which he could make a charge. This probably accounted for the two-out-of-three overcharge rate, so much out of step with results of investigation where genuine faults are "planted" in the set.

The BBB, or other laymen, cannot see this point. "A 13-year-old boy discovered the loose wire in three minutes," reports Mr. Dennison. It is useless to argue to laymen that with such unlooked-for

Public 'Gypped' in Radio Repair Racket, Bureau Says

Two out of three radio repair shops in Pittsburgh are "gypping" the public, the Better Business Bureau has charged.

Radio Repairmen Fight 'Gyp' Artists
Corrupt Practices Cleanup Started

Radio repair leaders here have proposed a code of ethics to weed out "gyps."

Repairmen To Fight RadioGyps

The Radio Servicemen's Assn. of Pittsburgh will clean up the radio repair "racket" which was exposed yesterday by the Better Business Bureau of Pittsburgh.

Radio Repair Code Planned

The Radio Servicemen's Assn. of Pittsburgh will clean up the radio repair "racket" which was exposed yesterday by the Better Business Bureau of Pittsburgh.

Radio Service Group Meets

Members of a new radio service group met last night to organize themselves to propose a code of ethics and weed out the "gyps."

New 1948 and F.M. Manuals

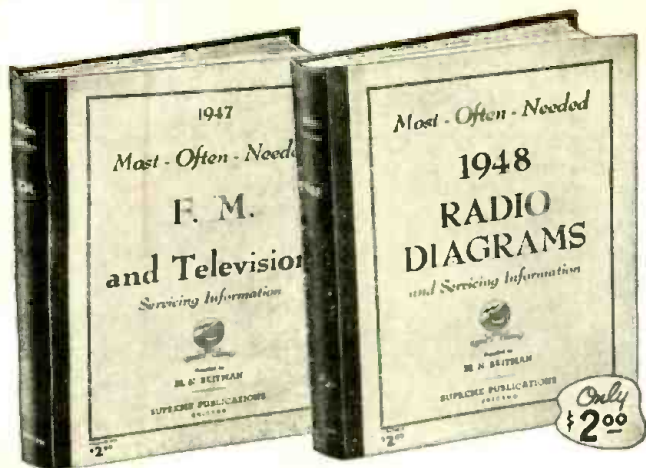

F.M. and Television

Use this new giant manual of factory instructions for troubleshooting, repairing, and alignment of any 1947-1948 F.M. and Television set. Every popular make, including new F.M. tuners, AM-FM combinations, and all types of television receivers. Detail circuit diagrams, theory of operation, test hints, alignment data, including both meter and oscilloscope methods. This is the material you need to fix any modern F.M. or Television set. Don't turn this profitable work away for lack of knowledge and information. Use this newest Supreme manual to save time and money on your very next F.M. job. Data presented on 192 large pages, 8½ x 11 in. Sturdy, manual-style binding. Just published. Special price. **\$2.00**

New 1948 Manual

Be prepared to repair quickly all new 1948 receivers. In this big single volume you have clearly-printed, large schematics, needed alignment data, replacement parts lists, voltage values, and information on stage gain, location of trimmers, and dial stringing, for almost all recently released sets. Makes toughest jobs amazingly easy. Find faults in a jiffy. Speed-up all repairs. The time saved on your next job will pay the \$2 bargain price for the complete manual—after that you use it FREE. A worthy companion to the 7 previous volumes used by over 120,000 shrewd radio servicemen. New manual covers models of 42 different manufacturers. Giant size: 8½ x 11", 192 pages + index. Manual-style binding. Price only **\$2.00**

BIGGEST BARGAIN IN RADIO DIAGRAMS

Make these two new mammoth volumes your money-saving source for data on all recently released receivers. Learn about modern circuit developments, be ready to repair any new radio no matter how complex. You pay only \$2 for each of these large manuals. With these two volumes on your workbench there is nothing else to buy, nothing else to pay—a whole year of radio diagrams and service data yours for a couple of dollars total. Again Supreme Publications beats all competition and gives radio servicemen greatest bargains in service information. Other volumes for previous years described below. **No-risk** examination granted to servicemen.

FIND ALL RADIO FAULTS DOUBLE-QUICK

You can speed-up and simplify radio repairs with SUPREME PUBLICATIONS Manuals. Service all radios faster, better, easier, save time and money, use these most-often-needed diagram manuals to get ahead, earn more per hour. For the remarkable bargain price (only \$2 for most volumes) you are assured of having in your shop and on the job, needed diagrams and other essential repair data on 4 out of 5 sets you will ever service. Every popular radio of all makes from old-timers to new 1948 sets, including F.M. and Television, is covered. Clearly printed circuits, parts lists, alignment data, and helpful service hints are the facts you need to improve your servicing ability. Save hours each day, every day, begin to earn more by making repairs in minutes instead of hours. Let these manuals furnish you with diagrams for 80% of all sets. There is no need to spend large sums for bulky, space-wasting manuals, or to buy additional drawings every few weeks; be wise, use SUPREME Manuals to get the most in diagrams and service data for the smallest cost. Act today and be money ahead with Supreme Publications.

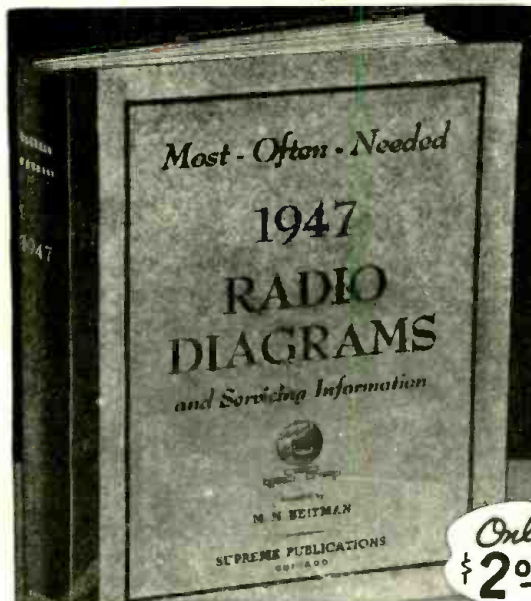

Models Made by:
R.C.A., Zenith, Philco, Sears, Fada, Emerson, Belmont, Detrola, Crosley, G.E., Westinghouse, Arvin, Majestic, Stewart-Warner, Admiral, Delco, Stromberg-Carlson, Wards, West'n Auto, Sparton, Motorola, and many others.



Use coupon to order manuals for examination
Popular sets of all makes from 1926 to 1948 are included.

Select Supreme Diagram Manuals and Record Changer Books you want to examine. Send the no-risk trial coupon. Use the manuals in your own home or shop for 10 days at our risk. See for yourself how easy it is to fix all sets with the right data. You will agree that Supreme Publications are the greatest values in service manuals. You must be completely satisfied, or return manuals and get your money back.

Record Changers Manuals

Post-War Models

Service expertly all modern (1945-1948) record changers. All popular makes. Just follow simplified factory instructions to make needed adjustments and repairs. Hundreds of photographs and exploded views. Large size: 8½ x 11 inches. 144 fact-filled pages. Price only \$1.50 postpaid.

Pre-War Models

Just what you need to repair quickly thousands of pre-war (before 1942) automatic record changers, manual units, platters, wireless oscillators, recorders, and combinations. Hundreds of mechanical and electrical diagrams. 128 large pages; giant size: 8½ x 11 inches. Price, only \$1.50.

See Your Radio Jobber or Send Coupon →

NO RISK TRIAL ORDER COUPON

SUPREME PUBLICATIONS, 9 S. Kedzie Ave., Chicago 12, ILL.

Ship the following manuals on trial under your guarantee of satisfaction or money-back.

- | | | |
|--|------------------------------------|-------------------------|
| <input type="checkbox"/> New F.M. and Television Manual... \$2.00 | <input type="checkbox"/> 1948 | PRICED AT ONLY \$2 EACH |
| <input type="checkbox"/> Post-War Record Changers..... 1.50 | <input type="checkbox"/> 1947 | |
| <input type="checkbox"/> Pre-War Record Players & Recorders 1.50 | <input type="checkbox"/> 1946 | |
| <input type="checkbox"/> I am enclosing \$..... send postpaid. | <input type="checkbox"/> 1942 | |
| <input type="checkbox"/> Send C.O.D. I am enclosing \$..... deposit. | <input type="checkbox"/> 1941 | |
| | <input type="checkbox"/> 1940 | |
| | <input type="checkbox"/> 1939 | 1926-1938 — \$2.50 |
| | <input type="checkbox"/> 1926-1938 | |

Name:

Address:

Supreme Publications

PUBLISHERS OF RADIO BOOKS, MANUALS, AND DIAGRAMS

9 South Kedzie Ave.

Chicago 12, Illinois

JULY, 1948

War Surplus Bargains Sold As Used Unless Otherwise Specified!



\$1995

NAVY CRV-46151 AIRCRAFT RADIO RECEIVER

Four bands, including broadcast (195-9,050 KC). Circuit is six-tube superheterodyne with mechanical band change or remote operated electrical band change. Remote band change and tuning controls included, making this set readily adaptable to mobile ham use. Powered from self-contained 24 V. DC dynamotor.

The sets are complete with tubes, mounting rack and remote controls.

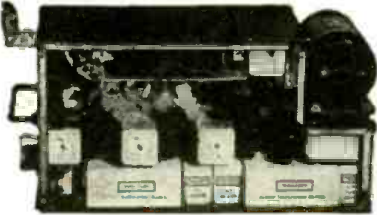

BC-733D LOCALIZER RECEIVER

A part of aircraft blind landing equipment. Operates on any six of its predetermined crystal controlled frequencies in the range of 108-120mc. Contains 10 tubes, three of which are 6X7-AT's and crystals. Ideal receiver for conversion to 144 mc. ham band or mobile telephone bands. For 24 V. DC operation. Size 14 1/2" x 7" x 4 1/2".

Price with dynamotor **\$5.95**
 Price without dynamotor **\$4.95**

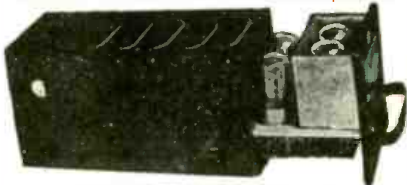

TURBO AMPLIFIER

Used for parts—shipped complete with the following tubes:

2.....7 C5's 1.....7 Y4 1.....7 F7

Price **\$1.75 ea.**

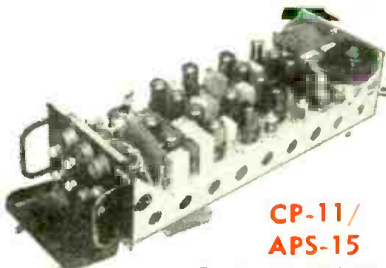

CP-11/APS-15

Contains 13-68N7 GT's, 1-5Y3 GT, 24 V. motor and blower (will operate on 110 V. 60 c.p.), 4—one mezhohm Precision wire-bound resistors, 80 —86 Kc crystal. Wgt. approx. 25 lbs. PRICE **\$995**

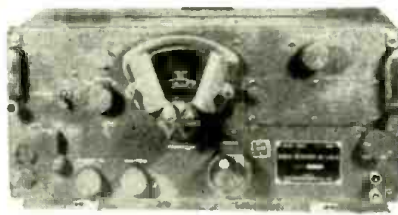

BC-348 COMMUNICATIONS RECEIVER—\$149.50

6 bands, 200-500 Kc. and 1.6-18 Mc. 2 stages RF, 3 stages IF, BFO, crystal filter, manual or AVC. Complete with tubes and 24 V. dynamotor. These receivers have been thoroughly checked in our work-shop and found in excellent condition.

BC-348, 110 V. AC power supply, including simple conversion instructions. Complete with tube **\$8.95**

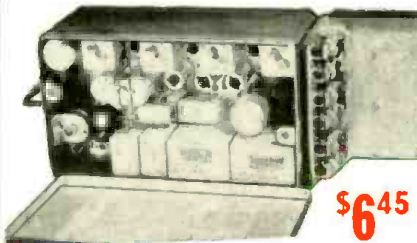

\$645

R-89/ARN 5 A GLIDE PATH REC.

Formerly used for blind landing but adaptable to many other uses such as receiver for new police or citizen's band. Band of operation 326-335 mc. on any of three pre-determined crystal controlled frequencies. Contains eleven tubes, 6 relays and other valuable parts. For 24 V. DC operation. Size 13 1/2" x 5 1/4" x 6 3/8". Price complete as shown.



INTERVALOMETER, \$2.25

Electronic timing device. Was used for releasing bombs at intervals. Ideal for dark-room timer, model train controller. (Contains relays, switches, pilot lights, resistors, knobs, etc.)

HRU (DC) POWER SUPPLY

24-28 V. at 70 a m p. 2000 watts gasoline engine generator with electric starter. Power supply which can be used to operate 24-28 V. equipment, start airplane engines, charge batteries, as a welding machine, lighting system, or for amateur radio station. 21 1/2", 17 1/2" x 24". Wgt. 115 lbs. **\$79⁵⁰**

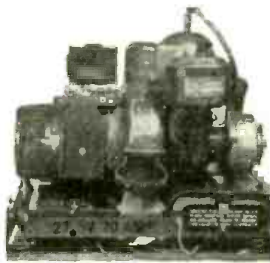

CO-AXIAL CABLE VALUES

CO-AXIAL CABLE VALUES THAT WE CAN ONLY OFFER TO CUSTOMERS WHO BUY MINIMUM OF 100 FOOT PER TYPE.

RG-8/U cable 52 ohms impedance (unmarked) \$2.95 per 100 foot
 RG-8/U cable 52 ohms impedance (marked) \$3.95 per 100 foot
 RG-29/UCO-AXIAL 53.5 ohms impedance (marked)..... \$3.95 per 100 foot

PRICES F.O.B. INDIANAPOLIS

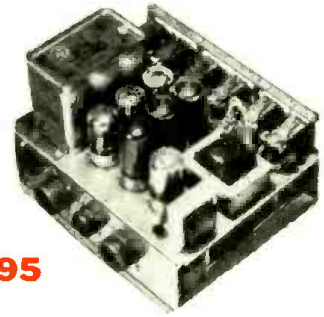

\$695

C-1 AUTO PILOT AMPLIFIER

Were used to control operation of Servo units, causing them to move the control surface of airplane in one direction or the other in response to signals received. The complete amplifier includes one rect. 7Y4, 3-7FT's for amplification and control, 3-TNT's for signal discrimination, 1 power transformer, 6 relays, 4 control pots, chokes, condensers, etc. Convert for use on radio controlled models, doors, etc. Operates from 24 V. DC. Size 9 1/4 x 6 1/4 x 7 3/4". Complete.

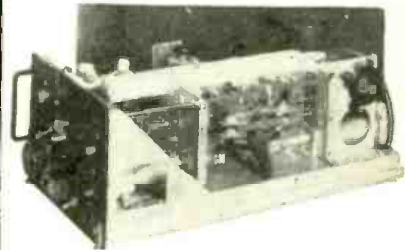

T-39/APQ-9 RADAR TRANSMITTER

Contains many excellent parts for the VHF experimenter such as a cavity oscillator using 2-RCA 8012 tubes rated at full output to 500 Mc. Tubes are forced air cooled by 24 V. DC motor, which is easily converted for 110 V. AC operation. Other valuable parts such as a pair of 807's, 2-6AC7, 1-931 and 1-6AG7 tubes; ceramic switch, potentiometers, gears, **\$12⁵⁰** revolution counter, etc.

AIRCRAFT RADIO RANGE FILTER



For helpful reduction of QRM on crowded CW bands. When attached to output of any communications receiver:

- 1—Will pass signal of 1020 CPS, eliminating others.
- 2—Will pass voice frequencies and eliminate 1020 CPS code signal.

Compact, light weight, with switch. Size 2 3/4" x 2 5/8" x 3 3/4". Price **\$2²⁵**

TERMS: CASH WITH ORDER

AMERICAN SURPLUS PRODUCTS CO.

537 N. CAPITOL AVE. INDIANAPOLIS, IND.

TERMS: CASH WITH ORDER

AMERICAN SURPLUS PRODUCTS CO.

537 N. CAPITOL AVE. INDIANAPOLIS, IND.

A Sensational Announcement to the "Top Third" of the Servicing Field!

Now, after two years of preparation, CREI introduces its new home study course in

TELEVISION AND FM SERVICING



G. E. PHOTO

100% Practical "On-the-Job" Course That Equips You to Install and Service ALL Types of Television and FM Receivers

1948 is the big changeover year—from radio to television.

It is the year for you and all servicemen to make the big decision. Either you are going to catch up with the new developments in the industry, or you are going to be passed by. There are new techniques—entirely new methods of technical "know how" to be learned and mastered, if you are going to be in a position to handle good-paying Television and FM business.

This new course was prepared by CREI at the request of several large manufacturers, distributors and dealers who said, "We must have more servicemen trained to handle the approximately 800,000 television sets and 4,000,000 FM sets to be produced this year alone!" CREI knows exactly what you need and every effort has been made to keep this course practical and to the point. If you are now in service work you will be able to thoroughly understand and apply each lesson. It has been reviewed and checked by qualified service experts who know what *you must know* to get ahead in this booming field.

Radio Service Division of

CAPITOL RADIO ENGINEERING INSTITUTE

An Accredited Technical Institute

Dept. 578, 16th & Park Rd., N. W., Washington 10, D. C.

Branch Offices: New York (7) 170 Broadway • San Francisco (2) 760 Market St.

CREI has never attempted "high pressure" selling of any kind. In introducing this course, we believe honestly that it can provide you with the ability you must have to hold your job—qualify for a better one—or start your own business.

To such familiar service terms as "tone, selectivity, circuit noise, AVC, feedback, etc.," must be added such terms as, "dipole, rasters, clippers, clamping circuits, synch pulses, blanking pedestals, etc." Do you understand this new language? Are you qualified to install and service all types of Television and FM Receivers?



TV and FM will make more progress in the next 10 months than they have in the past 10 years. Just think of the extraordinary opportunities this opens up for you. Here in one practical course at a popular price, CREI offers you security and more money.



Don't put it off. Get going now and get in on the big money that is going to be made by those men who have equipped themselves to handle the "sets of tomorrow."

Start your training now and you start applying your new-found knowledge immediately. Every lesson in this course can be helpful in your daily work. As you progress in your training you will find yourself equipped to handle complicated Television and FM work that only a few months ago looked "impossible". The time to start is now.

It costs you nothing but a few minutes time to read the interesting facts and the complete lesson-by-lesson outline. So practical, so simple to understand. Mail the coupon now for complete information.



MAIL TODAY

CAPITOL RADIO ENGINEERING INSTITUTE
16th & Park Road, N. W., Dept. 578, Washington 10, D. C.

Gentlemen:
Please send me complete details of your new home study course in Television and FM Servicing. I am attaching a brief resume of my experience, education and present position.

NAME _____

STREET _____

CITY _____ ZONE _____ STATE _____

I AM ENTITLED TO TRAINING UNDER G. I. BILL.

INSULATED PLATFORM

When working with power tools or metallic devices using power from the 117-volt line, it is a good idea to make sure your feet are not grounded. A concrete floor is an especially good conductor and an insulating platform should always be placed on it.

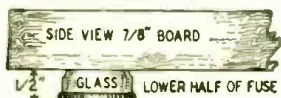

I made such a platform cheaply by using a piece of wood about 18 inches long, 12 inches wide, and 3/8 inch thick, and four old plug fuses with Pyrex bodies.

One-inch holes were drilled about 1 1/4 inches in from the corners of the platform, and the brass-threaded ends of the fuses were pressed into the holes. This keeps the platform about 1/2 inch from the floor and thoroughly insulates it.

OSCAR E. MALECH,
San Francisco, Calif.

RADIO TIMER

I often listen to the radio while in bed, and several times I have fallen asleep without turning it off. To avoid running down the batteries, I constructed a timer to turn off the receiver after a stated length of time.

The hour hand is removed from a cheap pocket watch and a small strip of spring bronze soldered to the watch face in the position shown. In the center of the spring is a silver contact.

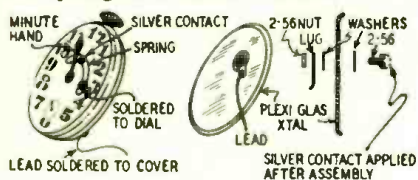

Immediately above the contact, on the plastic watch-crystal material, is bolted another contact, so that the two touch when the minute-hand is away from the assembly.

When the minute hand gets to the spring, it pushes it down, breaking the contacts and turning off the radio.

Because of exposed contacts, this timer should be used only on battery sets. A shorting switch, across the contacts, cuts out the timer for normal radio operation.

STANLEY A. OLLENDORF,
Oak Park, Ill.

CRYSTAL MOUNTING

Here is a convenient way to mount crystal diodes which do not have pigtail leads.

The large end is held in a miniature fuse clip, and the small end in a hearing-aid-battery jack. Clip and jack may be mounted on a bakelite or fiber base for convenience in placing the assembly on a chassis.

JOSEPH PATAY,
Toledo, Ohio

TEST LEAD SWITCHING

To eliminate the tangle of wires that results from a number of test instruments on the bench, I use this system of switching two pairs of test leads to various instruments.

The leads are connected to any of several meters or antennas by d.p.s.t. push buttons. Using a Mallory #2100 8-button assembly, two pairs of leads can each be switched to any of four instruments.

EDWARD L. SPEAL,
South Paris, Me.

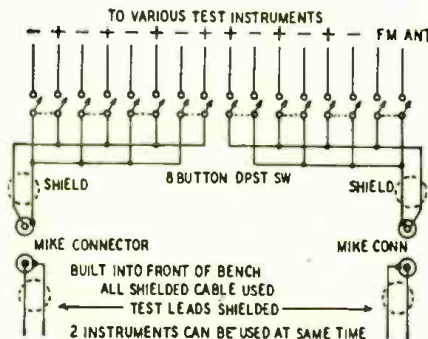

MOTORBOATING CURE

On small receivers there is often motorboating at one end of the band. Frequently, it is due to electrostatic coupling between the glass i.f. tube and the loop antenna.

To prevent this, I use a static shield made of horizontal strips of stiff copper wire. The strips are laid out on the bench, in the pattern shown by the drawing, and a right-angle piece of the same wire is laid across as shown. Spots of solder at each point where one wire crosses another hold the assembly together.

The shield is installed so it resembles a fence between the tube and the antenna. The right-angle strips are soldered to the chassis.

JOHN W. COOK,
Waynesboro, Va.

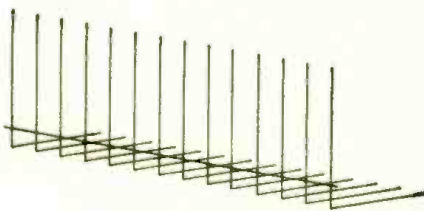

BOOK HOLDER

Books that are in use while a set is being serviced can be kept clean and out of the way by holding them to the back of the bench with a wire holder made from a wire coat hanger.

The hanger is cut in the center of the horizontal wire, and the hook is re-

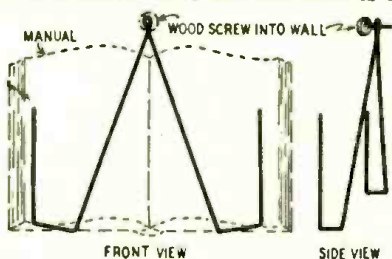

moved. A small loop is made in the wire just under the hook, and a wood screw and washer serve to fasten the loop to the wall. The remainder of the hanger is bent as shown in the drawing.

N. H. SILVERMAN,
Los Angeles, Calif.

SIGNAL TRACER

When no regular signal tracer is at hand, almost any receiver having a phono jack can be used for the purpose. Make up a shielded cord with a probe on one end and a phono plug on the other. A short length of wire attached to the shield ends in a small alligator clip to make the ground connection on the receiver under test. This setup is fine for audio signal tracing.

To trace r.f. signals, another similar assembly should be made up, but a crystal diode should be connected in series with the hot lead and, if possible, placed within the probe. Several such probes have been described in RADIO-CRAFT recently.

R. W. EUBANK,
Lexington, Ky.

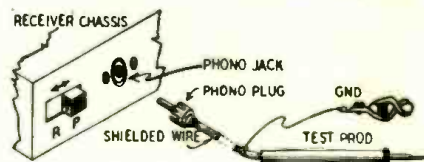

MUSICAL LIGHT

I obtained an interesting effect by making a neon lamp glow in synchronism with the sound coming from my receiver.

The neon lamp is connected in series with a condenser between the plate of the output tube and ground. The intensity of the glow varies with the loudness of the voice or music.

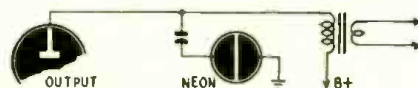

With 265 volts on the final tube plate of my receiver, I found that a 20- μ f electrolytic condenser worked best, with a General Electric NE-57 lamp (its starting voltage is 55 a.c. and 70 d.c.). A.c.-d.c. sets would probably require a lamp with lower starting voltage, and a different size condenser.

JOHN E. LOVETT,
Denver, Colo.

DENTAL MIRROR AID

Many points in the crowded space under the chassis of small sets are hard to examine. I use a dental mirror to get into these places. To insulate the handle of the mirror, a coating of tape is wrapped around it.

FRANK M. WANLASS,
Ogden, Utah

(Though this is a very old trick, RADIO-CRAFT makes no apology for republishing it. We feel servicing aids like this ought to be repeated at intervals, to inform beginners and remind the old hands.—Editor)

going to do that but the radio technician himself. This was the happiest feature of the whole Pittsburgh investigation. During the week of the exposé, six stories on the investigation were printed in Pittsburgh papers—and 11 on efforts by the repairmen to clean up the situation. The press there is strongly behind the reputable majority of the repairmen. The old repairmen's association, under the veteran repairman Bert Bregenzler, reorganized under the new name of Radio and Television Servicemen's Association, and pledged itself to the fight for reputable radio repair in Pittsburgh.

How can organization help the situation? Many report that dishonest repairmen simply do not join associations, or drop out as soon as they are criticized. The answer (discovered years ago by the Philadelphia Radio Servicemen's Association) is that the organization can be responsible for all radio repair, whether by members of the organization or not. The association acts as a bureau to receive all complaints from radio owners. It then gets in touch with the repairman and asks him to contact the owner. In most cases an adjustment is made immediately. If not, a committee inspects the set and makes a decision. Actually dishonest repairmen or equally dishonest or over critical customers will heed such decisions—they will not take a chance on going to court against such expert witnesses. Where the difficulty is due to a misunderstanding between repairmen and customer, it is usually easy to settle it.

Improved public relations

Organization is even more helpful in improving the reputation of the good radio technicians than in checking the bad. The experience of the new Associated Radio Servicemen of New York (City) is a striking case in point. Born under the worst possible auspices (a move to license all radio repairmen, with a \$30 annual license fee) the organization found itself compelled to defend the city repairmen from another "investigation" and attacks from a half-dozen radio commentators. Several newspapers joined in the hue and cry. The situation could hardly have been darker.

Hopelessly, president Liebowitz and secretary Edel started calling broadcast stations to protest unfair treatment. To their utter surprise, they were offered time to answer the charges, and even in some cases to face their attackers at the microphone. What followed was even more surprising. Without exception, the radio commentators were so impressed with the new association and its program that they swung behind it wholeheartedly. Today men like Paul Dennis, John McCaffrey, Lyle Van and J. Raymond Walsh are the strongest backers of the ARSNY.

These men have told their listeners—over the air and through their newspaper columns—to take their radios to shops which display the ARSNY decal in the window (see illustration) for fair treatment. These shops give itemized bills, stand back of their work, and can

RADIO REPAIRMEN
(Continued from page 44)

be checked up on immediately through their own organization.

Meanwhile the clamor about radio repair frauds and overcharging died

conclusion is all the more important because it was totally unexpected by the promoters of the Workshop. So struck were they that the first recommendation on their report is:

"One, and perhaps the best, way to correct the conditions we encountered on this tour is the creation of strong



This 12 by 4 inch decal window display is the identifying symbol of members of ARSNY.

quietly. The Grievance Committee of the ARSNY broadcast notice of its willingness to take up any customer's complaint, whether against a member or non-member, and received only 19 complaints during the first two weeks of its existence. Four-fifths of these were settled immediately by phone.

Technical improvement possible

The radio technician has as much to gain through organization from a technical point of view as from that of public relations. This point was startlingly brought out by the General Electric FM Travelling Workshop, a series of lecture and demonstration sessions designed to spread information on servicing FM receivers. The Workshop discovered that "except in those few communities where a strong radio servicemen's organization is in operation (our italics) . . . the average serviceman, through no fault of his own, does not have . . . the technique to service FM receivers properly." The

radio servicemen's organizations throughout the country. Such organizations, the report states, can:

Disclose new ways of doing better work, and new tools to work with.

Set qualifications and standards for their membership to keep servicing procedure at a high level.

Set up rules and regulations governing the conduct of radio work.

Set up schools for teaching radio service to prospective members.

Carry on local publicity campaigns.

All these methods have been proved effective by the older organizations (RADIO-CRAFT, March, 1948) and by the newer ARSNY. Other associations now springing up throughout the country will find them equally valuable. Both from a business and a technical standpoint, organization is the way out and up for the radio repair technician.

Time-Saving Repair Tips

By W. G. ESLICK

ONE would think that the average serviceman would know the simple quick tests and trouble-shooting methods described below, but to my surprise and disgust, too many don't. I have been manager of a large service shop and have worked in or visited many others, so know whereof I speak.

A headache in a.c.-d.c. radios may sometimes be due to intermittent filaments which won't show on the tube tester unless one stands over it for some time. Usually one can see the pilot light go on and off or off and stay off! Simply take one of the little neon testers advertised for around fifty cents and place it across each filament. Because of the minute current required to light the neon bulb and the complete series circuit (except the intermittent tube) the neon bulb placed across the faulty tube will light when the filament opens. Most men sweat over the tube tester to find the tube. (An a.c. voltmeter placed across each filament will often show a bad tube. Its resistance may be much higher or lower than normal, causing an abnormal voltage drop.—Editor)

To find a leaky coupling condenser coupled between a plate and grid: set your voltmeter on a 300-volt range or more and place between grid and chassis ground or the common ground circuit, then keep decreasing the voltage selector on your tester till a reading can be had. (Place positive prod on grid and negative prod to common ground or point from which grid bias is obtained. Leakage will cause the meter to show the small positive voltage on the grid. It varies according to leakage. This method catches the intermittent and I like it better than an ohmmeter test.

Here is another not-too-well known fact. Your voltmeter can be used as a resistor. Suppose you find the 6SQ7 plate voltage nil. With the voltmeter set on a high range (at least as high as the voltage in the radio for safety) touch the negative prod to the plate of the tube and the positive prod to B-plus. If the set plays, replace the resistor. This just saves time. The meter is already in use, so why hunt up a resistor and shunt it across the suspicious carbon stick when you have a resistor in your hands.

(Continued on page 55)

Servicing Farm Radios

Trouble in Silvertone Model 4722

By HARRY LEEPER

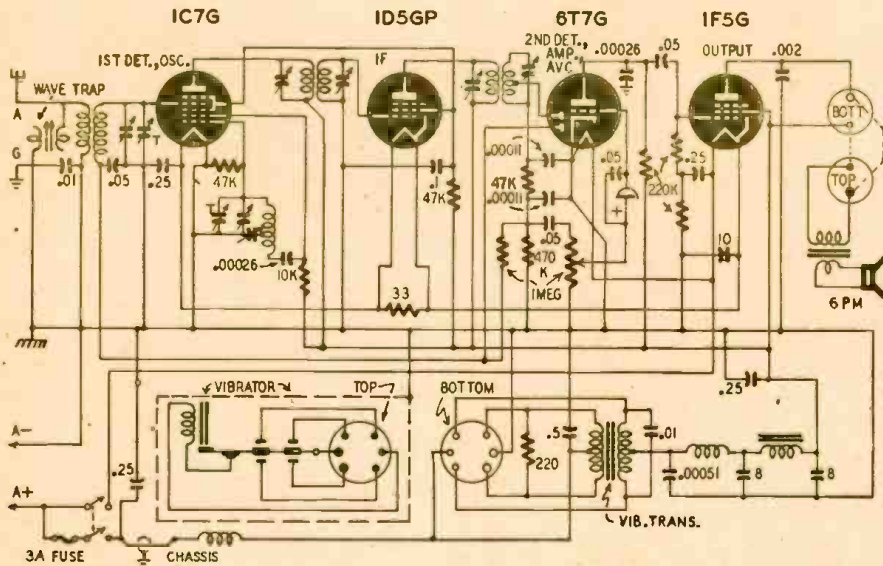

Fig. 1—Battery drain is reduced by using 2-volt tubes in mixer, i.f. and output stages.

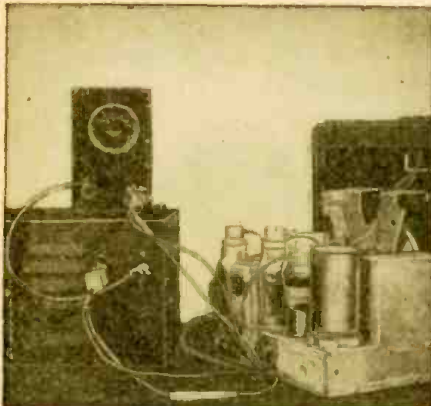

Fig. 2—Ammeter checks current used by set.

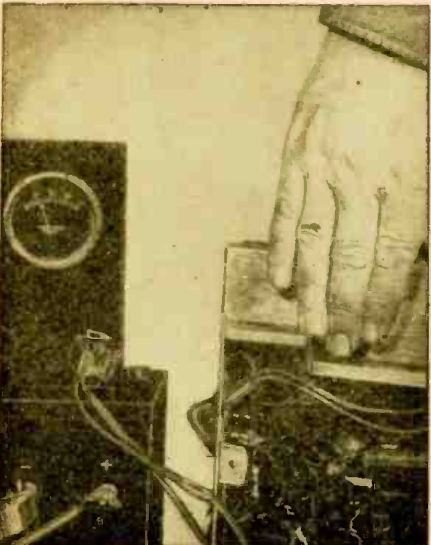

Fig. 3—Unusual heat shows trouble in set.

OCCASIONALLY the serviceman gets a farm radio which uses a vibrator and operates from a 6-volt battery. In testing such sets certain problems are encountered which are somewhat different from those found in the conventional a.c. home radio.

A receiver of this type is the Silvertone Model 4722, chassis 100.179, which uses three 2-volt tubes in series and one 6-volt tube, as Fig. 1 shows.

There were several complaints on one of these sets. When it worked, short circuits occurred when the battery leads touched, and there was noise when the radio was jarred. When brought into the shop, the set was no longer operating.

A battery eliminator made to test car radios was used as the test power supply, and an ammeter inserted in the d.c. circuit as in Fig. 2 showed about 12 amperes—entirely too much current for a radio of this type.

The vibrator could be heard in operation and after being connected for a few minutes, the metal cover over the bottom of the transformer terminals and the buffer condenser became warm. See Fig. 3.

The transformer buffer condenser—a .01- μ f unit—was suspected. It was disconnected, and an ohmmeter reading across this unit, shown in Fig. 4, revealed that it was shorted.

With this condenser disconnected and the eliminator turned on again, the ammeter reading dropped to around 4 amperes, as Fig. 5 indicates.

The defective condenser was replaced with one of like value rated at 1,600 volts.

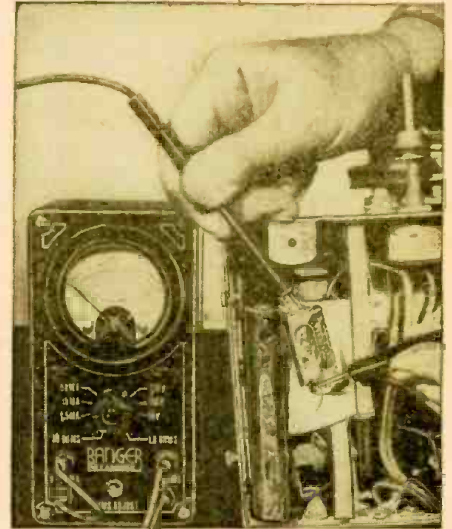

Fig. 4—Shorted buffers are troublesome.

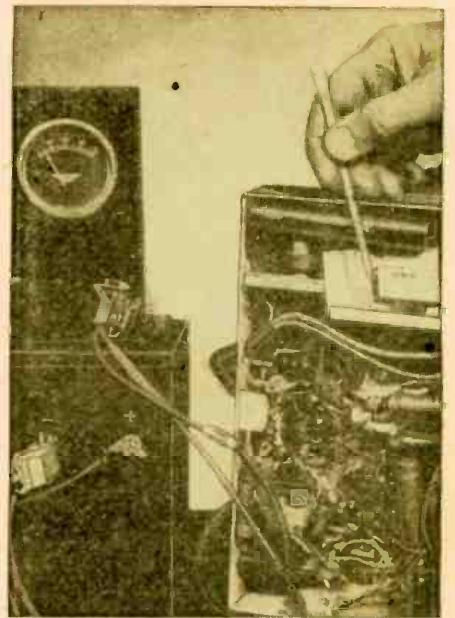

Fig. 5—Current is normal with the new buffer.



Fig. 6—A series lamp drops input voltage.

The radio would now operate, but the vibrator noise seemed louder. A check of the tube filament voltage showed 9 volts instead of 6.

The eliminator was designed to furnish 6 volts for auto sets drawing a fairly heavy current, and the higher voltage here was due to the lighter current requirements of this farm radio.

In order to reduce the filament voltage to a safe value, a 25-watt, 115-volt lamp was placed in series with the eliminator transformer primary as shown in Fig. 6.

The secondary voltage was then 5 volts. Other lamp combinations would have been possible, but, since the radio operated satisfactorily on 5 volts, the

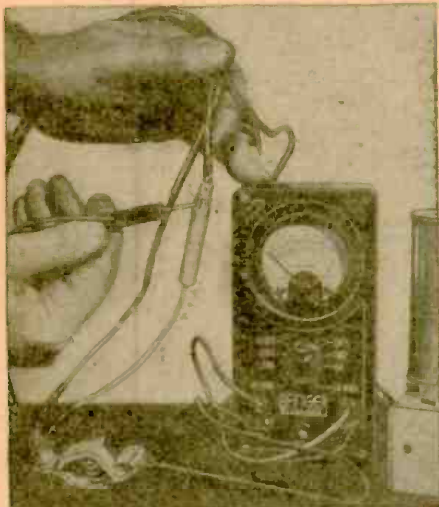

Fig. 7—Check the hot battery lead for shorts.

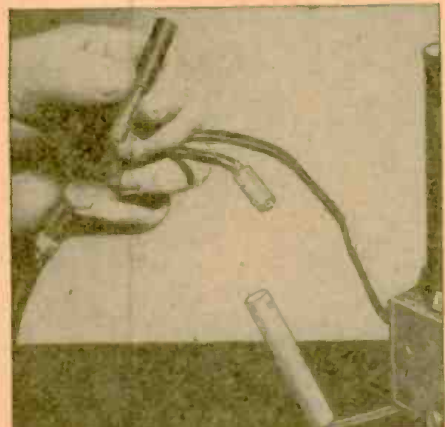

Fig. 8—Spaghetti guards against grounding.



Fig. 9—Taping protects lead from abrasion.

25-watt lamp was used for further tests.

The complaint of battery leads shorting was then investigated.

An ohmmeter test from the metal fuse holder to the battery clip on the same lead, which was the insulated lead of Fig. 7, showed a short circuit, indicating that the fuse was touching the metal holder.

Further check revealed that the fiber insulator which ordinarily insulates the fuse from the holder was missing: when the fuse holder touched the other uninsulated lead, a short circuit occurred.

A piece of fiber sleeving was placed over the fuse, as illustrated in Fig. 8, and this trouble was eliminated. As further protection, the battery leads were taped at the point of entrance to the cable sheath (Fig. 9).

The battery clips, corroded from chemical action, were cleaned by dipping them in a solution of water and baking soda (Fig. 10). Vaseline was applied to the clips to slow down any future corrosion.

The noise heard when the set was jarred was cleared up by tightening the speaker plug receptacle under the chassis. (Note the method in Fig. 11.) This plug, being only a 2-prong one, is not held in place as firmly as plugs having four or five prongs.



Fig. 10—Baking soda removes the corrosion.

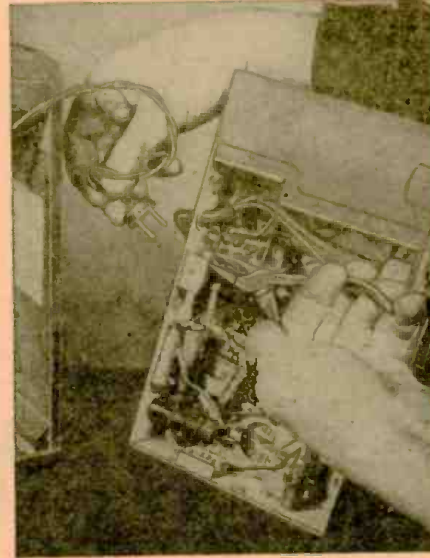

Fig. 11—Crimping socket pins reduces noise.

METERS Brand New

ALL CHECKED FOR ACCURACY!

0-500 MA DC 3 1/2", round, NX35 Westinghouse	\$ 3.00
0-5 Amps RF 3 1/2", round, NT35 Westinghouse, Internal TC	4.50
0-3 Amps RF 2 1/2", round, NT33 Westinghouse, less TC	3.50
0-10 & 0-250 MA DC combination, round, DW41 G.E.	2.50
0-3 MA DC 3 1/2", square, 327A Triplet	4.50
0-500 Volts AC 3 1/2" square 337A Triplet	6.00
0-2 Volts AC rectifier type 10,000/volt 327A Triplet, 3 1/2" square,	15.00
0-15 Ma. DC General Electric, type DO-41, Model AAW250, 3 1/2" round bakelite case	3.00
0-150 Volts AC Simpson, Model 6130, 2 1/2" metal case	3.50
0-35 Volts DC, Triplet, Model 327A, 3" square bakelite case.	4.00
0-50 Amps. AC, Triplet Model 337A, 3" square bakelite case.	7.50

RELAYS

All Brand New

RBM DPDT 110 v 60 cycle, make before break	75c
Relay, 6 MA 5000 Ohm DC resistance, SPDT	85c
Leach type 1127-FR 110 V 60 cycle DPST	\$1.50
Automatic Electric Co. DPDT 24 v DC 6 amp silver tungsten contacts	40c
Automatic Electric Co. delay relay, 20 ohm, silver tungsten contacts	40c
Starter relay, 28 volt operated, heavy duty construction	50c
Switch, pushbutton type DPST on/off type, to fit standard switchbox, 10 amps at 250 volts	25c
Switch, toggle type, bat handle, DPDT heavy duty contacts	35c
Leaf type switch, 4 poles, single throw, single hole mounting	25c



Microphone transformer, Ouncer type, for carbon mike to tube grid, circuit printed on case...NEW 50c
Transformer, two sets of windings each 1 to 1 ratio, good for frequencies of 1000 CPS and higher,

NEW 25c

Filter Choke, 19 henry 105 MA DC, resistance 170 ohms, metal cased, size about 3" x 3" x 4" high,

NEW \$1.50

Neon tube clear glass about 1/2" O.D. overall length about 11". Excellent for transmitter RF tuning indicator ...NEW 40c

All Prices F. O. B. Indianapolis

TERMS: CASH WITH ORDER

**AMERICAN SURPLUS
PRODUCTS CO.**

537 N. CAPITOL AVE.
INDIANAPOLIS, IND.

Pedro's Inductant Reasoning

By GUY SLAUGHTER



"The old blister was back again, only this time she brought two cops along with her."

I'M working on an FM job when the dame first comes into the shop, so Pedro waits on her. Pedro is a little Mexican kid who works for me. He doesn't know much radio but he comes in handy sometimes.

"Good morning, Senora," says Pedro, "Something I can do?"

I can hear the dame sniff clear back at the bench. She has a voice like a buzz saw.

"I wish to see the proprietor," she buzzes. "At once!"

I get up from the bench with a sigh. "Yes, lady," I say when I reach the counter. "I'm the proprietor."

"This radio," she gurgles, slamming it down on the counter. "I bought it here. I want it fixed." She stabs me with an accusing glare.

"All right lady," I say. "What's the matter with the set?"

"Everything," the old girl barks. "There's so much noise I can't hear the music." She's still glaring at me. "You ought to be ashamed young man, selling things like that!"

"But lady," I say. "Wait a minute. That set is four years old. Have you had any trouble with it before?"

"I should hope not," she buzzes. "I paid nearly twenty dollars for it, and I expect to get my money's worth!"

"Absolutely right, Senora," pipes up Pedro. "Should be good for years yet."

"I'll be back tomorrow morning," she breaks in. "Fix it so I won't have any trouble with it ever again, or I'll call in the Better Business Bureau!" She leaves, slamming the door and muttering to herself.

Pedro breaks into a gay little laugh, but his grin fades as I give him the eye. "What's so funny?" I demand.

"Uh . . . nothing, Herk," he says, grabbing a rag and going to work on the dust atop the counter.

"And lay off the 'Herk' stuff, see? From now on in it's Mister Newton, with the accent on the 'Mister'."

"Yes MISTER Newton," says Pedro glumly.

I finish tracking an FM job, and plug the dame's set in on the bench to warm

up. After 30 seconds or so the little job starts pouring out music, and the noise level is practically zero.

"Fixed already MISTER Newton?" Pedro says, coming back to the bench with his dust cloth. "What was wrong?"

"Must be an intermittent. We'll have to wait for it to act up." I cover it with a box I keep for the purpose, wanting it to get hot quick, and go on with my next job, ready to check it the minute it starts to noise up. But it doesn't, and when I close up that evening, it's still going strong.

Next morning about nine o'clock the old dame comes in. She stops at the counter, and stands there, tapping her foot and looking sour.

"Good morning, Senora," Pedro says. "You're bright and early, no?"

"Never mind that," says the dame. "Where's my radio?"

I have it back on the bench, of course, and it's still going strong. I pull the plug, do the line cord up into a neat hank, and carry it out front, thinking up my speech as I go.

"Good morning," I say, before she gets a chance to start talking. "There's nothing wrong with your radio. It must . . ."

"I should hope not," she breaks in. "I've given you nearly 24 hours to get it fixed. And this time it better stay fixed!" She grabs it out of my hands and departs, slamming the door.

"Huh," says Pedro, laughing. "Guess she is in a hurry."

"Yeah," I say. "I guess she is. But she didn't give me a chance to say I didn't have to fix it. And she didn't ask me what the charges were either."

"Oh well," says Pedro. "No work, no pay."

I go back to work after that, but in about an hour I hear the door open and close, and Pedro hollers back at me, all excited like.

"Hey Herk," he shouts. "I mean MISTER Newton. Guess who?"

So I rise wearily and go out front to find the same old dame again. This time she's got a cop with her. He's carrying the radio and looking rather stunned.

"Hello," I manage weakly. "I see you're back."

The dame has been silent up to now, but with that she opens up.

"Arrest him, officer," she screeches. "That's the man, arrest him!"

"What's it all about, mister?" the cop asks, and before I can get a word in, the old blister starts up with her routine again. This goes on for about five minutes, and all the time the dame gets

more and more insistent and screechy.

Finally Pedro snatches the radio from the cop's arms, sets it down on the counter, and plugs it in. And just as she strikes an all-time high in indignant squeals, music pours from the speaker. The old girl breaks off yelling, stops waving her arms, and gradually her sour puss assumes a look of enraptured pleasure.

"Well," she gurgles. "It works." And I throw a look of gratitude at Pedro.

The cop senses the crisis is past, and starts sneaking for the door. The old crone stops him with a look that would melt solder.

"Where are you going?" she demands. "Come back here!"

"I... I figured everything was okay, so I'd get back to my beat. The radio plays, doesn't it?"

"Yes," the old girl bleats. "It plays here." The accent is on the "here," and the implication is that it doesn't play elsewhere. That's my cue to speak up.

"Look, lady," I say. "A radio is a radio. If it plays here it'll play there..."

"Never mind the Gertrude Stein," she says, impaling me with a look. "I know a radio is a radio. But it won't play at my house. Nothing but noise comes out."

The cop looks weary now. "What's the score here?" he asks. "Did you gyp the lady like she says?"

"No!" I say, getting mad now. "This woman brings in a four-year-old radio and gives me the devil because it's noisy. I try it out and it works fine. She picks it up and the next thing I know she's back here with you. The radio plays, so tell her to take it home and leave me alone!" With that I head for the back room and dive into a five-band job with a burned-up bandswitch.

I hear voices out front for a while. Finally the door opens and closes, and I heave a deep sigh of relief.

"MISTER Newton," Pedro says, coming back and leaning on the bench. "MISTER Newton, you've got to be pretty smart to be a radio man, don't you?"

"Yeah, Pedro," I say. "I guess you do."

"Kind of like being a detective, ain't it?" says Pedro, dreamily.

I don't get it, and say so.

"I mean you got to find a clue, and then you figure what's wrong by inductive reasoning," says Pedro. "And then you fix it."

"Yeah," I murmur, trying to shove a 3/8-inch shaft through a 5/16-inch hole. "Yeah, I guess so."

"Well I got a clue," says Pedro, starting out front. "And the Senora will be back again."

"Whattya mean?" I holler, pulling my head out of the chassis. "If that old bag comes back again, tell her I've left for Pomona!"

I finally get my bandswitch wired up, and start out with the truck to make my weekly pick-ups and deliveries.

When I get back Pedro greets me very formally.

"MISTER Newton," he says, smiling a knowing, superior smile. "The lady was back again, and this time she brought two cops. Her radio still doesn't

TUBES FOR AMATEURS TUBES FOR INDUSTRIALS TUBES FOR MANUFACTURERS

... NEVER BEFORE AT THESE LOW PRICES!
Receiving—Transmitting—Special Purpose—All standard brands
—NEW—in original factory cartons. Over 1,000,000 tubes in stock for IMMEDIATE SHIPMENT!

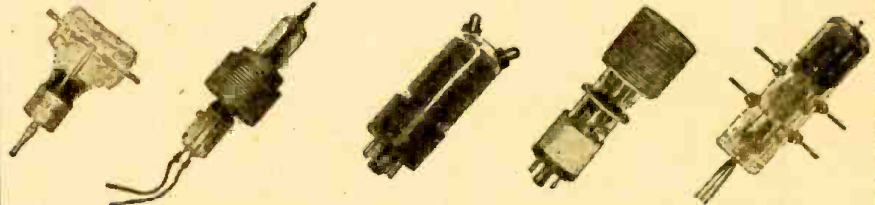

RECEIVING, TRANSMITTING AND SPECIAL PURPOSE TUBES

10 SPEC.30	345A5.95	8069.95	162516	1R499
10 Y49	3502.75	80785	162629	1T489
15 E95	350A5.75	8082.75	162929	1N599
30 SPEC.75	350B7.75	8091.50	16381.00	2C2149
45 SPEC.49	353A1.95	8104.50	164159	2C2239
1205.95	368AS7.50	8111.75	166579	2C2625
123A7.50	371B3.50	8122.95	205075	2C26A39
VT127A3.95	388A4.25	8135.50	205139	2C3435
204A25.50	434A3.95	8143.95	719319	2C4095
205B3.50	450TH12.75	8151.95	80013.90	2C441.50
21179	WL4685.50	8201.45	80052.95	3C2215.00
215A1.95	52729.50	829A1.75	80111.50	3C234.50
221A1.95	53020.00	833A29.50	80122.95	3B223.95
222A75.00	53110.00	83769	8012A2.95	3B2475
242C4.95	575A95	84169	8013A2.95	3C3065
249C1.95	6155.00	84369	80204.50	3C305.90
250TH14.00	WL632A5.00	85160.00	80252.50	2K2569
250TL8.00	703A5.95	CG66140.00	900149	2K269
256A12.00	707B12.50	86459	900239	23D41.75
266A10.00	713A1.25	86575	900339	28D78.00
274B1.00	714AY8.00	86675	900439	SD5354.95
285A1.95	720CY12.00	87669	900549	CW9379
286A1.45	721A3.25	88412.00	900639	C100E5.00
304TL1.25	724A3.95	953B39	1A5GT99	EF5050
304TH8.00	728A10.00	95439	1A7GT99	RK593.50
305A8.00	8001.95	95539	1B242.19	RK735.75
307A5.95	801A75	95649	1B2999	RW3039.95
316A85	8021.25	95739	1B3299	RK211.50
319CD1.95	8036.95	161685	1P2425	RK253.50
331A9.00	8053.50	161949	1S211.45	



KLYSTRON AND MAGNETRON TUBES
Raytheon—GE—Brand New—W.E., Etc.
2121A21362155
212221384126
212621394128
213221404129
21332151
417A6.95 723AB2.95 726A4.25 725A8.95
Complete Stock. Your Inquiries Invited.

\$10.95 Each

CATHODE RAY TUBES

ALL STANDARD BRANDS IN FACTORY CARTONS

9051.75	SAP11.75	7EP417.50
2AP11.75	3DP12.95	10DP434.50
3AP11.75	4AP103.50	12GP79.95
3BP11.75	7BP72.75	12JP455.00
3CP11.75	7DP412.95	15AP4109.50

Send for Our Complete Listing. Other Types in Stock.
Send for SPECIAL QUANTITY PRICES • Deduct 10% on orders over \$50.00 • Minimum order \$3.00 • Send 20% Deposit with order F.O.B. N. Y.

American Radio Supply Co.

120 Cedar Street New York 6, N. Y. Phone: BArcley 7-2685
WRITE — CABLE

work, and she said to tell you she was swearing out a warrant for your arrest."

"Oh no," I groan. "Why does everything have to happen to me?"

"She is charging you with 'fraudulently obtaining money under false pretenses,'" Pedro reads from a scrap of paper on which he has taken notes. "She claims you sold her a radio for twenty dollars, that said radio carried a guarantee, that she has returned it to you three separate times to have some adjustment made, that you have persistently and stubbornly refused to give her any satisfaction, and that you have, before witnesses, insulted her and practically thrown her out of your shop."

"Pedro," I say, giving him the old

eye. "Are you giving me the business?" "No, MISTER Newton. That's what she said. Can she do it?"

"Of course not," I groan. "But she can try, and that's almost as bad. An old bag like that can cause trouble."

"I stalled her off," Pedro goes on, smiling beatifically. "She won't do anything until tomorrow."

"How come?" "I told her if her radio didn't work right by tomorrow we'd give her a new one. That Stromberg-Carlson in the window." Pedro beams at me as if he's just done me a big favor.

"What?" I shout. "Were the cops here when you told her that?"

"Sure," says Pedro, calmly. "That's fine," I say, slapping my fore-

**EVERY SERVICEMAN
CAN afford
SUPERIOR
TEST EQUIPMENT**

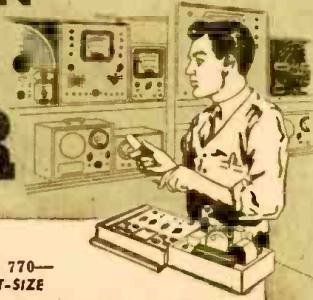

**THE NEW MODEL 770—
AN ACCURATE POCKET-SIZE
VOLT-OHM MILLIAMMETER**
(SENSITIVITY: 1000 OHMS PER VOLT)

Features:

- Compact—measures 3 1/4" x 5 7/8" x 2 1/4".
- Uses latest design 2% accurate 1 Mil. D'Arsonval type meter.
- Same zero adjustment holds for both resistance ranges. It is not necessary to readjust when switching from one resistance range to another. This is an important time-saving feature never before included in a V.O.M. in this price range.
- Housed in round-cornered, molded case.
- Beautiful black etched panel. Depressed letters filled with permanent white, insures long-life even with constant use.

Specifications: 6 A.C. VOLTAGE RANGES: 0-15/30/150/300/1500/3000 volts.
6 D.C. VOLTAGE RANGES: 0-7 1/2/15/75/150/750/1500 volts.
4 D.C. CURRENT RANGES: 0-11 1/2/15/150 Ma. 0-1 1/2 Amps.
2 RESISTANCE RANGES: 0-500 ohms. 0-1 Megohm.

The Model 770 comes complete with self-contained batteries, test leads and all operating instructions **\$13.90 NET**

We manufacture a complete line of radio test equipment. Write Dept. RC for FREE catalog today!

MFD. BY



SUPERIOR INSTRUMENT CO.

227 Fulton St., New York 7, N. Y.

at your regular jobber

head. "Witnesses yet!" I sink into a chair, and begin to twitch.

"How do you mean, witnesses?" asks Pedro.

"You know what that Stromberg-Carlson is worth?" I croak.

"Oh don't let that worry you, Herk . . . MISTER Newton," says Pedro. "She only gets that if her radio isn't fixed by tomorrow."

I just glare at him, speechless.

"The thing is," Pedro says, "we fix it before then."

"But there's nothing wrong with it!" I holler, finding my voice. "How can you fix something when there's nothing wrong with it?"

"She says it makes noises," Pedro goes on calmly. "And I got a clue."

"What kind of a clue?" I mumble.

"Well," he says, thoughtfully, "a radio that works here should work any place unless something is different. Right?"

"Yeah," I say, absently, wondering how many friends the old girl has, and how much business I'm able to lose. "Something different."

Pedro looks a little disappointed.

"Well," he says, "I know what's different there. She's got an outside aerial."

"That could be it!" I begin to see light. "Maybe it rubs against a rain pipe or something."

"Fire escape," says Pedro. "It rubs her fire escape."

"How do you know?"

"I sneaked over to her house and looked," says Pedro, a bit apprehensively. "While you were out. I wasn't gone but a minute. She lives in the next block."

"Even so," I say, "why should it start making a lot of noise all of a sudden?"

"She just started using it a couple of days ago," Pedro says. "Her nephew hooked it to the aerial for her. She told me about it this morning when you beat it back to the bench."

"Get her on the phone for me, Pedro," I say, taking off my coat and hanging it up.

He dials a number and hands me the phone. I recognize the voice at the other end when she answers it.

"Look, lady," I tell her, "if you'll take the aerial off your radio you won't get all that noise. Lady, believe me . . . The hell with your nephew, lady. Just take . . . Hello . . ." I hang up disgustedly. You can't talk to a dead wire.

I have a couple of calls next morning, and it's after ten o'clock when I get back to the shop. I enter apprehensively, making sure the Stromberg-Carlson is still in the window.

"Hi Herk," says Pedro, when I come in the door.

"What?" I say.

"I mean MISTER Newton," he says, smiling broadly.

"That's better," I say. "Heard from the old bag this morning?"

"Yup," says Pedro happily, producing a huge cake from beneath the counter. "She brought us this." There's a large wedge missing, and crumbs of



Better Products for the Radio Industry

**NEW G-C
STATIC CHASER
INJECTOR and POWDER**

Tire static powder kits—improve auto radio reception. Eliminates wheel static interference. New powder is blown into all the inner tubes—easy to use. For every car owner!
No. 5604—Injector for G-C Static Powder List \$1.50
No. 5605—G-C Static Powder Packet for 5 tires. List \$1.00
No. 5606—Kit—One Powder Packet and Injector List \$2.50



**NEW G-C
TUBE PULLER**

Makes it easy to remove or insert miniature tubes . . . simple to operate. Inserts or extracts tubes where fingers will not reach—into hard-to-reach places. Saves time and money. Ends tube breakage, prevents burnt fingers.
No. 5093—Miniature Puller. List \$ 1.65
No. 5093-D Display of 12. List \$19.80



**NEW G-C
MINIATURE
TUBE PIN
STRAIGHTENER**

Every Radio Man needs a tube pin straightener for the new miniature glass tubes. Each man should have 2 or 3—one to carry with him and several fastened to his bench.
No. 5191. List \$1.00



**NEW G-C FIELD
CHASS EZ**

Holds almost any radio chassis in position! Has special reversible hooks for flanged type chassis or, to tilt chassis back if necessary. Made with slide adjustment—takes only 5 seconds to install. No parts to lose—will never wear out. A real convenience for the radio serviceman!
No. 5207 Chass Ez. List \$3.65



G-C Products are available at leading distributors. Write for your copy of our new illustrated catalog.



Have you seen the new G-C "Speedex" Wire Strippers . . . write for illustrated literature.
RADIO DIVISION DEPT. D

GENERAL CEMENT Mfg. Co., Rockford, Ill., U. S. A.

Manufacturers of over 3,000 products • Sales offices in principal cities

icing about Pedro's mouth show its hiding place.

"Huh?" I say, staring blankly. "Who did?"

"The old blister," says Pedro, handing me a piece of cake. "She baked it for us because we fixed her radio last night."

"Huh?" I say. "We did?"

"Sure," says Pedro. "I told her we fixed it by remote control, and she's very happy." He shoves a slice of cake into his mouth all at once.

"Yeah," I stammer. "But . . . but . . . how . . . ?"

"Easy Herk," he says, through his cake. "Figured it out by inductant reasoning. I climbed her fire escape last night, cut out a hunk of aerial lead-in, and tied a piece of brown twine in its place." He licks his fingers. "She'll never know the difference, and now her radio works."

"Nice work, kid," I say, eyeing him reverently. "Good work, Pedro!"

"Senor Pedro," he says sternly. "With the accent on the 'Senor'."

"Okay, SENOR Pedro," I say, laughing. "You win, SENOR."

"Good cake, Herk," says SENOR Pedro. "Have some cake, Herk!"

REPAIR TIPS

(Continued from page 49)

When the set has distorted tone, set the voltmeter on a high range shunt meter between output tube grid and ground. If tone clears up, replace grid resistor. To check whether a tube or bias resistor is wrong, set meter on the 20-volt range and place across resistor. A normal reading for that tube usually means that both tube and bias are O.K. A full-scale reading (against the peg) means the resistor is bad. If plate voltage is O.K., a low bias reading means a bad tube (or shorted bypass or tone-control condenser).

When the radio distorts on locals and sounds O.K. on distant stations, place meter (250,000 ohms or more on 250-volt or higher range) between chassis and a.v.c. lead of r.f., antenna and i.f. coils. If tone clears up, there usually is an open series or a.v.c. load resistor. You can think of more tests of this nature. Remember, unless you are sure, to set meter range to correspond to B-plus voltage of radio.

I don't think 10% of the servicemen use an output meter. Try this to convince yourself that one is necessary. Align a radio by ear, then hook output meter and touch up the trimmers. You can still make the meter climb a little more, can't you? Another thing some servicemen don't use is a series condenser when aligning r.f. and antenna stages. Remember the test oscillator puts a load on the input tuned circuit and the alignment will be off. Use a small (250 µf) mica condenser with coil inputs. Hook the oscillator to a small loop and place it close to radio loop for sets with loops or hook the oscillator to something that isn't connected to the radio and the loop will pick signal up without being loaded.

HAMS... CHECK THESE ACTION-STARTER SERVICE MEN... VALUES



\$29.95

BARGAIN FM RECEIVER KIT

A complete receiver with its own wide range audio system and Alnico V PM speaker for complete static-free reception! Has 7 tubes plus Selenium rectifier. Operates as a tuner or self-contained FM radio . . . at the flip of a built-in switch. Operates on a regular 300 ohm FM antenna and twin lead-in. Comes in modern brown plastic cabinet. Complete with tubes. AD3-24457 \$29.95

SATISFACTION GUARANTEED OR YOUR MONEY BACK

3-TUBE, LOW COST PHONO AMPLIFIER

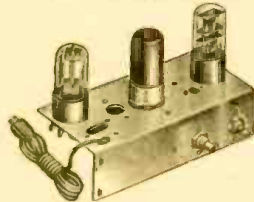

Now you can build you own hi-fidelity record player or record changer at a rock bottom minimum cost! Built-in continuously variable tone control for deep throated bass or clear toned treble output. Uses efficient 50L6, 12SQ7 audio amplifiers and 35Z5 rectifier. For 110 volt, AC-DC. Phono motor connects directly to amplifier. Complete with tubes but less output transformer. AD3-5B9584 — Less Tubes \$2.98 AD3-5B9583 — With Tubes \$4.95

PILOT LIGHT ASSEMBLY

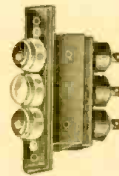

Three pilot lights, red, green, white, with frosted glass lenses and chrome plated rim, black finish. Sockets insulated and spring loaded. Size 3" long, 3/4" wide, 2 1/4" deep. Two mounting holes on 2 1/2" centers. AD3-5B6987 . . . 98c

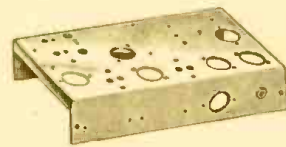

PUNCHED ALUMINUM CHASSIS — Punched and drilled for 5 or 6 tube permeability tuned receiver. Size 5"x10"x2". All corners smoothly machined. Precision punched for accurate placement. AD3-5B9579 29c

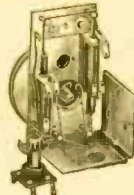

PERMEABILITY TUNER — To replace variable bank condenser in standard broadcast receivers. 4"x2 1/2"x2 1/2", dial drum is 2 1/2" in. With antenna coil, oscillator coil, oscillator padder coil and plans for 5 and 6 tube AC-DC superhet receiver. AD3-5B3574 \$1.29

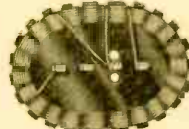

LOOP ANTENNA — For use with Permeability Tuner Cat No. AD3-5B3574. Matches input circuit. Compact, rugged. AD3-5B3575 19c

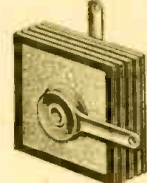

SELENIUM RECTIFIER — Costs less than tube and socket it eliminates. 1 1/2"x1 1/2"x1 1/8". 100 mil. cutting construction. Two rectifiers can be connected as a voltage doubler. AD3-10560 75c

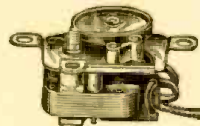

LIGHT DUTY RECORD CHANGER MOTOR — For most standard record changers and phono players. Speed 2500 r.p.m.; idler wheel 350 r.p.m. Size 4 1/2" long, 3 1/2" wide, 2 1/2" high. 22" insulated leads. AD3-5B7083 \$1.69

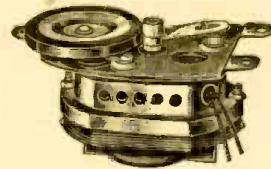

HEAVY DUTY RECORD CHANGER MOTOR — Replacement for Seeburg Model L changer. Speed 1700 r.p.m.; idler wheel 318 r.p.m. Flange holes for mounting. 12" insulated leads. Size 5 1/2" long, 3 1/2" wide, 3" high. AD3-5B7082 . . . \$2.25

TUBULAR ELECTROLYTIC CONDENSERS

Stock No.	Cap. Mfd.	Wkg. Volts	Size Ins.	EACH
AD3-3156	10	450	1 1/2"x2 1/2"	19c

AUTO GENERATOR CONDENSERS

AD3-5B3244	.5	19c
AD3-5B3245	1.0	29c

CONCORD RADIO CORPORATION

Dept. 523-J — 901 W. Jackson Blvd., Chicago 7, Ill.

ORDER NOW Just send name and address with Stock Number of item wanted. Your order will be given immediate attention.

FREE CATALOG

Absolutely no charge. 160 pages crammed with radio, TV and related electronic items. Get your FREE copy NOW.



A little carbon tet or cleaning agent used on the variable condenser at each end of shaft and on the shaft that turns pointer and gang condensers will clear up those tuning rasps and noises. Squirt a few drops in the volume control and clean contacts on wave band switch and phono-radio switch with a small brush. This takes out a whole lot of unwanted noise. Never use sandpaper on these contacts—it ruins them.

Here's a simple trick I've showed several servicemen. To find out where and what plates in the variable condensers are shorting, they used a magnifying glass and an ohmmeter and usually got nowhere. Unhook all wires from the stator plates and connect one stator to the B-plus in the radio. Turn shaft and

look for sparks and there is your short. Don't keep a short on B-plus too long. (Better put a resistor in series.—Ed.)

In one instance I had a small Westinghouse which had been to four radio shops and then sent to the distributor to cure a hum. All condensers were replaced and the hum was still bad. I placed a 'scope on the grids of the two push-pull 25L6's and a hum pattern was seen. The coupling condensers were unhooked and a pattern was still seen at the grids. Both 25L6's had cathode-to-heater short! These tubes had been checked many times. I checked them on a Precision, Sylvania, Supreme and a Superior and they didn't show the short. Use your 'SCOPE IF YOU OWN ONE. It's not good AS A DUST CATCHER.

TRANSFORMER CHECKER

Whether the experimenter winds his own transformers or uses commercial types, a shorted section or turn of the inductor can cause a lot of trouble. Using ordinary methods, such shorts are often very difficult to find. With the instrument diagrammed, even one short-

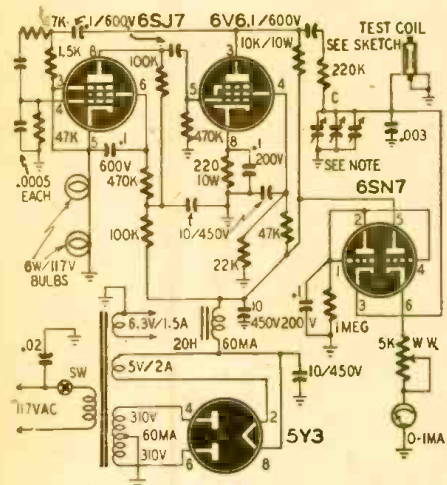

NOTE: C-3 GANG 410µmf, SLIGHTLY DETUNED FOR MAX. SENSITIVITY

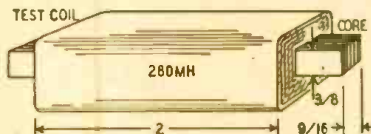

DIMENSIONS IN INCHES
1500T. N° 30ENAM. THIN LAYER WOUND ON PAPER INSULATION

ed turn of No. 33 wire is easily discovered.

The 6SJ7 and the 6V6, with their associated components, form an R-C audio oscillator. The test coil is connected to the oscillator and is tuned by condenser C to the oscillator frequency.

When an a.f. or power transformer or choke with a shorted turn or section is held close to the test coil, the vacuum-tube voltmeter, composed of the 6SN7 and the 0-1-ma instrument, deflects, showing that the oscillator frequency has been affected.

GUENTER BORCHERT,
Sao Paulo, Brazil

VOLTAGE REDUCTION

Output voltage from a power supply can be reduced without the use of bleeder or series resistors. Change the value

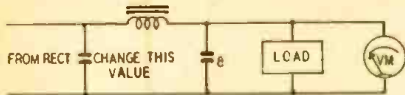

of the input filter condenser until the desired voltage appears across the load. This value usually is between 0.25 and 2 µf.

Any increased hum may in most cases be cancelled by increasing the size of the output filter condenser.

G. N. CARTER,
Nanaimo, B.C., Canada

(Where hum remains high, an additional resistor and condenser may be inserted to filter the supply to all stages before the output. Wattage of the resistor may be much lower than that of one used to filter the whole supply.—Editor)

JULY, 1948

Revolutionary Record Reproduction!

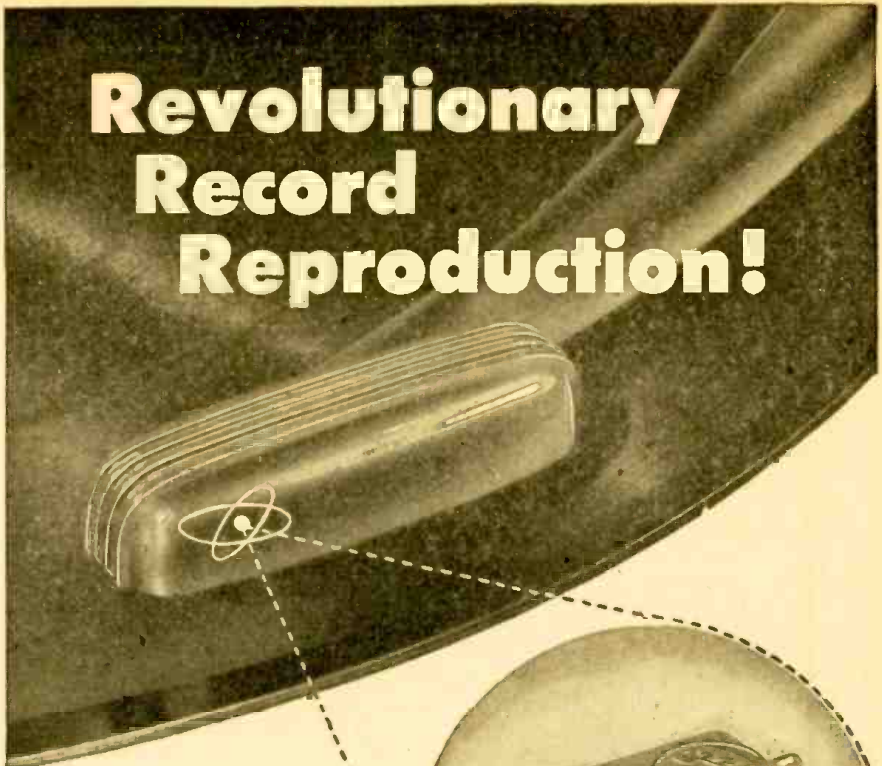

With This

LEAR

High Fidelity
Variable Reluctance

Magnetic Phono Pick-up

MP-103
LIST PRICE
\$12.00

"Knee-Action" Steps Over Surface Noise

PICK-UP PROFIT FOR SERVICEMEN . . . Daily service calls turn into profitable sales with this new LEAR magnetic phonograph pick-up. Profit for you and new improved revolutionary record reproduction for your customers. Its flawless performance has set a new standard for pick-up quality . . . actually transforms old style record reproduction into full rich mellow tones.

In this variable reluctance pick-up, LEAR engineering has developed the "knee action" permanent sapphire stylus which assures minimum surface noise and full tonal beauty of sound on all installations.

Turn this fast selling LEAR magnetic phonograph pick-up into profit for you. Don't wait! Write today for complete discount price list.

To Complete Your LEAR Sound Installation
LEAR PRE-AMPLIFIER, List Price — \$9.90

The new improved LEAR pre-amplifier provides additional amplification when used with MP-103 LEAR magnetic pick-up. Can be connected directly to old crystal cartridge input. Leads of convenient length are provided for connection into existing equipment. Two position switch permits high fidelity response to recordings.

FACTORY REPRESENTATIVES — DISTRIBUTORS: A few choice territories are still available for these and other fine LEAR electronic products. Write today giving full details.



110 Ionia Ave. N. W. Grand Rapids 2, Mich.

RADIOMEN'S HEADQUARTERS WORLD WIDE MAIL ORDER SERVICE!!!

DUE TO POPULAR DEMAND WE REPEAT THESE TERRIFIC BARGAINS

- Three assorted new MICROPHONES, including push-to-talk type\$1.49
- Ten assorted R. F. Chokes including high frequency types\$.35
- Five assorted AUDIO or FILTER CHOKES\$.99
- One Hundred assorted RESISTORS\$1.95
- Ten assorted JAN CABLE CONNECTORS, including SCR274,522 and BC375 types\$.99
- Six assorted OIL FILLED CAN TYPE CONDENSERS, all with mounting brackets\$1.49
- Ten assorted METAL & BAKELITE KNOBS—(no wooden knobs)\$.39
- Six assorted VARIABLE CONDENSERS, including butterfly types\$1.49
- Six assorted POWER and AUDIO TRANSFORMERS, all new\$1.98
- Six assorted isolantite and bakelite R. F. COILS, shielded and unshielded\$.99

The above ten assortments totaling over \$12.00 at the unbelievable bargain prices listed can be purchased together as one lot at a super-special total price of only \$10.00. All merchandise guaranteed to be as advertised.

BRAND NEW INVERTERS AND DYNAMOTORS

- PE 6A: A 24 to 32 V DC input, to 80 V AC regulated output converter\$12.95
- PE 19A: A 24 to 28 V DC input, to 80 V AC at 800 cps output\$9.95
- (We include a stepup transformer with each of the above so that 110 V AC is available from either.)
- 27 V DC input 285 V DC @ 75 MA output98c
- 27 V DC input. Output 300 V @ 150 MA, 150 V @ 15 MA and 12 V @ 5 Amp.\$5.95
- 12 V DC input. Output 300 V @ 150 MA, 150 V @ 15 MA and 12 V @ 5 Amp.\$12.00
- 13 or 26 V DC input. Output 800 V DC, 400 V DC @ 135 MA, and 9 V AC\$15.00
- (By running on 6 V AC, 60 cycle input, with a small amount of DC for field excitation, the above dynamotor will provide a good source of 12, 24, 400 or 800 V DC.)

UNIVERSAL MICROPHONE CO.'S latest model recorder platform with high quality recording amplifier complete with all necessary controls for volume, tone, playback, record, and public address applications. Unit features crystal playback and magnetic recorder head attached by special pantographic arrangement for making absolutely linear recordings. Complete with all tubes and matched speaker. Everything supplied but the cabinet for\$46.95

TUBES—All types in stock. 60% off on all tubes if ordered in lots of 10 or more.
TRANSFORMERS—All types in stock. **AUTO-TRANSFORMERS:** Steps up 110V, or steps down 220V to 110V—\$1.95.
FIL. TRANS.: 6.3v, 20 Amps—\$1.95; Universal Output Trans. 8 Watt—89c; 18 Watt—\$1.29; 30 Watt—\$1.69. **AUDIO TRANSFORMERS:** S. Plate to S. Grid. 3:1—79c; S. Plate to P.P. Grids—79c; Heavy Duty Class AB or B. P.P. inputs—\$1.49; Midget Output for AC-DC sets—69c; **MIKE TRANSFORMER** for T-17 Shure microphone, similar to UTC model type—\$2.00; Stancor SB or DB mike to line or xrid—\$1.95.

MIDGET 1 WATT RIG supplied complete with polystyrene coil forms for 3 ham bands. Size overall 3"x1"x2 1/2" high. Includes practically all necessary parts. Details on page 62 of January 1948 QST. Your cost\$1.50
 Battery pack for the 1 watt transmitter supplying 90 volts "B" and 1.5 volts "A"\$1.50
 110 V. AC power supply kit for the 1 watt transmitter ... \$3.50

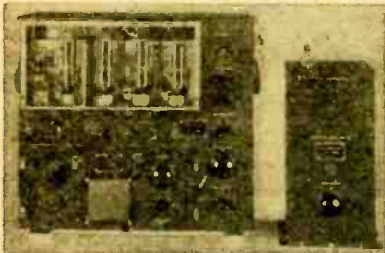

**GENERAL ELECTRIC
150 WATT
TRANSMITTER**
 Cost the Government \$1800.00
 Cost to you \$44.50!!!!

This is the famous transmitter used in U.S. Army bombers and ground stations, during the war. Its design and construction have been proved in service, under all kinds of conditions, all over the world. The entire frequency range is covered by means of plug-in tuning units which are included. Each tuning unit contains condensers, and antenna tuning circuits—all designed and hand calibrated. **POWER AMPLIFIER:** Neutralized class "C" stage, using 211 tube, and equipped with antenna coupling circuit which matches practically any length antenna. **MODULATOR:** Class "B" uses two 211 tubes. **POWER SUPPLY:** Supplied complete with either 12 or 24V dynamotor (SPECIFY), which furnishes 1000V at 350 MA. Complete conversion instructions for 10 and 20 Meter bands as well as 110V AC modifications are furnished. **SIZE:** 21 1/2"x23 3/4" inches. Total shipping weight 200 lbs., complete with all tubes, dynamotor power supply, five tuning units, antenna tuning unit and the essential plugs. These units have been removed from unused aircraft but are guaranteed to be in perfect condition.

has its own oscillator and power amplifier coils and to operate at top efficiency within its particular frequency range. Transmitter and accessories are finished in black crackle, and the milliammeter, voltmeter, and RF ammeter are mounted on the front panel. Here are the specifications: **FREQUENCY RANGE:** 200 to 500 KC and 1500 to 12,500 KC (will operate on 10 and 20 meter band with slight modification). **OSCILLATOR:** Self-excited, thermo compensated, and hand calibrated. **POWER AMPLIFIER:** Neutralized class "C" stage, using 211 tube, and equipped with antenna coupling circuit which matches practically any length antenna. **MODULATOR:** Class "B" uses two 211 tubes. **POWER SUPPLY:** Supplied complete with either 12 or 24V dynamotor (SPECIFY), which furnishes 1000V at 350 MA. Complete conversion instructions for 10 and 20 Meter bands as well as 110V AC modifications are furnished. **SIZE:** 21 1/2"x23 3/4" inches. Total shipping weight 200 lbs., complete with all tubes, dynamotor power supply, five tuning units, antenna tuning unit and the essential plugs. These units have been removed from unused aircraft but are guaranteed to be in perfect condition.

**TERRIFIC VALUE—
PORTABLE ELECTRIC DRILL**



Sold at less than established factory price so we cannot mention brand name)
 Only \$19.95 equipped with 1/4" Jacobs Geared Chuck and Key. Not an intermittent duty drill, but a full size rugged tool. Most convenient type switch, natural grip handle, and balance like a six shaper.
 Precision cut gears—turbine type cooling blower—extra long brushes. No stalling under heaviest pressure because of powerful 110 Volt AC-DC motor and multiple ball thrust bearing.
 Other bearings self-aligning lifetime-lubricating Chrysler Oilite type. Made for toughest year-in and year-out service in plant or on construction jobs.
 Amazing perpetual factory guarantee assures you of a lifetime of trouble-free use.
 25% deposit on C.O.D.'s. Full refund (you pay transportation) if not pleased with drill after trial.

PE-109 32-Volt DIRECT CURRENT POWER PLANT

This power plant consists of a gasoline engine that is direct coupled to a 2000 watt 32 volt DC generator. This unit is ideal for use in locations that are not serviced by commercial power or to run many of the surplus items that require 24-32V DC for operation. The price of this power plant is only \$58.95. We can also supply a converter that will supply 110V AC from the above unit or from any 16-32V DC source for \$12.95. Due to the fact that the PE-109 comes to us sealed in a heavy steel-strapped govt. case, it is impossible to inspect the individual units to determine if they are new or used, or what the condition is if used. Consequently we must sell them "as is." In general they represent a terrific bargain.

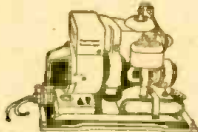

STEATITE VARIABLE CONDENSERS

Ideal for high-frequency applications in receivers and low power transmitter stages. All types have standard 1/4" dia. shafts.

10 mmf	\$.35—10	for \$2.90—100	for \$23.00
15 mmf	\$.35—10	for \$2.90—100	for \$23.00
25 mmf	\$.35—10	for \$2.90—100	for \$23.00
35 mmf	\$.40—10	for \$3.40—100	for \$28.00
50 mmf	\$.45—10	for \$3.70—100	for \$30.00
75 mmf	\$.50—10	for \$4.40—100	for \$38.00
100 mmf	\$.55—10	for \$4.50—100	for \$39.00
140 mmf	\$.80—10	for \$7.40—100	for \$64.00
160 mmf	\$1.00—10	for \$8.50—100	for \$70.00
140-140 mmf	\$1.60—10	for \$12.50—100	for \$100.00

Screw Driver Adjustment

\$.20—10	for \$1.80—100	for \$16.00
\$.20—10	for \$1.80—100	for \$16.00
\$.20—10	for \$1.80—100	for \$16.00
\$.25—10	for \$2.30—100	for \$20.00
\$.25—10	for \$2.30—100	for \$20.00
\$.30—10	for \$2.70—100	for \$25.00
\$.40—10	for \$3.60—100	for \$32.00

Butterfly condensers, rotor has two ball bearings and a 3/8" shaft.

15 mmf. per section	\$.50—10	for \$4.50—100	for \$40.00
30 mmf. per section	\$.60—10	for \$5.50—100	for \$50.00
50 mmf. per section	\$.70—10	for \$6.50—100	for \$60.00

Manufacturers and distributors write for prices on larger quantities.

WE HAVE OVER 250,000 VARIABLE CONDENSERS IN STOCK.

Minimum order \$3.00—All prices subject to change—25% deposit with C.O.D. orders

**GENERAL ELECTRIC RT-1248 15-TUBE
TRANSMITTER-RECEIVER**

TERRIFIC POWER—(20 watts) on any two instantly selected, easily pre-adjusted frequencies from 435 to 500 Mc. Transmitter uses 5 tubes including a Western Electric 316 A as final. Receiver uses 10 tubes including 955's, as first detector and oscillator, and 3-7HT's as IF's, with 4 slug-tuned 40 Mc. IF transformers, plus a 7117, 7E6's and 7F7's. In addition unit contains 8 relays designed to operate any sort of external equipment when actuated by a received signal from a similar set elsewhere. Originally designed for 12 volt operation, power supply is not included, as it is a clutch for any amateur to connect this unit for 110V AC, using any supply capable of 400V DC at 135 MA. The ideal unit for use in mobile or stationary service in the Citizen's Radio Telephone Band where no license is necessary. Instructions and diagrams supplied for running the RT-1248 transmitter on either code or voice in AM or FM transmission or reception, for use as a mobile public address system, as on 80 to 110 Mc. FM broadcast receiver, as a Facsimile transmitter or receiver, as an amateur television transmitter or receiver, for remote control relay hookups, for Geiger-Mueller counter applications. It sells for only \$29.95 or two for \$53.90. If desired for marine or mobile use, the dynamotor which will work on either 12 or 24V DC and supply all power for the set is only \$15.00 additional.

Cable Address: BUFRAD

BUFFALO RADIO SUPPLY, 219-221 Genesee St., Dept. 7 C. BUFFALO 3, N. Y.

RADIOMEN'S HEADQUARTERS - WORLD WIDE MAIL ORDER SERVICE!!!

BUFRAD CAR RADIO ANTENNAS

All of our car radio antennas are made of triple plated Admiralty Brass Tubing, complete with low loss shielded antenna leads and high quality fittings.
SIDE COWL—BR-1, 3 sections extend to 66". Your price—single units—\$1.50; in lots of 12—\$1.35 ea.
SKYSCRAPER—BR-2 has 4 heavy duty sections that extend to 98". Your price—single units—\$2.45; in lots of 12—\$2.25 ea.
TILT ANGLE—BR-3, may be adjusted to all body contours. 3 sections extend to 66". Single unit price—\$1.50; 12 lot price—\$1.25 ea.
VERSATILE—BR-4, single hole fender or top cowl mounting may be adjusted to conform with all body contours. 4 sections extend to 56". Single unit price—\$2.90; 12 lot price—\$2.75 ea.
THE MONARCH—BR-5, single hole top cowl mounting, 3 sections extend to 56". Single unit price—\$1.90; 12 lot price—\$1.75 ea.
AFTER SEEING OUR ANTENNAS AND COMPARING, YOU WILL NEVER BUY ANY OTHER MAKE!

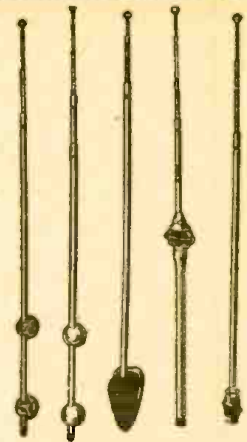

BR1 BR2 BR3 BR4 BR5

BENDIX SCR 522—Very high Frequency Voice Transmitter-Receiver—100 to 156 MC. This job was good enough for the Joint Command to make it standard equipment in everything that flew, even though each set cost the Gov't \$2500.00. Crystal Controlled and Amplitude Modulated—HIGH TRANSMITTER OUTPUT and 3 Microvolt Receiver Sensitivity gave good communication up to 180 miles at high altitudes. Receiver has ten tubes and transmitter has seven tubes, including two 832's. Furnished complete with 17 tubes, remote control unit, 4 crystals, and the special wide band VHF antenna that was designed for this set. These sets have been removed from unused aircraft and are guaranteed to be in perfect condition. We include free parts and diagrams for the conversion to "continuously variable frequency coverage" in the receiver.

The SCR 522 complete with 24 volt dynamotor sells for only \$37.95. The SCR 522 is also available with a brand new 12 volt dynamotor for only \$42.95.

FILTER CHOKES: 200, 300, 400, 500 ohm light duty—59c; 200 or 300 ohm heavy duty—99c; 250 ma 35 ohm, made for U.S. Navy, fully shielded—\$1.95; 75 ohm 125 ma—25c or 25 for \$4.25; "Melsaner type" tapped filter chokes—25c; 8 amp. iron core A filter—25c; Choke-condenser combination, ideal to replace any size speaker coil when installing PA speaker—79c.
130V. CIRCUIT BREAKERS of Magnetic type: Following Current Ratings in Stock: 1.25, 3, 4, 8 Amps. Please specify. \$1.95 each.
SEVEN ASSORTED I.F. TRANSFORMERS—\$1.98: Five Aerial, Oscillator Coils—69c.
MASTER RECTIFIER—Full wave, may be used for replacement, or in construction of all types of test equipment—\$1.25. Half Wave—90c.

FLUORESCENT LIGHT BALLASTS. Single 30 or 40 watt—\$1.68; Dual 40 watt High Power Factor—\$3.75.
HEADPHONES—Highest quality Signal Corps headset sets with 12' cord and plug \$1.25. 5' rubber covered patchcords with phone plug and socket—45c.
LINE FILTERS—110V—each unit contains two 2 mfd. oil filled condensers and a 15 amp. iron core choke. This filter has innumerable uses such as oil burner line filter, etc. A ten dollar value for 98c.
SELENIUM RECTIFIERS—Dry disc type 1 1/2, 1r, 1.2 Amp. maximum, suitable for converting DC relays to AC, for supplying filament source in portable radios, converting DC meters to AC applications, and also may be used in low current chargers—90c.

AUTO RADIO DEALERS! ATTENTION!

Nationally advertised brand of 1948 car radio which will fit practically any car and every pocketbook. Six tube superheterodyne with three gang condenser and 6 1/2" speaker. \$32.20 for sample, or Dealer price \$29.97 each, in lots of two or more.
 Here is an item that no serviceman who repairs auto radios should be without. Nationally advertised ATR battery eliminator that supplies perfectly filtered 6 VDC at 14 amps, from 110 AC\$36.00

AT LAST YOU CAN AFFORD A LABORATORY STANDARD MICRO VOLTER

The famous Measurements Corp. Model 78E, 5 Tube Laboratory Standard Signal Generator (that sold new, FOB Boonton, N. J., for \$310.00 net) is available in perfect condition for 25 to 60 cycle, 115 V AC operation. Until now this is the sort of tonight lab equipment that discriminating buyers have only rarely hoped would be released at a bargain price. Worth every cent the manufacturer asks, but available FOB Buffalo while our limited supply lasts for only \$59.95.
 Such companies as Admiral Corp. and John Meek, Inc., have ordered from us and repeated many times on these 78 generators for use in their labs and production line testings.



Model 78-E Standard Signal Generator.

MICROPHONES—All nationally known brands. Bullet crystal—\$5.45; Bullet Dynamic—\$7.45; Mike Jr.—60c; Handy Mike—90c; Lapel Mike—93c; SHURE T-17 MIKES, with push to talk switch—99c.
20 ASS'D COIL FORMS, including 11 ceramic, 3 polystyrene, and 6 fiber. All useful sizes—50c.
VARIABLE CONDENSERS: 350 MMFD, 5 gang—\$1.95; 4 gang \$1.49; 3 gang—83c; 7.5 to 20 MMFD, 1750p spacing, extra long shaft, Hammarlund—69c; miniature variables, 25 MMFD—39c; 50 MMFD—49c; 75 MMFD—59c; 100 MMFD—69c; 140 MMFD—79c.
INTERRUPTION FREQUENCY COILS for super-regenerative receivers or the tremendously popular FM adapters for standard broadcast sets. Iron core with a resonant frequency of 50 KC—39c; Air Core, 100 KC—29c.
30 MC IF TRANSFORMERS, double slug tuned—25c.
30 MC VIDEO AMPLIFIER PLATE COILS—Slug tuned—25c.
REMOTE CONTROL UNIT: Aluminum case 4x3x2" containing 2 potentiometers, triple pole switch, 4 knobs, gear mechanism, counter and phone jacks—59c.

1948 MODEL MUTUAL CONDUCTANCE TUBE TESTER. \$49.95

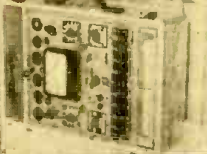

No possibility of good tubes reading "Bad" or bad tubes reading "Good" as on dynamic conductance testers or other ordinary emission testers. Attractive panel and case equal to any on the market in appearance. . . . Large 4 1/2" meter. . . . Calibrated micromho scale as well as a Bad-Good scale. . . . Front panel fuse. . . . Individual sockets for all tube base types—volts from .75 volts to 117 volts and complete switching flexibility allow all present and future tubes to be tested regardless of location of elements on tube base. . . . Indicates gas content and detects shorts or opens on each individual section of all local, octal and miniature tubes including cold cathode, magic eye and voltage regulator tubes as well as all ballast resistors. Name of the nationally known manufacturer withheld because of special price offer.
 Model "C"—Sloping front counter case\$49.95
 Model "P"—Handsome hand-rubbed portable case\$49.95
 Built-in-roll chart with either of above \$5.00 extra.

1948 MODEL OUTBOARD MOTOR AT DEALER WHOLESALE PRICE!!

Powerful deluxe twin cylinder outboard motor with automatic starter (no fumbling for a rope), a positive cooling unbreakable water pump, and an improved magneto for sensationally quick starts as well as smooth, efficient operation at slowest trolling speed or with the throttle wide open. Dozens of additional outstanding features are provided, such as corrosion resistant aluminum alloy castings, to protect the engine and give the unit a sleek, streamlined appearance; hardened alloy steel connecting rods with roller bearings, and a fused perfectly balanced crankshaft. Delivers a full 7.5 H.P. as rated by the Outboard Boating Club of America. Net weight—52 lb. Gross shipping weight including free steel storage stand—100 lb. For a limited time we are selling this motor, which is produced by the world's second largest maker of outboards to sell for more than \$30.00 above our price—for only \$139.00, brand new, FOB Buffalo.

SELENIUM RECTIFIERS. All types are rated at 130 V.A.C. Do not assort to make quantity.

25 MA \$45	10 for \$4.00	
75 MA70	10 for 6.50	50 for \$31.00
100 MA75	10 for 7.00	50 for 32.50
150 MA80	10 for 7.50	50 for 35.00
200 MA 1.05	10 for 10.00	50 for 47.50
250 MA 1.25	10 for 12.00	50 for 57.50

Cable Address: BUFRAD

CLOSING OUT

AIRPLANE INTERCOM AMPLIFIER—Complete with 4 tubes in aluminum case.....\$4.95
5" "SO" RADAR P.P.I. SCOPE, complete with 9 tubes, Selsyn motor and self-contained 110 V power supply designed to run on the AC supply on LST and PT boats. Various ranges from 2 to 80 miles. The most satisfactory scope available for navigational radar or panoramic television applications. Nationally advertised as surplus at \$100.00 by others. Our price only \$39.95
AIRCRAFT MARKER BEACON RECEIVER—Complete with dual purpose tubes and sensitive relay to control external circuits from received signals. Just the receiver you have been waiting for to control models, open doors from a distance, etc. PRICED AT only \$6.95

THE FOLLOWING DESIRABLE ITEMS AT SACRIFICE PRICES TO MAKE ROOM IN OUR WAREHOUSE FOR INCOMING STOCK

\$9.95 TAKES ALL THREE BIG BARGAINS

- AUDIO AMPLIFIER**—Undreamed of sound. Has 4 microphone inputs brought to jacks at rear panel. Various output impedances available at rear panel connections. Steel case with chrome handles, 9" long x 9" high x 6" deep. Tubes included. New in original carton. Shipping weight 15 lb. SUPER SPECIAL—\$4.95 while supply lasts. Satisfaction guaranteed or money refunded if returned prepaid within five days.
- RADIO HEADSETS**—Latest supersensitive type with rubber earpieces. Every pair guaranteed perfect. \$5.99 per pair OR 3 PAIRS FOR \$10.00.
- HOME WORKSHOP AT BARGAIN PRICE.** Accurate and precise 2 speed essential machine for the home workshop. Sturdy enough for light production work or factory standby service. Supplied with 56" of belt for connecting to any available electric motor or power take-off, such as on a jeep or tractor. Also included in this unbelievable offer are such accessories as a 1/2" drill chuck with specially hardened tool steel jaws, a 4" electric furnace high speed grinding wheel, a cotton buffing wheel with a large supply of buffing compound and a 4" steel wire scratch brush. Your cost \$6.00. Sole export agent.

BUFFALO RADIO SUPPLY, 219-221 Genesee St., Dept. 7 C. BUFFALO 3, N. Y.

SIGNAL TRACER

McMurdo Silver Co., Inc.
Hartford, Conn.

The Model 905A Spark is a sensitive aural dynamic signal tracer incorporating an 18-watt universal output transformer and test speaker which may be used separately. A new vacuum-tube hand-size probe is provided with switchable tip to permit either r.f./i.f. or a.f. signal tracing without the usual single-probe distortion. Frequency range of probe and amplifier is 20 cycles through 200 megacycles for AM, FM, and TV signal tracing. Ampli-

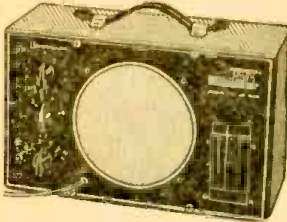

fication is so great that loud signals are had from a built-in 6-inch PM speaker on local stations when the probe is connected to small loop antennas. Undistorted power output is 3.4 watts. Two panel switches and a chart provide any of 30 transformer primary impedances from 325 through 70,000 ohms, single tube and push-pull. Model 910 is identical to Model 905A except that it does not include signal-tracing functions.—RADIO-CRAFT

FM POLICE RECEIVER

Radio Apparatus Co.
Indianapolis, Ind.

The R.A.C. Policalarm receiver allows police-call fans to listen to police dispatchers sending orders to squad cars in localities where equipment has been changed to the new FM police band.

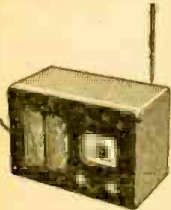

The receiver tunes from 152 to 162 mc, which also includes frequencies used by taxis and others mobile services. A superheterodyne circuit is used, with five miniature tubes and 10.7-mc i.f. A 5-inch speaker is included in the walnut cabinet, and a built-in antenna is furnished.—RADIO-CRAFT

D.C. CONVERTER

Electronic Laboratories, Inc.,
Indianapolis, Ind.

Many would-be television viewers live in areas where only d.c. power is available. The Model 110R15 converter is designed to furnish 15 to 150 watts of a.c. from a 110-volt d.c. line to operate table-model television receivers; the Model 110R30 furnishes 30 to 300 watts for console models.

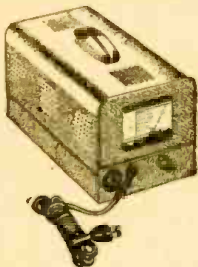

The converters use vibrators. Output is filtered completely for broadcast, television, short-wave, and FM bands. Regulation is sufficient to obviate the necessity for any external control of voltage.

The autostart feature allows the converters to be placed in whatever location is convenient; operating the power switch of the receiver automatically turns on the converter, allowing the receiver to be used just as it would be if connected to an a.c. line.—RADIO-CRAFT

FREQUENCY STANDARD

American Time Products, Inc.
New York, N. Y.

Type Z121A uses a hermetically sealed tuning fork as frequency con-



trol. It provides an accuracy of one part in 100,000, with a temperature coefficient of less than one part per million per degree Centigrade. Outputs are: 60 cycles, 0-110 volts at 0 to 10 watts (variable); 120-cycle pulses, 30 volts negative; 240-cycle pulses, 30 watts positive and negative. A clock is provided for comparing with time signals. Power input is 117 volts, 50 to 400 cycles at 45 watts.—RADIO-CRAFT

WIRE RECORDER

Webster-Chicago Corporation,
Chicago, Ill.

The Model 78 wire recorder makes use of the familiar Webster chassis containing the wire driving mechanism and the record, erase, and playback

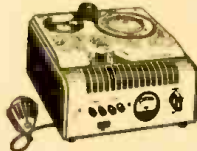

heads. The new unit provides a case for the chassis, together with the control switches and a properly calibrated volume indicator. Connections are provided to couple the recorder to the external amplifier or radio receiver necessary for recording and playback. Cords, plugs, and a microphone are furnished as well as a supply of wire.—RADIO-CRAFT

TUBELESS INTERCOM

Pa-Kette Electric Co.
Kearney, Nebr.

Intertalkie is a two-station intercom using no tubes. Power is supplied by three flashlight batteries. Loudspeaker

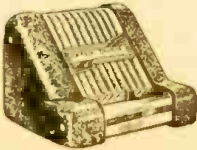

volume is obtained, eliminating necessity for earphones. The unit is enclosed in a plastic case which can be placed on a desk or hung on the wall.

Multitalkie system uses up to seven of the tubeless stations. Each station connected to the system may call any of the others affording maximum flexibility in communication.—RADIO-CRAFT

LINE ADJUSTER

Standard Electrical Products Co.,
Dayton, Ohio

Adjust-A-Volt transformers are variable to give an output of 0-140 volts from a 117-volt a.c. line for test or special purposes or to provide manual regulation in areas where line voltage is unsteady.

The transformers are available with primary and secondary windings for isolation of equipment from mains, and as autotransformers where isolation is not necessary. Both types are available with built-in meters to indicate the output voltage.—RADIO-CRAFT

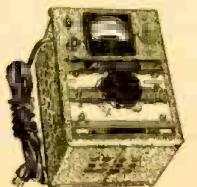
**TV VIEWING LENS**

Liquid Lens Corp.
Flushing, N. Y.

The All-Vue lens is made of specially prepared Dupont lucite, liquid-filled and permanently sealed. It is spherically designed to produce a perfect optical vision, and prefocused to eliminate adjustment. The lens enlarges the picture to 2 1/2 times its original size.

Perception of a magnified television picture direct from the coating of the tube rather than from the reflecting and diffusing area between the coating

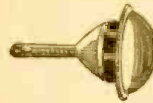

and the front surface of the tube is the new patent principle. Sharper images, better contrasts of blacks and whites, a clearer picture, and increased depth, with reduced glare and eye strain, are obtained. The picture is visible over an angle of 180 degrees.—RADIO-CRAFT

NOISE SUPPRESSORS

Minnesota Electronics Corp.,
Saint Paul, Minn.

Three new Goodell dynamic noise suppressor amplifiers are announced. Each contains the H. H. Scott suppressor circuit.

Model NSA-2 is a 6-tube unit with response to 12,000 cycles and effective noise reduction of over 25 db. Separate phono and microphone inputs are selected by a panel switch. Power output is 10 watts.



Model NSA-1 includes a preamplifier with built-in equalizer for popular magnetic pickups and an electron-ray tube for observation of suppressor gating. Two-chassis construction is used. Push-pull 807's give .18-watt power output.

Model NSAT-1 is similar to the NSA-1, but has four 6B4 push-pull parallel output triodes.—RADIO-CRAFT

SIX-INCH METERS

Marion Electrical Instrument Co.,
Manchester, New Hampshire

The Model 56 meter, measuring 6 1/2 x 5 1/4 inches, fills the gap between 4 1/2 and 8-inch meters. It has a 100-degree arc, 5/2-inch scale length, and large open face, making it easily adaptable to multiarc dials. It is supplied in a number of current ranges.



The bakelite case is designed with extra heavy cross sections that stand up under the most rugged use. Versatility is augmented through the use of Alnico II magnets in all normal ranges and Alnico V's in the more sensitive microammeter ranges.—RADIO-CRAFT

MINIATURE RELAY

Advance Electric & Relay Co.
Los Angeles, Calif.

The Tiny Mite relay (type 000) is thought to be the world's smallest relay. Only 0.35 cubic inch in volume, this relay has s.p.d.t. contacts rated at 0.35 amp at 60 volts d.c. or 115 volts a.c. (resistive load). Its average power requirement is from 0.35 to 0.50 watt, but can be made less by careful adjustment. Laminated phenolic keeps contacts above ground. Tiny Mite can be supplied for any coil voltage from 1 to 50 volts d.c.—RADIO-CRAFT

BOOSTER AMPLIFIER

Setchell Carlson, Inc.
Saint Paul, Minn.

Several 25-watt output channels are made available by the PA722 master and the 8422 booster amplifiers. The boosters fasten to the master with concealed tie bolts and connect with a simple plug-in.

The master amplifier has one phono and four microphone inputs, each with separate tone control, and 25-watt output with response flat to 8,000 cycles. Each 25-watt booster is flat to 10,000 cycles.—RADIO-CRAFT

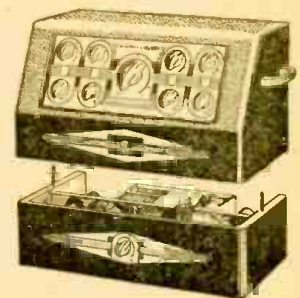
**MICROAMMETER**

Radio Corp. of America
Camden, N. J.

This ultrasensitive electronic microammeter is capable of measuring currents as low as one-billionth of an ampere. A portable, battery-operated instrument, it can withstand overloads of 10,000% without damage to the meter movement.

Use of external multiplier resistors allows the microammeter to be used as a voltmeter with resistance as high as 1 megohm per volt (with the addition of a 45-volt battery) as an ohmmeter to measure resistances up to 4,500 megohms.—RADIO-CRAFT

**PHONO AMPLIFIER**

Herman Hosmer Scott
Cambridge, Mass.

The type 210-A laboratory amplifier incorporating a new dynamic band-pass noise suppressor provides a complete phonograph system except for the turntable and loudspeaker. It is supplied with a matched variable-reluctance pickup cartridge.

The amplifier provides 20 watts output with less than 2% distortion. Below 8 watts, the distortion is under 1/2%. The output transformer is arranged to match speaker impedances between 2 and 500 ohms.

The frequency response of the amplifier exceeds 20,000 cycles—with the dynamic noise suppressor the response is flat to 10,000 cycles and extends to 16,000 cycles. Independent tone controls allow boost or attenuation at either end of the frequency range. A whistle filter is provided for AM reception.—RADIO-CRAFT

TEST LEADS

Koiled Kords, Inc.,
New Haven, Conn.

These test leads are somewhat similar in function to the spring-coiled telephone wires available from the telephone company. The 48-inch lengths in which they are sold can be cut to any size required by the user. In use, the leads, which are colored standard red and black, are pulled out to a convenient length. One foot of coiled lead will extend to 5 feet for use, and, when released, will spring back out of the way. Any type of pin plugs, prods or alligator clips may be attached.—RADIO-CRAFT

RADIO-CRAFT for

MONEY BACK GUARANTEE — We believe units offered for sale by mail order should be sold only on a "Money-Back-If-Not-Satisfied" basis. We carefully check the design, calibration and value of all items advertised by us and unhesitatingly offer all merchandise subject to a return for credit or refund. You, the customer, are the sole judge as to value of the item or items you have purchased.

The Model 88-A COMBINATION SIGNAL GENERATOR AND SIGNAL TRACER

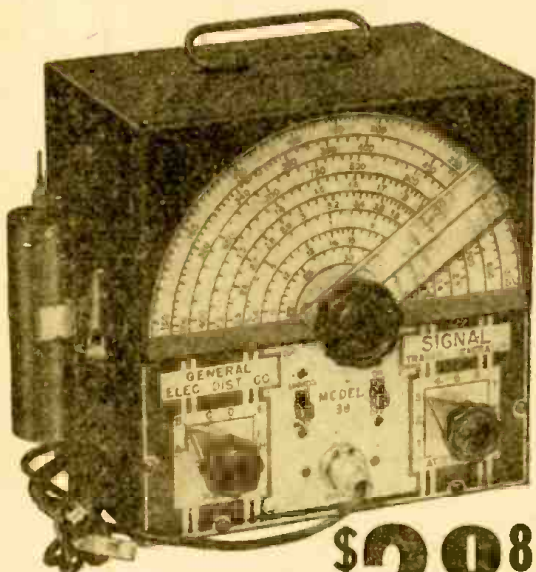

The Model 88 comes complete with all test leads and operating instructions.

ONLY **\$28⁸⁵** NET

The ultimate in signal tracing procedure is achieved by the Model 88, for the use of this model, enables you to use either the broadcast signal itself or the signal injected by the Signal Generator. This is especially useful of course when servicing "dead" or "intermittent" receivers. The Model 88 you will find is the greatest time-saver ever provided for by combining a full range Signal Generator and Signal Tracer into one unit the set up time for interconnecting, etc., is entirely eliminated.

Signal Generator Specifications:

- ★ Frequency Range: 150 Kilocycles to 50 Megacycles.
- ★ The R.F. Signal Frequency is kept completely constant at all output levels. This is accomplished by use of a special grid loaded circuit which provides a constant load on the oscillatory circuit. A grounded plate oscillator is used for additional frequency stability.
- ★ Modulation is accomplished by Grid-blocking action which has proven to be equally effective for alignment of amplitude and frequency modulation as well as for television receivers.
- ★ Positive action attenuator provides effective output control at all times.
- ★ R.F. is obtainable separately or modulated by the Audio Frequency.

Signal Tracer Specifications:

- ★ Uses the new Sylvania 1N34 Germanium crystal Diode which combined with a resistance-capacity network provides a frequency range of 300 cycles to 50 Megacycles.
- ★ Simple to Operate—Clips directly on to receiver chassis, no tuning controls.
- ★ Provision is made for insertion of phones of any impedance, a standard Volt-Ohm Milliammeter or Oscilloscope.

The New Model 606 TUBE & SET TESTER

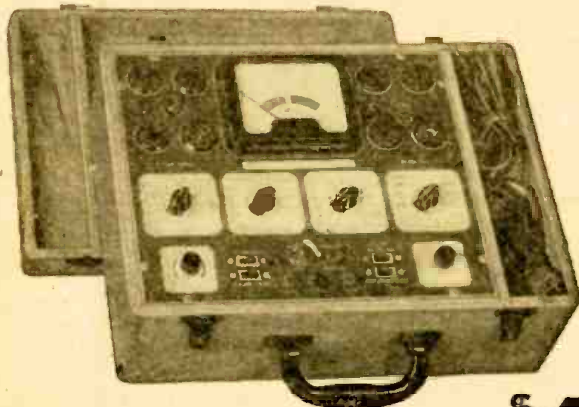

Model 606 comes housed in a beautiful hand rubbed oak cabinet complete with portable cover, test leads, tube charts, and detailed operating instructions—

ONLY **\$47.85** NET

A COMPLETE TUBE TESTER

- Tests all tubes including the new post-war miniature loctals such as the 12AT6, 12AU6, 35W4, 50B5, 117Z3, etc.
- Tests by the well-established emission method for tube quality, directly read on the scale of the meter.
- Tests shorts and leakages up to 3 Megohms in all tubes.
- Tests leakages and shorts of any one element against all elements in all tubes.
- Tests both plates in rectifiers.
- Tests individual sections such as diodes, triodes, pentodes, etc., in multi-purpose tubes.

A COMPLETE MULTI-METER

- 6 D.C. VOLTAGE RANGES:
0 to 7.5/15/75/150/750/1,500 Volts
- 6 A.C. VOLTAGE RANGES:
0 to 15/30/150/300/1,500 3,000 Volts
- 4 D.C. CURRENT RANGES:
0 to 1.5/15/150 Ma. 0 to 1.5 Amps.
- LOW RESISTANCE RANGE:
0 to 2,000 Ohms (1st division is 1/10th of an ohm.)
- 2 MEDIUM RESISTANCE RANGES:
0 to 20,000/200,000 Ohms
- HIGH RESISTANCE RANGE:
0 to 20 Megohms
- 3 DECIBEL RANGES:
-10 to +38 +10 to +38 +30 to +58 D.B.

20% DEPOSIT REQUIRED ON ALL C.O.D. ORDERS

GENERAL ELECTRONIC DISTRIBUTING CO. DEPT. RC-7 98 PARK PLACE,
NEW YORK 7, N. Y.

RECORDING AMPLIFIER

I have built an amplifier from the diagram on page 226 of the RCA Receiving Tube Manual (RC 15). How can I modify the amplifier to use it for recording?—A.V.F., Ottawa, Canada

A. The complete amplifier may be modified as shown. A crystal cutter may be used, as in the diagram, or a 4- to 8-ohm magnetic cutter may be connected in place of the output transformer dummy load resistance R.

A 5-pole, 4-position rotary switch (S1, S2, S3, S4, S5) selects one of the following functions:

Position 1—record from microphone only,

Position 2—record from microphone, and phono,

Position 3—record from phono or tuner,

Position 4—record playback or P.A. amplification.

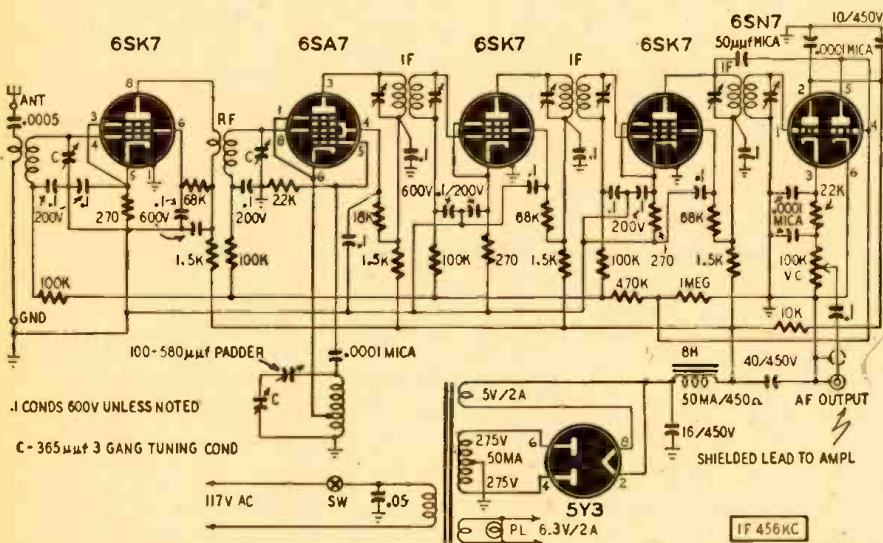

The output of this tuner may be connected to the phonograph input of any audio amplifier.

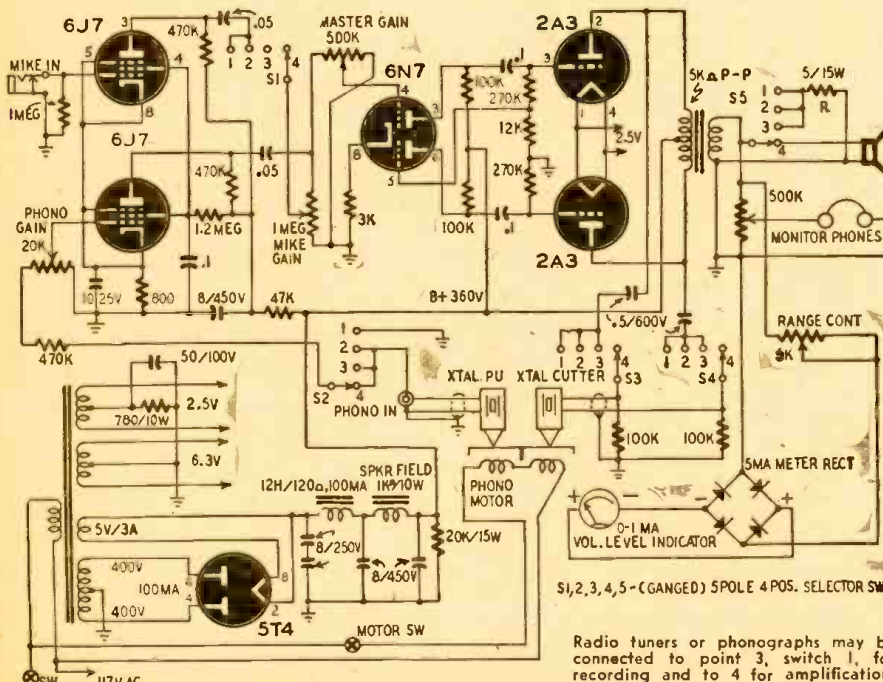

Recordings may be made with either a crystal or magnetic cutter driven by this amplifier.

SUPERHET AM TUNER

I would like a diagram of a superheterodyne AM tuner for use with my PA amplifier.—J.A.R., Lawrenceville, Pa.

A. Here is a tuner, the output of which can be connected to the phonograph input of a PA amplifier. Although the diagram is complete with power supply, the tuner may take power from the amplifier, provided the amplifier supply has reserve capacity.

Use a shielded lead between tuner and amplifier input. This tuner is designed to use standard broadcast coils. Its range may be extended as desired by using commercially available multi-band coils.

The oscillator padder is standard for the broadcast band. If short-wave bands are included, use oscillator padders as recommended by the coil manufacturer for each band.

FREQUENCY CHANGER

Please design a frequency changer with a 117-volt, 60-cycle input and a 117-volt, 400-cycle output, capable of supplying 150 watts.—T.J.K., Gary, Indiana.

A. The unit shown uses Continental tubes or equivalents. Both plates of each CE-210A should be paralleled.

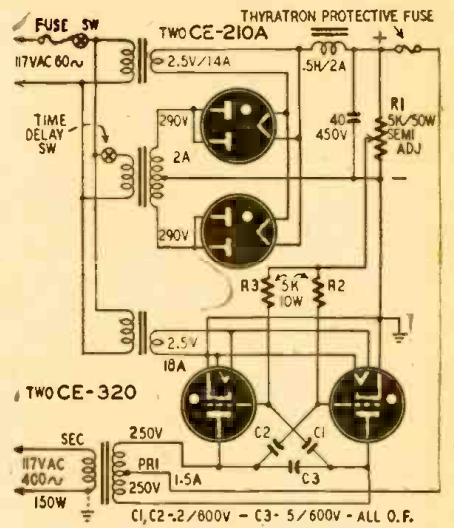

The output frequency depends on the values of R2, R3, C1, C2, and the setting of R1. The value of C3 may have to be changed from that shown.

It may be necessary to add or subtract turns from the output transformer.

BUTTERFLY TUNER

Please give me a diagram of a v.h.f. signal generator using surplus butterfly tuners and acorn tubes.—J.P.Z., Chicago, Ill.

A. In the diagram, a 955 is used as an oscillator and a 956 as a buffer amplifier to isolate the output from the oscillator. Although a second butterfly tuner is shown in the plate circuit of the 956, this could be replaced by an r.f. choke, which would give somewhat less output.

RFC-1, -2, and -5 are 40 turns of No. 24 d.s.c. wire 1/4 inch in diameter, close wound; and RFC-3, -4, -6, and -7 are 44 turns of No. 28 d.s.c. 1/2 inch in diameter, spaced to 1 inch in length.

This setup might be used to drive a 144- or 235-mc amateur transmitter, but great care would have to be exercised to make sure of in-band operation.

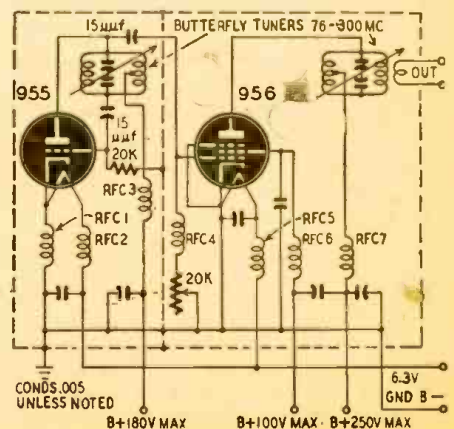

RADIO-CRAFT for

QUESTION TONE EQUALIZER

I have an audio amplifier using a pair of push-pull 6K7's resistance-coupled to a 6SC7. Please show how bass and treble tone controls can be used between these stages. I would like to use R-C circuits if possible.—V.C.C., Cordoba, Argentina.

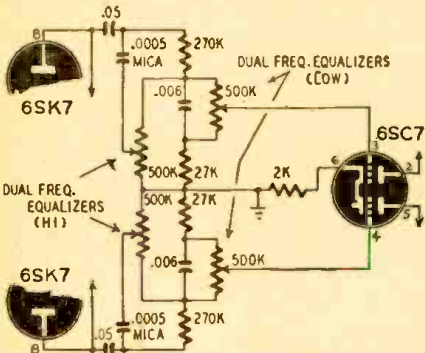

A. This circuit provides high- and low-frequency equalization. The control networks are in the grid circuits of the 6SK7. They are controlled with dual potentiometers.

QUESTION HIGH-RANGE OHMMETER

I would like to build an ohmmeter which would read up to about 1,000 megohms, using 1,500 to 2,000 volts on the test leads and a 0-1-ma meter. The unit should operate from 117-volt a.c.—D.M., Stockton, Calif.

A. A 0-1 milliammeter would require too high a voltage to give satisfactory results, measuring such high resistances. The circuit shown uses a 50- μ a meter.

To make the 660,000-ohm resistor, connect three 1-watt units of 220,000 ohms each in series. To make the 30-megohm resistor, use ten 3-megohm, 1-

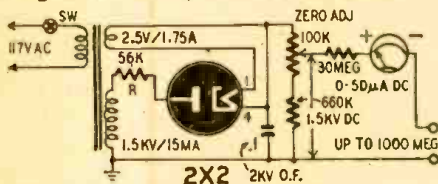

1000 MEG READING AT 1.5 μ A, 30 MEG AT CENTER SCALE

watt units. The accuracy of the ohmmeter will depend on the accuracy of the 30-megohm resistor, so each of the 10 units used in making it should be of 1% accuracy. The value of R may be changed, if desired, to give the zero set potentiometer suitable operating range.

QUESTION TELEPHONE FROM SURPLUS

I have two TS-13 surplus handsets. Please show how I can connect them as a shop-to-house telephone.—R.H.D., Oreland, Pa.

A. The telephone system shown requires three lines and a common grounded return. Two lines are for signal circuits and the other for ringing. The mike transformers T1 are designed to match a 70- or 75-ohm, single-button carbon mike to a 500-ohm line. The output transformers T2 are designed to match a 500-ohm line to a 3,500-ohm load, but you may use an output trans-

NEW, GUARANTEED SURPLUS!

MICROWAVE ANTENNA—

AS-217A/APG 15B. 12 Cm dipole and 13 inch parabola housed in weatherproof Radome 16" diam. 24V DC spinner motor for conic scan. Stock #SE-95. Shipping wt. 70 lbs. Price \$9.50 ea.



Remote Position Indicating System



6-12V 60 cycles. 5 inch indicator with 0 to 360° dial. Heavy duty transmitter. Stock #SE-115. Price \$9.95 per system.

DC MOTORS

John Oster. Series wound. 27V 7000 rpm. 1/100 H.P. Stock #SE-30. Price \$2.75 ea. Westinghouse—1171391. 27V 6.5 amps. series. Fan cooled. 8" diam. 4 1/2" lg. 1/2 H.P. Cont. duty. Stock #SE-156. Price \$6.75 ea. Delco 5069370. 27.5V Alnico field. 10,000 rpm. Straight shaft extension 0.125" diameter by 1/2" long. Stock #SE-16. Price \$4.75 ea. net. DC Timing Motor—Haydon 1/2 rpm. 29 volts. 100 mils. Stock #SE-157. Price \$3.75 ea. Constant Speed DC Motor—G.E. 5BA25MJ24. 24V DC 7100 rpm. RC noise filter. Stock #SE-100. Price \$8.50 ea. G.E. Reversible—5BC26AC134. 1/20 H.P. 24V @ 3.4 Amps. Shunt wound. Cont. duty. 4 1/2" diam. x 6 1/2" lg. 1 1/4" shaft extension. 3/8" diam. 2 1/4" sq. 1" conduit box mounted on motor. Explosion proof. Stock #SE-143. Price \$12.50 ea. Linear Actuator—Foote Bros. 10801. 1/6th H.P. reversible DC motor. 24V at 11.5 amps. Linear travel 5 inches. Limit switches for end of travel. Stock #SE-161. Price \$12.50 ea.

110 RPM. G.E. Aircraft Motor. 5BA10AJ18D. 27V @ 0.7 amps. 1 oz./ft. 1 1/2" diam. x 3 1/2" lg. 1/4" shaft extension 0.250 diam. with removable coupling. Stock #SE-98. Price \$2.95 ea. 250 RPM. Delco 5067127. 27V P.M. field. 1 1/4" diam. x 3 1/4" lg. 42 tooth 3/8" pitch diam. pinion on 0.250 shaft. Stock #SE-108. Price \$2.95 ea.

Null Type Synchro Indicator



Precision position indicator. Uses Bendix size 5 Selayn, rectifier tube, transformer, magic eye tube and illuminated 360° dial. Ideal for Hams, labs and experimenters. May be used with SE-43 Synchro transmitter.

Stock #SE-119. Price \$6.95 each.



Size 5 Synchro Generator

Similar to Navy Ordnance type 5G with shaft detail per Army Ordnance Dwg. C-78414. 115V 60 cy. Stock #SE-43. Price \$9.50 ea.

Tachometer Generator



Elinco PM-2
2.0 V. D.C. per 100 rpm. Use to 2000 rpm. Stock #SE-53. Price \$7.50 ea.

Elinco FB-55. 4.7 V. per 100 rpm. Use to 10,000 rpm. Stock #SE-3. Price \$12.50 ea.

Radio Compass Loop LP-21-LM. Stock #SE-99. Price \$9.50 ea. net. Phase Shift Capacitor—4 stator single rotor. 0-360° phase shift. Stock #SE-114. Price \$4.75 ea. Magnesium—Pioneer CL-3, 6 power. Transmitter or receiver. Stock #SE-6. Price \$3.75 ea.

60 CYCLE AC MOTORS

G. E. Reversible. 1/150 H.P. Shunt wound. 40 volts 5000 rpm. Split field. Stock #SE-18. Price \$4.75 ea. Stock #SE-19. Similar to above but not split field. Price \$2.75 ea. Barber-Colman. 0.001 H.P. wound shaded pole type. Reversible by relay or s.p.d.t. switch. Stock #SE-27. Price \$3.75 ea. Timing Motor—Haydon 1 rpm. 115V AC. Stock #SE-133. Price \$2.85 ea.

5BA10AJ18D

5067127



SE-98

SE-108

SERVO-TEK PRODUCTS Co.

Incorporated

247 CROOKS AVE.

Surplus Division

CLIFTON, N. J.

Write for our latest flyer or call ARmory 4-2677. Open account shipments to rated concerns. Others may order C. O. D. Prices F.O.B. Clifton.

former designed to match a 3,000- or 4,000-ohm load to a 500-ohm line and connect it in reverse.

Mike jacks J1 are for PL-68-type plugs. You can use Mallory SCA-2B or equivalent types. Receiver jacks J2 are standard phone jacks, Mallory SC-1A

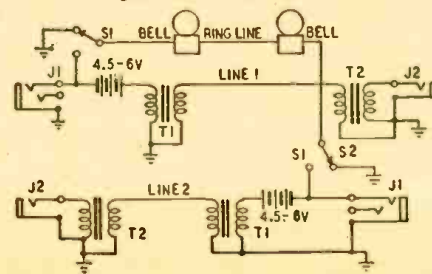

or equivalent. Switches S1 and S2 are s.p.d.t. push-button type. The normally closed contact is connected to ground. One of the two bells must be of the single-stroke type. It may be made from a standard vibrator type by connecting the line directly to the coils as shown. Do not use two vibrator-type bells.

CORRECTION

In the diagram of the 6AD7 Amplifier on page 25 of the May 1948 issue, the bleeder resistor is shown between two grounded points. It should be placed between the positive side of the power supply and ground. We thank Mr. Paul V. Zeyn, Sr., of Milton, Penna., for this correction.

Report From Britain

By Major Ralph W. Hallows

RADIO-CRAFT EUROPEAN CORRESPONDENT

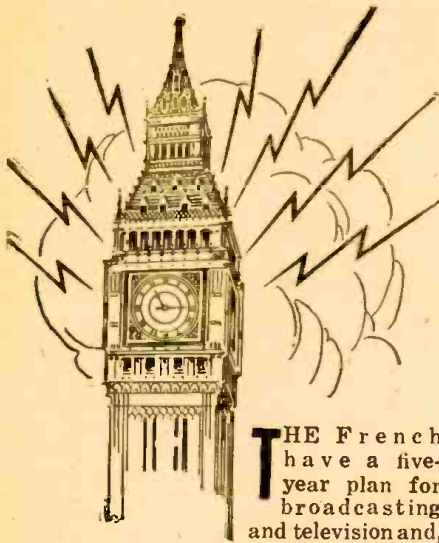

THE French have a five-year plan for broadcasting and television and, if I know any-

thing about their knack of getting things electrical done, they'll have it in operation sometime before the end of that period. The plan includes the reconstruction of the long-wave station at Allouis, which is to have 1,000-kw power output provided by a coupled pair of 500-kw transmitters; the erection of at least five medium-wave transmitters of 100-kw rating; the installation of a colonial chain in France itself and in her colonies, consisting of about a score of 20-100-kw shortwave transmitters; the inauguration of at least fifteen 5-kw FM transmitters; and the completion of television transmitters operating in the neighborhood of 12 mc at Paris, Marseilles, Lyons, and Lille. It seems likely that the definition adopted for these will be of the order of 1,000 lines, since all are intended to work in conjunction with big-screen public television theaters. The authority for this information is the French radio magazine *Le Haut Parleur* (*The Loudspeaker*), which generally knows what it is loudspeaking about!

Theater television

I mentioned some time ago that the J. Arthur Rank organization had gone ahead well with its plans for big-screen television in motion picture theaters. The original idea was to have television in several London theaters before the end of last year, but there was a hold-up of some kind and it may now be a month or two before audiences have their first view of it. Both BBC transmissions and special studio transmissions by Ciné Television Ltd., a subsidiary of Rank's, are to be screened. The latter will come from the Crystal Palace, where the late J. L. Baird had his studios. The Schmidt optical system will be used, the aspherical corrector lenses being molded from plastic by the new process developed by Dr. Starkie of Imperial Chemical Industries. I have seen big-screen images reproduced by this system, and they certainly are bright, contrasting, and detailed. I'd say, however, that television in its present form won't be accepted by theater audiences except for sports and spot news, in which the technical imperfections are outweighed by the interest value. I don't think television will become genuine big-screen stuff until at least a 1,000-line scanning system is developed—or until, as Mr. Gernsback holds, a revolutionary method of transmission and reception is found which will relegate scanning apparatus to the museums.

Sargrove invents "wireless" radio

I described some months ago the Sargrove method of mass-producing radios by metal-spraying molded plastic blanks. I have one of those little sets working

in my house now. The type I am using is intended purely for local use and gives a choice of two stations. It is a 2-tube, a.c.-d.c. receiver. The 55-volt heaters are connected (one can't say "wired," for there isn't an inch of wire in the things) in series; the set can thus be hooked directly to 110-volt lines. Mine are 200-volt, and a resistance winding in the line cord provides the necessary dropping. You'll see from the photograph how simple this set is to assemble, use, and service. Does it work? It certainly does. The nearest stations are 20 miles away, yet with a short antenna I have to use the volume control to prevent the loudspeaker from being overloaded. The quality of reproduction isn't, of course, what you get from a large console radio, but it's quite acceptable. Manufacturing costs of radios of this type must be extraordinarily small, and the sets should go far toward solving the problem of bringing radio within reach of the ordinary man in countries where wage rates are low. As you probably know, Britons call radio "wireless." But I never thought I'd see a wireless set that really *was* wire-less!

French televisers

It's good to see a French firm bringing out a whole range of television receivers. The Ontra Company is now marketing no less than six different types. Two sizes of tubes, the 18-cm and the 22-cm, which correspond approximately to 7 inches and 8 inches, respectively, are used in various models. The most ambitious of these televisers is a radio-video console of very neat design; the smallest a 13-tube table model for video only. The sound accompanying the vision program can be received by means of an ordinary broadcast set tuned to 1500 kc. A small converter unit using a 6E8 is connected between the television antenna and the broadcast receiver. This unit, matched to the input impedance of the average broadcast superheterodyne at 1500 kc, delivers the sound signal changed to that frequency. It seems a good method of turning out low-priced televisers, for most viewers already possess perfectly adequate broadcast radios which they are glad to use if it means a saving.

Swedes like radio

Sweden can claim the honor of being the most radio-minded country in Europe. Before the war 24% of her inhabitants owned radios, and now the proportion is higher. One reason for this progress is no doubt that power lines are available practically everywhere. I remember how impressed I was, when I first visited Sweden as a boy, by finding electric light far more com-

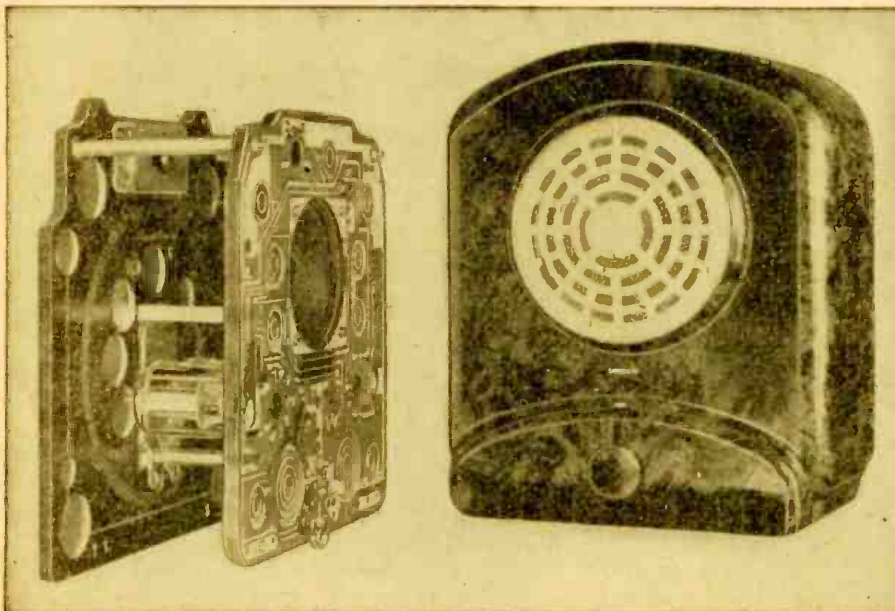

Wiring of this British receiver is appliued. Molded plastic blanks are sprayed with metal.

mon in their houses than in ours. The Swedes became electricity-minded years ago, with the result that they were ready to fall for broadcasting as soon as it came along—and fall they did. They soon had an extensive system in action, which has been steadily improved ever since. A new short-wave service of theirs will be of considerable interest to radio fans. This consists of programs specially planned for amateurs and dealing with radio topics. They are sent out three times every Saturday, but only two of the transmissions are likely to be received in the U.S., for the third (at 0745 GMT) is directed southeasterly. The transmissions directed toward America are:

1500 GMT: SDB2 10.780 mc
 SBT 15.155 mc
 0100 GMT: SDB2 10.780 mc
 SBU 9.535 mc

A new high-voltage supply

Considerable interest has been aroused by a new electronic gadget called the Westeht (short for Westinghouse Extra High Tension) which supplies 5,000 volts or more for the anodes of cathode-ray tubes in televisers and other equipment. It is for use in atom-smashing experiments. It consists of a number of half-wave metallic rectifiers and capacitors. Each unit rectifies and

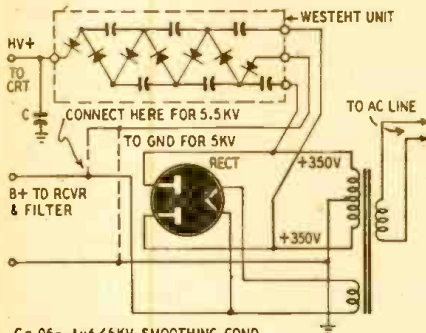

C-05-.1μf/6KV SMOOTHING COND
 Novel h.v. supply for scopes and televisers.

stores in its capacitor, the peak voltage developed by the preceding section. The voltage output depends on the number of rectifiers and storage units in use.

The figure shows how the unit is connected to the power pack. This type provides either 5.0 or 5.5 kv at 150-250 microamperes. Other models are available for voltages up to 20,000. This method has several advantages over other high voltage supplies, not the least of which is the small size of the unit. It measures only 2 3/4 inches in diameter by 9 inches high. Output voltage does not vary more than 7% for a total current swing of 100 microamperes.

Telev viewers in the New York City area now have a chance to test their sets above 200 mc. The new station WATV in Newark, N. J., is now operating on 210-216 mc (channel 13).

WATV is being picked up regularly in Brooklyn on an antenna less than 35 feet high. Signals are much weaker than those from the local stations.

To get the new station at its best, some antenna changes might be advisable, as most of the antennas now in use are designed for the lower band.—I.Q.

Special for Engineers, Technicians, Experimenters, and All Enthusiasts of Magnetic Recording

BUILD YOUR OWN MAGNETIC TAPE RECORDER

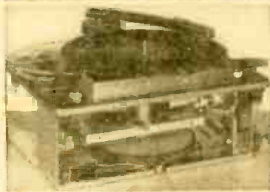

(Illustration shows Pickup mounted on arm bracket.)

WITH THIS DUAL-CHANNEL TWIN-TRACK RECORDER TWO-WAY CHASSIS

Now you can get a full hour's high-fidelity recording on a single 7 inch standard reel of Scotch Sound Recording or Brush Tape. This ultra-modern, precision-built tape recorder mechanism actually utilizes two sound tracks on standard 1/4 inch tape. One track records in the forward direction, and the other during reverse. Eliminates the necessity for rewinding.

You can use this chassis with any amplifier for recording or playback. Or you can construct an amplifier from any one of the special designs which are furnished with the unit. Circuit features include supersonic or DC erase, phono-radio-microphone input circuits, and provision for mixing microphone and radio-phon inputs. Advanced design principles provide for unbelievably quiet operation. Overheating is a thing of the past with this dynamically and electrically-balanced heavy-duty recording motor. Optional built-in turntable and phono-pickup enable you to use the unit for disc record playback, and to copy your records onto tape with or without self-accompaniment.

For matchless quality of magnetic recording and reproduction, and for exclusive built-in design features, the Twin-Track Recorder Chassis leads the field.

Supplied with 32 page instruction book containing circuit diagrams and construction data.

Check these Exclusive Features

1. ONE HOUR continuous play on standard 7" reel at tape speed of 7 1/2" per second.
2. Adjustable Frequency Response 50 to 9,000 cycles ± 3 db.
3. Cuts tape cost in half. No other recorder matches this economy.
4. Easy to thread. Threads directly from one reel to the other.
5. Heavy Duty Recording Motor prevents overheating.
6. High traction between capstan and tape. No tape slippage.
7. Twin Electronic Erase Heads for complete Supersonic or DC erase.
8. Constant tape speed precision drive. Reduces flutter and wow to a minimum.
9. Can be used for twin-channel stereophonic recording.
10. No rewinding necessary. Plays continuously during forward and reverse.
11. Unique design prevents development of eccentricities in capstan drive.
12. One tape channel can be used for compression-expansion control.
13. No bolts to loosen or pullers to slip.
14. Automatic switch and solenoid instantaneously reverses direction of tape travel.

COMING! Complete factory built recording unit with self-contained recording amplifier, playback amplifier, supersonic erase and bias oscillator and amplifier, plus cabinet, microphone and loud speaker. Priced from \$225.00. A postal card will get your name on our Twin-Track mailing list so that you will be among the first to know about our exciting new line of Magnetic Tape Recorders built around this revolutionary Twin-Track Recorder Chassis.

Magnephone Division **AMPLIFIER CORP. of AMERICA**

398-10 BROADWAY • NEW YORK 13, N. Y.

CALLING ALL CARS



WHERE MOBILE RADIOS MUST NOT FAIL...

JAMES PUSH-PULL VIBRATORS ARE MANDATORY

Over the years the performance of the James Vibrator has justly earned its outstanding reputation for maintained frequency and output. It is for this reason that so many police cars, and taxicabs require James Push-Pull construction.

Note these additional features:

- (1) Uniform accuracy of contact adjustment.
- (2) Angular positioned reed arms (patented)
- (3) Larger magnetic coil—more driving force.

New vibrator replacement guide will bring you up-to-date on vibrator inter-changeability.

Ask your Radio Parts Jobber or write

JAMES VIBRAPOWR CO.

3224 W. Armitage Ave,

Chicago 47, Illinois

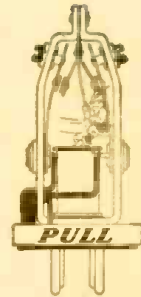
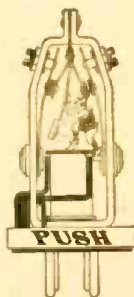

free
radio book

RADIOS
HAM
P. A.

Mail coupon for buying
Guide to the best values in Radio,
Ham and P. A. Equipment. Send too for the
newest ever jam-packed with bargains.

Spot-lite Values

**Pre-Amp
Phono Kit**



Build your own preamplifier kit for use with the new G.E. variable reluctance or Pickering pickup. This kit enables you to have a fine pre-amp and save money. Easy to build, with full instructions, all parts and 6SC7 tube. Complete with chassis, resistors, condensers, tube and all parts plus simple instructions and diagrams.

\$3.95

X 248-Pre-Amp Kit—your cost. . . .

3-Inch Nylon Tweeter

Makes a fine woofer-tweeter combination for any high-fidelity job. Heavy 7 oz. Alnico V magnet and a 32 ohm voice coil. Sturdy nylon one piece one for high frequency.

\$1.89

XPS 876 Wt. 2 lbs.—Your cost. . . .

from *Safayette*

MAIL NOW

New York
100 SIXTH AVE.
116 Federal St., Boston 10
24 Central Ave., Newark 2

Safayette Radio

RADIO WIRE TELEVISION, INC.
Dept. RC-8, 100 Sixth Avenue, N. Y. 13

Send #X248 @ \$3.95 ea. quantity

XPS 876 @ \$1.89 ea. quantity

Enclosed: check money order

Send catalog New Flyer C42

Name

Address

City Zone State

Radio School in Greece



One of 35 radio service technicians being graduated from the school run by K. Karayannis & Co. in Athens, Greece, is congratulated by Prof. George Athanassiadis of Athens University in the photo above. The course lasts nine months and includes physics and mathematics, as well as servicing techniques. Requirements for entrance are so high that only 80 students were selected from the 450 applicants during the 1946-47 season. This year 100 students are in training. Another school will soon be established at Salonika, and later, correspondence courses will be introduced in Greece.

Below, American radio equipment is demonstrated for the audience at the graduation exercises.



MOBILE BROADCAST RELAY IN DENMARK

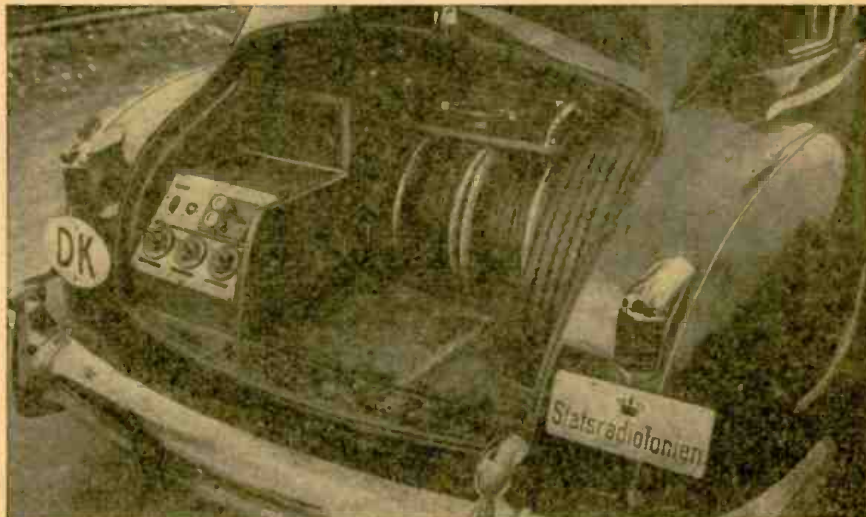

Transmitting equipment in rear of one of two standard Chrysler sedans used to relay local events to the Danish broadcast network. One of the cars is even fitted with twin turntables.

RADIO-CRAFT for

A CHALLENGE—Order a model 247. Disregard the unbelievably low price and compare it on the basis of appearance, quality and performance to any other Tube Tester (ANY MAKE, ANY PRICE). If you are not completely satisfied with the model 247 after a 15 day trial, return it to us for full refund—no explanation necessary. The model 247 is not surplus nor is it a hashed over pre-war model. It is newly designed and incorporates new advances in Tube Tester design. Read the description below and order one today!

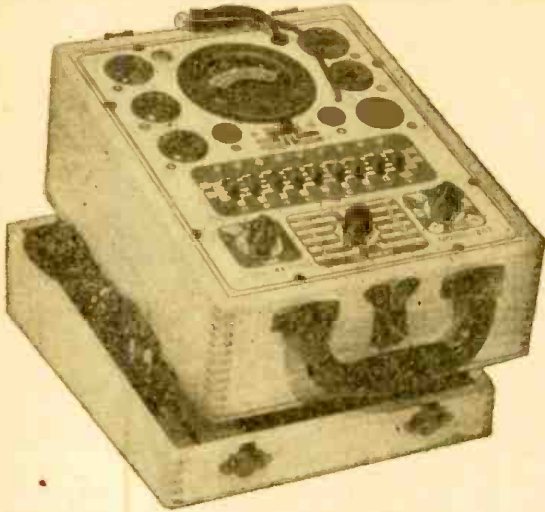

Model 247 comes complete with new speed-read chart. Comes housed in handsome, hand-rubbed oak cabinet sloped for bench use. A slip-on portable hinged cover is included for outside use. Size: 10 $\frac{1}{4}$ " x 8 $\frac{3}{4}$ " x 5 $\frac{1}{4}$ ".

ONLY
\$29⁹⁰
NET

The New Model 247

TUBE TESTER

Checks octals, loctals, bantam jr. peanuts, television miniatures, magic eye, hearing aids, thyratrons, the new type H.F. miniatures, etc.

Features:

- * A newly designed element selector switch reduces the possibility of obsolescence to an absolute minimum.
- * When checking Diode, Triode and Pentode sections of multi-purpose tubes, sections can be tested individually. A special isolating circuit allows each section to be tested as if it were in a separate envelope.
- * The Model 247 provides a super sensitive method of checking for shorts and leakages up to 5 Megohms between any and all of the terminals.
- * One of the most important improvements, we believe, is the fact that the 4 position fast-action snap switches are all numbered in exact accordance with the standard R.M.A. numbering system. Thus, if the element terminating in pin No. 7 of a tube is under test, button No. 7 is used for that test.

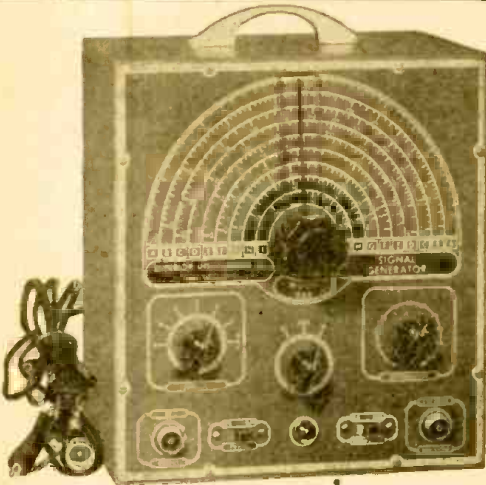

THE MODEL 650—AN A.C. OPERATED SIGNAL GENERATOR

RANGE: 100 KILOCYCLES TO 105 MEGACYCLES

- *RF obtainable separately or modulated by the Audio Frequency.
- *Audio Modulating Frequency—400 cycles pure sine wave—less than 2% distortion.
- *Attenuation—3-step ladder type of attenuator (T pad).
- *Uses a Hartley Excited Oscillator with a Buffer Amplifier.
- *Tubes: 6J5 as R.F. Oscillator; 6SA7 as modulated buffer and Mixer; 6SL7 as audio oscillator and rectifier.

Model 650 comes complete with coaxial cable, test leads and instructions. Housed in heavy gauge grey crystalline cabinet with beautiful two tone etched front panel. Size 9 $\frac{1}{2}$ " x 10" x 6". NET PRICE:

\$39⁹⁵



The New Model 670 SUPER METER

A Combination VOLT-OHM-MILLIAMMETER plus CAPACITY REACTANCE, INDUCTANCE and DECIBEL MEASUREMENTS.

D. C. VOLTS: 0 to 7.5/15/75/150/750/1500/7500.—A. C. VOLTS 0 to 15/30/150/300/1500/3000. Volts.—OUTPUT VOLTS: 0 to 15/30/150/300/1500/3000.—D. C. CURRENT. 0 to 1.5/15/150 Ma.; 0 to 1.5 Amps.—RESISTANCE: 0 to 500/100,000 ohms, 0 to 10 Megohms.—CAPACITY: .001 to .2 Mfd., 1 to 4 Mfd. (Quality test for electrolytics).—REACTANCE: 700 to 27,000 Ohms; 13,000 Ohms to 3 Megohms.—INDUCTANCE: 1.75 to 70 Henries; 35 to 8,000 Henries. DECIBELS: -10 to +18, +10 to +38, +30 to +58.

THE MODEL 670 COMES HOUSED IN A RUGGED, CRACKLE-FINISHED STEEL CABINET COMPLETE WITH TEST LEADS AND OPERATING INSTRUCTIONS. SIZE 5 $\frac{1}{2}$ " x 7 $\frac{1}{2}$ " x 3".

\$28⁴⁰
NET

Available for Immediate Shipment From Stock—20% Deposit Required on All C.O.D. Orders

MOSS ELECTRONIC DISTRIBUTING CO.

DEPT. RC-7 229 FULTON ST.
NEW YORK 7, N. Y.

FORT ORANGE

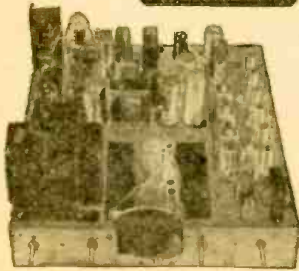

presents a
Complete Line of
TELEVISION ASSEMBLY'S
Champion Models
WITH DUMONT INPUTUNER



10" Champion model
273.10

12" Champion model
303.10

15" Champion model
393.10

The Dumont Inputuner tunes continuously from 44 to 216 megacycles without a break, covers all 13 channels as well as FM, amateur, and aviation channels. For ease and convenience of operation no band switching of any kind is required when tuning from channel to channel with the inputuner system. Just one simple operation to reach any desired station.

Standard Models

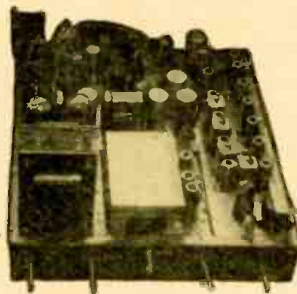

All Television Assemblies are complete and include: 29 RCA Tubes—plus CR Tube—Heavy Duty RCA 6.8 oz. slug 12" PM Speaker—Specially designed dipole antenna with 60 ft. lead in.

10" Standard model **229.50** 12" Standard model **259.50** 15" Standard model **349.50**

25% DEPOSIT—
BALANCE
C. O. D.

Superior performance is obtained with a new IF Video & Sound IF Strip (Pat. Pend.) aligned, wired, pretuned, tubed and tested. All circuits are contained on one chassis ready to use with the front end unit supplied. This front end will handle 13 channels and is aligned and tested, mounted on a separate chassis. Merely connect B plus filament and output IF leads to the television chassis. It is not necessary to make any RF alignments. These units utilize a clipper circuit which filters out ignition noises.

FORT ORANGE RADIO DISTRIBUTING CO.

642 BROADWAY, ALBANY, NEW YORK

STABLE OSCILLATOR

Alphons V. Wurmser, Bogota, N. J.
(assigned to Bell Telephone Lab.)
Patent 2,435,262

This generator requires only one tube for the production of modulated signals. Unlike grid-blocking schemes and similar circuits the output is highly stable and of sine-wave character.

The tube may be a 6SJ7 or similar type. Values shown are suitable for an output of 1,000 cycles modulated at 20 cycles, such as is needed in telephone communication. The LC circuit is tuned to the "carrier" or 1,000 cycles. The grid leak and condenser are chosen to have a time constant which emphasizes 20 cycles. They may be determined by experiment.

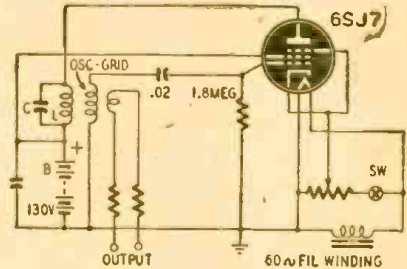

About 1 volt at 60 cycles is taken from the filament transformer and applied to the cathode to vary grid bias. Due to the non-linear tube characteristic the gain varies at 60 cycles and at various harmonics and sub-harmonics of 60 cycles. The 20-cycle sub-harmonic is especially strong because the grid circuit encourages this frequency.

Because of the whole-number ratio between 1000 and 20, these two frequencies lock in and each tends to become as stable as the line voltage injected into the cathode circuit. The modulation is complete and each frequency is practically a pure wave.

EFFICIENCY MEASUREMENT

John R. Boykin, Baltimore, Md.
(assigned to Westinghouse Elec. Corp.)
Patent No. 2,434,544

A transmitter is a circuit which converts d.c. to r.f. power. Efficiency is determined by dividing output power by input power. Ordinarily two separate meters are used, one for r.f. and the other for d.c., and the efficiency is found by dividing these values. Practically any adjustment in the transmitter will affect both readings and requires a new calculation.

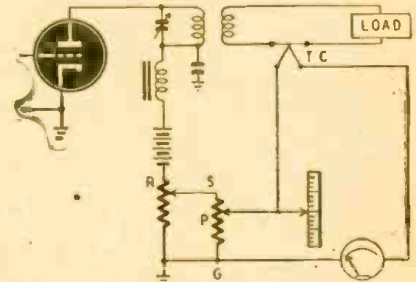

This method requires only a single d.c. galvanometer and no calculation to find efficiency. The r.f. power is measured by a thermocouple TC, which produces a voltage proportional to r.f. power. This voltage appears across PG. The d.c. voltage drop across R (and SG) is proportional to input power. The two voltages are connected to oppose each other.

There is some setting of P where the thermocouple voltage exactly equals that portion of the R voltage which appears across PG. At this setting there is no effective circuit voltage and therefore no galvanometer deflection. Then the transmitter efficiency is equal to the ratio PG/SG X 100. The scale may be calibrated directly in terms of efficiency.

Much time and labor is saved through use of this single, direct-reading dial. Changes in tuning, coupling, etc., produce corresponding changes in the galvanometer reading. In one direction it shows an increase in efficiency, in the other it indicates a reduction. After obtaining maximum efficiency, the dial is adjusted to bring the meter back to zero and the actual efficiency is then observed at once.

HOW TO GET THE MOST from only BASIC TEST EQUIPMENT

Servicing by Signal Substitution
The Simple, Modern, Dynamic Speed approach to receiver alignment and adjustment problems, FM-AM-TV.

- Nothing complex to learn
- No extra equipment to purchase
- Universal — non-obsolete
- Employs only Basic Test Equipment



S-S-S tells HOW — in simple, direct language.

New 9th edition now off the press. 100 pages of valuable information.

Available from all leading radio parts and equipment distributors or directly from factory at only 40c per copy.

PRECISION APPARATUS COMPANY, Inc. • 92-27 Horace Harding Blvd., Elmhurst 4, N. Y.

RADIO-CRAFT for

VARIABLE-OUTPUT POWER SUPPLY

Frederick A. Russell, Summit, N. J.
(assigned to United States Govt. as represented by the Sec'y of War)
Patent No. 2,438,417

A thyatron power supply has the advantages of low internal voltage drop and high current output. Ordinarily the tube grids are controlled by a variable-phase voltage which is not as easy to obtain as the variable-amplitude voltage used here.

A four-element thyatron, as shown in the figure, is used with a.c. voltages on its elements. The

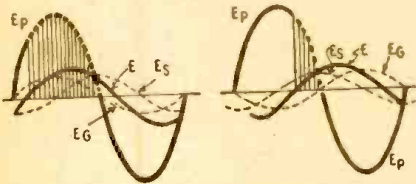
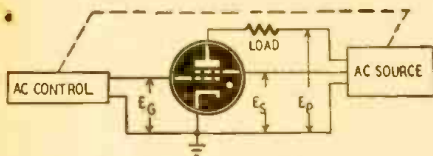

screen-grid is supplied by a voltage (E_s) which is 90 degrees out of phase with the plate voltage (E_p). This fixed phase difference may be obtained by using an R-C network within the a.c. source. The control grid voltage (E_g) is variable and in phase with the plate voltage.

The thyatron ionizes only when its plate is positive and the total effect of E_s and E_g is positive at the same time. After the tube breaks down, current will continue to flow through the load for the remainder of the positive half-cycle. Output is controlled by causing the break-down to occur earlier or later in the half-cycle.

With the basic circuit shown, the conduction period can be varied from zero to the entire positive half-cycle. The graphs show how the conduction period varies with a change in the amplitude of E_g . The shaded portion shows conduction interval. In the graphs E is the total effect of E_s and E_g . When it goes positive it causes the tube to break down. Note that E_g must be "weighted". In other words, if the control grid is 3 times as effective as the screen grid (due to its closer position to the cathode), then the actual value of E_g is multiplied by 3 before drawing its dashed curve.

RELAY TUBE

Paul W. Stutsman, Needham, Mass.
(assigned to Raytheon Mfg. Co.)
Patent No. 2,436,835

This new gas-filled tube is highly sensitive and stable. It can be actuated by less than 1 volt a.c. and requires negligible power input. The tube contains a cathode, an anode, and a control grid surrounded by a "cathanode". As its name suggests, the latter acts both as anode for the tube cathode and as cathode for the tube anode. The lower cathanode is spaced about .04 inch from the cathode. Other elements are spaced by about .015 inch. The tube is filled with inert gas, such as xenon and krypton, at a pressure of 10 mm of mercury.

Normally, sawtooth oscillations take place between cathode and lower cathanode because of

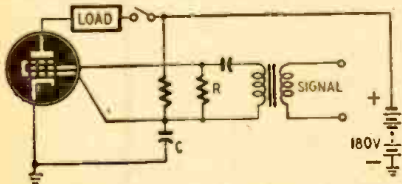

the slow charge and rapid discharge of C. Ionization is localized because a negative bias is built up on the control grid by leakage current flowing through the grid resistor. When a.c. appears on the control grid the local discharge spreads throughout the tube. A current of about 5 ma then flows from cathode to anode through the load until the switch is opened.

The critical signal (for tube breakdown) depends upon values chosen for R and C. Input power is negligible due to the extremely high values of R.

JULY, 1948

TRANSVISION



NEW... Sensational TRANSVISION Development now offers LARGE-IMAGE DIRECT-VIEW TELEVISION at low cost! BIGGEST VALUE in TELEVISION

Model 10BL TELEVISION KIT with FM Radio... Features Beautiful CABINET with BUILT-IN LENS... Gives LARGE 120 Sq. In. Picture

Roto-picture effect: Picture "rotates," giving the appearance of being in focus and clearly visible from every angle! Uses 10" Electromagnetic Direct-view Picture Tube. Features new-type cabinet with built-in lens which magnifies, clarifies and heightens contrast of the picture. The lens also creates the effect of apparent rotation of the picture, so that when the observer moves, the picture still seems to be in focus and clearly visible from any angle.



MODEL 10BL

ECONOMICAL KIT, EASY TO ASSEMBLE. In point of value, this Television Kit provides the opportunity of acquiring a LARGE-IMAGE direct-view television set at a VERY LOW PRICE; also very economical from a tube replacement angle. This model is available in KIT FORM, for easy assembly; no technical knowledge required. Simple step-by-step instructions are included. Saves as much as 50% over the cost of receivers with similar picture magnitude.

TECHNICAL DATA: Model 10BL uses a 10" Electromagnetic Direct-view Picture Tube; has complete F.M. Radio which comes completely factory-wired; receives all channels in any area; supplied complete with antenna and lead-in wire. The LENS is 15" x 11", giving a picture size of approx. 10" x 12" or 120 sq. in.; the highly-styled cabinet measures 26" wide x 17" high x 19" deep, available in Mahogany, Walnut, or Blonde finishes.

PRICES: TRANSVISION MODEL 10BL Television Kit, with FM; 10" tube, cabinet with built-in lens, antenna, 60 ft. lead-in wire. **NET \$299.95**

Scoop! New Revolutionary MODEL 7BL Television Kit with Specially Designed CABINET with BUILT-IN LENS

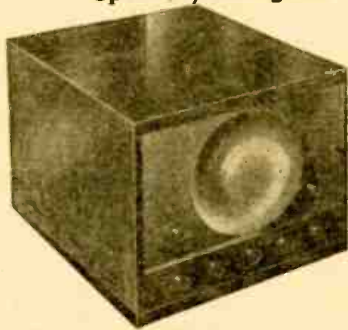

MODEL 7BL

- Uses 7" Electrostatic Picture Tube
- Gives 50 square inch picture of superior quality

FEATURES: Though it has a 7" tube, the effect is equivalent to a 10" set because the built-in lens magnifies the picture. Also picture performance is superior because the lens clarifies and heightens contrast of the image. Picture "rotates" apparently, as the observer moves, giving the effect of always facing the observer. This is effective to a very wide angle. Pre-tuned for 5 channels.

PRICE: Including cabinet with built-in lens, antenna, 60 ft. of lead-in wire. **NET \$189.00**

TRANSVISION "SERVICE NOTES"

The Key to Successful Television Servicing

Transvision's "Service Notes" is a compilation of confidential Television Notes and Information, the product of experience with over 20,000 television receivers, now made available to the public. The "Service Notes" is a most valuable compilation of instructions and data on Magnetic and Electrostatic Television Receivers. Though compiled in the course of servicing Transvision Kits, the information is applicable to any type of television receiver. "Service Notes" is complete with photographs and diagrams. The information is worth a small fortune. The cost is low.

NET \$1.95

All prices 5% higher west of Mississippi; all prices fair traded. For further information see your distributor, or write to:

TRANSVISION, INC. Dept. R.C. NEW ROCHELLE, N. Y.
In Calif.: Transvision of California, 85-72 Santa Monica Blvd., Los Angeles



**YOU'RE SAFE
at HOME!
for every ball game...**

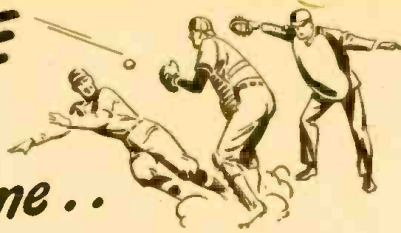

with the
**HIGHEST QUALITY
MEISSNER FM RECEPTOR**

● The thrill and incomparable beauty of FM reception is available to all with the Meissner model 8C FM receptor. A simple connection to any present AM radio . . . and the full scale fidelity of FM reception, unbelievably free from static, interference or fading, is brought to the listener as only the quality of Meissner skill can produce it. See and hear the new MEISSNER — there is nothing like it! Retail Price . . . \$57.50.

● New FM Band, 88 to 108 Mc. ● Audio Fidelity, flat within plus or minus 2 db. from 50 to 15,000 CPS ● Audio Output, 3 volts R. M. S. at minimum useable signal input, 30% modulation. ● For greater signal inputs, output voltages as high as 15 volts R. M. S. obtained without distortion. ● Power Supply, 105 to 125 volts, 50 or 60 cycle AC. Consumption, 35 watts ● Tube Complement, 2 type 6AG5, 2 type 6BA6, 2 type 6C4, 1 type 6AL5 and 1 type 6X5GT/G

M **MEISSNER MANUFACTURING**
DIVISION OF MAGUIRE INDUSTRIES, INC.
MT. CARMEL, ILL., U. S. A.

GREYLOCK
A Dependable Name in
RADIO TUBES

GT, Glass, and Miniature Types.
All Tubes Individually Boxed.
125A7, 125K7, 125Q7, 80L6, 12AT6. . . each 39c
12BA6, 12BE6, 35WA, 50B5 . . . each 49c
1RS, 1S5, 1T4, 354, 3Q4, 6AK5, 6AC5, 6AQ5.
6BE6, 6BA6, 6AU6, 6BJ6, 6X4, 11Z23 . . . each 49c
32L7, 70L7, 117L7 . . . each 59c
All Tubes carry RMA 90-Day Guarantee

PM SPEAKERS

4" Alnico No. 5 each \$1.19
5" Alnico No. 5 each 1.29

TERMS: Net COD. No order accepted for less than \$5.00
WRITE FOR BARGAIN CATALOG C-7
GREYLOCK ELECTRONIC SUPPLY CO.
30 Church Street New York 7, N. Y.

EASY TO LEARN CODE

It is easy to learn or increase speed with an Instructograph Code Teacher. Affords the quickest and most practical method yet developed. For beginners or advanced students. Available tapes from beginner's alphabet to typical messages on all subjects. Speed range 5 to 40 WPM. Always ready—no QRM.



ENDORSED BY THOUSANDS!

The Instructograph Code Teacher literally takes the place of an operator-instructor and enables anyone to learn and master code without further assistance. Thousands of successful operators have "acquired the code" with the Instructograph System. Write today for convenient rental and purchase plans.

INSTRUCTOGRAPH COMPANY

4701 Sheridan Rd., Dept. RC, Chicago 40, Ill.

TV PICTURE CONTROL

Patent No. 2,438,359
Richard G. Clapp, Haverford, Pa.
(assigned to Philco Corp.)

The second anode of a television picture tube is usually supplied with voltage from the horizontal sweep circuit. The saw-tooth current induces a very high potential which is further stepped up by autotransformer action and is then rectified by a diode. The low-impedance secondary of the transformer supplies sweep current for the deflection coils. If the picture width is adjusted (by changing the deflection coil current or by other means), the transformer load changes; this affects the high-voltage circuit which does not have particularly good regulation.

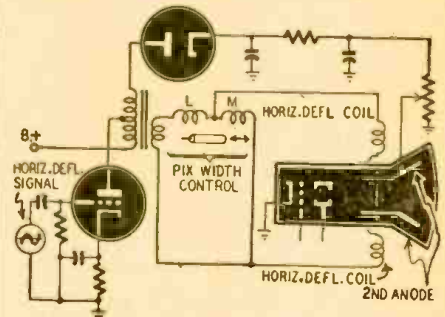

The picture control disclosed here is simple and effective. Two small coils are wound on a single form but separated to obtain negligible coupling. A powdered iron core, controlled by a threaded screw, is placed between the coils so that it approaches one as it moves away from the other. The impedance of both coils in series (see figure) remains fairly constant. As the screw is turned, the picture width varies because of the change of current through the deflection coils. However, the transformer load remains practically constant and does not affect the high-voltage supply.

In a typical control, the form is 2 inches long and 3/8 inch in diameter. L has 70 turns of No. 28 single-silk enamel-covered wire close-wound in three layers. M is wound in two pies separated by 1/32 inch, each having 130 turns of No. 41 s.s.c. In a particular TV receiver having a 340-μh deflection yoke, the picture was varied 20% with negligible change of high voltage. L increased from 37 to 122-μh, while M dropped from 3,200 to 1020 μh during this adjustment.

IMPROVED DIODE DETECTOR

Patent No. 2,437,493
Theodore G. Anderson, Kennett Square, Pa.
(assigned to Hazetone Research, Inc.)

Sharper tuning and higher fidelity are among the advantages claimed for this new circuit. The input impedance of the detector is increased many times without using high resistance in the load circuit.

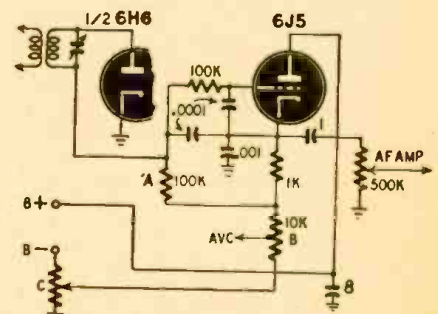

When a signal is received, diode current flows through the i.f. transformer and load to ground. The load is composed of A, B, and part of C. After filtering, only the a.f. component appears at the triode grid. This tube is used as a cathode follower. The circuits of both tubes are common, resulting in regeneration.

When the diode plate goes positive due to signal, current flows through the load and produces a negative potential at the upper ends of A and B. As the triode current through B is reduced, this resistor has an additional voltage drop which is in phase with the voltage due to the diode. This places additional negative bias on the diode and increases its input impedance.

RADAR VS. RAINDROPS

SYNTHETIC raindrops are helping research men to determine the effect of rain and snow on 1.25-cm (K-band) radar. Basis of the work is the assumption that if raindrops reflect or scatter K-band waves, it may be possible to spot storm or hurricane areas many miles away.

The 3-cm (X-band) radar waves, currently used in commercial marine radar, are not seriously hampered by rain or snow; but with the shorter K-band waves, the quality and range of echo reception varies considerably with the kind and magnitude of the precipitation. This variation has been attributed to absorption and scattering of microwaves by rain, snow, or water vapor.

Artificial raindrops are made in a range of carefully calculated sizes of ceramic powder and carbon black to obtain different electrical characteristics. In the tests a raindrop is fastened to a background that absorbs nearly all radiation not striking the drop. Microwave energy transmitted by a horn-type antenna is directed toward the raindrop, and is reflected into a receiving antenna placed at various distances.

A wave-guide balancing circuit actually measures the amount of scattering from the raindrop. First, microwave energy is transmitted without the raindrop in the field, and the amount of scattered energy received is balanced with a small signal from the transmitter fed into the balancing circuit. The raindrop is then placed in the field, causing a change in the received signal which unbalances the detector. The additional power needed to rebalance the circuit is a measure of the increase of scattered energy. The equipment is shown below.

Aim of the research is to verify two basic "guesses." One is that scattering of microwave energy from raindrops is most intense at certain frequencies. The other is that these frequencies are a function of the diameter of the individual particles of rain.

Courtesy Westinghouse Electric Corporation

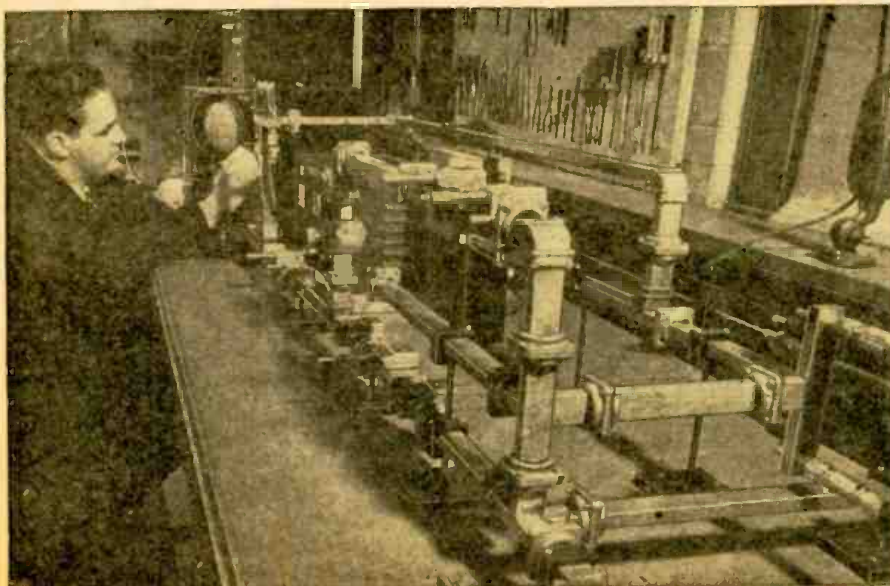

JULY, 1948

**ANOTHER ACA-100 AMPLIFIER EXCLUSIVE FEATURE
NON-FREQUENCY DISCRIMINATING SCRATCH AND NOISE SUPPRESSOR**



- Normal Response 20 to 20,000 cycles ± 1 db
- Rated Power Output 23 Watts at less than 1% Total Distortion
- Independent Push-Pull High and Low Frequency Controls
- Non-Frequency Discriminating Noise Suppressor
- Push-Pull Dynamic Volume Expander with Variable Timing

Models available to accommodate GE and Pickering Phono-Cartridges

Send today for our catalog No. 4806 which lists complete specifications of this amazing amplifier series.

An indispensable feature for the critical lover of fine music is some means of scratch and noise suppression. The ideal system must suppress noise without affecting frequency. This is precisely what is accomplished in the ACA-100 Amplifier Series.

An exclusive push-pull non-frequency discriminating scratch and noise suppressor circuit, based on the fundamental principle that scratch and noise is not noticeable at high volume levels, but becomes increasingly objectionable as the signal level decreases, is an important feature of the ACA-100 Amplifier. By automatically reducing the gain of the amplifier (under controlled conditions of attack and release timing) during low level passages, scratch is effectively reduced to one-tenth of its original volume. This automatic action operates equally well, regardless of the signal frequency, and thereby provides the only completely satisfactory means of scratch and noise suppression.

Yet this ingenious feature is only one of the many exclusive features which set the ACA-100 Amplifier apart by itself in the high-fidelity amplifier field! It actually has a higher fidelity than ever produced within any super-fidelity amplifier. A complete sense of realism is also achieved through automatic volume expansion with controlled timing. And every unit is accompanied by an Unconditional 5-Year guarantee!

AMPLIFIER CORP. OF AMERICA

398-10 BROADWAY • NEW YORK 13, N. Y.

LISTEN ONLY to the Signal You WANT to Hear

1020-CPS Pass Filter For Voice or CW Reception

Improves The Performance of ANY Receiver

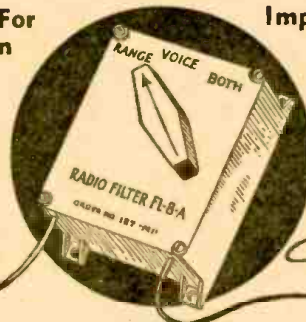
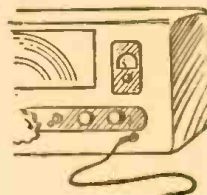

\$2.85

• Simply connect this "FL-8-A" between the output of your receiver and the headphones (or loud-speaker)—and **ELIMINATE** undesired signals, heterodynes and interference. It's a revelation! Background noises are reduced and selectivity is increased—by the mere flip of a switch. This is an aircraft WAR

SURPLUS item, made by UTC. Brand New, in original boxes. Get one or more at a small fraction of cost to Gov't. **ONLY \$2.85 each**, with two cords, plug and extension jack. Nothing else required. Send \$3.00, and we will ship **POSTPAID**.

OFFENBACH-REIMUS CO., 372 Ellis St., San Francisco 2, Calif.

DOCTOR, LAWYER, Indian Chief.



and radiomen especially are finding out that a coin radio operation in their locality is an easy, profitable adjunct to their own business. Requiring a minimum of investment in both time and money, Tradio is a natural for big earnings and a steady, long time income. You merely place the sets on a percentage basis in hotels, motor courts, taverns, restaurants, etc., and let them work for you.

Send for complete information today | Write Dept. U-7

TRADIO, Inc. ASBURY PARK NEW JERSEY

Radio - Television - Electronic Parts & Equipment Specials

TELEVISION-CATHODE RAY HIGH VOLTAGE

2000 volt D.C. Power Supply

Why bother with bulky and dangerous 60 cycle supplies or expensive R.F. power supplies when you can purchase a complete 2000 volt D.C. unit (not a kit), ready to plug into the 110 volt A.C. power line. The ridiculously low price has been made possible by a fortunate purchase of high quality components. These units are brand new, completely tested and guaranteed.

Price \$7.95

4000-6000 VOLT TELEVISION SUPPLY

Similar to the unit above, but has a much higher D.C. output voltage suitable for use with the new 7" and 10" television tubes.

PRICE\$12.50

DECALS

Now it is possible to give all your equipment that professional appearance by simply and quickly applying these handsome looking identification letters, which can be applied to any clean surface. These are available in the following sets: N372 Television—400 decals with markings such as: "Brilliance," "Contrast," "Vertical Hold," etc.

Price—\$1.35 per set

N373 Dials—50 assorted radio dials which give that engraved appearance. Price—\$1.00 per set

N374 Oscilloscope—400 decals with markings such as "Horizontal," "Focus," "Vertical Sensitivity," etc. Price—\$1.00 per set

N375 Receiver—1000 assorted decals with markings such as "Volume," "Tone," "Off," etc. Price—\$1.35 per set

N376 Transmitter—1000 assorted markings such as "Buffer," "E.C.O.," "Crystal," "Modulation," etc. Price—\$1.35 per set

N377 Audio—1000 assorted decals with markings such as "Volume," "Modulator," "500 ohm line," "Carbon Mike," "Speech Amplifier," etc. Price—\$1.35 per set

Cathode-ray tube Mask and Mounting bracket for 5" tubes. Excellent for use with 5" television sets or oscilloscope.

Price \$0.25

Chrome panel escutcheon for above—4½" diameter opening—suitable for use with cathode-ray tubes or round dials.

Price \$0.25

TELEVISION PICTURE TUBE—9 inch electromagnetic type. This is the MW22-2 tube used by GE in their television sets. Can be used in other sets designed for electromagnetic deflection. Has standard 3 prong base.

Complete with instruction booklet. \$13.95

A SCIENTIFICALLY DESIGNED PHONO SCRATCH FILTER

Resonated at approximately 4500 cycles effectively reducing objectionable needle scratches without altering the brilliancy of reproduction. Contains a HI-Q SERIES resonated circuit. Tested by means of an audio oscillator and an oscilloscope to give 22 db. attenuation with very low signal loss. Attenuation may be regulated by means of a SPECIAL MINIATURE gain control.

EASY TO ATTACH

Just two wires to clip on. Compact.

Price \$1.65

THREE TUBE PHONO AMPLIFIER

An assembled unit ready for installation using tone and volume control and six feet of rubber cord.

(Not including Tubes) \$2.95

With Complete Set of Tubes\$3.95

PHONO OSCILLATOR

Wireless phono oscillator transmits recording for crystal pick-ups or voice from carbon mike through radio without wires. Can also be used as an intercomm by using P.M. speaker as mike. Price

(excluding tubes) \$2.95

With Complete Set of Tubes\$3.95

SPECIAL! SPECIAL!

Mammoth assortment of radio and electronic parts, not less than TEN POUNDS of new transformers, chokes, condensers, resistors, switches, coils, wire, hardware, etc. A super-buy for experimenters, servicemen, and amateurs for only

\$1.25

Satisfaction guaranteed on all merchandise.
All prices F.O.B. New York City

WRITE FOR CATALOGUE

RADIO DEALERS SUPPLY CO.

135 Liberty St.

New York, N. Y.

PHILCO CONDENSERS

The values, number of units, and connections in the old Philco bakelite-cased bypass condensers may be quickly found by checking the list in Rider's Manual, Volume 11, Philco page 14. These units are hard to check without this list.

HARRY A. NICKERSON,
Boston, Mass.

REGAL MODEL L-46

My Regal Model L-46 tuned in only one strong station. Turned upside down, it played loudly for a few minutes and then stopped again. I noticed that the tuning condenser was slightly out of line. After I aligned it and soldered the mounting rivets to the chassis, volume was fully restored.

W. F. ONDER,
Arnold, Missouri

ZENITH 5678

Volume and tone change intermittently only if the volume is set at a low level. Replace .005- μ f condenser connected to the tone tap on the volume control through a 47,000-ohm resistor. Also check other condensers mounted near sources of heat.

JOSEPH FIEDERER,
Worcester, N. Y.

HARD-TO-FIND TUBE FAULT

A Stromberg Model 1204H played well on AM, but only intermittently when turned to the FM band. There was also a strong a.c. hum present. The trouble was traced to the 12BA6 i.f. amplifier tube which would momentarily short and then open up. A signal tracer was needed to locate the defective stage as a tube tester did not give any indication of the tube being bad.

HOMER L. DAVIDSON,
Fort Dodge, Iowa

ALIGNMENT CHECK

When the maximum a.v.c. voltage of a receiver is given in the service notes, the information can be used to make a quick check of the over-all alignment of the set. The maximum voltage cannot be obtained when the set is out of alignment.

JAMES R. LIMBECK,
Glendale, Calif.

MECK 5D7-WL-187

This set is an a.c.-d.c.-battery portable with a circuit that charges the B-batteries while the set is playing on a.c. Be sure to turn the switch to OFF when you have finished testing the set on a.c. If you pull the plug with the switch on, the charging circuit will place a drain of about 1.8 ma on the B-batteries and they will soon go dead.

JOHN GORT,
Rock Valley, Iowa

SILVERTONE 6140, 6152, 6153

These and other Silvertone models use bias cells in the grid circuit of the first audio stage. After a period of time, the cells deteriorate and cause a loss in volume. The results are seldom satisfactory when new cells are installed.

Insert a 0.01- μ f condenser in place of the cells and ground the grid through a 5-megohm resistor. The volume will increase considerably.

JOHN LISTIAK, JR.,
Warren, Ohio

BREWSTER 574 BB

The rivets in one end of the 12BE6 and 12BA6 sockets are used to ground the antenna loop to the chassis. These rivets may make bad connections and cause noisy reception. Since the chassis is aluminum, repair the set by placing a star washer and lug under one of the speaker supporting screws and soldering a lead to the center post of each offending socket.

MAURICE O. WHEELER,
Hudson, Mass.

ZENITH FORD GMFO90

If the tuning dial will not work for manual tuning, but makes a ratchet sound when turned, straightening the fingers on the back of the tuning shaft will fix the trouble.

WILLIAM PORTER,
Lafayette, Ind.

1946-47 HUDSON

If the pilot light seems to have too short life, replace it with a type 55, instead of the 51 installed at the factory.

WILLIAM PORTER,
Lafayette, Ind.

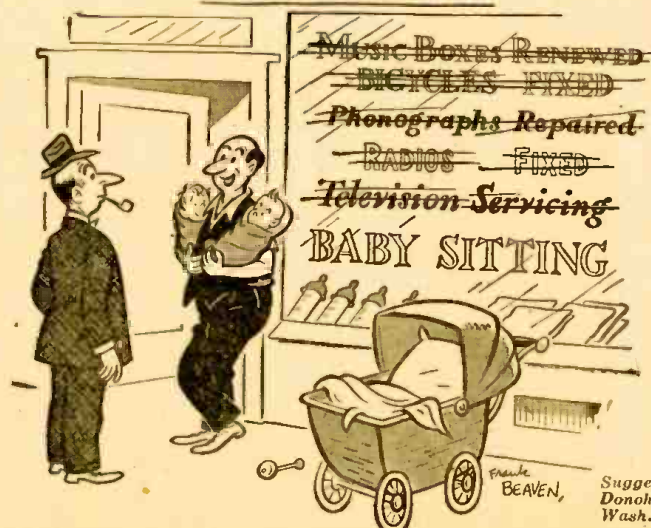

"So finally I says to myself: Brother, you'd better get into something permanent."

RADIO-CRAFT for

.... PHILCO 46-1209 AND 46-480

The 7F8 converter of these sets becomes noisy, and in some cases entirely bad, because of the high voltage on the plate of the mixer section. This can be cured by replacing R300, 4,700 ohms, with a 50,000 to 60,000-ohm resistor. Replacing this resistor will raise the voltage on the cathode. This is lowered to its normal value by removing R404, 100,000 ohms, connected between the B-plus line and the mixer cathode.

HAROLD V. GODFREY,
Ft. Worth, Texas

.... MOTOROLA TWIN 8

When the volume control was advanced, this auto radio motorboated badly. The 6A4/LA audio output tube was found to be oscillating at about 50 kc, with grid-blocking at an audio rate. The trouble was corrected by replacing the center-tapped driver inductor. The circuit could also have been rewired for a driver transformer, or else a 40,000-ohm resistor could have been connected from grid of the power tube to ground.

RADIO SERVICEMAN,
Worcester, N. Y.

.... RECORD DISTORTION

A radio-phono combination showed distortion when playing records, though radio reproduction was normal. The pickup used an Astatic Nylon 1-J crystal cartridge. Examination of the nylon needle showed that it was just touching the side of the spring needle guard. Repositioning the guard (held by two small screws) removed the distortion.

M. H. HARVEY,
Scotch Plains, N. J.

.... CROSLLEY 56PA, 56PB

To prevent the 3S4 from burning out, remove the wire connecting lug 3 to lug 8 on the 117Z6 socket. In its place, solder a 47-ohm, 1-watt resistor.

Crosley Service Instruction No. 1-03 shows a 140-ohm resistor in the diagram and a 47-ohm resistor in the text. The 47-ohm value is correct.

CROSLLEY SERVICE DEPARTMENT

.... PHILCO MODEL 42-1006

These sets were either dead or had intermittent reception and fading. The defect was found in the r.f. transformer and was due to a short between the leads of the 15,000-ohm resistor on the secondary winding and the outer turns of the primary coil.

The trouble was eliminated by pushing the resistor away from the primary coil.

J. C. PLOPPER,
Fontana, Calif.

.... TUBE PINS AS TIE LUGS

In many receivers the No. 1 pin on some of the tube sockets is used as a tie point for various components. Where the tube used is glass, there is usually no objection; but if a metal tube is substituted at any time, the tube envelope, connected to the No. 1 pin, may touch the chassis and ground the pin. It's a good idea to examine the socket before substituting a metal tube for a glass one.

GEORGE E. HUFF,
Miami, Okla.



COLLINS "Custom Built"
FM-AM TUNER

FLAWLESS Frequency Response

- A. M. Up to 10,000 cycles without loss.
- F. M. High Fidelity 10 Tube Armstrong.

Designed for those who demand the highest possible fidelity in radio reception, the Collins FM-AM Tuner utilizes the most advanced engineering principles and finest in component parts. Two separate and distinct tuners are used having only the audio and power supply common to both. This 17-tube quality tuner features voltage stabilization; and a specially developed tuning eye in the F.M. circuit. A full line of accessories is available for the Collins Tuner.

WRITE TODAY FOR FULL DETAILS

COLLINS Audio Products Co., Inc.

P. O. BOX 368 • WESTFIELD, N. J. • WE. 2-4390

NOBODY IS EVER ABLE TO BEAT "ABELL" WAR SURPLUS VALUES

500 KC SOS
XMITTER
New mds. in original pack **\$24.95**

Rugged, emergency transmitter. Operates from life raft, boat, or vehicles. Provides 20 seconds automatic code transmission of SOS or alarm signals, then, twenty seconds of 1000 cycle tone. Can be keyed manually for other messages. Hand crank powered. No batteries required. Speed indicator lamp and tuning control lamp included. Tubes are a 12SC7 (Audio Oscillator and Amplifier) and 12A6 (RF Oscillator). Radio and signal light is keyed by hand-powered generator, 300-foot antenna wire furnished. Spares: 2 Balloons; two hydrogen generators. Box Kite; Parachute, Signal Lamp, spare antenna wire and instructions, included in shockproof, wetproof bag. No experience required, any person can operate. Weight: 38 or 42 lbs. depending on hydrogen generators furnished.



MINE DETECTOR SCR 625
Ideal for locating buried metal, pipes, treasure, metallic fragments. Approximate depth of detection 6 feet, depending upon soil conditions. Supplied with batteries and tubes. Tested before shipment. Shipping weight, 70 lbs.



\$49.50

PREFABRICATED HAM SHACK

6 1/2 ft. x 6 ft. x 7 ft. high. Formerly Army Radar Hut. 1/2" water-proof plywood floor. Metal roof. Bolts, tools and instructions provided. 1/2 hour erection. Door, 3 large windows and 6 small windows. 800 lbs. wt.

\$69.50

LINEMAN'S SAFETY BELT and strap. Stated belt size. **\$5.75**

100 WATT XMITTER
BC 375.0-350 MA, 0.8 amp RF and 0-15 V meters. Lots of fine top quality parts for your medium power rig **\$10.95**

DESK STAND MICROPHONE
With switch, 6 ft. cord and plug. 200 ohm carbon button. **\$2.95**

SEND FOR SPECIAL VALUE BULLETINS

On our large stock of Radio and Photo Supplies. Tell us your wants. Above Prices Do Not include Postage.



WRITE OUR HAM DEPARTMENT

Lou Bremer W3LE in charge. Nationally known DX'er and Winner 1939 DX Marathon (Phone Section). **SATISFACTION GUARANTEED.** Order By Mail We ship C.O.D. Order today.

.... SHORTED AUTO ANTENNA

To make a quick test for a shorted or grounded antenna, disconnect the antenna lead from the receiver and touch it momentarily to an ungrounded lead from the battery. If a spark results, the antenna is shorting to either the auto body or to the shield of the lead-in cable.

RANDOLPH CHAMBERS,
Mobile, Alabama

.... RCA MODEL 56X

When the 30-50-µf filter condenser is replaced on these sets, shunt the 50-µf section with a 0.1 tubular condenser to prevent oscillation.

E. W. TEWS,
Milwaukee, Wis.

.... PUSH-PULL STAGES

During routine testing of a radio with push-pull output, I obtained readings of 300 ohms from the plate of one output tube to center tap, and 150 ohms from the other plate to center tap. The plate-to-plate resistance was 150 ohms. Upon investigation, I discovered that one plate was connected to the center tap, while one of the plate leads from the transformer was connected to B-plus.

This set was a new production model and the error was due to faulty wiring, but the same fault might also be found in a radio that had been "repaired."

J. L. FILION
Montreal, Quebec

NOW! BUILD 15 RADIOS \$14.75
COMPLETE KIT ONLY...



ABSOLUTELY NO KNOWLEDGE OF RADIO NECESSARY
YOU NEED NO ADDITIONAL PARTS!

THE PROGRESSIVE RADIO KIT is the ONLY COMPLETE KIT

Operates on 110-120 volts AC/DC. Contains everything you need. Instruction Book, Metal Chassis, Tubes, Condensers, Resistors and all other necessary radio parts. The 30-page Instruction Book written by expert radio instructors and engineers teaches you to build radios in a Professional manner. The first circuit built is a simple one-tube detector receiver. Each succeeding circuit incorporates new arrangements of detector, RF and AF amplifiers. This kit is excellent for learning the principles of receiver, transmitter and amplifier design. It is used in many radio schools and colleges. All of the commonly used detectors are used, including diode, grid leak, plate and infinite-impedance. The transmitters are designed with Hartley and Armstrong oscillators, using screen-grid and control-grid modulation. Both vacuum tube and selenium rectification are employed in these circuits. The circuits are designed to provide excellent performance. Altogether, fifteen circuits are constructed, including 11 receivers, 1 audio amplifier, and 3 transmitters. The sets start with simple circuits of 1 tube plus rectifier, gradually grow more complex, and finish with several examples of radio sets using three tubes plus rectifier.

PROGRESSIVE RADIO KIT . . . ONLY \$14.75

SPECIAL FREE OFFER
 Electrical and Radio Tester sent absolutely FREE with each Progressive Radio Kit. PLUS FREE membership in Progressive Radio Club. Entitles you to free expert advice and consultation service with licensed radio technicians. Write for further information or ORDER your KIT NOW!

The Hottest Combination in Years!
TOM THUMB CAMERA-RADIO Combination!

It's here . . . the Cameradio, indispensable for trips, hikes, ball games, every outdoor and vacation activity. Combines a fine Reflex Camera and a powerful Radio into one easy-to-carry unit. Order now . . . you'll double the enjoyment of every weekend!

- Precision Built
- Excellent Tone Quality
- Full Vision Slide-Rule Dial
- The Ideal Vacation Companion
- Portable Radio Battery Operated
- Reflex Camera, Standard #127 Films

ONLY \$28.75
 Less Batteries

Automatic AUTO RADIO

Tops in car radios, now at a new low price! Six-tube superheterodyne, with steady, full-toned reception. Mounting brackets included for easy installation in your car. Don't miss this big bargain!

- Six Tube Superheterodyne • Three Gang Condenser
- Powerful Long Distance Reception • Fits All Cars, Easy Installation • Mounting Brackets Included

\$29.97 Only



EICO MODEL 315 SIGNAL GENERATOR
 with micro-cycle band spread vernier tuning

Vitaly important for tuning and aligning FM and Television receivers where tuning is very sharp and critical. The extreme wide range and accuracy afforded by the microcycle vernier band spread dial assures accurate frequency adjustments. Vernier dial divided into 100 divisions. Any frequency can be tuned and repeated within .02% accuracy. Spring loaded split screws eliminate back lash and play providing smooth accurate tuning. Window casing encloses and protects the lighted dial and its fine pointer from accidents and jarring out of calibration.

Range: 75 KC to 150 MC • Complete broadcast band from 550 KC to 1700 KC covered on one range without switching • Unused coils are automatically shorted out to eliminate dead spots and absorption • Linear dial calibration, DOES NOT CROWD UP on high frequency end of dial • Accuracy better than .25% throughout the broadcast band and 1% on the higher frequencies • Just as accurate at high end of dial as at low end

\$64.50

VACUUM TUBE VOLTMETER
 MODEL 221

A completely new and different vacuum tube voltmeter at an unusually low price. Its amazing performance sets standards of accuracy, linearity, and stability not usually found in this type of instrument. Electronic AC ranges is more linear and accurate than was ever possible with a copper oxide rectifier. Completely electronic so meter can not be burned out. AC and DC ranges: 0-5, 10, 100, 500 and 1000 volts. Ohmmeter measures from 5 ohm to 1,000 megohms in 5 ranges. Each instrument is individually calibrated.

\$49.95



PROGRESSIVE ELECTRONICS CO. We pay Postage on Prepaid Orders. All C.O.D. Orders Shipped Collect.

WRITE FOR PROGRESSIVE QUANTITY PRICES Dept. RC-15 497 UNION AVE. BROOKLYN 11, NEW YORK

PEN-OSCIL-LITE

Extremely convenient test oscillator for all radio servicing; alignment • Small as a pen • Self powered • Range from 700 cycles audio to over 600 megacycles u.h.f. • Output from zero to 125 v. • Low in cost • Used by Signal Corps • Write for information.

GENERAL TEST EQUIPMENT
 38 Argyle Ave. Buffalo 9, N. Y.

TELEVISION RECEIVER—\$1.00

Complete instructions for building your own television receiver. 16 pages—11"x17" of pictures, pictorial diagrams, clarified schematics, 17"x22" complete schematic diagram & chassis layout. Also booklet of alignment instructions, voltage & resistance tables and troubleshooting hints. All for \$1.00.

CERTIFIED TELEVISION LABORATORIES
 Dept. C, 5507-13th Ave., Brooklyn 19, N. Y.

RADIOMEN SERVICEMEN BEGINNERS
MAKE MORE MONEY EASILY—QUICKLY
\$250. WEEKLY POSSIBLE
 We Show You How Information Free
MERIT PRODUCTS
 216-32V 132 AV, SPRINGFIELD GARDENS 13, N. Y.

TUBE SPECIALS

AC-DC five—50L6GT, 35Z5GT, 12SA7, K7, Q7GT... \$1.90
 Miniature five—50B5, 35W4, 12AT6, BA6, BEG... 1.90

*** TWO JUMBO ASSORTMENTS ***
 40—35Z5, 29-50L6, 10 ea. 35L6, 12SA7, K7, Q7, 100 tubes.
 40—35W4, 30-50B5, 10 ea. 12AT6, BA6, BEG, 100 tubes.
 Either of the above specials at only \$34.00

Every tube new and perfect. Guaranteed 100%.

Selenium rectifiers 100MA—ten for \$7.20
 Postage extra. 20% deposit on C.O.D. orders.
 Send for our new bargain list.

HALLMARK ELECTRONIC CORPORATION
 502 Communipaw Ave. Jersey City 4, New Jersey

... FREQUENCY DRIFT

Frequency drift or shift on the high end of the broadcast band may be caused by a defective oscillator trimmer condenser. Replacement of the condenser will often cure the trouble.

JOHN R. SIMPSON,
 Gainesville, Fla.

... DIRTY VOLUME CONTROLS

I use a hypodermic syringe filled with carbon tetrachloride to clean dirty volume controls. You can usually find an opening large enough to get a needle into, thereby eliminating the removal of the control.

A. W. POWELL,
 Rolfe, Iowa

... HALLICRAFTERS MODEL S-11

A slight crackling noise along with the signal was traced to a noisy tone control. A new control eliminated the trouble.

CLAUDE M. PREW,
 New London, N. H.

... SILVERTONE MODEL 6421

When retuning is required about every five minutes, check the eccentric rotor of the tuning condenser for any play. It may be necessary to replace the spring from the rotor to the condenser frame.

CLAUDE M. PREW,
 New London, N. H.

... NOISY CAR RADIOS

If an auto radio with a whip-type antenna is noisy, check to see if the small ball or bead at the tip is still attached. A missing ball usually causes high-frequency static at speeds over 25 miles per hour.

V. DE ROO,
 Dinuba, Calif.

... MOTORBOATING

Motorboating or other instability symptoms noticed when strong signals are tuned in may often be eliminated by bypassing r.f. stage screens or cathodes with high-capacitance electrolytic condensers.

JOHN R. SIMPSON,
 Gainesville, Fla.

... ROGERS 900 SERIES

The 89RS/6G7S tube used in some of these models is no longer available. As replacement for this dual-purpose tube, use an 89 as power amplifier and add a selenium rectifier.

R. LEROY BLINN,
 London, Ontario

... PHILCO MODEL 67-30

This set faded continually. However, it played fairly well on the local station. All voltages were normal and the tubes tested good. The trouble was traced to a defective antenna coil. After it was replaced with a universal replacement type, the set played perfectly.

The defect in the coil was probably due to a lowered Q caused by electrolysis.

BRIAN BAILEY,
 Brownwood, Texas

RADIO-CRAFT for

PHILCO MODEL 46-1209

Slight distortion occurred on the phono position only. The voltage measured at the No. 6 pin of the 7AF7 pre-amplifier tube was below normal.

Trouble was traced to the 470,000-ohm plate decoupling resistor which had increased in value.

JOSEPH A. DESLIENS,
Fall River, Mass.

TUBE REPLACEMENT

A 32L7 tube may be substituted for the discontinued type 25A7. Although the characteristics of the tubes are different, the change in output quality is not noticeable.

The filament dropping resistor in the receiver must be changed to increase the voltage across the 32L7 filament.

ROBERT P. KRAIG,
Olympia, Washington

RCA U-125

If the phono motor causes interference on this receiver, try grounding the motor frame to the receiver chassis. This should eliminate the trouble.

JAMES R. LIMBECK,
Glendale, Calif.

A.C.-D.C. SETS

Oscillation in a.c.-d.c. t.r.f. receivers can often be reduced by increasing the value of the bypass condenser from the plate of the detector to the chassis.

JAMES R. LIMBECK,
Glendale, Calif.

1946 MOTOROLA

If the 6SA7 seems to be intermittent and a replacement does not help, replace the oscillator coil. Checking oscillator coils is a good idea with all the late Motorola auto receivers, too.

WILLIAM PORTER,
Lafayette, Ind.

PHILCO 650

Volume was very low. All voltages checked O.K., but an ohmmeter showed a large difference between the resistances of the two halves of the output transformer primary. Replacement of this transformer restored volume to normal.

DONALD A. WEILER,
Metairie, La.

GE MODEL 304

Checking for intermittent reception on this set, I found that the coil-spring shielding on the lead to the tone control was too long. One end occasionally touched and grounded the connection. After a few turns of the spring were removed, the trouble disappeared.

E. W. TEWS,
Milwaukee, Wis.

PILOTUNER T-601

After a few weeks of operation, the pilot light begins to flicker and after a few hours, the set fails. Check the .01- μ f condenser between the No. 4 pin of the 6BA6 and ground. This condenser has been found shorted in a number of sets. These were replaced with .01- μ f 600-volt units and no further trouble has been experienced.

ARNOLD B. MARGOLIS,
Bronx, N. Y.

RADIO TUBES

For immediate shipment

R.M.A. Guaranteed
Below Distributor Costs
Individually Sealed Cartons

Type	Price
6K6GT	.40
6K5GT	.46
6V6GT	.46
6SA7GT	.46
6SJ7GT	.46
6SK7GT	.46
6SQ7GT	.46
6X5GT	.40
12SA7GT	.46
12SQ7GT	.46
12SK7GT	.46
12SJ7GT	.46
35L6GT	.40
35Z5GT	.32
50L6GT	.46

Popular Miniature Types Now Available

25% DEPOSIT REQUIRED ON C.O.D.
10% DISCOUNT ON LOTS OF 50 OR MORE
2% C.O.D.

RAVAC ELECTRONICS CORP.

432-4th Avenue
New York 16, N. Y.

TELEVISION HIGH VOLTAGE METER 0 to 30 KV



NOW
AVAILABLE
FOR THE
FIRST
TIME

AN ABSOLUTE MUST FOR PROJECTION TELEVISION WORK!

Here is an accurate High Voltage Meter that's a necessity for television service men, laboratory technicians and experimenters. It is a precision-made instrument with range from 0 to 30 KV, has 4" scale and only draws 20 microamps. Bakelite meter panel is housed in solid oak cabinet. Meter has jack connector for convenient connection to oscilloscope in checking voltage wave forms.

Net Price **\$67.50**

Send to Dept. B for FREE COMPLETE TECHNICAL INFORMATION AND DETAILS. Include 25% Deposit with Order. Balance C.O.D.

Pioneers in Projection Television
SPELLMAN TELEVISION CO., INC.
130 WEST 24th STREET • NEW YORK 11, N. Y.

2 out of 3 Need It!

ESPEY
The Custom-Built Chassis



According to the RMA,
over 18 million consoles
were built before '44!

That's right! The newest are four years old, and there are more than 11 million of them that are ten years old. Of the 18 million owners, 51%, or over 9 million LIKE their cabinets—in spite of the fact that the vast majority of receivers are hopelessly obsolete, lacking such present-day essentials as FM.

Furthermore, over 90% of the console owners WANT FM, but less than 6% HAVE it. What a replacement market!

It was to fill this tremendous need that ESPEY designed its line of top-quality custom-built chassis, supplied complete and ready to operate in your customers' cabinets.

For further details about the ESPEY replacement chassis, and the opportunities in the replacement industry, we urge you to write today to Dept. C-7.

ESPEY MANUFACTURING COMPANY INC.
529 EAST 72nd STREET - NEW YORK 21, N. Y.

"Established—1928"

AMSCO SERVICE KIT

- Kit includes assortment of:
- 1 pr. head-phones or lip mike.
 - 100 Resistors, 1/2 and 1-watt.
 - 100 Condensers, paper, mica, electrolytic & can.
 - 10 Switches, Toggle, Gang & Rotary.
 - 100 ft. Spazhettl, various sizes.
 - 12 Knobs, round and bar.
 - 2 lbs. Hookup wire.
 - 20 Fuses.
 - 6 Volume Controls.
 - 10 Tube Sockets.
 - 1 lb. Hardware (screws, nuts, lugs, etc.).
 - 10 Wire Wound Resistors, 10 & 25 watt.
 - 25 Connectors, Plugs, Ties.
 - 10 Jacks (Phone) & Tip.
 - 12 Padder Condensers.
 - 12 Terminal Boards.
 - 25 Ceramic Insulators.
 - 2 Panel Lights (1-neon).
 - 1 Screw Driver.
 - 1 Tube Puller.
 - 2 Allen Wrenches.
 - 2 Panel Fuse Holders.
 - 4 Binding Post Strips, and many other valuable items.

Bought individually would cost \$60.00—Now! Yours for only **\$9.95** complete

Available **1946 CATALOG** Write Today

AMERICAN SALES CO.

1811 W. 47th St. Chicago 9, Ill.

★ BUY SAVINGS BONDS ★

Wanted: 50,000 DEALER NAMES
Your Name IS NEEDED
TO COMPLETE OUR LIST!

To Get Your Name, Your Address, RSE Offers

CONDENSERS
 NATIONALLY ADVERTISED
 8—450-VOLT or
 40—150-VOLT
Choice of 10 \$2.90

LIMIT
 1 Deal to
 A Customer

Over 70% off on top quality, nationally advertised, name brand condensers. Check them any way you want—for capacity, leakage, power factor—if they're not the best you can buy, you get your money back!

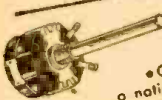

VOLUME CONTROLS

Our own private brand—made by a nationally known manufacturer. The kind that net for \$1.09. Noise-free carbon construction, standard shaft and bushing. Individually boxed in our colorful carton carrying the RSE quality seal of approval. Complete with switch, full range of sizes.

10 M ohms	100 M ohms	each	59c
15 M ohms	250 M ohms	per 10	\$5.50
25 M ohms	500 M ohms	ass'd.	
30 M ohms	1 Meg ohms		
2 Meg ohms			
500 M Knurled Shaft			

500 M ohms loss switch, 39c each, 100 for \$35.00

CLOSING OUT PHILCO CELLS PHILCO LAMPS
 We can no longer ship our famous "Philco Reconditioning Kits." We've sold out of needles and can't replace them. Here's your chance to "steal" the other two items. Until they are gone we offer Philco Selenium cells only, post paid (no hold'ers).....\$1.19
 Philco "Beam of Light" Lamps.....23c

OZ4's at 73% OFF!
 Until sold out—RSE offers 15000 new guaranteed OZ4 tubes. You know who made them—You can't go wrong at **59c**

PANEL METERS
 You fellows wanted them—So here's another of our famous meter specialists Made by the same company—all new, boxed, popular types—your chance to get those meters you've always wanted!

Model 341—0-500 Ma. R. F. thermo couple—3 inch bakelite case	\$3.95	each
Model 222—0-500 micro amps D. C. —2 inch brass case		
Model 322—1-0-1 (zero center) D. C. Mills—3 inch bakelite case		

ORDER INSTRUCTIONS
 Minimum order—\$2.00. 25% deposit with order required for all C.O.D. shipments. Be sure to include sufficient postage—excess will be refunded. Orders received without postage will be shipped express collect. All prices F.O.B. Detroit.

RADIO SUPPLY & ENGINEERING CO., Inc.
 125 SELDON AVE. DETROIT 1, MICH.

LEOTONE HAS HARD-TO-GET PARTS

RM-4 RECORDING MOTOR. Heavy duty 110V, 60 cycle shaded pole induction type. Silent operating for WIRE, TAPE or DISC RECORDING. Fans, heaters, etc. 5 1/16" O.D. shaft: 3/32" sq-x23/32". Less turntable, mtg. plate & reduction drive wheel. Smpg. wt. 6 lbs. **4.95**
WHILE THEY LAST

PRECISION RESISTORS: ±1% wire-wound. Famous makes. Ohmages: 2.35, 24.5, 95, 130, 405, 640, 1740, 2300, 7800, 30K or 50K—35c, 3 for 1.00
 Megohms: 1, .125, .22, .4, .5, .6 or .75 . . . 49
SPECIAL—1 megohm75

ALNICO MAGNETS—NEW EXPERIMENTAL KIT. Contains 10 asstd. powerful Bar. "U". Circular. Block, etc. . . 1.98
WRITE FOR LATEST ILLUSTRATED "ALNICO MAGNET" SUPPLEMENT

HEARING AID AMPLIFIER ASSEMBLY. Vacuum tube type. Make a REAL VEST POCKET RADIO or AMPLIFIER, adding only small tuner sect. & speaker or phone. Ready-wired miniature components include: 2 controls (1 & 4 meg), dble. choke, switch, resistors, condensers, output trans., etc. Complete with unit SCHEMATIC, less tubes (505, 506) & case. 2"x5"x1/2" deep. Weighs only 3/4 ozs. **2.49**

HEARING AID SUB-ASSEMBLY. Brand new precision made units containing miniature: 3 1/2 meg control, choke (2500 ohms DC), resistors, condensers, etc. All on bakelite chassis 2x2x3/4" . . 1.45

ALNICO V MAGNETIC PHONE UNITS (HS-30 headset replacement). Wide freq. response & sufficient volume for use as PM or PILLOW SPEAKER; DYNAMIC or CONTACT MIKE. 250 ohms imped. 3/4" O.D., 1/2" deep39

T-44A MICROPHONE (AAF). Sensitive twin-magnet type. With 5 1/4 ft. cord. PL-179 PLUG. & JK-26 JACK. BRAND NEW89

RADIO HARDWARE TREASURE. An indispensable assortment of approx. 1000 screws, nuts, washers, etc.45

PE-157 POWER SUPPLY. Incomplete unit, but a "gold mine" of relays, switches, jacks, selenium rect. chokes, etc. Portable hinged lid metal case (6"x8"x12"). OD grade finish. PLUS descriptive 173p. Tech. Manual. Smpg. wt. 20 lbs. 2.49

GET ON OUR MAILING LIST ALWAYS SOMETHING NEW A BETTER ONE—BUY LEOTONE FACTORY REPAIR SERVICE ON ALL SPEAKERS
 Min. Order \$2.00—20% deposit required on C.O.D.'s. Please add sufficient postage

LEOTONE RADIO COMPANY
 65 Dey St., N.Y. 7, N.Y.

NEW TELE PROJECTOR

A compact and efficient television projector which produces a 12 x 16-inch picture from a 1.4 x 1.86-inch image on the face of a 2 1/2-inch cathode-ray tube has been developed by the North American Philips Company, Inc.

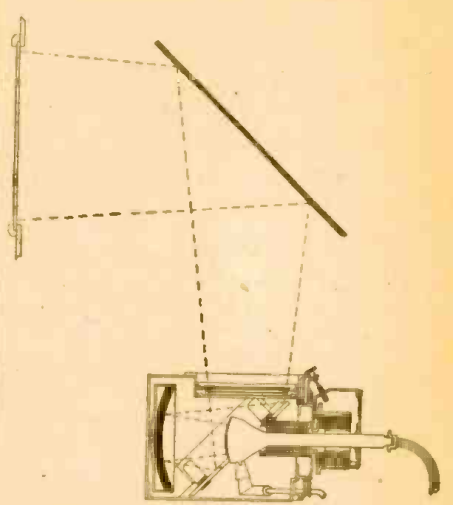

A multi-reflection optical system is used.

Known as the Protelgram, the system consists of the 3NP4 projection tube, an optical projection box including deflection and focussing coils, and a 25-kilovolt power supply.

The optical elements comprise a modified Schmidt system, mounted in a triangular array inside the projection box, as the drawing shows. A removable alignment assembly fastened to the outside of the box supports the tube and coils.

The 25-kilovolt supply consists prin-

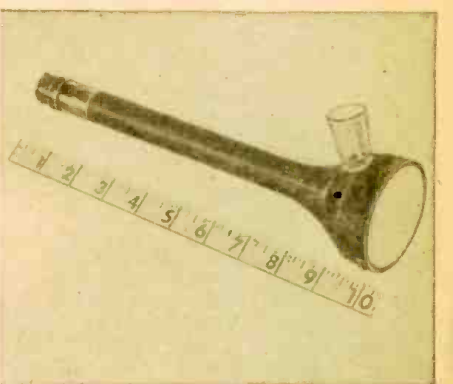

The tube. Cup insulates accelerating anode.

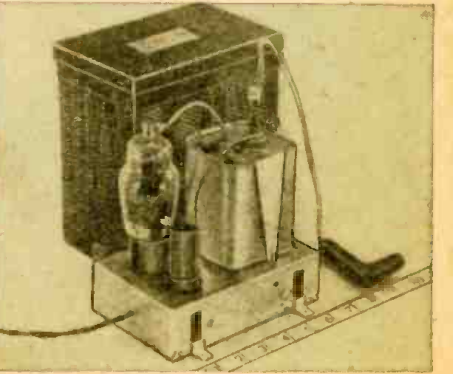

The 25-kilovolt radio-frequency power supply.

OUTSTANDING VALUES

Kit Model 210, a Three Way Portable Receiver
 Operating on either AC or DC or self-contained batteries . . . power switch conveniently located on front of set so that "battery" or "AC-DC" may be selected without opening case. Five-inch Alnico 5 permanent magnet dynamic speaker, and case covered with beautifully grained leatherette.

Multitester Kit Model M-3C
 A versatile, compact multitester 4" x 7" x 3" using a 3 1/2" rd. meter of 1000 ohms per volt sensitivity. Employs the following ranges: Volts AC or DC 0/5/50/150/500/1500. Milliampers D.C. 0/5/50/150. Ohms 0/2000/20,000/200,000.

All kits accompanied by a detailed illustrated instruction sheet. Many other kit models available. Write for Catalog M.

Now ready! New educational pamphlet—complete and simplified diagrams and instructions on all our models—50c

RADIO KITS COMPANY
 120 Cedar Street New York 6, N. Y.

RADIO-CRAFT needs more Technotes. Two types are wanted urgently—those which are characteristic of a given set and those which are very hard to find or require special ingenuity to solve. One year's subscription is given for each Technote.

RADIO-CRAFT for

cipally of a 6SR7 oscillator, a 6BG6-G amplifier, and a sealed transformer as-

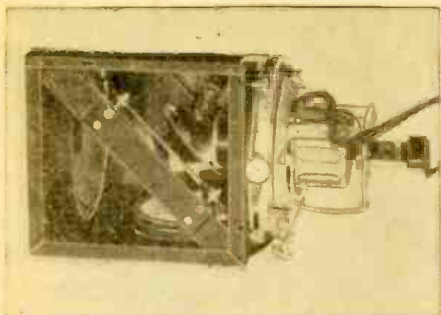

Equipment is compact, due to mirror system.

sembly containing three special rectifier tubes. A cascade voltage tripler circuit is used.

Opportunity In Television

"How can I equip myself to properly service television receivers?" is a question asked by many radio repair technicians. The answer, according to Harry Kalker, sales manager of the Sprague Products Company, is not at all hard to find.

More and more manufacturers are developing training courses, printing literature, and disseminating material to help the repairman to get the information and experience he needs. Television schools and correspondence courses are available to everyone who has the time and initiative to go after the information. Technical books and publications offer comprehensive cover-

**TELEVISION
Installation & Service
TECHNICIANS**

... are needed for our expanding television operations in New York City and vicinity. Applicants with radio or electronics service experience will be employed at salaries commensurate with ability and given necessary training in our work.

VETERANS

... with service experience as Radio, Radar or Electronics Technicians are well qualified and should apply for further information as to their future in television.

CIVILIAN

... Radio Service Experience can be quickly adapted to television work.

Apply in Person

Saturday or Sunday, Apr. 3rd or 4th, bet. 9 a.m. & 6 p.m.

RADIO CORP. of AMERICA

RCA Victor Division

185 East 24th Street. New York City

age of television, and radio magazines bring their readers up-to-the-minute articles on the latest authentic servicing data.

That time and money spent to acquire television knowledge is well invested is shown in the advertisement above, reprinted from a New York City daily newspaper.

More test equipment will be needed for television servicing, but higher cost

LAKE SPECIALS!

Natl. Brand Phono Pickup	Ea. \$ 1.95	Per 10 \$17.00
Natl. Brand Phono Motors	3.65	35.00
Gen. INS Record Changers 12"x11"	13.95	130.00
Allig. Port. Cab. for any changer		
17 1/2 x 17 1/2 x 10" Cutout for 6" Spkr.	7.95	75.00

SPEAKERS

3" 450 Ohm	1.49	14.00
4" 450 Ohm	1.49	14.00
5" 2750 Ohm or 450 Ohm	1.69	16.00
5" PM with 50L6 Transformer	1.39	13.00
6" PM	1.59	15.00
8" PM-1000 or 1800 Ohm field	3.50	32.00
5" Permafic Speaker-Special	.49	4.50
12" PM Heavy Duty Alnico-5	5.95	55.00
12" Dynamic 450 or 1000 Ohm	5.65	55.00

PARTS

500M Ohm Chgo. Tel. Val. cont. & switch	.39	3.50
50x30 Mfd. 150 V Natl. Brand Cond.	.42	3.90
40x40 Mfd. 150 V Natl. Brand Cond.	.42	3.90
40x40 Mfd. 150 V 20 Mfd. 25 V-F.P.	.39	3.75
Universal AC DC Line Cords	.50	4.75
All other Sizes from 135-350 Ohms	.45	4.25
100' 7x26 Bare Aerial Wftr	.22	1.95
70 Mil. Power Transf. 6 Volt	1.95	17.50
40 Mil. 2 1/2 V. Power Transf.	.85	8.00

AUTO AERIAL AND SUPPLIES

68" 3 Sec. Side Cowl Aerial	1.75	16.50
96" 3 Sec. Side Cowl Aerial	2.50	22.50
3 Section Univ. Mount	2.25	20.00
Spark Plug Suppressors	.10	.95
Distributor Suppressors	.10	.95
Generator Condensers 1/2 Mfd.	.20	1.95
7" Auto 6 Volt Speaker	3.65	35.00
7" Auto PM Dyn. Spkr. Heavy Duty	3.65	33.00
4 Prong Std. Oak Vibrator	1.39	13.50

Sale on Tubes—For Limited Time Only—50-10% Discount on List Prices of National Brand Tubes! 25% Deposit Required on All Orders

Write for our new 1948 illustrated catalog!

LAKE RADIO SALES CO.

615 W. Randolph Street. Chicago 6, Ill.

EXCEPTIONAL BARGAIN



GREAT BUY!

• War-Surplus headphones, deluxe type, with LONG CORD and adjustable headband. Made to strict Govt. specifications. 3,000-ohms impedance. Packed in original factory-sealed cartons. Sold at fraction of cost to Govt. Air-mail your order. Include postage for 2 pounds.

ONLY \$1.98

7-ft. Telescopic Whip Antennas.....\$1.75

PE-103 DYNAMOTORS

• GUARANTEED brand new, in air-tight sealed metal shipping containers. 6 or 12 volts input, 500v at 160-ma output. Complete with filters, circuit-breakers, etc. War Surplus. Finest ever offered. \$10.95 net.

OFFENBACH & REIMUS CO.

372 Ellis St. San Francisco 2, Calif.

of the receivers will justify greater charges than the usual hourly rate; this will pay for the test equipment.

SENCO DECLARES ANOTHER BUYER'S DIVIDEND!

LOWEST PRICE TUBES [ANYWHERE!]

EVERY TUBE IN CARTON			R.M.A. GUARANTEE		
Type	Each	Each	Type	Each	Each
024	69c	59c	6U6	49	39
1A3	45	39	6U7G	35	25
1A5GT/G	59	49	6V3G	59	49
1A7GT/G	55	45	6V6GT/G	45	39
1H5GT/G	59	49	6X5GT/G	43	39
1L4	49	45	7A4	59	49
1LH4	69	59	7A7	59	49
1LN5	69	59	7B6	44	35
1N5GT/G	59	49	7F7	49	44
1S5	59	55	7X7 (XXFM)	49	44
1T4	39	35	7Z5	44	35
1U5	36	30	7Y4	44	35
1V	45	39	12A6	29	25
2A5	54	43	12A8GT	35	28
2A6	45	35	12AT6	50	45
2A7	49	39	12BA6	50	45
2X2/879	35	29	12BE6	50	45
3A4	49	39	12I5GT	25	19
3B4	55	45	12J7GT	45	39
5U4G	50	40	12K7GT	45	39
5W4GT/G	39	34	12K8Y	35	25
5X4G	39	35	12Q7GT	45	39
5Y3G	40	37	12A7GT/G	40	32
5Y3GT/G	40	37	12SF7	35	32
5Y4G	39	32	12SJ7GT	35	29
5Z4	59	52	12SK7GT/G	45	35
6A7	50	45	12SQ7GT/G	40	32
6A8GT	49	39	12SR7	35	32
6A4	65	69	14A7	65	55
6AC7/1852	65	60	14B6	59	49
6AG7/6AK7	79	69	24A	49	39
6AK5	74	69	25L6GT/G	49	39
6B7	55	49	25Z5	45	35
6C4	29	25	25Z6GT/G	49	39
6C5GT	40	35	26	45	32
6C5MG	89	79	27	49	44
6C6	45	32	32L7GT	52	48
6C8G	37	29	35/51	42	32
6D6	49	45	35L6GT/G	45	39
6F5	55	45	35W4	43	40
6F6GT	45	39	35Y4	43	40
6H6GT/G	45	39	35Z3	44	35
6J5GT/G	45	39	35Z5GT/G	43	39
6J6	59	49	36	40	35
6J7GT	42	38	39/44	35	29
6K7G	50	41	41	49	45
6K7GT/G	49	39	47	49	39
6K8G	55	49	50A5	60	55
6L6G	59	49	50B5	42	32
6Q7GT	79	69	50L6GT	50	45
6R7	47	39	56	55	45
6R7GT	55	45	57	45	39
6SA7	49	39	58	45	39
6SA7GT/G	44	37	75	50	39
6SB7	55	45	76	49	45
6SB7GT	44	37	77	49	45
6SD7GT	39	34	80	35	27
6SG7	44	39	83V	79	69
6SH7GT	40	32	85	49	45
6SJ7GT	44	37	99V	35	25
6SK7GT/G	49	39	99X	35	25
6SL7GT	48	47	11Z6GT/G	89	76
6SN7GT	49	47	182B	99	89
6SQ7GT/G	44	37	1231	39	29
6SD7	49	39	1644	39	29

NATIONALLY ADVERTISED SPEAKERS ALL TERRIFIC BUYS!

3" P.M.—.68 oz Alnico V	ea. 90c
3" P.M.—1.47 oz Alnico V	\$1.15
4" P.M.—1 oz Alnico V	90c
5" P.M.—1 oz Alnico V	99c
5" P.M.—1.47 oz Alnico V	1.15
6" P.M.—2.15 oz Alnico V	1.55
8" P.M.—2.15 oz Alnico V	2.75
8" P.M.—6.8 oz Alnico V	3.69
10" P.M.—6.8 oz Alnico V	4.39
12" P.M.—3.2 oz Alnico V	4.95
12" P.M.—6.8 oz Alnico V	5.95
12" P.M.—21 oz Alnico 3 with 6V6 P.P. Output	\$7.95 complete
8" Dynamic 680 Ohms field with 6V6 P.P. Output	3.95 complete
12" Dynamic 680 ohms field with 6V6 P.P. Output	6.95 complete
12" Dynamic 1000 ohms field	5.95

POWER TRANSFORMERS All Fully Shielded.

Flush Mount	
100 mil—6.3v @ 2 amps	52.95
150 mil—6.3v @ 4 amps—5v @ 3 amps	75.0V C.T.
200 mil—6.3v @ 3.3 amps—5v @ 3 amps	81.5V C.T.

CARTRIDGES—
Brand New Stock
L70 Astatic Crystal Cartridge.....\$1.49
N7 Webster Crystal Cartridge.....1.49
Astatic Nylon Cartridge.....2.95

STANDARD BRAND VOLUME CONTROLS

Nationally Advertised
10,000 ohms V.C. with switch, 3" shaft.....45
25,000 ohms V.C. with switch, 3" shaft.....45
50,000 ohms V.C. with switch, 3" shaft.....45
100,000 ohms V.C. with switch, 3" shaft.....45
250,000 ohms V.C. with switch, 3" shaft—Tapped.....45
500,000 ohms V.C. with switch, 3" shaft—Tapped.....45
1 meg ohms V.C. with switch, 3" shaft—Tapped.....45
2 meg ohms V.C. with switch, 3" shaft—Tapped.....45

44c each

25% deposit on all orders, balance C.O.D., F.O.B. New York

SENCO RADIO, Inc.

73 West Broadway, N. Y. 7, N. Y. TELEPHONE BEEKMAN 3-6498

Edited By ELMER R. FULLER

ONLY \$89.50 IS THE COST!

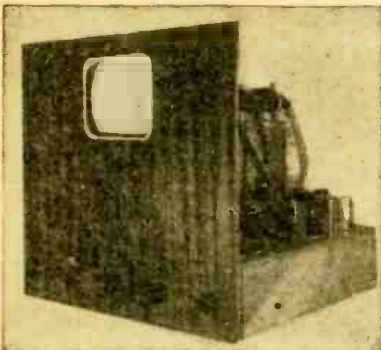

for the SENSATIONAL-NEW-IMPROVED
10 INCH

TELEVISION KIT

less tubes

Complete with 13 channel tuner, all parts and easy step-by-step following instructions and schematics.

\$89.50 less tubes

Kit complete with all tubes \$149.50
Cost of cabinet \$25.00

Using the new 13 CHANNEL TUNER which is pre-wired and factory aligned for the entire television spectrum. The kit builder merely installs this unit into his chassis and makes three connections. Contains an R.F. stage, oscillator and mixer. It is extremely small and compact. Using new I.F. coils which provide maximum gain and picture definition. Sound reception is high quality P.M. for complete listening pleasure.

SAME TELEVISION KIT—7 INCH, complete less tubes \$59.50; complete with all tubes \$99.50

IMMEDIATE DELIVERY FROM STOCK

Metropolitan ELECTRONIC & INSTRUMENT CO.
Dept. RC 42 WARREN ST. N. Y. 7, N. Y.

TECHNICAL KO's

OIL-FILLED CONDENSERS

.05 MFD	1000V	\$0.35
.05	500V	.14
.1	2500V	.75
.1	7500V	1.95
2x.1	7000V	4.10
.12	15000V	7.95
.25	1000V	.35
.25	4000V	2.15
.25	6000V	3.75
10x.25	600V	1.05
.5	600V	.28
.5	1000V	.40
.5	2000V	.75
.75	2000V	.60
.77	330VAC	.30
1.0	1000V	.45
2.0	200V	.20
2.0	600V	.40
2.0	1000V	.60
4.0	600V	.60
4.0	1000V	1.00
6.0	230VAC	.55
6.0	600V	.70
6.0	1000V	1.45
8.0	600V	.85
8.0	1000V	1.75
10.0	600V	1.00
30.0	90VAC	1.40
30.0	330VAC	3.75
25.0	25V	.40
100.0	25V	.50

TRANSMITTING MICAS

.000025	2500V	\$0.15
.00005	2500V	.15
.00005	3000V	.35
.00005	5000V	.85
.00007	2500V	.20
.00007	2500V	.20
.00025	2500V	.25
.00025	5000V	.85
.0008	2500V	.25
.00072	5000V	.85
.0008	5000V	.85
.001	2500V	.25
.0011	5000V	.85
.002	1200V	.20
.002	8000V	.65
.0025	3000V	.25
.003	2500V	.30
.003	3000V	.65
.004	2500V	.35
.005	1000V	.15
.005	3000V	.65
.006	2000V	.35
.008	1200V	.15
.01	1200V	.15

TUBES-CHOKE-POTS

Tubes—6V6 Metal	\$0.89
Tubes—12K5 Metal	.29
Choke—100MA-10H.	
250 Ohm	1.59
Pots: 20K-50K-100K	.19
Dual-1 Mex. 1/2	
Meg '250K-50K'	.30

- SHIELDED WIRE #22 50 Ft. for .65
- RESISTOR KIT Assorted 1/2 & 1W 100 for 1.49
- BATHTUB KIT 3x.1. 5. .05. ETC. 10 for .58
- CONDENSER KIT .01-.00001...100 for 2.99
- MICAS .01, .002, .005, ETC. All Values .08
- .01 150V PAPER (MIDGET) 60 for 1.00
- 0.1 600V PAPER 8 for 1.00

\$2.00 min. order F.O.B. N.Y.C. Add postage 50% deposit, balance C.O.D. with all orders. Manufacturers inquiries invited. Send for Flyer. Prices are subject to change without notice.

TECHNICAL RADIO PARTS CO.

265 Greenwich St. Dept. RC-2 N.Y. 7, N.Y.

HERE we are again with your shortwave station list, but this month we have something different for you. Our calls listed this month are few in number, but they are the ones most often heard, other than the U. S. stations, which were omitted. The stations listed can be used as check points on your dial because of their regularity of reception.

Several shortwave fans are approaching their receivers for dx reception in an unusual manner. Did you ever try concentrating your efforts on just one shortwave band, and trying constantly for dx on this one band? Try it for a few weeks, and you'll be surprised at the ones you have been missing.

Conditions during the past couple of months have not been very good from

the dx standpoint, and things do not seem very promising for the future. Reports have been very few lately, and even the few have not given much dope on schedules or frequencies. Can it be that the stations are maintaining their present schedules? The U. S. stations should be changing soon, but at this date nothing has been received regarding them.

Just how long we will publish this department only every other month is not known at present, but it is hoped that a schedule can be worked out and an announcement made regarding this matter in the next issue. If you have any suggestions for improving this department, please let your editor know of them. They will be greatly appreciated. So until next time, 73!

Freq.	Station	Location and Schedule
3.310	YVIRO	TRUJILLO, VENEZUELA; 1700 to 2130
3.370	YVIRT	MARACAIBO, VENEZUELA; 1730 to 2230
3.380	YV5RY	CARACAS, VENEZUELA; 0930 to 2230
3.390	YV4RK	MARACAY, VENEZUELA; 1800 to 2230
3.400	YV5RW	CARACAS, VENEZUELA; 0530 to 2230
3.460	YV4RP	VALENCIA, VENEZUELA; 1730 to 2130
3.460	YV4RQ	PUERTA CABALLO, VENEZUELA; 1700 to 2130
3.480	ZQ1	JAMAICA, BRIT. WEST INDIES; 1600 to 2200
3.490	YV3RS	BARQUISIMETO, VENEZUELA; 1630 to 2130
3.500	YV5RX	CARACAS, VENEZUELA; 0930 to 1400; 1530 to 2230
3.510	YV6RC	BARQUISIMETO, VENEZUELA; 1800 to 2130
3.530	YV5RS	CARACAS, VENEZUELA; 0530 to 2230
4.100	HCJB	QUITO, ECUADOR; 1800 to 2230
4.750	YV1RV	MARACAIBO, VENEZUELA; 0530 to 2130
4.770	YV1RY	CORO, VENEZUELA; 1600 to 2130
4.780	YV4RO	VALENCIA, VENEZUELA; 1630 to 2130
4.810	YV1RL	MARACAIBO, VENEZUELA; 0530 to 2230
4.810	HJBB	CUCUTA, COLOMBIA; 1700 to 2200
4.820	HJED	CALI, COLOMBIA; 1900 to 2300
4.840	YV1RZ	VOLERA, VENEZUELA; 1630 to 2145
4.850	HJCA	BOGOTA, COLOMBIA; 1900 to 2200
4.860	PRC5	BELEM, BRAZIL; 0600 to 0700; 0900 to 1100; 1530 to 2000 except Sundays
4.890	HJCH	BOGOTA, COLOMBIA; 1800 to 2200
4.920	HJAP	CARTAGENA, COLOMBIA; 0600 to 1300; 1700 to 2200
4.920	YV5RN	CARACAS, VENEZUELA; 0600 to 2230

Freq.	Station	Location and Schedule
4.950	HJQC	BOGOTA, COLOMBIA; 1000 to 1400; 1700 to 2300
4.960	HJAE	CARTAGENA, COLOMBIA; 1600 to 2230
4.990	YV3RN	BARQUISIMETO, VENEZUELA; 1630 to 2230
5.000	WWV	WASHINGTON, D. C.; U.S. Bureau of Standards; continuously day and night
5.870	HRN	TEGUCIGALPA, HONDURAS; 0800 to 1000; 1300 to 1500; 1800 to 2300
5.890	OAX4Z	LIMA, PERU; 1630 to 2330
5.950	HH28	PORT-AU-PRINCE, HAITI; 0600 to 0815; 1100 to 1300; 1730 to 2130
6.000	ZFY	GEORGETOWN, BRITISH GUIANA; 0545 to 0745; 0945 to 1145; 1415 to 1945
6.010	CJCX	SYDNEY, NOVA SCOTIA; 0530 to 2200
6.020	HJCX	BOGOTA, COLOMBIA; 0700 to 0800; 1400 to 2315
6.030	HP5B	PANAMA CITY, PANAMA; 1800 to 0030
6.040	XETW	TAMPICO, MEXICO; 0745 to 0045
6.070	CFRX	TORONTO, CANADA; 0600 to 0030
6.090	CBFW	MONTREAL, CANADA; 0730 to 1945; 2000 to 2400
6.100	PRE9	FORTALEZA, BRAZIL; 0900 to 1200; 1600 to 1900
6.100	Munich I	MUNICH, GERMANY; European beam, 1415 to 1700
6.160	HJCD	BOGOTA, COLOMBIA; 0700 to 0800
6.160	CBRX	VANCOUVER, CANADA; 0900 to 0200
6.160	HER3	BERNE, SWITZERLAND; 0245 to 0715; 1200 to 1700; 2030 to 2230
6.200	YV6RD	CIUDAD BOLIVAR, VENEZUELA; 1700 to 2315
6.240	HJCF	BOGOTA, COLOMBIA; 1700 to 2300
6.240	HIIN	CIUDAD TRUJILLO, DOMINICAN REPUBLIC; 1600 to 2230
6.280	HCJB	QUITO, ECUADOR; 1800 to 2400
6.310	HIIZ	CIUDAD TRUJILLO, DOMINICAN REPUBLIC; 1600 to 2255
7.200	Munich II	MUNICH, GERMANY; Balkan beam, 1115 to 1700



"He used to work in a restaurant."

RADIO-CRAFT for

Freq.	Station	Location and Schedule
7.300		MOSCOW, U.S.S.R.: 1300 to 1800; 1815 to 2100
7.380	HEK3	BERNE, SWITZERLAND: 1000 to 1045; 1510 to 1530
8.700	COCQ	HAVANA, CUBA: 0700 to 2330
8.830	COCQ	HAVANA, CUBA: 0530 to 0030
9.210	HIZG	CIUDAD TRUJILLO, DOMINICAN REPUBLIC: 0530 to 0830; 1300 to 1530; 1700 to 1845
9.270	COCX	HAVANA, CUBA: 0700 to 0030
9.380	OTC	LEOPOLDVILLE, BELGIAN CONGO: 0000 to 0200; 1100 to 1500
9.440	FZI	BRAZZAVILLE, FRENCH EQUATORIAL AFRICA: 0000 to 0130; 1100 to 2020
9.500	XEW W	MEXICO CITY, MEXICO: 0800 to 0200
9.540	VLR	MELBOURNE, AUSTRALIA: 0800 to 0915; 0930 to 1000; 1245 to 1415
9.540	Munich IV	MUNICH, GERMANY: East European beam, 1115 to 1700
9.550		PRAGUE, CZECHOSLOVAKIA: 1215 to 1230; 1315 to 1330; 1400 to 1430; 1445 to 1500; 1515 to 1530; 1600 to 1630; 1645 to 1700
9.550		PARIS, FRANCE: 0000 to 0130; 0715 to 0845
9.580	GSC	LONDON, ENGLAND: 1330 to 1345; 1430 to 1530; 1600 to 1615; 1815 to 2030
9.590	PCJ	HILVERSUM, NETHERLANDS: 2100 to 2200; Sundays and Wednesdays, 2200 to 2300
9.610	VLC6	SHEPPARTON, AUSTRALIA: 1000 to 1115; 1500 to 1615
9.630	CKLO	MONTREAL, CANADA: 1600 to 1800
9.670	TGWA	GUATEMALA CITY, GUATEMALA: 1830 to 2330
9.680	LRAI	BUENOS AIRES, ARGENTINA: 0800 to 2200
9.710		MOSCOW, U.S.S.R.: 2300 to 0730
9.740	OTC	LEOPOLDVILLE, BELGIAN CONGO: 1530 to 1645; 1700 to 2300
9.960	HCJB	QUITO, ECUADOR: 2230 to 2400; except Mondays; Mondays, 2300 to 0300; 0800 to 2150
11.630		MOSCOW, U.S.S.R.: 1930 to 0300; 0600 to 0800; 0830 to 1300
11.700	GVW	LONDON, ENGLAND: 2300 to 0030
11.700	SBP	STOCKHOLM, SWEDEN: 0140 to 0220; 0500 to 0650; 2000 to 2100; Sundays, 0215 to 1100
11.710	VLG3	MELBOURNE, AUSTRALIA: 0245 to 0245
11.710	HEI5	BERNE, SWITZERLAND: Mondays, Tuesdays, Thursdays, Fridays: 0215 to 0330
11.720	PRL8	RIO DE JANEIRO, BRAZIL: 0345 to 0700
11.720	CKRX	WINNIPEG, CANADA: 1000 to 2000
11.750	GSD	LONDON, ENGLAND: 2000 to 0300; 1215 to 1745
11.780		MOSCOW, U.S.S.R.: 0900 to 1000; 2000 to 2130; 2200 to 0100
11.830	CXA19	MONTEVIDEO, URUGUAY: 0600 to 2200
11.840		MANILA, PHILIPPINES: East Asia beam, 0430 to 1005
11.840	VLC7	SHEPPARTON, AUSTRALIA: 2330 to 0045; 1500 to 1615
11.840		PARIS, FRANCE: 0030 to 0130; 0145 to 0300; 1015 to 2245; 0000 to 0015
11.880		MOSCOW, U.S.S.R.: 1820 to 1930; 2000 to 2045
11.890		MANILA, PHILIPPINES: Far East beam, 0400 to 1005
11.900	XGOY	CHUNGKING, CHINA: 0400 to 0530; 0745 to 0830; 0845 to 1045
12.440	HCJB	QUITO, ECUADOR: 1400 to 2230; Mondays, 2230 to 2400
15.110	HCJB	QUITO, ECUADOR: 0500 to 1200; 1930 to 2230
15.140	GSF	LONDON, ENGLAND: 0600 to 0715; 0915 to 1015; 1030 to 1200; 1300 to 1600; 1615 to 2015; 2300 to 0100
15.170	TGWA	GUATEMALA CITY, GUATEMALA: 0730 to 1500
15.190	CKCX	MONTREAL, CANADA: 0845 to 1100; 1820 to 1935
15.230	VLG6	MELBOURNE, AUSTRALIA: 2330 to 0045; 0100 to 0145; 2200 to 2300; Saturdays and Sundays, 2100 to 2300
15.310	VLC4	SHEPPARTON, AUSTRALIA: 0245 to 0345; 0355 to 0750; 0900 to 1045
15.330		MANILA, PHILIPPINES: Indian-Parkistan beam, 0230 to 0345
17.530	FZI	BRAZZAVILLE, FRENCH EQUATORIAL AFRICA: 0000 to 0130; 0445 to 0745; 1100 to 1700
17.820	CKNC	MONTREAL, CANADA: 2345 to 0100; 0845 to 1630; 1820 to 2100

RADIO PRICES DOWN

Receiver prices are down about as far as they will go for this year, large brand-name manufacturers said recently. While some substantial cuts have been made in 1948-model prices as compared to those of 1947 sets, these were ascribed to higher production and increased manufacturing efficiency. From now on, said the makers, operating costs will keep a floor under prices.

One of the factors relieving large companies from worry about competitive price-slashing is the remarkable devotion of consumers to well-known brand names. As a result, sales of the big producers are holding up, while smaller companies are finding difficulty in making ends meet.

JULY, 1948

Just off the Press!
1948 Radolek RADIO PROFIT GUIDE



NEW COMPLETE RADIO PROFIT GUIDE FREE

RADIO REPAIR PARTS • TOOLS SOUND SYSTEMS • TUBES PHONO EQUIPMENT & SUPPLIES TEST INSTRUMENTS • ETC.

Big, new ENLARGED complete catalog showing thousands of Radio Bargains sent to you immediately. Helpful, money-saving buying information. Send coupon today!

BIG VALUES, LARGE STOCKS, FAST, DEPENDABLE SERVICE.

FREE... SEND TODAY

RADOLEK CO., Dept. C-057
601 W. Randolph St., Chicago 6, Ill.
Please send your Free Profit Guide Catalog and regular Supplements.

Name

Address

City Zone State

SAVE AT RADOLEK

McMurdo SILVER ADDS REVOLUTIONARY NEW SELECTIVITY

We use "revolutionary" advisedly. You'll agree when you add new "805" 100 kc. I.F. Amplifier to your present receiver that the phone/broadcast selectivity and noise reduction it gives are revolutionary. Less than this improvement has been described as "like nothing you've ever seen or heard before".

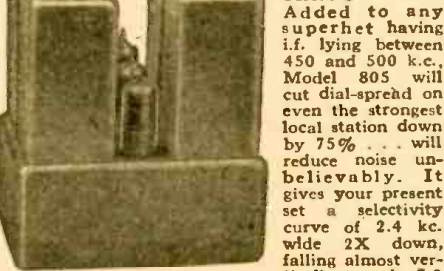

Added to any superhet having i.f. lying between 450 and 500 kc., Model 805 will cut dial-spread on even the strongest local station down by 75%... will reduce noise unbelievably. It gives your present set a selectivity curve of 2.4 kc. wide 2X down, falling almost vertically to only 7.2 kc. wide at 10,000X down—an engineering dream come true. 805 gives single-side-band selectivity, the ability to reject noises, heterodyne squeals and all ORM on one side of the signal or the other—yet get clear, crisp speech and music without deleterious side-band cutting.

Add Model 805 to your present set, and you have next year's new receiver today. Its selectivity gain-noise reduction is revolutionary.

Price, less 1 ea. 6BE6, 6BA6, 6C4 tubes \$18.90
Model 805K Kit with pictorial instructions \$15.90

OVER 37 YEARS OF RADIO ENGINEERING ACHIEVEMENT.
McMurdo Silver Co., Inc.
EXECUTIVE OFFICE: 1740 MAIN ST., HARTFORD 3, CONN.
FACTORY OFFICE: 1264 MAIN ST., HARTFORD 3, CONN.

30,000 SUCCESSFUL RADIO SERVICE-TECHNICIANS READ



EVERY MONTH

RADIO MAINTENANCE today fills a breach that has existed in the radio field for a long time. Already 30,000 technicians read RADIO MAINTENANCE every month because it is devoted entirely to the Radio Serviceman.

The RADIO MAINTENANCE staff specializes in the preparation of articles on every phase of Radio Maintenance in series form which may be filed and used for reference. The leading articles cover everything for the radio serviceman on Television, FM and AM; Test Equipment; Electronic Appliances; Tools; Antennas; Alignment; Troubleshooting; Repair; Construction; Pick-ups and Sound Amplification and Reproduction Equipment. Also, in RADIO MAINTENANCE each month there are departments on hints and kinks, the latest news of the trade, review of trade literature, radiomen's opinions, new products and news from the organizations. All articles are presented in a step-by-step precision style, clearly illustrated, with schematics, accurate photographs, specially prepared drawings, white on black charts, color diagrams, isometric projections and exploded views.

Binders in beautiful green simulated leather are now available for your RADIO MAINTENANCE magazines—see the current issue for details.

RADIO MAINTENANCE MAGAZINE RC7
460 Bloomfield Avenue,
Montclair 6, N. J.

Please send me RADIO MAINTENANCE for
 2 years, \$5 1 year, \$3
 Payment enclosed Bill me later

Name

Address

City—State

*Occupation

Title

Employed by

*Independent Serviceman — Dealer Serviceman—
Service Manager—Dealer—Distributor—Jobber.

BOLAND & BOYCE INC., PUBLISHERS

Yours FREE

150

150 NEW RADIO AND TELEVISION DIAGRAMS EXPLAINED

VALUABLE BOOK OF



Coyne's invitation to get acquainted! Send for this GREAT BOOK NOW. You pay nothing... buy nothing... it's yours FREE as a gift!

FULL SIZE, UP-TO-DATE, DIAGRAMS
Contains 150 most useful black on white RADIO AND TELEVISION DIAGRAMS—easy-to-read and understand. Shows latest Radio Circuits, including FM and Television with full instructions on how to read and use diagrams. You will also receive FIFTEEN facts on Coyne's practical pay-raising books which help radiomen and electricians get ahead on the job... earn more!

SEND FOR YOUR FREE BOOK TODAY
The supply is limited, so don't delay. CUT OUT AND MAIL THE COUPON BELOW NOW while our stock of these handy Free Diagram Books volume lasts.

Educational Book Publishing Division
COYNE RADIO & ELECTRICAL SCHOOL
500 S. Paulina Street Dept. B8-T1 Chicago 12, Illinois

CLIP COUPON AND MAIL-TODAY!

Educational Book Publishing Division
COYNE RADIO & ELECTRICAL SCHOOL, Dept. B8-T1
500 S. Paulina Street, Chicago 12, Illinois

Please rush me my FREE get acquainted gift copy of Coyne's "150 New Radio and Television Diagrams Explained." I am under no obligation to buy anything—no salesman will call.

NAME AGE

ADDRESS

CITY ZONE STATE

OCCUPATION

TIRET is Your Best Bet for Surplus

- 15E H. F. TUBE \$.75
- 15R H. F. TUBE70
- TR103Z DONGAS POWER TRANSFORMER... 2.00
- V5817 SUBMARINE 5W CHOKE 3.75
- 1.15 AMP DC—TEST VOLTAGE 5000
- 0-120—WESTON AMMETER 1.25
- 0-240 WITH SHUNT

TIRET ELECTRIC CO.
47-46 Vernon Blvd., Long Island City 1, N. Y.

FLASHLIGHT INSPECTION LAMP ASSEMBLY
WATER, VAPOR AND SHOCK PROOF
NEW—Govt. Surplus. Light up the "Hard-to-get-at" places. Fine for mechanics, electricians, radio repairmen, billing station attendants in the home and many other uses. Plastic 12" extension (6" stiff and 6" flexible). Adjustable to any angle. Originally priced over \$4.00. Our price each, with extra bulb, postpaid \$1.80



NATIONAL SURPLUS SALES CO., 723 E. 14th st. Kansas City, Mo.

OPPORTUNITY AD-LETS

Advertisements in this section cost 25c a word for each insertion. Name, address and initials must be included at the above rate. Cash should accompany all classified advertisements unless placed by an accredited advertising agency. No advertisement for less than ten words accepted. Ten percent discount six issues, twenty percent for twelve issues. Objectionable or misleading advertisements not accepted. Advertisements for August, 1948, issue must reach us not later than June 24, 1948.

Radio-Craft • 25 W. B'way • New York 7, N. Y.

MAGAZINES (BACK DATED)—FOREIGN, DOMESTIC, arts, books, booklets, subscriptions, phn-ups, etc. Catalog 10c (refunded). Cicerone's, 863 First Ave., New York 17, N. Y.

WE REPAIR ALL TYPES OF ELECTRICAL INSTRUMENTS, tube checkers and analyzers. Hazellon Instrument Co. (Electric Meter Laboratory), 140 Liberty Street, New York, N. Y. Telephone—B'rdway 7-4239.

YOU CAN ACCURATELY ALIGN SUPERHETERODYNE receivers without signal generator. Complete instructions \$1. Moneyback guarantee. Chas. Gates, Pecos 2, Texas.

LANCASTER, ALLWINE & ROMMEL, 436 BOWEN Building, Washington 5, D.C. Registered Patent Attorneys. Practice before United States Patent Office. Validity and Infringement Investigations and Opinions. Booklet and form "Evidence of Conception" forwarded upon request.

RADIOMEN, SERVICEMEN, BEGINNERS — MAKE more money, easily, quickly. \$250 weekly possible. We show you how. Information free. Merit Products, 216-32L 132nd Avenue, Springfield Gardens 13, New York.

SIX SECTIONS OF STEEL RADIO ANTENNA FOR 1400 kilocycles, slightly damaged, for sale to best offer F.O.B. Contact salvage agent S.A.L. R.R. Co., 608 W. Bay St., Jacksonville, Fla.

BUILD A SUPERSONIC OTCOMETER: AN ULTRA modern test instrument, incorporating a V.T. Voltmeter, V.T. Ohmmeter—Signal Tracer—Signal Generator—Amplifier—Auxiliary Power Supply—Speaker, Microphone and Pick-up tester, in one small portable cabinet. For complete Diagrams, Schematics, Panel Template, Chassis layout, assembly and operating instructions, send \$2 and this ad. to: Grand Federal Supply, Box 57, Argentine Branch, Kansas City 3, Kansas.

WESTERN ELECTRIC CARRIER TELEPHONE AND Telegraph Equipment and Components. Filters, repeating coil, transformers, equalizers. Types CF1, CF2, H, C, and other carrier equipment. Telephone and telegraph repeaters. Box No. RC-46. Radio-Craft, 25 West Broadway, New York 7, New York.

AMATEUR RADIO LICENSES. COMPLETE THEORY preparation for passing amateur radio examinations. Home study and resident courses. American Radio Institute, 101 West 63rd St., New York City. See our ad on Page 86.

TIE EXCHANGE—Send us one-to-six ties you're tired of and we will send you by return mail same number of beautifully cleaned attractive ties we received same way. All you pay is \$1.00 to postman upon delivery. Box 622, Pomona, California.

NEW CARTONED RADIO TUBES 39c. WRITE FOR bargain catalog. Henshaw Radio, 3313 Delavan, Kansas City, Kansas.

26 YEARS' EXPERIENCE RADIO REPAIRING AT your fingertips. I've perfected simple system you can follow step by step. No formulas or calculations. Cuts repair time to minimum. Total price \$2.00 postpaid or COD. Moneyback guarantee. Ross Radio, 14615-J Grand-trier, Detroit 27, Michigan.

\$3.00 FOR CARTOON IDEAS

RADIO-CRAFT prints several radio cartoons every month. Readers are invited to contribute humorous radio ideas which can be used in cartoon form. It is not necessary that you draw a sketch, unless you wish.

IDEAS NOT WANTED
No electrical or radio definitions wanted. Some of these were published in the past, but the subject is about exhausted.

All checks are payable on publication.

Address **RADIO CARTOONS, RADIO-CRAFT**
25 West Broadway, New York 7, N. Y.

SUGGESTS RADAR X-RAYS

Dear Editor:
The article by Mohammed Ulysses Fips on the Tubeless Homo-Heteradio (RADIO-CRAFT, April 1948) was most interesting. I don't think it is at all impossible to construct such a set.

Here is another idea for Fips to play with. I got the idea before I ever heard of radar, but now that radar is an accomplished fact, it fits in very nicely with my idea. Besides a radar transmitter, my scheme requires a source of X-rays (an X-ray tube), a photo-electric cell, and a television receiver.

Feed the X-rays from the tube into the photocell. Connect a high-gain high-power amplifier to the cell, and feed its output into the radar transmitter. Now train the combined radar waves and X-rays on a distant object, such as an airplane.

The returning waves (the reflections) are received on a radar receiver, using the same antenna as is used for transmitting—just as in standard radar practice. But note that the returning radar waves will contain some X-rays. These X-rays will have penetrated into the distant object to a depth determined by the strength of the rays.

Instead of feeding the received waves to an oscilloscope, channel them to a television receiver. On the screen will appear an X-ray picture of the inside of the airplane!

By varying the amplitude of the radar and X-rays (and the proportion in which they are mixed) it would be possible to reproduce on the television screen any object from 3 feet away to a distance of a half mile. Or for objects in the laboratory, the rays could be made to penetrate to the exact depth required, rather than using a fluoroscope, which penetrates the entire object.

There should be countless uses in medicine and in industry for the radar X-ray!

RALPH N. HUSE,
Sumner, Wash.

TREATS ALL SETS AS OWN

Dear Editor:
Unfortunately, there are quacks in every profession; in radio servicing there are a few, but enough to give honest repairmen a black eye. I notice, however, that these men are rapidly going out of business.

The pliers-and-screwdriver era is over. The tinkerer must be replaced by the well-trained professional man who uses the scope, signal tracer, and other precision instruments. I welcome licensing because it will eliminate the quacks and give the real service technician more prestige.

In my own business, my policy is to regard each receiver brought in for repair as my own—I give it my entire interest. Whenever possible, I make exact replacements of parts; and I never use "bargain" materials. I regard myself as a public servant whose mission is to bring music and enlightenment to the homes of my customers by keeping their radios in top condition.

IRVING HOROWITZ,
Niagara Falls, N. Y.

LICENSES FOR PROPRIETORS?

Dear Editor:
Speaking of licensing repairmen, why not license the proprietors of service shops, as well? Many complaints of excessive repair charges are justified because the owner of the shop, while he employs skilled men to do the actual work, is often unskilled himself. When he conforms to the popular practice of giving free estimates, he is forced to do a lot more guessing than if he were as experienced as the men he hires. A good repairman can give a pretty accurate estimate, but an estimator who is not an expert will usually quote a high price just to be safe.

OSCAR SCHECTAR,
Washington, D. C.

LESS COMMERCIALS FOR FM

Dear Editor:
Milwaukee has one FM station, which broadcasts the same programs as its AM affiliate.

FM sets were sold to people who wanted good music and other programs without much advertising. For a while, they got what they wanted; but now they hear soap operas and all the other standard AM programs.

Until we can have good programs, free of too many commercials—a one-minute commercial during each 15-minute program would be all right—FM is a dead issue here.

R. F. LANGNOR,
Milwaukee, Wis.

[FM broadcasting never has been publicized as an advertising-free medium of broadcasting. It has been hailed as offering higher fidelity and less interference. We can sympathize with dislike of soap opera and commercials, but we must point out that FM offers advantages even to listeners who enjoy soap operas. (Some people do enjoy them, strangely enough.)—Editor.]

A TEEN-AGER SPEAKS UP

Dear Editor:

I am writing to congratulate you on your most interesting editorial, *Radio as a Vocation*, which appeared in the April issue. I am studying radio and electricity at a vocational high school. Before reading the editorial I was undecided about taking up radio as a profession because I thought a college education was needed. I understand now that, though college is an advantage, it is not necessary.

I am sure many boys my age (15) have these problems about their future and their education. The problems are great because, in this atomic age, education is of vital importance to youth. Your editorial cleared up most of the problems. We will remember especially one word that you stressed: *specialization*.

DOMINICK BRUSCA,
Brooklyn, N. Y.

WANTS MORE BIOGRAPHIES

Dear Editor:

I have just finished reading the story about C. Francis Jenkins in the January issue of RADIO-CRAFT. May I congratulate you and the author George H. Clark on the manner in which this story was presented? It is a credit to the entire radio, electronics, and television field when author and publisher work together to present to the public this fine résumé of a man's life and love.

I hope to find many more similar articles in future issues of RADIO-CRAFT.
W. B. JARVIS,
The Electrolab
Vida, Oregon

CORRECTIONS

The circuit of the "Dual Test Instrument," on page 40 of the March, 1948, issue shows the pilot lamp connected between pins 3 and 7 of the 35Z5. This connection should be made between pins 2 and 3. The outside heater connections of the 35Z5 in the "Audio Amplifier," on the same page, should be to pins 2 and 7 instead of 2 and 3 as shown. The (unconnected) heater tap is brought out to pin 3.

We thank Mr. R. Privat, of Cloverdale, California, for calling this to our attention.

No values were given for the variable condensers used in the 5-Watt Transmitter, page 31 of the April 1948 issue. Condensers C1 and C2 are 50 µf and 140 µf respectively.

We thank Mr. S. J. Osterman of Rockaway Park, N. Y., for spotting this omission.

The Worcester Polytechnic Institute at Worcester, Mass., is having holes cut through doors and stairways for an experiment to measure accurately the speed of light.

Professor William B. Wadsworth who is conducting the experiment said that the speed is somewhere between 185,999 and 186,000 miles per second, but has never been precisely measured.

"We propose to find out accurately what it is," he added.

JULY, 1948

Miller
* BUILDERS OF QUALITY RADIO INDUCTIONS SINCE 1926

**NOW AVAILABLE TO THE
SERVICEMAN AND EXPERIMENTER THE
FAMOUS FRANKLIN "AIR LOOP"***

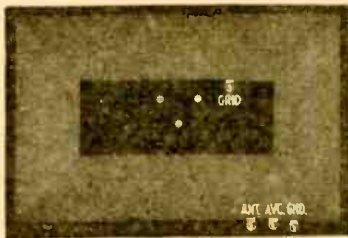

Patented construction provides highest performance and mechanical stability. Use this loop to modernize older sets and for your custom built Broadcast band receivers. "Q" in excess of 140 throughout the band.

An inductance-capacity—turns chart is packed with each loop to assist you in adjusting the loop to track with your set using any tuning condenser having a maximum of 250 to 480 uuf.

Cat. No. 703-A "Air Loop" Antenna Coil net price \$1.05.
Dimensions: 5 3/8" high X 8 1/8" wide X 1/8" thick.



The "Air Loop" is distributed nationally to the Jobber only by J. W. Miller Co.

*Mfg. by Franklin Airloop Corp. under Pat. #2,401,473

J. W. MILLER COMPANY
5917 S. Main St., Los Angeles, Calif.

Come to the Great
**SHOPS OF
COYNE**
where you learn by doing

**RADIO
ELECTRONICS—TELEVISION**
Quickly

**To Succeed in Television, You Need
All-Around Radio Training!**

Trained Radio men needed now. Get Radio training and be ready for a real future. Learn on actual equipment at Coyne. 49 years of training experience Not "Home Study". Free employment service to graduates. Many earn while learning. If you are short of money, ask about Student Finance Plan. Now added Training in Electric Refrigeration. G.I. Approved.

SEND COUPON FOR FREE BOOK

B. W. COOKE, President
COYNE ELECTRICAL & RADIO SCHOOL,
500 S. Paulina St., Dept. B8-8H, Chicago 12, Ill.
Send Big Free Book; also details about Coyne Part-Time Employment and Student Finance Plan.

NAME.....AGE.....
ADDRESS.....
CITY.....STATE.....

MAGIC BEAM

On-coming headlights of other cars automatically dim the headlights on your car with our Road Tested Magic Beam. (Photo Electric Principle). Easy to build. Operates on your car battery.

Complete kit and instructions.....\$18.00
Plans and instructions only.....1.00

Electromatic Mfg. Co.
LAWRENCE ROAD SALEM, NEW HAMPSHIRE

JULY SPECIAL

WIRE WOUND RESISTORS 450 Ohm, 10 Watt, 15 Watt, and 25 Watt
RESISTOR KITS \$1.45 10 for \$9.5 in any combination
100 assorted carbon and wire wound resistors... 1/2 to 10 watt. Wide range of values. All standard items.

CONDENSER KITS \$1.75
50 assorted paper and mica condensers... all new... good value.

Wireless Phono Oscillator \$4.52
Operates as far as 100 ft. from radio and can be used with automatic record changer and players... complete with 2 tubes all wired and tested. Diagram.

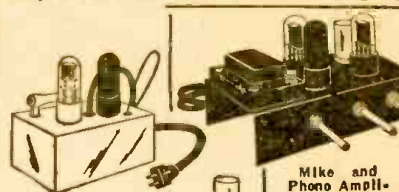

Phono Pre-Amplifier \$4.95
This unit is for G. E. Reluctance type cartridge. Completely wired, tested, Supplied with diagram, and tube 6SC7.

Mike and Phono Amplifiers \$12.95
This unit sold complete with power transformer, 3 tubes and 3 controls... all wired and tested. Diagrams supplied.

RADIO PARTS

G.E. Reluctance Cartridge. List \$7.95.....	\$4.54
4" PM Speakers.....	.95
5" PM Speakers.....	1.15
6" PM Speakers.....	1.55
5" 450 ohm dynamic Spk. with 50L6 output.....	1.95
Selenium Rectifiers—100 Ma Famous Make.....	.69
1/2 mcr. Volume Control and Sw. long shaft.....	.15
Osc. Coil 12SA7.....	.13
8 ft. line cord.....	1.89
Astastic Crystal Pickups.....	1.89
Astastic Crystal Cartridges L-70A, L-26A, L-40.....	1.59
Alliance Motor and Turntable.....	2.50

FAMOUS MAKE CONDENSERS

50x30 150V.....	\$.45	25 50V.....	\$.29
20x20 150V.....	.35	18 450V.....	.39
20x20 (10) 150V.....	.39	400V. or 600V. Per 10	
(25).....	.01 .02 .05.....		.49
8x8 450V.....	.49	.001. .002. .005.....	.49
25 25V.....	.2959

All Prices F.O.B. N.Y.C.—On C.O.D. 25% Dep.

THE ROSE COMPANY

88 West Broadway, Dept. (C) N.Y.7,N.Y.

Get Started in Radio

10 "HOW-TO-DO-IT" BOOKS



Get a solid foundation in radio by means of these 10 timely text books. Each clearly written, profusely illustrated, contains over 15,000 words. You'll be amazed at the wealth of information packed into these handy books. Excellent for reference—ideal for technical library. Your money back if not satisfied.

5 BOOKS for 50c
10 BOOKS for \$1.00
Sent to You Postpaid

- No. 1—How To Make Four Doodie Short Wave Sets
- No. 2—How To Make The Most Popular All-Wave 1 and 2 Tube Receivers
- No. 3—Alternating Current for Beginners
- No. 4—All About Aerials
- No. 5—Beginners' Radio Dictionary (Leading Terms)
- No. 6—How To Have Fun With Radio
- No. 7—How To Read Radio Diagrams
- No. 8—Radio for Beginners
- No. 9—Simple Electrical Experiments
- No. 10—Television

Remit by check or money order—register letter if you send cash or stamps.

RADIO PUBLICATIONS

25A West B'way. New York (7)

**STOCK REDUCTION CLOSE-OUTS
Last Time Offered**

Terrific Savings! Buy at Distributor Cost!

Your Cost	Distributor Cost
637 Jackson Tube Tester.....	\$67.50
640 Jackson Tube Tester.....	40.00
642 Jackson Tube Tester.....	50.00
643 Jackson Tube Tester.....	60.00
645 Jackson Tube Tester.....	40.00
650A Jackson Tube Tester.....	42.00
2413 Triplet Tube Tester.....	\$2.99
3212 Triplet Tube Tester.....	35.00
625N Triplet Volt OIM Milliammeter.....	60.00
2450 Triplet Volt. OIM Milliammeter.....	42.00

Also Mikes, Audio Amplifiers, Servos, Condensers and Resistors at Extremely Low Prices. Prior orders will get preference. All shipments 25% deposit with order, balance C.O.D. F.O.B. St. Louis, Missouri.

CREST CORPORATION

Dept. C-2, 3949 Forest Park Blvd., St. Louis 8, Mo.
Write for our complete catalog on Radio Parts and Equipment.

"Communications"

ARC-5 ACCESSORIES

Conversion Coils for Arc-5 Transmitters

M.O. Coils	P.A. Coils	Antenna Coils	Freq. Range
\$1.00 ea.	\$1.00 ea.	\$3.85 ea.	
# 6029	# 7247	# 6033	3-4 mc.
# 6030	# 9293	# 6034	4-5.3 mc.
# 6032		# 6035	7-9.1 mc.

CONVERSION KIT, consisting of 1-M-O coil, 1-P.A. coil, 1-ANTENNA COIL, in any one particular frequency range.....\$2.00
 Single Revr Mtg. Racks.....\$1.00. Dual.....\$1.50
 Single Revr Shock Mts. For Racks.....\$1.00. Dual.....\$1.00
 Dual Revr Control Boxes.....ea. \$1.00
 Modulation Trans. ARC #9466, bush pull 807's to Plates and screens of 2 807's in Parallel.....\$1.65

VARIABLE AIR CAPACITORS

2 sect. 365mmf/sec, with cable drive wheel attached.....\$3.95
 7 sec. 1-75 mmf. 4-1000 mmf. 2-200 mmf. Vernier rt angle drive. 60:1. Size: 1 1/2" x 3" x 3". Completely shielded.....\$3.25
 ARC No. 8558 variable receiving capacitor, 62 mmf/section, 3 sections. .03" spacing, 8 rotors. Worm drive ratio 33:1.....\$1.75
 ARC No. 4990 variable xmtg. capacitor, 22.4-145 mmf. .05" spacing, 11 rotors. Each.....\$1.00
 ARC 5032 Var. Xmtg. capacitor, 29.2-117 mmf. .06" spacing, 16 rotors, worm drive, 96:1.....\$1.00

CATHODE RAY TUBES

5BP1.....\$1.20

 3BP1-\$1.25.....5FP7-\$1.75
 3FP7-\$1.20.....5JP2-\$4.00
 5" CR Tube Viewing Hoods, leather.....\$1.75

POWER TRANSFORMERS

#5108: Pri: 117 v, 60 cy. Sec: 50 or 46 v, 200 ma. 5 v @ 2.4 amps, 5 v @ 1.2 amps.....\$2.50
 #5111: Bias Xfmr: Pri: 117 v, 60 cy. Sec: 300 v @ 42 ma, 55 v @ 125 ma, 45 v @ 35 ma.....\$2.45
 Plate Transformer, Amertran. Pri: 117 v, 60 cy. 1 Phase. Sec: 17,000 v, 144 ma. Oil-immersed and in case. With choke, 250 h, 100 ma. Oil immersed, 26"x29"x13".....\$65.00
 Step-Down or Isolation Xfmr. Amertran. Pri: 440/250/110 v.a.c., 60 cycles. 3KVA; Sec: 115 volts, 2500 volt insulation. Size 12"x12"x7".....\$40.00

FIL. TRANSFORMERS

Pri: 115 v, 50 to 60 cy. Sec: 6.3 v, 6.6 amp CT. \$2.65
 Pri: 117 v, 60 cy, sec: 4 v, 16 amps, 2.5 v, 1.75 amps.....\$3.50

24-VOLT AUTO-TRANSFORMER. Input: 117 v, 60 cy. Output: 24 volts, 5 amps. Size: 5"x3"x4 1/2". Term. sealed.....\$3.25
UNIVERSAL PLATE XFMR: Input: (Using vibrator) 6, 12, 24, 110 v. or 110/220 v., 60 cy. Sec: 420 vct. 30 ma. 6.3 v., 0.9 amp. 4"x4 1/2"x3". Completely shielded.....\$2.50
POWER PAIR: Trans & choke. Xfmr. pri.: 117 v, 50-60 cy. Output: 470 vct @ 60 ma, 6.3 v. @ 1.65 amp, 5 v @ 2 amp. PLUS a 6 by @ 50 ma choke.....\$1.75

POWER CHOKES

6 Hy @ 300 ma.....\$3.25
 Dual Choke: 2-2 Hy @ 10 Ma.....\$1.75
 Dual Choke: 7 Hy @ 75 Ma. 11 Hy @ 60 Ma.....\$1.50
 8.5 h @ 125 ma.....\$1.50
 25 h @ 65 ma.....\$1.10
 5 Hy, 40 ma, 312 ohms, 2,000 v test. 2"x2"x1 1/2". \$5.65
 2 Hy, 200 ma, 102 ohms, 2,500 v test.....\$5.85

OIL CONDENSERS

.1 mfd, 10 KVDC, GEPYR #14F101.....\$15.00
 .06 mfd, 15 KVDC, GEPYR 25F585-G2.....8.70
 1.5 mfd, 6000 vdc, Aerovox.....12.50
 .25 mfd, 20,000 vdc.....17.50
 .5 mfd, 2000 vac, 180 cy, GEPYR 25F640.....1.75
 10 mfd, 1,000 VDC.....1.75
 3x10 mfd, delta connected synchro-capacitor, 90 v, 60 cycles, GE.....4.95
 .1 mfd, 6000 vdc, GEPYR 25F509G2.....3.85

RELAYS

SD #TD97-1. SPDT, contacts: 12v, 1 amp, 30 sec thermal delay, operates from 12 vdc.....\$1.45
 Wheelock DPST (norm open) 5-7.3 v, 60 cycles, Contacts: 110v, 60 cy, 10 amps.....\$2.35
 4PST (Norm. open), 75 vdc, Contacts: 115 vdc, 4 amp contact SD#8dXX108.....\$1.75
 SPDT, 24 vdc, 9000 ohms, Contacts 1 amp, 115v, balanced armature type, Allied Control.....\$1.15
 SPDT, 115v, 60 cy, 4000 ohms, Contacts: 5 amp, 50 v Kurman #2221-90.....\$1.95
 DPDT, 22-28 vdc, antenna changeover, Leach 1077-BF.....\$1.15

MINIATURE TYPES

4PDT, 22-28 vdc, 350 ohms.....\$5.65
 4PDT, 22-28 vdc, 300 ohms DCR......55
 DPDT, 22-28 vdc, 300 ohms......45
 6PST, 22-28 vdc......60

A complete line of Western Electric Telephone Relays in stock. Send for Complete Listing.

All merchandise guaranteed. Mail orders promptly filled. All prices, F.O.B. New York City. Send Money Order or Check. Shipping charges sent C.O.D. Rated concerns send P.O.

COMMUNICATIONS EQUIPMENT CO.

131-C Liberty St., New York City 7, N. Y. Digby 9-4124

THAT TUBELESS HOMO-HETERADIO!

Dear Editor:

Unless RADIO-CRAFT prints this letter in their next issue, it is very possible that they may have a serious law suit on their hands. In the article by Mohammed Ulysses Fips, I.R.E.I.R.E. the sin of omission has been committed and in this case it is a very serious error. In the diagram at the bottom of page 22 in the April issue the polarity of the battery connections for the Tubeless Homo-Heteradio is not indicated. This is a grave omission.

I have constructed the T.H.H. and have found that when the motor rotates in a counterclockwise position the apparatus functions perfectly. But when the battery connections are reversed and the motor operates in a clockwise direction supersonic vibrations of high intensity are generated along with waves from the 57th and 61st octaves. These waves may be lethal to the experimenter. Fortunately, I have a receiver with a crystal squelch circuit in the same room as the T.H.H. The crystal absorbed these vibrations and saved me from a fate that I would rather not discuss. For the sake of the many radiomen who do not have crystal

squelch circuits available I recommend that RADIO-CRAFT make it very clear

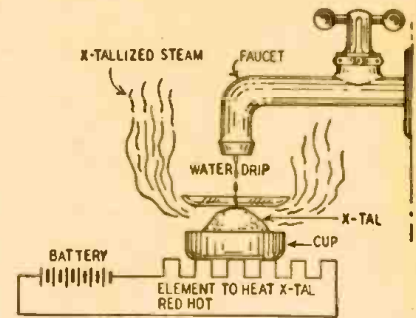

Crystal squelch circuit for Homo-Heteradio.

that the motor of the T.H.H. must be operated in a counterclockwise direction.

HOWARD L. FUNK,
Lynchburg, Va.

P.S. Except for this omission, I think that your magazine is tops.

P.S.S. In a second model of the T.H.H. I added one stage of amplification using a 4T1 tube and an electret for a power supply.

HOMO-HETERADIO ERRORS CORRECTED

Dear Editor:

Having been much impressed by the Tubeless Homo-Heteradio in your April issue, some of the boys in the lab decided to construct this fine example of post-war design. After taking the parts to a specially-built laboratory for tryout, we found several discrepancies in Fips' calculations, which caused us no end of trouble. Here are the corrections for the

table of vibrations, as verified by several universities and a number of 2500-tube electronic calculators:

The receiver is now operating satisfactorily and many new discoveries have been made. Its most outstanding accomplishment has been the prediction of the name of our next president.

JOHN J. DOE
Willawaa, Iowa

Octave	Original	Correction
20	1,047,576	1,048,576
46	70,368,744,177,644	70,368,744,177,664
47th	140,737,468,355,328	140,737,488,355,328
62nd	4,611,686,618,427,389,904	4,611,686,018,427,387,904

TABLE

A FEW IMPROVEMENTS ON FIPS

Dear Editor:

Your article on the Tubeless Homo-Heteradio by Mohammed Ulysses Fips in the April issue interested me greatly. For the past 20 years I have searched for a perpetual motion machine. Your radio, coupled to such a machine, would be the ultimate in receiver design because it would take no power—not even the siren-driving battery would be necessary. In addition, automatic tuning and a.v.c. might be added to your set by means of a slipping clutch.

I have attempted construction of a Heteradio, following your design but adding some improvements of my own. To avoid frequency drift, I used a synchronous 3600-r.p.m. motor for the siren. Varying the motor speed was obviously impossible, so to tune the set I provided push-button tuning by connecting 5 sirens to the motor through individual gear trains. The largest gear wheel is 23 3/4 feet in diameter and has 1731 1/2 teeth. The half tooth gives an

audible click with each revolution, which could be eliminated by increasing the gear diameter to 47 1/2 feet; I felt, however, that this would be a bit clumsy.

To accommodate the set and the battery-driven crystal-controlled power supply I built for it, I rented an unused airplane hangar, as the house was just slightly too small. For some reason, my wife decided to divorce me at about that time. I have been too busy to ask her just why.

Since increasing the size of the horn should increase the amount of pickup, I based my horn dimensions on the Mt. Palomar telescope lens. I mounted it atop the hangar and connected it to the receiver by means of a long stove pipe. Standard wave guide practice was followed rigidly. I placed several metal lenses in front of the antenna and had to brace the roof. A new assembly of motors and generators was purchased to rotate the assembly.

I find that when I turn on the various

RADIO-CRAFT for

machines, there is so much noise I cannot hear the stations I tune in. This, however, should be cured by acoustic redesign of the rooms.

The cost to date is in the neighborhood of \$37,000, but I feel I am well on the way to a commercial design. I will keep you informed about my progress and I am sure we can come to an agreement on patent rights which will allow us to follow together the rising star of the Fips Heteradio.

W. G. MURRAY,
Ottawa, Canada

A HOLLAND EXPERIMENTER

Dear Editor:

Here are pictures of a 12-tube oscilloscope and a 16-tube receiver I built. The scope contains r.f., a.f., and f.m. generators, horizontal and vertical amplifiers, sawtooth oscillator, and 3 rectifiers.

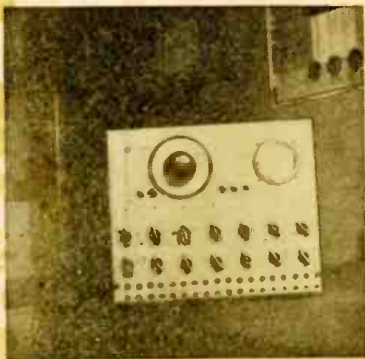

The oscilloscope's panel layout is neat.

The receiver line-up includes r.f. amplifier, mixer and oscillator, two i.f. stages, crystal filter, a.v.c. amplifier,

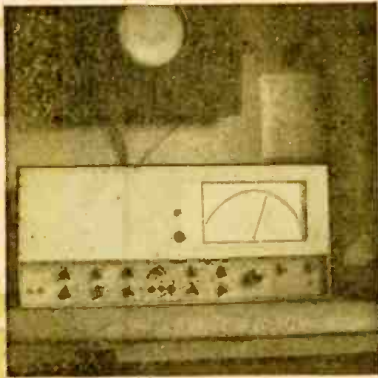

Receiver uses two separate power supplies.

noise suppressor, a push-pull output stage, and two rectifiers with voltage regulators.

A. A. BOSSCHART,
Delft, Holland

Matched units which would permit a customer to buy a radio-phonograph combination and televiser in two units were announced recently by Admiral Corporation and Hallcrafters. Thus the home radio-televiser can be purchased a piece at a time, as finances become available. The two-unit equipment is also a safeguard against obsolescence, as either the radio or the televiser can be replaced independently.

10 RADIO BOOKS TO KEEP YOU POSTED 50c EACH

RADIO-CRAFT LIBRARY

Why be hazy about some phases of radio construction and servicing when you can master them so easily with these low-priced books? The 10 volumes in the RADIO-CRAFT LIBRARY are the building blocks of education you need to construct a worthwhile career. They are as practical as your soldering iron and screwdriver. Written in simple language with plenty of illustrations. Large type, smart modern flexible covers. Everything about them helps to make learning a pleasure.

No. 29—HANDY KINKS AND SHORT CUTS. A carefully edited compilation of time savers. Kinks on Antennas—Power Supplies—Test Equipment—Servicing—In the Shop—Phonographs and Amplifiers—Coils and Transformers—Miscellaneous.

No. 30—UNUSUAL PATENTED CIRCUITS, 1944-1946. A selection of unusual circuits of great value to anyone interested in electronics. Control Circuits—Detectors and Amplifiers—Power Supplies—Miscellaneous Circuits—Paradox Circuits.

No. 31—RADIO QUESTIONS AND ANSWERS. Answers to most frequently asked questions. Clear schematics. Amplifiers—Receivers—Transmitters—Meters and Test Equipment—Interphones—Power Supplies—Phono Amplifiers—P. A. Systems.

No. 32—ADVANCED SERVICE TECHNIQUE. Visual Alignment—Tracking Problems—Negative Feedback—Tone Control Circuits—Adding Microphones to Sets—Matching Loudspeakers—Remote Juice Boxes—Servicing Record Changers—Hum Elimination—FM Servicing.

No. 33—AMPLIFIER BUILDER'S GUIDE. Tells how to build a wide variety of amplifiers. Detailed design information on: Push-Pull—Phase Inversion—Bass and Treble Boosters—Volume Expanders—Resistance Coupling—Internal Feedback.

No. 34—RADIO-ELECTRONIC CIRCUITS. Intercommunications Systems—Power Supplies—Balancing circuits—V.T. Voltmeters—Amplifiers—Receivers—Phono Amplifiers—Short Wave Adaptors—Electronic Relays.

No. 35—AMATEUR RADIO BUILDER'S GUIDE. Tells you how to Build: A 2 Meter Band Acorn Tube Set—Miniature Communications Receivers—Long Lines Transmitter—Beginner's Transmitter—Preselector—Rotary Beam Aerial—Power Supplies, etc.

No. 36—RADIO TEST INSTRUMENTS. A MUST for every radio man. Signal Tracers—capacity Meters—Portable and Bench Multi-checker—Signal Generators—Tube Checkers—Electronic Voltmeters—and many others.

No. 37—ELEMENTARY RADIO SERVICING. Planning the Service Shop—Equipping the Shop—Systematic Circuit Checks—Signal Tracing Methods—Servicing the Midget—Soldering—Servicing Volume Controls—How to Service Speakers.

No. 38—HOW TO BUILD RADIO RECEIVERS. This book contains a sufficient variety of sets to appeal to every radio fan. Includes: Short-Wave, Broad-band, Portable A.C. Operated, Miniature and Standard Receivers. Complete coil-winding data.

DEALERS! WRITE FOR QUANTITY PRICES

MAIL THIS COUPON

RADCRAFT PUBLICATIONS, Dept. R-C78
25 West Broadway, New York 7, N. Y.

Send me the volumes (50c each, postpaid) checked.

All 10 Books

I enclose \$..... 29 34

30 35

Your Name..... (Print Clearly) 31 36

Address..... 32 37

33 38

TUBULAR ELECTROLYTICS

Fresh stock Fully guaranteed

20 mfd. 150 V. 10 for \$1.79

20-20 mfd. 150 V. 10 for 2.49

8 mfd. 450 V. 10 for 1.85

Postage extra, 25% deposit on COD.

Write for our free bargain lists featuring "AMERICA'S BEST BUYS"

POTTER RADIO CO.
1312-1314 McGee St. Kansas City 6, Mo.

WANTED:

WILL PAY \$1.00 PER COPY

for the following copies

OFFICIAL SHORT WAVE LISTENER MAGAZINE

• June-July 1935 • April-May 1936

Copies must be in good condition.

Radio-Craft, 25 West Broadway, New York 7, N. Y.

TELEVISION I.F. KIT

Video and Sound I.F. System, including Peaking Coils

- Stagger tuned
- Hi-Definition Picture
- 4 Mc band width
- Sound rejection 150 to 1
- Adjacent channel rejection 100 to 1

COMPLETE
\$1377

CONDENSERS

Per Hundred	Each
.001-600V \$3.95	50-150V35
.01-600V 4.40	40/40/20-150V,25V .44
.05-600V 4.95	50/30-150V44
.1-600V 7.20	8-450V27
	16-450V36
16-150V24	16/16-450V59
20-150V25	20-450V39
20/20-150V29	30-450V47
30-150V28	40-450V54

RADIO TUBES—KNOWN BRANDS—BULK

	Each
80, 5Y3GT, 5Y4GT, 6C4, 9002	\$.42
35W4, 25Z5, 25Z6GT, 35Z5	.45
6F5GT, 6J5, 6SA7, 6SK7, 6SQ7	.47
36, 37, 77, 78, 6H6	.49
12AT6, 12BA6, 12BE6, 12SQ7	.49
12SA7, 12SK7, 6F6GT, 75	.49
6J7, 6K7, 6Q7, 6SF5, 6SN7	.55
35A5, 35L6, 50B5, 50L6	.55
43, 6A7, 6A8, 25L6, 1H5GT	.59
0Z4, 6X5GT, 7F7, 7N7, 7Y4	.65
1A5GT, 1A7GT, 1T5GT, 1N5GT	.74
1S4, 1R5, 1S5, 1T4, 3Q4, 3Q5	.79
14A7, 14B6, 14Q7, 35Y4, 3S4	.95
1LN5, 6AC7, 6L6G, 70L7	.95
1LC6, 1LH4, 1LA6, 117Z3, 117Z6	.95
25A6G, 117L7GT, 117P7GT	1.35

FM CONDENSER & COIL KIT

(88 to 108 Mc)

- Variable Condenser
- Discriminator Coil
- Oscillator Coil
- Two I.F. Coils
- Limiter Coil
- Antenna Coil
- Schematic Diagram
- Instructions

This Kit contains the vital parts needed to build an FM Tuner or Radio and for modernizing Pre-War FM Sets; all other parts needed are standard.

\$495

BROOKS RADIO DIST. CORP.
80 Vesey Street, Dept. A, New York 7, N. Y.

WAR SURPLUS BARGAIN SPECIAL!

Brand New BEAM ANTENNA ROTATOR MOTOR

\$595

Postpaid in Continental U.S.A.

- OPERATES DIRECTLY ON 110V AC, 60 CYCLES (Requires only 12 MFD Condenser)
- NO STEP-DOWN TRANS. NEEDED
- NO LINE RESISTOR NEEDED
- HIGH TORQUE — NO FREE SWING
- APPROX. 3/4 R.P.M.
- REVERSIBLE — ONLY THREE WIRES NEEDED
- ELECTRICALLY & MECHANICALLY QUIET
- LIGHTWEIGHT, RUGGED, QUIET
- MOTOR & GEARS OIL SEALED
- NO EXPENSIVE CONVERSIONS
- FLAT MOUNTING SURFACE — FOUR TAPPED HOLES
- FB. FOR 2-6-10-LITE 20 BEAMS

ALVARADO SUPPLY CO.
Dept. RC1, 903 So. Alvarado
Los Angeles 6, California

A Beautiful Cabinet To Double The Value Of Your Chassis!

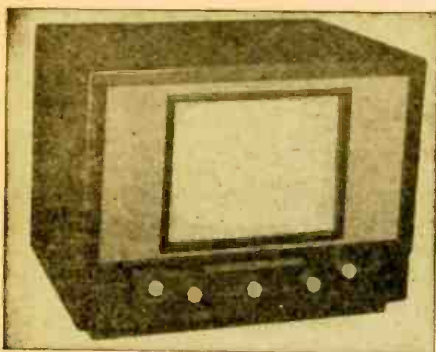

Specially Designed For Your "Transvision" Kit (12" and 15" Standard Models)

A hand-crafted cabinet made of the best 3/4 inch walnut and mahogany, for the custom-finished who seeks to give his set the advantage of commercial styling combined with exclusive construction. Dimensions: 29 1/2 inches wide, 21 inches high, 20 inches deep.

INCLUDES THESE BETTER FEATURES:

- 8 inch Rola P. M. speaker for natural tone
- Specially built milk-white Lucite mask, curved to fit 12" picture tube—protected with safety glass.
- Conveniently located slide switch operates concealed illumination for Lucite printed dial and jewel-covered light in base.
- English design recessed base—felt cushioned.
- Thoroughly ventilated for heat dissipation.

IT'S THE "NEW LOOK" FOR THE COMMERCIAL BUILDER!

This highly polished cabinet comes to you completely assembled, drilled for shafts, wired and ready for your chassis. Nothing else to buy. Furnished complete with step-by-step instructions and following kit of parts to complete installation of chassis: pin jacks, plugs, onyx catalin knobs (6 plain, 1 with pointer), special low-loss antenna block, assembly to raise CR tube, masonite back-board drilled for ventilation, heavy stack output transformer, fuse holder, strap for CR tube, caution labels, nuts, washers, bolts, screws.

12" MODEL	WALNUT OR MAHOGANY (BLOND WAH. \$10 ADD.) Available for both 5 and 7 shaft chassis	15" MODEL
\$79		\$89

F.O.B. B'klyn, N. Y. Terms: 10% with order, balance C.O.D. Order direct or thru distributor

Write for information on cabinets designed for use with "TELEVISION ASSEMBLY" Units.

TEL-CRAFT COMPANY

108 HAVEMEYER STREET
BROOKLYN 11, N. Y.



Learn ELECTRIC MOTOR REPAIR

at home . . . in spare time

Based on what can be learned from this big ELECTRIC MOTOR REPAIR book you can train quickly for profitable repair, installation and maintenance service on practically any electric motor! Explains motor trouble diagnosing, repair and re-winding. Covers A-C and D-C motors, synchronous motors and generators, etc., also motor control systems. Quick reference guides show how to handle specific jobs. Contains over 900 special pictures and diagrams.

ONLY \$5 for the complete training. 560 pages 900 illustrations

TRAIN FOR GOOD PAY IN AN UN-CROWDED FIELD!

SPECIALIZE IN "SOMETHING DIFFERENT!"
Send \$5 (\$5.50 foreign) cash or money order for ELECTRIC MOTOR REPAIR, or we will ship C.O.D. (in U.S.A. only) and you can pay postman. IF NOT MORE THAN SATISFIED, return book within 5 days and your \$5 will be refunded promptly.

Dept. RC-78 MURRAY HILL BOOKS, Inc.
232 Madison Avenue New York 16, N. Y.

Please say you saw it in **RADIO-CRAFT** when writing to advertisers

HARD-TO-GET PARTS

POWERFUL ALL-PURPOSE INDUCTION MOTOR

IDEAL FOR EXPERIMENTERS—101 USES



Sturdily constructed to precision standards, this fascinating shaded pole A.C. induction motor is powerful enough for a number of uses. Some of these are: Automatic Timing Devices, Current Interrupters, Electric Fans, Electric Chimes, Window Displays, Photo-cell Control Devices, Electric Vibrators, Small Grinders, Buffers and Polishers, Miniature Pumps, Mechanical Models, Sirens, and other applications.

Consumes about 15 watts of power and has a speed of 3,000 r.p.m. When geared down, this sturdy unit will constantly operate an 18-inch turntable loaded with 200 lbs. dead weight—THAT'S POWER!
Dimensions 2" high by 2 1/4" wide by 1 1/2" deep; has 4 convenient mounting studs; shaft is 1/8" long by 3/16" diameter, and runs in self-aligning oil-retaining bearings. Designed for 110-220 volts, 50-60 cycles, A.C. only. Shp. Wt. 2 lbs.
ITEM NO. 147
YOUR PRICE **\$2.95**

ULTRA MAGNET

LIFTS MORE THAN 20 TIMES ITS OWN WEIGHT
LITTLE GIANT MAGNET

Lifts 5 lbs. easily. Weighs 4 oz. Made of ALNICO new high-magnetic steel. Complies with specs. World's most powerful magnet ever made. The experimenter and hobbyist will find hundreds of excellent uses for this high quality permanent magnet. Measures 1 3/4" x 1 1/2" Shp. Wt. 3/4 lbs.
ITEM NO. 159
YOUR PRICE **\$1.50**



GENUINE MICROPHONE TRANSMITTERS

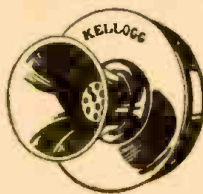

Regular telephone transmitters taken from a large telephone supply company's overstock. Work perfectly on 2 dry cells. Can be used on 110 volt. a.c. systems, call systems, inter-communications, a e t s, short-line telephone circuits, house-to-house or farm-to-farm phone lines. Use to talk through your own radio or as concealed dictaphone pick-up. Use study requirements on battery-operated rural telephone lines.

THESE ARE GENUINE TRANSMITTERS, MADE BY KELLOGG, WESTERN ELECTRIC AND STROMBERG-CARLSON, excellent in appearance and operation. Available in large quantities and one seldom offered in these times. Shp. Wt. 1 lb.
ITEM NO. 160
YOUR PRICE **\$1.95**

WATTHOUR METER



Completely overhauled and ready for immediate service. Designed for regular 110-volt, 60 cycle 2-wire A.C. circuit. Simple to install; 2 wires from the line and 2 wires to the load. Sturdily constructed in heavy metal case, 8 1/2" high, 8 1/2" wide, 4" deep. Selling house, G. E. Ft. Wayne, Sangamon, remarkable value and durable. Shp. Wt. 14 lbs.
ITEM NO. 33
YOUR PRICE **\$6.95**

AMAZING BLACK LIGHT!!

Powerful 250-Watt Ultra-Violet Source



The best and most practical source of ultra-violet light for general experimental and entertainment use. Makes all fluorescent substances brilliantly luminescent. No transformers of any kind needed. Fits any standard lamp socket. Brings out beautiful phosphorescent hues in various types of materials. Swell for amateur parties, plays, etc., to obtain unique lighting effects. Sub. only. Shp. Wt. 1 lb.
ITEM NO. 87
YOUR PRICE **\$2.50**

WESTERN ELECTRIC BREAST MIKE

This is a fine light-weight aircraft carbon microphone. It weighs only 1 lb.

Mike comes with breastplate mounting and has 2-way swivel-ink adjustment so that it can be adjusted to any desired position. There are 2 woven straps; one goes around neck, the other around chest. Straps can be snapped on and off quickly by an ingenious arrangement.

This excellent mike can be adapted for home broadcasting or private communication systems. By dismounting breastplate, it can be used as desk mike.

Comes complete with 6-foot cord and hard rubber plug. Finished in sherdardized plate, non-rustable. Shipping weight, 2 lbs.
ITEM NO. 152
YOUR PRICE **\$1.49**



HUDSON SPECIALTIES CO.

40 West Broadway, Dept. RC-7-48, New York 7, N. Y.

I have circled below the number of the items I'm ordering. My full remittance of \$ is enclosed (NO C.O.D. ORDERS UNLESS ACCOMPANIED WITH A DEPOSIT.)

On my deposit of \$ is enclosed (20% required), ship order C.O.D. for balance. NO C.O.D. ORDER FOR LESS THAN \$5.00. BE SURE TO INCLUDE SHIPPING CHARGES.

Circle Item No. wanted:

147 159 160 87 152 33

Name

Address

City

State

City

Book Reviews

CLAROSTAT SERVICE MANUAL (7th edition), published by Clarostat Manufacturing Co., Inc. 8 1/2 x 11 inches, 127 pages. Price fifty cents.

Servicemen can refer to this manual when selecting replacement tone and volume controls for receivers. Models are listed numerically in a column under the manufacturer's name. Adjacent columns contain original part numbers, catalog number of Clarostat replacement control and switch if one is used, total resistance in control, application and installation notes including circuit alterations where necessary.

MATHEMATICS FOR RADIO ENGINEERS, by Leonard Mautner. Published by Pitman Publishing Corporation. Stiff cloth covers, 9 1/4 x 6 1/2 inches, 319 pages plus index. Price \$5.00.

More and more radio technicians are beginning to realize that the screwdriver and the soldering iron ought to be backed up by a good theoretical knowledge of the equipment worked on. Especially with today's increasingly complex television and FM receivers, high-frequency heating, and other developments, a mathematical analysis of circuits is highly desirable.

This book takes the reader with a knowledge of basic algebra up through calculus. Designed to be used either as a home-study course for those without previous knowledge of higher mathematics or as a refresher for the graduate engineer, the text presents the work in a step-by-step fashion, and throughout, integrates it directly with electronics by using actual circuits as examples.

The 11 chapters begin with a review of fundamentals, circular trigonometric functions, complex algebra, and hyperbolic functions. From here, the author proceeds to higher mathematics, from differential calculus to the Fourier series.—R.H.D.

VIBRATOR POWER SUPPLY DESIGN (Fundamental Principles of). Compiled and published by P. R. Mallory & Co. Flexible fiber covers, 6 x 9 inches, 136 pages. Illustrated. Price \$1.00.

Theory and practical description of vibrator power supplies for radio sets, together with design data, formulas, and graphs for the student and engineer are included in this useful handbook. The opening chapters illustrate the circuits and action of vibrator power units, leading up to the basic structure of the vibrator, standard vibrators, and preliminary design considerations.

Basic power transformer characteristics are next discussed. A number of valuable charts are included, among them iron core-loss graphs, wire tables, and d.c. magnetization curves for various grades of transformer steels.

Examples of typical vibrator transformers are given, showing the application of the formulas and tables. Closing chapters deal with timing condensers, with numerous oscillograms to illustrate various adjustments of the vibrator, and the use of different-size condensers; in-

terference elimination; vibrator power-supply connections; inspecting and servicing of vibrators.

Anyone interested in this class of power supply will find this book useful, as it brings into one compact volume the essential data required for a thorough understanding of these often misunderstood devices.—H.W.S.

TRANSFORMERS — PRINCIPLES AND APPLICATIONS. By Carl H. Dunlap, W. A. Siefert and Frank E. Austin. Published by the American Technical Society. Cloth covers, 5 3/4 x 8 1/2 inches, 278 pages. Price \$2.75.

A book for the practical man, with sufficient mathematics to provide a thorough understanding of transformers and how they work. The work is divided into three sections: Construction—Theory, Connections and Operation—The Design of Small Transformers. Specially drawn diagrams help to make clear the action occurring in a transformer. Core and shell types are described and the text leads up to an explanation of the current and voltage relations in the transformer. The various iron and copper losses are explained, as well as the means of calculating these losses.

The closing section deals with the design of small transformers, including a 1,000-watt, 110-10,000-volt type, and one of 750 watts, for stepping down 110 volts to 10 volts. A section covers the checking of polarity and phase relations.—H.W.S.

BROADCAST OPERATORS' HANDBOOK by Harold E. Ennes. 5 1/2 x 8 3/4 inches, 265 pages plus index. Published by John F. Rider Publisher, Inc. Price \$3.30.

The duties of a broadcast operator are described in this book. Inclusion of studio, field, and transmitter work makes the description rather complete. The writer uses as examples the operation of several of the larger stations. While this adds interest for the reader unfamiliar with broadcasting, the information would be familiar to any technician far enough advanced to be employed by this class of station. The book will suffice to show the novice the problems he will encounter in his future work, but is of less value to the technician of medium experience.—R.H.D.

You Can Now Become A Prospector!

Here Is One Of The War's Top Secrets

BRAND (NEW) ARMY MINE DETECTORS!

Portable: Will Detect METALLIC and NON-METALLIC objects; Very Sensitive; using 955 Tube in detecting head; two tube amplifier using two 1N50t; headset; or microphone; also 150 micro meter; Power supply; 3-45-v.; one 6-v.; or 2 3-v. batteries. Complete with Instr. Less Batteries; packed in original case; ship. wgt. 108 Lbs.



F.O.B. from N. Y.

\$17.50

(Less Batteries)

\$26.40

With Batteries

F.O.B. N.Y.

NO C.O.D.

Send Order to

COLUMBO TRADING CO., INC.

304 Canal St., Dept. RC2, New York 13, N. Y.

EXCITING! EXCITER BARGAIN

25 to 40 WATTS

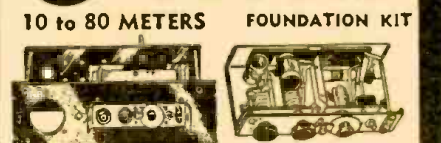

Engineered around the BC-610 series of plug-in tuning units. Described in the 11th edition Radio Handbook. Completed exciter uses GAG7 crystal or electron coupled oscillator, 6L6 buffer-doubler and 807 amplifier. Kit includes four tuning units (illustrated at right above with cover removed), special 5/4" aluminum relay rack panel, sockets for plug-in units and special hardware, together with full instructions and diagrams for assembling complete exciter. No. 31A28, FU-40 Foundation, Spec. **\$9.95**

PARTS KIT. Everything needed to complete exciter except tubes and power supply. Includes all mica condensers, resistors, RF chokes, sockets, meter switch, O-200 ma meter, key jack, and miscellaneous parts. No. 31A28A, Special Per Kit, Each..... **\$9.31**

DID YOU GET IT?
THE BIG B-A 1948 Catalog No. 481 — Everything in Radio and Electronics. Write if you have not received it. **FREE** on request.

BURSTEIN-APPLEBEE Company
1012-14 M'GEE STREET,
KANSAS CITY 6, MISSOURI

Do you need BINDING POSTS?

The XL PUSH POST with its Spring Action assures Constant Contact and quick connection. Manufactured in All Aluminum Type M at 12c each. Aluminum Body, Bakelite Top Type B1 at 15c each. Types CP or NP, ALL BRASS—STAINLESS STEEL SPRING & PIN. PROVEN by 240 HR. SALT SPRAY TEST as NON-CORROSIVE at 28c each. Manufacturers and Dealers Liberal Discounts

X. L. RADIO LABORATORIES
420 West Chicago Ave., Chicago 10, Ill.

RIDER'S New Television "HOW IT WORKS"

STOP "Wondering About" Television

STOP "Wondering About" Television

SIMPLE — BASIC EXPLANATION
Television is in the eye of the public and the radio man alike. Knowledge of its underlying theories is a must for anyone who hopes for a future in radio work. Rider, famous for his practical, easy-to-understand style of presentation has just published this new book with its easy-to-apply explanations on the biggest development since the very introduction of radio.

A GOLD MINE OF PRACTICAL FACTS
Here is practical theory. The first chapter deals with the transmission and reception of television signals in general, giving you a clear overall picture. The second chapter deals with frequency standards, the next with antennas. Television "How It Works," then goes into descriptions of the various portions of a television receiver: the r-f, oscillator, converter circuits in the front end, the sound channel, the video i-f system and detector, the video amplifier and d-o restorer, the sync and sweep circuits, picture tubes, power supplies. The conclusion covers alignment and servicing problems. The entire book carries the practical right along with the theoretical, ending up with the when and why of certain operations in television receiver maintenance.
The information in this book will be part of Vol. 1 Rider Television Manual, therefore if ordering the Manual (priced at \$15.00) you will automatically get this book.

A VALUABLE BOOK — YOU NEED NOW!
Though television may not now be in your area, it will be soon. You need the knowledge this book provides, now. Send handy coupon below, today.

Over 200 Pages — Illustrated . . . \$2.70
ORDER FROM YOUR JOBBER OR SEND COUPON DIRECT

----- COUPON -----

JOHN F. RIDER PUB. INC., 404 4th Ave., New York 16
Enclosed \$2.70 for Television "How It Works."
If I send it back within 10 days you will return my money.

Name _____
Address _____
City _____ (Zone No.) _____
State _____ RC

Below Wholesale Cost!!!
WESTERN ELECTRIC
BRAND NEW

\$2.95
F.O.B. N.Y.C.

35 watts—will handle up to 55

A sensational new in quality Reflex Speakers. Blasting and blaring completely eliminated by a heavy gauge metal Mela Trummet Section. The Western Electric driver unit, rated at 35 watts will safely handle 55 watts without blasting. A new plastic diaphragm replaces the standard metal type and is unconditionally impervious to climatic changes and free from atmospheric corrosion. Minimum power—maximum coverage. Reduces cost of installation.

• Full Frequency Response. • Ideal for concessions! Ball Parks, Mobile, P.A. Work
20% Deposit With Order—Balance C.O.D.
MANUAL KLEIN 74 CORTLANDT ST., N. Y. 7, N. Y.



Suggested by: Arthur A. Henriksen
"Just where did you say that needle was lost?"

RADIO SCHOOL DIRECTORY

PRACTICAL TECHNICAL TRAINING

SPECIALIZE in 6 months to 3 years

COURSES

- SERVICE**
6 to 12 Months
- Electricity
 - Welding
 - Refrigeration
 - Heating
- TECHNICIAN**
1 to 2 Years
- Electricity
 - Radio
 - Electronics
 - Refrigeration, Heating and Air Conditioning
- PROFESSIONAL**
3 Years
- Electrical Engineering
 - Bachelor of Science Degree
 - Major in Machinery or Electronics

Train in Electronics, Radio, Electricity for a substantial career in industry—or a business of your own. Prepare in one year to be a Technician—or in two additional years secure a Bachelor of Science Degree in Electrical Engineering with major in Electronics. More than 35,000 former students in industries the world over. 1,538 students now enrolled from 48 states and 13 overseas countries. Faculty of 72 specialists. Write for catalog and Personal Guidance Questionnaire—also mention course in which you are interested.

Terms start July, September, January, April



Dept. RC-748

North Broadway, Milwaukee, Wis.

RADIO ENGINEERING

FM—Television—Broadcast

Police Radio, Marine Radio, Radio Servicing, Aviation Radio and Ultra High mobile applications. Thorough training in all branches of Radio and Electronics. Modern laboratories and equipment. Old established school. Ample housing facilities. 7 acre campus. Small classes, enrollments limited. Our graduates are in demand. Write for catalog.

Approved for Veterans

VALPARAISO TECHNICAL INSTITUTE
Dept. C VALPARAISO, INDIANA

SOUND RECORDING SCHOOL

A practical engineering course in Sound Fundamentals, Recording, and Sound Transmission measurements; in a laboratory containing transmission sets, oscillators, square wave generator and intermodulation analyzer, and other equipment. Complete recording studio assimilating broadcast, motion picture and commercial sound recording, under the direction of H. M. Tremaine.

HOLLYWOOD SOUND INSTITUTE, Inc.
1040-C No. Kenmore Hollywood 27, Calif.

THIS COUPON MAY PROVE TO BE THE KEY TO YOUR SUCCESS IN ELECTRONICS

MELVILLE RADIO INSTITUTE

The Progressive Radio School
Managed by Radio Men

Licensed by the N. Y. State Board of Education
RECOGNIZED BY INDUSTRY
APPROVED FOR VETERANS

CUT IT OUT! FILL IT OUT! MAIL IT OUT!—NOW!

MELVILLE RADIO INSTITUTE RC
Melville Bldg., 15 W. 46th St., N. Y. 19, N. Y.

Send me without obligation information about your intensive courses:

- Radio Technician
- Radio & Television Servicing
- Radio Communications
- Fundamental Radio Mathematics

My Name.....

Address.....

A CAREER WITH A FUTURE! TELEVISION

- SHOP WORK • SHOP TECHNIQUES • THEORY • FULLY EQUIPPED LABORATORIES
- RADIO SERVICE & REPAIR
 - F. M. & TELEVISION
 - TRANSMITTER COURSES
- Preparing for F. C. C. LICENSES
- RADIO TECHNOLOGY
- MORNING • AFTERNOON • EVENING CLASSES • MODERATE RATES • INSTALLMENTS AVAILABLE UNDER G. I. BILL

DELEHANTY SCHOOL OF RADIO • ELECTRONICS • TELEVISION
105 EAST 13th STREET, NEW YORK 3, N. Y. • DEPT. R
LICENSED BY STATE OF NEW YORK

CORRESPONDENCE COURSES IN RADIO and ELECTRICAL ENGINEERING

ELECTRICAL ENGINEERING Get good grasp of Prepare yourself at Low Cost, for secure future. Modern course. So simplified anyone can understand quickly.

RADIO ENGINEERING Extra fine course in radio, work. Trains you to be super-service man, real vacuum-tube technician. Servicemen needed badly. Diploma on completion. Many graduates earning big pay.

Send postcard for Free Copies of school catalog, full details, all about deferred payment plan, experimental kits, etc. **\$25** Either Course

Lincoln Engineering School, Box 931-C-113, Lincoln 2, Nebr.

RADIO ENGINEERING I

Complete Radio Engineering Course. Bachelor of Science Degree. Courses also in Civil, Electrical, Mechanical, Chemical, Aeronautical Engineering; Business Administration, Accounting, Secretarial Science. Graduates successful. 65th year. Enter Sept., Jan., March, June. Write for catalog.

TRI-STATE COLLEGE 2478 College Ave. ANGOLA INDIANA

Hollywood Experts Help You **Make Good in RADIO-TELEVISION** at Home

Direct from Hollywood, nerve-center of broadcasting, Television, Radio and Sound activities, comes R-T-A's time-proven and tested home training. Here at last—easy to learn, home instruction that quickly qualifies you for steady, good-pay jobs or your own Radio business. 10 big kits of radio parts given at no extra charge. Get full details at once! Send postal for FREE BOOK "How to Make Good in Radio-Television."

RADIO TRAINING ASS'N OF AMERICA, Dept. RCF
5620 Hollywood Blvd. Hollywood 28, Calif.

RADIO COURSES

- RADIO OPERATING
- RADIO SERVICING
- F. M. TELEVISION
- CODE ELECTRONICS

• REFRIGERATION SERVICING

Write for Catalog and Picture Brochure
Y.M.C.A. TRADE & TECHNICAL SCHOOLS
15 W. 63rd St. (N'r B'way) New York City

WANTED:

Men and Women to Fill TOP RADIO JOBS
In AM—FM—Television

If you are looking for a career with a future, why not join the hundreds of graduates from the Don Martin School of Radio arts now successfully employed in the radio industry. The demand is great for qualified radio personnel in AM-FM-Television. Train now to be an announcer, script writer, disk jockey, newscaster, or radio engineer. Complete day and night classes . . . the latest equipment. Free placement service. Approved for veterans. Write for free booklet.

Don Martin School of Radio Arts
1655 North Cherokee St. Hollywood 28, Calif.

LEARN RADIO!

IN ONLY 10 MONTHS
PREPARE FOR A GOOD JOB!
COMMERCIAL OPERATOR (CODE)
BROADCAST ENGINEER
RADIO SERVICEMAN

Television Servicing—15 Months

Veterans get \$130.00 Equipment
SEND FOR FREE LITERATURE
BALTIMORE TECHNICAL INSTITUTE
1425 Eutaw Place, Dept. C, Baltimore 17, Md.

RADIO

TECHNICIAN and RADIO SERVICE COURSES
FM and TELEVISION

AMERICAN RADIO INSTITUTE
101 West 63rd St., New York 23, New York
Approved Under GI Bill of Rights
Licensed by New York State

RCA INSTITUTES, Inc.

Offer thorough training courses in all technical phases of **Radio and Television**
DAYS—EVENINGS WEEKLY RATES
VETERANS: RCA Institutes is approved under G. I. Bill of Rights
For Free Catalog Write Dept. RC-48
RCA INSTITUTES, Inc.
A Service of Radio Corporation of America
350 WEST 4TH STREET NEW YORK 14, N. Y.

SHORT CUT CODE SPEED Be an Expert

Learn to be a Telegraph or Radio Operator. Thousands of men needed. Intensely interesting work—good pay. Learn at home or wherever you are, quickly, easily, with the famous Candler Code Speed System. Qualify for amateur or commercial license. Book of particulars Free.

CANDLER SYSTEM CO.
Dept. 3-H, Box 928, Denver 1, Colo.

RADIO COURSES

Preparatory, Service, Broadcast, Television, Marine Operating, Aeronautical, Frequency Modulation, Radar.

Classes forming for fall term Oct. 1.
Entrance exam Sept. 20.
Veterans. Literature.
COMMERCIAL RADIO INSTITUTE
(Founded 1920)
38 West Bliddle Street, Baltimore 1, Md.

THE RADIO AMATEUR'S BEAM POINTER GUIDE, by John F. Rider. Published by John F. Rider Publisher, Inc., 8½ x 11 inches, 32 pages. Price \$1.00.

This compilation of tables will help amateur radio operators in this country (as well as several foreign cities) to point a beam antenna "on the nose" at any country or territory with an amateur radio prefix. The tables are corrected for compass deviation to show the bearing to any foreign prefix from 21 cities: Albuquerque, Atlanta, Boston, Buffalo, Butte, Chicago, Cincinnati, Dallas, Denver, Kansas City, Los Angeles, Miami, Minneapolis, New Orleans, New York, St. Louis, San Francisco, Seattle, Washington (D.C.), Buenos Aires, London, and Mexico City.

To use the tables, the operator need only turn to the chart of the city nearest him and read the magnetic bearing next to the prefix.

Minor corrections may be necessary if the antenna is more than 200 miles away from the nearest city listed. The cross index of countries and prefixes is useful in the event that the prefix is not known.—*R.F.S.*

MALLORY RADIO SERVICE ENCYCLOPEDIA (6th Edition), compiled and published by P. R. Mallory & Co., Inc., 8½ x 10¾ inches, 552 pages. Price \$2.00.

The latest edition of this well-known servicing encyclopedia hardly needs an introduction to men in the radio servicing industry. It is prepared along the lines of the earlier editions and contains information on almost all receivers, including some of the latest FM and television models.

The tables list Mallory catalog numbers for replacement tone and volume controls, electrolytic condensers and vibrators as well as the full tube complement, intermediate frequency, and diagram index to Rider's Manuals. A number of diagrams and notes are provided to assist in replacing faulty parts. This type of information is particularly useful when replacing condenser blocks and tapped volume and tone controls.

HIGH VACUA, Principles, Production and Measurement, by Swami Jnanananda, D. Sc., Ph.D., F. Inst. P. Published by D. Van Nostrand Co. Stiff cloth covers, 6 x 9 inches, 310 pages. Price \$5.50.

An exhaustive treatise on the subject. The discussions of fundamental theory

and measurement are highly technical and mathematical; the description of the various types of pumps and pumping methods is practical and simple. Thus the needs of both the engineer and the operator or maintenance man are met.

RADAR SYSTEM ENGINEERING (Volume I of the M.I.T. Radiation Laboratory Series), edited by Louis N. Ridenour. Published by McGraw-Hill Book Company. Stiff cloth covers, 6½ x 9¼ inches, 748 pages. Price \$7.50.

The work of 32 contributing authors, this book presents a broad picture of radar—its theory, development, and applications. Each of its 17 chapters—the work of one or more authors—is divided into a number of subchapters; each complete in itself. Among the chapter titles are: "Properties of Radar Targets," "Limitations of Pulse Radar," "Gathering and Presentation of Radar Data," and "Examples of Radar System Design."

While amply thorough in coverage, the book is surprisingly free from equations and mathematical examples. No special engineering training is required to read it with confidence and understanding. It contains much material on pulse generation and formation, high-frequency and video techniques which is of use to students of electronics and television.

All material is well illustrated with photographs, drawings, and diagrams. In some instances, there are diagrams of radar components now available on the surplus market. Experimenters and engineers may therefore find the book helpful in work on developmental projects with surplus equipment.—*R.F.S.*

MODERN RADIO INSTRUMENTS AND TESTING METHODS, by the Technical Staff of the Coyne Electrical and Radio School. 5½ x 8½ inches, 343 pages plus index. Published by the Coyne School. \$3.50.

Beginning with a chapter on the fundamental principles and workings of indicating meters, this book instructs the reader in the care and operation of standard servicing instruments and describes the techniques of making measurements of all types, up to and including oscilloscope tests. Tube testing and signal tracing are included as practical measurement techniques.

The simplest language is used, and the text is well illustrated with drawings and photographs.

RADIO AND THE LAW, by J. G. Moser and Richard A. Lavine. Published by Parker & Co. (Los Angeles). 7 x 10 inches, 386 pages, Price \$10.00.

The title is inexact, as with the exception of a few points of basic radio law referred to in connection with broadcasting, the whole book is devoted to broadcast radio and the law. As such, it is complete, covering subjects and quoting specific cases in all fields of broadcasting, including even internal management of broadcast stations.

The Communications Act is printed in full, as an appendix.

PLEASE TEAR OUT THIS ADV. AS REMINDER

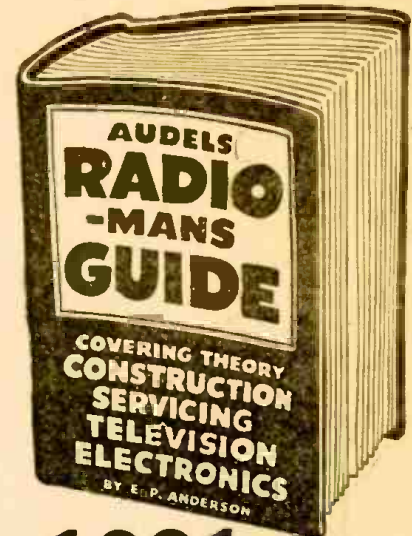

1001 RADIO FACTS AND FIGURES

AUDELS RADIOMANS GUIDE—914 Pages, 633 Illustrations, Photos, Wiring Diagrams, 38 Big Chapters, covering Radio Theory, Construction, Servicing, including Important Data on Developments in Television, Electronics and Frequency Modulation, Review, Questions and Answers, Calculations & Testing. Highly Endorsed—Indispensable for Ready Reference and Home Study.

\$4 COMPLETE • PAY ONLY \$1 A MONTH Step up your own skill with the facts and figures of your trade. Audels Mechanics Guides contain Practical Inside Trade Information in a handy form. Fully illustrated and Easy to Understand. Highly Endorsed. Check the book you want for 7 days' Free Examination.

Send No Money. Nothing to pay postman.

CUT HERE MAIL ORDER

AUDEL, Publishers, 49 W. 23 St., NEW YORK 10, N. Y.

Please send me postpaid for FREE EXAMINATION books marked (x) below. If I decide to keep them I agree to mail \$1 in 7 Days on each book ordered and further mail \$1 monthly on each book until I have paid price otherwise, I will return them.

- RADIOMANS GUIDE, 914 Pages . . . \$4
- ELECTRICIANS EXAMINATIONS, 250 Pages . . . 1
- WIRING DIAGRAMS, 210 Pages . . . 1
- ELECTRIC MOTOR GUIDE, 1000 Pages . . . 4
- ELECTRICAL DICTIONARY, 9000 Terms . . . 2
- ELECTRICAL POWER CALCULATIONS, 425 Pgs. . . 2
- HANDY BOOK OF ELECTRICITY, 1440 Pages . . . 4
- ELECTRONIC DEVICES, 216 Pages . . . 2
- ELECTRIC LIBRARY, 12 vol., 7000 Pgs., \$1.50 vol. . . 1
- OIL BURNER GUIDE, 384 Pages . . . 1
- REFRIGERATION & Air Conditioning, 1280 Pgs. . . 4
- POWER PLANT ENGINEERS Guide, 1500 Pages . . . 4
- PUMPS, Hydraulics & Air Compressors, 1658 Pgs. . . 4
- WELDERS GUIDE, 400 Pages . . . 1
- BLUE PRINT READING, 416 Pages . . . 2
- SHEET METAL WORKERS Handy Book, 388 Pgs. . . 4
- SHEET METAL PATTERN LAYOUTS, 1100 Pgs. . . 4
- AIRCRAFT WORKER, 240 Pages . . . 1
- MATHEMATICS & CALCULATIONS, 700 Pgs. . . 2
- MACHINISTS Handy Book, 1600 Pages . . . 4
- MECHANICAL Dictionary, 968 Pages . . . 4
- AUTOMOBILE GUIDE, 1700 Pages . . . 4
- DIESEL ENGINE MANUAL, 400 Pages . . . 2
- MARINE ENGINEERS Handy Book, 1280 Pages . . . 4
- MECHANICAL DRAWING GUIDE, 160 Pages . . . 1
- MECHANICAL DRAWING & DESIGN, 480 Pgs. . . 2
- MILLWRIGHTS & Mechanics Guide, 1200 Pgs. . . 4
- CARPENTERS & Builders Guides (4 vols.) . . . 6
- PLUMBERS & Steamfitters Guides (4 vols.) . . . 6
- MASONS & Builders Guides (4 vols.) . . . 6
- MASTER PAINTER & DECORATOR, 320 Pgs. . . 2
- GARDENERS & GROWERS GUIDES (4 vols.) . . . 6
- ENGINEERS and Mechanics Guides . . . 12
- Nos. 1, 2, 3, 4, 5, 6, 7 and 8 complete . . . 12
- Answers on Practical ENGINEERING . . . 1
- ENGINEERS & FIREMANS EXAMINATIONS . . . 1

Name _____

Address _____

Occupation _____

Employed by _____ R.C.F.

TELEVISION 1948!!

Train at an Institute that pioneered in TELEVISION TRAINING since 1938. Morning, Afternoon or Evening Sessions in laboratory and theoretical instruction, under guidance of experts, covering all phases of Radio, Frequency Modulation, Television, lead to opportunities in Industry, Broadcasting or own Business. Licensed by N. Y. State. Approved for Veterans. ENROLL NOW FOR NEW CLASSES Visit, Write or Phone

RADIO-TELEVISION INSTITUTE

480 Lexington Ave., N. Y. 17 (46th St.) Plaza 3-4585 2 blocks from Grand Central

FREE RADIONIC CATALOG

NEW! HOWARD W. SAMS REDBOOK
Complete data on ALL receiver replacement parts; tubes—capacitors—transformers—batteries—I.F. coils—cartridges—speakers—tridges—vibrators. Controls receiver model from 1938 to 1948.
Prepaid ... \$3.95

CHOCK FULL OF BUYS!

RADIO & TELEVISION PARTS - KITS
PUBLIC ADDRESS INTER-COMMUNICATORS / RECORDERS
RECORD CHANGERS TEST INSTRUMENTS
TUBES / AMATEUR EQUIP / CHANCELLOR RADIOS / HARDWARE
TECHNICAL BOOKS

RADIONIC EQUIPMENT COMPANY
170 NASSAU ST., NEW YORK 7, N.Y.
Tribune Theatre Entrance
Tel. Worth 2-0421 • Cable "CHANSLOR"

A MUST for all
• Service Dealers
• Amateurs
• Experimenters
• Industrials
• Institutions
• Government Agencies

RADIONIC EQUIPMENT CO., Dept. 107
170 Nassau Street, New York 7, N. Y.

Send at once your free catalogs, supplements and bargain lists as published—listing products of leading manufacturers of radio-electronic parts and equipment.

NAME

P.O. BOX or STREET

TOWN STATE

SHOOTS TROUBLE FASTER! **MAKES MORE MONEY FOR YOU ON THE JOB OR AT SERVICE BENCH**



PRICE \$9.95
at distributor or post-paid, direct.

Sorry, no COD's. Ohioans add 3% State Sales Tax.

Signallette
MULTI-FREQUENCY GENERATOR

In radio service work, time means money. Locate trouble faster, handle a much greater volume of work with the SIGNALLETTE. As a trouble shooting tool, SIGNALLETTE has no equal. Merely plug in any AC or DC line, start at speaker end of circuit and trace back, stage by stage, listening in set's speaker. Generates RF, IF and AUDIO Frequencies, 2500 cycles to 20 Megacycles. Also used for checks on Sensitivity, Gain, Peaking, Shielding, Tube testing. Wts. 13 oz. Fits pocket or tool kit. See at your dist. or order direct.

Clippard INSTRUMENT LABORATORY, INC.
DEPT. C, 1125 BANK STREET
CINCINNATI 14, OHIO
Qualified Jobbers write, wire for details.

Index to Advertisers

Abell Distributing Co.	73
Allied Radio Corporation	9
Alvarado Supply Co.	83
American Radio Supply Company	53
American Sales Company	75
American Surplus Products	46, 51
Amplifier Corporation of America	65, 71
Audel Publishers	87
Bell Telephone Labs.	16
Boland & Boyce, Inc.	7, 79
Brooks Radio Distributing Co.	83
Buffalo Radio Supply	58, 59
Burstein-Applebee Company	85
Capitol Radio Engineering Institute	2, 47
Certified Television Laboratories	74
Cleveland Institute of Radio	11
Clippard Instrument Laboratory, Inc.	88
Collins Audio Products Co.	73
Columbo Trading Co., Inc.	85
Communications Equipment Co.	82
Concord Radio Corp.	55
Coyne Electrical School	80, 81
Crest Corporation	4
DeForest's Training Institute	81
Electromatic Manufacturing Co.	81
Espey Manufacturing Co., Inc.	75
Esse Radio Company	6
Fort Orange Radio Dist. Co.	68
General Cement Manufacturing Co.	54
General Test Equipment	74
General Electronic Distributing Co.	41
Greylock Electronic Supply Co.	70
Hallmark Electronic Corporation	74
The Heubach Company	12, 13
Hudson Specialties	84
Instructograph Company	70
Manual Klein	85
Lafayette Radio	66
Lake Radio Sales Company	77
Lear Radio, Inc.	57
Leotone Radio Corporation	76
McMurdo Silver Company	8, 79
Meissner Manufacturing Div.	70
P. R. Mallory & Co., Inc.	Inside Back Cover
Merit Products	74
Metropolitan Electronic & Inst. Co.	78
J. W. Miller Company	81
Moss Electronic Distributing Co.	67
Murray Hill Books, Inc.	84
N. Silverstine	14
National Plans Company	88
National Radio Institute	1
National Schools	3
National Surplus Sales Company	80
Niagara Radio Supply Company	15
Offenbach & Reimus	71, 77
Opportunity Adlets	80
Potter Radio Company	83
Precision Apparatus Company	68
Progressive Electronics Company	74
Radio Corporation of America	Back Cover
Radcraft Publications, Inc.	83
Radio Dealers Supply Company	72
Radio Kits Company	76
Radionic Equipment Company	88
Radio Publications	81
Radio Supply & Engineering Company	76
Radolek Company	79
Ravac Electronics Corporation	75
John F. Rider Publisher, Inc.	85
Risco Electronics	68
The Rose Company	81

RADIO SCHOOL DIRECTORY
(Pages 86, 87)

American Radio Institute	
Baltimore Technical Institute	
Candler System Company	
Commercial Radio Institute	
Delehanty Institute	
Hollywood Sound Institute, Inc.	
Lincoln Engineering School	
Don Martin School of Radio Arts	
Melville Radio Institute	
Milwaukee School of Engineering	
RCA Institutes	
Radio Television Institute	
Radio Training Association of America	
Tri-State College	
Valparaiso Technical Institute	
YMCA Trade & Technical Schools	

Senco Radio, Inc.	77
Servo-Tek Products Company	63
Spellman Television Company	75
Sprayberry Academy of Radio	5
Superior Instruments	54
Supreme Publications	45
Technical Radio Parts Company	78
Tel-Craft Company	84
Tiret Electric Company	80
Tradio, Inc.	71
Transvision	69
Triplett Manufacturing Company. Inside Front Cover	
James Vibrapower	65
X.L. Radio Laboratories	85

RISCO HAS IT
All Changers Brand New

V. M. MIXER CHANGER
PLAYS 10" and 12" records at the same time \$15.50
2 for \$29
Soeburg Mixer, 3-post \$32.50
DETROLA \$13.75
G. I. RECORDERS
Single Speed \$22
Dual Speed \$26
40% off on Recordisc Recording Blanks.

\$15.50 Recordisc Recording Blanks.
Above Easily Attached to Any Radio
or CAN BE USED WITH AMPLIFIER BELOW

SERVICEMEN'S SPECIALS

100-INSUL RES. KIT 1/2, 1, 2W	\$1.45
15-ASST. BY-PASS COND.	.89
ALLIANCE PHONO MOTORS	2.50
ASTATIC L-70 CARTRIDGES	1.79
ASTATIC L-70 CARTRIDGES	1.45
ASTATIC NYLON 1-J, 3.45; MLLP.	1.95
50L6 OUTPUT TRANS.	.35
6V6 P.P. OUTPUTS	.55
IF TRANS. 456 KC SHIELDED INPUT OR OUTPUT	ea. .12
MEISSNER OSC. COIL 12SA7	.35
VOLUME CONTROLS 500 M 19c—W.S. (Switch)	.29
ANTENNA LOOPS, PRIM & SEC	.23
2-TUBE PHONO AMP. WIRED	1.95
2 TUBES	1.00
SYLVANIA 100 MA SELENIUM RECT.	.89
EVEADY MINIMA 674 BATTERY. New	1.49
GE PREAMPLIFIER WITH TUBE	4.25
6 FT. RUBBER LINE CORDS	.12
7EP4-TELEVISION TUBES	14.95
100 FT. 300 OHM LEAD IN	1.65
SUPERHER VARIABLE COND—365 MFD.	.59
100 FT. PHOSPHOR BRONZE DIAL CABLE.	.59
8 PUSH BUTTON SWITCH	.38
SPAGHETTI—36" LENGTH	.05

C-D—Solar—Aerovox—Etc.

20-20-150	.29	25x25V CAN	.16
20-20-150 CD	.49	8x500 FT. (CAN)	.39
8-450V	.29	10x10x10-400 V	.49
8x8-450V	.45	18x450V	.45
UP TO—.02—PAPER 4-600V		50x30x150V	.49
UP TO—.25			.10 for .42

25% on C.O.D. orders. Orders Filled as Received
VISIT OUR NEW SHOW ROOM
Free Catalog "C" Just Out
We Specialize in Mail Orders

PHONO AMPLIFIER
3-TUBE AC-DC
Wired and Tested \$2.75
Volume and Tone Controls
Set of 3-Tubes \$1.75
Output Trans.39
5" Alnico Spk. 1.19

PHONO OSC-2-TUBE
Wired & Tested \$2.75
2 Tubes—\$1.20.

RISCO ELECTRONICS
WHOLESALE DISTRIBUTORS
25 West Broadway, N. Y. 7, N. Y.

500 FORMULAS TO SUCCESS

MANY million dollar firms started with a single formula for which they paid a big price. Here you have 500—no less—tried and tested formulas, recipes and processes for making things all at the ridiculously low price of 25c.

Here is your opportunity to start a business with but a few dollars' capital and with undreamed of profits in prospect. You can also use these formulas in your own home to cut household expenses to the bone. Or you can put them to use in your workshop to cut costs as much as 1000%.

Quit paying out many dollars in profits to manufacturers, wholesalers, and dealers, when you can make the same thing yourself for a few cents. It's so easy when you follow our simple instructions.

66 PAGES, 3200 WORDS IN TEXT
Send for "500 FORMULAS AND RECIPES" to-day! Enclose 25c, that's all! You won't be asked for another cent now or later. Sold on a money-back guarantee.

NATIONAL PLANS COMPANY
P. O. BOX 26 R, STATION N, New York 23, N. Y.



CORRECTION

Silver FM Sweep Generator Model 906

Several specifications on this generator were wrongly given in the article on page 25 of the June issue. The actual range of the Silver Model 906 is from 90 kc to 210 mc; maximum FM deviation range is variable to 1 mc total swing (± 500 kc deviation); FM sweep frequency is at twice the power line frequency and amplitude modulation is variable from 0 to 100%. The power supply is not voltage-regulated.

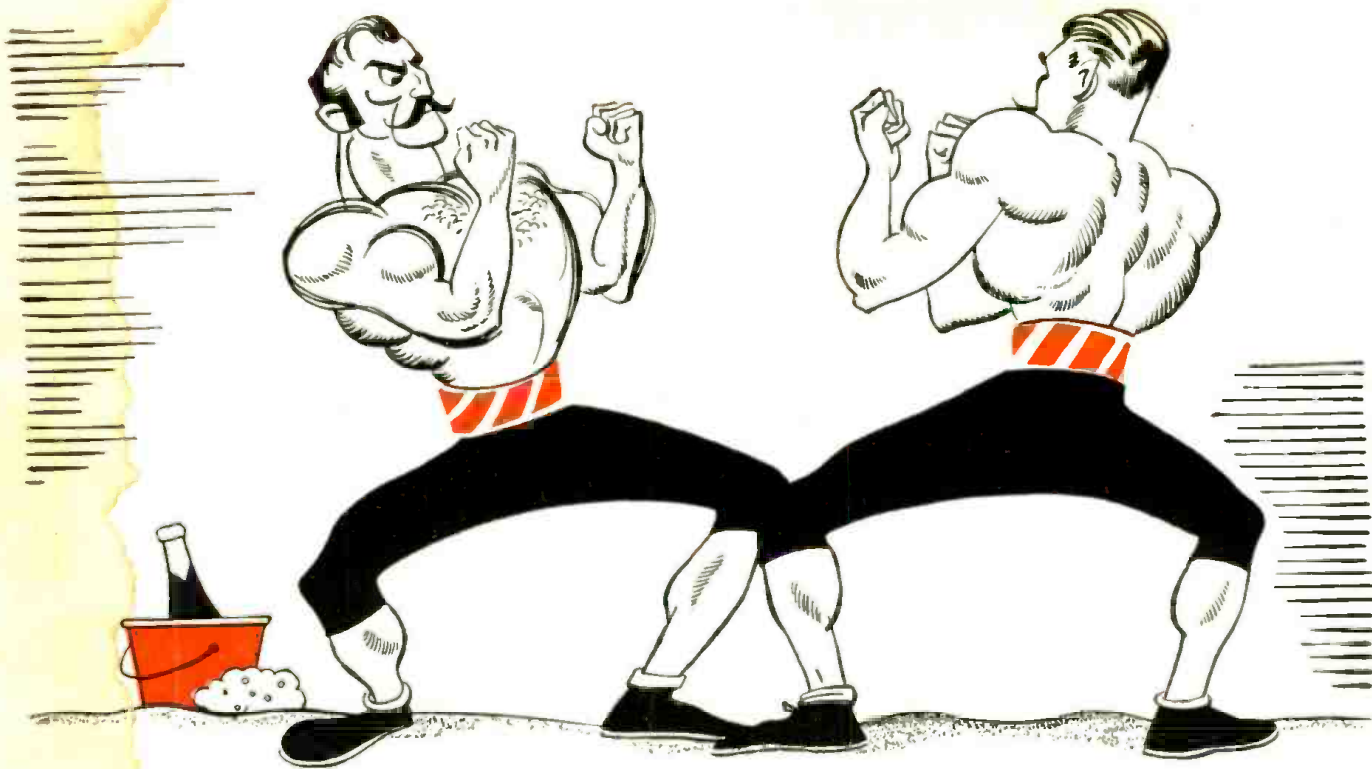

Equally Matched

There's no place for a "weight advantage" in the assembly of a vibrator. Unless every part is accurately matched to every other part the performance of the vibrator will be erratic.

Mallory vibrator parts are measured to a minute fraction of an inch and then assembled so that related parts match accurately. The reed matches the reed arms, the reed arms match each other, the weight matches the reed, and the contacts match the assembly. Even the finest scale could not register a significant difference.



The Mallory Replacement Vibrator Guide is free. The Vibrator Data Book is \$1.00—from your distributor or by mail.

Mallory Vibrators Make the Best Replacements

Careful manufacturing makes Mallory vibrators free of bounce and chatter, dependable in starting, and reliable in operation. More of them are used in original equipment

than all other makes combined. That's convincing proof they are the best replacement vibrators for you to stock.

In addition to assured quality, Mallory offers the most complete vibrator line in the business. Mallory standardization permits 12 basic vibrators to meet 90% of your replacement requirements. But a complete line of 52 vibrators is available to meet virtually every vibrator need.

The Mallory "Good Service for Good Business" Plan

will increase business and profits in your shop. A unique follow-up file makes it easy to keep customers.



You tie in with Mallory acceptance to develop new business—ask your distributor about it.

MORE MALLORY VIBRATORS ARE IN USE THAN ALL OTHER MAKES COMBINED

P. R. MALLORY & CO. Inc.
MALLORY

CAPACITORS . . . CONTROLS . . . VIBRATORS . . .
SWITCHES . . . RESISTORS . . . RECTIFIERS . . .
VIBRAPACK* POWER SUPPLIES . . . FILTERS

*Reg. U.S. Pat. & TM. Off.

APPROVED PRECISION PRODUCTS

P. R. MALLORY & CO., Inc., INDIANAPOLIS 6, INDIANA



Millions of Americans—with RCA television—will see history as it is made at the two National Political Conventions.

Look before you vote — with Television

This year, television joins press and radio as a "political reporter," in Philadelphia, at the Republican Convention, June 21, and the Democratic Convention, July 12. As political leaders step up to speak, you're right with them on the convention platform.

The Candidate will be televised as he looks into the camera—talks to the people, face to face. His appearance, smile, gestures, combine with the sound of his voice, and his message, to complete the transmission of his per-

sonality. You have a new opportunity to know your man!

Important as any in history, the 1948 conventions will be covered from start to finish by keen-eyed RCA Image Orthicon television cameras. Highlights and sidelights, all will be seen. And what the camera catches will be sharp and clear on the screens of RCA Victor home television receivers . . .

Today, 40,000,000 Americans are within reach of regularly scheduled daily television programs.

Television as an aid to good citizenship, through the formation of an informed public opinion, is one of the ways in which developments from RCA Laboratories serve the nation and its people. Advanced research is part of any instrument bearing the name RCA or RCA Victor.

When in Radio City, New York, be sure to see the radio, television and electronic wonders at RCA Exhibition Hall, 36 West 49th Street. Free admission. Radio Corporation of America, RCA Building, Radio City, N. Y. 20.



RADIO CORPORATION of AMERICA