

IN THIS ISSUE—NEW!

**FM**  
Station  
List

*TONE CONT. PAGE 35*

# RADIO CRAFT

HUGO GERNSBACK, Editor



**BRUNETTI  
WRIST-WATCH  
TRANSMITTER  
SEE PAGE 28**

**APR**  
1948

**30¢**

**RADIO-ELECTRONICS IN ALL ITS PHASES**

The **ONLY**  
Complete Servicing Reference  
on ALL Pre-War and Post-War Receivers

25% More Listings  
Than the  
5th Edition

Accurate  
Authoritative  
Complete  
in One  
Volume

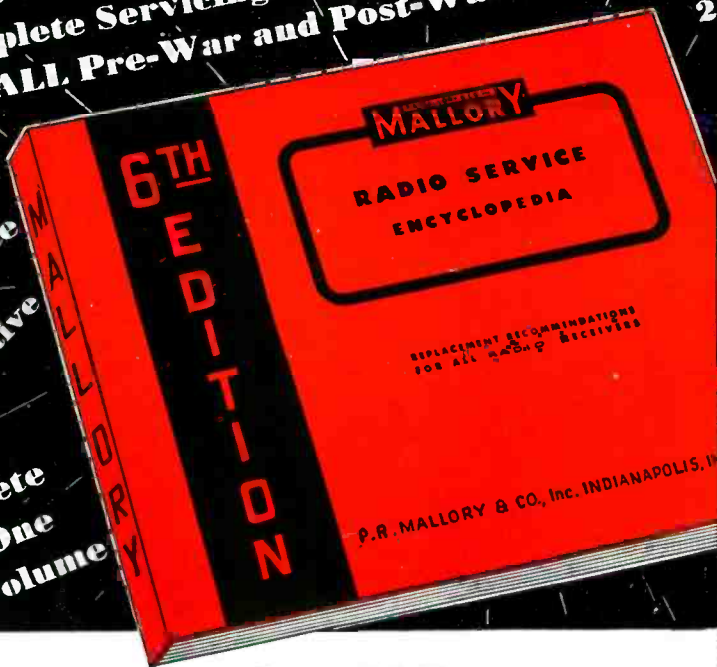

SALES of previous editions offer the best evidence of its worth.

Edition	Year	Copies sold
1st	1937	51,000
2nd	1938	25,000
3rd	1939	55,000
4th	1941	60,000
5th	1946	75,000

**Here's what you get:**

- Data on correct replacement parts
  - Circuit information
  - Servicing hints
  - Installation notes
  - IF peaks
  - Tube complements and number of tubes
  - References to Rider, giving volume and page number
- RESERVE YOUR COPY NOW**

# Ready April 1st— The 6th Edition Mallory Radio Service Encyclopedia

Here it is—up to date—the only accurate, authoritative radio service engineers guide, complete in one volume—the Mallory Radio Service Encyclopedia, 6th Edition.

Made up in the same easy-to-use form that proved so popular in the 5th Edition, it gives you the complete facts on servicing all pre-war and post-war sets . . . volume and tone controls, capacitors, and vibrators . . . circuit information, servicing hints, installation notes, IF peaks, tube complements and

number of tubes . . . and in addition, cross-index to Rider by volume and page number for easy reference. **NO OTHER BOOK GIVES YOU ALL THIS INFORMATION**—that's why it's a **MUST** for every radio service engineer.

25% more listings than the 5th Edition. Our ability to supply these books is taxed to the limit. The only way of being sure that you will get *your copy quickly* is to order a copy today. Your Mallory Distributor will reserve one for you. The cost to you is \$2.00 net. It's the buy of the year.

**THE MALLORY RADIO SERVICE ENCYCLOPEDIA**  
Complete—Authoritative—All in One Volume

P. R. MALLORY & CO., Inc.  
**MALLORY**

CAPACITORS . . . CONTROLS . . . VIBRATORS . . .  
SWITCHES . . . RESISTORS . . . RECTIFIERS . . .  
VIBRAPACK\* POWER SUPPLIES . . . FILTERS  
\* Reg. U. S. Pat. Off.

**APPROVED PRECISION PRODUCTS**

P. R. MALLORY & CO., Inc., INDIANAPOLIS 6, INDIANA

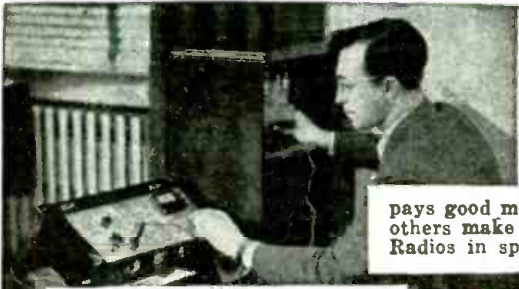

Building this  
**A. M. SIGNAL GENERATOR**  
gives you valuable experience. Provides amplitude modulated signals for test and experiment purposes.

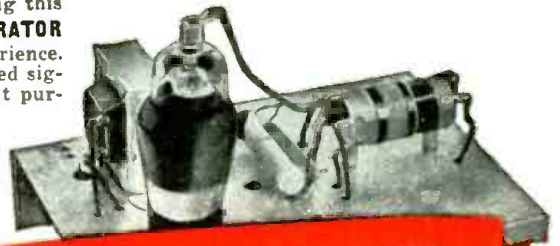

**RADIO SERVICING**

pays good money for full-time work. Many others make \$5, \$10 a week EXTRA fixing Radios in spare time.

**VETERANS**

You can get this training right in your own home under G. I. Bill. Mail coupon for full details.

# Learn RADIO by PRACTICING in Spare Time

## with Big Kits of Radio Parts I Send You

Do you want a good-pay job in Radio—or your own money-making Radio Shop? Mail Coupon for a FREE Sample Lesson and my FREE 64-page book, "How to Be a Success in RADIO—Television, Electronics." See how N.R.I. gives you practical Radio experience at home—building, testing, repairing Radios with BIG KITS OF PARTS I send!

**Many Beginners Soon Make Good Extra Money in Spare Time While Learning**

The day you enroll I start sending EXTRA MONEY manuals. You LEARN Radio principles from my easy-to-grasp, illustrated lessons—PRACTICE what you learn with parts I send—USE your knowledge to make EXTRA money fixing neighbors' Radios in spare time while still learning! From here it's a short step to your own full-time Radio Shop or a good Radio Job!

**Future for Trained Men is Bright in Radio, Television, Electronics**

It's probably easier to get started in Radio now than ever before because the Radio Repair Business is booming. Trained Radio Technicians also find profitable opportunities in Police, Aviation, Marine Radio, Broadcasting, Radio Manufacturing, Public Address work. Think of even greater opportunities as public demand for Television, FM and Electronic devices continue to grow! Send for free books now!

**Find Out What N. R. I. Can Do For You**

Mail Coupon for Sample Lesson and my 64-page book. Read the details about my Course. Read letters from men I trained, telling what they are doing, earning. See how quickly, easily you can get started. No obligation! Just MAIL COUPON NOW in an envelope or paste it on a penny postal. J. E. Smith, President, Dept. 8DX, National Radio Institute, Pioneer Home Study Radio School, Washington 9, D. C.

**My Course Includes Training in TELEVISION ★ ELECTRONICS Frequency Modulation**



You build this yourself early in the course—use it for practical Radio work on neighborhood Radios to pick up EXTRA spare time money!

You build this SUPERHETERODYNE CIRCUIT that brings in local and distant stations. You get practical experience putting this set through fascinating tests.

**BE A SUCCESS in RADIO I Will Train You at Home**

**Sample Lesson FREE**



Gives hints on Receiver Servicing, Locating Defects, Repair of Loudspeaker, I. F. Transformer, Gang Tuner, Condenser, etc. 31 illustrations. Study it—keep it—use it—without obligation! Mail Coupon NOW for your copy!



**GET BOTH 64 PAGE BOOK FREE SAMPLE LESSON**

**Mr. J. E. SMITH, President, Dept. 8DX National Radio Institute, Washington 9, D. C.**

Mail me FREE, without obligation. Sample Lesson and 64-page book about how to win success in Radio and Television-Electronics. (No salesman will call. Please write plainly.)

Name ..... ARE.....  
Address .....  
City ..... Zone..... State.....  
 Check If Veteran

**APPROVED FOR TRAINING UNDER GI BILL**

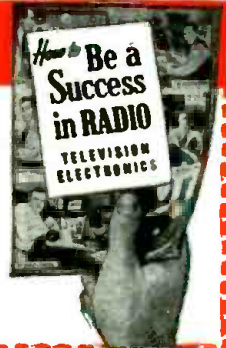



*Follow*

the NATIONAL UNION  
**TRIPLE-AID PLAN**  
to the  
BUSIEST SHOP IN TOWN

- N. U. BUSINESS BUILDERS**
- Window Decals
  - Book Matches
  - Dummy Cartons
  - Stationery
  - Job Tickets
  - Embosomat Signs
  - Newspaper Ad Mats
  - Telephone Ad Mats
  - Cartoon Cards
  - Window Trim Service
  - Tube Manuals
  - Circuit Manuals
  - Service Engineering Bulletins
  - Shop Notes
  - Window Displays
  - Outdoor Signs
  - Indoor Signs
  - Streamers
  - Banners
  - Imprinted Scotch Tapes
  - Shop Coats



**BUILD A BIGGER SERVICE BUSINESS WITH "N.U. BUSINESS BUILDERS"**

• NATIONAL UNION service promotion pieces are planned to sell *your skill . . . your integrity . . . your friendly service.*

Watch your sales climb as these Business Builders hammer home to your customers and prospective customers, the advantage of dealing with you.

The various pieces are skillfully designed to attract new customers . . . keep present customers . . . and regain lost customers.

Simplified shop and business forms tailored to the busy serviceman's needs are available, too!

Ask your N.U. Distributor to start you on the N.U. Triple-Aid Plan—TODAY!

**NATIONAL UNION RADIO CORPORATION**  
ORANGE, NEW JERSEY

- RECEIVING TUBES • TRANSMITTING TUBES • CATHODE RAY TUBES • TELEVISION TUBES • SPECIAL PURPOSE TUBES  
PHOTOTUBES • BALLASTS • BATTERIES • CAPACITORS • PANEL LAMPS • VIBRATORS • VOLUME CONTROLS

Make More Money in

# Radio

## TELEVISION & ELECTRONICS

**NOW!**

Get these 2 BIG BOOKS FREE!



If you are already employed in the great Radio Industry, you know how great the demand is for trained, experienced servicemen, operators and technicians. You know how fast the field is growing and how important it is to keep up with new developments in F.M., Television and Electronics. The Radio Industry is alive with opportunity for the qualified technician whose knowledge is up-to-the-minute. You can be an FM and Television specialist . . . get into the lucrative Radio Service Field . . . own a business of your own, if you prefer. National Schools of Los Angeles, for over 40 years a practical resident and home study trade school, has put into effect its New 1948 Training Program. This program, adapted to National's Master Shop Method Home Study Course, can qualify you in your spare time as a Radio and Television technician. For details of this Program fill out and mail the coupon below.



You build this fine modern Superheterodyne Receiver and other units, with the complete standard parts we send you. This valuable equipment becomes yours to use and keep.

You learn by building equipment with standard radio parts we send you



**NOW! New Professional Multitester Included!**

This versatile testing instrument is portable and complete with test leads and batteries. Simple to operate, accurate and dependable. You will be able to quickly locate trouble and adjust the most delicate circuits. You can use the Multitester at home or on service calls. It is designed to measure AC and DC volts, current, resistance and decibels. You will be proud to own and use this valuable professional instrument.

**SHOP METHOD HOME TRAINING from a Technical Trade Resident School**

**LEARN BY DOING**

Work with Real Experimental Equipment Furnished without Extra Cost as Part of your National Schools Training

National Schools brings its exclusive Shop Method of training right into your own home. You can learn the most up-to-date approved practical training projects, systems and modern circuits from the very beginning in your spare time. Here is sound and practical home training—the development of experienced instructors working with students right in the shops, NEW Television and Broadcast Studios and Experimental Laboratories of NATIONAL SCHOOLS—one of the most advanced technical trade education centers in the world.

**Take Advantage Now of these Outstanding Features of National Schools' 1948 Training Program**

1. National Schools' 1948 Course is planned to prepare you for real success in Radio Television and Electronics.
2. Experimental equipment supplied with the Course has been completely revised to give you the most up-to-date practical experience with new circuits, new units, etc., right in your own home.
3. New Television Lessons have been expanded to give you training in the latest developments in this important field.
4. The 1948 Course includes a Professional Multitester (shown above) for your use in spare or full-time Radio work.
5. National Schools gives you advanced training—the key to the better positions in Radio, Television, Electronics.
6. You are sent standard Experimental Equipment, including tubes and accessories, for building a modern Short Wave and Standard Broadcast Superheterodyne Receiver. All equipment becomes your personal property.
7. National Schools' 43 years of experience in Technical Trade Training . . . our modern shops and laboratories . . . highly trained instructors are back of your time-tested Training Plans for a brighter future.

Send Coupon and prove to yourself what YOU can do in RADIO and TELEVISION!

**EXPERIENCE IS THE BEST TEACHER.** You learn by experience with the exclusive National Shop-Method of Home Training. With the apparatus sent you, you actually build various types of standard equipment—a powerful superheterodyne receiver, a signal generator, an audio oscillator, low power Radio transmitter and other units. You make tests and conduct experiments that show you the why and how of Radio. You understand what makes the various elements of Electronics operate because you actually see them work for you. Not only do you gain splendid experience by this method of learning, but you receive valuable equipment you will use on the job in the practice of your profession as a Radio Technician. Mail the coupon and learn what this means to you.

**VETERANS**

If you qualify for training under G. I. Bill, check the coupon for a Special Bulletin.

G. I. APPROVED

**NATIONAL SCHOOLS**  
LOS ANGELES 37, CALIFORNIA EST. 1905



**FREE LESSON INCLUDED**

Examine the exclusive National Shop Method of Home Training. See for yourself how sound and practical it is. Be convinced that you can learn Radio, Electronics, Television—quickly and easily in your spare time. This trial is **ABSOLUTELY FREE**. Mail the coupon here for the books that tell you the complete story of National Schools Master Shop Method of Home Training in Radio, Electronics and Television. This is the **MODERN SYSTEM OF TRAINING**: it matches the rapid progress constantly being made in Radio, Television and Electronics. It is **TIME TESTED**. too. National Schools has been training men for more than a third of a century. It is the very same training that has helped thousands to more pay and greater opportunity. You owe it to yourself—your future—to read the book "Your Future in Radio, Electronics and Television"—**FREE** to you when you send in the coupon.

**MAIL OPPORTUNITY COUPON FOR QUICK ACTION**

MEMBER: NATIONAL COUNCIL OF TECHNICAL SCHOOLS  
**NATIONAL SCHOOLS, Dept. RC-4**  
4000 South Figueroa Street, Los Angeles 37, California

MEMBER: NATIONAL HOME STUDY COUNCIL  
(Mail in envelope or paste on penny post card)

Mail me **FREE** the two books mentioned in your ad, including a sample lesson of your course. I understand no salesman will call on me.

NAME ..... AGE .....

ADDRESS .....

CITY ..... ZONE ..... STATE .....

Check here if Veteran of World War II

**War Surplus Bargains Sold As Used Unless Otherwise Specified!**



**RADIO ALTIMETER APN/1**

A complete 460 mc. radio receiver and transmitter which can be converted for ham or commercial use. Tubes used and included: 4-12SH7, 3-12S17, 2-6H6, 1-VR150, 2-955, 2-9004. Other components such as relays, 24 V. dynamotor, transformers, pots, condensers, etc., make this a buy on which you can not go wrong. Complete as shown in aluminum case 18"x7"x7 1/4".

**\$8<sup>95</sup>**

**NAVY CRV-46151 AIRCRAFT RADIO RECEIVER**

INCLUDING CASE

**\$19<sup>50</sup>**



Four bands, including broadcast (195-9.050 KC). Circuit is six-tube super-heterodyne with mechanical band change or remote operated electrical band change. Remote band change and tuning controls included, making this set readily adaptable to mobile ham use. Powered from self-contained 24 V. DC dynamotor. The sets are complete with tubes, mounting rack and remote controls. No tables or prods.

**AIRCRAFT TRANSMITTER BC-457A or BC-458A**

Ideal to make over for master oscillator. Priced complete with tubes. Has built-in crystal for dial calibration. Used but in good condition. 5.3-7 MC or 4-5.3 MC FREE Mounting Rack with order of two or more.

**\$3<sup>95</sup>**



3-4 MC . . . \$5.75

**INTERPHONE AMPLIFIER RL-7**

Convert to high fidelity phone Amp. or speech Amp. Complete with tubes and dynamotor, for 24 V. DC operation. Used but in good condition.



SPECIAL PRICE **\$1<sup>95</sup>**

TERMS: CASH WITH ORDER

**AMERICAN SURPLUS PRODUCTS CO.**

537 N. CAPITOL AVE. INDIANAPOLIS, IND.

**ARC-4 TRANSMITTER & REC.**

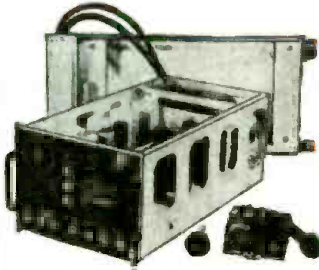

INCLUDING CASE

**\$17<sup>95</sup>**

Operates on any of its 4 predetermined crystal controlled frequencies in the range of 140 MC. Complete with tubes, remote control, junction box, shock mounting base and connecting plugs. This unit is ideal for amateur UHF or mobile telephone. Operates from self-contained 24 V DC dynamotor.

**(HRU) DC POWER SUPPLY**

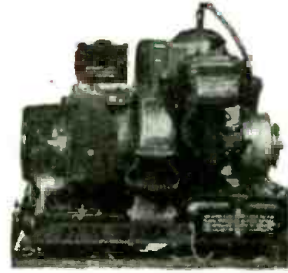

24-28 V. at 70 a m p. 2000 watts gasoline engine generator with electric starter. Power supply which can be used to operate 24-28 V. equipment, start airplane engines,

charge batteries, as a welding machine, lighting system, or for amateur radio station. 21 1/2", 17 1/2" x 24 1/2". Wgt., 115 lbs.

**\$72<sup>50</sup>**

Includes 20 ft. plug-in cable.



**BRAND NEW SCR-625 MINE DETECTORS**

ATTENTION, PROSPECTORS, MINERS, OIL COMPANIES, PLUMBERS, ETC.

Used by the Army to detect buried metallic mines. Its private use suggests the location of underground or underwater pipes, cables and ore-bearing rock, the location of metallic fragments in scrap materials, logs, etc., and the screening of personnel in plants for carrying of metallic objects. New, complete in original overseas packing container. Originally sold by War Assets for \$166.00. The U. S. Forestry Service has recommended procedure for using the SCR-625 Mine Detector to find concealed metal in tree logs and other timber products.

**\$79<sup>50</sup>**

**SCR-274N COMMAND SET**

SCR-274N Transmitter and Receiver Assembly consists of 13 pieces which are: 4 dynamotors, 1 modulator, 1 remote control box, 2 transmitters, 3 receivers and one antenna relay unit and it has its own individual dynamotor. Each receiver employs 12 V. tubes. Each transmitter contains four 12 V. tubes and has a variable frequency and crystal calibrated master oscillator, driving two 1625 final amplifier tubes, 55-watt output, with built-in silver plated variable inductance antenna matching device. Oscillator and final stage have simultaneous tuning and the dial is directly calibrated in MC. Transmitters have slugged and capacity tuning, built-in high voltage and antenna switches. Modulator furnishes plate supply for transmitters and is equipped with a dynamotor for high voltage. Also supplied is one antenna relay with built-in antenna meter. Transmitters make ideal VFO driver unit. Easily converted to 110 V. 60 cycle operation. Wt., approximately 100 lbs. PRICE..... **\$19.95**

**R-5/ARN-7 RECEIVER**

Three bands 200 to 1750 KC. Complete with 17 tubes required. This set is ideal for conversion to home broadcast Receiver addition to ham shack, etc. Reported sold for many times the price when brand new. A Receiver that would be hard to pick up at this price. ONLY **\$19<sup>95</sup>**

Control Head available \$2.50 ea.

PRICES F.O.B. INDIANAPOLIS

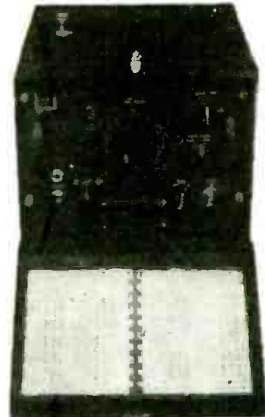

**BC-221 FREQUENCY METER**

Covers 125-20,000 Kc. Battery operated. Beautiful equipment,

**\$49<sup>95</sup>**



**OXYGEN TANKS**

These oxygen tanks, removed from surplus aircraft, have a capacity of 500 lbs. pressure. Type D2, with complete regulator assembly. Size of tank 22"x5". Wt. 7 lbs.

**\$5<sup>95</sup>**

TERMS: CASH WITH ORDER

**AMERICAN SURPLUS PRODUCTS CO.**

537 N. CAPITOL AVE. INDIANAPOLIS, IND.



**I Put You to Work with Your Hands to LEARN RADIO!  
You Build Receivers! You Make Typical Defects Occur  
and Make Tests to Prove the Theory!**

**YOU GET  
8 BIG KITS OF RADIO  
PARTS & EQUIPMENT  
including**

**2-BAND SUPER  
RECEIVER!**

**and 16 RANGE METER  
FOR TESTING**

**LEARN RADIO  
to MAKE MONEY!**

**LOW COST TRAINING — EASY PAYMENT PLAN!**

**You Learn at Home How to  
Build and Test Dozens and  
Dozens of Circuits — Simple  
and Complex!**

**YOU DO  
OVER 175  
INSTRUCTIVE  
EXPERIMENTS**

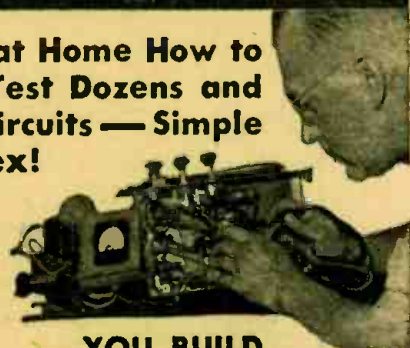

**YOU BUILD  
ALL THESE TESTERS  
..... AND MORE!**

I give you a fine, moving-coil type Meter Instrument on Jewel Bearings — with parts for a complete Analyzer Circuit Continuity Tester. You learn how to check and correct Receiver defects with professional speed and accuracy.

You'll get valuable experience and practice building this Signal Generator and multi-purpose Tester. Makes a breeze out of fixing Radios and you don't have to spend money on ready-made Equipment.



Soldering, wiring, connecting Radio parts . . . building circuits with your own hands — you can't beat this method of learning. When you construct this Rectifier and Filter, Resistor and Condenser Tester, etc., you get a really practical slant on Radio that leads to a money-making future.

F. L. SPRAYBERRY, PRESIDENT of the SPRAYBERRY ACADEMY OF RADIO. This is the man who directs your study. His years of experience and Radio "know-how" assure you of the finest in home Radio Training!

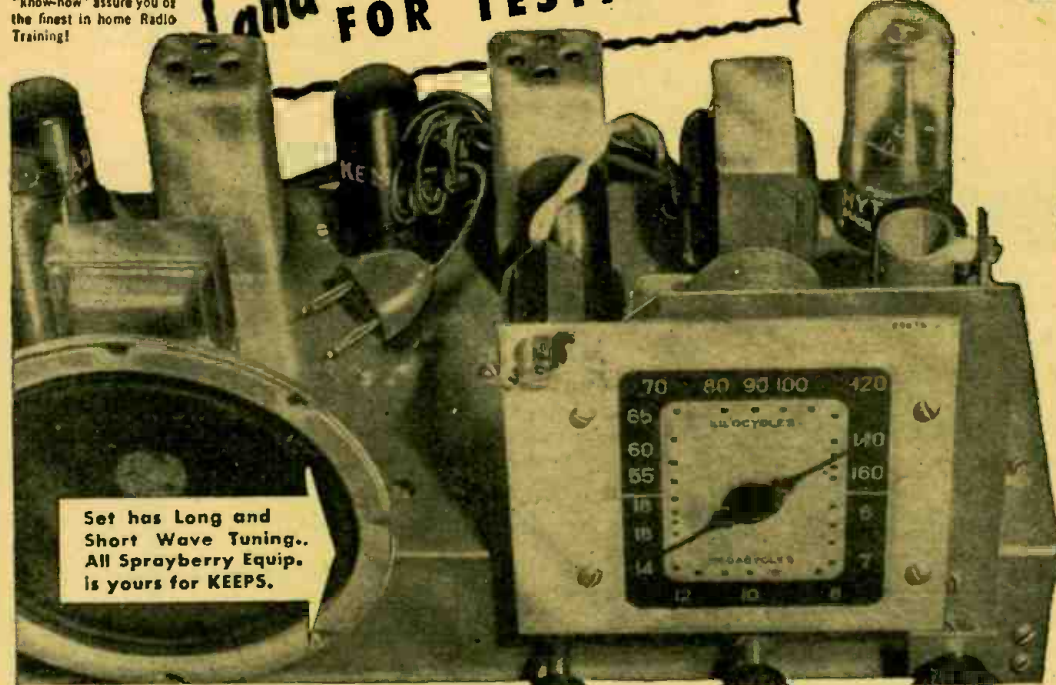

Set has Long and Short Wave Tuning. All Sprayberry Equip. is yours for KEEPS.

**SPRAYBERRY HOME TRAINING is PLANNED to MAKE MONEY for you FAST!**

I train you with regular professional Radio Equipment. I tell you exactly what to do . . . how to do it. You handle Radio Parts, see them operate, learn what they're for. With the fine Kits I supply, you learn how to build Radio Circuits, construct your own Test Equipment. I'll show you how to cause typical Radio defects so you can watch and see how they act. You learn the latest methods for trouble-shooting and repair. All this adds up to

the finest kind of "bench" experience. And you get it right in your own home. In no time at all, you'll be ready for a business of your own or a good job in Radio, FM, Television, Radar, Industrial Electronics, etc. Now's the time to get started!



**VETERANS!**

Approved for G.I. Training Under Public Laws 16 and 346. Mail Coupon for Full Details.

**SEND FOR MY VALUABLE FREE BOOKS!**

**"How to Read Radio Diagrams and Symbols"**

A wonderfully complete new book, which explains in simple English how to read and understand any Radio Set Diagram. Includes translation of all Radio symbols. Send for this volume at once! It's free! With it I'll send you another Big Free Book, describing in detail my Radio Electronic Training!

**SPRAYBERRY ACADEMY OF RADIO**

F. L. Sprayberry, President  
Room 2048, Pueblo, Colorado

Please rush my FREE copies of "How to MAKE MONEY in RADIO, ELEC. TRONICS and TELEVISION" and "HOW to READ RADIO DIAGRAMS and SYMBOLS."

Check here if a veteran.

Name ..... Age .....

Address .....

City ..... State .....

(Mail in envelope or paste on penny postcard)



# ADDS 3 NEW LCETI



## NEW MODEL 905A "SPARX" SIGNAL TRACER AND UNIVERSAL TEST SPEAKER

The new "SPARX" is here — the super-sensitive r.f., i.f. a.f. signal tracer, phono pick-up, microphone and speaker tester. Like all SILVER LCETI, it goes far beyond the ordinary. Built-in is a 6" PM speaker and 8 watt truly universal output transformer with two panel switches give impedances of 325 thru 70,000  $\Omega$  single or push-pull. In the new 905A "SPARX" you get the world's finest signal tracer, the world's most universal test speaker, separately usable universal output transformer — three instruments for the price of one.



ONLY \$44.50 NET



## NEW FM & TV SWEEP SIGNAL GENERATOR

FM and TV are here — must be serviced by every technician today. Model 909 and any good 'scope does the TV and FM alignment job — visually — easily — simply — perfectly — and fast. Three bands 2 thru 266 mc., linear electronic sweep panel variable from 40 kc. to 10 mc. It's no wonder Model 909 — first announced in late January — is the "hottest" instrument in radio. Model 909 is another "must" for every service laboratory — new Silver inventions make it newest and by far the best. With complete instructions.



ONLY \$48.50 NET



## NEW MODEL 910 UNIVERSAL TEST SPEAKER

Six-inch high-quality PM speaker and 8 watt truly universal output transformer of the new "SPARX" give you any transformer impedance, single or push-pull, from 325 thru 70,000  $\Omega$ . Panel jacks and switches permit combined or independent use of transformer and/or high-quality 6" PM (3  $\Omega$  voice coil) speaker. Chart on panel instantly shows correct switch positions for 30 different impedances — can't get lost. Size and style matches "VOMAX", 906 FM/AM Signal Generator — all SILVER LCETI.



ONLY \$22.70 NET

★ LCETI — Laboratory Caliber Electronic Test Instruments. See them at your favorite jobber.

SEND FOR COMPLETE CATALOG. See these and Silver communication transmitters, receivers, "Micromatch", TV preamplifier, pretuned freq. multiplier at your jobber.

OVER 37 YEARS OF RADIO ENGINEERING ACHIEVEMENT  
*McMurdo Silver Co., Inc.*  
EXECUTIVE OFFICES: 1240 MAIN ST. HARTFORD 3, CONN.  
FACTORY OFFICE: 1249 MAIN ST. HARTFORD 3, CONN.





ABOVE: TELEVISION offers YOU one of today's thrilling, newer fields with possibilities for a bright and promising future. The above scene shows some of the modern equipment at D.T.I. used in preparing men for TELEVISION.

# • Television

## • RADIO

## • Industrial ELECTRONICS



One of today's most promising fields is INDUSTRIAL ELECTRONICS. D.T.I. can prepare you for this field — either at home or in our modern Chicago laboratories. See HOW you may get started toward this fascinating work now. Fill in — mail the coupon below today!

## Get FREE Facts About YOUR Future in These Fields

**SEE HOW YOU MAY MAKE REAL MONEY, HAVE A GOOD JOB, OR A BUSINESS OF YOUR OWN . . .**

Mail the coupon below and you will receive, absolutely FREE, facts showing how you may get started toward a good job or a business of your own in RADIO or ELECTRONICS. See how readily you may begin to realize your life-long ambition for a REAL FUTURE. See how you may make your start toward a field that also includes such interesting branches as F-M Radio, Broadcast Radio, Aviation Radio, 2-Way Train Radio, Police-Cab-Truck Radio, Sound Recording.

**NO ADVANCED EDUCATION, NO EXPERIENCE NECESSARY**

Our Chicago Laboratory and Home Training have been designed to prepare you and to get you started in Radio and Electronics — whether or not you have a higher education or previous experience. Don't delay . . . mail the coupon below today!



With our HOME TRAINING you receive actual radio parts from which you make 133 experiments and build 7 radio receivers . . . plus loose-leaf lessons with fold-out diagrams . . . plus HOME MOVIES to help you learn easier, faster.

## 2 TRAINING PLANS — TAKE YOUR CHOICE

1. You may come to our modern, Chicago laboratories, where you train with the aid of capable instructors and some of the finest Radio-Electronic equipment. We will find comfortable living quarters for you.
2. Or, if you prefer, you may STUDY AT HOME — using modern, commercial-type radio equipment, well illustrated lessons and HOME MOVIES. You can do this in your SPARE TIME, without interfering with your present job.

## VALUABLE EMPLOYMENT SERVICE

When you complete either training, our effective Employment Service goes to work for you, to help you get started toward a real future in Radio-Electronics. Don't delay!

## MAIL THIS OPPORTUNITY COUPON NOW!

Mr. E. B. DeVRY, President  
 DeForest's Training, Inc.  
 2533 N. Ashland Ave., Dept. RC-E4  
 Chicago 14, Illinois

**ACCEPTED FOR G.I. TRAINING**

Please show me how I may get started toward a good job or a business of my own in Radio-Electronics.

Name \_\_\_\_\_ Age \_\_\_\_\_  
 Address \_\_\_\_\_ Apt. \_\_\_\_\_  
 City \_\_\_\_\_ Zone \_\_\_\_\_ State \_\_\_\_\_

If under 16, check here for special information.
  If a discharged Veteran of World War II, check here.

**DeForest's Training, Inc.**  
**CHICAGO, ILLINOIS**

Associated with the DeVry Corporation  
 Builders of Electronic & Movie Equipment

**12 & 24 VOLT  
FIL. XFMR'S**

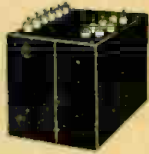

Size: 3" x 3 1/4" x 3" (as shown).....\$1.50

(All primaries 110 v. 60 cycles.) No. 517:  
Output: 12 v. @ 10 amp or 24 volts @ 5 amps.....\$2.75  
No. 2217: Output: 24 volts @ 3 amp.....\$1.50

**SONAR SOUND DETECTION UNIT**

Ideal for detecting under water sounds, such as fish swimming in schools, within a 15 mile area. Using a Rochelle salt crystal, which is about 1000 times more sensitive than quartz. It is completely enclosed in a solid rubber sheath. This sound detector was originally used in harbor defenses. Coupled to an audio amplifier, this can be found to have many valuable applications. It's the Model JB which contains 7 microphone units.....\$12.50

**RADAR  
AIRCRAFT**

**"Communications"**

**AMATEUR  
INDUSTRIAL**

**RACK FOR COMPLETE RIG**

Size 46" high, 24" wide, 22" deep. Black crackle finish, with special receiver mounting panel. Has 3 decks. 8-tube electronic control amplifier and hundreds of useful parts for that new rig. Below are a few of the items.



- 11-1" Jewels
- 4-AC outlets
- 2-0-3 amp. RF meters
- 1-40-0-40 ammeter
- 2-ceramic switches
- 1-ohmite pot
- 5-AC relays

- 3-fuse blocks
- 2-115v.a.c. contactors
- 1-6" AC gong
- 7-Panel controlled circuit breakers (4-15 amp, 2-35 amp, 1-50 amp)
- 3-Large push button switches
- 3-Wall type switches
- 1-Reset push button switch
- 1-Microphone jack
- 3-Meters on 5-hole meter panel
- 5-Large Jones strips
- 1-4" dpdt heavy duty knife switch

Don't miss this exceptional buy! The parts alone are worth many times this special price.....\$45.00

**MICROWAVE TUBES  
(Magnetrons)**



TUBE	FREQ. RANGE	PK. PWR	OUT PRICE
2J31	2820-2860 mc.	285 Kw.	\$10.00
2J21-A	9345-9405 mc.	50 Kw.	\$25.00
2J22	3267-3333 mc.	265 Kw.	\$15.00
2J26	2992-3019 mc.	275 Kw.	\$15.00
2J27	2955-2982 mc.	275 Kw.	\$15.00
2J32	2780-2820 mc.	285 Kw.	\$15.00
2J38	PKG. 3249-3263 mc.	5 Kw.	\$25.00
2J55	PKG. 9345-9405 mc.	50 Kw.	\$25.00
3J31	24,000 mc.	35 Kw.	\$17.50
W.E. 700-A	680.710 mc.	100 Kw.	\$35.00
W.E. 720BY	2800 mc.	1000 Kw.	\$25.00

MAGNETS for 2J21-A(725-A), 2J22, 2J26, 2J27, 2J31, 2J32 and 3J31, each.....	Price
Field Strength	
Gauss	
4850	\$ 8.00
1500	4.5-3.00
1000	Adjustable
(Electromagnet)	2 3/4" to 3" 2 1/2" \$12.00
2100	1 1/2" 3/4" \$ 4.00

**TRANSFORMERS**

All Primaries—117 V 60 cycles  
#5102: 1080 vct @ 55 ma. 6.3 v. @ 1.2 amp. \$2.35  
#5110: 1100 v. @ 70 ma, tapped @ 550 v. (for use with H.W. rect.).....\$2.75

**FILAMENT TRANSFORMERS**

#5123: 6.3 vct @ 5 amp, 6.3 vct @ 1 amp.....\$2.15  
#5109: 27 volts @ 8.8 amp, 6.3 v. @ 2.5 amp.....\$2.75  
#13163: 2.5 v. @ 1.75 amp, 5 v. @ 3 amp, 6.5 v. @ 5 amp, 6.5 v. @ 8 amp.....\$5.35  
Doughnut Fil. Xfmr. Two 5.1 v. windings @ 5 amp. each, 15,000 volt test.....\$7.50  
No. 5058: 6.3 VCT @ 2A, 6.3 VCT @ 2A, 6.3 VCT @ 2A.....\$2.25  
No. 5126: 5 VCT @ 3A, 5 VCT @ 3A, 5VCT @ 6A.....\$2.25  
No. 5100: 6.3 VCT @ 1.2 A, 5000 V test.....\$1.35  
No. 5080: 6.3 V NCT @ 6A, 6.3 V NCT @ 1.5 A.....\$1.40  
No. 5056: 6.3 VCT @ 9 A, 6.3 VCT @ 2.2 A, 6.3 VCT @ 2.2 A.....\$2.50  
No. 5057: 6.8 VCT @ 1 A, 5 VCT @ 3 A, 5 VCT @ 3 A.....\$2.50  
UX 6899: 5 V @ 5.5 A, 5 V @ 5.5 A, 29,000 Volts Test.....\$24.50

**POWER CHOKES**

6 Hy @ 150 ma.....\$1.50  
6 Hy @ 300 ma.....\$3.25  
1 Hy @ 800 Ma, 7.5 Ohms.....\$8.95  
Dual-Choke: 2-2 Hy @ 100 Ma.....\$ .90  
Dual Choke: 7 Hy @ 75 Ma, 11 Hy @ 60 Ma.....\$1.50  
8.5 h @ 125 ma.....\$1.50  
25 h @ 65 ma.....\$1.10

**H. V. OIL CAPACITORS**

(All Nationally  
Advertised Brands)

.08 mf @ 1500 VDC, type MX80.....\$11.50  
.03 mf @ 2000 VDC, type 551A-50.....12.75  
.045 mf @ 2000 VDC, type G1.....12.75  
.00015 mf @ 20 KV, type 1970-404.....25.00  
.0001 mf @ 20 KV, type G3.....25.00  
.0051 mf @ 15 KV, type G4.....25.00  
.006 mf @ 16 KV, type G3.....17.50  
.002 mf @ 15 KV.....20.00  
MFRS: Send your requirements for bathubs, Micars, Hardware, resistors, & connectors.

**CATHODE RAY TUBES  
5BP1... \$1.20**



3BP1—\$1.25 ..... 5FP7—\$1.75  
3FP7—\$1.20 ..... 5JP2—\$4.00

**WIRE RECORDING MAGAZINES**

Magazine for KS 12009 recorder, made by W.E. Comes with wire for 1/2-hour recording. Has elapsed time indicator, recording and erase features. Size: 1 1/4" L x 7" W x 5 1/4" H. Loss Drive Motor.....\$30.00

**EMERGENCY TRANSMITTER SCR 578**

Famous Gibson girl! Transmits automatic SOS signal on 500 kc emergency wave. Can be keyed manually to transmit further data. No batteries required. Hand operated. A MUST at this price.....\$25.00  
With Kite, etc.....\$35.00



**ANTENNA AN/122-A.** Used in 4-element adcock arrays for high gain and directivity, each dipole element is 12' long, made of 1/2" tubing. Excellent for that new 6 or 2-meter beam. Don't miss this great value.  
\$5.65 each or 4 for \$20.00

**ANTENNA AN/104-A.** The famous AX-handle antenna, used with the SCR 522. Ideal for mobile quarter wave, because of its streamline construction; or 2 units can be used to form a dipole for 2 meters or for TV and FM reception. Consists of copper sheath 21' long coated about a wooden support, with 83-1R coax connector.....\$7.50 ea. or 2 for \$13.50

**ANTENNA AN 128 A.** 2 parallel vertical dipoles working against a square reflector. Impedance is 50 ohms. Broad band pass. Makes an ideal antenna, with high gain and directivity on 2 meters. APX 5 x 4'. New.....\$40.00

**DYNAMOTORS**

PE 73 CM(G.E.) Power supply for BC 375 Input: 28 VDC Output: 1000 VDC @ 350 Ma. New.....\$4.95  
BD 77KM Power supply for BC 191. Input 14 v.d.c. Output 1000 v. @ 350 ma. Army release; Excellent Cond.....\$5.95  
MFRS: Write for quantity prices and discounts on above items.  
PE 101-C Input 13/26 VDC @ 12.6/6.3 A. Output: 400 VDC @ 135 Ma., 800 VDC @ 20 Ma. 9 VAC @ 1.12 A. New.....\$3.49  
PE 86 N, Input: 28 VDC, Output: 250 VDC @ 80 ma, without filter.....\$3.95  
PC 77, Input 12 VDC, Output 275 VDC @ 110 Ma, 500 VDC @ 50 Ma.....\$3.25  
DAG 33A Input: 18 VDC @ 3.2 A, Output: 450 VDC @ 60 Ma.....\$2.45  
DM 33: Input 28 VDC @ 7 a. Output: 274 VDC @ 250 Ma. Power supply for SCR 540 modulator.....\$3.95  
DM 23560: Input: 27VDC @ 1.75 A. Output: 285 VDC @ 75 Ma.....\$1.75  
DM 21: Input: 14 VDC, Output 235 VDC @ 90 Ma. Power supply for BC 312.....\$2.49  
PE 55, Input: 12 vdc @ 25 amp. Output 500 vdc @ 400 ma. (slightly used) Ex. cond. \$4.95  
MP 10 G Power supply, using 2 dynamotors. Input: 24-28 vdc. Output: 1000 vdc @ 400 ma. 230 vdc @ 100 ma. New, complete with relays, filters, etc. BENDIX.....\$40.00

B-19 power pack (dynamotor). Input: 12 vdc @ 8.4 amp. Output: 275 vdc @ 110 ma. 500 vdc @ 50 ma. New, complete in metal case with 2 plugs, filters, etc.....\$4.75

DM 28-R, Input: 28 v.d.c. @ 1.25 amp. Output: 270 v.d.c. @ 70. ma. New, with enclosed terminal box.....\$3.25  
ZA/USA .0515, Input: 12/24 v.d.c. @ 4/2 amp. Output: 500 v.d.c. @ 50 ma. Compact square shape, size: 7 1/4" x 4 1/4" x 3".....\$3.95  
ZA/USA .0516, Input: 12/24 v.d.c. @ 8/4 amp. Output: 275 v.d.c. @ 110 ma., 12 v.d.c. @ 3 amp. Compact square, size: 7 1/4" x 4 1/4" x 3".....\$4.25

35X055, Input: 19 vdc @ 3.8 amp. Output: 300 vdc @ 85 ma.....\$2.20  
DM-25: In 14VDC 2.3A Out 250VDC 50 ma.....\$2.49  
DM-34: In 14VDC 2.8A Out 220VDC 80 ma.....\$2.49  
DM-42: In 14VDC, Out 515/1030 VDC 215/260 ma and 2/8VDC.....\$3.95

**INVERTERS**

PE 206-A, Input: 28 v.d.c. @ 38 Amp. Output: 80 volts @ 500 volt-amp, 800 cy. Leland Electric. New, complete with instruction book, relays, filters, etc.....\$12.50  
PE 218—Input: 25-28 v.d.c. @ 92 amp. Output: 115 volts, 1500 volt-amps, 380/500 cy. Leland Electric. New.....\$15.00

**ARC-5 ACCESSORIES  
CONVERSION COILS FOR ARC-5  
TRANSMITTERS**

M.O. Coils	P.A. Coils	Antenna Loading Coils	Freq. Range
\$1.00 each	\$1.00 each	\$ .85 each	
#6029	#7247	#6033	3-4 Mc.
#6030	#9293	#6034	4.5-3 Mc.
#6032	#9295	#6035	7-9.1 Mc.

**CONVERSION KIT,** consisting of 1-M-O coil, 1-P.A. coil, 1-ANTENNA COIL, in any one particular frequency range.....\$2.00  
ARC No. 6558 variable receiving capacitor. 62 mmf/section, 3 sections, .03" spacing, 8 rotors. Worm drive ratio 33:1.....\$1.75  
ARC No. 4990, variable xmtg. capacitor, 22.4-145 mmf, .05" spacing, 11 rotors. Each.....\$1.00  
ARC 5032 Var. Xmtg. capacitor, 29.2-117 mmf, .06" spacing, 18 rotors, worm drive: 96:1.....\$1.00  
Single revr. mtg. racks.....\$1.00  
Dual mtg. racks (revr.).....\$1.50  
Shock mounts for rack.....\$1.50  
DUAL CONTROL BOXES FOR BCVR'S.....\$1.00

**HI-FI OUTPUT TRANSFORMER**

W.E. #KS 9490, 9000 ohms p-p plates to 9 ohm voice coil. Handles 250 watts. Freq. response: -1.25 db @ 100 cy. 0 db @ 1000 cy, -3 db @ 10 kc, -3 db @ 50,000 cy. Weight: 1 1/2 lbs. New.....\$3.95

**RECTIFIER TUBES**

355-A... \$4.50 705-A... \$1.25

1619's—6L6 with 2.5 V. Filament—5 for \$1.00

**TEST SET 159TPX**

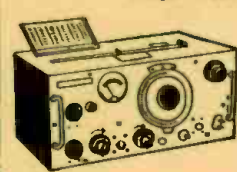

Measures frequency between 150-200 Mc. by heterodyne method. Pwr. Output of XMTTR can be measured directly. Measures DC voltages up to 500 V. Operates on 110 V, 400 cy. Complete with tubes, crystal, calibration chart. Conversion kit for 60 cy.....\$29.95

**HEADSETS**

Dynamic mike and headset combination. A high quality, efficient unit, used in B-19 tank Xmttrs. Mike & phones complete, new.....\$2.75  
R-15 headsets: 8000 ohms impedance, rubber cushions. Comes with 8' cord & plug PL 55. New \$1.95. Used, in good condition.....\$ .60  
HS 30 headset. Insert type headset cuts out background noise, and low impedance (500 ohms) assures efficiency and high fidelity. A MUST for every ham at this price.....\$ .85  
Xfmr to match 8000 ohms output.....\$ .35  
R-2A headsets, 10,000 ohms impedance, with headband, 8' cord, and PL 55 Plug. Slightly used, in excellent condition.....\$2.25

**COAX CABLE**

RG9/U 51 ohm silver coated. Min. 50 ft. length, per ft. .07 1/2

All merchandise guaranteed. Mail orders promptly filled. All prices, F.O.B. New York City. Send Money Order or Check. Shipping charges sent C.O.D.

**COMMUNICATIONS EQUIPMENT CO.**

131 C. Liberty St., New York City 7, N.Y.

Digby 9-4124

**AMPHENOL LOW-LOSS SERIES CONNECTORS**

83-1 R. Female.....27c  
83-1AP Rt. angle.....27c



**"SCR 522"**  
\$13.75

The famous SCR 522 Radio Transmitter and Receiver, for operation on the 2 meter band (100 to 156 M.C.), is now available, complete with all 18 tubes in EXCELLENT condition at an unbelievably low price. This set is easily converted to 6 meter operation, if you prefer.

Now only ----- \$13.75  
(Shipped express charges collect)



**BC221 Frequency Meter** NOW ONLY \$24.50

The famous BC-221 Signal Corps. Frequency Meter is now offered at an unbelievably low price of only \$24.50 each. These meters cover from 125 K.C. to 20 M.C. and are accurate to approximately .01 of 1 Percent. They are used but in excellent condition complete with calibration chart, tubes and crystal.

(Shipped express, charges collect)



**PHANTOM ANTENNA**  
85¢

A transmitting antenna, for use on approximately 450 MC. Complete with standard coax connector. A weather-proof unit. (Add 25c to cover handling and postage).

**Transformers** \$1.50

A real transformer buy. 110 volt 60 cycle primary will give you anything from 3.5 volts to 80 volts with plenty of amperage. Will run many 24 volt aircraft motors and gadgets. Brand new guaranteed.

(Add 35c to cover Handling and Postage)

**SIGNAL GENERATOR \$29.50**

LS-1 Squadron Signal Generator (Navy Type CML-60049) used for Type ZA Glide path equipment. Frequency range 90-95 mc. Amplitude modulated - variable frequency; audio oscillator tuned to 60 cycles. R F level measured by self contained VTUM. Contains 0.50 micro-amp meter.

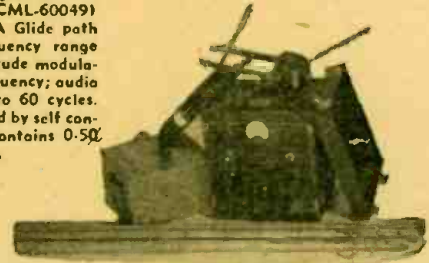

**Aircraft XMTRS.**

only \$3.30 each

BC-457-A, 4 to 5.3 MC and BC-458-A, 5.3 to 7 MC. These transmitters are companion sets to the 453, 4, and 5 receiver series. They are used, but in excellent condition. It's really built rugged and makes an excellent 55 watt transmitter. With tubes.

Shipped Express Collect



**1300' Rubber Covered Wire**  
ONLY \$18.00

New 4 conductor 16 gauge rubber covered cable. Color coded. Used by United States Government as Field Telephone Cable. 1300 feet on steel reel. F.O.B. Our warehouse Shipped motor freight or express shipping charges collect.



**12 Volt 50 Amp Generators**

These generators are excellent for truck or bus use. They also will make a fine power supply for your radio shack or nice light welder. Brand new in original boxes as pictured with pulley, \$9.45 each or with keyed shaft less pulley - \$7.95 each.

(Shipped Express Collect)

**500' Telephone Wire now only \$2.95**

3 conductor braided insulated copper and steel telephone wire. It is of copper for conductivity and steel for strength. Worth at least 3c per foot, yet due to an exceptional buy we can now offer it at less than 1c per foot.

(Shipped express charges collect)

**Stock Up**



**WILLARD 1 VOLT BATTERIES**  
ONLY \$1.25 each

Brand new, Compact, spill proof, Built-in Hydrometer. Group several together for higher voltages. Uses Standard Electrolyte. Guaranteed. Add 35c to cover postage and handling.

**66" AUTO ANTENNA**  
\$1.29

A brand new heavily chrome plated side cowl antenna, originally used on 46 and 47 Hudsons. Telescopes to 66" long, fits most cars up to 1947. Originally sold for many times this price. (Add 40c to cover postage and handling.)

**IMPORTANT!**

All merchandise subject to prior sale, minimum order \$2.00. No C.O.D. orders accepted. Michigan residents must add 3% State sales tax.

**More Scoops!**

- B. C. 450 A. Control Box For 274 Command Receivers \$1.50
- B. C. 434 F Control Box \$1.25
- N. 6 A. Gun Sight \$1.00
- RCA Antenna Reel (Model M-1) (19611) \$1.49

Add 25c each to cover Postage and Handling on all above items.

**Meters 99¢**



Brand new Bowers D.C. Volt meter, 0 to 9 volts in 2" case with 2 3/4" Flange each .99c

Brand new Bowers D.C. Ammeter 0 to 100 amp scales (600 ma. movement with 100 amp shunt) same case as volt meter each .99c

Add 20c each to cover postage and handling

**CATHODE RAY TUBE BARGAINS**

3 CP 1 (Indicator screen) -----	.95	5 FP 7 -----	1.75
3 DP 1A (Indicator screen) -----	.95	5 CP 1 -----	1.95
3 FP 7A -----	1.35	5 BP 1 -----	2.45
3 AP 1 -----	1.45	5 HP 1 -----	2.45
3 HP 7 -----	1.45	5 JP 1 -----	2.45
3 BP 1 -----	1.50	7 BP 7 -----	2.65
908 -----	1.50	7 CP 1 -----	3.25
		9 GP 7 -----	3.50

Add 25c to cover shipping charges on all 3" tubes, 35c on all 5" tubes, 40c on all 7" tubes, 9" tubes shipped express charges collect.



**N. SILVERSTINE CO.**

6532 EAST McNICHOLS ROAD DETROIT 12, MICHIGAN

*"Seven Acres of Surplus"*



Incorporating  
SHORT WAVE CRAFT\* TELEVISION NEWS\*  
RADIO & TELEVISION  
\*Trademark registered U. S. Patent Office

Editorial: Radio As A Vocation . . . . . by Hugo Gernsback 17  
Radio-Electronics Monthly Review . . . . . 18, 19  
Radio Thirty-Five Years Ago . . . . . 81

**Radio and Electronics**

Standard Television Sets Become Projectors . . . . . 21  
Tubeless Homo-Heteradio . . . . . by Mohammed Ulysses Fips, I.R.E.I.R.E. 22  
British Radio Design . . . . . by Major Ralph W. Hallows 26  
European Band-Change System . . . . . by D. E. Ravalico 47

**Communications, Amateur Radio**

Brunetti Wrist-Watch Transmitter . . . . . by Hugo Gernsback 28  
The Junior Demon 5-Watt Transmitter . . . . . by G. Carroll Utermahlen, W3HVD 31

**Servicing**

The Radioman Expands His Business . . . . . by C. J. Whitton 20  
Radio Set and Service Review (Bendix Model 847S "Facto Meter") . . . . . 30  
'Scope Checks Car Radios . . . . . by Walton N. Hershfield 56  
Renew that Cabinet! . . . . . by Harry Leeper 58  
Six New Tubes . . . . . 60

**Test Instruments**

Tiny Self-Powered Electronic Voltmeter . . . . . by Louis L. Kwasniewski 24

**Sound**

Hi-Fi 35-Watt Amplifier . . . . . by H. R. E. Johnston 32  
Tone Control Adventure . . . . . by James R. Langham 35

**Construction**

Capacity-Relay Intruder Alarm . . . . . by Milton Kalashian 25  
A Stable Regenerative Receiver . . . . . by Otto L. Wooley 34  
Most-Needed Circuits . . . . . 36  
A Real Swing Key . . . . . by L. B. Robbins 78

**Departments**

Transatlantic News . . . . . by Major Ralph W. Hallows 38  
FM Station List . . . . . 40  
The Question Box . . . . . 42  
Radio-Electronic Circuits . . . . . 44  
Technotes . . . . . 48  
New Radio-Electronic Devices . . . . . 49  
Try This One . . . . . 50  
New Radio-Electronic Patents . . . . . by I. Queen 54  
Communications . . . . . 84  
Book Reviews . . . . . 87

**HUGO GERNSBACK**  
*Editor-in-Chief*  
**FRED SHUNAMAN**, *Managing Editor*  
**M. HARVEY GERNSBACK**,  
*Consulting Editor*  
**ROBERT F. SCOTT, W2PWG**,  
*Technical Editor*  
**ANGIE PASCALE**,  
*Production Manager*  
**I. QUEEN, W2OUX**, *Editorial Associate*  
**ELMER FULLER**, *Shortwave Editor*  
**G. ALIQUO**, *Circulation Manager*  
**JOHN J. LAMSON**,  
*Advertising Director*  
**ALFRED STERN**, *Promotion Manager*

**In An Early Issue**

MYSTERY RADIO RELAY  
DOUBLE-BRIDGE VOLTMETER  
WIND-DRIVEN GENERATORS

**On the Cover:**



Dr. Cleo Brunetti's wrist-watch-radio, as worn by Miss Dorothy S. Dowling, a Bureau of Standards employee, Washington, D.C.

Chromatone by Alex Schomburg from Harris & Ewing photo.



Member Audit Bureau of Circulations  
RADCRAFT PUBLICATIONS, INC. Hugo Gernsback, President; M. Harvey Gernsback, Vice President; G. Aliquo, Secretary

Contents Copyright, 1948, by Radcraft Publications, Inc. Text and illustrations must not be reproduced without permission of Copyright owners.

RADCRAFT PUBLICATIONS INC. • PUBLICATION OFFICE 29 Worthington Street, Springfield 3, Mass. Address all correspondence to N. Y. office. EDITORIAL AND ADVERTISING OFFICES 25 West Broadway, New York 7, N. Y. Telephone REctor 2-9690. BRANCH ADVERTISING OFFICES: Chicago: 308 W. Washington Street, Chicago 6, Ill. Tel. Randolph 7363. Detroit: Frank Holstein, Manager, Room 402 Lexington Bldg., 2970 West Grand Blvd., Detroit 2, Mich. Telephone Madison 7026-7. Los Angeles: Ralph W. Harker, Manager, 606 South Hill St., Los Angeles 14, Calif. Tel. Tucker 1793. San Francisco: Ralph W. Harker, Manager, 582 Market St., San Francisco 4, Calif. Tel. Garfield 2481.

RADIO-CRAFT, April, 1948, Volume XIX, No. 7. Published monthly on 25th of month preceding date of issue. Allow one month for change of address. When ordering a change, please furnish an address stencil impression from a recent wrapper. All communications about subscriptions should be addressed to the Circulation Manager, Radio-Craft, 29 Worthington St., Springfield 3, Mass., or 25 West Broadway, New York 7, N. Y.

SUBSCRIPTION RATES: United States and possessions, Mexico, Central and South American countries, \$3.50 a year; \$6.00 for two years; \$8.00 for three years. Canada, \$4.00 a year; \$7.00 for two years; \$9.50 for three years. All other foreign countries, \$4.25 a year, \$7.50 for two years; \$10.25 for three years.

FOREIGN AGENTS: Great Britain: Atlas Publishing and Distributing Co., Ltd., 18 Bride Lane, Fleet St., London E.C.4. Australia: McGill's Agency, 179 Elizabeth Street, Melbourne. France: Brentano's, 37 Avenue de l'Opera, Paris 2e. Holland: Technisch Bureau Van Boerle, Bemelmans & Co., Heemsteedsche, Dreef 124, Heemstede. Greece: International Book & News Agency, 17 Amerikis Street, Athens. So. Africa: Central News Agency, Ltd., Cor. Rissik & Commissioner Sts. Johannesburg; 112 Long Street, Capetown; 369 Smith Street, Durban, Natal. Universal Book Agency, 70 Harrison Street, Johannesburg. Middle East: Steimatzky Middle East Agency, Jaffa Road, Jerusalem. India: Susil Gupta (Distributors) Co., Amrita Bazar Patrika Lt., 14 Ananda Chatterjee Lane, Calcutta.

# Which Do You Want?



Better Pay



A Nice Home



A New Car



Greater Security



Happy Vacations  
and Travel

Jobs worth  
\$3000 to \$7500  
are opening up  
right now for  
**FCC Licensed  
Radiomen**

# How to Pass FCC Commercial Radio Operator LICENSE EXAMS



## GET YOUR FCC TICKET IN A FEW SHORT WEEKS

Get your license easily and quickly and be ready for the \$3000 to \$7500 jobs that are open to ticket holders. CIRE training is the only planned course of coaching and training that leads directly to an FCC license.

### IT'S EASY WITH CIRE COACHING AND TRAINING

Your FCC ticket is recognized in all radio fields as proof of your technical ability. Employers often give preference to license holders, even though a license is not required for the job. Hold an FCC "ticket" and the job is yours!

### Look what these students say:

"Thanks to this course, I now have a very good job in a local power plant's test department. I couldn't have obtained this job without the math and basic electrical theories in the first part of Section I of this course." Stud. No. 2893N12

"I have been working for Police Radio Station WPFS in Asheville for five months since getting my second-class ticket." Stud. No. 2858N12

"You may be interested to know that I am employed at the local broadcast station, where I am a transmitter operator. I took and passed the FCC examinations last February." Stud. No. 2754N12

**CLEVELAND INSTITUTE OF RADIO ELECTRONICS**  
RC-4 Terminal Tower Cleveland 13, Ohio

Approved for Training under "G. I. Bill of Rights"

RADIO-CRAFT for APRIL, 1948



I can train you to pass your FCC License Exams in a few short weeks if you've had any practical radio experience — amateur, Army, Navy, radio servicing or other. My time-proven training plan can help put you, too, on the road to success—

EDW. H. GUILFORD, Vice-President.

Let me send you **FREE** the entire story. Just fill out the coupon and mail it. I will send you, free of charge, a copy of "How to Pass FCC License Exams," plus a sample FCC-type Exam and Catalog A, describing opportunities for you in Radio-Electronics.

**Get All 3 FREE Send Coupon Now!**

**CLEVELAND INSTITUTE OF RADIO ELECTRONICS**  
RC-4 Terminal Tower, Cleveland 13, Ohio

I want to know how I can get my FCC ticket in a few short weeks. Send me your **FREE** booklet "How to Pass FCC License Examinations" (does not cover exams for Amateur License) as well as a sample FCC-type exam and Catalog A, describing opportunities in Radio-Electronics.

NAME .....

ADDRESS .....

CITY..... ZONE..... STATE.....

Veterans check for enrollment information under G.I. Bill.

**NO OBLIGATION — NO SALESMEN.**

## The battle of the atoms

Telephone equipment is constantly at war against invisible forces of nature which seek to take it apart, atom by atom. On all fronts, Bell Laboratories chemists must fight corrosion — an enemy able to make a telephone circuit noisy or perhaps to sever it altogether.

An example: for years lead cable had lain protected in wooden ducts. Then in certain areas something began to eat the sheath, exposing wires to moisture. Corrosion chemists of the Laboratories were called in. The corrosion, they found, came from acetic acid generated in the wood during the preservative treatment then in use. They pumped in neutralizing ammonia. Corrosion stopped. Now telephone duct wood is controlled for acidity.

In a large city, smoke-polluted air was coating the silver surfaces of contacts with sulphide. Noisy circuits resulted. Chemists discovered minute traces of sulphur vapor in the air. They filtered incoming air with activated charcoal. Today, the latest telephone contacts are of palladium — not affected by sulphur.

Corrosion in metals is only one type of deterioration which engages Bell chemists against hostile forces. Plastics, paper, metals, rubber, textiles, coils, waxes and woods all have enemies. But knowledge, and persistence, are steadily winning out—to the benefit of the telephone user.

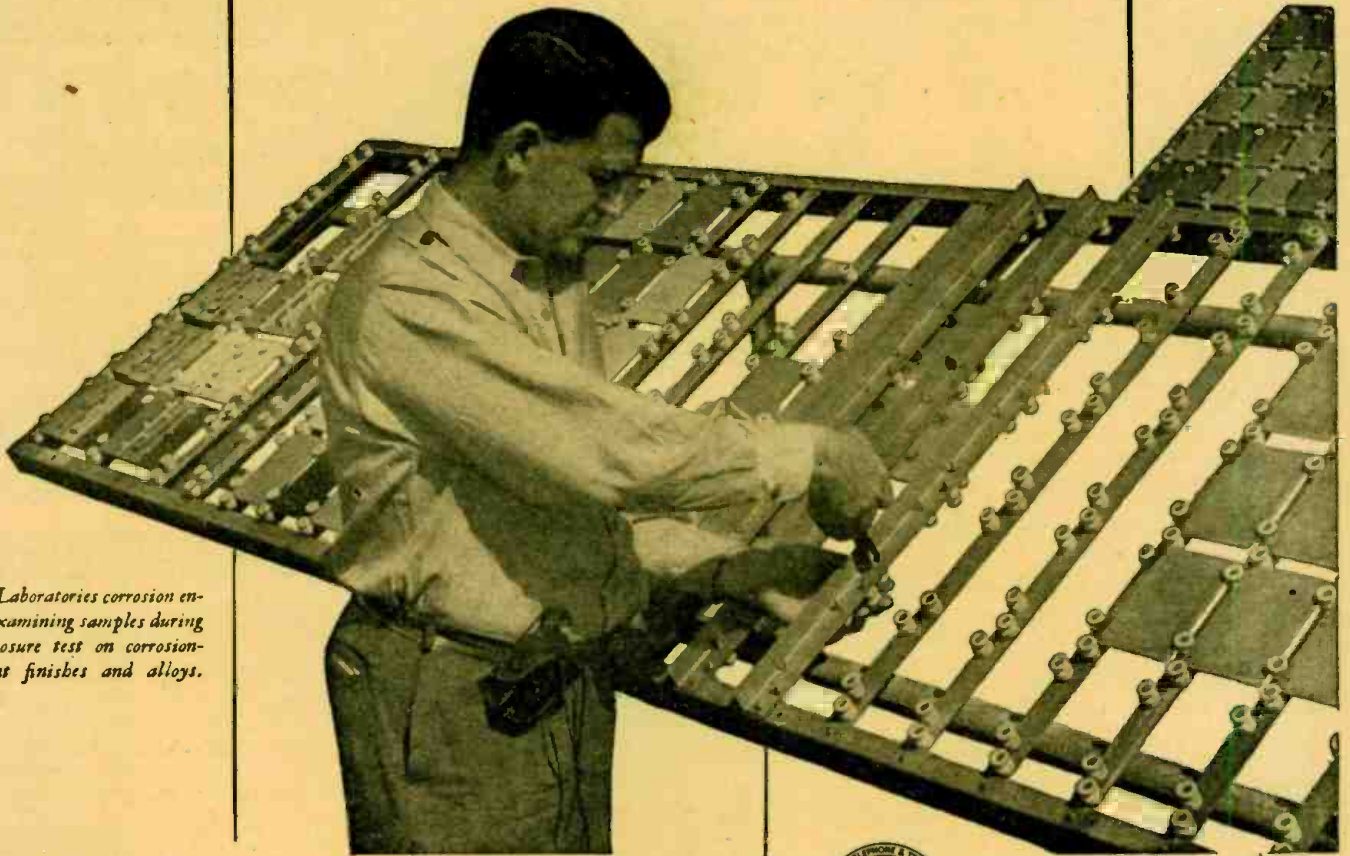

*A Bell Laboratories corrosion engineer examining samples during an exposure test on corrosion-resistant finishes and alloys.*

**BELL TELEPHONE LABORATORIES**



EXPLORING AND INVENTING, DEVISING AND PERFECTING FOR CONTINUED IMPROVEMENTS AND ECONOMIES IN TELEPHONE SERVICE

RADIO-CRAFT for APRIL, 1948

# HOWARD W. SAMS WINS "OSCAR" FOR AID TO RADIO SERVICE INDUSTRY!



The handsome plaque awarded to Howard W. Sams carries the inscription: "The Federation of Radio Servicemen's Associations of Pennsylvania Award to Howard W. Sams in Recognition of His Outstanding Efforts in Behalf of the Radio Service Industry, 1947." The award is a tribute to the practical usefulness of PHOTOFACT Publications—the world's finest radio service data—indispensable to the Radio Serviceman.

## PHOTOFACT Publications Cited as Outstanding Effort in Behalf of Servicemen

"For Outstanding Efforts in Behalf of the Radio Service Industry"—reads the citation of the first annual award bestowed on Howard W. Sams by the Federation of Radio Servicemen's Associations of Pennsylvania. The "Oscar" was presented before a group of over 600 persons, including many radio industry leaders, at a banquet held on January 12, 1948, at Philadelphia's Bellevue-Stratford Hotel. The surprise ceremony was arranged as a demonstration of appreciation for the significant, practical aid made available to Radio Servicemen in PHOTOFACT Publications, and for the efforts of the SAMS' organization in behalf of the Radio Service Industry. This spontaneous demonstration marks a milestone in the Radio Service field. It is a healthy sign of growing recognition of the Serviceman's importance to the Radio Industry.



## These Are the Award-Winning Service Aids that Earn More Money for You!



Own PHOTOFACT Volumes 1, 2 and 3—world's most complete, accurate, practical radio service data manuals. Here is everything you need for faster, easier, more profitable servicing—bound in easy-to-use volumes. Exclusive Standard Notation Schematics; photo views keyed to complete replacement parts lists; exhaustive electrical and mechanical analysis of every set covered. Brings you right up to January 1948! Have the exclusive advantages that are now earning bigger profits for thousands of servicemen!

Vol. 1. All post-war models up to Jan. 1, 1947.  
Vol. 2. Models from Jan. 1, 1947 to July 1, 1947.  
Vol. 3. Models from July 1, 1947 to Jan. 1, 1948.

YOUR PRICE, EACH VOLUME, IN EASY-TO-USE DELUXE BINDER... **\$18.39**



### Radio Receiver Tube Placement Guide

Shows you exactly where to replace each tube in 5500 radio models, covering 1938 to 1947 receivers. Each tube layout is illustrated by a clear, accurate diagram. Saves time—eliminates risky hit-and-miss methods. You'll use this handy pocket-sized book every single day. 192 pages, completely indexed. Order several copies now. **ONLY \$1.25**



### Dial Cord Stringing Guide

The book that shows you the one right way to string a dial cord. Here, for the first time, in one handy pocket-sized book, are all available dial cord diagrams covering over 2300 receivers, 1938 through 1946. Makes dial cord restringing jobs quick and simple. A "must" for every service bench and tool kit. Order your copies now. **ONLY .75c**

### 1947 Automatic Record Changer Manual

Nothing like it! Complete, accurate data on over 40 post-war models. Exclusive exploded views, photos from all angles. Gives full change cycle data, information on adjustments, service hints and kinks, complete parts lists. **PLUS**—for the first time—complete data on leading WIRE, RIBBON, TAPE and PAPER, DISC RECORDERS! 400 pages; hard cover; opens flat. Order now! **ONLY \$4.95**



## BOOST YOUR EARNING POWER!

- Mail This Order Form to HOWARD W. SAMS & CO., INC. 2924 E. Washington St., Indianapolis 6, Indiana.
- My (check) (money order) for \$..... enclosed.
- Send..... SAMS' TUBE PLACEMENT GUIDE(S) at \$1.25 per copy.
  - Send PHOTOFACT Volume 3 (including Sets Nos. 21 through 30) in DeLuxe Binder, \$18.39.
  - Send Volume 2.  Send Volume 1 (\$18.39 each).
  - Send..... SAMS' 1947 AUTOMATIC RECORD CHANGER MANUAL(S) at \$4.95 each.
  - Send..... SAMS' DIAL CORD STRINGING GUIDE(S) at \$0.75 per copy.

Name.....

Address.....

City..... State.....

**HOWARD W. SAMS & CO., INC.**  
INDIANAPOLIS 6, INDIANA

Export—Ad. Auriema—89 Broad St., New York 4, N. Y.—U. S. of America  
Canada—A. C. Simmonds & Sons, 301 King St., East—Toronto, Ontario

**PHOTOFACT SERVICE**

"The Service that pays for itself over and over again"



# ESSE Specials!

Do not fail to closely examine this list of bargains. We believe that every item listed below is a sensational value that soon can never be repeated. All equipment advertised herein is unconditionally guaranteed to the customer's satisfaction to this extent: Return any item advertised within five days after delivery for full refund except transportation charges (both ways).

## WALKIE TALKIE

BC 222 and BC 322 — Frequency 27.7-52.2 Mc. using 2 oscillator coils—52.8-65.8 Mc. using 1 oscillator coil. Crystal calibrator used to select amplitude modulated channels at every 400 Kc of separation. Uses one type 30 and type 33 tube.

**\$39.50**

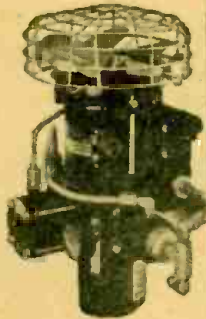

## AIR COMPRESSOR

Made by General Electric Co. Will pump pressure up to 1000 lbs. per sq. in. 2-stage type—air-cooled, powered by a 24 V. DC motor. Ideal in shop for use with airgun, small paint sprayer, and numerous other applications. Small, compact, precision built. **\$12.95**  
Only .....

## RADAR XMTR

T-39/APQ-9

Contains 2—807's, 2—6AC7 1—931 and 1—6AG7 tubes; ceramic switch; potentiometers; gears; revolution counter; Cavity oscillator using 2—RCA 8012 tubes rated at full output to 500 Mc. (tubes are forced air-cooled by 24 V. DC motor—easily converted 110 V. AC operation); a goldmine of parts for the VHF experimenter. **\$12.50**  
Price .....

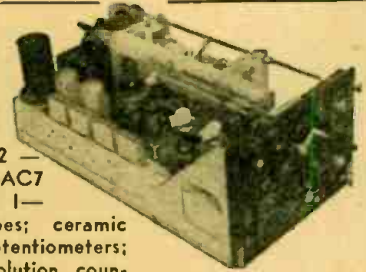

## (HRU) DC POWER SUPPLY

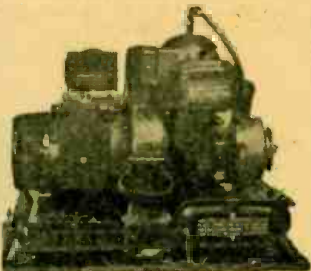

24-28 V. at 70 a m.p. 2000 watts gasoline engine generator with electric starter. Powers supply which can be used to operate 24-28 V. equipment, to start airplane engines, to

charge batteries, as a welding machine, lighting system, or for an amateur radio station. Height, 21½"; Width, 17½"; Length, 24¾", and weight, 115 lbs. **\$72.50**



## INTERVALOMETER

Electronic timing device. Was used for releasing bombs at intervals. Ideal for darkroom timer, model train controller. (Contains relays, switches, pilot light, resistors, knobs, etc.) **\$225**

## BC-375 MOPA TRANSMITTER

*A really fine buy!*

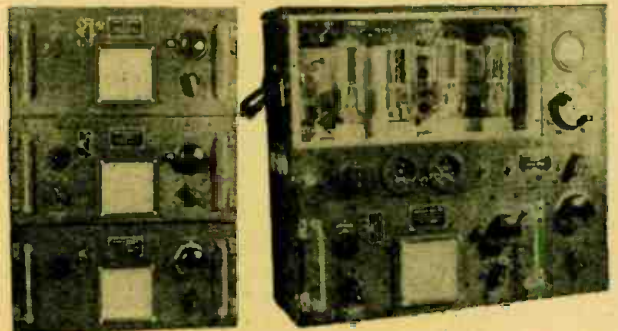

The most famous of all surplus transmitters. Was used by the Army bombers and ground stations during the War. Frequency range is covered by means of plug-in tuning units as shown below. Each tuning unit has its own oscillator and power amplifier coils and condensers, and antenna tuning circuits all designed to operate at top efficiency within its particular frequency range. Transmitter and accessories are finished in black crackle, and the milliammeter, voltmeter, and RF ammeter are mounted on the front panel. **FREQUENCY RANGE:** 200-500 Kc. and 1500-12,500 Kc. (Will operate on 10 and 20 meter band with slight modification.) **OSCILLATOR:** self-excited, thermp-compensated, and hand calibrated. **POWER AMPLIFIER:** neutralized class "C" stage, using 211 tube, and equipped with antenna coupling circuit which matches practically any length antenna. **MODULATOR:** Class "B"—uses two 211 tubes. **POWER SUPPLY:** Dynamotor which furnishes 1000 V. at 350 Ma. **CONVERSION** instructions and diagram for 110 V. AC furnished upon request for \$1.00.

PRICES: As follows—

Transmitter only .....	<b>\$12.50</b>
Tuning units TU-5B, TU-6B, TU-7B, TU-8B, TU-9B, TU-10B, TU-26B, choice..	<b>\$2.50</b>
Dynamotor PE-73C .....	<b>\$3.95</b>
Antenna tuning unit (BC-306A) .....	<b>\$4.95</b>

## TELRAD 18-A FREQUENCY STANDARD

Checks signals in the range of 100 Kc. to 45 Mc. with a high degree of accuracy. Self-contained power supply for 110, 130, 150, 220, and 250 V. 25-60 Cy. AC. Complete with tubes, dual crystal, and instruction book. Brand new. One of the best buys on the surplus markets. **\$24.95**



## BC-348 COMMUNICATIONS RECEIVER, \$69.50

6 bands, 200-500 Kc. and 1.5-18 Mc. 2 stages RF, 3 stages IF, BFO, crystal filter, manual or AVC. Complete with tubes and 24 V. dynamotor. These receivers have been thoroughly checked in our workshop and found in excellent condition.

BC-348, 110 V. AC power supply, including simple conversion instructions. Complete with tube.. **\$8.95**



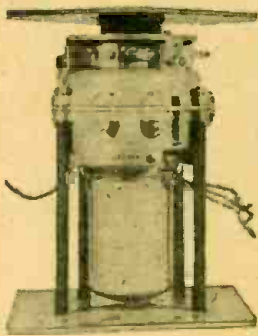

**ROTATOR MOTOR FOR YOUR BEAM ANTENNA**  
**\$9.95**

24-32 V. AC or DC operated. Reversible—only 3 wires required. Approximately 3/4 RPM. 7056 to 1 gear reduction (no free swing). Powerful motor. Rugged precision gear train, and sturdy thrust bearing—will support and turn any ham beam. Weather-proof housing. Motors are easily converted into an FB beam rotator! Conversion data included. \$9.95  
**MOTOR WITH ANTENNA MOUNTING PLATES WELDED ON.....\$6.00 extra**  
**SELSYN TRANSFORMER FOR SELSYN INDICATORS, 110 V. AC input, 25 V. AC output \$2.75**  
**TRANSFORMER FOR BEAM MOTOR, 110 V. AC input, 2-12 V. Secondary windings. Rating 11 amps.....\$4.95**



**Selsyn Indicators**

For use with beam rotators for indication of direction of beam. Operate from 15-24 V. 60-cycle AC supply Wiring instructions.

Large Model 5" diameter **\$285**

Small Model 3" diameter **\$289**



**AIRCRAFT RADIO RANGE FILTER FL-8-A**

For helpful reduction of QRM on crowded CW bands. When attached to output of any communications receiver:

- 1—Will pass signal of 1020 CPS, eliminating others.
  - 2—Will pass voice frequencies and eliminate 1020 CPS code signal.
- Compact, light weight, with switch. Size 2 3/4" x 2 1/2" x 3 3/4".  
**Price ..... 2.25**



- A—Resistor kit composed of 150 or more assorted wattages. Containing various resistors of up to 10 megohms. Many with gold bands. An honest-to-goodness bargain. Box 2.65
- B—Condenser Kit. Contains assortment of 25 various condensers including 2-2Mfd. 600 V. filters, 1-1000 Mfd. 15 V. filter 4-1 Mfd. 400 V. paper by-pass, 3-3 gang midget trimmers, etc.....2.65
- C—Hardware Kit containing about 5 lbs. of radio hardware including nuts, bolts, washers, shafts, gears, grommets, lugs, screws, spacers. It is a gold-mine of invaluable parts.....1.95



- D—Resistor mounting lugs and terminal strip kit. Assorted sizes and shapes. Many, Many, Many 1.00
- E—Tube Socket Kit. 25 or more assorted sockets having various usable sizes.....1.50
- F—Switch Kit consisting of assortment of 10 rotary and toggle switches. Price.....1.25



- A—Cond. (Solar) 10 Mfd. 1000 V. (New).....2.00
- B—Cond. (GE Pyranol) 8 Mfd. 1000 V. DC (New).....1.75
- C—Cond. (Chi. Ind. Cond. Corp.) 4 Mfd. 2000 V. (New).....2.50
- D—Cond. (Cornell-Dubilier) 1 Mfd. 4000 V. (New).....3.00
- E—Cond. (Chi. Ind. Cond. Corp.) Dual 8.5 Mfd. 1000 V. (New).....3.50



- F—Cond., .25 Mfd. 400 V. (New).....10
- G—Cond., .125 Mfd. 400 V. (metal cased) (dual condenser) (New).....15
- H—Cond., 1.75 Mfd. 50 V. (New).....15
- J—Cond. (GE Pyranol) 2 Mfd. 600 V. (New).....50
- L—Cond., 4 Mfd. 600 V. DC (GE Pyranol) (New).....50
- M—Cond., 4 Mfd. 300 V. (New).....35
- N—Cond., 30 Mfd. 330 V. AC (GE Pyranol) (New).....3.00

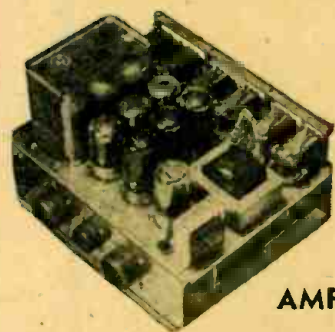

**C-1 AUTO AMPLIFIER**

Were used to control operation of Servo-units, causing them to move the control surface of airplane in one direction or the other in response to signals received. The complete amplifier includes one rect. 7Y4, 3-7F7's for amplification and control, 3-7N7's for signal discrimination, 1 power transformer, 6 relays, 4 control pots, chokes, condensers, etc. Convert for use on radio controlled models, doors, etc. Operates from 24 V. DC. Size 9 1/4 x 6 1/4 x 7 3/8". **\$6.95 Complete**

**APN-1 RADIO ALTIMETER**



A complete 460 Mc. radio receiver and transmitter which can be converted for ham or commercial use. Tubes used and included: 4-12SH7, 3-12SJ7, 2-6H6, 1-VR150, 2-955, 2-9004. Other components such as relays, 24 V. dynamotor, transformers, pots, condensers, etc., make this a buy on which you cannot go wrong. Complete as shown in aluminum case **\$8.95** 18" x 7" x 7 1/4".

**BC-645 Ultra Hi-Frequency Transmitter-Receiver**



You read about it recently in QST! Originally operated in the frequency band from 450 to 500 Mc. Can be converted to 420 Mc. amateur band. Consists of complete transmitter and modulator system, and receiver. Instructions for conversion to AC supply. Complete with 15 tubes..... **\$11.95**  
**BRAND NEW**



- 6 V. (New) (Dry-charged).....\$3.00
- 6 V. (In metal carrying case) (Add electrolyte specific gravity 1.265) (Drugstore) .....4.00



**Radio Co**  
**130 W. New York St.**  
**Indianapolis 4, Ind.**

Unless Otherwise Stated, All of This Equipment Is Sold As Used  
**CASH REQUIRED WITH ALL ORDERS**  
**Orders Shipped F.O.B. Collect**

# Are you Building a Business ... or Burning your Bridges?

Would you patronize a dentist who filled your teeth with plaster of Paris?

Would you trust your children's lives to a doctor who prescribed cut-rate pills?

Your business, too, is built on *customer confidence!* And your reputation is too valuable to risk with inferior or unknown products. The cost of the parts you use in the average repair job is insignificant com-

pared with your investment in your *reputation.*

That's why we say—**YOUR CUSTOMERS AND YOUR REPUTATION CAN AFFORD ONLY THE BEST! . . . SPRAGUE.**



CAPACITORS

# SPRAGUE

\*KOOLOHM

RESISTORS

• T.M. Reg.  
U. S. Pat. Off.

SPRAGUE PRODUCTS COMPANY, North Adams, Mass.

JOBGING DISTRIBUTING ORGANIZATION FOR PRODUCTS OF SPRAGUE ELECTRIC CO.

## Reach for a **SPRAGUE** and Know You're Right!

The superiority of the new Sprague type TM High-Temperature Molded Paper Capacitors didn't happen by chance. You can use this better unit in your work today only because of more than four years of intensive research and one of the largest retooling programs in Sprague's history. That's why we can say "*The First Truly Practical Molded Paper Tubulars are Sprague TM's*"—and it is also the reason you can use them on any job with confidence and pride.

- Highly Heat Resistant
- Conservatively Rated
- Moisture Resistant
- Small in Size
- Non-inflammable
- Mechanically Rugged
- Completely Insulated

**UNCONDITIONALLY  
GUARANTEED!**

You can stake your reputation on Sprague replacement parts. If used at rated capacitance and voltage, they are **UNCONDITIONALLY GUARANTEED** to give satisfactory performance. Insist on Sprague and get the best!

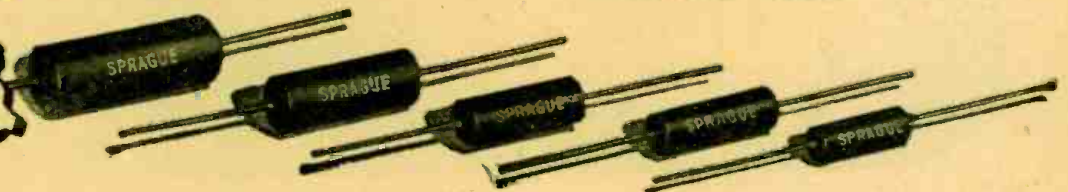

# RADIO AS A VOCATION\*

*The radio-electronic field is more lucrative than ever.*

By HUGO GERNSBACK

IT IS estimated from best available sources that the radio industry as a whole today employs no less than one hundred and fifty thousand\*\* men in all its branches.

This includes everybody, from the lowest-paid radio assembler girl up to the highest-paid radio executive. In between, we run the entire gamut of all classes of radio men and *the classification of all of them would take more space than this printed page!*

The young man eager to enter the radio field today has a tremendous field before him with numerous branches of the industry from which to choose. Each succeeding year, new subdivisions of the various branches are being added and the field constantly expands and keeps enlarging. The major branches of radio today may be roughly summarized as follows:

Radio set manufacturing, radio tube manufacturing, radio parts manufacturing, television, general electronics, radio broadcasting, radio servicing; and a great many minor branches.

I constantly receive letters from young men who write to me that they "wish to get into the radio game." As a rule, the writers do not state their qualifications or their educational background, and it is almost impossible without closely questioning the subject, to determine just where he will fit in best. It is useless to speak in generalities to these people without having made a careful survey of their mental equipment. One man might fit in well as a serviceman and might make a success of it, while the same man as a research engineer or broadcasting engineer would be totally unfit. For this reason, it is impossible to give hard and fast rules, it being impracticable for the outsider to arrive at any definite conclusion.

We cannot all be radio executives or research engineers of high order. We may not have the right mental equipment for this. In many ways, the college graduate who has taken up electrical engineering is fitted for an entirely different capacity than the man who has only a high school education; but, of course, there are exceptions. Some of our best radio executives have had no college education. Here then, again, the mental equipment and other educational background play a big role.

No two cases are ever alike for two men. No two men will react exactly alike; neither will their likes be exactly the same; nor will they fit into the same positions equally well.

There is, however, a general rule—that may be summarized in *one word*—which the young man who wishes to enter the radio industry should be told about. In the first place, what are his personal likes in the matter?

What are the goals he is striving for? Some men who wish to reach the top do not care how low they start; anything that comes along will be taken as the first rung of the ladder to be climbed. Others have fixed ideas as to what they wish to tackle. My own recommendation to would-be aspirants to a position of importance in the radio industry has always been expressed in one word—"Specialization."

What the radio industry of today needs more than anything else is specialists in the various branches. There are too many half-baked, irresponsible young men who just hold down jobs and never get anywhere. These form by far the largest percentage of the total manpower of the radio industry. *It is the minority who specialize, and who, as a rule, get somewhere.*

And it makes little difference in this respect whether they are college graduates or not. Of course, if you can afford to go through college and take the various courses (always provided that you know how to take advantage of the teaching offered at college), you will emerge from college with a first-class background which will enable you to "go places" in the radio industry. By far, the greater majority of young men, however, are not so fortunate. They find it necessary to earn a living after they leave high school. A large proportion of these either take a good radio correspondence course or visit a resident school for a number of months. Others, who cannot afford this, get their entire knowledge from practical work in the field and from radio books and publications. In the end, it all amounts to the same thing. If they have the correct mental make-up, it will get them just as far with one type of education as with another—and often the self-taught man has been able to go as far as the college graduate. Edison, for instance, never had better than a high school education,

*(Continued on page 81)*

**R**ADIO-CRAFT continues to receive many letters from young men eager to make radio-electronics their profession. For them and untold thousands we reprint on this page an editorial first published in the November, 1935, issue of RADIO-CRAFT.

What was written then applies even more truly today. Since World War II the radio-electronics field has grown to undreamed-of proportions. The estimate of 265,000 radio-electronic technicians in all the various branches today is a conservative one. The number still grows by leaps and bounds year after year.

\*Reprinted from November 1935 RADIO-CRAFT.

\*\*Corrected estimate, as of 1948, 265,000.

## BROAD-BAND METAL LENS

which can theoretically handle from 50 to 100 television channels or tens of thousands of simultaneous telephone messages was announced last month by Dr. Winston E. Kock of Bell Laboratories.

The new lenses are based on the theories of light transmission through atomic and molecular structures; in fact, one type of the new lens looks somewhat like a model of a crystalline molecule shown in almost any physics textbook.

One such lens consists of an array of metallic spheres. The radio waves, in passing through the lens, set up electric currents in the spheres and thereby produce the same effect on the radio waves that the molecular lattices of a glass or crystalline lens produce on light waves.

Thus the new lenses are built by scaling up (increasing the size of) the molecular lattice structure of a dielectric or non-conductor, such as glass, and then substituting electrically conductive elements for the molecules. These elements need not be spheres but can be small strips of conducting material, such as aluminum or copper foil.

The earlier metallic lenses were constructed of rows of conducting plates

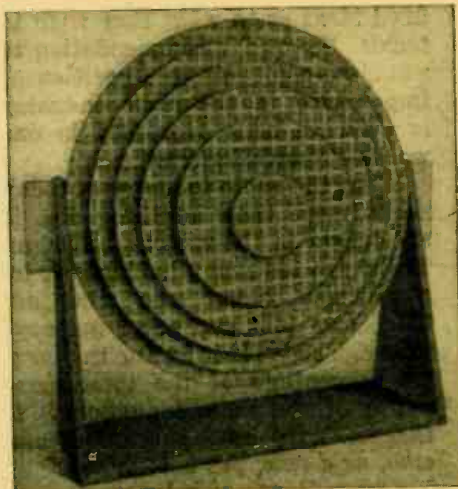

This "printed circuit" metal lens is made of tin squares sprayed onto polystyrene sheets.

and operate on wave-guide principles which speed up the radio waves as they pass through the lens. In the new type lens, the wave is slowed down as in an ordinary glass lens. Dr. Kock and his associates have demonstrated that lenses constructed on this principle can be used over a much wider band of wave lengths.

One lens, for example, could be effective at all microwave lengths between a half-inch and four inches. Such a lens could theoretically handle 50 to 100 television channels. Available techniques limit present lenses to only eight such programs in the relatively narrow wave length band between three and three and one-half inches.

It had been known for some time that glass lenses could focus microwaves just as they focus light waves. But such lenses would have to be so big and so heavy that they are completely impossible for radio relay applications. Such a lens might be 10 feet in diameter and weigh several tons.

# RADIO-ELECTRONICS

Then the thought occurred to Dr. Kock that if the lattice structures which are believed to constitute atoms and molecules could focus light waves, a scaled-up or magnified model of such a lattice structure would also focus electro-magnetic or radio waves of correspondingly scaled-up wave length.

Since even the very short radio waves known as microwaves are 100,000 times longer than light waves, a scaling-up of the molecular model by that ratio produces a lens which can focus microwaves.

**TELEVISION** interference must continue with the prospect of blotted-out and disrupted picture reception if present-day television-receiver standards and frequency assignments are not changed, the engineering staff of the American Radio Relay League testified at a special hearing of the Federal Communications Commission last month.

At the hearing, which was held mainly to consider rearrangement of the present television frequency channels, ARRL representatives cautioned against continuation of frequency assignments that invite technically unavoidable interference, not only from amateurs but also from police and fire-department radio, mobile telephone circuits, industrial users, and diathermy installations in hospitals and doctors' offices.

**LARGEST TELEVISION** studios in the world are being constructed in New York City by the Columbia Broadcasting System, Frank Stanton, president of the network, announced last month.

Mr. Stanton said that the studios will occupy more than 700,000 square feet of space and will be in operation by April.

**A RADAR-PROOF** container for air shipment of photoflash bulbs was announced last month by Sylvania Electric Products, Inc.

The new development is aimed at protecting air shipments of the bulbs from ignition by radar. It has been found that under certain conditions radar may set off the flash bulbs.

The radar-proof canister resembles containers used to hold perishable food.

**MOVIEGOERS** in 1975 will be able to watch events as they happen anywhere throughout the world with the aid of guided missiles and television, Eric Johnston, president of the Motion Picture Association, predicted last month.

He envisaged planetarium-type theaters in which "the audience will sit around a circle and watch the action being produced on a giant dome . . . instead of on a flat screen."

Mr. Johnston explained that guided missiles travelling at a speed which could take them around the earth in two and a half hours would carry pickup equipment to transmit these images in full color.

**TELEVISION** set owners in New York, Philadelphia, and Chicago are only lukewarm toward the television programs they now receive, but eager for a pay-as-you-see system that will telecast first run movies, Broadway plays, and other costly entertainment features unavailable on free television.

These facts were determined by a survey just completed by William Bethke, educational director of LaSalle Extension University in Chicago.

The survey, he reports, covered 9,341 television set owners in New York, Philadelphia, Chicago, and adjacent areas. Letters were sent to television set owners with return postcards for answering two questions: First: Was the set owner satisfied with the television programs he now receives. Second: In addition to free programs would he be willing to pay a reasonable fee for home viewing of first-run movies, Broadway plays, newsreels, and championship sport events not available on free television. The return figures show that 76% of the set owners in Connecticut, 64% in New York, 52% in New Jersey, 70% in Chicago, and 49% in Philadelphia would be willing to pay for programs.

**FACSIMILE BROADCASTING** on a large scale by FM broadcasters has its first indication in a letter filed with the Federal Communications Commission by the FM Association last month.

Filed in protest against proposed rates for 15,000-kc circuits for FM networks, as submitted by the American Telephone and Telegraph Co., the FMA letter claimed that the transmission of programs and facsimile simultaneously over the same circuit is possible, but that restrictions by AT&T would preclude duplexing of programs and facsimile.

Rates proposed for FM network facilities are approximately double those for ordinary radio networks, according to the FM Association.

**REVISION OF RULES** governing the operation of low-power oscillators is being considered, the Federal Communications Commission announced last month. This low-power equipment includes devices ranging from phonograph oscillators to carrier-current transmitters.

This announcement was made because of the apparently increasing general interest in such apparatus. It is intended to "sound a note of caution" to present and prospective users and manufacturers of devices which operate within such rules.

**FACSIMILE EDITIONS** of the *New York Times* were transmitted last month in a large-scale demonstration of this service. The material was written by the staff of the newspaper and transmitted over WQXR-FM. The editions had four pages 11½ inches long and 8 inches wide.

# MONTHLY REVIEW

**RADAR SIGNALLING** for the Chicago elevated transit lines was proposed in a report submitted to the Chicago Transit Authority committee by Captain William C. Eddy last month.

In operation, a transmitter on the front of the train sends out a signal which is reflected back to a receiver by a special reflector on the rear end of the train ahead. If there is a safe distance



How the proposed radar system will operate.

between the two trains, an automatic computer lights a green lamp on the engineer's control panel. An unsafe distance between the trains causes a red lamp to glow. If the distance between the trains becomes dangerously short, the train brakes lock automatically to prevent a crash.

**COMPLAINTS** by customers against radio repairmen have been greatly exaggerated in radio and newspaper reports, the newly-organized Association of Radio Servicemen of New York City discovered last month.

Aroused by widespread accounts of malpractice by radio repairmen, the Association offered to handle complaints from any radio owner who had suffered at the hands of any unscrupulous radio servicemen. The offer was publicized widely in the city newspapers.

Two weeks after the notice was issued only 20 complaints had been received, 17 of which were settled immediately. During the same period—unexpectedly—more than 30 requests for service were made. These were referred to the Association member nearest each job. Thus favorable reactions outweighed unfavorable ones by 50%. A further 16 requests for advice were also classed as favorable.

**GOVERNMENT CONTROL** of broadcasting in Argentina was protested in a letter from the Inter-American Association of Broadcasters to the president of the Argentine Congress last month. The letter is the result of a study made by the IAAB on the Argentine Congress' proposal to turn over the control of broadcasting stations to the government.

A report filed with the letter states that during 1947 many stations were closed and licenses cancelled. It also protested against the government practice of ordering stations to drop regular schedules for a broadcast in the political interest of the government.

RADIO-CRAFT for APRIL, 1948

**SHORTWAVE HEATING** and blasts of dry air are now being used to kill the larva inside silkworm cocoons. This new method, the Japanese silk industry claims, produces a silk as tough and durable as synthetic fibers.

Silkworms were formerly killed by plunging the cocoons into boiling water and drying them with hot air. The new electronic process avoids the intense heat which it is believed to reduce the tensile strength of the old product.

**DR. W. R. G. BAKER** of the General Electric Company was elected vice-chairman of the Electrical Standards Committee of the American Standards Association at a meeting in New York City last month. He will serve as chairman of the communications and electronic section.

Dr. Baker's appointment by the ASA is expected to give the radio and electronic industry greater representation in the national standardization work.

**A 5,280-MILE** conversation on microwaves was made last month at an alumni meeting at the Massachusetts Institute of Technology. This call set a record for long-distance microwave transmissions. In the call, the voice of Paul M. Byle, engineer for the Bell Telephone Laboratories, made 12 round trips on the microwave circuit between Boston and New York.

This transmission climaxed a demonstration by engineers of the Bell Laboratories and the American Telephone and Telegraph Company. The demonstration also included calls to an automobile, a trawler at sea, to Nantucket Island and Hawaii.



Dr. McKay of Bell Labs with diamond amplifier equipment. Insert: diamond in its holder.

**AMPLIFICATION** with a diamond rather than the conventional vacuum tube was announced by Bell Laboratories last month. The method is based on the discovery that when beams of electrons are shot at an insulator—in this case a diamond chip—electric currents are produced in the insulator which may be several hundred times as large as the current in the original electron beam.

The process itself is somewhat similar to the technique of translating the energy of a beam of light into electricity which underlies the operation of the well-known photoelectric cell.

One of the major difficulties encountered came when the Bell physicists found that as the current started to flow in the diamond chip, the electrons became trapped in the tiny imperfections which are present in all crystals. Thus, after the first fraction of a second, the induced current wasted away under the opposition of the trapped electrons.

To overcome this, the investigators applied an alternating voltage to the diamond chip so that current flowed through the diamond one way for a fraction of a second and then in the other direction, reversing itself 120 times a second. Alternately negative and positive charges are drawn through the crystal and some of each kind are trapped. The trapped positive charges cancel out the effect of the trapped electrons, or negative charges, and the induced current is allowed to flow freely.

The experiments stemmed directly from previous pioneer research in which current was induced in diamonds by bombarding them with alpha particles. This earlier investigation promises development of a new laboratory tool for counting alpha particles. It would do essentially the same thing as the familiar "Geiger counter." The new device, however, would have smaller size, lower operating voltage and a faster counting rate.

Texoma Radio's new auto radio section.

By C. J. WHITTON



Interior view of the new auto radio repair department and part of main radio repair section.

*The Radioman*

# Expands His Business

**S**HOULD we expand? Do we actually need more floor space and facilities? Will our business continue to warrant an expansion that is apparently needed at this time? This is a problem that many a radioman has to meet at one time or another in his career. We at Texoma were recently confronted with these perplexing questions and our answer was an emphatic Yes.

In arriving at this conclusion we did not consider our past success nor did

we rely upon our own judgment as to what the future might bring. The answer to these first two questions were found, in our own business records. For the first, many valuable outside sources of information were called upon to give us a definite answer. These sources of information are available to any business, whether it be large or small, and the data that may be had for the asking in all probability took months to compile and represents several million dollars spent on research. These silent partners

of your business are glad to help you and you can be sure that the information they give you will be to your advantage because they stand to lose or gain with you.

At the head of our list of information sources is our banker. A word here in regard to the part your banker should play in your business will not be amiss. Handle all of your transactions by check. By depositing your entire shop income and making all payments by check, you have created two assets to your business. You have secured an indisputable receipt for

payments made, and you have placed at the disposal of your banker a complete financial record of your firm. He can study this record and tell you more about your financial condition than you can. Remember, too, that if your decision is to expand your business, in all probability you will have to call upon this banker for that little financial boost that will be needed in most cases. The advice you receive from him will be based on the outlook for several years to come, for it would be foolish for him to invest money in your business on the prospects of a few months.

Our next source of advice is our jobbers and suppliers. They too stand to lose or gain by your decision. Business done with your main suppliers should be handled on an open account basis when possible. This again accomplishes two things. It gives you an established credit rating which, if properly handled, is another valuable asset. Second, your jobber can at a glance determine from your ledger sheet the direction of your buying trend. This when coupled with the trend of his area will help him in advising you. Remember that the business trends of localities are often misleading, so rely upon someone who already has this cross-sectional information. It will save you lots of time and trouble.

Our final questions were placed with our local business associates: our hotels, garages, theaters, and managers of large chain concerns. Here again we receive an unbiased opinion because each fellow's business is dependent upon another's success.

Our answers: From the banker, (Continued on page 74)

## A New Year and New Links In Our Chain of Improvements!



Interior View of Texoma Radio Co., Featuring the Recently Completed Car Radio Service Department

### To a Greater Growing Denison!

As the old saying goes, "A chain is no stronger than its weakest link"—we believe that business must be founded on the satisfaction of customers who are the links that make progress in business possible.

In less than two years we have undergone two major expansion programs, adding new installations, space and equipment to better serve our customers, who have made our anticipated growth a reality.

Our friends and customers and their splendid reception of the services that we have to offer are wholly responsible for the expansion programs we have been able to complete.

We want to sincerely thank every citizen of this community and promise them a guaranteed service on all repair work that we are privileged to do for them.

**Texoma Radio Co.**

"COMPLETE RADIO AND APPLIANCE REPAIR SERVICE"

124 West Chestnut Phone 2430

An excellent example of how the radio technician can use advertising.

# Standard Television Sets Become Projectors

**L**ARGE-SCREEN television is a treat for which we will have to wait for some years, say the engineers of some of the biggest radio and television companies. Serviceman and engineer William Spellman refuses to look at the problem so patiently and philosophically, and has produced his own large-screen television here and now. He has custom-engineered a large number of ordinary television receivers to work with a large screen, and is now—in co-operation with Colonial Television Co. of the Bronx, New York—selling such sets to points as far away as Los Angeles.

Mr. Spellman's system is simple. He installs a high-voltage, projection-type tube in place of the regular viewing tube of a standard televiser, provides a 30-kilovolt r.f. power supply for it, and mounts a projection lens ahead of the tube. The lens is adjustable to focus on a screen, which can vary in size up to 6 x 8 feet with excellent definition, and may be as large as 12 x 16 feet where especially large pictures are required.

The high-voltage power supply, shown in Photo 1, is a standard r.f. job with a pair of 6Y6's as oscillators and three 8016/1B3 rectifiers in a voltage-tripling circuit. The high-voltage portions of the circuit are all mounted on Lucite, as may be seen from the photograph.

An ordinary low-voltage power pack supplies power to the oscillator tubes. The 2 sections of the new pack are mounted in the lower half of a wheeled cabinet, in the top half of which the televiser is installed.

Photo 2 shows a top view of this top compartment as seen through a removable center panel in the top of the cabinet. The high-voltage, projection-type

television tube has ample room in the space occupied by the original 10- or 12-inch viewing tube, even with part of the lens assembly ahead of it. The lens itself, together with the viewing tube, is shown in Photo 3. It is manufactured especially for television projection by Bausch and Lomb.

Mr. Spellman has found that, though a standard televiser will produce satisfactory projection images, it is advisable to modify the video amplifiers if very large screens are to be used. Improved contrast and definition result, he claims.

Not a large number of sets have been produced up to the present, and the demand has been such that Mr. Spellman has found it expedient to accelerate his operations through combining with the Colonial Television Co. to turn out a larger number. Most of his sets are being used by theaters or exhibitors, and of course in bars and grills. The largest audience recorded was at the Shriners' Auditorium in Los Angeles, where 4,800 people viewed a program projected on a 12 x 16-foot screen. Reception, according to *Billboard* magazine, was quite satisfactory.

Operation of the projection televisers is as simple as that of any other type of television receiver, the only additional adjustment being that of the optical lens, which must be focused on the screen like a home movie projector.

It is expected that kits for converting ordinary televisers to large-screen machines will be made available to experimenters. The cost will not be low—totaling something over \$300. This would make the conversion more attractive for commercial than home use, though no doubt many experimenters would be interested.



Colonial President Emerson adjusts the lens.



Photo 3—The projection lens and 30-kv tube.

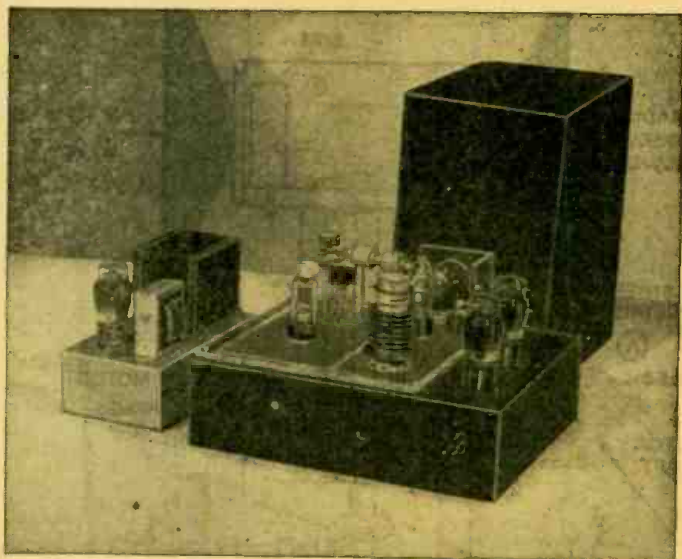
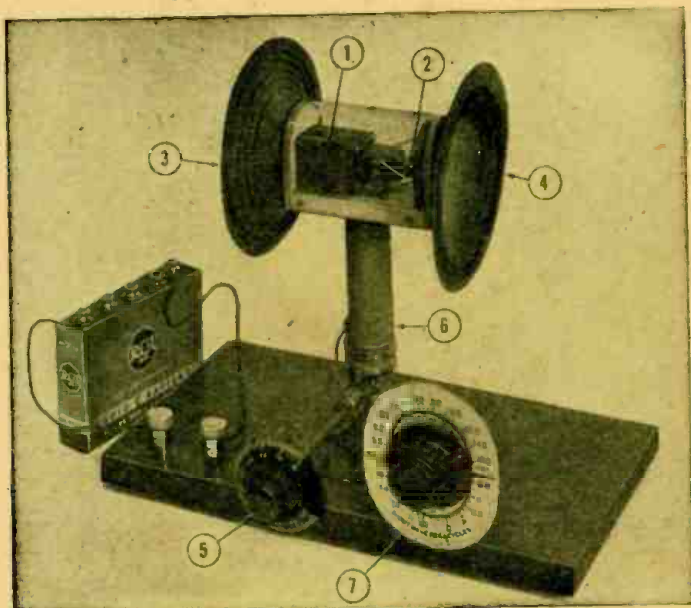

Photo 1, above—The 30-kv r.f. unit and the low-voltage power pack which supplies it. Fig. 2, right—Top view of a standard televiser showing how the high-voltage projection tube and lens are installed.



# Tubeless Homo- Heteradio

By MOHAMMED ULYSSES FIPS, I.R.E.I.R.E.\*



A recent model of the tubeless Homo-Heteradio which contains neither tubes nor radio parts, except a rheostat. 1. Special high-speed motor. 2. Supersonic siren. 3. Intake of radio waves. 4. Loudspeaker. 5. Dial to rotate Heteradio mounted on shaft 6. 7. Rheostat, which controls motor speed, tuning the radio.

A completely revolutionary type of radio is described here. It bears not even a remote resemblance to present-day radios. It is so new that readers will have to reorient their thinking completely from present-day radio technique.

**E**VER since the advent of the vacuum-tube and our modern radio receiver, we have read from time to time that a tubeless radio had been invented.

Despite many press notices, up to very recently no radio which did not depend on the electron tube existed to the best of my knowledge. I exclude from this the typical old crystal receiver which worked beautifully with excellent reproduction. It, too had no tubes.

The question, therefore, arises: How could a tubeless, crystalless radio set come about? In my opinion—which goes back for many years—it should not be impossible to build a *purely mechanical* radio, completely disregarding our present radio ideas. Some time ago I set out to prove just that. The present article is the result of my exhaustive investigations and studies on this fascinating subject.

To begin with, speaking broadly, the waves which broadcast our present radio signals from our radio broadcast stations are no different than any other vibrations in space. I refer you to the schedule on the next page entitled: "Table of Vibrations," whose effects are recognized today. You will observe that the entire known spectrum of vibrations starts with the first octave and goes up to the 62nd octave at present. In this spectrum will be found sound-waves, supersonic sound waves, electrical waves (which include radio waves) heat waves, light rays, chemical rays, and X-rays. *These waves are all related to each other, but vary in frequency, or rate of vibration.*

The first octave, be it noted, encompasses waves vibrating at two vibrations per second. At the other end we find the 62nd octave where the waves vibrate at

the enormous frequency of 4,611,686,-618,427,389,904 vibrations per second.

Electrical and radio waves, known as electromagnetic waves not only vibrate much faster than sound waves, but in an unknown manner. Sound waves are vibrations of physical substances, such as air, water, the metal of bells, etc. If we enclose an electric bell in a bell-jar and pump the air gradually out of it, the sound dies away. Radio waves move better when there is no air in their path than through it, or any other medium. We know that radio waves are of a vibratory nature but neither Drs. Alexander, Armstrong, and de Forest together can tell us *what* it is that vibrates.

Radio waves as we have seen, are related to sound waves *except that they vibrate infinitely faster.* The human ear cannot hear these radio waves for the

Elements of the new heteradio. The heart of the new radio is the supersonic siren shown also in detail "A". The siren gives from 500,000 cycles upward taking in the entire broadcast frequency range. By means of a special heterodyne effect, audible sounds are converted from radio frequency waves. Heteradio motor runs by means of small 6-volt battery. Direction control moves Heteradio into optimum position to receive radio frequency waves.

simple reason that somewhere above 18,000 vibrations a second the human ear can no longer detect the waves directly.

Scientists think that there may be some living entities that can hear radio waves, but so far this has not been proved.

Thus we know that canary birds can hear supersonic waves around a frequency of 30,000. Presumably there may be insects or other organisms that can hear much higher up the scale, but this today remains merely an assumption.

We do know, however, that the radio waves are all around us. Indeed, while you are reading this, radio waves of thousands of radio stations pass right

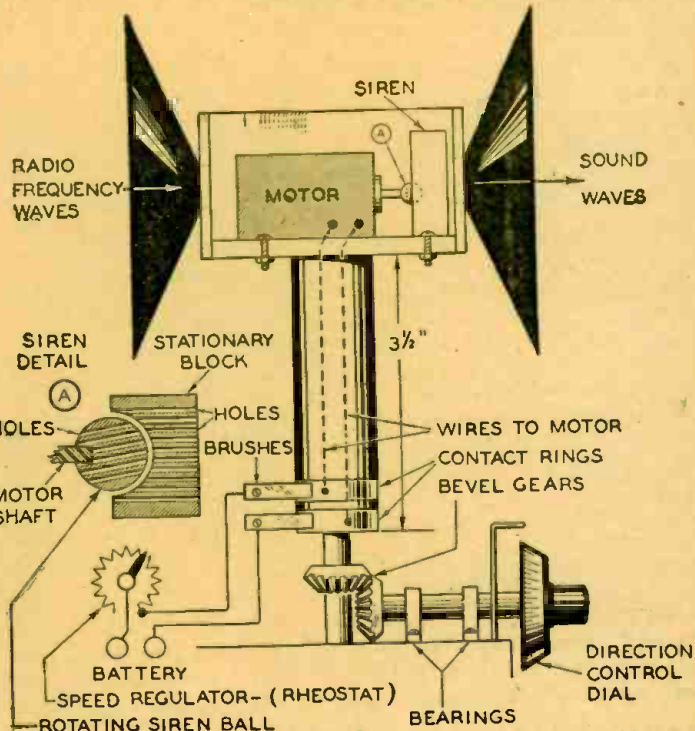

\*Islamic Royal Euclidean Intransigent Radio Engineers



through you, through your head, through your body, and through the building in which you sit (except where steel or other metallic masses cut off the waves.) Because the human ear cannot directly hear radio waves we must make them heard by means of crystal detectors, or radio tubes in various ways well known to every radioman.

Using radio tubes, we first detect the wave in our detector tube; then after detection we step it up by means of high amplification after which it is fed into the loudspeaker. The latter then gives off sound waves which we hear at the lower frequencies between 8 and 18,000 vibrations a second.

This method is a most circuitous one and it is easy to see that there should be something much less complicated than our complex radio sets.

At this point I must digress and show that in principle the tubeless radio is really not revolutionarily new, because in the past radio waves have been made audible to the human ear without radio crystals or radio tubes.

If you wish to read more about this I refer you to H. Gernsback's editorial "Superadio" printed in the April 1947 issue. In December 1946, Johns Hopkins University scientists accidentally discovered that a strip of Columbium nitride about the size of a pin, when cooled to minus 444.4 degrees Fahrenheit detects radio waves without any radio tubes. Radio programs could be heard distinctly, however, it was necessary to have the Columbium nitride strip connected to an amplifier.

Going back even further, as you will read in the same editorial—ever since radio broadcasting started in the early 20's, newspapers from all over the world have reported a number of most unusual and unorthodox radio reception cases. For example a cold-water faucet a block away from a Boston radio broadcast transmitter emitted music or speech when the water was turned on. A few blocks away a housewife almost fainted when a frying pan on a gas stove gave out music and lectures that could be heard throughout the flat.

But nothing much was ever done about these effects in reducing them to a workable radio receiver without using orthodox radio tubes and other radio components. Here matters rested.

Many of these instances were probably special cases of ordinary electrical detection. The celebrated case of John Moscovitz, the Newark cutlery worker, who at all times heard station WOR, is a case in point. Engineers discovered that carborundum particles from his grinding wheel had lodged in the metallic bridgework of his teeth, making him a living crystal receiver.

How the currents thus detected were turned into sound has never been satisfactorily explained, but it is supposed that part of his auditory nerve when stimulated by the modulated currents from his bridgework passed the sensation of sound to the brain.

No such explanation will serve in the case of the cold-water faucets, or frying pans, which picked up and reproduced broadcast signals. Here the radio waves

acting directly on physical matter produced sound. It was these instances I studied, and from them I learned how sound was produced directly from radio waves—learned, indeed, to duplicate such effects.

The secret of the mystery lies in the statement a few paragraphs back "radio waves travel better when there is no air or other medium in their way." It has long been known that radio waves are absorbed in air, and to a much greater

source of local power—like de Forest's B-battery—which could be modulated or controlled by the incoming signal.

I imagined a purely mechanical wave converter which would make radio waves audible. Here is the way I finally worked it out in building my revolutionary receiver.

Suppose we wish to detect and listen directly to radio waves having a frequency of 570,000 cycles (570 kc), which is equal to 526.3 meters.

For this we build a supersonic siren which can go beyond 570 kc. To drive the siren we use a powerful extra-high speed electric motor. We put an ordinary rheostat in series with the motor so we can control its speed accurately. We now connect the motor and the rheostat to the battery and drive the motor at the correct speed.

I found out that in order to do so the motor would have to run at the rate of 300,000 revolutions per minute, or 5,000 revolutions per second. That is pretty high speed and at present hard to obtain.

But, suppose we take the fifth harmonic or 100,000 cycles. The speed of the motor can, therefore, be made much lower, or 1,000 revolutions per second—60,000 revolutions per minute. This today is not impossible of obtaining.

Now we must have a siren. No standard siren could operate at this speed without flying to pieces. So I designed a Ball-Siren. This comprises a steel ball which has bored through it a number of small holes at an angle. Around this small ball, which is only about 3/16 inch in diameter, a shell was built exceedingly close to the siren ball. This made a tiny siren giving off high-frequency supersonic sound. As the weight of the ball rotor is less than 2 grams, at the high centrifugal speeds to which the ball is subject it will not undergo destructive strains. I found it was necessary to use an especially high-grade steel so it would not fly apart under the stresses at the tremendous speed.

Now, when the siren is turned on at full speed I can readily obtain sufficiently high supersonic vibrations at radio frequencies from 500,000 cycles upward, through the entire broadcast band.

How can we now hear the radio waves? This is done by simply creating interference between the siren waves and the radio waves. In other words, a heterodyne effect.

Incidentally, the heterodyne effect, first demonstrated by Fessenden, operates as follows:

A local generator of radio-frequency waves is made to generate signals a few hundreds or thousands of cycles away from the frequency of the incoming signal wave. The two sets of waves, being

(Continued on page 62)

### TABLE OF VIBRATIONS

Whose Effects Are Recognized and Studied  
Number of Vibrations per Second

1st Octave.....	2	
2nd "	4	
3rd "	8	
4th "	16	
5th "	32	
6th "	64	
7th "	128	SOUND
8th "	256	
9th "	512	
10th "	1,024	
15th "	32,768	SUPERSONIC
20th "	1,047,576	
25th "	33,554,432	
30th "	1,073,741,824	RADIO
35th "	34,359,738,368	
40th "	1,099,511,627,776	LITTLE-KNOWN RADIO & INFRA-RED
45th "	35,184,372,088,832	
46th "	70,368,744,177,644	
47th "	140,737,468,355,328	HEAT
48th "	281,474,976,710,656	
49th "	562,949,953,421,312	LIGHT
50th "	1,125,899,906,842,624	
51st "	2,251,799,813,685,248	ULTRA-VIOLET
57th "	144,115,118,075,855,872	
58th "	288,230,376,151,711,744	UNKNOWN
59th "	576,460,752,303,423,488	
60th "	1,152,921,504,606,846,976	X-RAYS
61st "	2,305,843,009,213,693,952	
62nd "	4,611,686,618,427,387,904	COSMIC & UNKNOWN

The above table gives vibrations from the 1st to the 62nd octave, to better understand the operation of the Tubeless Heteradio receiver.

extent in better conductors. But absorption merely means that the radio wave does work in the medium—transfers some of its unknown electrical energy into mechanical energy—actual motion of the molecules of the substance through which it passes. This is of course the secret of the examples just given. Water or iron set in motion by the waves, usually assisted by some rectifying action which reduced the effect of radio frequency vibrations and allowed their audio modulation to stand out, is probably the explanation of all these effects.

I was soon able to produce speech and music with a variety of such devices. Only trouble was that, like the old crystal receiver, they were dependent on power received from the broadcast station. Loud signals were obtainable for only a mile or so from high-powered broadcasters. What was needed was a

FIG. 1

Heterodyne action. If frequency A is (for example) 1,000 kc and B 1,001 kc, a wave of the form A + B will be produced. This produces a 1,000-cycle note (BF) in following circuits.

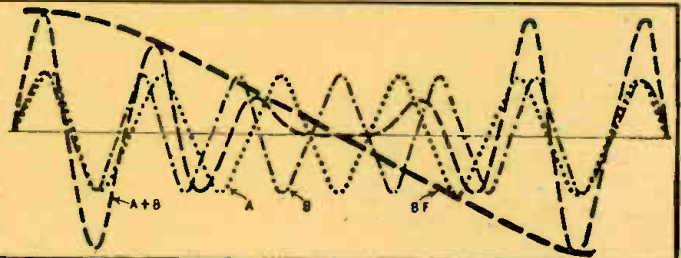



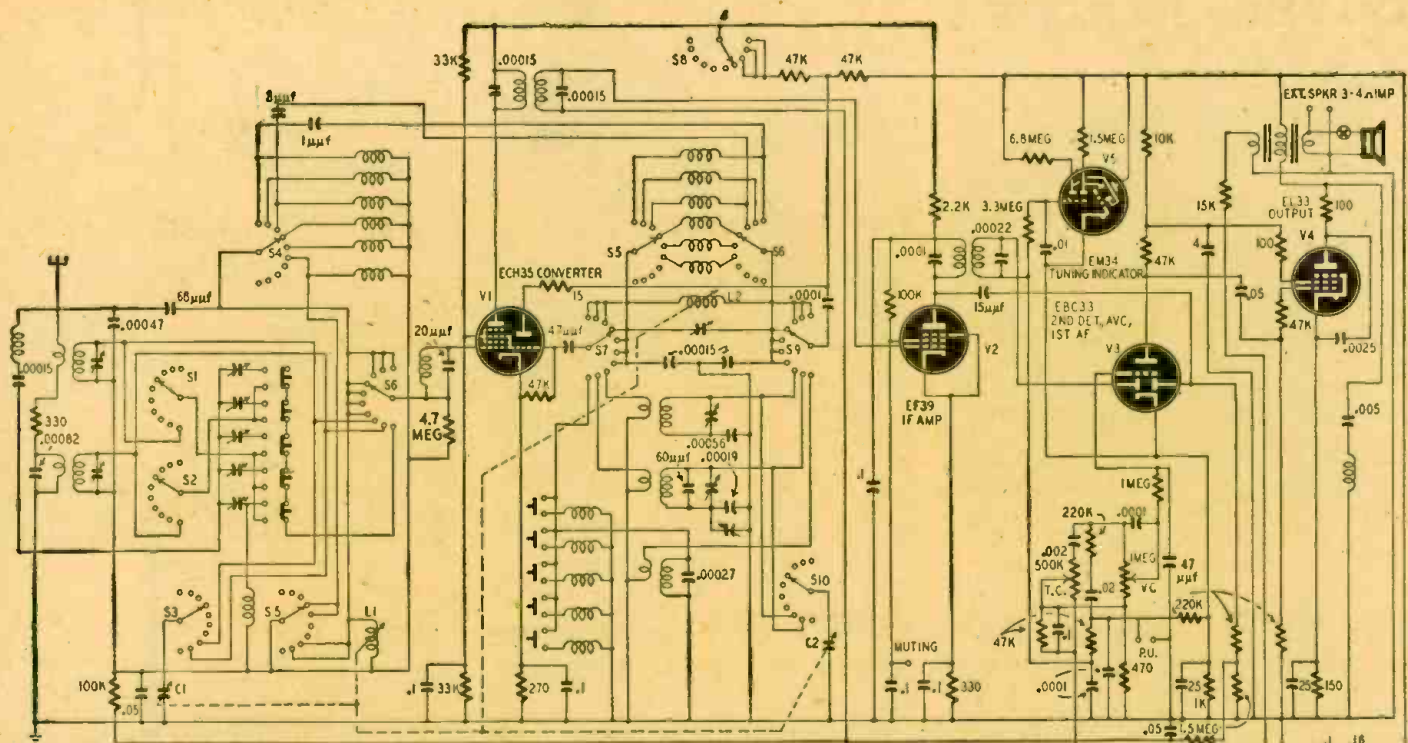

Fig. 3—The schematic of the Ecco A 28. This radio has a novel band-switching arrangement.

unconventional way. The heptode section is a variable-mu i.f. amplifier, the output of which is demodulated by the left-hand diode of V3. The a.f. voltage is fed back to the grid of the triode portion of V2, which becomes the a.f. amplifier. The triode control grid of V2 receives its bias from the power supply voltage divider through the 470,000-ohm decoupling resistor and the 2.2-megohm grid resistor. The a.f. from the detector is filtered by a 1-megohm resistor and an 82- $\mu$ f bypass condenser. A.v.c. voltage from the right-hand diode of V3 is developed across an 820,000-ohm resistor and is fed through a decoupling network to the heptode control grids of V1 and V2. The .0039- $\mu$ f condenser and the 500,000-ohm potentiometer in the grid circuit of V3 form a continuously variable tone control.

Negative feedback is provided in a novel way. A.f. voltage from the secondary of the output transformer is taken to the frequency discriminating circuit L19, L20, and the 22-ohm resistor in series with the volume control. The voltage across this resistor is fed to the control grid of the triode V2 in antiphase

to the signal voltage. A pickup can be connected to the socket marked P.U. Inserting a plug into this socket opens the switch shown above P.U., and closes the one beside it, silencing the radio section.

There with only 3 tubes is a superheterodyne complete with a.v.c., negative feedback over 2-stages, tone control, and provision for phonograph pickup. The trio of tubes is doing the work of at least 7 tubes. The set may be used either with its built-in plate antenna or with an outside aerial.

Another clever example of the 3-tube superheterodyne (the KBBM 20) is seen in Fig. 2. Here the tubes are a heptode, a variable-mu duo-diode-pentode, and a beam tetrode. The first tube is a straightforward electron-coupled converter. The pentode portion of V2 is reflexed and it acts first as an i.f. amplifier, transformer-coupled to the output of V1. The output of its pentode plate circuit is fed to the 2 diode plates. The a.f. voltage is developed across the 470,000-ohm resistor in the diode circuit, and fed through an R-C filter back to the control grid of V2, where it is amplified

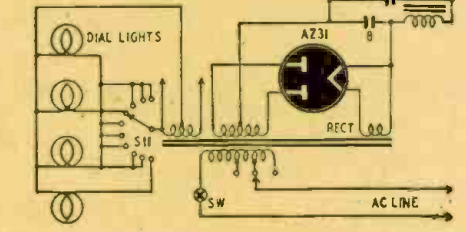

by the triode formed by the cathode, control grid, and screen grid. The .02- $\mu$ f condenser in the screen-grid circuit couples the output to the control grid of V3, and the .0005- $\mu$ f condenser bypasses any remaining r.f. to ground. The resistor in series with the control grid of V3 is an r.f. stopper. Another part of output of the diodes is fed back to the control grid of V1 as a.v.c.

The intermediate frequency of these sets is 470 kc.

Radio manufacturers are beginning to pay more attention to the needs of the man who has to repair their sets when they go bad. Not so long ago receivers seemed almost to have been designed with a view to making repairs and adjustments as difficult as possible!

(Continued on page 82)

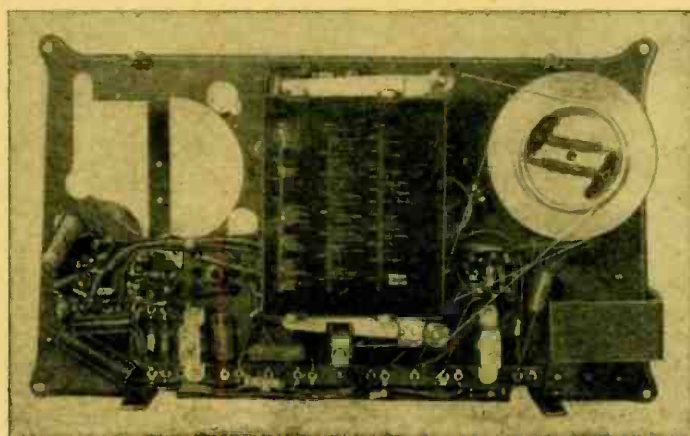
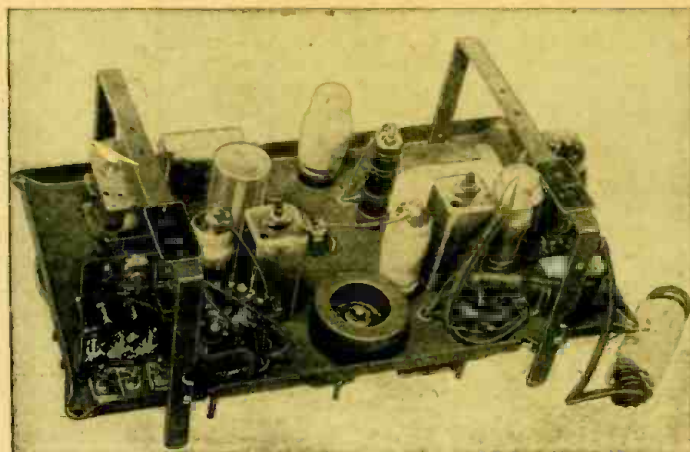

Murphy U 102, showing straps which hold chassis clear of bench. The serviceman can reach every part of the Murphy U 102 easily.

## COVER FEATURE

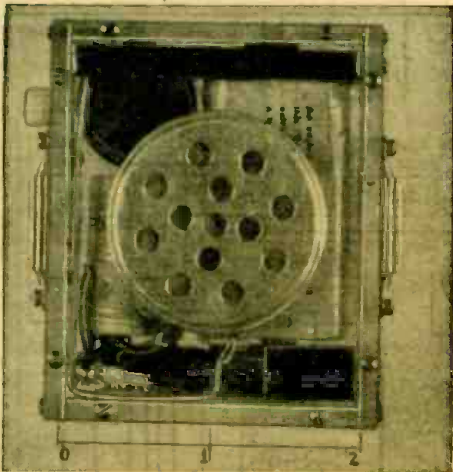

Close up view of transmitter.

# Brunetti Wrist-Watch Transmitter

By HUGO GERNSBACK

**Even smaller radios than this 2-x 3-inch transmitter may be made when smaller and better batteries are built.**

**P**ERHAPS the most revolutionary advance in radio set building methods was developed during World War II. This is known as the printed circuit technique.\* The man chiefly responsible for most of the new ideas in this branch of radio is Dr. Cleo Brunetti and his co-workers of the National Bureau of Standards.

When it became necessary, during World War II, to design extraordinarily small radio sets which, however, had to be extremely efficient at the same time, it was Dr. Brunetti who solved the host of problems which made these tiny radios possible.

In the proximity fuse, for instance, a tiny radio transmitter with combined radar was required. This entire transmitter (complete with batteries, tubes, etc.) is so small that it fits in the head of the small projectile. In use the shell

is set to explode at a predetermined height from the ground, or from any object it may pass in flight. When the shell reaches this point, a radar impulse bouncing back from the ground (or object) to the shell, activates the proximity fuse, which now bursts.

Actually millions of these were manufactured during World War II and did much in helping to win the war. Many similar radio weapons were designed by Dr. Brunetti and his associates.

Dr. Brunetti, who is the Chief of the Engineering Electronic Section of the National Bureau of Standards, is a physicist of the first order. He and his associates had to overcome tremendous difficulties in compressing a standard radio transmitter into a space that measures less than the fist of a small child. Extraordinary problems had to be solved in carrying out this work, which included much pioneering in many different directions.

So important has this new technique become, that the Bureau of Standards felt it necessary to bring out a 44-page book entitled: "Printed Circuit Techniques" by Cleo Brunetti and Roger W. Curtis. This is a National Bureau of Standards circular No. 468, for sale by the Superintendent of Documents, U. S. Government Printing Office, Washington, D. C., for 25c. In this book will be found all the various complex techniques that have enabled Dr. Brunetti and his

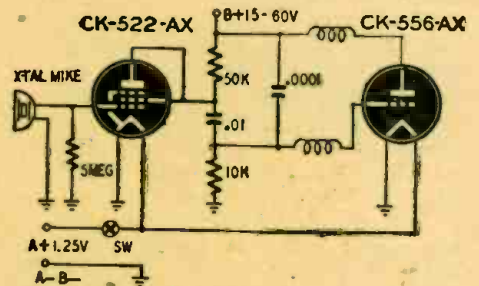

The wrist-watch radio transmitter schematic. The wrist-watch radio transmitters actually staff to build radio transmitters actually down to the size of a lipstick case (minus batteries and microphone).

One of the most recent Brunetti developments is his wrist-watch radio transmitter featured on this month's cover. It is so small that it can be worn like a wrist watch. The entire transmitter (including crystal microphone, A and B batteries) is all housed in the plastic case. The size of the case is  $2\frac{1}{4}$  x  $2\frac{11}{16}$  inches. From the diagram it will be noted that there are two tubes, a CK522AX and a CK556AX.

These are well-known miniature battery types. The A-battery is a small Mallory dry cell which measures about 1 inch in diameter and  $\frac{5}{8}$  inch in height. The B-battery is a small hearing-aid type manufactured by several battery manufacturers.

The wrist-watch radio is a transmitter only and has no receiver. There is no aerial, yet the transmission is reliable over a range of about 100 ft. Any receiver tuned to the correct wavelength (in the 6-mc region) can receive the signals.

In a demonstration, which the writer witnessed, Dr. Brunetti was walking



Dr. Brunetti's smallest and latest transmitter compared with a box of ordinary book matches.

about the floor whispering into the wristwatch radio, yet his voice came out clear and strong from the table radio receiver at a considerable distance away from the transmitter. As a matter of fact it is necessary to be some little distance away, otherwise there will be an audio feedback howl.

Dr. Brunetti built a similar miniature pocket-radio for President Truman, which was presented to him on Christmas Day. In the White House there are a number of receivers attuned to the President's transmitter. The President can now walk about the entire White House, including grounds, and talk to the personnel wherever he is located. It is not possible to "talk back" to the President as there are no radio transmitters for the White House staff.

There are many practical uses for wristwatch transmitters of this type, only a few which are listed here:

During building construction when the architect or the foreman wishes to talk to a temporary office, contact can easily be established.

Such a walking transmitter is a great boon in commercial departments between stock clerks and main office.

For mines, quarries, etc., foremen—if equipped with a wristwatch radio—can keep in touch with the distant office at all times. It would be particularly effective during mine disasters. These are only a few uses. There are of course thousands of others.

Dr. Brunetti has not stopped at the small wristwatch radio, but has since developed even smaller units. A number of these are reproduced here for the first time in any publication.

There is, for instance, an astonishing new two-stage audio amplifier, illustrated in these pages, which is incredibly small. This amplifier (complete with tubes) is a cylindrical plug-in unit and weighs 17 grams (a little over half an

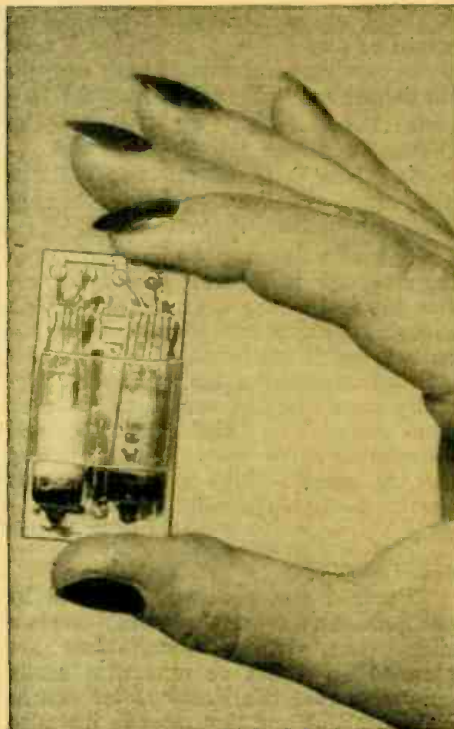

Another view of the new smallest transmitter, shown also on preceding page.

ounce). It is 1 1/4 inches long and 11/16 inch in diameter. The prongs are 7/16 inches long. The entire amplifier is cast in solid transparent plastic. Therefore, it cannot be taken apart or opened. The only way this could be done would be by dissolving the plastic in a solvent. It could not be taken apart mechanically because in the process all the parts would be ruined. The circuit diagram of this transmitter is also reproduced here. It is probably at the moment the smallest two-stage audio amplifier ever made.

Since Dr. Brunetti constructed his wristwatch radio—shown on the cover of RADIO-CRAFT this month—he has developed an even smaller one. It is the smallest ever built up to now. The small flat two-tube transmitter is shown in our illustrations. The entire circuit is printed on a 1/16 inch lucite plate; the transmitter (tubes, resistors, circuits, base plate, etc.) weighs exactly 8 grams (2/7 oz.). The tiny set, smaller than a book match, measures 1 inch by 1 15/16 inch and is 5/16 inch in maximum height.

As we go to press Dr. Brunetti has come up with some even more astonishing versions of his miniature radios. During the first part of last February he demonstrated his "Half-Dollar Radio Station" before the local section of the Institute of Radio Engineers in Washington.

He exhibited a whole "network" of radio broadcast transmitters which he carried in his pockets. Among others he demonstrated a tiny transmitter which fits in an empty lipstick container. He also had a "Calling Card Radio," the size of a calling card.

His "Half-Dollar Broadcasting Unit" is built on a square which barely covers a 50c piece. The thin plastic square measures 1 1/4 inches each way. Flat painted lines, which are the radio circuits, are used instead of wires. The tiny tubes are soldered to the flat surface. Small hearing-aid batteries supply the power for this sub-miniature radio station.

Dr. Brunetti also presented a duplicate vestpocket transmitter and receiver of the type presented to President Truman, as above mentioned.

These small radio transmitters and receivers are no longer in the theoretical stage nor are they "stunt" exhibition pieces. The National Bureau of Standards, in a recent survey revealed that more than 65 radio manufacturers have begun to use printed circuit techniques in various of their products.

There is already in use at present a hearing aid manufactured with the printed circuit. Plans are under way for two-way personal radios at present.

Dr. Brunetti illustrated to the assembled engineers at Washington how large stores can use the midget transmitters in routine inventory taking. The idea for this use of miniature radios came from an executive of a large chain store. One clerk would count the stock, broadcasting by radio the resulting stock figures to the main office where they would be recorded and tabulated. This would be quicker than having the clerk write down the results himself, because

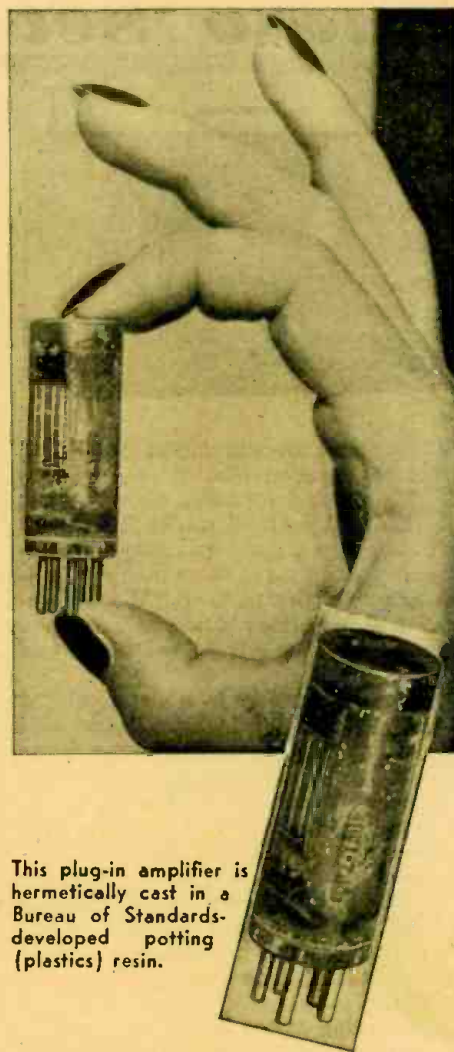

This plug-in amplifier is hermetically cast in a Bureau of Standards-developed potting (plastics) resin.

he could not count stock while writing, whereas the voice transmission to a competent stenographer works twice as fast.

At the present time Dr. Brunetti and his staff feel that while the electronic parts of their radios have shrunk to a size never contemplated before, the battery interests have not kept pace with electronic developments.

Both A and B batteries still bulk many times the space of electronic parts of the miniature radios. It is along this line of attack that greatest progress is expected in the immediate future.

During the war years dry-battery manufacturers have made some advance

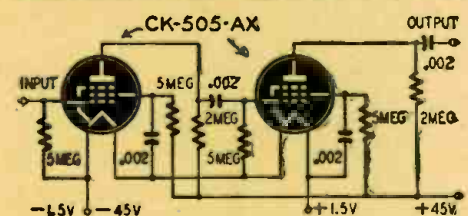

Schematic of the potted two-stage amplifier.

in reducing dry cells to smaller size, but they are still far too bulky and much too large.

If it were not for the bulky batteries, Dr. Brunetti's various transmitters and receivers could be made far smaller than they are today. It is felt, however, that this problem too will be solved in the near future, once the battery interests understand how tremendously important sub-miniature radios will become in the future.

# Radio Set and Service Review

## ◀ Bendix Model 847S "Facto Meter"

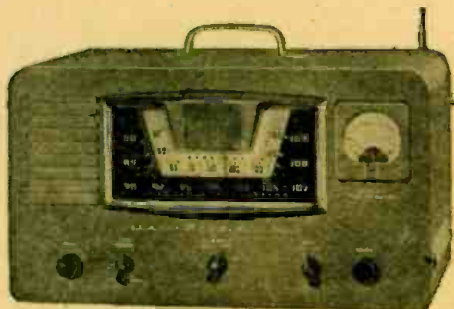

**T**HE new Bendix Model 847S field test receiver—called the Facto Meter—is an 8-tube, a.c.-operated, FM-AM portable set. It is designed specifically as an aid to radio installation crews and servicemen making field-strength measurements on FM and standard AM broadcast bands.

Its tuning range is 540—1620 kc and 88—108 mc.

The set is enclosed in a metal cabinet 11 inches high, 17¾ inches wide, and 6¼ inches deep and features a large built-in tuning meter and a 33¼-inch telescopic antenna that may be used on FM and AM reception. This antenna can be connected to either the FM or AM antenna terminals by a switch on the side of the cabinet. A 300-ohm FM antenna and a single-wire broadcast antenna and ground can be connected to terminal strips on the rear of the chassis.

The tuning meter has two sensitivity ranges. The ratio between ranges is 5 to 1 on the AM band and 10 to 1 on the FM band. It has a linear scale calibrated 0 to 10. When the meter reads 5 or above on the high range, excellent FM reception is possible at the location where measurements are made. When the needle falls between 1 and 5, reception is good. On the low range, readings between 1 and 5 show poor reception, and

above 5 shows good reception. The set should be tuned for maximum needle deflection on each station.

### FM vs. AM propagation

There is considerable difference in the propagation characteristics of standard broadcast frequencies and the very high frequencies used for FM. The broadcast signal—1600 kc or lower—has a tendency to follow the earth's surface and may be received on the ground wave for distances of 400 miles or more under normal terrain and atmospheric conditions. Obtaining fair broadcast reception is no problem—even in remote locations—as the average broadcast set will pull in a number of stations if given a chance.

In steel-framed buildings, the structure may absorb the signal and cause dead spots and poor reception on sets with built-in aerials. Outdoor aerials improve reception, but there are times when they are not practical or their use is prohibited. In such cases the Facto Meter can be used to locate spots accurately where signal levels are highest, and sets will give best results within the building. Areas of maximum signal strength are located by extending the antenna of the field test receiver and moving it around the room or building while watching the meter. Meter deflection indicates spots where the signal is strongest.

FM signals—in the order of 100 mc—act very much like light rays and travel in straight lines with comparatively little bending. Best reception is usually obtained when the receiving location is in the service area—where receiving and transmitting antennas are in the *line of sight*. This distance may be calculated from the formula:  $D1=1.4\sqrt{H}$ . D1 is distance in miles, H is elevation of observation point in feet, and 1.4 is a constant used to allow for v.h.f. refraction. Fig. 1 is a comparison of broadcast and v.h.f. signals.

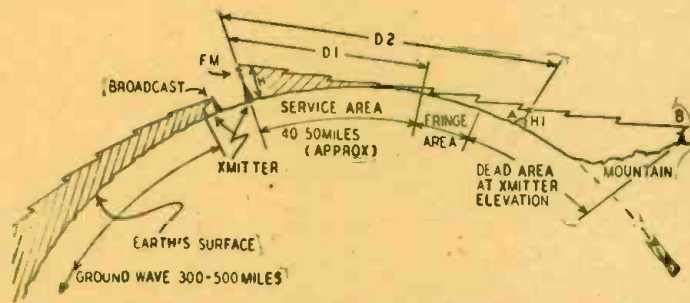

Fig. 1—A comparison of broadcast and v.h.f. signal propagation.

The service area of an FM station depends largely on the height of its antenna above surrounding terrain. The service area includes all the space within a radius of D1. H is the height of the transmitting antenna. Reception is possible in the fringe area where the receiving antenna is normally below the line of sight but signals are relatively weak. Best results are obtained when the receiving antenna is mounted as high as possible so as to extend the line-of-sight path between transmitting and receiving antennas. Signals may be received at any point A in the dead area if the receiving antenna is high enough. Its height may be found from the formula:  $D.2=1.4\sqrt{H}+1.4\sqrt{H1}$ . D.2 is the distance between transmitting and receiving locations, and H and H1 are heights of transmitting and receiving antennas in feet, respectively.

Good signals may be received atop the mountain at B—far beyond the service area—because the receiver is high enough for direct reception of the transmitted signal. (Antenna installation and orientation can become a problem normally requiring the services of two or more men.) The height, location, and orientation of the antenna and routing the transmission line are problems of particular importance.

### Field survey

The field test receiver, operated by one man, can answer these problems in a short time. Where installations are planned on a flat or otherwise easily accessible roof the Facto Meter can be carried about and the antenna installed

(Continued on page 76)

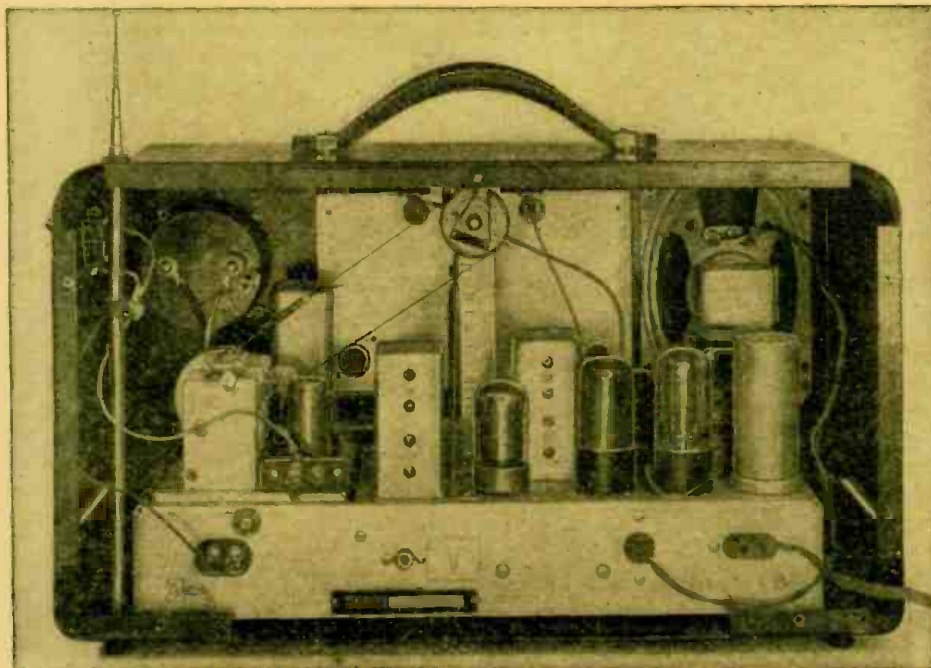

Above—The receiver with metal back removed. The telescopic antenna is partly collapsed.

# The Junior Demon 5-Watt Transmitter

By G. CARROLL UTERMAHLEN, W3HVD



"JUNIOR" was a prewar baby, born of my desire for a compact transmitter capable of local and dx contacts with a minimum of power. This midget demon has, at one time or another, gone all out in his efforts to mate with another c.w. station and, at such times, has disregarded his usual operating procedures. Junior, you see, is trying for WAS!

Most hams have been spoiled by high power, so here is the chance to test your operating ability with the barest essentials! Junior is capable of getting out in a big way. A good antenna, proper tuning, and clean operating ability will enable this peanut whistle to reach hundreds of miles out into the night.

A 70L7-GT tube was used because it was the only tube of its type available when the original Junior was built. A 117L7-GT tube may be substituted for the 70L7-GT by omitting the line-cord resistor and noting the proper changes in tube socket connections. The circuit component values are not critical, but substitutions should be made with care.

Several of these little rigs have been built by other hams, and while some did make changes in parts values, all of the rigs worked very satisfactorily.

Construction details will vary with the materials available. The following dimensions are given as a guide for those who are interested in duplicating the original unit.

The aluminum chassis is of 1/16-inch stock, and is 2 3/8 inches high, 6 inches long, and 3 1/4 inches deep.

A 3/16-inch slab of Masonite is used as a front panel. It is 5 1/2 inches high and 6 3/16 inches long. All voltage-carrying parts are mounted on the front panel (under the chassis) or, if chassis mounting is more convenient, the parts should be carefully insulated from the chassis itself. No ground should be al-

lowed to come in contact with the chassis or any voltage-carrying component!

The crystal, tube, both coils, and the antenna-tuner variable condenser are above deck. The remaining parts are below deck. A careful survey of the chassis and panel will indicate the proper placement of parts with the least possible crowding.

Nearly every amateur agrees that the 40-meter band is the best for all-around good results with low power. Forty meters offers interstate QSO's with low power during normal periods, and still greater distances may be spanned during periods of skip. The 5-wattter is designed to operate on 40 meters. It has been used with good results on other bands (80 and 160), but the coil data are for 40-meter inductances only.

L1, the plate-tank coil, consists of 14 turns of No. 24 d.c.c. wire, wound on a standard 4-prong tube base 1 1/2 inches in diameter. L2, the link-line coupling coil, is wound over L1 (using a thickness of paper tape as insulation between coils) and consists of 4 turns of No. 24 d.c.c. wire wound near the "cold" end of tank coil L1.

L3 and L4 are the antenna tuning coil. L4 consists of 38 turns of No. 14 enameled wire, close-wound, on a large size 4-prong coil 1 1/2 inches in diameter, and is tapped at the 8th turn starting from the ground end of the coil. After the first tap the coil is tapped at every 5th turn. The placement of taps is not critical, but the more taps available, the better the coupler can be adjusted to a given load. Coat L4 with Duco cement and allow to dry before adding L3. L3 consists of 2 turns of hookup wire wound over the first 8 turns of L4. L3 is first wound over L4, after which the remaining wire is twisted to form the link-line, the opposite end of which is connected to L2. Before winding L3-L4, remove the 4 metal prongs from the coil form by sawing them flush with the bottom of the form with a hacksaw. Drill a hole in the center of the bottom to mount it on the chassis. BC1 and BC2 are small

battery clips, and are shifted about on L4 when the transmitter is being matched to a given antenna.

Putting Junior on the air is a very simple matter and requires little effort. Plug the line cord into a convenient outlet, either a.c. or d.c., and the coil L1-L2 and a 40-meter crystal into their sockets. Set C2 at minimum capacitance, and with BC1 and BC2 out of the circuit, close the key and rotate the tank tuning condenser C1 until a flashlight bulb attached to a small loop of wire and held over L1 glows brightest. Then back off C1 a bit, so that the oscillator is not at the peak of resonance. If this is not done, either the oscillator will quit when the antenna is coupled to the transmitter, or the emitted signal will be rough or chirpy. Remember: Do not operate the oscillator too near resonance!

## Antenna tuning

With the key open, attach BC1 about midway up the coil L4 and BC2 to a random tap on the coil between BC1 and

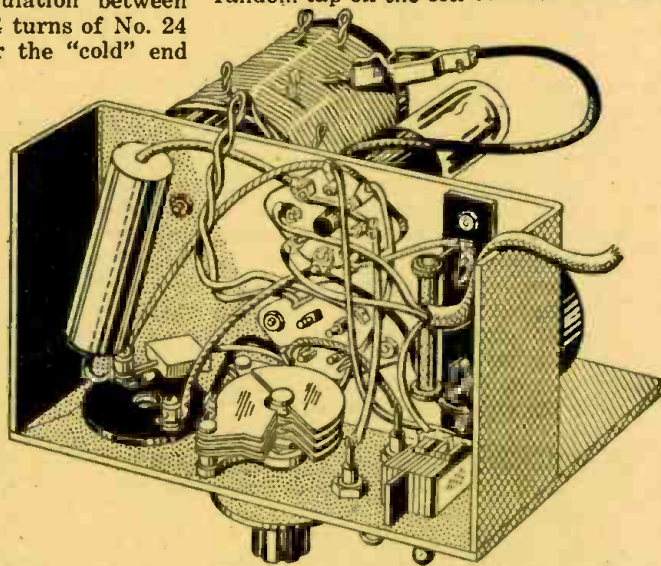

This illustration shows the under-chassis wiring of the 5-watt demon.

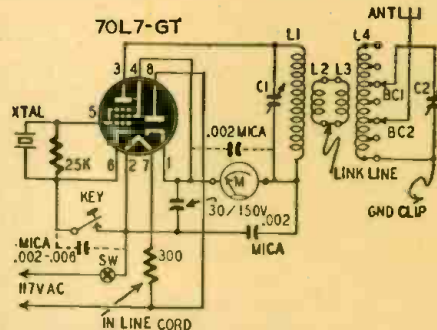

Schematic of the 1-tube a.c.-d.c. transmitter. Two additional capacitors are suggested.

# Hi-Fi 35-Watt Amplifier

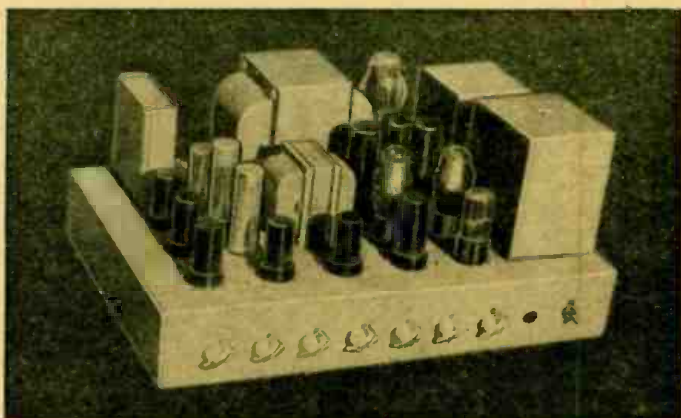

Front of the 35-watt high fidelity public address amplifier.

*The author describes a good amplifier and tells how he obtained the design figures*

By H. R. E. JOHNSTON

THE primary consideration in the design of a PA amplifier for the reproduction of music is frequency response. It is easier to extend the frequency range of an amplifier than it is to eliminate the hum and distortion that an extended frequency range usually reveals. As power is increased the problem becomes increasingly difficult.

Tentative specifications of our proposed new amplifier were:

1. Frequency response flat  $\pm \frac{1}{4}$  db from 50 to 15,000 cycles;
2. Distortion less than 1%;
3. Hum level 62 db down from full output;
4. 18-db negative feedback;
5. Bass boost and attenuation;
6. Treble boost and attenuation.

To be sure of obtaining results approaching these specifications, a great deal of theoretical work was done before construction was started. The design considerations as well as the finished product may be interesting to readers.

For low-power applications, low- $\mu$  triodes operating class A give good results and offer no problems in design. As power increases, class-A operation becomes prohibitively inefficient. To keep the power input within reason for power (20 to 40 watts output), class-AB1 operation is necessary. It is also necessary to use pentode or beam-power tubes in the output stage.

The second-harmonic distortion generated in class-AB1 operation is easily eliminated by connecting the tubes in push-pull. Distortion due to imperfect voltage regulation is a different matter and is more difficult to eliminate.

The usual procedure for reducing distortion when beam-power tubes are used, is to apply 10% negative feedback from the plates to the grids. When 10% negative feedback applied to 6L6's, distortion is reduced by slightly more than half, or 6 db. The tube manuals rate 6L6's operating class AB1 at 2% distortion. Theoretically then, 10% negative feedback should reduce this distortion to less than 1%.

However, the figure of 2% distortion is valid only when the tubes are working into a pure resistive load and with perfect regulation of all voltages. But under actual operating conditions, distortion is usually much more than 2%.

In the amplifier illustrated, this problem of distortion was attacked from both ends. First, by increasing the negative feedback factor and, second, by improving the voltage regulation. Ten percent negative feedback over one stage was not considered adequate. It was decided that the feedback factor must be increased either by increasing the gain A in the feedback loop or the percentage of output voltage B fed back. The most practical method was to increase A

by applying negative feedback over 2 stages instead of one. The factor A then becomes  $A_1A_2$  where  $A_1$  is the gain of the driver stage and  $A_2$  the gain of the output stage.

The gain of the driver stage is 9. The coupling network (explained later) introduces a loss of  $\frac{1}{3}$  or a gain of  $\frac{2}{3}$ , and the output stage has a gain of 13. The total value of A in AB is  $9 \times \frac{2}{3} \times 13$  or 78. The negative feedback factor is 10% or  $-0.1$ , and is obtained from a separate winding on the output transformer. AB is then  $78 \times (-0.1) = -7.8$ .

## Hum and distortion reduction

$1-AB$  is a factor by which the percentage of distortion without feedback is divided to determine the amount of distortion with feedback, and in this case is  $1 - (-7.8)$  or 8.8. Assuming that distortion within the tube is 3% and distortion due to reactance in the load is 5%, the total distortion without feedback is 8%. With negative feedback it would then be

$$\frac{8}{8.8} = 0.91\%$$

Any hum in the output stage due to inadequate filtering is reduced in the same proportion:

$$\frac{\text{hum without feedback}}{1-AB} = \text{hum with feedback.}$$

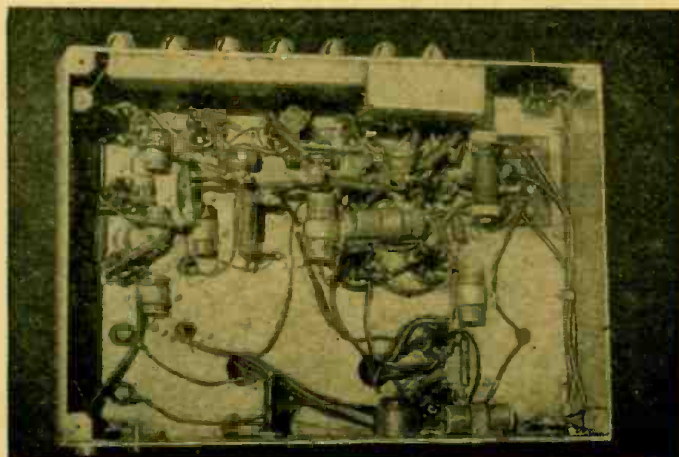

Point-to-point wiring is used between stages of the amplifier.

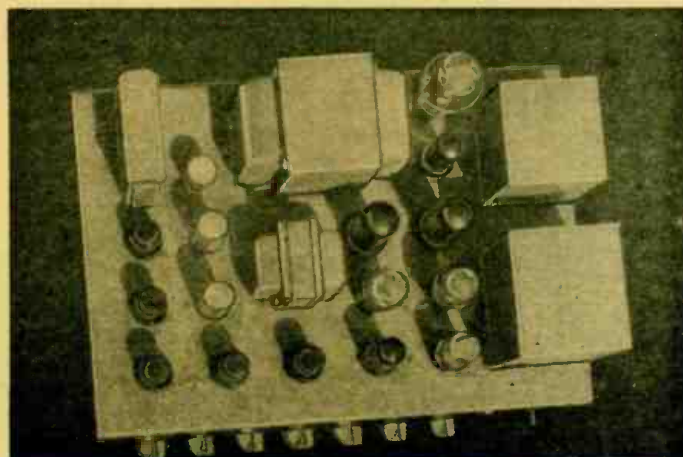

The heavy transformers and chokes give good voltage regulation.



As a point of interest, the hum level in this amplifier is 38 db down from the standard reference level of .006 watt.

Negative feedback also lowers the effective output impedance of an amplifier as shown in the equation:

$$\text{Effective output impedance} = \frac{R_p}{1 - \mu AB}$$

where:

$R_p$  is plate resistance of output tube;  
 $\mu$  is amplification factor of the output tube;

$A$  is the gain between grid of driver and grid of output tube without feedback;

$B$  is the voltage feedback factor.

The lowered effective output impedance greatly assists in damping out transients in the voice coil.

When a large amount of negative feedback is applied over 2 or more stages, oscillation at very low and very high frequencies often results due to phase shift. The coupling network between the driver and output stage was designed to prevent this from occurring.

Another factor to be considered is that change in gain with negative feedback determines the peak voltage required at the grids of the driver tubes for full power output.

The change in gain with negative feedback is given by the equation:

$$\frac{\text{gain without feedback}}{1 - AB} = \text{gain with feedback.}$$

Since the over-all gain of the driver and output stages without feedback is 78 and  $1 - AB$  is 8.8, the total gain with feedback is 8.86.

The peak grid-to-grid voltage required by the driver is equal to the peak output voltage divided by 8.86.

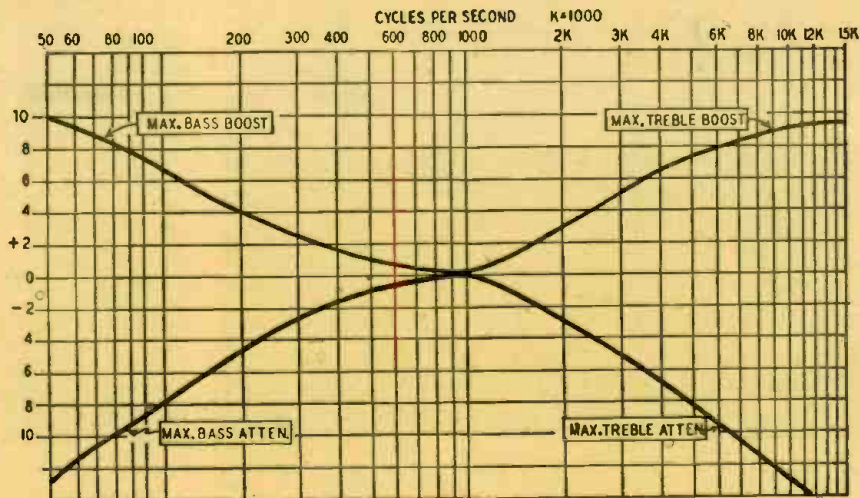

Fig. 1—Amplifier response under maximum tone control settings.

The r.m.s. plate voltage of each 6L6 at full output is the square root of  $\frac{1}{2}$  power output times  $\frac{1}{2}$  plate-to-plate load impedance, or:

$17.5 \times 3,300 = 240$  volts r.m.s. The peak-to-peak output voltage is  $240 \times 1.414 \times 2$  or 679 volts. The voltage required by the driver is 76.5 volts peak.

### The amplifier circuit

The front end of the amplifier is conventional. There are 4 inputs; 2 high-impedance microphone inputs, 1 phono input, and 1 radio input. There is a gain control for each input and a master gain control. The treble boost and attenuation circuit is located between the third and fourth stages. All single-ended stages are isolated from one another and the filtering in the decoupling network reduces hum to a very low level.

The frequency response is flat within

$\frac{1}{4}$  db from 50 to 15,000 cycles. Distortion is less than 1%, and the hum level is 62 db down from full output. Total negative feedback is 18 db.

The power transformer has 2 high-voltage windings. One winding supplies plate and screen voltages for the output tubes; the other furnishes the plate voltage for the voltage amplifiers. Good voltage regulation is obtained by using a single-section choke-input filter, with a low-resistance choke and a transformer with good regulation. Good screen voltage regulation is provided by using 2 regulator tubes in series across the screen lead. Note well the size of the components in the illustrations. Plenty of iron and copper are necessary for the best audio quality.

Choice of an output transformer is important, but is limited to those having

(Continued on page 75)

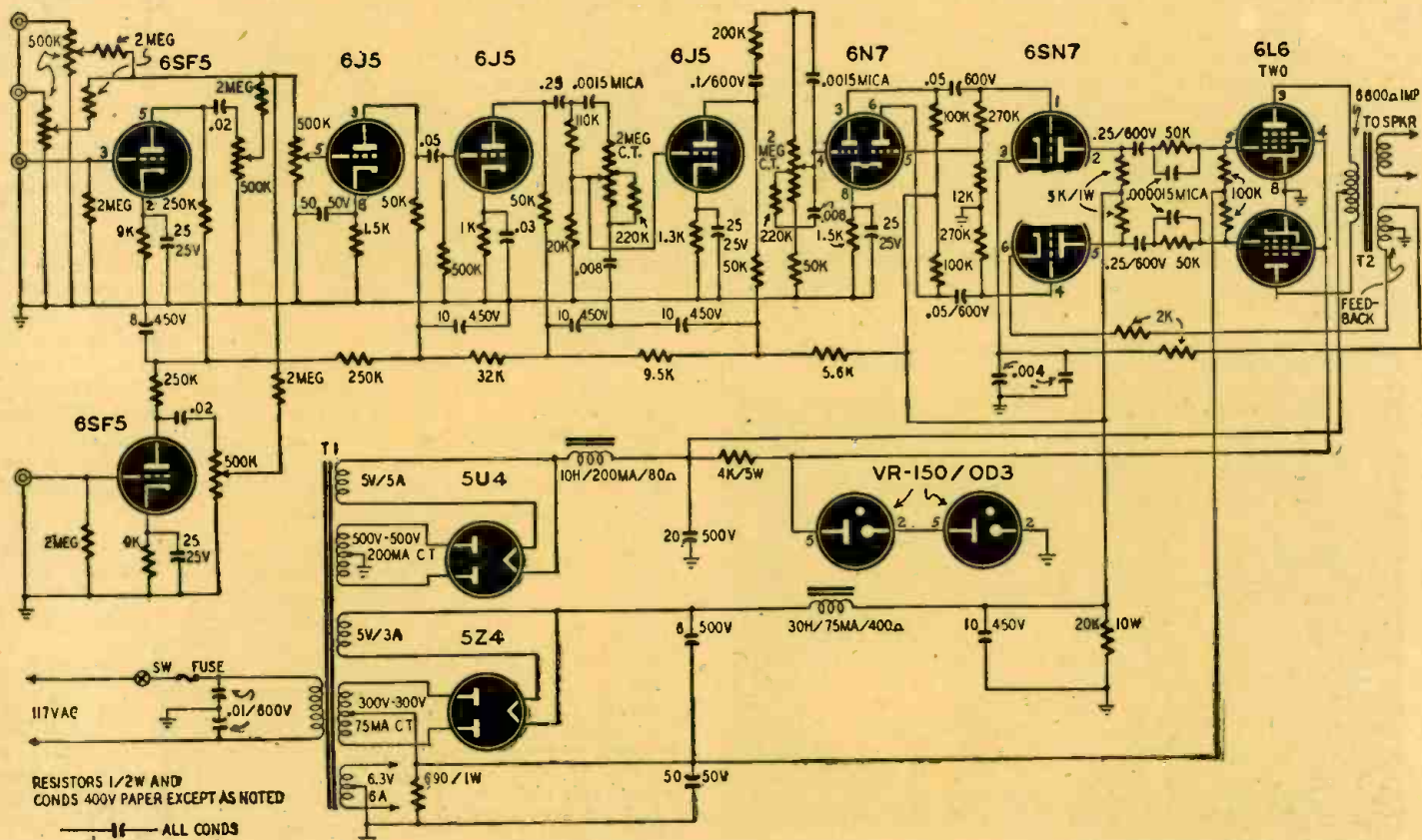
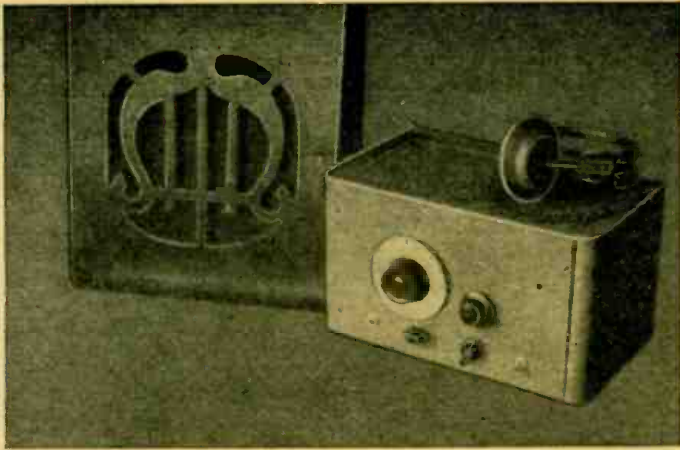
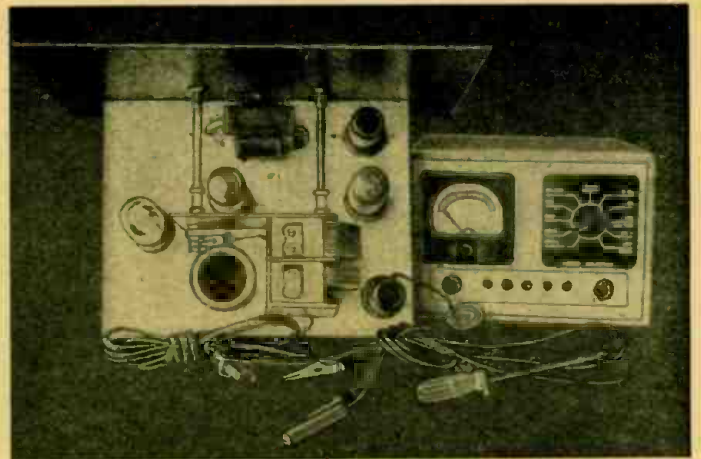

Fig. 2—The circuit of the amplifier. The bass and treble tone controls are located between the third and fifth amplifier stages.



The output transformer permits use of phones or magnetic speaker.



This top view shows how condenser placement avoids hand capacity.

# A Stable Regenerative Receiver

By OTTO L. WOOLEY

**M**ORE than 20 years ago we built our first receiver, a 1-tube regenerative. That 1-tuber, a WD-11, cost exactly \$5. Small wonder then that for economic reasons the most popular set of that era was the one using the minimum number of tubes! For some reason, that trend of thought has continued through the years; but today when the same amount of money will purchase a double handful of far better tubes, any set builder is passing up a good bet if he doesn't use enough tubes to insure consistent maximum performance.

Looking through the tube manual recently we had a sudden urge to see what could be done with our old regenerative circuit. The straight regenerative has certain drawbacks. It is likely to radiate and it is sensitive to hand capacity. These disadvantages were reduced to the point where they were no longer objectionable by careful design and layout. Radiation from the receiver was eliminated by including an untuned r.f. amplifier.

There is no noticeable gain in a stage of this type, but it stabilizes the detector, making the control of feedback

non-critical. Furthermore, antenna effects due to antenna coupling to the detector are almost completely wiped out.

Hand capacitance has been a real aspirin-sales booster since the earliest days of radio. To combat this nuisance, a substantial steel panel was used. It was well bonded to the chassis with a

voltage tubes all have the same pin connections and can be interchanged to compare their operation.

The 20,000-ohm resistor in the grid circuit of the untuned r.f. amplifier may be replaced by a 2.5-mh r.f. choke.

A broadcast-type tuning condenser was used in this set. One designed for

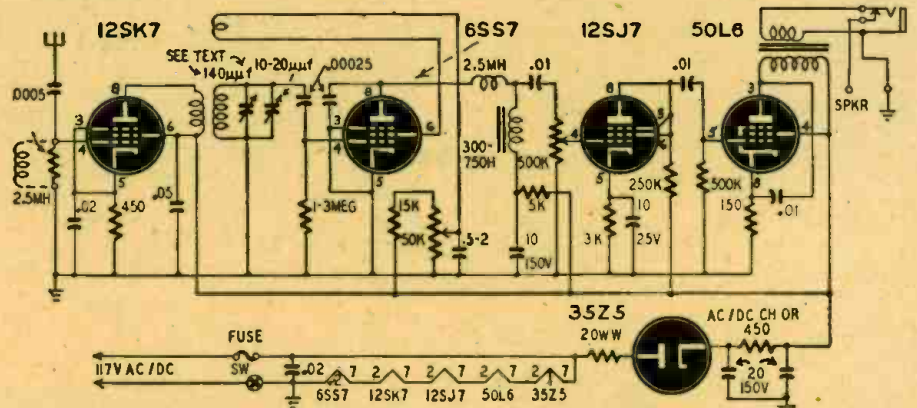

Complete schematic of the receiver. Choke coil or resistor may be used in antenna circuit.

short, heavy piece of copper braid. The parts were laid out so that the tuning unit and associated components remained well back on the rear portion of the chassis, and the band-set and band-spread condensers are coupled to the knobs by fiber shafts. The result is that no hand-capacitance effect is noticed, even on the 10-meter band.

There is nothing new in any part of the circuit except possibly the use of a remote cutoff tube for the detector in place of the more commonly used sharp cutoff type. However, the 3 low-

short-wave tuning might be preferred by SWL's. Standard, 3-winding, manufactured plug-in coils are used for the different bands. If these are unavailable they can be wound easily on standard coil forms.

A coil for the broadcast band can be constructed with a primary of 25 turns No. 30 or 32, a secondary of 90 turns No. 28, and a tickler of 15 to 20 turns No. 30 or 32. The coil is wound on a 1½-inch diameter, 6-prong coil form. Coils for other bands can be determined by experiment.

Impedance coupling is used between the detector and the first audio tube. A small audio choke of at least 300 henries is used. This type of coupling permits the detector to work into a more suitable load than if resistance coupling were used between stages.

The audio system is conventional except that the first audio tube is triode-connected. The output transformer has a 2,500-ohm primary to match the 50L6

(Continued on page 83)

Under-chassis wiring is not critical except for the filament leads.

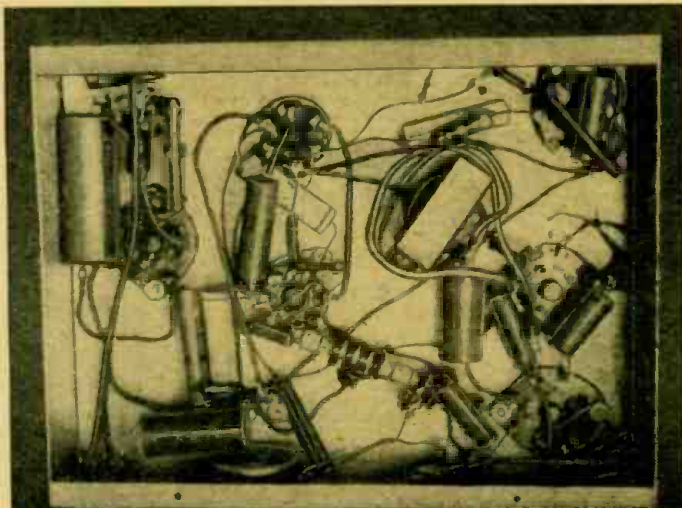

# Tone Control Adventure

**Engineer James Langham proves again  
that curves don't always mean results**

By JAMES R. LANGHAM

It was some time ago that the XYL came home with a story about a friend's big, fancy, custom-built radio. "Instead of just one knob that cuts out the highs, they have two. One boosts the lows, and one boosts the highs. Couldn't you rig us up something like that?"

"Why, I guess we can manage," I remarked foolishly. "You see, we make up an M-derived or constant K-filter section for highs and another for lows and..."

"I'm no engineer," she said. "You figure it out, and I'll build it."

I was young and innocent then: I believed what the textbooks said about filters, and I thought I knew a lot about electronics. So I got out the books and slide rule and spent about 2 hours computing the constants for a pair of bridged-T filters. I figured the sizes for 4 coils and 4 condensers and even plotted the theoretical curves for each. I drew up a sketch so she'd know just where to put them into the circuit and then tossed the papers lightly in her direction and departed. I don't know if I thought she'd have built it by the time I got home that afternoon or not. I may have. So help me, I may have.

The XYL was a mite irritated when I got home. "Look, knucklehead," she said, "you may be a fire-ball of a designer, but you sure aren't very practical."

"Mmmm?" I inquired. Mild curiosity. "Something troubling you, dear?"

She had a lot of catalogs and a worried look. "Where were you planning on getting these fancy chokes? Such as 0.183 henrys and 13.2 millihenries and—they're not standard sizes at all. Nobody sells them."

I grinned at her. "That's right, dear. You'll have to wind them up yourself or get someone else to do it."

My tone was a mistake. She announced immediately (and loudly) that by all that was holy she was not going to wind up any coils. If I could persuade someone else to do it, O.K. If not, I would have to wind them myself.

Well, after I phoned downtown to a couple of places, I announced I would be glad to wind them. "I don't see how they can expect \$15.00 for winding a simple little coil. I'll do it myself."

For the next month I wound coils. Air core and iron core. I used an egg-beater hand drill and bought quantities of wire. Then I would go over to the technical school and check them on the bridge. Then I would add or take off turns until the inductance was right. Then I would check the Q, and then get another form and start over again. Finally I had the 4 coils. They were within 2% of the design values, and they were nicely potted (beeswax and rosin). And I decided I

had learned something valuable—it isn't easy to wind coils.

The XYL kept her word and wired the things up. She bridged condensers and found room on the chassis and did her wiring neatly with squared corners. She was really excited about it.

She put on Scheherazade—lots of

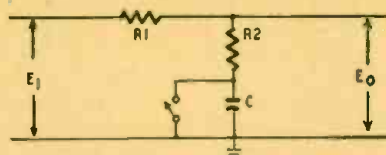

$$E_0 = E_1 \frac{R_2}{R_1 + R_2} \text{ WITH SWITCH SHORTED}$$

$$E_0 = E_1 \frac{\sqrt{R_2^2 + X_C^2}}{\sqrt{(R_1 + R_2)^2 + X_C^2}} \text{ WITH SWITCH OPEN}$$

Fig. 1—A circuit to boost the bass notes.

highs and lots of lows. She wanted to twist the two new knobs and hear the ends go up and down.

Something was a little wrong. The low control made the hum level go up and down, but it didn't seem to affect the low notes in the music. The high control was better. You could hear an increase in the high level when the control was twisted, but there seemed to be an unpleasant accompanying distortion there too.

We stood there glaring at each other. "The wiring looks nice anyhow," I got in the first blow.

"The engineering looked good too," she said sweetly. "Those curves were

lovely. The theoretical ones, I mean."

I called for peace. "I guess that bass filter needs more shielding. It picks up hum."

She nodded. "I'll say it does."

We tried shielding the coils. (Incidentally, the best shielding seemed to be beer cans.) Then we tried putting a higher level into the filters so the induced hum would be lower than the signal. We even lit the low-level filaments with d.c. so the hum would be low enough.

After we did enough things it got almost fair. There were limits to the amount of boost we could give it, though. If we turned up the bass much, it sounded muffled; and if we turned up the treble to match, the distortion came up with it. One day I came home to find the XYL showing off our outfit to a friend. She pointed to a newly blank panel. "No tone control at all," she said. "We find that if the tonal balance is proper, tone controls aren't needed. In fact, we avoid distortion by not having any tone controls."

I listened and it sounded good. She had jumped over the filters and, by golly, it sounded better than it had for some time. So I adopted her line of reasoning and argued with the fellows that really high-fidelity amplifiers shouldn't have any tone control.

I was squelched soon by this argument: "What if your pick-up or your speaker or the record falls off at the

(Continued on page 70)

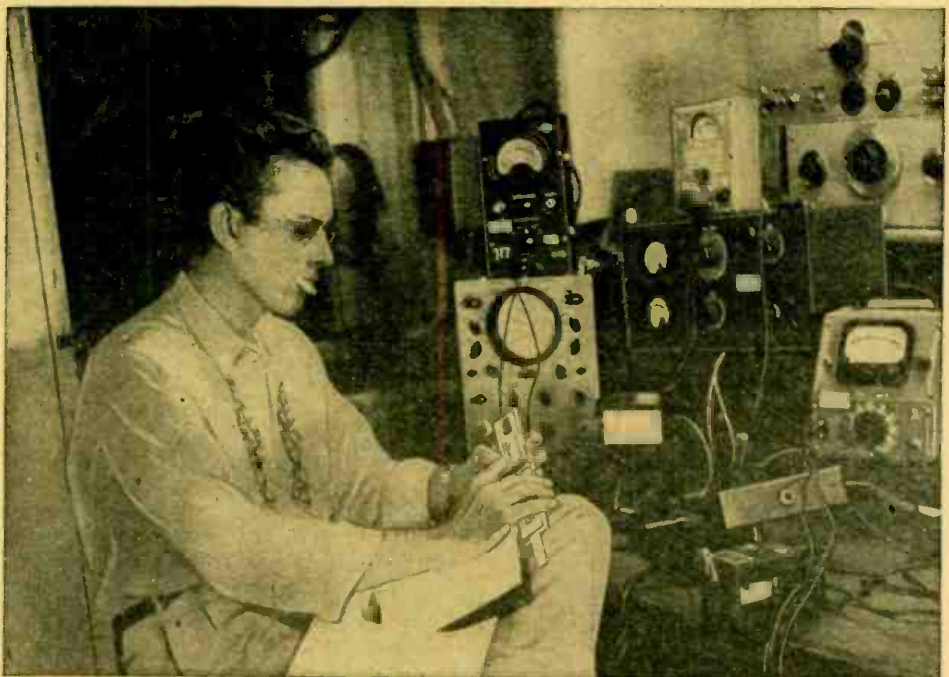

I figured the sizes for 4 coils and 4 condensers and even plotted the curves for each.

# Most-Needed Circuits

Most-often-requested items are power supplies, converters, r. f. heaters and diathermy equipment

**O**UR technical staff receives repeated requests for diagrams of oscilloscopes, receivers, converters, electronic controls, and power supplies. A few of those most in demand are presented here.

## Power supply for BC-654-A

The BC-654-A, a part of the SCR-284-A, is a receiver and transmitter tunable from 3700 to 5800 kc. The receiver and transmitter are designed to operate with power units PE-104-A and PE-103-A, respectively. These operate from 6- or 12-volt vehicular storage batteries and supply the receiver and transmitter with plate, bias, and filament voltages.

The PE-103-A is available on the surplus market and delivers 500 volts at 160 ma while drawing 21 amperes at 6 volts d.c. or 11 amperes at 12 volts d.c. These units are equipped with circuit breakers and are ideal for marine, mobile, and emergency transmitters or amplifiers.

The a.c.-operated supply shown in Fig. 1 is designed to replace the battery-operated units. The codes on the output terminals refer to connectors and their respective pin numbers on the BC-654-A. Connections to pins 3 and 8 on connector 1K3 are reversed on sets with serial numbers below 9,500, and power-supply connections should be made accordingly.

Full-wave dry rectifiers are used in the low-voltage sections of the supply. Rec 1 and Rec 2 are Mallory types 1B12C3 and 1BR4, respectively. Other makes may be used if manufacturers' specifications are followed closely.

The voltage across terminals 3 and 4 should not exceed 10.8 volts with no load. If the output from the rectifier

with full load exceeds 6 volts, remove turns from Sec. 1. Maximum permissible a.c. voltage across terminals 1 and 2 is 3.6, and the output of the rectifier should not exceed 1.5 volts under load. Remove turns from Sec. 2 until voltage is normal.

These secondary windings supplying the dry rectifiers can be replaced with filament transformers altered to deliver the required output voltage. For example: Sec. 2 may be replaced with a 6.3-volt, 2-ampere center-tapped filament transformer. The halves of the secondary are connected in parallel.

Choke Ch 1 must carry at least 3 amperes. Its resistance should not be greater than 0.6 ohm. Ch 2 has a maximum resistance of 1.3 ohms and should carry 800 ma safely. Both chokes may be made by winding new coils on cores of old 200-ma chokes. Use No. 16 s.c.e. magnet wire on Ch 1 and No. 22 s.c.e. on Ch 2. Wind on as many turns as space permits and adjust the air gap for best filtering. The .013-henry, 4-ampere chokes currently available on the surplus market may be used for Ch 1 and Ch 2.

## All-band converter

A number of surplus receivers tune to 455 kc. Some tune from about 600 kc down as low as 15 kc. Others cover portions of the long- and short-wave bands. The converter shown in Fig. 2 is designed to extend the range of the RAK-7, BC-453, RBL-3, and similar receivers through the broadcast band to 18 mc.

Oscillator and antenna coils are standard commercial 3-band assemblies designed to tune from about 540 kc to 18 mc when used with 365- $\mu$ f condensers and 455- or 456-kc i.f. amplifiers. Oscillator padders Cp are selected for use

with the average assemblies tuning 540- to 1700-kc, 1700- to 5500-kc and 5.5- to 18-mc ranges. The capacitance of the padder increases with frequency range.

Other bands can be covered by selecting separate coils for the desired ranges. Follow manufacturer's specifications on oscillator padders. One set of broadcast coils and a set of 12- to 36-mc coils can be used to extend the range of the BC-348, BC-779, and similar receivers to include the broadcast and 10-meter bands.

The converter-output transformer T1 is a standard 455- or 456-kc i.f. transformer with the secondary coil and trimmer removed. The output of the converter is capacitance-coupled to the receiver antenna posts through a .006- $\mu$ f mica condenser.

## Low-voltage D.C. supplies

Low-voltage d.c. supplies are handy for operating electroplating equipment, pipe and electronic organs, generator fields, testing automobile radios, and numerous other applications.

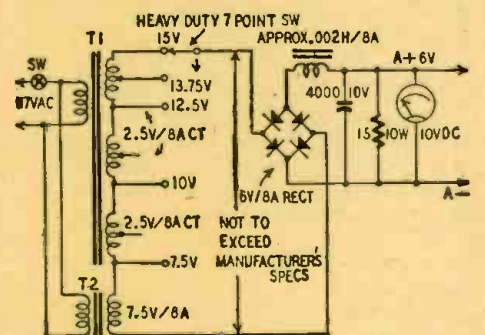

Fig. 3—A power supply for low-voltage use.

The circuit shown in Fig. 3 is designed to deliver 6 to 8 volts at up to 10 amperes, depending on the rectifier unit used. Operating conditions for dry rec-

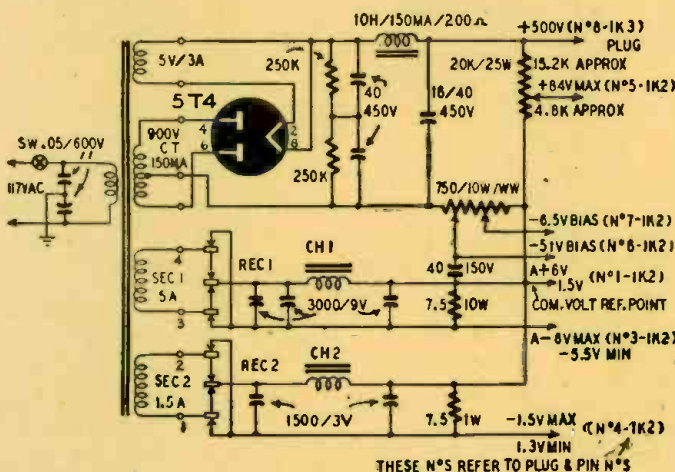

Fig. 1—Line-operated power pack for BC-654-A or similar receivers.

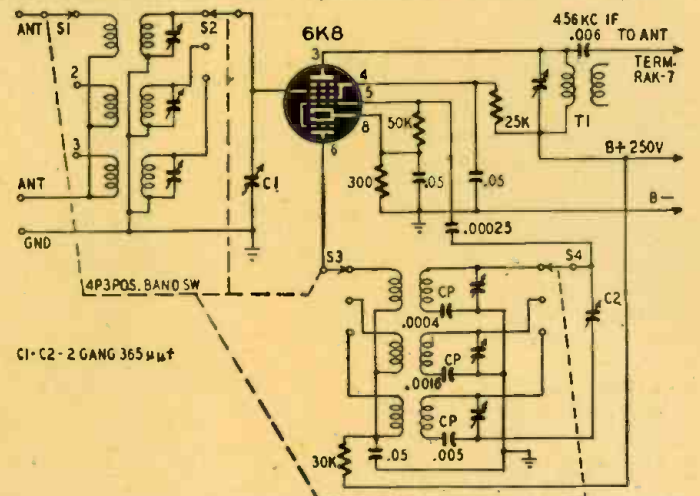

Fig. 2—This all-wave converter has an output frequency of 456 kc.



# Transatlantic News

By Major Ralph W. Hallows

RADIO-CRAFT EUROPEAN CORRESPONDENT



**W**HAT a marvelous instrument the modern television camera is! A few evenings

ago I watched on the television screen a play which was transmitted from a theater in London in the course of an ordinary performance and without a single lumen of extra lightning. One or two afternoons later I saw an international Rugby football match played on a typically English winter afternoon when low clouds, mist, and fine drizzling rain combine to produce what the poets call a "dim religious light." (Football fans have other words for it.) Not much use switching on, I thought, after a glance through the window at the gloom outside. To my utter amazement the images were clear, sharp, and full of detail, although the commentators sitting in the grandstand complained bitterly about the difficulty of seeing what was going on. We televisioners, obviously, saw better than they did!

It will be a strange business if commentators change over to the screen of a television monitor tube on days when the light is too dim for the human eye to see the game direct.

The camera now used by the BBC is more light-sensitive than the eye. It incorporates a modified form of Zworykin's orthicon. I wonder if users of television receivers in this and other countries fully realize the magnitude of their debt to that great American genius? But for the iconoscope, supericonoscope, and image orthicon tubes, television might still be in the scanning-disc stage, with little or no entertainment value.

## Table model televisers

I was interested to read in a recent number of RADIO-CRAFT that in America table-model televisers are expected this year to outsell consoles by about 2 to 1. The console is still the more popular model here, mainly because of the better quality of the sound reproduction, but it would not surprise me if people here soon begin to show a preference for the table model.

The height of the television screen above the floor is more important than many designers yet realize. It should not be much above or below that of the televisioners' eyes. The height depends, not only on the natural upholstery of the viewer and the artificial upholstery of

his chair, but also on whether he prefers to take his television while sitting bolt upright, or lolling back at his ease. Screen-height in the console is fixed. But with the table model the viewer can sit as he pleases and arrange the height of the televiser to suit his own requirements. If, for example, the set normally rests on a rather low table, it can always be raised with some of those large, unread books which so many people's bookshelves contain.

There's another reason why the table model is winning popularity on this side of the Atlantic. Try asking half a dozen friends to see a television program on a console model with a 48-square-inch image. You'll not find it too easy to seat



This unusual table lamp conceals a 3-tube radio as well as a built-in loudspeaker.

them so that all can see reasonably well. It's fine for those in the front whose eyes are at about the right level, but the fellows standing behind them may not be very enthusiastic over the distorted images that they see. With a table model and a little ingenuity you can give everyone a good view. Here's a chance for inventors. Why not a table-type televiser standing on spring-loaded lazy-tongs supports? Raise or lower it to the height you want and it stays put!

## The slot antenna

Quite a bit of attention is being given to the possibilities of the slot antenna for v.h.f. reception, including television. Briefly, if in a sheet of metal you punch a narrow slot of the correct dimensions and connect a feeder line to it as shown in the drawing, it behaves as a half-wave dipole, except that the polar diagram is the exact opposite of what you'd expect. The vertical slot has the same polar diagram as a horizontal half-wave dipole, and vice versa. In theory the plate in which the slot is made should be of infinite area, but very good working results are obtained with plates of reasonable size. The slot antenna was

first used during the war, for centimeter radar. It's a ticklish job to erect and feed an array of half-wave dipoles for a wave length of, say, 5 centimeters. But the difficulty vanishes if you punch out the array as a pattern of slots in the walls of a wave guide, and the results are first rate. It is possible that arrays of slots made in the steel framework of apartment buildings can be used as master antennas to provide FM and television reception for every home in the building.

## Map making by radar

There are enormous areas of the world surface which have never been accurately surveyed and mapped. Today their survey is being speeded by radar techniques. The old way of making maps is to cover the ground on foot, establish datum lines, sometimes of great length, and base triangulations and levelings on these lines. This method makes for great accuracy; but it takes a long time and the cost is high, particularly if dense forests and precipitous mountains make the going difficult. The modern method is to photograph the ground from airplanes, piece the photographs together, and make the map from the resulting composite picture. But such a map is not accurate unless the photographs are referred to a system of points on the ground whose positions are fixed with precision. That is where radar comes in.

Radar survey methods are now used in both the great African continent and in New Zealand. In New Zealand the main purpose of the radar survey is to add contour lines and other details to existing maps, but in Africa the object is to produce, at the rate of at least 100,000 square miles a year, accurate maps of huge tracts of country of which nothing more than a rough survey has been made so far.

The radar beacon is one of the most  
(Continued on page 69)

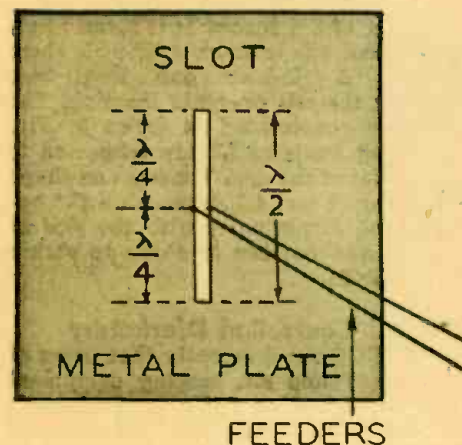

This novel antenna was used first for radar.

The New Model 777

# TUBE & SET TESTER

## 20,000 OHMS PER VOLT!!



### TUBE TESTER SPECIFICATIONS:

- Tests all tubes including 4, 5, 6, 7, 7L, Octals, Locals, Television, Magic Eye, Thyratrons, Single Ended, Floating Filament, Mercury Vapor Rectifiers, New Miniatures, etc. Also Pilot Lights.
- Tests by the well-established emission method for tube quality, directly read on the scale of the meter.
- Tests leakages and shorts of any one element against all elements in all tubes.
- Tests both plates in rectifiers.
- Tests individual sections such as diodes, triodes, pentodes, etc., in multi-purpose tubes.
- New type line voltage adjuster.

### V.O.M. SPECIFICATIONS:

- D.C. VOLTS: (at 20,000 Ohms Per Volt) 0 to 7.5/15/75/150/750/1,500 Volts
- A.C. VOLTS: (at 10,000 Ohms Per Volt) 0 to 15/30/150/300/1,500/3,000 Volts
- D.C. CURRENT: 0 to 1.5/15/150 Ma. 0 to 1.5 Amperes
- RESISTANCE: 0 to 5,000/50,000/500,000 Ohms 0 to 50 Megohms
- DECIBELS: (Based on zero decibels equals .006 Watts into a 500-Ohm line.) -10 to +18 db., +10 to +38 db., +30 to +58 db.

Model 777 operates on 90-120 Volts 60 cycles A.C. Housed in beautiful hand-rubbed cabinet. Complete with test leads, tubes, charts and detailed operating instructions. Size 13" x 12 1/2" x 6".

**\$59<sup>95</sup>**  
NET PRICE

### Distributed by the following jobbers:

#### ALABAMA

Bossmmer Radio Supply Co., 116-18 N. 20th St., Bessemer, Ala.  
 Forbes Distributing Co., Inc., 1912 Fourth Ave., North Birmingham, Ala.  
 Bill Erwin Radio Co., 926 First Ave., Gadsden, Ala.  
 Allen & Jemison Co., 220 Greenboro Ave., Tuscaloosa, Ala.

#### COLORADO

Western Electronic Laboratories Co., 909 Eighteenth St., Denver, Colorado

#### CALIFORNIA

Valley Electronic Supply Co., 1302 W. Magnolia Blvd., Burbank, Calif.  
 El Monte Electronics Co., 992 East Valley Blvd., El Monte, Calif.  
 Valley Radio Supply, 440 Blackstone Ave., Fresno 3, Calif.  
 Hagerty Radio Supply, 6826 San Fernando Rd., Glendale 1, Calif.  
 Hollywood Radio Supply Co., 5521 Hollywood Blvd., Hollywood 28, Calif.  
 Pacific Radio Exchange, Inc., 1407 Cahuenka Blvd., Hollywood 28, Calif.  
 Alvarado Supply Co., 903 S. Alvarado, Los Angeles 6, Calif.  
 Y & H Radio & Electronic Supply, 2035 W. Venice Blvd., Los Angeles 6, Calif.  
 Universal Radio Supply Co., 1404.04 Venice Blvd., Los Angeles 6, Calif.  
 Figart's Radio Supply Co., 6320 Commodore Sloat Dr., Los Angeles 36, Calif.  
 Kieruff & Co., 820 W. Olympic Blvd., Los Angeles, Calif.  
 Radio Parts Sales Co., 3220 So. Vermont Ave., Los Angeles 37, Calif.  
 Electronic Sales Co., 5559 West Adams Blvd., Los Angeles 16, Calif.  
 Electric Supply Co., 149 12th Street, Oakland 7, Calif.  
 Pasadena Radio Supply & Equipment Co., 30 W. Colorado St., Pasadena, Calif.  
 Sacramento Electric Supply, 711 Capital Ave., Sacramento, Calif.  
 Arrowhead Radio & Television Supply, 1216 "D" St., San Bernardino, Calif.  
 Electronic Equipment Distributors, 1228 2nd Ave., San Diego 1, Calif.  
 San Francisco Radio & Supply Co., 1282 Market St., San Francisco 2, Calif.  
 Offenbach Reimus Co., 372 Ellis St., San Francisco, Calif.  
 Frank Quement, Inc., 161 West San Fernando St., San Jose, Calif.  
 E. E. Abbott Co., 345 Francisco Blvd., San Rafael, Calif.  
 G & M Equipment Co., 4505 Van Noys Blvd., Sherman Oaks, Calif.

#### CONNECTICUT

L. N. Walhaus, 1132 Norman St., Bridgeport, Conn.

#### DISTRICT OF COLUMBIA

Capitol Radio Wholesalers, 2120 14th St., N. W., Washington, D. C.  
 Kenyon Radio Supply, 2214 14th St., N. W., Washington, D. C.  
 Rucker Radio Wholesalers, Inc., 1312 14th St., N. W., Washington, D. C.  
 Silberman Radio & Electric Co., 3223 14th St., N. W., Washington, D. C.  
 Sun Radio of Washington, D. C., 938 F. St., N. W., Washington, D. C.

#### ILLINOIS

Belmont Radio Supply, 1921 W. Belmont St., Chicago 13, Ill.  
 Crescent Radio Components, 4324 W. Fullerton Ave., Chicago 39, Ill.  
 Radio Doctors' Supply House, 220 East Station, Kankakee, Ill.  
 Larsen Motorola Distributing Co., 1202 4th Ave., Moline, Ill.  
 Homback Supply Co., 2008-30th St., Rock Island, Ill.

#### INDIANA

Radio Service Headquarters, 725 S. Main St., Elkhart, Ind.  
 Van Sickle Radio Supply Co., 34 W. Ohio, Indianapolis 4, Ind.  
 Clinkaman Radio, 814 W. Main St., Peru, Ind.

#### KANSAS

Overton Elec. Co., Inc., 522 Jackson St., Topeka, Kansas

#### MASSACHUSETTS

Radio Shack Corp., 167 Washington St., Boston, Mass.  
 Harold's Radio Distributors, 48 Brattle St., Boston, Mass.  
 Springfield Sound Co., 147 Dwight St., Springfield 3, Mass.

#### MICHIGAN

Mark's Stores, Inc., 1333 Broadway, Detroit 26, Mich.  
 Fulton Radio Supply Co., 265 W. Cortland St., Jackson, Mich.  
 Electric Products Sales Co., 427 E. Michigan Ave., Lansing 29, Mich.  
 Omic Dist. Co., 601 E. Genesee Ave., Saginaw, Mich.

#### MARYLAND

Lytton Distributing Co., 1829 N. Fulton St., Baltimore, Md.

#### MISSOURI

Tri-State Radio & Supply, 136 Bartlett St., Poplar Bluff, Mo.  
 Walter Ashe, 1125 Pine St., St. Louis 1, Mo.

#### NEBRASKA

Arbor Co., 823 Central Ave., Nebraska City, Nebr.  
 Radio Supply Co., 618 Lincoln Blvd., York, Nebr.

#### NEW JERSEY

General Radio Supply, 207 N. Broadway, Camden, N. J.  
 Nidisco, Inc., 608 Anderson Ave., Cliffside, N. J.  
 Trade Radio, 10 Morris St., Hackensack, N. J.  
 Nidisco, Inc., 713 Newark Ave., Jersey City, N. J.  
 Variety Electric Co., Inc., 601 Broad St., Newark, N. J.  
 Continental Sales Co., 195 Central Ave., Newark, N. J.  
 William Radio Supply, 210 French St., New Brunswick, N. J.  
 Nidisco, Inc., 205 Madison St., Passaic, N. J.  
 Nonmouth Radio Supply, 396 Shrewsbury Rd., Red Bank, N. J.  
 Nidisco Trenton, Inc., 126 So. Warren St., Trenton, N. J.

#### NEW YORK

Hudson Valley Asbestos Corp., 170 Central Ave., Albany 6, N. Y.  
 Scheller Radio Co., 263 Oak St., Buffalo 3, N. Y.  
 C. A. Winchell Radio Supply Co., 37 Central Ave., Cortland, N. Y.  
 W. Rd. Radio Laboratory, 6 Hamilton Ave., Croton-on-Hudson, N. Y.  
 F. C. Harrison Co., 106 W. Church St., Elmira, N. Y.  
 Arace Brothers, 502 Broadway, Kingston, N. Y.  
 Metropolitan Elect. & Dist. Co., 42 Warren St., New York 7, N. Y.  
 Brooks Radio Distributing Corp., 80 Vesey St., New York 7, N. Y.  
 Arrow Electronics, 82 Cortlandt St., New York 7, N. Y.  
 General Electronic Dist. Co., 98 Park Pl., New York 7, N. Y.  
 Legri B. Co., Inc., 848 Amsterdam Ave., New York 25, N. Y.  
 National Radio Dist., 299 So. Blvd., New York 59, N. Y.  
 Moss Electronic Distributing Co., 229 Fulton St., New York 7, N. Y.  
 Roy C. Stage, 263 Erie Blvd., West, Syracuse, N. Y.  
 Trojan Radio Co., 426 River St., Troy, N. Y.

#### NEW MEXICO

Supreme Radio Supply, 129 West 2nd St., Roswell, N. M.

#### NORTH CAROLINA

Eastern Radio Supply, 459 Hay St., Fayetteville, N. C.

#### OHIO

Olson Radio Warehouse, Inc., 73 East Mill St., Akron, Ohio  
 Olson Radio Warehouse of Cleveland, 2020 Euclid Ave., Cleveland, Ohio  
 Progress Radio Supply Co., 413 Huron Road, Cleveland 15, Ohio  
 Whitehead Radio Co., 120 East Long St., Columbus 15, Ohio  
 Lifetime Sound Equipment Co., 511 Jefferson Ave., Toledo, Ohio  
 Steward Electric Service, 116 Seroto St., Urbana, Ohio

#### PENNSYLVANIA

The Spence Electric Store, 1310 12th Ave., Altoona, Pa.  
 Williams Auto Sales Co., Clearfield, Pa.  
 Kritz Bros., Kohn & Oak Sts., Norristown, Pa.  
 Nat Lazar Radio Co., 42-41 Lancaster Ave., Philadelphia 4, Pa.  
 Almo Radio Co., 507 Arch St., Philadelphia 6, Pa.  
 Barnett Bros. Radio Co., 145 N. 7th St., Philadelphia 6, Pa.  
 Radio 437 Store, 437 Market St., Philadelphia 6, Pa.  
 M & H Sporting Goods Co., 512 Market St., Philadelphia 6, Pa.  
 Warner Radio Co., 631 Market St., Philadelphia 6, Pa.  
 Leedom Research Laboratories, 5832 Hefferman St., Philadelphia 24, Pa.  
 York Radio & Refrigeration Parts, 265 W. Market St., York, Pa.  
 J. R. S. Distributors, 644 W. Market St., York, Pa.

#### SOUTH CAROLINA

Bates Radio & Supply Co., 7 South Main St., Greenville, S. C.

#### TENNESSEE

Chemcity Radio & Electric Co., 12 Emory Park, Knoxville 17, Tenn.  
 Hermitage Music Co., 423 Broad St., Nashville 3, Tenn.

#### TEXAS

Electronic Equipment & Engineering Co., 1322 1/2 S. E. Elizabeth St., Brownsville, Texas  
 Electronic Equipment & Engineering Co., 1310 S. Staples St., Corpus Christi, Texas  
 Paul Blackwell Co., 2016 Richardson St., Dallas 1, Texas  
 Wilkinson Bros., 2406 Ross St., Dallas, Texas  
 Car Parts Depot, Inc., 721 Texas St., El Paso, Texas  
 Mission Radio, Inc., 814 S. Fress St., San Antonio 5, Texas  
 The Harzla Company, Inc., 1305 Austin Ave., Waco, Texas

#### VIRGINIA

Ashman Dist. Co., 807 Granby St., Norfolk 10, Va.  
 D. R. Johnston Co., 1315 East Cary St., Richmond 19, Va.  
 Mattson's Radio, 519-21-23 W. Broad St., Richmond 22, Va.

#### WASHINGTON

White's Elec. Radio & Appliance Store, W. 908 First Ave., Spokane 8, Wash.

#### WISCONSIN

Valley Radio Distributors, 518 N. Appleton St., Appleton, Wis.  
 Standard Radio Parts Co., 1244 State St., Racine, Wis.

MANUFACTURED  
BY

**SUPERIOR INSTRUMENTS CO.**

227 FULTON STREET  
NEW YORK 7, N. Y.

# FM STATION LIST

**R**ADIO-CRAFT presents this month its first list of FM radio stations of the United States. It has not been practical to print such a list in earlier issues, as the number of FM stations was increasing so rapidly that any such list would have been almost useless by the time it could be printed. This list is complete as of February 25, 1948.

In addition to those below, there are also 38 non-commercial FM stations between 88 and 92 mc, on which information is not immediately available. We hope to include all these in the June list.

New stations are still coming on the air daily, but the

initial rush is over, and we believe it will be possible from now on to keep a reasonably up-to-date list. To this end, we will print revised lists as often as necessary—every other month for a time. Shortwave station data will appear in alternate issues.

Stations are listed by frequencies for easy identification. A listener may not always hear the call letters perfectly, but can always note the frequency of an unknown station on the dial of his own receiver. As many stations announce their channel numbers, a conversion table of frequencies and channel numbers is printed on this page.

FREQUENCY (MC)	CALL	LOCATION
44.1	W2XMN	Alpine, N. J.
90.5	KWGS-FM	Tulsa, Okla.
92.1	KLZ-FM	Denver, Colo.
92.1	W2XEA	Alpine, N. J.
92.3	KUMB	Des Moines, Iowa
92.3	KVNJ-FM	Fargo, N. D.
92.3	WCOH-FM	Newnan, Ga.
92.3	WCOL-FM	Columbus, Ohio
92.3	WDUL	Duluth, Minn.
92.3	WBCF-FM	Superior, Wisc.
92.5	KCMC-FM	Texarkana, Texas
92.5	KYV-FM	Philadelphia, Pa.
92.5	WFRS	Grand Rapids, Mich.
92.5	WGOV-FM	Valdosta, Ga.
92.5	WINC-FM	Winchester, Va.
92.5	WMBD-FM	Peoria, Ill.
92.9	KDKA-FM	Pittsburgh, Pa.
92.9	KGDM-FM	Stockton, Calif.
92.9	KOAD-FM	Omaha, Neb.
92.9	KONO-FM	San Antonio, Tex.
92.9	WBNY-FM	Buffalo, N. Y.
92.9	WBUR-FM	Burlington, Iowa
92.9	WBZ-FM	Boston, Mass.
92.9	WEEU-FM	Reading, Pa.
93.1	KWBW-FM	Hutchinson, Kan.
93.1	WAIR-FM	Winston-Salem, N. C.
93.1	WFBL-FM	Syracuse, N. Y.
93.1	WHYN-FM	Holyoke, Mass.
93.1	WJBK-FM	Detroit, Mich.
93.1	WKAT-FM	Miami Beach, Fla.
93.1	WKBH-FM	La Crosse, Wisc.
93.3	WGBR-FM	Goldsboro, N. C.
93.3	WIP-FM	Philadelphia, Pa.
93.3	WJTN-FM	Jamestown, N. Y.
93.3	WKPB	Knoxville, Tenn.
93.3	WKYC	Paducah, Ky.
93.3	WRBL-FM	Columbus, Ga.
93.3	WTMJ-FM	Milwaukee, Wisc.
93.5	KOCS-FM	Ontario, Calif.
93.7	KRFM	Fresno, Calif.
93.7	KXOK-FM	St. Louis, Mo.
93.7	WCSI	Columbus, Ind.
93.7	WLAW-FM	Lawrence, Mass.
93.7	WSGN-FM	Birmingham, Ala.
93.9	KSPI-FM	Stillwater, Okla.
93.9	WCOU-FM	Lewiston, Maine
93.9	WNYC-FM	New York, N. Y.
93.9	WRC-FM	Washington, D. C.
94.1	KERN-FM	Bakersfield, Calif.
94.1	WGST-FM	Atlanta, Ga.
94.1	WHBC-FM	Canton, Ohio.
94.1	WIBG-FM	Philadelphia, Pa.
94.1	WKOK-FM	Sunbury, Pa.
94.1	WMIX-FM	Mt. Vernon, Ill.
94.1	WEAU-FM	Eau Claire, Wisc.
94.3	WDRC-FM	Hartford, Conn.
94.3	WGUY-FM	Bangor, Maine
94.3	WJLK-FM	Asbury Park, N. J.
94.5	KAMT-FM	College Station, Texas.
94.5	WIS-FM	Columbia, S. C.
94.5	KGKL-FM	San Angelo, Texas
94.5	WMLL	Evansville, Ind.
94.5	WMOT-FM	Pittsburgh, Pa.
94.5	WNDB-FM	Daytona Beach, Fla.
94.5	WSYR-FM	Syracuse, N. Y.
94.7	KOCY-FM	Oklahoma City, Okla.
94.7	KROC-FM	Rochester, Minn.

FREQUENCY (MC)	CALL	LOCATION
94.7	WAPO-FM	Chattanooga, Tenn.
94.7	WENR-FM	Chicago, Ill.
94.7	WMAS-FM	Springfield, Mass.
94.7	WMCP	Baltimore, Md.
94.9	KAKC-FM	Tulsa, Oklahoma

### FM frequencies and channel numbers

Channel		Channel		Channel		Channel	
mc.	No.	mc.	No.	mc.	No.	mc.	No.
88.1	201	93.1	226	98.1	251	103.1	276
88.3	202	93.3	227	98.3	252	103.3	277
88.5	203	93.5	228	98.5	253	103.5	278
88.7	204	93.7	229	98.7	254	103.7	279
88.9	205	93.9	230	98.9	255	103.9	280
89.1	206	94.1	231	99.1	256	104.1	281
89.3	207	94.3	232	99.3	257	104.3	282
89.5	208	94.5	233	99.5	258	104.5	283
89.7	209	94.7	234	99.7	259	104.7	284
89.9	210	94.9	235	99.9	260	104.9	285
90.1	211	95.1	236	100.1	261	105.1	286
90.3	212	95.3	237	100.3	262	105.3	287
90.5	213	95.5	238	100.5	263	105.5	288
90.7	214	95.7	239	100.7	264	105.7	289
90.9	215	95.9	240	100.9	265	105.9	290
91.1	216	96.1	241	101.1	266	106.1	291
91.3	217	96.3	242	101.3	267	106.3	292
91.5	218	96.5	243	101.5	268	106.5	293
91.7	219	96.7	244	101.7	269	106.7	294
91.9	220	96.9	245	101.9	270	106.9	295
92.1	221	97.1	246	102.1	271	107.1	296
92.3	222	97.3	247	102.3	272	107.3	297
92.5	223	97.5	248	102.5	273	107.5	298
92.7	224	97.7	249	102.7	274	107.7	299
92.9	225	97.9	250	102.9	275	107.9	300

94.9	KFPW-FM	Fort Smith, Ark.
94.9	KING-FM	Seattle, Wash.
94.9	KSFH	San Francisco, Calif.
94.9	WABW	Indianapolis, Ind.
94.9	WCMW-FM	Canton, Ohio

### WANTED: FM SCOUTS

FM is a new art in Radio. Much of it remains to be learned by engineers. The behavior of radio waves in the FM band is still understood imperfectly. According to theory, FM signals should not reach much beyond the horizon. Yet often they do. In some cases extraordinary DX reception has been reported.

RADIO-CRAFT readers can render the radio art a distinct service in reporting such phenomena as well as others, to us regularly. We will publish such information as well as the "FM Scouts" name in this department, beginning with the June issue. Address all letters to FM Department, c/o this magazine.

THE EDITORS.

FREQUENCY (MC)	CALL	LOCATION
94.9	WMRC-FM	Greenville, S. C.
94.9	WQAM-FM	Miami, Fla.
94.9	WWCF	Greenfield, Wisc.
94.9	KSCJ-FM	Sioux City, Iowa
95.1	KFXM-FM	San Bernardino, Calif.
95.1	WEW-FM	St. Louis, Mo.
95.1	WGBA-FM	Columbus, Ga.
95.1	WGPA-FM	Bethlehem, Pa.
95.1	WHBS-FM	Huntsville, Ala.
95.1	WRXW	Louisville, Ky.
95.1	WTRF-FM	Bellaire, Ohio.
95.1	WTMA-FM	Charleston, S. C.
95.3	KGBS-FM	Harlingen, Texas
95.3	KSJO-FM	San Jose, Calif.
95.3	WSRS-FM	Cleveland Heights, Ohio
95.5	KECA-FM	Los Angeles, Calif.
95.5	KRBA-FM	Lufkin, Texas
95.5	KPRA	Portland, Oregon
95.5	WBGE-FM	Atlanta, Ga.
95.5	WDLM	Chicago, Ill.
95.5	WHPE-FM	High Point, N. C.
95.5	WPAM-FM	Pottsville, Pa.
95.6	WKNB-FM	New Britain, Conn.
95.7	WMMW-FM	Meriden, Conn.
95.7	WMUR-FM	Manchester, N. H.
95.7	WTPS-FM	New Orleans, La.
95.9	WEMZ	Allentown, Pa.
96.1	WBCM-FM	Bay City, Mich.
96.1	KCRA-FM	Sacramento, Calif.
96.1	KFMX	Council Bluffs, Iowa
96.1	KLCN-FM	Blytheville, Ark.
96.1	WMBH-FM	Joplin, Mo.
96.1	WOHS-FM	Shelby, N. C.
96.1	WOWO-FM	Fort Wayne, Ind.
96.1	WTAG-FM	Worcester, Mass.
96.3	KRKD-FM	Los Angeles, Calif.
96.3	WBK	Chicago, Ill.
96.3	WINX-FM	Washington, D. C.
96.3	WJCM-FM	Rice Lake, Wisc.
96.3	WQXR-FM	New York, N. Y.
96.3	KRON	San Francisco, Calif.
96.5	KSEI-FM	Pocatello, Idaho
96.5	KXYZ-FM	Houston, Texas
96.5	WGH-FM	Norfolk, Va.
96.5	WHEF-FM	Rochester, N. Y.
96.5	WTIC-FM	Hartford, Conn.
96.5	WBUZ	Bradbury Heights, Md.
96.7	WEAW	Evanston, Ill.
96.7	WSTC-FM	Stamford, Conn.
96.7	WVAW-FM	Cheviot, Ohio.
96.9	KCRK	Cedar Rapids, Iowa
96.9	KFBK-FM	Sacramento, Calif.
96.9	KRBC-FM	Abilene, Texas
96.9	WBR-FM	Buffalo, N. Y.
96.9	WIBX-FM	Utica, N. Y.
96.9	WJHP-FM	Jacksonville, Fla.
96.9	WLAN-FM	Lancaster, Pa.
96.9	WLAV-FM	Grand Rapids, Mich.
96.9	WOPI-FM	Bristol, Tenn.
96.9	WPAD-FM	Paducah, Ky.
96.9	WXHR-FM	Cambridge, Mass.
97.1	KKLA	Los Angeles, Calif.
97.1	KPFM-FM	Portland, Oregon
97.1	KTUL-FM	Tulsa, Okla.
97.1	WASH	Washington, D. C.
97.1	WBZA-FM	Springfield, Mass.

(Continued on page 73)



# Now! BIG RECEIVER QUALITY IN THE LOW-PRICED FIELD!!

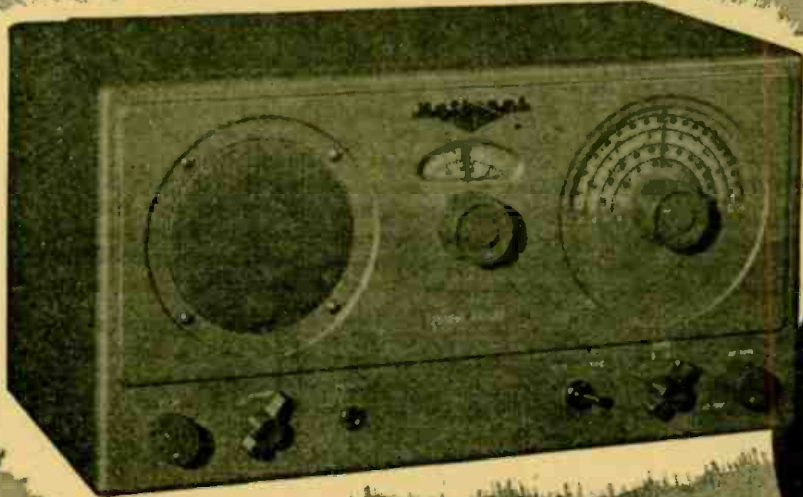

THE NEW  
NATIONAL  
NC-33  
**\$65.95**  
AMATEUR NET

Here's the receiver you've been waiting for! A real communication receiver covering all frequencies from 500 kcs to 35 mcs, the brand new NC-33 offers the same fine workmanship that distinguishes National's more expensive receivers. Dollar for dollar, feature for feature, it's better built, better looking, better performing! See it — compare it — today at your dealer's. You'll decide it's the perfect choice for your shack, living room, playroom or den!

- Operates from 110-120 volts AC or DC. Ideal for shipboard and other uses where DC only is available.
- Electrical bandsread on all bands! Broadcast, amateur, police and foreign bands plainly marked.
- Automatic noise limiter assures optimum reception under all operating conditions.
- CW oscillator with pitch control provides superb CW reception.
- Lightweight — easy to carry.

TO FIND YOUR NEAREST NATIONAL DEALER SEE THE CLASSIFIED SECTION OF YOUR 'PHONE BOOK

*FREE! Big New 1948 National Catalog!*



**National**  
EST. 1914  
**NATIONAL COMPANY, Inc.**  
MALDEN, MASSACHUSETTS

**NATIONAL COMPANY, Inc.**  
61 Sherman St., Malden 48, Mass.  
Gentlemen: Please send me your new 1948 catalog of National receivers, components and parts.

NAME .....

STREET .....

CITY ..... ZONE ..... STATE .....

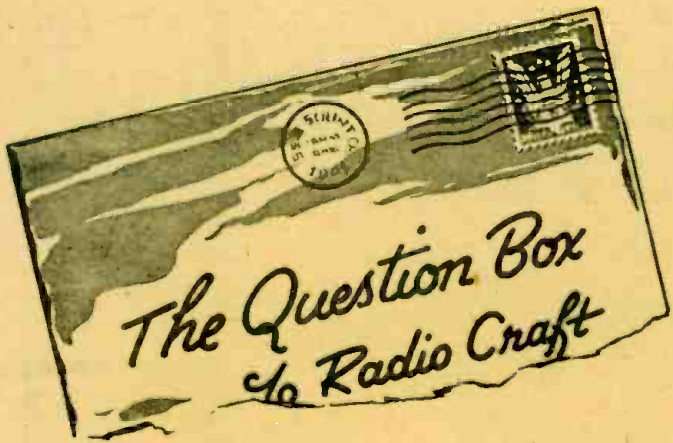

Question Box queries will be answered by mail and those of general interest will be printed in the magazine. A fee of 50c will be charged for simple questions requiring no schematics. Write for estimate on questions that may require diagrams or considerable research. Six to 8 weeks is required to draw up answers involving large schematics.

### THREE-WAY PORTABLE RECEIVER

**?** I want to build a 3-way portable radio using a 1LC6, 1LN5, 1LD5, 1LB4, and a 50Y6. Please print a suitable diagram.—J.C.A., Randolph Field, Texas.

sold for use with 365- $\mu$ f capacitors. The padder should then be the capacity specified by the manufacturer, if it differs from the 175-500  $\mu$ f shown here.

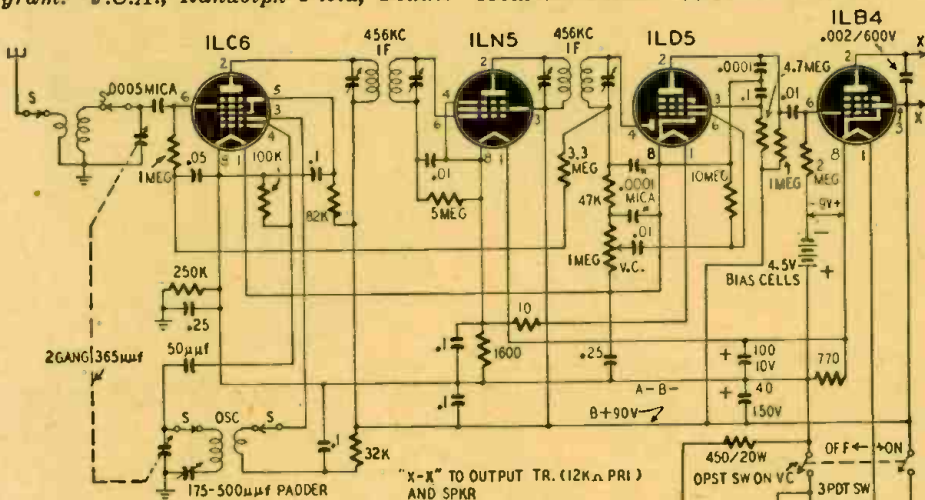

**A.** You should not have trouble with the set if the diagram given here is followed. All condensers are rated at 200 volts, and the resistors may be 1/2-watt size unless otherwise specified. Multi-band operation is possible by connecting a band-change switch at points S on the diagram. Standard coil assemblies can be used on broadcast and short-wave bands. These should be standard coils

### PHONOGRAPH OSCILLATOR

**?** Please design a phono oscillator using subminiature tubes and hearing-aid batteries. I would like to use it with a crystal mike or crystal pickup. I want the unit to tune to the high-frequency end of the broadcast band.—M.K., Philadelphia, Pa.

**A.** Your specifications for a phono oscillator are met in this design. The smallest available components should be

used to make a compact unit. The oscillator coil is wound on a 3/8-inch form. The grid coil has 180 turns of No. 34 enameled wire, jumble-wound to occupy 3/16 inch. The plate or tickler coil has about 30 turns of No. 34 enameled wire, spaced 1/16 to 1/8 inch from the lower end of the grid coil. The position and number of turns on the tickler should be varied for best operation.

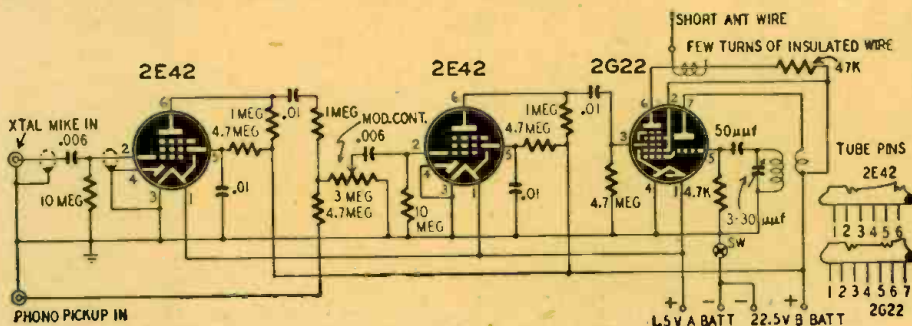

### I.F.'S FOR FM

**?** Why was the i.f. of FM receivers changed from 4.3 to 10.7 mc when new bands were established? A.F.C., Waverly, Wis.

**A.** To eliminate image interference. The image frequency is twice the i.f. away from the signal frequency. With a 4.3-mc i.f., the image of an 88-mc signal is 96.6 mc which is within the band. With a 10.7 mc i.f., the image is outside the band at 109.4 mc where it cannot cause interference.

This was the reason the older 175-kc intermediate frequency for broadcast receivers was abandoned for the higher 465-kc frequency.

### 24-VOLT SUPPLY

**?** I would like a diagram of a power supply delivering 24 to 28 volts d.c. at 14 to 18 amperes. This is to be used to operate Army surplus radio equipment.—D.L.R., Hornell, N. Y.

**A.** A full-wave bridge rectifier is used in this supply to deliver the required current and voltage. A number of different types of dry rectifiers can be used for the job, and the a.c. input voltage, A should not exceed manufacturer's specifications for the rectifier you select. The primary of the transformer should have a 750-volt-ampere rating. The primary and secondary may be tapped to permit voltage adjustment as the rectifier ages.

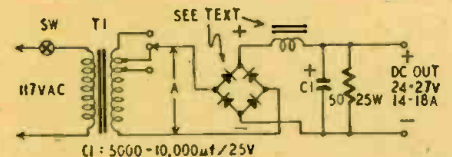

The capacitance of the condenser will depend on the amount of filtering needed. The choke has an inductance of .005 henry and 0.6-ohm d.c. resistance. It may be made by winding 64 turns of No. 11 single-cotton enameled wire on a 1 1/2 x 1 1/2-inch (2 1/4-square inch) core. The air gap, about 0.018 inch, should be adjusted for best results.

Transformers of the type specified are seldom available commercially and may have to be wound to specifications. Substitutes can be made by connecting the secondaries of several high-current filament transformers in series to get the required voltage for the rectifier unit.

## Why YOU SHOULD BUILD YOUR OWN TEST EQUIPMENT

1. You save two-thirds in cost. With increasing prices of most everything, labor costs are an important factor. Eliminating assembly labor costs, we can offer Heathkits at about one-third the cost of factory built equipment.
2. You have all the fun and learn while you save. Through knowledge of construction gained in assembly, better use can be made of the instruments.

Build  
YOUR  
OWN

# TEST EQUIPMENT

with HEATHKITS

IDEAL TELEVISION  
and FM SERVICING  
COMBINATION

The NEW 1948

HEATHKIT 5 INCH

## OSCILLOSCOPE KIT

### Features

- Frequency compensated vertical and horizontal amplifiers.
- Beautiful two color panel.
- Sweep circuit supplying 15 to 30,000 cycles.
- All controls on front panel.
- Ideal for television and radio trouble shooting.
- Convenient portable size—weighs only 26 pounds.
- Cabinet dimensions 8 1/2" x 13" high by 17" deep.
- Provision for external synchronization.
- Test voltage post on front panel.
- Deflection sensitivity .65 volts per inch full gain.
- Frequency response plus or minus 20% from 50 cycles to 50 KC.
- Input impedance 1 megohm and 50 MMF.
- Tubes supplied: 2 6SJ7, 2 5Y3, 1 884, 1 58PP.
- Operates from 110 volt 60 cycle AC.
- Power supply delivers 1100 volts negative, 350 volts positive, making 1450 volts available for the CR tube.
- All oil filled condensers used, assuring long life.



**\$39.50**

Nothing ELSE  
TO BUY...

## HEATHKIT SINE AND SQUARE WAVE AUDIO GENERATOR



The ideal matching instrument to the Heathkit Oscilloscope for advanced service technique in television and FM servicing. Supplies sine or square wave 20 cycles to 20,000 cycles. Excellent wave form and extremely low distortion. Everything supplied. Grey crackle cabinet, beautiful two color calibrated panel, 5 tubes, 110V power transformer, 1% calibrating resistors, all other parts and detailed blueprints and instructions.

Only  
**\$34.50**

## HEATHKIT SIGNAL GENERATOR KIT

### Features

- 110 Volt 60 cycle operation with transformer power supply.
- Completely isolated from power line.
- Can be used on any type receiver.
- Supplies fundamentals from 150 KC to 34 MC in five bands.



**\$19.50**

Shipping Wt. 7 lbs.  
• Convenient, portable—Dimensions 9" x 6" x 4 3/4" deep, weight 4 1/2 lbs. Complete with detailed blueprints which enable the constructor to assemble an instrument he will be proud to own.

- Useful harmonics to over 100 MC.
- 400 cycle audio frequency modulation available separately for audio testing.
- Supplies either pure RF or modulated signal.
- Highly accurate calibration with calibration adjustment for exact frequency.
- Approximately 30% modulation.
- Uses 6SN7 as oscillator and audio frequency amplifier and 6X5 as transformer power supply rectifier.

The NEW

## HEATHKIT VACUUM TUBE VOLTMETER KIT

The most essential tool a radio man can have, now within the reach of his pocketbook. The Heathkit VTVM is equal in quality to instruments selling for \$75.00 or more. Features 500 microamp meter, transformer power supply, 1% glass enclosed divider resistors, ceramic selector switches, 11 megohms input resistance, linear AC and DC scale, electronic AC reading RMS. Circuit uses 6SN7 in balanced bridge circuit, a 6H6 as AC rectifier and 6X5 as transformer power supply rectifier. Included is means of calibrating without standards. Average assembly time less than four pleasant hours, and you have the most useful test instrument you will ever own. Ranges 0-3, 30, 100, 300, 1000 volts AC or DC. Ohmmeter has ranges of scale times 1, 100, 1000, 10M and 1 megohm, giving range .1 ohm to 1000 megohms. Complete with detailed instructions. Add postage for 8 lbs.

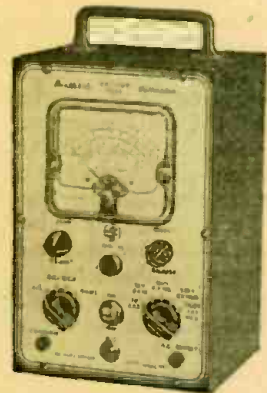

**\$24.50**



## HEATHKIT HIGH FIDELITY AMPLIFIER KIT

Build this high fidelity amplifier and save two-thirds the cost. Push pull output using 1619 tubes (military type 6L6's), two amplifier stages using a dual triode (6SN7), and a phase inverter give this amplifier a linear reproduction equal to amplifiers selling for ten times this price. Every part supplied; punched and formed chassis, transformers (including quality output to 3-8-15 ohm voice coil), tubes, controls, and complete instructions. Add postage for 20 lbs. 12" PM speakers for above.....\$6.95



**\$14.95**

### HEATH SELLS DIRECT TO THE BUILDER . . . .

Our engineers enjoy the friendly contacts with those who build Heathkit equipment, and can serve them better through direct relationships. Without the necessity for discounts to dealers, the equipment can be made available to you at the lowest possible cost. Send your order direct and we shall be glad to ship COD, or you may send cash in advance if desired.

**No ORDERS UNDER \$2.00**



The **HEATH COMPANY**

DEPT. C. • BENTON HARBOR, MICHIGAN

# RADIO-ELECTRONIC CIRCUITS

## TV CAPACITOR DISCHARGER

The bright spot appearing on television screens after the set is turned off is due to the charge remaining on the high-voltage filter condenser. A simple, inexpensive method of removing the charge uses a 15E tube.

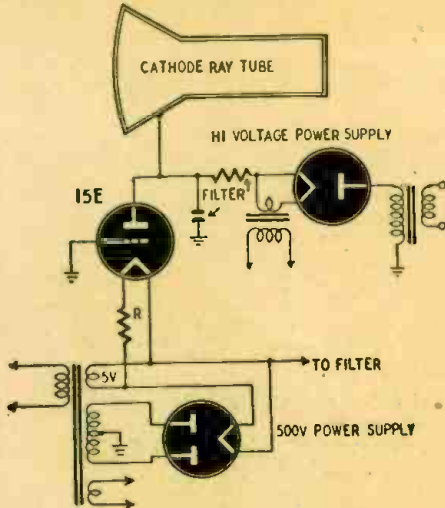

The plate of the tube is connected to the high-voltage power supply, but draws no current because the tube is cut off by the high bias voltage. As soon as the power is turned off, the bias voltage drops rapidly to below cutoff before the 15E filament has cooled off appreciably. The tube then conducts and quickly discharges the high-voltage condenser through the low-voltage bleeder.

To prolong the tube life, use a 1.2-ohm, 5-watt resistor to drop the filament voltage to about half its value. If the 5-volt supply cannot furnish the additional current, use a separate 2.5-volt transformer.

Any other high-voltage tube may be used if the 15E is not available. Cutoff bias can be found by dividing the plate voltage by the amplification factor.

RICHARD H. HOUSTON,  
Washington, D. C.

## AUDIO OSCILLATOR

Designed for classroom use, this simple audio oscillator uses a push-pull output transformer as the tank coil of a Hartley oscillator. The output frequency is close to 1,000 cycles, but can be changed by either juggling the values or switching condensers across the output transformer primary.

Any triode with a 0.3-ampere filament and grid and plate tied together, or a 25Z5, can be used as a half-wave recti-

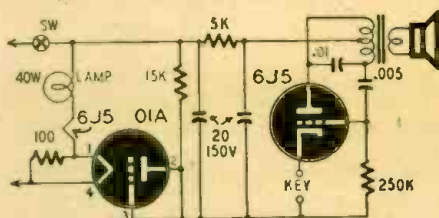

fier, and a 40-watt lamp drops the line voltage to the right value for the tube filaments.

The values are not critical and the whole unit can be built into a small cabinet.

GLENN KETCHNIE,  
Blyth, Ontario

## SUPER REFLEX RECEIVER

The reflex receiver shown uses a single 6SJ7 and has r.f. feedback from both the plate and the suppressor grid, giving very great amplification. Detection takes place in the suppressor-grid circuit, and the audio is amplified in the plate circuit.

The coils are close-wound adjacent to each other with No. 30 d.s.c. wire on a 2-inch diameter form and have 70 turns each.

If the set overloads on strong signals, adjust the 250,000-ohm volume control for best reception.

ROBIN TUCKER,  
Montreal, Quebec

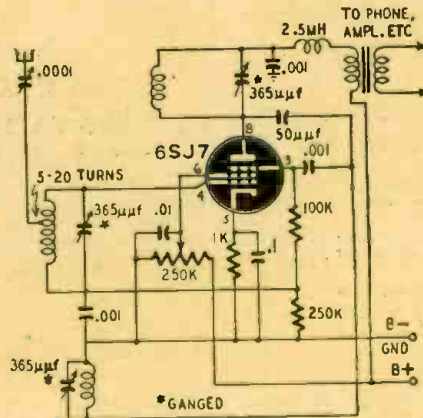

## NOVEL POWER SUPPLY

Here is a simple way of getting the most output with the least battery drain in a car transmitter.

Use a 250-volt Vibropack to power the oscillator and speech amplifier, and a 500-volt dynamotor to power the r.f. amplifier and modulator. But, instead of

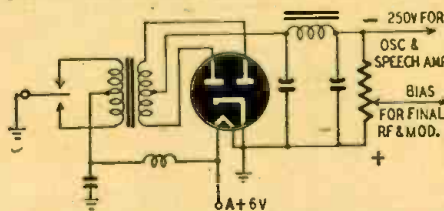

grounding the negative terminal, ground the positive lead. Now the Vibropack can supply bias voltage to the r.f. amplifier and modulator and still leave the full 250 volts for the speech amplifier and oscillator.

Some of the advantages of this system are:

1. Bias voltage does not subtract from the voltage available to the oscillator and speech amplifier.

2. There is no power loss in dropping resistors from high voltage supply for oscillator and speech amplifier use.

3. There is no loss of high voltage due to cathode resistor, either in the r.f. or modulator stages.

4. The oscillator plate-tuning condenser can be grounded without using parallel feed, since the positive on the Vibropack is grounded.

ZOLTAN T. BOGAR,  
Laurel, Maryland

## SIMPLE INTERCOM

A single-wire line and a good ground are the only connections needed for this intercom system. It can be easily made with surplus microphones and head-

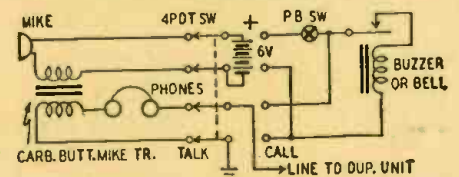

phones. To call the other station, throw the switch to the call position, press the button, and throw the switch back to the talk position.

When not in use, both switches should be in the call position.

RICHARD HERMAN,  
Chicago, Illinois.

(A surplus handset, type TS-15, would be ideal for this type of simple intercommunicator.—Editor)

## FULL-WAVE BIAS SUPPLY

A 25Z5 is used in this circuit as a full-wave bias rectifier operating from the high-voltage plate supply transformer. The cathodes of the 25Z5 are connected to the plates of the high-voltage rectifier tube.

In operation, current flows through the cathode attached to the plate of the main rectifier which is not conducting at the time.

The filament transformer for the 25Z5 can be replaced with a 290-ohm, 5-watt resistor to drop the line voltage to 25.

This bias supply should not have more than 245 volts r.m.s. applied to the cathodes to prevent breakdown between the cathode and the heater, which might otherwise occur.

JOHN KWIETINSKAS,  
Duquesne, Pa.

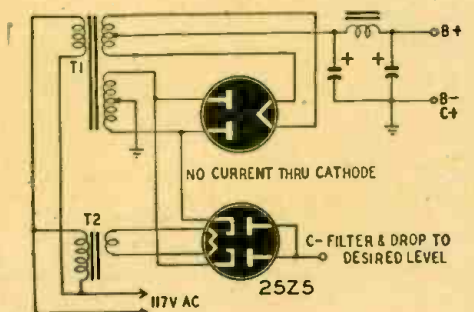

# TELEVISION ASSEMBLY CO.

INTRODUCES THE

*Champion Models*  
with

## DUMONT INPUTUNER



The Dumont Inputuner tunes continuously from 44 to 216 megacycles without a break, covers all 13 channels as well as FM, amateur, and aviation channels. For ease and convenience of operation no band switching of any kind is required when tuning from channel to channel with the inputuner system. Just one simple operation to reach any desired station.

Assemble the Champion model of your choice, 10" flat surface screen picture, 51 sq. in. picture, 12" screen picture with 75 sq. in. picture or the 15" screen picture with 120 sq. in. picture.

All Champion Models are complete with all tubes and components including the CR Tube.

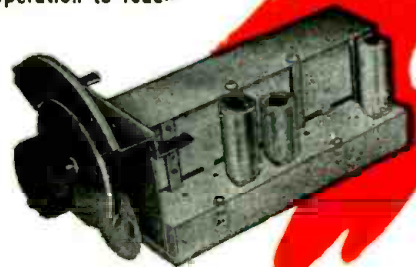

10" FLAT SURFACE

**\$ 273.10**

NET

12" SCREEN PICTURE

**\$ 303.10**

NET

15" SCREEN PICTURE

**\$ 393.10**

NET

## *Standard Models*

NOW AVAILABLE WITH  
THE STANDARD MODELS—  
FM RADIO AT A SLIGHT  
ADDITIONAL COST OF  
\$7.95.



All Television Assemblies are complete and include: 29 RCA Tubes-1 CR Tube-Heavy Duty RCA 6.8 oz. slug 12" PM Speaker-Specially designed dipole antenna with 60 ft. lead in.

Superior performance is obtained with a new IF Video & Sound IF Strip (Pat. Pend.) aligned, wired, pretuned, tubed and tested. All circuits are contained on one chassis ready to use with the front end unit supplied. This front end will handle 13 channels and is aligned and tested, mounted on a separate chassis. Merely connect 8 plus filament and output IF leads to the television chassis. It is not necessary to make any RF alignments. These units utilize a clipper circuit which filters out ignition noises.

10" FLAT SURFACE

**\$ 229.50**

NET

12" SCREEN PICTURE

**\$ 259.50**

NET

15" SCREEN PICTURE

**\$ 349.50**

NET

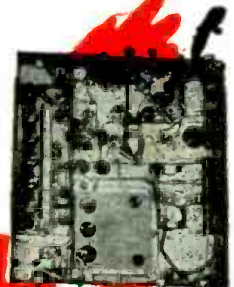

TERMS: 20%  
DEPOSIT WITH  
ORDER. BALANCE  
EXPRESS COLLECT.

Visit MILO'S Sound Studio, "It's New York's Finest"  
Tune in our programs over WGYN-FM New York every day

# MILO

National Distributors of Radio, Television, and Electronic Equipment

*Radio and Electronics Corp.*

200 GREENWICH STREET, NEW YORK 7, N. Y., BEekman 3-2980

BRANCH STORE: 160-13 NORTHERN BOULEVARD, FLUSHING, N. Y.



**WANTED!**

**Chief Engineers,  
Studio Engineers,  
Transmitter  
Engineers**  
for more than

**1000 FM\* & 2250 AM  
BROADCAST STATIONS**  
the FCC indicates will be in  
operation by the end of 1948

\* As of Jan. 1948:  
374 FM stations  
on the air.  
636 FM stations  
with construction  
permits and  
conditional grants.



**MAIL COUPON TODAY  
FOR THIS 24-PAGE  
FREE BOOKLET!**



**Yes, Plenty of Good-Paying Jobs...  
BUT Only for those Qualified**

FM is actually coming into its own this year . . . more than 1000 with permits and grants now on the air, or soon to be. Over 1500 standard broadcast stations now in operation . . . 2250 on the air by the end of the year. Television receivers are on mass production lines. New TV stations are going on the air throughout the country.

Radio-electronics is not only expanding in job opportunities but it is also growing in technical complexity. Rapid developments in every branch of the field are leaving many radio technicians and servicemen far behind the parade of progress. These are the men who fail to realize that their technical knowledge must grow with the expansion of the industry.

What does this mean to you? It means

you must study not only to hold the job you now occupy . . . but study to qualify for the better job you want. CREI modern technical training can (within a comparatively short time) qualify you for the better jobs and help enable you to step ahead of those who have failed to improve their ability through technical training.

Beginning right now CREI can provide the on-the-job training that equips you with the technical ability to go after—and GET—the important, high salaried jobs. Get all the facts today about the unprecedented opportunities that await you. Learn how CREI spare time training can help you as it has helped thousands of other professional servicemen advance to better jobs during the past twenty years.

**VETERANS! CREI TRAINING AVAILABLE UNDER THE "G. I." BILL**

**Capitol Radio  
Engineering Institute**

*An Accredited Technical Institute*

**Dept. RC-4, 16th and Park Road, N. W., Washington 10, D. C.**

**Branch Offices: New York (7): 170 Broadway San Francisco (2): 760 Market St.**

Capitol Radio Engineering Institute  
16th and Park Road, N. W., Dept. RC-4  
Washington 10, D. C.

Gentlemen: Please send me your free booklet, "CREI training for your better job in RADIO-ELECTRONICS," together with full details of your Home Study training. I am attaching a brief resume of my experience, education and present position.

Check One Course:

Practical Television

Practical Radio-Electronics

Name \_\_\_\_\_

Street \_\_\_\_\_

City \_\_\_\_\_

Zone \_\_\_\_\_ State \_\_\_\_\_

I am entitled to training under the G. I. Bill.

# BIG MONEY IN RADIO

SEE THESE BRAND NEW  
RADIO BOOKS FREE

## COYNE'S *New 5 Volume Set* "APPLIED PRACTICAL RADIO"

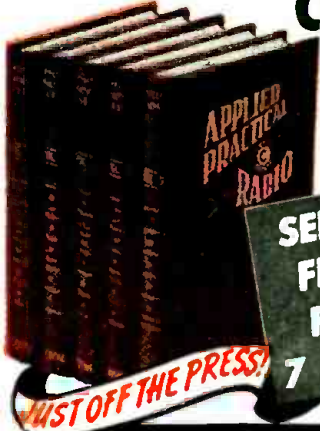

You men who want to go places in Radio, and who know how much a solid working knowledge of the field helps to get the big money—this is IT! Over 1500 pages of down-to-earth Radio, from simplest principles to newest Television! It's all there easy to understand—how and why it works . . . how to construct, install, service, PA, short-wave, auto-radio, aviation, radio-phonographs, FM, testing instruments and trouble-shooting short-cuts, phototubes—you name it, COYNE'S got it, in "Applied Practical Radio"!

GET THIS  
BOOK  
FREE  
for LOOKING  
AT SET



Brand New!  
Explains circuits  
of latest sets

SEE IT  
FREE  
FOR  
7 DAYS

**PRACTICAL! CLEAR! COMPLETE!**

5 big volumes—1000 illustrations and diagrams, with step-by-step photographs which "break down" the equipment for you to show what makes it "tick". Up-to-the-minute, complete, easy to follow . . . written as only COYNE books are written!

VALUABLE BOOK FREE for Looking at 5-Volume Set

Send This Coupon  
NOW

You must SEE these books to know how easy it is to prepare for the big jobs in radio. Here's our special offer—we'll send the complete 5-volume set for your 7-Day FREE Examination. And with it, we'll include our valuable, new guide for all radiomen, "150 New Radio Diagrams Explained", absolutely FREE! If you keep the 5-volume Set all you pay is \$3.00 within 7 days after the books arrive and \$3.00 per month until \$16.75 is paid—or you can pay \$15.00 cash price. If you don't want the set, return it and you OWE NOTHING. But either way you keep the "150 Radio Diagrams Book" as a gift. That book is ABSOLUTELY FREE.

SEND NO MONEY REMEMBER—Coupon is not an order, just a request to see set free and get the FREE BOOK. But offer is limited, so act at once!

**COYNE ELECTRICAL & RADIO SCHOOL (Founded 1899)**  
500 S. Paulina St., Dept. 48-T1, Chicago 12, Ill.

EDUCATIONAL BOOK PUBLISHING DIVISION  
COYNE ELECTRICAL & RADIO SCHOOL  
Dept. 48-T1, 500 S. Paulina St., Chicago 12, Ill.

O. K., send me, postpaid, your new 5-volume set, "Applied Practical Radio" on 7 days Free Trial per your offer in Radio-Craft. Be sure to include as a gift the book of 150 New Radio Diagrams Explained, absolutely FREE.

NAME \_\_\_\_\_ AGE \_\_\_\_\_  
ADDRESS \_\_\_\_\_  
TOWN \_\_\_\_\_ ZONE \_\_\_\_\_ STATE \_\_\_\_\_

**FREE BOOK**

## European Band-Change System

AN INTERESTING type of receiver, this Italian model, is basically a 4-tube superheterodyne, but is novel because a rotating coil turret is used to switch the different coils into the circuit. The photograph of the chassis shows the band-switch turret rather well.

The band switch is divided into two sections, one half containing the an-

By D. E. RAVALICO

tenna and mixer coils, and the other half the oscillator coil. Five wiping contact points on each section connect the coils to the various circuits. (This system is similar to the one used in the Meissner Signal-Shifter.)

A 4-gang variable condenser is used for tuning—two sections for the mixer coil, and two sections for the oscillator coil. When the band switch is in the long-wave position, the two condenser sections for each coil are connected in parallel to increase the low-frequency coverage. On the other bands, however, only one section of the condenser is used with each coil.

Unlike American sets, the band-switch knob is on the side of the cabinet.

Only the mixer-oscillator tube and the coil-switching circuit are shown in the diagram, the rest of the receiver circuit being conventional.

The receiver operates on a.c. on any line voltage from 110 to 275 by means of a specially tapped power transformer. The power transformer and rectifier are a separate unit which is connected to the receiver by a power cable. The d.c. filter is on the receiver chassis. A separate loudspeaker plugs into terminals on the chassis.

An electron-ray indicator tube near the top of the dial is used as a tuning indicator.

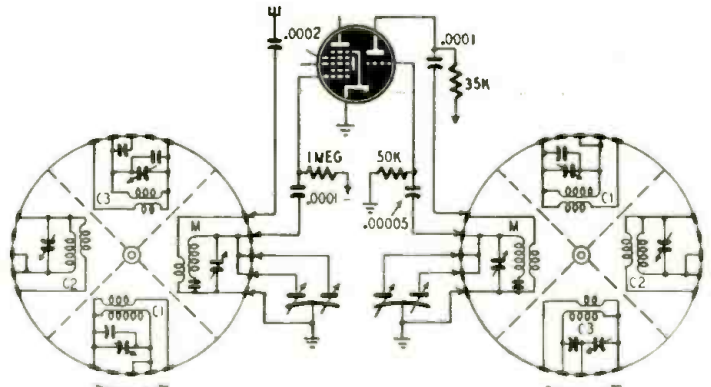
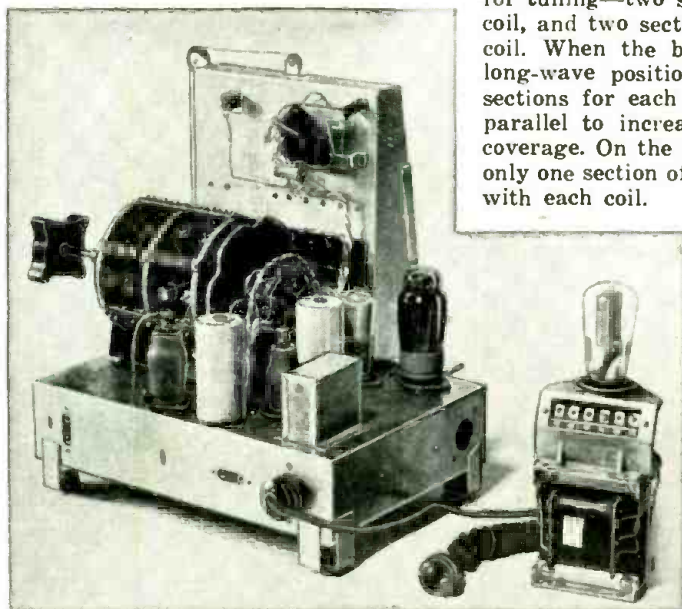

# ALLEN'S Money Savers on GOV'T SURPLUS ITEMS

**SCR 578 TRANSMITTER** (Gibson Girl) complete with tubes, 300' antenna wire on reel; all lights, handles, holding strap, hand driven generator. Brand New..... **\$9.95**

**PARACHUTE** over 70 sq. ft. orange nylon material; over 192' of 3/16" double reinforced white nylon braid; also 15' of 1/4" webbing, 3 safety buckles **\$4.95**



**RUBBER BALLOON** extra heavy; inflate to 4' in dia. Brand New..... **\$1.49**

**HYDROGEN GENERATOR**..... **49c**

**KNAPSACK** approx. 3 cubic ft. water repellent, felt lined..... **\$1.19**

**BOX KITE** collapsible; 17" sq 34" high..... **\$1.49**

**ANTENNA WIRE** over 300' on reel; copper braided..... **\$2.49**

**SAVE \$3.10**—buy these 7 items: Instruction manual included..... **\$18.95** for only

Motor Driven **GEAR BOX**: two 24v DC shunt wound motors; can be used as low voltage AC motor from 8 to 24v input; complete with micro switch, 50 gears and control box. Brand New..... **\$3.50**

**BC357 RECEIVER** complete with tubes, highly sensitive relay. Operates on 4/10 mil. can be converted to 2 1/2 to 6 and 10 meter receiver. Price..... **\$2.50**



**STANDARD LIP MICROPHONE** T-45—complete with PL291-A plug; ready for use. Instruction book included. Brand New..... **25c**

**THROAT MIKE** T-30—double throat type; PL-291 plug. M199 neckband. Works into any 200 ohm impedance input circuit. Instruction sheet included..... **39c**

**HS-23 HEADSET**—8000 ohm impedance. PL-54 plug..... **98c**

**HS-33 HEADSET**—600 ohm impedance..... **98c**

**KELLOGG** operator transmitter carbon microphone T-28E; adjustable swivel and extension bracket, with special 10 ft. ES2528-8 cord. Brand New..... **\$7.95**

**EARPHONE RECEIVERS R-14**—high impedance light weight watch case type, double magnet, black bakelite cap; with PL-54 plug..... **98c**

**HEADSET P-19** with 2 R-15, 12,000 ohm total impedance receivers; includes 2 rubber cushions. PL-55 plug, 8 ft. cord. New..... **\$2.39**

**HANDMIKE T-17B**—200 ohm, single button carbon mike, push button switch. Ideal for home transmitter or portable rig; 5 ft. rubber cord, PL-68 plug and dust cover. Brand New..... **89c**

**HANDSET TS-13**—200 ohm carbon mike, 2500 ohm earphone, 8 ft. rubber cord, 1-PL55 and 1-PL68 plugs attached. Brand New..... **\$2.95**

**HANDSET TS-15A**—200 ohm, same as above can be used in intercom, radio & telephone work..... **\$1.98**

**HANDSET TS-9AP**, 75 ohm imp, 6' cord. Brand New..... **\$2.50**

**R-57 ARMS RECEIVER**, 11 tubes, 3 xtals; 328 to 335 Mc. Brand New..... **\$14.95**

**RC-103A GLIDE PATH RECEIVER**, complete; includes dynamotor, control box, mountings, plugs, tubes etc. Ready for immediate installation. In original packing. Brand New..... **\$75.00**

**R-5 ARN7 RADIO COMPASS RECEIVER**, Three bands 200 to 1750 Kc complete with 15 tubes. This set is ideal for conversion to home broadcast. Can also be converted to meet CAA approval for use in plane. 115v 400 cycle power supply. Schematic included. Like New. Special..... **\$19.85**

**INVERTER ATR**..... **\$5.50**

**INVERTER PE-115B**..... **\$12.50**

**INVERTER PE-118A**..... **\$16.00**

**DYNAMOTOR BD-86A**..... **\$4.50**

**DYNAMOTOR PE-94**..... **\$10.00**

**PLATE VIBROPACK PE-97**..... **\$5.00**

**WHIP ANTENNA AN-131A**—Half wave 40 to 48 meg. 10 1/2 ft. long. Comes in 8 all brass sections, connected on a spring steel cable. Good for FM reception, mobile or fixed station; can be converted to fishing rod. In original sealed carton. Brand New. Only..... **\$1.00**

**RADIO ALTIMETER**—Transmitter Receiver RT7/APN1—complete with 14 tubes; 418 to 456 meg. 27v dynamotor. Certified by CAA; cost (Govt.) \$2,010. Bargain..... **\$11.95**

**BC-456B MODULATOR UNIT** complete with tubes, 3 relays; parts worth more than our low price of..... **\$3.95**

**BC AL429**—6 tube communications receiver & **BC AL430**—4 tube transmitter, with tubes, less coils. Each \$6.95. Both..... **\$15.95**

## RADIO RECEIVER BC-1023A



Ultra High Frequency, covering 62 to 80 mc range. An extremely sensitive relay, works on 4/10 of mil. Contains 4 tubes—12GH7—6SQ7—6SC7—6U6TG. Brand New... **\$3.50**

**TBX 2-5-6 NAVY MODEL TRANSMITTER RECEIVER**, versatile because of freq. range of 2 Mc to 4.5 Mc for transmitter and 2 Mc to 8 Mc for receiver. It's adaptable for various types of power supplies, such as 8v-12v-24v dynamotor and 110v AC powerpacks. This unit is excellent for ship to shore and ship to ship communication. Range 30 miles CW and 15 miles phone. Complete with tubes and 29 crystals without cabinets..... **\$29.95**

**JENSEN LOUD SPEAKER**—12 inch, high fidelity, enclosed in metal housing; like new..... **\$12.00**

**BC-191 & 375 TRANSMITTER**, complete with tubes and 5 tuning units..... **\$29.50**

### FREQUENCY METERS

BC 221..... **\$55.00**

BC 341A..... **\$3.50**

BC 374..... **\$14.50**

**T 28 APTI TRANSMITTER** Ultra high frequency, 12 tubes; Freq. range from 93-212 Mc. Includes two 24V DC blower motors. Complete with tubes..... **\$39.00**

**T-9 APQ 2**..... **\$30.00**

**FIELD TELEPHONE RM-29** with handset, generator, ringer &c. in strong steel case. Brand New..... **\$14.95**

**RECEIVER AN CRW2** high freq., 6 tubes and 2 sensitive relays. Can be used for controlling purposes. Complete with tubes & dynamotor. Brand New..... **\$7.00**

**RECEIVER AN CRW 2A** high freq.; 5 tubes and 3 sensitive relays. Used for controlling purposes. Complete with tubes & dynamotor. Brand New..... **\$7.00**

**CONVERTER**, electronic; 110v DC to 110v AC; 250 watt cap; complete with plugs and heavy duty vibrator..... **\$14.95**

**TEST EQUIPMENT IE/46B**—Freq. meter 906D; Receiver 1066B; Signal generator 196B; complete with antenna, tubes, charts, etc.. Brand New. All three units..... **\$29.85**

**FIELD TELEPHONES EE-8** with handset generator, ringer, etc., in strong leather case..... **\$10.00**

**TRANSFORMER** and cord assembly for matching low impedance headsets to high impedance output circuit, 6' cord, PL540 plug. Brand New..... **30c**

**G.E. 50 WATT** ceramic tube sockets; for 211-838, 250T.H. and other type tubes. New, each..... **50c**

**TRANSMITTING KEY** on Thigh Clamp J-45— with 5 ft. cable and PL55 plug..... **35c**

**SA-280U**—Beautiful black plastic microphone switch; 2 1/4" long, 1" diameter; push button make and break, press to signal. Screw type, can be used with or without case. Good for interoffice buzzer, closet lights, doorbells, phonograph recorder. Can be mounted or used by hand. Each..... **26c**



All Merchandise is War Surplus and is Sold as used unless otherwise specified.  
**Write for Quantity Discounts**  
Prompt Delivery—Write Dept. RCA  
25% Deposit Required on C.O.D. Orders  
Shipped F.D.B. New York. Minimum Order \$2.00

**T. ALLEN CO., INC.**  
564 Atlantic Ave. Brooklyn 17  
Tel. Main 5-6294 New York

## TECHNOTES

### ... MECK TRAIL-BLAZER

New sets using miniature tubes may have considerable hum at low volume. The B-voltage is too high, causing the oscillator to produce a strong signal which results in interference from the short-wave bands. Both of these troubles may be eliminated by connecting a 75- to 100-ohm, 1-watt resistor between the 35W4 cathode and the input filter condenser.

H. R. NEWELL,  
Bradford, N. H.

### ... HAMMARLUND HQ-129 X

The defect in this receiver was progressive loss of signal in the first stage over a period of time. This was due to particles of metal from the switch contacts being deposited on the insulating material of the switch and partially short-circuiting the coil. Measuring across the switch with the coil not in circuit, a resistance of 50 ohms was found.

To repair the set, I applied high voltage from the power supply across the switch. This eliminated the partial short circuit.

ALVA H. CLARK,  
Tarboro, N. C.

### ... PHILCO 46-806

Complaint: distortion and fading. To eliminate this trouble, replace the .006 paper coupling condensers in the audio stages (C-200 and C-202 on manufacturer's diagram) with mica condensers of the same capacitance. Usually only one of these condensers is defective, but replacing both will prevent any further trouble.

R. V. BLIKFONTEIN,  
South Africa

### ... I.F. INTERFERENCE

Interference from marine radio stations, whose signal frequencies are close to the intermediate frequency of a receiver, may be eliminated by connecting half of an i.f. transformer in series with the antenna. The i.f. coil and trimmer condenser form a parallel-resonant wave trap which, when tuned to the interfering signal, should eliminate it completely.

R. N. HORAN,  
Poughkeepsie, N. Y.

### ... GE MODEL 50 RADIO CLOCK

A common complaint about these radios is that the power switch cannot be turned to the radio position. The trouble in this case is cleared up by merely putting a drop of oil on the cam that operates the switch contacts.

JACK C. WHITE,  
Jackson, Miss.

### ... HUNTING INTERMITTENTS

When servicing intermittent sets that cut out after long periods of time or unexpectedly, a 250-watt heat lamp may be used to open up the defective component. Concentrate the heat from the lamp on different parts of the set. Take care that condensers are not ruined by excessive heat.

ANDY R. HARCAR,  
Birdsboro, Penna.



**New**

# RADIO-ELECTRONIC DEVICES

## METER PANEL

Simpson Electric Co.  
Chicago, Ill.

The Model 1005 electrical laboratory combines the functions of over 60 separate instruments. It consists of 6 individual 4 1/2 inch rectangular instruments, each with a complete set of ranges. In addition to a.c. and d.c. voltage and current ranges, a multirange ohmmeter and a single-phase wattmeter have been included. For extreme sensitivity required in testing circuits where only a small amount of current is available, an instrument is provided with a sensitivity of 50 microamperes, providing 20,000 ohms per volt on all d.c. voltage ranges.

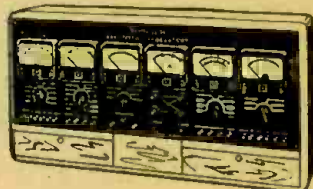

There is also a complete coverage of decibel ranges from minus 10 to plus 55 for volume indications.

The unit is approximately 34x17x9 inches and weighs 37 lbs. Two compartments for accessories and instructions are located at the base of the cabinet. All connections are made to binding posts located on the panel. Test leads and break-in plug are furnished.—RADIO-CRAFT

## SPEAKER SYSTEM

Brociner Electronics Laboratory  
New York, N. Y.

The Klipsch speaker system uses a horn for the low frequencies as well as for the high-frequency range.

The low-frequency horn is folded and uses a corner of a room as an integral part of the acoustic system so its performance is equivalent to much larger conventionally designed horns. With both the high- and low-frequency speakers coupled to horns, their relative efficiencies are nearly equal. It is not necessary to attenuate the high-frequency unit to match the low-frequency output. The high-frequency horn

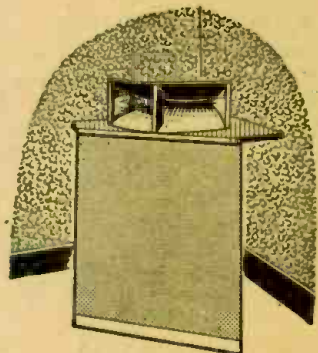

provides a 90-degree horizontal distribution pattern of frequencies above 500 cycles, to match the dispersion of the low-frequency horn. The frequency range of the system is from 30 to 15,000 cycles. The dividing network is a constant-resistance, parallel type, providing 12 decibels per octave attenuation, and has a crossover frequency of 500 cycles. An L-pad permits adjustment of balance to suit individual conditions. Because of the horn loading, even at full power, distortion is of the order of 1/100 to 1/400 of that of direct radiators.

The system is available as a complete unit, or individual components can be obtained separately. Model 1A is rated at 20 watts and other models provide power-handling capability up to 60 watts in one unit.—RADIO-CRAFT

## SWEEP CALIBRATOR

Browning Laboratories, Inc.  
Winchester, Mass.

The Model GL-22 sweep calibrator is a pulsed timing marker oscillator de-



signed for use with standard oscilloscopes and synchroscopes for accurate measurement of time intervals on either triggered or recurrent sweeps. Variable amplitude markers of either polarity are provided for use as intensity markers or directly on the cathode-ray tube plates as deflection markers. Markers available are 0.1, 0.5, 1.0, 10, 100 microseconds. A positive or negative variable-width gate pulse output is provided for test purposes. The pulse duration corresponds to the duration of the marker group. Operation is by external synchronizing triggers or from an internal trigger generator, with output triggers of both polarities available at the front panel.

The unit measures 14x7x7 inches and weighs 20 pounds.—RADIO-CRAFT

## SWEEP GENERATOR

McMurdo Silver Co., Inc.  
Hartford, Conn.

The new Model 909 sweep generator is designed to permit rapid and simple visual alignment of FM and television

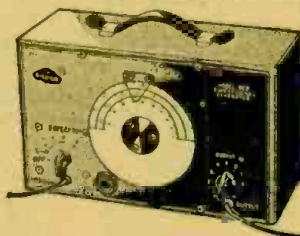

r.f., i.f., and video amplifiers. It covers a center-frequency range of 2 mc through 226 mc in 3 bands. Frequency modulation is adjustable from 40 kc to over 9 mc, and output is adjustable from zero to 1/2 volt maximum with panel controls. Synchronization of the oscilloscope, used to trace visually alignment "pictures" is at power line frequency (or selected multiple or sub-multiple), or by a 120-cycle, saw-tooth synchronizing voltage available from the generator.—RADIO-CRAFT

## POLYSTYRENE WINDOW

American Phenolic Corporation  
Chicago, Illinois

A clear polystyrene windowpane for radio applications makes it possible to bring the antenna lead-in into the room without cutting through the window casing or drilling through the glass. The glass pane is replaced with the plastic sheet which can be drilled to accommodate feed-through insulators or to



pass wire or co-axial cable. The polystyrene does not discolor under light or absorb water.

These windowpanes are available in all sizes and thicknesses.—RADIO-CRAFT

## TELEVISION ANTENNA

Camburn, Inc., Woodside, N. Y.

The Double Decker antenna is designed to give a favorable standing-wave ratio over the entire range of television frequencies. The stacked dipoles provide broad band response and high signal strength. Reception is unidirectional at right angles to the antenna.

The array can be rotated and tilted for best signal strength.

This antenna is also available for FM.—RADIO-CRAFT

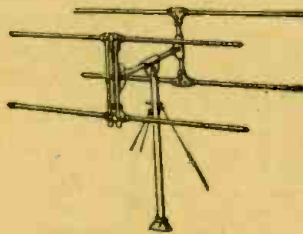

## REMOTE SPEAKER

Dapco Products, Inc.  
Defiance, Ohio

An auxiliary radio speaker has been designed for easy installation on the package deck behind the rear seat in an auto sedan or coach. It does not require a recess hole to be cut in the shelf, but is held in place with 2 small self-tapping screws.

The Re-Mote 5-inch speaker has a sealed, dustproof voice coil and fixed resistors to match all standard car radios, and includes a volume control.

It is housed in a plastic case, with louvers on top for proper acoustical balance and tone quality.—RADIO-CRAFT



## TELE-FM PREAMPLIFIER

Vision Research Laboratories  
Richmond Hill, N. Y.

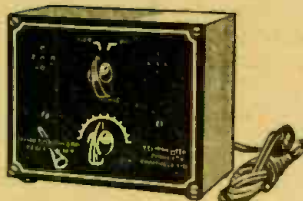

This television preamplifier boosts the strength of weak stations to a point where suitable reception is possible. It is entirely self-contained and is connected to the television set by attachment in series with the antenna. A 2-position switch on the front panel is switched on for the preamplifier or off for normal set operation.

The unit is 3x5x6 inches and is furnished in 3 models covering channels 1-6, 7-13, and 88-108 mc.—RADIO-CRAFT

## ANTISTATIC POWDER

General Cement Mfg. Co.  
Rockford, Illinois

This is a powder which minimizes auto radio static interference due to the accumulation of static electricity on the car. The powder is poured into a powder injector which is screwed onto the tire valve. Air pressure is then used to blow it into the inner tube.—RADIO-CRAFT

## PORTABLE RECORDER

Air King Products Co., Inc.  
Brooklyn, N. Y.

This recorder embodies a 5-tube (including rectifier) amplifier with radio attachment cord. It plays either 10- or 12-inch records and comes equipped with permanent needle. Recordings from the phonograph or radio can be made directly through the amplifier, and voice also can be dubbed in through the microphone while recording from radio.

The recorder includes an automatic shutoff to turn the motor off after the wire rewinds. A safety lock prevents accidental erasures, and a visual indicator checks recording level.—RADIO-CRAFT



## GEIGER COUNTER

Amperex Electronic Corporation  
Brooklyn, N. Y.

These Geiger-Mueller counter tubes are physically redesigned for standardized production.

New developments include direct bonds between mica and metal and mica and glass, eliminating many of the difficulties inherent in gasketed or waxed seals.

The first series to be released includes counter tubes for beta, gamma, and X-rays.—RADIO-CRAFT

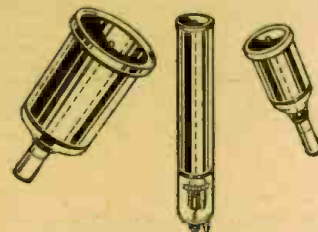

## PICKUP EQUALIZER

Radio-Music Corp.  
Port Chester, N. Y.

The new EL-3 equalizer has been designed for simplified operation plus good reproduction from both vertical and lateral recordings. The system allows using one arm for vertical only and one arm for lateral only, on one turntable or separate tables, by connecting both arms to the equalizer. Switching the equalizer from vertical equalization to lateral allows changing from one arm to the other . . . at the same time, the correct equalization is thrown in. Both the RMC vertical and lateral reproducers can be replaced by the RMC universal head.—RADIO-CRAFT

# TRY THIS ONE

## TUBE SOCKET PUNCH

This socket punch is easily made and can cut about 20 holes before it needs resharping.

To make the cutter, grind a socket from a socket-wrench set to the shape shown in the drawing. The outside diameter of the socket is 1 1/8 inches (for a 1 1/8-inch hole), but a larger or smaller size may be used if desired.

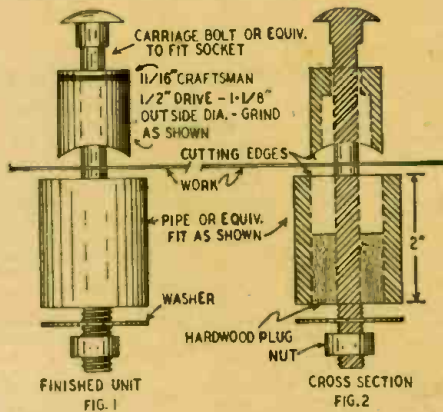

The die for the cutter is made of a piece of thick-wall pipe cut off square. It should fit snugly around cutter but not bind, if the hole is to be a clean one. Force a hardwood cylinder halfway into the pipe and drill it accurately through the center for a snug, sliding fit for the bolt.

Choose the bolt to fit the drive hole of the socket without any play. If the socket has a square drive hole, use a bolt with a square collar that can fit into it.

JOHN KWIETINSKAS,  
Duquesne, Pa.

## SIGNAL GENERATOR

An excellent signal generator can be constructed from a surplus 2-volt vibrator. It provides a.f. and r.f. signals for trouble-shooting and aligning of re-

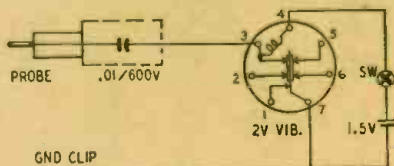

ceivers. It is compact and easily carried around, and the operating cost is low because it uses only a 1 1/2-volt battery. A volume control can be added to control the output.

JOHN ZVERLOFF,  
Akron, Ohio

## HANDY TOOLS

Hacksaw blades can be ground into small sharp knives that are useful around the workshop. Facial tissue can be cemented to a piece of broken blade to get into places that a pipe cleaner cannot reach.

ELMER C. CARLSON,  
Brooklyn, N. Y.

## FOR EASY SOLDERING

When it is necessary to solder a lead or component to a chassis and solder with rosin flux will not stick, try using Kester aluminum solder. I have used this a number of years and have not been troubled with corrosion. It will even adhere—but not too well—to that white brittle metal often used for phono tone arms and dial drums.

THOMAS RUMNEY,  
Toronto, Canada

## TEST-POINT ADAPTER

Test-point adapters may be made cheaply from midget wafer tube sockets.

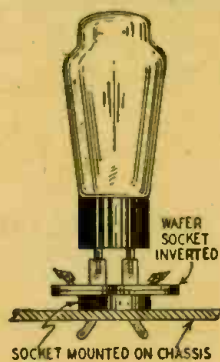

Remove the tube from the set and plug it into an inverted wafer socket. Then plug the whole back into the socket on the chassis. The prongs from the wafer socket project and can be hooked onto easily with pee-wee or crocodile clips. The receiver can, in most cases, be tested without removing it from the cabinet.

JOHN ZVERLOFF  
Akron, Ohio

## TUBE REMOVER

A sewing-machine screw driver is the basis of this novel tube remover. To make it, hold about 3/4 inch of the screw driver blade in a vise and bend it sharply 45 degrees.

Slip the bent end of the screw driver blade between the base of the tube and its socket. A little leverage on the handle will force the tube out easily.

OSCAR E. MALECH,  
San Francisco, Calif.

## CLEANING SPEAKERS

An easy way to remove iron filings and bits of metal from between the voice coil and field pole of dynamic speakers is to pass alternating current through the field coil. This demagnetizes the core and permits the small bits of metal to be shaken or blown out.

W. HARVEY MERWIN,  
Jensen Beach, Florida

## SELENIUM RECTIFIER HOLDER

Here is a new way to install selenium rectifiers in radios designed for vacuum-tube rectifiers. Cut a slot the width of the new unit in a tube base to within 1/16 inch of the bottom. Solder insulated leads to the terminals and fit the entire assembly into the slot. Pull the wires through the prongs in the base and

solder them. The wires should be pulled tight to hold the rectifier firmly in place.

After the circuit wiring is changed, plug the new rectifier into the tube socket.

GEORGE J. DASKO,  
Oka, Quebec

(Another method of installing a selenium rectifier was suggested by R. V. Johnson of Chicago, Illinois. It is to solder a tube prong to each strap attached to the unit. The rectifier is installed by merely plugging it into the tube socket after rewiring the set. Many parallel suggestions have been made by servicemen and experimenters. —Editor)



## VOLTAGE BOOSTER

Where low line voltage causes poor reception on receivers, a toy or filament transformer can be used to boost the line voltage to close to its normal rating.

The required transformer secondary voltage depends upon the amount of increase desired, and can be varied in

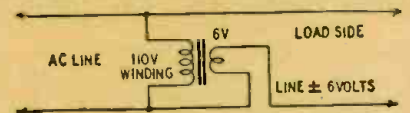

many toy transformers. The 2 windings must be connected to add voltages and to prevent bucking—correct connections can be determined with a voltmeter.

GEORGE PURAINEN,  
Sudbury, Ontario

## STRIPPING LITZ WIRE

Do you have trouble stripping insulation from Litz wire and the fine wires commonly used on pickups and headphones? If so, try passing a lighted match slowly under the end of the wire. This will char the insulation sufficiently to permit it to be pulled off. Use care so that the fine wires will neither char nor melt.

FRED PEARSALL,  
Medford, N. Y.

## SHORT INDICATOR

A light bulb connected in parallel with the fuse connected to the service bench is a good short-circuit indicator. If the fuse melts, the lamp will light. The

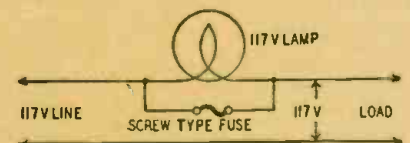

lamp should be a small one, that will not impair the action of the fuse. A 7 1/2-watt bulb is adequate.

JOHN A. FLOR,  
Milwaukee, Wis.

# BUY from America's STOREHOUSE of QUALITY PARTS

## VOLUME CONTROLS



1000 ohm wire wound midgets - manufacturers close out - 1/4" shaft 3/8" long - list \$1.25 - over 90% off.

EACH **12c**  
SEALED Box of 252 **24.95**

## OUTPUT TRANSFORMERS

Clean stocks - long leads - mounting feet - made to fit where you need them.

For 6F6-6K6 - to 4 ohm voice coil - size 2" x 1 1/4" x 1 3/8".  
50L6-35L6-25L6 to 4 ohm voice coil 1 3/8" x 1 3/8" x 1 3/8".  
Specify quantity of each type you need at.....



**49c**

## MULTI-USE WIRE

An old favorite - back again! Stranded No. 22 tinned wire - glass "ROCKBESTOS" 1000 volt insulation - fireproof aircraft wire - a wartime development - at this low price you can use the best.



100 feet..... **45c** 1000 feet..... **3.89**

## Pep-Up PHILCO CHANGERS

Here are the two most important items in "Beam of Light" changers - and priced to give you more profit!  
Selenium cell only, no holder, post paid..... **1.80**

Special original equipment lamp.... **27c**

## 8/8/8 - 450 VOLT CONDENSERS

A nationally advertised triple 8 mfd. - 450 volts - inverted screw mounting - insulated aluminum can 1 1/4" x 4" - insulated leads 6" long. List price \$4.25. One time only at..... **89c**

## MIDGET I. F. TRANSFORMERS

Back again - by popular demand! RSE scores again with a new and better I.F. 1 400-500 KC range - 4 1/4" square x 2 1/2" high - ceramic based mica trimmers - high gain iron cores - pep up old receivers - ideal for new construction - and now available in either input or output types - for peak performance! Individually boxed in the colorful RSE carton. List price \$2.10. LR1 - input; LR2 - output; Specify Type.

Each	Matched Pair	Dozen	Egg Crate of 100
<b>36c</b>	<b>69c</b>	<b>3.95</b>	<b>29.00</b>

## PANEL METERS

Top quality instruments! All new - not war surplus - boxed - seven popular types - priced right - your chance to get those meters you've always wanted!

Model 332 - 0-150 A.C. volts - 3" round flush mounting black brass case.

Model 221 - 0-30 D.C. volts - 2" round flush mounting bakelite case.  
Model 324 - 0-400 D.C. volts - 3" round projection mounting - bakelite case.

Model 331 - 0-30 A.C. amps. - 3" round flush mounting bakelite case.  
Model 322 - 0-150 D.C. volts - 3" round flush mounting black brass case.

Model 347 - 0-150 MA radio frequency thermocouple - 3" square bakelite case.

Model 341 - 0-500 MA radio frequency thermocouple - 3" round bakelite case.

Supply limited - order now - list models you desire.

**2.95**  
EACH

**3.95**  
EACH

# RADIO SUPPLY & ENGINEERING CO., Inc.

125 SELDEN AVE. DETROIT 1, MICH.

LOWEST PRICES

## .5-300 VOLT CONDENSERS



A name brand manufacturers close-out special - we pass the savings on to you! New fresh stock - size 3/4" x 2 1/4" - tinned leads - all guaranteed 60c List - your discount 90%.

Net Each 10 for 100 for  
**6c 49c 395**

## VOLUME CONTROLS

Our own private brand - made by a nationally known manufacturer - you have this same control on your shelf now - the same kind that net for \$1.09! Standard noise-free carbon construction - 3/8" bushing - 1/2" shaft, 2" long - complete with switch. Ideal all purpose replacement control - individually boxed in our colorful carton carrying the RSE quality seal of approval.



Full range of sizes - with attached switches!

10 M ohms	15 M ohms	25 M ohms	50 M ohms	100 M ohms	250 M ohms	500 M ohms	1 Meg ohms	2 Meg ohms	500 M Knurled Shaft
									500 M ohms less switch, 39c ea. 100 for \$35.00

**59c each**  
**55.00 per 100 assorted**

## MODEL 451A AC-DC Volt-Ohm-Meter



A dependable instrument of wide utility - sensitivity 1000 ohms per volt. Ranges: Volts AC, DC, and Output Ranges: 0-10/50/100/500/1000. Ohms full scale, 500,000. Ohms center scale, 7200.

TEST LEADS **.59**

NET complete with batteries..... **14.90**

## MODEL 312 Volt-Ohm-Milliammeter



An economy pocket meter featuring a 2" moving vane meter.

Reads: AC-DC volts, 0-.25/50/125/250; Mills AC-DC, 0-.50; Ohms, 100,000; mfd. .05-15.

Jacks provide range selection

NET Complete with cord and plug.... **6.75**

## OZ4 TUBES



New, guaranteed, made by the only maker of OZ4's. Buy now! Hit that car radio business hard - \$2.20 List - 60% or more off - limited quantity

In colorful RSE box **88c**

Egg crate of 100 **\$.79.**

## PAPER BY-PASS CONDENSERS



Name brand condensers made by a prominent eastern manufacturer! Regular nationally advertised jobber - serviceman line! New, fresh, full capacity standard merchandise - not surplus - all guaranteed! Check the list prices - our low nets - no need to figure the discount - buy 'em now, they've hit bottom!

Mfd.	Volts	List Price	Net Each	Per 100
.01	600	30c	10c	\$ 9.15
.02	600	30c	11c	\$ 9.95
.05	600	40c	14c	\$12.95
.1	600	45c	16c	\$14.95

Quantity Prices not assorted.

## A STAR STUDDED STOCK



And every item a "Star Studded Item" - only standard merchandise by nationally known manufacturers is ever advertised by RSE. Remember our policy - your money back if not 100% satisfied!

## PHONO PICKUP CRYSTALS

Standard types - Set Manufacturers close-out - all Guaranteed



P30-W60 - One of the newest and finest - osmium tipped permanent needle - 1.8 volts output - fits standard mounting holes. List price \$7.50 you pay us..... **2.69**



P93-W57A - stamped metal case - pin type terminals - 1/2 oz. pressure - 1.6 volt output - 5000 cycle cutoff. List price \$5.55 - Our special..... **1.98**



L70 - new postwar design - solder terminals - 1 1/4 oz. pressure - 1 volt output - 4000 cycle cutoff. List price \$5.55 - we quote you..... **1.98**



L75 - another new type - 1 1/4 oz. pressure - .75 volt output - 6000 cycle cutoff. List price \$5.55 - 64% off..... **1.98**



L40 - the prewar favorite in a die cast case - used in millions of phonographs - solder terminals - 1 1/4 oz. pressure - .6 volt output - 4500 cycle cutoff. List price \$4.45 - your cost..... **1.98**

## SEND FOR FREE CATALOG



## ORDER INSTRUCTIONS

Include full remittance with orders of \$3.00 or less. Include 25% deposit with all C.O.D. orders of \$3.00 or more. All shipments sent express collect if postage is not included. Prices subject to change without notice. BE SURE TO INCLUDE SUFFICIENT POSTAGE. EXCESS WILL BE REFUNDED.



# RADIOMEN'S HEADQUARTERS WORLD WIDE MAIL ORDER SERVICE!!!

## DUE TO POPULAR DEMAND WE REPEAT THESE TERRIFIC BARGAINS

- Three assorted new MICROPHONES, including push-to-talk type .....\$1.49
- Ten assorted R. F. Chokes including high frequency types .....\$ .35
- Five assorted AUDIO or FILTER CHOKES .....\$ .99
- One Hundred assorted RESISTORS .....\$1.95
- Ten assorted JAN CABLE CONNECTORS, including SCR274,522 and BC375 types .....\$ .99
- Six assorted OIL FILLED CAN TYPE CONDENSERS, all with mounting brackets.....\$1.49
- Ten assorted METAL & BAKELITE KNOBS—(no wooden knobs) .....\$ .39
- Six assorted VARIABLE CONDENSERS, including butterfly types .....\$1.49
- Six assorted POWER and AUDIO TRANSFORMERS, all new .....\$1.98
- Six assorted isolantite and bakelite R. F. COILS, shielded and unshielded .....\$ .99

The above ten assortments totaling over \$12.00 at the unbelievable bargain prices listed can be purchased together as one lot at a super-special total price of only \$10.00. All merchandise guaranteed to be as advertised.

Aluminum gear box 18x8x7 that contains two powerful electric motors and two matched gear trains, 62 gears in all varying in size from 1/2 to 4 inches in diameter. This unit is readily converted to rotate a beam antenna or any other similar usage.....\$3.00  
**BRAND NEW 110 V AC INPUT POWER SUPPLY**, in grey enameled shock-mounted case 9" x 10" x 16". Several heavy duty resistors, 3 chokes, 4-1000 V and 600 V oil-filled condensers, 1 relay, 2-5U4's, 3 voltage regulator tubes, safety interlock, and several fuses are included in this regulated power supply at the bargain price of .....\$9.95

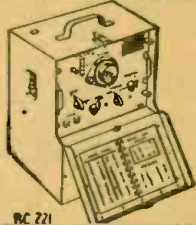

BC 221

**BC-221 FREQUENCY METERS** with calibrating Crystal and calibration charts. A precision frequency standard that is useful for innumerable applications for laboratory technician, service man, amateur, and experimenter at the give away price of only \$36.95.

**100 KC crystal calibrator kit** containing everything that is necessary to construct a 100 KC osc. that will supply 100 KC marker points to your receiver so that it may be used for frequency determination. The 100 KC crystal is worth far more than the price that we are asking for the complete kit.  
 Kit 100K Plate and fil voltage supplied by receiver .....\$9.95  
 Kit 100KA Same as above, including 110 VAC or DC self-contained power supply .....\$12.95

RT1463 7 tube amplifiers containing 3-7F7, 1-7Y4, 3-7N7, 4 potentiometers, numerous resistors, filter and bypass condensers, filter chokes, power and audio transformers, and six sensitive plate relays. A military development that provided amazing stepless control proportional to correction required for alterations, rudder and elevator, in the original application. A control amplifier of the ordinary type would deflect the rudder by some arbitrary amount when the ship was blown off the course to port or starboard. The result would either be that the correction was insufficient and the plane continued off course, or the correction would be too great, starting a series of tackings and would greatly increase fuel consumption and elapsed time in reaching the objective. This phenomenal unit, with its 3 amplifiers and six 5000 ohm relays in bridge circuits, will accurately control any 3 operations, related or unrelated, in minutely adjustable uniquely quantitative variations in either forward or reverse directions. 9"x7"x8" black crackle aluminum case. Brand new in original carton. \$9.95.



### SCR-274N COMMAND SET

The greatest radio equipment value in history

A mountain of valuable equipment that includes 3 receivers covering 190 to 550 KC; 5 to 6 MC; and 6 to 9.1 MC. These receivers use plug-in coils, and consequently can be changed to any frequencies desired without conversion. Also included are two Tuning Control Boxes; 1 Antenna Coupling Box; four 28 V. Dynamotors (easily converted to 110 V. operation); two 40-Watt Transmitters including crystals, and Preamplifier and Modulator. 29 tubes supplied in all. Only a limited quantity available, so get your order in fast. Removed from unused aircraft and in guaranteed electrical condition. A super value at \$29.95, including crank type tuning knobs for receivers. Without these knobs the receivers can't be tuned, and are only useful for parts. Don't buy without knobs!

**RECORDING AMPLIFIER**, 3 stage, 110 V, 25 or 60 cycle high gain amplifier built by recently bankrupt manufacturer specifically for recording use. Transformer for low impedance wire recorder head or magnetic cutter included on chassis. Tone and volume controls and switches on chassis for playback, recording or use as public address amplifier. Complete with tubes .....\$9.95

## GENERAL ELECTRIC 150 WATT TRANSMITTER

Cost the Government \$1800.00  
 Cost to you \$44.50!!!!

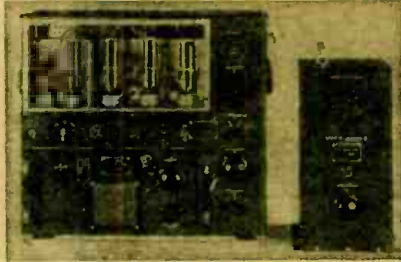

This is the famous transmitter used in U.S. Army bombers and ground stations, during the war. Its design and construction have been proved in service, under all kinds of conditions, all over the world. The entire frequency range is covered by means of plug-in tuning units which are included. Each tuning unit contains a variable capacitor, antenna tuning circuit, and antenna tuning circuit—all designed in black crackle, and the milliammeter, voltmeter, and RF ammeter are mounted on the front panel. Here are the specifications: **FREQUENCY RANGE:** 200 to 500 KC and 1500 to 12,500 KC. (Will operate on 10 and 20 meter band with slight modification). **OSCILLATOR:** Self-excited, thermo compensated, and hand calibrated. **POWER AMPLIFIER:** Neutralized class "C" stage, using 211 tube, and equipped with antenna coupling circuit which matches practically any length antenna. **MODULATOR:** Class "B"—uses two 211 tubes. **POWER SUPPLY:** Supplied complete with dynamotor which furnishes 1000V at 350 MA. Complete instructions are furnished to operate set from 110V AC. **SIZE:** 21 1/2 x 23 1/2 inches. Total shipping weight 200 lbs., complete with all tubes, dynamotor power supply, five tuning units, antenna tuning unit and the essential plugs. These units have been removed from unused aircraft but are guaranteed to be in perfect condition.

has its own oscillator and power amplifier coils and condensers, and antenna tuning circuit—all designed in black crackle, and the milliammeter, voltmeter, and RF ammeter are mounted on the front panel. Here are the specifications: **FREQUENCY RANGE:** 200 to 500 KC and 1500 to 12,500 KC. (Will operate on 10 and 20 meter band with slight modification). **OSCILLATOR:** Self-excited, thermo compensated, and hand calibrated. **POWER AMPLIFIER:** Neutralized class "C" stage, using 211 tube, and equipped with antenna coupling circuit which matches practically any length antenna. **MODULATOR:** Class "B"—uses two 211 tubes. **POWER SUPPLY:** Supplied complete with dynamotor which furnishes 1000V at 350 MA. Complete instructions are furnished to operate set from 110V AC. **SIZE:** 21 1/2 x 23 1/2 inches. Total shipping weight 200 lbs., complete with all tubes, dynamotor power supply, five tuning units, antenna tuning unit and the essential plugs. These units have been removed from unused aircraft but are guaranteed to be in perfect condition.

### BRAND NEW INVERTERS AND DYNAMOTORS

- PE 6A: A 24 to 32 V DC input, to 80 V. AC regulated output converter .....\$12.95
- PE 19A: A 24 to 28 V DC input, to 80 V AC at 800 cps output .....\$9.95  
 (We include a step-up transformer with each of the above so that 110 V AC is available from either.)
- 27 V DC input. Output 285 V DC @ 75 MA output .....\$5.95
- 27 V DC input. Output 300 V @ 150 MA, 150 V @ 15 MA and 12 V @ 5 AMP .....\$9.95
- 12 V DC input. Output 300 V @ 150 MA, 150 V @ 15 MA and 12 V @ 5 AMP .....\$12.00
- 13 or 26 V DC input. Output 300 V DC, 400 V DC @ 135 MA, and 9 V AC .....\$15.00  
 (By running on 6 V AC, 60 cycle input, with a small amount of DC for field excitation, the above dynamotor will provide a good source of 12, 24, 400 or 800 V DC.)

### GENERAL ELECTRIC RT-1248 15-TUBE TRANSMITTER-RECEIVER

**TERRIFIC POWER**—(20 watts) on any two instantly selected, easily pre-adjusted frequencies from 435 to 500 Mc. Transmitter uses 5 tubes including a Western Electric 315 A as final. Receiver uses 10 tubes including 955's, as first detector and oscillator, and 3-7H7's as IF's, with 4 slug-tuned 40 Mc. IF transformers, plus a 7H7, 7E8's and 7F7's. In addition unit contains 8 relays designed to operate any sort external equipment when actuated by a received signal from a similar set elsewhere. Originally designed for 12 volt operation, power supply is not included, as it is a cinch for any amateur to connect this unit for 110V AC, using any supply capable of 400V DC at 135 MA. The ideal unit for use in mobile or stationary service in the Citizen's Radio Telephone Band where no license is necessary. Instructions and diagrams supplied for running the RT-1248 transmitter on either code or voice in AM or FM transmission or reception, for use as a mobile public address system, as on 80 to 110 Mc. FM broadcast receiver, as a Facsimile transmitter or receiver, as an amateur television transmitter or receiver, for remote control relay hookups for Geiger-Mueller counter applications. It sells for only \$29.95 or two for \$53.90. If desired for marine or mobile use, the dynamotor which will work on either 12 or 24V DC and supply all power for the set is only \$15.00 additional.

### SCR-284 TRANSMITTER-RECEIVER

This medium power transmitter and the accompanying 7-tube very sensitive receiver are natural for 80 or 40 meter operation (phone or CW), on either fixed stations or mobile applications. These units are brand new and come complete with 17 tubes, key, microphone, 200 KC calibrating crystal and instructions and diagrams for use with up to 100 watts input to the final stage on 40 or 80 meters for either phone or CW, using vehicle or 110 Volt power supply. Your cost .....\$39.95  
 Minimum order \$3.00—All prices subject to change—25% deposit with C.O.D. orders

### PE-109 32-Volt DIRECT CURRENT POWER PLANT

This power plant consists of a gasoline engine that is direct coupled to a 2000 watt 32 volt DC generator. This unit is ideal for use in locations that are not serviced by commercial power or to run many of the surplus items that require 24-32V DC for operation. The price of this power plant is only \$58.95. We can also supply a converter that will supply 110v AC from the above unit or from any 16-32V DC source for \$12.95.



Cable Address: BUFRAD

**BUFFALO RADIO SUPPLY, 219-221 Genesee St., Dept. 4C. BUFFALO 3, N. Y.**

# SUPER BUYS

for the HAM & EXPERIMENTER

Save your steps, chum—you can't beat these values anywhere. Come in or write in, but get your order in fast while they last.

## KIT OF 100 IRC RESISTORS

Standard types; 1/2, 1, and 2 watts. Insulated, metallized and coded. Tolerances of 5, 10 and 20%.



No. KPS496 your cost only \$1.95

## WEBSTER-CHICAGO WIRE RECORDER FOUNDATION UNIT



MODEL 79 Reduced to \$44.10

Now—make your own professional wire recorder at a sensational saving. It's identical to the model used in The Webster Portable Wire Recorder.

It has a complete wire transporting mechanism, triple-purpose recording head, oscillator coil, 15-minute spool of recording wire plus an instruction sheet with circuit diagram. You can employ any standard Armour type recording spool and make recordings up to a full hour. 10 1/2" x 8 3/4" x 5 1/2" (3 1/2" below main plate; 2" above). Net wt.: 10 lbs. Model No. KPS698

**Lafayette Radio**  
Radio Wire Television, Inc.

100 Sixth Avenue, New York 13, N. Y.

542 E. Fordham Rd., Bronx 58, N. Y.      110 Federal St., Boston 10, Mass.  
24 Central Ave., Newark 2, N. J.

ORDER NOW -- MAIL COUPON

LAFAYETTE RADIO, Dept. JD-8  
100 Sixth Ave., New York 13, N. Y.

( ) Send No. KPS496 @ \$1.95 ea. Quantity ( )

( ) Send Model 79 @ \$44.10 ea. Quantity ( )

Enclosed: ( ) Money Order ( ) Check

( ) Rush your newest flyer C-41

Name .....

Address .....

City ..... Zone ..... State .....

# New Radio-Electronic Patents

By I. QUEEN

## LOCATION OF TRANSMISSION LINE FAULTS

Dale H. Nelson, Southampton, N. Y., and James R. Cosby, Towson, Md. (assigned to Western Union Tel. Co.) Patent No. 2,425,554

Several methods have been available for the approximate location of a transmission line fault, such as a short-circuit or an open. A bridge or similar device may be used to calculate the approximate position. If the insulation remains unbroken, however, the exact location cannot be definitely determined.

If the defective conductor runs parallel and close to another conductor known to be good, the following method will determine the exact location of a fault. Audio power, for example at 1000 cycles, is applied in opposite phase to the lines. This may be done by connecting each line at opposite ends of a transformer secondary, with the center terminal grounded.

A linesman with portable detecting apparatus near the lines will pick up the fields radiated by them. So long as there is no defect in either conductor the radiation from either of them is cancelled by the other. A pair of headphones or a meter indicates no signal. As the linesman passes the point of defect this cancellation no longer occurs, and a loud signal will be heard.

In some cases the two lines may not have the same impedance per length, and in addition the

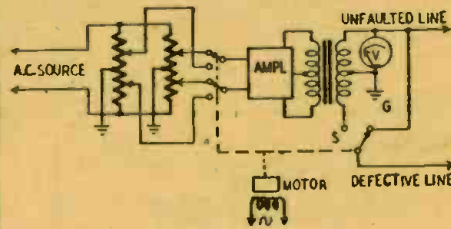

secondary winding of the transformer may not be exactly center-tapped. This produces some signal even without a line fault. The schematic shows a modified form of the invention which eliminates this difficulty and produces an abrupt change at a fault. Three ganged switches are operated by a motor M so that they periodically change from one circuit to another. When the switch S is in the upper position (as shown) it connects the faulted line to the same transformer terminal as the unfaultered line. In the lower position the faulted line is connected to the opposite end of the winding. The input potentiometers are adjusted for correct voltage at V (about 50 volts) at each position of the switches and for equal input voltage either side of ground. The adjustment is necessary because the impedance of both lines together will differ from the impedance of only one line.

To detect a faulted point the linesman adjusts the potentiometers and as the motor operates there will be alternate periods of no signal and a loud signal so long as no fault exists. As the linesman passes a line defect there is an abrupt and very noticeable change in the signal character because no cancellation exists. Only a continuous signal is then heard.

## ELECTRONIC SEWING

Benjamin W. Merz, Narberth, Pa. and Albert M. Schweda, Chicago, Ill. (assigned to Union Special Machine Co.) Patent No. 2,434,330

This instrument is designed to seal or "sew" electronically. Either one or both parts to be bonded may be a thermoplastic although this is not necessary.

A variable-speed motor controls 2 rotatable shafts, to each of which is fixed a wheel. Each shaft (and wheel) is insulated from the other, and each is supplied with r.f. power from a transmission line. Preferably, each line including shaft and wheel is a quarter-wave in length so that a potential loop exists at each wheel.

The material to be bonded may be in the shape of a bag or package. This bag is placed between the wheels which rotate in opposite directions, so that the bag is moved along between them. The r.f. energy produces heat between the wheels and causes the thermoplastic material to become

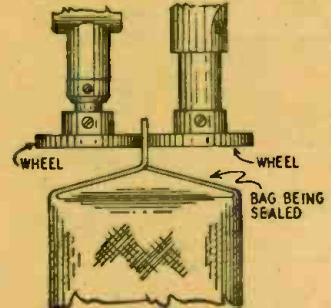

sticky. When the material is not thermoplastic, it is necessary to add a strip of film of thermoplastic substance between the sides of the bag. Again heat causes it to become sticky sealing the bag. The wheels and shafts should be of good heat-conducting material, otherwise the work (such as a bag) may overheat.

## POWER MEASUREMENT

George N. Kamm, Boston, Mass. (assigned to United States of America, as represented by the Secretary of War) Patent No. 2,432,199

For several years thermistors have found important use in power measurement. Because of their tiny size and high sensitivity to changes in heat, they can be used at very high frequencies to measure power in the order of microwatts where other methods are strictly limited.

As ordinarily used, the r.f. power heats the thermistor and lowers its resistance. If the element is removed from the r.f. circuit and measured on a bridge, the new resistance value will indicate the power dissipated in it. Special care must be taken since the bridge current itself may heat the thermistor.

In this new circuit the problem is much simplified. Since the thermistor forms part of a bridge during power measurement, the instrument becomes direct-reading and indicates continuously after a preliminary calibration.

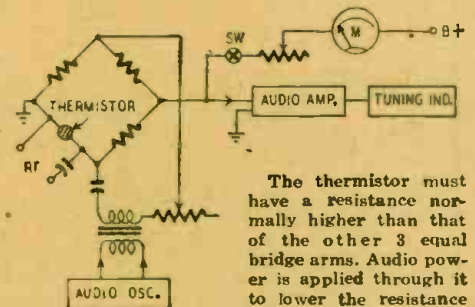

The thermistor must have a resistance normally higher than that of the other 3 equal bridge arms. Audio power is applied through it to lower the resistance and balance the bridge.

This is indicated by absence of an audio signal through the amplifier. Then the d.c. switch SW is closed and current is adjusted for

$$I = 2 \sqrt{\frac{W}{R}}$$

through M. In this equation R is the resistance of the thermistor at balance and W, the power being dissipated in the thermistor, is also equal to the full-scale reading of the tuning indicator. With this current flowing through the bridge the amplifier gain is adjusted for full-scale reading on the indicator which may be calibrated in watts.

The instrument is now calibrated for power readings. The d.c. switch is opened, and the r.f. is applied to the thermistor through an isolating condenser. The calibration may be checked at intervals to eliminate errors due to changes in ambient temperature.

# Did You Know?

Radio service men in **29** countries of the world and every state of the U. S. buy their parts and equipment from

**OLSON RADIO WAREHOUSE Inc.**



OLSON CUSTOMERS --

**46,000** of them -- would fill MADISON SQUARE GARDENS **2½ TIMES!**



OLSON is hot for

**SPEED!** Every

order we receive is shipped out the same day. Olson trucks,

loaded with shipments, are constantly rolling to the Post Office, Express Office and Airport to keep our customers happy!

OLSON is a **CRANK** on **QUALITY!**

We're fussy as old hens about everything we sell. Expert technicians, specially qualified to judge radio material, keep careful watch on the quality of all Olson tubes, parts and test equipment. No duds, no lemons from Olson!



OLSON gives you an **IRON-CLAD** Guarantee with every purchase. If you are not 100% satisfied, your money will be returned without question!

## GET THIS BOOK!

**EXPLAINS FM!**

Helps you do a better FM servicing job in less time!

Shows the latest circuits and methods of alignment. Details on the oscilloscope and sweep frequency signal generator, and how to use them. A gold mine of practical information!

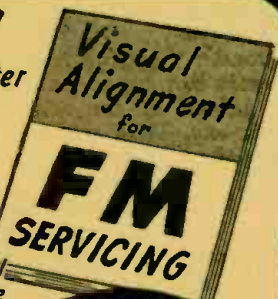

ONLY **25¢** POSTPAID

**FREE** with every FM BOOK

OLSON'S MONTHLY BARGAIN BULLETIN

OLSON gets **"ORCHIDS"** from contented customers every day. We mean thank-you letters on the quality, quick service, low prices and friendly interest they get from Olson Radio Warehouse Inc. We modestly suggest you'll like to do business with Olson, too. Try us!



## OLSON RADIO WAREHOUSE INC.

73 E. MILL ST., DEPT. 119, AKRON, OHIO

- Send me the new FM SERVICING BOOK. I enclose 25c.  
 Send me the Olson Bargain Bulletin FREE.  
 I am a Repair Man.  I am an Amateur or Experimenter.

NAME \_\_\_\_\_

ADDRESS \_\_\_\_\_

CITY \_\_\_\_\_ STATE \_\_\_\_\_

# TRANSVISION

## 12" TELEVISION KITS— Standard and De Luxe Models



12" KIT (Table Model)

Picture Size 1½ Times LARGER  
than with 10" Tube!

A big 75 square inch picture!

Sharp, steady picture achieved with advanced Transvision television circuit. Picture has remarkable brightness even in lighted room (no darkening of room is required). IDEAL FOR HOME or COMMERCIAL INSTALLATIONS.

12" TRANSVISION TELEVISION KIT  
Standard Model ..... List \$289.00  
12" TRANSVISION TELEVISION KIT  
DeLuxe Model with Superb Built-In F.M. RADIO.  
Tops in value ..... List \$359.00

### FM RADIO CONVERSION UNITS:

All Transvision 12" STANDARD Television Kits can now be had equipped with superb FM Radio at the following small additional charges:

For 12" KITS ALREADY ASSEMBLED, FM Conversion Unit ..... List \$12.50  
For new 12" KITS (non-assembled), FM Conversion Unit ..... List \$7.95

## ENLARGING LENS (15")



15" Picture Enlarging Lens



ENLARGES  
and  
CLARIFIES  
the  
PICTURE

...  
Optically  
Ground  
and Polished

Engineered by Transvision, this new plastic lens does two things—it enlarges and clarifies the picture. Has wide angle of vision. When placed about 1" from 12" or 10" tube, this lens almost doubles the picture area; when placed further away, it increases the enlargement still more. Optically ground and polished; 50% greater light transmission than equivalent glass lens; 1/3 weight of glass lens of similar magnification power. Equipped with adapter for installation on cabinets.

LIST  
15" lens (125 sq. in. picture) ..... \$36.95  
12" lens ( 75 sq. in. picture) ..... 25.95  
10" lens ( 52 sq. in. picture) ..... 19.95

All prices fair traded. . . . All prices 5% higher west of the Mississippi River.

See your local distributor, or for further information write to:

**TRANSVISION, INC.** DEPT. R.C.  
385 North Ave. New Rochelle, N. Y.

# 'Scope Checks Car Radios

By WALTON N. HERSHFIELD

WHEN servicing car radios, time is often a very important factor, particularly when an irate tourist or a traveling salesman simply must have that radio repaired immediately. Several short cuts will speed up work when the serviceman is pressed for time.

The oscilloscope is now becoming an everyday item in the modern service shop. Its application to car radio servicing merely requires a certain amount of know-how.

Excluding tube failure, most car radio trouble is found in the power supply

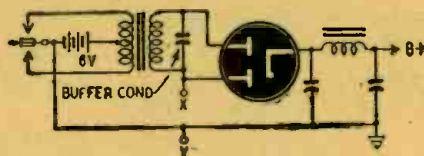

Fig. 1—Nonsynchronous vibrator power supply.

system. Because of the rugged construction necessary for car radios, considerable time is often required to open the radio, inspect the power supply, and diagnose the trouble. The power supply is often shielded, and to inspect it requires still more labor time. If the rectifier tube or vibrator can be removed from the socket, it is possible to check the power

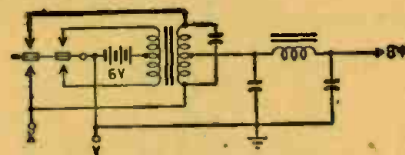

Fig. 2—The less common synchronous vibrator.

supply without opening the set further. Wrap a wire around either plate pin of the rectifier tube or in the case of a synchronous vibrator, connect the wire to one of the secondary pins of the vibrator. Take care to prevent the wire from shorting to ground, or serious damage to either the vibrator or transformer may result. Once the wire is in place merely connect the vertical plates of the 'scope between this point and ground.

For general reference, the circuit in Fig. 1 is a nonsynchronous power supply and Fig. 2 a synchronous one. The 'scope is connected between points X and Y on both circuits.

### Wave forms tell the story

Turn on the set and study the waveform from the rectifier or vibrator on the 'scope.

Fig. 3 shows an ideal vibrator wave shape. The distance a-b represents the duration of point contact; b-c represents

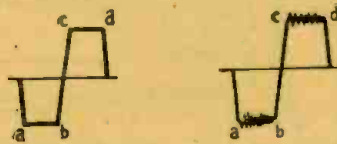

Fig. 3

Fig. 4

the time required for the vibrator reed to swing and contact the other point for time interval c-d; b-c also represents the amount of voltage change taking place in the vibrator transformer. Keep in mind that the horizontal axis represents time and the vertical axis voltage.

In Fig. 4 we see a ragged line for the point contact periods a-b and c-d. This means that the vibrator points are worn or pitted, and replacement is necessary.

The small notch at a and c in Fig. 5 shows insufficient buffer capacitance. If the buffer is open, the wave shape becomes like the dotted line, and the peak voltages become excessive. The vibrator points are rapidly ruined due to arcing caused by the absence of buffer capacitance to absorb the voltage surges when the vibrator points open.

In Fig. 6 excessive buffer capacitance is indicated by the lack of sharpness at points b and c. This indicates that the value of the buffer condenser is too large. A shorted buffer condenser causes the fuse in the radio to burn out; or if the fuse does not open, excessive current is drawn through the vibrator, the points become red hot and eventually fuse together. If a wave shape similar to that of the dotted line is observed on the 'scope, this is what has happened.

### Sells new vibrators, too

Since most vibrators have a vibration frequency of 120 cycles, a new vibrator can be checked and the horizontal sweep settings of the 'scope noted. After this

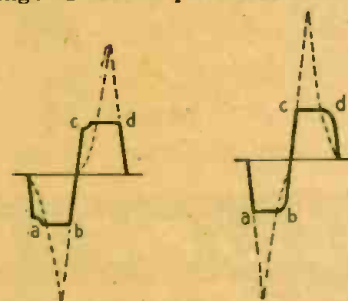

Fig. 5

Fig. 6

setting frequency changes from normal due to metal fatigue and loss of temper in the vibrating reed, are easily seen. Use only one complete cycle of the vibrator for comparison on the 'scope screen.

It is apparent that in many cases a vibrator with worn contacts or a leaky buffer condenser, can be found and replaced while the radio is in the shop for other repairs. This will help maintain the shop reputation for "keeping them fixed." The hum of the vibrator tells very little except in extreme cases. From the standpoint of sales it is often a good policy to invite the customer to the service bench to see the condition of his vibrator. For comparison plug a new vibrator into the socket to show the new and improved wave shape. The 'scope does the selling.



**MONEY BACK GUARANTEE** — We believe units offered for sale by mail order should be sold only on a "Money-Back-If-Not-Satisfied" basis. We carefully check the design, calibration and value of all items advertised by us and unhesitatingly offer all merchandise subject to a return for credit or refund. You, the customer, are the sole judge as to value of the item or items you have purchased.

## The Model 88-A COMBINATION **SIGNAL GENERATOR** AND **SIGNAL TRACER**

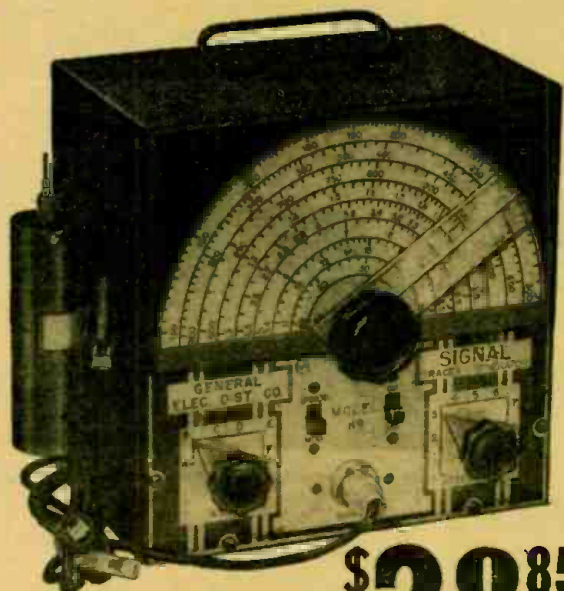

The Model 88 comes complete with all test leads and operating instructions.

**ONLY \$28<sup>85</sup> NET**

The ultimate in signal tracing procedure is achieved by the Model 88, for the use of this model, enables you to see either the broadcast signal itself or the signal injected by the Signal Generator. This is especially useful of course when servicing "dead" or "intermittent" receivers. The Model 88 you will find is the greatest time-saver ever provided for by combining a full range Signal Generator and Signal Tracer into one unit the set up time for interconnecting, etc., is entirely eliminated.

### Signal Generator Specifications:

- ★ Frequency Range: 150 Kilocycles to 50 Megacycles.
- ★ The R.F. Signal Frequency is kept completely constant at all output levels. This is accomplished by use of a special grid loaded circuit which provides a constant load on the oscillatory circuit. A grounded plate oscillator is used for additional frequency stability.
- ★ Modulation is accomplished by Grid-blocking action which has proven to be equally effective for alignment of amplitude and frequency modulation as well as for television receivers.
- ★ Positive action attenuator provides effective output control at all times.
- ★ R.F. is obtainable separately or modulated by the Audio Frequency.

### Signal Tracer Specifications:

- ★ Uses the new Sylvania 1N34 Germanium crystal Diode which combined with a resistance-capacity network provides a frequency range of 300 cycles to 50 Megacycles.
- ★ Simple to Operate—Clips directly on to receiver chassis, no tuning controls.
- ★ Provision is made for insertion of phones of any impedance, a standard Volt-Ohm Milliammeter or Oscilloscope.

## The New Model 60-T **TUBE & SET TESTER**

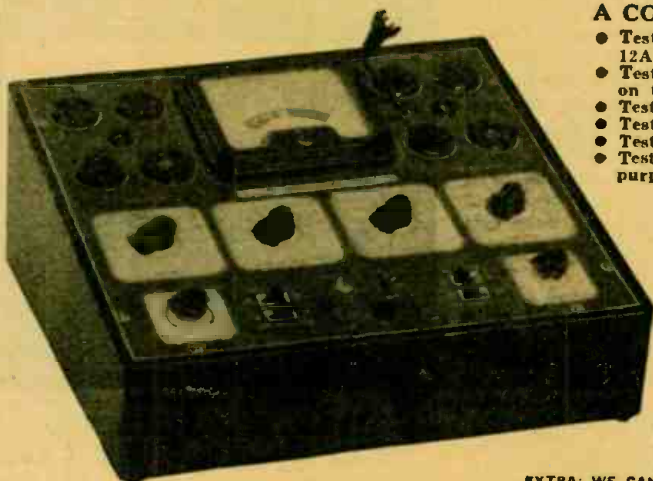

### A COMPLETE TUBE TESTER

- Tests all tubes including the new post-war miniature loctals such as the 12AT6, 12AU6, 35W4, 50B5, 11723, etc.
- Tests by the well-established emission method for tube quality, directly read on the scale of the meter.
- Tests shorts and leakages up to 3 Megohms in all tubes.
- Tests leakages and shorts of any one element against all elements in all tubes.
- Tests both plates in rectifiers.
- Tests individual sections such as diodes, triodes, pentodes, etc., in multi-purpose tubes.

### A COMPLETE MULTI-METER

- 6 D.C. VOLTAGE RANGES:  
0 to 7.5/15/75/150/750/1,500 Volts
- 6 A.C. VOLTAGE RANGES:  
0 to 15/30/150/300/1,500 3,000 Volts
- 4 D.C. CURRENT RANGES:  
0 to 1.5/15/150 Ma. 0 to 1.5 Amps.
- LOW RESISTANCE RANGE:  
0 to 2,000 Ohms (1st division is 1/10th of an ohm.)
- 2 MEDIUM RESISTANCE RANGES:  
0 to 20,000/200,000 Ohms
- HIGH RESISTANCE RANGE:  
0 to 20 Megohms
- 3 DECIBEL RANGES:  
-10 to +38 +10 to +38 +30 to +58 D.B.

Model 60-T operates on 90-120 Volts 60 Cycles A.C. Housed in sloping leatherette covered cabinet. Comes complete with test leads, tube charts and detailed operating instructions.

EXTRA: WE CAN NOW SUPPLY THE MODEL 60 HOUSED IN A BEAUTIFUL HAND-RUBBED OAK CABINET, COMPLETE WITH PORTABLE COVER MAKING IT SUITABLE FOR EITHER BENCH OR OUTSIDE USE. ONLY \$2.75 ADDITIONAL. SPECIFY MODEL 60-C.

**\$49<sup>85</sup> NET**

20% DEPOSIT REQUIRED ON ALL C.O.D. ORDERS

**GENERAL ELECTRONIC DISTRIBUTING CO.** DEPT. RC-4 98 PARK PLACE,  
 NEW YORK 7, N. Y.

# WE'VE MOVED!

MORE SPACE-BETTER SERVICE at SENCO

## BEST BUYS IN TUBES I

EVERY TUBE IN CARTON		R.M.A. GUARANTEED	
Type	Each	Type	Each
0Z4	69c	7A4	53c
1A3	45	7A7	58
1A5GT	59	7B6	44
1U5	36	7F7	49
1V	45	7Y4	44
1L4	55	7X7	44
1T4	69	7AF7	44
185	69	12A6	35
2A5	65	12A8GT	45
2A6	79	12AT6	50
2X2	79	12BA6	50
3A4	69	12BE6	50
384	69	12J5GT	49
5U4G	50	12J7GT	45
5W4GT	40	12K7GT	45
5Y3GT	40	12K8	65
5Y3G	42	12Q7GT	45
5Y4G	40	12SA7GT	40
5X4G	40	12SF7	39
6A7	50	12SQ7GT	40
6A8GT	49	12SK7GT	45
6AC5	98	12SR7	39
6AC7	65	12SJ7GT	55
6AK5	74	14A7	65
6AG7/6AK7	89	14B6	59
6B7G	55	24A	49
6C4	29	43	54
6C5GT	40	47	49
6C6	45	57	45
6C8G	37	58	45
6F6GT	45	71A	39
6H6	45	75	50
6H6GT	45	76	45
6J5GT	45	77	35
6J7GT	42	80	40
6K6GT	45	83V	99
6K7GT	49	85	49
6L6G	50	25L6GT	49
6Q7GT	47	25Z5	49
6S7	59	25Z6GT	45
6U7G	35	35W4	43
6V6GT	45	35Y4	43
6X5GT	49	35Z3	44
6SA7GT	44	35Z5GT	43
6SJ7GT	44	35L6GT	45
6SK7GT	49	35/51	49
6SL7GT	49	50L6GT	50
6SN7GT	49	117Z6GT	89
6SQ7GT	44	50B5	42
6SG7	44	32L7GT	59

### Outstanding SENCO Special!

NATIONALLY ADVERTISED CRYSTAL MIKE

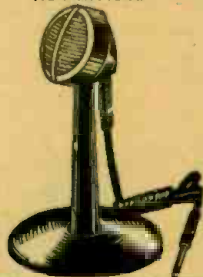

With 7 ft. mike cable and PL 55 plug and stand.

**ONLY \$4.39 COMPLETE**

POPULAR BRAND  
12" PM SPEAKER WITH 21 OZ. MAGNET  
6V6 push pull output transformer mounted on speaker with cord and plug attached

**\$8.95 COMPLETE**

#### REAL SPEAKER VALUES

3 1/4" Cone 4" Sq. Frame	\$1.19 ea.
4" P.M. Speaker	1.15
5" P.M. Speaker	1.55
5 1/2" Cone 6" sq. Frame	1.55
6" P.M. Speaker	2.75
8" P.M. Speaker	4.95
12" P.M. Speaker	1.89
4x6 Inch P.M. Speaker	

Standard Brand AC PHONO MOTOR AND PICKUP

60 cycles, 115 volts, with Turntable. Complete

**\$4.35**



**FREE** NEEDLE CUP with motor and pickup

25% deposit on all orders, balance C.O.D., F.O.B. New York

# SENCO RADIO, Inc.

73 West Broadway, N. Y. 7, N. Y.  
TEL. BECKMAN 3-6498

# Renew That Cabinet!

BY HARRY LEEPER

WHILE your customer is unable in most cases to see replacements made in repair jobs, he or she will be quick to note improvements made on the radio cabinet. Such improvement tends to instill a pride of ownership in the customer as well as confidence in your ability and in the repairs hidden under the chassis. Appearance of the radio cabinet usually may be brightened and scratches stained by using a few inexpensive tools as illustrated below.

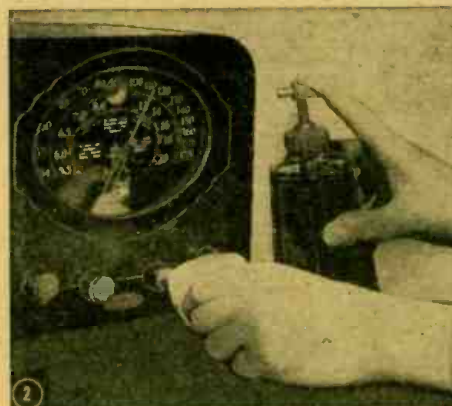

Photo 1. Dust from the speaker grille cloth and around the edges of the cabinet wood is quickly removed with a small brush picked up at the dime store.

Photo 2. Cleaning of glass dial faces is speeded up and done efficiently with liquid window cleaner used in a sprayer. The inside of the glass also should be cleaned while the chassis is out of the cabinet.

Photo 3. Stains and marks from various substances contacting the cabinet can usually be removed with light brushings of carbon tetrachloride.

Photo 4. Shallow scratches are easily treated with a *Scratch Stick* made by General Cement Co. The bare spot is first stained with the crayon end of the stick.

Photo 5. The stick is reversed and the oiled brush end is used. This works well with walnut and mahogany finishes. However, deep cuts may require application of regular liquid stain with a small brush.

Photo 6. The last step is the use of a good furniture polish over all the cabinet. A cloth should be carried in the tool kit and final polish given the cabinet after it is replaced in the customer's home.

### NAZIS USED WAR TELE

Television was used by the German military in experiments with guided missiles during the last war according to a report on TV progress by the Office of Technical Services, Department of Commerce. Civil television remained at a standstill during the war though programs were supplied to military hospitals until the transmitter was bombed.

### RADIO ITEMS INDEXED

The more important articles in RADIO-CRAFT are indexed in a little publication published by Richard H. Dorf, 255 West 84th St., New York, N. Y. This amateur index service is a monthly mimeographed booklet which lists the most interesting articles in 14 radio and electronics magazines. Cost is \$1.00 per year.

**ALLIED'S NEW** **FREE**  
**1948 RADIO CATALOG**

**172 VALUE-PACKED PAGES**

*Send for it now!*



**The Preferred Radio Buying Guide**

It's off the press—the new 1948 ALLIED Radio Catalog! Get the Radio Buying Guide that's used by thousands of expert servicemen, engineers, soundmen, Amateurs, builders and experimenters. The new ALLIED Catalog—radio's biggest book—brings you 172 pages packed with the widest selections of the newest and finest equipment, at really low, money-saving prices! Here's everything in radio for everyone in radio: new Television and home receivers, packaged Sound Systems and P. A. equipment, latest Amateur receivers and station gear, test instruments, builders' kits, thousands of parts, tubes, tools, books—the world's largest stocks of nationally-known equipment. Take advantage of ALLIED'S speedy, expert shipment and the personal attention of seasoned old-time radio men. Get the details, too, of radio's newest and most liberal Time Payment Plan. Send today for your FREE copy of ALLIED'S newest, greatest Catalog—the preferred Radio Buying Guide!

**LARGEST STOCKS • QUICK, EXPERT SERVICE**

Get your **FREE** copy of  
Radio's most complete Catalog  
Use the coupon below—**NOW!**

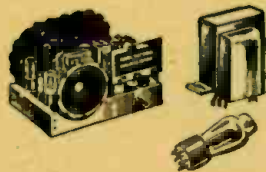

**RADIO'S LEADING  
BUYING GUIDE!**

**MORE THAN 10,000 ITEMS**

Everything in radio for everyone in radio! Complete lines of all leading makes of parts and equipment—all from one great, centralized source. For newest developments and best values, see your ALLIED Catalog.

**TELEVISION & HOME RADIOS**

A special selection of outstanding models—table radios, consoles, combinations, FM-AM—plus new Television, offered first by ALLIED at real savings. Hand-picked models—the choice of experts!

**AMATEUR STATION GEAR**

Here's heaven for the Ham! You'll find everything you need for your shack in the new ALLIED Catalog. See all the latest releases in receivers, transmitters, parts, station equipment—biggest Ham listings in radio!

**NEW P. A. EQUIPMENT**

Packaged, ready-to-use Sound Systems; amplifiers guaranteed for one full year; everything in speakers, microphones, P. A. accessories, intercom and recording equipment—leading headquarters for Soundmen!



**THE WORLD'S  
LARGEST  
RADIO  
SUPPLY  
HOUSE . . .**



ALLIED RADIO CORP.  
833 W. Jackson Blvd., Dept. 2-D-8  
Chicago 7, Illinois

Send FREE New ALLIED Catalog.

Name.....

Address.....

City..... Zone..... State.....

# OHMITE RESISTORS



**a Complete Line for  
the Radio Serviceman**

You can get exactly the type and size you want when you select an Ohmite resistor. Ohmite's extensive line includes Little Devil composition resistors (available only from Ohmite distributors), Brown Devil vitreous enameled wire-wound resistors, and Dividohm adjustable resistors. All are made in a wide variety of resistance values and wattage ratings, with a tolerance of  $\pm 10\%$ . All will provide trouble-free operation—and complete customer satisfaction.

Send for Catalog No. 19

**OHMITE MANUFACTURING CO.**  
4895 Flournoy St., Chicago, Ill.

## NEW Ohm's Law Calculator



A new and improved handy pocket size (9" x 3") calculator. All computing scales on one side. Shows RMA resistor color code. Only 25c.



Be Right with...

# OHMITE

RHEOSTATS • RESISTORS • TAP SWITCHES

## Six New Tubes

RCA has announced six new Tubes. Three of them, the "Special Red" 5691, 5692, and 5693—specifically designed for industrial and commercial applications requiring tube features of at least 10,000 hours life, exceptional uniformity and stability of characteristics, and rigidity to resist shock and vibration. The unique structural design of these tubes make them capable of withstanding impact shocks of 100g for extended periods.

The 5691, 5692, and 5693 are recommended in general as replacements for the 6SL7-GT, 6SN7-GT, and 6SJ7, respectively, in equipment where long life, rigid construction, extreme uniformity, and exceptional stability are needed, and where the operating conditions are within their ratings. Except for slight differences in characteristics, they are identical with their standard receiving-tube counterparts.

The "Special Red" Tubes are distinctive in appearance—the glass-octal types 5691 and 5692 have red bases and the metal type 5693 has both a red base and a red envelope.

The other three are beam power tubes of the miniature type. They are the 6AS5, 35C5, and 50C5.

The 6AS5 is intended for use in the output stage of automobile and a.c.-operated receivers. It is capable of delivering 2.2 watts at the relatively low plate and screen voltages.

The 35C5 and 50C5 are designed for use in the output stage of a.c.-d.c. receivers. They are capable of providing 1.5 watts and 1.9 watts, output respectively, with only 110 volts on plate and screen.

Except for slightly higher voltage ratings, and a different basing arrangement, the 35C5 and 50C5 are the same as the types 35B5 and 50B5. They are also, within their maximum ratings, the performance equivalents of the 35L6-GT and 50L6-GT. The typical operation characteristics of the 6AS5 and the maximum ratings of the 35C5 and 50B5 are shown in the following tables:

6AS5		
Heater:		
Voltage (a.c. or d.c.)	6.3	Volts
Current	0.8	Ampere
Typical Operation:		
Plate Voltage	150	Volts
Grid No. 2 Voltage	110	Volts
Grid No. 1 (Control-Grid) Voltage	-8.5	Volts
Peak AF Grid No. 1 Voltage	8.5	Volts
Zero Signal Plate Current	35	Milliamperes
Max. Signal Plate Current	36	Milliamperes
Zero Signal Grid No. 2 Current (Approx.)	2	Milliamperes
Max. Signal Grid No. 2 Current (Approx.)	6.5	Milliamperes
Transconductance	5600	Micromhos
Load Resistance	4500	Ohms



The "Special Red" long-life filament tubes.

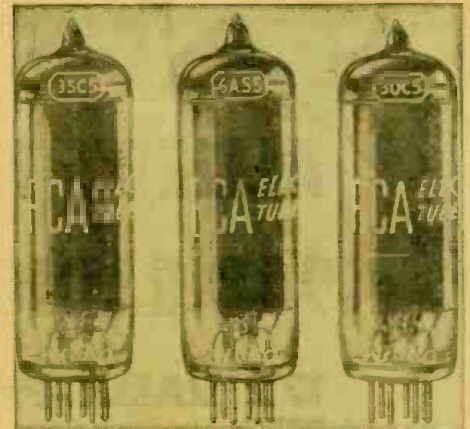

Miniature output tubes 35C5, 6AS5 and 50C5.

Total Harmonic Distortion	10	Per cent
Max. Signal Power Output	2.2	Watts

35C5		
Maximum Ratings, Design-Center Values:		
Plate Voltage	135	max. Volts
Grid No. 2 (Screen) Voltage	117	max. Volts
Plate Dissipation	4.5	max. Watts
Grid No. 2 Dissipation	1.0	max. Watt
Peak Heater-Cathode Voltage:		
Heater negative with respect to cathode	180	max. Volts
Heater positive with respect to cathode	180	max. Volts
Bulb Temperature (at hottest point on bulb surface)	250	max. °C

50C5		
Maximum Ratings, Design-Center Values:		
Plate Voltage	135	max. Volts
Grid No. 2 (Screen) Voltage	117	max. Volts
Plate Dissipation	5.5	max. Watts
Grid No. 2 Dissipation	1.25	max. Watts
Peak Heater-Cathode Voltage:		
Heater negative with respect to cathode	180	max. Volts
Heater positive with respect to cathode	180	max. Volts
Bulb Temperature (at hottest point on bulb surface)	250	max. °C

**Amsco KITS!**  
BEAT THESE PRICES  
IF YOU CAN

100 Resistors 1/2 & 1 Watt asst.	\$1.69
100 Mica Condensers asst.	2.89
100 By-pass Tubular Cond. asst.	5.89
25 Electrolytic Cond. asst.	3.29
50 Bath Tub Cond. asst.	2.59
20 Padder Cond. 1-2-3-4	.99
12 Variable Air Trimmer Cond. asst.	1.49
20 Knobbs asst.	1.39
25 Tube Sockets asst.	2.49
20 Wire Wound Resistors 5-10-25W asst.	1.89
6 Mike Buttons asst.	.89
20 R.F. Chokes asst.	.99
10 Volume Controls asst.	1.79
5 lbs. Hardware asst.	4.29
6 Chokes and Output Transformer asst.	.79

519 Items .....\$33.35

Above Kits Sold Separately  
... or the Entire Lot as  
Shown. Yours for Only **\$29<sup>95</sup>**

AND GET A MAGNESYB  
REMOTE INDICATOR **FREE!**

1 T24 Mike with Cord and Switch ....\$0.79  
5BP1 and 5CP1  
TUBES, \$2.69 ea.

New, FREE 1948 Circular Available  
Now! Write Today for Yours!

**AMERICAN SALES CO.**

1811 W. 47th St. Chicago 9, Ill.

# SENSATIONAL VALUES

The New Model 247

## TUBE TESTER

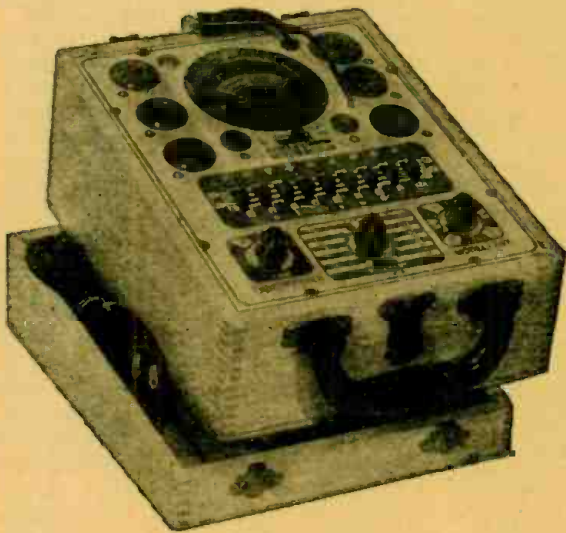

Model 247 comes complete with new speed-read chart. Comes housed in handsome, hand-rubbed oak cabinet sloped for bench use. A slip-on portable hinged cover is included for outside use. Size: 10 $\frac{3}{4}$ " x 8 $\frac{3}{4}$ " x 5 $\frac{3}{4}$ ".

ONLY  
**\$29<sup>90</sup>**  
NET

Incorporates a newly designed element selector switch which reduces the possibility of obsolescence to an absolute minimum. Any pin may be used as a filament pin and the voltage applied between that pin and any other pin, or even the "top-cap."

The new free-point system described above permits the Model 247 to overcome the difficulties encountered with other emission type tube testers when checking Diode, Triode and Pentode sections of multi-purpose tubes, because sections can be tested individually when using the new Model 247. The special isolating circuit allows each section to be tested as if it were in a separate envelope.

The Model 247 provides a super sensitive method of checking for shorts and leakages up to 5 Megohms between any and all of the terminals. Continuity between various sections is individually indicated. One of the most important improvements, we believe, is the fact that the 4 position fast-action snap switches are all numbered in exact accordance with the standard R. M. A. numbering system. Thus, if the element terminating in pin No. 7 of a tube is under test, button No. 7 is used for that test.



### The New Model 650 SIGNAL GENERATOR

RANGE

100 Kilocycles to  
105 Megacycles

R. F. obtainable separately or modulated by the Audio Frequency.

\* Audio Modulating Frequency—400 cycles pure sine wave—less than 2% distortion.

\* Attenuation—3-step ladder type of attenuator (T pad).

\* Uses a Hartley Exciter Oscillator with a Buffer Amplifier.  
\* Tubes: 6J5 as R.F. Oscillator; 6AS7 as modulated buffer and Mixer; 6SL7 as audio oscillator and rectifier.  
Complete with coaxial cable, leads and instructions.

REDUCED  
FROM \$48.75  
TO **\$39<sup>95</sup>**



SEE and HEAR the  
Signal with the  
new CA-12

### SIGNAL TRACER

FEATURES:

- \* Comparative intensity of the signal is read directly on the meter—Quality of the signal is heard in the speaker.
- \* Simple to operate. Only one connecting cable—No tuning controls.
- \* Highly sensitive—Uses

an improved vacuum-tube voltmeter circuit. \* Tube and resistor capacity network are built into the detector probe. \* Built-in high gain amplifier—Alnico V speaker. \* Completely portable—Weights 8 pounds—measures 5 $\frac{1}{2}$ " x 6 $\frac{1}{2}$ " x 9".  
Complete with self-contained batteries and instructions.

Reduced  
from \$34.85 to **\$29<sup>95</sup>**



### The New Model 670 SUPER METER

A Combination VOLT-OHM-MILLIAMMETER plus CAPACITY REACTANCE, INDUCTANCE and DECIBEL MEASUREMENTS.

D. C. VOLTS: 0 to 7.5/15/75/150/750/1500/7500.—A. C. VOLTS 0 to 15/30/150/300/1500/3000 Volts.—OUTPUT VOLTS: 0 to 15/30/150/300/1500/3000.—D. C. CURRENT. 0 to 1.5/15/150 Ma.; 0 to 1.5 Amps.—RESISTANCE: 0 to 500/100,000 ohms, 0 to 10 Megohms.—CAPACITY: .001 to .2 Mfd., 1 to 4 Mfd. (Quality test for electrolytics).—REACTANCE: 700 to 27,000 Ohms; 13,000 Ohms to 3 Megohms.—INDUCTANCE: 1.75 to 70 Henries; 35 to 8,000 Henries. DECIBELS: -10 to +18, +10 to +38, +30 to +58.

THE MODEL 670 COMES HOUSED IN A RUGGED, CRACKLE-FINISHED STEEL CABINET COMPLETE WITH TEST LEADS AND OPERATING INSTRUCTIONS. SIZE 5 $\frac{1}{2}$ " x 7 $\frac{1}{2}$ " x 3".

**\$28<sup>40</sup>**  
NET

Available for Immediate Shipment From Stock—20% Deposit Required on All C.O.D. Orders

**MOSS ELECTRONIC DISTRIBUTING CO.**

DEPT. RC-4, 229 FULTON ST.  
NEW YORK 7, N. Y.

## TUBELESS HOMO-HETERADIO

(Continued from page 23)

50  
to  
18,000  
C. P. S.!



### THE NEW NC-108 FM TUNER-RECEIVER

Now...National offers an 88-108 Mc. band FM tuner-receiver designed to meet the most exacting demands of high-fidelity enthusiasts! Flat from 50 to 18,000 cps,  $\pm 2$  db, the new NC-108 may be connected to your amplifier or the phono input of your radio. Built-in speaker, audio output stage and tone control also permit use as separate monitoring receiver. Built to National's famous standards of quality, the NC-108 is worthy of the finest in amplifiers and speakers. Nine tubes plus rectifier and tuning eye.

**\$99.50**

Amateur Net

For complete specifications see the National dealer listed in the classified section of your phone book, or write direct to



slightly out of step, will at certain times reinforce, at others neutralize each other. This alternate reinforcement and neutralization takes place at a frequency which is the *difference* between the two frequencies. Thus, by *heterodyning* an inaudible 500-kc signal (for instance) with an equally inaudible one of 501 kc, an audible 1-kc (1,000-cycle) note is produced. This principle is still the standard method of receiving continuous-wave telegraph signals.

In the Heteradio, the supersonic sound frequency is adjusted to *exactly* the carrier frequency of the incoming wave. For example, to receive a station on 1,000 kc, the sonic generator is set to that frequency. It is then at *zero-beat*, and as long as the carrier is unmodulated, nothing will be heard. As soon as modulation is applied, *sidebands* appear above and below the carrier, and these are heterodyned by the siren. For example, if a 100-cycle note is sounded on an instrument at the 1,000-kc station, a frequency of 1,000,100 and 900,900 cycles appears as well as the original 1,000-kc (1,000,000 cycles) of the carrier. The siren heterodynes with both of these to produce a note of 100 cycles. A symphony orchestra is reproduced in the same manner. See Fig. 1 page 23.

Since the strength of a signal reproduced by the heterodyne method depends on the product of the received and the heterodyning signal, the power output can be made very great by selecting a siren of desired size and output.

Now, when the proper adjustment is made on the Heteradio rheostat a point will be reached where the supersonic siren waves will clash with the radio frequency waves. A careful adjustment is made with the rheostat whereby the siren waves will be at *dead beat* with the radio waves. The result now becomes audible through the sound loud speaker cone shown in illustration, page 22.

This siren draws its air supply from a horn-shaped collector which is turned in the direction of the broadcast station. As pointed out, the molecules of air are acted upon by these waves, actually being set into mechanical motion. Thus the air stream drawn into the siren is actually modulated with the program transmitted by the station.

This sounds much more complicated than it actually is and once you understand the theory you will ask yourself why it had not been done long before. The answer is that, like all important inventions, no one had thought of it before.

I next calibrated my rheostat to read not in the speed of the motor, but in kilocycles as shown in the illustration. To tune the set to receive the various stations, I merely turn the rheostat from one point of the scale to the other. In this way I can do fine tuning so that whatever broadcast station I wish to get, I tune in, just as I would tune any regulation radio set—it is that simple.

The housing which contains the motor

and the siren is formed from a plastic shield. The housing thus becomes a wave mixer. In order to get the maximum effect—since my sound collector is highly directional—I revolve the entire housing with its two cones by means of gears attached to a dial. Thus the wave apparatus can be rotated through 180 degrees around its axis. At certain points radio broadcast stations will come in much stronger than at others, as would be expected. The same thing occurs with a standard portable radio that has a loop aerial; stations will come in better in one position of the set than in another.

My mechanical radio receiver works in a like manner. I had no difficulty in bringing in all the local stations after I had built in certain refinements in my wave apparatus.

In order to show how the wave action works out in practice we have added a diagram which explains the Homo-Heterodyne feature. See page 22.

You may ask: where is the volume control? There isn't any, except the rotating control that spins the wave apparatus on its axis. At the best point on the compass the sound issues loudest. At right angles to this, the volume is weakest.

How loud is the loudest station? Not quite as loud as a regulation radio set, but good enough to hear the stations all over the room. If more intensity of sound is required it would be necessary to build a somewhat larger siren in order to obtain more volume. That is the only way that sound intensity can be increased with the Tubeless Homo-Heteradio.

You will appreciate that the set described here is one of my early models and that other refinements will come

(Continued on page 64)

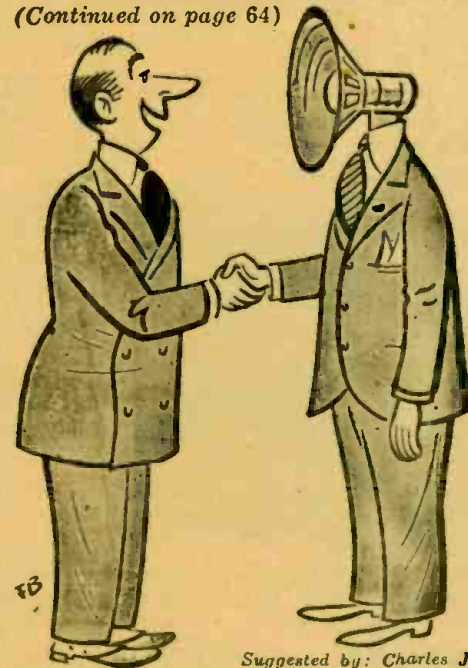

Suggested by: Charles J. Sikoma, Brookings, S. D.

"You are the most dynamic speaker I ever heard."

# Everything in RADIO and electronics in **ONE** book! over **1000** pages

A complete, easy-to-read handbook . . . All the expert knowledge in radio at your fingertips . . . instant reference in 12 big sections in the

## RADIO DATA BOOK

handsomely bound in red & gold

Plan every operation in radio and electronics with the *Radio Data Book*. This new radio bible will be your lifelong tool . . . you will use it every day, on the board, at the bench, in the field! Use it for construction, troubleshooting and testing. The **RADIO DATA BOOK** will be your invaluable aid in design, experiment and in layout. It will help make your production better, faster and easier. In any and every operation in radio and electronics, you will use the **RADIO DATA BOOK!**

The **RADIO DATA BOOK** is a work of complete authority, prepared by engineers with many years of practical experience. They have been assisted by the Boland & Boyce staff of editors skilled in preparing electronics manuals for the U. S. Signal Corps for many years. These men have worked for several years gathering material for this book . . . all the knowledge of radio principles and operation . . . all the statistics . . . all the newest developments in electronics . . . every possible angle and detail. Eighteen months were spent digesting this material into the most concise, the clearest, and the most readable form. The result is this invaluable manual . . . The **RADIO DATA BOOK**. Whether you use this book for general reference, for scientific instruction, or for education, one thing is certain—the practical help, the daily usefulness you will derive from it will prove to be worth many, many times its astonishingly low price!

Advanced Sale . . . first printing. Only 10,000 available . . . To make sure to get your **RADIO DATA BOOK**, mail your order **NOW!**

### CONTENTS

Each section is a **COMPLETE** coverage of its subject . . . 12 sections 12 books in **ONE!** 1000 pages . . . Schematics . . . Accurate photographs . . . Specially prepared drawings . . . White on black charts . . . Diagrams . . . Isometric projections and exploded view.

- Section 1. **THE 150 BASIC CIRCUITS IN RADIO.**  
Every circuit is analyzed and explained in a Johnny-on-the-spot reference for any occasion.
- Section 2. **COMPLETE TEST EQUIPMENT DATA.**  
Know more about the test instruments you now have. . . Find the new ones you want to buy. . . They're ALL in here—impartially described!
- Section 3. **TESTING, MEASURING AND ALIGNMENT.**  
Simplified operation of the Oscilloscope . . . See what's happening inside any radio circuit . . . Dynamic alignment—AM, FM and TELEVISION made easy with the Oscilloscope . . . Scientific use of the Vacuum Tube Voltmeter, Signal Generating Equipment and other basic instruments.
- Section 4. **ALL ABOUT ANTENNAS.**  
AM-FM-Television . . . design, installation, characteristics, construction and feed.

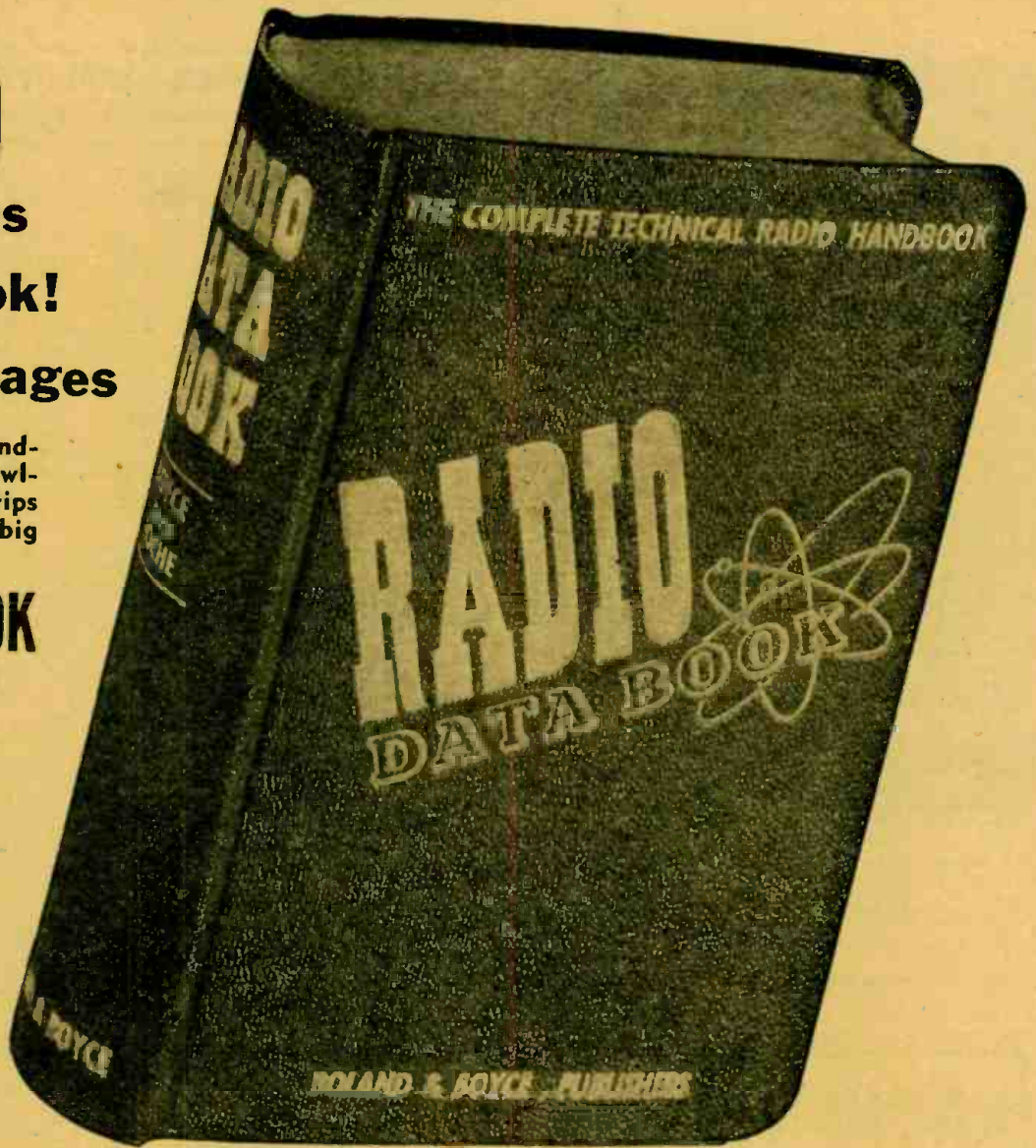

- Section 5. **SOUND SYSTEMS.**  
Planning, installing and servicing a PA System. A complete chapter on every component . . . How to select and combine components . . . estimating costs . . . even acoustic requirements!
- Section 6. **RECORDING.**
- Section 7. **COMPLETE TUBE MANUAL: Receiving, Transmitting and Commercial.**  
A flick of the page brings you to all the data and ratings of any tube model!
- Section 8. **CHARTS, GRAPHS AND CURVES.**  
Quick calculation devices . . . Plotting curves, nomographs, rules and tables for speedy solutions to radio problems.
- Section 9. **CODES, SYMBOLS AND STANDARDS.**  
Handy reference to all radio symbols and abbreviations: code symbols, phrases and characters . . . Where you want them . . . When you want them!
- Section 10. **50 TESTED CIRCUITS DESIGNED FOR OPTIMUM PERFORMANCE.**  
Find any circuit you want with complete parts lists and specifications. . . One tube receivers to complete AM, FM and Television receiver circuits Amplifiers . . . Transmitters . . . Test Equipment and Control Circuits . . . All with the latest engineering refinements.
- Section 11. **DICTIONARY OF RADIO AND ELECTRONIC TERMS.**
- Section 12. **RADIO BOOK BIBLIOGRAPHY.**

12 complete books in one—only \$5.00. Less than 42¢ per book

Mail This Coupon To Your Jobber Today or Direct to:

**BOLAND & BOYCE INC., PUBLISHERS** RC-4  
460 BLOOMFIELD AVE., MONTCLAIR 3, N. J.

Please send me a copy of  
THE RADIO DATA BOOK Enclosed is \$5.00. (5.50 foreign)

NAME .....

ADDRESS .....

CITY ..... ZONE .....

STATE .....

**BOLAND & BOYCE INC., PUBLISHERS**

# FREE RADIONIC CATALOG

CHOCK FULL OF BUYS!



RADIO & TELEVISION PARTS - KITS  
PUBLIC ADDRESS INTER-COMMUNICATORS - RECORDERS  
RECORD CHANGERS TEST INSTRUMENTS  
TUBES - AMATEUR EQUIP'T - CHANCELLOR  
RADIOS - HARDWARE  
TECHNICAL BOOKS

A MUST for all  
• Service Dealers  
• Amateurs  
• Experimenters  
• Industrials  
• Institutions  
• Government Agencies

**RADIONIC EQUIPMENT COMPANY**  
170 NASSAU ST., NEW YORK 7, N.Y.

Tribune Theatre Entrance  
Tel. WOrth 2-0421 • Cable "CHANSLOR"

RADIONIC EQUIPMENT CO., Dept. 104  
170 Nassau Street, New York 7, N. Y.

Send at once your free catalogs, supplements and bargain lists as published—listing products of leading manufacturers of radio-electronic parts and equipment.

NAME .....

P.O. BOX or STREET .....

TOWN ..... STATE .....

## RADIO TUBES

For immediate shipment

R.M.A. Guaranteed  
Below Distributor Costs  
Individually Sealed Cartons

Type	Price
6K6GT	.40
6K5GT	.46
6V6GT	.46
6SA7GT	.46
6SJ7GT	.46
6SK7GT	.46
6SQ7GT	.46
6X5GT	.40
12SA7GT	.46
12SQ7GT	.46
12SK7GT	.46
12SJ7GT	.46
35L6GT	.40
35Z5GT	.32
50L6GT	.46

RATED ACCOUNTS—2% 10 DAYS  
ALL OTHERS 2% C.O.D.  
10% DISCOUNT ON LOTS OF 50 OR MORE

**RAVAC ELECTRONICS CORP.**  
432—4th Avenue  
New York 16, N. Y.

## TUBELESS HOMO-HETERADIO

(Continued from page 62)

later. Note that the receiver which I have shown in these pages is purely experimental and does not represent a model such as will be built later and sold to the public.

Here are a few things that I must mention, in connection with the Homo-Heteradio.

Experimenters building this receiver will have to be very careful because at a certain point in the supersonic spectrum one runs right smack into an unknown field. There are human risks in the supersonic siren.

These were recently reported by Drs. C. H. Allen, H. Frings, and I. Rudnick, of the Pennsylvania State College.

While the siren cannot be heard by human ears, after a while, a person close to it gets dizzy. At certain supersonic speeds the sound kills insects by overheating their bodies. Indeed, at certain frequencies the siren heats anything the sound blast touches.

I had no trouble with my own siren because it runs at far greater speed than the normal supersonic whistles or sirens. But, if you experiment with it, necessary caution must be taken.

I must further report an incident which greatly grieves me and which shows once more that the path of the pioneer is not easy nor strewn with roses. I was asked to give a lecture on my new tubeless radio invention before a number of radio manufacturers at the New York State Radio College recently. A big crowd had assembled to listen to my revolutionary new radio receiver and

after a successful demonstration there was a tremendous amount of excitement among the milling crowd, who closely inspected my Tubeless Homo-Heteradio.

In order to answer a number of questions, the audience was seated again, while I proceeded to the blackboard in order to explain certain technical phases of the Heteradio.

In the midst of the lecture I was shocked beyond words when suddenly someone started to shoot at my Heteradio which was standing on a table at my right. It seems the madman had concealed a machine gun and it only took a few bursts to wreck every vestige of a receiver. I then heard of angry talk that a receiver of this type would certainly wreck the entire radio industry.

Evidently some fiend who thought I would take away his livelihood was bent on killing me, so I promptly took refuge under the table near the blackboard. Just then another round of bullets whizzed above me. There ensued a panic in the audience and in a few seconds the hall was cleared.

After a few minutes I ventured from my hiding place beneath the table. Just then there was another sound of something falling down—right beside me. I looked around, but there was no one in sight. Shaking and stupefied at the near tragedy I picked up the object that had fallen from the wall. It proved to be a large leaf calendar, such as used in schools. I picked it up gingerly. It had been riddled with bullets, but the date still remained intact. Mockingly it read:

APRIL 1.

## TINY SELF-POWERED ELECTRONIC VOLTMETER

(Continued from page 24)

little device, voltage multiplier and signal tracer probes were constructed. The voltage multiplier probe (Fig. 2) extends the range up to 5,000 volts, multiplying the existing ranges 10 times. With this probe, the effective input resistance is 75 megohms. The signal tracing probe (Fig. 3) makes it possible to use this instrument for simple r.f. and a.f. measurements. It cannot be used for exact a.c. measurements since the rectification efficiency of a crystal diode probe is not constant for varying voltages, and the d.c. output is not proportional to the a.c. input. Nevertheless it is very useful for making comparative gain measurements and checking antenna efficiency. For best results, voltages measured with this probe should not exceed 50. The effect of plate current on the meter is neutralized by applying some of the filament voltage across it through the 1,000-ohm potentiometer. The potentiometer is varied till the

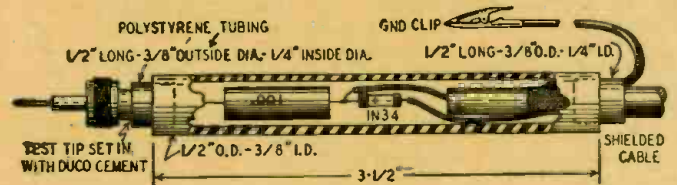

Fig. 3—This probe makes a signal tracer out of the v.t. voltmeter. The 1N34 rectifies radio and audio frequency at all signal levels.

meter reading is reduced to zero.

## Get Started in Radio



10 "HOW-TO-DO-IT" BOOKS

Get a solid foundation in radio by means of these 10c timely text books. Each clearly written, profusely illustrated, contains over 15,000 words. You'll be amazed at the wealth of information packed into these handy books. Excellent for reference—ideal for technical library. Your money back if not satisfied.

5 BOOKS for 50c

10 BOOKS for \$1.00

Sent to You Postpaid

- |  |  |
|--|--|
| No. 1—How To Make Four<br>Doyle Short Wave Sets                          | No. 6—How To Have Fun<br>With Radio      |
| No. 2—How To Make The<br>Most Popular All-Wave 1<br>and 2 Tube Receivers | No. 7—How To Read Radio<br>Diagrams      |
| No. 3—Alternating Current<br>for Beginners                               | No. 8—Radio for Beginners                |
| No. 4—All About Aerials  | No. 9—Simple Electrical Ex-<br>periments |
| No. 5—Beginners' Radio Dic-  | No. 10—Television                        |

Remit by check or money order—register letter if you send cash or stamps.  
**RADIO PUBLICATIONS**  
25A West B'way, New York (7)



# New SUPREME 1948 and F.M. Manuals



## BIGGEST BARGAIN IN RADIO DIAGRAM MANUALS

Make these two new mammoth volumes your money-saving source for data on all recently released receivers. Learn about modern circuit developments, be ready to repair any new radio no matter how complex. You pay only \$2.00 for each of these large manuals. With these two volumes on your workbench there is nothing else to buy, nothing else to pay—a whole year of radio diagrams and service data yours for a couple of dollars total. Again Supreme Publications beats all competition and gives radio servicemen greatest bargains in service information. Read about other volumes for previous years described at the left and below. **No-risk** examination granted to servicemen.

### F.M. and Television

Use this new giant manual of factory instructions for troubleshooting, repairing, and alignment of any 1947-1948 F.M. and Television set. Covers every popular make, including F.M. tuners, AM-FM combinations, and all types of television receivers. Detail circuit diagrams, theory of operation, test hints, alignment data, including both meter and oscilloscope methods. This is the material you need to fix any modern F.M. or Television set. Don't turn this profitable work away for lack of knowledge and information. Use this newest Supreme manual to save time and money on your very next F.M. job. Data presented on 192 large pages, 8½x11 in. Sturdy, manual-style binding. Just published. Special price.. **\$2.00**

### New 1948 Manual

Be prepared to repair quickly all new 1948 receivers. In this big single volume you have clearly-printed, large schematics, needed alignment data, replacement parts lists, voltage values, and information on stage gain, location of trimmers, and dial stringings, for almost all recently released sets. Makes toughest jobs amazingly easy. Find faults in a jiffy. Speed-up all repairs. The time saved on your next job will pay the \$2 bargain price for the complete manual—after that you use it FREE. A worthy companion to the 7 previous volumes used by over 120,000 shrewd radio servicemen. New manual covers models of 42 different manufacturers. Giant size: 8½ x 11 in. 192 pages + index. Manual-style binding. Price, only.. **\$2.00**

## FIND ALL RADIO FAULTS DOUBLE-QUICK

You can speed-up and simplify radio repairs with SUPREME PUBLICATIONS Manuals. Service radios faster, better, easier, save time and money, use these most-often-needed diagram manuals to get ahead, earn more per hour. For the remarkable bargain price (only \$2 for most volumes) you are assured of having in your shop and on the job, needed diagrams and other essential repair data on 4 out of 5 sets you will ever service. Every popular radio of all makes from old-timers to new 1948 sets, including F.M. and Television, is covered. Clearly printed circuits, parts lists, alignment data, and helpful service hints are the facts you need to improve your servicing ability. Save hours each day, every day, begin to earn more by making repairs in minutes instead of hours. Let these manuals furnish you with diagrams for 80% of all sets. There is no need to spend large sums for bulky, space-wasting manuals, or to buy additional drawings every few weeks; be wise, use SUPREME Manuals to get the most in diagrams and service data for the smallest cost.

## YOU CAN SERVICE ALL OLDER RADIOS WITH



**1947 1946 1942 1941 1940 1939 1926-38**  
**MOST-OFTEN-NEEDED RADIO DIAGRAMS** **DIAGRAMS**  
 Each manual has between 192 and 208 pages of diagrams and service hints; large size, 8½x11". Price, each. **\$2.00** | **240 Pages** | **Price \$2.50**

## Record Changers Manuals

### Post-War Models

Service expertly all new (1945-1948) record changers. Follow simplified factory instructions to make needed adjustments and repairs. Hundreds of photographs and exploded views; thousands of test hints; service instructions for all popular makes. Large size: 8½ x 11 inches. 144 fact-filled pages. Available at your jobber or post-paid, only **\$1.50**

### Pre-War Models

Just what you need to repair quickly thousands of pre-war (before 1942) automatic record changers, manual units, pick-ups, wireless oscillators, recorders, and combinations. Hundreds of mechanical and electrical diagrams. Instructions for adjustments and repairs. Most popular units of all makes. 128 large pages. 8½x11 in. Price, only **\$1.50**

See Your Radio Jobber or Send Coupon →

# Supreme Publications

PUBLISHERS OF RADIO BOOKS, MANUALS, AND DIAGRAMS

9 South Kedzie Ave.

Chicago 12, Illinois

RADIO-CRAFT for APRIL, 1948

## SATISFACTION GUARANTEED

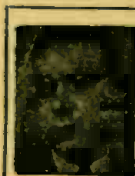

Compiled by M.N. Beitman, radio engineer, teacher, author, & serviceman.

Select Supreme Diagram Manuals and Record Changer Books you want to examine. See listing in left-hand column. Send the convenient no-risk trial coupon. Use the manuals in your own home or shop for 10 days at our risk. Decide for yourself that Supreme Publications are the greatest values in service data. You must be completely satisfied, or return manuals and receive your money back. Write today. We guarantee 24-hour service.

**Models Made by:**  
 R.C.A., Zenith, Philco, Sears, Fada, Emerson, Belmont, Detrola, Crosley, United Motors, G.E., Westinghouse, Arvin, Majestic, Stewart-Warner, Admiral, Delco, Stromberg-Carlson, Western Auto, Sparton, Motorola, Wards, Gamble, and many others.

## NO RISK TRIAL ORDER COUPON

SUPREME PUBLICATIONS, 9 S. Kedzie Ave., Chicago 12, ILL.

Ship the following manuals on trial under your guarantee of satisfaction or money-back.

- New F.M. and Television Manual \$2.00
- Post-War Record Changers..... 1.50
- Pre-War Record Players..... 1.50

I am enclosing \$....., send postpaid.

Send C.O.D. I am enclosing \$..... deposit.

- 1948
  - 1947
  - 1946
  - 1942
  - 1941
  - 1940
  - 1939
  - 1926-1938 — \$2.50
- PRICED AT ONLY \$2.00 EACH**

Name: .....

Address: .....

## OUTSTANDING VALUES



**Kit Model 210, a Three Way Portable Receiver**  
Operating on either AC or DC or self-contained batteries . . . power switch conveniently located on front of set so that "battery" or "AC-DC" may be selected without opening case. Five-inch Ainico 5 permanent magnet dynamic speaker, and case covered with weather tested aircraft material. Price of Model 210 complete with tubes . . . . . **\$18.95**

### ALSO AVAILABLE

**Model AC-7 Superheterodyne Receiver**  
was designed to give the student and radio enthusiast a 110 VOLT 60 CYCLE receiver . . . Simple to build and also one of excellent performance in the broadcast band range. This kit utilizes 1 stage of tuned radio frequency amplification in combination with IRON CORE antenna, R.F. and oscillator coils giving excellent selectivity and sensitivity over the entire tuning range. This receiver contains a full vision, 8" slide rule glass dial, a magic eye tube, and an 8" PM speaker and output transformer to match a 6V6 tube. Kit comes complete, ready for assembly.

### Multitester Kit Model M-3C

A versatile, compact multitester 4" x 7" x 3" using a 3 1/2" rd. meter of 1000 ohms per volt sensitivity. Employs the following ranges: Volts AC or DC 0/5/50/150/500/1500. Milliamperes D.C. 0/5/50/150. Ohms 0/2000/20,000/200,000. Price Complete **\$10.95**

### NOW READY

### Custom-Built Television Chassis

Complete with 12" tube . . . . . **\$300.00**  
with 15" tube . . . . . **\$350.00**  
Samples on display at our showroom.

Many other kit models available. Write for catalog M.

## RADIO KITS COMPANY

120 Cedar Street New York 6, N. Y.

## "DYNOPTIMUM" TUBE TESTER

Model 322



gives you more test features, at lower cost, than any other tube tester on the market. **now only \$37<sup>95</sup>**

Compare this value-packed instrument . . . feature for feature, performance against performance. You'll see instantly why you can be many dollars ahead with this unexcelled tube tester. Order today from your local supplier. Write direct for catalog.

- Accurate tests due to famous Dynoptimum circuit
- Easier to operate than other testers—only three selector switches
- Provides for quality—short—leakage and noise tests
- Up to date including miniatures and sub miniature tubes.
- Operating instructions and tube chart gives approximately 800 tube testings

R. C. P. INSTRUMENTS—BEST FOR EVERY TEST

## RADIO CITY PRODUCTS CO., INC.

152 West 25th Street, New York 1, N. Y.

## BRITISH RADIO DESIGN

(Continued from page 27)

In contrast to these, the Murphy U 102 seen in accompanying photographs may be described as the serviceman's joy. The chassis stands vertically in the tall, narrow cabinet, and can be withdrawn simply by removing 4 screws. The projecting metal straps permit its being placed in any position on a workbench without the risk of damaging tubes, components, or wiring. Every part of every circuit is completely accessible. Another advantage of this type of construction is that the tuning scale and tuning drive are rigidly mounted without brackets.

### Higher-class equipment

Turning to the more expensive receivers, the Ekco A 28 in Fig. 3 is one of the most interesting designs. The circuits of this set are by no means simple. Basically it is a superheterodyne with a magic-eye tuning indicator. Its com-

Negative feedback is carried out by means of a third winding on the output transformer. The feedback to the grid of V3 is divided into 2 branches, one going to a treble-boost filter and the other to a bass-boost filter. Both are continuously variable. The user can adjust the tone balance of the 10-inch loud-speaker's output to his own liking.

### An interesting short-waver

The last example is the Murphy A-104, a set designed to simplify tuning on the short waves. This again is a 4-tube-plus-rectifier set, only the circuits of the first 2 tubes being shown in Fig. 4. It achieves ease of tuning on the short waves comparable to that of the Ekco A28 by simpler and less expensive methods. The band switch, for instance, has only 5 gangs with 15 live contacts, in the place of 13 gangs with 59 live contacts. There is but a single short-

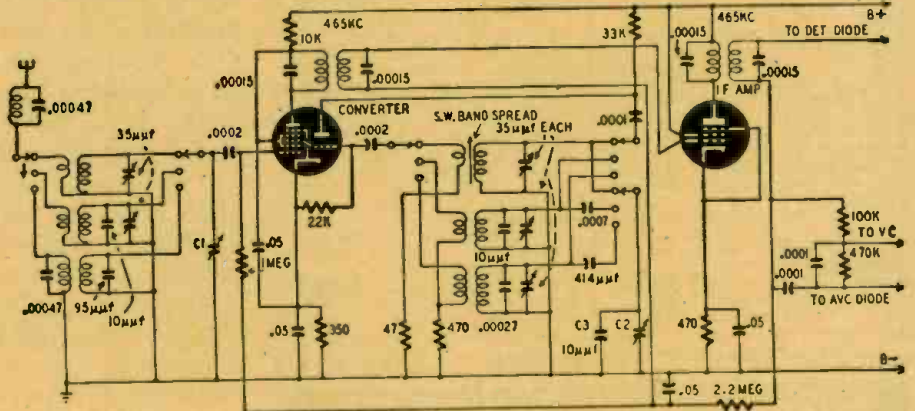

Fig. 4—The simple r.f. end of the Murphy A-104. Its tuning scale is over 50 inches long.

plexities are the band-switching and band-spreading arrangements, the tone control, the whistle filter, and the negative-feedback circuit. Besides the broadcast and long-wave bands with push-button tuning on 5 stations, the set covers the short waves from 5.8 to 21.7 mc and receives the sound accompanying television on 41.5 mc.

There are no less than 7 short-wave bands, each with full-scale tuning. As soon as the 13-gang band switch is tuned to one of the short-wave positions, the 2-gang variable tuning capacitor C1, C2 is automatically cut out; the oscillator is changed to the Colpitts type, and the ganged iron-dust cores of the master inductances L1 and L2 are moved inward or outward by the tuning drive. With this arrangement short-wave stations are as easy to tune in as those in the broadcast band. The 41.5-mc television sound channel is fixed-tuned, the second harmonic of the oscillator being used in conjunction with a setting on the 21-mc band.

With the European 9-kc separation between broadcasting channels, heterodyne whistles are apt to be troublesome. This receiver eliminates them with an acceptor filter tuned to 9 kc in the plate circuit of V4. It is a .005-µf condenser in series with a large iron-cored coil.

wave range, but so good is the band spreading on this range that the effective length of the tuning scale is over 50 inches! When the switch is turned to the short-wave position a window in the front panel lights up. On this is projected the optically magnified image of a portion of the scale. The actual scale is photographed on a glass plate fixed to the spindle of the 2-gang variable tuning capacitor and moves with it. Concentric with the main tuning knob is a smaller one, which controls the movement of a plunger in the oscillator plate tuning coil. A hairline indicator, yoked to the plunger, moves over the enlarged scale appearing in the window. The optical and electrical components are so well co-ordinated and the band spreading is even over the whole range and a station once logged always reappears at the same dial setting.

Later I hope to describe further British radio and television receivers. Some very interesting new types of both are coming along.

A handy hearing aid is reported by W. B. Hutchins of San Antonio, Texas. Besides acting satisfactorily as a hearing aid, it also brings in the programs of local station KFYM, which is about a block from Mr. Hutchins' place of business.



Lectures by M. N. Beitman, radio engineer, teacher, author, & serviceman.

Use my 19 years of Radio Experience To Double Your Earning Cut Servicing Time in 1/2

30 LECTURES COMPLETE ONLY \$3.00

GET ahead in radio servicing by using ideas and tricks of an expert. Add years of valuable experience to your present radio knowledge. Improve your servicing ability double-quick; avoid costly mistakes. Use

this new giant three-books-in-one lecture-manual of practical facts, time-saving hints, hundreds of circuits, suggestions, "know-how" tips, and explanations. Lick the hard cases in a jiffy. Find the cause of every puzzling radio defect. Benefit by using M. N. Beitman's 19 years of successful radio experience to your own advantage.

**BOOK ONE**

**BUSINESS SIDE OF RADIO SERVICING**

Four complete lectures by M. N. Beitman. Discussion of radio service problems. Opening and operating a radio store and shop. Selecting the right location. Store arrangement. Tested advertising ideas that cost little—bring big results. Window display suggestions. Service department. Model shop. What to charge. Bookkeeping and records.

**BOOK TWO**

**EQUIPMENT USED FOR LOCATING FAULTS**

Visual and aural time-saving methods. Meters, volt-ohm-milliammeters, related circuits. Vacuum tube voltmeters. Voltage and resistance point-to-point servicing. Tube testers (emission, leakage, dynamic, and mutual conductance types). Using a signal generator. Cathode ray oscilloscope as a servicing tool. Tuned signal tracers. Simplified signal tracing technique. Condenser testers. Bridges. Advanced test equipment. Twelve illustrated lectures on all modern test equipment.

**BOOK THREE**

**RADIO CIRCUITS AND TROUBLE-SHOOTING INCLUDING TELEVISION AND F.M.**

Fourteen easy-to-follow lectures on radio testing and making repairs. Tests for audio voltage and power amplifiers. Audio corrective circuits. Inverse feed-back. Phase inverters. Understanding impedance. Loud-speakers and output transformer matching. Function and adjustment of tuned circuits (a non-mathematical treatment for servicemen). Detector and AVC circuits. Troubles in R.F. and I.F. stages. Superhet converters and alignment hints. Power supplies: A.C., AC-DC, doubler types. Television facts. F.M. fundamentals and receiver description. Trouble-shooting and alignment in F.M. receivers. All 30 lectures of all 3 books, only \$3.00, see top of next column for more details.

**SOLVES ALL ADVANCED SERVICING PROBLEMS**

Let these lectures show you how to improve your store or shop to obtain free advertising for your business, what to charge, and how to keep records. Down-to-earth practical help on the business side of radio. Many lectures describing circuits, operation, and application of modern radio test equipment of every type. Meters, volt-ohmmeters, vacuum tube voltmeters, tube testers, analyzers, signal generators, oscilloscopes, signal tracers, condenser testers, Q-meters. Testers of R.C.A., Supreme, Weston, Superior, Meissner, Feiler, Bliley, Precision, and others completely described. Also fourteen lectures on radio circuits and advance trouble-shooting. See list of topics at left. Material on Television. Frequency Modulation lecture originally delivered by Westinghouse engineers.

**KNOWLEDGE TO PUT YOU ABOVE COMPETITION**

Complex and unusual radio faults may waste hours of your valuable time. The author has foreseen all possible problems (above the elementary level) and provided explanations and practical solutions in this unique on-the-job manual. Keep it on your work bench to aid and guide you on tough repairs. Use the thousands of hints and advanced servicing suggestions to speed up routine jobs. No other training book or course can compare to this new manual. Just published. Be first to use it and forge ahead of others. Learn to do complicated repairs in minutes instead of hours.

**LECTURE-COURSE WORTH \$60 YOURS FOR ONLY \$3.**

Think what it would have cost you to attend in person the 30 lectures completely printed in *Advanced Radio Servicing* manual. Perhaps \$60, maybe even more figuring carfare. But in this giant volume you have every word of all lectures, plus illustrations of every slide used, and many additional photographs and charts. And the special bargain price for the complete 30 lectures in the giant manual, as shown at the top of page, is only \$3.00, full price. Take advantage of this remarkable bargain and secure on "no-risk" trial this practical radio training that will add years to your own experience. Send coupon today. Examine and use material for 10 days under our satisfaction guaranteed or money-back terms.

**Guarantee**  
We guarantee you complete satisfaction or will refund your total remittance.  
SUPREME PUBLICATIONS

**SIMPLIFIED RADIO SERVICING**

A Companion Manual for Those Needing More Help



Use the job-sheets, blue-prints, and charts of this low-priced manual to brush up on elementary radio servicing. Explains parts, circuits, trouble-shooting, servicing with and without test equipment. Includes over 1,000 practical service hints, recommends hundreds of tests using a 5c resistor and a filter condenser. Full price only..... **\$1.50**

**NO RISK TRIAL ORDER COUPON**

SUPREME PUBLICATIONS, 9 S. Kedzie Ave., Chicago 12, ILL.

Please send manuals checked. 24-hour speedy service. You guarantee satisfaction or will refund my total remittance.

Advanced Radio Servicing, \$3.00  Simplified Radio Servicing, \$1.50  
New, 3-volumes-in-one manual Elementary Companion, Volume

I am enclosing \$..... send postpaid.  
 Send C.O.D. I am enclosing \$..... deposit.

Name: .....

Address: .....

**Supreme Publications**  
PUBLISHERS OF RADIO BOOKS, MANUALS, AND DIAGRAMS

See Your Radio Jobber or Send Coupon →



**YOUR DOLLAR  
BUYS MORE AT  
MID-AMERICA**

**PERMEABILITY TUNER**

Build a really HOT 5 or 6 tube AC-DC superhet receiver! Takes place of old-style band condenser, rf and antenna coils; regular 455 KC intermediate frequency. Complete with permeability tuned oscillator coil, 4" x 2 1/2" x 2 1/4" diameter dial drum. Order MA-2169 Loop Antenna 15c; and MA-2914 drilled, punched Chassis 39c. **MA-2167 \$124**

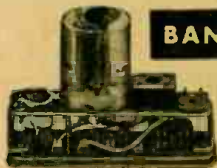

**BANTAM 1-WATTER**

BCR-746-A tuning unit used as foundation for Bantam 1-Watter described in Jan. 1948 QST. Makes tiny crystal-controlled CW xmitter. Measures only 3 3/4" long, 2 1/2" high, 1 1/2" wide. Requires only 1 1/2 volts "A", 30 to 90 volts "B". Draws 8 to 15 ma under load. Supplied less crystal, IS4 tube and plug-in coil. MA-907. **24c**



**DACO TUBE TESTER**

Tests performance, leakage, shorts in ALL receiving tubes, even sub-miniature and acorn. Fully shielded, dust-proof case. High-visibility meter. Illuminated chart. Tests every tube element. 110 volt AC. MA-2193. **\$29.50**

PORTABLE TUBE TESTER, same as above with case. MA-2194. **\$32.50**

**MINIATURE TUBE-PIN STRAIGHTENER**

Steel die for straightening pins on fragile miniature tubes (1S5, 6AK5, 9002, 35W4, etc.). Quickly aligns pins. Simply plug tube into die. Only 1 1/4" high with 1 1/2" mounting centers for bench installation. MA-2139. **27c**

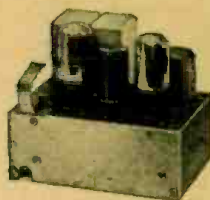

**CRYSTAL OSCILLATOR UNIT**

Used as frequency standard. Unique sub-assembly: 12SL7GT twin triode combination 200 KC calibration oscillator, frequency tripler; 12SA7 converter; 12SL7GT signal detector, MGV audio oscillator (1000 cycle note). Frequency divider and multiple circuits provide 50KC fundamental, harmonics to 18 mcs. Shipped with tubes, schematic diagram, less 200KC crystal. MA-OSC-3T. **\$2.95**

**ORDER FROM THIS AD!**

Quantities are limited, so get your order in now! Minimum order shipped, \$2.50. Send 25% deposit, balance COD. Get on our mailing list to receive BIG BARGAIN BULLETINS that list latest, greatest buys in radio parts, electronic equipment. Send orders to store address. Desk RC-48

**MID-AMERICA CO. Inc.**

STORE: 2412 S. Michigan Ave. Chicago 16, Ill.  
WAREHOUSE: 2307 S. Archer Ave. Chicago 16, Ill.

**INTRUDER ALARM**

(Continued from page 25)

age appears on its grid as negative bias. Under normal conditions, the 50L6 plate current is just sufficient to throw the relay.

A 50,000-ohm, wire-wound control permits the screen-grid voltage to be varied from 90 to about 115, thus controlling the sensitivity of the unit by varying the amplification of the 50L6.

When anyone nears the feeler, the oscillator is detuned and the plate current rises, producing a greater voltage across R1. The 50L6 plate current is cut off or reduced to a point where the relay drops out, opening or closing the external alarm or control circuits connected to the relay contacts.

The relay is an 8,000-ohm, s.p.d.t. unit designed to close at 3 ma and open at 0.6 ma. It was made by Sigma and is a popular surplus item. Its armature and movable contact are connected to the frame, so we mounted it on insulating material before fastening it to the chassis. Other relays of equal sensitivity will work just as well, of course. Remember that the relay is tripped under normal operation. If you want an external circuit to close when the capacity relay operates, the plate relay should have normally closed or double-throw contacts. Contacts on sensitive relays are seldom designed to carry more than 1 amp; use an auxiliary relay if heavier current flows in the controlled circuit.

The unit was built on a 7 x 4 x 2-inch metal chassis. The third tube shown in the photograph is not used. The chassis was left over from previous experiments, so a dummy was plugged into the empty socket to improve the appearance of the unit. The electrical circuit is isolated from the chassis to avoid possibility of shock. Some constructors may find it advisable to shield the entire control unit so the relay will not trip when you approach it.

**Operation and adjustment**

When the unit is wired and checked, turn it on and measure the voltage between the 12J5 grid and the bottom of the oscillator coil. Be sure to use a v.t.v.m. or sensitive d.c. voltmeter—20,000 ohm per volt or better. Voltage at this point indicates oscillation. We measured 5 volts at this point with a v.t.v.m., but voltage varies with different tubes and operating conditions.

(If the oscillator is adjusted to about 550 kc, you can check for oscillation by listening for the fundamental or harmonics on a near-by broadcast set.—Editor)

With C1 at full capacitance, resonate the plate circuit. Resonance can be indicated by temporarily connecting a low-range d.c. milliammeter between the plate coil and R1.

If the relay has adjustable contacts, adjust them so there is very little space between the armature and fixed contact when the relay coil is excited. This adjusts the plate relay to its most sensitive point.



**Train for Good pay in ELECTRIC MOTOR REPAIR**



The busiest, most profitable electrical service of all!

ELECTRIC MOTOR REPAIR is a big, 570-page training book that can quickly help you learn this important work at home—for only \$5 for the complete course. Written especially for beginners. Tells what to do—exactly how to do it. Everything is explained simply, thoroughly and understandably. Based on what can be learned from this big book alone, you can train for prompt, profitable service on practically every electric motor in common use.

**AN UNCROWDED, BIG-PAY FIELD!**

The electric motor repair expert is a valuable, well-paid man. There are big opportunities for the work almost anywhere. Statistics show there are 11 electric motors in the average small American home. Big homes have many more—in oil burners, air conditioners, record players, cleaners, refrigerators, clocks, mixers, fans, washers, etc. And there are millions more in industry! Good motor repair men are scarce. Even many big appliance shops must send motors back to the factory for repair or to motor specialists!

ELECTRIC MOTOR REPAIR book teaches you the work from the beginning. Every important step is demonstrated both in text and visually by more than 900 special illustrations. Quick reference guides show how to handle specific jobs. Widely used for training beginners and for daily reference in busy motor shops. Covers practically every modern motor type and BOTH mechanical and electrical motor control systems. Unique Duo-Spiral Binding divides book into 2 sections so that both text and related illustrations can be studied together.

**BORROW IT FOR 5 DAYS ALL THIS... for only \$5!**

Send coupon now. Practice from ELECTRIC MOTOR REPAIR for 5 full days. See how interesting the work is—how rapidly it can be learned. Then, if not more than satisfied, return book and your money will be cheerfully refunded and no questions asked!

ELECTRIC MOTOR REPAIR includes complete discussions of motor parts, connections, reversing, trouble analyzing procedure, re-winding, etc. Gives full instructions on split phase motors; capacitor motors; repulsion-type; polyphase; alternating-current and direct-current types; universal, shaded-pole and fan motors; d.c. generators; synchronous motors and generators, etc., as well as motor control units.

**YOU CAN'T LOSE ON THIS OFFER!**

Dept. RC-48, Murray Hill Books, Inc.  
232 Madison Ave., New York 16, N. Y.

Rush me a copy of "ELECTRIC MOTOR REPAIR" for which I enclose \$5 (\$5.00 foreign); or  send C.O.D. (in U.S.A. only) for this amount and I will pay postman \$5 plus postal charge when he delivers book. If book is not what I need, I'll return it within 5 days and you guarantee to refund my \$5.

Name .....

Address .....

City & Zone..... State.....

Attach the antenna or feeler, and open C1 slowly until the relay armature is attracted. Keep away from the feeler when making this adjustment.

When the unit is properly adjusted, there is about 35 volts of bias on the 50L6. When anyone approaches the feeler, this voltage rises to about 40, cutting off plate current and releasing the relay. These voltages vary slightly with different tubes, so try different ones if you have trouble with the circuit. Other combinations of tubes can be used by selecting the proper filament dropping resistor.

### TRANSATLANTIC NEWS

(Continued from page 38)

important aids to radar mapping. Thanks largely to the miniature radio tube, it is now so small and light that the ground survey parties can transport and install it, even in the most difficult country—and a small number of radio beacons, accurately placed, makes it possible to survey a vast tract of land from the air.

### Table lamp radio

The latest type of invisible home radio hails from France. It looks exactly like any ordinary table lamp, with a frilly silk shade. But built into the pedestal is a 3-tube superheterodyne. The loud-speaker (concealed by the shade) is just below the light-bulb socket, and the wire frame supporting the shade forms the antenna. The set is intended only for local reception. A single small knob operates preset tuners to give a choice of 5 stations. The idea of a table lamp radio is not new. I recall reading about 25 years ago in an American magazine an article called "Reading by Audion Light." It describes a receiving set, using the original battery-operated audions, made in the form of a hanging lamp. The 5 tube sockets were arranged so that the tubes were upside down and threw all the light from their filaments on to the table below. As the audions were bright emitters requiring about 3/4 amp at 4 volts for their filaments, the 15 watts consumed by the 5 tubes in the set should have given the ingenious inventor quite a reasonable amount of light for his reading.

The French government levies a tax on all radios—500 francs on the first one, and 100 francs for each additional set. In return it is responsible for eliminating all sources of noise interference from the radio. Thirty technicians—members of the government's "parasitic service"—cover Paris and the surrounding area to check on all reports of interference. About 7,000 investigations are made each year.

Locating the trouble is not easy, since all electric conductors and appliances are possible transmitters of parasitics. Frequently, the interference comes from a doctor's old-fashioned diathermy machine or an electric razor. The owners of these noisemakers are legally subject to fines and imprisonment, but those who refuse to correct abuses are the most likely to be punished.

# MAKES 90 OUT OF 100 RADIO TROUBLES Easy to Repair!

Complete, Easy Instructions for Repairing Common Troubles in Practically Every Model and Make of Radio in Use Today



**Eliminates Needless Testing—Enables You to Repair Two Radios in the Time Ordinarily Required for One**

What's wrong with the radio you want to repair? A defective transformer? Wiring insulation trouble? A faulty capacitor or resistor? Don't guess! Don't waste time in needless, tedious testing! Just look up that particular make and model in Ghirardi's famous RADIO TROUBLESHOOTER'S HANDBOOK. Nine times out of ten, this big book will tell you exactly what is wrong—and exactly how to repair it. You don't have to be an expert to use the HANDBOOK—and there's no better way of getting invaluable, practical service training.

**TELLS WHAT TO DO • EXACTLY HOW TO DO IT**

As valuable to a radio repairman as a recipe book is to a cook!

**\$5** 744 big, manual-size pages!

**PAYS FOR ITSELF ON THE FIRST JOB!**

Over 400 pages are chock-full of this factual Case History repair data on over 4,800 receivers, auto radios and record changers of 202 different manufacturers—practically every radio set in use today! Over 300 additional pages contain hundreds of repair charts, tube charts, data on tuning alignment, transformer troubles, tube and parts substitution data, color codes—all designed to help you repair any radio ever made EASIER, BETTER and FASTER. Ideal for either busy service shops or for beginners. Only \$5 complete—on our 5-day Money-back Guarantee basis.

### DO EVERY JOB EASIER, BETTER, FASTER

Ghirardi's RADIO TROUBLESHOOTER'S HANDBOOK (above) is the ideal book for training new helpers, repairing either cheap or expensive sets quickly and profitably, eliminating needless test time and equipment—and MAKING MORE MONEY.



# ALL THE SCIENCE OF RADIO-ELECTRONIC SERVICING IN ONE GIANT BOOK

**A Complete Course for Service Beginners...Ideal As a "Refresher" for Those Already in Business**

Alfred A. Ghirardi's MODERN RADIO SERVICING gives you a COMPLETE, MODERN EDUCATION in truly professional radio-electronic service methods of the kind that will be your "Open, sesame!" to the big-money opportunities that only well-trained servicemen are in a position to grasp. It is a complete, scientific servicing course from A to Z. You'll be surprised how easily understandable it makes every phase of the work even if you have had no previous service training. And, if you are already in the business, you'll be pleased to learn how this big 1300-page book will serve as a "refresher" course. Not only will it help you handle repair jobs quicker, better and more profitably, but it also will give you the necessary basic training to equip you for profitable industrial electronic work. Specifically written and designed for home study. 1300 pages; 706 clear illustrations. 720 Self-Test Review Questions make it easy for you to check your progress every step of the way. Fully indexed. Only \$5 on our famous 5-Day Money-back Guarantee.



1300 pages  
... Over 300 illustrations!

### ENDORSED BY EXPERTS

MODERN RADIO SERVICING brings you the kind of professional "Know How" that will pay big dividends for years to come. Covers test instruments and their use, preliminary trouble checks, scientific circuit analysis and trouble-shooting, parts repair and substitution, how to start a successful service business and hundreds of other subjects.

### MONEY-BACK GUARANTEE

MURRAY HILL BOOKS, INC., Dept. RC-48, 232 Madison Ave., New York 16, N. Y.

- Enclosed find \$..... for books checked; or  send C.O.D. (U.S.A. only) for this amount plus postage. I may return the books for refund within 5 days if not fully satisfied.
- RADIO TROUBLESHOOTER'S HANDBOOK \$5 (\$5.50 foreign)
- MODERN RADIO SERVICING \$5 (\$5.50 foreign)
- MONEY-SAVING COMBINATION OFFER: Both of the above big books, only \$9.50 (\$10.50 foreign)

Name .....

Address .....

City & Dist. No. .... State .....



### SPECIAL OFFER!

Let TROUBLESHOOTER'S HANDBOOK save you time on common service jobs! Let MODERN RADIO SERVICING train you for complete professional, electronic work. Get BOTH BIG BOOKS at the special price of only \$9.50. Send coupon today!

# THE DIFFERENCE IS IN THE LISTENING PLEASURE

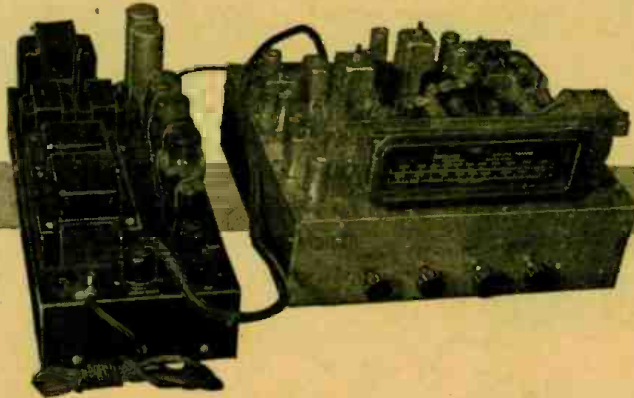

## Meissner MODEL 9-1093 AM-FM TUNER AND AMPLIFIER

If you appreciate the best — then this MEISSNER tuner is for you! As shown above, it is delivered complete with tubes, two antennas and all hardware required to mount chassis units in cabinet. The antennas consist of a low impedance 12" x 16", noise reducing loop for AM broadcast and an indoor type folded dipole, 300 ohm, for FM broadcast. Cabinet and speaker not included.

- Power output of 18 watts at less than 2% harmonic distortion.
- Audio fidelity, flat within plus-minus 2db. from 50 to 15,000 CPS.
- Frequency ranges, 535 to 1620 KC. (AM Band) and 88 to 108 MC (FM Band).
- Hum level, 65 db. below full output.
- Sensitivity, less than 20 microvolts.
- Phonograph Input, compensated for either magnetic or crystal pickup.

- Tone Control, combination control provides bass boost up to 11db. at 40 CPS and treble attenuation up to 13db. at 10,000 CPS.
- Power Supply, 105 to 125 volts, 50-60 cycle. Consumption, 190 Watts.
- Tube complement, 3 type 6SK7, 1 type 6SA7, 1 type 6H6, 5 type 6AG5, 1 type 6C4, 2 type 9001, 1 type 6AL5, 2 type 6J5, 1 type 6U5/6G5, 1 type 6SN7GT, 2 type 6L6, 1 type 5Y3G and 1 type 5V4G.
- Chassis Weight, tuner, 18 pounds, amplifier, 27 pounds.

# MEISSNER MANUFACTURING

DIVISION OF MAGUIRE INDUSTRIES, INC.  
MT. CARMEL, ILL., U. S. A.

### GIANT PENNY SALE EXTENDED THROUGH APRIL 30 PAY 1¢ MORE — GET 2

Your tremendous response made us hunt up more items we know you need—because you asked for them. GREATER BUYS THAN EVER! PHENOMENAL BARGAINS EVERY ONE!  
For example a G.M. Relay #13016 4PDT 240 ohms 24v D.C. 10 Amp Contacts. No. R16 sells for \$1.25. YOU GET 2 FOR \$1.26.  
A Weston Model 301 50-0-50 D.C. Ma 3 1/4" NEW No. M11 sells for \$4.95. YOU GET 2 FOR \$4.96.  
Chokes, resistors, Ceramic Sockets, High Voltage Transformers, Relays, Selenium Rectifiers, Westinghouse Meters, Connectors, Rheostats, Condensers, Tubes and hundreds of other parts.  
WRITE FOR SPECIAL SALE CATALOGUE—FOR THE BUYS OF A LIFETIME!

**Universal/General Corp.**  
365 Canal St., New York 13 (Dept. C-R) Walker 5-9642

**CORRECTION:** The grid of V120A in the RCA 630TS Televiser Schematic, January, 1948, page 49, should be connected to pin 1, not pin 4 as shown.



## STEADY PROFITS

### YOUR OWN BUSINESS with **CORADIO** The Coin Operated Radio

Place these specially built radios that play 1 or 2 hours for 25c in the thousands of available hotel rooms, tourists courts, etc. They yield immediate profits and steady income. Install Coradio, the finest made. Limited capital required. Send for further information. Write today.

**CORADIO** Coin Operated Radio  
108 W. 31 Street Dept. RC, New York 1, N. Y.

## tone control (Continued from page 35)

low end or the high end? Aren't tone controls desirable to compensate for unbalance in other parts of the system?" That argument is right and proper, so I shut up.

I breadboarded. I spent my evenings for some time reading up on controls, trying them out and wondering what made them work. Finally I saw what was going on. All I wanted was an a.c. voltage divider that used reactances in one leg. Something that would give a different ratio at one frequency than at another.

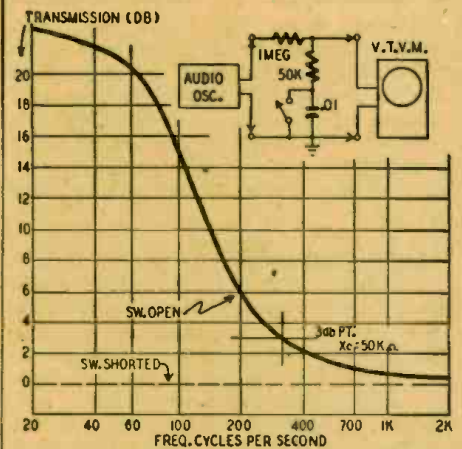

Fig. 2—Operation of the bass-boost circuit.

This is what I ended with: Fig. 1 shows the basic circuit for lows. Close the switch and you have a normal voltage divider.

$$\text{Output is } \frac{R2}{R1 + R2} \times \text{input.}$$

Now let's open our switch—the condenser then comes into the circuit. At low frequencies the reactance is high and we have an output:

$$\frac{\sqrt{R2^2 + XC^2}}{\sqrt{(R1 + R2)^2 + XC^2}} \times \text{input.}$$

We can easily pitch that anywhere we want by juggling the size of C and R2. We will end with a curve like Fig. 2. The bass rise will start up and be 3 db where the reactance of C equals R2. It will go up at a rate that approaches 6 db per octave until it starts to level off. The leveling-off spot (3 db from the top) will be where R1 equals the impedance to ground or  $(R2^2 + XC^2)^{1/2}$ .

O.K. you say, but you're still not boosting the bass! You're just cutting down the treble. That's right, but you don't have to look at it that way. You can say this is a filter with an insertion loss of N db. When the switch is flipped, you get a bass boost of 0.8N db. Try it and see. You can make the resistors 1 meg and 50,000 ohms, which will give an insertion loss of 26 db and a bass boost of approximately 20 db (when you flip your switch). Make C a .01-µf condenser, and the bass rise will start around

400 cycles and go up very nicely. What's that? You want smooth control and not 20-db boosts? Okay, take out the switch and put in a potentiometer. Try a 500,000-ohm pot and see how nicely you can bump up the bass in your radio programs.

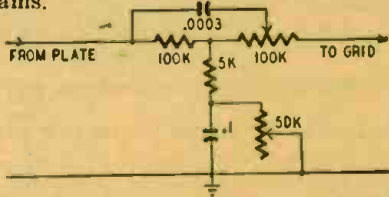

Fig. 3—A treble boost condenser is included.

How about treble? Easy! Now we want a series condenser instead of one to ground. Let's put an isolating resistor at the output of our bass booster and run a condenser across it to the input of the next stage. Since we have pretty high resistances it will have to be a small condenser to have just the highs affected, so let's cut everything down by 10. We can use a 100,000-ohm, series-dropping resistor, 5,000 ohms in the leg to ground and, a bass condenser of 0.1  $\mu$ f. Then let's use another 100,000 ohms to isolate the back end, and fool around with different-sized condensers for the treble. A .0003 mica seems about right. The treble rise begins around 2,500 to 3,000 cycles. Amazingly enough, that's where the reactance of the .0003 condenser equals the 200,000 ohms in parallel with it. Fig. 3 shows how it works.

That one can be made smoothly adjustable too. Let's make the isolating resistor a 100,000-ohm variable. Then the condenser will slide back to where our bass-boost voltage divider will keep any highs from getting through, or slide up toward the next grid where our highs will pound out like mad.

Here's something to remember: if you keep your resistances and reactances in the same proportion, you can multiply your constants by 10 or 1/10 or anything else. That means you can juggle things around to suit varying conditions. If this circuit is to follow a triode with low plate impedance, keep the 100,000 ohms, 0.1  $\mu$ f, and 5,000 ohms. If you are using a pentode, you'll lose gain with it because a pentode likes a higher load resistance. O.K. then, change to 1 megohm and .01- and 50,000-ohm values. It'll still act the same. If you want your bass or treble boosts to come lower in the audio band, just increase the capacitance a bit; if you want higher boosts (louder, I mean), juggle your resistance ratio. I prefer these sample values because they suit my ear and my turntable rumble. Don Lee put out something like \$1,500 for his turntables because he wants the rumble to be very low. Us guys with our \$10 motors—we can't boost our bass too much or we listen to rumble instead of music. Don't forget, too, that we are throwing away gain with this business. We throw away 26 db with these constants and get about 20 db back at the extreme ends of the band. Our middle is still down 26 db. So let's plan on having an extra 26 db of gain somewhere else in our system.

(Continued on page 72)



TROUBLE-FREE SERVICE from  
STANDARD BRAND PARTS  
RCA • Ampertite • Simpson •  
Jensen • Stancor • Ohmit •  
Shure • Billett • Dumont •  
IRC • Triplet • Sprague •  
Cornell-Dublier • Meissner  
and hundreds of other  
MAIL COUPON FOR FREE COPY

# FREE!

## NEW COMPLETE Concord RADIO CATALOG

160 Value-Packed Pages of the  
Latest and Best in RADIO • TELE-  
VISION • Electronic Equipment!

The Only Complete Up-to-the-Minute Catalog  
of Radio Parts — Sets — Amplifiers — Testers —  
Ham Gear — Kits • Immediate Shipment.

### Save on Values Like These!



#### Automatic Record Changer

Simple to operate, simple gearless foolproof mechanism. Plays 10 twelve inch or 12 ten inch records automatically. Lightweight high fidelity crystal pickup, only 1 1/2 oz. needle pressure. Overall size: 10 1/2 x 12 1/2 x 8", requires 6" above the motor board and 2" below. With mounting hardware. Shpg. wt. 20 lbs.

**X184AD.....\$12.95**

Walnut finished mounting base for above changer, 12 1/2 x 11 3/8 x 2 1/4. C22361—AD.....\$1.95



#### Seeburg Intermix Changer

New Seeburg "Intermix" changer designed to handle up to 12 ten inch or twelve inch records intermixed. Automatically shuts off after last record is played. Simple to operate—easy to load and unload. Overall size: 14 1/2 x 14 1/2 x 7 1/4". Requires 4 1/2" above the motor base and 2 1/2" below.

**5B9576AD.....\$37.50**

**Dynatenna FM Antenna**

The STROMBERG-CARLSON Dynatenna folded dipole antenna designed for use with all FM receivers. Insures maximum efficiency of receivers over entire FM band. Adjustable dipoles calibrated for both new and old FM band give optimum reception of stations in the vicinity. Plastic mounting block allows setting for either vertical or horizontal polarization. Complete with 60 ft. twin lead-in, insulators, hardware and instructions.

**5B9578AD.....\$4.95**

#### Special Photoflash Condenser

• Special Low Price  
• High Energy Rating  
• Small, Lightweight  
Small lightweight photoflash condensers. Peak voltage 2500, energy storage 21.9 watt seconds, capacity 7 mfd. Good results possible with just two condensers, professional results can be obtained by using 3 or 4 condensers connected in parallel. A real buy at this special low price.

**5B3240AD.....\$3.95**

#### Reliance Volume Controls

Guaranteed quality at low prices. Full length shaft. Standard 1/4" bushing. Switches are affixed, SPST. \*have audio or antenna taper, others have linear taper.

Less Switch	With Switch	Ohms
C8112AD	C8123AD	25,000
C8115AD	C8119AD	50,000
C8114AD	C8129AD	100,000
C8116AD	C8120AD	250,000
C8117AD	C8121AD	500,000
C8113AD	C8128AD	500,000
C8118AD	C8122AD	1 megohm
C8105AD	C8127AD	1 megohm
C8111AD	C8133AD	2 megohm

Less Switch, each.....34c  
With Switch, each.....44c

#### Selenium Rectifier

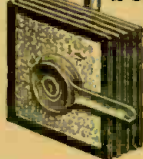

• No Warmup  
• Easily Installed  
• Costs Less  
Saves space—only 1 1/4 x 1 1/4 x 11-16"—fits where tube won't. Costs less than tube and socket eliminated. Long life, built to last the life of set. Rated at 100 ml. Connect two to deliver 250 volts at 80 ml. from 117 V A.C.

**C10560AD.....75c**

#### 6-in. PM Speaker



High quality all purpose 6" PM speaker. High permeability permanent magnet. One-piece seamless cone, plated metal frame. Voice coil impedance 3.2 ohms. 6" diameter, VC dia. 1/4". Normal output, 4 watts, peak 6 watts. Depth 2 1/8-16". Less output transformer. Shpg. wt. 3 lbs.

**X144AD.....\$1.79**

#### 15-in. Dynamic Speaker



Excellent constructed high quality 15" dynamic speaker. Designed for general applications such as FM and AM receivers, fine phonographs, broadcast and recording monitoring and public address systems. 16 ohm voice coil impedance. Field 12,500 ohms. Dustproof spider and voice coil construction.

**5B7015AD  
\$12.95**

# CONCORD

RADIO CORPORATION

CHICAGO 7 ATLANTA 3  
901 W. Jackson Blvd. 265 Peachtree St.  
Downtown Chicago Branch: 229 W. Madison  
Lafayette Radio Corp.

Concord Radio Corporation, Dept. 144  
901 W. Jackson Blvd., Chicago 7, Ill.  
Yes, rush FREE COPY of the comprehensive  
new Concord Radio Catalog.

Name.....  
Address.....  
City.....State.....

# LEEDS

The Home of RADIO

## In Our 26th Year

### Quality - Price - Dependability

#### CS—DIFFERENTIAL RELAY

Dual coil with armature pivoted between coils. All contacts normally open. Operates 220-250 Volts. 8000 Ohms each coil, contacts S.P.D.T. Controls rated 2 amps. at 110 VAC. Ideally suited for balanced or bridge type circuits where limited current or power is available. Will withstand 12 G Vibration up to 60 cycles at 35,000 feet altitude.

Special low price ..... **95c**



#### STEEL CHASSIS

10 x 17 x 3.....	\$1.38	11 x 17 x 3.....	\$1.66
5 x 10 x 3.....	87c	13 x 17 x 3.....	\$2.22
7 x 13 x 2.....	96c	7 x 7 x 2.....	63c
10 x 14 x 3.....	\$1.35	4 x 17 x 3.....	99c

#### STEEL CANS AND BOXES

4 x 4 x 2.....	68c	12 x 7 x 6.....	\$1.69
4 x 5 x 3.....	78c	15 x 9 x 7.....	\$2.35
6 x 6 x 6.....	99c	11 x 12 x 8.....	\$2.25

#### 1/2 INCH STEEL PANELS

5/4 x 19.....	87c	10 1/2 x 19.....	\$1.22
7 x 19.....	96c	12 1/2 x 19.....	\$1.46
8 1/2 x 19.....	\$1.10	14 x 19.....	\$1.62

#### 1/2 INCH ALUMINUM PANELS

5 1/2 x 19.....	\$1.74	8 1/2 x 19.....	\$2.25
7 x 19.....	\$1.84	10 1/2 x 19.....	\$2.87

All above Black Crackle finish. Grey panels to order.



#### ATTENTION!! ALL SCR-522 OWNERS

Remote Control Boxes for SCR 522's. Brand New in Original Packing; Consists of 5 push button switches, 5 Western Electric Pilot Assemblies, with Pilot Bulbs and Dimmer, and lever Switch all finished in Black Crackle. Order yours Today for only..... **\$1.25 ea.**

Antenna Plug 46-PS-1 for 522A ..... 15c ea.

#### POWER TRANSFORMER

655-0-655 volts @ 320 mll. 110 volt AC Primary. Thordarson power transformer, fully shielded. Net weight approx. 17 lbs. Special..... **\$4.95**

#### FILAMENT TRANSFORMERS

6.3 volts @ 6 amps. A swell buy ..... \$1.50  
10 volts @ 8 amps. 7500V Insulation ..... \$3.84

#### OIL FILLED CONDENSERS

1 Mfd. 600 VDC...35c      7 Mfd. 330 VAC. \$1.25  
2 Mfd. 600 VDC...35c      0.1 Mfd. 7500 VDC. 1.50  
10 Mfd. 600 VDC...98c      2x.1 Mfd. 7000 VDC. 2.00  
2 Mfd. 1000 VDC...69c      .02 Mfd. 8000 VDC. .98

SPECIAL 16 Mfd. 400 VDC W.E. ....98  
1 Mfd. 5000 VDC Solar .....2.95

#### MICA CONDENSERS

.01-600V Postage Stamp      Each 5c  
.003-2000V Postage Stamp      100 for \$4.75  
.006-600V Postage Stamp

#### DYNAMOTOR 5047

D.C. input 27.0 volts at 1.75 amps.      95c each  
D.C. output 285 volts at .075 amps.  
Continuous Duty Rating. Brand New.

#### 5 BPI CATHODE RAY TUBES

5" Green Screen. Brand New in original cartons. You'll want a few at this low price... **\$1.45**

832 TUBES—Brand New, Guaranteed.      \$2.15  
Special .....

#### Wire Wound Potentiometer

100,000 ohm, precision made. G.R. type, 25 watt, 6" diameter. Brand new..... **\$1.95**



Heineman Circuit Breakers      95c  
3 & 5 amp. sizes.....

#### RADIO TRANSMITTER & RECEIVER APS-13

17 Tubes

410 - 420 Mc. light weight fully enclosed, 30 Mc. IF, complete with tubes 5-846; 8-6AG5; 2-2D21; 1-VI-105; Schematic supplied with each unit. Only **\$11.95**



#### Items You May Be Looking For

In-23A X-Tal Diodes 35c each 3 for.....\$1.00  
Mike to Grid Ouncer Transformer 25:1 Ratio Low to High Imp. 35c each 10 for .....\$2.95  
Arc-5 Silver Plated Banana Plugs per doz .....10c  
De Jur Wire Wound Pot 20,000 Ohm. 12 watts .....49c  
Meissner Shielded 2.5 MA RF Choke .....19c  
R8-8 Octal Sockets low loss bakelite .....8c  
1/100 amp. instrument fuses 8AG size per 12 .....50c

DM-43A DYNAMOTOR. Manufactured by G. E. Nov. Input 24v @ 23 amps. 7500 RPM; output 515/1030/278 v. @ 215/260 milliamps; filtered. Special ..... **\$2.95**

#### Well Known Make CONDENSERS

Oil Filled 2 Mfd.—10,000 volt D.C. Height 11 inch, width 1 1/4 inch, depth 3/4 inch. Connecting insulators are 3 inch high, 2 inch in diameter. Net weight 36 lbs. Pfd. 1001-23. They are Brand New and the list price has been \$192.00. If you can use them rush your order, they won't last long at this special price of ..... **\$13.95**

If not rated 25% with order, balance C.O.D. All prices F.O.B. our warehouse New York. No order under \$2.00. We ship to any part of the globe

## LEEDS RADIO CO.

75 Vesey Street Dept. RC4  
Cortlandt 7-2612 New York City 7

## BONAFIDE VALUES

**SHURE T17B**  
Push Button Carbon Mike  
**88c**  
With Cord and Plug  
Value \$12.00

**2 TUBE PHONO OSCILLATOR**  
 Complete with tubes. 3525, 12SK7. Use with record player, and tune in on any radio. Complete. All Wired ..... **\$4.75**

**3 Tube PHONO AMPLIFIER** Volume and tone control ALL WIRED with Tubes.....**\$4.95**

**WEBSTER #156 CHANGER AUTOMATIC STOP** ..... **\$25.95**

**G.I. RECORDER AND PLAYBACK CRYSTAL CUTTER** ..... **\$19.95**

**G. I. OR DETROLA RECORD CHANGER**  
Plays 10- and 12-inch records. **\$14.49**

Telescopic Aerial—8 ft., 8 Section—Brass — With Mounting Bracket... 1.79  
With Heavy Shielded Lead ..... 2.19

25% Deposit, Bal. C.O.D. Plus Charges Write for Latest Catalog  
**BONAFIDE RADIO CO.**  
89 1/2 Cortlandt St., Dept. J, N.Y.7, N.Y.

## TONE CONTROL

(Continued from page 71)

Another thing. This whole system merely illustrates a method of correcting tone. You can use any part of it anywhere in an amplifier if you keep your levels and impedances in mind. To get 1 volt out at 1 kc, you have to put in 21 volts. So don't try to get 20 volts out. Not many tubes will put 400 volts in. Also if you run in a millivolt, you'll get only about 1/20 millivolt out; and that's pretty low, and you may have troubles with hum.

The hum has to be kept down with any system that boosts bass. You can shield your early filaments or even use d.c. if the level is very low and you want a lot of bass. Care in layout and wiring is most important. A 100-ohm potentiometer across the filament leads with the center to ground is handy. Most filament center taps aren't at the center, and you can balance out hum beautifully with a potentiometer. This was standard practice in the old receivers which used 26's and 45's in the audio end, and some of them had pretty good quality!

We arrived at this particular system by trial and error and fooling around. Others have also arrived at it. In case you never ran across it or in case you never understood it—here it is. The controls are completely independent of each other, and you'll be pleased with the way it works.

## APRIL SPECIALS

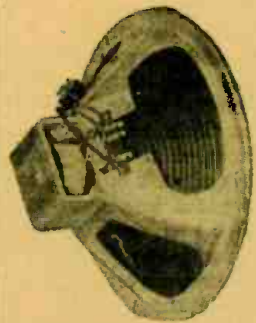

**RCA 12" DYNAMIC SPEAKER**  
Here's the buy of the year—a 12 inch RCA dynamic speaker with field coil of 375 ohms resistance. Voice coil 6-8 ohms. Your cost at Almo, \$4.95  
**YOUR COST \$4.95**

#### BC-645

Fifteen tube BC-645 converts to 420-500 MC. Instructions included for conversion for voice or CW and AC Power Supply Modulator. You probably have the few parts on hand necessary for conversion. At a price everyone can afford. Brand new. In original cartons, complete with tubes.



**YOUR COST \$9.95**

10% Cash with Orders **ALMO** Phone LO 3-9255  
Covers the Globe  
509 ARCH STREET PHILADELPHIA, PENN.



## FM STATION LIST

(Continued from page 40)

FREQUENCY (MC)	CALL	LOCATION
97.1	WELD-FM	Columbus, Ohio.
97.1	WRCM	New Orleans, La.
97.1	WTCN-FM	Minneapolis, Minn.
97.1	WWJ-FM	Detroit, Mich.
97.3	KTRN	Wichita Falls, Texas
97.3	KWBR-FM	Oakland, Calif.
97.3	KWBR-FM	San Francisco, Calif.
97.3	WHCU-FM	Ithaca, N. Y.
97.3	WHP-FM	Harrisburg, Pa.
97.3	WIL-FM	St. Louis, Mo.
97.3	WKWK-FM	Wheeling, W. Va.
97.3	WNBC-FM	New York, N. Y.
97.3	WROL-FM	Knoxville, Tenn.
97.3	WTAR-FM	Norfolk, Va.
97.3	WTOG-FM	Savannah, Ga.
97.5	KPOR	Riverside, Calif.
97.5	WAKR-FM	Akron, Ohio
97.5	WIOD-FM	Miami, Fla.
97.5	WLVA-FM	Lynchburg, Va.
97.9	KFAB-FM	Lincoln, Nebr.
97.9	WBTM-FM	Danville, Va.
97.9	WEHS	Chicago, Ill.
97.9	WFAA-FM	Dallas, Texas.
97.9	WGYN-FM	New York, N. Y.
97.9	WJLB-FM	Detroit, Mich.
97.9	WLPM-FM	Suffolk, Va.
97.9	WLTN	Lewistown, Pa.
97.9	WMAR-FM	Baltimore, Md.
97.9	WMRF-FM	Lewistown, Pa.
97.9	WRNY-FM	Rochester, N. Y.
97.9	WWPG-FM	Palm Beach, Fla.
98.1	KQV-FM	Pittsburgh, Pa.
98.1	KOZY	Kansas City, Mo.
98.1	KRSC-FM	Seattle, Wash.
98.1	WBRL	Baton Rouge, La.
98.1	WCAU-FM	Philadelphia, Pa.
98.1	WCOD-FM	Richmond, Va.
98.1	WFMR	New Bedford, Mass.
98.1	WFNC-FM	Fayetteville, N. C.
98.1	WSAL	Saginaw, Mich.
98.3	KAGH	Pasadena, Calif.
98.3	WEEX	Easton, Pa.
98.3	WHNY-FM	Hemstead, N. Y.
98.3	WLAD-FM	Danbury, Conn.
98.3	WPIK	Alexandria, Va.
98.3	WTFM-FM	Tiffin, Ohio
98.5	KBIX-FM	Muskogee, Okla.
98.5	KLOK-FM	San Jose, Calif.
98.5	KOPY	Houston, Texas
98.5	WAGE-FM	Syracuse, N. Y.
98.5	WBRE-FM	Wilkes-Barre, Pa.
98.5	WCBT-FM	Roanoke Rapids, N. C.
98.5	WHLD-FM	Niagara Falls, N. Y.
98.5	WJPF-FM	Herrin, Ill.
98.5	WNAM-FM	Neanah, Wis.
98.7	KDYL-FM	Salt Lake City, Utah
98.7	KVWC-FM	Vernon, Texas
98.7	WBAM	New York, N. Y.
98.7	WCTP	Greensboro, N. C.
98.7	WGNB	Chicago, Ill.
98.7	WHOP-FM	Hopkinsville, Ky.
98.7	WJNO-FM	West Palm Beach, Fla.
98.7	WPAG-FM	Ann Arbor, Mich.
98.7	WSOY-FM	Decatur, Ill.
98.7	WVVA-FM	Wheeling, W. Va.
98.9	KJBS-FM	San Francisco, Calif.
98.9	WCOA-FM	Pensacola, Fla.
98.9	WHBF-FM	Rock Island, Ill.
98.9	WHFM	Rochester, N. Y.
98.9	WKBN-FM	Youngstown, Ohio
98.9	WKY-FM	Oklahoma City, Okla.
98.9	WSNJ-FM	Bridgeton, N. J.
98.9	WSPA-FM	Spartanburg, S. C.
99.1	KUGN-FM	Eugene, Ore.
99.1	KWK-FM	St. Louis, Mo.
99.1	WDOO-FM	Oneonta, N. Y.
99.1	WGTR	Boston, Mass.
99.1	WHIO-FM	Dayton, Ohio
99.1	WMAZ-FM	Macon, Ga.
99.1	WNAV-FM	Annapolis, Md.
99.1	WSLS-FM	Roanoke, Va.
99.1	WTH-FM	Port Huron, Mich.
99.3	KGAR-FM	Garden City, Kan.
99.3	WBBM	Chicago, Ill.
99.3	WFRO-FM	Fremont, Ohio
99.5	KISS	San Antonio, Texas
99.5	KRIC-FM	Beaumont, Texas

FREQUENCY (MC)	CALL	LOCATION
99.5	KTSJ	Topeka, Kan.
99.5	WABF	New York, N. Y.
99.5	WAFM-FM	Birmingham, Ala.
99.5	WEFM	Chicago, Ill.
99.5	WJLS-FM	Beckley, W. Va.
99.5	WGFM	Schenectady, N. Y.
99.5	WMFR-FM	High Point, N. Y.
99.5	WMIN-FM	St. Paul, Minn.
99.5	WNLC-FM	New London, Conn.
99.5	WSON-FM	Henderson, Ky.
99.7	KPDR-FM	Alexandria, La.
99.7	KTFI-FM	Twin Falls, Idaho
99.7	WCJT	Louisville, Ky.
99.7	WJAS-FM	Pittsburgh, Pa.
99.7	WMC-FM	Memphis, Tenn.
99.7	WSAP-FM	Portsmouth, Va.
99.9	KBMT	San Bernardino, Calif.
99.9	KMYC-FM	Marysville, Calif.
99.9	KVEC-FM	San Luis Obispo, Calif.
99.9	WBT-FM	Charlotte, N. C.
99.9	WCLO-FM	Janesville, Wisc.
99.9	WERC-FM	Erie, Pa.
99.9	WFNS-FM	Burlington, N. C.
99.9	WHFB-FM	Benton Harbor, Mich.
99.9	WKRQ-FM	Mobile, Ala.
99.9	WKRT-FM	Cortland, N. Y.
99.9	WSAN-FM	Allentown, Pa.
99.9	WTRT-FM	Toledo, Ohio.
00.1	WKBR-FM	Manchester, N. H.
00.1	WLB-FM	Lebanon, Pa.
00.1	WMUS-FM	Muskegon, Mich.
00.3	KGW-FM	Portland, Maine
00.3	KMPC-FM	Hollywood, Calif.
00.3	KSL-FM	Salt Lake City, Utah
00.3	WACE-FM	Chicopee, Mass.
00.3	WCLT	Newark, Ohio
00.3	WGBG-FM	Greensboro, N. C.
00.3	WHO-FM	Des Moines, Iowa
00.3	WMGM-FM	New York, N. Y.
00.3	WSAV-FM	Savannah, Ga.
00.3	WWLH	New Orleans, La.
100.5	KSBR	San Bruno, Calif.
100.5	KMBC-FM	Kansas City, Mo.
100.5	WHMA-FM	Anniston, Ala.
100.5	WHTN-FM	Huntington, W. Va.
100.5	WMNE	Boston, Mass.
100.5	WLDS-FM	Jacksonville, Ill.
100.5	WNB-FM	Binghamton, N. Y.
100.5	WWNY-FM	Watertown, N. Y.
100.7	WBAB-FM	Atlantic City, N. J.
100.7	WBIB	New Haven, Conn.
100.7	WBML-FM	Macon, Ga.
100.7	WBOX-FM	Louisville, Ky.
100.7	WCEC-FM	Rocky Mount, N. C.
100.7	WCIL-FM	Carbondale, Ill.
100.7	WHKX	Cleveland, Ohio
100.7	WKIL	Kankakee, Ill.
100.7	WSVA-FM	Harrisonburg, Va.
100.7	WTJS-FM	Jackson, Tenn.
100.9	WABX-FM	Harrisburg, Pa.
100.9	WCFR	Fall River, Mass.
101.1	KGLO-FM	Mason City, Iowa
101.1	KHJ-FM	Hollywood, Calif.
101.1	KTRH-FM	Houston, Texas
101.1	KVCI-FM	Chico, Calif.
101.1	KXLW-FM	Clayton, Mo.
101.1	WBBB-FM	Burlington, N. C.
101.1	WBCA-FM	Schenectady, N. Y.
101.1	WBOW-FM	Terre Haute, Ind.
101.1	WCAC-FM	Anderson, S. C.
101.1	WCBS-FM	New York, N. Y.
101.1	WJPG-FM	Green Bay, Wisc.
101.1	WLWA-FM	Cincinnati, Ohio
101.1	WXYZ-FM	Detroit, Mich.
101.1	WWDC-FM	Washington, D. C.
101.3	WATG-FM	Ashland, Ohio
101.3	WCFC-FM	Beckley, W. Va.
101.3	WGAL-FM	Lancaster, Pa.
101.3	WSBF	South Bend, Ind.
101.3	WSRK	Shelbyville, Ind.
101.5	KFMB-FM	San Diego, Calif.
101.5	KMUS	Muskogee, Okla.
101.5	KGKB-FM	Tyler, Texas
101.5	KYFM-FM	San Antonio, Texas
101.5	WFMD-FM	Frederick, Md.
101.5	WIBA-FM	Madison, Wisc.

(Continued on page 79)

## SIGNAL - TRACER - GENERATOR

- PENCIL PROBE
- HIGH GAIN TRACER
- BUILT-IN DETECTOR
- SIG. INJECTOR GEN.
- AC-DC OPERATION



**\$16.50**  
ONLY

Ready to operate—Signal Tracer with loudspeaker operation—Signal Generator—Multivibrator—Puts out strong A.F., I.F., R.F. signal 1000 cycles to 25 megacycles.

## PHONO-OSC... AMPLIFIERS



PHONO - OSC - AMPLIFIER 35Z5, 12SQ7, 50L6 Hi-Gain. HI-FL. AC DC Amp. Complete ..... **\$4.69**  
Wireless Phono-Osc. Mike or Phono inp. Complete with tubes ..... **\$4.49**  
Wired .....

## YORK DISTRIBUTORS

523 Knickerbocker Ave., Bklyn. 21, N. Y.

## OPPORTUNITY AD-LETS

Advertisements in this section cost 25c a word for each insertion. Name, address and initials must be included at the above rate. Cash should accompany all classified advertisements unless placed by an accredited advertising agency. No advertisement for less than ten words accepted. Ten percent discount six issues, twenty percent for twelve issues. Objectionable or misleading advertisements not accepted. Advertisements for May, 1948, issue must reach us not later than March 24, 1948.  
Radio-Craft • 25 W. B'way • New York 7, N. Y.

**MAGAZINES (BACK DATED)—FOREIGN, DOMESTIC.** arts, books, booklets, subscriptions, pin-ups, etc. Catalog 10c (refunded). Cicerone's, 863 First Ave., New York 17, N. Y.

**WRITE DEPT. RO 20 FOR OUR LATEST FREE BARGAIN** list of Radio and Electronic parts. R.C. Radio Parts and Dist. Co., 733 Central Ave., Kansas City 6, Kansas.

**YOU CAN ACCURATELY ALIGN SUPERHETERODYNE** receivers without signal generator. Complete instructions \$1. Moneyback guarantee. Chas. Gates, Pecos 2, Texas.

**RUBBER STAMPS, ETC., FOR SALE.** COOKSON, Box 0-RC, Puzico, Missouri.

**TESTING EQUIPMENT, ALL TYPES AND MODELS.** Expertly repaired and calibrated. Free estimates. METROPOLITAN ELECTRONICS, 42 Warren St., N. Y. 7, N. Y.

**26 YEARS' EXPERIENCE RADIO REPAIRING AT** your fingertips. I've perfected simple system you can follow step by step. No formulas or calculations. Cuts repair time to minimum. Total price \$2.00 postpaid or COD. Moneyback guarantee. Ross Radio, 14615-J Grand, river, Detroit 27, Michigan.

**LEARN ELEMENTS OF RADIO AT HOME. IDEAL** course for beginners. \$15.00. Write Waca Radio School, 1421 Sixth Street, S.E., Minneapolis 14, Minn.

**WE REPAIR ALL TYPES OF ELECTRICAL INSTRUMENTS,** tube checkers and analyzers. Hazelton Instrument Co. (Electric Meter Laboratory), 140 Liberty Street, New York, N. Y. Telephone—BARELAY 7-4239.

**LANCASTER, ALLWINE & ROMMEL, 438 BOWEN** Building, Washington 5, D.C. Registered Patent Attorneys. Practice before United States Patent Office. Validity and infringement investigations and opinions. Booklet and form "Evidence of Conception" forwarded upon request.

**AMATEUR RADIO LICENSEES. COMPLETE CODE** and theory preparation for passing amateur radio examinations. Home study and resident course. American Radio Institute, 101 West 63rd Street, New York City. See our ad on page 86.

**RADIOMEN, SERVICEMEN, BEGINNERS -- MAKE** more money, easily, quickly. \$250 weekly possible. We show you how. Information free. Merit Products, 216-32L, 182nd Avenue, Springfield Gardens 13, New York.

**PHONOGRAPH RECORDS 20c. CATALOGUE.** Paramount, KQ-313 East Market, Wilkes-Barre, Penna.

**NEW CARTONED TUBES 39c each. 100 ASSORTED** for \$35.00. 1R5, 1R5, 1T4, 3V4, 3V4, 5Y3GT, 6A8GT, 6C5GT, 6K7GT, 6Q7GT, 6V6GT, 6SA7GT, 6SD7GT, 6SK7GT, 6X4GT, 6X5GT, 12AX6, 12AT6GT, 12BA6, 12BE6, 12BE6, 12K8, 12SA7GT, 12SK7GT, 12SQ7GT, 25L6GT, 32L7GT, 35B5, 35LA, 35V4, 35Z5, 47, 50B5, 50L6, 70L7GT, 80, 89, 117L7GT. Write for bargain flyer. Henshaw Radio Company, 3313 Delavan, Kansas City 2, Kansas.

**RADIOS, RECORD PLAYERS, TUBES, PARTS. SEND** for free bargain list. Hallmark, 594 Communipaw, Jersey City 4, New Jersey.

**FOR SALE—AMATEUR RADIO STATION ONLY \$24.50.** Receiver & Transmitter 10-40-75 meter. For details write Stanley MacMichael 1/2 R & M Radio Co. 1426 N. Quincy Street, Dept. RC-2, Arlington, Va.

# MONEY TALKS!

DOUGLAS OFFERS *The Lowest of Low Prices on the Map!*

## TRANSVISION TELEVISION KITS

EVERY TELEVISION KIT GUARANTEED!

- Standard 12" Model—Picture size 7 1/2 square inches, 22 tubes and 12" picture tube. High fidelity FM sound reproduction. Advanced television circuit provides brighter and sharper pictures. Complete Kit. **\$289.50**
- Deluxe 12" Model—Same as above plus the following **ADDITIONAL FEATURES** 50-216 mc. continuous tuning . . . Covers the entire FM band and all 13 television channels . . . Cut-off switch eliminates unused tubes when set is used only as FM radio. Complete Kit. **\$359.00**
- 10" Television kit—Complete with tubes, 8" alnico speaker, antenna front panel, factory wired and tuned R.F. units. Complete Kit. **\$199.00**
- 7" Television Kit—Same as above with 7" picture tube. **\$169.00**
- LIST . . . We have a complete line of television components • Dealers Prices on Kits upon request

### DOUGLAS SPECIALS

- R.C.A. Television Glare Reducer—Reduces glare, improves contrast, provides real viewing comfort. Simple to attach or remove, leaves no marks on your set. Your cost . . . **\$1.50**
- Television Blow-up lens enlarges any 7" television picture to equivalent picture of 10" television set, complete with all mounting brackets. Your cost . . . **\$19.95**
- New-Vision U.H.F. Sweep Generator for F.M.-Television-Broadcast Frequencies. Complete with test leads. Your cost . . . **\$68.50**
- ADAPTOL 3 tube AM Superhet tuner A.C.-D.C. Self contained power supply. Permeability tuned drift-free I.F.'s. Compact. Approximately 4 1/2 x 3 1/2 x 3 3/4. Your cost . . . **\$42.45**
- 2 TUBE PHONO OSCILLATOR—Complete with tubes, use with any record player or changer and tune on any radio. Your cost . . . **\$4.85**
- 2 TUBE PHONO AMPLIFIER—Complete with all tubes. Your cost . . . **\$4.95**
- General Industries Recording Mechanism—Latest 1947 recording assemblies with 4 ohm cutters and crystal play-back. 78RPM . . . **\$17.50**
- Webster #56 Record Changer Automatic Stop . . . **\$25.95**
- Webster #50 Record Changer for 10" or 12" records . . . **\$21.00**
- 5" P.M. SPEAKERS . . . **\$1.05**

**TUBES**—COMPLETE LINE OF ALL HARD TO GET TUBES. SEND US YOUR ORDER AND WE WILL SURPRISE YOU WITH PROMPT DELIVERY AT DISCOUNT PRICES

IF IT'S HARD TO GET — WE HAVE IT!!!

Send for illustrated flyer

25% Deposit, Balance C.O.D. Plus Charges

### DOUGLAS RADIO SUPPLY COMPANY, INC.

DEPT. A-1 128 GREENWICH STREET NEW YORK 6, N. Y. WOrth 4-0470-1

## Just off the Press! 1948 Radolek RADIO PROFIT GUIDE



**NEW COMPLETE RADIO PROFIT GUIDE FREE**

RADIO REPAIR PARTS • TOOLS  
SOUND SYSTEMS • TUBES  
PHONO EQUIPMENT & SUPPLIES  
TEST INSTRUMENTS • ETC.

Big, new ENLARGED complete catalog showing thousands of Radio Bargains sent to you immediately. Helpful, money-saving buying information. Send coupon today!

**BIG VALUES, LARGE STOCKS,  
FAST, DEPENDABLE SERVICE.**

**FREE...SEND TODAY**

RADOLEK CO., Dept. C-048  
601 W. Randolph St., Chicago 6, Ill.  
Please send your Free Profit Guide Catalog and regular Supplements.

Name .....  
Address .....  
City ..... Zone ..... State .....

**SAVE AT RADOLEK**

## STAHL "SEZ" if it's Radio-Electrical-Electronic Equipment—Parts—Supplies—Sets these BARGAINS must interest you.

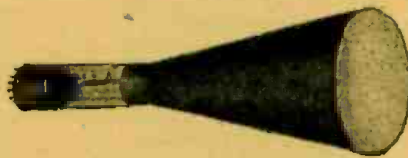

### OUR MONTHLY SPECIAL

5 inch Cathode Ray, Type 5BP1 tubes. In their original cartons; Brand New. At this price every scope owner should buy a few, and keep in reserve. How can you go wrong for only **\$1.95**

Crystal Calibrated  
Signal Generator I-222-A **\$54.50**  
Operation from 110-117 volts, 60 cycles, consumes 40 watts. Self-contained power supply. COMPLETE WITH TUBES.

WILCOX CW 3 **\$13.95**  
7 Tube Receiver  
Complete with 1 set of coils—5.1 meg. to 10 meg. and an additional set of tubes. Brand new in original cases. Export packed.

INTERPHONE AMPLIFIER **\$3.45**  
Brand New—24V. input. with dynamotor; 2 tubes. volume control, carbon or magnetic microphone input. Grey finish metal cabinet.

MICROPHONE AMPLIFIER BC 216A **\$1.95**  
Brand New—Aluminum case, 2 single button carbon mike input, requires 12V filament, 150V plate. Uses a 39/44 and 6F7 tube. Complete Job in case and all, less tubes

### MANY OTHER ITEMS

Prompt Delivery—Write Dept. RC4  
25% deposit required on C.O.D. order  
Shipped F.O.B. New York. Min. Order \$2.00

## MICHAEL STAHL, INC.

39 VESEY ST.  
Tel. WOrth 4-2882-3-4 New York 7, N. Y.

## THE RADIOMAN EXPANDS

(Continued from page 20)

"Your business methods are sound, your deposits have shown an above-average increase, and we are willing to supply the financial aid required." Need more be said? From the jobber, "The outlook for your type of service looks good. Go ahead." From the businessmen, "We wouldn't be expanding ourselves if we didn't think it wise."

Once the decision to expand has been made, don't become overly optimistic, because the work has only just begun. The next step should be to determine which facilities need to be expanded and to what extent. In our individual case, we own our present building, which was built to our specifications immediately following the close of the war (see RADIO-CRAFT, March, 1947). The size of this building was determined entirely by the amount of materials available at the time and was necessarily smaller than we desired. However, we kept the thought of future expansion in mind, and designed this original structure in such a way that future additions would not detract from the unique features incorporated in it.

A review of our records showed us that our auto radio service was growing by leaps and bounds. This meant that to continue to handle this service on a year-round basis drive-in facilities would have to be incorporated in our new building. This drive-in had to be arranged so that it would not interfere with the floor space required for additional shops in which to house our rapidly growing personnel. Our final plan called for drive-in space to handle three autos under cover and three glassed-in service shops identical to the one in our original building.

The next step was to prepare detailed scale floor plans and specifications. We were fortunately able to prepare these ourselves, thus saving architectural expenses and also assuring us that our windows, lighting fixtures, and structural supports would be placed where we wanted them. At this point, it began to look like the deck hadn't been shuffled very well because the next two cards we drew were jokers. These jokers were in the form of estimates prepared from identical plans and specifications. One for slightly over \$4000, the other a few dollars under \$2000. Again we called upon our friend, the banker, for advice. He assured us that both men were of equal integrity and ability so we chose the lower bid of the two. We later learned that the contractor submitting the higher bid maintained his own material supply yard with several employees here and a large clerical staff to prepare his cost estimates, while the other one worked from his home and all of his employees were "on the job workers."

After the contractor moves in you might feel that your worries are over, but you have many headaches in store yet. Material shortages, delays, bad weather, and many other unforeseen problems continue to arise.

But eventually everything is completed. You at last relax in an easy

## VERIFIED SPEAKERS

"They Glorify the Tone"

WRIGHT

2232 University Avenue

Inc.

St. Paul 4, Minnesota

chair, place your feet on the desk, and doze into a dream of what a nice little business you have when suddenly you are rudely awakened by the thundering calm that has descended on the old place. A quick survey shows you that with extra floor space, added employees, and increased efficiency, the boys are no longer dashing around at a mad pace but are actually hunting for a job to do. It is then up to you to expand your business as well.

Here are a couple of methods we have used to good advantage in securing new business as well as holding our old customers. Your remodeling or building program is news to your community, so avail yourself of the free reader publicity that your local paper will carry for you if you give them your plans and an outline of your expanded service in your locality. The following business promoter has more than paid for itself in the three months that we have had it in operation. We purchased 14 small table model radios of a well-known brand and offered a free loan service to our customers while their radio is under repairs. All of our advertising carries the catchy phrase "uninterrupted listening pleasure, you may use our radio while yours is being repaired."

Here's how it works. We charged the initial cost of these radios to equipment. They are not offered for sale, and the tag on each radio plainly states this fact. However, the basic laws of psychology tells us that the general public wants something they can't have. This results in a great number of sales with no effort on your part. When one of these radios is sold, it is immediately replaced. The profits from this sale are placed in an equipment reserve and used to maintain these radios.

### HI-FI 35-WATT AMPLIFIER

(Continued from page 33)

the special feedback winding. (The Stancor A-3851 and Thordarson T-17S13 are examples.) It should be rated at 35 watts at least. Plate-to-plate impedance should be 6,600 ohms.

The amplifier is built on a 12 x 17 x 3-inch chassis. Controls from left to right are: master gain, No. 1 microphone gain, No. 2 microphone gain, phono gain, radio gain, treble control, and bass control.

Point-to-point wiring is used throughout, with all components securely fastened to the chassis. All controls and input leads are shielded to keep hum pickup at a minimum. All circuit values were carefully calculated and should be adhered to if duplicate results are to be expected.

In actual operation, music and speech are reproduced with a clarity seldom heard in an ordinary public address system.

Readers will note that manufacturers do not recommend the use of 6L6's at the ratings given in this article, though such ratings have been deemed permissible in the past. Cautious constructors might reduce voltages to bring power output down to about 25 watts or—possibly even better—use 807's in place of the 6L6's.



Living Room Concerts

More Economical



Airport & Train Announcements

Cannot Tangle



Broadcast Station Monitoring

**Now Available!** 8 HOURS OF CONTINUOUS PLAY ON THE **MAGNETAPE RECORDER**

Longer Playing Time



Industrial Factory Work Music



30 Second Rewind



Conference Recording

Now — on this one amazing instrument, you can record and play back with unmatched fidelity, any sound that can be heard. Enjoy complete operas and symphonies without record-changing pause, or annoying needle talk and needle chatter. Edit and rearrange your recorded material with ease. The ideal recorder-reproducer for home, office, industry and broadcast station.

Quieter Operation



Passenger Entertainment

Also, for the first time, in one compact instrument, you have a choice of three tape speeds for high fidelity, medium fidelity, or 8-hour voice recording. Write today for illustrated technical Magnetape Recorder and accessory catalog. Send 25c for A. C. Shaney's latest booklet, "Elements of Magnetic Tape Recording—and 999 Applications."

Easy Editing



Recorded Lectures

Improved Response Range



Copying Valuable Disc Records

Complete Automatic Erasing

## AMPLIFIER CORP. of AMERICA

398-10 Broadway

New York 13, N. Y.

## TUBES! TUBES! TUBES! THOUSANDS OF TUBES

LOWEST PRICES!

[NEW, STANDARD BRANDS—QUANTITY PRICES ON REQUEST—MINIMUM ORDER \$5.00]

TYPE	PRICE	TYPE	PRICE	TYPE	PRICE	TYPE	PRICE	TYPE	PRICE
1A3	.98	6AG5	.89	6U5	.98	35Z5	.69	802/RK25	1.49
1A5	.49	6AG7	.98	6V6GT	.89	37	1.10	803	8.95
1A7GT	1.10	6AK5	.69	6V6G	.89	37	.69	804	6.75
1B24	2.49	6AL5	.99	6X4	.98	38	.89	805	3.75
1B38	4.50	6AQ5	.98	6X5	.89	39/44	.59	807	1.25
1G4	.98	6AT6	.75	7AE7	.75	41	.69	808	2.95
1G5	.44	6AU6	.89	7B7	.69	45	.64	809	1.50
1G6	.98	6B4	1.29	7C4	1.50	47	.90	810	5.95
1H4G	.98	6BB6G	.89	7C5	.89	50B5	.89	811	1.95
1L4	.89	6B8	.99	7F7	1.25	50L6GT	.75	812	3.15
1R4/1294	1.29	6BG6	3.49	7L7GT	1.39	70L7	.89	812H	6.90
1T4	.58	6C4	.64	10Y	.69	71A	.69	813	5.95
1H5	.99	6C5	.51	12A6	.89	75	.69	814	4.39
1N5GT	1.10	6C6	.75	12AH7	2.39	75T	2.39	815	2.25
1L5	1.92	6C21	12.95	12AT6	1.10	77	.75	826	1.75
1R5	1.10	6D4	.89	12BA6	.89	78	.75	829A/B	2.95
1S5	1.10	6D6	.49	12BE6	.89	79	1.10	830B	5.25
2A3	1.39	6FA	1.39	12C8	.89	80	.53	832A	2.25
2C22	.69	6F5	.51	12H6	.44	82	.98	833A	34.50
2C26A	.75	6F6	.79	12J5	.69	83V	.89	836	1.15
2C34	.98	6F6G	.80	12K8	1.25	84	.75	837	2.50
2C40	2.60	6F7	.98	12SA7GT	.99	85	.89	838	3.75
2C44	1.75	6F8	1.10	12SG7	.89	100TS	3.00	841	.69
2D21	.75	6G6	1.10	12SH7	.89	117L7	1.89	845	3.75
2E22	1.50	6H6	.49	12S17	.79	117Z3	.89	860	3.00
2E25	3.95	6I4	1.50	12SK7	.69	117Z6GT	1.10	861	50.00
2E30	2.25	6I5	.49	12SL7	1.10	121A	2.65	866A	.75
2J32	20.00	6J6	.49	12SN7GT	.79	205B	4.50	872A	1.95
2J33	20.00	6J7	.89	12SQ7GT	.99	211	.98	874	1.95
2JB51	4.95	6K8	.49	12SR7	.79	215A	3.00	884	.75
2X2	.69	6K7	.59	12X3	.98	217C	2.50	923	.49
3A4	.49	6K8	1.25	14A7	1.10	250TH	12.95	954	.49
3B7	.98	6L6	1.25	14B7	1.10	304TL	2.49	955	.49
3B22	4.95	6L6G	1.20	14H7	1.25	307A	6.25	956	.75
3B24	.98	6L7	.98	14J7	1.25	316	.89	957	.49
3D6/1299	.89	6N7	.89	14R7	1.10	371A	1.39	958A	.49
3E29	2.95	6Q5	.98	15E	1.50	371B	3.00	959	.49
3Q4	1.10	6Q5G	.98	23D4	.49	394A	4.50	991	.50
3Q5GT	.58	6Q7	.98	23D6	.98	417A	19.95	1005	.39
3S4	4.25	6R7	.89	24G	.89	446A	1.25	1006	.39
4C25	7.95	6SA7	.90	25AGGT	.75	450TH	12.95	1613	.95
4E27/257B	4.95	6S07	.85	25L6GT	.75	703A	7.50	1614	1.75
5R4GY	1.15	6SF5	.79	25Z5	.75	705A	1.85	1616	1.39
5T4	1.25	6SG7	.79	25Z6	.98	713A	1.65	1619	.98
5U4	.44	6SH7	.39	28D7	.75	715B	4.95	1622	1.75
5V4G	.98	6SJ7GT	.69	30	.78	717A	.69	1624	.98
5W4	.98	6SK7	.79	32L7	1.50	721A	3.95	1625	.49
5Y3	.60	6SL7	.89	34	.98	723A/B	5.50	1626	.49
5Y4G	.58	6SN7GT	.69	35L6GT	.75	725A	12.50	1629	.59
5Z3	.89	6S07	.89	35Y4	1.10	725A	12.50	1631	1.49
5Z4	.89	6SR7	.89	35W4	.69	800	2.25	1631	1.49
6A6	.75	6SS7	.75	35Z3	.99	801A	1.10	1641/RK60	.79
6AB7	1.25							12JP4	60.00
6AC7	.99							13AP4	110.00
								20AP4	270.00

20% DEPOSIT WITH ALL ORDERS UNLESS RATED

### NIAGARA RADIO SUPPLY CORP. 160 GREENWICH STREET NEW YORK 6, N. Y.



**A Better Cone  
Buy Leotone**

**NEW "JUMBO" RADIO PARTS  
ASSORTMENT**

AMATEURS! SERVICEMEN! EXPERIMENTERS!—You can't afford to miss this outstanding buy in new & dismantled radio & electronic parts! 17 FULL POUNDS OF COILS, TRANSFORMERS, SPEAKER REPAIR PARTS, HARDWARE, RESISTORS, CONDENSERS, SUB-ASSEMBLES, etc. All these and MORE for only **\$2.95**

**HEARING AID COMPONENTS**



Famous make miniature size units that have many applications where space is limited.  
**BONE CONDUCTOR RECEIVER.** Sensitive dynamic type. Makes excellent CONTACT (musical pick-up) MIKE; MINIATURE or PILLOW SPEAKER. 1 1/2" x 1/2" x 1/2" ..... 2.95  
4 for 9.95

**MIDGET OUTPUT TRANSFORMERS** (1 1/8" x 3/4" x 1/2"). One of the smallest made. High limit to voice coil. For personal & portable sets, intercoms, etc. .... 49



**MIDGET AUDIO CHOKES** (3/4" x 3/4" x 1/2"). 4500 ohms DC. Use in filter circuits, impedance coupling, etc. .... 49

**ALNICO MAGNETS**



**ALNICO MAGNETS**—Many sizes & shapes always in stock. Write for latest illustrated supplement. **APRIL SPECIAL!**—EXPERIMENTAL ALNICO MAGNET KIT. Contains 10 asstd. Bar, Circular, "U", Block, etc. 1.95

**PORTABLE A.C. AMPLIFIER  
(Lic. by W.E.)**

Here is a professional type **HIGH FIDELITY** unit at an amazingly low price. Wide freq. response for use with Musical Instruments, Speech or Phone input, FM Tuners, etc. Features: 8" Alnico PM speaker; 2 inputs (magnetic or crystal); vol. & tone controls. Beam Power output. Beautiful, sturdy 2 tone brown leatherette case (13 1/2" x 15 1/2" x 7 1/2"). Shtg. wt. 12 lbs. List price—\$64.50.  
**LEOTONE'S PRICE—While They Last \$24.95**  
In lots of 3—ea. 21.50

**BARGAIN KITS FOR SERVICERS**

- #1 R F Antenna & Osc. coils, 10 asstd. .... 98
- #3 MOULDED BAKELITE CONDENSERS, 50 asstd. .00001 to .2mfd. 200-600WV. Clearly marked ..... 2.95
- #4 TUBULAR BY-PASS CONDENSERS, 50 asstd. .001 to .2mfd. 200-600 WV. Standard brands ..... 2.49
- #5 ELECTROLYTICS, 10 asstd standard capacitors. Incl. multi-section & can ..... 1.95

**PORTABLE AC-DC AMPLIFIER**—A high quality, low-priced unit with all of the above features PLUS the AC-DC advantage. Attractive blue or brown leatherette case (16 1/2" x 13" x 5 1/2"). Shtg. wt. 12 lbs.  
**A LEOTONE SPECIAL ..... \$24.95**

**RHEOSTAT SPECIALS!!**

Famous makes, 1/4" shafts. 25 watt—250 ohm (tap at 125 ohms) ... .39  
50 watt—15 ohms ..... 98



**TUBES:** Perfect condition but in unsealed cartons. Most types in stock at up to 80% of list. Every tube guaranteed 90 days.  
#20, 27 or 31 ..... 29  
#75, 77, 78, 8H6 or 8H7 ..... 39  
#37, 39, 5Y3, 5W4, 5Z4, 6CS, 6FS, 6F6, 6J7, 6K8, 6SA7, 6SD7, 6SF6, 6SH7, 6SJ7, 6U7 or 12SK7 ..... 59  
#1A7, 1B5, 6X4, 6X5, 7A7, 50, 50B5 or 50L6 ..... 59  
**TUBE CARTONS:** Plain  
Miniature (1 1/2" sq. x 2 1/4") Per 100 ..... 98  
GT size (1 1/2" sq. x 3 1/4") Per 100 ..... 1.25  
Medium (1 1/2" sq. x 4 1/4") Per 100 ..... 1.49  
Large (2" sq. x 5") Per 100 ..... 1.79

**BUTTERFLY TUNERS,** 240-1200 Mc. Silver plated, with crystal holder, 2 3/4" O.D. .... 1.89  
RG-8/U CO-AX CABLE, 52 ohm, 4 ft. lengths with 2 PL-259 (83-1SP) connectors ..... 39  
200 OHM CARBON MIKE BUTTON for either replacement in T-30V Mike or used as CONTACT MIKE, DETECTORPHONE, etc. O.D. 3/8", 3/16" deep. .... 39

Get on our mailing list—Always something new!

**PROMPT EXPERT SERVICE ON ALL SPEAKER AND PHONO PICK-UP REPAIRS**  
Min. Order \$2.00—20% Deposit Required on All Orders.  
Please Add Sufficient Postage. Write Dept. RC-4



**RADIO CO.**

**MAKERS OF CONES AND FIELD COILS**  
65-67 DEY STREET, NEW YORK 7, N.Y.  
WORTH 2-0284-5  
12,000 SQ. FT. OF RADIO PARTS

**RADIO SET AND SERVICE REVIEW**

(Continued from page 30)

at the spot where signal is strongest. The antenna is oriented by turning the set on its side so the telescopic antenna is horizontal. The set is given a quarter-turn in each direction and the meter reading noted. The dipole should be mounted parallel to the antenna of the set for maximum signal.

Fig. 2 shows how reflected and direct signals may aid and oppose each other at the receiving antenna. Each serrated section represents one wave length. The direct and reflected signals are in phase at A, and the signal is strongest. At B, they are out of phase—do not arrive at the antenna at the same time, as indicated by the unequal wave-length sections—and the signals cancel to create a dead spot or minimum-signal area. This condition is most serious in television, where it causes ghosts, but may have a decisive effect on FM reception.

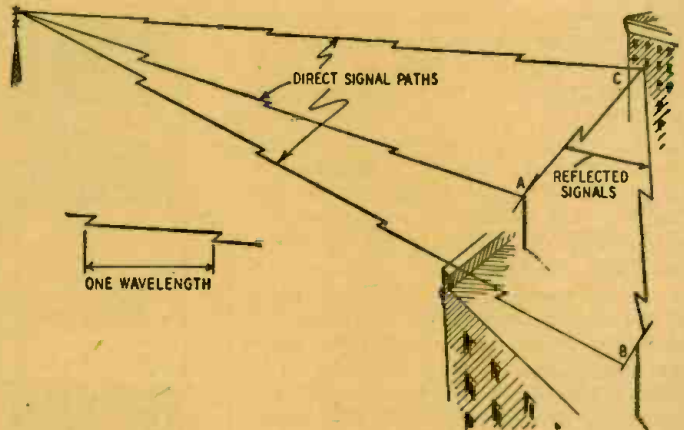

Fig. 2—Reflection aids direct signal at A but opposes it at B.

In areas where signals are generally weak, the serviceman can mount a good FM dipole on a 15- or 20-foot pole and connect it to the test receiver through a 300-ohm line. The antenna can then be moved about the roof to locate the best spot for installation.

Many FM tuners and receivers have built-in aerials. If outdoor aërials are prohibited—as they are in many apartment buildings and hotels—a serviceman should make a field strength survey inside the building to see if the signal is strong enough for good reception before completing the sale or making an installation.

While making the measurements, the test receiver should be moved around the room and the relative strength of signals from all stations in the vicinity noted. One station may come in strongest in one place in the room, and another station may be weakest at the same place. The set should be installed where it gives best reception from all stations. Loops

are usually employed in sets with built-in antennas. These are often highly directional, and it is possible that the set may be placed so it will not receive desired signals with best results. The Facto Meter may be turned on end and rotated for maximum signal. The set when installed should then be so its loop

is parallel to the telescopic antenna when in a position of best reception.

Fig. 3 shows how reflected and direct signals may aid or oppose inside a room. Signals may be reflected from the walls of the room just as they were from the building at C in Fig. 2. A and B have the same meaning in each drawing.

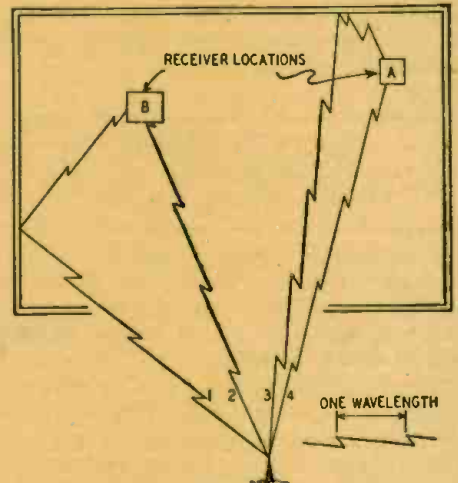

Fig. 3—Room reflections may affect signals.

**ANOTHER New BROWNING DEVICE**

**FM TUNER Model RV-10**

Small, compact, easily mounted high fidelity FM tuner. Armstrong FM circuit. Range: from 88 to 108 MC.

Frequency meters. WWV standard frequency calibrator Oscilloscope. Power supply and square wave modulator Capacitance Relay. FM-AM Tuners. FM Tuner.

KNOW THE ENTIRE BROWNING LINE • ENGINEERED FOR ENGINEERS

Write Dept. J for Catalog



**BROWNING LABORATORIES, INC.**  
WINCHESTER, MASS.

**500 FORMULAS TO SUCCESS**

MANY million dollar firms started with a single formula, for which they paid a big price. Here you have 500—no less—tried and tested formulas, recipes and processes for making things . . . all at the ridiculously low price of 25c. Here is your opportunity to start a business with but a few dollars' capital and with untreamed of profits in prospect. You can also use these formulas in your own home to cut household expenses to the bone. Or you can put them to use in your workshop to cut costs as much as 1000%. Quit paying out many dollars in profits to manufacturers, wholesalers, and dealers, when you can make the same thing yourself for a few cents. It's so easy when you follow our simple instructions.



86 PAGES, 3200 WORDS IN TEXT  
Send for "500 FORMULAS AND RECIPES" today. Enclose 25c, that's all! You won't be asked for another cent now or later. Sold on a money-back guarantee.  
**NATIONAL PLANS COMPANY**  
P. O. BOX 26 R, STATION N, New York 23, N. Y.





**\$69<sup>50</sup>\***

Complete, less tubes

## ESPEY Television Kit

Learn television with the unique, modern, low-priced ESPEY Television Training Kit. FREE with every kit—a new pictorial type instruction book, containing easy-to-follow, step-by-step assembly instructions. No previous knowledge necessary to build — and LEARN from — this ESPEY kit.

### FEATURES

- 18 tubes, including 15 miniatures.
- 3 stage, stagger tuned pix i.f.
- 21.25 Mc sound i.f. Trap tuned.
- Balanced FM discriminator.
- Portable—weighs only 17 lbs.
- Uses 3" low-cost cathode ray tube. Magnifier makes 20 sq. in. picture.
- Can be aligned with ordinary test oscillator and V. T. Voltmeter.

KIT INCLUDES all i.f., power, blocking oscillator transformers, chokes, capacitors, resistors, speaker, and sockets riveted into place on punched and welded chassis. Tubes are easily available through your distributor.

(\*Prices 5% higher west of Rockies)

For full details write to Dept. C

**ESPEY MANUFACTURING COMPANY, INC.**  
526 EAST 73rd STREET, NEW YORK 24, N. Y.



### TINY RADIO!

**FITS IN YOUR HAND**

REALLY WORKS TOO!  
(Unbreakable RED plastic cabinet, NO TUBES, BATTERIES OR ELECTRIC "PLUG-INS")  
Works on new Patented "Permacrystal" and Roto Tuner! EASY TO USE! SHOULD LAST FOR YEARS!

GUARANTEED TO WORK on local radio programs by following directions! or send only \$3.00 (bill, money order or check) and pay postman \$2.99 plus postage on delivery. COMPLETE READY TO PLAY—MARVELOUS GIFTS—BARGAIN PRICED! GET YOUR TINY RADIO NOW!  
PAKETTE PRODUCTS CO., Inc., Dept. TRC-4, Kearney, Neb.



**\$5993**

**NOW Sound**  
FOR YOUR SILENT PROJECTOR  
*Economically*

Convert your 16mm silent projector to sound (regardless of make) with Apex sound head & radiofilm adapter. Guaranteed excellent performance. Write today for free information.

APEX VIDEO • 12209 U Branford St. • Roscoe, Calif.

### A REAL SWING KEY

ONE RADIO amateur, who is now rehabilitating his shack, has installed a clever and novel means of clearing the operating space when using phone. His two keys have been fastened to a bench panel that can be instantaneously swung up for use or turned down with the keys out of sight.

A 10-inch-square hole was cut in the top surface of the bench. This, by the way, was built of 3/8-inch stock. A square panel was cut from 3/4-inch stock—the stock must be twice the thickness of the bench top. Allow about 1/16-inch clearance on the sides and enough clearance front and rear to permit the panel to pivot on its center line. The keys are mounted on one side of the panel in a position convenient to the operator.

A hole was drilled through the center of the panel, as shown, and a piece of 3/8-inch brass pipe driven through it to allow about 3/4-inch to project on each side. A 1/4-inch hole was previously drilled in the pipe and positioned to coincide with a hole in the key side of the panel.

The panel was then fitted into the opening and the under side of the bench marked for depressions which must be cut to bring the panel flush with the table top. Small bearing plates hold the

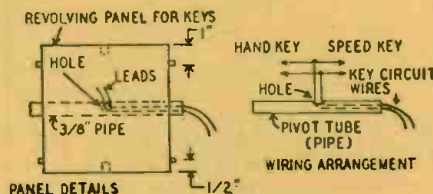
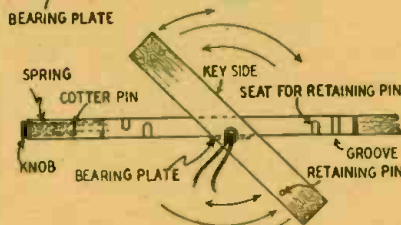
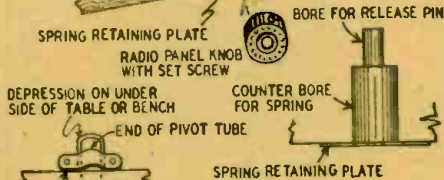
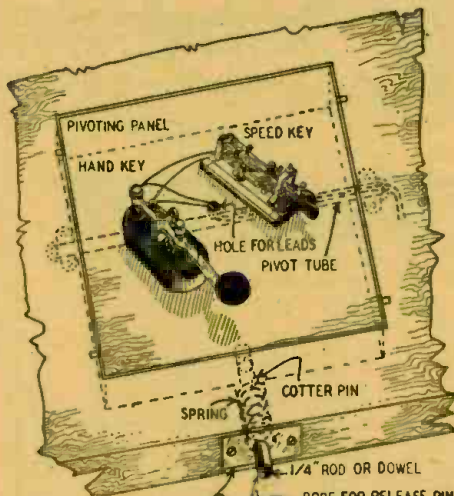

## HARD-TO-GET PARTS

### POWERFUL ALL-PURPOSE INDUCTION MOTOR

IDEAL FOR EXPERIMENTERS—101 USES



Sturdily constructed to Precision standards, this self-starting shaded pole A.C. induction motor is powerful enough for a number of uses. Some of these are: Automatic Timing Devices, Current Interrupters, Electric Fans, Electric Chimes, Window Displays, Photoelectric Control Devices, Electric Vibrators, Small Grinders, Buffers and Polishers, Miniature Pumps, Mechanical Models, Sirens, and other applications.

Consumes about 15 watts of power and has a speed of 3,000 r.p.m. When geared down, this sturdy unit will constantly operate perfectly on 2 dry cells. Loaded with 200 lbs. dead weight—THAT'S POWER!  
Dimensions 3" high by 2" wide by 1 1/2" deep; has 4 convenient mounting studs; shaft is 3/16" long by 3/16" diameter, and runs in self-aligning oil retaining bearings. Designed for 110-20 volts. 50-60 cycles. A.C. only. Shp. Wt. 2 lbs.  
ITEM NO. 147  
YOUR PRICE ..... **\$2.95**

### ULTRA MAGNET

LIFTS MORE THAN 20 TIMES ITS OWN WEIGHT

LITTLE GIANT MAGNET

Lifts 5 lbs. easily. Weighs 4 oz. Made of ALNICO new high-magnetic steel. Complete with keeper. World's most powerful magnet ever made. The experimenter and hobbyist will find hundreds of excellent uses for this high quality permanent magnet. Measures 1 1/4" x 1 1/4" Shp. Wt. 3 1/2 lbs.  
ITEM NO. 189  
YOUR PRICE ..... **\$1.50**



### GENUINE MICROPHONE TRANSMITTERS



Regular telephone transmitters taken from a large telephone supply company's overstock. Work perfectly on 2 dry cells. Can be used on P.A. systems, call systems, intercommunications in e. g. short-line telephone circuits, house-to-house or farm-to-farm phone lines, also to talk through your own radio or as concealed telephone pick-up. Useful replacements on battery-operated rural telephone lines.

THESE ARE GENUINE TRANSMITTERS. MADE BY KELLOGG, WESTERN ELECTRIC AND STROMBERG-CARLSON, excellent in appearance and operation, remarkable value and one seldom offered in these times. Shp. Wt. 1 lb.  
ITEM NO. 160  
YOUR PRICE ..... **\$2.10**

### WATTHOUR METER



Completely overhauled and ready for immediate service. Designed for regular 110-220 volt, 60 cycle 2-wire A.C. circuit. Simple to install: 2 wires from the line and 2 wires to the load. Sturdily constructed in heavy metal case. 8 1/2" high, 6 1/4" wide, 5" deep. Westinghouse, G. E., Ft. Wayne, Sangamo or other available make Shp. Wt. 14 lbs.

ITEM NO. 33  
YOUR PRICE ..... **\$7.50**

### AMAZING BLACK LIGHT!

Powerful 250-Watt Ultra-Violet Source

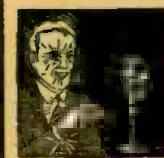

The best and most practical source of ultra-violet light for general experimental and entertainment use. Makes all fluorescent substances brilliantly luminescent. No transformers of any kind needed. Fits any standard lamp socket. Brings out beautiful opalescent hues in various types of materials. Swell for amateur parties, plays, etc. to obtain unique lighting effects. Shp. Wt. 1 lb.  
ITEM NO. 87  
YOUR PRICE ..... **\$1.95**

### WESTERN ELECTRIC BREAST MIKE

This is a fine light-weight aircraft carbon microphone. It weighs only 1 lb. Mike comes with broadcast mounting and has 2-way swiveling adjustment so that it can be adjusted to any desired position. There are 2 woven straps; one goes around neck, the other around chest. Straps can be snapped on and off quickly by an ingenious arrangement. This excellent mike can be adapted for home broadcasting or private communication systems. By dismantling breastplate, it can be used as desk mike. Comes complete with 6-foot cord and hard rubber plug. Finished in spherulized plate, non-rustable. Shipping weight, 2 lbs.  
ITEM 152  
YOUR PRICE ..... **\$1.49**



### HUDSON SPECIALTIES CO.

40 West Broadway, Dept. RC-4-48, New York 7, N. Y.

I have circled below the numbers of the items I'm ordering. My full remittance of \$..... (include shipping charges) is enclosed (NO C.O.D. ORDERS UNLESS ACCOMPANIED WITH A DEPOSIT.) OR my deposit of \$..... is enclosed (20% required), ship order C.O.D. for balance. NO C.O.D. ORDER FOR LESS THAN \$5.00. BE SURE TO INCLUDE SHIPPING CHARGES.  
Circle Item No. wanted:  
147 159 160 87 152 33

Name .....

Address ..... Please Print Clearly

City ..... State .....

panel in position and permit it to pivot on its axis.

The panel is kept rigid by a release pin formed from a piece of metal rod, a spring, and a radio knob. This is operated through a hole in the front edge of the bench. The compression spring keeps the release pin seated in a hole in the front edge of the panel.

Short 1/16- or 1/8-inch pins are set in the sides of the panel where they seat in depressions in the table surface and provide additional support. Grooves are cut in the sides of the hole—at the rear—to permit the panel to swing through 180 degrees.

The keying wires are run through one end of the tube and up through the center hole where they are connected in parallel to the two keys. It is here where the side pins prevent the panel from turning too far and eventually wringing off the wires as they pass into the tube.

With this idea it is a simple matter to pull out the retaining pin, swing the panel completely over and then let the pin back into place. A reverse motion is then necessary when the first side is to be brought uppermost. L. B. ROBBINS

**SURPLUS SPECIAL**—Small 110 v. AC open frame motor, 1/4" shaft, 2700 R.P.M., 1/70 H.P., mfg. by BARBER COLE—\$2.00 ea. MAN CO.  
**TRANS Pri. 200, 220, 240 V. 50 cy; Sec 75, 85, 95, 105 V.—1.5 A; Pri 195 V.A.—\$4.50**  
 Test 2000 V.

CAPACITORS	
1190 mfd. 50 volt	1.25
1500 mfd. 50 volt	1.65
2000 mfd. 50 volt	1.95
500 mfd. 200 v.	1.75
SWITCHES	
Slide switch: Stackpole DPDT	.15
SPDT momentary, center off position, long bat handle	.29
4 pole DT 10A, 125 v.	.50
SPDT center off position, 6A, 125v.	.29
Toggle Bat Handle DPST	.35
CONDENSERS	
Condensers, Variable, dual 2.5 to 10 mmf.	.45
2 Gang 280 mmf per section 1/4" shaft, mycalex insul.	1.00
Condensers, Variable, Ceramic Insul. shaft 5/16x3/4 L.	
C118-10-45 mmf with coil, tunes to 31 mes	.50
C122-7-27 mmf with coil, tunes to 58 mes	.50
C108-11-115 mmf	.35
15-330 mmf 1/4" shaft Brass Plate, Ceramic	.75
OIL Filled Condensers:	
.03 mfd. 7500 v. DC	1.15
.30 mfd. 2000 v. DC	.85
1 mfd. 2500 v. DC	1.25
1 mfd. 1200 v. DC	.65
4 mfd. 2000 v. DC	2.75
10 mfd 1500v. DC	3.15

# 73 DE W2BOT

**MISCELLANEOUS**

3 A.G. Bakelite fuse Post	\$.25
4 A.G. Bakelite fuse Post	.25
Circuit Breakers—Heinemann—5 Amp	.95
PL259A Coax Connector and Socket, Silver Plated for RG8U and RG11U	.60 pr.
Right Angle Adapter M359A	.30
7 Ft. Telescopic Am.	1.00
Variable Ceramicon 4-30 mmf. 7-45 mmf.	.25
Filament Transformer: 5 volts @ 4 amp, 110 volt pri. open frame, porcelain standoffs. Mfd. by G.E.	1.50
0 to 15 DC Milliammeter, Simpson 3 1/2" Bakelite case	2.95
Pilot Light Assy. 1" Ruby Jewel complete with 110 v. AC Candelabra base bulb	.50
12 v. Edwards' Buzzer complete with push button	.40
Rectifier, Copper oxide. Full wave 110 VAC input, 100 VDC @ 1 amp. output	3.50
Solenoid, 6VDC Complete with plunger and mtg. Bracket	1.25
Microphone, T 17 with push to talk switch Cord and plug	.59
Sound powered phones, TS 10K (unused) Pr. 25.00	
10-Point Jones Connector—Male & Female	1.00

**SYNCHRONOUS MOTOR**  
 1/4" shaft 110 v. AC 60 cy. 4/5, 1, 1 1/5, 1 1/2 RPM. 2.2 watts.  
 Mfg. by Hayden Mfg. Co. **\$1.75**

No sale less than \$2.00. All prices FOB New York City. Add 25c to cover postage. 20% Deposit required with all orders. All Prices subject to change without notice.

**A. M. RADIO SALES COMPANY** 345 CANAL ST. NEW YORK CITY 13, N. Y.

## FM STATION LIST

(Continued from page 73)

FREQUENCY (MC)	CALL	LOCATION
101.5	WJBC-FM	Bloomington, Ill.
101.5	WRAL-FM	Raleigh, N. Y.
101.5	WSPD-FM	Toledo, Ohio
101.7	KPNI	Palo Alto, Calif.
101.7	KWIL-FM	Albany, Ore.
101.7	WFAH-FM	Alliance, Ohio
101.7	WLIN-FM	Merrill, Wis.
101.9	KARM-FM	Fresno, Calif.
101.9	KFXD-FM	Nampa, Idaho
101.9	WCTS	Cincinnati, Ohio
101.9	WGAN-FM	Portland, Maine
101.9	WGHF-FM	New York, N. Y.
101.9	WGNC-FM	Gastonia, N. C.
102.1	KSTP-FM	St. Paul, Minn.
102.1	WELL-FM	Battle Creek, Mich.
102.1	WEWS-FM	Cleveland, Ohio
102.1	WFIL-FM	Philadelphia, Pa.
102.3	WGAY-FM	Silver Spring, Md.
102.5	WFJS	Freeport, Ill.
102.5	WIBW-FM	Topeka, Kan.
102.5	WISE-FM	Asheville, N. C.
102.5	WOAI-FM	San Antonio, Texas
102.5	WDR-FM	Syracuse, N. Y.
102.5	WPLH-FM	Huntington, W. Va.
102.7	KFMY	Fort Dodge, Iowa
102.7	KOKX-FM	Keokuk, Iowa
102.7	WAAT-FM	Newark, N. J.
102.7	WCAO-FM	Baltimore, Md.
102.7	WSMB-FM	New Orleans, La.
102.7	WTRI-FM	Troy, N. Y.
102.9	KFOR-FM	Lincoln, Nebr.
102.9	KPRC-FM	Houston, Texas
102.9	WCYS-FM	Springfield, Ill.
102.9	WFMU	Crawfordsville, Ind.
102.9	WLET	Toccoa, Ga.
102.9	WPEN-FM	Philadelphia, Pa.
102.9	WPIC-FM	Sharon, Pa.
102.9	WRLD-FM	Lanett, Ala.
103.1	KRJM	Santa Maria, Calif.
103.1	WCTW	New Castle, Ind.
103.1	WFMO-FM	Jersey City, N. J.
103.1	WJJW	Wyandotte, Mich.
103.1	WRGK	Brookfield, Ill.
103.1	WRGK	La Grange, Ill.
103.3	WDBQ	Dubuque, Iowa
103.3	WIZZ	Wilkes-Barre, Pa.
103.3	WLOG-FM	Logan, W. Va.
103.3	WSBA-FM	Montgomery, Ala.
103.3	WSFA-FM	York, Pa.

(Continued on page 80)

## TELEVISION I. F. KIT

Video and Sound I.F. System including Peaking Coils

Complete **\$11.97**

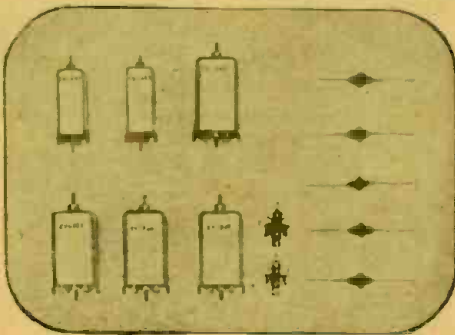

- Stagger tuned
- HI-Definition Picture
- 4 M.C. band width
- Sound rejection 150 to 1
- Adjacent channel rejection 100 to 1

## BUILD YOUR OWN FM TUNER OR FM RADIO

FM-Condenser & Coil Kit—(88 to 108 Mc)

- Variable Condenser
- Discriminator Coil
- Oscillator Coil
- Two I.F. Coils
- Limiter Coil
- Antenna Coil
- Schematic Diagram
- Instructions

**\$4.95**

This Kit contains the vital parts needed to build an FM Tuner or Radio and for modernizing Pre-War FM Sets; all other parts needed are standard.

**BROOKS RADIO DISTRIBUTING CORP.**  
 80 VESEY STREET DEPT. A NEW YORK 7, N. Y.

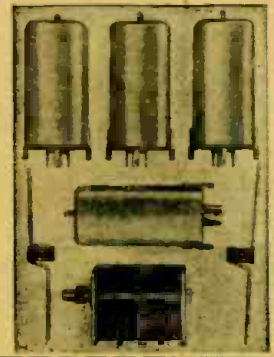

## WANTED: WILL PAY \$1.00 PER COPY

for the following copies  
**OFFICIAL SHORT WAVE LISTENER MAGAZINE**  
 • June-July 1935 • April-May 1936  
 Copies must be in good condition.  
 Radio-Craft, 25 West Broadway, New York 7, N. Y.

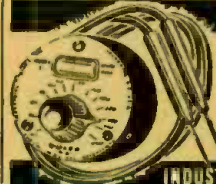

**FLASH THAT VOLTAGE**  
 Turn that knob. Extinguish the neon glow. Instantly read voltage right off dial. MINI-VOLT measures 65 to 660 v. AC. Also DC. Tells whether AC or DC. Virtually burnout-proof. Guaranteed for 10,000 hours' operation. Bakelite case. 12" flexible test leads and test prods. A "must" in electrical and radio work. Only \$2.50 postpaid!

**INDUSTRIAL DEVICES, INC., EDGEWATER 3, N. J.**

## INVALUABLE!

ELEMENTS OF MAGNETIC TAPE RECORDING and 999 APPLICATIONS



by A. C. SHANEY

AVAILABLE FOR ONLY **25c**

Contains schematic diagrams

**AMPLIFIER CORP. of AMERICA**

398-10 Broadway New York 13, N. Y.



## Better Products for the Radio Industry

### NEW G-C STATIC CHASER INJECTOR and POWDER



Tire static powder kits—improve auto radio reception. Eliminates wheel static interference. New powder is blown into all inner tubes—easy to use. For every car owner!

- No. 5604—Injector for G-C Static Powder ..... List \$1.50
- No. 5605—G-C Static Powder Packet for 5 tires ..... List \$1.00
- No. 5606—Kit—One Powder Packet and Injector ..... List \$2.50



Have you seen the new G-C "Speedex" Wire Strippers... write for illustrated literature.  
RADIO DIVISION DEPT. D

### NEW G-C TUBE PULLER

Makes it easy to remove or insert miniature tubes... simple to operate. Inserts or extracts tubes where fingers will not reach—into hard-to-reach places. Saves time and money. Ends tube breakage, prevents burnt fingers.



- No. 5093—Miniature Puller..... List \$ 1.50
- No. 5093-D Display of 12..... List \$18.00

### NEW G-C FIELD CHASSIS

Holds almost any radio chassis in position! Has special reversible hooks for flanged type chassis or, to tilt chassis back if necessary. Made with slide adjustment—takes only 5 seconds to install. No parts to lose—will never wear out. A real convenience for the radio serviceman!



G-C Products are available at leading distributors. Write for your copy of our new illustrated catalog.

## GENERAL CEMENT Mfg. Co., Rockford, Ill., U. S. A.

Manufacturers of over 3,000 products • Sales offices in principal cities

## RISCO HAS IT

All Changers Brand New

### V. M. MIXER CHANGER



PLAYS 10" and 12" records at the same time.

DETROLA, 13.75  
MAGUIRE, 10.50  
STOPS AFTER  
LAST RECORD;  
PERMANENT  
NEEDLE. 2-  
POST.

\$15.50

Above Easily Attached to Any Radio or CAN BE USED WITH AMPLIFIER BELOW

### SERVICEMEN'S SPECIALS

- 100—INSUL. RES. KIT 1/2, 1, 2W.....\$1.65
- 25—MICA COND.—CODED..... .89
- 15—ASST. KNOBS..... .89
- 15—ASST. BY-PASS COND..... .89
- 15—ASST. SOCKETS..... .69
- 10—ASST. VOLUME CONTROLS..... .89
- TEST LEADS, 50 IN. LONG..... .29
- NEON TESTERS..... 2.50
- ALLIANCE PHONO MOTORS..... 1.79
- ASTATIC L-70 or SHURE GLIDER PICKUPS..... 1.79



**PHONO AMPLIFIER**  
3 TUBE AC-DC  
Wired Vol. & Tone \$2.75  
Control  
Uses 12SQ7, 50L6, 35Z5.  
Wired & Tested  
Set of 3 Tubes.....\$1.95  
Output Trans..... .39  
3" Astatic Spk..... 1.19

**PHONO OSC-2-TUBE**  
Wired & Tested \$2.75  
2 Tubes—\$1.50

25% on C.O.D. orders. Orders Filled as Received  
VISIT OUR NEW SHOW ROOM  
Free Catalog "C" Just Out  
We Specialize in Mail Orders  
25 WEST BROADWAY N. Y. 7.

## RISCO ELECTRONICS WHOLESALE DISTRIBUTORS

Television network problems have now been solved, E. W. Engstrom of RCA laboratories told the Sigma Xi Society at Cornell University last month. Radio relays and co-axial lines have conquered technical obstacles and television is also well on the way toward solving its economic problems, he said.

## GREYLOCK

A Dependable Name in  
RADIO TUBES

GT, Glass, and Miniature Types.  
All Tubes Individually Boxed.  
12SA7, 12SK7, 12SQ7, 50L6, 12AT6,  
12BA6, 12BE6, 35W4, 50R5, each 39c  
1R5, 1S5, 1T4, 3A4, 3Q4, 6AK5, 6AC5, 6AC7,  
6AQ5, 6BE6, 6BA6, 6AU6, 6BJ6, 6X4, each 49c  
32L7, 70L7, 117L7, each 59c  
All Tubes Carry RMA 90-Day Guarantee

### PM SPEAKERS

- 4" Astatic No. 5 .....each \$1.19
- 5" Astatic No. 5 .....each 1.29

TERMS: Net COD. No order accepted for less than \$5.00  
WRITE FOR BARGAIN CATALOG C-4  
**GREYLOCK ELECTRONIC SUPPLY CO.**  
30 Church Street New York 7, N. Y.

## FULLY AUTOMATIC POP-UP ELECTRIC TOASTER

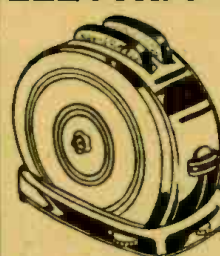

Available Now!

Automatic release  
no burning... adjust-  
able to light, medium,  
dark... removable  
crumb tray for easy  
cleaning... al-  
chromium in attractive  
design. Complete with  
cord.

Each ..... \$11.37  
Lots of 6 ..... \$11.17  
Ea. ....

25% With Order—balance C.O.D.

1 YEAR GUARANTEE  
4 YEAR WARRANTY  
Write for Our New Catalog on Fast Selling Money-Making Gifts and Small Electric Appliances  
**Wholesale Distributors**  
**SHEFFIELD RADIO & APPLIANCE CO.**  
918 W. Belmont Ave., Dept. A, Chicago 14, Ill.

New FM stations will go on the air at the average rate of 50 a month in 1948, the FM Association predicted in January.

## FM STATION LIST (Continued from page 79)

FREQUENCY (MC)	CALL	LOCATION
103.3	WSM-FM	Nashville, Tenn.
103.5	KYSM-FM	Mankato, Minn.
103.5	WSTV-FM	Steubenville, Ohio.
103.7	KQW-FM	San Francisco, Calif.
103.7	WROV-FM	Roanoke, Va.
103.7	WSAR-FM	Fall River, Mass.
103.7	WTBY-FM	Gadsden, Ala.
103.9	KENO-FM	Las Vegas, Nev.
103.9	KOPP-FM	Ogden, Utah.
103.9	WDLB-FM	Marshfield, Wisc.
103.9	WFAS-FM	White Plains, N. Y.
103.9	WJEM	Springfield, Ohio
103.9	WTAL-FM	Tallahassee, Fla.
103.9	WXNJ	Green Brook Twp., N. J.
103.9	WXNJ-FM	Plainfield, N. J.
104.1	KFUO-FM	St. Louis, Mo.
104.1	KMPM	Monroe, La.
104.1	WJW-FM	Cleveland, Ohio
104.1	WMUN	Muncie, Ind.
104.1	WSJS-FM	Winston-Salem, N. C.
104.3	KGNC-FM	Amarillo, Texas
104.3	KTOK-FM	Oklahoma City, Okla.
104.3	KWLK-FM	Longview, Wash.
104.3	WITH-FM	Baltimore, Md.
104.3	WLOS-FM	Asheville, N. C.
104.5	KIXL-FM	Dallas, Texas
104.5	KRCC	Richmond, Calif.
104.5	WHIS-FM	Bluefield, W. Va.
104.5	WWST-FM	Wooster, Ohio
104.7	WHVA	Poughkeepsie, N. Y.
104.7	WIST	Charlotte, N. C.
104.7	WJEJ-FM	Hagerstown, Md.
104.7	WOPT-FM	Oswego, N. Y.
104.9	KURY-FM	Edinburg, Texas
104.9	KONG	Alameda, Calif.
104.9	WMCK-FM	McKeesport, Pa.
105.1	KCLI	Los Angeles, Calif.
105.1	WDNC-FM	Durham, N. C.
105.1	WQDI	Quincy, Ill.
105.1	WFMJ-FM	Youngstown, Ohio
105.3	WWHG	Hornell, N. Y.
105.5	WFOB	Fostoria, Ohio
105.7	KIMV	Hutchinson, Kan.
105.7	KUOA-FM	Siloam Springs, Ark.
105.7	KXEL-FM	Waterloo, Iowa
105.7	WDAE-FM	Tampa, Fla.
105.7	WMBS-FM	Uniontown, Pa.
105.7	WRUN-FM	Rome, N. Y.
105.7	WSIC-FM	Statesville, N. C.
105.9	KFI-FM	Los Angeles, Calif.
105.9	KOMA-FM	Oklahoma City, Okla.
105.9	KSBS	Kansas City, Kan.
106.1	KGO-FM	San Francisco, Calif.
106.1	KIDO-FM	Boise, Idaho
106.1	WKJG-FM	Fort Wayne, Ind.
106.1	WKNP-FM	Corning, N. Y.
106.1	WLOB-FM	Claremont, N. H.
106.3	WMLN	Mt. Clemens, Mich.
106.5	WBEN-FM	Buffalo, N. Y.
106.5	WFML	Washington, Ind.
106.5	WRGA-FM	Rome, Ga.
106.5	WSTP-FM	Salisbury, S. C.
106.7	WGTM-FM	Wilson, N. C.
106.9	WMIT	Winston-Salem, N. C.
107.1	WAJL	Flint, Mich.
107.1	WCAP-FM	Asbury Park, N. J.
107.1	WWDX-FM	Pateron, N. J.
107.3	KSEO-FM	Durant, Okla.
107.3	WBNB	Beloit, Wisc.
107.7	KFSA-FM	Fort Smith, Ark.
107.7	WAYS-FM	Charlotte, N. C.
107.9	KXOA-FM	Sacramento, Calif.

## LET'S GET ACQUAINTED!

THREE 35Z5 TUBES (Std. Brand) \$1.00  
SEND CASH CHECK OR MONEY ORDER  
10, 12SQ7 TUBES \$4.90 • 10, 5Y3 TUBES \$3.30  
All Tubes Std. Brand and in Individual Cartons  
10, 40-20 150V COND \$4.90  
50 Assorted BY PASS \$3.50  
OUTPUT TRANS, 2,000; 5,000; 7,000-3.5ohms .55  
THIS COUPON MUST ACCOMPANY ORDER  
RADIO SERVICEMEN. Write for Free, Illustrated Bargain Bulletin.  
**JOYCE RADIO DISTRIBUTING CO.**  
Box 2068, HOLLYWOOD 28, CALIF.



## BA BARGAIN SPECIALS



**LOW  
LOW  
PRICE!**

### MASTER-REMOTE INTER-COMS

Push button selection for 1 to 5 remote stations from this quality built 4 tube, 2 watt Master station. Several remotes can be "paged" at one time. Remote stations can originate call to Master. Very simple to install with any 3 conductor cable. Sturdy, good looking wood cabinets, walnut finished. Master 12 x 7 1/4 x 6 1/4". Remote 6 1/4 x 7 x 4".  
 No. 32A234K, Master Station and  
 One Remote—ONLY..... **\$29.95**  
 No. 32A235X, Additional  
 Remote Stations—ONLY..... **\$7.88**  
 No. 2A113, 3 Conductor  
 Cable—100 Foot..... **\$2.60**

### THE "DOUBLE TWENTY" FLUORESCENT UNIT

- Plugs in Any Outlet
- Hangs in Any Position
- Underwriter's Approved



Improved heavy steel, high reflection baked white enamel inside, gray outside. Hangs anywhere, with wire or chain, in a "jiffy." With 6 foot attached cord ready to plug in any outlet. Ideal for your hobby nook, repair shop, store, etc. Shipped complete with two 20 watt lamps. Size 25 1/4 x 9 1/4 x 5 1/4", wt. 10 lbs.  
 No. 30A60..... **\$8.28** 6 of  
 Spec. Each..... **\$7.73**

WRITE FOR YOUR COPY OF CATALOG No. 481 IF YOU DID NOT RECEIVE IT.



## SPECIALS!

BC-454 COMMAND RECEIVER (274N Series)  
 3 to 6 MC—Complete with tubes— **\$5.95**  
 New

COMMAND TRANSMITTERS  
 (274M Series)—Complete with tubes & crystal  
 BC-457: 4 to 5.3MC ..... **\$5.95**  
 BC-458: 5.3 to 7MC ..... **5.95**  
 BC-456 MODULATOR (Brand New) ... **2.95**

RADIO PARTS  
 Assorted—100 mica condensers ..... **\$1.19**  
 100 Resistors 1/3 to 1 watt ..... **.95**  
 100 Tubular bypass condensers, assorted  
 .01 to .1, all 600 Volt ..... **4.69**  
 Electrolytic condensers 50-30, 150 Volt  
 10 for **2.89**  
 1/2 Meg. Volume Controls 1" shaft with  
 switch ..... **10 for 3.00**  
 1/2 Meg. Volume Controls 1" shaft with  
 out switch ..... **10 for 1.95**  
 Crystal Pick-up, new light wt. .... ea. **1.79**

## Brand NEW! TUBES Brand NEW!

CATHODE RAY TUBES } **\$1.19** each  
 5CP1 - 5BP1 - 5FP7 - 7BP7 - 3FP7 }  
 5BP4 ..... **\$1.95** each

RECEIVING TUBES  
 954 9006 12SR7 } **39c** each  
 957 35W4 12K8 } Lots of 50-10%  
 9003 12C8 } discount  
 1625 } **19c** each  
 1629 }

304TL Transmitting tube **\$1.95** each  
 Brand New

All Shipments F.O.B. Chicago  
 20% deposit required on all orders  
**ARROW SALES INC. Dept. D**  
 59 WEST HUBBARD ST., CHICAGO 10, ILLINOIS  
 Telephone: SUPERIOR 5575

## EASY TO LEARN CODE

It is easy to learn or increase speed with an Instructograph Code Teacher. Affords the quickest and most practical method yet developed. For beginners or advanced students. Available tapes from beginner's alphabet to typical messages on all subjects. Speed range 5 to 40 WPM. Always ready—no QRM.



**ENDORSED BY THOUSANDS!**  
 The Instructograph Code Teacher literally takes the place of an operator-instructor and enables anyone to learn and master code without further assistance. Thousands of successful operators have "acquired the code" with the Instructograph System. Write today for convenient rental and purchase plans.

**INSTRUCTOGRAPH COMPANY**  
 4701 Sheridan Rd., Dept. RC, Chicago 40, Ill.

## RADIO AS A VOCATION

(Continued from page 17)

yet he had a mentality of the highest caliber; and most of his knowledge was gained from books and publications.

In the final analysis, everything depends upon yourself. The more you know about a given subject, the more you specialize in it; and the more you know about it the greater are the chances that you will succeed.

Coupled with this, you require other qualities. It is, for instance, not enough that you are another Edison or a Marconi unless others know about your qualifications. The world, as a rule, does not run after you, *you must put yourself ahead*; in other words, you must know how to sell yourself to the radio industry. This can be accomplished only by bringing yourself to its attention, either by personal contact, by letter writing, or by writing for various radio publications and thus getting a reputation in the radio industry.

The radio industry is no different from any other, when it comes to man-power. Competition is just as keen in radio as it is in any other industry, and perhaps in many respects more so. It has, however, plenty of room for the young man of the right mental caliber. Every radio organization needs good men and is willing to pay their price; every organization needs specialists in their own line, men who can think for themselves, men who can do things, men with initiative, and men who believe in the future of radio. And after everything is said and done, always remember that radio is still in the earliest stage of its infancy; and that the young men who enter radio (and its legion of subdivisions) today, will "make" the great radio industry of tomorrow.

## Radio Thirty-Five Years Ago

In Gernsback Publications

HUGO GERNSBACK	
Founder	
Modern Electric	.....1908
Electrical Experimenter	.....1913
Radio News	.....1919
Science & Invention	.....1920
Radio-Craft	.....1929
Short-Wave Craft	.....1930
Wireless Association of America	.....1908

Some of the larger libraries in the country still have copies of ELECTRICAL EXPERIMENTER on file for interested readers.

- From the April, 1914 ELECTRICAL EXPERIMENTER
- Sources of Energy for Radio Transmitters
- Design and Construction Details of Radio Antennae by *H. Winfield Secor*.
- Marconi Lights a Lamp Six Miles Away
- A Simple Radio Break-In System by *J. W. Waite*.
- An Adjustable High-Tension Condenser by *I. Rabi*.
- Crystal Detectors on Parallel by *Alexander Polson*.
- Lamp Test for Adjusting Detectors by *Arthur R. Darling*.

## the radio that AMAZES even the EXPERTS



There is no other radio like Hallicrafters' precision-made Model S-38. Four bands bring you thrilling land, sea, air communications from all parts of the world plus finer quality on your favorite broadcast program. Perfect for den, library, office. Extra clear, strong reception anywhere. AC/DC. Write for Catalog P38 and where to buy.  
 Model S-38... **\$47.50**

## hallicrafters RADIO

Get a Hallicrafters and listen for the Gaitt-Hallicrafters mobile, radio-equipped expedition now operating via short wave from the Mountains of the Moon, Africa.

THE HALLICRAFTERS CO.  
 4401 W. Fifth Ave., Chicago 24, Illinois

## NOW AVAILABLE! Amplifier for GE pickup



New circuits for the first time enable you to attain full benefit from the new General Electric Model DL 1RM 6C Variable Reluctance Magnetic pickup. Employs an exclusive, humless (DC on heaters) pre-equalized pre-amplifier to produce the most satisfying musical amplifier the world has ever known. If you are a perfectionist, you are the one for whom the ACA-100GE was designed. Send for technical literature.

**AMPLIFIER CORP. of AMERICA**  
 398-10 Broadway • New York 13, N. Y.

Portable radios will be powered by sunlight within 25 years, predicts Columbia's president Frank Stanton.

# Radio - Television - Electronic Parts & Equipment Specials

## TELEVISION-CATHODE RAY HIGH VOLTAGE

2000 volt D.C. Power Supply

For an unbelievably low price, we can supply a completely filtered television or cathode ray 2000 volt D.C. power supply. Why bother with bulky and dangerous 60 cycle supplies or expensive R.F. power supplies when you can purchase a complete 2000 volt D.C. unit (not a kit), ready to plug into the 110 volt A.C. power line. The ridiculously low price has been made possible by a fortunate purchase of high quality components. These units are brand new, completely tested and guaranteed.

PRICE .....\$7.95

## 4000-6000 VOLT TELEVISION SUPPLY

Similar to the unit above, but has a much higher D.C. output voltage suitable for use with the new 7" and 10" television tubes.

PRICE .....\$12.50

## RADIO KITS

The kits contain all the required parts except wire and solder for their construction into an efficient working unit comparable with the best post-war type of units. The simplified diagrams furnished make it possible for any radio student, experimenter, or amateur to construct these kits.

5 Tube AC-DC superhet kit furnished in a brown plastic cabinet of artistic design, cabinet size (9"x5"x6")

Variable condenser tuned; with 2 double tuned I. F.'s.

Tubes used: 1 - 12SA7, 1 - 12SQ7, 1 - 12SK7, 1 - 35Z5 and 1 - 50L6

PRICE \$11.95 Including 3 Standard tubes

## 6 TUBE 3 WAY PORTABLE KIT

• For operation on 110 volt AC or DC and battery

• Superheterodyne circuit

• Full vision dial

• High gain loop

• Cabinet of Blue Aeroplano cloth finish, size 13x9x7"

• Tubes used 1A7, 1H5, 3Q5, 117Z6 and 2 - 1N5

PRICE \$13.75 Not including tubes Extra for kit tubes \$3.75

## 6 TUBE, 2 BAND SUPERHET KIT

Bands covered BC 550-1600 KC and 6-18 MC

Power supply 105-125V AC, DC

Full vision dial

Variable condenser tuned, with two double tuned I. F.'s 455KC

Walnut veneer wood cabinet

PRICE \$15.75

## A SCIENTIFICALLY DESIGNED PHONO SCRATCH FILTER

Resonated at approximately 4500 cycles effectively reducing objectionable needle scratch without altering the brilliancy of reproduction. Contains a HI-Q SERIES resonated circuit. Tested by means of an audio oscillator and an oscilloscope to give 22 db. attenuation with very low signal loss. Attention may be regulated by means of a SPECIAL MINIATURE gain control.

EASY TO ATTACH

Just two wires to clip on. Compact. PRICE .....\$1.65

## THREE TUBE PHONO AMPLIFIER

An assembled unit ready for installation using tone and volume control and six feet of rubber cord

(Not including Tubes)

With Complete Set of Tubes .....\$3.95

## PHONO OSCILLATOR

Wireless phono oscillator transmits recording for crystal pick-ups or voice from carbon mike through radio without wires. Can also be used as an Intercomm by using P.M. speaker as mike. Price \$2.95 (excluding tubes)

With Complete Set of Tubes .....\$3.95

## SPECIAL! SPECIAL!

Mammoth assortment of radio and electronic parts, not less than TEN POUNDS of new transformers, chokes, condensers, resistors, switches, coils, wire, hardware, etc. A super-buy for experimenters, servicemen, and amateurs for only .....\$1.25

Satisfaction guaranteed on all merchandise. All prices F.O.B. New York City  
WRITE FOR CATALOGUE

**RADIO DEALERS SUPPLY CO.**

135 Liberty St.

New York, N. Y.

## 5-WATT TRANSMITTER

(Continued from page 31)

shows a meter reading of 50 ma at 110 volts. A mere 5.5-watt input; but just take a few looks at Junior's record!

As an experiment, on a sultry July afternoon, a 15-foot piece of wire was attached to the rig and stretched down an upstairs hall. A W8 was raised, but the QSO was not completed. A W9, in Chicago, was also raised; this contact also fell through, but not before Junior had been given a signal report of RST 5-8-9X! With a 132-foot antenna, working a gainst ground, the little rig has worked (from Baltimore) about 20 states in the following districts: W1, W2, W3, W8, W9, and W0, plus VE2 and VE3! These QSO's have been duplicated many times, some being successful contacts and some being the usual "Sorry OM, QRM got you that time" variety.

(Sent to RADIO-CRAFT for testing, the little transmitter was set up in the Bronx, and worked W3, W8, W9, and—Crown of the evening—G2! Tests were stopped immediately. T9 note was reported on most contacts, though the note can be stopped by tuning the output too

close to the crystal frequency.—Editor)  
And all this with a transmitter that uses less than five dollars worth of mafe-



rial and can be thrown together in a few hours by any reasonably adept ham! Cost is not the only advantage, either. With more attention to compactness, this would make an ideal rig for vacationing amateurs, fitting in a corner of the suitcase.

Considering expenditure and results, this 5-watter is a really useful addition to any ham shack, whether the operator is a beginner or an old timer. Give Junior a whirl some frosty winter night, and you'll forever rue the day that you started buying high-power transformers and bottles. Unless, that is, you prefer brawn to brains. And some do!

## RADIOMEN! YOU EARN MORE WHEN YOU KNOW

### Modern RADIO INSTRUMENTS

**JUST PUBLISHED!**

Here is the book every radioman needs. Brand new, up-to-the-minute. Tells all about modern radio and electrical testing equipment and how to use it. Money-making short-cuts on trouble-shooting, servicing, construction, and other jobs. Over 350 pages, 220 photos and diagrams. Covers Multipliers, Resistors, Ohmmeters, Oscilloscopes and many others. You see actual equipment torn down in step by step photos. All data pre-tested in the Coyne radio shops.

**SEND NO MONEY**

Group is just a request to see and use this great book for 7 days at our expense. Fill out the coupon and send it in. Then examine MODERN RADIO INSTRUMENTS for 7 days, FREE, before deciding if you want to keep it. ACT NOW!

**SEND COUPON TODAY!**

COYNE ELECTRICAL & RADIO SCHOOL, Dept. 48-72,  
500 S. Paulina St., Chicago 12, Ill.

Yes! Please send "Modern Radio Instruments and Testing Methods" on FREE TRIAL. If satisfied after 7 days, I will pay you \$3.50 plus postage—if not, I'll return book and owe nothing.

Name ..... AGE.....  
Address .....  
City ..... Zone ..... State.....  
 Check here if you want book sent C.O.D.—you pay postman \$3.50—Coyne pays postage. Same 7 days' examination and return privilege.

### TUBULAR ELECTROLYTICS

*Fresh stock Fully guaranteed*

20 mfd. 150 V. ....	10 for \$1.79
20-20 mfd. 150 V. ....	10 for 2.49
8 mfd. 450 V. ....	10 for 1.85

Postage extra. 25% deposit on C.O.D.  
Write for our free bargain lists featuring  
"AMERICA'S BEST BUYS"  
**POTTER RADIO CO.**  
1312-1314 McGee St. Kansas City 6, Mo.

## TUBE SPECIALS

**FROM OUR FREE CATALOG**

- ★ 5 tube Kit: 50B5, 35Z5, 12SA7, K7-Q7.....\$2.75
- ★ 5 tube Kit: 50B5, 35W4, 12AT6, 6A6, 6BE6.....\$2.75
- ★ Acorn tubes: Nos. 954, 956, 956, 957, 958A... 49c
- ★ Hear Aid Tubes: CK501AX to CK509AX... 49c
- ★ Submini. Proximity fuse diodes, 6.3 fil. .... 49c
- ★ 70L7.....79c
- ★ 70L7.....79c
- ★ TUBE SPECIALS.....59c each, 10 for \$5.00
- ★ 1K5, 1K5, 1T4, 1V, 354, 6AH6, 6AK5, 6AL5, 6AN5, 6AT6, 6BA6, 6BE6, 6C4, 6H6, 6L6, 6N4, 6N7, 6X4, 12BA6, 12BD6, 12SA7, 12BE6, 25Y5, 50B5, 717A, 9001, 9002, 9003, 9006
- ★ RK-34 and RK75 transmitting tubes .....90c ea.
- ★ Scarce Tubes: 6AC5, 25A6, 25A7 .....79c ea.

Write for free catalog  
20% Dep. Bal. C. O. D.—Min order: \$3.00  
**COMMERCIAL RADIO Dept. C1**  
36 BRATTLE STREET, BOSTON 6, MASS.

## HIGH-VOLTAGE R.F. COILS

The experimenter who wishes to construct an r.f. high-voltage generator, such as described in the May, 1947, issue of RADIO-CRAFT, can make the coils without a coil-winding machine by winding the wire on spider-web forms cut out of thin composition board or heavy stencil paper, both of which are available in art supply stores. (Excellent forms for this purpose could be cut from polystyrene sheets.—Editor)

In cutting and winding the forms the inside dimensions and the number of turns given in the original descriptions should be followed. The layers may be spaced with nuts or spacing washers from a discarded condenser. The screw holding the forms together should be brass.

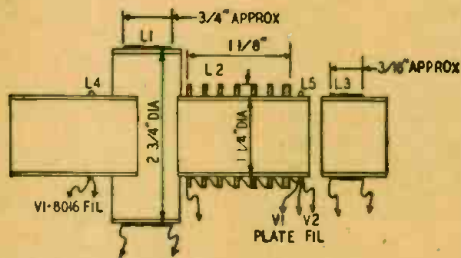

My original coil forms had 7 sections, but the coils will be flatter and neater if a larger number of sections are cut, at least 11 or 13. The forms must be cut with an odd number of sections.

Coil forms of this type will take up much more space than the conventional type, but the experimenter can try smaller diameter forms and more layers. With this arrangement, it pays to experiment with the number of turns in the grid coil.

Coils of this type may not be as efficient as those of modern design, but they can be made without special equipment.

Incidentally, for those who do not have a beam-power tube handy, other tubes will work. I used a 59. It operates more efficiently as a triode, with the control and screen grids tied together and the suppressor grid connected to the plate. I found a low value of grid resistor gave best results.

HAROLD WALKER,  
Philadelphia, Penna.

## A STABLE REGENERATIVE RECEIVER

(Continued from page 34)

to the speaker voice coil. The output terminals are brought out to the rear of the chassis. Inserting the headphone plug in the jack silences the speaker.

A small a.c.-d.c. choke may be used in place of the 450-ohm resistor in the power supply.

Since the set uses an a.c.-d.c. power supply, take care not to ground the chassis. A 1-ampere fuse in the line is sufficient protection in case of an accidental short circuit.

If you have wondered what a good regenerative receiver is capable of doing try building this one. The results are really worthwhile. It is no temperamental plaything, but a receiver you will enjoy listening to and operating.

RADIO-CRAFT for APRIL, 1948



# NOW! BUILD 15 RADIOS

## COMPLETE KIT ONLY... \$14<sup>75</sup>

**ABSOLUTELY NO KNOWLEDGE OF RADIO NECESSARY  
YOU NEED NO ADDITIONAL PARTS!**

### PROGRESSIVE SCOOPS!

#### FM COIL & CONDENSER KIT

Designed for operation on 88-108 MC (new band), contains 2 IF transformers, 1 Limiter Transformer, 1 Discriminator Transformer, 1 RF coil, 1 Variable condenser, Schematic and wiring instructions. Excellent for schools, experimenters and Radio Hobbyists.  
Price only ..... \$4.95

#### CONDENSER KIT

50 Paper Tubular Condensers. Values from .002 mfd to .1 mfd. 400 V. DC to 600 V. DC.  
Only \$1.95

#### RESISTOR KIT

100 Carbon Resistors, 1/2 Watt., RMA color-coded. Values from 120 ohms to 2.2 megohms \$1.50  
10-10 MFD. 450 W.V. DC Electrolytic Condensers ..... 65c  
20-20 MFD. 150 W.V. DC Electrolytic Condensers ..... 30c  
40-40 MFD. 150 W.V. DC Electrolytic Condensers ..... 45c  
Antenna and RF Coil Set (Broadcast Band) ..... 59c  
6" Alnico Slug Speaker... \$1.69  
Selenium Rectifiers ..... 79c  
Midget Soldering Iron 35 Watts 110/120 volts UL approved 69c  
55 Watt Soldering Iron UL approved ..... \$1.90  
75 Watt Soldering Iron UL approved ..... \$2.40  
Long Nose Pliers and Cutters ..... \$1.45

#### PROGRESSIVE RADIO TOOL KIT

contains 75 Watt 110/120 Volt soldering iron, long nose pliers & cutters, screwdriver, insulated alignment tool ..... \$3.25

#### ESPEY CUSTOM-BUILT AM-FM HIGH FIDELITY RECEIVERS--Model No. 7-8C

1. AC Superhet AM-FM receiver.
2. Frequency Modulation Circuit.
3. 11 finest quality tubes, including rectifier.
4. 4 dual purpose tubes give 15 tube performance.
5. Automatic volume control.
6. Full-range volume control.

7. High-Fidelity AM-FM reception.
8. Full-range combination bass-treble tone control.
9. 13 watt (maximum) Push-Pull Audio Output.
10. 10 inch PM speaker with Alnico V magnet.
11. Indirectly illuminated "slide-rule" dial.

12. Loop antenna for AM and Folded Dipole antenna for FM reception supplied.
13. Provisions for external antennas.
14. Wired for phonograph operation.
15. Licensed under RCA and Hazeltine patents.
16. RMA listed.

\$25.00 deposit required with C.O.D. orders

Your Price \$82.50

WRITE FOR PROGRESSIVE QUANTITY PRICES

**PROGRESSIVE ELECTRONICS CO., Dept. RC-12**  
497 UNION AVE. ● BROOKLYN 11, NEW YORK

We pay Postage on Prepaid Orders. All C.O.D. Orders Shipped Collect.

## Do you need BINDING POSTS?



The XL PUSH POST with its Spring Action assures Constant Contact and quick connection. Manufactured in All Aluminum Type M at 22c each. Aluminum Body, Bakelite Top Type B1 at 15c each. Types CP or NP, ALL BRASS—STAINLESS STEEL SPRING & PIN. PROVEN by 240 HR. SALT SPRAY TEST as NON-CORROSIVE at 28c each. Manufacturers and Dealers Liberal Discounts

### X. L. RADIO LABORATORIES

420 West Chicago Ave., Chicago 10, Ill.

Nearly 200 million receiving tubes were sold by member companies of the RMA in 1947, that association reported last month.

Of the year's total of 199,584,827 tubes, more than 2/3 were sold for new sets, and approximately 1/10 for re-

## ROTA-BASE

NEW HANDY LAB. DIAL actually gives a "prong" picture of radio tube connections. INSTANTLY, ACCURATELY. No more valuable time lost thumbing pages or on lengthy readings. Filament, grid, plate, cathode, etc., to more than 300 tube types are shown. NOW ONLY \$1.00 postpaid, or sent C.O.D. plus postage. Order TODAY, money refunded if you are not delightfully pleased.

### REED MFG. CO.

1750C Burbank Blvd. N. Hollywood, Calif.

### RADIOMEN SERVICEMEN BEGINNERS

## MAKE MORE MONEY EASILY—QUICKLY

\$250. WEEKLY POSSIBLE

We Show You How Information Free

### MERIT PRODUCTS

216-32V 132 AV, SPRINGFIELD GARDENS 13, N.Y.

placement purposes. The remainder were sold for export and to government agencies.

## WAR SURPLUS BARGAIN KIT



### 4 LAMPS ELECTRONIC PHOTO FLASH EQUIPMENT. THE FAMOUS "MODEL 1503" AIR-CRAFT FLASH UNIT.

This powerful high quality equipment was made for the U. S. Air Corps and will be shipped to you brand new in original boxes.

#### • THE POWER SUPPLY

is built into a beautiful gray finished case, with all connectors, relay control, 2 condensers each 2000 Volts, 50 M.F.D. light output 110 Watt seconds, can be used with any 12 Watt battery as a professional studio flash equipment. The power pack alone is worth more than the price we are asking for the complete unit.

• THE FOUR HIGH SPEED FLASH TUBES are plastic sealed, unbreakable, 12 million peak lumens light output for more than 15,000 flashes.

• IN ADDITION TO THIS WE SUPPLY: aluminum reflectors, transformer, connectors, connecting cords, spare parts, diagram and instructions on how to use it for battery or on how to convert the unit for 110 Volt A.C.

• IT IS THE BEST VALUE IN WAR SURPLUS MATERIAL.

WHILE THEY LAST. **\$68<sup>00</sup>**  
PRICE complete . . . .

**CINEX, INC., Dept. CR**  
165 WEST 46th ST. New York 19, N. Y.

## APRIL SPECIAL

Resistor Kits \$1.45  
100 assorted carbon and wirewound resistors . . . 1/2 to 10 watt. Wide range of values. All standard items.

Condenser Kits \$1.75  
50 assorted paper and mica condensers. . . All new . . . Good value.



Mike and Phono Amplifiers \$14.95

This unit sold complete with power transformer, 3 tubes and 3 controls . . . all wired and tested. Diagrams supplied.



AC DC Radio Kits \$11.95  
Super-hot circuit. 5 tubes, 4" Alnico 5 speaker complete with bakelite cabinet, tubes, and instructions.

Wireless Phono Oscillator \$4.52  
Operates as far as 100 feet from radio and can be used with automatic record changer and players . . . complete with 2 tubes all wired and tested. Diagram.



Phono Pre-Amplifier \$4.95  
This unit is for G.E. Reluctance type cartridge. Completely wired, tested. Supplied with diagram, and tube 68CT.

Battery Radio Kits \$10.50  
Operates on self contained "B" and "A" batteries . . . broadcast 550 to 1800 Kc. Has 4 tube super-hot circuit. Complete with tubes, case and instructions. Batteries extra, \$1.75.

RADIO PARTS	
4" PM Speaker . . . . .	\$1.15
5" PM Speaker . . . . .	1.15
6" PM Speaker with 50L6 output . . . . .	1.60
6" PM Speaker . . . . .	1.55
6" PM Speaker with 50L6 output . . . . .	1.90
5" 450 ohm dynamic speaker with 50L6 output . . . . .	2.39
Selenium Rect. Boxed, 100 Ma. . . . .	.69
1/2 mex. Volume Controls and Sw. long shaft . . . . .	.35
6 ft. line cord . . . . .	.13
Qsc. Coil 12SA7 . . . . .	.15
Astatic Crystal Pickups . . . . .	1.89
Alliance Motors and Turntables . . . . .	2.50
G.I. dual speed home recording Model R90L 28.98	

ALL PRICES F.O.B. N.Y.C.  
ON C.O.D. ORDERS 25% DEPOSIT  
**THE ROSE COMPANY**  
88 West Broadway Dept. (C). N. Y. 7. N. Y.

# Communications

WANTS STRAIGHTFORWARD CIRCUITS ONLY

Dear Editor:

James R. Langham's article, "Adventures in High Fidelity" was a *wow*. I have not yet made up my mind as to whether I ought to sue you for injuries to my laughing gear. I am old-fashioned in my ideas on the requirements and tubes for quality amplifiers. Have nothing but Bronx cheers for feed-back, Ring-around-the-Rosy circuits when a plain class-A 1- to 5-watt amplifier is more than enough to blow speakers and drive a good recording head.

I am a fall guy for such articles as "Build Your Own Recording Studios," etc. The more I read the more confused I become, what with the 3 different reference levels, the K's vs the M's, the condenser markings and the different recording characteristics, which are ridiculous and change overnight.

I took up a general discussion of these matters with an expert "record jockey"

at NBC in New York City, a while ago, and it ended in his telling me that I should take a recording course and get modern ideas. Looking around, I found a school over in Jersey. I was dumfounded at the vast number of tubes in the amplifiers to drive the 2 recording heads on a pair of small recorders which looked like the machines the late Thomas Edison used to work with.

The instructor turned on the amplifiers and a swell 200-horsepower howl started up. He then explained he had forgotten to close the studio door. I backed out and have given up the idea of becoming modernized on sound. I am going back to Western Electric's principles and systems, except the up-and-down recording.

Let's have a few more nonsensically sensible articles by Mr. Langham.

RALPH W. NICHOLS,  
Miami Shores, Florida

## COSMO-COMPO RADIOS WILL RUIN SERVICEMEN?

Dear Editor:

Your December, 1947, RADIO-CRAFT has an article on the new *Cosmo-Compo* radio.

The heading of the article reads: *This Radio Services Itself*. Above it is a hand holding a soldering iron. What is of the gravest importance to every serviceman is the *cross that cancels that figure out*. That cross means the cancellation of the efforts made by every serviceman now in business, those who are still learning to read diagrams and

those who have spent years learning how to do an artistic, neat, and complicated job of wiring.

The only thing this new idea has done is to make it possible for the customers to take the profit out of the servicing profession. This means that the good old American way of life, which carries with it security, education, better economic conditions and luxuries, will soon be only a dream for the serviceman.

This smart idea coming on the market means that the art of radio serv-

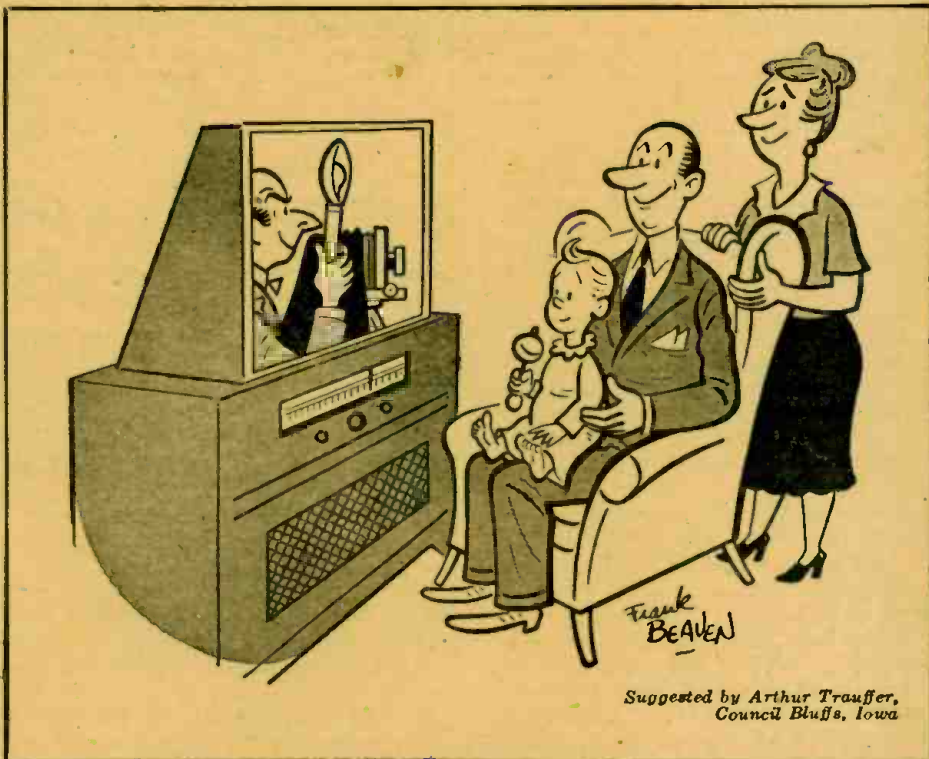

Suggested by Arthur Trauffer,  
Council Bluffs, Iowa

icing returns to the days when any *jack-out-of-the-box* with a nail file and a pair of pliers, was a radio repairman. This radio would cause all the hours of work and hard study, and the many dollars for test equipment, to have been spent in vain. And all the labor and time spent in developing a successful servicing business would also be wasted.

With this type of radio the public would be able to make *any repair* the same as if only a tube were out. Why not let the radio profession stay out of the hands of the novice? Let him change tubes, but don't make it possible for him to replace any stage of his set that may be dead.

Radio servicing is a proud profession for those who are in it, and can still be the idol that catches the eyes and interest of many to come. It will cease to be such if there are no profits in it for the poor serviceman who even now finds it hard to meet his bills. The radio serviceman is a human being, and is entitled to win his bread the same as anyone else. He has to buy food, clothing, shelter, and all the things that are necessary for a decent life. They should not be cut off just because someone has per-

fectured an idea that will put him on Easy Street.

KENDALL W. WILLIAMS,  
Xenia, Ohio

(Even if it were true that this invention might make it necessary for some radio technicians to seek new jobs, that would be no argument against it. Would our correspondent wish us to still ride horseback to work? In fact, if his ideas were followed, we would have no radios to repair, as the earlier inventors of electrical equipment would have been prevented from throwing the artisans in older crafts out of work.

But it is not true. The wagon makers Studebaker and Fisher, for example, did not starve to death with the invention of the motor-driven vehicle, but prospered as manufacturers of automobiles and motor car bodies, respectively. The intelligent radio technician will progress and prosper with improvements in the technique.

It is, of course, not entirely certain that this new technique will prove technically and economically superior to present methods of production and servicing. *All the more reason for the serviceman to keep alert!*—Editor)

### WANTS FEDERAL SERVICEMAN'S LICENSE

Dear Editor:

I want to add a few words to the subject: Should servicemen be licensed?

I think that the serviceman should be licensed by the Federal Government and that licensing requirements should be uniform for the whole country. The serviceman could post this federal license in his shop to prove to his customers that he knows his business.

The examination should be similar to the radio operator license examinations except that it should be devoted to questions on radio servicing. The license should be issued free after the serviceman passes the test.

The licenses could be of different classes: one type would be for the learner, or the fellow just starting out in servicing; another class would be for the

man with a fairly good knowledge of servicing; and a third class for the all-around serviceman with experience in FM and television. There could be also a separate license for sound-system technicians.

A board of radio engineers and servicemen could be set up to determine the nature of the examination questions.

The Government should not regulate wages or charges for servicing, because rates vary in different parts of the country.

I believe that this licensing would obviate any comment from the public about underhanded dealings in the radio servicing industry.

HERBERT C. TAYLOR,  
Keysville, Virginia

### A COMBINATION CODE TEACHER



This interesting code teacher uses a disc of the old Omnigraph type which sets up any one of four tones, works a mechanical key to give the student the "feel" of the code, projects dots and dashes on a transparent dial and flashes a blinker at the same time. By thus co-ordinating all the senses, learning time is cut down, reports Harold Herman of Chicago, its constructor.

Prepare For A Good Job Now in

# RADIO SOUND and TELEVISION



LEARN QUICKLY IN  
THE GREAT SHOPS OF  
**COYNE**

Get ready for a better job, bigger pay NOW in Radio. Cash in with "All-around" knowledge of Radio—Sound—Television. Train on actual equipment not by "Home-study". You learn quickest at COYNE because it's a real SHOP course!

**G. I. APPROVED...also Finance Plan for NON-VETERANS.** Don't let lack of cash hold you back. Many earn while learning. FREE Employment Service to graduates. Get facts today!

### SEND COUPON FOR FREE BOOK

Send at once for Big Free Book on Radio, Sound and Television, and facts about our Finance Plan.

MAIL THIS COUPON TODAY

B.W. COOKE, Pres.,  
Coyne Electrical and Radio School  
500 S. Paulina St., Dept. 48-84, Chicago 12, Ill.  
Please send Big FREE Book and complete details

NAME .....

STREET .....

CITY ..... STATE .....

## NOW—A REALLY HIGH-POWERED— Radio Engineering Library

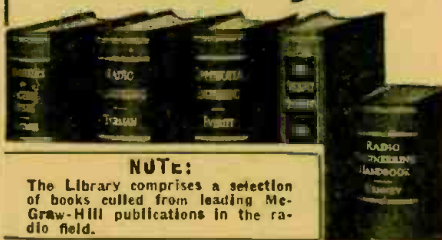

**NOTE:**  
The Library comprises a selection of books culled from leading McGraw-Hill publications in the radio field.

• especially selected by radio specialists of McGraw-Hill publications

• to give most complete, dependable coverage of facts needed by all whose fields are grounded on radio fundamentals

• available at a special price and terms

THESE books cover circuit phenomena, tube theory, networks, measurements, and other subjects—give specialized treatments of all fields of practical design and application. They are books of recognized position in the literature—books you will refer to and be referred to often. If you are a practical designer, researcher or engineer in any field based on radio, you want these books for the help they give in hundreds of problems throughout the whole field of radio engineering.

### 5 VOLUMES, 3319 PAGES, 2289 ILLUSTRATIONS

1. Eastman's FUNDAMENTALS OF VACUUM TUBES

2. Termon's RADIO ENGINEERING

3. Everitt's COMMUNICATION ENGINEERING

4. Mund's HIGH FREQUENCY MEASUREMENTS

5. Henney's RADIO ENGINEERING HANDBOOK

10 days' examination. Easy terms. Special price under this offer less than books bought separately. Add these standard works to your library now; pay small monthly installments, while you use the books.

10 DAYS' FREE EXAMINATION—SEND COUPON

McGraw-Hill Book Co., Inc. 330 W. 42nd St., N.Y.C. 18

Send me Radio Engineering Library, 5 vols., for 10 days' examination on approval. In 10 days I will send \$2.50, plus few cents postage, and \$3.00 monthly till \$27.50 is paid, or return books postpaid. (We pay postage on orders accompanied by remittance of the first installment.)

Name .....

Address .....

City and State .....

Company .....

Position .....

RC-4-48

# RADIO SCHOOL DIRECTORY

## PRACTICAL TECHNICAL TRAINING

**SPECIALIZE in 6 months to 3 years**

### COURSES

#### SERVICE

- 6 to 12 Months
- Electricity
- Welding
- Refrigeration
- Heating

#### TECHNICIAN

- 1 to 2 Years
- Electricity
- Radio
- Electronics
- Refrigeration, Heating and Air Conditioning

#### PROFESSIONAL

- 3 Years
- Electrical Engineering Bachelor of Science Degree Major In Machinery or Electronics

Train in Electronics, Radio, Electricity for a substantial career in industry—or a business of your own. Prepare in one year to be a Technician—or in two additional years secure a Bachelor of Science Degree in Electrical Engineering with major in Electronics. More than 35,000 former students in industries the world over. 1,538 students now enrolled from 48 states and 13 overseas countries. Faculty of 72 specialists. Write for catalog and Personal Guidance Questionnaire—also mention course in which you are interested.

Terms start APRIL, July, Sept.

**MILWAUKEE**  
**SCHOOL OF ENGINEERING**  
A TECHNICAL INSTITUTE

Dept. RC-448

North Broadway, Milwaukee, Wis.

**THIS COUPON MAY PROVE TO BE THE KEY TO YOUR SUCCESS IN ELECTRONICS**

**MELVILLE RADIO INSTITUTE**

The Progressive Radio School  
Managed by Radio Men

Licensed by the N. Y. State Board of Education  
RECOGNIZED BY INDUSTRY  
APPROVED FOR VETERANS

**CUT IT OUT! FILL IT OUT! MAIL IT OUT! — NOW!**

MELVILLE RADIO INSTITUTE RC  
Melville Bldg., 15 W. 46th St., N. Y. 19, N. Y.

Send me without obligation information about your intensive courses:

- Radio Technician
- Radio & Television Servicing
- Radio Communications
- Fundamental Radio Mathematics

My Name.....

Address.....

**A CAREER WITH A FUTURE!**  
**TELEVISION**

Shop Work • Shop Techniques • Theory  
FULLY EQUIPPED LABORATORIES

- RADIO SERVICE & REPAIR
- F. M. & TELEVISION
- TRANSMITTER COURSES  
*Preparing for F.C.C. LICENSES*
- RADIO TECHNOLOGY  
*A Junior College Level Course preparing for positions in Radio-Electronic Engineering Field.*

MORNING • AFTERNOON • EVENING CLASSES  
MODERATE RATES • INSTALLMENTS

Available Under G. I. Bill  
COME IN AND SEE OUR STUDENTS AT WORK

**DELEHANTY** SCHOOL OF  
RADIO • ELECTRONICS • TELEVISION  
105 EAST 13 ST., N. Y. 3, N. Y. • DEPT. T  
LICENSED BY STATE OF NEW YORK

**WANTED**

**Men and Women to Fill Top Radio Jobs!**

Worried about your future? Longing for a career that means more money... success? It's yours if you hurry to fill the great demand for qualified radio personnel needed everywhere. Train now to be an announcer, disk jockey or radio technician. Complete day and night time classes. Hundreds of thrilling jobs await you—key positions in radio stations, airlines, and maritime service. Free placement service offered. Write for our catalog outlining the courses offered.

Approved for Veterans

**Don Martin School of Radio Arts**

1655 North Cherokee St. Hollywood 28, Calif.

**CODE SENDING RECEIVING SPEED**

Be a "key" man. Learn how to send and receive messages in code by telegraph and radio. Commerce needs thousands of men for jobs. Good pay, adventure, interesting work. Learn at home quickly through famous Candler System. Write for FREE BOOK.  
**CANDLER SYSTEM CO.**  
Dept. 3-D, Box 928, Denver 1, Colo., U.S.A.

**TELEVISION 1948!!**

Train at an Institute that pioneered in TELEVISION TRAINING since 1938. Morning, Afternoon or Evening Sessions in laboratory and theoretical instruction, under guidance of experts, covering all phases of Radio, Frequency Modulation, Television, lead to opportunities in Industry, Broadcasting or own Business. Licensed by N. Y. State. Approved for Veterans. ENROLL NOW FOR NEW CLASSES  
Visit, Write or Phone

**RADIO-TELEVISION INSTITUTE**

480 Lexington Ave., N. Y. 17 (46th St.)  
PLaza 3-4585 2 blocks from Grand Central

**FM-RADIO-TV PRACTICAL TRAINING**

Four fully-equipped laboratories provide the PRACTICAL training essential for successful careers in Radio Communications (FCC licenses) and in Radio-Television Servicing (Technician). Train under the supervision of technical specialists—with commercial-type equipment. Investigate why WRCI SPECIALIZED TRAINING methods are outstanding! why WRCI laboratory-trained specialists are in demand. Read our illustrated bulletin before enrolling in any school. Approved for veteran training—non-veterans accepted. Send for free copy of Bulletin-E today.

**Western Radio Communications Institute**  
Specialists in Radio-Electronics Training  
631 West Ninth Street, Los Angeles 15, Calif.

**LEARN RADIO!**

IN ONLY 10 MONTHS  
PREPARE FOR A GOOD JOB!  
COMMERCIAL OPERATOR (CODE)  
BROADCAST ENGINEER  
RADIO SERVICEMAN

Television Servicing—15 Months

Veterans get \$130.00 Equipment  
SEND FOR FREE LITERATURE  
**BALTIMORE TECHNICAL INSTITUTE**

1425 Eutaw Place, Dept. C, Baltimore 17, Md.

**V RADIO ENGINEERING**

**FM—Television—Broadcast**

Police Radio, Marine Radio, Radio Servicing, Aviation Radio and Ultra High mobile applications. Thorough training in all branches of Radio and Electronics. Modern laboratories and equipment. Old established school. Ample housing facilities. 7 acre campus. Small classes, enrollments limited. Our graduates are in demand. Write for catalog.

Approved for Veterans

**VALPARAISO TECHNICAL INSTITUTE**  
Dept. C VALPARAISO, INDIANA

Hollywood Experts Help You **Make Good in RADIO-TELEVISION** at Home

Direct from Hollywood, nerve-center of broadcasting, Television, Radio and Sound activities, comes R-T-A's time-proven and tested home training. Here at last—easy to learn, home instruction that quickly qualifies you for steady, good-pay jobs or your own Radio business. 10 big kits of radio parts given at no extra charge. Get full details at once! Send postal for FREE BOOK "How to Make Good in Radio-Television." R-T-A APPROVED FOR VETERANS.  
RADIO TRAINING ASS'N OF AMERICA, Dept. RCD, 5620 Hollywood Blvd. Hollywood 28, Calif.

**RCA INSTITUTES, Inc.**

Offer thorough training courses in all technical phases of **Radio and Television**  
DAYS—EVENINGS WEEKLY RATE

**VETERANS:** RCA Institutes is approved under G. I. Bill of Rights

For Free Catalog Write Dept. RC-48

**RCA INSTITUTES, Inc.**  
A Service of Radio Corporation of America  
78 VARICK STREET NEW YORK 13, N. Y.

**RADIO COURSES**

Preparatory, Service, Broadcast, Television, Marine Operating, Aeronautical, Frequency Modulation, Radar.

Classes now forming for the summer term  
June 1. Entrance exam. May 17.  
Veterans. Literature.

**COMMERCIAL RADIO INSTITUTE**  
(Founded 1920)  
38 West Biddle Street, Baltimore 1, Md.

**RADIO**

TECHNICIAN and RADIO SERVICE COURSES  
**FM and TELEVISION**

**AMERICAN RADIO INSTITUTE**

101 West 63rd St., New York 23, New York  
Approved Under GI Bill of Rights  
Licensed by New York State

# BOOK REVIEWS

**AN APPROACH TO RADIO**, by J. B. Shrewsbury. Published by Electronic Industries. Stiff cloth covers, 6 1/4 x 9 inches, 288 pages. Price \$4.50.

The author has written this book to present radio theory in a very simple and non-technical manner. It gives the necessary information to the beginner to permit him to approach a more detailed study of radio.

The book is divided into eight chapters covering receivers, audio oscillators and amplifiers, and transmitters. There are many drawings and schematics throughout the book and information is given for the construction of simple receivers.

**PATENT NOTES FOR ENGINEERS**, prepared and edited by C. D. Tuska and other members of the patent Department of RCA Laboratories. Published by RCA Review. Stiff cloth covers, 6 x 9 1/4 inches, 165 pages. Price \$2.50.

The material in this book was prepared primarily for use by the patent department of RCA Laboratories. However, inventors, research groups and engineers will find its contents useful in obtaining a better understanding of patent terminology and the problems of the inventor and the patent attorney.

The book clearly defines an invention and sets forth the requirements of a patentable invention. A number of citations or case records have been included to show some of the problems that may be met by the inventor. It is worth a place on the bookshelf of all persons engaged in research and development work.—*R.F.S.*

**HOWARD W. SAMS DIAL CORD STRINGING GUIDE**, compiled and published by Howard W. Sams & Company. Heavy paper covers, 5 1/2 x 8 1/4 inches, 112 pages (not numbered). Price 75 cents.

A collection of 522 diagrams showing how to string dials on most popular radios. Since often a number of receivers have an identical dial-stringing system, the diagrams are useful for far more than 522 sets. With a complete index and an introductory chapter on dial-stringing.

## ELECTRICAL TRAINING

Intensive 32 weeks' residence course in fundamentals of industrial electrical engineering, including radio, electronics. Prepares for technician, engineering aides. Approved for veteran training. 54th year. Enter July 26, Nov. 22. Catalog.

**BLISS ELECTRICAL SCHOOL**  
7544 TAKOMA AVENUE  
WASHINGTON 12, D. C.

## CORRESPONDENCE COURSES IN RADIO and ELECTRICAL ENGINEERING

**ELECTRICAL ENGINEERING** Get good grasp of wide electrical field. Prepare yourself at Low Cost, for secure future. Modern course. So simplified anyone can understand quickly.  
**RADIO ENGINEERING** Extra fine course in radio work. Trains you to be super-service man, real vacuum-tube technician. Servicemen needed badly. Diploma on completion. Many graduates earning big pay.  
Send postcard for Free Copies of school catalog, full details, all about deferred payment plan, experimental kits, etc. **\$25** Course  
Lincoln Engineering School, Box 931C.110, Lincoln 2, Nebr.

**AUSTRALIAN SHORT WAVE HANDBOOK**, edited by John Moyle, VK2JU. Published by Associated Newspapers Pty. Ltd. Paper covers, 8 x 11 1/4 inches, 120 pages. Price 2 shillings (Australian).

This handbook of radio call signs and short wave technique was prepared for the Australian radio amateur and set builder. It begins with a short introduction to short waves and includes hints on receiving conditions and on obtaining short wave verification or QSL cards. Its second chapter is a listing of Australian commercial and amateur radio stations.

The remainder of the book includes circuits and construction details on receivers, transmitters, antennas, and modulators. This material, reprinted from *Radio and Hobbies* (Australia), is of interest to any radio experimenter or amateur.—*R.F.S.*

**UNDERSTANDING VECTORS AND PHASE**, by John F. Rider and Seymour D. Uslan. Published by John F. Rider. Flexible fiber covers, 5 1/4 x 7 inches, 153 pages. Price 99 cents.

A book for the radio serviceman, this is an excellent example of what can be done by the practical writer for the practical reader. The authors realized that vectors are inherently far simpler than much of the mathematics traditionally taught as preparation to their study, and have produced a book which can be understood by any radioman with a knowledge of arithmetic and simple geometry.

Methods of handling vectors and calculating impedance, reactance and resistance in circuits containing various combinations of resistors and reactors are clearly explained. Incidentally, many radio servicemen will find in this book their first understandable exposition of the FM discriminator.

**RADAR BEACONS**, edited by Arthur Roberts. Published by McGraw-Hill Book Co. Stiff cloth covers, 6 1/2 x 9 1/4 inches, 489 pages. Price \$6.00.

This book is Volume 3 in the M.I.T. Radiation Laboratory Series. The equipment and systems described in it, however, are the collective result of work done in the United States, England, Canada, and other countries.

The book is divided into four parts. The first discusses the nature of radar beacons and the principles on which beacon systems are designed. The second section deals with the design of radar beacons, covering r.f. components and circuits in beacon systems.

Beacon interrogator system design is carefully discussed in part three. Bandwidth considerations in receivers and transmitters, antenna design, and indicators are also discussed from several points of view. Field operation of beacon system is covered in the last section.

There is also a complete bibliography of reference books and glossary of the new terms used in the text.

PLEASE TEAR OUT THIS ADV. AS REMINDER

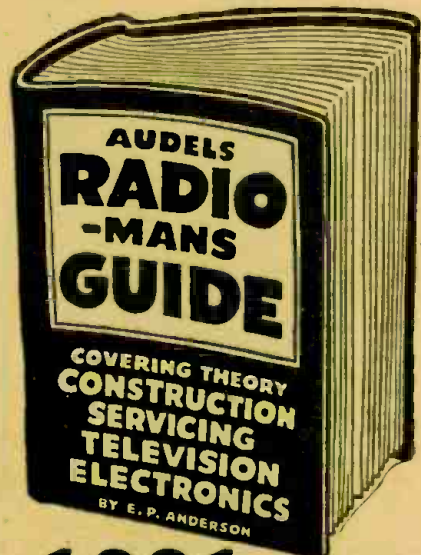

## 1001 RADIO FACTS AND FIGURES

**AUDELS RADIOMANS GUIDE**—914 Pages, 633 Illustrations, Photos, Wiring Diagrams, 38 Big Chapters, covering Radio Theory, Construction, Servicing, Including Important Data on Developments in Television, Electronics and Frequency Modulation, Review Questions and Answers, Calculations & Testing. Highly Endorsed—Indispensable for Ready Reference and Home Study.

**\$4 COMPLETE • PAY ONLY \$1 A MONTH**  
Step up your own skill with the facts and figures of your trade. Audels Mechanics Guides contain Practical Inside Trade Information in a handy form. Fully illustrated and Easy to Understand. Highly Endorsed. Check the book you want for 7 days Free Examination.

Send No Money. Nothing to pay postman.

## CUT HERE MAIL ORDER

**AUDEL, Publishers, 49 W. 23 St., New York 10, N. Y.**

Please send me postpaid for FREE EXAMINATION books marked (X) below. If I decide to keep them I agree to mail \$1 in 7 Days on each book ordered and further mail \$1 monthly on each book until I have paid Price—otherwise, I will return them.

- RADIOMANS GUIDE, 914 Pages . . . \$4
- ELECTRICIANS EXAMINATIONS, 250 Pages . . . 1
- WIRING DIAGRAMS, 210 Pages . . . 1
- ELECTRIC MOTOR GUIDE, 1000 Pages . . . 4
- ELECTRICAL DICTIONARY, 9000 Terms . . . 2
- ELECTRICAL POWER CALCULATIONS, 425 Pgs. . . 2
- HANDY BOOK OF ELECTRICITY, 1440 Pages . . . 4
- ELECTRONIC DEVICES, 216 Pages . . . 2
- ELECTRIC LIBRARY, 12 vol., 7000 Pgs., \$1.50 vol. . . 2
- OIL BURNER GUIDE, 384 Pages . . . 1
- REFRIGERATION & Air Conditioning, 1280 Pgs. . . 4
- POWER PLANT ENGINEERS Guide, 1500 Pages . . . 4
- PUMPS, Hydraulics & Air Compressors, 1658 Pgs. . . 4
- WELDERS GUIDE, 400 Pages . . . 1
- BLUE PRINT READING, 416 Pages . . . 2
- SHEET METAL WORKERS Handy Book, 388 Pgs. . . 1
- SHEET METAL PATTERN LAYOUTS, 1100 Pgs. . . 4
- AIRCRAFT WORKER, 240 Pages . . . 1
- MATHEMATICS & CALCULATIONS, 700 Pgs. . . 2
- MACHINISTS Handy Book, 1600 Pages . . . 4
- MECHANICAL Dictionary, 968 Pages . . . 4
- AUTOMOBILE GUIDE, 1700 Pages . . . 4
- DIESEL ENGINE MANUAL, 400 Pages . . . 2
- MARINE ENGINEERS Handy Book, 1280 Pages . . . 4
- MECHANICAL DRAWING GUIDE, 160 Pages . . . 1
- MECHANICAL DRAWING & DESIGN, 480 Pgs. . . 2
- MILLWRIGHTS & Mechanics Guide, 1200 Pgs. . . 4
- CARPENTERS & Builders Guides (4 vols.) . . . 6
- PLUMBERS & Steamfitters Guides (4 vols.) . . . 6
- MASONS & Builders Guides (4 vols.) . . . 6
- MASTER PAINTER & DECORATOR, 320 Pgs. . . 2
- GARDENERS & GROWERS GUIDES (4 vols.) . . . 6
- ENGINEERS and Mechanics Guides . . . 12
- Nos. 1, 2, 3, 4, 5, 6, 7 and 8 complete . . . 12
- Answers on Practical ENGINEERING . . . 1
- ENGINEERS & FIREMANS EXAMINATIONS . . . 1

Name \_\_\_\_\_

Address \_\_\_\_\_

Occupation \_\_\_\_\_

Employed by \_\_\_\_\_ R.C.F.

# PERSONAL \$14<sup>95</sup>

PORTABLE RADIO KIT  
WEIGHS ONLY 3 1/2 LBS.

IMMEDIATE  
DELIVERY  
ORDER YOUR  
KIT NOW.

**4 TUBE  
SUPERHET-  
ERODYNE  
EVERYTHING  
FURNISHED  
INCLUDING  
TUBES AND  
BATTERIES  
MODEL X-45**



- Size 6 1/2" x 3 1/4" x 4 1/4". • Weighs only 3 1/2 lbs.
- Two-tone colored plastic cabinet, 4-tube superhet.
- AVC • Two-gang condenser. • Lucite dial. Loop aerial, built-in lid. Looks like and is a commercial radio kit.

• Simple assembly and wiring instructions. This kit is ready for immediate delivery. The same nationally known factory that manufactures tens of thousands of this radio, is line-producing this radio kit for us. Every part, from the cabinet down to the last resistor, is matched. The chassis is ready punched; all you do, is mount the parts and wire. This radio kit will assemble into a beautiful personal radio for you. Just the same as it does for the factory. We furnish you a diagram, photograph of the completed chassis and full assembly instructions so that those with a minimum knowledge of radio may wire this kit. The beautiful case is made of metal with plastic hinged lid and snap on back. The lucite face of the receiver has an inlaid gold design. The circuit is the conventional two gang superhet type, with A.V.C. Receives the broadcast band, 540 to 1650 KC. Uses miniature tubes: 1R5 converter, 1R5 detector A.V.C., 1T4 amplifier and 3S4 power amplifier. Alnico V PM speaker. The loop antenna is built in the lid. Radio comes on automatically when lid opens. Operates on self-contained batteries. Eriod complete with tubes and 67 1/2 volt "B" battery and flash cell (Not AC-DC). Nothing else to buy. Model X-45. Price \$14.95. Send a \$4.00 deposit. Balance will be sent C.O.D. With full remittance include postage for 6 lbs.

**McGEE RADIO CO.**

1227 McGEE ST. KANSAS CITY, MO.

## HI-FI AMPLIFIER DIAGRAMS



**NOW YOU**

can build and service the latest **HIGH FIDELITY** amplifiers using the easy to follow, tested and proven circuits contained in **PRACTICAL AMPLIFIER DIAGRAMS!**

The only complete book of its kind on the market. 45 one to eleven tube amplifiers with phase inversion, inverse feedback, bass boost, treble boost, compression and expansion recording amplifiers, multi-channel amplifiers, pre-amplifiers, portable P.A. amplifiers, and many others!

**ALSO Big Section On Servicing All Type of Amplifiers Included!**

102 large 8 1/2 x 11 inch pages spiral bound.

Available NOW at your dealer for only \$2.00 or order DIRECT.

**OS-TRONIC PUBLICATIONS**

196 W. 37th Place, Los Angeles 7, Calif.

## ANOTHER *New* BROWNING DEVICE

FM -AM TUNER Model RJ-12

Superb FM reception; quality AM reception. Single antenna for both bands. Separate RF and IF systems on both bands. Armstrong FM circuit.

Frequency meters. WWV standard frequency calibrator Oscilloscope. Power supply and square wave modulator Capacitance Relay. FM-AM Tuners. FM Tuner.

KNOW THE ENTIRE BROWNING LINE • ENGINEERED FOR ENGINEERS

Write Dept. J for Catalog



**BROWNING LABORATORIES, INC.**  
WINGHESTER, MASS.

# INDEX TO ADVERTISERS

A. M. Radio Sales Company.....	79	General Test Equipment Company.....	89
T. Allen Co. Inc.....	48	Greylock Electronic Supply Company.....	80
Allied Radio Corporation.....	59	The Halldorson Company.....	77
Almo Radio Company.....	72	Hallcrafters Company.....	81
American Sales.....	60	The Heath Company.....	43
American Surplus Products.....	4	Hudson Specialties.....	78
Amplifier Corporation of America.....	75, 79, 81	Industrial Devices, Inc.....	79
Apex Video Company.....	78	Instructograph Company.....	81
Arrow Sales, Inc.....	81	Joyce Radio Distributing.....	80
Audel Publishers.....	87	Lafayette Radio.....	54
Bell Telephone Laboratories.....	12	Leads Radio Company.....	72
Boland & Boyce, Inc., Publishers.....	63	Leotone Radio Corporation.....	76
Bonafide Radio Company.....	72	McGee Radio Company.....	88
Brooks Radio Distributing.....	79	McGraw-Hill Book Company, Inc.....	85
Browning Laboratories.....	76, 88	McMurdo Silver Company.....	6
Buffalo Radio Supply.....	52, 53	P. R. Mallory & Company, Inc.....	Inside Front Cover Inside Back Cover
Burstein-Applebee Company.....	81	Meissner Manufacturing Company.....	70
Capitol Radio Engineering Institute.....	46	Merit Products.....	83
Cinex Corporation.....	84	Metropolitan Electronic & Instrument Co.....	88
Cleveland Institute of Radio.....	11	Mid-America Company.....	68
Commercial Radio.....	82	Milo Radio & Electronic Corporation.....	45
Communications Equipment Company.....	8	Moss Electronic Distributing Company.....	61
Concord Radio Corporation.....	71	Murray Hill Books, Inc.....	68, 69
Coradio.....	70, 80	National Company, Inc.....	41, 62
Coyne Electrical School.....	47, 82, 85	National Plans Company.....	76
DeForest's Training Institute.....	7	National Radio Institute.....	1
Douglas Radio Supply Company.....	74	National Schools.....	3
Espey Manufacturing Company, Inc.....	78	National Union Radio Corporation.....	2
Esse Radio Company.....	14, 15	Niagara Radio Supply.....	75
General Cement Manufacturing Company.....	80	Ohmite Manufacturing Company.....	60
General Electronic Distributing Company.....	57	Olson Radio Warehouse.....	55

ONLY \$89.50 IS THE COST!

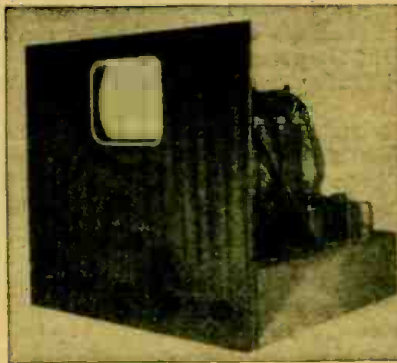

## FOR THE NEW 10 INCH TELEVISION KIT

LESS TUBES (52 square inch picture)

Complete with all tubes \$149.50

**COMPLETE—READY TO ASSEMBLE  
WITH FULL INSTRUCTIONS**

*Nothing Else to Buy!*

A complete Television Kit using a ten-inch tube which gives a 52-square inch picture. A pre-wired, pre-aligned, 13-channel tuner containing an r.f. oscillator and mixer, affords complete television coverage in all localities. A well-engineered piece of equipment, this receiver affords three stages of high-gain video amplification, slug-tuned for maximum gain and efficiency. The instructions are written in an easy step-by-step system enabling accurate construction. Alignment procedure without the use of expensive test equipment is given in detail. Comes Ready to Assemble with Full Instructions!

Also 7" Television Kit—Complete, Less Tubes—\$59.50. Complete with Tubes—\$99.50.

**IMMEDIATE DELIVERY FROM STOCK**

*Metropolitan* ELECTRONIC & INSTRUMENT CO.

Dept. RC 42 WARREN ST. N. Y. 7, N. Y.

## PEN-OSCIL-LITE

Extremely convenient test oscillator for all radio servicing: alignment • Small as a pen • Self powered • Range from 700 cycles audio to over 600 megacycles u.h.f. • Output from zero to 125 v. • Low in cost • Used by Signal Corps • Write for information.

**GENERAL TEST EQUIPMENT**

38 Argyle Ave. Buffalo 9, N. Y.

## RADIO SCHOOL DIRECTORY (See Pages 86, 87)

American Radio Institute  
Baltimore Technical Institute  
Bliss Electrical School  
Candler System Company  
Commercial Radio Institute  
Delehanty Institute  
Lincoln Engineering School  
Don Martin School of Radio Arts  
Melville Radio Institute  
Milwaukee School of Engineering  
RCA Institutes  
Radio-Television Institute  
Radio Training Association of America  
Valparaiso Technical Institute  
Western Radio Communications Institute

Radio City Products Company, Inc.....	66
Radio-Craft.....	79
Radio Dealers Supply Company.....	82
Radio Kits Company.....	66
Radio Publications.....	64
Radio Supply & Engineering Company.....	51
Radioic Equipment Company.....	64
Radolek Company.....	74
Ravac Electronics Corporation.....	64
Reed Manufacturing Company.....	83
Risco Sales Company.....	80
The Rose Company.....	84
Howard W. Sams & Co., Inc.....	13
Senco Radio, Inc.....	58
Sheffield Radio & Appliance Company.....	80
N. Silverstine.....	9
Sprague Products Company.....	16
Sprayberry Academy of Radio.....	5
Michael Stahl, Inc.....	74
Superior Instruments.....	39
Supreme Publications.....	65, 67
Sylvania Electric Products.....	Back Cover
Technical Radio Parts Company.....	77
Tradio, Inc.....	77
Transvision.....	56
Universal General Corporation.....	70
Wright, Inc.....	74
X. L. Radio Laboratories.....	83
York Distributors.....	73





## MALLORY VIBRATORS start like the proverbial bat

Mallory Vibrator contact materials are specially alloyed to resist oxidation. The design of the contact arms and their carefully controlled timing provide self-cleaning con-

tacts. That's why you can count on Mallory Vibrators for sure starting.

The precision with which related parts are balanced assures accurate output and dependable service over a long life.

These are some of the reasons why more

Mallory Vibrators are used for original equipment than all other makes combined. These same reasons make Mallory the best replacement line for you to handle.

In addition to assured quality, Mallory offers the most complete line in the business. Mallory standardization permits 12 basic vibrators to meet 90% of your replacement requirements. But a complete line of 52 vibrators is available to meet virtually every vibrator need.



*The Mallory Replacement Vibrator Guide is free. The Vibrator Data Book is \$1.00—from your distributor or by mail.*

### THE MALLORY "GOOD SERVICE FOR GOOD BUSINESS" PLAN

will increase business and profits in your shop.

A unique follow-up file makes it easy to keep customers.

You tie in with Mallory acceptance to develop new business—ask your distributor about it.

**MORE MALLORY VIBRATORS ARE IN USE THAN ALL OTHER MAKES COMBINED**

P. R. MALLORY & CO. Inc.  
**MALLORY**

CAPACITORS . . . CONTROLS . . . VIBRATORS . . .  
SWITCHES . . . RESISTORS . . . RECTIFIERS . . .  
VIBRAPACK\* POWER SUPPLIES . . . FILTERS

\*Reg. U.S. Pat. Off.

**APPROVED PRECISION PRODUCTS**

P. R. MALLORY & CO., Inc., INDIANAPOLIS 6, INDIANA

**Look for the distributor  
who displays this sign!**

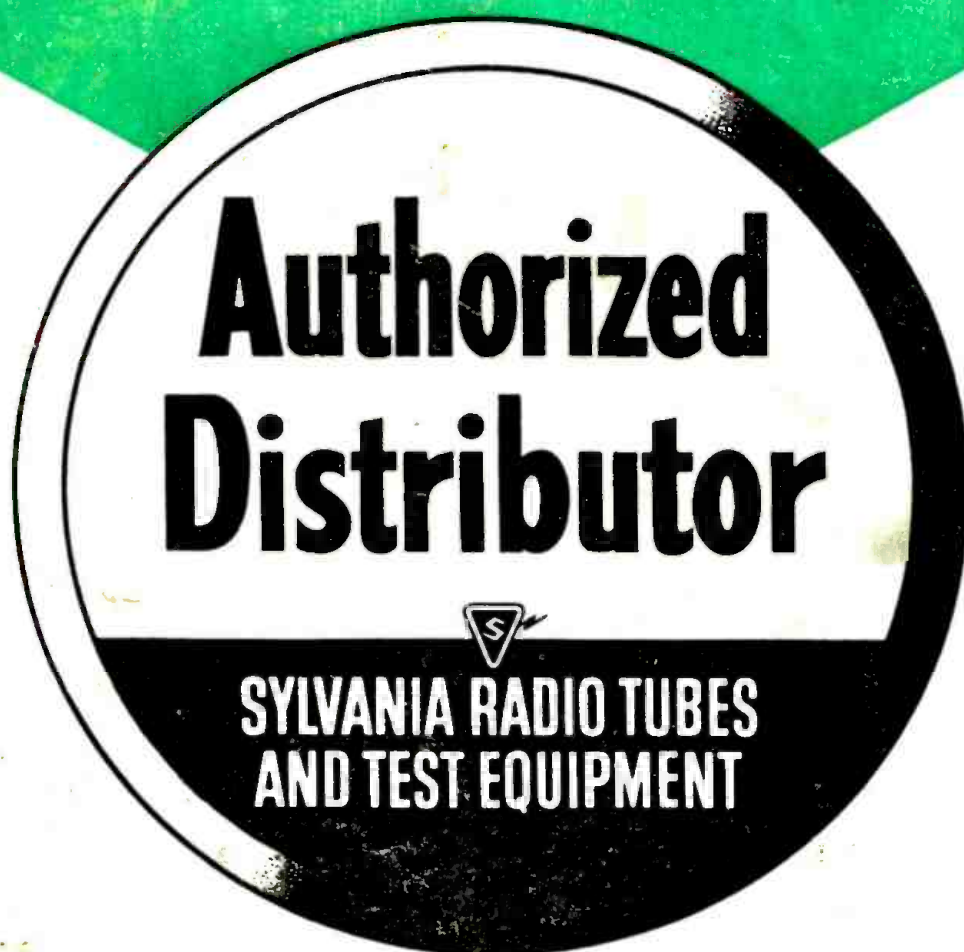

**A**S a part of its 1948 program, Sylvania Electric will supply each of its authorized distributors with this new decal, printed in red, yellow, black and three shades of green. It's worth your while to look for this sign on

his windows, doors and trucks — it is your assurance that this distributor will supply you with genuine Sylvania radio tubes and top-quality test equipment — and that you can count on prompt, courteous service as well!

*Sylvania Electric Products Inc., Radio Tube Division, Emporium, Pa.*

**SYLVANIA**  **ELECTRIC**

MAKERS OF RADIO TUBES: CATHODE RAY TUBES: ELECTRONIC DEVICES: FLUORESCENT LAMPS. FIXTURES. WIRING DEVICES: ELECTRIC LIGHT BULBS