

HUGO GERNSBACK, Editor

# RADIO CRAFT

ELECTRONIC MUSIC  
ON LIGHT BEAMS  
SEE PAGE 22



*In this issue—*

Re-Orienting the BC-625  
Vest-Pocket Multitester  
Lamp Bulb Resistors

APR

1947

25¢

CANADA 30¢

RADIO-ELECTRONICS IN ALL ITS PHASES

# NEW

## Simpson Model 305RC Tube-Tester with

### "No Backlash"\* Roll Chart



With the addition of the new Simpson "No Backlash"\* Roll Chart to the 1947 version of our Model 305, this famous instrument becomes beyond question the finest tube-tester on the market in its price range. Read the description of this new Roll Chart in the panel below.

Model 305RC provides for filament voltages from .5 volts to and including 120 volts. It tests local, single ended tubes, bantams, midgets, miniatures, ballast tubes, gaseous rectifiers, acorn tubes, Christmas tree bulbs, and all popular radio receiver tubes.

Like other Simpson tube-testers, the Model 305RC incorporates 3-way switching which makes it possible to test any tube regardless of its base connections or the internal connections of its elements. This method, the result of exhaustive research and expensive construction, protects the Model 305RC against obsolescence to a degree not enjoyed by competitive testers. No adapters or special sockets are required. In addition to having a complete set of sockets for every tube now on the market, this tester has a spare socket, to provide for future tube developments.

The Model 305RC has provision for testing pilot lamps of various voltages as well as Christmas tree bulbs. It tests gaseous rectifiers of the OZ4 type—also tests ballast tubes direct in socket for burnouts and opens. Has neon bulb of proper sensitivity for checking shorts. This tube-tester is fused, and has the latest improved circuit. It provides for line adjustment from 100 to 130 volts, with smooth vernier control.

Model 305RC is distinguished for its beautiful exterior. It has a two-tone metal panel in red and black on a satin-finished background. Sockets and controls are symmetrically arranged for quick operation. The large, modern, fan-shaped instrument has an exceptionally long scale. It has "good" and "bad" English markings, also a percentage scale for matching and comparing tubes. Cases, both portable† and counter style, are made of strongly built hardwood, durably and beautifully finished.

Size, 11"x11"x6". Wt. 10 lbs. Shipping wt., 15 lbs.  
Dealer's net price, portable or counter model.....\$59.50  
For 60 cycle 115 volt current only.

For 220 volt or 60 cycle, add..... 7.50  
Standard Model 305, with book-type speed chart 49.50

**Counter Model 305RC.** Same instrument as portable model, but set in fine walnut finished hardwood case, with tilted, easy-to-use panel.

†Finished hardwood cases are standard on portable models. When these are not available, the instrument is housed in attractive simulated-leather covered case.

### \*6 Exclusive Features Make This the Finest Roll Chart Ever Designed for Tube-Testers . . . . .

- "No Backlash" feature of this Roll Chart automatically takes up all slack in the paper chart and, by keeping it in constant tension, makes it impossible to turn the selector wheel without turning chart. Gives precision selection at all times. Also prevents chart from tearing or getting out of alignment.
- Gearing is such that only 6 turns of selector wheel will run the entire length of the 12½ ft. chart.
- Easy to read. The clear Lucite window is just wide enough to show 2 tube settings, or both settings on a multi-purpose tube.
- Entire unit removable by taking out four screws. Just lift from receptacle to make new entries or install new chart.
- Chart ingeniously fastened to rollers, affording easy replacement and constant alignment.
- Rigid, light-weight construction. Gear driving mechanism incorporates heavy-duty precision brass gears and ports.



# Simpson

INSTRUMENTS THAT STAY ACCURATE

**SIMPSON ELECTRIC COMPANY**  
5200-5218 W. Kinzie Street, Chicago 44, Illinois  
In Canada, Bach-Simpson, Ltd., London, Ont.



Building this  
**A. M. SIGNAL GENERATOR**  
gives you valuable experience.  
Provides amplitude modulated signals  
for test and experiment purposes.

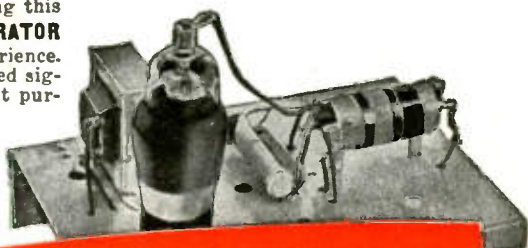

**RADIO SERVICING**

pays good money for full time work. Many others made \$5, \$10 a week EXTRA fixing Radios in spare time.

**VETERANS**

You can get this training right in your own home under G. I. Bill. Mail coupon for full details.

**Learn RADIO**  
by **PRACTICING** in Spare Time

with Big Kits  
of Radio Parts I Send You

Do you want a good-pay job in Radio—or your own money-making Radio Shop? Mail Coupon for a FREE Sample Lesson and my FREE 64-page book, "How to Be a Success in RADIO—Television, Electronics." See how N.R.I. gives you practical Radio experience at home—building, testing, repairing Radios with BIG KITS OF PARTS I send!

**Many Beginners Soon Make Good Extra Money in Spare Time While Learning**

The day you enroll I start sending EXTRA MONEY JOB SHEETS. You LEARN Radio principles from my easy-to-grasp, illustrated lessons—PRACTICE what you learn with parts I send—USE your knowledge to make EXTRA money fixing neighbors' Radios in spare time while still learning! From here it's a short step to your own full-time Radio Shop or a good Radio Job!

**Future for Trained Men is Bright in Radio, Television, Electronics**

It's probably easier to get started in Radio now than ever before because the Radio Repair business is booming. Trained Radio Technicians also find profitable opportunities in Police, Aviation, Marine Radio, Broadcasting, Radio Manufacturing, Public Address work. Think of even greater opportunities as Television and Electronics become available to the public! Send for free books now!

**Find Out What N. R. I. Can Do For You**

Mail Coupon for Sample Lesson and my 64-page book. Read the details about my Course. Read letters from men I trained, telling what they are doing, earning. See how quickly, easily you can get started. No obligation! Just MAIL COUPON NOW in an envelope or paste it on a penny postal. J. E. Smith, President, Dept. 7DX, National Radio Institute, Pioneer Home Study Radio School, Washington 9, D. C.

My Course Includes Training in  
**TELEVISION \* ELECTRONICS**  
Frequency Modulation



You build this SUPERHETERODYNE CIRCUIT that brings in local and distant stations. You get practical experience putting this set through fascinating tests.

You build this MEASURING INSTRUMENT yourself early in the course—use it for practical Radio work on neighborhood Radios to pick up EXTRA spare time money!

**BE A SUCCESS in RADIO**  
I Will Train You at Home

**Sample Lesson FREE**



Gives hints on Receiver Servicing, Locating Defects, Repair of Loudspeaker, I. F. Transformer, Gang Tuner, Condenser, etc., 31 illustrations. Study it—keep it—use it—without obligation! Mail Coupon NOW for your copy!



**GET BOTH 64 PAGE BOOK SAMPLE LESSON FREE**

Mr. J. E. SMITH, President, Dept. 7DX  
National Radio Institute, Washington 9, D. C.

Mail me FREE, without obligation, Sample Lesson and 64-page book about how to win success in Radio and Television-Electronics. (No salesman will call. Please write plainly.)

Age .....

Name .....

Address .....

City ..... Zone ..... State .....

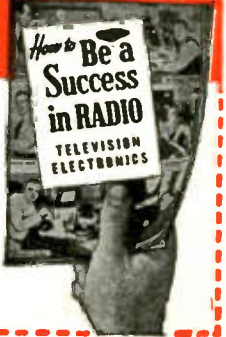

**APPROVED FOR TRAINING UNDER GI BILL**

# SYLVANIA NEWS

## RADIO SERVICE EDITION

APR.

Prepared by SYLVANIA ELECTRIC PRODUCTS INC., Emporium, Pa.

1947

# A PERFECT COMBINATION FOR A COMPLETE SERVICING JOB: SYLVANIA TUBES PLUS SYLVANIA TESTING EQUIPMENT

Now, in addition to selling the best in tubes, radio servicemen can simplify their testing and troubleshooting job with the latest and finest in testing equipment.

The same high standard of manufacture that has always distinguished Sylvania Radio Tubes

has been incorporated into these accurate, new instruments. This Sylvania high-quality combination — tubes plus testing units — means that you will be able to give methodical, dependable service easily and economically. Remember to take advantage of this combination now.

### COUNTER TUBE TESTER

Here's the last word in counter testers — made by the men who have tested tubes by the million. Not only does it test every type of radio tube in common use today, but provision has been made to permit quick adaptation to new tube types.

The Sylvania Counter Tester Model 139 is styled as carefully as it is engineered. Its smart two-tone green panel, with its white dial markings, is in harmony with the surroundings of the most progressive radio store. Compact, Portable Tube Tester Model 140 also available.

### POLY (MULTI-PURPOSE) METER

The Sylvania Poly (MULTI-PURPOSE) Meter Model 134 provides, in a single compact instrument, the means of making a multitude of electrical measurements and tests. Electrical values measured include audio, A.C. and R.F. voltages (up to 300 mc); D.C. voltages from 0.1 to 1,000; direct currents from 0.1 milli-ampere to 10 amperes; resistances from  $\frac{1}{2}$  ohm to 1,000 megohms.

Instrument is compactly built, attractively styled, includes all essential accessories.

### OSCILLOSCOPE, TYPE 131

This instrument is especially useful in rapid receiver alignment and troubleshooting. Controls are easily accessible. Hood shades face of 3-inch cathode ray tube permitting use of instrument in well-lighted room. The cathode ray tube is shock-mounted and shielded against stray fields.

Cabinet is steel construction, ventilated with louvers, and finished in attractive pearl-gray baked enamel. Easily carried; weighs only 18 pounds. Eight-foot power cord provided for quick installation.

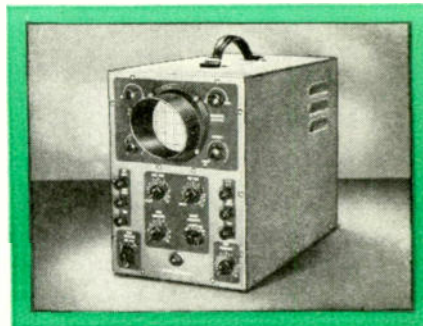
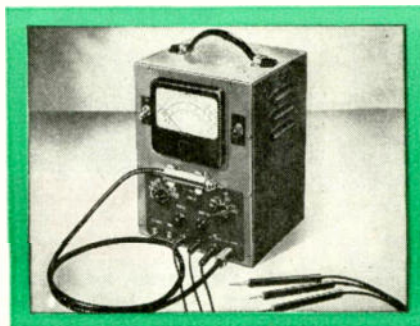
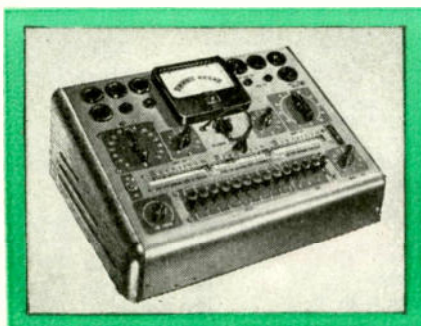

SEE YOUR SYLVANIA DISTRIBUTOR, or write to Radio Tube Division, Emporium, Pa.

# SYLVANIA ELECTRIC

MAKERS OF RADIO TUBES; CATHODE RAY TUBES; ELECTRONIC DEVICES; FLUORESCENT LAMPS; FIXTURES; WIRING DEVICES; ELECTRIC LIGHT BULBS

how to repair test instruments

# MEET "THE CAPACITOR" . . .

how to increase store traffic

new-tube characteristics

late  
circuit  
designs

free ads

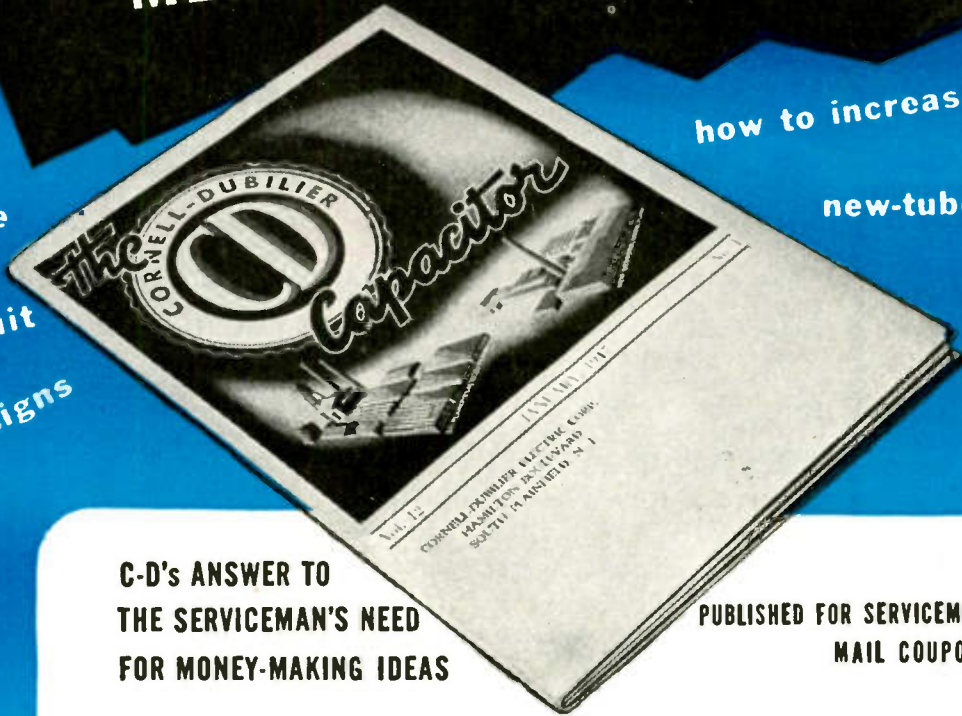

## C-D's ANSWER TO THE SERVICEMAN'S NEED FOR MONEY-MAKING IDEAS

PUBLISHED FOR SERVICEMEN — ABSOLUTELY FREE MAIL COUPON BELOW

Yes Mr. Serviceman—"The Capacitor" is the magazine that's published solely for *you*—to help you speed up servicing procedures—to help you build up a profitable business.

How can I step up store traffic? Where can I sell that spare signal generator? Every serviceman asks questions like these almost daily. "The Capacitor" is the place to find the answers.

It is the ideal magazine for servicemen because it isn't cluttered up with lengthy how-to-build-it articles for experimenters and gadgeteers. Instead its articles are down-to-earth, condensed, factual—dealing entirely with situations that face professional servicemen—and approaching these situations from the serviceman's viewpoint.

"EASY READING—SIMPLIFIES CIRCUITS"—*"I want to thank you for mailing me copies of 'The Capacitor.' The special items are of particular interest because of their easy reading and their simplification of otherwise complex circuits."* A paragraph from one of the many servicemen letters received every day.

Put "The Capacitor" to work in your shop—building your income—NOW. *Don't wait. Mail coupon TODAY—your free subscription will start immediately.*

THE TRADING POST—Free ads for servicemen! Whether you have something to sell, want to buy something—or if you're looking for a new helper—send the information to "The Capacitor" and it will be published in The Trading Post which appears in each month's issue.

DO YOU ASK THESE QUESTIONS?—What's wrong with that new FM job that came in last week? Why does that old t-r-f set keep breaking into oscillation?

GET THIS COUPON IN THE MAIL TODAY

1910 1947



**CORNELL-DUBILIER**  
WORLD'S LARGEST MANUFACTURER OF  
**CAPACITORS**

MICA

PAPER

BYRANOL

ELECTROLYTIC

Cornell-Dubilier Electric Corporation Dept. RC-4

South Plainfield, New Jersey

Please start my FREE subscription to "The Capacitor" at once.

Name.....

Address.....

City..... Zone..... State.....

# Learn RADIO TELEVISION ELECTRONICS

I'LL TRAIN YOU AT HOME IN YOUR SPARE TIME



For a Good Pay Job or  
A BUSINESS OF YOUR OWN!

My Proven  
2-Way Method Helps You Get  
into Radio *Quicker!*

**HERE'S PROOF OF THE QUALITY OF  
H.R.T.I. TRAINING**

**1st, 2nd and 4th Prizes Won by  
H. R. T. I. Students In Open Contest**

With over 250 students and graduates from many Radio schools, as well as experienced radio men, competing to find the best Radio Technicians in Cuba . . . 7 out of the first 10 prizes were won by H.R.T.I. Graduates! These **PROVEN RESULTS** speak for themselves! You can't afford to gamble with your future. Choose the Radio School with the success record . . . H.R.T.I.

**WHAT WINNER OF FIRST PRIZE SAYS:**



"Your training methods are so practical, and so clear, that no one should have difficulty in learning. I found everything so easy that it makes me feel that anyone who takes your course can be sure of success."

LUIS ILLADA, Havana, Cuba

**WHAT SECOND PRIZE WINNER SAYS:**

"I am very happy about my success, but it is to you and the H.R.T.I. staff that I owe my success. I am deeply grateful to H.R.T.I. for I have received all and MORE than you promised when I enrolled."



ALFREDO RODRIGUEZ, Oriente, Cuba

**WHAT WINNER OF FOURTH PRIZE SAYS:**

"The 1st, 2nd and 4th prizes were won by H.R.T.I. students! This shows that H.R.T.I. is one of the best schools! Over 250 radio technicians competed. Among them were real experts of established radio shops as well as students of nearly every known school. You will notice, from the enclosed newspaper, that the 4th prize was won by me, and I owe it all to your easy method of teaching."

GODFREDO REYES, Oriente, Cuba

Find out about the money-making opportunities Radio offers you. Learn how you can qualify for a good-pay job or start a business of your own *without capital*. Send below coupon for my big FREE book, "Your Opportunities in Radio & Television," which tells of radio's vast opportunities and how **HOLLYWOOD RADIO & TELEVISION INSTITUTE** has been training men for success in Radio for over 17 years, in over 40 different countries, through its proven **2-WAY METHOD—LESSONS PLUS HOME SHOP PRACTICE!**

**YOU PERFORM OVER 300 RADIO TESTS AND EXPERIMENTS**

I send you 9 kits of radio parts with which you make hundreds of interesting,

fascinating tests and experiments. You learn the "whys and hows" of radio *first hand, by doing*. Thus, you learn *more thoroughly, faster!*

**MANY H.R.T.I. STUDENTS EARN MONEY IN SPARE TIME WHILE LEARNING**

From the very start, through special "Spare Time Work Sheets," I show you how to earn money in spare time by doing good-pay radio jobs that abound in nearly every neighborhood. Many students earn \$5, \$10, and more a week while learning. A mighty good way to lay the foundation for a future radio business of *your own*.

Now is the time to start preparing for **YOUR** career in this fast-growing industry. Take the first step—send coupon for my big FREE Book today.

**YOU GET 9 KITS OF RADIO PARTS WITH WHICH YOU PERFORM OVER 300 EXPERIMENTS**

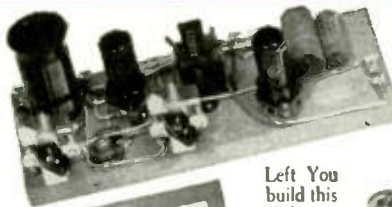

Left: You build this transformer coupled audio stage. (Experiment No. 260)



Above: You build this tuned radio stage, regenerative detector and audio amplifier. (Experiment No. 329)



Left: You build this Multi-purpose Shop Test Panel. 5 Test instruments in one.



Left: You build this A. C. Power Supply.

**YOU LEARN BY DOING**

You build these and many other radio circuits and testers with the 9 kits I send you, to help you learn faster, more thoroughly. All kits become your property.



**BIG FREE BOOK**

**HOLLYWOOD IS A WORLD CENTER**

of radio broadcasting and manufacture—television—motion picture production. Thus, H.R.T.I. is in an excellent location to bring you modern, up-to-the-minute instruction.

Before you decide on any course you owe it to your future to find out about H.R.T.I. training. Read what graduates in 40 different countries say about this famous course. Just paste coupon on a postcard or send in envelope. No salesman will call.

**HOLLYWOOD RADIO & TELEVISION INSTITUTE**  
810 West 6th Street, Los Angeles 14, California

**C. H. Mansfield, President, Dept. F-1  
Hollywood Radio & Television Institute  
810 West 6th St., Los Angeles 14, Calif.**

Send me your FREE book, "Your Opportunities in Radio, Television & Electronics" which explains your 2-way training method. (No salesman will call)

Name \_\_\_\_\_ Age \_\_\_\_\_

Address \_\_\_\_\_

City \_\_\_\_\_ Zone \_\_\_\_\_ State \_\_\_\_\_

**DON'T PUT IT OFF, MAIL THIS COUPON AT ONCE!**

**Old-Timers say:  
"Keep up  
the good work!"**

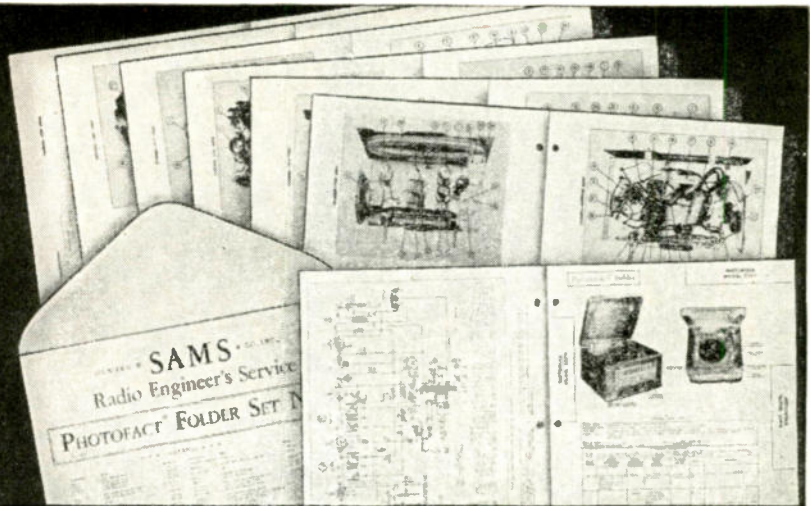

**Seasoned Servicemen get  
Invaluable Help from  
PHOTOFACT\* FOLDERS**

**Exclusive  
PHOTOFACT  
Features**

"PHOTOFACT FOLDERS far exceed any service data I ever saw in my 15 years' experience in the radio field. Keep up the good work!"—Edmund H. Barnard, Gloucester, N. J.

"PHOTOFACT FOLDERS are all but human. They're the best I've ever seen—and I've seen everything since the early days of radio."—Ben Davis, Galena Park, Texas.

"Have never seen anything like it in 20 years of servicing. A gift from heaven."—Saunders Radio & Sound Co., Baltimore, Md.

"In 20 years of servicing radios, I've never seen diagrams so clear and easy to read, so complete in every detail. How can you put out so much for so little?"—Hollis L. Hicklin, Cristobal, Canal Zone.

**COMPLETE**

Everything you need in one handy, unified form—large schematics, pictorials keyed to parts lists and adjustment data, complete listings of parts values and replacements, alignment, stage gain, circuit voltage and resistance analysis, coil resistances, dial cord stringing, disassembly instructions, record changer analysis and repair.

**ACCURATE**

All sets are actually taken apart and analyzed by experts in the Sams laboratories. Every part is measured, tested and quadruple-checked for accuracy. All data is original. This means the data you get is right.

**CURRENT**

PHOTOFACT FOLDERS are issued twice monthly, as the new receivers come off production lines. You don't have to wait for information. As receiver changes are made, you get correction and addition sheets for your files. Your data is always up to the minute.

**EASY TO USE**

All diagrams are coded to numbered parts lists. Everything is positively identified for fast work. All folders are set up in uniform, easy-to-follow style: big type, big illustrations—no hunting, guessing or eye strain—no more loss of time and temper.

Hundreds who have been in radio servicing for ten years and more express complete satisfaction with PHOTOFACT FOLDERS. They say it's the best service they've ever found for saving time and money—and they ought to know.

Whether you're an old-timer or newly established, you'll find PHOTOFACT FOLDERS indispensable—equal to another man in your shop for less than 9c per day. They will save you hours of time and effort: place at your fingertips all the information you need to do a better job—information compiled from a personal analysis of each receiver.

PHOTOFACT FOLDERS are the result of actually examining and testing

\*Trade Mark Reg.

sample sets that are brought to our laboratories. They cover all the latest radios, phonographs, record changers, recorders, communications systems and power amplifiers as they hit the market. And they come to you in sets of 30 to 50 at only \$1.50 per set. This low cost includes membership in the Howard W. Sams Institute, which entitles you to free service on special problems affecting your business.

PHOTOFACT FOLDERS actually cost you nothing because they pay for themselves over and over again in time saved. Spend less time, do better work at more profit. Order your PHOTOFACTS today. See your distributor, or use the convenient coupon.

**Set No. 15 Due March 10—Set No. 16 Due March 25**

MAIL THIS ORDER FORM TO YOUR DISTRIBUTOR TODAY. If you do not know his name and address, send it directly to Howard W. Sams & Co., Inc., 2924 East Washington Street, Indianapolis 6, Indiana, and we will see that your nearest distributor gets it. In Canada write to A. C. SIMMONDS & SONS, 301 King Street East, Toronto, Ontario. Canadian Price, \$1.75.

Send Set No. 15  Send Set No. 16  Send me Volume 1 (including Sets Nos. 1 to 10 inclusive) with De Luxe Binder, \$18.39.

(Circle one or more of following) Send Set No. 11, 12, 13, 14 (\$1.50 a set)

(Circle one or more of following) Send Set No. 1, 2, 3, 4, 5, 6, 7, 8, 9, 10 (\$1.50 a set)

My (check) (money order) (cash) for \_\_\_\_\_ is enclosed.

(If you send cash, be sure to use registered mail.)

PLEASE PRINT

Name \_\_\_\_\_

Address \_\_\_\_\_

City \_\_\_\_\_ Zone \_\_\_\_\_ State \_\_\_\_\_

HOWARD W. **SAMS** & CO., INC.  
**RADIO**  
**PHOTOFACT SERVICE**

In Canada—write to A. C. SIMMONDS & SONS,  
301 King Street East, Toronto, Ontario

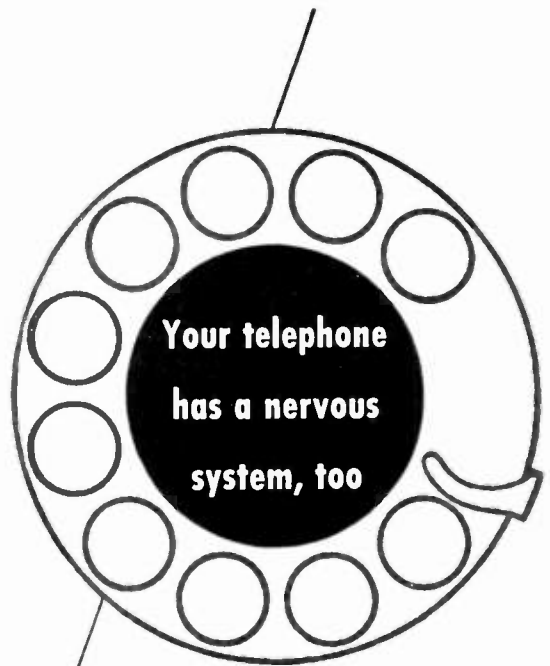
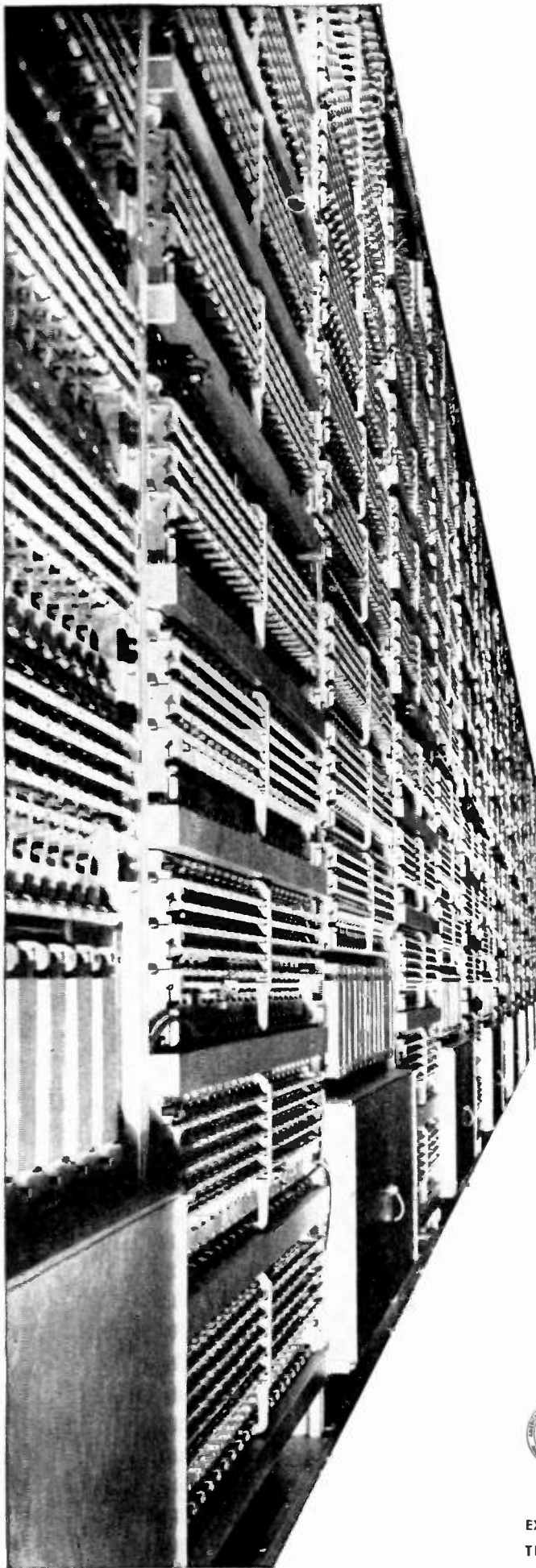

**W**HEN you spin the dial of the latest type of telephone system — known as “common control switching” — you order into action a giant nervous system. It sends electrical impulses through an intricate maze of circuits: more than 10,000 contacts can be opened or closed in a single dial call.

This system takes your order, remembers it, translates it into its own electrical language, throws out sensitive “feelers” to find a through route, plans how to make the connections, makes them, puts through the call—and, if the preferred paths are busy, finds an alternate route to take the call.

The complex art of telephone switching is brought to a high state of development at Bell Laboratories to serve the Bell System. Some day through “common control switching” a dial in San Francisco may set up a connection through to a subscriber in New York.

■  
*Left:* Backstage on your dial telephone call — some equipment in a typical “common control switching” office.



**Bell Telephone Laboratories**

EXPLORING AND INVENTING, DEVISING AND PERFECTING FOR CONTINUED ECONOMIES AND IMPROVEMENTS IN TELEPHONE SERVICE

RADIO-CRAFT for APRIL, 1947





# NOW! An Amazing Opportunity to LEARN RADIO AT HOME

I SEND YOU 8 BIG KITS OF RADIO PARTS

Including a **COMPLETE 6 TUBE SUPER-HETERODYNE RECEIVER**

**I TRAIN YOU RIGHT by PUTTING YOU TO WORK with REAL PROFESSIONAL EQUIPMENT!**



**LEARN HOW TO BUILD CIRCUITS! TEST! REPAIR!**  
YOU DO OVER 175 INSTRUCTIVE EXPERIMENTS

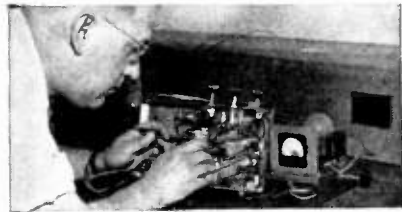

**YOU BUILD THIS USEFUL TEST EQUIPMENT!**

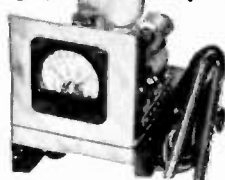

I give you a fine, moving-coil type Meter Instrument on Jewel Bearings — with parts for a complete Analyzer Circuit Continuity Tester. You learn how to check and correct Receiver defects with professional accuracy and speed.

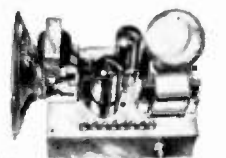

You'll get valuable experience and practice building this Signal Generator and multi-purpose Tester. Makes a breeze out of fixing Radios and you don't have to spend money on outside, ready-made equipment.

**HERE'S THE EASIEST, MOST PRACTICAL WAY OF ALL TO PREPARE FOR GOOD PAY in RADIO ELECTRONICS and TELEVISION!**

I train your mind by putting you to work with your hands on a big 6-Tube Superheterodyne Receiver. And, believe me, when you get busy with real Radio Parts — 8 big Kits of them — you really LEARN Radio and learn it RIGHT! You get the practical stuff you need to be useful in Radio, and that's what it takes to make money. You don't have to worry about what to do with these 8 Kits of Parts. Step by step, I show you how to build circuits, test, experiment, trouble-shoot. And you don't need any previous experience. The Sprayberry Course starts right at the beginning of Radio! You can't get lost! Simplified lessons, coupled with real "Shop" practice, makes every subject plain and easy to understand and remember. Soon after you begin Sprayberry Training, I'll send you my sensational BUSINESS BUILDERS.

**A BUSINESS OF YOUR OWN . . . OR A GOOD RADIO JOB**  
You'll find out how to get and do neighborhood Radio repair jobs for nice profits and rich experience while learning. This sort of work can easily pave the way for a Radio Service business of your own. But with Sprayberry Training, you're not limited. You can swing into any one of the swiftly expanding branches of Radio-Electronics INCLUDING Radio, Television, FM, Radar, Industrial Electronics. Be wise! Decide now to become a fully qualified RADIO - ELECTRONICIAN. Get full details about my Training at once! Mail coupon below for my 2 big FREE Books.

Soldering, wiring, connecting Radio parts . . . building circuits — you can't beat this method of learning. When you construct this Rectifier and Filter, Resistor and Condenser Tester, etc. you get a really practical slant on Radio.



## RUSH COUPON!

**SPRAYBERRY ACADEMY OF RADIO**  
F. L. Sprayberry, President, Room 2047, Pueblo, Colorado  
Please rush my FREE copies of "How to MAKE MONEY in RADIO, ELECTRONICS and TELEVISION," and "HOW to READ RADIO DIAGRAMS and SYMBOLS."

Name ..... Age .....  
Address .....  
City ..... State .....

(Mail in envelope or paste on penny postcard)

### GET THESE VALUABLE FREE BOOKS

"How to Read Radio Diagrams and Symbols"

Here's a valuable and wonderfully complete new book which explains in simple English how to read and understand any Radio Set Diagram. Includes translation of all Radio symbols. Send for this volume at once. It's free! Along with it, I will send you another Big Free book describing in detail my Radio-Electronic Training.

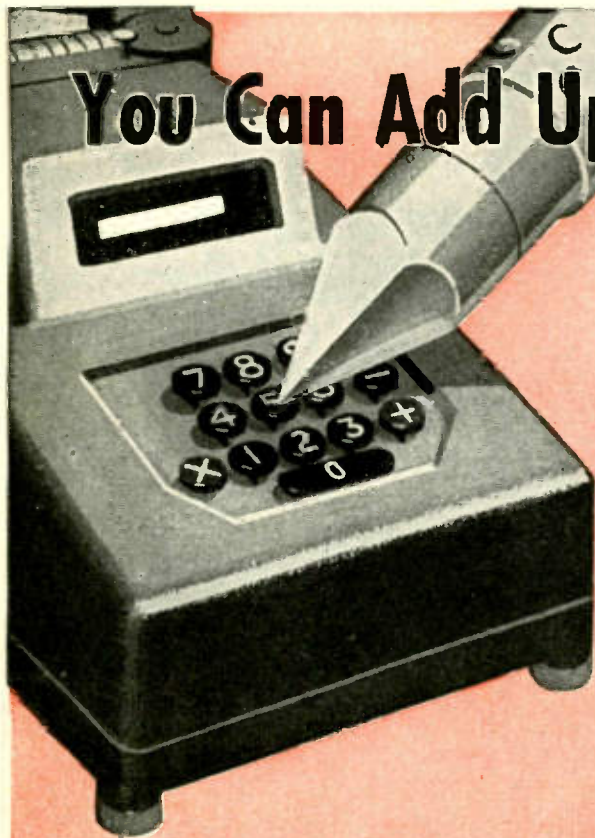

# You Can Add Up Your Income with a SOLDERING IRON!

**Y**ES, it's a fact that you may not have realized . . . but every minute your soldering iron is busy, you are busy making money. *And you can make even more money if you will suggest to your customers a complete "FIND AND FIX" treatment for sets.*

A complete "FIND AND FIX" reveals parts about ready to go as well as those that are shot, saves your customers extra trips, prevents the embarrassment of parts going sour right after leaving your shop.

IRC's Volume Control Cabinet, Resistor Assortment Kits and Basic Kit cut down unnecessary trips to your distributor for parts, give you more time for soldering . . . for making your time *pay*. Order from your local IRC Distributor today. International Resistance Company, 401 N. Broad Street, Philadelphia 8, Pennsylvania. *In Canada:* International Resistance Company, Ltd., Toronto, Licensee.

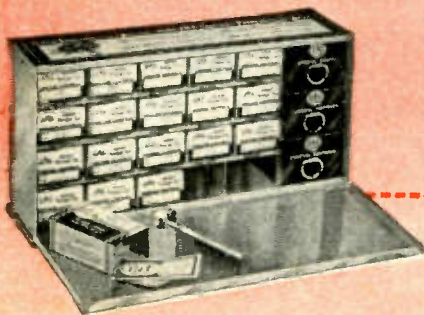

### The IRC Volume Control Kit

18 All-purpose controls, 6 switches and 5 special shafts in an attractive factory-pocked steel cabinet.\*

### The 3 IRC Balanced Resistor Assortments in Resist-O-Cabinets\*

No. 1. 59 assorted insulated composition and power wire wound resistors, including adjustable types.

No. 2. 100 of the most used ranges in 1/2 watt insulated composition and insulated wire wound resistors.

No. 3. 83 top quality resistors in the 1-watt range.

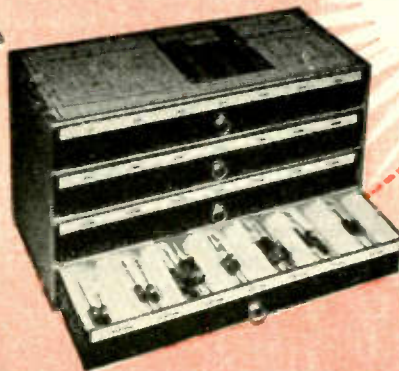

### The IRC Basic Kit

471 "basic" resistors in a wide variety of types and ranges, plus 6 additional bands for adjustable types. All metal cabinet.\*

\*Cabinets are furnished at no charge, not sold separately.

KEEP YOUR IRON  
IN THE FIRE



# INTERNATIONAL RESISTANCE COMPANY

Wherever The Circuit Says  $\Omega$

Copyright, 1947, International Resistance Company

Now IN YOUR OWN HOME Learn

# RADIO ELECTRONICS

The Practical  
"HOME-TESTED"  
Modern "A-B-C" Way



YOU USE ALL OF THESE RADIO PARTS  
TO BUILD AND OPERATE  
**7**  
DIFFERENT RADIO RECEIVING CIRCUITS

**NO PREVIOUS RADIO OR ELECTRICAL EXPERIENCE NECESSARY**

DeForest's Training, Inc. provides every major home study aid to help you learn Radio-Electronics rapidly and thoroughly . . . to give you the experience and confidence needed for a responsible, Good-Pay Job, or to Start a Business of Your Own! Here is a REAL opportunity field for YOU . . . when you are a trained Radio-Electronics man! Just think of the tremendously exciting future ahead of FM Radio, Aviation and Broadcast Radio, Sound Motion Picture Equipment, Servicing and Sales of Radio Equipment, etc. Put yourself in this picture . . . See how you can benefit from a PRACTICAL training in this fascinating work! Think, too, of the coming possibilities ahead of Radar, Facsimile and Television. Send TODAY for the interesting, opportunity-revealing book, "Victory for You!" See how others probably no more talented or ambitious than you, have advanced in earning power after this training . . . how YOU can do it too! Mail the coupon NOW!

INCLUDING:

1. Simple Receiver
2. Two Tube Receiver
3. Tuned Radio-Frequency Receiver
4. Short Wave Receiver
5. Aviation Band Receiver
6. 4-Tube Superheterodyne
7. 5-Tube Superheterodyne with Magic Tuning Eye

... PLUS SCORES OF OTHER FASCINATING, INSTRUCTIVE RADIO-ELECTRONIC EXPERIMENTS

WITH THE HELP OF

- A** EIGHT Big Kits of Actual "Learn-by-Doing" Radio Parts and Assemblies with which you make 133 fascinating SHOP METHOD EXPERIMENTS in your own home! Imagine building 7 different Radio Receivers that operate!
- B** A 16 mm Home Movie Projector and Twelve Reels of "Learn-by-Seeing" Home Movie Films . . . for picture-clear, fast understanding of Radio Fundamentals!
- C** Modern, well-illustrated, Loose-leaf Lessons, prepared in clear, simple, understandable language . . . to guide you throughout your training!

THEN GET THE HELP OF OUR EFFECTIVE EMPLOYMENT SERVICE

16 MM MOVIE PROJECTOR YOU USE "LEARN-BY-SEEING" MOVIES

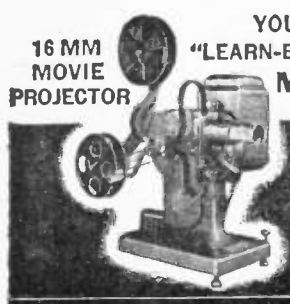

**VETERANS!**  
Big things are happening at DeForest's Training, Inc. for veterans! See how you can prepare yourself WITHOUT COST for a GOOD JOB or a BUSINESS OF YOUR OWN in the vast Radio-Electronic opportunity field.

DEFOREST'S TRAINING, INC. INCLUDES INSTRUCTION IN MOTION PICTURE SOUND EQUIPMENT, FM RADIO AND TELEVISION . . . RESIDENTIAL TRAINING IN OUR MODERN CHICAGO LABORATORIES ALSO AVAILABLE—ASK US FOR INFORMATION!

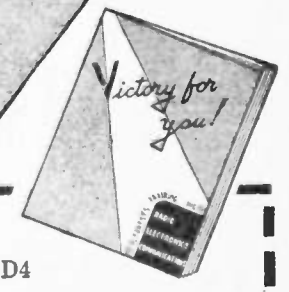

E. B. DEVRY, President  
DeFOREST'S TRAINING, INC.  
2535-41 North Ashland Ave., Dept. RC-D4  
Chicago 14, Illinois, U.S.A.

Send FREE "VICTORY FOR YOU!" BOOK, showing how I may make my start in Radio Electronics.

Name \_\_\_\_\_ Age \_\_\_\_\_  
Address \_\_\_\_\_ Apt. \_\_\_\_\_  
City \_\_\_\_\_ Zone \_\_\_\_\_ State \_\_\_\_\_  
 If under 16, check here for special information.  If a discharged Veteran of World War II, check here.

**DeFOREST'S TRAINING, INC.**  
CHICAGO 14, ILLINOIS

# APRIL • 1947

Editorial: Superadio.....by Hugo Gernsback 17  
 Radio-Electronics Monthly Review.....18, 19  
 New! Cryston Lapel Radio.....by Mohammed Ulysses Fips, I.R.E., A.I.E.E. 24

## Electronics

Antenna Principles, Part V—Directional Arrays for 300 Mc and Higher...by Jordan McQuay 20  
 Television for Today, Part XI—Electromagnetic and Electrostatic Deflection Systems  
 by Milton S. Kiver 37  
 Heat-Operated "Radar".....46

## Amateur Radio

The Postwar Radios—Reviewing the Hallicrafters S-40.....28  
 BC-625 on 144 Mc.....by L. W. May, Jr., W5AJG 35

## Servicing

Lamp Bulb Resistors.....by John B. Parchman 23  
 Radio Data Sheet 345 (Admiral Model 6RT44-7B1).....40  
 Neglected Servicemen.....by E. H. Ehle 44

## Sound

New "Primatone" Organ.....22  
 A Small Recording Studio, Part II—The Technique of Making a Phonograph Record  
 by J. C. Hoadley 34  
 Multi-Station Intercoms, Part II—Master-Remote Systems and Circuits...by Richard H. Dorf 33

## Test Instruments

Vest-Pocket A.C.-D.C. Volt-Ohm-Milliammeter.....by William Lyon 26  
 New Ideas in a V.T. Voltmeter.....by C. F. Van L. Weiland 30

## Construction

De Luxe Phono Oscillator.....by W. G. Eslick 42

## Departments

Transatlantic News.....by Major Ralph Hallows 39  
 Available Radio-Electronic Literature.....47  
 The Question Box.....48  
 New Radio-Electronic Devices.....50  
 World-Wide Station List.....Edited by Elmer R. Fuller 52  
 Radio-Electronic Circuits.....54  
 Try This One.....56  
 New Radio-Electronic Patents.....72  
 Communications.....76  
 Book Reviews.....79



Incorporating  
 SHORT WAVE CRAFT TELEVISION NEWS  
 RADIO & TELEVISION

### HUGO GERNSBACK

Editor-in-Chief

### FRED SHUNAMAN

Managing Editor

### M. HARVEY GERNSBACK

Consulting Editor

### ROBERT F. SCOTT, W2PWG

Technical Editor

### I. QUEEN, W2OUX

Editorial Associate

### ELMER FULLER

Shortwave Editor

### ANGIE PASCALE

Production Manager

### G. ALIQUO

Circulation Manager

### JOHN J. LAMSON

Advertising Director

### ALFRED STERN

Promotion Manager

### On THE COVER:

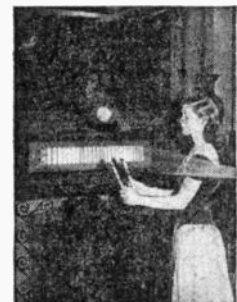

The "Primatone," an electronic musical instrument which operates with light beams and photocell wands.  
 Chromatone by Alex Schomburg  
 from photo by W. Illes.



RADCRAFT PUBLICATIONS, INC. Hugo Gernsback, President; M. Harvey Gernsback, Vice President; G. Aliquo, Secretary

Contents Copyright, 1947, by Radcraft Publications, Inc. Text and illustrations must not be reproduced without permission of Copyright owners.  
 RADCRAFT PUBLICATIONS, INC. • PUBLICATION OFFICE 29 Worthington Street, Springfield 3, Mass. • EDITORIAL AND ADVERTISING OFFICES 25 West Broadway, New York 7, N. Y. Telephone REctor 2-9690.

BRANCH ADVERTISING OFFICES: Chicago: 308 W. Washington Street, Suite 1413, Chicago 6, Ill. Tel. Randolph 7363. Cleveland: Burdette Phillips, Manager, 405 Erie Bldg., Cleveland, Ohio. Tel. Main 9645. Detroit: Frank Holstein, Manager, 307-8 Boulevard Bldg., Detroit, Mich. Los Angeles: Ralph W. Harker, Manager, 606 South Hill St., Los Angeles 14, Calif. Tel. Tucker 1793. San Francisco: Ralph W. Harker, Manager, 582 Market St., San Francisco 4, Calif. Tel. Garfield 2481.

RADIO-CRAFT, April, 1947, Volume XVIII, No. 7. Published Monthly on 28th of month preceding date of issue. Allow one month for change of address. When ordering a change, please furnish an address stencil impression from a recent wrapper. All communications about subscriptions should be addressed to the Circulation Manager, Radio-Craft, 25 West Broadway, New York 7, N. Y.

SUBSCRIPTION RATES: United States and possessions, Mexico, Central and South American countries, \$2.50 a year; \$4.00 for two years; \$6.00 for three years. Canada, 3.00 a year; \$5.00 for two years; \$7.50 for three years. All other foreign countries, \$3.25 a year; \$5.50 for two years; \$8.25 for three years. Special rates for members of the Armed Forces in U.S., or those addressed by A.P.O. or F.P.O. mail, \$2.00. Entered at Post Office, Springfield, Mass., as second-class matter under the Act of March 3, 1879.

FOREIGN AGENTS: Great Britain: Atlas Publishing and Distributing Co., Ltd., 18 Bride Lane, Fleet St., London E.C.4. Australia: McGill's Agency, 179 Elizabeth Street, Melbourne. France: Brentano's, 37 Avenue de l'Opera, Paris 2e. Holland: Technisch Bureau Van Baerle, Bemelmans & Co., Heemsteedsche Dreef 124, Heemstede. Greece: International Book & News Agency, 17 Amerikis Street, Athens. So. Africa: Central News Agency, Ltd., 369 Smith Street, Durban, Natal. Universal Book Agency, 70 Harrison Street, Johannesburg. Middle East: Steimatzky Middle East Agency, Jaffa Road, Jerusalem. India: Magazines Distributors, 5 Bombay Mutual Annexe, Gunbow Street, Fort, Bombay 1.

Grasp the **NEW OPPORTUNITIES** in

# RADIO ELECTRONICS AND TELEVISION NOW!



**Modern Radio — FM Broadcast and Reception — Television — Industrial Electronics; Power, Control, Communications — new equipment and methods demand new technical ability and experience. Keep up to date with the latest.**

**MODERN RADIO EQUIPMENT FOR YOU TO USE AND KEEP**



The very essence of National Shop Method Home Training is EXPERIENCE. You get actual experience by working with modern Radio and Electronic equipment—building many types of circuits. You may build a fine, long distance MODERN SUPERHETERODYNE, signal generator, miniature radio transmitter, audio oscillator, etc.—many other standard actual operating pieces of equipment—conduct cathode ray and other experiments. This practical work advances with your training—YOU LEARN BY DOING!

## Shop Method Home Training

By a Real Established Resident School with its own FM Studios, Shops and Laboratories.

### TRAIN WITH ADVANCED TECHNIQUE

The good jobs in Radio Electronics now go to the men who are equipped to handle them. It takes training and experience. National Schools, one of the oldest and largest trade schools in the country, makes it possible for you to get this training right in your own home IN YOUR SPARE TIME.

National maintains modern resident training Studios, Shops and Laboratories where instructors and engineers are working constantly to improve training methods. SHOP METHOD HOME TRAINING is a logical extension of this practical system.

A FREE lesson that shows you how practical and systematic this new training method is will be sent you without obligation. You may keep and use this lesson to prove to yourself just how practical National Training really is. Get one of the many NEW JOBS that demand new techniques and methods in Modern Radio. Get your share of the NEW BUSINESS that servicing the new sets and equipment demands. Experts agree that Radio, Television and Electronics present opportunities

much greater than ever before!

Radio is expanding with far-reaching improvements in reception. No one knows yet how great the Television market will be. Electronics will touch almost every walk of life—in industry and in the home.

**TURN YOUR INTEREST IN RADIO INTO A CAREER THAT WILL ASSURE YOU SUCCESS AND SECURITY.**

### FIND OUT WHAT NATIONAL TRAINING CAN DO FOR YOU

Where do you stand today in modern industrial progress? What does the future hold for you? You owe it to yourself to investigate this opportunity. With National Training YOU GET AHEAD FAST—you may step into a good position or start a business of your own, with little capital, even before you complete your National Course.

Fit yourself for a career of independence, good earnings, success and security in one of the fastest growing fields in industry. For full information, just send your name and address on the coupon and mail it TODAY.

# FREE LESSON

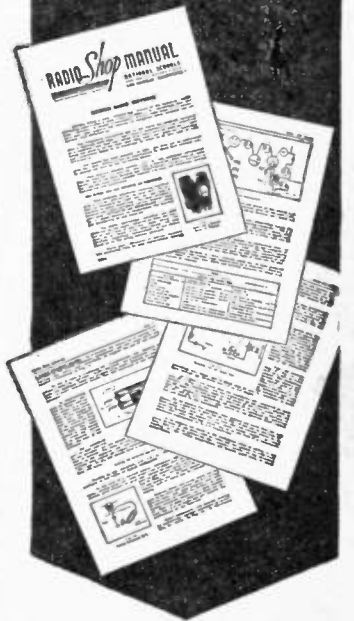

## Get This Book FREE

The big book presents the facts about the field of Electronics and your opportunities in it together with full information about the advanced National Training. Read it and make up your own mind that National Training will equip you for a great future. No salesman will call on you from National. The book is FREE with your sample lesson. Clip and mail the coupon TODAY!



## See What National Training Has Done For These Men

National Shop Method Home Training wins good jobs, independence and security. Take the word of National men who have established records in their favorite Radio, Television, or other branches of Electronics.



From O. K. Ivey, Washington, D. C., comes this endorsement: "I believe National offers the best course to be had... Keep up the good work."

Here's a statement from R. E. Wright, Blackfoot, Idaho: "Due to my training at National I was selected to instruct in the laboratory work of Navy and Marines."



Clifford Hannah, Portage La Prairie, Manitoba, Canada, writes: "My training has brought results as I'm in line for another raise thanks to National's encouragement and thorough training."



Joseph Michel, Jr., Granite City, Illinois, writes: "I am enthused with National training. I am now earning \$225 a month as a radio operator and technician and \$20 a week more in my shop at home."



Read what other enthusiastic students have written about National Training in the big 40 page book we will send you.

## NATIONAL SCHOOLS

LOS ANGELES 37, CALIFORNIA EST 1905

### MAIL OPPORTUNITY COUPON FOR QUICK ACTION

National Schools, Dept. 4-RC  
4000 South Figueroa Street, Los Angeles 37, California

(Mail in envelope or paste on penny post card)

Mail me FREE the two books mentioned in your ad including a sample lesson of your course. I understand no salesman will call on me.

NAME ..... AGE .....

ADDRESS .....

CITY ..... STATE .....

Include your zone number

Check here if veteran of World War II

# "COMMUNICATIONS" VALUES AT DISPOSAL PRICES!

## MICROWAVE PARTS AND EQUIPMENT



Magnetrons!! Type 2J32 (JAN.) just released. The 2J32 is designed for 10 cm. operation. Rated at 300 kw peak pulse power. Complete information supplied. Listed at \$200. Our Price \$25.50

- 2J38 Magnetron, 3240 mc., complete with magnet \$37.50
- 3J31's just received. One cm. magnetron listed at \$95. OUR PRICE \$20.00
- Magnets for magnetrons, each \$13.00
- 715-B Pulse Power Tube. \$9.50
- KLYSTRON oscillator tubes 2K25/723ab designed for 3 cm operation. New, with complete data. Listed at \$38.00 \$7.75
- Duplexer using 1B24 for 3 cm \$10.00
- 724B ATR Tubes, used in duplexers, each \$1.50
- 30 mc oscillator-amplifier with 2 6AC7's. Uses 723ab. Wave guide input, xtal detector. With 6AC7's \$10.00
- With 6AC7's and 723ab \$16.50
- Thermistor Beads (D-170396), for use with UHF and Micro-Wave Equipment (List \$3.00). In separate sealed containers \$9.50

## 3 CM wave guide sections

- Silver Plated Directional Couplers with a 20 DB drop with:
- A. Wave Guide. 90° bend 15" \$4.00
  - B. 15° bend in wave guide 15" \$4.40
  - C. 30° bend in wave guide 10" long \$3.95
  - D. 90° bend in wave guide 15" long also 90° bend in coupler \$5.50
  - E. T Section with choke terminations \$5.00
  - G. 150° bend with 90° twist 3/4" radius with pressurizing nipple and coax coupler \$3.95
  - H. 2 1/2 foot 3 cm wave guide choke to cover fitting \$4.95
  - J. 5 foot 3 cm wave guide section, per foot \$1.95
  - K. Slotted Dipole Antenna 3 cm \$4.00
  - 90° bend in wave guide 15" \$5.00
  - L. Choke flange for 3 cm. 1" x 3/4". 2 for \$1.45
  - M. 10 cm. Wave guide, per ft. \$2.00
  - 16 ft. lengths.

## RELAYS

- A. SPDT Leach 1353 115V/60 cps. coin silver contact 10 A. Rating. This relay is actually DPDT with a Bridge between the two poles. Easily converted to DPDT. \$1.25
- C. SPDT contacts; coil rated 115V/60 \$1.39
- D. SPST Latching relay made by Kurman. Make coil 115V/60; DCR 1500 ohms. Break coil 115 vdc 10 ma; DCR 5000 ohms. \$2.95
- E. DPST Telephone type; 2 p. 1 el; 1 open cont. rating 5a at 50c; coil rating 3.5 ma (at 12K ohms); 1000 vac \$1.05
- F. DPDT Steatite Insulated 10 amp silvered contacts, made by Leach \$1.95
- G. SPDT Struthers-Dunn sensitive keying relay, 5 MA-DC Coil. 110V/60 cycles—2 Amp contacts \$1.49

## TECHNICAL MANUALS

- RC 191 (same as 375) \$50
- SCR 193 (combines 312) \$50
- RCVR and 191 TXmtr \$50
- SCR 528 \$50
- SCR 508 \$50
- SCR 538 \$50
- ZA-1 Landing equipments \$50

## SPECIAL ITEMS

- Visors for 5 inch 'scopes \$ .75
- Tube shields for 2AP1 \$ .98
- Broadcast band push-button tuning units, inductive or capacitive types \$1.49
- Helmholz Phase Shifting Coils \$2.25
- Mushroom rubber earphone cushions for lightweight sets, 2 pr. \$ .89
- Dihedral sockets with 1 1/2 ft. leads for 3BP1 and 5CP1 \$1.20
- Oscilloscope chassis, completely punched, for use with a 2 inch tube. Octal sockets included 15"x11"x9" \$1.50
- Microwave Signal Generator—2700 to 3000 mc. Regulated power supply—115V/60c. Contains output meter. Made by Western Electric. Value \$300. \$75.00
- Microphone element T-30-K for throat mike selling 2 for \$ .50
- Microphone unit MC-419 for lip microphone \$ .98
- 140 mmf split stator variable midgeet condenser \$1.49
- Silver button mica condensers, 175-180-185 mmf, each \$ .05
- Lots of 100 \$4.50
- Silver button mica condensers: 400 and 500 mm, each \$ .10
- Lots of 100 \$9.50
- Feed-through glass insulator 7/8" long. Beehive external section \$1.10
- Black crackle finished cabinet for relay rack mounting 19" W x 25" H x 15" D with hinged door in back \$6.00

## Ohmite Wire-Wound Rheostat

- Model H 250 Ohms 25 Watt \$ .98
- Model H 125 Ohms 25 Watt \$ .98
- Model J 1800 Ohms 50 Watt \$ 1.25
- Model K 3000 Ohms 100 Watt \$ 1.98
- Model L 250 Ohms 150 Watt \$ 2.25
- Model N 220 Ohms 300 Watt \$ 3.00
- Model P 1200 Ohms 225 Watt \$ 2.75

## I.F. XTAL FILTER

I-F Crystal filter for RC-312, BC-342. Resonant at 470 kc. Crystal included. \$6.95



## SONAR SOUND DETECTION UNIT

Ideal for detecting underwater sounds, such as fish swimming in schools, within a 15 mile area. Using a Rochelle salt crystal, which is about 1000 times more sensitive than quartz, as the active unit the sound is transmitted up a 60 ft. length of cable. It is completely enclosed in a solid rubber sheath. This sound detector was originally used in harbor defense. Coupled to an audio amplifier, this can be found to have many valuable applications. Ask for SD-1. \$695

## RA-58-A HI-VOLTAGE POWER SUPPLY

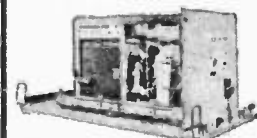

Ideal for breakdown insulation testing, or as a source of power for a pulse transmitter. This unit supplies continuously variable voltages between 500 and 15,000 volts DC at 35 ma. A voltage doubler circuit using two 705A rectifiers and two 1 mf condensers is employed. RMS ripple voltage at maximum power is 8%. THIS UNIT OPERATES FROM 115 v/60c. Variable voltage is obtained by means of a Variac in the primary circuit of the high voltage transformer. Size is 21"x17 1/2"x29" deep. Net weight 31.4 lbs. This unit sells for \$116 at the low price of \$116

## "2 FOR A DOLLAR" SPECIALS

- Modulation Xformer 807 to pr. 807's Imp Xformer Single Button to Grid 20-1.
  - Audio Coupling Xformer 600 ohms CT to 150, 4,000, 250 choke 2 Hy. @ 160 ma.
- 2 FOR A DOLLAR**

## DP 12 Famous Navy High Power Direction Finder

The DP-12 is a Navy direction finder, made by RCA with a frequency range of 100-1500 mc. The input impedance is (1.15V/60 c). The tube line-up is 3-8D6; 2-7G; 1-6AF6; 1-1523. This unit is equipped with loop output junction box, flexible transmission line, input transformer, deck bearings, cable drums, operating pedestal, hand wheel, azimuth scale, loop antenna assembly, and loop pedestal. This unit is a buy for any seagoing vessel \$195.00

## CW-3 RELAY RACK RECEIVER



This superhet receiver will operate on any fixed frequency from 1900 kc. to 15,000 kc. Uses 7 tubes. Operating frequency is determined by Xtal. With 2 coil groups 5.4 to 10 mc; 9.4 to 16.5 mc. available. Priced new with spare tubes and one set of coils (9.4-16 mc.) less Xtal \$21.50

Extra set coils 5.4-10 mc. \$ 3.00

## HI-VOLTAGE TRANSFORMERS

3200 volts, AC 150 M.A. 115 volt. primary, 60 cycles. Designed for half wave operation with 150 M.A. output each, two transformers hooked up with secondaries in series and primaries in parallel will give 3,000 volts, output at 300 M.A. from a full wave rectifier. These are conservative, continuous commercial ratings \$7.25

Jefferson Power Transformers 115 v 00c/600 vct-85 Ma./6.3v-7.3A/5v-2A/0.3-3A \$3.50

Power supply transformer. Made by Subsig. Pri. 115/60 cps Sec. 1:750vct. 113a; Sec. 2:0.3vct-5a; Sec. 3:5v-3a. 2500TV specially priced at \$5.95

## CHOKES

- 12 hr-12 hr @ 150 ma., 15 amp. rating, each price \$3.35
- 12 hr @ 165 ma 200 ohms DCR made by Thordarson. Price \$2.00
- 59 hr @ 100 ma 850 ohms DCR made by Jefferson. Price \$2.00
- 2.6 hr @ 800 ma stud and terminals at bottom made by G. E. \$3.50

## AUDIO TRANSFORMERS, MODULATORS, ETC.

- Modulation xfmr: typical for 211's el. A50W \$1.35
- Modulation xfmr: pr. 811's to 813. 5.00
- Audio output transformer Split pri. 1500 OHMS each side. Secondary impedance 85 ohms center-tapped —6:1 ratio, 100-watts output. \$5.30
- Line to Voice coil transformer. Pri 600 ohms. Sec. 6 ohms. 1200 Test volt \$1.45

## NEW U.S. NAVY MODEL RAK-7 SHIP RECEIVER

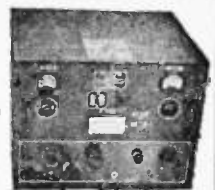

\$69.95

15 kc to 600 kc. 6-tube receiver with AVC-Band pass filter-Audio filter—Noise limiter—Precision tuning with a Vernier dial—Voltage regulated power supply with three tubes, for 60 cycle, 115 volts. Can be battery operated. Complete with spare parts box weighing 73 lbs., tubes and instruction book.

## Test Set EE65

Made by Conn. T & E Corp. \$29.50

This unit is used for checking and maintaining field telephone systems by testing for all types of failures in the lines, such as opens, shorts, grounds, crosses with other lines, capacity between lines, insulation resistance, and many of the other faults possible in a phone system.

## Army-Navy Type Headphones Type HS23

Leather covered headband, detachable rubber cushions, lightweight headset with 2,000 ohm DCR, 8000 impedance, with 6 ft. cord and P1-55. New in cartons \$2.50

Used—in good condition \$1.50

## TUBE SPECIALS

Tube Type	Approx. List	Your Cost
2AP1	\$12.00	\$3.75
3BP1	15.00	3.95
3BP7	27.00	2.98
5BP1	20.00	4.95
5BP4	20.00	7.95
5CP1	45.00	4.91
5CP7	48.00	6.00
5FP4	35.00	4.85
5FP7	32.00	3.97
5JP2	48.00	8.98
837	2.80	1.35
872A	7.50	2.45
705A	22.30	8.78
241B-WE	85.00	40.00
841	165.00	85.00
304TH	8.00	8.00

Sockets for 5CP1, 5BP1, 3BP1, 705A, 829 \$0.95 ea.

## Hi-Volt Oil Condenser

- .15-.15mf 6000vdc GE \$4.50
- .1-1mf 7000vdc GE 2.00
- .1-1mf 26F435 GE 2.00
- In lots of 50 \$1.75
- .13-.15 mf 8000vdc Sprague Vitamin 9 5.25
- G.E. Pyranol 23F47 5.25
- 2mf 4000v. List \$30 5.25
- G.E. Pyranol 23F47 5.25
- 2mf 5000v. List \$27 4.75
- C-D TC 50010 1 mf 5000v. List \$30 4.50
- G.E. 14F191 .1mf 10000v. List \$37 6.75
- Synchro Capacitor Mark 1 Mod. 2 type 3 C 10-10-10-Mr. Delta connected made by GE 00v. 60c. \$4.00

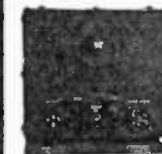

NEW POWER SUPPLY for LM-18 freq. meter. Output: 290 v @ 20 ma; 13 v @ 600 ma. Input: 105-125 v @ 60 cps; 260 ma; 27.6 W. type 84 rectifier tube; shock mounted. Complete with input and output (plugs) tube included \$14.75

## Oil Filled Condensers

1 mf 300 vdc	\$0.25
2 mf 300 vdc	.30
4 mf 300 vdc	.35
4 mf 400 vdc	.55
5.5 mf 400 vdc	1.15
2 mf 550 vdc	.30
2.5 mf 600 vdc	.25
.85 mf 600 vdc	.30
1 mf 600 vdc	.35
2 mf 600 vdc	.40
3 mf 600 vdc pyr	.65
4 mf 600 vdc pyr	.70
6 mf 600 vdc pyr	.95
8 mf 600 vdc	1.49
15 mf 600 vdc	1.75
1 mf 1000 vdc	0.85
2 mf 1000 vdc	.98
1 mf 1500 vdc	1.05
1 mf 1500 vdc	.30
2 mf 400 ac/1000	.95
4 mf 1500 vdc	1.30
1 mf 2000 vdc	1.20
1 mf 2500 vdc	1.20
Ory Elect. Cond.	
500 mf 200 vdc	1.95
4000 mf 30 vdc	2.25

All merchandise guaranteed. Mail orders promptly filled. All prices F.O.B. New York City. Send Money Order or Check. Shipping charges sent C.O.D.

SEND FOR FLYER

# COMMUNICATIONS EQUIPMENT CO.

131-C Liberty St., WH 4-7658, New York City 7, N.Y.

# What does it take to WAKE you up?

Present-day expansion of the radio-electronics industry is almost UNBELIEVABLE. The tremendous growth of the art is so rapid and in so many directions that already the demand for TECHNICALLY QUALIFIED radiomen has created a condition wherein there are many MORE GOOD JOBS than there are capable men to fill them.



By the end of 1947 the total number of broadcasting stations (AM, FM and Television) will have almost tripled since shortly before the war. Airlines and airports are rapidly installing new radio communications and radar equipment. Every major railroad has adopted radio communications, as have large trucking and taxicab companies. Manufacturing is at an all-time high as millions of home receivers, broadcasting equipment, etc., are produced. Television receivers are now in regular production.

All of this means that OPPORTUNITY IS HERE . . . Now!

Every page in this magazine could be filled with such astounding facts concerning career opportunities available to trained radiomen. The point is, what are you going to do about it? Just figure out for yourself how many good jobs are waiting to be filled. You can't say, "I don't need more training." EVERY radioman needs to increase his technical knowledge if he wants to keep ahead of the competition that is bound to come . . . if he wants to go after — and GET — the better jobs that offer good money and personal security.

If you have a commonplace job. If you have the ambition to hold a position of greater responsibility with higher pay . . . then a CREI spare time program for self-improvement will help you accomplish your ambition at this opportune time. It costs you nothing to read the interesting facts. Write today for the list of CREI radio-engineering courses.

## MAIL COUPON FOR FREE BOOKLET

If you have had professional or amateur radio experience and want to make more money, let us prove to you we have the training you need to qualify for a better radio job. To help us intelligently answer your inquiry — PLEASE STATE BRIEFLY YOUR BACKGROUND OF EXPERIENCE, EDUCATION AND PRESENT POSITION.



### CAPITOL RADIO ENGINEERING INSTITUTE

16th & Park Road, N. W., Dept. RC-4, Washington 10, D. C.

Gentlemen: Please send me your free booklet, "CREI training for your better job in RADIO-ELECTRONICS", together with full details of your home study training. I am attaching a brief resume of my experience, education and present position.

CHECK  PRACTICAL RADIO ENGINEERING  
COURSE  PRACTICAL TELEVISION ENGINEERING

NAME.....

STREET.....

CITY..... ZONE..... STATE.....

I am entitled to training under the G.I. Bill.

VETERANS! CREI TRAINING AVAILABLE UNDER THE "G.I." BILL!

## Capitol Radio Engineering Institute

An Accredited Technical Institute

DEPT RC-4, 16th and Park Road, N. W., Washington 10, D. C.

NEW YORK (7): 170 BROADWAY • SAN FRANCISCO (2): 760 MARKET ST.

# HERSHEL *Offers* BETTER BARGAINS... BIGGER BUYS



## TUNING UNIT

Turning Unit BC 375. Approx. 65 M.M.F.D. cond., coils, RF chokes diats, ass'd micro condensers 2500 WVDC. over \$50.00 in parts. Cat. No. TU-101.....

**\$375**

All Orders  
7.O.B.  
Detroit

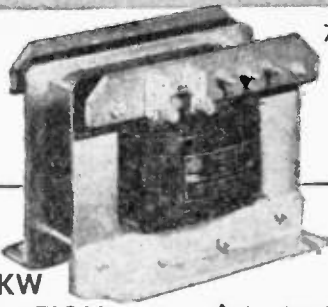

## 1 KW MODULATION TRANSFORMER

Special at **\$14.95**

BUY NOW AND SAVE

Minimum Order \$2.00

RCA modulation transformer is conservatively rated at 550 Watt audio to modulate that new KW rig. Really rugged construction with protective flashover gaps, which are adjustable. Terminals and gaps are mounted on a "Mycalox" terminal board. The laminations that make up this transformer are of high audio quality and are extremely thin, making it impossible for the core to "chatter or talk." Audio Watts—350 Sec. #1—450 Mills Sec. #2—80 Mills Turns Ratio—Pri: Sec. #1-1:1 Pri: Sec. #2-5:1 Pri: Sec. #2 Top—25:1. Impedance Ratio—Pri: #1-1:1 Sec. Pri: Sec. #2-25:1 Pri: Sec. #2 Top—625:1. DC Resistance—Pri: 135 ohms Sec: #1, 112 ohms; Sec. #2, 99 ohms. Transformers insulation tested: Pri. 8000V.; Sec. #1-11-000V, Sec. #2-2000V. to the rest of the coils and core. Primary center-tapped for Class "B" modulators. Secondary #2 will carry 80 Mills to modulate screens of beam power or screen grid tubes. Primary will match any Class "B" tubes up to 10,000 ohms plate to plate, such as 810's, 75T's, 800S's, 28120's, 203's, HY512's, 211's, 813's, 828's, 80S's, 2032's. Size 9 1/2" wide, 7 1/2" deep, 7 1/4" high. Heavy channel iron mounting brackets. Weight approx. 40 lbs. Catalog number MT-100.

## BM-1FF TRANSMITTER AND RECEIVER

The famous boat anchor released from Government surplus, has been widely used on the 144 MC band. It can now be used as a transmitter and receiver. Shipping weight 100 lbs. Your price, less tubes and power transformer. Catalog number RT-102.....

**\$14.95**

## FILAMENT TRANSFORMERS

- Thordarson 6.3 V-4 amps., 6.3 V-4.5 amps., 9.7 V-5 amp., pri. 110 V AC 25 or 60 cy.—Cat. No. FT-11..... **\$1.95**
- Thordarson pri. 110 V 60 cy.—sec. 6.3 V 6 A, CT—Cat. No. FT-12..... **\$1.49**
- Thordarson 110 V 60 cy. pri., sec. #1-2.5 V, 10 A Ct, 3000 V ins., sec. #2 10 V 3.25 A, Two 5 V 3 A; 6.3 V 1 A—Cat. No. FT-13..... **\$4.95**

## SHALLCROSS ACRA-OHM WIRE WOUND RESISTORS

- 2,000 ohm 25,000 ohm 70,000 ohm
  - 3,300 ohm 30,000 ohm 75,000 ohm
  - 9,000 ohm 30,000 ohm 100,000 ohm
  - 15,000 ohm 60,000 ohm 160,000 ohm
  - 18,000 ohm 65,000 ohm 600,000 ohm
- ±IW 39c ea. <sup>3</sup> for **\$1.00**

## CONDENSERS

Cat. No.	Cap. MFD.	Working Volts	Your Cost
C110.....	1.....	5000 Oil.....	\$3.95
C111.....	3.....	4000 Oil.....	\$4.95
C112.....	1.....	1000 Oil.....	44c
C114.....	8.....	600 Oil.....	95c
C115.....	2.....	600 Oil.....	49c
Westinghouse 1 MFD 6000 volts WVDC.....			\$7.95
Westinghouse 1 MFD 10,000 volts WVDC.....			\$12.95

## VARIABLE CONDENSERS

100 MMFD variable APC Type, Cat. No. T-21.....	<b>59c</b>
30 MMFD variable APC type, Cat. No. T-22.....	<b>25c</b>
12 MMFD variable 1/4" shaft, Cat. No. T-23.....	<b>30c</b>

## CHOKES

Thordarson 8 HY 150M choke, Cat. No. FC-201.....	<b>95c</b>
Thordarson 8 HY 175M choke, Cat. No. FC-202.....	<b>\$1.49</b>
Thordarson 12 HY 25M choke, Cat. No. FC-203.....	<b>39c</b>
Thordarson 8 HY 350M choke, Cat. No. FC-204.....	<b>\$4.95</b>



## THORDARSON T 48003

2H-7H 550 MA swing choke size 4 1/2 x 5 1/2 x 5 1/2 square black crockle case. Cat. No. FC-205.....

**\$5.95**

## 3 LBS. ASST. RADIO HARDWARE

**\$1.00**

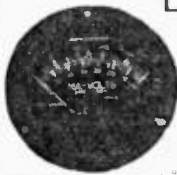

Westinghouse meter, 0-1 MA movement, 2" round case, scale calibrated 0-140 and 0-500. Includes mounting hardware. Cat. No. M-101.....

**\$2.95**

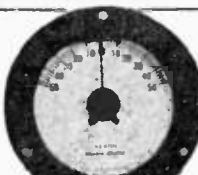

Western Electric meter, 4" round, zero center, 0-1/2 MA each side. Cat. No. M-102.....

**\$3.95**



Westinghouse meter, 0-1 RF amps, 2" round case, internal thermocouple, in original box. Includes mounting hardware. Cat. No. M-103.....

**\$2.95**

READRITE 2" SQUARE METER O-5..... **59c**



## DYNAMOTOR

Power supply—inputs 6 or 12 V, output 500 VDC at 160 MA, mounted on box with circuit breakers, relays, interference filter and two 10 H. cables. U. S. Govt. surplus. Cat. No. DM-101.....

**\$9.95**

## PIN STRAIGHTENER

For miniature tubes—Gov't cost \$4.80 our price—Cat. No. **49c**

## SELSYN MOTORS

The ideal way of indicating the position of rotary beams, wind indicator, etc. (400 cycles). Line card and instructions for 110 VAC operation furnished.—Cat. No. SM-100.....

**2 for \$3.95**

## Hot Spot Specials

- Ass't resistors 1/2 watt fully insulated, in popular ohmages. Cat. No. R-5—per 100..... **\$1.49**
- Ass't micro condensers, Cat. No. C-12—per 100..... **\$1.95**
- Wafer sockets, 4-5-6-7 and 8 prong. Cat. No. WF-4—per 100..... **\$2.95**
- 12" Utah P. M. Speaker, Alnico #5 with 6F6 output transformer. Cat. No. ST-100..... **\$6.95**
- Ass't knobs push on wood and plastic. Cat. No. KP-100—per 100..... **\$1.95**
- 6J4..... **\$1.50**
- 6J6..... **95c**
- Johnson sockets #210-25W. Cat. No. JS-210..... **49c**
- 955-9004 tubes. Cat. No. T-99..... **65c**

- Sockets for acorn tubes. Cat. No. AT-10..... **19c**
- 8.8 MFD 350 WVDC, 20 MFD 150 WVDC, round con. Cat. No. RC-88..... **69c**
- Hallcrafters volume knobs—SX 28..... **15c**
- Pots—screw driver shaft 2 meg, 21 meg, 150M, 50M, 25M, 5M, 2M, 200 ohm—ea..... **29c**
- A 144 MC Radar Osc., uses 15 E or Hy 75. Enclosed silver plated tank with variable coupling. Complete less tube..... **\$3.95**
- Jacks PL 55, PL 68..... **15c**
- Powdered iron slug with Isolantite coil form to match, ideal for broad tuning E.C.O..... **25c**
- Powdered iron 1/4 slug..... **10c**

## RECEIVER AND TRANSMITTER

SCR-522. 100-156 MC receiver and transmitter complete with 18 tubes. Used, in good condition. Cat. No. RT-10..... **\$29.95**

## HALLICRAFTER RECEIVER

R45/ARR7—contains xtal filter, variable I.F. selectivity A.V.C. and A.N.L. Osc. patterned after SX28A. Hallcrafters, voltage regulator complete with tubes and power supply components for 110V operation. Cat. No. SX28A..... **\$139.50**

Mich. Sales add 3% Sales Tax

Write for **FREE** Bulletin

## R44/ARR-5 HIGH FREQUENCY

receiver. Patterned after S-36A by Hallcrafters. Receives FM and AM signals in the spectrum between 78 and 145 mcycles. Circuit has 14 tubes including voltage regulator for high frequency oscillator. Has two position selectivity control. Contains no internal power supply. Has acorn tubes RF, Osc., and Mixer. Complete with components for power supply including transformer, choke, filter condensers, and rectifier tube..... **\$100.00**

# HERSHEL RADIO CO.

5249 GRAND RIVER

DETROIT 8, MICHIGAN

20% DEPOSIT REQUIRED ON ALL C.O.D. ORDERS



# Start your own RADIO SERVICE SHOP

Choose one of these  
3 GREAT NEW DEALS

Includes TEST EQUIPMENT, TUBES, PARTS, TOOLS

3 complete going-in-business packages, (If necessary, they can be changed to suit your needs.)

There never was a better opportunity than now to start a profitable business of your own. No fuss, no worry. Here's everything you need. Details upon request. Write, wire or phone!

**\$99<sup>50</sup>**

**\$179<sup>50</sup>**

**\$350<sup>00</sup>**

## Featherweight Miniature

### TEST INSTRUMENTS

Compact — Accurate — Priced Right!

- Jeweled Meter • Range Selector Switch
- All multipliers bridge tested for 1% accuracy
- Zero adjustment—built in batteries
- Molded bakelite case only 3-15/16" x 2-7/8" x 2"



#### MODEL 450A

Volt—Ohm—  
Milliammeter

A fine instrument having a sensitivity of 1000 ohms per volt.

Ranges: Volts DC, 0-5/10/50/500/1000;  
Mills DC, 0-1;  
Ohms full scale, 0-5000/50,000/500,000;  
Ohms center scale, 30/300/3000.

NET complete with batteries **9.75**

#### MODEL 451A

AC-DC

Volt—Ohm—  
Milliammeter

A dependable instrument of wide utility—sensitivity 1000 ohms per volt.

Ranges: Volts AC, DC, and Output Ranges, 0-10/50/100/500/1000;  
Ohms full scale, 500,000.  
Ohms center scale, 7200.



NET complete with batteries **13.65**

#### MODEL 451B

Same instrument as above but has 2500 ohms per volt sensitivity.

NET complete with batteries **15.15**



#### MODEL 452A

Volt—Ohmmeter

A superb instrument—100 microampere meter gives 10000 ohms per volt sensitivity.

Ranges: Volts DC, 0-10/50/100/500/1000;  
Ohms full scale, 0-2000/20,000/200,000/2  
Megs;  
Ohms center scale, 30/300/3000/30,000.

NET complete with batteries **13.65**

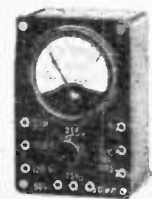

#### MODEL 312

Volt—Ohm—  
Milliammeter

An economy pocket meter featuring a 2" moving vane meter.

Reads: AC-DC volts, 0-25/50/125/250;  
Mills AC-DC, 0-50;  
Ohms, 100,000;  
mfd. .05-15.  
Jacks provide range selection.

NET Complete with cord and plug **6.00**

### TURNTABLE STAND

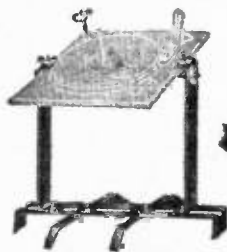

**\$3.91**



With each stand we send a stroboscope free.

All steel—adjustable—holds turntable 15" above bench—tilts to any position—speeds work—saves time—prevents damage to parts—pays for itself on first job—you need several at this low price.

### PHILCO BEAM OF LIGHT

Selenium cell only, no holder, postpaid... **\$1.80**

(Puts new life into Philco Changers)

Sapphire needle only, no mirror, postpaid **\$1.20**

### SHORT WAVE RECEIVERS

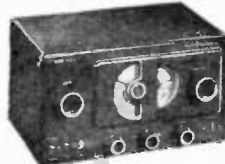

Hallcrafters S-38... **\$47.50**

S-40 (Replaces S-20R)... **89.50**

SX-42 (Replaces SX-28A)... **275.00**

### SELENIUM RECTIFIERS



Direct permanent replacement for 117Z6—117Z3, etc. No filament—no socket—no trouble.

1 to 5 **1.08** net 6 to 49 **98c** net 50 or more **90c** net

### V. M. AUTOMATIC CHANGER



A Two Post Changer with well-made mechanism—plays 10" or 12" records intermixed. Low pressure crystal pickup. Size 14" x 14". Packed two to a factory-sealed carton, factory guaranteed.

SPECIAL **15.95** EACH CARTON OF TWO **29.95**



### INTERFERENCE FILTERS

A plug type filter eliminates noise when used in line cord of small motors, vacuum cleaners, etc. A "natural" for increased sales.

net each... **82c**

### SLIDE RULE DIALS

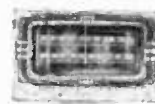

Crowe No. 534—direct ratio drive—antique bronze es-cutcheon 2 3/8" x 4"—pointer travel 3 3/4". NET with pilot lamp bracket... **\$1.47**



### JEWELLED PILOT LIGHT ASSEMBLIES

- Candelabra screw base for 110 volt lamp.
- Mount in 1" hole.
- Lamps removable from front of panel.
- Available marked 1-2-3 or 4 on back of lens.

YOUR CHOICE net **19c**

Include full remittance with orders of \$3.00 or less. Include 25% deposit with all C.O.D. orders of \$3.00 or more.

### RADIO TUBES



Get our monthly list of available tubes and discounts. Largest available stock of standard brand tubes maintained at all times.

**RADIO SUPPLY & ENGINEERING CO., Inc.**  
125 SELDEN AVE. DETROIT 1, MICH.

SEND FOR FREE BARGAIN BULLETIN

# SPRAGUE TRADING POST

**SPRAGUE  
IF-37  
FILTER**

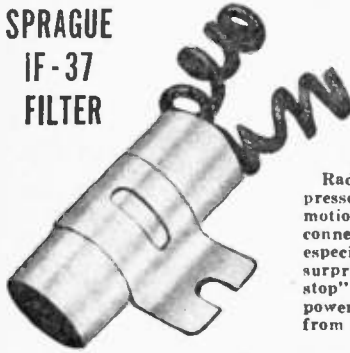

## STOP RADIO NOISES FROM FLUORESCENT LAMPS!

Radio noises caused by fluorescent lamps CAN be suppressed—easily, quickly and effectively. No lost time or motion. Just install a Sprague IF-37 Filter on each fixture, connecting it directly across the incoming leads. IF-37's are especially designed for the job—and you'll be pleasantly surprised how effective they are in suppressing "hard-to-stop" interference that is so often conducted down the power lines, even to remotely located receivers. Buy them from your nearest Sprague jobber today.

WRITE for a copy of the complete 40 page Sprague Catalog of capacitors, resistors, interference filters & test equipment.



## SWAP - BUY - SELL

**FOR SALE**—Stancor #510 P.P. amplifier transformer input with 8" 15w P.M. speaker. Want Rider's manuals #11 and 10; station set-up allocator; 4, 6 or 8 power binoculars, scope or what have you? John Repa, Jr., Main St., Richlandtown, Pa.

**WANTED**—Stancor battery eliminator to be used as power for car radios when testing on bench. Young Radio Service, 729 W. Dominick St., Rome, N. Y.

**WANTED**—Rider manuals—any numbers. For sale: RCA 5" scope #160; also Philco sig. gen. 070. Like new. E. Vockeroth, 1746 N. Campbell St., Chicago 47, Ill.

**FOR SALE**—Appliance tester complete with instructions. Tests irons, toasters, electric clocks, etc. Only \$5. Sal Radio Service, 1431 Park Ave., Cranston, R. I.

**WANTED**—Capacitor checker, any make in good condition such as RCQ, BF50, CF-1-60 or HN. Also need a point-to-point analyzer and speaker tester. E. Sujak, 5321 W. 30th Place, Cicero 50, Ill.

**PART TIME WORK WANTED**—Radio mech. graduate wishes part time job (Saturdays & evenings) in radio service shop. Ben Gerstein, 456 Brooklyn Ave., Brooklyn 25, N. Y. (Pr. 4-2025).

**FOR SALE**—Radio City Products #702 sig. generator, good as new, \$45, or what have you? H. W. Colp, Bridgewater, Nova Scotia, Canada.

**WANTED** for cash or trade: I #1, trans. 1.1 to 120v sec. 120v. pri. AC. Also power trans. 120v PR1-70v and 6.5v secondary. Also 50 m.a. 3 1/2" meter, 1-600v IC. J. R. Reed, 2178 W. 3rd St., Durango, Colo.

**FOR SALE**—Ghirardi's "Radio Physics Course" #2; various other books and magazines. Write for list. Philco #40 table model radio, broadcast and short wave, \$12; B19 tank receiver and transmitter, new and complete, \$59. Write for list of other radio articles for sale. Alfred Livingston, 12-01 Ellis Ave., Fair Lawn, N. J.

**WANTED**—Zenith chassis 5905 with or without tubes and speaker. Cash. State price and condition of set. Mullins Radio Service, 152 Ella Hanson, Tullahoma, Tenn.

**POSITION WANTED**—Electronic technician, MetLife grad. AAP radar, first class phone license \$40. New York area. Sieg Altmann 1110 College Ave., New York 56, N. Y.

**WANTED**—Flash-O-Graph (neon) tube, part 3-1424 MS belonging to Radio Radio, model RA, a very old receiver. Will pay cash. Bettencourt's Experimental & Radio Shop, 75 Stockland St., S. Dartmouth, Mass.

**FOR SALE OR EXCHANGE**—Magnavox 33-1/3 rpm record player and playback machine. Has built-in 35 mm. still projector. Complete with tubes, loud speaker and connecting cable. Excellent for class lecture work, etc. Lewis B. Thornton, 138-25 Union Turnpike, Flushing, N. Y.

**WANTED**—Complete set of Rider manuals; also Wilex-Gay portable recorder A-103 dual speed. Herman's Radio Service, 803 W. Locust St., Bloomington, Ill.

**FOR SALE**—Triplet radio tester in carrying case including v-o-m. signal generator and tube tester in cover. Used very little, \$25. H. J. Krauser, 416 Wilson Ave., Green Bay, Wisconsin.

**WILL TRADE** latest N.R.I. course on Radio and Television for cut-film camera or home recorder. Stanley J. Radwanski, 1536 S. Spaulding Ave., Chicago 23, Ill.

**WANTED**—Two tubes, 6N6 or 6AB6 or 6145. H. & W. Radio & Appliance Co., Julius J. Horwitz, P.O. Box 1108, San Angelo, Texas.

**FOR SALE**—Following tubes at 20% off list: 117GP; 395; 1L45; 114T; 1E7GT; 117G; 75; 26; 617G; 6K8; 615G; 6N5; 12847; 128F5; 6N5; 6U6; 53; 46; 12A6; 2A4G; 1223; 5Z3; 6N7G; 6A4; 6F7; 514G; 39/44; 42 and 43, Joseph Anderson, New Sweden, Maine.

**FOR SALE**—Weston analyzer, brand new, #772, \$55. Peter P. Loden, 8749 Crispin St., Philadelphia 36, Pa.

**FOR SALE OR SWAP**—Radio engineer—electrical and radio servicing books, also assorted Audels books. All new, 1/3 off list, or will swap for test eqpt. Walter Israel, 97 Washington Ave., Winthrop 52, Mass.

**FOR SALE**—One 5Y3 tube; 700v 90 ma. CT. transformer with 5 and 6.3v CT. windings (at 2-3 amps.); 10 11Y 100 ma. filter choke; 40 mh. 50 ma. choke; two 100mmf. var. sine spaced midgeits; 50 mmf. var. midgeit; 15 mmf. double-space var. condenser. Lee Kent, 6507 N. Bell Ave., Chicago, Ill.

**FOR SALE**—400 new and used tubes at low prices. Will sell all or in small amounts. Also have some parts and a few used meters. Write for details. Arnold Castner, P.O. Box 297, Hillsboro, N. H.

**HELP WANTED**—Need radio service man for thriving shop in small midwestern city. Write giving full details of experience and educational background. King's Radio Service, P.O. Box 361, Montpelier, Idaho.

**WANTED**—RCA Victor service notes for 1939. Cash or trade. What do you need? Nadybol Radio, 2710 No. Central Park Ave., Chicago 47, Ill.

**FOR SALE**—Hickok #4900-S radio set tester, ac & dc volts 0 to 2500, 1M per volt; ohms 0 to 10 meg., also cap. and O.P. Adam W. Miller, First St., Meadville, Pa.

**FOR SALE**—Hickok 188X signal generator complete with D.B. output meter and 100/1000 KC crystal calibrator, new condition, \$100. Precision 912P tube checker complete with latest charts, less than year old, \$37.50. 25% down, balance C.O.D. Cumples Radio Service, 2607 Broadway, Galveston, Texas.

**WANTED**—Input I.F. transformer and osc. coil assembly for Majestic 15. Cash or trade. What do you need? Middle Radio Service, 15 George St., Milford, N. H.

**FOR SALE OR TRADE**—1912 Precision tube tester, perfect condition; 5-tube 1947 model RCA radio & automatic record changer, walnut cabinet, cost \$99.50, sacrifice at \$79.50. Like new. W.J. Phillips, Box 433, Bellington, W. Va.

**FOR SALE**—Radio-Craft and Service magazines, 1936 to 1946, 15c per copy or \$1.50 per year. All have covers. Radio News, 1922 to 1930, 10c per copy, or \$1 per year. Majestic chassis 420 ac-dc battery portable, all new tubes, \$24. Also, photograph cabinet, \$8. Write for details. Lawrence Roehner, 77 Church St., Wilkes-Barre, Pa.

**WANTED**—Short wave receiver. Have Arzus A2F, 35mm. F4 and other camera eqpt. to trade. Also scarce tubes and parts to trade or sell. H. Gushwita, 147 Chester St., Brooklyn 12, N. Y.

**FOR SALE**—U.T.C. type PA-2L6 output transformer, \$11; Hallicrafters 8-11W receiver, \$28; Simpson #260 v-o-m meter with case, new, \$40; Chekatube #C111 tube checker, \$10. Eugene Wille, 3435 N. 47th St., Milwaukee 10, Wisc.

**WORK WANTED**—Went spare time radio service work in shop or appliance store in Racine, Kenosha, Milwaukee area of Wisconsin. Saturdays or evenings only. Myron C. Jones, 924 Racine St., Racine, Wisc.

**FOR SALE**—Seventy-five 3" meters, all kinds of amateur radio parts. The Radio Laboratory, 912 W. 151st St., East Chicago, Indiana.

**WANTED**—Used tube tester and oscilloscope. Cash or trade. What do you need? Robert Heckman, Earlville, Ill.

**FOR SALE**—W.R.L. MT100 multimeter v.o.m., cost \$18.75, brand new with pair #1 test leads. Will send postpaid for \$15. Adam Palmer, P.O. Box 63, Blacklick, Pa.

**FOR SALE**—Closing out all my stock at list less 40% or better in quantities. All new tubes including 1N5; 11I5; 6A7; 6SK7; 6SQ7; 6SJ7; 7Y4; 7C7; 12AE7; 12B5; 9001; 128A7; 128K7; 128Q7; 6AK5; 6AK6; 2E24; 50L6; 25Z6; 3Z5; 35L6; 2E24; 50L6; 117Z6; 27; 30; 45; 41; 42; 46; 55; 75; 76; 77; 78; 80; XXFM, etc. Write for details. Eddie Howell, Route #2, Dillon, S. C.

**WANTED**—Table model tele-receiver. Name, make, model, condition, price and channels covered. Have for sale 75 50L6's, new; 50 35Z5's, new, 30% off list. J. W. Smith, 1602 W. Pratt St., Baltimore 23, Md.

**URGENTLY NEEDED**—New or fairly new 3" or 4" magnetic speaker in good condition and highly sensitive to weak signals as used in some circuits shown in science magazines before the war. Herod Stephanian, Rt. #3, Box 443, Tulare, Calif.

**FOR SALE**—L.L. Cooke electrical course, 75 lessons, \$18; 8 vols. McGraw-Hill "Practical Electricity", \$17; 7 vols. Power Plant Operation, \$15; 7 vols. Hawkins Electrical Guides, \$3.50. Ed. Tischer, 56 Carey Ave., Wilkes-Barre, Pa.

**FOR SALE**—Gen. Radio arm box, 7 steps each side c.t. 1000 ohms. Type R10, \$15. Gen. Radio variometer type 107P total ind. at 100° 0.37 millihen., \$15. W.C. Nielson, 60 Kay St., Newport, R. I.

## YOUR OWN AD RUN HERE FREE

The Sprague Trading Post is a free advertising service to our radio friends. Providing only that it fits in with the spirit of this service, we'll gladly run your own ad in the first available issue of one of the six radio magazines in which this feature appears. Write CAREFULLY or print. Hold it to 40 words or less, and confine it to

radio subjects. Make sure your meaning is clear. No commercial advertising or advertising offering merchandise to the highest bidder is acceptable. Obviously, Sprague assumes no responsibility in connection with merchandise bought or sold through these columns or the resulting transactions.

Send your ad to

Dept. RC-47, SPRAGUE PRODUCTS COMPANY, North Adams, Mass.  
(Jobbing distributing organization for products of the Sprague Electric Co.)

**ASK FOR SPRAGUE CAPACITORS and \*KOOLOHM RESISTORS by name!**

\*Trademark Reg. U.S. Pat. Off.

# SUPERADIO

## *A Recent Discovery May Herald a New Radio Era*

By HUGO GERNSBACK

ON December 18, 1946, Johns Hopkins University of Baltimore announced the discovery of what they termed a new method of radio reception. By using it, radio broadcast waves may be picked up and detected without the use of radio tubes, electric current, antenna, or condensers.

The discovery was made accidentally by Dr. Donald H. Andrews, Professor of Chemistry, and Dr. Chester Clark of the University staff, with Peggy McEwan, a laboratory technician. They were experimenting with an infra-red bolometer, developed during the war for "seeing" in the dark. Connected to the bolometer was a strip of Columbium nitride. The latter, about the size of a pin, was placed in a *cryostat*, which is an instrument that cools objects down to about 15 degrees above absolute zero, or roughly minus 444.4 degrees Fahrenheit.

A loudspeaker was in the bolometer circuit because the scientists found this arrangement more useful than a more complex visual method of checking their results. The experimenters were astounded when suddenly the loudspeaker began to emit a radio program from the local station WBAL.

Later experiments confirmed the fact that the strange phenomenon was due to the tiny strip of Columbium metal, which when cooled to a few degrees above the absolute zero point, became *superconductive*. In this state the metal becomes highly sensitive to radio frequency currents and acts as a receiver capable of operating a small loudspeaker. Other stations aside from WBAL were brought in on the speaker in subsequent experiments.

The bolometer used by the Johns Hopkins scientists is a copper mounting about one inch in diameter. It contains a threadlike ribbon of Columbium nitride, connected to two wire leads. This is the heart of the bolometer, which is exceedingly sensitive to infra-red waves. But that it was even more sensitive to radio waves caused a sensation!

Said the scientists—with commendable restraint:

"No claim is made for the device as a revolutionary discovery which will change all accepted methods of radio reception.

"But the inescapable fact is evident that a small ribbon of Columbium which has been nitrided does, under proper operating conditions, become radio-receptive."

To better understand what happens when metals are cooled to a temperature approaching absolute zero, I quote from my article in the February, 1928, issue of SCIENCE & INVENTION (page 883):

"Science now knows that outer space contains no heat whatsoever, and that all space is at an absolute zero,\* which, expressed in figures, is minus 459.4 degrees

Fahrenheit. These are well-known facts, and have been known for years, but the experiments of excessive degrees of cold by Professor Kamerlingh Onnes at the University of Leyden, made during the past few years, have given us a great deal of food for thought. Professor Onnes, by means of liquefying helium, has been able to approach absolute zero closely, reaching the low temperature of minus 457.6 degrees F. At such extremely low temperatures, a number of astonishing things begin to happen.

"It is well known that an electric current heats. If the conductor passes enough current it becomes white hot, as for instance the filament in an incandescent lamp. But if you took the same electric lamp bulb into outer space hundreds of miles above the earth's surface and tried to light it up with the identical current, a most surprising thing would be seen. You would find that it no longer would light, for the simple reason that at such extreme colds, all conductors of electricity lose their resistance entirely. Professor Onnes was able to send tremendous currents through very thin conductors that would ordinarily have become white hot and burned up or volatilized. Under such extreme colds, conductors are termed *supra-conductors*, because they become supra-conductive to the electric current. But that isn't all. Inasmuch as metallic wires in absolute zero lose all resistance, once an electric current is started in a conductor, that current will keep on flowing without stopping. Here we have a sort of perpetual motion, but of course it requires so much power to obtain it that it would not be practical."

The unimaginative will no doubt say that radio is not likely to be revolutionized by the discovery of the Johns Hopkins scientists. It may be contended that the expensive and cumbersome apparatus to generate the excessive cold would make such a radio receiver totally impractical. Granted for the moment. But what will the story be in 10 or 15 years when new research has shown that the same results can be had with comparatively simple and inexpensive means? Radio progress has a habit of picking up unusual odds and ends and turning them into spectacular results. Without the old Edison effect, there would have been no radio tube. Without Hertz's spark coil there would have been no electromagnetic waves to detect and consequently no wireless nor radio.

At this moment the radio phenomenon of the Columbium metal—while superconductive—is not understood at all by scientists. There are several theories on the action, but none so far has given a full explanation. In due time the veil will be lifted—and then we will have real surprises. When that time comes our radio receivers will certainly be totally revolutionized—our entire concepts of

(Continued on page 73)

\* Recent astronomical researches indicate the temperature in open space of the universe is 3 to 4 degrees above absolute zero.—H. G. Source: Professor Donald Menzel, Harvard Observatory.

# RADIO-ELECTRONICS

## Items Interesting to

**IRE MEMBERS** of New England will meet at Cambridge, Mass., on May 17. This is a postponement of the original May 3 date announced in this magazine. The group, now known as the North Atlantic Section of the Institute of Radio Engineers, will gather at the Hotel Continental.

Six technical papers will be read and a large space devoted to exhibits by New England radio and electronic manufacturers. Non-members of the IRE are invited, but advance registration is considered essential as facilities are limited.

The Cincinnati Section of the IRE are also holding a May meeting. Their technical conference will be devoted to problems of television, and will be held May 3.

**COLOR TELEVISION** licenses have been granted a French concern by Columbia Broadcasting System, it was learned last month. The company, Sadir-Carpentier of Paris, has been granted manufacturing rights for television transmitting and receiving apparatus under all the present Columbia patents.

The company, it was said, will prepare proposals to the French government authorities for establishment of a national color television broadcasting system in France.

A group of the firm's engineers, led by M. Jean A. Widemann, in charge of the television department, are due in the United States early this spring to make a detailed study of CBS techniques, it was reported.

**FACSIMILE NEWSPAPERS** will be available to the public on a straight subscription basis this Fall, John S. Knight, publisher of the Miami *Herald*, declared last month. His *Herald*, he said, has already started experimental transmissions and expects to be the first regular facsimile newspaper.

Bringing the morning paper from the breakfast table to the bed itself, facsimile "is the most radical change in newspaper publishing methods since the invention of typesetting machines," he said.

Members of the *Herald* have already been working several months on problems and details of the revolutionary new method of newspaper publication.

**AMERICAN BROADCASTING** in Europe was described last month as "only fair" by Everett Holles, news editor of station WBBM, Chicago. In Vienna, he states, the Russians have a station which is listened to by 80 percent of the population, while the American radio in nearby Salzburg devotes its broadcasts largely to folk music and food recipes. He also characterized the American broadcast station in Berlin as a "crackerbox."

Reports of the first broadcast to Russia from the new station in Munich, coming through at about the same time as Mr. Holles' report, indicate that overall Russian response was favorable but the programs needed livening up.

A critique from State Department officials in Moscow reported that the announcers' accent was very good, and superior to the BBC, but the British broadcasters, they added, had superior diction. They also reported that there was too much dramatic effort which tended to overemphasize delivery and distract attention from program content. Reception was described as "only fair."

Russians were reported to feel that although the talk on American historical background was "interesting" it was also confusing and long-winded.

**LOWER PRICE TRENDS** in radio receivers were seen last month with the announcement of a 20-percent cut in the price of a popular Emerson model. Lower prices have also been set on a number of less well-known brands, in some cases the cut being greater than 20 percent.

The Emerson cut, according to the president of the company, Benjamin Abrams, was made to widen the consumer market and step up production to a point where suppliers of raw materials and components would be warranted in quoting lower bids as a result of manufacturing and overhead economies on their own volume.

**JAMMED ILS SIGNALS** on planes approaching La Guardia Field was due to image interference, the serviceman's old bugaboo, reports from New York stated last month. The ILS (Instrument Landing System) signals were "captured" irregularly by FM transmissions from New York stations, pilots reported.

Investigators discovered that the 110-mc signals were beat against a 103-mc oscillator in the plane receivers to produce an i.f. of approximately 7 megacycles. Signals from WGYN, on 96.1 mc, produce the same i.f. when beaten against the 103-mc oscillator. It is presumed that the receiver input circuits were not sufficiently selective to reject signals from the broadcast station 14 megacycles off the tuned frequency, the "mirror image" twice the intermediate frequency from the channel.

The trouble, which is suspected to be one of the factors which led to the crash-landing of an American Airlines DC-3 plane on a beach near New York City last January, has been cleared up by filter circuits in the receivers.

**STANDARD FREQUENCIES** broadcast by the Bureau of Standards station WWV have been increased to 8, ranging from 2.5 to 35 mc. The 4 new frequencies are 20, 25, 30 and 35 megacycles. Accuracy of the standard broadcast frequencies has been increased fivefold, and is now better than 1 part in 50 million.

A total of eight radio frequencies (2.5, 5, 10, 15, 20, 25, 30 and 35 mc) is now given. Seven or more transmitters are on the air at all times, day and night. This insures reliable coverage of the United States and extensive coverage of other parts of the world.

The services are: 1. standard radio frequencies, 2. time announcements, 3. standard time intervals, 4. standard audio frequencies, 5. standard musical pitch, 440 cycles per second, corresponding to A above middle C, 6. radio propagation disturbance warning notices. All of the frequencies are useful for field intensity recording by persons interested in studies of radio propagation. The 4 highest frequencies are broadcast particularly for this purpose. The radio frequencies and other data are:

Radio frequency mc/sec.	Time broadcast EST	Power output, kw.	Audio frequency cycles/sec.
2.5	7 pm to 9 am	1.	440
5	7 pm to 7 am	10.	440
5	7 am to 7 pm	10.	440 and 4000
10	continuously	10.	440 and 4000
15	continuously	10.	440 and 4000
20	continuously	0.1	440 and 4000
25	continuously	0.1	440 and 4000
30	continuously	0.1	440
35	continuously	0.1	440

The station call letters, WWV, and other announcements in voice are given each hour and half hour.

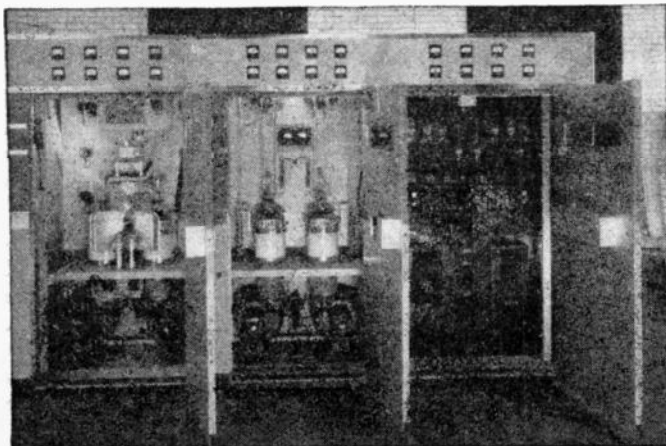

The transmitter which broadcasts one of the frequencies from WWV. Radio-frequency stage is at left, a.f. amplifier center and the control panel at right.

# MONTHLY REVIEW

## the Radio Technician

**ELECTRONIC COMPUTERS** for weather forecasting may be a step toward control of weather according to Dr. V. K. Zworykin of RCA. "The hope for effective weather control rests in the fact that the condition preceding many of the weather processes which it may be desirable to control is essentially unstable," he explained. They are "characterized by the accumulation of large amounts of potential energy during an extended period.

"Thus, while the energy finally released may be enormous, that required to trigger the release may be quite modest. Furthermore, the magnitude of the triggering energy required will greatly depend on the time and place at which it is applied. Since the electronic forecaster should make it possible to observe the effect of applying given amounts of energy at different points of the weather map almost instantaneously, it will point the way to the most economic measures which will lead to the desired change in the evolution of the weather."

Control methods might include blackening or whitening strategic areas, causing convection currents in the air above them.

**HOW DE FOREST DISCOVERED** and perfected the vacuum tube oscillator is told by F. J. Mann in a story reviewing the history of the Federal Telephone and Radio Corporation in last month's issue of *Electrical Communication*.

The vacuum tube oscillator, came into being in 1912 while Dr. de Forest was head of research in the laboratory of the Federal Telegraph Company, predecessor of Federal Telephone and Radio Corporation. The audion had recently been adapted to use as an amplifier and investigation was under way to find means of eliminating annoying howls and squealing which accompanied the tube's amplifying functions. Dr. de Forest soon determined that the tubes were producing not only audible squeals but inaudible radio frequencies as well. Thus was born the device which, together with the audion amplifier, introduced the science of electronics.

**NINE OUT OF TEN PEOPLE** intend to buy a television receiver sooner or later, according to a recent survey by students of New York's City College. Only 6 per cent, however, were ready to buy immediately. Prices they were willing to pay ranged from \$150 to \$500, with the majority wanting a set at less than \$250.

**A RADAR-BEACON AIRLINE** across the entire United States will be set up this year, according to the Navy Bureau of Aeronautics.

**A PEANUT PHOTOTUBE**, recently released by the Radio Corporation of America, is expected to have new uses in industry. The new electron tube, designated RCA-1P42, is the smallest phototube ever offered commercially. About the size of a .22 caliber long rifle cartridge, it has a maximum diameter of only  $\frac{1}{4}$  inch and an overall length just under 1-13/32 inch. It is activated by light entering through a tiny window at its larger end.

Comparing favorably with larger phototubes in sensitivity, the tiny new tube is expected to find many applications in business and industry, particularly in devices and machines where the size of former phototubes has been a problem. In multiple-circuit control devices, the new tube makes possible either smaller devices or more circuits in the same space. In animated signs, for example, where each phototube is individually wired to a light in the corresponding position on the signboard, many more of the new smaller 1P42 tubes may be used in a given area. When light, projected through slides or film, falls on and activates the more closely spaced tubes, sharper and clearer pictures can be reproduced on the lighted signboard.

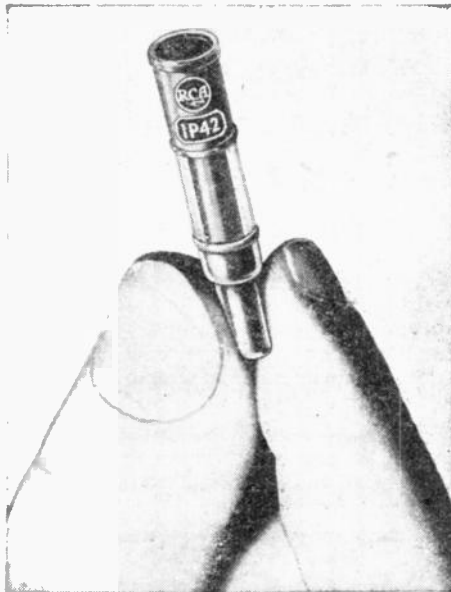

The new photocell has a diameter of  $\frac{1}{4}$  inch.

**SCIENTIFIC AWARDS** were granted last month by the Institute of Radio Engineers to Dr. Albert Rose of the RCA Laboratories, Princeton, N. J., and J. R. Pierce, Technical Staff of the Bell Telephone Laboratories. The two scientists were granted the Morris Liebmann Memorial Prize for 1946, Dr. Rose for his work in developing the Orthicon television camera tube, and Mr. Pierce for his development of the travelling-wave tube.

Twenty-five engineers and scientists were also elected to Fellowships in the

IRE. These included: Benjamin DeF. Bayley and Frank H. R. Pounsett of Canada; Pedro J. Noizeux of Argentina; Sir Robert Watson-Watts of England and the following from the United States: George P. Adair, George L. Beers, Lloyd V. Berkner, Edward L. Bowles, Robert F. Fields, Donald G. Fink, W. W. Hansen, Capt. David W. Hull, USN; Fred V. Hunt, Karl G. Jansky, Ray D. Kell, Charles V. Litton, James W. McRae, I. E. Mouromtseff, D. E. Noble, R. M. Page, J. A. Pierce, C. A. Priest, W. W. Salisbury, E. N. Wendell and R. S. Burnap.

**CHIEF SIGNAL OFFICER** of the U. S. Army is now Major General Spencer B. Akin, who succeeds Major General Harry C. Ingles, retired.



General Akin, New Chief Signal Officer.

General Akin was born in Greenville, Mississippi in 1889. He graduated from Virginia Military Institute and was appointed a second lieutenant of infantry in 1910. His career included service in the Philippines (1911) at various points in the United States, the Canal Zone, and, in 1941, again in the Philippines area.

He became Signal Officer of the U. S. forces in the Far East, later accompanying General MacArthur to Australia and acting as his Chief Signal Officer. He also served as Chief of Signal Intelligence Service and of Radar and Radio Counter-Measures Service in the Far East, the Southwest Pacific Area and the Army Forces of the Pacific.

During World War II, in addition to his other duties, he established and became Chief of the Research Section of General Headquarters, Southwest Pacific Area.

For his services in the defense of the Philippines he was awarded both the Distinguished Service Cross and the Distinguished Service Medal. General Akin has received no less than 7 other U. S. and foreign decorations, including the Philippine Commonwealth Distinguished Service Star. Most of these awards and decorations were won during the Second World War.

# ANTENNA PRINCIPLES

## Part V—Directional Arrays for 300 Megacycles and Higher

By JORDAN McQUAY

**A**N TENNAS designed to operate in the u.h.f. region of the radio spectrum—above 300 megacycles—employ most of the basic principles of antenna technique but also introduce some entirely new concepts of radio transmission and reception. Chief among these is the high degree of directivity obtained through use of antenna arrays.

An array—as described in previous articles of this series—is an arrangement of antenna elements. One or more radiating dipoles in conjunction with one or more reflectors, directors, or other dipoles, are used to provide, through their combined action or interaction, considerable directivity and consequent large antenna gain. An array may consist of a large number of elements (Photo A) or a minimum of two elements (Fig. 2).

As in other antennas, a transmitting array is the same as a receiving array, both electrically and structurally. Their functions are reciprocal.

The size of an antenna array is directly proportional to the operating wavelength. Theoretically, an array might be constructed for use at any wavelength. Practically, however, this tends to be impractical for waves longer than about 1 meter (or frequencies smaller than 300 mc) because of the direct relationship between wavelength and the physical size of the antenna elements.

For instance, an adequate directional array for operation at 100 meters might

conceivably be a quarter-mile long and almost as high!

Primarily for this reason, use of complex directional arrays is usually confined to the transmission and reception of radio waves less than 1 meter in length. And the full range of usefulness of arrays extends down to about 10 centimeters in length.\*

Radio waves less than 1 meter in length have quasi-optical characteristics. They act very much like infrared light waves.

With a suitable radiating array, u.h.f. waves may be confined and focused into a very narrow beam of r.f. energy, and then directed toward a similar receiving array. These radio waves travel along direct or semioptical paths. There is no ground wave. Propagation does not depend upon the sky wave, as in the low frequencies.

Arrays used for either transmission or reception are mounted at least 12 wavelengths above ground in normal practice. Thus, they are considered as functioning in free space and independent of ground effects.

Dipole elements, whether radiating or parasitic, are usually constructed of conductive tubing. Metal rods can also be used, however, since microwave energy is confined to the outside of such metals.

All elements of an array are mounted in a fixed position. If mobility in any direction is desired, the entire array is moved without disturbing the relative positions of the elements: dipoles, reflector, or directors.

U.h.f. signals transmitted by an array of horizontally mounted dipoles are horizontally polarized, and such signals can be clearly and strongly received only by an array consisting of horizontally mounted receiving dipoles. Similarly, an array of vertically arranged elements will send signals that

are vertically polarized and can be received well only by a vertically arranged receiving array.

Horizontally polarized waves are more generally used in u.h.f. practice because, unlike their vertical counterpart, they are not attenuated when passing close to the earth's surface.

Thus, the position (horizontal or vertical) of the various elements of an array in any plane determines the

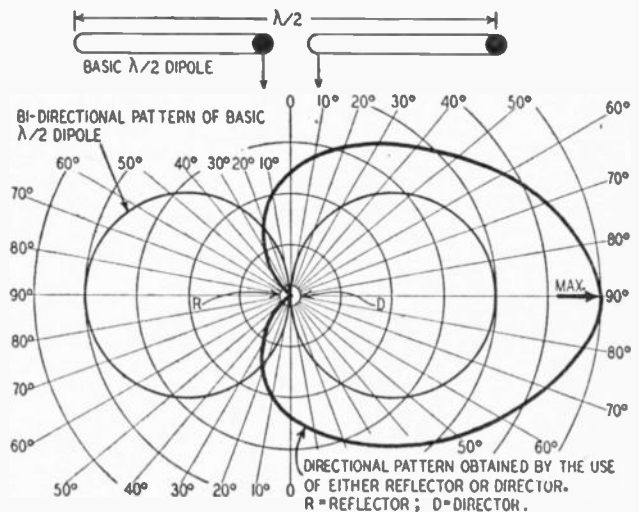

Fig. 1—How adding a director or reflector alters the dipole pattern.

polarity of the microwaves sent or received.

The number and structural arrangement of the elements determine the pattern of field strength or field intensity. Thus they affect the power gain and the degree of directivity of the array. Extremely directional antenna arrays may have directional patterns only a few degrees in width (generally measured at half-power points).

Even though u.h.f. arrays provide a limited range of transmission, this high degree of directivity is a distinct advantage. It permits multiple use of the same wavelength by countless stations having only small geographic separation. The high resolving power of u.h.f. waves has made possible radar and other navigational aids for airplanes and ships at sea. In this uncrowded region of the radio spectrum, wide bands are available for single channels useful to television, facsimile, and carrier telephony.

Directivity provides either an effective increase in transmitter power or receiver sensitivity, depending upon use of the antenna array. The same directional characteristics apply to receiving

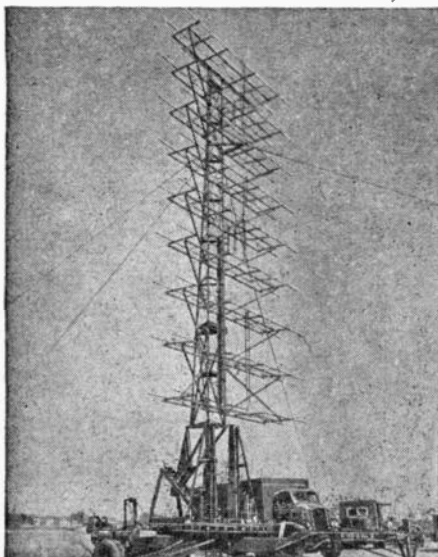

Photo by U.S. Army Signal Corps  
Photo A—Billboard array used by Army radar.

\* At wavelengths of less than 10 centimeters, arrays are replaced by parabolic reflectors, lens systems, horns, and other radiating devices which will be discussed in the next issue of RADIO-CRAFT.

as well as transmitting arrays, resulting in very large power gain between the two points.

Use of ultra high frequencies simplifies general system design, since the physical dimensions of the components or elements of the circuits are of the same order as the length of the radio waves passing through the equipment.

For this reason, in u.h.f. technique it's desirable to have a visual conception of the actual length of the radio waves being transmitted or received.

Simplest of all antennas is a half-wave dipole isolated completely in free space.

If it were possible to feed energy either to one end or the center of such a theoretical dipole, radiation would take place at right angles to the dipole.

Since, in normal u.h.f. practice, the radiating dipoles are usually situated in a horizontal position with respect to the earth, this theoretical dipole (and all arrays that follow) will be considered in terms of the horizontal position. (All dipoles and arrays discussed transmit or receive horizontally polarized waves.)

The complete shape of the radiation pattern of the theoretical dipole in free space resembles a doughnut, with the dipole passing through the center (RADIO-CRAFT, December 1946, p. 23). A horizontal cross section of the pattern resembles a figure eight in shape, and is bidirectional (Fig. 1).

## Reflectors

This bidirectional radiation of a half-wave dipole may be affected by reflectors or directors, parasitic elements assisting in the unidirectional concentration of energy.

A reflector is placed behind a radiating dipole, in a position opposite in direction to the desired field of maximum intensity. But a director is placed

before, or in front of, the radiating dipole, in a position toward the desired field of maximum intensity. Neither type of element is electrically connected to the radiating or receiving circuit.

The simplest type of reflector consists of a single piece of rod or tubing, very similar in shape and general appearance to the radiating dipole. However, the reflector is slightly longer than the radiating dipole.

Such a reflector is mounted parallel to and about one-quarter wave behind the dipole. A typical arrangement (Fig. 2) employs a reflector 5 percent longer than the center-fed half-wave dipole, spaced  $0.2\lambda$  behind the radiator. The reflector is entirely parasitic in nature. It absorbs power from the dipole and then reradiates it, acting somewhat like a second dipole. Length and spacing of the reflector cause the reradiation to have a phase and polarity relation with the original radiation such that the two fields of intensity add in the desired direction of power gain and cancel in the opposite direction.

Only a small amount of energy travels beyond the reflector, because the two fields cancel when they are of opposite polarity and phase. However, reflected energy arrives back at the dipole with the same polarity and in phase with the radiating dipole, adding to the field intensity in a direction opposite to the reflector. The resultant field-strength pattern (Fig. 1) reveals pronounced directivity at right angles to the dipole.

## Directors

A director is similar in shape and construction to a reflector, but is slightly shorter than the radiating dipole. The director is placed parallel to and about one-tenth wave in front of the dipole. It is a parasitic element, unconnected to a source of circuit energy, and consists of a single piece of rod or tubing.

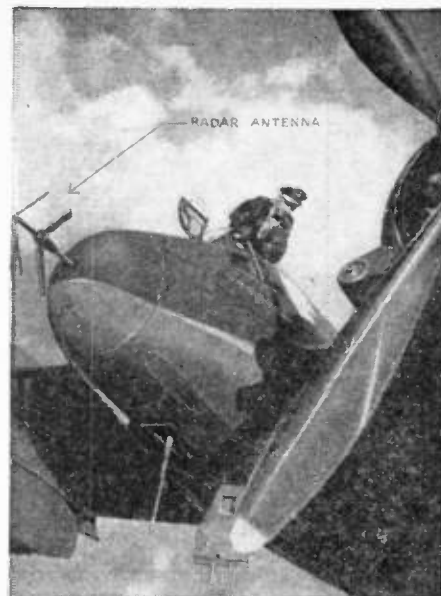

British Official Photo

Photo B—Radar antenna in Beaufighter nose.

A typical arrangement (Fig. 2) employs a director 5 percent shorter than the center-fed half-wave dipole, spaced  $0.1\lambda$  in front of it.

The director acts as a second dipole by absorbing power from the radiating dipole and then reradiating it. However, due to length and spacing of the director the reradiation has a phase and polarity relation with the original radiation such that the two fields of intensity add in one direction and cancel in the opposite direction. The resultant field-strength pattern is similar to the pattern with a dipole and a reflector.

An example of the practical use of a radiating dipole and a director is the radar antenna (Photo B) used on many airplanes, where economy of space is a factor.

In summary, directors and reflectors exert somewhat similar influences on a radiating dipole when used separately. When used in combination, directional  
(Continued on page 69)

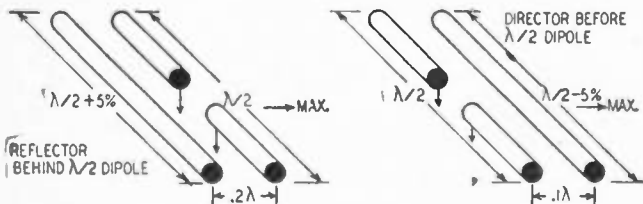
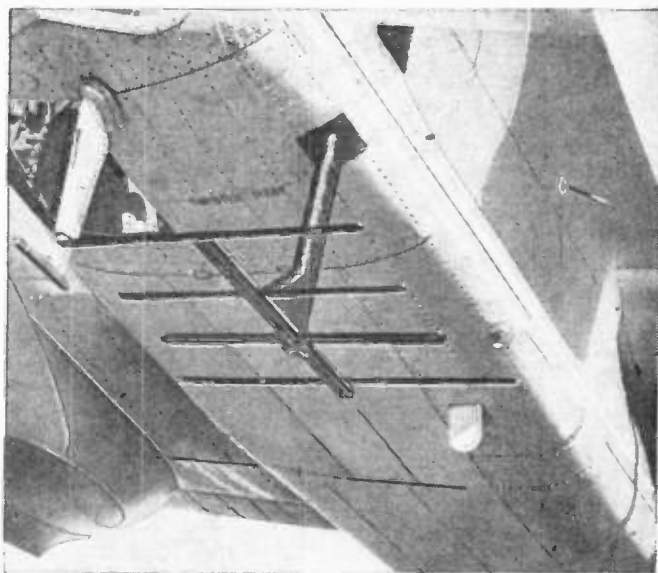
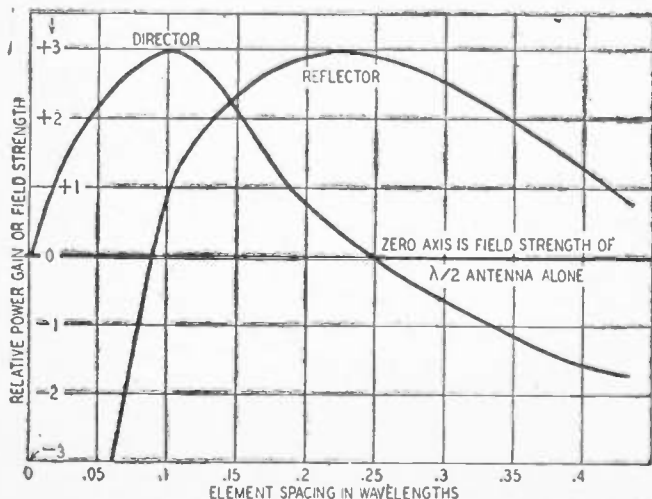

Fig. 2—Same directivity is provided with either director or reflector.



British Official Photo

Photo C, above—A 4-element Yagi array under RAF night-fighter nose.

Fig. 3, left—Effect of spacing of parasitic element on antenna gain.

# New "Prismatone" Organ

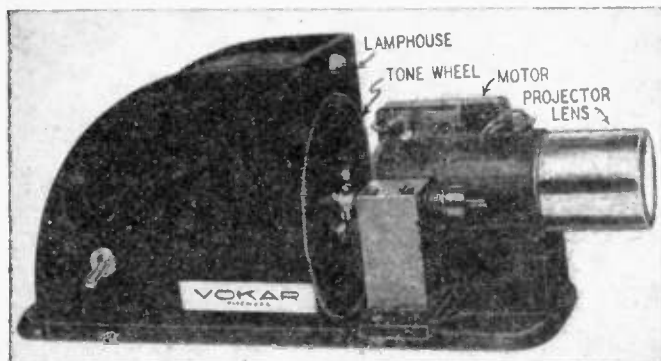

The projector which produces the Prismatone's modulated light band.

**New and Simple "Tone-Wheel"  
Electronic Musical Instrument  
Combines Sound With Striking  
Color Effects**

**T**HE *Prismatone* promises to be by far the most attractive of all the lower-priced electronic music instruments. Like all electronic instruments, however, it requires a skilled operator. Music is picked up from its keyboard of colored light with a pair of photoelectric cells. The colors, incidentally, are only for the musician's benefit—white light would produce the same tones, but the colors enable the player to distinguish notes more easily.

This instrument is the invention of Leslie Gould, well known Connecticut inventor of many electronic devices. RADIO-CRAFT in the past has described several electronic musical devices invented by Mr. Gould; last August we printed his newest development, the *Sonicator*, a radar-like instrument for small boats.

The instrument works on the *tone-wheel* principle. A translucent disc spinning ahead of a light breaks up the light into rapidly alternating patterns of light and shade. If the pattern on the disc is uniform, the frequency of the pattern projected through the edge

of the disc is greater than that projected nearer the center, because of the greater speed at which the outer parts of the wheel move. Two photoelectric cells mounted on convenient handles are held in the light beam and pick up the interrupted pattern. They then translate it into electrical voltages of the same frequency, which are amplified to produce musical notes.

A small lantern-slide projector is the heart of this instrument. A slotted mask limits the projected light to a broad band, which is broken up by the tone wheel. The dark portions of the wheel separate the "keys," while dyes on the translucent portion give them their color.

Tone-wheel instruments have been constructed of metal, with holes to pass the light. The Prismatone can be adapted to this type of wheel by covering the slot with a strip of transparent plastic, which can be colored in rows to produce the keyboard.

Mr. Gould's instrument uses the tone wheel shown below. It is made of a heavy plastic resembling transparent

celluloid. The pattern was impressed on it by coating the disc with a sensitizing emulsion and transferring the pattern

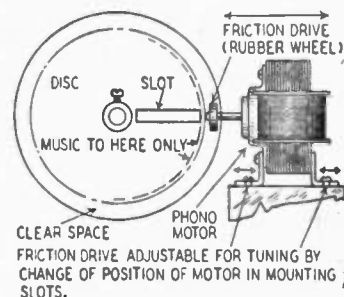
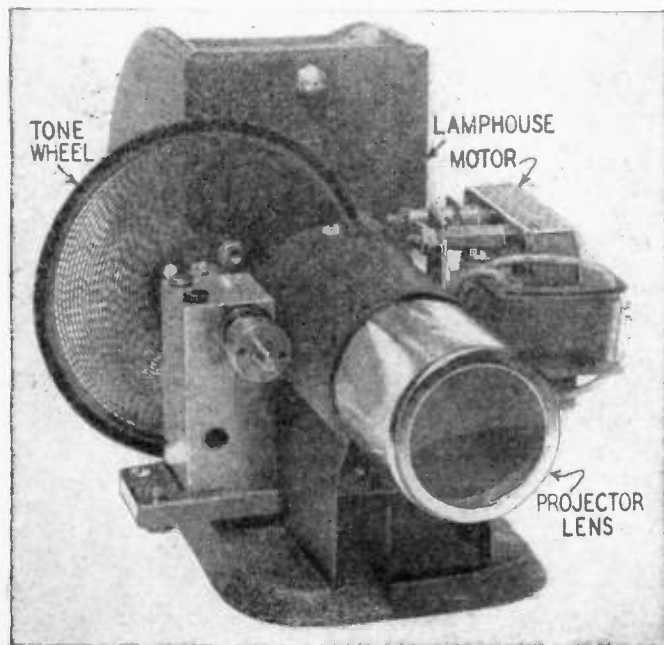

Fig. 1—End view showing slot and rim drive.

photographically from a hand-drawn negative. The wheel is mounted in a small lantern-slide projector, as shown in Fig. 1 and the two photos.

A small phonograph motor drives the wheel. By mounting it on a slotted base, its rubber rim drive can be moved in and out on the tone wheel to vary the speed. That is how the instrument is tuned. Such tuning has the advantage that all

(Continued on page 63)



Front view. Friction drive slides in or out on wheel rim for tuning.

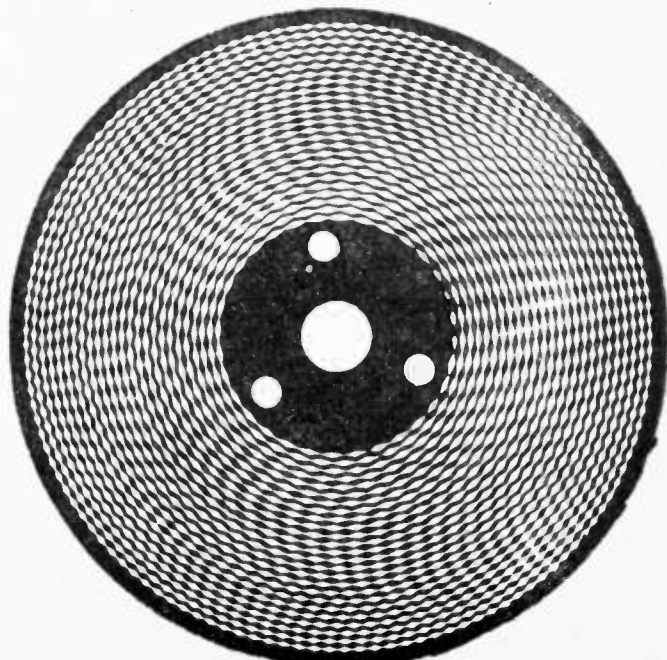

This photo of the tone wheel may be used as a pattern for reproduction.



# Lamp Bulb Resistors

By JOHN B. PARCHMAN

**M**OST radio men consider the incandescent lamp bulb a lowly thing useful only when it gets dark. Actually, the lowly lamp bulb can be used for many things around the radio or electric shop, such as for resistances, continuity checks, dummy antennas, and voltage or current measurement.

Most radio or electrical men have used test lamps which incorporate a lamp bulb to locate blown fuses or to check the presence of voltage in convenience outlets, and as indicating devices, etc. How many ever used one to check the presence of line voltage at the set? Many sets are dead simply because of a faulty line cord or plug which is discovered in many cases only after the

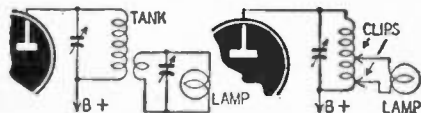

Fig. 1—Lamps used in dummy antenna circuits.

switch and most of the tubes (in a series string) or the switch and transformer have been checked for continuity.

One of the greatest objections to the lamp bulbs for such uses have always been that the resistance of an incandescent filament-type lamp varies over a considerable range according to the amount of current passing through it. This property can be used to advantage in some applications. The tungsten filament in lamps is an excellent regulating filament. It is not as good as nichrome wire and some of the more complex alloy wires used in automatic ballast-regulating tubes because the resistance does not remain constant for large variations of current. But when the resistances of the lamps are known (see the tables in this article), this characteristic is not serious in many applications. The voltage regulation for a given current range can be obtained from the tables. Curves can be plotted by the reader on suitable graph paper from the data given in these tables. Such curves were not included in this article because of space limitations and the difficulty of reproducing the curves in sufficient detail for accurate use.

## R.F. power measurement

Among the common uses of light bulbs in the radio field is as dummy antennas or for measuring a transmitter's power

output. The law requires some form of dummy antenna to minimize unnecessary interference. One of the cheapest methods is to use incandescent lamp bulbs coupled to the plate tank coil by means of a pickup coil or clipped directly across a few turns of the tank coil. The higher the resistance of the lamp (the lower the wattage), the greater the number of turns required for coupling. The coupling should be varied until the greatest brilliancy is obtained for a given power input. At frequencies below 15 or 20 megacycles, the lamp is practically a resistance load. At frequencies above 30 megacycles, reactance of the leads, etc. introduces loss of power. To eliminate as much loss as possible, leads should be soldered to the terminals of the lamp instead of using a socket. Some losses may be eliminated by making the lamp load resonant with a variable condenser (see Fig. 1). Other circuits are given in various handbooks and texts.

A lamp which would light up to approximately normal brilliancy at the apparatus power input value should be chosen.

## Measurement by comparison

When more accurate check methods are not available, the brilliancy of the lamp connected to the apparatus under test may be compared with the brilliancy

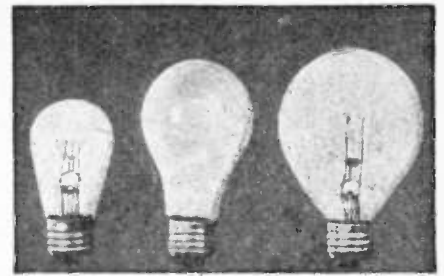

Just a few of the many lamp types available.

of a similar lamp connected to a known source of supply such as the 115-volt line (see Fig. 2). A closer comparison can be made if a colored filter is used to view the lamps. If no such filter is available, one can be made by holding a piece of glass over a smoky flame. Care should be taken to secure an even deposit on the glass. The deposit of soot or carbon black collected on the glass

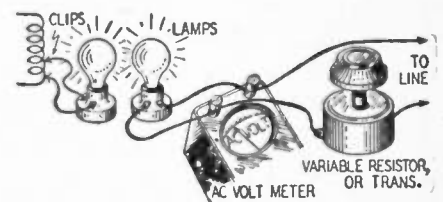

Fig. 2—Set-up for comparison measurements.

serves as a light filter. When viewed through such a filter, the brilliancy of the two lamps can be readily compared. They are made to match by varying the voltage supplied to the standard lamp.

A variable source of voltage can be obtained by using resistance in series with the lamp or with an autotransformer or Variac.

The voltage supplied to the standard lamp can be easily determined, after the brilliancy has been matched, with a common a.c. voltmeter, which can be found on most radio benches.

From the tables given in this article, you can find the current passing through the lamp and the resistance

(Continued on page 58)

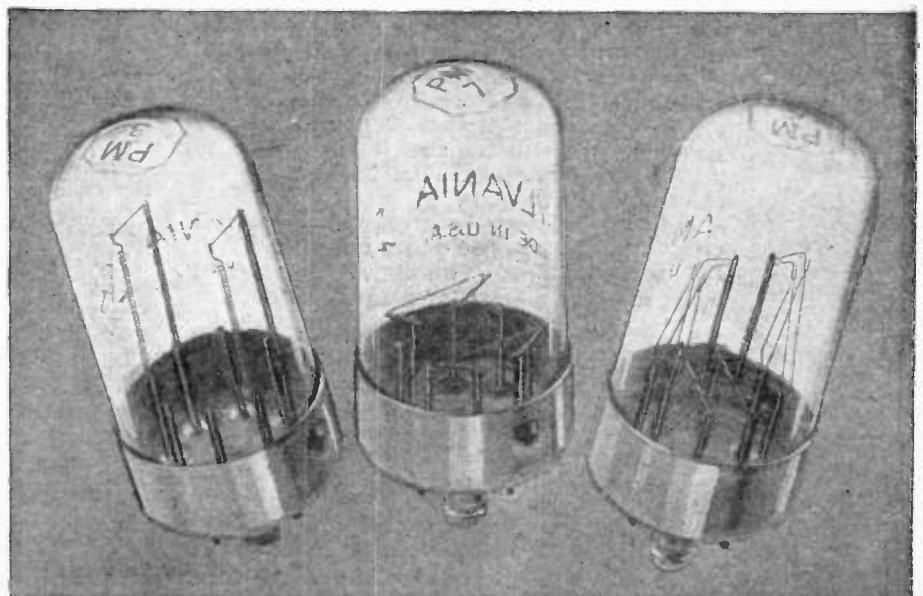

Photos courtesy Sylvania Electric Products  
One filament in these power measurement lamps carries r.f.; the other, easily measured a.c.

# New! Crystron Lapel Radio

By MOHAMMED ULYSSES FIPS, I.R.E., A.I.E.E.\*

WHEN RADIO-CRAFT's big January number came out, no one was as dejected as yours truly. Granted that Lee de Forest IS a great inventor and that he certainly deserves all the credit in the world for his many marvelous inventions, why all the fuss about his vacuum tube—the audion?

What's so good about it? Anyone could have invented the audion—yes, even I! There was the well-known Edison effect and the Fleming diode tube. All that de Forest did was to take the Edison effect, brush up on it, then take the Fleming valve and stick a question mark, in the form of a bent paper clip, between the hot filament and the plate—presto! the audion was born! Easy as apple pie!\*\*\*

If this sounds boastful, let me show you how easy it is to outfox de Forest and beat him at his own game. I don't claim to be a genius—all I have is good old American radio horse sense and what I did anyone could have done.

When I saw that fat January issue with all the audion hubbub, I set myself to thinking and vowed to discover such a revolutionary radio device that it would completely outmode every radio tube in existence! And it didn't take years to do it either—I did it in 33 days flat! So here is the story of the invention of the revolutionary CRYSTRON: Everyone who has the slightest notion about radio knows that the old crystal detector was by far the best for fidelity in reproducing sounds—music, speech, etc.—ever devised. Its clarity as a

translator of radio waves into audible sounds is far greater than the best radio vacuum tube. What's more, it requires no power, no batteries, and it is exceedingly cheap. But its drawback was that you had to use headphones to listen to your radio programs—you could not amplify the signals.

Then in 1925 Gernsback coupled the crystal detector to the vacuum tube; he called it the *Interflex*. (See Fig. 1) This amplified the signals better than two tubes. During World War II this

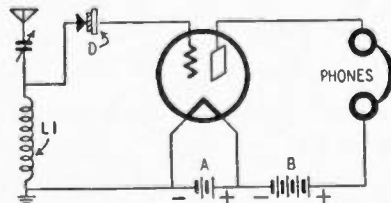

Fig. 1—Gernsback Interflex, 1925.

\*International Radio Expert; Author: Industrial Electronic Equilibrium.

\*\*We are afraid Fips did not read the January issue of RADIO-CRAFT at all. If he had, he would know that de Forest evolved the audion step by step from the Welsbach mantle to the final goal—the audion. The grid looks simple now—after de Forest invented it. The discovery of the New World looked easy, too—after Columbus had found it. —Editor.



The Crystron receiver may be worn like a piece of costume jewelry.

circuit was dusted off and, a new and better crystal detector was perfected—the Germanium detector. This combination made history in our radar sets, proximity fuses, etc.

The thought suddenly struck me: *Why not combine the crystal with the vacuum tube—all in a SINGLE component?* This I did. (See Fig. 2.) Here we have a crystal detector (silicon, galena, or copper pyrites) in the usual style, with a fixed catwhisker. Now comes the NEW BIG THOUGHT—the *grid*. The grid can be a single or multiple, sharply pointed wire or wires, coming *very* close to the catwhisker wire—but never touching it. The combination is then placed in the usual glass bulb, which has a high vacuum. Now the incoming signal will be steered or triggered as in a regulation vacuum tube with a notable exception—NO A-BATTERY IS REQUIRED. (See Fig. 3).

From the pointed grid I graduated to the “capacitive grid.” (See Fig. 4.) Here the grid is coupled to the crystal and to the thumbtack-shaped catwhisker, which is the cathode.

Two thin mica films separate the flat crystal from the catwhisker. This arrangement is better than the first one.

But I wasn't satisfied—wanted something better and more powerful. That desire led to the final model: The Crystron (*crystal-electron*). (See Fig. 5.) The Crystron was made by INSERTING A GRID BETWEEN CATWHISKER AND CRYSTAL!

Obviously such an arrangement could not work without a stream of electrons, such as is supplied by a hot filament. By coating

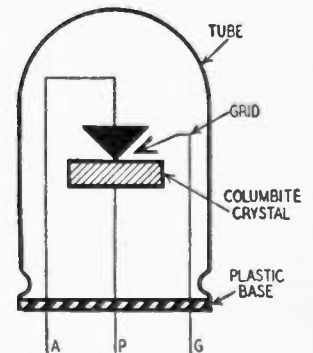
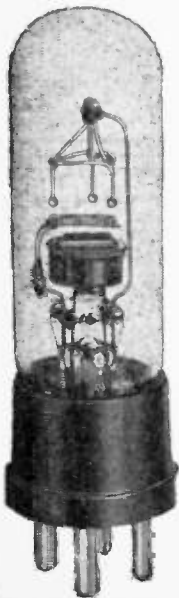

Fig. 2—A grid crystal tube.



*The Crystron—Revolutionary New Radio Tube*

the tip of the catwhisker with a speck of radioactive material and placing the parts in a high vacuum, we have a simple and extraordinarily powerful source of electrons. In addition I discovered a new exceedingly sensitive and stable crystal called *Columbite*, far better than Germanium, used in the best present-day crystal detectors. Basically, the Crystron **REQUIRES NO A OR B BATTERY** for its operation. Indeed, a regenerative Crystron circuit drives a loudspeaker with excellent volume on most local stations. (See circuit in Fig. 6.) Note that no batteries are used.

A photograph shows the actual and historic autopowered Crystron as first designed. Many radioactive substances were tried in the Crystron—thorium, uranium, radium, plutonium, and neptunium—the latter two radioactive elements being the ones used in the atomic bomb. (See photo, lower left, page 24.)

For practical purposes I finally found a comparatively cheap radioactive isotope, which gives excellent results. For security purposes, however, I cannot here divulge the exact substance used.

I built a variety of different Crystrons, some with double radioactive catwhiskers, screen grids, double crystals,

# PERPETUAL LAPEL RADIO

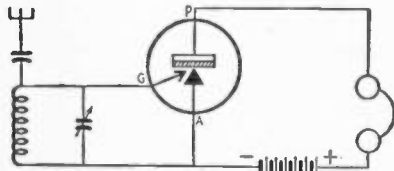
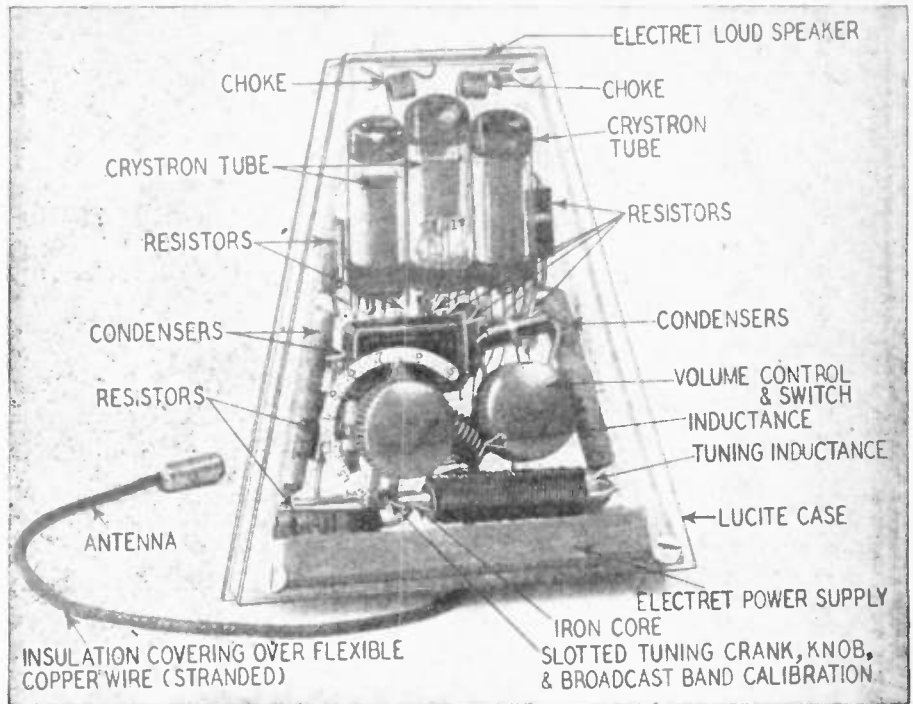

Fig. 3—The simplest Crystron circuit.

electric Crystrons, television Crystrons, Crystron-Klystrons, Crystron-Magnetrons—all will soon appear to make this a glorious new radio age.

In this article only a single practical application of the Crystron is presented—the *Crystron Lapel Radio*. This was easily designed to fit such a very small space, because no batteries whatsoever are used. It was found, however, that the output volume of the Crystron could be enormously increased if additional electric potential was used, particularly where more than one Crystron is employed.

But instead of a B Battery, which soon wears out, I make use of the electret\* principle. It is the first time that a multiple electret has been employed in a radio set to supply the necessary high voltage.

Moreover the electret does not wear out—any more than does a permanent magnet. Therefore we really have now, also for the first

etc. It can be seen that the Crystron combinations are endless, as are its circuits—it is the beginning of an entirely new radio art, so vast that no one can foresee its ultimate end. Photo-

time a PERPETUAL RADIO RECEIVER that needs no batteries or outside power supply!

Up to the time of my experiments, the electret had been merely a scientific curiosity though the Japanese used them in microphones during the war. They were made of fragile and perishable wax. I tried to make plastic electrets, but found that a special quartzite glass was far better than any material heretofore used.

The *Perpetual Crystron Lapel Radio* uses three electrets in one block. (See Fig. 7.) The common negative, or back, is covered with a thin sputtered film of silver. The positive side is divided in three areas, each with its sputtered silver film, and with insulating strips of uncoated glass between them. Dividing the positive area this way prevents any interaction between circuits.

The radio is an unconventional superheterodyne. The oscillator coil is an ordinary permeability-tuned broadcast coil, with a tap for the crystode (cathode) of the converter tube. The signal input (antenna) is attached to the same circuit. No serious attenuation of the signal frequency results, because the coil tunes broadly and the intermediate frequency is low.

(Continued on page 49)

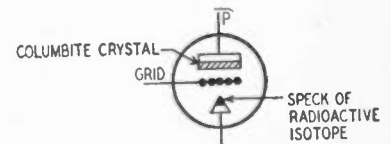

Fig. 5—The Crystron in its final form.

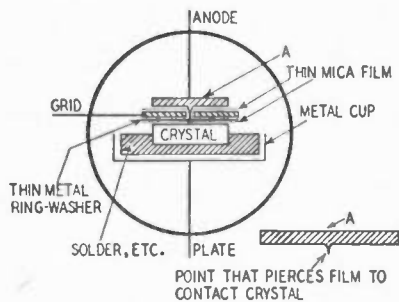

Fig. 4—A capacitive-grid crystal tube.

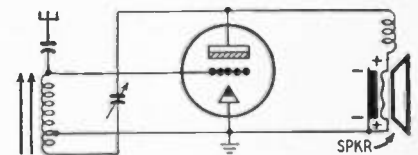
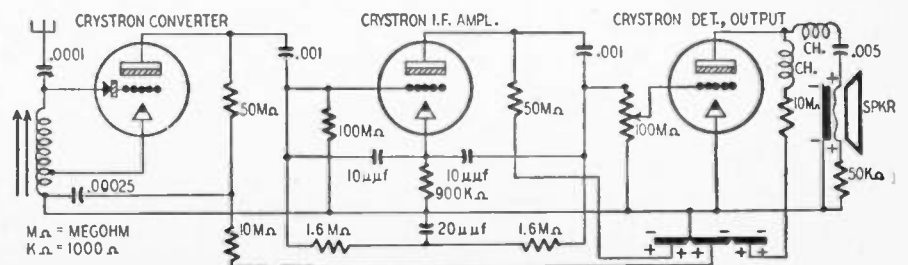

Fig. 6—A batteryless Crystron receiver.

\*For further study of the *electret*, its principles and practical applications, see RADIO-CRAFT, November, 1945, page 88.—Editor.

Fig. 7—Crystron superhet with 3-segment electret and electret speaker, autodyne mixer circuit and bridged-T i.f. stage.





# Vest-Pocket A.C.-D.C. Volt-Ohm-Milliammeter

By WILLIAM LYON

Based on a new 1-inch milliammeter, this little instrument is mounted in an ordinary cigarette case. Despite its small size it is fully as effective as the ordinary portable multitester.

THE appearance on the radio market of a 1-inch diameter, highly sensitive thousand-ohm-per-volt meter made it possible to have a real midget V.O.M.—a vest-pocket a.c.-d.c. volt-ohm-milliammeter. This little instrument is made by the M.B. Manu-

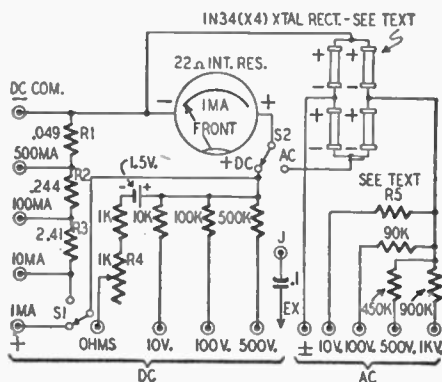

Fig. 1—The instrument's circuit is standard.

facturing Co., Inc. It is only 1 inch in diameter, has sapphire jewels and steel pivots, with an Alnico No. 5 magnet.

To construct a V.O.M. a satisfactory housing is necessary. We used a transparent plastic, telescope-type cigarette case of the size used for standard brands.

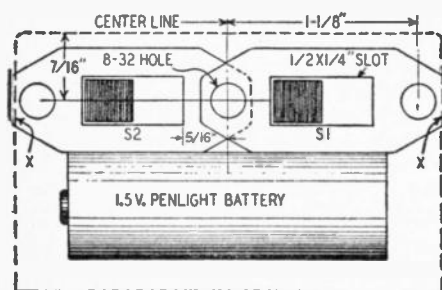

Fig. 2—How the two switches are installed.

Fig. 1 is a schematic diagram of the instrument. Standard components have been used throughout. No tricks or gimmicks have been employed, and the only part that requires fabrication is the meter shunt employed for d.c. readings.

If the substitutes for tip jacks on the meter housing are at all puzzling,

it must be understood that standard tip jacks would extend so far into the case as to make subpanel assembly difficult, if not utterly impossible. Therefore we draw the various leads through small drill holes, twist them around the end of long-nose pliers, and solder them for rigidity. Transparent cigarette cases are made from low-melting-point plastics so that deft handling of the soldering iron is necessary to run enough extra lead to imbed the jacks into the wall of the housing.

Minor variations in the sizes of components made by various manufacturers makes it inadvisable to dimension completely the construction drawings. Partial dimensions are given in Fig. 2. It is very probable, however, that the reader can use Figs. 3 and 4 as drilling templates. The holes for jack leads (Y on Figs. 3 and 4) should be not much wider than the gauge of wire of the resistors and hookup wire employed. Such dimensions usually run from 2½ to 3 thousandths of an inch.

If you have used Figs. 3 and 4 as drilling templates, you can use the calibrations and markings exactly as used on the model (see the photos), attaching them with transparent scotch tape.

It is a good idea to get all of the drilling and cutting done first. Cut the holes for the switches S1 and S2. Dimensions on Fig. 2 are for Wirt sliding button switches. The only drilling made is for the center hole where it will be seen that the mounting ears overlap. The end holes are too close to the walls of the case, so slots through which the mounting ears can protrude are cut as close to the inside of the back wall as possible. See points X on Fig. 2.

It will be necessary to mount the switches before mounting the meter. These units are double-pole, double-throw. Their lugs are to be bent over and soldered together so that they form

bridges. They are now single-pole, double-throw units of good rigidity. A lead is then wired from the d.c. side of S2 to the center position of S1. The plus lug of the meter is bent down to meet the center position of S2 and soldered. The a.c. side of S2 is left open and can later be reached with a small soldering iron.

On the front of the top, clearing the inside of the top wall by about 1/16 inch, the hole for the meter is cut. It should be 15/16 inch in diameter. The hole of the cardboard mount on which the meter is delivered can be used as the cutting template. The edge of the hole should be chamfered with a file, or a shaping piece on the end of a hand drill. This will permit the threaded wall of the meter to cut its own complementary thread on the plastic case.

When the meter is mounted, it should be turned in about 2 thread turns and then the binding ring should be turned in against the case with the rubber washer placed between it and the wall. When the meter is delivered, these parts will be found placed for normal panel mounting, which is opposite to that used here.

From the 1-ma side of S1 a lead is brought out through hole Y (Fig. 3).

Returning to the bottom of the case, we mount the potentiometer R4. This is a midget IRC replacement volume control with removable shaft. The face plates on the shaft side of the unit are removed by prying up the flanged lugs of the metal protecting shell. The middle contact is bent in forward and the other two contacts are cut off close to the potentiometer. The 1,000-ohm series resistance is then soldered to what metal is left of the contact that will have top position when the unit is mounted. The free end of the fixed resistance is cut short and a piece of stranded, covered hookup wire is at-

tached. This is left free to be attached to the negative end of the battery as the last operation. The ohmmeter subassembly is now completed and, without shaft, can be forced down into the case so that the shaft socket and lug slip simultaneously into the slot X and the square hole Z. The square hole is essential. The placement cannot be conveniently negotiated if the proper-sized round hole is cut! The metal back of the potentiometer is covered with scotch tape for insulation.

R1, R2, and R3 constitute a series shunt, the sum of the three values. The author unwound a 3-ohm wire-wound resistor, measured the total required on a good ohmmeter and then divided it up by simple arithmetic based upon the linear measurement of the necessary wire. Drops of solder were applied at the tapping-off points and the wire was rewound on a plastic strip 2 inches long by 1/2 inch wide. Holes were drilled at each end of the strip and the wire ends drawn through them. Leads were then soldered to the tapping-off points and drawn out through the proper holes noted on Fig. 4, right, and formed into lugs. A bare lead from the opposite end of the shunt is drawn out through hole Y, Fig. 4, left. At the same time a flexible, covered lead is attached and left free, later to be attached to the minus side of the meter.

Four Sylvania 1N34 Germanium crystals are used as a full-wave rectifier, giving a flat response equivalent to the d.c. scale of the meter. The knee of the curve of the a.c. scale occurs at 0.2 volt. This can be disregarded in radio service work. (See *H.F. Crystal Diodes*, March 1946, *RADIO-CRAFT*.)

The rectifier can be assembled just as you see it laid out on the diagram, Fig. 1. Four holes can be drilled in a piece of plastic 2 inches long by 3/4 inch wide at the points indicated as wire joinings on Fig. 1. Draw the pigtailed through these holes and attach flexible, covered leads to all points except the one that attaches to the voltage resistors. Wrap the assembly in a piece of acetate and seal with transparent scotch tape. (A small sheet of acetate is obtainable from almost any art or photo supply store.) The assembly is now pushed down into the case with the middle lead from the underside coming out through the a.c. common hole at the middle bottom position on the front. The assembly has been placed with the plus end toward the minus side of the meter. This lead is left free, later to be attached to the minus lug on the meter in common with the common d.c. lead. The lead from the minus end of the rectifier goes to the a.c. side of S2. The necessary resistors fan out from the top middle connection with their pigtailed coming out through the holes shown on Fig. 4, front, and formed into lugs. R5 for the 10-volt scale requires a bit of experiment, because of resistance variations in the 1N34's. The writer found the proper value from among a number of 7,500-ohm resistors. These usually have a fairly heavy plus tolerance.

The d.c. voltage resistors are now brought out through their respective holes (Fig. 4, front), the same as the a.c. units. They are joined in common with a flexible lead extending to the middle position of S1.

A piece of acetate is slipped down between the d.c. and a.c. resistors and bent over so that its opposite end can be slid down next to the back wall. A certain amount of pressure is applied from the battery when the case is closed, and the acetate prevents shorting.

For the battery assembly a lead is brought from the center position of S1 and soldered to the positive end of the battery. The lead from the ohmmeter assembly is now attached to the negative end of the battery. All free leads are connected as previously instructed, the battery is placed immediately under S1 and S2, all flexible leads are bunched up into the upper left under S1 and the case is closed. The top will now come down to within 3/16 inch of a flush

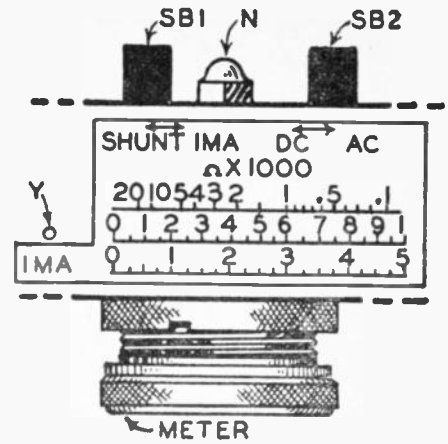

Fig. 3—A top view, showing switch mounting.

The volume control shaft is cut down to accommodate a knob and is placed into the slot to set the shorted meter to zero for resistance readings. The knob is withdrawn when not in use so the

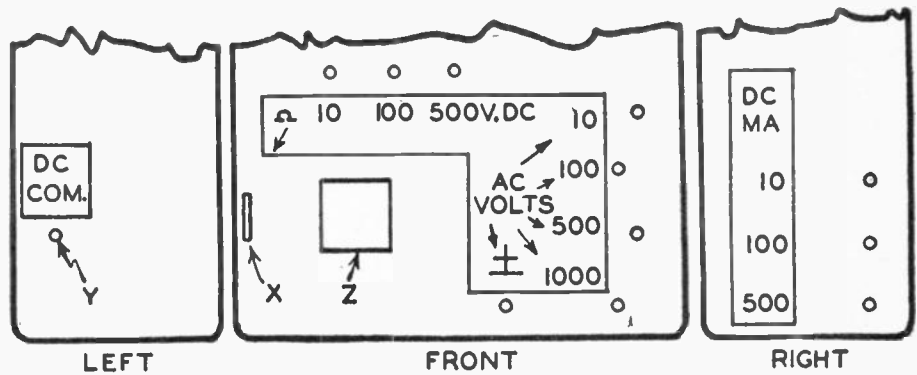
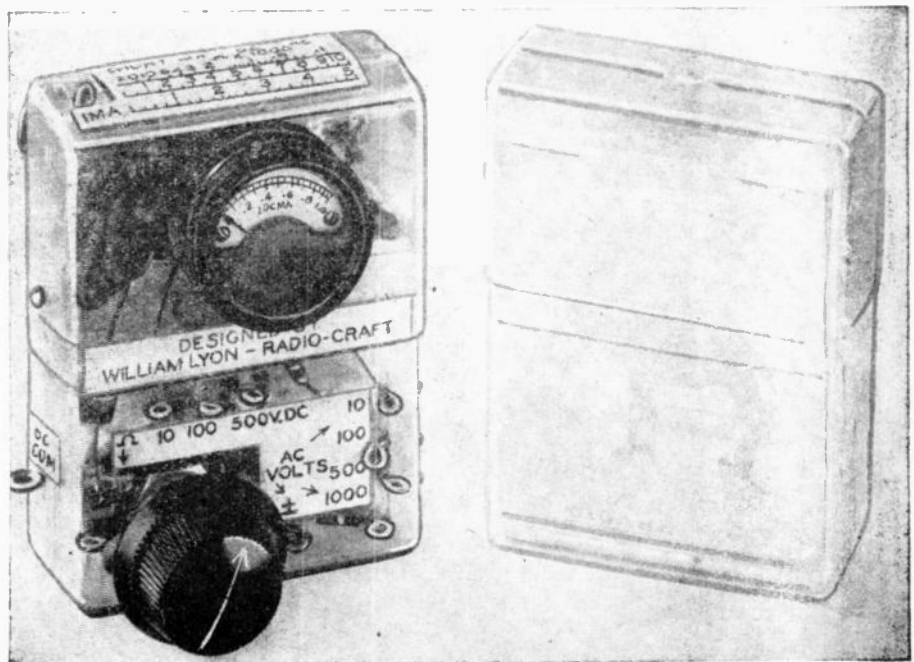

Fig. 4—Drilling and cutting templates for left side, front and right side of the case.

joining with the bottom. A hole is now drilled on the left and right sides and a self-threading screw used to insure the constant engagement of the top and bottom of the cigarette case. This screw is visible on the middle of the left side of the photo below.

lugs for d.c. voltage measurements will be more freely available.

J through EX (Fig. 1) is an extension to a test cord for output readings in conjunction with the a.c. scale only. The test leads must have alligator clips for attachment to the panel lugs.



Size of the little checker as compared with the pack of cigarettes in an identical case.

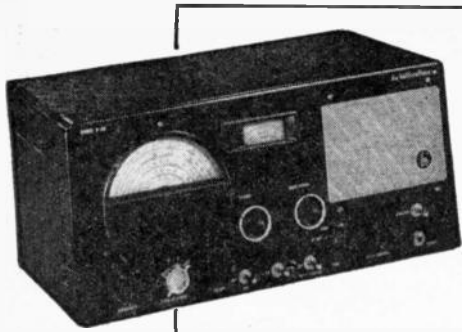

# The Postwar Radios

## Reviewing the Hallicrafters S-40

**T**HE Hallicrafters Model S-40 is the newly arrived descendant of a long line of Sky Champion receivers. Judging from the results of tests made by the staff of RADIO-CRAFT, it is one of the most efficient communications receivers in its price range and will do a good job of pulling in elusive amateur or commercial short-wave stations for the ham or short-wave listener. A 9-tube superheterodyne circuit is used with full coverage from 550 kc to 44 mc in four bands as follows:

- Band 1—550 kc to 1780 kc
- Band 2—1.74 mc to 5.4 mc
- Band 3—5.3 mc to 15.8 mc
- Band 4—15.3 mc to 44 mc

The cabinet, designed along modern lines, is finished in metallic gray with chrome trim. Panel lettering is in silver-gray and red. Red letters are on all dial settings used for the broadcast band to simplify operation for the broadcast listener. The dial scales are on green translucent plastic. Over-all dimensions are 18½ inches wide by 9 inches high by 11 inches deep.

The receiver was tested in two locations and found to be sensitive and selective enough for average ham or short-wave receiving. The calibration was off an equal amount of dial coverage on all bands on the receiver tested. On 5 mc, the error is almost 2 kc. This shift in calibration probably was caused by the main dial slipping on the condenser shaft. Even with this handicap, a few hours of operation will enable the operator to compensate for the error and to spot band edges accurately.

Electrical band-spreading is used with small single-plate straight-line frequency rotors meshing with the stators of the main tuning gang. The dial on the band-spread condenser is calibrated from 0 to 100 over 360 degrees. With the main dial set on the high-frequency limits of the amateur bands, each division on the band-spread scale covers 5.25 kc on 80 meters, 3.33 kc on 40 meters, 8 kc on 20 meters, and 21.5 kc on 10 and 11 meters.

### The circuit and tubes

The set has a 6SG7 r.f. amplifier; 6SA7 oscillator-mixer; two 6SK7 i.f. stages; 6SQ7 second detector, first a.f. amplifier and a.v.c.; 6H6 automatic noise limiter and a.v.c. gas gate (to be explained later); 6J5 b.f.o.; 6F6-G power amplifier; and 80 rectifier.

The input of the receiver is designed for either single-wire or doublet antennas. The band switches have shorting sections that ground unused coils to prevent resonant absorption and dead spots in the tuning range.

The 6SG7 in the r.f. stage is a high-frequency variable- $\mu$  pentode with a transconductance of 4,000  $\mu$ mhos—about twice that of a 6SK7. It is stabilized by 22-ohm resistors in the control grid and plate leads to suppress parasitic oscillations. The antenna and r.f. coils have air cores on bands 1 and 2 and variable permeability cores on bands 3 and 4. On band 1 inductive coupling is used between the primary and secondary of the r.f. coil, while on band 2 the 6SG7 plate is coupled to the B-plus through

a 6,800-ohm resistor—the primary of the band 3 r.f. coil supplies inductive coupling. On bands 3 and 4, inductive and capacitive coupling is used to increase the gain at the high-frequency ends of the bands.

The oscillator-mixer is a 6SA7 with variable inductance and variable capacitance adjustments for accurate tracking. On the 3 lower bands, the oscillator uses the conventional electron-coupled circuit operating 455 kc above the signal frequency. On band 4, the 6SA7 cathode is grounded and the screen grid is the anode of a shunt-fed Hartley oscillator tuned below the signal frequency. The oscillator is stabilized with a 3- $\mu$ f temperature-compensating condenser across the main tuning gang and a 10-ohm resistor in the oscillator grid circuit. (During the shakedown tests, the set was tuned to zero beat with WWV from a cold start. No drift was noted after several hours of operation.)

The output of the mixer is transformer-coupled to the 455-kc i.f. amplifier section. The grid lead of each 6SK7 is tapped down on the secondary winding of its input transformer to prevent i.f. circuit detuning which might be caused by changes in input capacitance caused by variations in effective grid bias with manual or automatic volume control. The cathode returns of the 6SK7's are tied to the cathode return of the 6SG7 and connected to ground through a 10,000-ohm sensitivity control.

The diodes of the 6SQ7 are tied together in a conventional half-wave detector circuit with a total of 687,000 ohms in the diode load. A part of the voltage developed across the load is filtered and applied to the r.f. and i.f. stages as a.v.c. bias. When the a.v.c. is turned off, the grids are returned to ground through a 150-ohm resistor.

A 2-stage resistance-coupled 1-watt a.f. amplifier, using the triode section of the 6SQ7 and a 6F6-G, works into a 5-inch PM speaker built into the receiver cabinet. A phone jack, located on the front panel, connects the phones in parallel with the grid of the 6F6-G and opens the leads to the speaker voice coil. A 3-position resistance-capacity tone control is ganged with the on-off switch in the a.c. line. The stand-by-receive switch removes the B-plus from the set and grounds the grid of the 6F6-G.

One of the diodes of a 6H6 is a shunt-type automatic noise limiter. When the noise limiter switch is ON, the plate and cathode are connected across portions of the detector load so that the

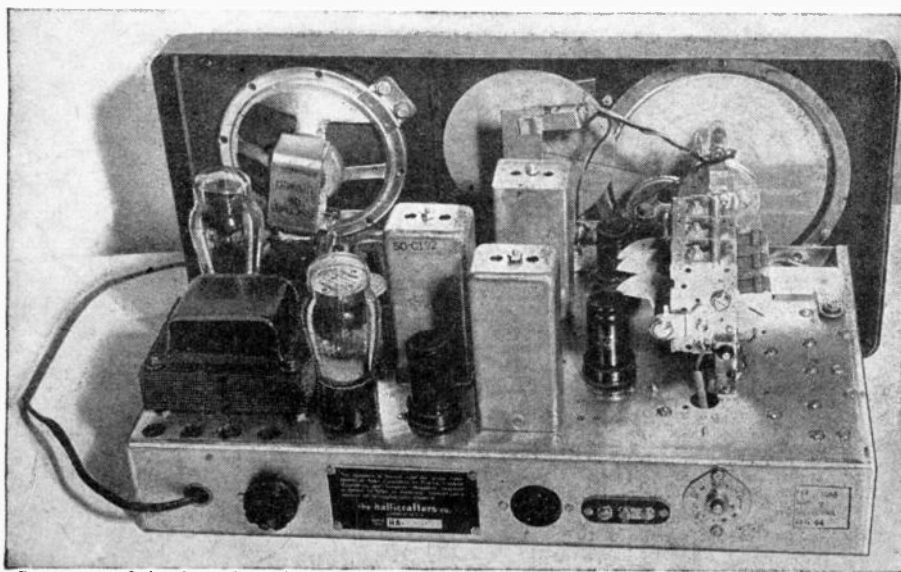

Rear view of the S-40 shows layout of tubes and components. Note the bandspread condenser.



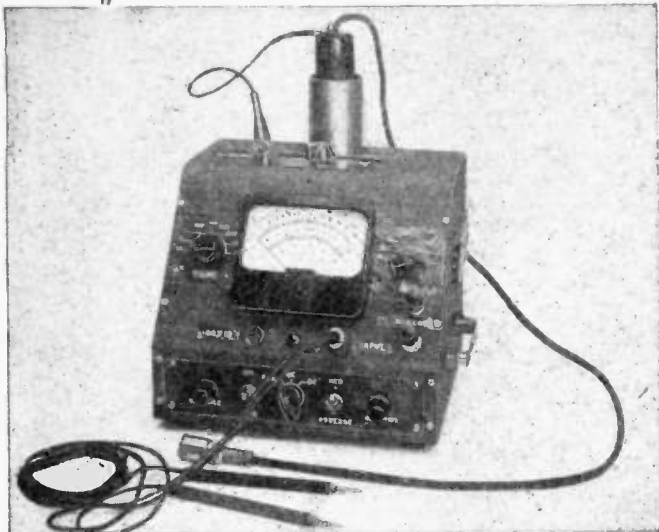

# NEW IDEAS IN A V. T. VOLTMETER

By C. F. Van L. WEILAND

The "turret" is the a.c. probe, which now is a rectifier for the meter.

**M**ORE than two years ago this writer wanted a vacuum-tube volt-ohmmeter that would fill his needs as a home experimenter and constructor. At that time it had to be assembled from parts already on hand or that still could be found in a wartime market.

The meter had to meet the following specifications:

A combined laboratory and test bench vacuum-tube volt-ohmmeter of high precision (1% or better).

High stability.

Easy calibration with simple equipment, and equally easy recalibration when this becomes necessary.

Voltage ranges from 1 to 1,000 v, a.c. and d.c. (6 ranges).

Frequency range from lowest a.f. to highest r.f. in FM and television, H.f. by a.c. probe, lower frequencies with the all-around test leads.

Resistance measurement from 1 to 100 ohms to 1 to 100 megohms.

High input impedance for all ranges, retained as well as possible at high frequencies for a.c. measurements.

The transfer of test leads to other terminals for different measurements to be kept down to a minimum.

The diagram is presented in Fig. 1, subdivided into its principal functional components as indicated.

## Circuit and construction

Both circuit and construction are conventional. For those who wish to obtain maximum capability in a minimum of space, the two VR-150 regulating tubes may be replaced by a resistance-type divider splitting the supply voltage into two equal voltages, one positive and the other negative to ground (or chassis). The regulation and circuit stability will still be excellent. Be sure that the two voltages of approximately 150 volts (positive and negative) are equal before final calibration is started.

The amplifier is a push-pull circuit, employing degeneration for added circuit stability.

A ceramic tube socket is used for

the 6SN7 amplifier tube to avoid leakage and keep all leads—especially the grid connections—as short as possible, to keep pickup voltages to a minimum. When this is done, no extra shielding will be required.

Any reliable microammeter of 200-microampere sensitivity is suitable for attaining the minimum range of 1 volt a.c. with the 9- and 8-megohm resistors in series between cathode of the probe tube and ground, as specified. If a higher minimum range than 1 v a.c. is satisfactory, a less sensitive meter may be used.

In the development of the instrument two meters were tried to investigate the damping effects of an external shunt: a Roller-Smith of 200-microampere sensitivity, and a Marion 100-microampere meter. The first has the advantage of a rather long knife edge. The Marion meter already has a very strong damping which, of course, was improved by the outside shunt, a wire-wound resistor of approximately 1,000 ohms, shunting the meter down to the required sensitivity of 200 microamperes. Both meters have given excellent results.

The meter is made reversible by the double-pole, double-throw switch (S2 in the diagram), so that a right-hand deflection will be obtained when the red test lead is in contact with a plus d.c. voltage, the chassis or the black lead being negative. If the rectified a.c. voltage is taken off the cathodes of the 6H6 probe tube and the plates of the tube are at ground potential, no reversal of the switch S2 will be needed when changing over from d.c. to a.c. measurements.

## The input system

The input system consists of the following parts, which are indicated in the diagram (Fig. 1):

1. An input receptacle (or socket) for all measurements except d.c. voltage



Close-up. The various functions may be read direct from the photo.



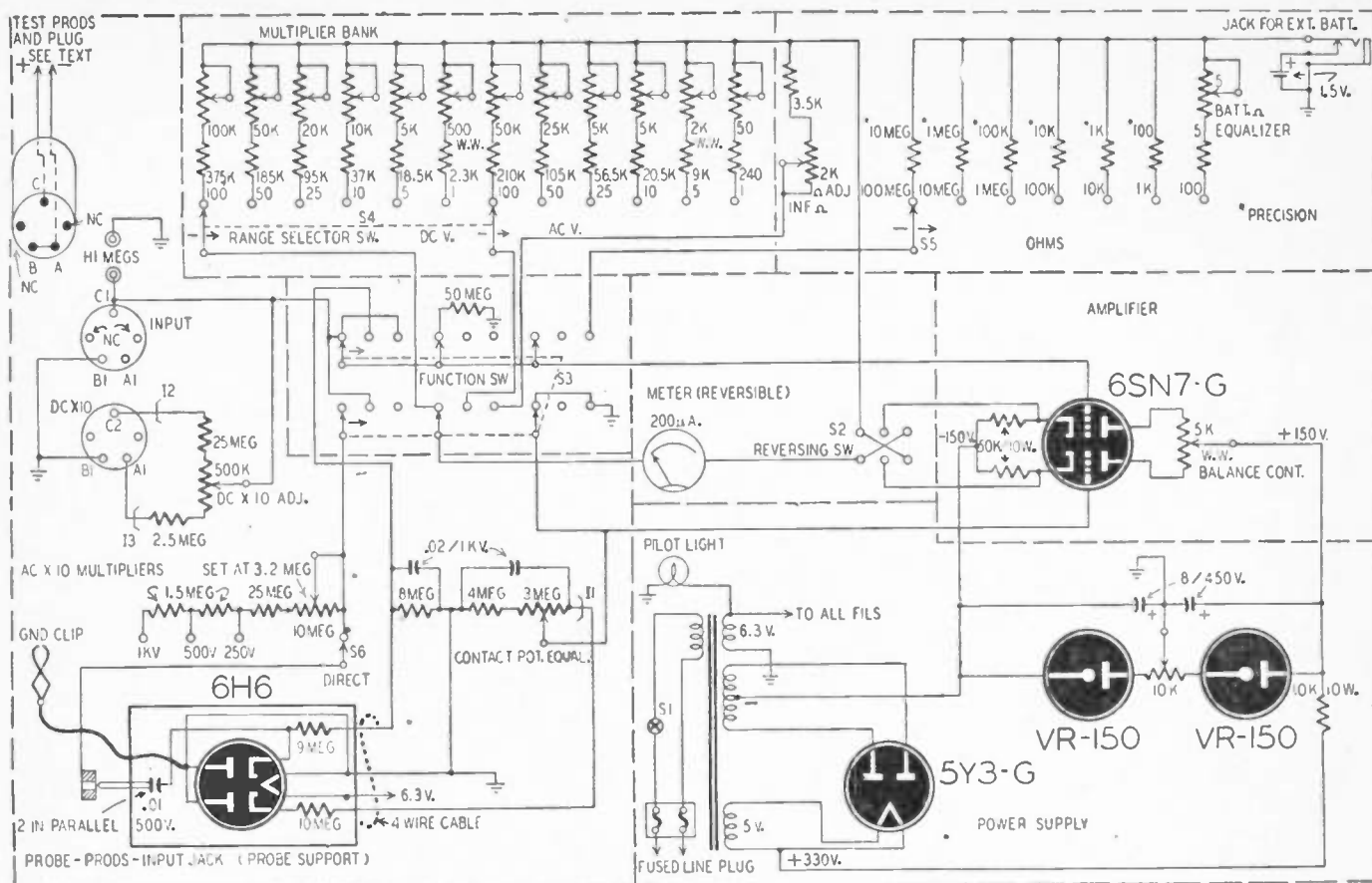

Fig. 1—Interesting features: Balanced-to-ground circuit, probe used as meter rectifier and individual calibration of each of the voltage ranges.

× 10. 2. An input for d.c. voltage × 10, with associated multiplying network. 3. The a.c. voltage × 10 multiplying network and switch. 4. The a.c. probe with associated filters and contact potential equalizer.

From 1 and 2 above it can be seen that all measurements are made from a single input socket, marked *Input* in the diagram, except for the measurement of voltages over the highest or 100-v d.c. range of the basic instrument. For higher voltages than this the D.C. × 10 input socket is used which, by means of the multiplying network across the two "live" terminals of the socket, multiplies the normal range voltages by 10, yielding 10 times 25, 50, or 100 when the range switch is set on these voltages. The decade multiplier network is disconnected from ground and kept floating when the high-voltage measurement socket is not in use.

In addition to the input socket a set of binding posts, marked *Hi Megs* in the diagram, is provided for the measurement of resistances over 10 megohms. These binding posts are necessary to eliminate error due to the test-lead insulation connected in parallel to the high resistor to be measured. One of them is connected to ground and actually does not need to be insulated from the chassis except perhaps for the sake of symmetry. The other binding post is insulated from the metal of the chassis by a ceramic feed-through insulator of high quality to prevent leakage between the two binding posts.

For the same reason, and to prevent undue leakage at the higher voltages

and frequencies in particular, the two inputs consist of miniature polystyrene 5-contact tube sockets with two of the bushings drilled out (marked *NC* in Fig. 1) to facilitate easy insertion and removal of the plugs. The plugs consist of a fitting miniature 5-prong plug, preferably of mica, or better still polystyrene if obtainable. The writer was unable to obtain either of these and has used a regular bakelite plug.

The a.c. probe of the a.c. input system is shown diagrammatically in the diagram Fig. 1 and its constructional details are shown in Figs. 2-a and 2-b, and 3. The construction of the probe itself can be followed through from these figures.

It will be noted in Fig. 1 that one half of the diode rectifier is used for delivering a voltage to the second grid of the 6SN7 tube to cancel the contact potential generated by the probe's rectifier. The resistor-condenser combinations in the cathode circuits of course are filters intended to remove the a.c. component from the rectified d.c. delivered by the probe. The relation of the resistors is such that if the resistor in one cathode leg plus that between it and ground equals 17 megohms, as is the case here, then, for true balancing of the rectifier load the two in the other leg plus P should also total 17 megohms. If P is chosen at 3 megohms then it

follows that the resistor between it and ground is to represent a total of 17 minus (3 plus 8 megohms) or 6 megohms. It may be found necessary to juggle part of this resistor on the grounded side of P and the remainder on the other side to assure that the contact potential equalizer will be at the correct electrical location to cancel out the contact potential. In the author's model the resistors are as shown.

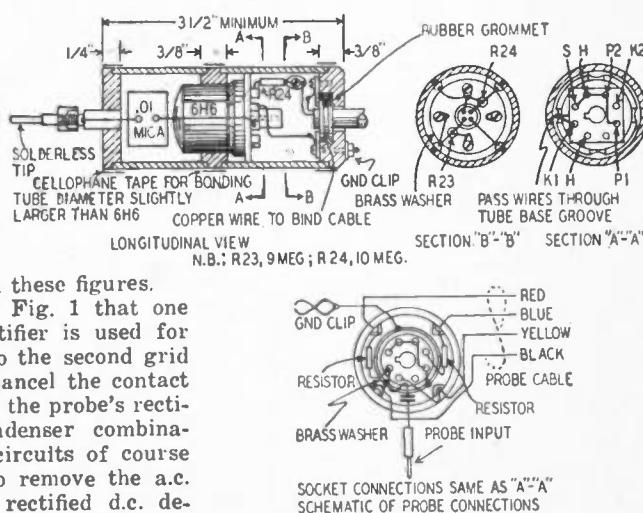

Fig. 2-a, above—Detail of a.c. probe-rectifier, and 2-b, below, its correct socket connections.

The function selector is a 6-pole 3-position switch and is marked S3.

As this switch carries the essential connections to the grids, probe, etc., its

location should be such that the runs will be as short as possible and the insulation of the switch should be ceramic to avoid leakage. The functioning of this switch can be studied further from the diagram.

### The range selector

The range selector consists of a 2-pole 6-point switch which can either be of the breaking or nonbreaking contact type; either is applicable to vacuum-tube voltmeters. Because no high resistance is connected to this switch, it may be of standard bakelite or equivalent insulation.

This switch selects the 6 a.c. and the 6 d.c. ranges of the instrument by plac-

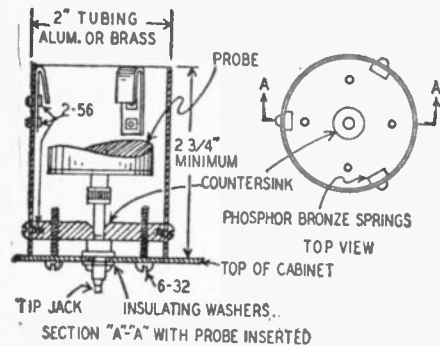

Fig. 3—The turret housing for the a.c. probe.

ing a resistor of different value for each range in series with the microammeter.

The resistance values of these resistors for the voltage ranges indicated are the following:

Voltage	Resistance d.c.	Resistance a.c.
100	425 K ohms	235 K ohms
50	210 " "	117.5K ohms
25	105 " "	59 " "
10	42 " "	23 " "
5	21 " "	10 " "
1	2.580 "	265 "

This resistance in the circuit was measured with a regular ohmmeter (Simpson 260) and the direct relation of the resistance values to the voltage

ranges is to be noted. This holds true except for the 1-volt range for d.c. and down to the 10-volt range for a.c. It is a yardstick for the linearity of the instrument as a whole.

From the resistor values given with Fig. 1 it is seen that the needed multiplying resistance is made up of two parts, one fixed and one variable. The variable part consists of a potentiometer of about 20 percent of the total needed resistance. The potentiometer should be set at half its total resistance to yield the resistance value required for a given range. In other words, the calibration of the vacuum-tube voltmeter ranges can be easily set and reset at about 10 percent plus or minus of the true indication, fulfilling the third requirement of the specifications.

For the fixed resistors good quality 10 percent, 1/2-watt insulated carbons were used mounted on a resistor strip underneath the chassis. The variable part or potentiometers consists of good quality small carbon units of the values indicated. They were purchased in the surplus market at a very reasonable price.

The arrangement of the fixed resistors and potentiometers for calibration is clearly shown in the photo (page 65). The potentiometers are arranged in vertical rows of three on mounting brackets. Figs. 2, 3 and 4 show in some detail how the construction of the complete instrument was carried through.

### The a.c. multiplier

A.c. multiplication is attained by placing a resistance in series with the probe input, as shown in Fig. 1. As the probe draws current this resistance causes a voltage drop, bringing the voltage down to a value suitable for direct application to the probe's input tip.

It was found that the current drain through the probe does not vary much when changing the a.c. voltage range switch from the 25-volt to the 100-volt range and applying corresponding volt-

ages to the input of the probe. Consequently, once a correct reading for 250 volts a.c. has been established through the potentiometer and 25-megohm resistor, only a small correction is needed for the 500- and 100-volt ranges through the two 1.5 megohm series resistors.

The respective values established for the model built were 10 megohms for the potentiometer, set at 3.2 megohms, and 25 megohms for the resistor, but slight changes may be necessary in other individual instruments. The potentiometer was obviously unnecessarily large at 10 megohms, and 5 megohms will be used in subsequent models. A correct reading is obtained at 250 volts input with the range switch set at 25 volts and the function selector switch on a.c. With the range selector on 50 volts, a true reading at 500 volts was obtained with a resistor of 1.5 megohms added to the previous total of 28.2 megohms. An additional 1.5 megohms was required in series with the latter total to obtain a true reading for readings between 500 and 1,000 volts a.c. with the range selector set at 100.

### Ohmmeter standards

The ohmmeter circuit is conventional and needs no further explanation. The ohmmeter scale is plotted against the d.c. scale and follows the equation:

$d = 50Rx / (Rx + R)$  scale divisions  
for a scale calibrated 0 to 5 and consisting of 50 scale divisions as in the present case.

The resistance standards are 1/10 of the maximum resistance indicated on the OHMS scale, i.e. 10 ohms for the 100 ohms scale and 10 megohms for the 100 megohms scale. The resistance standards are selected as closely as conditions permit with the aid of a standard ohmmeter of good quality (in comparison with precision resistors if possible). These standards consist of good-quality insulated carbon resistors of 1/2-watt or 1-watt value. Standards  
(Continued on page 64)

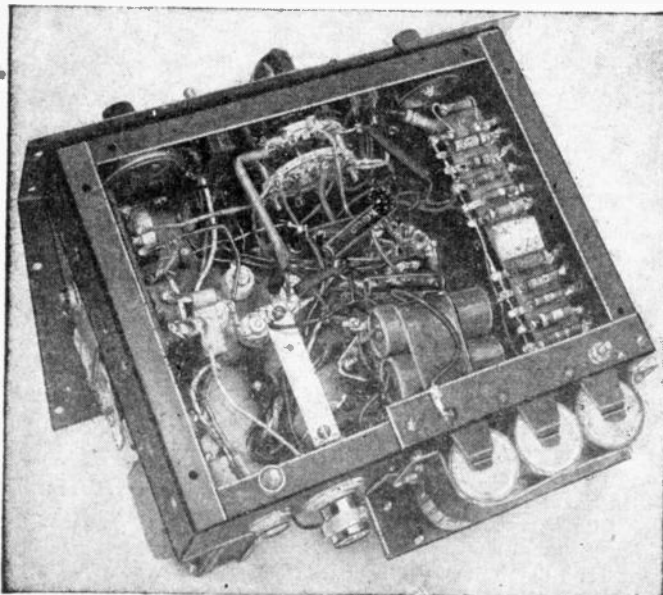

Above—Under-chassis view. Sockets are for the line and a.c. probe.  
Fig. 4, right—A top view and parts layout plan of the instrument.

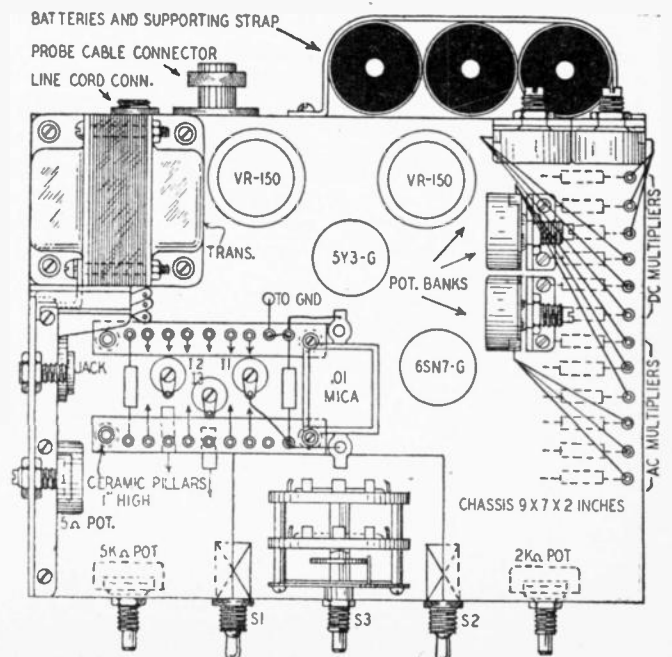

# Multi-Station Intercoms

## Part II—Master-Remote Systems and Circuits

By **RICHARD H. DORF**

**F**OR applications where a central executive wants contact with subordinates who need not talk to each other, the master-to-remote system is much less expensive. The master station contains the same amplifier, but only one master need be used and switching is somewhat different.

The master and two remotes of such a system are shown in Fig. 3. The master amplifier is again shown in block form. The circuit may be that of Fig. 1 (March issue) or any other standard intercom. The remote consists only of a speaker and a normal-call switch.

When the master wishes to speak to a remote, its operator rotates the selector to the number of the remote and presses down the T-L switch. His speaker is connected thereby to his input transformer and his output transformer is switched to the remote speaker through the selector. When he releases his T-L switch, the remote operator speaks into his speaker (without using any switches). His voice is heard in the master speaker.

Any remote may call the master, regardless of the position of the selector. The line labeled "input" is directly connected to the master input, and the

normal-call switch on any remote will connect that remote to the input line and enable the master to hear it.

### Simpler equipment

The circuit of Fig. 4 is a simplification of that in Fig. 1. It uses a single 117L7 in each master. The tube is used as a voltage amplifier at the transmitting station and as a power amplifier at the receiving end. Each signal goes through double amplification, achieving the same result as the previous circuit with half the number of amplifier tubes and no separate rectifiers.

Due to the low amplification of each individual unit, hum level is normally low, but when two units are cascaded, as in operation, the additive hum levels may necessitate use of a filter choke. If so, a standard a.c.-d.c. choke of about 8 henries is adequate. If a greater value is available, so much the better.

The switching diagram is shown in Fig. 5. Again, one side of each item is common. When station 1 is listening, his output transformer is connected, through his T-L switch, to his speaker, and his input is carried out on line 1

through connection "x." Station 2 is transmitting and his speaker is connected to his input transformer. His output goes through the T-L to the arm of his selector, thence out on line 1. Going into amplifier 1 through the "x" connection, the voice is amplified again and is heard in the station 1 speaker.

### Some construction hints

In constructing any of these units, the best procedure is to procure the

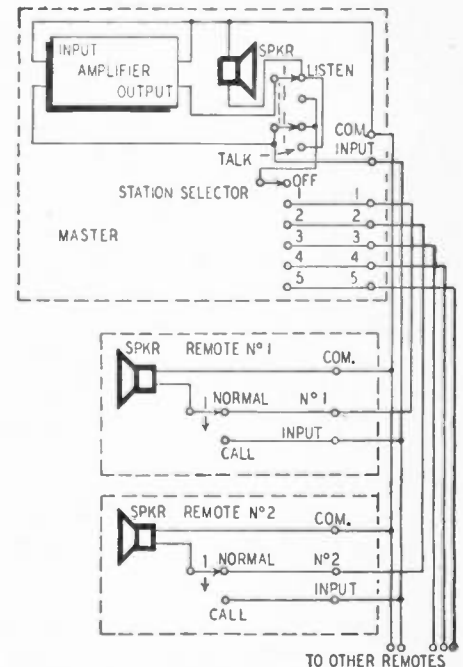
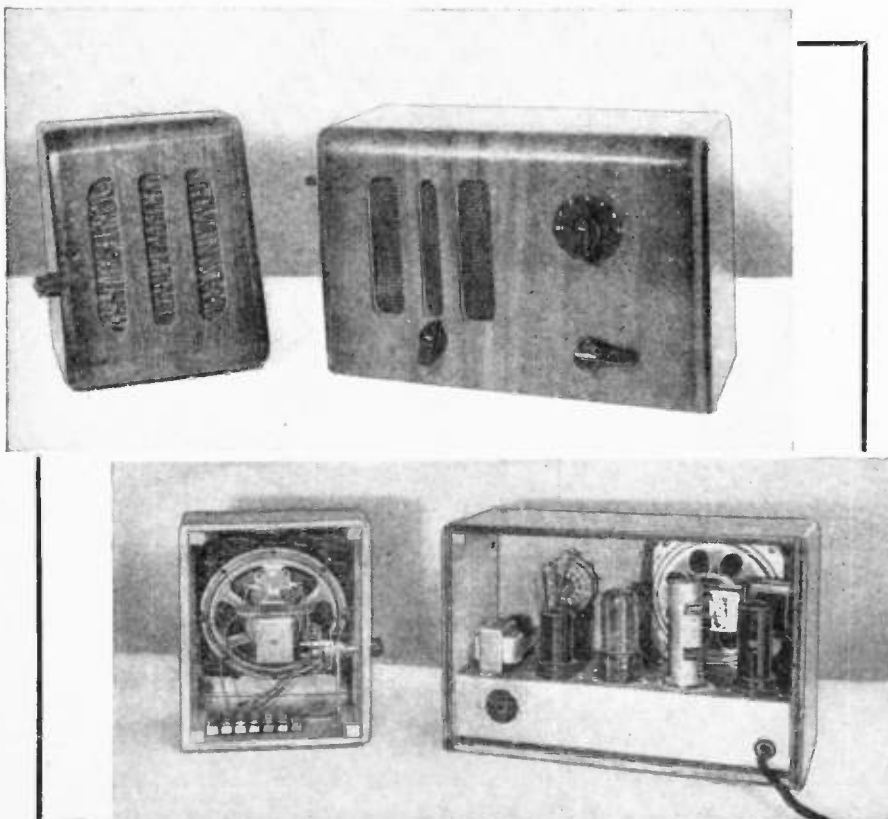

Fig. 3—How master-remote system is wired.

wood cabinets first. The chassis then can be cut to size and the parts assembled. Making a template and considering parts placement carefully will assure good-looking, uniform jobs. Everything should be securely mounted. Lug terminals should be used to support condensers, resistors, and loose leads. Making intercoms is a very satisfactory way for the erstwhile amateur or experimenter to start earning money from his hobby, but it should be remembered that a neat, strong, professional job must be done to avoid equipment failure and with it damage to a developing reputation.

The holes in the cabinet must be cut with care. The outside is a thin veneer and will easily splinter. Therefore, if holes are started from the inside, use a small drill and then enlarge from the outside. To avoid complications the author uses rotary On-Off switches rather than toggles. The station selector is mounted on a standard 2-inch angle iron fastened to the chassis.

(Continued on page 70)



Front and rear views of master and remote units of intercommunication system.

# A SMALL RECORDING STUDIO

## Part II—The Technique of Making a Phonograph Record

By J. C. HOADLEY



Above—Mr. Hoadley's recording equipment.

**M**AKING a good-quality disc requires a lot more effort than merely lowering the cutting head on the disc. The first job is to compensate the system to produce a flat frequency characteristic on the disc. This is done by applying frequencies from 30 to 10,000 cycles to an amplifier input and cutting a disc. These frequencies may be obtained from an audio oscillator or from a tone test record such as the Columbia M-10003, played on another turntable with a pickup which has been compensated so that its output is constant.

The light pattern of a reflected point source is observed on the disc. If the light is placed as in Fig. 1, a band of reflected light will appear on the cut disc. The width of the band measures the amplitude of the recorded sound. The object in constant-velocity recording is to produce a light band whose width is constant for all frequencies. (See A in Photo A.) In constant-amplitude recording we get the familiar Christmas-tree pattern shown at B. The width of the light band should double for each successive octave. This is a very precise method of measuring frequency response. Measurements can be made with a ruler and then converted from inches to decibels, if desired. Using this method, it is simple to give our recording system any special cutting-frequency characteristic.

The response will vary with the sharpness of the cutting needle, the cutting-needle pressure, the type of cutting needle, and the cutting-needle angle. The cutting needle should be vertical or nearly so. The accepted angle is between 88 and 90 degrees. The quietness of the recording is profoundly affected by the cutting angle and the

sharpness of the needle. Sapphire needles are the best, with stellite and the alloys running second. A steel needle is not sharp enough nor ground accurately enough for professional results, and has a very short life. It will cut only one 12-inch disc. The stellite is good for several hours of cutting time and may be resharpened. The sapphire may be used for 6 to 10 hours and may be sharpened repeatedly.

The needle should be adjusted to make the quietest cut, the depth of which should be just deep enough for your playback pickup to track. The accepted cut is 0.002 inch wide, and it should be slightly narrower than the land between the grooves (60:40 is the accepted ratio of cut to land).

The chip, as it comes from the cutter, should be reasonably straight and feel soft. It should be of the approximate size and "feel" of human hair. If it is kinky or dry, the recording disc is old and dry; or, possibly, the needle is dull. A dull needle will be accompanied by high hiss level and will require great cutting pressure.

### Mechanical Excellence Necessary

Rumble is caused by motor vibration being transmitted to the recording via the various mechanical linkages, and by binding or ill-fitting moving parts. The

commonest cause is too great a pressure of the motor drive pulley against the rubber idler wheel which drives the turntable rim. The least pressure which allows sufficient friction to give adequate power should be used. If there is binding in the overhead assembly or play in the lead screw, a low-frequency sound will be imparted to the disc. Either type of rumble will be indicated by a pattern of spokes of various shapes

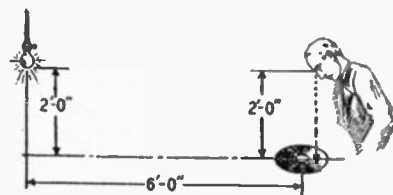

Fig. 1—Set-up for viewing the light pattern.

noticeable on the surface of the disc. The remedy is a mechanical correction of the motor drive pulley or overhead assembly.

The cutting head must move freely in a vertical plane so as to follow any irregularities on the record surface. If it binds, the depth of cut will be uneven and accompanied by an irregular hiss level, and the cutting head is likely to bounce in extreme cases. This is a par-

(Continued on page 74)



Photo A—A and B are constant-velocity and constant-amplitude patterns respectively. C is an example of bad resonant peaks showing severe distortion caused by over-modulation.



quency of 16 mc. That is, the second-stage output is multiplied to 48 mc.

The third stage is also a tripler, but here the v.h.f.-type tube 832 (VT-118) is brought into play. This is a very efficient little bottle, by now well known to the amateurs, and works wonderfully well in the v.h.f. spectrum. This 832 stage, being a tripler, converts the incoming 48-mc energy from the output of the second stage to the desired final frequency of 144 mc. The plate circuit of this stage utilizes a hairpin line-type

of tank condenser for maximum tripler efficiency, although a butterfly-type split-stator condenser is bridged across it for tuning purposes.

The final r.f. stage makes use of another 832 (VT-118) operating straight through for a power amplifier. This feeds the antenna which can be anything from a 20-ohm to 500-ohm load. Variable coupling is provided by a swinging link and all coils and lines are silverplated throughout.

The audio section of the BC-625 con-

sists of the speech amplifier tube, a type VT-199 (6SS7), which is actuated by a carbon mike, a 500-ohm line from the station speech amplifier, or equivalent. This stage is then coupled to the push-pull modulator stage consisting of two type VT-134's (12A6's), which in turn modulates the plate and screen of the final 832 r.f. amplifier as well as the screen of the 832 tripler driver stage which drives the final. This is a trick seldom seen in amateur practice, but which it might be well to emulate on the v.h.f.'s.

Hardly any changes are required to adapt this Army SCR-522 to the 2-meter band. Here at W5AJG, these modifications took the following lines, although after a look or two at the equipment, each ham no doubt will have his own ideas.

Since fixed-station operating is desired from the home location, and because of a future possibility of changing the role of the 522 from a complete transmitter to a driver for more power (everybody dreams of more power), it was decided not to use the rack (FT-244), nor the case (CS-80), but to remove the transmitter (BC-625) and mount it upon a standard 7x19-inch relay-rack aluminum panel.

### Layout and construction

The panel was laid out according to the drilling sketch on this page and two mounting brackets were made to bolt to the transmitter chassis. All controls are brought out to the front panel and tuning is done in the conventional way. The photographs showing the modified views will bring out the details clearly. At this point it is well to mention the push-button ratchet-type tuning system originally used. An ingenious arrangement to be sure—one that could be applied to ham use, no doubt—but to avoid complications and too heavy brain work, it was scuttled in favor of regular tuning knobs.

As well as shifting to any of four preset channels, this push-button arrangement also selected the proper crystal at the same time and also tuned the BC-624 receiver—but that is another story.

A new 4-position crystal switch is brought out through the front panel for selection of any one of 4 crystals from 8,000 to 8,225 kc. The original crystal switch was removed and the wiring merely substituted on the new switch. In the old arrangement, the 3 crystals not in use were grounded. In the modified arrangement, this was not done—mainly to simplify the contact arrangement needed.

The oscillator and frequency-multiplier tuning knobs as well as the final amplifier plate tuning are lined up in a group of four along the middle right of the panel. These shafts were made by sawing the correct length of 1/4-inch brass welding rod and drilling and tapping one end for 8/32 threads. Each shaft is thus merely screwed down tight to its proper tuning-condenser control in the original transmitter, since each shaft

(Continued on page 75)

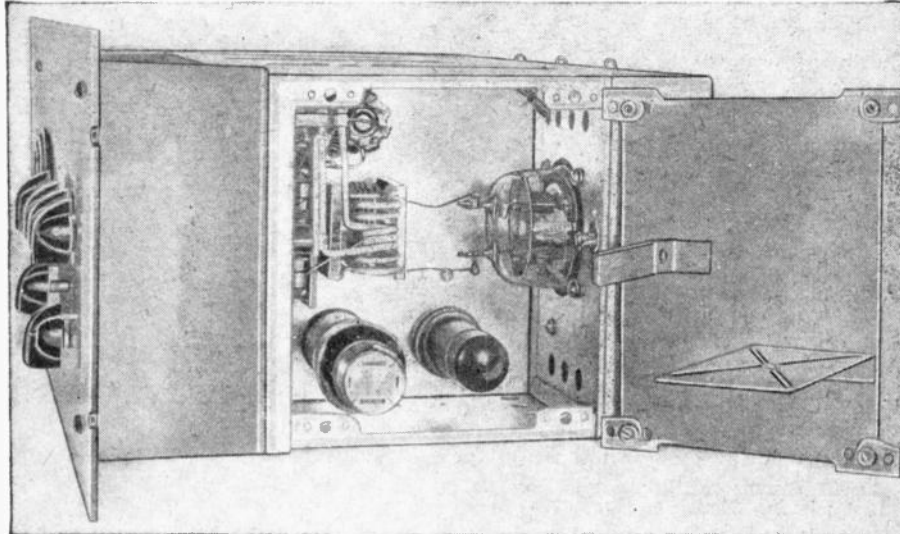

End view of final amplifier compartment showing 832 amplifier. Note shield on the cover.

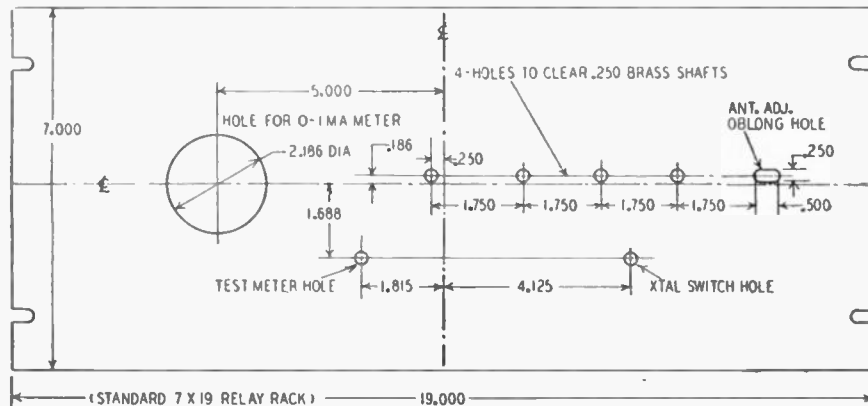

This front panel drawing is dimensioned so the constructor may use it as a drilling sketch.

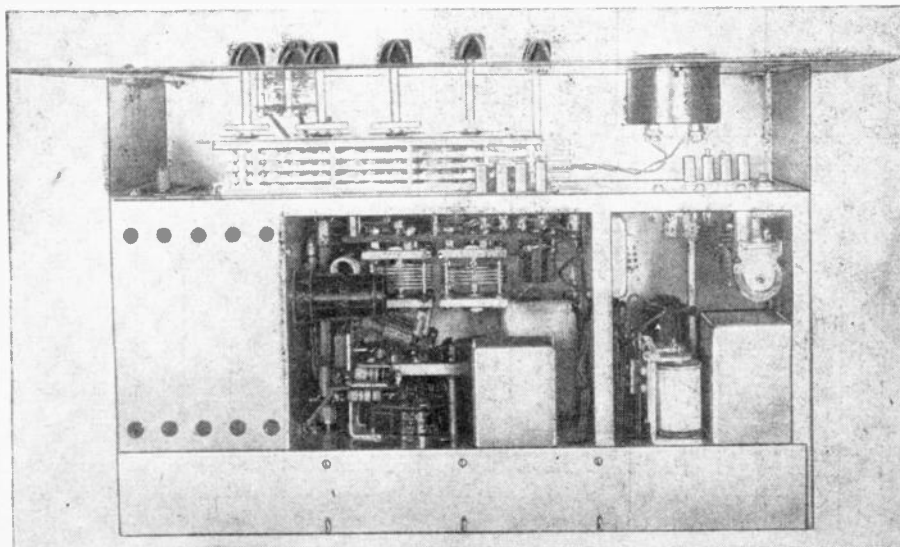

Top view of transmitter, showing how extension shafts are fastened to the original dials.

# TELEVISION FOR TODAY

## Part XI—Electromagnetic and Electrostatic Deflection Systems

By MILTON S. KIVER

A COMPLETE electrostatic deflection system, combining the synchronizing and deflecting circuits is shown in Fig. 1. Deflection and clipping occur in the synchronizing pulse detector which is one half of a 6H6. The time constant of R1 and C1, in the detector load network, produces a bias across C1 which permits conduction through the tube only at the synchronizing pulses. At these moments, the charge on C1 is replenished and the pulse of current develops a pulse across R2. From R2 the pulse is transmitted through L1 and the .05- $\mu$ f condenser to the 1852 pulse amplifier. L1 maintains the high-frequency response of the transfer network from the detector. Square waves contain many harmonics and loss of the higher-frequency components would round out the steep sides of the pulse and destroy the sharp, clean trigger action. The 1852 amplifies the pulse while completely removing any vestiges of image signal that may still be attached to it. The output network of the 1852 consists of a 5,000- and a 20,000-ohm series resistor. The pulses are separated by R-C filters in the branches leading to the horizontal and vertical sweep oscillators. The grid circuit of the horizontal oscillator has a high-pass filter composed of a 50- $\mu$ f condenser and a 2,200-ohm resistor. Because of the extremely low time constant, only the sudden changes at the start and end of each pulse are effective in producing pips across the 2,200-ohm resistor.

At the input to the vertical sweep oscillator, we find a long time-constant filter, determined by a 2.2-megohm resistor and a 0.001- $\mu$ f condenser. A second 2.2-megohm resistor is shunted to ground to complete the d.c. path for any electrons caught in the grid circuit.

Both sweep oscillators are cathode-coupled multivibrators. Each is synchro-

nized by a negative pulse, which drives one half of the multivibrator into cut-off and forces the other half into conduction. This discharges the saw-tooth generating condensers C2 and C3 and causes the beam to retrace into position for the following line. C2 is the charge-discharge condenser in the horizontal circuit; C3 performs the same function in the vertical circuit. Condenser C2 is charged through the 470,000-ohm resistor and the 500,000-ohm width control during the interval that the half of the multivibrator to which it is attached is nonconducting. The position of the movable arm of the potentiometer determines how fast C2 charges. This in turn controls the horizontal sweep of the electron beam. In the vertical system, there is no direct control of the charging of C3. Instead, the height control is connected as a volume control and the proper amount of saw-tooth voltage tapped off.

### The sweep circuit amplifiers

The 6F8-G horizontal sweep amplifier is a conventional double triode functioning as an amplifier and phase inverter to develop a balanced output for the horizontal deflection plates of the cathode-ray tube. Tracing the leads from C4 and C5, we note that, besides going directly to the horizontal deflection plates, they are also attached, through 2.2-megohm resistors, to a centering network. The saw-tooth deflection voltages are placed across the 2.2-megohm resistors while a d.c. centering voltage is fed through the resistors to the plates.

In the vertical deflection system the layout is almost identical, the only difference, necessitated by the variation in saw-tooth frequency being in values of certain parts.

The method of centering the electron beam is simple. Two parallel 1-megohm potentiometers form a resistance network. A third parallel branch across the potentiometers contains two 470,000-ohm resistors in series with each other. From the connection between the two 470,000-ohm resistors, leads run to one horizontal and one vertical deflection plate. From the movable arm of each of the 1-megohm potentiometers there is a connection to the other vertical or horizontal deflection plate. As long as the movable arm of each potentiometer is at its midpoint, no difference of potential will exist between either the two vertical or the two horizontal plates. If the beam does not position correctly, adjustment of the proper centering or positioning potentiometer will bring the beam to its proper place.

The centering controls are placed as close to the highest cathode-ray tube potential as possible to avoid affecting adversely the electron beam. Physically, in the cathode-ray tube, the deflection plates are located well within the electric field of the second anode. To reduce distortion of the field as much as possible, static voltages on the plates are at the second-anode voltage. The saw-tooth deflection voltages then vary the deflection-plate potential for a linear deflection of the beam.

In certain television receivers, with small screens, single-ended amplifiers are used. In such a receiver, one plate of each deflection set must be tied directly to the second anode while the second plate of the set is varied above or below this fixed potential for deflection of the beam. When the beam is at either edge of the screen, the potential of the second plate may vary considerably from that of the other plate or the second anode. The accelerating field is then distorted and the beam is thrown out of focus. The visual result is a

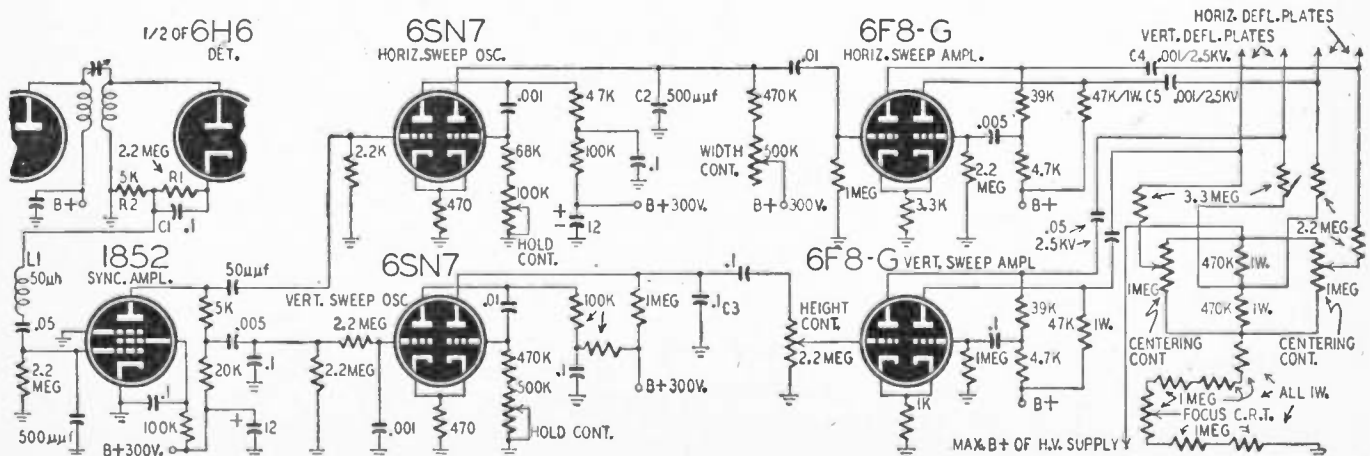

Fig. 1—A typical system for electrostatic deflection of the cathode ray. This method is employed in many small television receivers.





# Transatlantic News

From our European Correspondent, Major Ralph Hallows

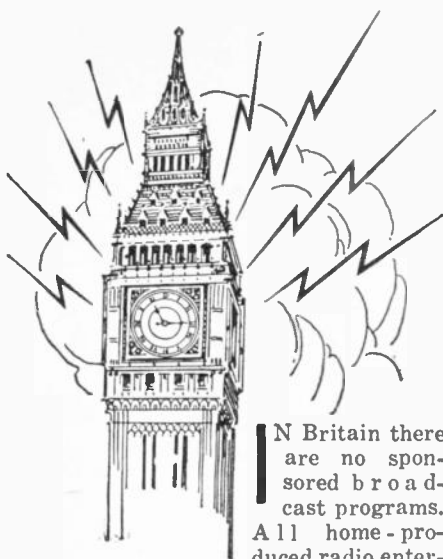

**I**N Britain there are no sponsored broadcast programs. All home-produced radio entertainment is furnished by the BBC in return for the annual fee of \$4, which we pay for the license to use a receiving set. Since nearly 11,000,000 people take out such licenses each year, the BBC's annual income is not too bad. The aim of the BBC is to put on the air daily three alternative programs—high-brow, low-brow, and middle-brow—which can be received well in any part of these islands by ordinary sets. The high-brow program is a recent innovation and one of the big surprises of the day is the warm welcome given to it by all sections of listeners. Owing to postwar hold-ups we have not yet reached the stage at which the three alternative programmes are available in every remote corner of the country from triple high-power transmitters. The middle-brow and the low-brow programs, however, are radiated by 100-kw stations and can be heard well nearly everywhere—but not quite everywhere.

Britain contains many large areas in which deep, narrow valleys are separated from one another by ranges of hills. There is, further, the big problem of built-up areas, in which the attenuation of radio signals is acute. This is particularly true in the London neighborhood: about 30 percent of our population lives within a 30-mile radius of London.

The London triple transmitter is situated a dozen miles north of the capital at Brookman's Park. Until recently its 877-kc 100-kw middle-brow transmission has been poorly received in homes 40 miles or more away to the south, though in other directions reception has been entirely satisfactory. Fading after dark has been the main trouble. To combat this the BBC has just erected the last word in *antifading antennas*.

This takes the form of a 500-foot lattice-steel mast which can be readily tuned as a half-wave vertical radiator: 877 kc corresponds to 342.1 meters, or 1,122 feet. The mast is divided into two sections. The lower part, 400 feet in height, stands on 3 hollow cylindrical insulators, each 1 foot high. Between the two sections of the mast is another

triplet of low-capacitance insulators.

At the junction between the two sections is a platform carrying a variable inductor. At the top of the upper section are radial booms, each 30 feet long, made of tubular steel and joined at their ends by peripheral wires. The ends of the booms are telescopic. The booms and their wires form an adjustable capacitance loading.

The variable inductance coil is connected between the upper and lower portions of the mast. With these and the telescopic booms at the top the inductance and capacitance loading can be so regulated as to provide that distribution of current in the antenna which gives the desired elevational polar diagram, with maximum ground wave and minimum sky wave.

The radiator thus can be closely adjusted to secure the greatest possible no-fading range. The new antenna has proved highly successful, perfectly steady reception being now secured in large areas where fading was once prevalent.

## Fishing by radar

Around the coasts of Britain swim vast shoals of herrings, which move always in a clockwise direction as they make their interminable circuits of these islands. So persistent is the instinct inherited through millions of years that herrings placed in a glass aquarium tank continue to circle it clockwise as long as they live. The fishing fleet follows them round the coast, starting its annual voyage off the northwest coast of Scotland and working its way right around. The fishermen have now pressed into their service the echo-sounding machine, which works on the radar principle. One of their big difficulties is that the shoals swim at different depths at different times. When they are near the surface it is not difficult to locate them visually; but often they travel considerable distances at great depths. Then the fishermen might spend days finding them by ordinary methods. The principle of the echo sounder is well known. In the Marconi Visagraph type an audio oscillator transmits waves straight downward from the bottom of the ship. These rebound from the sea floor and are picked up by a receiver. It passes them through an amplifier to a visual indicator, recording the travel time of the waves translated into depths. It has been found that if there is a shoal of fish below the ship, two echoes are received, a strong one from the sea floor and a fainter one from the fish. The instrument has been adapted to give a continuous graph, showing the depth at which the shoal is moving. By steaming to and fro a vessel can ascertain the

size of the shoal from the area which it occupies. The echo sounder is now being used most successfully for locating not only herring shoals, but also those of other fish.

## Planes and television

At one time it was believed that radio relays would be used as links between  
(Continued on page 67)

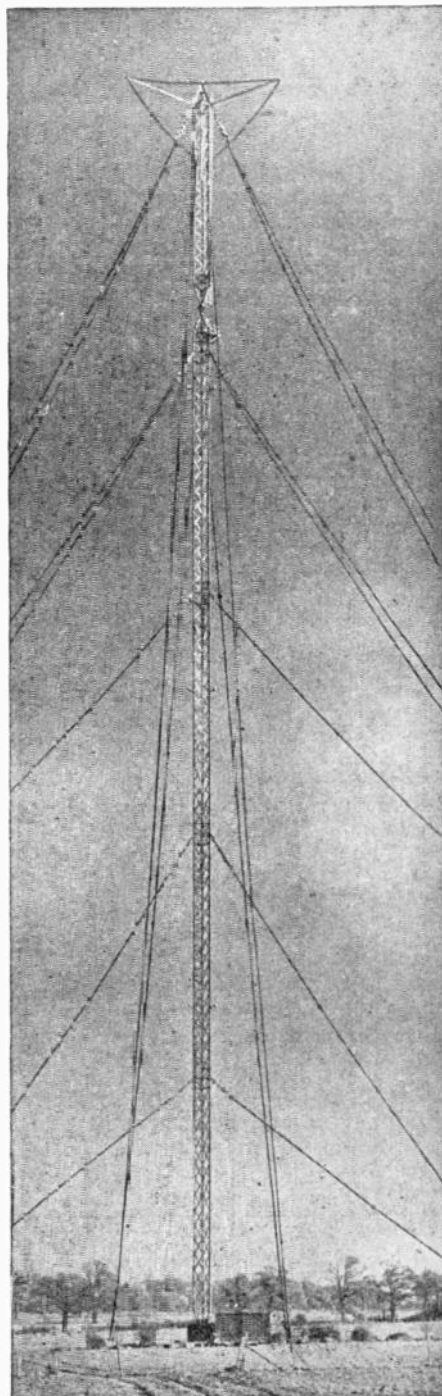

Courtesy British Insulated Callendar's Cables, Ltd.  
The BBC's two-section anti-fading antenna.

# RADIO DATA SHEET 345

## ADMIRAL MODEL 6RT44-7B1



### FEATURES:

Automatic Record Changer

7-Tube Receiver

2-6SK7

6SA7

2-6SQ7

6V6

5Y3

Aeroscope Antenna

Two Tuning Bands

535 to 1600 kilocycles

9 to 12.5 Mc. (25 and 31 meter short-wave band)

Cabinet

20 inches wide, 12 $\frac{3}{4}$  inches high, 18 $\frac{5}{8}$  inches deep

### ALIGNMENT PROCEDURE

1. Loop must be connected during alignment. Check the set screws that hold the tuning drum to the shaft to see that they are tight and that the drum has not slipped on the shaft. The correct position of the drum can be seen on the manufacturer's stringing diagram.
2. In the closed position the stop on the rear of the dial drum must be against the stop post.
3. With the gang wide open, all slugs should be  $\frac{1}{8}$  inches out of their coil forms. If there is any serious deviation or if there has been any tampering, turn the adjusting screws until this distance is correct.
4. Be sure both the set and the signal generator are thoroughly warmed up before starting alignment.
5. Turn receiver Volume Control full on.
6. Use lowest output setting of signal generator that gives a satisfactory reading on meter.
7. Proceed in sequence as outlined below.

Step	Connect Signal Generator To	Dummy Antenna Between Radio and Signal Generator	Signal Generator Frequency	Tuning Gang Setting	Adj. Trimmers in Following Order to Max.
1	Set Band Change Switch to Broadcast		455 kc	Set Pointer to Upper Limit	A, B, C, D
	6SA7 Pin No. 8	0.1 Mf			
2	Before proceeding to step 3 check pointer travel as outlined in manufacturer's data under "Pointer Adjustment."				
3	Black Loop Lead	20 MMf If not available wrap several turns of generator lead around the black loop lead.	1605 kc	Set Pointer to Upper Limit	E, F, G
4	Black Loop Lead		1300 kc	Set Pointer to 1300 mark on Slide Rail	H, I, J
5	Set Band Change Switch to Short Wave Position.				
6	Black Loop Lead	400 ohms	12.5 mc	Set Pointer to Upper Limit	K, L, M
7	Black Loop Lead	400 ohms	12.0 mc	Set Pointer to 1300 mark on Slide Rail	N, O, P

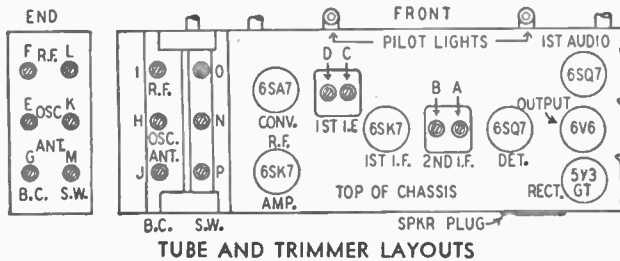

TUBE AND TRIMMER LAYOUTS

### REPLACING TUNING SLUG

If it becomes necessary to change a tuning slug proceed in the following manner: Set the gang to its wide open position, unsolder and remove the old slug. Set the slug adjusting screw about half way down. Place the new slug in such a position that  $\frac{1}{8}$  inches of its length is above the coil form. Solder it in this position, making sure that it does not slip during the operation and that the slug wire is straight. Proceed to realign the set as shown in the chart.

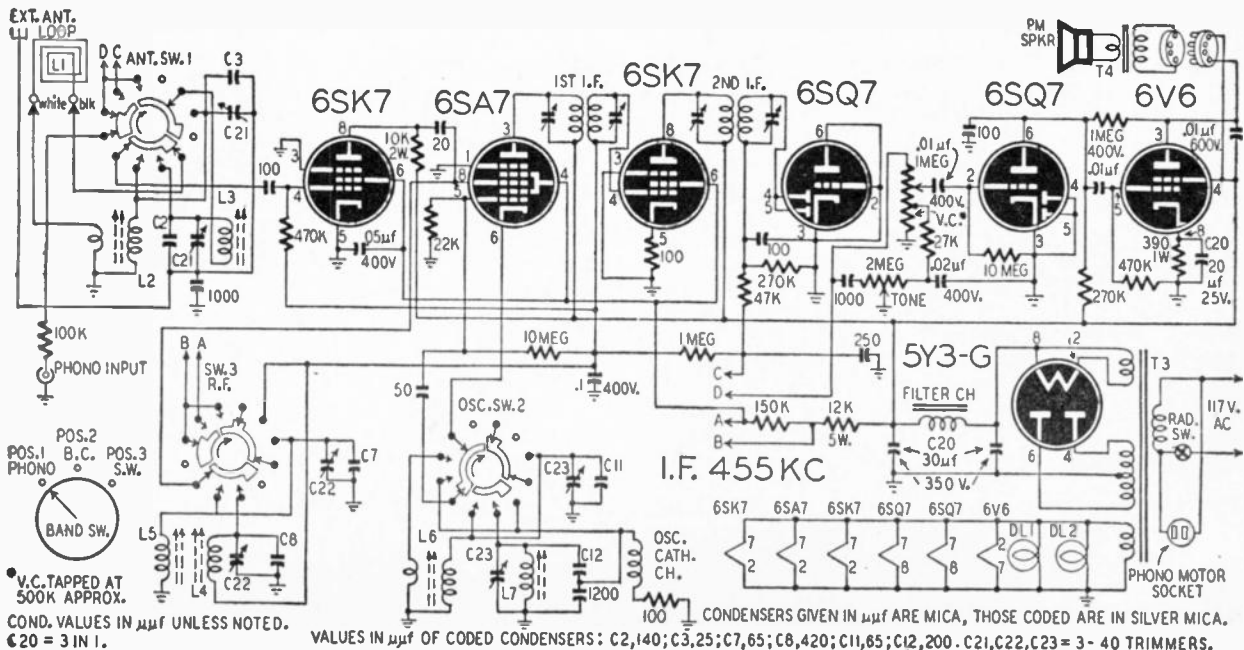

COND. VALUES IN  $\mu$ f UNLESS NOTED.  
C20 = 3 IN 1.

VALUES IN  $\mu$ f OF CODED CONDENSERS: C2, 140; C3, 25; C7, 65; C8, 420; C11, 65; C12, 200. C21, C22, C23 = 3-40 TRIMMERS.



Television today is clearer, sharper, and brighter—thanks to the improved kinescope, or picture tube, perfected at RCA Laboratories.

## ***The Picture Tube that brought "life" to television***

The screen on your home television table model receiver is the face of a large picture tube. And the skater you see on the face of the tube is the *identical twin* of the skater being televised.

Pioneering and research in RCA Laboratories led to the development of this tube which allows none of the original realism to be "lost in transit." It reproduces everything the television camera sees, shows you every detail, keeps the picture amazingly lifelike and real.

An RCA Victor television receiver brings you all the action, drama and ex-

citement that you'd enjoy if you were at the event in person—and on top of that it's all brought to you in the comfort of your own home . . . you don't have to move from your favorite chair.

RCA Laboratories has made possible outstanding advances in every phase of television. And for television at its finest, be sure to select the receiver bearing the most famous name in television today—RCA Victor.

*Radio Corporation of America, RCA Building, Radio City, New York 20. Listen to the RCA Victor Show, Sundays, 2:00 P. M., Eastern Standard Time, NBC Network.*



Exclusive "Eye-Witness" feature on all RCA Victor home television receivers "locks" the picture in tune with the sending station. It assures you *brighter, clearer, steadier* pictures. If television is available in your vicinity, ask your RCA Victor dealer for a demonstration.



**RADIO CORPORATION of AMERICA**

# TRANSVISION TELEVISION KIT

Offers you a High Quality  
TELEVISION RECEIVER

Ready for Easy,  
Rapid Assembly

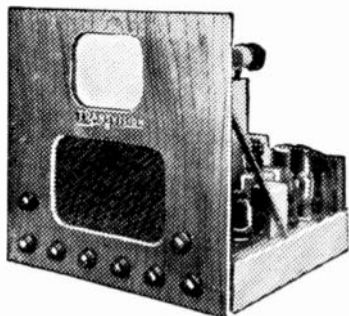

Easy-to-Assemble: No knowledge of television required. COMPLETE easy-to-follow INSTRUCTION SHEET gives you all the knowledge you need.

This Kit INCLUDES SOUND, all component parts, and the following:—

1. Specially designed Television Antenna.
2. A \$30.00 Lectrovision seven-inch Picture Tube . . . plus ALL other tubes.
3. Pre-tuned R-F unit.
4. Finished front panel.
5. All solder and wire . . . and sixty feet of low loss lead-in cable.

Operates on 110V.: 50-60 cycles A.C.  
COMPLETE KIT  
Your cost **\$159.50**

PLAY THE  
*Recorded Music*  
YOU LIKE—when YOU LIKE  
with the new Post-War

WEBSTER  
Model 50  
**\$21.60**



Compact and efficient, this new record changer gives trouble-free operation, true fidelity of reproduction, and is gentle to records.

**IMMEDIATE INSTALLATION**  
We can now add phono-music to your radio or replace your old record changer with a new Webster Model 50. Drop in today and talk it over.

10% DEPOSIT WITH ALL ORDERS

**ALMO**  
Covers the Globe

509 ARCH STREET  
PHILADELPHIA 6, PA.

LO 3-0513

LO 3-4559

# DE LUXE PHONO OSCILLATOR

RECENTLY we constructed several phono oscillators using the 6A8, 35L6, and 117L7 in various circuits. All of these were found to be lacking in some respect.

It occurred to us that an electron-coupled oscillator with a resonant plate should work well when high-level modulation is applied to the control grid.

In its final form, the oscillator was a 12SA7 with a tapped coil in a conventional e.c.o. circuit. The plate circuit was fed through the secondary of a single-layer broadcast-band antenna coil. The grid and plate coils are mounted at right angles to each other to pre-

vent interaction between the circuits which will cause unstable operation.

with a very sensitive portable receiver and a good signal was heard up to 80 feet. At 100 feet, it could hardly be heard and it was inaudible at 125 feet. An oscillator of this type may radiate for quite some distance. The FCC formula (157,000 divided by the frequency in kilocycles) is used to determine the maximum legal radiation distance in feet. If the unit is operated on 1500 kc, the distance would be  $157,000 \div 1500$  kc or 105 feet. If the signal can be heard at this distance, the length of the antenna should be reduced. Under no circumstances can it be allowed to interfere with any other person's re-

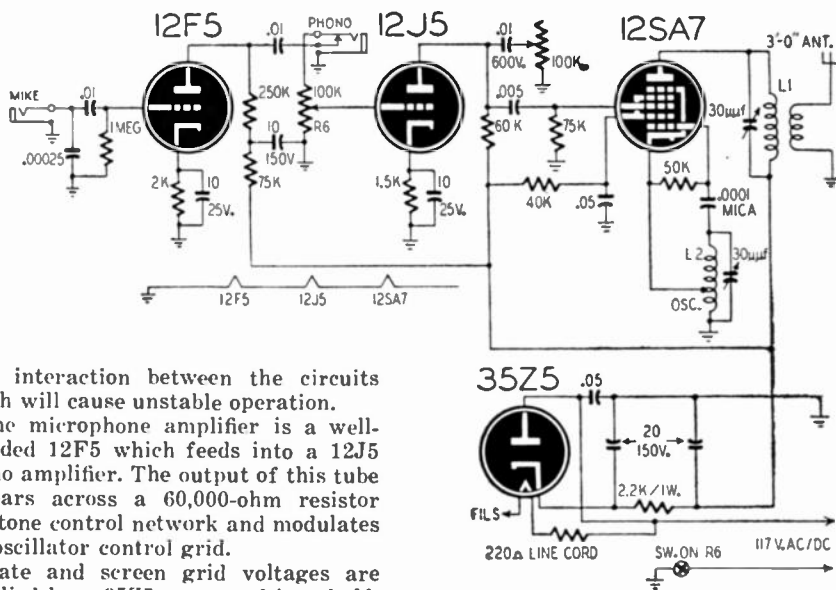

vent interaction between the circuits which will cause unstable operation.

The microphone amplifier is a well-shielded 12F5 which feeds into a 12J5 phono amplifier. The output of this tube appears across a 60,000-ohm resistor and tone control network and modulates the oscillator control grid.

Plate and screen grid voltages are supplied by a 35Z5 connected in a half-wave rectifier circuit.

All parts are mounted on a 10-inch chassis to prevent crowding. Shielding grid leads and running filament wires close to the chassis and well away from grid and plate leads will reduce hum in the microphone amplifier circuit. No fader control was used since we did not plan to use the microphone and phonograph at the same time. When the phono jack is plugged in, the output lead from the 12F5 is opened.

The oscillator is turned on and allowed to warm up for a short period. A broadcast receiver is tuned to a clear channel around 1,500 kc. (In some areas a suitable clear channel cannot be found on the high end of the band. In this case a 350- $\mu$ f trimmer should be used across the plate coil and a 500- $\mu$ f trimmer across the oscillator coil.—Editor)

The oscillator trimmer is tuned until the carrier hiss is heard. Modulation is applied from a phonograph and the plate trimmer adjusted for maximum volume. If the radio has a tuning indicator, the trimmer adjustment is made for maximum needle deflection or minimum shadow. An antenna less than a yard long may be connected to the primary of the antenna coil.

The audio amplifiers provide more than enough output to modulate the oscillator fully. The oscillator was tested

reiver, even within the 105-foot distance, as such interference immediately makes it illegal. In almost every case, too much radiation is caused by too long an antenna. Cut it down or take it off altogether! It is also a good idea to operate the oscillator as close to the receiver as convenient, making strong radiation unnecessary.—W. G. Eslick

## U.H.F. RECORD REACHED

Highest frequencies used in television transmission have now attained almost a billion megacycles, according to a report from the Allan B. Du Mont Laboratories. The high-frequency waves are, of course, ordinary light which is being used in a new system of relaying television programs. A cathode-ray tube is used to transmit the television-modulated light beam, and a photocell to receive it and turn it back to electric impulses for retransmission from local television stations.

The light-beam technique, according to Dr. T. T. Goldsmith, director of research for the laboratories, will make possible a marked reduction in the cost of inter-city television broadcasting, will simplify the sending of color, and will improve the fidelity of telecast images.

*Now Available for Immediate Delivery!*

**THE NEW MODEL 670**

# SUPER-METER



The Model 670 comes housed in a rugged, cradle-finished steel cabinet complete with test leads and operating instructions. Size 5 1/2" x 7 1/2" x 3".

**\$ 28<sup>40</sup>**  
NET

*A Combination*

**VOLT-OHM MILLIAMMETER  
plus CAPACITY REACTANCE  
INDUCTANCE and  
DECIBEL MEASUREMENTS**

*Added Feature:*

The Model 670 includes a special GOOD-BAD scale for checking the quality of electrolytic condensers at a test potential of 150 Volts.

*Specifications:*

D.C. VOLTS: 0 to 7.5/15/75/150/750/1,500/  
7,500 Volts  
A.C. VOLTS: 0 to 15/30/150/300/1,500/3,000  
Volts  
OUTPUT VOLTS: 0 to 15/30/150/300/1,500  
3,000 Volts  
D.C. CURRENT: 0 to 1.5 15/150 Ma. 0 to 1.5  
Amperes  
RESISTANCE: 0 to 500/100,000 ohms 0 to 10  
Megohms  
CAPACITY: .001 to .2 Mfd. .1 to 4 Mfd. (Quality  
test for electrolytics)  
REACTANCE: 700 to 27,000 Ohms 13,000 Ohms  
to 3 Megohms  
INDUCTANCE: 1.75 to 70 Henries 35 to 8,000  
Henries  
DECIBELS: -10 to +18 +10 to +38 +30  
to +58

PLEASE PLACE YOUR ORDER WITH YOUR REGULAR RADIO PARTS JOBBER. IF YOUR LOCAL JOBBER CAN-  
NOT SUPPLY YOU, KINDLY WRITE FOR A LIST OF JOBBERS IN YOUR STATE WHO DO DISTRIBUTE OUR  
INSTRUMENTS OR SEND YOUR ORDER DIRECTLY TO US.



**SUPERIOR INSTRUMENTS CO.**

**Dept. RC 227 FULTON ST., NEW YORK 7, N.Y.**

I'll Train You Quickly—at Home—in Your Spare Time—to Make More Money in the Fastest Growing Industry in the World!



WHO SAID IT COSTS A LOT OF MONEY TO LEARN RADIO ELECTRONICS?

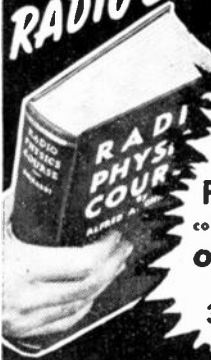

Ghirardi's Famous RADIO PHYSICS COURSE costs you only \$5 complete and it is complete! 36 BIG COURSES IN ONE!

**FOR BEGINNERS!**

No previous experience needed

Send coupon today! Examine Ghirardi's big, 972-page RADIO PHYSICS COURSE for five full days. See how this one giant book at ONLY \$5 can give you complete, basic training to pave the way for a brilliant future in Television, Radio, Frequency Modulation, Facsimile, Broadcasting, Communication, Servicing, Industrial Electronics, etc. Prove to yourself that training doesn't need to be expensive to be really good!

**9 OUT OF 10 RADIO MEN CAN'T BE WRONG!**

Actually, this famous book has given more people their start in Radio-Electronics than any other book or course ever published. On an actual survey among 817 men already in radio, 724 of them 9 OUT OF 10 answered that Ghirardi's RADIO PHYSICS COURSE is their choice as the finest, easiest to understand training on the market—and far better than any other book or course they have ever seen!



**LEARN FAST! LEARN RIGHT!**

... as fast as you can read! You'll be pleasantly surprised how RADIO PHYSICS COURSE helps you master subjects that other courses make seem very complicated. Starting with Basic Electricity—over 300 pages—it takes you through the entire Radio-Electronics field. Everything is omitted or condensed. You buy it for only \$5 complete—ON OUR MONEY BACK GUARANTEE. You progress as fast as spare reading time permits. Many students have completed it in a few weeks. 972 pages, 508 illustrations and 856 self-test review questions make study doubly easy. Rush coupon. You cannot lose!

**'BORROW' IT FOR 5 FULL DAYS!**

**MAIL ORDER—Rush Coupon**

D. P. RC-47, Murrey Hill Books, Inc., 232 Madison Ave., New York 16, N. Y.

Enclosed find \$5.00 (or more) for Ghirardi's 972-page RADIO PHYSICS COURSE book; or \$5.00 for 5 full days postage and forwarding (C.O.D.). In either event, if not satisfied, it is understood I may return book in 5 days for complete refund of my money.

Name .....  
Address .....  
City & Zone ..... State .....

**MONEY-BACK GUARANTEE**

**NEGLECTED SERVICEMEN**

*An appeal for more service from the Distributor*

By E. H. EHLE\*

WHAT is the most important tool or piece of equipment in the radio parts industry? The soldering iron! Most industries depend on certain fundamental methods of connection: the plumber relies on screw threads; the electrical industry clamps its connections. In our industry (with the possible exception of tubes to sockets) every connection must be soldered.

Recognition of the relationship of the number of soldering irons in use and the length of time each is functioning to the volume of business done by distributors and parts manufacturers leads to a series of interesting questions and conclusions. What are we, as an industry, doing to keep the soldering iron hot and in operation? What are any of us doing to make certain that more parts are soldered in more places hourly? Over 70 distributors in 22 states agreed that:

1. The serviceman spends about half his time—4 to 5 hours a day—at the bench.
2. Most servicemen could use additional personnel at the bench.
3. Servicemen have an average of about one week's work ahead of them.
4. Less than 10 percent are aggressively selling radio service.
5. Those who sell appliances probably will go for the quick dollar when appliances are available and consider the bench a "poor relation."

Remember, these are averages, but averages—not exceptions—make up our national volume of business.

The serviceman wants to work from 8:30 am to 5:00 pm, but he is in a fast-moving industry full of new ideas. He wants to see new products! Must he be forced to do so during his productive time? Or should distributors take a leaf from the books of our most successful merchants, and arrange to open at noon and stay open till 10:00 pm once or twice a week?

The serviceman wants an adequate supply of parts. Has he had them? No! Why are his inventories—and those of his distributor—lean? Because he and the distributor recognize that some parts prices may be too high. If true, the condition should be corrected. If not, both distributor and serviceman should be told, so they may rebuild inventories safely and have available parts on hand, thus saving man-hours at the bench.

The sale of vacuum-tube devices will expand only to the degree they can be kept in service. Industrial and commercial applications for electronic time-and-money-savers must depend on the availability of standard repair parts and an organization of men who can use these parts intelligently and quickly 24 hours a day. None of us would use

indoor plumbing unless we were confident that both repair parts and a plumber were immediately available. The same holds true for electronic devices.



Mr. E. H. Ehle, author of this article.

The serviceman will grow to whatever stature necessary, or, if the occupation is established as a legitimate community function with industry backing, others will be attracted who can be counted on to do their share in the forthcoming electronic era. One of the best places to secure such trained manpower is from the ranks of the amateur or—to define him more clearly—the hobbyist. Here again the industry as a whole is neglecting a golden opportunity.

The average man with a few extra dollars and a hobby works from 9:00 am to 5:00 pm. He can't find time to talk to a distributor about a rig or parts to buy. No one is available to help or encourage him. In a very few instances is the distributor's "ham shack" open one night a week. Take a look at the other hobby stores in your community! They are holding their customers by merchandising methods geared to customer needs. Are we?

Consider these facts:

1. The plumber is a respected man in his community who has a place of business, operates his shop on a businesslike basis, and isn't afraid to look his banker in the eye.

2. The same is true of the filling station business, the electrical contractor, the painter, the plasterer, the paper hanger, the carpenter, and a host of other small businessmen.

3. What are you as a distributor or your organization doing to:

(a) Provide adequate business and technical training to servicemen and would-be servicemen?

\*Vice-President, International Resistance Co., Philadelphia, Penna.

- (b) Select with care servicemen you sell?
- (c) Help these servicemen you do select to handle their operations on a businesslike basis?
- (d) Help them develop more business?
- (e) Encourage the interest of a higher-type personnel in electronic service as a profession?
- (f) Elevate the standing of the service business to a professional status?

4. Are you training your salesmen to help their service accounts in such problems as:

- (a) Proper stocking of repair parts.
- (b) Improved appearance of their stores.
- (c) Proper window and store decorations.
- (d) How to greet and handle customers.
- (e) How to go after the hundreds of thousands of radio sets requiring service now.
- (f) How to justify and get a loan at the bank.
- (g) Proper charge for repairs.
- (h) Proper setup of shop including recommended test equipment.
- (i) How to collect overdue accounts.

These are but a few questions and suggestions concerning a rapidly developing business. I hope they will serve to stimulate further thinking and action which will benefit the service profession and the independent parts distributor, and will accelerate the introduction and use of many new electronic devices.

Condensed from the NEDA Bulletin.

### BRITISH AMATEUR CALLS

American radio fans have curious ideas about certain aspects of British ham life. Even the Call Book blunders badly in referring to our "Districts" based on the number contained in the allotted call signs. These numbers have no significance, and thus it is possible to find G2, 3, 4, 5, and 6 all in the same town! Don't ask why! That's the way the Postmaster General issued them; they started with the 2's and worked up!

Then again, there are the three-letter calls, another source of perplexity to U.S. hams. Prewar transmitting licenses were issued without examination, other than the applicant satisfying the Postmaster General that he needed it for experimental purposes. If everything was satisfactory, an A.A. (artificial aerial) license was issued together with a three-letter call. This permitted playing round with transmitting gear using an artificial aerial only. Further application was needed for a full radiating license and this was usually granted after six months or so, following a code test.

A.A. licenses now have been discontinued and applicants have to pass two tests, technical and code. Exemption may be permitted in either or both, if the applicant can produce recognized qualifications proving his proficiency. Many of the three-letter calls now on the air are prewar A.A. license holders who do not have to take the technical test.

The examination consists of a 3-hour paper set by the City and Guilds of London Institute, and is held periodically at a number of centers throughout the country. In the first, 145 of the 182 candidates passed.—*R.E.G. Coop.*

**FREE send for it now!**

**VALUE-PACKED**

# ALLIED'S NEW RADIO CATALOG



### EVERYTHING IN RADIO FOR EVERYONE IN RADIO!

Send for your FREE copy of the handiest, most complete Buying Guide for Everything in Radio! Packed with the latest, finest values in radio and electronic supplies . . . parts, tubes, test instruments, communications receivers, Ham gear, Public Address equipment, home radios, tools, books . . . more than 10,000 items of nationally known, guaranteed quality . . . the world's largest and most complete stocks. For fastest service, expert help, lowest prices, depend on ALLIED! Send for FREE Catalog now . . .

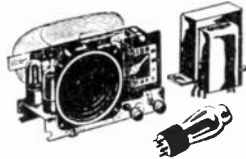

**MORE THAN 10,000 ITEMS.** Everything in radio and electronic supplies to serve the needs of engineers, servicemen, dealers, soundmen, amateurs, and builders. Complete stocks of all the leading makes. Guaranteed quality. Lowest prices. Get everything you need from one dependable source—ALLIED—Radio's Leading Supply House for everyone in Radio!

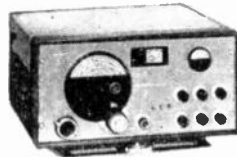

#### HAM GEAR

Earliest delivery on latest communications receivers, transmitters and Amateur station equipment. Time payment plan; trade-ins accepted. Expert Amateur Service.

#### HOME SETS

New 1947 radios and radio-phonos. Radios for radio men! Handsome styles. Wonderful performance. Outstanding complete line of radio values!

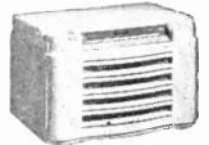

**NEW P. A. EQUIPMENT.** Entirely new line of complete Packaged Sound Systems for every public address requirement. New styling, new design features. Everything in amplifiers, speakers, microphones, accessories. New intercom systems. New professional-type sound apparatus. Everything for the Soundman!



#### HANDY RADIO BOOKS

- Radio Formulas and Data . . . . . 10c
- Dictionary of Radio Terms . . . . . 15c
- Radio Circuit Handbook . . . . . 25c
- Radio Builders' Handbook . . . . . 15c
- Simplified Radio Servicing . . . . . 10c
- Radio Data Handbook . . . . . 25c
- ALL 6 BOOKS No. 37-799 . . . \$1.00

#### HELPFUL CALCULATORS

- These radio reference aids provide valuable data quickly:
- Parallel Resistance and Series Capacitance Calculator, No. 37-980 . . . 25c
- R-F Resonance and Coil Winding Calculator, No. 37-955 . . . 25c

ALLIED RADIO CORP.  
833 W. Jackson Blvd., Dept. 2-D-7  
Chicago 7, Illinois

**FREE**

- Send FREE 1947 RADIO CATALOG
  - Send Books checked above
  - Send 6 Books No. 37-799
  - Send Calculators checked above
- } S.....enclosed

Name.....  
Address.....  
City.....Zone.....State.....

# ALLIED RADIO

*Everything in Radio and Electronics*

# SILVER "VOMAX"



IMITATION . . .  
SINCEREST OF  
FLATTERY

The true worth of "VOMAX" is proven not alone by overwhelming preference by service technicians, by research laboratories. It gets top rating through the copying of its new inventions by at least four manufacturers! No imitation provides the range, utility or universality exclusive to "VOMAX". Recognized by those "in the know", sales of "VOMAX" far exceed those of any would-be competitor. So, cost to you of the genuine, original "VOMAX" is from 10% to over 65% lower than its imitations. Only \$59.85 net.

So superior as to be imitated, "VOMAX" stands unequalled. It alone gives you the astronomically high meter input resistance so necessary to servicing AM, FM and TELE receivers — a feature not obtained by imitations. Add a total of 51 voltage, current, resistance and db. ranges. That's why "VOMAX" is the overwhelming choice of experts — be it for use or copying. Can you afford less than the best — when the best costs you least?

# "SPARX"

"QUICKEST TROUBLE  
FINDER EVER"

says J. P. FITZGERALD



... of his new "SPARX" visual-aural dynamic signal tracer, writing from Madison, Wisc.: "I cannot afford to be without this valuable instrument one minute. It is the quickest trouble-finding apparatus I have ever used." To repair any radio you've first got to find the trouble. "SPARX" will locate r.f., i.f., a.f. trouble in 30 seconds per tube! Think what that means in profits to the thousands of your competitors already using "SPARX". It will boost your profits, too . . .

"SPARX" is the same great "buy" at only \$39.90 as "VOMAX", world's most popular, most copied, universal vacuum-tube voltmeter. Of matching size and style, thousands in use prove its vital worth to every service technician interested in guarding his profits. "SPARX" traces signals through a receiver from antenna to speaker, circuit by circuit, locating trouble points, both audibly and visually. Its speaker switches to panel jacks for shop test use — another SILVER plus-value.

Send Post Card for Catalog for new measuring equipment, communication receivers, transmitters, kits, parts. See them at your favorite Jobber.

OVER 36 YEARS OF RADIO ENGINEERING ACHIEVEMENT

*McMurdo Silver Co., Inc.*

1249 MAIN ST., HARTFORD 3, CONNECTICUT

## HEAT-OPERATED "RADAR"

THE idea of using heat radiation to detect the presence or approach of a body was presented to the Patent Office in April, 1934. A patent for it was recently issued to Harold A. Zahl of Fort Monmouth, N. J., who has assigned it to the U. S. Government as represented by the Secretary of War. The length of time involved suggests that this idea may have been kept as a war secret for some time.

The detection of a target by heat-wave radiation seems entirely feasible. The greatest distance known to have been covered by radio waves is only from the earth to the moon and back, whereas for a number of years astronomers have measured the heat radiation from stars too distant to be visible.

Heat radiation is indicated by a thermopile which consists of a large number of thermocouples in series. Either antimony and bismuth or bismuth and silver are sensitive couples. It is possible to measure a less than .00001-degree change by suitable circuits. Ordinarily the thermopile works into a sensitive direct-current meter, but when the d.c. is interrupted and amplified much greater sensitivity is obtained.

To eliminate the background of ambient temperature which would be measured otherwise, Mr. Zahl has conceived the idea of using two similar thermopiles to buck each other. Therefore, when no heat-emitting or heat-absorbing body is present, the indication is zero as shown in Fig. 1. The two collectors are parabolas resembling microwave radar antennas (Fig. 2).

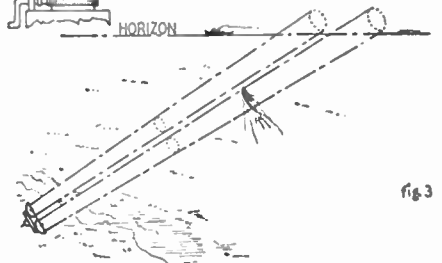
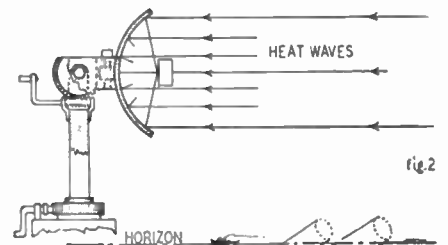
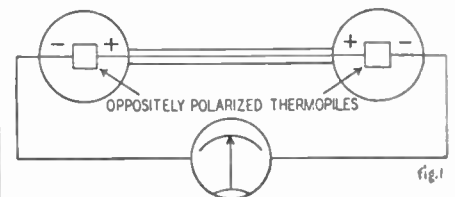

The presence of a body is indicated in one of two ways: either through direct radiation from the body, such as a smokestack of a ship (See Fig. 3.) or through absorption of temperatures when the reflector is aimed at sky, landscape or sea.



The waves detected include those of infra-red frequencies, and the method is effective at night, during fogs, etc. The possible range is equal to that of radar u.h.f. systems.

A disadvantage of heat detection is that the distance of the object is unknown unless two stations are used and triangulation resorted to. On the other hand, this method is far more simple and less costly than radar.—*I.Q.*

### AVAILABLE LITERATURE

You may secure copies of these bulletins simply by listing their numbers on your letterhead (do not use post-cards) enclosing remittances where necessary, and mailing to *Available Literature*, c/o RADIO-CRAFT, 25 West Broadway, New York 7. This saves the work of writing separate letters to each manufacturer.

#### 265—RADIO SYMBOLS GUIDE

A two-page pamphlet prepared and distributed by Sun Radio and Electronics Co. It reproduces symbols that have been standardized by the ASA and includes symbols for such late electronic developments as velocity modulated tubes, ignitrons and magnetrons.

—*Gratis*

#### 266—STANDARD RATE BOOK

A booklet suggesting standard rates for radio servicing, based on Chicago. Published by Oelrich Publications. Labor is calculated at \$3.00 per hour, and various bench and minimum charges suggested. Of the 44 pages of the booklet, 26 are devoted to proposed charge schedules for various types of radio apparatus, with listings of general service to be performed.—*Price \$1.00.*

#### 267—ELECTRON TUBE GUIDES

Two 15-page tube guides are published by RCA. Form PG-101 gives characteristics and tube-base connections for transmitting-type power amplifiers as well as voltage regulators, thyratrons, ignitrons, and gas rectifiers. Form No. 1275-C lists socket connections and characteristics of receiving-type tubes and some kinescopes. Light-face type is used on tube designations of discontinued tube types to indicate those tubes that soon may be obsolete.—*Price 10 cents each.*

### CORRECTION

An error appeared in the diagram of the "Multitester" Plus V.T.V.M." on page 83 of the January issue. The diagram shows the center terminal of the lower section of Sw1 connected to J1. This connection should be open and the line from J1 connected to the right-hand terminal of the lower section. This terminal was shown open on the original diagram.

In the third paragraph of the first column of the same page, Sw1 is called a d.p.d.t. switch. This is actually a double-pole three-position switch.

Our thanks to Mr. Joseph Jahoda, of Maspath, N. Y., for calling our attention to the error in the diagram.

# Announcing...THE NEW TURNER MODEL 20X HAND MICROPHONE

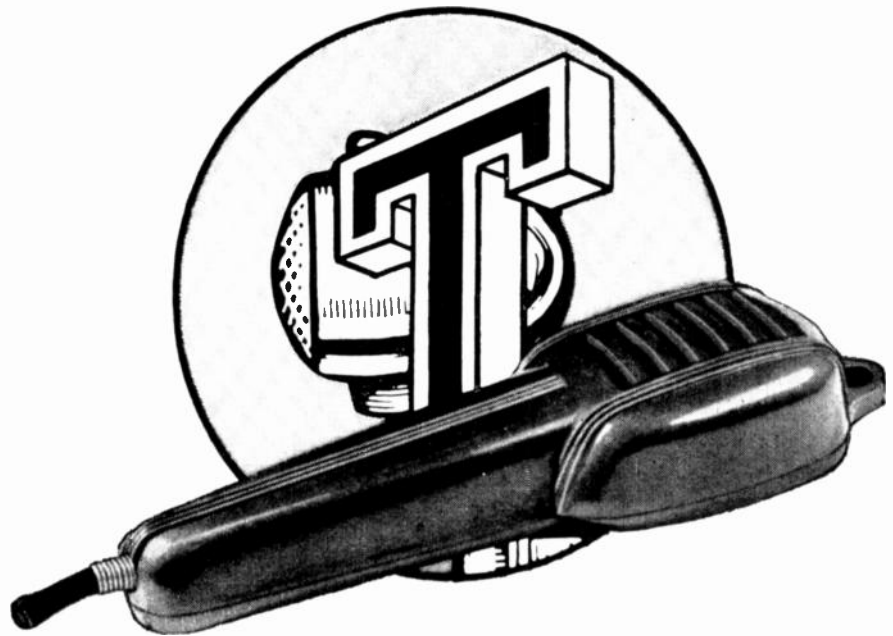

## a little mike with a **BIG** future

We're mighty proud of this new addition to the line of Microphones by Turner. Small in size yet *big in performance* it inherits those qualities of sound engineering and careful workmanship that have made the name Turner a symbol for precision and dependability.

The New Model 20X is designed to appeal to owners of home recorders and amateur communications equipment. It has innumerable applications in offices and factories and for paging and call system work. Sound pressure tests reveal remarkable performance characteristics for a low priced unit. Its circuit features a Metalseal crystal which withstands humidity conditions not tolerated by the ordinary crystal. Response to voice and music is smooth and flat within  $\pm 5$ db from 40-7000 c. p. s. Level is 54db below 1 volt/dyne/sq. cm. Finished in lustrous brown baked enamel, the Model 20X is light in weight and natural to hold. It may be hung on a hook. Furnished complete with 7 ft. attached shielded cable.

WRITE FOR BULLETIN

## THE TURNER COMPANY

902 17th Street N. E. • Cedar Rapids, Iowa

*Microphones* BY TURNER



"THE PASSWORD TO SOUND PERFORMANCE"

LICENSED UNDER U. S. PATENTS OF THE AMERICAN TELEPHONE AND TELEGRAPH COMPANY, AND WESTERN ELECTRIC COMPANY, INCORPORATED. CRYSTALS LICENSED UNDER PATENTS OF THE BRUSH DEVELOPMENT COMPANY.

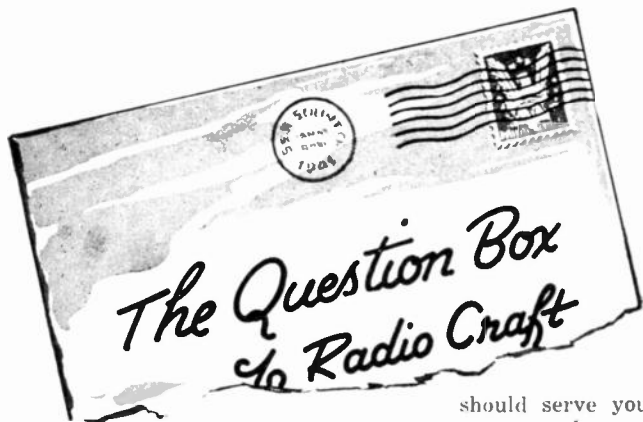

Question Box queries will be answered by mail and those of general interest will be printed in the magazine. A fee of 50c will be charged for simple questions requiring no schematics. Write for estimate on questions that may require diagrams or considerable research.

## BATTERY ELIMINATOR

Please print a diagram of an a.c.-d.c. power supply to be used with a Philco Model 37-38 battery receiver. The filament drain is 0.72 ampere at 2 volts. The high-voltage supply should give 135 volts tapped at 90 volts. The current drain is 20 ma. Bias requirements are 3 and 9 volts.—E.P.R., Cincinnati, Ohio

Here is a power-supply circuit that has been drawn to your specifications. Filament voltage is supplied by connecting a dry-disc rectifier across the output of a 6.3-volt 1-ampere filament transformer. CH 1 is made by removing the windings from a small choke and replacing this winding with as many turns of No. 22 enamel wire as can be wound in the core space. A 2-ohm variable resistor permits the filament voltage to be adjusted to 2 volts.

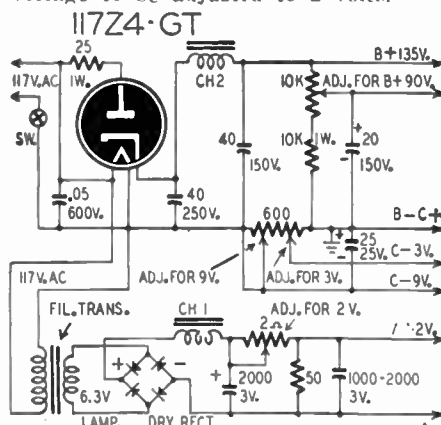

ALL FINAL VOLTAGE ADJ. MUST BE MADE AT FULL LOAD

Variable controls are provided for adjustment of intermediate B-plus voltage and bias voltages. All adjustments should be made under load.

Many of the exposed metal parts of this eliminator are live and should be insulated from bodily contact. Do not use an external ground on the receiver unless a blocking condenser is connected in the ground lead.

## DARKROOM TIMER

I would like to have a circuit showing how I may construct a visual and audible timer for use in a darkroom. I have a small a.c. power supply that delivers 240 volts at 40 ma. Can this be used to supply power for the timer?—F.D., Jersey City, N. J.

Here is a diagram of a timer that

should serve your purposes. The 1- $\mu$ f paper condenser charges at a rate determined by the setting of the 500,000-

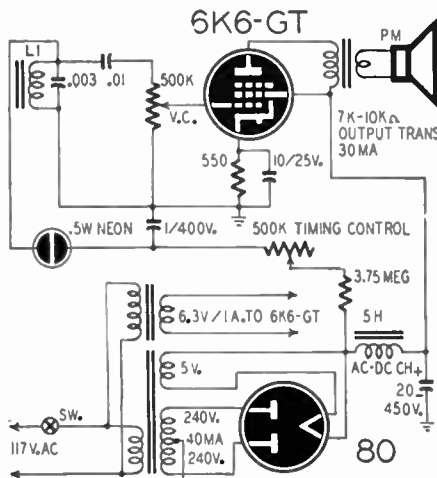

ohm timing control. When the charge on the condenser equals the ignition voltage of the neon bulb, the bulb ignites and discharges the condenser. The charging cycle begins again and will continue indefinitely. The charging and discharging surges will react on the grid circuit of the 6K6 to produce audible pulses with a tone determined by the inductance of choke and the capacity of the shunting condenser.

The tone choke L1 may be any high-impedance a.f. choke or one winding of an old a.f. transformer. If your power transformer does not have a 6.3-volt winding, a small filament transformer should be used.

## TUNER ALTERATIONS

I am planning to construct the hi-fi i.r.f. tuner described on page 401 of the March, 1946 issue. Can you suggest a means of replacing the diode detector with a 6J5 connected as an infinite impedance detector? I would like to retain

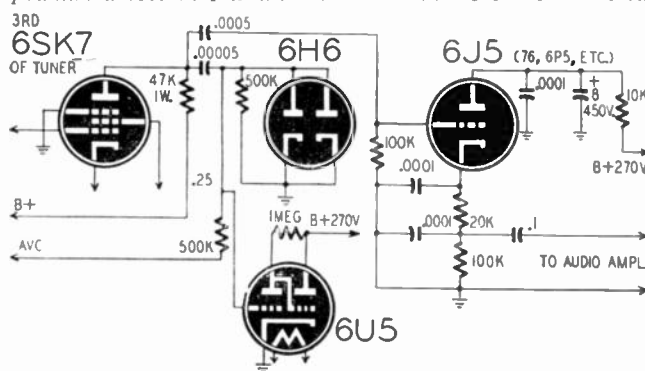

the 6H6 as a.v.c. rectifier and add a 6U5 tuning indicator. —H.R.E., Toronto, Canada.

The circuit shown has been drawn to your specifications. If the 6U5 overloads on comparatively weak signals, try connecting its grid to the opposite side of the 500,000-ohm resistor.

## COIL DATA

Please print coil data for the 1-tube set on page 467 of the April 1946 issue, to cover the broadcast band with a 365- $\mu$ f condenser.—B.A.G., Tuscaloosa, Ala.

The loop antenna may be wound with about 50 turns of No. 16 to No. 22 insulated wire. It is assumed that you are using a case which would give a loop size of about 3 by 4 inches. Turns may be added or removed to get proper coverage. The feedback tap is made at a point between 12 and 16 turns from the grid end as required to give stable regeneration. The other tuned circuit may use a standard r.f. coil.

## 1,000-CYCLE OSCILLATOR

I would like to have a diagram of a simple 1,000-cycle oscillator to use with the Electronic Multichecker described in the 1946 Radio Electronic Reference Annual.—C.J.H., Kansas City, Mo.

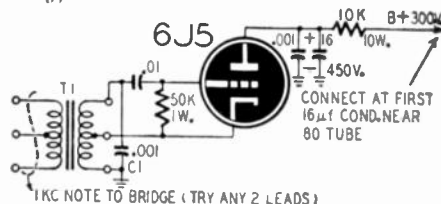

Here is a circuit of an oscillator that may be used as a source of 1,000-cycle current. The value of C1 will determine the frequency of the tone. If the inductance of T1 is 25 henries, the oscillator will tune to the required frequency with a 0.001- $\mu$ f condenser for C1.

T1 may be a push-pull inter-stage transformer or one designed to couple a pair of push-pull plates to a universal line. Any two leads on the output side of the transformer may be connected to the bridge.

**NEW!  
CRYSTRON LAPEL RADIO**  
(Continued from page 25)

The converter tube, like the hot-cathode types, is a multi-element device. A small Columbite rectifier crystal in its control-grid circuit rectifies the incoming signal and permits it to modulate the oscillations produced in the triode circuit.

The oscillator is a modified Hartley, with plate at r.f. ground potential. Because a condenser direct from plate to ground produced too strong oscillations, it was tapped off at a point on the plate resistor determined by experiment.

After mixing in the converter, the signal goes to the second tube, an i.f. amplifier hooked up in a bridged-T circuit, which is tuned very sharply to 100 kc. Gain measurements with a vacuum-tube voltmeter are hard to make because the meter loads the high-resistance circuits, but the stage has a gain of at least 100 and may be nearly twice that. The measuring difficulty is practically the same as that the serviceman experiences in ordinary receiver circuits with the old 1,000-ohm-per-volt meter.

The power amplifier has a larger radioactive element in its crystode, and has a lower amplification factor and internal resistance than the other tubes.

I revived the almost-forgotten condenser speaker for the little radio. This  
(Continued on page 57)

**MORE SMASH BUYS at  
National Radio Distributors**  
FAMOUS NATIONAL RADIO KITS

NOW—Immediate Delivery from stock

**COMPONENT PARTS MOUNTED ON CHASSIS FOR EASY WIRING**  
All Radio Kits complete, including beautiful plastic cabinet, built-in loop antenna, new Alnico speaker, and full instructions for assembly. For 110-125 volts AC/DC.



White Plastic Cabinets now available, \$1.00 additional.  
**MODEL N.R.-7-5 TUBE SUPERHETERODYNE**, uses 12SA7, 12SK7, 12SQ7, 60L6 & 35Z5 tubes. Your net \$11.95  
Kit of 5 Matched Tubes, new Alnico speaker, and full instructions for assembly.  
**MODEL N.R.-8-5 TUBE "TWO BAND" SUPERHETERODYNE**, uses Tubes as above.  
**BAND 1—550/1600 K.C.** Your net \$13.95  
**BAND 2—8/18 Megacycles** Your net \$13.95  
Kit of 5 Matched tubes Your net 4.50  
**MODEL N.R.-6-8 TUBE SUPERHETERODYNE**, uses 2-12SK7, 12SA7, 12SQ7, 35L6 & 35Z5 tubes. Your net \$13.75  
Kit of 6 Matched tubes Your net 5.50  
**MODEL N.R.-1-4 TUBE T.R.F.**, uses 50L6 & 35Z5 tubes. Your net \$10.95  
Kit of 4 Matched tubes Your net 3.50

**THIS MONTH'S SPECIALS**

**RADIO TUBES**: R.C.A., Konrad, National Union, Sylvania, Hytron, 12A7, \$1.75; 12L7, \$1.81; 50L6, \$3.83; 25L6, \$3.31; 25Z5, \$7.74; 35Z5, \$8.66; 50A5, \$1.50; 1LA6, \$1.81. These and other hard-to-get tubes available now.  
**F.T.R. Selenium Rectifiers**—75 ma. Ea. \$ .68, 6-40 Ea. \$ .80.  
**SPEAKERS**: 4" or 5" P.M. Alnico V Ea. \$1.49, 6" P.M. Alnico V Ea. \$1.99. Case lots of 20 deduct 10%.  
**CONDENSERS**: 100 Abt. 11 by-pass tubular type paper condensers, .00025 to .1 mfd. Absolutely fresh stock; all fully guaranteed; all 600 volt. Net \$5.95.  
**PHONO MOTORS**: Rim drive, self-starting, 9" turn-table for 110 V. AC. Alnico Ea. \$3.75. Rotor 11 Ballantine Ea. \$4.28.  
**VOLUME CONTROLS**: All sizes; from 5,000 ohm to 2 Megohms, WITH SWITCH. Ea. \$3.99, 10 for \$5.50.  
**PORTABLE RECORD CARRYING CASES**: Tab index; holds 50 records. Ea. \$2.25.  
**PORTABLE RECORD CARRYING CASES**: Solid Wood construction; leatherette covered. With index; holds 50 records; sturdy brass fittings; with lock & key. Ea. \$4.50.  
**BROILER CORDS**: 6' High & Lov sides. Heavy duty type for all type broilers. Ea. \$ .80, 10 for \$6.50.  
**AUTO ANTENNAS**: 3 section 66" long. A triple chromed Admiralty brass finish. Low loss lead. List \$4.00. YOUR NET Ea. \$1.79. Lots of 3 Ea. \$1.75.  
**ESSICO SOLDERING IRONS**: 65 Watt, Plug Tip Ea. \$1.85 100 Watt, Plug Tip, Ea. \$2.35

Write for **NEW FREE CATALOG**. It's just out. Please send at least 25¢ with order. We will ship balance C.O.D. We ship all over the world, usually same day as order is received. Cable address: Enardco, N. Y.

**National Radio Distributors**  
899 r Southern Blvd., New York 59, N. Y.

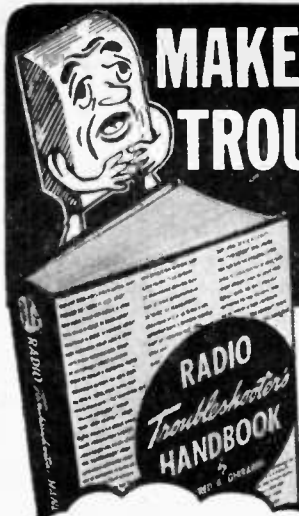

**MAKES 90 OUT OF 100 RADIO TROUBLES Easy to Repair!**

Complete, Easy Instructions for Repairing Common Troubles in Practically Every Model and Make of Radio in Use Today

**Eliminates Needless Testing—Enables You to Repair Two Radios in the Time Ordinarily Required for One**

What's wrong with the radio you want to repair? A defective transformer? Wiring insulation trouble? A faulty capacitor or resistor? Don't guess! Don't waste time in needless, tedious testing! Just look up that particular make and model in Ghirardi's famous **RADIO TROUBLESHOOTER'S HANDBOOK**. Nine times out of ten, this big book will tell you exactly what is wrong—and exactly how to repair it. You don't have to be an expert to use the **HANDBOOK**—and there's no better way of getting invaluable, practical service training.

**TELLS WHAT TO DO EXACTLY HOW TO DO IT**

As valuable to a radio repair man as a recipe book is to a cook!

**\$5**

744 big, manual-size pages!

**PAYS FOR ITSELF ON THE FIRST JOB!**

Over 400 pages are chock-full of this factual Case History repair data on over 4,800 receivers, auto radios and record changers of 202 different manufacturers—practically every radio set in use today! Over 300 additional pages contain hundreds of repair charts, tube charts, data on tuning alignment, transformer troubles, tube and parts substitution data, color codes—all designed to help you repair any radio ever made **EASIER, BETTER and FASTER**. Ideal for either busy service shops or for beginners. Only \$5 complete—on our 5-Day Money-back Guarantee basis.

**DO EVERY JOB EASIER, BETTER, FASTER**

Ghirardi's **RADIO TROUBLESHOOTER'S HANDBOOK** (above) is the ideal book for training new helpers, repairing either cheap or expensive sets quickly and profitably, eliminating needless test time and equipment—and **MAKING MORE MONEY**.



**ALL THE SCIENCE OF RADIO-ELECTRONIC SERVICING IN ONE GIANT BOOK**

**LEARN AT HOME ...without an Instructor**

Alfred A. Ghirardi's **MODERN RADIO SERVICING** gives you a **COMPLETE, MODERN EDUCATION** in truly professional radio-electronic service methods of the kind that will be your "Open, sesame!" to the big-money opportunities that only well-trained servicemen are in a position to grasp. It is a complete, scientific servicing course from A to Z. You'll be surprised how easily understandable it makes every phase of the work even if you have had no previous service training. And, if you are already in the business, you'll be pleased to learn how this big 1300-page book will serve as a "refresher" course. Not only will it help you handle repair jobs quicker, better and more profitably, but it also will give you the necessary basic training to equip you for profitable industrial electronic work. Specifically written and designed for home study. 1300 pages; 706 clear illustrations. 720 Self-Test Review Questions make it easy for you to check your progress every step of the way. Fully indexed. Only \$5 on our famous 5-Day Money-back Guarantee.

1300 pages  
Over 500 illustrations!



**ENDORSED BY EXPERTS**

**MODERN RADIO SERVICING** brings you the kind of professional "Know How" that will pay big dividends for years to come. Covers test instruments and their use, preliminary trouble checks, scientific circuit analysis and trouble-shooting, parts repair and substitution, how to start a successful service business and hundreds of other subjects.

**MONEY-BACK GUARANTEE**

**MURRAY HILL BOOKS, Inc., Dept. RC-47,**  
232 Madison Ave., New York 16, N. Y.

- Enclosed find \$..... for books checked; or  send C.O.D. (U.S.A. only) for this amount plus postage. I may return the books for refund within 5 days if not fully satisfied.
- RADIO TROUBLESHOOTER'S HANDBOOK \$5** (\$5.50 foreign)
- MODERN RADIO SERVICING \$5** (\$5.50 foreign)
- MONEY-SAVING COMBINATION OFFER:** Both of the above big books, only \$9.50 (\$10.50 foreign)

Name .....  
Address .....  
City & Dist. No. .... State .....



**SPECIAL OFFER!**

Let **TROUBLESHOOTER'S HANDBOOK** save you time on common service jobs! Let **MODERN RADIO SERVICING** train you for complete professional, electronic work. Get **BOTH BIG BOOKS** at the special price of only \$9.50. **Send coupon today!**

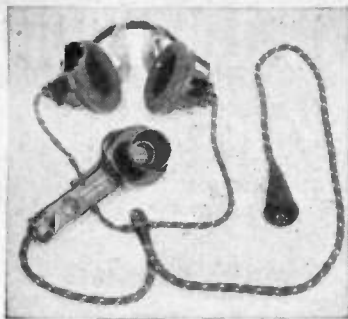

## ARMY RADIO PHONES

They're Weather—Water and Shock Proof

When we say they are made to Army specifications, that's enough assurance they must be of best quality. These Army Radio Phones are perfect and were O.K.'d by Signal Corps Inspectors. These Dynamic Mikes and Receivers, were used on aircraft and tank inter-communication systems. Use them for recording, for batteryless phone, for pocket size set loud speaker or talk through your radio set. We bought a good many of these Radio Phones, they are brand new, and cost a great deal more than you can get them for. A complete dynamic hand mike, 2 earphones, headband, cord set. **\$345**

A wonderful buy for only . . . . .

G.E. 1/25 Watt neons with wire leads or Min. Bayonet Base. Specify. 10 for 80c  
 J-37 Telegraph Key 1/4" Contact. . . . . 69c  
 Co-ax Cable 52 ohm per "C" ft. . . . . \$4.50

**NATIONAL #686  
 POWER SUPPLY  
 VIBRATOR TYPE**  
 Input 6VDC. Out-  
 put 165V 50 Ma.  
 For your Battery  
 or Mobile Receiver  
 List price \$56.93  
 Your cost 9.95

## SELSYNS

115VAC Type 5  
 per pair \$5.00

115VAC Type II-1  
 per pair \$9.00

**OHMITE Adjustable 50 Watt 25 OHM Re-  
 sistor . . . . . 15c**  
 10 FOR \$1.25

Circuit Breakers—Heineman Magnetic, 115  
 V.A.C. Choice of 5, 7, 20, 35 amps each 95c  
 0-1 Ma. McClintock 2" Bakelite Meter \$2.45  
 0-3 Ma. Gruen 2" Bakelite Meter . . . . . 1.95  
**NATIONAL ACN Dials . . . . . \$2.98**  
**NATIONAL XR50 slug tuned Coil Forms 1.00**  
**NATIONAL AR2 slug tuned 75 to 220**  
 mc Coils . . . . . 1.70  
**NATIONAL AR5 slug tuned 37 to 110**  
 mc coils . . . . . 1.45

## OIL CONDENSERS

10 MFD 600 V.D.C. Cornell Dubilier . . . \$ .98  
 2 MFD 2000 V.D.C. Cornell Dubilier . . . 1.75  
 8 MFD 1500 V.D.C. Aerovox . . . . . 3.25  
 10 MFD 1500 V.D.C. Cornell Dubilier . . . 3.45  
 0.1 MFD 7500 V.D.C. Aerovox . . . . . 1.50

**IN 23 XTAL DIODE 3 for 51c**  
 4x4x2 Black Crackle Steel Cabinet. Removable  
 top and bottom complete with screws. . . . 49c  
 10 FOR \$4.00

## FREE and RATE GYRO

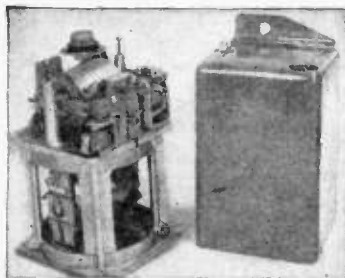

Schwein 24 Volt Gyro. **\$5.00**  
 Complete in case,

If not rated 25% with order, balance C.O.D.  
 All prices F.O.B. our warehouse New York.  
 No order under \$2.00

We ship to any part of the globe

## LEEDS RADIO CO.

75 Vesey St., Dept. 45  
 Cortland 7-2612 New York City 7

**NEW**

# RADIO-ELECTRONIC DEVICES

## FM-AM TUNER

Browning Laboratories, Inc.  
 Winchester, Mass.

The Model RJ-12 FM-AM tuner is designed for high-fidelity reception in the new high-frequency FM band as well as the standard broadcast band. Separate r.f. and i.f. systems are used for both bands. The r.f. section for FM uses miniature tubes. The tuning range on the FM band extends from 87 to 109 megacycles and on the broadcast band from 530 to 1650 kilocycles. The Armstrong circuit employed in the FM section uses two cascade limiters to ensure maximum noise rejection. Bandwidths of i.f. amplifiers are such that high-fidelity audio output is realized. A stage of r.f. is used on both FM and AM. One Antenna is used for FM and AM.

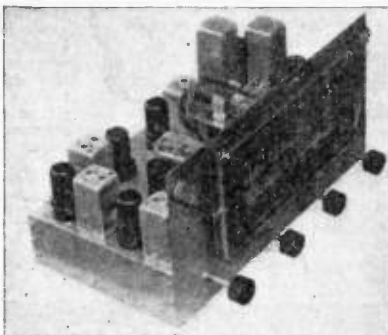

The dimensions of the tuner exclusive of power supply are; height 7 3/8", width 13 1/2", depth 9 inches. The power supply is a small separate unit.—RADIO-CRAFT

## MIDGET VOLUME CONTROL

Centralab, Div. of Globe-Union, Inc.  
 Milwaukee, Wis.

The Model 1 Radiohm is specifically designed as a high-quality volume attenuator for hearing aids, pocket radio receivers and miniature amplifiers. It is smaller than a dime and is designed to accommodate many variations in specifications. It is a perfect companion for sub-miniature tubes, batteries and other components. The new unit will be available in 500-ohm to 5-meg sizes.

Other features are three mounting

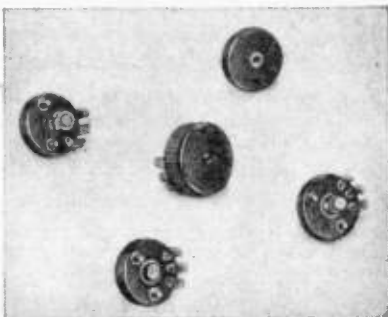

positions, optional cam for external switch and internal rotation stop.—RADIO-CRAFT

## ELECTRONIC MULTIMETER

Hickok Electrical Instrument Co.  
 Cleveland, Ohio.

The new Model 203 electronic multi-meter measures wide ranges of capacity, resistance, inductance, a.c. and d.c. voltage and current. The d.c. and a.c.

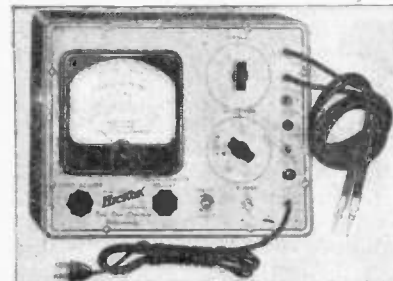

input impedances are 15 megohms and 12 megohms, respectively. Voltages, a.c. and d.c., and milliamperes, d.c., are measurable in ranges of 0-3, 12, 30, 120, 300 and 1200. Resistances are measured in seven ranges from 1.0 ohm to 10,000 megohms.

Operating from a 105-125 volt a.c. line the power consumption is 20 watts. Five tubes are used, including two rectifiers and a voltage regulator.—RADIO-CRAFT

## PLASTIC EARPHONES

Telex, Inc.  
 Minneapolis, Minn.

The Telex Monoset is worn under the chin rather than over the head. Designed like a stethoscope, the set has two hollow tubes stemming from a tiny round speaker and adjustable to the



proper head width. The ends are tipped with clear plastic earpieces which fit directly into the ears.

The entire unit, including speaker and miniature plug-in cord attachment, weighs only 1.2 ounces. This device can be used in practically any application where conventional earphones would be employed.—RADIO-CRAFT

**SERVICEMEN**

**Check This Column for Lowest Prices on Quality Parts**

**TUBES:** A warehouse full, including the new miniatures. Order all types you need. We'll try to supply you completely. Special this month: Sylvania 6V6—3 for \$2.00; RK-75 or 207 Transmitting tubes only \$2.50 each; 6L6G—99c; 6SD7 (replaces 6SK7)—59c.

**POWER TRANSFORMERS—**Half-shell type, 110V, 60 cy. Centertapped HV winding. Specify either 2.5 or 6.3V filament when ordering.  
 For 4-5 tube sets—450V, 40MA, 5V & 2.5 or 6.3V.....\$1.49  
 For 5-6 tube sets—650V, 43MA, 5V & 2.5 or 6.3V..... 1.75  
 For 6-7 tube sets—675V, 50MA, 5V & 2.5 or 6.3V..... 1.99  
 For 7-8 tube sets—700V, 70MA, 5V & 6.3 or two 2.5..... 2.35  
 For 9-11 tube sets 700V, 100MA, 5V & 6.3 or two 2.5V..... 2.85  
 For 9-15 tube sets—600V, 150, A, 5V & 6.3V..... 2.85

**TRANSFORMERS—**All types in stock. **AUTO-TRANSFORMERS:** Steps up 110v to 220v, or steps down 220v to 110v—\$1.95.  
**FIL. TRANS:** 6.3v, 8 Amps—\$1.98; 5v, 10 Amps—\$1.98; Universal Output Trans. 8 Watt—89c; 18 Watt—\$1.29; 30 Watt \$1.69. **AUDIO TRANSFORMERS:** E. Plate to S. Grid. 3:1—79c; S. Plate to P.P. Grids—79c; Heavy Duty Class AB or B. P.P. Inputs—\$1.49; Midget Output for AC-DC sets—69c; **MIKE TRANSFORMER** for T-17 Shure microphone, similar to UTC speaker type—\$2.60.

**MICROPHONES—**All types, nationally known brands. Bullet crystal—\$5.45; Bullet Dynamic—\$7.45; Milne Jr.—60c; Ilanuy Mike—90c; Lapel Mike—83c; Shure T-17 Mikes, with push to talk switch—99c.

**CONDENSERS—PAPER TUBULAR 600 WV—**.001—8c; .002—8c; .005—8c; .01—9c; .02—9c; .05—10c; .1—10c; .25—23c; .5—36c; **ELECTROLYTICS:** 8mfd. 200v—20c; 10mfd. 35v—20c; 30mfd. 150v—23c; 20/20mfd. 150v—35c; 30/20mfd. 150v—46c; 50mfd. 150v—43c; 8mfd. 475v—35c; 16mfd. 350v—65c; **OIL-CONDENSERS:** 4mfd. 600v—49c.

**FILTER CHOKES:** 200, 300, 400, 500 ohm light duty—59c; 200 or 300 ohm heavy duty—99c; 250 MA, 35 ohm, made for U.S. Navy, fully shielded—\$1.95; 75 ohm, 125 MA—25c, or 25 for \$4.25; 8 amp. iron core A—filter—25c.

**110 V. CIRCUIT BREAKERS** of Magnetite type: Following Current Ratings in Stock; 1.25, 3, 4, 8 Amps. Please specify. \$1.99.

**SEVEN ASSORTED I.F. TRANSFORMERS—**\$1.98; Five Ass't Oscillator Coils—69c.

**PERMEABILITY TUNERS—**Attractive slide-rule dial, compactly replaces dial, tuning condensers, oscillator and antenna coils in broadcast band receivers. Special \$3.43.

**WILLARD** rechargeable 2 volt storage batteries for G.E. portable radios \$2.95.

**SPEAKERS—**PM dynamo type 4"—\$1.55; 5" \$1.55; 6" \$1.95; 8"—\$3.95; 10" \$5.95; 12" \$7.50.

**CRYSTAL PICK-UPS—**Two nationally known makes, one \$1.90, the other at \$2.29.

**PHONO MOTORS—**110V, 60 Cycle, with turntable—\$4.25.

**HEADPHONES—**Highest quality Signal Corps headsets with sponge rubber ear cushions. 12" cord and plug \$1.00. 6" rubber covered patchords with phone plug and socket—25c.

**RELAYS—**Guardian SPST 12-24v, has heavy duty 15 Amp. Contacts—\$1.25; Guardian 12 to 24v D.C. triple make, single break relay 5 for \$3.75; Sigma supersensitive 2000 ohm D.C. SPDT Relay. (May be adjusted to operate on less than 1 Milliampere)—\$2.50.

**6 POLE DOUBLE THROW,** Telephono Type 2000 ohm Ro-lays, Super Sensitive, \$2.50 each, or two for \$4.50.

**SELENIUM RECTIFIERS—**Dry disc type 1 1/2" by 1" 1.2 Amp. maximum, suitable for converting DC relays to AC, for supplying filament source in portable radios; converting DC meters to AC applications, and also may be used in low current charkets—90c.

**METER RECTIFIERS—**Full wave, may be used for replacement, or in construction of all types of test equipment—\$1.25. Half Wave—90c.

**FILTER CHOKES—**200, 300, 400, 500 ohm light duty—59c; 200 ohm hvy. duty—99c; 250 MA, 35 ohms DC res. Made for U. S. Navy, fully shielded—\$1.95.

**LINE FILTERS—**110V—each unit contains two 2 mfd. oil filled condensers and a 15 amp. iron core choke. This filter has innumerable uses such as oil burner line filter, etc. A ten dollar value for 98c.

**PHONO AMPLIFIERS—**A real AC, 110V, 60 Cycle, 6 Watt Amplifier suitable for PA systems and phonographs; with a husky power transformer. Complete with tubes—\$12.95.

**PUBLIC ADDRESS AMPLIFIERS—**25 Watts peak output, 5 tubes, separate controls for Microphone and Phono Inputs. \$65.00 value for only \$32.00.

**WIRE—NO. 18 POST,** 2 conductor parallel zipcord, brown, 250' spools—\$5.25, 500' spools—\$9.95, No. 18 PO brown rayon covered parallel lampcord, 500' spools—\$12.25, No. 18 8V round rubber covered double wire for wash machines, vacuum cleaners, etc. 25' spools—\$6.95, Rubber covered mike cable 250' Spools—\$25.00. All kinds hook-up wire 1c per ft. Single stranded conductor shielded lead with brown rubber over shield, super special, \$1.20 per 100 ft., \$10.00 per 1000 ft.

**20 ASS'T. COIL FORMS—**including 11 Ceramic, 3 Polystyrene, and 6 Fiberral useful sizes—45c.

**VARIABLE CONDENSERS—**350 MMFD, 5 Gang—\$1.95; 4 Gang—\$1.49; 3 Gang—83c; 2 Gang—79c; 7.5 to 20 MMFD, 1750 V., extra long shaft Hammarlund—69c; miniature variables—25 MMFD—39c; 50 MMFD—49c; 75 MMFD—59c; 100 MMFD—69c; 140 MMFD—79c.

**TRANSMITTING R. F. CHOKES—**4 ple. 350 MA—25c or 5 for \$1.00.

**INTERMEDIATE FREQUENCY COILS** for super-regenerative receivers or the tremendously popular FM adapters for standard broadcast sets. Iron Core with 50 KC resonant frequency—39c; Air Core, with 100 KC resonant freq.—29c; 30 MC IF TRANSFORMERS—Double slug tuned—25c. **VIDEO AMPLIFIER PLATE Coils—**Slug tuned—25c.

**REMOTE CONTROL UNIT—**Aluminum Case 4"x3"x2" containing 2 potentiometers, triple pole switch, 4 knobs, gear mechanism, counter and phone jack—59c.

**110 Volt Power Plant**

110V, 60 Cycle generator direct-connected to gasoline engine. Worth a million for emergency or standby service for hospitals, theaters, hotels or for general service in hunting lodges, camps or boats. A gift at \$175.00. We can also supply the above unit for the same price with a direct coupled 32 volt D.C. generator, in which case we include absolutely free our \$29.95 32 Volt D.C. to 110 Volt A.C. converter which can also be used to supply 110V. A.C. from batteries or farm lighting plants.

**GENERAL ELECTRIC RT-1248 15-TUBE TRANSMITTER-RECEIVER**

**TERRIFIC POWER—**(20 watts) on any two instantly selected, easily pre-adjusted frequencies from 435 to 500 Mc. Transmitter uses 5 tubes including a Western Electric 316 A as final. Receiver uses 10 tubes including 955's, as first detector and oscillator, and 3-7H7's as IF's, with 4 slug-tuned 40 Mc. IF transformers, plus a 7H7, 7E6's and 7F7's. In addition unit contains 8 relays designed to operate any sort of external equipment when actuated by a received signal from a similar set elsewhere. Originally designed for 12 volt operation, power supply is not included, as it is a cinch for any amateur to connect this unit for 110V AC, using any supply capable of 400V DC at 135 MA. The ideal unit for use in mobile or stationary service in the Citizen's Radio Telephone Band where no license is necessary. Instructions and diagrams supplied for running the RT-1248 transmitter on either code or voice, in AM or FM transmission or reception, for use as a mobile public address system, as an 80 to 110 Mc. FM broadcast receiver, as a Facsimile transmitter or receiver, as an amateur television transmitter or receiver, for remote control relay hook-ups, for Geiger-Mueller counter applications, and it sells for only \$29.95. 10% less if ordered in lots of two or more. If desired for marine or mobile use, the dynamotor which will work on either 12 or 24V DC and supply all power for the set, is only \$15.00 additional.

**BENDIX SCR 522—**Very High Frequency Voice Transmitter-Receiver—100 to 156 MC. This job was good enough for the Joint Command to make it standard equipment in everything that flew, even though each set cost the Gov't. \$2500.00. Crystal Controlled and Amplitude Modulated—HIGH TRANSMITTER OUTPUT and 3 Microvolt Receiver Sensitivity gave good communication up to 180 miles at high altitudes. Receiver has ten tubes and transmitter has seven tubes, including two 832's. Furnished complete with 17 tubes and four crystals for \$36.00. Dynamotor is \$8.50 additional. None sold without dynamotor. We include complete diagrams and instructions for the simple conversion of the 522 to 110V AC operation.

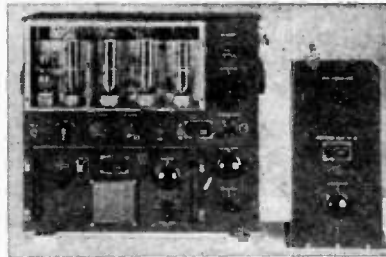

**GENERAL ELECTRIC 150 WATT TRANSMITTER**  
 Cost the Government \$1800.00  
 Now only \$44.50!

This is the famous transmitter used in U.S. Army bombers and ground stations, during the war. Its design and construction have been proved in service, under all kinds of conditions, all over the world. The entire frequency range is covered by means of seven plug-in tuning units which are included. Each tuning unit has its own oscillator and power amplifier coils and condensers, and antenna tuning circuits—all designed to operate at top efficiency within its particular frequency range. Transmitter and accessories are finished in black crackle, and the milliammeter, voltmeter, and RF ammeter are mounted on the front panel. Here are the specifications: **FREQUENCY RANGE:** 200 to 500 KC and 1500 to 12,500 KC. (Will operate on 10 and 20 meter band with slight modification). **OSCILLATOR:** Self-excited, thermo compensated, and hand calibrated. **POWER AMPLIFIER:** Neutralized class "C" stage, using 211 tube, and equipped with antenna coupling circuit which matches practically any length antenna. **MODULATOR:** Class "B"—uses two 211 tubes. **POWER SUPPLY:** Supplied complete with dynamotor which furnishes 100V at 350 MA. Complete instructions are furnished to operate set from 110V AC. **SIZE:** 21 1/2 x 23 x 9 1/2 inches. Total shipping weight 200 lbs., complete with all tubes, dynamotor power supply, seven tuning units, antenna tuning unit and the essential plugs. These transmitters are priced to move fast: Order today and be the proud owner of one of the finest rigs obtainable.

**6-BAND COMMUNICATIONS RECEIVER BC-348**

Featuring coverage from 200 to 500 Kc. and 1500 to 18,000 Kc. on a direct reading dial with the finest vernier drive to be found on any radio at any price—extreme sensitivity with a high degree of stability—crystal filter—BFO with pitch control—standard 6 volt tubes. Contains a plate supply dynamotor in compartment within the handsome black crackle finish cabinet, the removal of which leaves plenty of room for installation of a 110V, 25 or 60 cycle power supply. These receivers, which make any civilian communications receiver priced under \$200.00 look cheap and shabby by comparison, are only \$44.50. Power supply kit for conversion to 110V, 25 or 60 cycle, is only \$8.50 additional.

**SCR-274 N COMMAND SETS,** including 3 separate 6 tube superhet receivers, 2 separate transmitters, each with 40 watts output, modulator and DC power supply. Bargain price for all 6 pieces complete with tubes ..... \$39.95

**INSTRUMENT BARGAINS OF A LIFETIME!**

**BC-221 FREQUENCY METERS** with calibrating crystal and calibration charts. A precision frequency standard that is useful for innumerable applications for laboratory technician, service man, amateur, and experimenter, at the give-away price of only..... \$39.95  
**RADAR OSCILLOSCOPES—**Complete with 27 tubes including 5-inch cathode ray tubes—\$39.95

**300 MILLIAMPERE METERS—**G.E. or Westinghouse, 3 1/2 inch diameter, flush mounting. Priced at \$2.25 each, or 5 for \$10.00

**AIR CRAFT MARKER BEACON—**Complete with 3 tubes and sensitive relay to control external circuits from received signals. Just the receiver you have been waiting for to control models, open doors from a distance, etc. Priced at only..... \$ 4.95  
**AIRPLANE INTERCOM AMPLIFIER—**Complete with 4 tubes in aluminum case—\$ 4.95

**BC-654 TRANSMITTER-RECEIVER—**Complete with 17 tubes and 200 Kc. calibrating crystal ..... \$39.95

**BUFFALO RADIO SUPPLY, 219-221 Genesee St., Dept. 4C, BUFFALO 3, N. Y.**

-In New Jersey...

...it's **VARIETY**

**Sensationally New  
TELEVISION  
RECEIVER KIT**

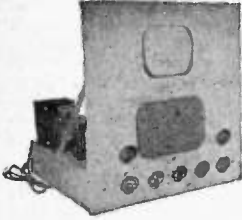

Ready for easy, rapid assembly. No knowledge of television required. Complete easy-to-follow instruction sheet gives you all the knowledge you need.

Reception is clear and sharp... comparable to a moving picture.

All necessary components are included: nothing is required except a screw driver, cutting pliers and a soldering iron. Only the highest quality standard parts are used—the list price value of these parts alone is more than \$300. 110 volts, 60 cycles A.C. **\$159<sup>50</sup>**

**Federal Teleco Selenium Rectifier**

Replaces Rectifier Tube ..... **\$1.09** each  
6 or more ..... **99c** each

**Guaranteed Volume Controls**

Less Switch ... **48c** 10 for ..... **\$4.45**  
With Switch ... **59c** 10 for ..... **\$5.45**  
500,000, 100,000, 50,000, 25,000 ohms; 1/2 meg, 1 meg, 2 megs.

**RESISTOR CABINETS**

All wood construction. Six shelves, 24 compartments ..... **\$3.89**

**R.C.A.-T65 CABINET**

Packed in original carton. Beautiful inlaid veneer with grill cloth. Speaker baffle for 5" speaker. Rubber feet. **\$4.95** each. Three for **\$14.00**

**Bargain! Guaranteed!**

**100 Assorted Bypass Condensers, 600 V**  
Value ..... **\$11.00**  
**Special \$6.95**

**SPECIAL!** 20 x 20 150 WV. Electrolytic condensers. Fresh stock, guaranteed. Value \$8.75 **10 for \$4.95**

**WELLER SPEED IRON**

Saves Time and Money Soldering heat in 5 seconds. For Radio, Electronic, Telephone, Telegraph, Test, Repair, Laboratory, etc. Complete with 2 extra tips. **\$12.95** net

**SUPERIOR  
Model 670  
Super-Meter**

A Combination Volt-Ohm Milliammeter plus Capacity Reactance Inductance and Decibel Measurements.



Complete with test leads and instructions ..... **\$28.40**

Write Dept. C-4, for our FLYER. 20% Deposit with order required. Please add sufficient postage. Excess will be refunded.

**Variety ELECTRIC CO., Inc.**  
601 Broad St., Newark 2, N. J.

**WORLD-WIDE STATION LIST**

Edited by **ELMER R. FULLER**

**A** FEW changes have been made in schedules since the last issue. Paris, France is now heard best from 2100 to 2245 hours EST on two frequencies, 9.550 megacycles and 11.840 megacycles. Programs are in English, and are beamed to North America. Moscow is being heard on the east coast on 7.240 megacycles from 1300 to 1800 and from 1815 to 2100. Radio Saigon is reported on 11.780 megacycles from 1800 to 2000 hours, with very good reception. Colombo, Ceylon, is now being heard on a new frequency, 15.120 megacycles from 1330 to 1530 on Sundays only. Other hours may be in use soon, so watch for them.

Radio Martinique has moved from 9.170 megacycles to a new spot at 9.350 megacycles. They are heard signing off at 2100 hours. Switzerland is now heard from 2030 to 2200 on 9.650, 9.530, and 6.160 megacycles directed to North America. A program of tips on dx listening is being presented from Australia at 2010 on Saturdays from VLA9 on 21.600 megacycles; at 0025 on Sundays from VLC4 on 15.320 megacycles, VLG7 on 15.160 megacycles, VLA4 on 11.770 megacycles, and VLB9 on 9.610 megacycles; and at 1715 Saturdays to Eng-

land on VLC10 on 21.680 megacycles, VLB6 on 15.200 megacycles, and VLA4 on 11.770 megacycles. These programs are conducted by Ernest Suffolk, who welcomes reports, which will be acknowledged over the air on his programs.

XGOY in Chungking is now being heard from 1045 to 1145 hours on 6.140 megacycles. News in English is given at 1100 hours. Chungking is also heard on 11.900 megacycles from 0500 to 0630 and from 1045 to 1145 hours.

The ten- and twenty-meter ham bands have been very active but with the usual run of hams being heard. Nearly every South American country is represented. An American ham was heard recently from Calcutta using the call VU2AY with 84 watts on 20-meter phone. This is what we call dx, and is the best reported here for some time. Let's have some reports on these ham bands, as well as the commercials. Several G.I.'s are being heard from Europe and the Pacific.

Keep up the good work, and let us hear from you. Send all correspondence to Elmer R. Fuller, Shortwave Editor, c/o Radio-Craft, 25 West Broadway, New York City, 7.

Freq.	Station	Location and Schedule	Freq.	Station	Location and Schedule
11.700	HP5A	PANAMA CITY, PANAMA: 0700 to 2200	12.210	VIENNA, AUSTRIA:	1145 to 2030
11.700	GVW	LONDON, ENGLAND: 2300 to 0030; 0600 to 0715; 0830 to 1015; 1130 to 1600; 1800 to 2330	12.250	ADAK, ALASKA:	1800 to 0100
11.700	SBP	STOCKHOLM, SWEDEN: 2000 to 2100	12.260	REYKJAVIK, ICELAND:	Sundays, 0900 to 0930
11.710	VLG3	MELBOURNE, AUSTRALIA: 0230 to 0345; 0100 to 0145	12.440	QUITO, ECUADOR:	0600 to 1000; 1400 to 2330; Sundays, 0700 to 1630; 1700 to 2200
11.710	HE15	BERNE, SWITZERLAND: Tuesdays and Fridays, 1000 to 1130; Saturdays, 1550 to 1625	13.050—WNRI	NEW YORK CITY:	European beam, 0600 to 1800
11.720	PRL8	KIEV, U.S.S.R.	13.050	KCBR	SAN FRANCISCO, CALIFORNIA: Oriental beam, 2215 to 0100
11.720	OTC	RIO DE JANEIRO, BRAZIL: heard at 0530 to 0730	14.560	WNRX	NEW YORK CITY: European beam, 0600 to 1800
11.740	COCY	HAVANA, CUBA: 0930 to 0100	15.000	WWV	WASHINGTON, D. C. U.S. Bureau of Standards: frequency, time, and musical pitch; broadcast continuously day and night
11.740	CEI174	SANTIAGO, CHILE: 1700 to 2400	15.110	GWG	LONDON, ENGLAND: 0000 to 0400; 0600 to 1015; 1100 to 1315; 1500 to 1600
11.740	HVJ	VATICAN CITY: 0015 to 0025; 0830 to 0900; 1100 to 1145	15.110	HCJB	QUITO, ECUADOR: 0500 to 1200; 1330 to 2330
11.750	GSD	LONDON, ENGLAND: 1215 to 1600; 1615 to 1200	15.120	HVJ	VATICAN CITY: 0830 to 0930; 1100 to 1145
11.770	VLA4	MELBOURNE, AUSTRALIA: 1100 to 1200; 1530 to 1830; 2345 to 0045	15.140	GSF	LONDON, ENGLAND: 2300 to 0400; 0600 to 0815; 0830 to 1745
11.780	HP5G	PANAMA CITY, PANAMA: 0745 to 1000; 1200 to 2230	15.150	SBT	STOCKHOLM, SWEDEN: 0130 to 0215; 0600 to 0700; 1000 to 1315
11.780	MOSCOW, U.S.S.R.:	0900 to 1000; 2000 to 2130; 2200 to 0100	15.160	JZK	TOKYO, JAPAN: 1730 to 1815
11.820	GSN	LONDON, ENGLAND: 2300 to 0030; 0100 to 0500; 1030 to 1430; 1700 to 2030	15.170	TGWA	GUATEMALA CITY, GUATEMALA: 1200 to 2000
11.830	MOSCOW, U.S.S.R.:	2200 to 0600; 0730 to 0845; 1100 to 1600	15.180	GSD	LONDON, ENGLAND: 2300 to 1200; 1230 to 1745
11.830	CXA19	MONTEVIDEO, URUGUAY: 0600 to 2200	15.190	CKCX	MONTREAL, CANADA: 0800 to 1200
11.830	CONSTANTINE, ALGERIA:	0030 to 0300; 1200 to 1800	15.190	TAQ	ANKARA, TURKEY: 0000 to 0200; 0415 to 0730
11.840	VLG7	SHEPPARTON, AUSTRALIA: 0800 to 0915	15.220	JTL3	TOKYO, JAPAN: 1800 to 0230
11.840	PARIS, FRANCE:	0000 to 0045; 0100 to 0145; 0545 to 0615; 1045 to 1130; 1315 to 1730; 1830 to 2345	15.230	VLGG	MELBOURNE, AUSTRALIA: 2100 to 2300
11.880	MOSCOW, U.S.S.R.:	2200 to 0600; 0720 to 1900	15.230	MOSCOW, U.S.S.R.:	2200 to 2400; 0530 to 0830; 0915 to 0930; 1030 to 1230
11.880	LRR	ROSARIO, ARGENTINA: 0600 to 1800	15.260	GSI	LONDON, ENGLAND: 0400 to 0430; 1030 to 1400
11.880	MOSCOW, U.S.S.R.:	2200 to 0230	15.290	VUD3	DELHI, INDIA: 2245 to 0030; 0130 to 0145; 0200 to 0400; 0445 to 0815
11.900	XGOY	CHUNGKING, CHINA: 0500 to 0630; 1045 to 1145	15300	GWR	LONDON, ENGLAND: 0600 to 0900; 1045 to 1330; 1400 to 1430; 1700 to 1800
11.900	CXA10	MONTEVIDEO, URUGUAY: 1830 to 2115	15.310	GSP	LONDON, ENGLAND: 2345 to 0030; 0100 to 0500; 0500 to 0815; 1200 to 1315; 1615 to 1845
11.930—GVX	LONDON, ENGLAND:	0515 to 0530; 0600 to 0630; 0700 to 0730; 0745 to 0900	15.310	VLG4	SHEPPARTON, AUSTRALIA: 2045 to 2145; 0010 to 0045; 1730 to 1800; 1900 to 1915; 2200 to 2225
11.960	HEK4	BERNE, SWITZERLAND: 1645 to 1715 except Saturdays	15.310	HER6	BERNE, SWITZERLAND: Saturdays, 1000 to 1200
11.970	FZ1	BRAZZAVILLE, FRENCH EQUATORIAL AFRICA: 0000 to 0230; 0445 to 0800; 0930 to 1030; 1100 to 2020	15.320	MOSCOW, U.S.S.R.:	2200 to 2300; 0000 to 0500; 0530 to 0800; 0830 to 1100
11.990	CSX	LISBON, PORTUGAL: 0800 to 1000	15.340	MOSCOW, U.S.S.R.:	2200 to 0800; 1000 to 1100
12.000	CEI180	SANTIAGO, CHILE: 0600 to 0800; 1600 to 2300	15.350	PARIS, FRANCE:	0700 to 0900
12.080	MOSCOW, U.S.S.R.:	0800 to 1100	15.450	LONDON, ENGLAND:	0100 to 0500; 0600 to 0700; 1700 to 1845
12.090	GRF	LONDON, ENGLAND: 2300 to 1615; 1700 to 2030			

Freq.	Station	Location and Schedule
15.590	FZI	BRAZZAVILLE, FRENCH EQUATORIAL AFRICA; 0445 to 0800; 0930 to 1030
17.440	HVJ	VATICAN CITY; 0715 to 0845
17.530	FZI	BRAZZAVILLE, FRENCH EQUATORIAL AFRICA; 0000 to 0130; 0445 to 0745; 1100 to 1700
17.700	GVP	LONDON, ENGLAND; 0600 to 1115; 1200 to 1800
17.710	GRA	LONDON, ENGLAND; 0600 to 0815
17.730	GVQ	LONDON, ENGLAND; 0100 to 0500; 0800 to 1215
17.760		PARIS, FRANCE; 0700 to 0900; 1100 to 1230
17.770	DTC	LEOPOLOVILLE, BELGIAN CONGO; 0500 to 0930; 1130 to 1645
17.790	GSG	LONDON, ENGLAND; 0500 to 1030
17.800	DIX5	LAHTI, FINLAND; 0130 to 0200; 0500 to 0545; 0800 to 1700
17.810	GSV	LONDON, ENGLAND; 0100 to 0400; 0500 to 1430
17.820	CKNC	MONTREAL, CANADA; 0830 to 1500
17.830	VUD10	DELHI, INDIA; 0400 to 0430; 0445 to 0700
17.840		BRUSSELS, BELGIUM; 0500 to 0630; 0045 to 0115; 1000 to 1245
18.020	GRQ	LONDON, ENGLAND; 0100 to 0500; 0830 to 0845; 0900 to 1430
18.080	GVD	LONDON, ENGLAND; 1030 to 1245; 1300 to 1500
18.130	PMC	BATAVIA, NETHERLANDS INDIES; 2330 to 0930
21.470	GSH	LONDON, ENGLAND; 0500 to 1215
21.530	CSJ	LONDON, ENGLAND; 0500 to 0815
21.640	GRZ	LONDON, ENGLAND; 0600 to 0900
21.550	GST	LONDON, ENGLAND; 1030 to 1130
21.750	GVT	LONDON, ENGLAND; 0100 to 0500; 1030 to 1130
26.100	GSK	LONDON, ENGLAND; 0615 to 1000

A 300-volt dry battery which weighs only 1 pound has just been announced by National Carbon Co. Known as the Eveready Mini-Max No. 493, it is 2 11/16 inches long, 2 11/32 inches wide and 3 15/16 inches high.

#### WIRELESS PHONO OSCILLATOR

Transmits recordings from phono pickup or voice from mike to radio without use of wires up to 500 ft. Neatly designed.

Complete kit, less tubes .....\$3.49  
Above kit assembled and tested ..... 4.49  
Tubes for above kit (12SA7, 35Z5) ..... 1.49

IMMEDIATE DELIVERY  
Jobbers, Write for Quantity Discounts on Amplifiers and Oscillators.

CONSTANT ELECTRIC, Dept. C

112 Cornelia Street Brooklyn 21, N. Y.

#### LATEST TELEVISION COMPONENTS

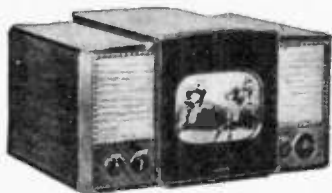

#### AS USED IN THE NEW RCA 10" RECEIVERS

50° deflection yoke .....\$14.75  
Focusing coil ..... 7.95  
Ion Trap ..... 5.10  
Vertical output Transformer ..... 8.50  
Horizontal output Transformer with 9000 V. and 1 V. windings for second anode supply ..... 18.00  
Five band RF Switch and Coil assembly 5.60  
Cathode Ray tubes for Television and Oscilloscopes from 1" to 16"

Also

Receiving Tubes Capacitors (Ceramic, oil filled, mica, etc.)  
Sockets and other television components  
Coaxial Cable

Send 50¢ for complete catalog including diagrams for RCA, GE, Dumont, Stromberg-Carlson, Andrea, and Viewtone Television Receivers.

World's First Specialized House In Television  
**TELETRONICS SERVICE AND SUPPLY CORP.**

264 West 40 St. New York 18, N. Y.  
Phone PE-6-8730

# New! CONCORD'S

## LATEST CATALOG OF

# RADIO PARTS

## AND ELECTRONIC EQUIPMENT



### Thousands of Newest Items! Immediate Shipment!

Largest stocks of all leading lines of nationally-known Radio Parts and Electronic Equipment on hand at all times at lowest prices for the amateur and professional radio man.

Just off the press—48 exciting pages of radio parts, equipment, and supplies for dealers, servicemen, amateurs, maintenance, testing, building and experimenting—Thousands of items NOW IN STOCK and ready for IMMEDIATE SHIPMENT! Big feature sections of Radio Sets, Communications Receivers, Amplifiers, Replacement Parts, Ham Gear, Record Players and Portables, Record Changers and complete Sound Systems. Page after page of bargains in top-quality standard-make radio parts and electronic equipment.

### Mail Coupon NOW for FREE COPY

Mail coupon below TODAY for your FREE COPY of this latest Concord Buying Guide and Bargain Catalog of Radio needs you can order for SAME DAY SHIPMENT from complete stocks in Chicago and Atlanta.

# CONCORD

RADIO CORPORATION  
LAFAYETTE RADIO CORPORATION  
CHICAGO 7, ILL. ATLANTA 3, GA.  
901 W. Jackson Blvd. 265 Peachtree St.

CONCORD RADIO CORP., Dept. RC-47  
901 W. Jackson Blvd., Chicago 7, Ill.  
Yes, rush FREE COPY of the new  
Concord Bargain Catalog.

Name.....  
Address.....State.....  
City.....

# SURPLUS SURPLUS SURPLUS

## RADIO TRANSMITTER

BC 1306, complete with two tubes, 2E22 and VR 105 uses two 3A4's that are missing **\$6.00**

## MINE DETECTOR

Complete with tubes new **\$9.95**

## NAVY INTERPHONE AMPLIFIER

Type R-7, complete with tubes less dynamotor (dynamotor 75c extra) **\$2.00**

## KEYER

TG-10, with photoelectric cell, has complete 20 watt amplifier, also 1/20 horsepower, 60 cycle AC motor enclosed in black crackle case 15" x 21" x 10 1/2", 110 volt, 60 cycle using a pair 6L6's in the output **\$15.00** (less tubes)

## POWER TRANS

100 mill 2-6.3 5V 700 ct **\$1.25**  
60 cy—110V

## RESISTORS

(assorted) **\$7.50**  
Per thousand

No order accepted  
less than \$5.00

Thousands of parts and tubes in stock. Tell us your needs.

Send check, money order or merely enclose currency (at your risk)

# RADIO CENTER

2530 EAST DAVISON

Phone TU 1sa 3-0355

DETROIT 12, MICHIGAN

# RADIO-ELECTRONIC CIRCUITS

## TRACER FROM BLOOPER

While planning a new untuned signal tracer, I decided to see what could be done with an old seldom-used regenerative receiver (Fig. 1). The plug-in coil was removed and a tube base connected as a jumper to connect the cathode

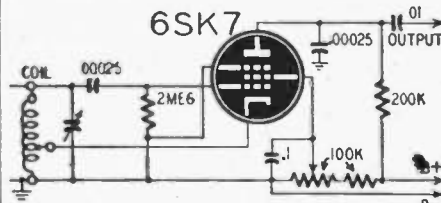

to ground. A shielded probe was made and connected to the antenna post. The regeneration control became the gain control. With the tracer (Fig. 2) in

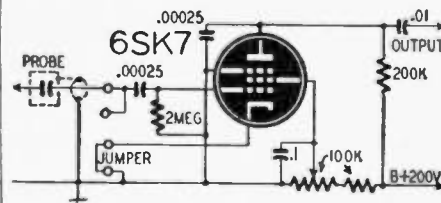

action it is possible to follow a signal from the antenna to the detector of a receiver.

When the coil is replaced the unit becomes a tuned tracer or signal generator.

WESLEY NEELANDS,  
Toronto, Canada

## 25-WATT AMPLIFIER

An output of 25 watts by the amplifier described is produced with minimum distortion. It can be constructed on a relatively small chassis. A push-pull input stage is used to eliminate phase inverters and coupling transformers. 6SQ7's were used in the input stage, but 6SF5's may be used. Input from a pickup or high-gain mike is through a

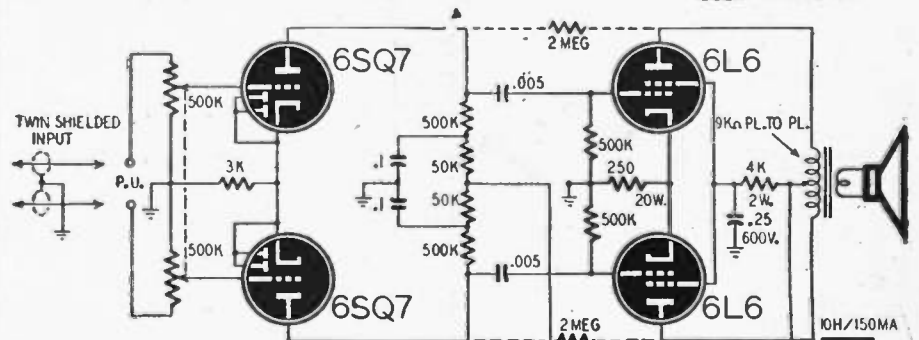

2-conductor shielded cable. The conductors are connected to the high sides of the ganged volume controls and the shield is grounded. If desired, inverse feedback may be used by connecting two 2-megohm resistors as shown by the dotted lines.

FRANK GUE,  
Edmonton, Canada

## TIME-DELAY CIRCUIT

The specially designed time-delay circuit illustrated operates a control relay a predetermined length of time after the control voltage has been applied. Upon removal of the control voltage, an equal time interval will elapse before the relay is deactivated.

With switch S1 in position No. 1, the bias developed across the cathode resistor charges condenser C through the control resistor R. This biasing voltage reduces the plate current of the tube to a point at which the relay contacts

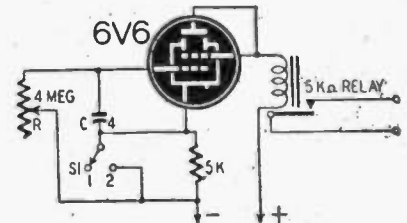

open. When the switch is thrown to position No. 2, the cathode resistor is shorted to permit the charge to leak off the condenser through the variable resistor. The relay closes when the plate current has risen to the proper value.

JOSEPH A. SIDERMAN,  
Eatontown, N. J.

## A.C.-D.C. PHONO MOTOR

Portable a.c.-d.c. phonographs are often equipped with a.c. motors which make them useless in d.c. districts. I have converted a portable unit so that  
(Continued on page 77)

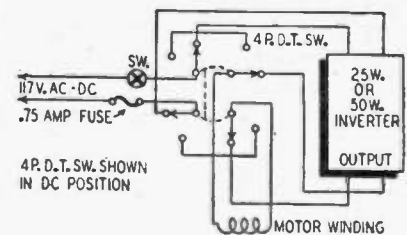



# ESSE Specials!



THIS EQUIPMENT HAS BEEN REMOVED FROM SURPLUS AIRCRAFT—AND IS SOLD AS USED . . . .

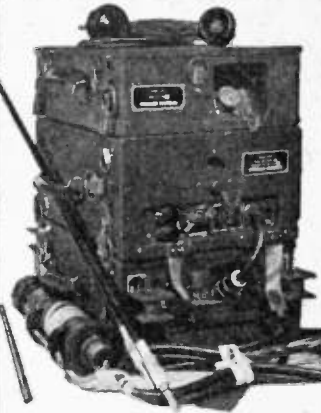
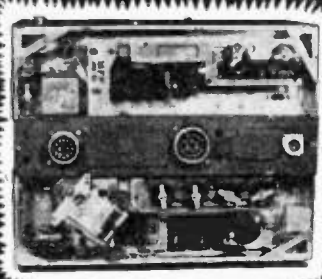
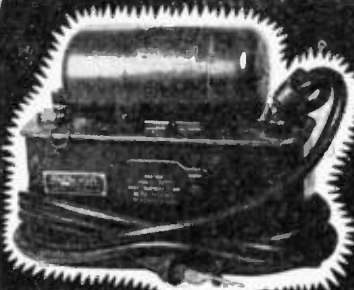
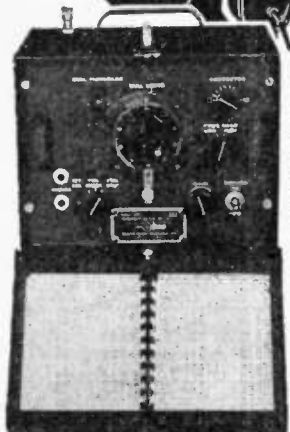

### PE-103 DYNAMOTOR UNIT

Brand new. Used to power your field or mobile transmitter. Designed for use with the BC-654 transmitter and receiver. Input—6 V DC 21 amps., 12 V. DC 11 amps. Output—500 V DC 160 Ma. Filtered output. Hi-Current relay switches and overload protect switches self contained in unit. Shipped in original overseas moisture-proof container. Weight of unit 53 lbs.

Price, Brand New.....\$8.95 ea.

### SCR-522 100-156 Mc. RECEIVER AND TRANSMITTER

One of the most interesting and useful pieces of surplus equipment. Designed for plane and ground station use, this unit offers remote control of any four pre-selected crystal controlled frequencies in the spectrum of 100-156 Mc. This spectrum covers facsimile, air navigation aids, airport control, railroad, police, urban telephone, as well as the amateur band 144-148 Mc. October Radio News gives details for converting the SCR-522 receiver section, BC-624.

Transmitter section, BC-625, is voice amplitude modulated and has an output of 8-9 watts.

Tubes used and included: 2—6J7, 1—12A6, 1—6G6, 2—6X7, 1—12J5GT, 3—12SG7, 1—12CB, 1—9002, 3—9003, 1—12AH7GT

Used, with tubes, less dynamotor and remote control.

Price .....\$22.50 ea.

Dynamotor for the above SCR-522:

Price .....\$3.50 ea.

### TRANSCEIVER — REC. — TRANS. BC-620-H

Portable, low power, frequency modulated. Range of approximately 5 miles. 2 channels, crystal controlled operation on any two of eighty different channels spaced 100 KC apart — range from 20-27.9 MC battery operated — either proper dry cells or 6 or 12 V. storage used with proper vibrator and power supply. 36 watt maximum output on 12 V. input. Complete as shown, with tubes — less crystals

Price .....\$49.50 ea.

### 221 FREQUENCY METER

125-20,000 KC operation. Accuracy of .01%. Furnished complete with tubes, original crystal and calibration charts.

Price .....\$34.85 ea.

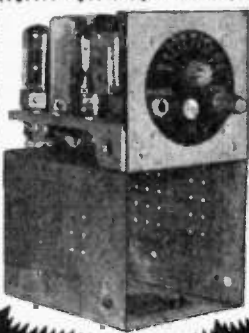

### 5-TUBE AIRCRAFT RECEIVER

200-400 KC operation

Complete with tubes for 24 V. operation.

Price .....\$4.95

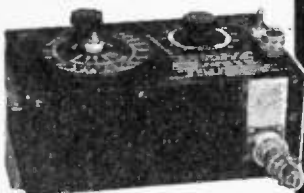

### INTERVALOMETER

Used to release bombs at pre-determined intervals—adaptable for use as a timing device in photography, etc.

Price .....\$2.75 ea.



### TURBO AMPLIFIER

Used for parts—shipped complete with the following tubes:

- 2.....7C5's
- 1.....7Y4
- 1.....7F7

Price .....\$1.75 ea.

Made by PALMER

### TRANSMITTING AND MISCELLANEOUS TUBES

- A...832A.....\$3.50 ea.
- B...807......95 ea.
- C...3BP1.....4.25 ea.
- D...5CP7.....4.95 ea.
- E...4E27.....3.75 ea.
- F...829B.....3.75
- G...VT-232 (E-1148)......65 ea.

### BC-375-E GENERAL ELECTRIC MOPA TRANSMITTER

Frequency range of 200-500 Kc. and 1,500-12,500 Kc. is covered by means of 2 plug-in tuning units furnished. By slight modification operation on 10 and 20 meters is possible. Oscillator is self-excited temperature compensated type. Power amp. is neutralized class "C" using 211 tube and is equipped with antenna coupling circuit to match practically any antenna. Modulator is class "B" using two 211 tubes. Power supply is 24 V. DC dynamotor which furnishes 1,000 V. at 350 M. A.

Transmitter output conservatively rated at 42.5 watts, phone 75 watts CW, but may be pushed to 150 watts.

Complete as shown with tubes, dynamotor, seven tuning units, and cable connector plugs. Removed from bombers, sold as used.

Price complete .....\$29.75

**TERMS:**  
CASH with ORDER or 25%  
BALANCE C.O.D.  
All Items Shipped Collect



# Radio Company

130 W. New York St. • Indianapolis 4, Ind.

# LEARN ELECTRIC MOTOR REPAIR!



**A PROFITABLE  
ADDITION TO  
ANY RADIO SERVICE  
BUSINESS**

This big book shows you how—every step of the way—  
**only \$5**

## IT PAYS TO SPECIALIZE IN SOMETHING DIFFERENT

There's good money in electric motor repair! The field is not crowded—and what could be a finer more profitable addition to your already established radio service business? Every home you visit on radio work has many motor-driven appliances. Be the man who can repair them!

**ELECTRIC MOTOR REPAIR**, the unique new book by the publishers of the famous Ghirardi Radio-Electronic books, teaches you the work from the very beginning. Explains every detail of motor trouble diagnosing, repair and rewinding. Covers a-c and d-c motors, synchronous motors and generators and mechanical and electrical control systems.



### A "BENCH" BOOK

Based on what you can learn from this big book alone, you can train for prompt, profitable motor service. Quick reference guides for use right at the bench show exactly how to handle specific jobs. Invaluable for beginners or for daily reference in busy shops. Unique Duo-Spiral Binding divides book into 2 sections permitting text and the more than 900 diagrams and illustrations to be seen AT THE SAME TIME.

### "BORROW" IT FOR 5 FULL DAYS!

Send coupon now! Practice from **ELECTRIC MOTOR REPAIR** for 5 days. If not more than satisfied, return book and every cent will be cheerfully refunded.



## NO RISK COUPON mail today

Dept. RC-47, Murray Hill Books, Inc.  
232 Madison Ave., New York 16, N. Y.

Enclosed is \$5 (\$5.50 foreign) for a copy of **ELECTRIC MOTOR REPAIR** Book, or send C.O.D. for \$5 plus postage (no foreign C.O.D.'s). In either event, if not satisfied, it is understood I may return book in 5 days for complete refund of my money.

Name .....

Address .....

City & Dist. No. .... State .....

# TRY THIS ONE

## DISCARDED STARTERS

Discarded fluorescent starters can be used in radio and electronic apparatus either as voltage regulators or as a.f. oscillators.

Remove the can and condenser and connect the terminals across a source of variable d.c. voltage. Measure the voltage across the terminals as the voltage is varied. Reverse the connections and repeat the tests to find which connection gives the best regulation. When the best connection has been determined, mark the terminal that is connected to the B-plus lead. The tube will fire at approximately 115 volts d.c. and extinguish at 80 volts. It will carry a 10-ma current with a change of 5 volts from 0.1 ma to 10 ma, and is applicable to conventional voltage-regulator circuits. A starter may also be connected

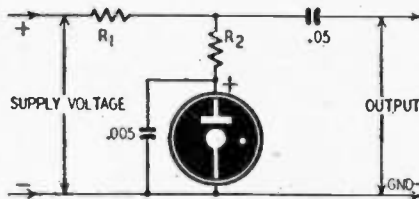

as an a.f. oscillator whose frequency may be controlled by plate voltage or the value of R1 plus R2. The output voltage is determined by the ratio of R1 to R2. The table gives the values of R1 plus R2 to give a 400-cycle note for different supply voltages.

Supply Volts (d.c.)	R1 plus R2 (ohms)
110	90,000
140	200,000
180	500,000
250	1,000,000

The tubes from starters are also useful in power supplies with poor regulation. Connect one of the units in series with a resistor connected as a bleeder across the 250-volt tap. This reduces the high starting voltage that often plays havoc with filter condensers. When the load is applied to the supply, the tube extinguishes, removing the bleeder load.

W. Z. BUGIELSKI,  
Grand Haven, Mich.

## ISOLATION TRANSFORMER

When servicing and operating a.c.-d.c. radio and electronic equipment there is constant danger of shock or injury unless line polarity is strictly observed. This danger may be avoided by using an isolating transformer. One may be built from two power transformers with burned-out or shorted secondaries.

Select two transformers, preferably with capacities of 100 watts or greater.

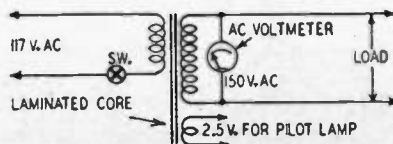

One of these transformers should have core-type laminations; the other a shell-type core. Remove the secondaries from the one with the shell-type core, then carefully unwind the primary. Remove the secondaries from the transformer with the core-type laminations and in their place rewind the primary from the other transformer. In some case a winding may be found which can be slipped on the core leg "as is".

Apply 117 volts a.c. to one of the primaries and measure the voltage across the other while working into a light load. Reverse the windings and again read the voltage under load. If the voltage is low on the output winding, add a few turns to it to bring the voltage up to 117. A 200-ohm, 200-watt potentiometer inserted at the point X, and a 150-volt a.c. meter across the output winding will decrease the output voltage to any required level.

The unit may be improved by re-winding one of the low-voltage secondaries over either of the windings to supply voltage for a pilot lamp.

HYMAN HERMAN,  
Flushing, N. Y.

## SOLDERING KINK

Strongly soldered joints, especially where several components are tied together, can be made by using a spiral connector. A spiral connector is made by winding bare copper wire in a tight

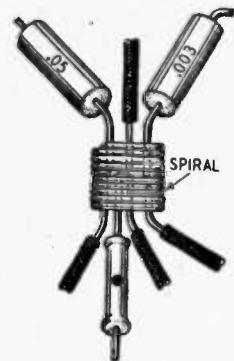

springlike spiral about 1/4 inch long. The diameter will depend on the number of wires to be joined. Leads from the components may be inserted into either or both ends and solder flowed into the spiral. This makes a good electrical connection that is mechanically strong.

MARCEL STRUDLER,  
Tel-Aviv, Palestine.

## FADED TUBE NUMBERS

Many schemes have been suggested for reading type numbers on glass tubes after they have faded. I find that placing the tubes in an icebox for a short time will cause moisture to form on the tube, and the numbers will stand out clearly. Be sure to mark the number permanently on the base. A scratch awl or china marking pencil can be used.

BILL KEENE, JR.,  
Wichita, Kansas

**NEW!**  
**CRYSTRON LAPEL RADIO**  
(Continued from page 49)

old speaker never had a fair chance, demanding as it did a high polarizing voltage at a time when there was nothing better than B-batteries to supply it. It consists of a thin metal sheet suspended close to and in front of a metal plate, with a high polarizing voltage between them. The voltage on the thin sheet is varied by the signal, causing it to be attracted and repelled by the heavy back plate. This vibration back and forth reproduces the speech or music. I used an electret for the back plate, and thus kept a voltage higher than 600 between it and the sheet of aluminum foil which formed the diaphragm of my improved speaker. Instead of the perishable rubber which was used in the old speakers as an insulating cushion between diaphragm and back plate, a war-developed plastic was used.

As soon as I finished the construction of the Crystron Lapel Radio I took it over to the Editor of RADIO-CRAFT and proceeded to demonstrate it to him. It  
(Continued on page 61)

**Instructions So Complete**  
**Anyone Can Build Our**  
**NEW MODEL S-5C RADIO**



Our model S-5C uses the universally accepted super-heterodyne circuit containing the following tubes: 12SA7, 12SK7, 12SQ7, 50L6, 35Z5 and tunes from 550 Kc. to 1600 Kc. Model S-5C (Illustrated) . . . complete kit less tubes. Bakelite cabinet and brand new illustrated instruction sheet, showing simple detailer, step-by-step diagrams.

**OUR INSTRUCTION SHEET COVERS EVERYTHING**

- Pictorial Diagram
- Schematic Diagram
- Photographs
- Step-by-step wiring instructions

Available at your local distributor or write to us for catalog M

Other Models Available

**RADIO KITS COMPANY**

120 Cedar Street New York 6, N. Y.

I'd like to show you  
how I've sold my unpatented  
**INVENTIONS**  
**GEORGE PEARCE**

47J Bartholomew St., PEABODY, MASS.  
If five thousand people in America will benefit from your invention, you can sell it within sixty days.

# Metropolitan

## NO LOWER PRICES ANYWHERE!

**THE NEW MODEL 111**  
**AC-DC Quality MULTITESTER**

A New Pocket-Size Volt-Ohm-Milliammeter with features never before available in an instrument of this size and price.

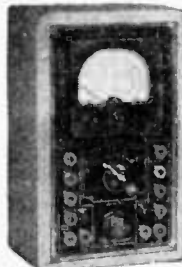

D.C. Voltmeter: 0-5-50-250-500-2,500 volts. A.C. Voltmeter: 0-10-100-500-1,000 volts. Output Voltmeter: 0-10-100-500-1,000 volts. D.C. Milliammeter: 0-1-10-100 milliamperes. D.C. Amperes: 0-1-10 amperes. Ohmmeter: 0-500-100,000 ohms; 0-1 megohm. Decibel Meter: -8 to +55 db. The scale is calibrated for line of 500 ohms impedance. For other impedances correction charts are supplied. Model 111P, in portable case (not illustrated) including testing leads and complete instructions \$19.85 Model 111A, open face as shown, complete with instructions

**\$16.85**

**The New Model B-45**  
**Battery Operated**  
**SIGNAL GENERATOR**  
for servicing AM, FM and Television Receivers

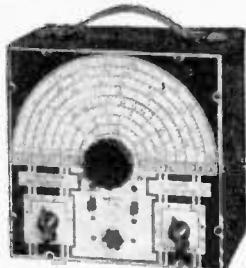

R.F. frequencies from 150 Kilocycles to 50 Megacycles (150 Kc. to 12.5 Mc. on Fundamentals and from 11 Mc. to 50 Mc. on Harmonics). Complete with shielded test lead, self-contained, batteries and instructions. Net

**\$27.75**

**The Model 689-1F**  
**WESTON OHMMETER**



A convenient, pocket size ohmmeter for checking circuits by the resistance and continuity method. The energy for the resistance readings is supplied by a self-contained 1.5 volt No. 2 standard large flashlight cell. Built to meet U.S. Army Requirements for Accuracy and Durability!

This Ohmmeter also has a double range 0-10 and 0-1000



ohms for the accurate measurement of low resistance values. Model 689-1F comes complete with operating instruction, test leads and LEATHER CARRYING CASE. List price \$25.50 Our Price

**\$14.85**

We carry nearly 5,000 instruments in stock. All models listed below are available for immediate delivery.

**PRECISION APPARATUS INSTRUMENTS**

8328-31 Range AC-DC Multi-Range Tester	\$23.04
844P-34 Range AC DC 600 volts AC and DC VOLT-OHM MILLIAMMETER	32.20
856P-44 Range Super-Sensitive 600 volts AC-DC TESTER 20,000 ohms per volt DC	49.94
864-AC DC VOLT-OHM-DECIBEL-MILLIAMMETER with large 9" meter	59.60
912P-Dynamic Mutual Conductance Tube Tester	61.20
E-200-A.M.-F.M. and Television Signal Generator	64.15
FV-10P-6000 volts AC and DC Vacuum Tube Multi-Range Meter	71.81
924P-Combination Dynamic Mutual Conductance Tube Tester, Battery Tester and 33 Range AC-DC Multi-Range Set Tester	84.20
954P-Combination Mutual Conductance Tube Tester, Battery Tester and 37 Range Super-Sensitive AC-DC Multi-Range Set Tester, 20,000 ohms per volt DC	99.20

**WESTON ELECTRICAL INSTRUMENTS**

687-Volt-Ohm Milliammeter	\$26.45
779-Super Sensitive Analyzer	76.45
785-Industrial Circuit Tester	103.66
798-Mutual Cond. Tube Checker and Analyzer	187.10

**SUPREME INSTRUMENTS**

542-Multi-Tester	\$18.95
589-Tube and Battery Tester	48.95
599-Tube and Set Tester	62.50
565-Vacuum Tube Voltmeter	63.50
578-Signal Generator	68.95
804-Combination Tube and Set Tester	89.50
546-Oscilloscope	89.75

**McMURDO SILVER CO.**

903-"Sparx" Dynamic Signal Tracer	\$39.90
901-Capacitance Resistance Bridge	49.90
900-"Vomax" Vacuum Tube Voltmeter	59.85
906-A.M.-F.M. Signal Generator	89.90

**RADIO CITY PRODUCTS**

447-Multi-Tester	\$17.95
448-Multi-Tester	24.50
322-Dynoptimum Tube Tester	41.51
461-P-Sensitive Multi-Tester	42.63
664-Electronic Multi-Tester	45.00
703-Signal Generator	49.50
315-Rollchart Tube Tester	59.50
802N-Combination Tube & Set Tester	59.50
668-V.T.V.O. Capacity Meter	73.01
805-Combination Tube & Set Tester	89.50
665A-V.T. "Billionaire" Insulation Tester plus VTVM	92.61

**SUPERIOR INSTRUMENTS**

CA-11-Signal Tracer	\$18.75
670-Super Meter	28.40
CA-12-Audible-Visual Signal Tracer	34.85
400-Tube Tester	39.50
650-Signal Generator	48.75
400-Electronic Multi-Tester	52.50
600-Combination Tube & Set Tester	62.50

**SHALLCROSS MFG. COMPANY**

Decade Resistance Boxes	\$13.50
Portable Galvanometers	27.50
630-Wheatstone Bridge	75.00
837-Kelvin Wheatstone Bridge	100.00
638-2-Kelvin Wheatstone Bridge	150.00

**ALLEN B. DUMONT LABORATORIES**

185A-Electronic Switch and Square Wave Generator	105.00
274-5" Oscilloscope	\$115.50
WATERMAN "Pocket" Oscilloscope	55.00
MONITOR Crystalliner Signal Generator	57.50
BLILEY Crystal Controlled Signal Generator	69.50
200-Electronic Measurements Mutual Conductance Tube Tester	49.85

**ORDERS FILLED SAME DAY RECEIVED!**

TERMS: 25% Deposit, Balance C.O.D. Or Full Payment with Order.  
**SEND FOR FREE CATALOG**

**Metropolitan ELECTRONIC & INSTRUMENT CO.**

Dept. C, 6 MURRAY STREET, Cable Address: METRONICS  
NEW YORK 7, N. Y., U. S. A. Phone: BArlay 7-5556



This technique can also be used to determine voltages in the absence of an a.c. voltmeter. Of course, it is necessary to calibrate the source of supply voltage for the standard lamp before beginning testing. In this case, the brilliance of the lamps is matched and the voltage read from the calibrated supply used for the standard lamp.

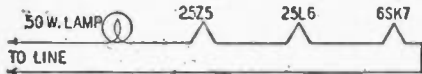

Fig. 3—Lamp used as a high-wattage resistor.

Possibly one of the oldest uses for incandescent lamps is as an inexpensive means of obtaining voltage drops. For example, we have a piece of apparatus which uses three tubes and desire to operate it from the regular power source with a series resistor or ballast lamp. The tubes naturally should be selected to have the same current rating, 300 milliamperes, 150 milliamperes, etc. For the sake of illustration, suppose a 25L6, 25Z5, and a 6SK7 tube were to be operated from a 115-volt a.c. supply. These tubes all draw 300 ma of filament current and have a combined voltage drop of 56. Therefore, a drop of 59 or 60 volts at 300 ma must be obtained in a dropping resistor. By referring to curves drawn from the data given in the tables, it is found that a 50-watt lamp would give a resistance of 204 ohms and a current of 295 ma for a voltage drop of 60. (Fig. 3.)

For accurate measurement of power

# GET YOUR FCC Commercial Radio Operators' LICENSE

*Now...*

How To Pass  
FCC  
LICENSE  
EXAMINATIONS

CLEVELAND INSTITUTE  
OF  
RADIO ELECTRONICS  
Terminal Tower - Cleveland, Ohio

Don't Delay—  
Write Today!

IT'S EASY IF YOU FOLLOW OUR PLAN  
Thousands of new jobs are opening up—FM, TELEVISION, MOBILE COMMUNICATION SYSTEMS, are only a few of the radio fields which require licensed operators.

TIME IS IMPORTANT TO YOU!

You can get your License quickly with NILSON'S MASTER COURSE in RADIO COMMUNICATION and exclusive CIRE Workbooks of Instructional Aids. Saves you many hours of random, undirected study. Assures a MINIMUM of time in getting your ticket.

FREE BOOKLET tells you the Government Requirements for all classes of commercial licenses—Sent immediately upon receipt of coupon. Approved for Veteran Training Under G-I Bill of Rights.

CLEVELAND INSTITUTE OF RADIO ELECTRONICS  
RC-4 TERMINAL TOWER CLEVELAND 13, OHIO

MAIL THIS COUPON

CLEVELAND INSTITUTE OF RADIO ELECTRONICS,  
RC-4 Terminal Tower, Cleveland 13, Ohio

Gentlemen: Please send information about your Home Study Course for preparation for FCC Commercial License Examinations. (This book does not cover Examinations for Amateur License.)

NAME .....

ADDRESS .....

CITY ..... Zone.....STATE.....

If a Veteran Check here.

200 Pages

Establishing and  
Operating an...

Electrical  
Appliance and  
Radio Shop

# FREE

Gift  
of the  
Month!

**Olson Gives You a Big, Authoritative Book  
on How to Operate a Radio Shop Successfully**

200 pages of practical advice and information, to help you make a go of your Radio and Appliance Shop. This book was recently prepared by recognized authorities in co-

operation with the Radio Manufacturers Association. If you are in business for yourself, or planning to open a shop or store, YOU NEED THIS VALUABLE BOOK.

CONTENTS: Business For Yourself — Selecting a Location — Building, Equipment, Layout—Financing, Legal Organization, Regulation — Buying — Sources of Supply — Receiving and Stocking — Retail Salesmanship — Advertising and Sales Promotion — Window and Interior Display — Repair Services — Major Appliance Sales — Traffic Appliance Sales — The Farm Market — Personnel — Record Keeping — Credit Management and Expense Control — Development and Growth.

HOW TO GET IT: We will send you a FREE COPY of this book with each order for \$10 or more, during the next 30 days. Your order must be written on one of our official order blanks, which is sent with our FREE Confidential 48-Page Radio Repairman's Price Guide. Just mail the coupon!



**OLSON RADIO WAREHOUSE**

73 E. MILL ST., DEPT. 75, AKRON, OHIO

Please send me Official Order Blank and Confidential Radio Repairman's Price Guide. No charge, of course.

NAME .....

ADDRESS .....

CITY ..... STATE .....

Clip this Coupon --  
PASTE ON A PENNY POSTCARD AND  
**MAIL TODAY**

# NEWARK'S SENSATIONAL SALE OF SURPLUS RECEIVERS and TRANSMITTERS

**6-Band, 8-Tube SUPERHET  
BC-348  
RECEIVER  
\$49<sup>50</sup>**

Here's the perfect rig for Hams... for aircraft, marine, mobile use, etc. Has 6 Bands covering 200 kc to 18.0 mc (excluding BC). Highly sensitive receiver with extremely low noise level.

Features Include: Crystal Band-Pass Filter, Voltage Regulated Osc., 2 Stages RF Mixed, 3 IF's, 6 Bands, 8 Tubes, Built-in 28 volt Dynamotor—easily converted to 110 volt operation. Electrically Perfect and Guaranteed—removed from unused aircraft. An Amazing Buy! Approx. 50 lbs.

**FREQUENCY  
METER \$39<sup>50</sup>  
BC-221**

A really beautiful precision outfit that every amateur should own. This Frequency Meter can be used as Signal Generator and VFO. Helps you meet FCC Regulations.

Meter has Crystal Calibration in all ranges, 125 kc to 20,000 kc. Includes original Calibration Charts and Crystal, which alone is worth almost our price for the entire unit. Works on 110 VAC, Vibropack, or Batteries. Electrically Perfect and Guaranteed—removed from unused aircraft. Complete with Tubes, ready to operate. Don't miss it!

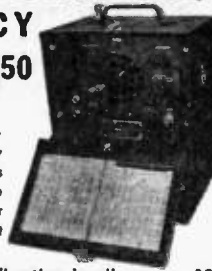

## Great Transceiver Value!

### SCR-274 N COMMAND SET

What a Buy! All this valuable gear for practically a sang! Use these units as stand-by rigs or salvage the precision components. Either way you get phenomenal value.

YOU GET... 3 Receivers covering 190-550 kc; 3-6 mc; 6-9.1 mc, 2 Transmitters with Crystals covering 3-4 mc and 4-5.3 mc, 4-24 volt Dynamotors (easily converted to 110 volt operation), Modulator, 2 Tuning Control Boxes, Antenna Coupling Box, 29 Tubes Included. A small mountain of equipment. . . . Electrically Perfect and Guaranteed—removed from unused aircraft. Parts alone worth many times the amazing price. Limited Quantity, Get your order in NOW!

**\$39**

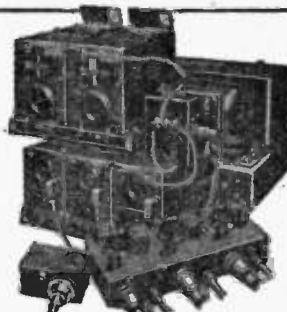

**75 WATT PHONE RIG  
BC-375 E  
AAF  
XMITTER**

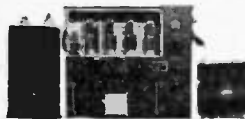

A complete transmitting outfit for CW or phone operation. Cost over \$2,000 to make. You pay less than 50¢ a watt... while stocks last!

You Get... 7 Tuning Units, 200-12000 kc; 24 volt Dynamotor (easily converted to 110 volt operation) with Relay, Filter, and Fuses; Antenna Tuning Unit BC-306A; Complete Set of Tubes. Electrically Perfect and Guaranteed—removed from unused aircraft. Wgt. about 400 lbs. A wonderful buy for any Ham!

**\$32<sup>50</sup>**

See Newark's famous BARGAIN COUNTERS!

**All-Purpose 2-METER RIG  
SCR-522  
RECEIVER  
TRANSMITTER  
\$38<sup>50</sup>**

By all means get this swell VHF Transceiver... one of the finest and most economical 2-Meter rigs you can buy today. Now available for a small fraction of the original cost. Consists of 10-Tube Superhet Receiver with squelch circuit, 7-Tube Xmitter, Remote Control Box, 28 volt Dynamotor (easily converted to 110 volt operation). Complete outfit with 17 Tubes, 8 Crystals. Perfect and Guaranteed—removed from unused aircraft. About 100 lbs. All for one Bargain Price.

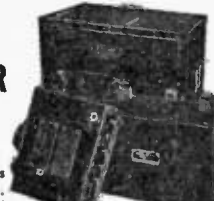

## LAMP BULB RESISTORS

(Continued from page 59)

output, current, and voltage, a series of power-measurement devices are available on the market. Examples of these are the power-measurement lamps made by Sylvania Electric (RADIO-CRAFT, March, 1944). These lamps are designated PM3, PM4, PM5, PM6, PM7, PM8, and PM9. They have two filaments in one bulb and operate on the principle (brilliance comparison) described in this article. Their resistance ranges from 36 ohms to 310 ohms. Their power ranges from 0.005 to 25 watts at frequencies from 15 to several hundred megacycles. Their voltage drops range from 0.5 to 55.

Table No. 1  
RESISTANCE IN OHMS  
Voltage a.c., r.m.s.

Lamp Size (Watts)	25	50	75	100	120
6	1315	1670	1970	2220	2400
10	758	1020	1210	1350	1440
15	500	675	790	890	960
25	302	394	475	530	576
40	160	217	275	327	360
50	132	177	220	263	288
60	108	149	185	217	240
75	91	124	151	174	192
100	71	97	115	132	144
150	44	62	77	88	96
200	33	47	57	65	72

Table No. 2  
CURRENT IN MILLIAMPERES  
Voltage a.c., r.m.s.

Lamp Size (Watts)	25	50	75	100	120
6	19	30	38	45	50
10	33	49	62	74	83
15	50	74	95	112	125
25	83	127	158	188	208
40	157	230	272	305	335
50	190	282	340	380	415
60	232	335	405	460	500
75	277	402	495	575	625
100	350	517	650	760	835
150	565	807	980	1130	1250
200	765	1070	1320	1525	1670

ORDER FROM New York or Chicago 50% Deposit Required with C.O.D. Orders Send Full Amount of Order—Save C.O.D. Chgs. Prices Subj. to Change

NEW YORK Offices & Warehouse 242 W. 55th St., N.Y. 19

**NEWARK** CHICAGO 323 W. Madison St. Chicago 6, Ill.  
**ELECTRIC COMPANY, INC.**

New York City Stores: 115-17 W. 45th St. & 212 Fulton St.

# BIG PROFITS

On These Fast-Moving Electrical Appliances

- Travel-Maid Traveling Electric Iron... 4.15
- Improved Steam Electric Iron..... 8.48
- Mercury Automatic Electric Iron..... 3.29
- No. 1106 Dominion Push-up Toaster... 5.98
- Faraday Electric Broilmaster..... 2.39
- General Mfg. Automatic Elec. Iron... 4.97
- Streamlined Electric Iron..... 2.37
- I-Burner Electric Stove..... 1.22
- Neco Stain. Steel Flip-Flop Toaster... 2.94
- Novel-Aire 5 Tube Super. Radio.... 13.79

Write for Illustrated Catalog on Radios, Phonographs, Electrical Appliances, Lamps, etc.

25% with order—Balance C.O.D.

**SHEFFIELD RADIO AND APPLIANCE, INC.**

Wholesale Distributors

916 W. Belmont Ave., Dept. RC4, Chicago 14, Ill.

## Supplying Every Electronic Need

- FOR THE—
  - RADIO SERVICE MAN
  - AMATEUR
  - STUDENT
  - EXPERIMENTER
  - INDUSTRIAL
- WRITE FOR ILLUSTRATED PRICE LIST

**CRABTREE'S**  
**WHOLESALE RADIO**  
DALLAS 2608 ROSS AVE. TEXAS

Three new atomic age elements have now been named. Element 43, the first to be artificially made, is technetium; from the Greek word "artificial." Astatine, element 85, is from the Greek "un-

## TELEGRAPH KEYS

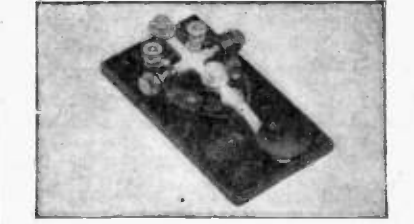

Made to government specifications Bakelite base—89c ea. postpaid

**THE GATEWAY CO.**  
P. O. BOX 926 BROCKTON, MASS.

stable," and francium, element 87, was named by its discoverer, Mlle Perey, after France. Only element 61, discovered in the atomic pile, is now without a name.

# ALL ITEMS LISTED BELOW NOW AVAILABLE FOR IMMEDIATE DELIVERY *from* STOCK



**Our Policy:** All units are sold subject to one year guarantee except when components are damaged through misuse. We do not solicit orders for any unit that does not meet our requirements for accuracy and honest value. Any item purchased from us is sold with the understanding that it may be returned for full refund after a 10 day trial.

## The New Model B-45 SIGNAL GENERATOR

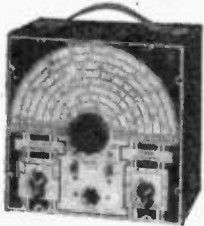

Self-modulated—provides a highly stable signal. RF frequencies from 150 Kc. to 12.5 Mc. on Fundamentals and from 11 Mc. to 50 Mc. on Harmonics. Modulation is accomplished by gridlocking action—equally effective for alignment of amplitude and frequency modulation as well as for television receivers. Self-contained batteries. All calibrations are etched on the front panel.  
Complete, ready to operate

**\$27<sup>75</sup>**

## The New Model 450 TUBE TESTER



**SPEEDY OPERATION** assured by newly designed rotary selector switch which replaces the usual snap, toggle, or lever action switches.

- Specifications:
- \* Tests all tubes up to 117 Volts.
  - \* Tests shorts and leakages up to 3 Megohms in all tubes.
  - \* Tests individual sections in multi-purpose tubes.
  - \* New type line voltage adjuster.
  - \* Noise Test: Tip jacks on front panel for plugging in either phones or external amplifier will detect microphonic tubes or noise due to faulty elements and loose internal connections.
  - \* Works on 90 to 125 volts 60 Cycles A.C. Complete with all operating instructions.

**\$39<sup>50</sup>**

## The New Model 670 SUPER METER

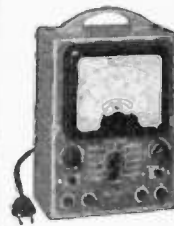

A Combination VOLT-OHM MILLIAMMETER plus CAPACITY REACTANCE INDUCTANCE and DECIBEL MEASUREMENTS.

*Added Feature:*

The Model 670 includes a special GOOD-BAD scale for checking the quality of electrolytic condensers at a test potential of 150 Volts. Complete with test leads and operating instructions

**\$28<sup>40</sup>**

20% DEPOSIT REQUIRED ON ALL C.O.D. ORDERS

**GENERAL ELECTRONIC DISTRIBUTING COMPANY**  
Dept. R. C. 98 PARK PLACE, NEW YORK 7, N. Y.

### NEW! CRYSTRON LAPEL RADIO (Continued from page 57)

had worked exceedingly well in the laboratory and brought in every station within 200 miles with earsplitting volume. Fiercely proud of my revolutionary invention, I expected a fat check for my article.

I explained the new principle of the Crystron to the Boss, who listened interestedly, if incredulously. Finally near the end of my technical talk he interrupted me rather impatiently, as is his habit.

Taking the big cigar from his mouth he snapped, "Well, Fips, let's hear that Lapel Radio, and make it snappy."

Smilingly I turned the knob. Nothing happened. I muttered, "Loose connection, probably. It worked O.K. half an hour ago." I then opened the set and fiddled around with it, while perspiration began to drip from my forehead and hands—but I couldn't get a sound from the damned thing. In this excruciating predicament, every pore now exuded hot, burning perspiration. My fingers and hands moved like a slow-motion film—it seemed tortuous minutes before I could straighten out my body from its previous bent position.

All the while the Big Boss, his face now an apoplectic purple, kept advancing menacingly. Already he had grabbed my precious Crystron Lapel Radio, which—as if by magic—had now  
(Continued on page 80)

## Nationally Known AUTOMOBILE ANTENNAS

Side Cowl—3 Section 66"  
Sturdy, Rustproof  
**\$4.75 LIST \$2.13 NET**

Deluxe Side Cowl—4 Section 100"  
Sturdy, Rustproof  
**\$7.45 LIST \$3.36 NET**

Top Cowl (Fender Mount)—3  
Section 56"  
**\$5.95 LIST \$2.58 NET**

Universal Cowl or Fender  
Mount—3 Section 68"  
**\$5.95 LIST \$2.58 NET**

All are complete, ready for installation.  
All are chrome-plated.

VIBRATORS—Standard 4-Prong, \$1.40 each 10 FOR \$12.50	CONDENSERS—.005 mfd. 1200 V DC Buffer Condensers 19 CENTS EACH—10 FOR... \$1.50 100 FOR \$12.50—1000 FOR... \$100.00
STANDARD DISTRIBUTOR AND SPARK PLUG SUPPRESSORS 17 cents each 10 for \$1.50 100 for \$12.50	STANDARD VIBRATOR TRANSFORMERS ..... \$0.98 each
CROWE REMOTE CONTROL AUTO HEADS For All Makes, All Years... \$3.82 each Tone Controls ..... 1.71 " Volume Controls ..... .73 "	SPECIAL—SPECIAL—SPECIAL St. Clair Vacuum Tube Voltmeter—6 DC Voltmeter Ranges—6 AC Voltmeter Ranges—Ohmmeter Range from 0.1 Ohms to 1000 Megohms—Accuracy 2% Plus or Minus FORMERLY \$52.50, NOW \$42.50

A COMPLETE LINE OF TUBES ARE NOW AVAILABLE  
\*CORRECTION—HOLLYWOOD BROILERS—List Price \$19.95

Write for Our Latest Catalogue

**RADIO PARTS COMPANY**  
612 W. Randolph Dept. "C" Chicago 6, Illinois

**ELECTRICIANS! RADIOMEN!**  
Here's the Answer  
Book to Bigger Pay!

**ELECTRICAL & RADIO  
TROUBLE  
SHOOTING  
MANUAL**

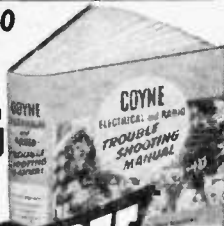

**Yours for 7 Days FREE**

**EARN MORE**

by quickly spotting troubles! This great book tells you where to look—how to find—what to do! 612 pages—8 1/2" x 11"—really 4 books in one: (1) New Step-by-Step Trouble Shooting, (2) 500 Shop Prints, (3) Electrical and Radio Dictionary, (4) Spare Time "Fill In" Jobs. Take it with you on every job—let it take you into the higher money bracket—put you in demand as "doctor" for troubles. Written by the Coyne School—an Approved Veteran Training Institution—and backed by 48 years shop experience.

**SEND NO MONEY** Coyne wants you to see for yourself how others have increased their earnings through this book. Read our **FREE TRIAL OFFER COUPON** below, and rush it to us today.

**7-DAY FREE TRIAL COUPON**

**COYNE ELECTRICAL SCHOOL, Dept. 47-T2**  
Educational Book Div., 500 S. Paulina St., Chicago 12, Ill.  
Send postage prepaid, your new Coyne Electrical and Radio Trouble Shooting Manual. After 7 days Free Trial, I'll either return it and owe nothing, or send \$3 and pay balance of \$4.50 in 2 months. Or I'll pay \$6.95 cash price in 7 days. (Prices now reduced on new large edition—thousands sold at \$9.00.)

NAME \_\_\_\_\_  
ADDRESS \_\_\_\_\_  
CITY \_\_\_\_\_ ZONE \_\_\_\_\_ STATE \_\_\_\_\_  
 Check here if you want Manual sent C.O.D. You pay post-  
man \$3.95 plus small C.O.D. fee. Money back guaranteed.

A new "memory tube" multiplies two 12-digit numbers in 0.00000001 second.

**Use these low-priced Diagram Manuals  
To simplify and speed-up radio repairs**



**Covering 1946, 1942, 1941, 1940, 1939, 1926-1938**

Each manual contains between 192 and 240 pages. Price each \$2.00

This volume \$2.50

Service radios faster, better, easier, save money and time, use these most-often-needed diagram manuals to get ahead in radio servicing. Clearly printed circuits, parts lists, alignment data, service hints are the facts you need to improve your servicing ability. Save hours each day, every day. Let these six volumes furnish diagrams for 80% of all sets you will service.

**See Your Radio Jobber or Send Coupon**

**Supreme Publications**

PUBLISHERS OF RADIO BOOKS, MANUALS, AND DIAGRAMS

9 S. KEDZIE AVE.

CHICAGO 12, ILL.

**TELEVISION FOR TODAY**

(Continued from page 38)

If these oscillations extend beyond the blanking interval, they appear on the image. In the horizontal system, a bright bar of light will be seen at the left-hand side of the screen. In the vertical system, the effect will be at the top of the image. In either instance, the oscillations must be killed before the blanking voltage releases the electron beam.

In the horizontal system, the best method of damping the oscillations is with a diode tube. In the circuit of Fig. 2, a 5V4-G is shunted across the secondary of the output transformer. The tube becomes a low-resistance shunting path whenever the plates become positive. During the negative half of the transient wave, the tube is non-conductive and its resistance is infinite. Hence, with proper connection of the tube across the secondary winding, there will be no loss of energy during the saw-tooth current build-up, but sufficient energy will be absorbed during the retrace period to prevent sustained oscillations.

In the vertical system, the change in current during retrace is not as rapid as in the horizontal system, therefore a

simple R-C damping circuit is satisfactory. In Fig. 2, this R-C filter is composed of a 0.025- $\mu$ f condenser and 1,000-ohm resistor across the secondary terminals of the vertical output transformer. An R-C filter is not feasible in the horizontal network because it would prevent building up the much larger voltage required to bring about the reversal of current during the retrace interval.

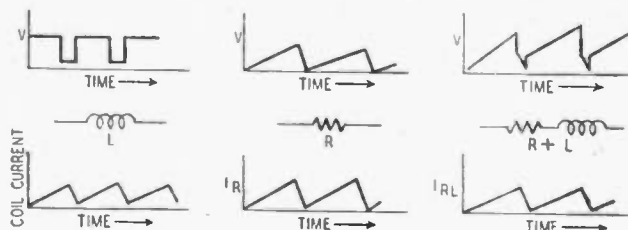

Fig. 4—How sawtooth voltage is obtained for magnetic deflection.

One final word about the electromagnetic deflection system. The electron beam is centered by passing a direct current through each coil. The current may be reversed by rotation of the centering potentiometer, or no current at all supplied if there is no need for centering. The centering potentiometer has a fixed tap. When the movable arm is at that tap, no d.c. flows through the coils. Opposite potentials are obtained on either side of the fixed tap.



## NEW "PRISMATONE" ORGAN

(Continued from page 22)

notes are tuned in one operation. A clear space is provided at the edge of the disc.

The wands below contain a pair of photoelectric cells and have holes drilled in their sides near one end to permit light to strike the cells. By intercepting the beam of light to a given key, the operator can produce any desired note. The shadow of the tube on the key acts as a guide. By turning the wand slightly, so that more or less light enters, volume can be controlled. Output of the wands is to the high-impedance input of a high-fidelity amplifier. Since

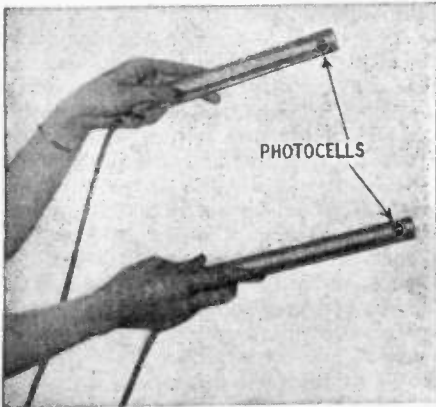

The two photocell operating wands.

this may be any standard commercial model, no mention of the amplifier is made in this article.

For more spectacular effects, the operator may wear finger rings with small selenium barrier-cell photoelectric cells instead of the regular wands.

The present model has two full octaves, including sharps and flats (25 keys). A larger instrument can be built by using a larger tone wheel with a suitable motor and projector. Two or more projectors can also be used, with as many keyboards as desired. By superimposing these keyboards on the screen many new effects can be secured.

### Still the BEST BUY in a COMBINATION TESTER

#### RCP Model 802N COMBINATION TUBE-SET TESTER

Immediate Delivery  
from stock.



A complete tube tester and a complete set tester, with only 5 simple switches to operate for both tube and set tester combined.

#### RANGES

DC VM. 0/10/50/500/1000 at 1000 ohms per v.  
AC VM. 0/10/50/500/1000.  
DC MA. 0/1/10/100/1000 DC Ammeter 0/10.  
Ohmmeter 0/500/5000/1,000,000/10,000,000. Low ohm center.  
D.B. Meter—8/15/15 to 29/29 to 49/32 to 55 db.  
Four range output meter—same as AC volts. Size: 12 1/2 x 12 3/4 inches. Weight: 11 1/2 lbs. Complete in handsome hardwood case, with test leads, self-contained batteries, ready to operate. NET **\$59.50**

**ADSON RADIO CO.**  
221 FULTON ST., NEW YORK 7, N. Y.

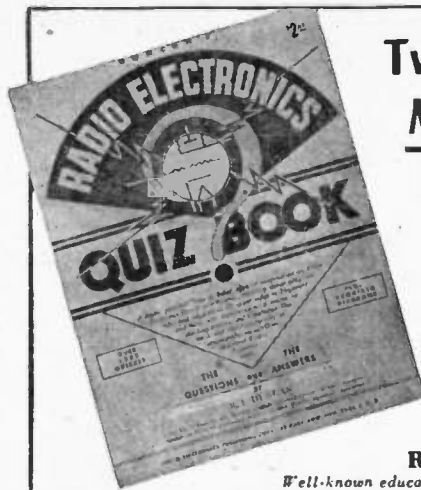

## Two New MUST Books

By

**R. L. Duncan**

Well-known educator and Radio-Electronics author,  
Colonel, Sig. Corps Res.; Member, Amer. Inst. of E.E.,  
Inst. of Radio Engineers, Veteran Wireless Operators' Assn.



This Quiz Book is of inestimable value to students, trainees and those with experience as a means for checking knowledge and training. It is tops as a pre-examiner for radio license examinations. A highly practical "True or False" type of question and answer treatise containing more than 1200 quizzes, plus the required circuit diagrams. This book points the way... acclaimed as a superior means for determining the scope of your Radio-Electronics "know how".

This Dictionary of Radio-Television-Radar is prepared especially for technicians, students, mechanics, operators, experimenters, trainees, amateurs and others associated with the radio-electronics industry... arranged for ready reference and practical application in one streamlined up-to-date book containing Formulas, Symbols, Conversion Tables and various essential data, as well as definitions of terms and technical expressions encountered in the broad field of Radio-Electronics.

*You Need These Books... Order Them NOW!*

Only \$2.00 for the Quiz Book and \$1.50 for the Dictionary at your dealer, or if he cannot supply you, order direct. Remit by money order or check—do not send cash.

**RADIO-ELECTRONICS PUBLISHING CORP., DEPT. RC4, 15 PARK ROW, NEW YORK 7, N.Y.**

# LOOK! COMPARE! BUY!

### SPEAKERS

5" Alnico 5 Magnet, \$1.25  
each  
Minimum order, 3  
6" Alnico 5 Magnet, \$1.98  
each  
Minimum order, 3

All other sizes in stock, at money-saving prices.

### AUTO RADIO SUPPLIES

4 PRONG Universal non-sync. VIBRATORS \$1.39  
Minimum order, 6  
OZ4 TUBES, each \$1.07  
Minimum order, 6

SPARK Plug SUPPRESSORS .11  
See our Catalog for full line of auto aeriels.

### PHONO SUPPLIES

Phono Motor & Turntable... \$3.39  
Crystal Pickup Arms... 2.49  
Webster No. 50 Changer... 21.17  
Webster No. 56 Changer... 26.66  
Webster No. 70 Changer... 43.20

Free \$2.50 permanent needle with each changer.

### Volume Controls

1/2 MEG. volume control with switch and long shaft, ea. \$0.99  
Minimum order, 6

15 ASSORTED \$1.95  
Volume controls (less switches)

### Money KITS Saving

100 Insulated Resistors, 1/2, 1 & 2 Watt \$1.95  
20 Assorted Wire Wound resistors... 1.95  
50 Popular Assorted Mica Condensers... 2.50  
20 Assorted Tube Sockets... 1.00  
20 Assorted Trimmers... 1.00  
I.F.'s 455 KC... .45

### WIRE

400 ft. (approx.) of wire in assorted colors and gauges, solid & stranded in 2 to 4 feet lengths, per pkg. 99c

### CONDENSERS

Tubular Paper (600 V. Test)		
Mfg.	Price Ea.	Per 100
.01	.08	\$ 6.50
.02	.08	6.50
.05	.10	8.00
.1	.12	9.00
.25	.17	13.50
.001	.08	6.50
.002	.08	6.50
.005	.08	6.50
.006	.08	6.50
.5	.26	22.50
"Illinois" Electrolytics		
Mfg.	VDC	Price
10	25v	.25
100	25v	.55
12	50v	.38
16	150v	.35
20	150v	.38
24	150v	.38
30	150v	.40
50	150v	.50
8	450v	.38
10	450v	.43
16	450v	.55
20	450v	.60
40	450v	.88
100	15v	.49
"Illinois" Duals		
16-16	150v	.58
20-20	150v	.65
30-30	150v	.70
40-20	150v	.70
50-30	150v	.70
8-8	450v	.65
10-10	450v	.70
20-20-20	150v	.99

10% discount on all electrolytics if purchased in lots of 10 or more. Mica Condensers, all sizes, 8c each.

### COMPARE TUBES SAVE!

OZ4	\$.07	1T4	\$.90	6J5GT	\$.58	7Y4	\$.85	50B5	\$.90
1A7GT	.85	3Q5GT	1.00	6J7G	.72	35W4	.50	117L7GT	1.50
1R5	.90	35A	.90	6K7GT	.68				
1S5	.90	6F7	.90	6SK7GT	.70				

MINIMUM ORDER, 10 TUBES

Minimum Order, \$3.00—20% with order, Balance C.O.D.—WRITE FOR CATALOG

**ELECTRONIC PARTS, Inc.**

Dept. C4 622 W. Randolph St., Chicago 6, Ill.

**NEW IDEAS IN A V.T. VOLTMETER**  
(Continued from page 32)

which are too far from the desired value should be replaced by others; those near enough can be padded by placing another resistor in series or parallel with them. As the ohmmeter range switch will measure resistors as high as 100 megohms, its insulation should be of ceramic material or equivalent to prevent undue leakage.

There are two minor departures from conventional ohmmeter construction. The first is a provision made for an external battery and the other is the addition of a potentiometer, marked *Battery Resistance Equalizer* in Fig. 1.

The standard for the 100-ohm range is a 10-ohm resistor and consequently, the current drain from a 1½-volt dry cell is 150 ma when there is no other resistance in series with it, as when adjusting the meter for "infinite" indication before each resistance measurement. Frequent repetition of this might exhaust the small meter battery in a short period. Therefore, insertion of a No. 6 dry cell is made possible for the lowest ohmmeter range by the jack (a regular phone jack with a "normally closed" break contact).

The internal resistance of a dry cell increases considerably with age. This battery resistance is placed in series with the standard for the lowest resistance range. It actually forms part of the standard, and therefore, the internal battery resistance may greatly impair the true readings before the meter battery is entirely exhausted. Hence the adjustable standard for this range which should preferably be used with an external cell and the need for a re-

*Now Ready*

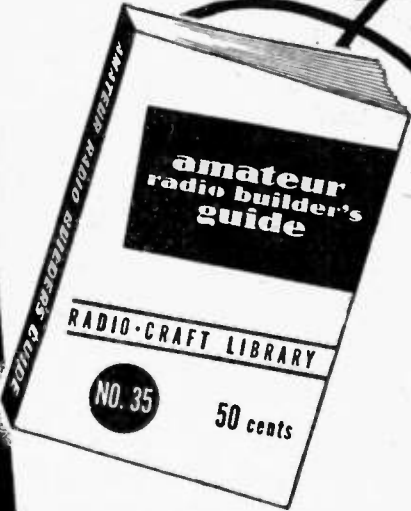

*The Two Latest Titles in the*  
**RADIO CRAFT NEW LIBRARY SERIES**  
50¢ each  
*Nine Recent Titles*

- # 29 HANDY KINKS AND SHORT CUTS
- # 30 UNUSUAL PATENTED CIRCUITS 1944-1946
- # 31 RADIO QUESTIONS AND ANSWERS
- # 32 ADVANCED SERVICE TECHNIQUE
- # 33 AMPLIFIER BUILDER'S GUIDE
- # 35 AMATEUR RADIO BUILDER'S GUIDE
- # 36 RADIO TEST INSTRUMENTS
- # 37 ELEMENTARY RADIO SERVICING
- # 38 HOW TO BUILD RADIO RECEIVERS

Two more titles in this popular new series are rolling off the press. The two latest—described below—like the others, give you the most recent, reliable technical information and are as modern in appearance as 1947 radios and cars. The type is fresh, clear-cut, easy to read. The books are bound in flexible covers, smartly designed. In short, everything connected with these volumes is up-to-the-minute and practical to the nth degree. You'll find them constructive helps in building up your knowledge of radio.

**NO. 31 RADIO QUESTIONS AND ANSWERS**

Here are the answers to questions most frequently asked of the "Question Box" editor of RADIO-CRAFT. The material selected is well diversified and chosen for practical application to workaday problems. Circuit diagrams are supplied with the answers.

**NO. 35 AMATEUR RADIO BUILDER'S GUIDE**

A book for the amateur operator who builds his own. Practical and down-to-earth, it tells you how to build transmitters, receivers, and other ham gear. Construction data on a 430-mc transmitter, an HK-24G c.w. transmitter, a miniature communications receiver, an acorn-tube preamplifier, and many others. Whether you're an amateur now, or just studying for your ticket, you'll want this book.

SEE YOUR DEALER IF HE CAN'T SUPPLY YOU, USE COUPON

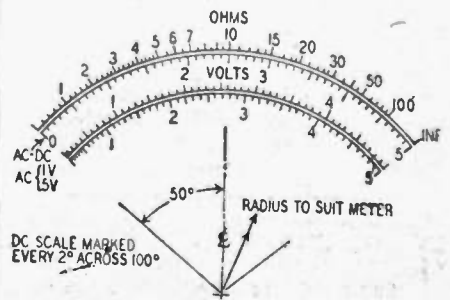

Fig. 5—Drafting details on the meter scale.

adjustment of the battery resistance equalizer each time a new measurement or a series of measurements is made.

**Hints for the constructor**

- Keep all input leads to the grids short to minimize stray pickups.
- Avoid shielding, especially in close quarters, to prevent shorts.
- When going through the chassis use feed-through insulators, preferably of the ceramic type (I-1, I-2, and I-3 in the diagram).
- Use only the very best quality of material available; mica condensers of the working voltage indicated, even if this voltage will never be approached. This provides excellent in-

RADCRAFT PUBLICATIONS, Dept. 47  
25 West Broadway, New York 7, N. Y.  
Send me the volumes (50c each, postpaid) checked. My dealer is unable to supply.

I enclose \$.....  
Your Name .....  
(Print Clearly)  
Address .....  
Dealer's Name .....  
Address .....

( ) ALL NINE BOOKS

- |                             |                             |
|-----------------------------|-----------------------------|
| <input type="checkbox"/> 29 | <input type="checkbox"/> 36 |
| <input type="checkbox"/> 30 | <input type="checkbox"/> 36 |
| <input type="checkbox"/> 31 | <input type="checkbox"/> 37 |
| <input type="checkbox"/> 32 | <input type="checkbox"/> 38 |
| <input type="checkbox"/> 33 |                             |

sulation. For the same reason, hook-up wire, resistors, etc., should all be of the very best; they will be cheapest in the long run.

Before starting, plan and make a sketch of what you want to make; a test bench instrument such as the one described here or a portable unit. For a portable unit which is to be used

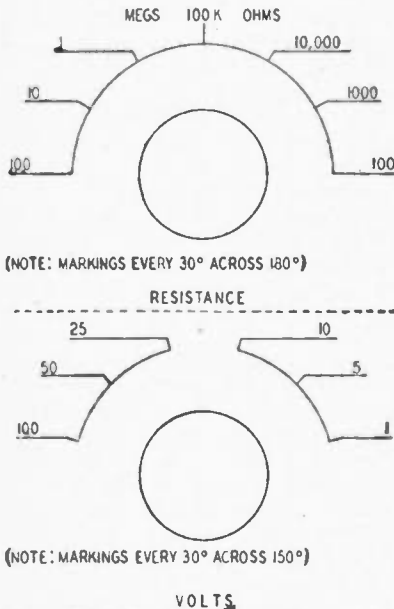
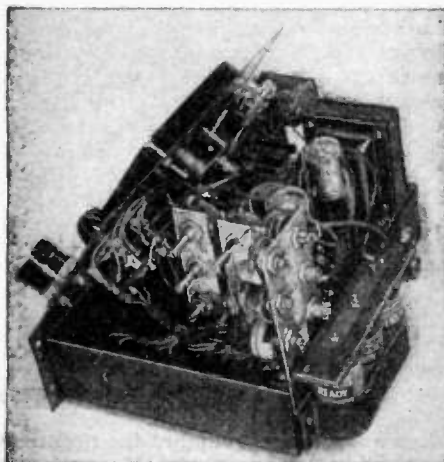

Fig. 6—Markings for Volts and Ohms switches.

in small quarters the following omissions are suggested, some of which have already been indicated in the foregoing text:

Make the instrument "fixed," i.e., do away with all the readjustment potentiometers for the low-voltage calibrations and the volts x 10 adjustments, using fixed resistors instead.



The voltage range adjusters are well seen here.

Modify the probe support so that it can be mounted flush with the front panel. Omit the regulating tubes and replace them by a wire-wound center-tapped voltage divider.

### Calibration and scales

Fig. 5 shows the scales for the completed instrument and Fig. 6 the markings for the VOLTS and OHMS range switches.

(Continued on page 66)

# "ROBERTS"

## COMBINED PORTABLE TUBE and CIRCUIT ANALYSER

The Most Modern Service Instrument Ever Offered to the Radio-Service.

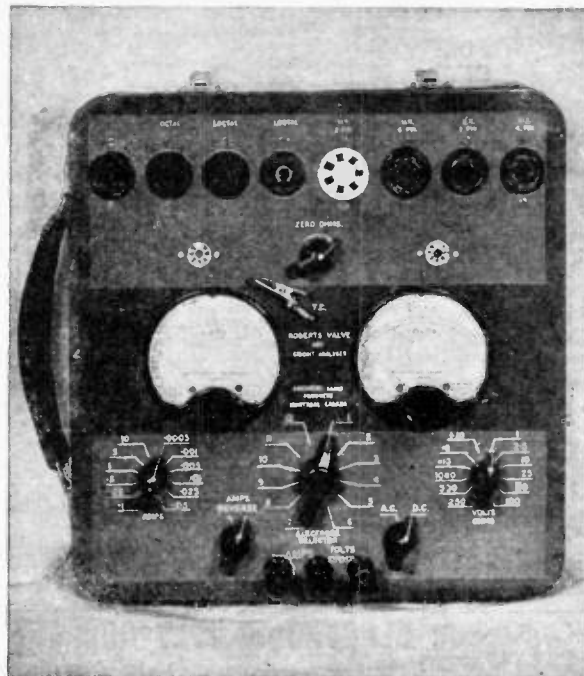

- Test Tubes for Current, any electrode, A/C & D/C, 11 ranges 0- 2.5 amps.
- Tests electrodes for Volts, any electrode, A/C & D/C, 16 Ranges 0- 1000.
- Does the above tests SIMULTANEOUSLY.
- Checks resistance any electrode, Tube to Chassis, 3 Ranges 0- .5 megohm.
- Can be used as Universal Meter, 2000 ohms per Volt.
- Meters protected against overload, B.S. Standards, Moving Coil Movements.
- Meters Glass Toughened, Scales 3/4", easily READ.
- Invaluable for testing A/C & D/C Radio Receivers.
- All the ADAPTORS supplied with the "ROBERTS" are ready wired.
- Guaranteed for 12 MONTHS. 12"x12"x-6 1/2". Weight Approx. 13 lbs.

Until now, the fastest and most reliable Method of Analysing faults in Radio, has been the Signal Tracing method with the aid of PRODS.

We have gone one better in our endeavours to give the radio serviceman a BETTER ANALYSER. Our ADAPTOR SYSTEM worked in conjunction with the "ROBERTS SWITCH" (World Patents) puts this ANALYSER right at the TOP as the MOST MODERN & EFFECTIVE ANALYSER ever produced.

The "ROBERTS ANALYSER" has made the prod system in circuit testing OBSOLETE.

By the "ROBERTS" Method every Tube Circuit is fully tested without even disassembling the Chassis & all Radio Service-men will appreciate the simple and effective method of operation, apart from the time saving element so often the difference between profit and loss.

Some 35,000 "ROBERTS ANALYSERS" have been sold or ordered in the past six months by Radio men in countries abroad. We now take pleasure in offering this ANALYSER to American Radio Service-men.

Price, F.O.B. Verdun, Canada, \$129.00 complete. All orders C.O.D.

For further information write for our Bulletin:—

**JOHN AMBLER, ADVANCED RADIO PRODUCTS**

330 SIXTH AVE., VERDUN, QUEBEC, CANADA

### ARMY-NAVY HEAD PHONES \$2.49



B-A made a lucky buy. Genuine U. S. Signal Corps head phones, 8000 highly sensitive, bi-ohms impedance. Only polar magnets. \$2.49 a pair plus 20c postage and pkg. chgs. Retail value \$13.50. Order No. 17A37.

FREE Catalog

GET THIS catalog, latest developments in radio and electronic parts and devices, newest ham gear, gadgets and bargains.

BURSTEIN-APPLEBEE CO., 1012 McGee St., Kansas City 6, Mo.

Send me your new FREE catalog.

Send me \_\_\_\_\_ pairs of phones at \$2.49 plus 20c pair postage. I enclose \$ \_\_\_\_\_ in payment. RC

NAME \_\_\_\_\_  
 ADDRESS \_\_\_\_\_  
 TOWN \_\_\_\_\_ STATE \_\_\_\_\_

Come to the famous

### SHOPS OF COYNE

where you learn by doing



### TRAIN FOR RADIO ELECTRONICS-TELEVISION IN A FEW WEEKS

Prepare For A Good Job Now With A Lifetime Future!

Trained Radio men needed now. They will be needed too, in the years to come. Don't be caught napping. Get a Radio training now and be ready. Learn by Doing. Free employment service for life after graduation. Many earn while learning. If you are short of money, ask about our Student Finance Plan. Now added Training in Electric Refrigeration. We are also equipped to train those who qualify under G. I. Bill. Men with Physical Disabilities may qualify for training at no cost to them for tuition and subsistence. Mail coupon for details.

SEND COUPON FOR FULL DETAILS

B. W. COOKE, Director, Radio Division  
 COYNE ELECTRICAL SCHOOL  
 500 S. Paulina St., Dept. 47-8H, Chicago 12, Ill.

Send Big Free Book; also details about Coyne Part-Time Employment and Student Finance Plan.

Send G. I. Bulletin  Physical Disability

NAME \_\_\_\_\_ AGE \_\_\_\_\_  
 ADDRESS \_\_\_\_\_  
 CITY \_\_\_\_\_ STATE \_\_\_\_\_

## NUMBERS 2 and 3 OF THE

# WALSCO Hit Parade

IT'S HERE THE NEW, COLORFUL EASY TO APPLY



**FELT  
FLOCK  
FINISH**

### COMPLETE FELT FLOCK SPRAY OUTFIT

Now you can do your own finishing of: Radio cabinets and speaker grilles, phonograph turntables and record cases, novelties, crafts, hobbies and numerous other items.

10 brilliant colors available. The kit (as pictured) contains patented WALSCO Felt Flock Spray Gun, together with necessary materials, such as undercoats, Ivory and brown felt flocks, brush, instructions, etc.,

CATALOG NO. K-50—List Price \$10.75

Write for full information on these items. Dept. 4B

**WALSCO products**  
Help The Radio Man

WALTER L. SCHOTT CO. BEVERLY HILLS, CALIF. CHICAGO 5, ILL.

## WALSCO STAPLE DRIVER

- Pays for itself on the first job
- A sensational tool for installing wires and cables, that saves time and money.
- Used by Radio, Public address and Intercom Technicians.
- Staples into corners and other inaccessible places.
- Staples on hard surfaces such as plaster, hardwood, etc.
- Can be loaded in 10 seconds.



The WalSCO Staple Driver is a real time and trouble saving tool for the radioman. Also extremely useful for general stapling. This device automatically positions the staple after which it is driven to a pre-adjusted depth with one or two strokes of the palm of the hand. A small trigger controls the feeding mechanism. Wires and cables up to 1/4" in diameter can be quickly installed with the WalSCO Staple driver.  
Price \$4.95 Dealers Net (including box of staples)

## NEW IDEAS IN A V.T. VOLTMETER

(Continued from page 65)

For calibration, a voltage supply of 100 and 10 volts both a.c. and d.c. of sufficient current output, together with a reliable standard meter for 100 volts a.c. and d.c., is required.

The 100-volt and 10-volt potentials can be subdivided by decade resistor dividers. These dividers can be made up for the 100-volt and the 10-volt supplies of 10 wire-wound resistors, compared and equalized by using an adequate reading on a regular ohmmeter scale. Remember that the higher the current capacity of the supply, the lower the resistance of the resistors of the decade units can be and the smaller the error will be when shunted by a high-impedance meter to be calibrated or checked.

With the above equipment available, precise readings are obtainable on the vacuum-tube volt-ohmmeter or other meter to be calibrated from 100 to 0 volts in steps of 10 volts and from 10 to 0 volts in steps of 1 volt.

A nice test bench and calibrating source of voltage and power, either regulated or nonregulated, may be easily devised when a few old power transformers, preferably with 5-volt and 2.5-volt center-tapped windings, a rectifier tube for the high-voltage d.c., and copper-oxide rectifier for the low voltage are handy. The author made one out of three transformers, supplying 150 ma at 250 volt d.c., 0 to 20 volts a.c. (by putting the 2.5- and 5-volt windings in series) and 250, 500, 750, and 1,000 volts or more a.c. at about 100 ma.

### The paste-up meter markings

Professional-looking scales and markings as shown for this meter were made by careful drawing of the scale or marking at twice or more its original size. For the lettering, paste-up letters used in making show window signs and price tags were used. These were obtained in New York from the Tablet and Ticket Company, but as they are used by all stores, no doubt a local source of supply can be found by asking your store manager.

After these India-ink drawings were finished, a photostat negative of the exact size required was made, from which any number of black-on-white scales of the correct size may be obtained at any time. The markings were left in the deep brown background of the negative with white lettering by making a negative from a reduced positive. The reduced scale was pasted on the original metal scale plate of the meter.

No expensive drafting equipment or lettering sets were used in the making of these items, and they can be simulated easily by anyone with average drafting skill.

Should there be sufficient demand, a future article will be devoted entirely to the making of such scales and markings and the calibration of meters of high input resistance in general, using the meter here described and some other simple but generally useful equipment, as a practical example.

## EASY TO LEARN CODE

It is easy to learn or increase speed with an Instructograph Code Teacher. Affords the quickest and most practical method yet developed. For beginners or advanced students. Available tapes from beginner's alphabet to typical messages on all subjects. Speed range 5 to 40 WPM. Always ready—no QRM.

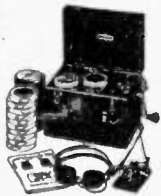

### ENDORSED BY THOUSANDS!

The Instructograph Code Teacher literally takes the place of an operator-instructor and enables anyone to learn and master code without further assistance. Thousands of successful operators have "acquired the code" with the Instructograph System. Write today for convenient rental and purchase plans.

## INSTRUCTOGRAPH COMPANY

4701 Sheridan Rd., Dept. RC, Chicago 40, Ill.



### The MYSTERY of SELF

Unlock the secrets of self! Explore your mental world. Receive the keys to the hidden laws of life. Become the master of your affairs... the creator of your own happiness. FREE book explains. Write: Scribe O.T.V.

The ROSICRUCIANS (AMORC)  
San Jose - California

### SERVICE MEN!

- RCA Radiotron
- Tungsol
- Raytheon
- Sylvania
- New Astatic QT-J
- Nylon Crystals

\$5.24 each

Write for our latest bulletin, Dept. C2 Distributors of RADIO EQUIPMENT

## CHIEF ELECTRONICS

104 MAIN STREET, POUGHKEEPSIE, N. Y.  
The Square Deal Supply House

## 12 lbs. SURPLUS RADIO PARTS \$2.00

A gold mine of parts for repairmen, amateurs, and experimenters... sockets, condensers, resistors, transformers, coils, hardware, wire, etc., etc. An outstanding bargain in usable parts! Send \$2.00 cash, check or M.O. today! (Pay small express charges on receipt.)

### ELECTRONIC PARTS, INC.

Dept. C4, 622 W. Randolph St., Chicago 6, Ill.

## ELECTRONIC VOLT-OHMMETER

1185 POSTPAID

### 110 VOLTS AC 20 RANGES

0.5/10/50/100/500/1000/5000 volts DC and AC 0-1,000,000 ohms in six overlapping ranges. Sensitivity: over MILLION OHMS per VOLT on 5 volt range.

Complete kit includes all component parts, tubes, punched and drilled chassis and beautifully enameled panel. Easily assembled and wired.

Special slideback circuit developed during war by scientist at the California Institute of Technology gives amazing sensitivity and flexibility while completely eliminating necessity of batteries and expensive meter. Each instrument is individually calibrated. Dial scale over nine inches long!

In addition to performing the usual volt-ohm functions, this instrument easily measures these voltages: SUPERHET OSCILLATOR, AVC, AFC, TRUE GRID BIAS AT THE GRID, BIAS CELLS without affecting the circuit. Measures the exact leakage resistance of INSULATION, TUBES, CONDENSERS. It can be used with a signal generator for SIGNAL TRACING.

### STERLING ELECTRONIC COMPANY

166 N. Sierra Bonita Ave., Dept. 2, Pasadena 4, Calif.

## ONLY 60¢ ELECTRIC MOTOR

60¢

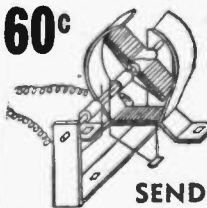

CONSTRUCTION KIT  
EASY TO ASSEMBLE  
FUN-- EDUCATIONAL  
IDEAL GIFT

Runs on a Single Dry Cell (not included). Use it to run Toy Pumps, Pulleys, Etc.

SEND CHECK—MONEY ORDER or CASH (at your own risk) to

The Haydn Chem. Co., Dept. U1, Box 27, Kenmore 17, N.Y.

## WAR SURPLUS

Lathes, Milling Machines, Drill Presses, Sawing equipment, Motors and thousands of miscellaneous items. Also information on Helicopters, Sleeper Trailers, Garden Tractors, Power Lawn Mowers, Welders, Jet Impulsion for Cars and Tractors, Farm Conveyors, Dump hoists for trailers and wagons, etc.

### THE WAYNE ENGINEERING CO.

DEPT. 1120 GREENVILLE, OHIO

### \$3.00 FOR CARTOON IDEAS

RADIO-CRAFT prints several radio cartoons every month. Readers are invited to contribute humorous radio ideas which can be used in cartoon form. It is not necessary that you draw a sketch, unless you wish.

### IDEAS NOT WANTED

No electrical or radio definitions wanted. Some of these were published in the past, but the subject is about exhausted.

All checks are payable on publication. Address RADIO CARTOONS, RADIO-CRAFT, 25 West Broadway, New York 7, N. Y.

## TRANSATLANTIC NEWS

(Continued from page 39)

the transmitters of the television chain soon to come into being here. Now, it is almost certain that this will not be so. The reason? Interference caused by aircraft in flight. Have you ever seen it on a television screen? I saw a striking instance the other day. The scene on the screen became blurred and rather muzzy. It was particularly noticeable that well-lit stationary objects had a double outline. Moreover, the rather faint shadow outline of each was gradually moving in toward the real one. That reflection was caused by a low-flying plane, passing near an imaginary line between my aerial and the transmitter. The reflected waves, arriving by a longer path, produced the displaced secondary outlines. These moved inward as the plane's approach reduced the difference in length between the direct and reflected paths. Trials have shown that this sort of interference would be widespread with radio links and for that reason the television transmitters in different parts of the country will be interconnected by co-axial cables.

### Television screen sizes

Some extremely interesting information about television picture sizes was produced during the recent discussion of the subject by the Radio Section of the Institution of Electrical Engineers. There can be no doubt that people want a larger screen than is now available and that there will be no rush to buy televisions until they get it. Hitherto no one has been able to say why this should be: a 12 x 10-inch image viewed at about 8 feet has exactly the same angular dimensions to the eye as a home moving picture 3 feet x 2 feet x 6 inches viewed at 24 feet. But there is no question as to which is the more pleasant to watch. Why should this be? One speaker hit the nail on the head, I thought, clearing up a point which has not previously been explained. At 24 feet the eye adjusts itself to infinity focus, a restful condition. At the shorter distance it is always rather strained. The argument was clinched by another speaker who had tried cine pictures of 10 x 8 inches—viewed at a distance of 6 to 8 feet—on his family. Their objections were violent! There is no doubt in my mind that television will always be a semi-flop until we can give the viewer a screen measured in feet rather than in inches—and we cannot do that with the cathode-ray tube. Never in history has there been a bigger opportunity than the one which now awaits the inventor of a system which will emancipate television from the cathode-ray tube screen and the scanning time base.

### Miniature Spot-Welder

Some months ago rumors circulated of a small spot-welding apparatus, suitable for making the connections usually soldered in radio gear, which had been

(Continued on page 68)

# HARRISON HAS IT!

# HARRISON HAS IT!

We are Factory Authorized Distributors for the top quality manufacturers and we now have in stock lots more new, latest improved production ham gear! Visit our stores today, for everything you need. We promise you fresh, clean material—quicker—at the lowest current prices—and, above all, our sincere desire to be of friendly, helpful service.

As one of the world's largest distributors of Communications equipment, we are delivering plenty—right now! ALL MAKES—practically all models. If you want yours in the quickest possible time send your order to HARRISON!

Send in your parts orders, too—if it's new, if it's good, if it's made by a leading manufacturer—

## Harrison Has It!

COLLINS:	
75A-1 .....	\$375.00
HALLICRAFTERS:	
8X-42 new FM-AM 54-110	
inc less speaker	\$275.00
8-96A FM-AM-CW 27.8-143	
mc	307.50
S-87, FM-AM 190-210 mc.	591.75
S-40	89.50
S-68	47.50

COLLINS:	
32V-1 .....	\$ 475.00
80K-1 complete	
with 310A-1 exciter	1,250.00
MECK 60T....	150.00

OTHER MODELS AND MAKES WILL BE IN STOCK AS THEY BECOME AVAILABLE

## RECEIVERS

HAMMARLUND:	
HQ-129X, with speaker in cabinet.....	\$173.25
SPC-400X New "Super-Pro" 35 to 30mc, with pack, and speaker in cabinet.....	347.25
NATIONAL:	
NO-240-D, with speaker.....	241.44
NC-46, with speaker.....	97.56
HRO-5TA1, with pack and speaker.....	306.71
1-10A, with tubes.....	67.50
RME:	
RME 45, with speaker.....	198.70
RME 84, with speaker.....	88.70

## TRANSMITTERS

TEMCO:	
75GA .....	\$ 495.99
500GA .....	1,600.00
ABBOTT TR-4B, New 2 meter transmitter-receiver, with tubes	59.80

Complete stock—quicker deliveries—lowest prices—top trade-in allowances—easy 6% Budget Plan, if desired—and my personal attention to your wishes, all insure your complete and lasting satisfaction with every transaction. I guarantee you'll like doing business with me!

Send me your order, today. A small deposit (you name it) will bring you your new equipment. Balance C.O.D., or tell me what Budget Plan terms you want.

Twenty-two years of experience serving Amateurs in all parts of the world is at YOUR command.

Vy 73 de

*Bil Harrison, W2AVA*

### HARRISON SELECT SURPLUS

Read our ads—past and future—for real values in selected surplus material. Reasonably priced—honestly described—guaranteed perfect! You don't "take a chance" when you buy Harrison Select Surplus!

**HAM HEADQUARTERS**  
Since 1925!



## HARRISON RADIO CORPORATION

9 WEST BROADWAY • NEW YORK CITY 7

PHONE—BARclay 7-9854 - EXPORT DEPT.—CABEE—"HARRISONRAD"

[JAMAICA BRANCH—172-31 Hillside Ave.—REpublic 9-4102]

### A.C. CURRENT ANYWHERE!

With Katolight Plants and Generators furnish the same kind of current as the highlines. Sizes 500 watts to 100 KW. Also Manufacturers of Rotary Converters, Frequency Changers, 32 and 110 Volt D.C. Motors in 1/2, 1/3 and 1/2 H.P. A.C. Motors, single phase in 1/2 and 2 H.P. only.

**KATOLIGHT**  
120 Rock St., Mankato, Minn.

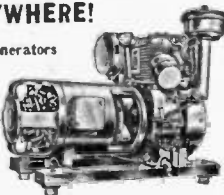

### ROTA-BASE

**NEW MANDY LAB. DIAL.** Simply turn the movable dial to the tube number desired on the ROTA-BASE and complete correct connections are instantly indicated on the "prong" diagram. Filament, grid, plate, cathode, etc., to more than 300 tube types are given. No more valuable time lost on lengthy reading or thumbing of pages. ROTA-BASE actually gives a "prong" picture of the connections. **PRICE NOW ONLY \$1.00.** Postage prepaid or sent C.O.D. plus postage. Money back if not delightfully pleased.

**REED MFG. CO.** 411 S. Main St., Los Angeles, Calif.

### PREPARED ASSORTMENTS

#### GUARANTEED FIRST QUALITY

100	1/3 Watt Resistors All Insulated.....	\$2.98
100	1/2 Watt Resistors All Insulated.....	3.98
100	1 Watt Resistors All Insulated.....	4.45
50	2 Watt Resistors All Insulated.....	3.98
50	200 Volt Paper condensers.....	2.45
50	Mica Condensers.....	2.98
20	Dry Electrolytic Filter Condensers.....	6.75
10	25 ft. Rolls Hookup Wire—Ass'd colors	1.98
10	Volume and Tone Controls—No Switches	1.98
100	ft. Spaxhetti and Vinylite.....	.98
10	Coils I.P., R.F. Ant. and Osc.....	3.98
20	Wafer and Ceramic Band Switches.....	3.98
20	Auto Suppressors.....	2.98
50	Electrical Wiring Devices, Plugs, Taps, Base, Elements, Fuses, etc.....	5.00

SEND FOR TRUTONE COMPLETE RADIO AND ELECTRICAL LIST

Terms: 25% deposit required with order. Balance C.O.D. Merchandise sent prepaid if full remittance accompanies order.

### TRUTONE PRODUCTS CO.

303 W. 42nd St. Dept. C New York 18, N. Y.

The most common trouble in television sets reported to date is rectifier failure.

# SCOOP!



**ARMY BC-645 I.F. UNIT.** Net \$16.95. Early in the war, when radar picked up a plane, there was no way of knowing whether it was friendly or not. That was before BC-645 was invented. BC-645 sent out a signal that identified the plane as American. It probably saved more lives than any other piece of electronic equipment made. With some modifications the set can be used for 2-way communication, voice or code, on the following bands: ham band 420-450 mc., citizens radio 460-470 mc., fixed and mobile 450-460 mc., television experimental 470-500 mc. Equipment capable of doing the job of the modified set sells for hundreds and hundreds of dollars. The 15 tubes alone are worth more than the sale price. 4-7F7, 4-7H7, 2-7E6, 2-6F6, 2-955 and 1-Wc16A. It now covers 460 to 490 mc. Each BC-645 is shipped with a Belmont factory printed conversion diagram, showing how to make AC power supply modulator and how to make Transmitter and Receiver changes. Most ham and experimenter already have the few parts necessary. New BC-645 with tubes less power supply. . . . . \$16.95 Two for . . . . . \$29.90

that identified the plane as American. It probably saved more lives than any other piece of electronic equipment made. With some modifications the set can be used for 2-way communication, voice or code, on the following bands: ham band 420-450 mc., citizens radio 460-470 mc., fixed and mobile 450-460 mc., television experimental 470-500 mc. Equipment capable of doing the job of the modified set sells for hundreds and hundreds of dollars. The 15 tubes alone are worth more than the sale price. 4-7F7, 4-7H7, 2-7E6, 2-6F6, 2-955 and 1-Wc16A. It now covers 460 to 490 mc. Each BC-645 is shipped with a Belmont factory printed conversion diagram, showing how to make AC power supply modulator and how to make Transmitter and Receiver changes. Most ham and experimenter already have the few parts necessary. New BC-645 with tubes less power supply. . . . . \$16.95 Two for . . . . . \$29.90

## SENSATIONAL SURPLUS BUY



**BC-654-A.** Transmitter-Receiver 12 watts (W. 8 watts phone. 3800 to 5800 KC \$19.95. Used but in apparently good order. Offered with 3-307A tubes but less receiver tubes. The 7 tube superhet receiver has 2 RF stages. Designed for 1 1/2 volt octal tubes. Could be converted to heater tubes. Has built in 200 KC crystal calibrator. The 200 KC crystal and 9.3 RF thermocouple ammeter and 3-307A tubes are worth the price we are asking for the whole unit. First come first served. BC-654-A transmitter-receiver less power supply. Each. . . . . \$12.95 With all tubes and spares. . . . . \$16.95

## 1947, COMPLETE RADIO KITS

**SENSATIONAL PEE WEE AC-DC KIT Model K-PW.** Size 6 1/2 x 5 1/2 inches. Very small in size; uses pee wee tubes 1K5, 1T4, 185 and 354 and new dry disc rectifier. Conventional superhet circuit with AVC; 2 gang condenser. Receiver broadcast 500 to 1700 KC loop ant. This set when wired according to our diagram will make a hot little personal radio. This kit is priced complete; just as all our kits are, with tubes, cabinet and speaker; nothing else to buy. . . . . Net \$11.95



**5-TUBE AC RADIO KIT** superhet circuit using new permeability tuning unit. Covers broadcast 550 to 1700 KC. Beautiful walnut cabinet 12 1/2 x 6 5/8 x 5 1/2 inches. Loop ant. Everything complete including 6SA7, 6BK7, 6SQ7, 6K6 and 5Y3 and diagram Model K-5A. Net . . . . . \$16.95

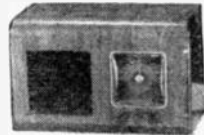

**KIT K-7A 7 tube AC superhet 550 to 1700 KC.** Has push-pull audio stage with tone control and 6 1/2 inch 5 PM speaker. Conventional circuit with AVC. Similar in appearance to model K-5A except has slightly larger cabinet. Loop ant. Everything complete including diagram and tubes 6SA7, 6BK7, 6H6, 6SN7, 2-6G6, 5Y3. A real value. . . . . Net \$19.95

**DELUXE AC-DC KIT J-D5** Beautiful walnut cabinet and all the parts to build a broadcast 550 to 1700 KC 5 tube AC-DC radio. Superhet with side rule dial, 2 gang tuning condenser and loop aerial. Everything furnished: includes speaker and tubes 12K6, 12SK7, 12SR7, 35Z5 and 50Y3 and diagram. Kit J-D5. Net . . . . . \$14.95

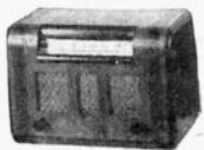

**NEW PLASTIC CABINET AC-DC SUPERHET KIT.** Cabinet size 7x6 1/2 x 10 1/4". Attractive slide rule dial. 2 gang tuning condenser. Receiver broadcast 550 to 1650 KC. Has latest Alnico 5 PM speaker Loop antenna; all parts simplified diagram and tubes 12K6, 12SK7, 12SR7, 35Z5 and 35Z5 furnished. Kit P-48 Net. . . . . \$12.95



## Two-Tube Phono Oscillator, \$3.69

**COMPLETE, WIRED AND TESTED.** 800 to 1500 KC. Model B-4. Has audio gain stage for proper power output. Complete with tubes ready to operate. . . . . \$3.69 Mike Oscillator model C-4 is similar to model B-4 except has added gain stage for crystal mike. Complete with 3 tubes and fader control \$4.95. Crystal mike \$4.90 extra.



20% DEPOSIT, BAL. C.O.D. WRITE FOR FLYER.  
**McGEE RADIO CO.**  
1225-C McGee St.; KANSAS CITY, MO.

## TRANSATLANTIC NEWS

(Continued from page 67)

evolved in Germany during the war and used for the construction of delicate electrical appliances in which complete reliability was essential. To track down the makers and to obtain technical details proved a long and difficult business, but I have at last been able to do this. Here, published for the first time, are particulars of a device which played an important part in the production of several of Hitler's secret weapons.

The cylindrical handle of the tool is made of plastic material and is about 10 inches in length by 1 inch in diameter. Fig 1 shows the working parts. A kind of steel nozzle at the end of the handle forms the welding head. Free to move in the aperture of the head is a rod carrying a carbon electrode. On the rod, which can be pushed forward into the aperture of the head by pressure on the actuating knob, is mounted the iron core of a solenoid. Two leads run through the handle to the low-voltage side of a line transformer. One of these is connected direct to the rod carrying the carbon; the other is connected through the solenoid to the welding head.

The aperture of the head is placed over the work and the tool is pressed well down so that the head makes good electrical contact with at least one of the two parts to be welded. The actuating knob is now gently pressed with the forefinger. This causes the carbon to travel toward the work until contact is made. As soon as this happens, current passes through the windings of the solenoid, which now exercises a pull on the iron core mounted on the rod.

The rod is thus retracted and an arc is formed on the "break"; but the actuating knob rebounds from the pad of

the fingertip (remember that the finger pressure *must* be light), bringing the carbon again into contact with the work. The result is an intermittent arc, between the carbon and the work, of heat sufficient to make the metal parts flow and become firmly welded together.

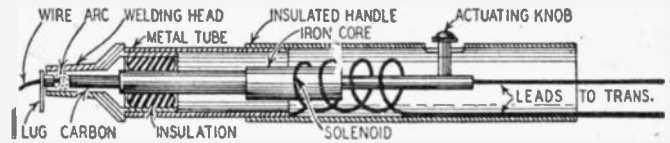

Fig. 1—Cross-section view of the small German radio spot-welder. The lug at left end is the work being done, not part of the tool.

Parts made of most of the commonly used metals and having cross sections not exceeding a diameter of 1/8-inch can be welded in this way in from 1/4 to 2 seconds, according to their nature and size. The only common metal that cannot be welded at all is zinc. Some metals, such as bronze and silver, do not weld easily; when they do have to be joined, this tool provides a ready means of making firm, secure joints by the process of hard-soldering.

The ordinary soft-soldered joint is always apt to be a weak spot in radio and electrical apparatus. With spot-welding dry joints just do not happen and, as no flux is required, there is no fear of subsequent corrosion.

Mechanically-minded readers may like to try their hands at making up small spot-welders on these lines. For their guidance, the carbon should have a diameter of about 6 millimeters and the low-voltage winding of the transformer should be able to supply up to 10 amperes of current at 20-35 volts. This seems a heavy load in comparison with the electric soldering iron, until you realize in welding no current whatever passes except in the brief periods in which a weld is actually in progress.



### CANNON-BALL

is a good Headset guaranteed to satisfy you. For sensitivity, clarity of tone, dependable performance, use a Cannon-Ball Headset. Folder R-4 illustrates complete line. Write

Scientifically Built  
Heavy bar magnets greatly increase their efficiency.

**C. F. CANNON COMPANY**  
SPRINGWATER, N. Y.

## Headset Headquarters

## RADIO BOOKS

BY MAIL

OVER 125 TITLES IN STOCK

SAME-DAY SHIPMENT ON 98% OF ALL MAIL ORDERS. Books of nearly all radio publishers. If you don't know price, send deposit and we'll ship C.O.D.

SEND STAMP FOR CATALOG TO EDITORS AND ENGINEERS, Ltd.  
1305 Kenwood Road • Santa Barbara, California

## The HOUSE OF A MILLION RADIO PARTS

### BARGAINS IN TUBES

BRAND NEW INDIVIDUALLY BOXED

1T4	.....List \$2.20	.....Your Cost \$ .99
1B5	.....List 2.20	.....Your Cost 1.09
1T4	.....List 2.20	.....Your Cost 1.09
2B7	.....List 1.80	.....Your Cost .99
2X2/879	.....List 3.20	.....Your Cost 1.50
3A5	.....List 2.20	.....Your Cost .99
3Q4	.....List 2.20	.....Your Cost 1.09
354	.....List 2.20	.....Your Cost 1.09
5Y3GT	.....List .95	.....Your Cost .55
6AC7	.....List 3.20	.....Your Cost 1.60
6AG5	.....List 3.20	.....Your Cost 1.90
6AK5	.....List 3.20	.....Your Cost 1.90
6B4G	.....List 2.65	.....Your Cost 1.40
6B7	.....List 1.80	.....Your Cost .99
6B8	.....List 2.65	.....Your Cost 1.40
6C8	.....List 2.20	.....Your Cost 1.09
6D6	.....List 1.35	.....Your Cost .69

Thousands of other tubes and radio supplies on hand. Write for bulletin No. 28.

### Lifetime Sound Equipment Co.

911-913 Jefferson Ave., TOLEDO 2, OHIO

## ANTENNA PRINCIPLES

(Continued from page 21)

radiation and consequent power gain are almost doubled because both reflector and director influence radiation similarly. The reflector element is generally 5 percent longer than the half-wave radiating dipole; the director 5 percent shorter in length. The important factor of phase is controlled by these dimensions *plus* the structural spacings between the parallel elements.

Spacing is important. And *optimum* spacing—in terms of relative field strength, or power gain—may be determined from the design chart, shown in Fig. 3.

For maximum power gain use of a reflector with a dipole requires a spacing between  $0.2\lambda$  and  $0.25\lambda$ . When a director is used, the spacing is more critical, the optimum value being about  $0.1\lambda$ .

Combining a director and a reflector to influence the radiation of a half-wave dipole causes a two-fold increase in both field intensity, directivity, and power gain. Because the three elements are

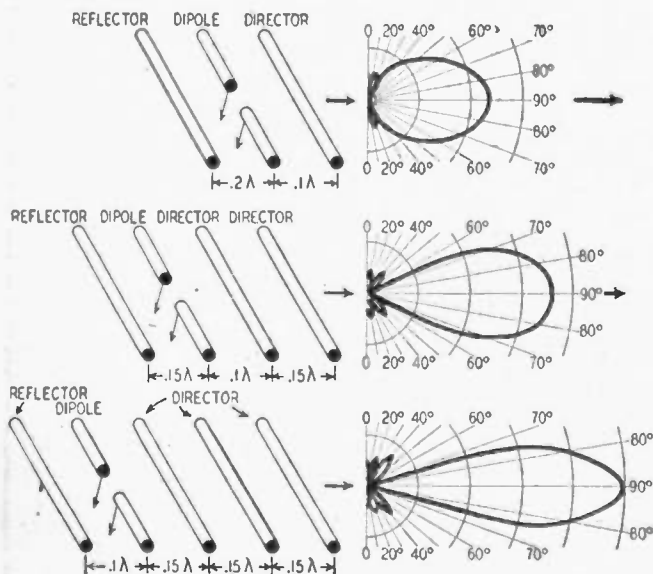

Fig. 4—Directivity is increased by increasing number of elements.

arranged parallel and in a horizontal plane, they are known as *horizontal* arrays. The array (Fig. 4) produces a horizontal radiation beam with a width of about 60 degrees, measured at half-power points.

Addition of a *second* director provides greater power gain and more directivity. Dimensions of the second director are the same as those of the primary director, but the greater spacing between the two directors should be noted. Beam width of 40 degrees is typical.

Such an array is standard equipment for radar-equipped RAF night-fighters (Photo C), and is also used for other types of radar installations on aircraft, where available space is limited.

Use of *three* directors with a dipole and reflector further improves the directional effects of the horizontal array and provides a radiation beam approxi-

mately 15 degrees in width.

Four directors with a dipole and reflector are used on each of four "legs" of the extremely directional array of a U.S. Army combat radar set. Consisting of 4 phased sets of horizontal arrays, the antenna can be considered as an *array of arrays*. The combined radiation pattern provides a very narrow beam less than 8 degrees in width.

Almost *any* number of directors can be used with a reflector and single radiating dipole. Some radio amateurs have used as many as 8 or 10 directors in a horizontal array. The practical limit is about 4 or 5 directors, all of the same dimensions.

# Make Money In Radio

These publications will show you how to do it

**HOW TO MAKE MONEY IN RADIO** by Ivan D. Long, president of Western Radio Institute, Inc. A complete manual for opening and conducting a money-making Radio Service business. How to choose a location, How to Advertise, How to Keep Records, How to Handle the Customer, How to Relieve the Service Man of Un-skilled Jobs, How to Service Radios by the Step-by-Step Method which is easy to follow and covers every type of radio receiver; includes a proven Schedule of Prices. No radio man can afford to be without this book. Postpaid..... **\$4.95**

**SERVICING THREE-WAY PORTABLE RADIOS**, by Lyle C. Treacle, Chief Instructor Western Radio Institute, Inc. A simple discussion of how to handle these tricky little portables and make money from servicing them. Breaks down the circuits of each type, shows how to service each difficulty and how NOT to damage the set while repairing it. Available for immediate delivery. Postpaid **\$2.95**

**FCC SIMULATED PRACTICE EXAMS**—By Lyle C. Treacle. If you can pass these tests you can be reasonably sure of passing the official FCC examinations. Available for Elements 2, 3, 4, 5, 6. Five different "multiple choice" type exams for each element, with answer sheets for checking your results. State element for which exams are desired. Per 5 exams for any element, postpaid..... **\$1.25**

**QUICK-REPAIR CHARTS**—Short-cuts to repair any radio receiver. By Lyle C. Treacle. State whether for AC-Superhet, AC-DC-Superhet, AC-TRF, or AC-DC-TRF receivers. Per chart..... **.50**

**AVC MADE EASY**, By Lyle C. Treacle. A simple analysis of Automatic Volume Control service problems. Covers Delayed AVC, Amplified AVC, and Quiet AVC. Has descriptions and circuits of various systems used. Each, postpaid..... **.75**

Order from

## DALE'S OF DENVER

Publishers

510 15th Street

Denver 2, Colorado

## QUIK-LABELS CODE CARD SYSTEM

Removable Self-Starter Strip exposes ends of Labels for you to peel!

DON'T PICK. USE SELF-STARTER STRIP TO PEEL LABELS.

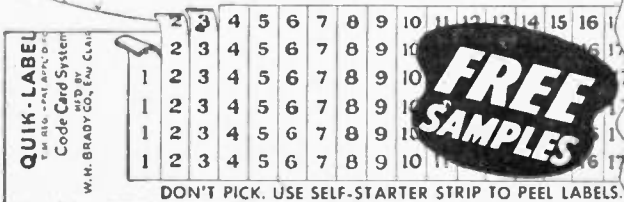

DON'T PICK. USE SELF-STARTER STRIP TO PEEL LABELS.

1 → PEEL 2 → APPLY 3 → IDENTIFY

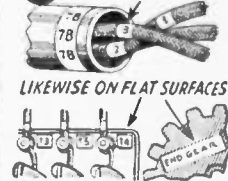
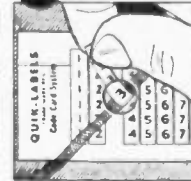
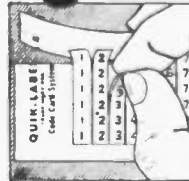

LIKEWISE ON FLAT SURFACES

\* Patents Pending

QUIK-LABELS code Wires, Leads, Circuits, Relays, Parts, etc., faster and cheaper. ● Pre-cut to exact size, QUIK-LABELS come on handy cards. ● Ready to use, they stick-quick without moistening, replace slow and costly string tags, roll tapes, decals, stencils, metal tabs, etc. ● Resist dirt, grease, oil, abrasion. ● \*Self Starter Strip automatically exposes ends of Labels for you to grasp instantly—no more finger-picking.

**W. H. BRADY COMPANY** Established 1914

Manufacturers of Self-Sticking Tape Products  
802 N. 3rd STREET, MILWAUKEE 3, WISCONSIN  
I'm interested. Send me all the facts on QUIK-LABELS.

Name \_\_\_\_\_ Title \_\_\_\_\_  
PLEASE ATTACH TO YOUR COMPANY LETTERHEAD

## Do you need BINDING POSTS?



The XL PUSH POST with its Spring Action assures Constant Contact and quick connection.

Manufactured in All Aluminum Type M at 12c each.

Aluminum Body, Bakelite Top Type B1 at 15c each.

Types CP or NP. ALL BRASS—STAINLESS STEEL SPRING & PIN. PROVEN by 240 HR. SALT SPRAY TEST as NON-CORROSIVE at 28c each.

Manufacturers and Dealers Liberal Discounts

**X. L. RADIO LABORATORIES**

420 West Chicago Ave., Chicago 10, Ill.

**Are You Missing  
The Best Values  
In Radio?  
SEND FOR THIS NEW  
FREE  
CATALOG NOW!**

Here's the handiest, most complete radio buying guide in America. Contains over 10,000 items of nationally known quality. Brings to your door step the world's largest and most complete stocks of radio and electronic equipment. Save time, work and money—send for your free copy.



**MAIL COUPON  
BELOW FOR  
144  
VALUE-PACKED  
PAGES**

- PARTS.** America's biggest stock of quality parts and equipment. Everything for hams, soundmen, engineers, servicemen, experimenters. All leading makes at economy prices.
- RADIO SETS.** The new Lafayette Catalog is a regular parade of all the latest 1947 models, including phonoradios, portables, communication receivers. Latest styling—outstanding performance—wonderful values.
- P.A. Sound systems** for every type of public address installation. Complete listing of amplifiers, microphones, speakers, accessories. Many new developments listed for the first time.

**Lafayette Radio**  
RADIO WIRE TELEVISION, INC.  
100 Sixth Ave. • N. Y. 13  
110 Federal St. • Boston 10  
24 Central Ave. • Newark 2, N.J.

Paste Coupon on Penny Post Card

**LAFAYETTE RADIO, Dept. JD-7**  
100 Sixth Ave., New York 13, N. Y.  
Please send new Lafayette Radio Catalog at once.

Name.....  
Address.....  
City..... Zone..... State.....

**MULTI-STATION INTERCOMMS**  
(Continued from page 33)

The Talk-Listen switch is just beneath this, on the chassis apron. The cabinets come with speaker grill all cut and covered, so mounting these two switches just halfway between the right edge of the speaker opening and the right edge of the cabinet will give a balanced appearance.

If the time necessary is justified, the new Millen panel-marking transfers may be used to mark the On-Off switch

switch plate may be cemented to the wood, over the selector switch shaft, with Duco or similar cement.

While the veneer on the cabinets is not bad wood, putting on a coat of clear shellac is a good idea. It helps protect the wood and gives a polished look.

The rear of the cabinets can be left open, but better voice quality, volume and appearance will result from closing them. White Bristol board or any fairly heavy cardboard is

satisfactory. Do not measure the board and cut it; the cabinets are not absolutely square. Lay the back of the cabinet on a sheet of the backing and trace the outline. Then cut with a razor blade and trim to fit. A miniature wood screw in each corner will hold the board in place. Be careful to make the guide hole for these screws in the center of the ply to avoid splitting it.

A hole may be cut in the backing to accommodate the line cord and the interconnecting cable. However, it is easier and just as satisfactory simply to cut away about 2 inches of the bottom all the way across, thus avoiding having the backing torn by the cables.

It will be noted that a multiconnector plug and socket are used to plug

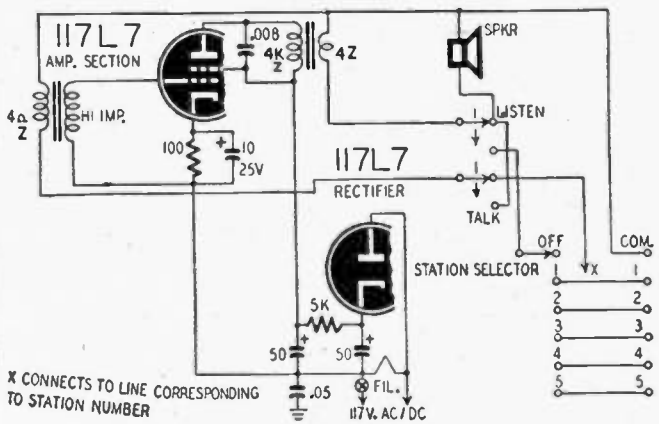
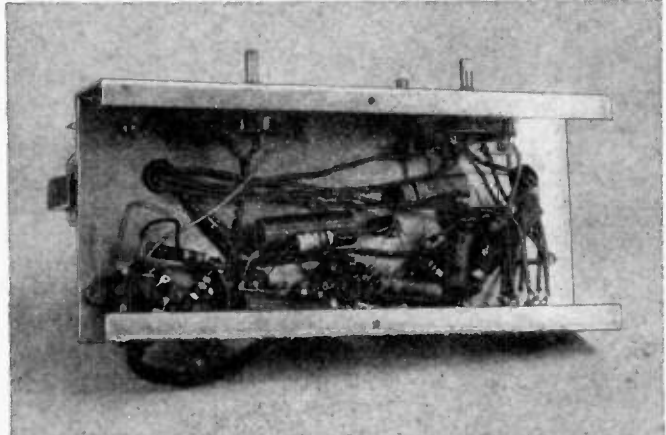

Fig. 4—A simple system which uses 1 tube at each end of the circuit.



An under-chassis view of 3-tube master unit of Fig. 1 (March issue).

and the station selector numbers. If not, a standard Off, 1-to-5 position circular

the line system into the master units, while the remotes are simply connected

**Send and Receive Code**  
with this 2 WAY PROFESSIONAL  
**TELEGRAPH PRACTICE SET**

Some as used by U. S. Signal Corps.  
Learn code quickly and have loads of fun with your "private" Intercom system.

List Price \$9.95  
YOUR COST Only \$5.95  
Complets with everything  
Includes 2 Lionel keys, 2 Speedex HF buzzers, 2 code plates, battery, wire, etc. and instruction sheet.  
Send check or M.O.

**AUDIO SALES CO. 11 WARREN ST. NEW YORK 7, N. Y.**

Temperature rise of water through which v.h.f. waves are passed is used to measure their power in a microwave wattmeter invented at Brooklyn Polytechnic Institute.

**S.S.S.**

"Servicing by Signal Substitution"

Learn about this modern dynamic approach to radio servicing with ONLY BASIC TEST EQUIPMENT.  
... Fully described in a 120 page book available from your Precision Distributor or factory at 35¢.  
... Schools are invited to inquire regarding quantity orders from our Educational Division.

**PRECISION APPARATUS COMPANY INC.**  
ELMHURST 4, N. Y.  
Manufacturers of Fine Test Equipment  
RADIO • TELEVISION • ELECTRICAL • LABORATORY



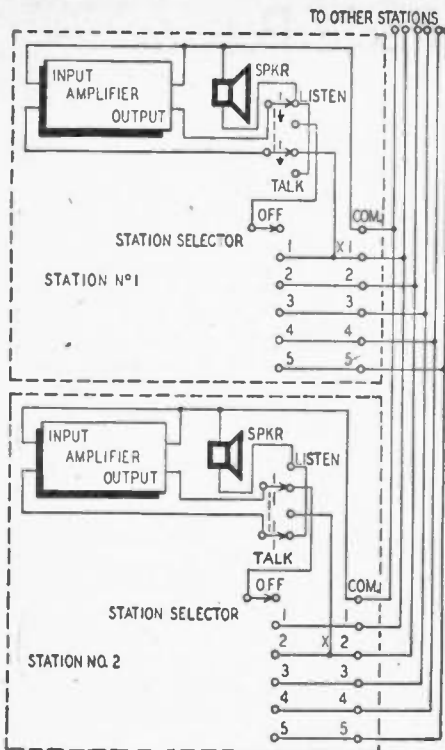

Fig. 5—Wiring diagram, 1-tube master system.

to two leads on a convenient terminal strip. Connections to these remotes may be so made that a solid cardboard or Masonite back can be fitted permanently.

The next article of this series, to appear in an early issue, will show in detail the junction boxes and connections and will deal with the actual problems of installation and servicing.

## OPPORTUNITY AD-LETS

Advertisements in this section cost 20 cents a word for each insertion. Name, address and initials must be included at the above rate. Cash should accompany all classified advertisements unless placed by an accredited advertising agency. No advertisement for less than ten words accepted. Ten percent discount six issues, twenty percent for twelve issues. Objectionable or misleading advertisements not accepted. Advertisements for May, 1947, issue must reach us not later than March 28, 1947.  
Radio-Craft • 25 W. Broadway • New York 7, N. Y.

**TELEVISION RECEIVER COIL KITS INCLUDING** complete set of 10 matched coils for 5 or 7" Television Receiver. Instructions wrapped around each coil include typical circuit application. Kits are shipped prepaid, \$4.95 each. Vision Research Laboratories, P.O. Box 52, Kew Gardens 15, New York.

**TELEVISION RECEIVER EASILY CONSTRUCTED** from our plans. Vision Research Labs announces new line of television booklets written especially for the ham experimenter. Booklets now available (\$2.00 each): "Design and Construction of a 7" Television Receiver" and "Visual Alignment Sweep Generator." Booklets contain theory, practical details, illustrations, schematic diagrams, etc. Vision Research Laboratories, P.O. Box 52, Kew Gardens 15, New York.

**SPECIAL OFFER**—**BRAND NEW SURPLUS** General Electric 3-Inch Meters, 1 Milliamperes Movement, Antiglare Glass, \$3.25. Box 4P.

**REPAIRMEN, HAMS! GET NEEDED RADIO-ELECTRONICS** books by mail. Send stamp for illustrated catalog. D. B. Nephews Publishing Company, Dept. C1, 300 Pacific Street, Brooklyn 2, N. Y.

**CORRESPONDENCE COURSES AND SELF-INSTRUCTION** books slightly used. Sold, Rented, Exchanged. All subjects. Satisfaction guaranteed. Cash paid for used courses. Complete information and 100-page illustrated bargain catalog Free! Write—Nelson Co., Dept. 39, Chicago 5, Ill.

**WE REPAIR ALL TYPES OF ELECTRICAL INSTRUMENTS**, tube checkers and analyzers. Hazelton Instrument Co. (Electric Meter Laboratory), 140 Liberty Street, New York, N. Y. Telephone—Barclay 7-4239.

**MAGAZINES (BACK DATED)—FOREIGN, DOMESTIC**, arts, books, booklets, subscriptions, pin-ups, etc. Catalog 10c (refunded). Cleorone's, 863 First Ave., New York 17, N. Y.

**AMATEUR RADIO LICENSES COMPLETE CODE** and theory preparation for passing amateur radio examinations. Home study and resident courses. American Radio Institute, 101 West 63rd Street, New York City. See our ad on page 80.

**FREE WHOLESALE BULLETIN, TUBES, PARTS**. Bargain prices. Henshaw Radio Supply, 3313 Delavan City, Kansas City, Kansas.

**USED CORRESPONDENCE COURSES AND EDUCATIONAL** Books Bought, Sold, Rented, Catalog Free. Educational Exchange, Henshaw, Ala.

# Musical Distinction

WITH  
**ABSOLUTE FIDELITY  
AMPLIFICATION**

DESIGNED BY A. C. SHANEY

A new and spectacular development in amplifiers now enables you to clearly identify all the instruments in a full orchestra!

As a result of nearly 20 years of specialized audio research and development, we can now place in your hands a new means to make the most fascinating, uplifting, and enjoyable journey into the realm of perfect sound reproduction—through the medium of the most satisfying musical amplifier the world has ever known.

If you are one of those discriminating persons for whom anything less than the best is a disappointment, you are one for whom the ACA-100DC Amplifier was designed. Send for literature.

## AMPLIFIER CORP. of AMERICA

398 Broadway, New York 13, N. Y.  
A. C. Shaney's FM-AM AMPLIFIER MANUAL is still available at 25c

"So may the outward shows be least themselves  
The world is still deceived with ornament"

William Shakespeare

## VERIFIED SPEAKERS

Do not come in fancy cartons

Everything goes into their  
Efficient and Sturdy construction

That's why RADIO SERVICEMEN like them

# WRIGHT INC.

2232 UNIVERSITY AVENUE ST. PAUL 4, MINN.

**BUILD RADIO PHONOGRAPH COMBINATION**, Complete kits: catalog. Radion, 6922C, 21st Ave., Brooklyn 4, N. Y.

**A GREAT MONEY SAVER, COMPLETE WITH TUBES**, \$10.95. Details Radio, 9418 Ave A., Brooklyn, New York.

**MAGNETIC WIRE RECORDER KIT**, \$200 value, \$49. P. O. Box 363, Hoboken, N. J.

**RADIO MEN—LOWEST PRICES IN AMERICA. BIG** Stock. Write for latest Catalogue. McGee Radio, 1330 Broadway, Denver, Colorado.

### SUPER-HET KIT, \$9.75!!

Plastic Cabinet—uses 50L6, 35Z5, 125M7, 125A7

Kit of 4 matched tubes for above kit.....	\$3.95
Wireless Phono Oscillator kit.....	2.95
Above kit, wired & tested.....	3.95
Kit of matched tubes for wireless.....	2.35
3-Tube phono amplifier kit.....	2.75
Above kit, wired & tested.....	3.75
Kit of matched tubes for phono.....	3.15

All kits are complete with instructions.

**RADIONIC DESIGN**

709 E. 5th Street

New York 9, N. Y.

## AMAZING NEW RADIO!

Pocket or  
Purse size  
SMALL AS A PACK OF CIGARETTES! weighs only a few ounces—Beautiful black chrome plastic case. Uses new war born crystal diode, Hi-Q-slide dial. NO tubes, batteries or electric "plugs." Usually receives local broadcasts without outside aerial wires.

**GUARANTEED TO PLAY** when used according to instructions sent with each radio! You can use it at home, in offices, hotels, cabins, in bed, etc.—lots of fun—real entertainment!

**Send Only \$100** (cash, money order, check) and pay postman \$2.99 plus delivery fees on arrival or send \$3.99 for postpaid delivery. Complete as shown Ready to Play with self contained personal phone. For Girls—children will love it—grown-ups too! An exceptional value—order yours and enjoy the many good radio programs coming! Don't be without your Pa-Kette Radio another day! (All foreign orders \$5.00 U.S. cash.)  
Pa-Kette Electric Co., Dept. RC-4 Kearney, Nebraska



Chemical Laboratory  
Dial Cable Kit

Dial Belt Kit - Alignment Kit

G-C NO. 5025  
PROFESSIONAL  
ALIGNMENT KIT

Complete alignment and neutralizing kit in steel box. Has every tool to service any set; 30 tools. List \$19.95



G-C ELECTRONIC  
CHEMICAL  
LABORATORY

Ideal for all servicemen. 18 bottles and chemicals in hvy. (free) steel rack. No. 998.....List \$11.12



G-C SERVICEMEN'S  
DIAL CABLE KIT NO. 1

Contains four 25 ft. spools of dog ear dial cable with free assortment of eyelets and clamps. No. 77-SK.....List \$4.76



G-C SERVICEMEN'S  
DIAL BELT KIT

Fine woven replacements for all sets. Easy to install. Supplied with steel box in kits of various quantities.



No. G-25—kit of 25 belts.....List \$6.70  
Available at leading jobbers.  
Write for catalog.

SEE OUR EXHIBIT—BOOTH # 96  
1947 RADIO PARTS CONFERENCE  
Stevens Hotel, Chicago • May 13-16  
RADIO DIVISION DEPT. D

GENERAL CEMENT Mfg. Co., Rockford, Ill., U. S. A.  
Manufacturers of over 3,000 products  
Sales offices in principal cities

RADIO PARTS  
SOUND SYSTEMS  
ELECTRONIC  
APPARATUS

Depend on  
RADOLEK

Radolek's big Free Profit Guide Catalog and Profit Bulletin supplements keep you abreast of the rapidly changing radio situation. Buying from Radolek means greater values, better service and more profits. Make Radolek your buying headquarters.



RADIO PARTS



SOUND SYSTEMS

FREE  
CATALOG



Large Stocks  
Fast Service

SEND TODAY!

RADOLEK CO., Dept. C-116  
601 W. Randolph St., Chicago 6, Ill.  
Please send your FREE Profit Guide Catalog.

Name.....

Address.....

SAVE AT RADOLEK

# New Radio-Electronic Patents

By I. QUEEN

## WIDEBAND COUPLING

Ahmet H. Nevzi, Philadelphia, Pa.  
Patent No. 2,405,515

It is difficult to design a good video amplifier because of stray coupling and loss in the coupling between stages. To flatten out the frequency response it is necessary to reduce stray capacitance between components, leads and ground.

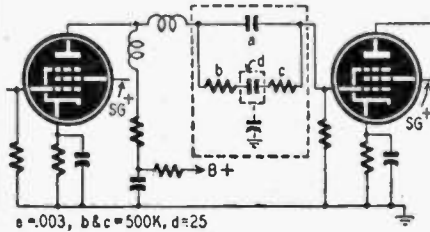

A typical coupling network is shown within the box in the first figure. It is composed of an R-C network in which the stray and distributed capacitance to ground must be kept low to avoid resonance effects and power loss. Typical component values are shown.

The figures show how the new design permits the construction of components having

much higher efficiency. The small coupling condenser is placed within the larger paper wound condenser. The two ends of the unit are carbon discs which are actually the two resistors used at either end of the network. Not only does this method simplify the assembly of the unit but it reduces the capacitance to ground of the several components and their leads. The result is higher gain over a wider band of frequencies.



EXPLODED VIEW



COMPLETE UNIT

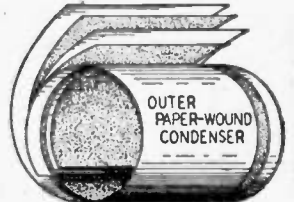

OUTER PAPER-WOUND CONDENSER

## NEUTRON DETECTOR

William E. Shoupp, Pittsburgh, Pa.  
(Assignor to Westinghouse Elec. Corp.)  
Patent No. 2,408,230

The Geiger-Muller counter is widely used as a detector of ionized particles. Only very recently, however, the uncharged particles of an atom, the neutrons, have become important in atomic physics. They have an essential role in the production of atomic energy by nuclear disintegration.

This invention permits the detection of uncharged particles through a modification of

existing equipment. The inner glass surface of a Geiger-Muller tube is coated with an atomic fission material, such as uranium or thorium. Since neutrons pass readily through the glass envelope, they will break up atoms upon bombarding the inner coating, thus making available ionized particles. As in conventional devices, these particles are readily detected. It is necessary, however, to use a comparatively low voltage across the Geiger-Muller tube to prevent it from recording unrelated particles or radiation such as gamma rays or X-rays which may be present.

Each ionized particle within the counter chamber causes a pulse of current through it with a resultant voltage drop across the grid resistor of the first tube. Resistor R is designed to produce a sufficiently large drop so that the voltage across the

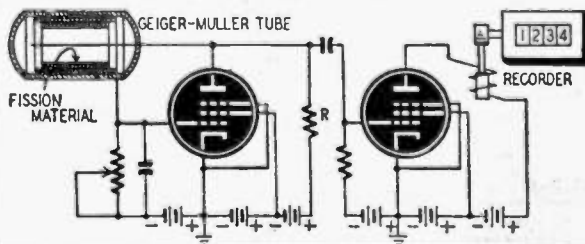

## WAR SURPLUS SPECIAL \$25.00 OFFER

On receipt of \$25.00 we will ship you freight collect a large assortment of choice government surplus radio items, subject to your inspection and approval. After inspecting them, if you are not completely satisfied, return the shipment to us freight collect and we will refund your \$25.00. But you must surely want to keep it, therefore, we can afford to make this offer. You should be able to sell enough of the items that you do not need to pay for the entire lot.

Our warehouses are filled with thousands of choice government surplus radio items. Many of them we do not have in sufficient quantity to advertise nationally. And if we inventoried and cataloged them, their cost would be greatly increased. In this way you can purchase desirable war surplus radio material at the lowest possible price.

Therefore we make you what we consider a highly advantageous offer. If you mention a few items you prefer, we will try to include them in the shipment. State whether you want our commercial or ham assortment.

THE ABELL DISTRIBUTING CO.  
5 E. Biddle Street, Baltimore 2, Maryland

## AMSCO SPECIAL

### SERVICE KIT

Kit includes assortment of:

- 100 Resistors, 1/2 and 1-watt.
- 50 Condensers, paper, mica and can.
- 10 Switches, toggle and gang.
- 100 ft. Spaghetti, various sizes.
- 12 Knobs, round and bar.
- 2 lbs. Hookup wire.
- 20 Fuses.
- 6 Volume Controls.
- 10 Tube Sockets.
- 1 lb. Hardware (screws, nuts, lugs, etc.)
- 25 Connectors & Plugs
- 10 Jacks (Phone)
- 12 Padder Condensers.
- 12 Terminal Boards with Resistors.
- 25 Ceramic Insulators.
- 1 Screw Driver.
- 1 Tube Puller.
- 2 Allen Wrenches.
- 2 Panel Fuse Holders.
- 4 Binding Post Strips, and many other valuable items.

Your Cost **\$9.95** Complete

Free—Experimenter's Kit with First 500 orders.

Write for our catalog.

AMERICAN SALES CO.

1811 W. 47th St.

Chicago 9, Ill.

# SCARCE TUBES

At Good Discounts  
All Popular Standard Brands

New Guaranteed Sealed Cartons

024, 1LA6, 1LNS, 1P5, 2A3, 5Z4, 6AB, 2A5, 2A6, 6E5, 6F5, 6J8, 6K5, 6K8, 6F5, 6Q7, 7A8, 7B8, 7B5, 7B7, 7C5, 7F8, 7G7, 12A8, 12F5, 12J7, 12K7, 12Z3, 14Q7, 14R7, 25A7, 25L6, 25Y5, 25Z5, 25Z6, 30, 32L7, 33, 35, 35A5, 35Y4, 35Z3, 43, 45, 47, 50A5, 50V6, 55, 57, 58, 59, 70L7, 71A, 84, 117L7, 117M7, 117N7, 117P7, 117Z3, 117Z6, XXL and many others.

## THIS MONTH'S SPECIALS!

Five-tube All-American Kit  
50L6, 35Z5, 12SA7, 12SK7, 12SQ7 ..... \$3.65  
25Y5 exact replacement for 25Z5. List price \$3.20 ..... Your cost 75c  
Acorn Tubes guaranteed 954, 955, 956, 957. 49c each  
6AK5 tubes guaranteed ..... 75c each  
Hearing Aid tubes. All types.  
501AX, 509AX ..... 49c each  
6AH6 Tubes ..... 49c each  
Condensers. Brand New. Individually Boxed. Fully Guaranteed for one year. Used by leading radio manufacturers at a price you can't beat.  
20/20 MFD at 150V ..... 45c each  
8 MFD at 450V ..... 32c each  
16 MFD at 450V ..... 45c each  
20 MFD at 150V ..... 32c each

SPECIAL DISCOUNT ON ALL LARGE ORDERS  
WRITE OR WIRE FOR CATALOG  
WE SHIP ANYWHERE



## COMMERCIAL RADIO

36 BRATTLE ST., BOSTON 8, MASS.

Department M

## PEN-OSCIL-LITE

Extremely convenient test oscillator for all radio servicing; alignment • Small as a pen • Self powered • Range from 700 cycles audio to over 600 megacycles a.h.f. • Output from zero to 125 v. • Low in cost • Used by Signal Corps • Write for information.

### GENERAL TEST EQUIPMENT

38 Argyle Ave. Buffalo 9, N. Y.

## Electronics Made Easy!



### Magi-Klips KIT

Build 18 Experiments at Home—  
No Tools!

RADIO RECEIVER, HOME BROADCASTER, PHOTOELECTRIC RELAY, CODE PRACTICE OSCILLATOR, SIGNAL TRACER, REMOTE CONTROL RELAY, Phonograph Transmitter, Intercommunication Amplifier, Code Transmitter, Radio Frequency Oscillator, Telephone Line Amplifier, Electronic Switch, Phonograph Amplifier, Temperature Control Relay, Contact Detector, Electronic Metronome, Interval Timer (one-shot), Interval Timer (repeating).

With a Magi-Klips kit you cover the entire field of electronic engineering theory quickly in your spare time. It's simple to arrange the components for each circuit. No soldering. No tedious wiring. Kit operates on 110 v. AC or DC and includes 35Z5 rectifier, 50L6 power amplifier, 12SK7 double triode, powerful 4" speaker-mike, plate relay, broadcast and SW coils, tuning condenser and generous supply of resistors, condensers, chokes, extra wire. Parts worth double the price of kit.

Kit's 48-page manual has complete instructions and diagrams easily followed by the beginner. Remember, you need no tools, except possibly a screw-driver, with a Magi-Klips electronic experimenter's kit ..... \$39.95 complete

DEER & TAYLOR COMPANY  
1340 Miltvia St.  
Berkeley 9, Calif.

Please ship  Magi-Klips electronic kit (s).  
I enclose \$ .....  
 Please mail illustrated folder on the Magi-Klips kit.  
Name .....  
Street .....  
City ..... State .....

Geiger-Muller tube becomes too low to sustain the ionization. Therefore each pulse is detected separately. The greatly amplified pulses in the second tube plate circuit energize an electromagnet and operates the plunger which is coupled to a mechanical recorder.

## SUPERADIO

(Continued from page 17)

radio may well be changed completely.

It is even possible that the radio phenomenon of superconductivity may be linked with another imperfectly understood old radio phenomenon:

Ever since radio broadcast started in the early twenties, newspapers from all over the world reported most unusual and unorthodox radio reception. In Boston, for example, a cold-water faucet a block away from a radio broadcast transmitter gave out music or speech when turned on. A few blocks away a housewife almost fainted when a frying pan on a gas stove emitted music and lectures that could be heard throughout the flat. Similar strange radio sounds have been reported in the press for years.

The radio engineer shrugs this off as "an imperfect contact effect". But it is not too easy to understand just why a faucet or a frying pan should become a sonorous loudspeaker without any radio apparatus and electric current—even if near a broadcast station.

Many years ago, on a trip from New York to Bermuda I was on deck of a steamer in a somewhat foggy night. Suddenly the overhead two-wire antenna became very audible! The operator was transmitting with an old de Forest spark transmitter. I was far away from the wireless shack, consequently I could not hear the transmitter itself. But the antenna gave out peculiar, weird, crackling sounds and I could follow the code easily. This phenomenon has been verified by others. It doesn't occur at all times, but only when conditions are right.

Others have heard speech and music issue from overhead radio antennas of broadcast stations at certain times.

All this proves that there can be radio reception without orthodox radio receiving instruments, such as radio tubes, conventional tuning devices, and electric current.

Evidently there is more to radio reception than meets the eye. To quote Shakespeare:

"There are more things in heaven and earth, Horatio,  
Than are dreamt of in your philosophy."

## AMPLIFIER

For Call System or  
Phono. Amplifier

\$2.95



- Complete with tubes • Compact—wired
- Ready to Operate • Uses 35Z5—50L6.

N. J. INDUSTRIAL CO.

309 ELM ST. NEWARK 5, N. J.

## MONEY-SAVE RESCO THRILLS

Save on Nationally Advertised  
**FLASHLIGHTS**

Reg. 1.19 Two-Cell  
Utility Flashlight

Army type. Convenient side clip. Complete with bulb. Strong beam.

Resco's Price **82¢**

Reg. 1.30 Two-Cell  
Industrial Flashlight

Durable ribbed case. Throws strong beam. Complete with bulb.

Resco's Price **89¢**

Batteries for above each **6 1/2¢**

Reg. 45c Pocket-Size  
"Bantam" Flashlight

3-inch aluminum case. Fits into pocket. Gives plenty of light. With battery and bulb.

Resco's Price **39¢**



RESCO'S FAMOUS  
**10,000-PLAY**  
Phonograph NEEDLE

With sapphire jewel tip.

**1 85**

Reg. \$5 ..... Resco's Price 1 for \$17

Resco has all types of  
**PERMEABILITY  
TUNERS**

- 3 color dial scale; gold, buff, brown
- All units prepacked at factory
- Tune from 540 to 1600 KC
- Individually packed, ready to use



NO. A-230

Superhetrodyne

Complete with matched oscillator coil. Smooth drive. Includes hook-up diagram, chassis diagram and instruction sheet.

Resco's Price **2 85**

NO. A-210

Superhetrodyne

Slide Rule Type

5" scale. Smooth drive, includes extended acetate window and hook-up diagram.

Resco's Price **4 05**

No. A-260

Regenerative  
Tuner

Replaces single gang variable condenser. Complete with coil.

Resco's Price **1 44**

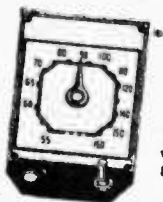
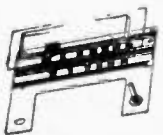

Write for Big, Value-Packed Bulletin  
Include Postage with Cash Orders

**Radio Electric**  
SERVICE CO. OF PENNA., INC.

7TH AND ARCH STREETS, PHILA. 6, PENNA.  
Branches at 5133 Market St. and 3145 N. Broad St.,  
Phila. Also in Wilmington, Del., Easton, Pa., Allentown, Pa.

# LIERS

## AT BARGAIN PRICES

Look at this list!

A. C. VOLTMETER Triplett Model 331 J.P. 3 1/2". round flush bakelite case, white scale, 0-150 volts. Complete with external wire wound precision resistor to increase range to 300 Volts.

A. C. AMMETER Triplett Model 331 J.P. (same as above) 0-30 Amps A.C.

**SPECIAL OFFER BOTH METERS ONLY \$8.95**

D. C. MILLIAMMETER DeJur Amsco Model 310. 3 1/2". round flush bakelite case. 0-1 M.A. movement with 0-4 Kilovolt, white scale. Complete with paper volt ohm milliammeter scale and wiring diagram showing how to make an analyzer.

**SPECIAL \$3.95**  
In lots of 10 at \$3.50 each

MICROAMMETER General Electric, Model DO-41. 3 1/2". round flush bakelite case. 150-0-150 microampere, 75 ohms resistance, zero center movement, blank scale marked "Balance-Set Power"

**EACH \$4.50**

MICROAMMETER G.E., DO-41. 3 1/2". 0-500 microampere. Scale 0-20 K.V. with paper V.O.M.A. scale

**EACH \$4.95**

### MILLIAMMETERS

G.E., DO-41. 3 1/2". round flush bakelite case. 0-1 M.A. movement. Knife edged pointer. Spec. Black scale with paper V.O.M.A. scale. **EACH \$4.50**

G.E., DO-41. 3 1/2". round flush bakelite case. 0-1 M.A. Standard white scale. **EACH \$4.95**

G.E., DO-53. (3 1/2" Square flush bakelite case) 0-20 M.A. **EACH \$3.25**

G.E., DO-41. 3 1/2". round flush bakelite case. 0-50 M.A. Black Scale **EACH \$3.25**

G.E., DO-41. 3 1/2". round flush bakelite case. 0-200 M.A. **EACH \$3.95**

D.C. KILOVOLT-METER DO-41. 3 1/2". round flush bakelite case. 0-2.5 K.V. Black scale, with external precision, wire wound resistor. **EACH \$6.95**

A.C. VOLTMETER G.E., AO-22. 3 1/2". round flush bakelite case. 0-150 Volts A.C. **EACH \$5.95**

A.C. AMMETER G.E., AO-22. 3 1/2". round flush bakelite case. 0-80 Amperes. **EACH \$4.50**

RUNNING TIME METER G.E., 3 1/2". round flush bakelite case. Up to 9,999.9 hrs. Operates on 10-12 volt, 80 cycle. Ideal for counting the total hours of operation of the power tubes on transmitters, etc. **EACH \$3.50**

### MILLIAMMETER

WESTINGHOUSE, 3 1/2". RX-35 Square Bakelite case, white scale, long narrow Spade pointer. 0-1 M.A. movement, 55 ohms resistance with standard 0-1 M.A. scale as illustrated. Complete with paper Volt-Ohm Milliammeter scale. This meter was made for the Gov't to be used in various types of radio transmitters and receivers. **EACH \$4.95**

MILLIAMMETER Westinghouse, Type NX-35. 3 1/2". round flush bakelite case. 0-200 M.A. **EACH \$3.95**

D.C. VOLTMETER Westinghouse, NX-35. 3 1/2". round flush bakelite case. 0-50 Volts. 200 ohms per volt. **EACH \$3.95**

D.C. VOLTMETER Westinghouse, NX-35. 3 1/2". round flush bakelite case. 200 Volts. 1000 ohms per volt. **EACH \$3.95**

D.C. KILOVOLT-METER Westinghouse, NX-35. 3 1/2". round flush bakelite case. 0-1.5 K.V. Complete with external wire wound precision resistor and mounting clips. **EACH \$6.95**

D.C. KILOVOLT-METER Westinghouse, NX-35. 3 1/2". round flush bakelite case. 2.0 K.V. with two external wire wound precision 1 Kilovolt resistors. To make this a dual range 0-1 & 0-2 Kilovoltmeter. Complete with mounting clips. **EACH \$7.25**

A.C. VOLTMETER Westinghouse, Type NA-35. 3 1/2". round flush bakelite case. 0-15 Volt A.C. **EACH \$3.95**

A.C. VOLTMETER Westinghouse, NA-35. 3 1/2". round flush bakelite case. 0-150 Volt A.C. **EACH \$5.50**

A.C. AMMETER Westinghouse, NA-35. 3 1/2". round flush bakelite case. 0-75 Amp. A.C. **EACH \$4.50**

DECIBEL METER Weston Model 301. 3 1/2". round flush bakelite case. General purpose type. Black dial, white markings. Scale marked "-20 to 0 DB". Zero DB equals 1.73 volts, 6 Milliwatts. Calibrated for 500 ohm load. Lower scale marked -15 to +5 DB, which can be used if an attenuator or resistor network is provided. **EACH \$4.50**

SIGNAL STRENGTH ("S") METER Simpson Model 25. 3 1/2". round flush bakelite case. Use this on the plate circuit of your receiver to show the relative strength of incoming signals. Scale calibrated—6 to 100 DB above 1 microvolt. 5 M.A. Zero right movement with translucent scale, for internal scale illumination from rear of meter. Complete with socket, lamp & circuit diagram. For further details refer to pages 164-165 & Fig. 730 B of Radio Amateur's Handbook. **EACH \$4.50**

## SURPLUS—NEW GUARANTEED

Gov't Inspected

All orders F.O.B., N. Y. 25% Deposit required on C.O.D.'s. Be sure to include sufficient postage, excess will be refunded.

**MARITIME SWITCHBOARD**  
336 Canal Street  
NEW YORK 13, N. Y.

## A SMALL RECORDING STUDIO

(Continued from page 34)

ticularly efficient way to ruin sapphire needles, as they are likely to shatter their points by digging into the base material.

The shavings are a particularly annoying part of recording. In a professional set-up they should be picked up with a suction pump and directed through a piece of hose to a metal container filled with water. These highly inflammable shavings are a fire hazard. They may be brushed toward the center of the turntable with a loosely held handkerchief, or with a so-called "chip chaser," a brush so placed on the table as to direct the shavings toward the center. For recording for professional users, the discs may be recorded from inside out so that the needle is moving away from the shavings.

### Cutting Speed and Record Size

The recording-frequency characteristic will depend somewhat upon the speed at which the recording is being made. At 78 r.p.m., the disc can be cut in to a 4-inch diameter, and the high-frequency response will be good. At 33 1/3 r.p.m., it is considered good practice not to record below an 8-inch diameter. With any lower speed of the record past the cutting head, the high-frequency excursions would be crowded together closer than the radius on the tip of the cutting needle, which is in the order of .002 inch. The playback pickup would not follow these extremely crowded excursions. The closer you get to the center of the record, the closer together the 10,000-cycle variations will be. When they are closer than .002 inch, the needle obviously cannot follow them. It is desirable, therefore, to increase the high-frequency amplitude by equalization, when nearing the center of the disc at 33 1/3 r.p.m., to counteract the falling high-frequency response of the disc. On some machines this is done continuously by a mechanical arrangement. It can be done, however, by advancing the high-frequency boost control in small smooth steps to produce a recording in which the high-frequency response seems constant.

When you have cut a disc, see that it is protected from dust, which will cause a great increase in surface noise in a very short time. It is wise to instruct your customers to so protect their recordings.

Attractive labels can be printed or made photographically to provide free advertising and to remind your customers where to come when they require additional recordings.

Other equipment, such as a cathode-ray oscilloscope for distortion observation, audio oscillators, vacuum-tube voltmeters, portable recorders, sound trucks, etc., would be desirable in a completely equipped recording studio, but that outlined here is adequate for a good job of commercial recording, and constitutes the basic set-up to which can be added all the many refinements.

## AMATEURS and RADIO REPAIRMEN

10 lbs. of Useful Radio Parts  
**Only \$1.79**

INCLUDES:

★ 1 Back Geared Motor  
to operate on 24 volts D.C.  
or 110 volts A.C.

Resistors • Chokes • Condensers  
Contact Points • Sub Assemblies  
Tuners, etc., etc.

**GEORGE BROOKS & ASSOCIATES**  
220 SOUTH HALSTED STREET CHICAGO 6, ILLINOIS

Make any record player wireless with these brand new

## TWO-TUBE PHONO OSCILLATORS

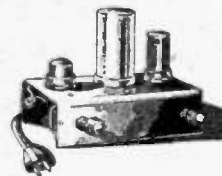

Operates as far as 100 feet from a radio and can be used with Automatic Record Changers, Players or Microphone. Uses 2 tubes. Complete with tubes. **NET \$5.95**

Supplied in kit form with "easy-to-follow" instructions for assembly. Complete with all parts, instructions and tubes. **NET \$4.95**

**D. & D. RADIO**

160 Duane St., Dept. C. New York 13, N. Y.

## BE YOUR OWN BOSS!

MAKE MORE MONEY



\$1.00 VALUE

**25c**

40,000 WORDS IN TEXT

NO ADS ALL "MEAT!"

In "CASH IN" you now get THE real money-makers—dozens of profitable tested mail order plans, confidential business secrets, dozens of practical tested formulas, successful tested schemes—actual experiences of men who have started on a shoe-string—with less than \$10 capital. 25c a copy postpaid. Send U. S. stamps, money order, or coin.

Money Back Guarantee

NATIONAL PLANS COMPANY

Box 26RA, Ansonia Station New York 23, N. Y.

## RADIO SERVICEMEN! EXPERIMENTERS—INDUSTRIALS

Send today for our new illustrated 1947 CATALOG of RADIO and ELECTRONIC PARTS and SUPPLIES. Just off the press! Write today!

Illustrated Catalog **FREE!**

**NATION-WIDE RADIO**

Dept. B, 572 W. Randolph St., Chicago 6, Ill.

Amateurs of the Midwest meet for a two-day hamfest May 24 and 25, at Hawkeye Downs, home of the Iowa State Fair.

The program calls for technical papers, banquet at Cedar Rapids, with ARRL President George Bailey as speaker, entertainment and special events.

**BC-625 ON 144 MC**  
(Continued from page 36)

was threaded for a preset locking device. The original ratchet tuning arrangement need not be removed at all, but merely disengaged from the tuning condensers.

In the original transmitter, a pair of pins was provided for plugging in a 0-1-ma test meter for tuning. Each circuit was then selected by a 6-position meter test switch. The test meter was external and used only when the set was in for repairs or a retuning job. As modified, this meter is made permanent on the panel and the leads permanently soldered to the meter receptacle pins. This meter test switch also gets a 1/4-inch extension shaft through a brass coupling, so that it projects through the front panel.

**The meter switch positions**

The six positions of the meter test switch correspond to the following circuits:

- Position No. 1:  
1st frequency-multiplier plate circuit.
- Position No. 2:  
2nd frequency-multiplier plate circuit.
- Position No. 3:  
Power Amplifier plate circuit.
- Position No. 4:  
Not used (some earlier models used this position as antenna indicator; it was discontinued on later sets).
- Position No. 5:  
Power Amplifier grid circuit.
- Position No. 6:  
Not used.

Incidentally, panel lettering was done with the new Millen decalcomania panel marking kit (No. 59001). This probably is the best bet for panel marking yet devised for the average amateur without other facilities. Nice work results if a little care is used in applying the letters. The antenna coupling is variable with

ed. A loop absorption wave meter is still a most useful and handy gadget to have around just to make sure.

Using a power supply which delivers 300 volts and around 260 ma, representative currents as read on the test meter will be:

Position	Normal Reading	Full Scale Represents (MA)	Actual Current (MA)
No. 1	0.4	50	40
No. 2	0.5	100	50
No. 3	0.6 to 0.7	100	100
No. 4	Not Used		
No. 5	0.6 to 1.0	2	2
No. 6	Not Used		

This will represent a power input to the final of 20 watts and it is safe to assume that of this amount, 12 watts is being delivered to the antenna.

**Power and bias supplies**

A word regarding the filament and bias requirements: The filament energy is most easily obtained by connecting two small 6.3-volt filament transformers in series to provide the 12 volts required by the set in its original condition. No changes are required in the filament wiring. Since the total drain is only around 1 1/2 amperes, small transformers are quite capable of handling the work.

The plate supply can be any pack delivering 300 volts at 260 ma and the bias requirements is -150V. This negative bias voltage may be obtained by tapping below ground on the B-supply or by using B-batteries. While it is entirely feasible to reconstruct the circuit to provide for this necessary bias by various RI drops through additional circuit resistors, it is strongly recommended that the original specifications be adhered to—that is, providing this amount of external bias by the method described.

Efficient harmonic multiplication depends a great deal on the proper bias

and drive, and most problems in getting on the 144-mc band and higher stem from insufficient and incorrect drive and/or bias. This set is engineered properly, and furthermore has proved itself in long and gruelling service. Should B-batteries be used for bias, one may expect long periods of service from them.

As it stands, the unit is a dandy little 12-15-watt crystal-controlled 144-mc transmitter. It will also serve nicely as a driver for more power later. As a mobile job, the unit is unsurpassed, and, in the event that occasion should ever demand emergency operation it should do a fine job as a QRR transmitter.

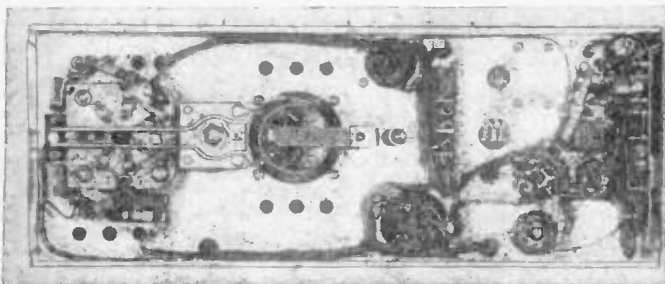

Bottom view—First 832 and its hairpin tank line are well shown here.

a setscrew. This is adjusted through the oblong hole which is shown on the right-hand end of the panel. A screw driver adjusts this feature. The final tube is held in place in the BC-625 by a piece of Mycalex strip which is bolted to the right cover plate enclosing the final amplifier compartment. The photograph showing the final amplifier tube and tank circuit makes this clear. By turning four locking screws, tubes are easily changed, antenna coupling adjusted, etc.

**Tuning procedure**

Tuning up is quite simple and straightforward. The circuits are designed so that there will be little likelihood of incorrect harmonics being select-

**RADIOMEN! Here's the Way to Bigger...**

**A Complete Practical Set of RADIO Home Study and Reference Books** for Only **\$9.75** CASH PRICE



**Yours FREE To Try 7 Days**

NOW—a new 1947 set of practical, "down to earth" books for the man who wants to get ahead in RADIO and realizes he must know modern radio and television to handle a bigger job. "Applied Practical Radio" gives the radio worker the information he needs to advance in his job or radio business. Yet, this great set is written simple enough for the beginner. This is the only set of its kind in America today.

**APPLIED PRACTICAL RADIO Tells All in 3 Handy Volumes**

Here is practical, working knowledge of RADIO as it is used TODAY—from basic-principles to latest advances in Television. The facts are boiled down, including the "know how" to construct, install and service all types of Radio and Television apparatus. Unique picture instruction method takes equipment apart to show what makes it work and how to keep it going.

**FREE!**  
1 year of Consultation Service & Tech Bulletins included.

**Everything New in Radio Made Easy**

The hundreds of interesting up-to-the-minute subjects covered include Frequency Modulation, Television, Auto Radio, Public Address Systems, Multi-Band Receivers, High Frequency and Short Wave—everything in radio today from A to Z. Over 1000 pages with 600 illustrations and new diagrams.

**10 to 1 GUARANTEE**  
Set must earn 10 times its cost or Coyne sends money back on its return at end of 1 year.

**Send No Money—See Books Free**

But don't take our word for what these great books can do for you—see them yourself. Just fill in coupon below and mail it today. Coyne sends you "APPLIED PRACTICAL RADIO" to look over 7 days FREE. If you feel set isn't everything we say AND MORE, just return it at our expense and you owe nothing. If you keep the set you need pay only \$3 after 7 days and \$3 per month (see coupon). You can't lose on this offer, so don't delay—send that coupon NOW.

**Backed by Coyne School's 20 years of Radio shop experience**

**COYNE ELECTRICAL SCHOOL**  
Radio Division, Dept. 47-T1  
CHICAGO 12, ILL.



**FREE TRIAL COUPON**

EDUCATIONAL BOOK PUBLISHING DIVISION,  
COYNE ELECTRICAL & RADIO SCHOOL, Dept. 47-T1  
500 S. Paulina St., Chicago 12, Ill.

Send me Coyne's new 3-Volume Set, "APPLIED PRACTICAL RADIO" for FREE examination. After 7 days I'll either return it and owe nothing, or pay \$3 and \$3 a month to total \$10.75. Or I'll pay \$9.75 cash price in 7 days. Include 1 yr. FREE Consultation Service, Technical Bulletins and 10 to 1 Guarantee.

NAME ..... AGE .....

ADDRESS .....

TOWN ..... ZONE ..... STATE .....

I Send C.O.D. I'll pay postman \$6.75 plus \$4.00 fee. Same money back guarantee after 7-day trial.

REPAIR SERVICE ON ALL  
PEAKER AND PHONO PICK-  
UP REPAIRS

# APRIL LEOTONE SPECIALS

Minimum Order \$2.00—20% Deposit Required on all  
orders. Please Add Sufficient Postage. WRITE  
DEPT. RC-4.

## !!! SURPLUS SPECIALS !!!

- SELSYN 5G SYNCHRO-TRANSMITTERS.** 115V. 60 cycle. Brand new. Operate in pairs as trans. and follower. 3 1/2"x5". Per pair (12 lbs) \$10.49
- UHF BUTTERFLY TUNING CONDENSERS.** Silver plated, twin rotors, ball bearing shafts. Ranges: 135-485 MC (O.D. 4 1/4") or 240-1200 MC (O.D. 2 1/2"). Either type. 2.49
- 4 TUBE AMPLIFIER (2-7C5 7F7 7Y4)** Used as electronic supercharger control. 110V. 400 cycle. Black crackle finish case & slide-in chassis. Contains: power trans. 7 mica and oil cond. 7 resistors. 4 loctal sockets plus other components worth several times the price. 8 3/4"x4 1/2"x3 3/4". Less tubes. 1.49
- POWER RHEOSTATS.** Heavy duty, standard brands. 25 watt—20, 50, 100, 200, 375, 500 or 1000 ohms .89
- 50 watt—2, 40, 75, 250, 500, 3K, 7.5K or 10K ohms 1.27
- SPECIALI—50 watt—15 ohm.** .98
- Cathode Ray Tube Socket, 14 prong .49
- 9 ft. Whip Antenna. Flex. Lightweight (8 oz.) 1.39
- 10 sections. Weatherproof finish
- Antenna Base. Heavy duty, adjustable 180 degrees. Mtg. 6 1/2"x4 1/2". Complete with hardware .49
- Binding Posts (FM-175) Heavy duty plated brass, needle contact, knurled head. 1/2" O.D., 3/4" high —12 for 1.00
- HEADPHONES—Army HS-33.** 2000 ohms. Leather covered, adj. forks. With PL-54 plug 1.27
- Rubber phone cushions for above, pair .20
- Headbands (HS-33) only with PL-54 and cord .33
- PL-54 plug & 13' lined double phone cord .1
- JK-26 ext. jack for PL-54. Bakelite shell .23
- Frequency Meter Tech. Manual (Navy) Theory & operation. 39 illust. & diagrams. 58 pp. 1.00
- "FM" Tech. Manual (Army) 88 illust., 46 diagrams. 240 pp. .39

## ALNICO MAGNETS

- 
- #1—Bar, 7/8"x1/4"x1/4" .39
  - Bar in shorter lengths, per inch .13
  - #2—Face, 1 1/2"x1 3/4"x7/8" high .93
  - #3—Heavy duty bar, 2 1/2"x1 3/4"x5/16" .93
  - #4—Face, 3/4"x3/4"x3/4" high .39
  - #5—Polished, 7/8"x9/16"x3/8" high .35
  - #6—Polished bar, 9/16"x1/4"x1/4" .20 for 1.00
  - #7—Face by 1/2"x3/4" high .10
  - #8—ALNICO V.h'shoe, poles 3/8" sq. 1 1/4" high .75
  - #9—ALNICO V.h'shoe, poles 9/16" sq. 1 1/2" high .98
  - #10—ALNICO V.h'shoe, poles 1"x1 1/2"x2 3/4" high 5.95
  - #11—Horseshoe ea. pole 1 1/16" O.D., 2 1/4" high 1.29
  - #12—(similar to #5) 3/4"x3/4"x7/16" .35
  - #14—Polished heavy duty bar, 3"x1 1/4"x1/4" (magnetized lengthwise, wide or narrow sides) 1.29

## SERVICEMEN'S KITS

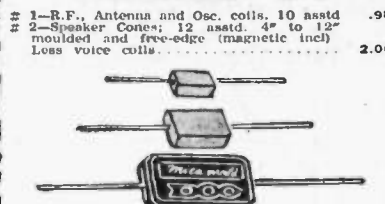
- 
- #1—R.F., Antenna and Osc. coils, 10 asstd. .98
  - #2—Speaker Cones; 12 asstd. 4" to 12" moulded and free-edge (magnetic incl) 2.00
  - Loss voice coils
  - #3—BAKELITE MICA CONDENSERS: 50 asstd. .0001 to 2mfd. 200-600WV. clearly marked 2.95
  - #4—Tubular By-Pass Condensers: 50 asstd. .001 to .25mfd. 200-600WV. Standard brands 2.49
  - #5—Dial Scales: 25 asstd. airplane and slide-rule (acetic and glass included) 2.98
  - #7—Escutcheon Plates: 25 asstd. airplane, slide-rule and full-vision types 2.95
  - #8—Knobs: 25 asstd. wood and bakelite, incl. push-on, setcrew and push-button types 1.00
  - #9—Wafer Sockets: 12 asstd. 4 to 7 prong .25
  - #10—Voltage Dividers: 10 asstd. standard, multi-tapped. HI-wattages included. 1.98
  - #11—Shield Cans; 15 asstd. for coils, tubes, transformers, etc. 1.00
  - #12—Mica Trimmers and Trimmers: 15 asstd., incl. multiple and ceramic base types .69
  - #14—Volume and Tone Controls: 10 asstd., wire-wound and carbon. Low switches. 1.49
  - #15—Wire-wound Resistors: 15 asstd. ohmages, 5 to 20 watts; incl. enameled and canohms .98
  - #16—F Coils; 6 asstd., including shielded and slug-tuned. Peaks unmarked. 1.95
  - #17—Dial Windows: 12 asstd. sizes, incl. flat and moulded acetate and convex glass 1.29
  - #18—Bakelite Coil Forms: 18 asstd. popular sizes up to 3" diam. .98
  - #19—High Resistance Units: 25 asstd. carbon, ferrite-ended, 25000 to 5 megohms. 49
  - #20—SPEAKER REPAIR KIT. A real money and time saver. Contains: 20 asstd. paper rings, 10 spiders, 25 asstd. voice coil forms, 3 yds. felt strips, 20 chamois leather segments, kit of 16 shims and tube of spkr. cement. All for 2.49
  - #21—Metal Cased By-Pass Condensers: 20 asstd. paper-wound, multi-section: 200-400WV .98
  - #22—Resistor Assortment: 20 carbon and wire-wound, 1/3 to 3 watts. 49

- TUBES: Perfect condition, but not in sealed cartons. Guaranteed for 90 days.
- #26, 27 or 56 .29
  - #24, 42, 75, 77, 78, 80, 5Y3, 6F5, 6H6, or 6K7 .39
  - #50, 6A3, 6AR, 6SA7 or 12SK7 .59
- Brand new RCA UX-200 tubes in sealed cartons. Ideal triode detector. 8 for 1.00
- WAFER SELECTOR SWITCHES.** All with shafts. Double pole, 5 position. .29
- Double pole, 6 position, 2 decks. .39
- Single pole, 11 position, 3 decks. .49
- RADIO HARDWARE TREASURE.** Over 1000 screws, nuts, washers, lugs, etc. PLUS handy 36 compartment cardboard kit box. .59
- EXPERIMENTAL TUBES.** 20 asstd. sizes and base types for testing, research, etc. Fil. tested. 1.00
- CAN AND CHASSIS FOUNDATION.** 5 tube punched chassis and cover. Cadmium plated steel. 11"x9 1/2"x4 1/4" .95
- Celotex Speaker Baffles. 14"x14"x1/2". Specify size or speaker .33
- ALUMINUM PANELS (6727):** 8"x8" .39
- 8"x8"—49; 8"x10"—59; 8"x15" .79
- BAKELITE PANELS:** 1/2" glossy brown. 7"x10" .59
- 7"x14"—69; 7"x18"—79; 9"x14" .85
- 1/2" Linen Bakelite Strips, 11"x1 1/2"—3 for .25
- Speaker Grille Cloth. Decorative gold or silver weave. Per square foot .20
- Victor Power Transformer for models H-32, 45, 52 or 75. Unshielded 5.93
- DPDT TOGGLE SWITCHES (H&D 6A/125V.** external lugs, bakelite case. Split ball. .39

10" N.B.C. RECORDINGS. For home, P.A. systems, demonstration, etc. Each contains 2 complete, different 15 min. "Voice of the Army" dramatic programs with music. Over 60 different titles, such as: On the Boam, Dinner Date, etc. 33-1/3 RPM. 5 asstd. records. 1.49



**LEOTONE RADIO CO.**  
MAKERS OF CONES AND FIELD COILS  
65-67 DEY STREET, NEW YORK 7, N.Y.  
WORTH 2-0284-5  
12,000 SQ. FT. OF RADIO PARTS

## Another MILO First!

The Sensational New  
**EDWARDS FM TUNER**  
FOR IMMEDIATE DELIVERY

**\$52.50**  
NET

### Features:

- ★ New Type Tuner (Three High Q Tuned Lines)
- ★ Full FM Band Coverage 87.5 to 109 Megacycles
- ★ All tuning lines and contacts silver plated
- ★ Permeability tuned ceramic I F and discriminator transformers
- ★ AC operated 105-130 Volt—60 cycles  
Self contained power supply

5 Tubes: 6AG5, 6J8 two 6SH7, 6SM7, 6AL5, 6V5, 7Y4.  
Shipping weight approximately 10 pounds.  
Orders Shipped in Relation of Receipt.

If not rated, 20% with order,  
balance C.O.D. Dept. C.

**Milo Radio and Electronics Corp.**  
200 GREENWICH ST., N. Y. 7, N. Y.  
BEekman 3-2980-1  
Cable address "Milelectro New York"

## RADIO SERVICEMEN

- Meissner I.F. Coils 465 K.C. HI. Gain. .50.59
- Meissner Oscil. Coils 465 K.C. 3 Tap .39
- Speakers, Tebor Alnico V 4" or 5" 1.69
- Mallory 10-10 450V—20—25V F.P. Cond .85
- Cadet 20—20—150V Condensers .49
- By Pass Cond.—600V .005—01—02 .07
- Centralab Vol. Cont. with switch—5 Mag. .59
- Resistor Kit—100 Asstd—1/3 to 1 Watt. R.M.A. 1.95
- Tubes—1T4—1R5—1R5—3B4 .97

Nationally known 5 and 6 tube radios.  
Write today for complete list of specials  
**JOYCE RADIO DISTRIB. CO.—Hollywood 28, Cal.**

## RADIO TUBES

Most Critical Types in Stock 50L6, 1A7, 35Z5, etc.  
Brand New, in Sealed Cartons  
100% GUARANTEED  
Repairmen and Dealers, Write For  
Available List at Trade Discounts

## RADIO-EXPERTS

178 E. 33rd St., Dept. C, Paterson 4, N. J.

# COMMUNICATIONS

SHOULD SAPPHIRE NEEDLES BE USED?

Dear Editor:

The otherwise excellent article by J. C. Hoadley entitled "Sound System Improvement" was marred, in my opinion, by the writer's contention that sapphire and diamond tipped phonograph needles are "easy" on the records.

Several articles in recent technical publications have served to show that records can be easily ruined after a few plays with a hard-tipped needle. I believe a past issue of RADIO-CRAFT carried a testing laboratory's report that sapphire pointed needles were "excessive" in their record wear. The Bell Telephone System's Monograph B-998 (on recording and reproducing materials for disk recording) states that an abrasive material is included in commercial phono records, in order to grind the needle to fit the groove of the record,

and to prolong record life. A new steel needle, being relatively sharp, has a point pressure on the record of from 20 to 100 tons per sq. inch. In a matter of seconds, this needle point area is so reduced that the pressure is lowered to about 5 tons per sq. inch. It would therefore seem obvious that a jewelled point (which is practically immune to wear by the record) will cause very large needle point pressures. However, maybe some other considerations enter into the picture.

Perhaps, Mr. Editor, RADIO-CRAFT could carry some scientific analysis of this controversial question. Until then, this writer will continue to use fibre needles which cannot injure the records, and apply treble accentuation in the interests of high fidelity.

EDWARD R. NEEDHAM,  
Drummondville, Quebec

## MR. HOADLEY REPLIES

Dear Editor:

In reference to Mr. Needham's letter, I would like to quote directly from page 52 of the November RADIO-CRAFT: "In the case of transcriptions, it is necessary to use a light weight pickup, preferably with a sapphire or diamond

needle." Transcriptions consist of either soft vinyl acetate original recordings or vinyl pressings containing no abrasive.

It is not considered good modern practice for a needle to fit the entire groove, but rather it should ride approximately half way between the top and the bot-

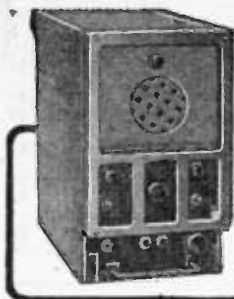

### U. S. SIGNAL CORPS 2-WAY TALKING SYSTEM

A Western Electric product. Use them for inter-office communication, house to garage, mother's room to baby's room, on the farm and many other places. Sensitive enough to pick up the slightest whimper. Sturdy all steel construction. Has push-to-talk switch. Speaker is built in. Tube line-up 5Y3, 6SJ7 and 6K6. Can be used as a 4-watt modulator for your ham rig. The small unit is a speaker-receiver. Connect as many as 10 speakers in parallel. Comes ready to operate. Just plug into 110 volt AC line. 100 ft. of speaker cable is supplied. Complete with master and one speaker-receiver.....

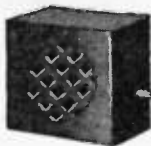

\$3250  
\$495

Extra speaker-receiver.....

### RADIO PARTS ASSORTMENT

Hundreds of valuable and useful radio parts. Transformers, coils, condensers, wire, sockets, escutcheons, lugs, etc., etc.

A Better Buy  
10 lbs. \$1.69



### HS-30 HEARING AID TYPE HEADSET

Hi-fidelity, flat, from 100 to 10,000 cycles, impedance 128 Ohms, will operate across low impedance voice coil. With matching transformer impedance is 8000 ohms. Brand new, complete with plug and transformer.....

\$1.98



### HS-16 HEADSET

Noise-proof, rubber-cushioned, equipped with 2 matching transformers, magnesium earcups. A superior headset. 8000 ohms impedance. Brand new.....

\$2.98

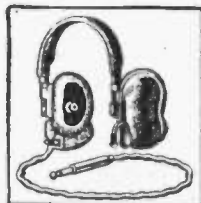

### HOT SPECIALS

1619 Tube. Characteristics same as 6L6 only with a 2 1/2 volt filament. Use as a replacement for a 47 or a 2A5.....

\$ .69

20.7 Megacycle double iron core tuned IF transformers. Four to a complete set. Use them for FM or Video. Can easily be trimmed down to 10 Megs with a single ceramic condenser.

\$2.98

Set of four matched coils.....

\$1.79

6L6 Output transformer.....

\$ .49

2500 Ohm 100 Watt adjustable resistor..

\$1.00

Kit of 50-1 and 2 Watt resistors, sizes 25, 150, 1000, 3000, etc.....

BC-312, 342 I.F. Crystal Transformer, resonant at 470 KC. Replace that 1st I.F. with this unit and separate those crowded ham-bands.....

\$6.49

Double Button Mike-to-Grid Trans....

\$ .59

Kit of 10 R.F. & Osc. Coils.....

\$ .98

Pwr.-Trans. 350-0-350, 60Mils, 6.3v @ 3a, 5v @ 2a.....

\$2.15

RA-20 Power Supply—for Signal Corps Receiver BC-342. Replace battery pack on BC-312 to convert to 110v, AC operation.....

\$14.89

Output Transformer—Pri. 10,000 Ohms, Sec. 4,000 250, 4 Ohms.....

\$ .69

### 10 METER CONVERTER

27 to 30 Megacycles

Designed for Army surplus receivers such as the BC 342, BC 348, BC 312, etc. Uses a single 6SA7 fixed oscillator at 16 megs. Adjust plate output and grid input signal for maximum. Calibrate and tune the entire band on your receiver. The power for the converter comes from the receiver. Our special adapter secures the power from the receiver by a plug-in arrangement. When this is not possible instructions will indicate the correct tapping point. In ordering be sure to mention the model receiver.

Complete Instructions and plans.....

\$1.00

Kit of parts and plans for complete operation.....

\$12.00

Complete unit wired and tested.....

\$18.00



### BROADCAST BAND CONVERTER

100 KC to 1650 KC

For owners of Army-Navy surplus receivers. Adapter supplied uses a 6SA7 tube mixer-oscillator. Beats BC signal against 3 Megs. Tune in on short wave. Tested with BC-312, 342, NC100-ASD, BC-348 and others. In ordering state model.....



Cash, Check or M.O. Write Dept. C-A

**THOR ELECTRONICS**  
5051 N. Clark St., Chicago 40, Ill.

tom of the groove. Modern pickups designed to play these transcriptions operate at pressures from 0.3 to 1.0 ounce and consequently do not cause such high pressures to be exerted on the groove walls. Furthermore, it is an easily verified fact that sapphire has the lowest coefficient of friction of all the needle materials. The best pickups all use jeweled styli and you will find that broadcast stations play both transcriptions and shellac pressings with sapphire-needle pickups almost exclusively. A very popular pickup with these stations is the Western Electric 9A pickup which uses either a sapphire or diamond needle (Western Electric builds Bell Telephone equipment). They have brought out a new pickup, the 9B, for use with shellac pressings, and it also contains a sapphire needle.

The use of a sapphire point presupposes a light pickup, preferably one with a built-in needle.

In conjunction with the use of fibre needles, where do you suppose the shavings from the needle go? They are forced into the smaller groove modulations and firmly fixed there by the high unit pressures of each new point. This effectively removes the higher frequencies from the record and causes distortion of the remaining lower ones. A new steel needle does very much the same thing except that it leaves microscopic sharp steel cutting tools embedded in the record material. This increases the surface noise and is instrumental in more quickly destroying

the next needle. It is interesting to note that broadcast stations replace their sapphire playback needles as often as once every four months, showing that they are not as hard as one might think.

Authorities for the information on the shape of playback styli are Isabel L. Capps, owner of the company which grinds all the recording needles and jeweled playback needles, and Howard A. Chinn, Chief Audio Engineer, Columbia Broadcasting System, Inc. (*Electronic Industries*, November, 1946 issue; pages 64 and 65).

The situation is further clarified by the release of the new series of Vinyl pressings. The old shellac pressing is on the way out. These new pressings contain no abrasive, will yield almost noiseless reproduction with a light weight jewel-point pickup and will last almost indefinitely in the process.

J. CARLISLE HOADLEY,  
West Newton, Mass.

### RADIO-ELECTRONIC CIRCUIT

(Continued from page 54)

its motor can be used on either type of current by adding a small 117-volt a.c. inverter and a 4-pole 2-position switch to cut in the inverter for d.c. operation.

If the entire unit is designed to operate from a.c. lines, a heavier inverter may be used and the amplifier power cord connected across its output.

GEORGE A. FELIX,  
Valley Stream, N. Y.

### POWERFUL ALL-PURPOSE INDUCTION MOTOR

IDEAL FOR EXPERIMENTERS—101 USES

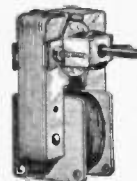

Sturdily constructed to precision standards, this self-starting shaded pole A.C. induction motor is powerful enough for a number of uses. Some of these are: Automatic Timing Devices, Current Interrupters, Electric Fans, Electric Chimes, Window Displays, Photo-cell Control Devices, Electric Vibrators, Small Grinders, Buffers and Polishers, Miniature Pumps, Mechanical Models, Sirens, and other applications.

Consumes about 15 watts of power and has a speed of 3,000 r.p.m. When geared down, this sturdy unit will constantly operate an 18-inch turntable loaded with 200 lbs. dead weight—THAT'S POWER! Dimensions 3" high by 2" wide by 1 3/4" deep; has 4 convenient mounting studs; shaft is 7/8" long by 3/16" diameter and runs in self-aligning oil-retaining bearings. Designed for 110-220 volts, 50-60 cycles. A.C. only. Shp. Wt. 2 lbs.

ITEM NO. 147  
YOUR PRICE..... \$2.95

### HUDSON SPECIALTIES

40 West Broadway, Dept. RC4-47  
NEW YORK 7, N. Y.

### ORDER NOW

Signal Corps 1-222A Signal Generator  
8 to 15, 150 to 230 MC..... \$69.95  
300 Ohm Amphenol Twin Lead, per 100 ft..... 2.90  
75 Ohm Amphenol Twin Lead, per 100 ft..... 2.00  
P23 Army Head Set, 8000 Ohm with 5 ft. Cord and plug..... 2.95  
3 Gang 410 MMFD, Per Section Condenser. Excellent Quality..... 2.95  
2" PM Speaker (Bakelite case) used in Walkie Talkie..... 1.95  
24G Transmitting Tube..... 1.49  
National ACN Dials..... 3.00  
4 MFD 600 Volt Oilfilled condenser, standard can mounting..... 1.59  
JAN type 2c40 Lighthouse tube, new in cartons 3.95  
Complete line of RCA, TAYLOR, GE, and EIMAC Tubes. Write Us Your Needs in Any Ham Equipment.

### DOW RADIO

1759 E. COLORADO PASADENA 4, CALIF.  
Pasadena Phone—5ycamore 3-1196  
Los Angeles Phone RYan 16683

Cost of television antenna installations may run from \$35 to \$50."

**HIGHBRIDGE'S BEST BUY  
NEW DYNAMIC  
TELEVISION KIT**

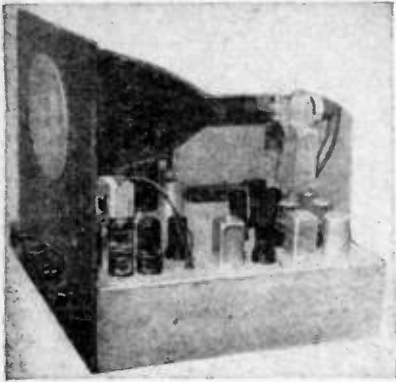

**COMPLETE \$159.50**  
With Tubes—Parts—Cabinet

**Exclusive Mail Distributors**

**Check These Outstanding Features:**

- Three stages of video I.F. amplification—3.5 MC bandwidth.
- Receiver may be aligned easily without use of signal generator.
- Complete resistance and voltage analysis chart for easy trouble shooting supplied with each kit.
- If transformers are slug tuned for high gain and maximum efficiency.
- Safety interlock switch supplied with each unit.
- Simplicity of operation—only 5 controls on front panel.
- Schematic diagrams are broken down into simple circuits for ease in wiring.
- Picture is very stable—does not jump or tear out even under unusual receiving conditions.
- 4 Channels—provisions for six.
- Seventeen tubes including large picture tube.
- Picture tube is seven inches in diameter and gives a picture 28 square inches in size.
- All parts are unconditionally guaranteed to be electrically and mechanically perfect.

Set comes complete with all necessary information sheets, parts, drilled and punched chassis, beautifully finished front panel and modernistic cabinet. Hardware and other necessary items are also included. **NOTHING ELSE TO BUY.**

**SONAR SOUND DETECTION UNIT**  
In Original Overseas Packing

Ideal for detecting underwater sounds within an area of 15 miles. Using a Rochelle salt crystal as the active unit the sound is transmitted up a 60 ft. cable. Completely enclosed in a solid rubber sheath. Originally used in harbor defense. Coupled with audio amplifier it has many valuable uses. **\$7.95**

**SELETRON SELENIUM RECTIFIERS**

- 50 to 99 .85
- 6 to 49 .90
- 1 to 5 .99



Quotations on larger quantities furnished upon request

**USEFUL FOR:** ★ AC-OC Portables ★ Intercom Power Supplies ★ Console Radios ★ Replaces 29 Types of Rect. Tubes

Gives Instant Reception—Requires No "Warm Up"  
Replaces Tube & Socket—Prolongs Life of Set  
Requires Less Space—Increases Sensitivity  
Made to Last The Life of the Set



**NEW BATTERY BOOSTER**

Powerful—Efficient—Economic

A compact, lightweight, automatic, constant voltage battery charger which is especially designed to help car, truck or tractor owners keep 6 volt storage batteries fully charged. 4"x4"x5". Weighs 4 lbs. packed. Operates on 105-120 v AC 60 Cy. DC 6 v 4-2 amp. Complete with 6 ft. AC cord with molded rubber plug and 6 ft DC cord with **\$11.95** alligator clips.

NEW No. 631PI/SNA Glass Strobotron tubes. Each **\$3.25**

Vision Research Laboratory design and construction of modern 5 or 7 inch television receiver Instruction Book and complete set of coils. Special **\$6.95.**

All Prices FOB New York City, N. Y.

**HIGHBRIDGE RADIO - TELEVISION & APPLIANCE CO.**

340 CANAL NEW YORK 13,  
343 CANAL NEW YORK

**INDEX TO ADVERTISERS**

Abell Distributing Company	72	National Radio Institute	1
Adson Radio Company	63	Van Sant, Dugdale & Company	11
Bass & Weber Company, Inc.	65	National Schools	11
Advanced Radio Products	65	The Mayers Company	73
Allied Radio Corporation	45	N. J. Industrial Company	60
George Brodsky Advertising	42	Newark Electric Company	59
Almo Radio Co.	72	The Charles Brunelle Company	59
E. L. Brown Advertising	72	Olson Radio Warehouse	71
American Sales Company	72	Jessop Advertising Company	71
American Television Laboratories, Inc.	72	Opportunity Adlets	71
Turner Advertising Agency	71	Pa-Kette Radio Company	71
Amplifier Corporation of America	71	Arrow Advertising Company	57
Sternfield-Godley	79	Pearce, Jr., George W.	70
Audel Publishers	79	Precision Apparatus Company	70
Grant & Wadsworth	70	Shappe-Wilkes, Inc.	
Audio Sales Co.	6		
Bass & Weber Company, Inc.	6		
Bell Telephone Labs	69		
N. W. Ayer & Son	74		
Brady, W. H.	51		
Brady-Parkinson Company	65		
Brooks & Associates, George	68		
The Schram Advertising Company	13		
Buffalo Radio Supply	66		
International Advertising Agency	59		
Burstein-Applebee Company	73		
Frank E. Whalen Advertising Company	12		
C. F. Cannon	53		
M. J. Werner Advertising	3		
Capital Radio Engineering Institute	62, 75		
Henry J. Kaufman & Associates	65		
Chief Electronics	60		
The Graphic Company of Advertising	74		
Cleveland Institute of Radio Electronics	69		
Kenneth Kolpein Advertising	73		
Commercial Radio	77		
Goulston Company, Inc.	63, 66		
Communications Equipment Company	55		
Borough Advertising Company	60		
Concord Radio Corporation	72		
E. H. Brown Advertising Agency	61		
Constant Electric	67		
Cornell-Dubilier	66		
Reiss Advertising Agency	67		
Coyne Electrical School	63, 66		
Phil Gordon Advertising Agency	55		
Coyne Electrical School	60		
McJunkin Advertising Agency	60		
Crabtree Wholesale Radio	74		
D. & D. Radio	69		
Dale's of Denver	73		
Bill Bonsib Advertising	9		
Deer & Taylor, Inc.	77		
Spencer W. Curtiss Advertising	63, 68		
DeForest's Training Institute	63, 66		
Lauesen & Salomon	55		
Dow Radio	60		
Editors & Engineers, Ltd.	72		
Electronic Parts, Inc.	61		
Campbell & Reynolds Advertising	73		
Esso Radio Co.	67		
Gary A. Ruben Advertising	66		
Gateway Company	67		
General Cement Mfg. Company	14		
Sander Rodkin Advertising Agency	78		
General Electronic Distributing Company	4		
Bass & Weber Company, Inc.	77		
General Test Equipment Co.	66		
Suzanne Hayman Advertising	66		
Harrison Radio Company	67		
Altomari Advertising Agency	66		
Haydn Chemical Co.	14		
Melvin F. Hall Advertising	78		
Hershel Radio Company	4		
Hugh Allen Agency	77		
Highbridge Radio-Television & Appliance Co.	66		
Burke & Wayburne Advertising Agency	66		
Hollywood Radio & Television	67		
Barton A. Stebbins Advertising	66		
Hudson Specialties	67		
Instructograph Company	66		
Turner Advertising Agency	67		
International Resistance Company	66		
John Falkner Arndt & Company, Inc.	67		
Joyce Radio Distributing Company	66		
Katolight	67		
Greve Advertising Agency	66		
Lafayette Radio	67		
Reiss Advertising Agency	66		
Leeds Radio Company	67		
Bass & Weber Company, Inc.	66		
Lectone Radio	67		
Altomari Advertising Agency	66		
Lifetime Sound Equipment Company	67		
The Miller Agency Company	66		
McGee Radio	67		
Westgate Advertising Company	66		
McMurdo Silver Company	67		
Edward Owen & Company	66		
P. R. Mallory & Company, Inc.	67		
Aitkin-Kynett Company	66		
Maritime Switchboard	67		
Metropolitan Elec. & Instrument Company	66		
Bass & Weber Company, Inc.	67		
Milo Radio & Electronics Corp.	66		
Burke & Wayburne Advertising Co.	67		
Murray Hill Books Company	66		
Harry P. Bridge Advertising	67		
Nation-Wide Radio Company	66		
The Schram Company	67		
National Plans Institute	66		
National Radio Distributors	67		
Burke & Wayburne Advertising Agency	66		

**RADIO SCHOOL DIRECTORY**  
(See Page 80)

American Radio Institute	54
Sternfield-Godley	41
Baltimore Technical Institute	64
Boston Technical Institute	78
Candler System Company	73
Rand-Ries Advertising	63
Commercial Radio Institute	76
Don Martin School of Radio Arts	57
Hollywood Sound Institute	61
Nelson Advertising Service	15
Lincoln Engineering School	71
Buchanan-Thomas Advertising	58
Melville Radio Institute	72
Seidel Advertising	67
Milwaukee School of Engineering	5
Klau-Van Pieteron-Dunlap Associates	66
RCA Institutes	66
United Radio-Television Institute	66
Radio Center	5
Radio Corporation of America	66
J. Walter Thompson Advertising	66
Radio-Craft Library Series	66
Radio Dealers Supply Co.	66
Burke & Wayburne Advertising Agency	66
Radio Electric Service Co.	66
David Zibman Advertising	66
Radio-Electronics Publishing Corporation	66
George Elliott Advertising	66
Radio-Experts	66
Radio Kits	66
Hamburg Advertising Agency	66
Radio Parts Company	66
Sydney Lovitt Advertising	66
Radio Supply & Engineering Company	66
Karl G. Behr Advertising Agency	66
Radionic Design	66
Radionic Equipment Company	66
Republic Advertising Agency	66
Radolek Company	66
Turner Company	66
Reed Mfg. Co.	66
Rosicrucians, The	66
Richard Jorgensen Advertising	66
Howard W. Sams and Company, Inc.	66
Aitkin-Kynett Company	66
Schott, Walter	66
Ross, Gardner & White Advertising	66
Sheffield Radio & Appliance Company	66
Sidney K. Lenby Advertising	66
Simpson Electric Company	66
Kreicker & Meloan Advertising	66
Sprague Products	66
Harry P. Bridge Advertising Agency	66
Sprayberry Academy of Radio	66
Harry P. Bridge Advertising Agency	66
Starling Electronic Company	66
Superior Instruments	66
Bass & Weber Company, Inc.	66
Supreme Publications	66
Henry H. Teplitz Advertising	66
Sylvania Electric Products, Inc.	66
Newell-Emmett Company	66
"TAB" Technical Apparatus Bldrs.	66
Bass & Weber Company, Inc.	66
Telectronics Service & Supply Corp.	66
Burke & Wayburne Advertising Agency	66
Thor Electronics	66
McGivern-Child Co.	66
Trutone Products Company	66
Moselle & Eisen	66
Turner Company	66
W. D. Lyon Company	66
Variety Electric Company	66
Bass & Weber Company, Inc.	66
Wayne Engineering Company	66
Wright, Incorporated	66
Key Advertising	66
X.L. Radio Labs	66

**BARGAIN PRICE LIST!**

Competition is increasing. Write for catalogue for low price, quality Parts, Test Equipment, Radio Kits, and Radio Receivers.

**RADIO DEALERS SUPPLY COMPANY**  
135 Liberty St., N. Y. 6, N. Y.

Name .....

Address .....

City .....

Zone .....

State .....



# BOOK REVIEWS

**DRAFTING FOR ELECTRONICS**, by L. F. B. Carini, Ph. D. Published by McGraw-Hill Book Co. Stiff cloth covers, 6 x 9 inches, 211 pages. Price \$2.50.

A book on drafting for radio and electronics has long been needed. This work is the more valuable because of the author's thorough knowledge of the principles behind the schematics. As he himself points out, "knowledge of the fundamentals of circuit development is to be regarded as desirable" to any draftsman who is to do justice to a radio schematic.

The book is useful both to the draftsman who wishes to do electronic or radio drawing and to the radioman who wishes to learn fundamentals of draftsmanship. Such fundamental matter as the selection and handling of drafting tools and materials, essentials of lettering, and preparation of drawing prints are presented. Three chapters are devoted to the schematic diagram, and two others to patent drawings and industrial electronics practice, respectively.

**THE SERVICING OF TELEVISION RECEIVERS**, prepared and published by the Service Division of Philco Corporation. Hard paper covers, 8½ x 11 inches, 140 pages. Price \$2.25.

This book is a timely addition to the bookshelf of the radio serviceman who may have occasion to install and service television receivers. The text is so prepared that it may be read with equal ease by a technical or non-technical reader. It is exceptionally well illustrated with photographs and diagrams.

The first of its five sections covers briefly the basic television system. The second gives a general over-all picture of the television video signal as it is picked up by the receiver and the third section provides a clear-cut step-by-step analysis of the receiving equipment, illustrated with block diagrams and basic schematics. The authors discuss briefly the types and properties of television receiving antennas in the fourth section. The concluding section contains 30 pages of detailed reference material on servicing a television receiver.—R.F.S.

**RADIO ELECTRONICS QUIZ BOOK**, prepared under the supervision of R. L. Duncan. Published by Radio-Electronics Publishing Corporation. Heavy paper covers, 8½x11 inches, 108 pages, typewriter type. Price \$2.00.

This radio quiz book contains over 1,200 questions and answers in a "true or false" examination. It is divided into several sections: Basic Theory and Practice; Basic Radio Law; Radiotelephony; Advanced Radio Telephony; Radiotelegraph; and Advanced Radio-telegraph. The questions are numbered consecutively from 1 to 1,289. Two sections in the back of the book give the answers. The first states whether the statement is true or false; the second gives the correct answers for the false statements.

Schematic diagrams are provided for many of the questions. These are simple in form, showing fundamental circuits, single stages, or parts of two stages in transmitters and receivers.



Suggested by: W. D. Moss, Washington, D. C.

Every time I tune in Frank Sinatra—it squeals.

## 7 DAYS FREE EXAMINATION

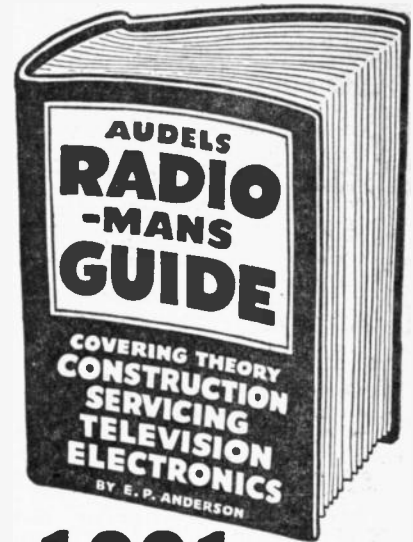

### 1001 RADIO FACTS AND FIGURES

**AUDELS RADIOMANS GUIDE**—914 Pages, 633 Illustrations, Photos, Wiring Diagrams, 38 Big Chapters, covering Radio Theory, Construction, Servicing, including Important Data on Developments in Television, Electronics and Frequency Modulation, Review, Questions and Answers, Calculations & Testing. Highly Endorsed—Indispensable for Ready Reference and Home Study.

**\$4 COMPLETE • PAY ONLY \$1 A MONTH**  
Step up your own skill with the facts and figures of your trade. Audels Mechanics Guides contain Practical Inside Trade Information in a handy form. Fully illustrated and Easy to Understand. Highly Endorsed. Check the book you want for 7 days' Free Examination.

Send No Money. Nothing to pay postman.

## CUT HERE MAIL ORDER

**AUDEL, Publishers, 49 W. 23 St., NEW YORK 10, N. Y.**

Please send me postpaid for FREE EXAMINATION books marked (x) below. If I decide to keep them I agree to mail \$1 in 7 Days on each book ordered and further mail \$1 monthly on each book until I have paid price. Otherwise, I will return them.

- RADIOMANS GUIDE**, 914 Pages . . . \$4.
- ELECTRICIANS EXAMINATIONS**, 250 Pages . . . 1.
- WIRING DIAGRAMS**, 210 Pages . . . 1.
- ELECTRICAL DICTIONARY**, 9000 Terms . . . 2.
- ELECTRICAL POWER CALCULATIONS**, 425 Pgs. . . 2.
- HANDY BOOK OF ELECTRICITY**, 1340 Pages . . . 4.
- ELECTRONIC DEVICES**, 216 Pages . . . 2.
- ELECTRIC LIBRARY**, 12 vol., 7000 Pgs., \$1.50 vol. . . 2.
- OIL BURNER GUIDE**, 384 Pages . . . 1.
- REFRIGERATION & Air Conditioning**, 1280 Pgs. . . 4.
- POWER PLANT ENGINEERS Guide**, 1500 Pages . . . 4.
- PUMPS, Hydraulics & Air Compressors**, 1658 Pgs. . . 4.
- WELDERS GUIDE**, 400 Pages . . . 1.
- BLUE PRINT READING**, 416 Pages . . . 2.
- SHEET METAL WORKERS Handy Book**, 388 Pgs. . . 1.
- SHEET METAL PATTERN LAYOUTS**, 1100 Pgs. . . 4.
- AIRCRAFT WORKER**, 240 Pages . . . 1.
- MATHEMATICS & CALCULATIONS**, 700 Pgs. . . 2.
- MACHINISTS Handy Book**, 1600 Pages . . . 4.
- MECHANICAL Dictionary**, 968 Pages . . . 4.
- AUTOMOBILE GUIDE**, 1540 Pages . . . 4.
- DIESEL ENGINE MANUAL**, 400 Pages . . . 2.
- MARINE ENGINEERS Handy Book**, 1280 Pages . . . 4.
- SHIPFITTERS Handy Book**, 272 Pages . . . 1.
- MECHANICAL DRAWING COURSE**, 160 Pages . . . 1.
- MECHANICAL DRAWING & DESIGN**, 480 Pgs. . . 2.
- MILLWRIGHTS & Mechanics Guide**, 1200 Pgs. . . 4.
- CARPENTERS & Builders Guides (4 vols.)** . . . 6.
- PLUMBERS & Steamfitters Guides (4 vols.)** . . . 6.
- MASONS & Builders Guides (4 vols.)** . . . 6.
- MASTER PAINTER & DECORATOR**, 320 Pgs. . . 2.
- GARDENERS & GROWERS GUIDES (4 vols.)** . . . 6.
- ENGINEERS and Mechanics Guides** . . . 12.
- Nos. 1, 2, 3, 4, 5, 6, 7 and 8 complete . . . 12.
- Answers on Practical ENGINEERING** . . . 1.
- ENGINEERS & FIREMANS EXAMINATIONS** . . . 1.

Name \_\_\_\_\_

Address \_\_\_\_\_

Occupation \_\_\_\_\_

Employed by \_\_\_\_\_ R.C.F.

# RADIO SCHOOL DIRECTORY

PREPARE NOW FOR SKILLED JOBS IN RADIO AND ELECTRONICS

## CAREERS in RADIO

**INTENSIVE COURSES**—Thorough, technical education for progressive men and women.

1. **RADIO TECHNICIAN**—The MRI General Course. Includes F.M. & Television. Prepares for FCC Broadcast Licenses.
2. **RADIO & TELEVISION SERVICING**—Prepares for employment as Repairman on Standard Broadcast, F.M. & Television Receivers.
3. **RADIO COMMUNICATIONS**—Prepares for FCC Operators' License. Leads to position as Merchant Marine or Flight Radio Officer, Commercial Operator.
4. **FUNDAMENTAL RADIO MATHEMATICS**—The MRI Preparatory Course. Required pre-training for students lacking a basic mathematical background.

**MELVILLE RADIO INSTITUTE**  
45 W. 45th St., N. Y. 19, BR 9-5080  
"The Radio School Managed By Radio Men"

Licensed by the State of New York

**MELVILLE RADIO INSTITUTE**  
45 West 45th St., New York 19, N. Y.

GENTLEMEN: RC

Send me **FREE** information about your school.

Name.....

Address.....

**MAIL THIS COUPON NOW**

## RADIO-TELEVISION TECHNICIAN'S COURSE

- New Classes starting every 5 weeks.
- Women Students invited.
- Approved for veterans—Public Law No. 346 and No. 16.

Write for Free Bulletin on Courses

**HOLLYWOOD SOUND INSTITUTE, Inc.**

1040 N. Kenmore Ave., Los Angeles

Dept. B

MO 1-2345

## CORRESPONDENCE COURSES IN RADIO and ELECTRICAL ENGINEERING

**ELECTRICAL ENGINEERING** Get good grasp of wide electrical field. Prepare yourself at Low Cost, for secure future. Modern course. So simplified anyone can understand quickly.

**RADIO ENGINEERING** Extra fine course in radio, public address, photo-electric work. Trains you to be super-service man, real vacuum-tube technician. Servicemen needed badly. Diploma on completion. Many graduates earning big pay.

Send postcard for Free Copies of school catalog, full details, all about deferred payment plan, experimental kits, etc.

**WRITE \$25** Either school catalog, full details, all about deferred payment plan, experimental kits, etc.

Lincoln Engineering School, Box 931C-98, Lincoln 2, Nebr.

## COMMERCIAL RADIO INSTITUTE

A radio training center for twenty-six years.

### RESIDENT COURSES ONLY

Broadcast, Service, Aeronautical, Television and Marine telegraphy classes; Preparatory Course now forming. Literature upon request. Veteran training. Classes now forming for July 1st.

Dept. C, 38 West Biddle St., Baltimore 1, Md.

## SOUND RECORDING SCHOOL

A practical 9 months' course in Sound Fundamentals, Recording, and Sound Transmission measurements; in a laboratory containing transmission sets, oscillators, square wave generator and intermodulation analyzer, and other equipment.

Two complete recording studios assimilating broadcast, motion picture and commercial sound recording, under the direction of H. M. Tremaine.

Approved for Veterans

DON MARTIN SCHOOL OF RADIO ARTS  
1655 Cherokee St., Hollywood, Calif.

**NEW!**  
**CRYSTRON LAPEL RADIO**  
(Continued from page 61)

grown as big as a coffin. He was holding it between his two huge hairy, ape-like hands and with an insane, laughing yell swung it up and crashed it with a fearful splintering sound down on my head. . . .

\*\*\*\*\*

When I came to I was in a white-walled room, lying on a high bed. My bandaged head was aching terrifically with a constant high-frequency throb. "What happened . . . Where am I?" I murmured weakly.

## GET INTO REFRIGERATION AND AIR-CONDITIONING

Build your future in fast-growing industry. Prepare for high pay jobs or get into your Dept. own business. Resident R4 classes only.

Send ad with name and address for information. **VETERANS** Eligible for training under G. I. Bill. Check here

**BOSTON TECHNICAL INSTITUTE**  
School of Refrigeration  
4707 Euclid Ave., Cleveland 3, Ohio

## RADIO COURSES

Servicing, Broadcast Engineering, Commercial Operating, Television

**INDIVIDUAL LABORATORY WORK—LEARN BY DOING! DAY AND EVENING CLASSES**

Approved by the Maryland State Department of Education and the Veterans Administration

**FREE TO VETS—TEXTBOOKS, TOOLS, TEST SET**

Write for Bulletin

**BALTIMORE TECHNICAL INSTITUTE**  
1425 Eutaw Place—Dept. C. Baltimore 17, Maryland

"You slipped on a banana peel and fell down the whole length of the subway stairs—all 32 of them. At the bottom your head hit the steel-clad edge

of the last step and cracked your skull neatly—but not fatally," said the man in white. "Incidentally, this is the City Hall Hospital, and you had better rest now."

"One more question, Doctor—when did it happen, and what day is this?"

"The accident occurred the day before yesterday, and you've been uncon-

scious ever since. And today, if you didn't know it already, happens to be

**APRIL FIRST."**

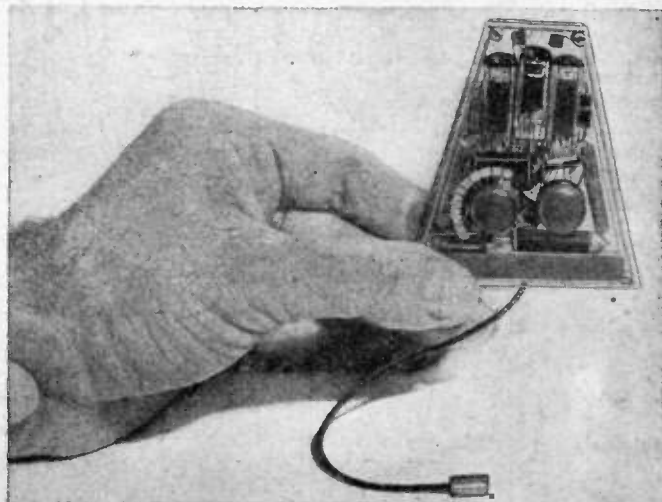

**RCA INSTITUTES, Inc.**  
Offer thorough training courses in all technical phases of **Radio and Television**

**DAYS—EVENINGS** **WEEKLY RATES**

**VETERANS:** RCA Institutes is approved under G. I. Bill of Rights

For Free Catalog Write Dept. RC-47

**RCA INSTITUTES, Inc.**  
A Service of Radio Corporation of America  
75 VARICK STREET NEW YORK 13, N. Y.

**LEARN**

**RADIO—TELEVISION—FM**

Complete courses in all phases given in both day and evening classes.

Veterans accepted under G.I. bill

**United Radio Television Institute**

225 Halsey Street Newark 2, N. J.

**RADIO**

RADIO Technician and Radio Communications courses. Register now for new classes starting first MONDAY of each month. Day and Evening Classes.

**AMERICAN RADIO INSTITUTE**  
101 West 63rd St., New York 23, N. Y.  
APPROVED UNDER GI BILL OF RIGHTS.

**CODE SENDING SPEED**

Be a "Key" man. Learn how to send and receive messages in code by telegraph and radio. Commerce needs thousands of men for jobs. Good pay, adventure, interesting work. Learn at home quickly through famous Candler System. Write for **FREE BOOK**.

**CANDLER SYSTEM CO.**  
Dept. 3-D, Box 928, Denver 1, Colo., U.S.A.

**PRACTICAL TECHNICAL TRAINING FOR YOU**

Specialize in Electronics, Radio, Electricity, Refrigeration, Heating and Air Conditioning, or Welding. Prepare in one year for position as Technician, or in two additional years secure your B. S. Degree in **ELECTRICAL ENGINEERING** with major in Machinery or Electronics.

Write for booklet "Career Building"

**MILWAUKEE SCHOOL OF ENGINEERING**  
"A TECHNICAL INSTITUTE"

RC-447 N. Broadway and E. State, Milwaukee, Wis.



# TELEVISION-

*Does it Hold  
A Future  
For You?*

## **SPECIAL INVITATION TO WAR VETERANS**

With extensive new training facilities under the personal supervision of the famed inventor of the radio vacuum tube, Dr. Lee de Forest, we are able to accept additional applications from Veterans for Television training under the G.I. Bill of Rights. For qualified men who are seriously considering entering a residence school, we have a limited number of Home Study Courses which are available free of charge. Your success with this course will not only help you to decide your own future in Television but will also aid us greatly in qualifying you for residence training.

Send your name and address for your Eligibility Questionnaire. If you qualify under the simple rules, you may start your Home Study Television Course at once and entirely without cost or obligation to you.

# **American Television Laboratories, Inc.**

5050 BROADWAY • CHICAGO 40, ILLINOIS

# Mallory Contributions to Television

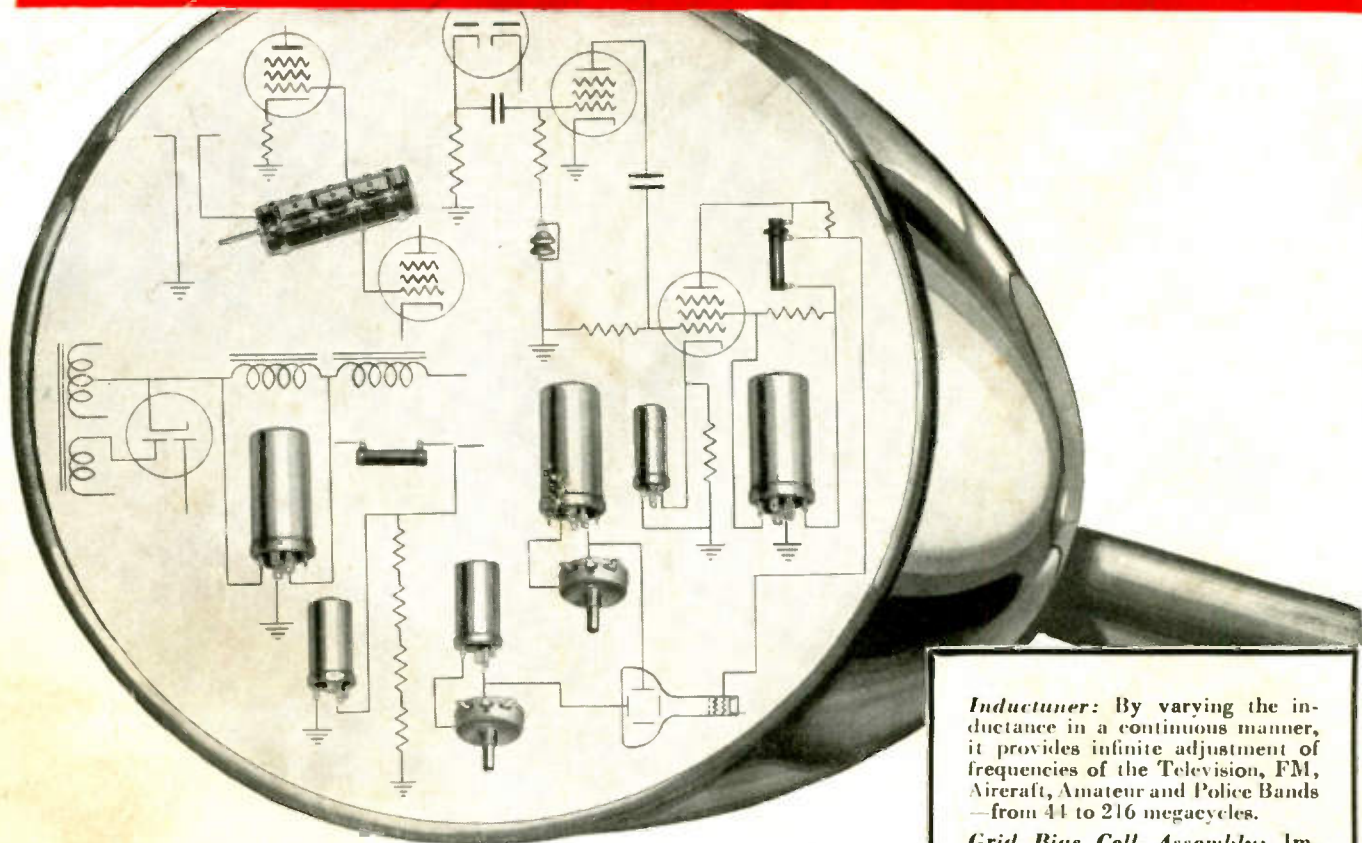

ANTICIPATING the day when servicing of television sets will be as common as present-day servicing of radio sets, Mallory has long been engaged in planning, designing and building television components.

The result of this foresight is shown in the typical television circuits illustrated above—circuits in which no less than ten different Mallory parts find an important place. Three of these parts—the Inductuner\*, the Videocoupler and the Grid Bias Cells—are of exclusive Mallory design.

The important point about these products is that they conform to standards for which Mallory is famous. Each in its own right is a true "Approved Precision Product." Each has the earmark of premium quality. You expect more and get more from Mallory components. That's true, too, of these television products.

\*Reg. U. S. Pat. Off.

**Inductuner:** By varying the inductance in a continuous manner, it provides infinite adjustment of frequencies of the Television, FM, Aircraft, Amateur and Police Bands—from 44 to 216 megacycles.

**Grid Bias Cell Assembly:** Improves picture quality by aiding low frequency response and effectively eliminating stray pick-up.

**Videocoupler:** Widens frequency response, resulting in better picture definition.

**FP 550 Capacitor:** A unique decoupling and screen bypass capacitor.

**10 Watt Vitreous Enamel Resistor:** Used as a voltage dropping or bleeder resistor in low voltage power supply.

**WP 540 Capacitor:** Bypass for vertical centering.

**WP 510 Capacitor:** Bypass for horizontal centering.

**WP 505 Capacitor:** Bypass in compact container for video stage cathode circuit.

**FP 135 Capacitor:** Filter in low voltage power supply; effectively eliminates 60-cycle "hum band" distortion.

**Carbon Controls:** Used as tone, volume and contrast controls. (Not shown.)

**Wire Wound Controls:** Used for horizontal and vertical centering.

P. R. MALLORY & CO. Inc.  
**MALLORY**

VIBRATORS . . . VIBRAPACKS\* . . . CAPACITORS . . . VOLUME  
CONTROLS . . . SWITCHES . . . RESISTORS . . . FILTERS  
. . . RECTIFIERS . . . POWER SUPPLIES.

\*Reg. U. S. Pat. Off.

**APPROVED PRECISION PRODUCTS**

P. R. MALLORY & CO., Inc., INDIANAPOLIS 6, INDIANA