

RADIO CRAFT

IMPROVING
SOUND
EQUIPMENT
SEE PAGE 20



In this issue—

Servicing Theater Sound
Audio B-F Oscillator
Intercom for the Home

NOV

1946

25¢

CANADA 30¢

RADIO-ELECTRONICS IN ALL ITS PHASES



Teleran pictures—air traffic control by radar plus television.

Teleran—"radio eyes" for blind flying!

It's a television "information please" between airplane and airport—with the pilot's questions given split-second answers on a television screen mounted in the cockpit.

Teleran (a contraction of TELEvision—Radar Air Navigation) collects all of the necessary information on the ground by radar, and then instantly transmits a television picture of the assembled data to the pilot aloft in the airplane.

On his receiver the pilot sees a picture showing the position of his airplane and the position of all other aircraft near his altitude, superimposed upon a terrain map complete with route markings, weather conditions and unmistakable visual instruc-

tions. The complex problem of air traffic control is well handled by Teleran.

Teleran—another achievement of RCA—is being developed with Army Air Forces co-operation by RCA Laboratories and RCA Victor, endless sources of history-making developments in radio and electronics. They are also your assurance that any product bearing the RCA or RCA Victor monogram, is one of the finest instruments of its kind science has yet achieved.

Radio Corporation of America, RCA Building, Radio City, New York 20 . . . Listen to The RCA Victor Show, Sundays, 2:00 P. M., Eastern Standard Time, over the NBC Network.



Instrument Panel of the Future. The Teleran indicator, mounted in a cockpit, simplifies the pilot's job by showing his position relative to the airport and to other planes in the vicinity. It promises to become one of the most useful developments in the history of aviation.



RADIO CORPORATION of AMERICA

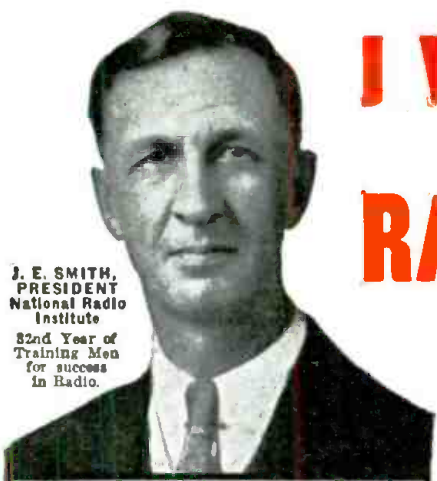

J. E. SMITH,
PRESIDENT
National Radio
Institute
32nd Year of
Training Men
for success
in Radio.

I WILL TRAIN YOU TO START A SPARE TIME OR FULL TIME RADIO SERVICE BUSINESS WITHOUT CAPITAL

You Build These and Many Other Radio Circuits with 6 Kits of Parts I Supply

By the time you've conducted 60 sets of Experiments with Radio Parts I supply, made hundreds of measurements and adjustments, you'll have valuable PRACTICAL Radio experience for a good full or part-time Radio job!

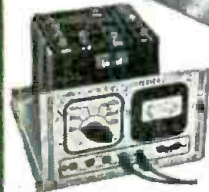

You build MEASURING INSTRUMENT above early in Course, useful for Radio work to pick up EXTRA spare time money. It is a vacuum tube multimeter, measures A.C., D.C., R.F. volts, D.C. currents, resistance, receiver output.

Building the A. M. SIGNAL GENERATOR at right will give you valuable experience. Provides amplitude-modulated signals for test and experimental purposes.

You build the SUPERHETERODYNE CIRCUIT above containing a preselector oscillator-mixer-first detector, i.f. stage, diode-detector-a.v.c. stage and audio stage. It will bring in local and distant stations. Get the thrill of learning at home evenings in spare time while you put the set through fascinating tests!



The men at the right are just a few of many I have trained, at home in their spare time, to be Radio Technicians. They are now operating their own successful spare time or full time Radio businesses. Hundreds of other men I trained hold good jobs in practically every branch of Radio. Doesn't this PROVE my "50-50 method" of home training can give you BOTH a thorough knowledge of Radio principles and the PRACTICAL experience you need to help you make more money in the fast-growing Radio industry?

Let me send you facts about opportunities in the busy Radio field. See how knowing Radio can give you security, a prosperous future... lead to jobs coming in Television, Electronics. Send coupon NOW for FREE Sample Lesson and 64-page, illustrated book. Read how NRI trains you at home in spare time. Read how you practice building, testing, repairing Radios with SIX BIG KITS of Radio parts I send you.

Many Beginners Soon Make Extra Money in Spare Time While Learning

The day you enroll I start sending EXTRA MONEY JOB SHEETS. You LEARN Radio principles from my easy-to-understand, illustrated lessons—PRACTICE what you learn by building, testing and experimenting with parts I send—USE your knowledge to make EXTRA money fixing neighbors' Radios in spare time while still learning! From here it's a short step to your own full-time Radio Shop or a good Radio job!

Future for Trained Men Is Bright in Radio, Television, Electronics

It's probably easier to get started in Radio now than ever before, because the Radio Repair Business is booming. Trained Radio Technicians also find profitable opportunities in Police, Aviation, Marine Radio, Broadcasting, Radio Manufacturing, Public Address work. Think of even greater opportunities as Television, FM, and many new, war-developed Electronic devices become available to the public! Soon, there will be more Radio equipment to install, operate, maintain and repair than ever before in all history! Get the facts on all these opportunities. Send for FREE books now!

Find Out What NRI Can Do For You

Mail Coupon for Sample Lesson, "Getting Acquainted with Receiver Servicing," and my FREE 64-page book. It's packed with facts about Radio's opportunities for you. Read the details about my Course. Read letters from men I trained, telling what they are doing, earning. See how quickly, easily you can get started. No obligation! Just MAIL COUPON NOW in an envelope or paste it on a penny postal. J. E. SMITH, President, Dept. 6MX, National Radio Institute, Pioneer Home Study Radio School, Washington 9, D. C.

I Trained These Men

SPARE TIME RADIO BUSINESS



"I have a spare time Radio and Electrical business of my own which has been very profitable, due to the efficient training I received from your Course. Last year I averaged over \$50 a month." —FRED H. GRIFFIE, Route 3, Newville, Pa.

"I am doing radio work in my spare time, and find it a profitable hobby. My extra earnings run about \$10 a week. I certainly am glad I took your N.R.I. Course." —FERDINAND ZIRBEL, Chaseley, North Dakota.



"About six months after I enrolled I started making extra money in radio. I am a farmer and just work on radios evenings and stormy days. That brought me a profit of \$600 in the last year." —BENNIE L. ARENDS, RFD 2, Alexander, Iowa.

I Trained These Men

FULL TIME RADIO BUSINESS



"Not long ago I was working 16 hours a day in a filling station at \$10 a week. Now I have my own radio business and average over \$80 a week. The N.R.I. course is fine." —ALBERT C. CHRISTENSEN, 116-10th Avenue, Sidney, Neb.

"Previous to enrolling for your radio training I made \$12 per week in a hardware store. Now I operate my own repair shop, and often clear \$35 to \$45 a week." —FREDERICK BELL, 76 Golf Ave., St. John's, Newfoundland.



"Am making over \$50 a week profit from my own shop. Have another N.R.I. graduate working for me. I like to hire N.R.I. men because they know radio." —NORMAN MILLER, Hebron, Neb.

SAMPLE LESSON FREE

I will send you a FREE Lesson, "Getting Acquainted With Receiver Servicing," to show you how practical it is to train for Radio at home in spare time. It's a valuable lesson. Study it—keep it—use it—without obligation! Tells how Superheterodyne Circuits work, gives hints on Receiver Servicing, Locating Defects, Repair of Loudspeaker, I.F. Transformer, Gang Tuning, Condenser, etc. 31 illustrations.



**My Radio Course Includes
TELEVISION • ELECTRONICS
FREQUENCY MODULATION**

GOOD FOR BOTH 64 PAGE BOOK SAMPLE LESSON FREE

**J. E. SMITH, President, Dept. 6MX
National Radio Institute, Washington 9, D. C.**

Without obligating me, mail your Sample Lesson and 64-page book FREE. I am particularly interested in the branch of Radio checked below. (No salesman will call. Please write plainly.)

- | | |
|---|---|
| <input type="checkbox"/> My own Radio Service Business | <input type="checkbox"/> Operating Broadcasting Station |
| <input type="checkbox"/> Spare Time Radio Servicing | <input type="checkbox"/> Industrial Electronics |
| <input type="checkbox"/> Service Technician for Radio Stores or Factory | <input type="checkbox"/> Public Address Systems |
| <input type="checkbox"/> Aviation Radio | <input type="checkbox"/> Ship, Harbor, Gov't., Military Radio |

(If you have not decided which branch you prefer—mail coupon for facts to help you decide.)

Name Age

Address

City Zone State

Approved for Training under GI Bill

Win Rich Rewards in Radio



National Union Announces an

EXCLUSIVE RADIO MERCHANDISING

PLAN for Service Engineers



HERE IT IS AT LAST! The radio line thousands of service engineers have been waiting for—yes, the radio that has *everything* the service trade needs to cash-in on today's big pent-up new set demand.

And who else but National Union could provide a merchandising plan for radio sets—so perfectly fitted to the service engineer's special needs?

For over 15 years National Union products, plans and policies have been shaped for the exclusive benefit of service dealers.

And now N.U. RADIO SETS are here—for the same service men who have so long known and used other N.U. products—and have found the N.U. way of doing business a better, more profitable one for their special type of operations.

THE LINE—5 models, of which one 5-tube and one 6-tube model are now ready; three others available in 90 days.

THE PRODUCT—Top quality throughout; precision-built chassis; beautiful cabinets in modern designs.

PERFORMANCE—Thoroughly up-to-the-minute; N.U. sets compare with the best in their class.

PRICES—Competitive with established brands.

VOLUME REQUIREMENTS—None! N.U. sets are not sold on a franchise basis. Order whatever quantity you need.

DISTRIBUTION—Sold only through N.U. Distributors and Service Dealers.



PRESENTATION MODEL No. G619. 6 Tubes. AC-DC. Tuned R.F. Stage. Superheterodyne Circuit. Loop Aerial. Automatic Volume Control. Illuminated Slide-Rule Dial. Standard American Broadcasts. Mahogany Veneer All-Wood Table Cabinet, 13" x 8 $\frac{3}{4}$ " x 6 $\frac{1}{2}$ ".



COMPANION MODEL No. 571. 5 Tubes. AC-DC. Superheterodyne Circuit. Built-in Antenna. Automatic Volume Control. 2-Gang Air Condenser Tuning. Illuminated Slide-Rule Dial. Standard American Broadcasts. Walnut Veneer All-Wood Table Cabinet, 13 $\frac{3}{8}$ " x 7 $\frac{3}{8}$ " x 8 $\frac{1}{8}$ ".

OTHER MODELS NOW BEING PLANNED

- A 3-Way (AC-DC-Battery) Portable Model.
- A Combination Table Model Radio-Phonograph with Automatic Record Changer.
- A 6-Tube Battery-Powered Farm Radio Table Model.

Here, for the first time, is a practical post-war radio line for the service engineer to handle—a group of fine modern radio sets—but *above all* a proven merchandising plan which *fits*. Ask your N.U. Distributor for the complete facts today!

NATIONAL UNION RADIO CORPORATION, NEWARK 2, N. J.

NATIONAL UNION RADIOS, TUBES AND PARTS

Transmitting, Cathode Ray, Receiving, Special Purpose Tubes • Condensers • Volume Controls • Phototubes
Panel Lamps • Flashlight Bulbs • Radio Sets • Auto Vibrators • Ballasts • Batteries

MID-AMERICA HAS EVERYTHING FROM "A" TO "Z"

ANTENNAS

32 1/2" Collapsbl Vertical.....49c
10 Mtr Collapsbl Vertical.....\$1.49
12 1/2 Foot Telescopic.....\$1.95
Phantom A-27, 2.4.5 mc.....\$1.49

CABLE

Co-Axial RG8U Standard
Amphenol 52 ohm.
Per 100 ft.....Per ft. 8c
Per 1000 ft.....Per ft. 6c
Co-Axial RG54-A/U, 58 ohm
Per 100 ft.....Per ft. 7c
Per 1000 ft.....Per ft. 5c
Eight cond. shielded, colored rubber ins. six
of #20, two of #16. Heavy rubber jacket,
external tinned woven shielding. O.D. 9/16"
Per 100 ft.....Per ft. 10c
Per 1000 ft.....Per ft. 7 1/2c

COIL FORMS

Kit of 10 Ceramic transmitting coil
forms.....\$1.49

CONDENSERS

Kit of 10 Bathub condensers.....\$1.49

AIR PADDER CONDENSERS

Ceramic Insulation, Screwdriver Adjmt.
100 mmf.....29c
140 mmf.....49c
Following sizes available—5, 15, 25, 35 and
50 mmf, each.....19c
KIT of 10 Asstd. Air Padder
Condensers.....\$1.49

G.E. PYRNOAL CONDENSERS

MFD	VDC	PRICE	MFD	VDC	PRICE
.25	1000	39c	.1	7500	\$1.95
1	500	39c	4	1500	\$2.95
1	600	49c	10	1000	\$2.95
2	600	89c	12	600	\$3.50
1	1000	98c	15	1500	\$3.95
6	600	98c	1.5	6000	\$4.95

HEAVY DUTY OIL FILLED CONDENSERS

MFD	VDC	PRICE	MFD	VDC	PRICE
.075	16000	\$4.95	3	4000	\$ 4.50
1.5	6000	8.95	10	6000	24.95
Dual 1 mfd 3000 VDC.....\$3.95					
Dual 1 mfd 7500 VDC.....\$9.95					

TUBULAR PAPER CONDENSERS

MFD	VDC	PRICE	MFD	VDC	PRICE
.01	600	9c	.3	200	10c
.006	1000	10c	.1	1000	15c
.05	600	10c	.004	1600	19c

VARIABLE CONDENSERS

GANG	MMF	PRICE	GANG	MMF	PRICE
2	10	49c	1	500	\$1.29
1	50	49c	2	370	\$1.49
1	13	69c	3	75	\$1.49
2	35	98c	4	140	\$1.95

MISCELLANEOUS CONDENSERS

Hi-voltage Mica. Kit of 10 pieces,
from 600-2500 volts.....\$3.95
Hi-voltage Mica. Kit of 10 pieces,
from 3000-5000 volts.....\$5.95
Mica. Kit of 25 pieces. Asstd sizes from
.00005 to .001, 300-600 v., per kit.....\$1.99

DYNAMOTORS

Kit of 3 listed below.....\$4.95

SIZE: 3 3/8" x 6" long, excluding shaft.
R.P.M. 4000.

INPUT		OUTPUT	
VDC	AMPS.	VDC	AMPS.
6-9	6.4	450	60
12	3.5	480	42
24	1.75	480	42

MID-AMERICA SPECIALS

AT-3 Antenna Tuning Unit

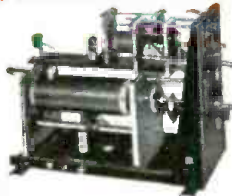

An outstanding achievement in high frequency
design! Covers all frequencies between 1.5 and
18 MC without use of plug-in inductance. Tunes
any single wire antenna from 15 ft. whipl to long
wire. Ceramic insulation constructed to with-
stand high r. f. voltages. Simple to operate.
Black wrinkle finish case
measures 10 1/2" wide, 14 1/2"
high, 24" deep. Packed for shipment—wt. 56 lbs. Less

SPECIAL PRICE
\$26.95

12 mmf and 50 mmf vacuum condensers

SPEAKERS



5" Alnico Speaker,
4 Ohm VC, Limited
Quantity.....\$1.70
6" PM 2.5 Alnico V.....\$2.95
10" PM, 18 oz. slug.....\$7.95

AP-10 JENSEN Speechmaster, 5 Watt
PM in metal housing less base.....\$4.95

HEAVY DUTY LINE FILTER



Solar
Elim-O-Stat
Type EN106, SPECIAL
CSLS3199, 20 amps,
115 V.A.C., 600 V.D.C. **\$1.79**

QUANTITY BUYERS

Dealers... Jobbers... Industrials... Schools...
and other quantity buyers—write for special trade dis-
counts on items listed as well as hundreds of others.

HAND SET

Type TS-13
Telephone type with 200 ohm car-
bon mike and 2000 ohm earphone plus talk
switch and cords with plugs.....\$2.95

HEAD SET

Type HS-23
8000 ohm impedance, with cushions,
12" cord and PL-54 plug.....\$1.50

INVERTERS

Input 27 VDC 35 amps, output 115 VAC
4000 cps.....\$4.95
Input 24 VDC 1 amp., output 26 VAC 400
cps 6 VA.....\$1.95

KEYS

Transmitting J-38.....75c
Automatic Keyer TG-10-H with oscillator
and 25 watt amplifier. 110 VAC, 60 cycle
operation (less tubes).....\$39.95

MICROPHONES

Single button carbon hand mike,
with press-to-talk switch, 5 ft. cord with
PL-68 three circuit plug.....\$1.75
Single button carbon lip mike. Fastens over
upper lip, attaches to headset. With short
cord and PL-291 plug.....89c
Single button carbon mike. Attaches to
headset and held in front of mouth by
bracket. Aviometer type 9042.....98c
KIT of 3 microphones, as listed above \$2.95

IMPORTANT!

To assure fastest possible service and delivery,
please send 25% deposit with your order.
Balance C. O. D. Send orders to store address. All
prices shown are F. O. B. Chicago warehouse.

RHEOSTATS

50 ohm, 25 watt.....59c
70 ohm, 25 watt.....59c
2500 ohm, 25 watt.....79c

SWITCHES

Antenna
DPDT Hi-voltage, knife.....39c
MICROSWITCHES
Type C, white top, SPST, normally closed,
#WZ-7RSTC2.....39c
Type C, #BZ-R5, SPDT.....39c
Type C, #BZ-3RDTC, SPDT.....39c
GE #CR1070C103-A3 momentary SPST
normally closed.....39c

PRESS-TO-TALK
DPST, NO, with 5 ft cord, UL-68 and
JK-48.....24c

PUSH BUTTON
10 Button, momentary contact, non-locking,
right hand.....49c
10 Button, momentary contact, non-locking,
left hand.....49c
5 Button, pos. action, locking.....49c
4 Button, pos. action, locking.....49c

TOGGLE
Lever type, 3PDT 10 amp 250 VAC.....59c
Push type SPST NO, 3 amp 250 VAC.....29c

KIT of 10 SELECTOR SWITCHES.....\$1.49

TUBES

Immediate Delivery

6AC7	97c
6AG5	\$1.19
6J6	97c
6SLGT	79c

TRANSFORMERS

Universale output transformer, single or
push-pull tubes to any voice coil. Rate at
10 watts.....\$1.20
Power transformer, primary 105-125 VAC
60 cps, Secondary 5 volts 190 amps.....\$14.95

TRANSMITTER

BC-223-A, 80 meter band; phone, CW,
ICW; VFO or crystal controlled; 25 watt
output.....\$22.50

Transmitter-Receiver

Portable FM Transceiver SCR-510,
range 5 miles, 20 to 27.9 MC, crystal con-
trolled with 80 crystals, complete.....\$79.50

VOLUME Control

Kit, 10 volume and tone controls, no
switches, long shafts.....\$1.79

WIRE

Single conductor #18 solid, rubber
ins. OD 1/8" black, green only
Per 100 ft.....69c
Per 1000 ft.....\$5.45

Two conductor, #14 stranded with external
tinned woven braid, O.D. 3/8"
Per 100 ft.....Per ft. 8c/ft.
Per 1000 ft.....Per ft. 6c/ft.

ZILLIONS

of other big-value parts, transmitters,
tubes, and electronic equipment listed in
MID-AMERICA'S Catalog. It's free for the
asking. Just send coupon below and your
FREE copy will be mailed at once.

GUARANTEED

All items shown in this ad are
guaranteed as rated by nationally-
advertised manufacturers and are
new, unused and in perfect condition.

Motor Speed Controls

10 ohm, 7.07 amp, 500 watt, flush
mounting.....\$3.95
12.5 ohm, 10 amp, 500 watt, bracket mount-
ing.....\$3.95
175 ohm, 3.7 amp, 800 watt, 125 volts,
bracket mounting.....\$4.95

POWER SUPPLIES

Portable vibrator type, input 6/12/24
VDC, output 200 VDC 120 ma.....\$1.95
Mobile, dynamotor type, input 12 VDC 12
amps, output 275 VDC 110 ma, and 500
VDC 50 ma, complete with fuse and fil-
ters.....\$9.95

RECEIVER

Long Wave Receiver RAK-7, 15 to
600 KC, 110 VAC operation, complete with
power supply and tubes.....\$64.50

RECTIFIER

Dry Disc
Full-wave, 64 VAC input, 30.2 to 33.5
VDC output at 5.2 amps.....\$4.75

RESISTOR KITS

20 asstd—5, 10, 25 watt wire wound,
popular sizes.....\$1.79
10 Candohms 5 to 20 watts,
IRC or equiv.....75c

FREE Catalog

MID-AMERICA CO.

STORE
2412 S. Michigan Ave.
Chicago 16, Ill.
PHONE: VICTory 5987

WAREHOUSE
2307 S. Archer Ave.
Chicago 16, Ill.
PHONE: VICTory 7820

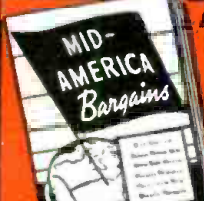

Mid-America Co., Inc., Dept. R C - 116
2412 S. Michigan, Chicago 16, Illinois
Send me at once—ABSOLUTELY FREE—your brand-
new catalog listing hundreds of "hard-to-get"
radio parts, transmitters, and electronic equipment
... ALL AT MONEY-SAVING PRICES.

NAME.....
ADDRESS.....
CITY..... STATE.....

YOU CAN GIVE BETTER, FASTER SERVICE with these

3 BALANCED RESISTOR ASSORTMENTS

STURDY, HANDSOME Resist-O-Cabinet

FREE WITH EACH ASSORTMENT

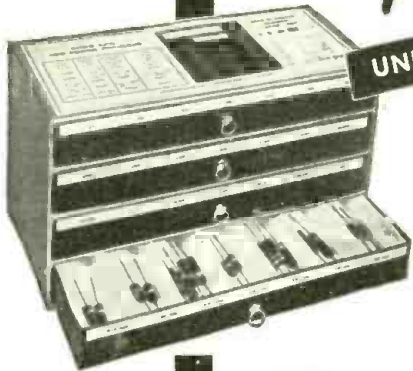

UNIVERSAL ASSORTMENT

Balanced resistor assortment. Includes 59 IRC Type BT Insulated Metallized Resistors and "universal" 10-Watt Power Wire Wound Types AB and ABA. The ABA (adjustable) type makes possible every range from a few ohms up to 10,000 ohms.

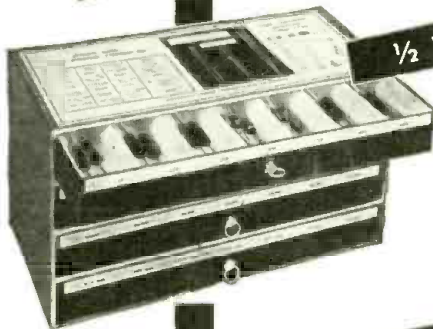

1/2 WATT ASSORTMENT

100 Type BW-1/2 and BTS Resistors. A complete assortment of most used ranges in the popular 1/2-Watt Insulated Metallized and Insulated Wire Wound Types.



1 WATT ASSORTMENT

83 Type BW-1 and BTA Insulated Resistors. Every service engineer should have all of these top-quality 1-watt resistance ranges at his fingertips.

No one knows better than you that up-to-the-minute appearance and modern, efficient service pays off in your shop.

That's why IRC offers three Resistor Assortments to equip you for quick, easy resistor replacements on almost any job. Any one or all three IRC assortments, arranged according to type and range, are in neat, sturdy cardboard Resist-O-Cabinets that stack firmly one on top of the other. The cabinets are supplied absolutely *free* with each assortment ordered at standard resistor prices. Get in touch with your IRC distributor *today*

EASY TO STACK →

Bases of Resist-O-Cabinets are arranged for stacking so that several cabinets may be used to increase stock capacity.



INTERNATIONAL RESISTANCE CO.

401 N. BROAD ST., PHILADELPHIA 8, PA.

Canadian Licensee: International Resistance Co., Ltd., Toronto

NOW SPRAYBERRY RADIO TRAINING

GIVES YOU 8 BIG KITS OF RADIO EQUIPMENT

WITH A COMPLETE 6 TUBE SUPER-HETERODYNE RECEIVER

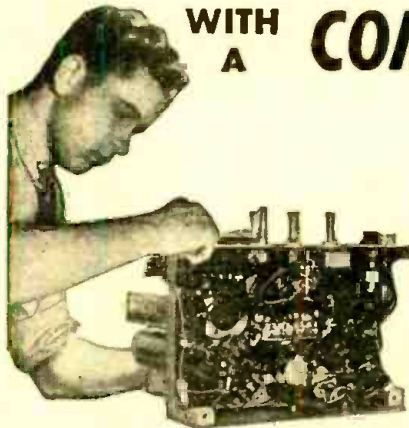

YOU LEARN RADIO SERVICING THROUGH INTENSIVE "SHOP-BENCH" PRACTICE

YOU DO EXPERIMENTS, CONSTRUCTION, TROUBLE-SHOOTING

I'll show you how to perform over 175 Instructive Experiments—how to build countless Radio Circuits. You'll learn a new, fast way to test Radio Sets without mfg. Equipment.



I give you a fine, moving-coil type Meter Instrument on Jewel Bearings—with parts for a complete Analyzer Circuit Continuity Tester. You learn how to check and correct Receiver defects with professional accuracy and speed.

You'll get valuable experience and practice building this Signal Generator and multi-purpose Tester. Makes a breeze out of fixing Radios and you don't have to spend money on outside, ready-made equipment.



Soldering, wiring, connecting Radio parts . . . building circuits with your own hands—you can't beat this method of learning. When you construct this Rectifier and Filter, Resistor and Condenser Tester, etc., you get a really practical slant on Radio that leads to a money-making future.



HERE'S THE LATEST, SIMPLEST WAY TO TRAIN at HOME for a GOOD LIVING in RADIO-ELECTRONICS & TELEVISION

I train your mind by putting you to work with your hands on a big 6-Tube Superheterodyne Receiver. And, believe me, when you get busy with real Radio Parts—8 big Kits of them—you really LEARN Radio and learn it RIGHT! You get the practical stuff you need to be useful in Radio, and that's what it takes to make money. You don't have to worry about what to do with these 8 Kits of Parts. Step by step, I show you how to build circuits, test, experiment, trouble-shoot. And you don't need any previous experience. The Sprayberry Course starts right at the beginning of Radio! You can't get lost! Simplified lessons, coupled

with real "Shop" practice, makes every subject plain and easy to understand and remember.

A BUSINESS OF YOUR OWN . . . OR A GOOD RADIO JOB

Soon after you begin Sprayberry Training, I'll send you my sensational BUSINESS BUILDERS. You'll find out how to get and do neighborhood Radio repair jobs for nice profits and rich experience while learning. This sort of work can easily pave the way for a Radio Service business of your own. But with Sprayberry Training, you're not limited. You can swing into any one of the swiftly expanding branches of Radio-Electronics INCLUDING Radio, Television, FM, Radar, Industrial Electronics. Be wise! Decide now to become a fully qualified RADIO-ELECTRONICIAN. Get full details about my Training at once! Mail coupon below for my 2 big FREE Books.

SEND FOR THESE FREE BOOKS



"How to Read Radio Diagrams and Symbols"

Here's a valuable and wonderfully complete new book which explains in simple English how to read and understand any Radio Set Diagram. Includes translation of all Radio symbols. Send for this volume at once! It's free! Along with it, I will send you another Big Free book describing in detail my Radio-Electronic Training.

SPRAYBERRY ACADEMY OF RADIO

F. L. Sprayberry, President, Room 20116, Pueblo, Colorado

Please rush my FREE copies of "How to MAKE MONEY in RADIO, ELECTRONICS and TELEVISION," and "HOW to READ RADIO DIAGRAMS and SYMBOLS."

Name Age

Address

City State

(Mail in envelope or paste on penny postcard)

MAIL COUPON TODAY!

RADIO CRAFT

AND POPULAR ELECTRONICS

Incorporating
SHORT WAVE CRAFT TELEVISION NEWS
RADIO & TELEVISION



HUGO GERNSBACK, *Editor-in-Chief*
FRED SHUNAMAN, *Managing Editor*
M. H. GERNSBACK, *Consulting Editor*
R. F. SCOTT, W2PWC, *Technical Editor*
I. QUEEN, W2OUX, *Editorial Associate*
ELMER FULLER, *Shortwave Editor*
A. PASCALE, *Production Manager*
G. ALIQUO, *Circulation Manager*
JOHN J. LAMSON, *Advertising Director*
ALFRED STERN, *Promotion Manager*

IN AN EARLY ISSUE

Instability in Apparatus
Complete Tracer in Probe
The Cinematic Analyzer
Antenna Fundamentals

Published by Radcraft Publications, Inc.
Publication Office: 29 Worthington Street,
Springfield 3, Mass.
Editorial and Advertising Offices: 25 West
Broadway, Tel. RE 2-9690, New York 7, N. Y.
Chicago Advertising Office: Radio-Craft, 308
W. Washington Street, Suite 1413, Chicago 6,
Ill. Tel. Randolph 7363.
Cleveland Advertising Office: 405 Erie Bldg.,
Cleveland, Ohio. Burdette Phillips, Manager.
Tel. Main 9645.
Detroit Advertising Office: 307-8 Boulevard
Bldg., Detroit, Mich. C. Frank Holstein, Man-
ager.
Los Angeles Advertising Office: 606 South
Hill Street, Los Angeles 14, Calif. Ralph W.
Harker, Manager. Tel. Tucker 1793.
San Francisco Advertising Office: 582 Market
St., San Francisco 4, Calif. Ralph W. Harker,
Manager. Tel. Garfield 2481.
RADIO-CRAFT is published monthly on the
25th of the month preceding that of date.
Subscription rates: United States and pos-
sessions, Mexico, Central and South American
countries, \$2.50 a year, \$4.00 for two years,
\$6.00 for three years. Canada. \$3.00 a year,
\$5.00 for two years, \$7.50 for three years.
All other foreign countries, \$3.25 a year,
\$5.50 for two years, \$8.25 for three years.
Special rates for members of the Armed
Forces in U. S., or those addressed by A.P.O.
or F.P.O. mail, \$2.00. Entered at the post
office at Springfield as second-class matter
under the Act of March 3, 1879. All com-
munications about subscriptions should be
addressed to: Circulation Manager, Radio-
Craft, 25 West Broadway, New York 7, N. Y.

Notice of CHANGE of ADDRESS should
reach us at least one month in advance. When
ordering a change, please furnish an address
stencil impression from a recent wrapper if
you can. Address changes cannot be made
without the old address as well as the new.

Foreign Agents

London—Atlas Publishing and Distributing
Co., Ltd., 18 Bride Lane, Fleet St., London,
E.C. 4.
Melbourne—McGill's Agency, 179 Elizabeth
St., Australia.

Text and illustrations of this magazine are
copyright and must not be reproduced without
permission of the copyright owners.
Copyright, 1946, Radcraft Publications, Inc.

RADCRAFT PUBLICATIONS, INC.:
Hugo Gernsback, *President*
M. Harvey Gernsback, *Vice Pres.*
G. Aliquo, *Secretary*

Contents November, 1946 Volume XVIII No. 2

Editorial: The Tele-Theatre by Hugo Gernsback 13
Radio-Electronics Monthly Review 14

ELECTRONICS

Magnetostriction Pickup by R. F. Scott 16
Television for Today, Part VI—Contrast and Gain Control Systems
by Milton S. Kiver 25
Coils, Cores and Magnets, Part II by H. W. Schendel 27

AMATEUR RADIO

Universal 1-Kw Amplifier by Harry D. Hooton, W3KPX 22

SERVICING

Servicing Movie Sound by Hubert W. Watkins 23
The Postwar Radios—The Telechron Musalarm 30
Radio Data Sheet 341 (Garod Model 6AU-1) 33
How Does the Signal Get Through? by Zygmunt Hof 48

SOUND

Sound System Improvement (Cover Feature) by J. Carlisle Hoadley 20
Sound Engineering—No. 25 Edited by A. C. Shaney 31

CONSTRUCTION

Home Intercommunicator by George W. Schultze 17

TEST INSTRUMENTS

A Precision Instrument by McMurdo Silver 18
Beat-Frequency Oscillator by John W. Straede 28

DEPARTMENTS

World-Wide Station List by Elmer R. Fuller 32
Transatlantic News by Major Ralph Hallows 29
Technotes 40
Radio-Electronic Circuits 34
Try This One 36
The Question Box 50
New Radio-Electronic Patents by I. Queen 58
Communications 76
Books Reviews 79

ON THE COVER

The experimental home sound-recording laboratory
of Mr. J. C. Hoadley at West Newton, Mass., is
shown on our cover this month. The two-unit speak-
er cabinet is described in the story on page 20.
The recorder is at right, and with other features
of the lab, will be described in future articles.



Chromatone by Alex Schomburg from photo by J. C. Hoadley

Now You can Use.

ALL OF THESE RADIO PARTS

to help You learn

RADIO

FASTER-EASIER AT HOME



YOU CAN BUILD **133**
FASCINATING EXPERIMENTS

At home—in your spare time—you get real Radio experience from these many *interchangeable* Radio parts and sub-assemblies. Our handy "Block System" eliminates unnecessary mechanical work; the convenient spring clip connections save a great deal of time. You quickly build Radio circuits that work. You experiment with Photo-Electric Cell "Magic" . . . a 5 tube Superheterodyne Receiver . . . a Radio Telephone, and scores of other fascinating projects. Little wonder learning Radio at home is so practical . . . effective and real fun—with this modern "Home Laboratory."

YOU USE "LEARN-BY-SEEING" MOVIES!

Think of the pleasure, as well as help you get from the use of a 16mm. Motion Picture Projector and exciting "movie" TRAINING FILMS. You will be surprised how much faster . . . easier . . . Home Movies help you understand Radio-Electronic fundamentals. Here's a preferred training method of tomorrow—*yours today*. See the principles of what you're learning—in motion . . . ANIMATED! See circuit actions otherwise hidden from the eye. You get this big Radio home training advantage—exclusively from DeFOREST'S TRAINING, INC. So act now! Mail coupon for complete details.

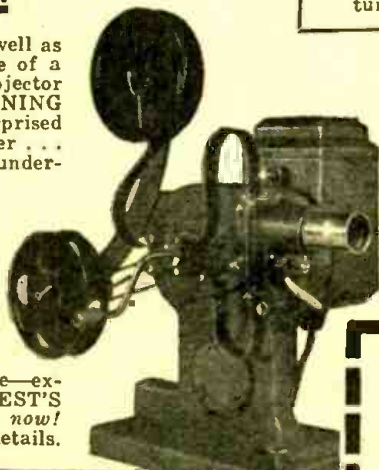

VETERANS!

Big things are happening at DeForest's Training, Inc., for veterans! See how you can prepare yourself WITHOUT COST for a GOOD JOB or a BUSINESS OF YOUR OWN in the vast Radio-Electronic opportunity field.

See how our fascinating SHOP METHOD Radio Training at home can help you toward a good start in the Billion Dollar Radio-Electronic Field. Write for our BIG FREE book, "VICTORY FOR YOU!" that has helped many to good pay jobs. You'll be surprised at the opportunities ahead in F.M. Radio, Aviation Radio, Broadcast Radio, a Profitable Business of Your Own, Motion Picture Sound Equipment, Electronics—plus the exciting future possibilities ahead of Television, Radar, etc.

YOU Get "ALL THREE"

Where else can you get such a combination of PROVED MAJOR training features as—(A) modern loose-leaf lessons that are well illustrated with helpful diagrams; (B) the use of "Learn by Seeing" home movie films and a 16 mm. MOVIE PROJEC-

TOR—and (C) eight big kits of "Home Laboratory" Radio parts to give you valuable practical Radio experience—at home.

You Also Get EFFECTIVE EMPLOYMENT SERVICE . . .

to help you get started toward a Radio-Electronic job or a business of your own. Residential training in our Chicago laboratories also available! DeFOREST'S TRAINING, INC., INCLUDES INSTRUCTION IN MOTION PICTURE SOUND EQUIPMENT, FM RADIO AND TELEVISION . . .



DeFOREST'S
TRAINING, INC.
CHICAGO, ILLINOIS

DeFOREST'S TRAINING, INC., Dept. RC-C11
2535-41 N. Ashland Ave., Chicago 14, Illinois, U.S.A.
Send—FREE and WITHOUT OBLIGATION—illustrated book, "VICTORY FOR YOU" and KIT SUPPLEMENT, showing how Home Movies and Home Laboratory can speed my preparation for a place in the Radio-Electronics industry.

Name _____ Age _____
Address _____ Apt. _____
City _____ Zone _____ State _____
 If under 16, check here for special information.
 If a discharged veteran of World War II, check here.

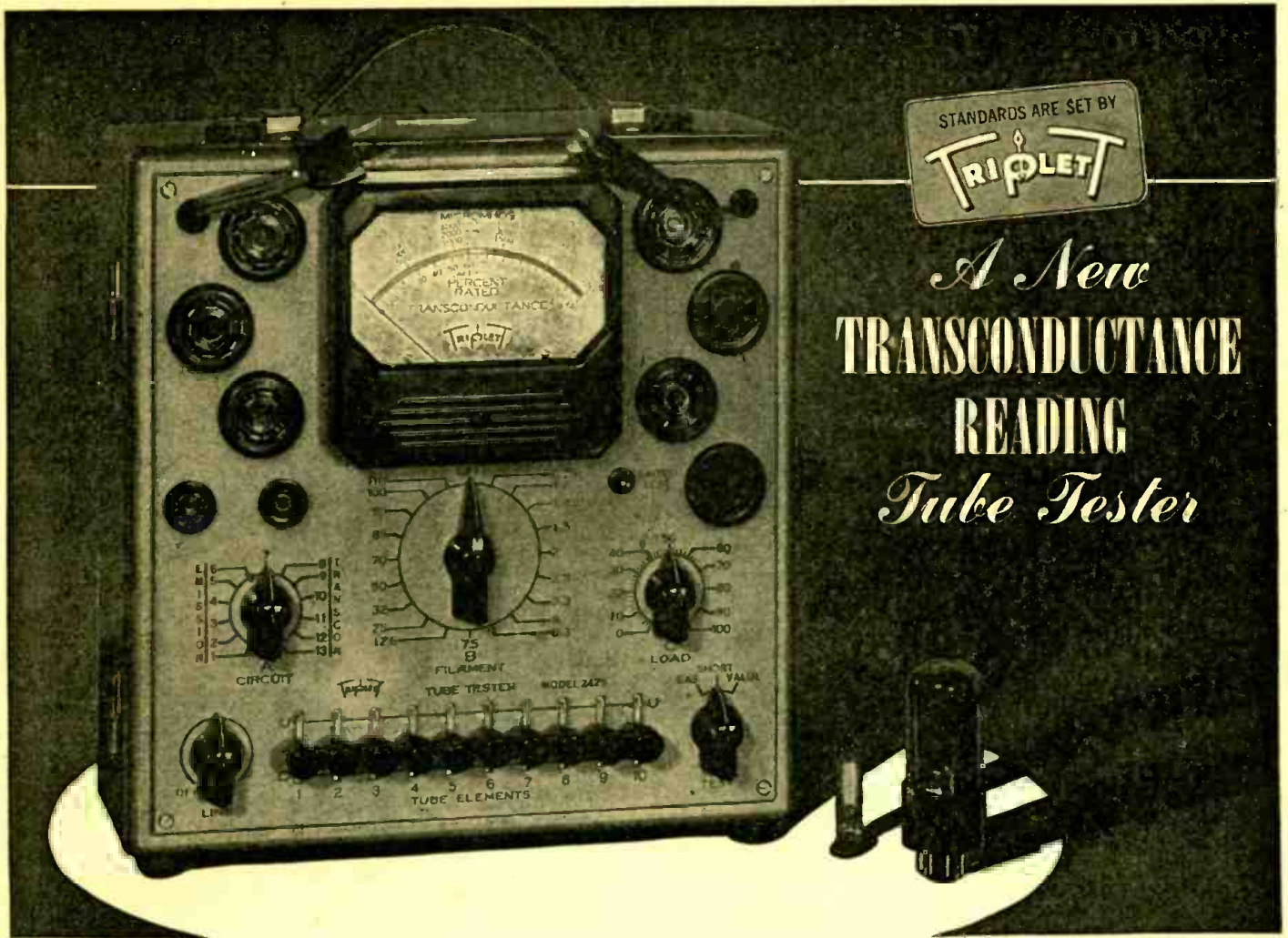

STANDARDS ARE SET BY
TRIPLET

A New
TRANSCONDUCTANCE
READING
Tube Tester

For the Man Who Takes Pride in His Work

Microhmo (Dynamic mutual conductance) readings and simplified testing—are two of the 20 exclusive features in the new model 2425 tube tester. A new approach to transconductance checking is made possible through a simple measurement directly proportional to Gm and a properly calibrated measuring instrument. There is no possibility of grid overloading due to excessive signal. “Short” and “open” tests of every tube element, including shield, inter-element connections and taps. Gas Test rounds out full check of all tubes. R.M.A. numbering of three-position lever switches gives instant reference for special tube testing. Switching flexibility allows full coverage of present and future tubes. No hunting—individual socket for each tube base type eliminates error. Excellent design, portability and appearance, amplified by Triplet engineering through all 20 features, make Model 2425 the outstanding 1947 tube tester.

New Easy = Test
ROLL CHART ATTACHMENT

Has all the advantages of both roll chart and book chart in adding new data. The location is right and settings can be made easily and quickly. Fits in carrying compartment in tester cover when not in use.



Precision first

Triplet

...to last

ELECTRICAL INSTRUMENT CO. BLUFFTON.

MAKE MORE MONEY

IN Radio TELEVISION & ELECTRONICS

Now!

GET THESE 2 BIG BOOKS

FREE!

You men already in Radio know how great the demand is for trained, experienced servicemen, operators and technicians. You know how fast the field is growing and how important it is to keep up with developments — F.M. Receivers, Electronics and Television. You know, too, a fellow cannot learn too much about any industry for **REAL SUCCESS**. Whether you have experience or are merely **INTERESTED** in radio as an amateur, you must recognize the **WONDERFUL OPPORTUNITY** right within your grasp to cash in on your natural abilities. Make them pay dividends. Get into the **EXPERT RADIO SERVICE FIELD**. Be an F.M. and **TELEVISION specialist—OWN A BUSINESS OF YOUR OWN**, if you prefer. Fill out and mail the coupon below for all the details of our plan.

Get the Latest Inside Information—Short Cuts—Trade Secrets by

Here's Just a Few of the Interesting Facts you Learn with the **FREE MANUAL**.

1. Routine for diagnosing Radio Troubles.
2. Preliminary Inspection of Receivers.
3. How to Check Power Supply.
4. How to Identify Various Stages of Receiver.
5. How to Trace the Circuit and Prepare Skeleton Diagram.
6. How to Test and Measure Voltages.
7. How to Test Speaker in Audio Stages.
8. How to Test Detector, I. F., R.F., and Mixer Stages.
9. Complete Reference Table for Quickly Locating Receiver Troubles.



SHOP METHOD HOME TRAINING

FROM A REAL ESTABLISHED RESIDENT SCHOOL

Now the famous National Schools brings its exclusive Shop-Method of training right into your own home. You can learn the most up-to-date, approved projects, systems and circuits step by step in your spare time. This is the sound practical training you want and need—the development of experienced instructors working with thousands of students right in shops, NEW F.M. broadcast studios and experimental laboratories of **NATIONAL SCHOOLS**—one of the most advanced trade educational centers in the world.

National Trained Men Now Making the Best Money in History

The real value of National training shows up on the quick progress our men make on the job.

Incomes that seemed fantastic only a short time ago are now being reported by National Graduates. And this is only a sample of what the future holds for the **MAN WHO KNOWS RADIO, ELECTRONICS, F.M., TELEVISION** and allied subjects. National is proud of the progress its graduates are making all over the world. Read the facts—the actual proof in the books we send you **FREE**.



LEARN BY DOING

Work with Real Experimental Equipment Furnished without Extra Cost as Part of Your National Training

Experience is the best teacher. You learn by experience with the exclusive National Shop-Method of Home Training. In the course of your study you actually build various types of receivers—a powerful superheterodyne, a signal generator, an audio oscillator and others—you make tests and conduct experiments that show you the why and how of things. You understand what makes the various elements of electronics operate because you actually see them work for you. Not only do you gain marvelous experience by this method of learning but you receive valuable equipment you will use on the job in the practice of your profession as an electronics expert. Mail the coupon and learn what this means to you.

Send the Coupon and prove to yourself what YOU can do in RADIO!



Be Sure Of Your Success And Security

Don't let your post-war ambitions lag. Don't let YOUR future depend on others. Build a career for yourself. Never in all history has the returning serviceman, or war worker been confronted with such a great future if he reaches out and grasps it NOW. Here is a new world opening before you. You can soon step into an essential, well paid position or, with little capital, **GET INTO BUSINESS FOR YOURSELF**. It isn't a bit too soon to start now. Radio men are vitally needed. Fill out and mail the coupon immediately and examine the **NATIONAL SHOP METHOD HOME TRAINING COURSE** carefully, without obligation.

FREE LESSON INCLUDED

Examine the exclusive National Shop Method of Home Training. See for yourself how sound and practical it is. Be convinced that you can learn Radio, Electronics, Television—quickly and easily in your spare time. You can't tell until you try. This trial is **ABSOLUTELY FREE**. Fill out the coupon immediately while you are thinking about it and drop it in the mail at once.

Mail the coupon here for the books that tell you the complete story of the marvelous new system of training in Radio, Electronics and Television. Learn the facts of this exclusive shop-method of home training. See for yourself! **DECIDE FOR YOURSELF!**

This is the **MODERN SYSTEM OF TRAINING**; it matches the rapid progress constantly being made in Radio, Television and Electronics. It is **TIME TESTED**, too. National Schools has been training men for more than a third of a century. It is the very same training that has helped thousands to more pay and greater opportunity.

You owe it to yourself—your future—to read the book "Your Future in Radio, Electronics and Television"—**FREE** to you when you send in the coupon.

NATIONAL SCHOOLS

LOS ANGELES 37, CALIFORNIA EST. 1905



MAIL OPPORTUNITY COUPON FOR QUICK ACTION

National Schools, Dept. RC-11

(Mail in envelope or paste on penny post card)

4000 South Figueroa Street, Los Angeles 37, California.

Mail me **FREE** the two books mentioned in your ad, including a sample lesson of your course. I understand no salesman will call on me.

NAME AGE

ADDRESS

CITY ZONE STATE

Check here if Veteran of World War II.



IF-37 FILTERS

Only \$1.11 each
NET

IT TAKES RADIO NOISES OUT OF FLUORESCENT LAMPS

Sprague IF-37 Filters are specifically designed for fluorescent lamp interference suppression. They offer the most effective way to suppress "hard-to-stop" interference conducted down the power line to remotely located receivers. One filter is required for each auxiliary. They are installed simply by connecting them

directly to each fixture across the incoming leads.

Note to Radio Dealers: Install Sprague IF-37 Filters on every fluorescent light in your own store to suppress noise for better, quieter radio and television demonstrations!

A NEW SPRAGUE ATOM

Handiest, most convenient dry electrolytic capacitor for vertical chassis mounting!

In Type LM Universal Mounting Replacements, Sprague offers a new Atom dry electrolytic which can be mounted in any position to replace inverted can, spade-lug or similar vertical-mounting capacitors. Equipped with special mounting devices to replace screw type can mounting, LM Atoms fit any chassis hole from 3/16" to 1/8" diameter. Their separate positive and separate negative leads can be connected together to get common positive or negative sections. Because they prevent section-to-section electrolysis, they are especially recommended to replace old common positive condensers. Like all Sprague Atoms, Type LM Capacitors are made with famous Sprague etched foil and are completely sealed and moisture-proofed.

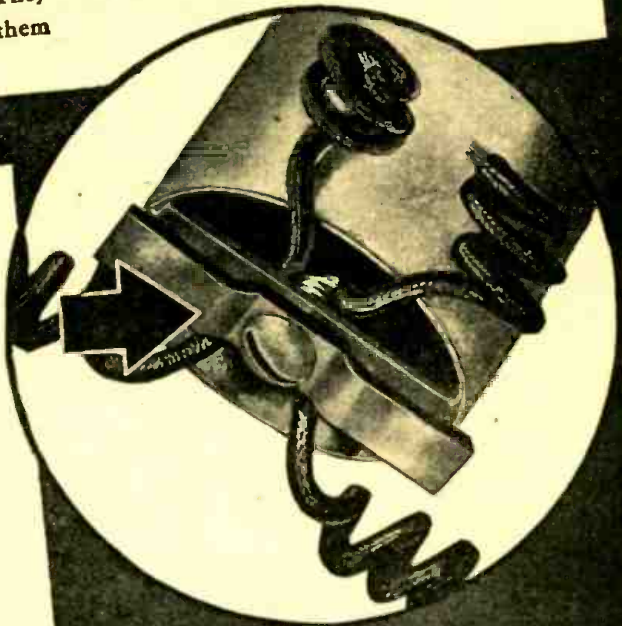

THESE ARE ALL THE MOTOR-START CAPACITOR REPLACEMENT TYPES I EVER NEED!

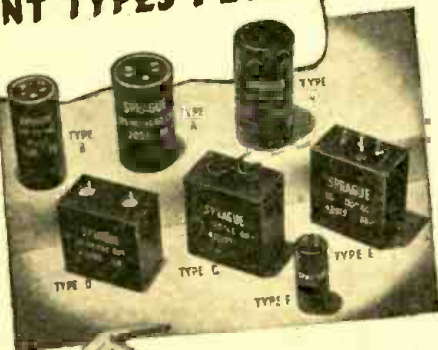

WRITE for new Sprague Catalog

MAKE MONEY ON REFRIGERATOR REPAIR JOBS

When you've repaired the radio . . . why not repair the refrigerator, too? Make one trip pay for two jobs! Use these Sprague Universal Motor-Start Capacitors for every motor starting need. The seven shown here are all you'll require. They're always in stock . . . quick, easy to install . . . and absolutely dependable! They always fit—the terminals are right for quick installation. For details on how to select the exact unit needed for any standard motor, write for Sprague booklet: "A NEW COMPLETE STORY ON MOTOR STARTING CONDENSERS." It's free!

SPRAGUE PRODUCTS COMPANY

NORTH ADAMS, MASSACHUSETTS

Jobbing Distributing Organization for Products of the Sprague Electric Co.

WHATEVER YOU NEED IN RADIO OR ELECTRONICS
PARTS...SETS...KITS
TESTING EQUIPMENT...TOOLS
PUBLIC ADDRESS EQUIPMENT
TRANSMITTERS
YOU CAN GET IT AT NEWARK!

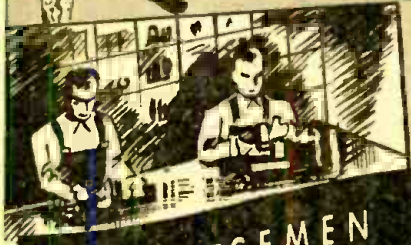

SERVICEMEN

Three big stores, each carrying tremendous stocks, are ready to serve you with tools, replacement parts, test equipment, sets or anything else you need. Wire, write or telephone if you can't visit one of our stores. If you can visit with us you'll find our trained staff of tremendous help to you.

SERVICE

Mail orders are shipped the same day they are received. You don't have to wait when you buy from Newark. On special inquiries, we give you full information, prices and delivery dates promptly. Newark will give you service that will help you serve your customers better.

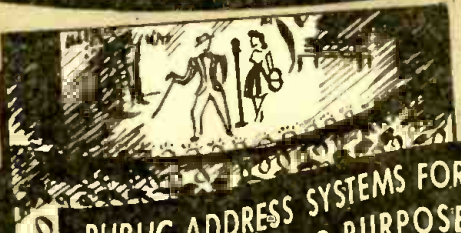

PUBLIC ADDRESS SYSTEMS FOR EVERY NEED AND PURPOSE

No matter what your public address needs may be, Newark has the outfit that will do the job for you. All the well known, standard makes are carried in stock. Delivery is fast and dependable . . . in New York and Chicago we maintain our own delivery system . . . for out-of-town customers we ship orders the same day they are received.

All our stores are staffed by trained men who know public address needs and can help you select the outfit that will best serve your purpose. If your needs are unusual, they know how to make up special combinations to satisfy them efficiently.

If you can, visit one of our stores. If you can't come to see us, write, phone or telegraph and your inquiry will be answered promptly and fully. Newark has the stock, Newark has the 'know how', Newark can help you.



BUILD YOUR OWN RADIO AND ELECTRONICS DEVICES AT LOW COST

With Newark's kits and parts you can easily build radio receivers, transmitters, amplifiers, and other exciting radio and electronics devices.

• • •
 Make a good radio receiver for yourself or a fine record player with automatic changer at tremendous savings. You can construct these and many other radio and electronics devices easily. Our men know how to make them and will gladly show you if you can visit one of our stores—or will explain clearly by mail.

FOR GOOD BUYS AND A GOOD TIME VISIT OUR BIG BARGAIN COUNTERS

These big bargain counters in all our stores, are loaded down with special items available in quantities too small to advertise. Marvelous war-time sets, new small gadgets you can have fun with . . . all sorts of new parts and special things you'll want to see. Come in, look around and ask all the questions you wish. Come in often you'll have a wonderful time.

WRITE FOR OUR BIG BARGAIN BULLETIN LISTING THE LATEST AVAILABLE EQUIPMENT

Magazines are printed months before you read them, stocks change, new things are developed and made, so we give you the very latest news about the very newest things in radio and electronics in our Big Bargain Bulletin. Send for your copy today and know all about the latest equipment first. When writing address Dept. F-1



New York City Branches: 115-17 W. 45th St. & 212 Fulton St.

RADIOMAN'S HANDBOOK

Backed by 20 years of Shop Experience

JUST PUBLISHED

AT LAST, here's the book that radiomen everywhere have been waiting for—a book that gives them the answers to *problems they meet daily on the job!* It's a library of practical working information condensed into 350 pages of solid facts—just what radiomen told us they wanted in a **PRACTICAL REFERENCE BOOK.**

A Pocket-Size Reference Book Supplying "PAY RAISING" Answers on the Job!

Planned so that you can take it with you on the job, the *Radioman's Handbook* gives you the information you want—when you need it! You'll be able to make quick calculations—to give ready answers—to show the boss that you're on your toes when it comes to practical knowledge of radio construction, design, installation and operation. *This is the road to a more responsible job—higher pay!*

The *Radioman's Handbook* is a *practical reference book—not a textbook.* You won't have to study it—its hundreds of subjects are completely indexed for quick spotting. Diagrams and tables make every subject clear—easy to grasp. *Authoritatively written from, and backed by 20 years radio shop experience of the Coyne Electrical School, the Radioman's Handbook contains all the latest facts on radio. It's a book that has been worth waiting for!*



What This Great Book Contains

This partial list of the hundreds of subjects and over 3000 facts covered will give you some idea of the scope and completeness of this handy book:

- MATERIALS
- TRANSFORMERS
- CAPACITORS & CAPACITANCE
- ABBREVIATIONS
- AMPLIFIERS
- COILS & COIL WINDING
- CIRCUITS
- RADIO RESISTANCE
- RESONANCE & COUPLING
- POWER FORMULAS & INSULATION
- OSCILLATORS & ANTENNAS
- RECEIVING TUBES (WIRE TABLES, etc.)
- RECEIVERS
- SOUND SYSTEMS & DEVICES
- ... AND MANY MORE

\$ 3 25

Try this
BOOK
FOR
7 days
FREE

Electrical Facts for Radiomen COYNE'S APPLIED PRACTICAL ELECTRICITY

Free TRIAL OFFER
Up-to-date 7 Volume Electrical Reference Set

Here, in 7 volumes, is a complete reference library covering the entire field of electricity—from home wiring to radio; from telephony to diesel. Over 3000 subjects are extensively covered, profusely illustrated by more than 2000 diagrams and photos.

The radioman, with his training and technical knowledge, finds this set the easy way for him to get an electrical background that will enable him to branch out into Electricity fields that tie in with RADIO. In this way, the Coyne 7 volume set enables the radioman to supplement, and increase his earnings.

See for Yourself. Get this set for 7 days' FREE TRIAL. Look them over, check your toughest problem against them. Then, if you are not 100% satisfied, return them at our expense. Or keep them and send \$3 down, \$3 monthly until \$21.00 is paid (cash price \$19.75). Check the coupon NOW.

COYNE ELECTRICAL SCHOOL
TECHNICAL BOOK DIVISION
500 S. PAULINA ST., DEPT. 86-T1 CHICAGO 12, ILL.

We want you to find out for yourself, FREE, how much this book will mean to you! Send no money, just fill out and mail the coupon, and we'll send you the book for 7 days' Free Trial. Look it over, take it with you on the job, feel the confidence you'll get by knowing you have all the answers in your pocket.

Then, after 7 days, if you don't agree that the Coyne Radioman's Handbook is everything we say it is, return it at our expense and owe nothing. If you are convinced that this book is worth many times its low cost, just send \$3.25 at the end of 7 days, and the book is yours. You have nothing to lose examining this book FREE, so fill out and mail coupon NOW!

FREE TRIAL COUPON

Technical Book Division, COYNE ELECTRICAL SCHOOL, Dept. 86-T1
500 S. Paulina St., Chicago 12, Illinois

Send me, for 7 days' FREE TRIAL, the Coyne Radioman's Handbook. After 7 days I'll either return the book and owe nothing, or keep it and send you \$3.25 for payment in full.

Send me, for 7 days' FREE TRIAL, the Coyne 7 Volume Set of Applied Practical Electricity. After 7 days I'll either return them and owe nothing, or send \$3.00 and \$3.00 per month until \$21.00 is paid or send \$19.75 cash.

(1 year of Consultation Service, and Technical Bulletins are included with this set, FREE, to keep you informed on the latest radio, electrical and electronic developments.)

Name.....Age.....

Address.....

City.....Zone.....State.....

Where Employed.....

If you prefer to pay postman cash price as indicated above when books arrive, check here. Same 7-day examination and money-back guarantee of satisfaction.

THE TELE-THEATRE

The Tele-Chain-Theatre in Every U. S. Town Now Feasible

AS we have intimated many times before in these columns, television applications are far more complex than those of radio.

Thus radio, besides having penetrated the home, is also used to a considerable extent in automobiles, in schools, in factories, in rest rooms, and in many other locations. Television will not only duplicate this penetration, but will also go into many places where radio has never gone before.

To mention a few, retail and department stores are already beginning to display and sell merchandise via television. Thus a showing by a famed couturière or modiste can be done routinely from a central stage. Television outlets in various parts of the store, in lounges, etc., will faithfully reproduce in colors the actual event on the floor where the showing is held. Thus, instead of exhibiting the latest modes to a comparatively few women, thousands can now view.

The factory superintendent can supervise operations on his multi-screens from all over the shop and see what is going on in any part of the plant.

It will be simple for the head of a large organization to talk to all his executives so they can not only hear, but see him as well. This from a psychological viewpoint is a great improvement over the ordinary public address system now in vogue.

Merchandising in general will be tremendously stimulated by television. The store window now becomes a place to view not only a few items, scattered in the window, but the passerby will see displays from the entire store via the large television screen in the window.

Such novel expansions of television in the years just ahead will be far more complex than anything we have known in our past and present radio days.

Commercial television—an endeavor totally apart from television in the home—will soon be big business. The two branches should never be confused with each other because they are distinct and separate.

Naturally, commercial television sets are elaborate and expensive affairs; therefore, the price consideration is not of great importance if we compare it with the television receiver in the average home.

With the recent advances in business television, the television theatre envisaged for many years will soon be a reality. It is now much nearer in realization than it ever was, and it is certain that before many years have elapsed, the United States will have many such proposed theatres.

We reprint, here, an editorial from the January-February 1932 issue of the writer's former publication, TELEVISION NEWS. What was said 14 years ago holds

good today, indeed, the television theatre is now a positive necessity.

In our smaller communities, particularly, the lack of the live theatre is felt acutely. The motion picture—canned entertainment—must always remain synthetic. It is never *real*, no matter how good or gripping the film play.

But a tele-theatre audience, viewing a television production, knows it faces live actors at the exact instant the action is unrolling—not months or years afterwards. There is a vast psychological difference between a motion picture play and a televised one. Television now has it in its power to bring a great cultural force to every stratum of the entire country. The 1932 article follows:

THE TELE-THEATRE

(An editorial from the Jan.-Feb. 1932 issue of TELEVISION NEWS.)

It is pretty well conceded, by most authorities on the subject, that the "legitimate" theatre is doomed to extinction in the not-too-distant future.

The great inroads which the motion picture has made on the legitimate stage, are becoming more serious right along and, if something is not done soon, we may have nothing but motion pictures left; because, from year to year, it becomes more unprofitable for producers to put on legitimate performances. The reason for this is, of course, that it is impossible to give a "legitimate" performance for 50c—which would then be competing with the motion-picture houses. The prices for the drama in New York, for a good orchestra seat, are from \$3.50 up; and for musical comedy shows from \$6.60 up. Plainly, these prices are too high. Hence, the decline of the legitimate theatre.

What, then, is the solution? I propose the following remedy, which I believe is sound; and I am certain that it will have to come to pass in the not too distant future. *Television is the key to the situation.*

Audience and Distant Stage Joined by Television

Recently, when the Sanabria Giant Television Screen was about to be exhibited at the *Broadway Theater* in New York City, I was asked by the management to supply some new ideas, to attract the public at large and secure favorable publicity for television.

I suggested, at the time, that an attempt be made to connect the stage of another theatre to the one at the *Broadway Theater*, and televise a distant performance on the *Broadway* screen. This suggestion was adopted, and the *Broadway Theater*, by means of a television transmitter, picked up the images (Continued on page 54)

RADIO-ELECTRONICS

Items Interesting

TELETYPERS which sent impulses shaping the actual letters being transmitted were used by the German forces, investigators of the Department of Commerce reported last month.

Standard American teleprinters send impulses that activate a separate printing key for each letter, while the Nazi instrument sent impulses that formed the vertical and horizontal lines of actual letters. One advantage of this system was that interference in the circuit distorted the shape of the letters in words instead of printing the wrong letters as with American teletypes.

Described as simple and rugged, the German machine weighed only 60 pounds. Chief disadvantage was reported to be the fact that it can only send 150 characters a minute.

A MASS SPECTROMETER recently devised to check leaks in vacuum apparatus or other air-tight equipment is sensitive enough to detect a leak so small that it would take more than a thousand years to deflate an ordinary auto tire.

The leak detector, scientists of the General Electric Co. stated last month, discovers helium gas in quantities as small as 1 in 400,000. The gas is sprayed over an area suspected to contain a leak, and as soon as an ultra-minute quantity has penetrated the vacuum space, its presence is indicated.

Immediate application of the detector is for tests of high-vacuum equipment, ranging from ordinary radio tubes to the gigantic vacuum chambers used in atom-smashing apparatus. It is expected to find employment also in the chemical industry and other fields where high-vacuum processes are important.



A leak which would deflate the balloon in 6000 years is detectable.

PRICE CUTS on "off-brand" radios were foreshadowed last month by two of New York City's largest radio-store chains. Sales were held by both chains, at which table models of other than nationally-known brands were sold at a reduction of as much as 20 percent.

Spokesmen for both concerns stated that the sales were for the purpose of "clearing stocks for standard brands." An increasing tendency on the part of the public to wait for nationally-known names and a distrust of some of the unknowns turned out in the early part of this year appears to be the main factor influencing the slow sale of "off-brand" radios. A second important factor is the increasing production of standard sets, which during the summer months outstripped the highest pre-war rate by almost 20 percent.

FLUORESCENT lighting interference with radio reception may be greatly reduced with a simple piece of screenwire, Dr. L. F. Shorey of the University of Vermont declared last month.

Speaking before the Illuminating Engineering Society in its convention at Quebec, Dr. Shorey, together with S. M. Gray of Sylvania Electric Products, Inc., presented a study of radio interference caused by fluorescent lamps in the home. Their report discusses how such interference is measured and reduced below a tolerable noise level.

Total interference, they said, results from three sources; feedback through the wires of the house circuit; radiation of the high-frequency current components from the wires; and radiation coming directly from the lamps.

Line feedback is reduced by the use of an electrical filter, while bulb radiation interference is reduced by the application of a wire-mesh screen built into the lamp shade.

"By a proper combination of these two schemes," they declared, "total interference is

suppressed to a quite satisfactory level even with small distances separating the lamp and receiver antenna."

COST OF RADAR research and development was greater than that of the atomic bomb, states a booklet issued last month by Wesley W. Stout, former editor of *The Saturday Evening Post*.

According to Mr. Stout, \$2,700,000,000 worth of radar equipment had been delivered to the services up to July, 1945, while the cost of the atomic bomb is given as around \$2,000,000,000.

RADAR SETS will be used in studying the atom at the University of California, Professor Ernest O. Lawrence of cyclotron fame told physicists last month.

The radar equipment will be used to energize a *linear accelerator*, a device in which the particles to be speeded up are projected down a cylinder divided into sections. An electrical charge is applied to each of these sections at the correct instant to give the moving particle an accelerating impulse.

Fifteen radar sets, each connected to one section of the accelerating tube, will furnish the shocks which speed up the particles.

The linear accelerator is not a new device, but was abandoned in favor of the cyclotron because before the war no devices existed which could supply large amounts of power at high frequencies. Accelerations of two million volts were the utmost that could be obtained. With postwar apparatus, a billion volts is a theoretical possibility.

A RADIO "BINGO" GAME was raided by police last month, and summonses issued to the parties responsible for the game. The incident occurred at Radio CKAC, Montreal, and the persons called upon to justify their actions in court are Julien Riopel, organizer and producer of the game, and Conrad Giguere, representative of the sponsor.

The game, which is called "Zingo," was played with the aid of 45,000 cards distributed throughout the city, on which the players recorded their numbers in standard bingo fashion.

Unceremoniously halted by the Montreal morals squad on its third presentation, all equipment has been impounded to await court test of its legality.

TELEVISION RECEIVER shortage does not exist (if you want the right models) a prominent television manufacturing executive stated in New York last month. His company, he said, was ready to make immediate delivery on a de luxe projection model selling for approximately \$2750. Other companies were advertising models priced from \$2400 to as "low" as \$600.

MONTHLY REVIEW

to the Technician

PARALLEL RADIO BEAMS determine the true speed of an airplane with an accuracy impossible in any earlier method of measurement, the Army Air Forces reported last month.

Three parallel beams at right angles to the course are used. The speeding planes cut these beams as they pass over the course, and as they cut each beam send a signal to the ground. The elapsed time between the signals is compared with the known distance between the beams, and the speed computed. The method may be used with either high- or low-flying planes.

Numerous other methods have been used to measure true air speed, but all had severe limitations. Various types of instruments installed in planes give approximate but not true speed. A radar system which followed the plane in flight was not sufficiently accurate, while a method of timing by use of vertical wires, cameras and a timing motor was effective only at low altitudes.

The radio beam method operates accurately in any weather and any altitude, and is the first system capable of measuring speed at or above the speed of sound. A similar installation at Muroc Army Air Base, Calif., will be used to check the speed of rockets and pilotless aircraft.

TELEVISION RECEIVER COSTS are likely to be considerably higher than previously estimated, the *New York Herald-Tribune* reported last month. Present indications, the paper stated, are that prices will be roughly one-third to one-quarter higher than originally expected. With installation and guaranty costs added, the advance becomes even more impressive.

This would place some of the lowest-price sets close to \$300. Many of these, it was indicated, will include only television sight-and-sound, with standard frequency modulation broadcasting reserved for the higher-priced models.

Just what effect increased prices will have on the market is difficult to estimate, it was said. That the increases will come as a disappointment to many would-be purchasers of sets can be inferred from the recent survey released by Sylvania Electric Products, Inc. The survey showed that the average price quoted by families interested in buying a set is between \$200 and \$250. However, 43 percent thought they would pay between \$150 and \$250.

Meanwhile, New York newspapers were carrying advertisements of television-AM-FM-phonograph combinations in elaborate cabinets at \$2400, with a cheaper model at \$1500; "orders are being taken" for another set at \$600.

LIGHT-WEIGHT RADAR newly designed for planes will increase flying safety, according to a last month's release by the Army Air Materiel Command. Only a little larger than a home radio, the new apparatus weighs 125 pounds, and can be used in any craft large enough to carry five passengers. The new radar, designed to remove the hazard of flying in darkness or fog, has a 360-degree microwave scan, and reflections from objects give accurate fluorescent pictures of cities, rivers and terrain.

By flipping a switch, the scope can be made to trace any one of five ranges. The large-scale details of the four-mile setting are best suited for close traffic flying, while the 90-mile range is most useful for cross-country navigation. The other ranges are intermediate.

The new device, known as the APS-10, is the first of a series of projected light-weight, easy-to-operate and maintain search radars. It was developed in conjunction with the government's Radiation Laboratory in Massachusetts, and with radar manufacturers. Future plans call for a 75-pound unit, which will provide even greater range at still lower cost.

COSMIC RAYS may cause a radio set to go "completely berserk" at high altitudes, an Army Air Force report stated last month. The report was based on experiments carried on by a B-29 which was converted into a flying laboratory to operate at 35,000-foot altitudes.

These rays and "other mysterious energy radiations" may make considerable modifications necessary in high-flying radio and radar apparatus for planes and rockets, according to the report.

(Yet radio waves themselves do not seem affected, otherwise the recent classic moon-radio experiment, where waves were reflected from the moon to the earth, could not have taken place.—*Editor*)

RADIO PRODUCTION will reach a peak late in 1947, R. C. Cosgrove, vice-president and general manager of the Crosley Corporation, told the appliance group of the Western Merchandise Mart.

The present capacity for manufacturing radios is roughly double that of the prewar period, he stated. Radio production for June, the last month for which figures were available, was 1,378,000 sets. This rate sets an all-time record, but is still lower than manufacturing capacity would permit.

SIR JAMES JEANS, possibly the most widely-read scientist of the present day, died on September 17 at his home in Surrey, England, after suffering some time from a heart condition. His age was 69.

Known best to the public for his interpretations of modern science in common language, he was known to his fellow scientists as a cosmogonist, and was prominent in the development of nebular theories.



Probably more important to the world were his many books for the layman, which made it possible for the common man to get an idea of what the "long-hairs" were talking about. Extending even to nucleonics and the Einstein theory, these books, with those of his colleague, Sir Arthur Eddington, and others, did much to dispel the suspicion of and enmity toward science so common among the public during the last generation.

Sir James spent part of his career in the United States, serving as Professor of Applied Mathematics at Princeton University for five years, during the period Woodrow Wilson was president of that institution.

ANTENNA INSTALLATION, considered a serious problem in marketing television receivers, has been solved by one manufacturer by setting up an independent installation company. According to a statement issued last month by Hamilton Hoge, president of U.S. Television, the new company, Television Installations, will personally supervise all consumer installations on UST television receivers.

These installation groups will consist of teams of two men—one to read the pattern at the receiver and the other to make necessary adjustments on the roof. The men will be equipped with a two-way telephone to work together closely.

MAGNETOSTRICTION PICKUP

A Very Wide Frequency Range Marks This Novel Device

A PHONOGRAPH pickup which works on an entirely new principle has been announced. That principle is *torsional magnetostriction* — the variation of

twist will be equal on both sides. This may be demonstrated by holding a strip of paper, about one inch wide by twelve inches long, by the ends. Have someone grasp the strip at the middle and twist gently in each direction. Note that the amount of twist on either side of center is equal and increases as the angle of rotation is increased. This is illustrated in Fig. 1-a.

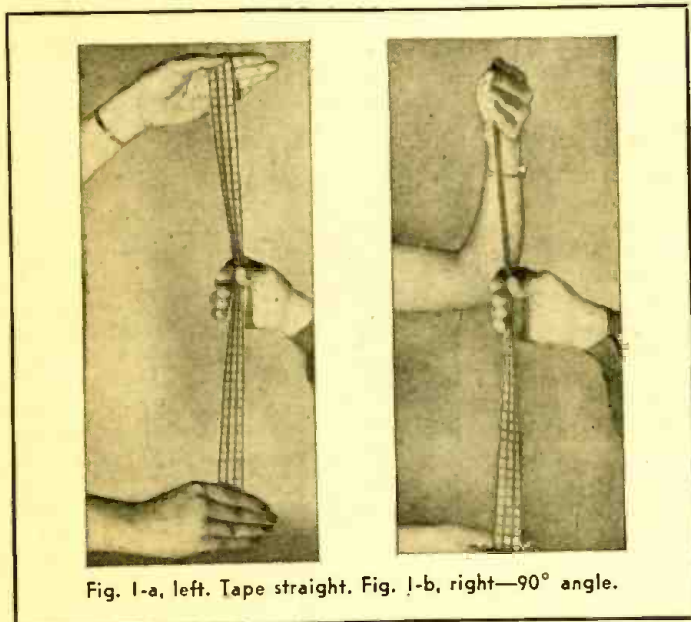

Fig. 1-a, left. Tape straight. Fig. 1-b, right—90° angle.

magnetic reluctance in a magnetostrictive wire when subjected to torsional stress in the presence of a magnetic field.

Magnetostriction is that property of certain ferromagnetic metals, such as nickel, iron, cobalt and manganese alloys which cause them to shrink or expand when placed in a magnetic field. Conversely, if subjected to compression or tension the magnetic reluctance changes, thus making it possible for a magnetostrictive wire or rod to vary a magnetic field in which it may be placed. This is true for lateral as well as longitudinal strains, and on this principle the magnetostriction pickup works.

If the ends of a ferromagnetic wire are fixed and a twisting motion applied to the center, in either direction, the

straight state. The wire used in the magnetostriction pickup is similarly twisted through 90 degrees, the ends looped and the wire secured in a magnetic field.

DETAILS OF THE PICKUP

A practical pickup is shown in exploded form in Photo A. A permanent reproducing stylus is fastened securely at right angles to the center of a piece of nickel or other magnetostriction wire. Two pickup coils, each wound with 100 turns of fine wire, are placed over the magnetostrictive wire on each side of the stylus. The ends are then looped over themselves and the wire given a slight twist and fixed between the poles of a horseshoe magnet. The wire is held in place and prevented from

untwisting by looped ends that fit snugly into slots in the poles of the magnet as shown in the photo.

With the twisted wire in place, any motion of the stylus will cause the halves of the wire to twist in the same direction but the previous 90-degree twist will cause the torsion on one half of the wire to increase as that on the other half decreases. This twisting and untwisting motion in the halves of the wire will increase the leakage flux factor around one coil and reduce it around the other. It is this varying magnetic field that causes voltage to be generated in the pickup coils.

Since the change in flux is opposite in each half of the wire, it is necessary to connect the coils in what would normally be series-opposing. With the coils so connected the output voltage is the sum of the voltages in each coil. This connection also makes it possible to take full advantage of the even-harmonic cancellation characteristics of push-pull operation. This effect is shown graphically in Fig. 2.

The TM pickup, shown in Photo B, has an impedance of 4 ohms and is capable of generating .086 volt across a 100,000-ohm load. It is capable of reproducing frequencies up to 26,000 cycles, far beyond the human ear's ability to hear! Over the range of both commercial recordings and high fidelity transcriptions, the torsional magnetostriction pickup's response is uniformly true. While the sound frequencies of most commercial recordings are limited to a maximum of about 6500 cycles, and transcriptions to about 12,000 cycles, the high fidelity of the new pickup war-

(Continued on page 65)

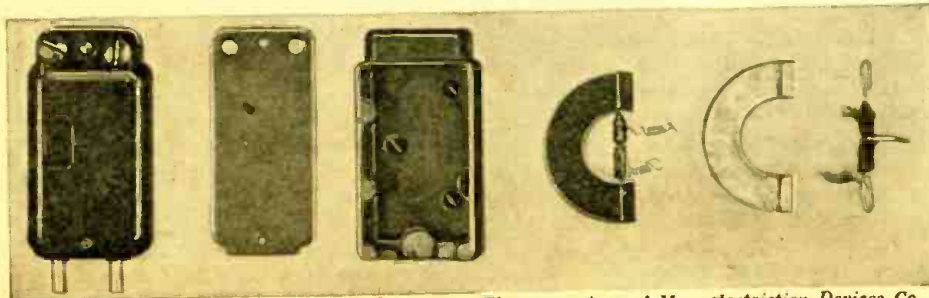

Photo A—Exploded view of the pickup. The important working parts are shown at right.



Photo B—Magnetostriction pickup in its case.

HOME INTERCOMMUNICATOR

An Efficient Set for Residential Use

THE business or industrial intercommunication system is often extensive and expensive.

To justify a home installation, certain limitations and requirements must be recognized. The system described was developed to satisfy the following criteria:

1. Cost of the installation must be kept to a minimum. In most instances a home "intercom" or "squawk-box" falls in the luxury category, and the economics of the situation must be treated in that light.

2. The amplifier must be able to respond instantly with almost no warming-up wait, but at the same time must be economical on tubes and power.

3. The substations must be able to call the master station by voice rather than by signal to allow announcements to be made without waiting for a reply. Any substation operator may talk to the master station on his own initiative, but need not be able to contact other substations. The master station may hold a conversation with any one of the substations.

4. Amplifier and speakers must be capable of transmitting speech to and from a point somewhat removed from the speaker. That is, the system must be able to transmit intelligence even though the user is several feet from the station.

5. Interstation wiring must be as simple as possible, to avoid excessive material and installation costs. This means that high voltages and the need for shielded conductors must be eliminated.

A PRACTICAL SYSTEM

The original installation consists of a master station and three substations. Any number of substations can be installed, and additional ones can be placed in the system at any time. The master station is located in the "boss" bedroom, while the substations are installed in "Granddad's" room, the kitchen, and the basement shop. The wire

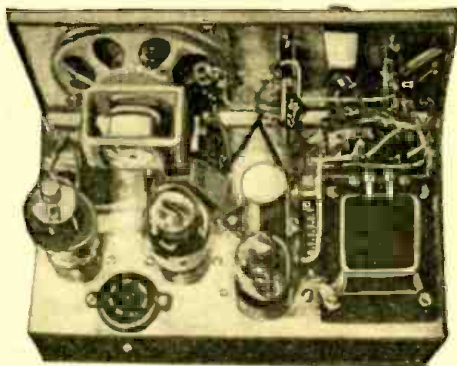

A back view of the central control station.

length from the master set to the most remote station is about 100 feet.

The circuit diagram, Fig. 1, shows a conventional two-stage audio amplifier with a 6C6 tube resistance-coupled to a type 41. Many other tube combinations will suggest themselves, but the one given is quite satisfactory. The input transformer T2 can be a conventional output transformer. The author used a compact surplus unit about

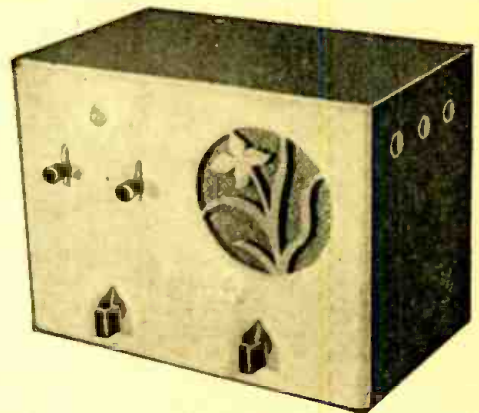

The central control station in its cabinet.

works well. The condenser C7 bypasses strong radio broadcast signals picked up by the interstation wiring. The capacity value of this condenser is not critical, but without it, the author's amplifier reproduced a twenty mile distant fifty-kilowatt program very nicely (but undesirably) with S2 in the "listen" position.

Also across the primary of T2 is placed R8. This was found necessary to eliminate the loud "beep" from the master station speaker when, on throwing the power switch to OFF, S4 is opened and the filter condensers momentarily supply B-voltage. R8 in the author's set is 1000 ohms. No decrease in signal volume was observed because of its insertion. It was found that a resistor of about 30,000 ohms across the secondary of T2 achieved the same results.

THE SWITCHING SYSTEM

The input circuit within the amplifier was wired with shielded conductor to eliminate objectionable feed-back. T3 is a conventional output transformer. The permanent magnet speakers, which also double as microphones, are preferably all identical. The ones shown in the photos are 4-inch, a compromise between compactness and reasonable response. The talk-listen switch, S2, allows switching the speakers from the speaker function to the microphone function at the will of the master station operator. S2 is a double-pole double-throw lever action switch with spring return. It is arranged so as to be normally in the "listen" position.

The power supply uses about the smallest standard line transformer available. A 6X5-GT rectifier was used in the original outfit, but an 80 or a 5Y3-G would be satisfactory. An a.c.-d.c. type power supply was ruled out because of the positive grounding of the amplifier B-minus. The rectifier circuit is conventional, giving a B-plus voltage of 310 d.c. In one of the primary

(Continued on page 55)

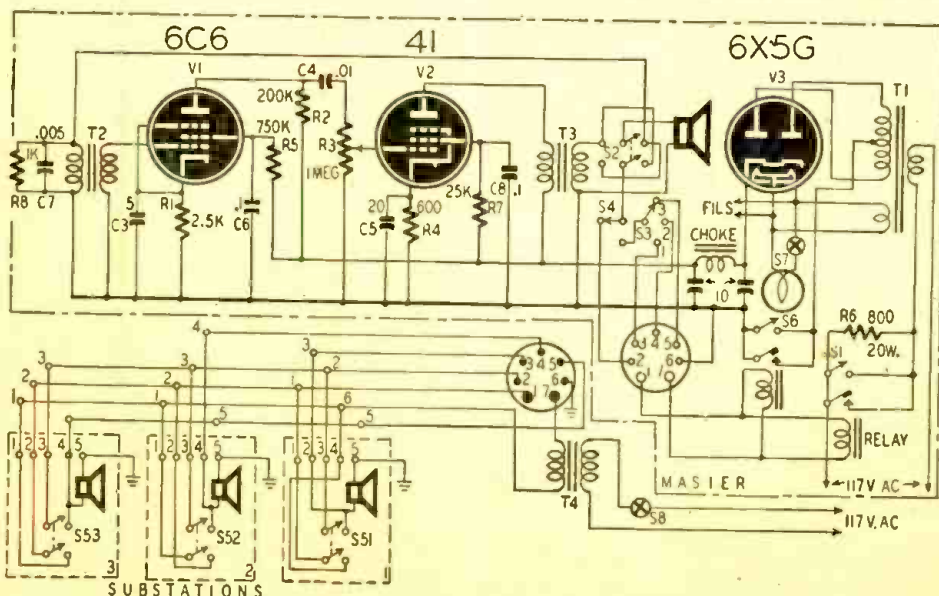

Fig. 1—Schematic of the central control station, substations and the switching system.

A PRECISION INSTRUMENT

Laboratory Accuracy in a Serviceman's C/R Bridge

IN the early days of one- to five-tube battery receivers with usually but a single function per tube and circuit, location and correction of troubles was simple indeed. The exact reverse is true today, for even the simplest type of five-tube broadcast receiver has several multiple-function tubes, each function having its own separate circuit and set of component parts. Most important is that each one of these circuits—and there can be many indeed in a complex modern receiver—employs a large number of individual capacitors and resistors. Even partial failure or alteration in value of but one of the many unimportant-appearing little capacitors or resistors can—and usually does—cause the poor performance which the technician is employed to correct.

Drawing upon his thirty-five-odd years of experience in the design of high-quality radio receivers as a guide to the precise types and forms of measuring equipment which can most effectively serve the serious maintenance technician, the writer has recently completed a piece of measuring equipment going far beyond the rough approximations heretofore available at low cost. It has been his goal to bring to the maintenance profession those orders of accuracy heretofore available only in laboratory instruments costing several hundred dollars or more, and hence beyond reach of most service organizations.

* 1249 Main Street, Hartford, Connecticut

If, in the design laboratory, it has been necessary to measure resistors and capacitors to an accuracy of a few percent, then it is obviously desirable that the maintenance technician be able to do likewise. Excellent approximations of resistance values may be made by a well designed and built ohmmeter. Capacity may not be so measured accurately, for *two values* enter into capacitance measurements—actual capacitance in microfarads or micromicrofarads, *plus power factor*. Considering only resistance measurements for a start, the good ohmmeter cannot be particularly accurate over much of its range because of the characteristic slope of its meter scale. The usual ohmmeter scale is "open" over its lower half and its accuracy can be excellent over this portion of its scale. Over the upper half, however, the scale graduations become increasingly crowded, since they must reach practically infinity at full-scale. Allowing for the normal and usual ± 2 percent accuracy of even the best meters, a glance at the upper half of the ohmmeter scale in terms of graduation crowding versus such meter variation shows why high accuracy cannot be anticipated. It is true that this condition can largely be set at nought by provision of such a multiplicity of resistance ranges that it is seldom necessary to use the crowded high end of the scale in practice. Nevertheless, the really accurate method of measuring resistance is by means of the Wheatstone Bridge—the ohmmeter

serves an essential function but for truly accurate measurement the bridge is a "must".

SUPERIORITY OF THE BRIDGE

It is true that an ordinary a.c. voltmeter or ammeter can be used to measure capacitance in the usual ohmmeter manner, but what actually happens is that the technician measures *capacitive reactance* which is then translated into capacity in terms of that capacitance which exhibits a given capacitive reactance at the particular a.c. frequency of measurement. Such attempts at measurement of capacitance cannot be more than approximately useful, since they ignore power factor. It is possible to find a capacitor apparently quite satisfactory so far as capacitance goes, yet have this capacitor exhibit such a high power factor as to be operationally useless. The fundamental Wheatstone Bridge method permits measurement of both capacitance and power factor, and so is a prime essential to the serious technician. Such a bridge may be so designed that it can provide resistance measurements with accuracy far exceeding the ohmmeter method, hence is most desirable.

One of the disadvantages of bridges so far available to the service technician is not alone that their accuracy left much to be desired because of low-cost components and the cursory test and calibration necessary to yield a low final selling price, but their lack of range as well. The equipment designer and the maintenance technician alike must be able to measure down to a fraction of an ohm, a fraction of a micromicrofarad—as well as up toward 1000 megohms and 1000 microfarads. Small compression mica trimmer capacitors—even air trimmers—of extremely low capacity can be causes of trouble and so must be capable of measurement in any well-equipped shop. Low values of resistance measurement are also necessary when "shooting trouble" in auto radio primary circuits, a.c. receiver heater circuits and the like. High ranges of resistance must be accurately determined in grid leaks and performance-impairing circuit leakage, while high values of capacitance appear in the filter capacitors of battery eliminators for portable battery sets as well as in "a.c., b.c. and d.c." sets themselves.

PRACTICAL PRECISION BRIDGE

The capacitance-resistance bridge illustrated and diagrammed covers the direct range of 10 ohms through 1000 megohms and 10 μf through 1000

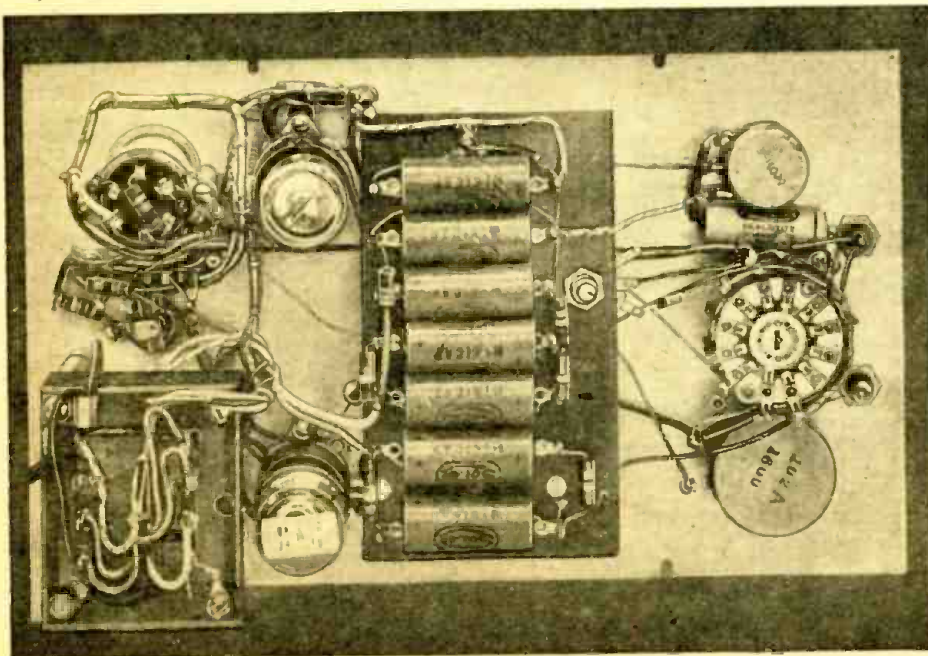

The careful wiring essential to a capacitor bridge is illustrated in this back-panel view.

μf. This is not its real range, for in operation it reaches down to ¼ ohm and ¼ micromicrofarad—low enough to cover compression mica trimmers and high-resistance or faulty connections in auto radio heater and vibrator input circuits, where high current requirements necessitate low circuit resistance. Values of unknown capacitances and resistances below 10 μf and 10 ohms are measured and indicated directly, as the increment such low values add on the bridge dial when they are shunted across some convenient small value of capacitance or resistance first connected to the bridge terminals and measured. With a 10 μf capacitance (conveniently provided by a pair of wires twisted together just sufficiently to give a 10 μf indication on the bridge) it becomes possible to measure accurately capacitances as low as ¼ μf. The same is true for resistance, substituting a 10 ohm resistor for the 10 μf test capacitor.

Power factor of capacitors in the ranges usually made up of paper, oil and electrolytic structures should be measurable up to 50 percent. Since paper capacitors seldom are made below .001 μf, and as mica, ceramic and air capacitors seldom exhibit poor power factor without complete failure, we may establish power factor measurement as essential in the range of .001 μf up through 1000 μf.

For electrolytic capacitor measurement and reforming after idle periods the ideal bridge must incorporate a source of continuously variable d.c. potential which may be applied to any capacitor under test. Provision must be made for determination of leakage currents through electrolytic capacitors as well.

If we can provide means for measuring condenser capacitance under conditions where actual d.c. operating voltages are applied at the same time that capacity is being measured, we may locate those intermittent condensers which are the bane of the service technician; condensers which test correctly out of circuit but which fail to function when restored to the equipment from which they were disconnected because a d.c. potential not present in outside measurement is reapplied to them.

Fig. 1 and the photos illustrate and diagram a capacitance-resistance bridge satisfying all of the requirements set forth above, a precision measuring instrument yielding an accuracy in measurement of capacitors and resistors of ±3 percent nominally over the range of ¼ μf or ohm up through 100 μf or megohms; with such laboratory order of accuracy falling off slightly only between 100 and 1000 μf or megohms. Using it, power factor may be accurately determined, polarizing voltages may be applied to any and all types of capacitors during actual capacitance measurement, leakage currents in two ranges of 0-10 and 0-100 ma may be measured—even insulation resistance up to 1000 megohms with 0 to 500 volts d.c. applied may be accurately determined.

Operation is simple as it is accurate. The power cord plug inserted into any 105/125 volt, 50/60 cycle a.c. mains outlet, the bridge is turned on by moving the lower right knob from OFF to ON, and tubes allowed to warm up. Middle right lever switch set to BRIDGE, it is only necessary to connect an unknown resistor or capacitor to the two left panel jacks by means of the clip leads supplied and set RANGE knob to that position which allows the electron-ray tube to open to a maximum for some setting of the 5-inch dial, when the value of the unknown is read directly from the dial setting multiplied by the indicated RANGE knob figure. The upper left knob allows adjustment to the degree of "eye" opening which yields most accurate readability. The lower left knob reads power factor directly in percent at that setting which, after the bridge is balanced, yields greatest farther opening of the "eye." D.c. polarizing voltage is applied in accordance with the rating of the capacitor under test by appropriate setting of the lower right knob and depressing of the button-switch immediately above it. Capacitor leakage current is read on the "eye" as the percentage of closure it exhibits when the lever switch is thrown to the 10 or 100 ma leakage positions with polarizing voltage applied. No eye closure indicates no leakage current; full eye closure indicates 10 or 100 ma leakage current, depending upon lever switch position.

Fig. 1 illustrates circuit-wise how all of these functions are incorporated in an instrument measuring only 12¾ inches long, 7¾ inches high and 6 inches deep over knobs, in a weight of but 10

pounds, and all with large and costly laboratory instrument accuracy. The actual bridge measuring circuit itself consists of a 4-arm Wheatstone Bridge circuit in Carey-Foster form. The main



Front view of the Silver Model 904 Capacitance-Resistance Bridge.

dial controls the ±2 percent precision potentiometer P1 which constitutes two simultaneously variable arms of the bridge. A third bridge "arm" is always the unknown, or X, connected to the INPUT terminals. The fourth, or "standard" arm consists of C1, C2 or C3 for three capacitance ranges, or of R1, R2 or R3 for three resistance ranges. To obtain the two special high ranges of 10 to 1000 μf or megohms, special "expanding" resistors R4, R4a are cut into circuit at one or the other end of P1 by the range switch S1, S1a, S1b. Standard resistors are held to ±1 percent accuracy; capacitor standards, of mica and special mineral oil construction, to ±2 percent.

This type of bridge circuit wherein two arms are varied simultaneously and oppositely in value yields the advantage of a 100 to 1 range for each rotation of P1, plus the desirable logarithmic scale calibration wherein accuracy is substantially constant percentage-wise at low, medium or high settings of the dial scale. It also lends it-

(Continued on page 51)

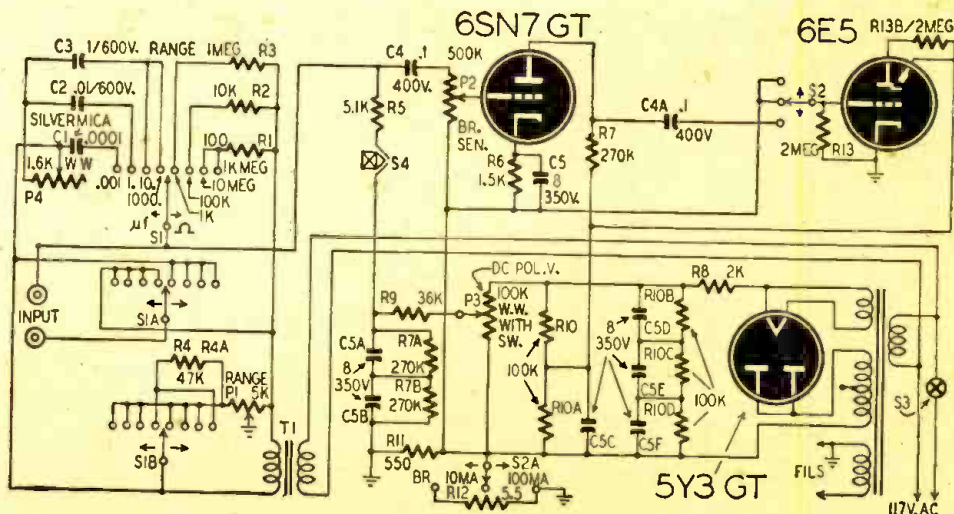

Fig. 1—Complete schematic of the bridge. Measurements are made with three main controls.

SOUND SYSTEM IMPROVEMENT

A NUMBER of years' experience building maximum-fidelity amplifiers and sound systems have led to the formulation of a set of rules, which, if followed, will enable the listener to realize the best from any sound system.

First and foremost, the psychological factor must be considered. People are definitely different in their tastes and desires, and these desires change with the type of program they are listening to. Your amplifier should be equipped with some means of varying its response curve, preferably with independent treble and bass controls.

It is often stated (and rightly so, if the statement is qualified) that a flat amplifier is ideal. If we had a flat microphone, a flat amplifier and a flat speaker, located in a perfect acoustic chamber, and if the speaker output were exactly as loud as the sound source, the system would indeed be ideal.

Even with this theoretically perfect sound system, if we turned the volume down to one-half the loudness of the sound source, it would no longer sound like the original, because we have introduced a new variable, our ears. The human ear's response curve varies with loudness. The lower the volume the less ability there is to hear very low and very high frequencies.

Room acoustics have a profound effect on the ultimate sound of a system, and as there are few ideal rooms outside of broadcasting stations or laboratories, this is another item to be reckoned with. In addition to these things, few pickups, speakers and microphones are flat.

FREQUENCY RESPONSE

Now that we have an idea of what we have to contend with, let's get down to cases. Though the frequency response of a system is important, the

Excellent reproduction of recorded music depends on three factors: compensation for recording characteristics, a good amplifier, with special attention to the output transformer, and a speaker and baffle system which turns the output to sound with a minimum of distortion

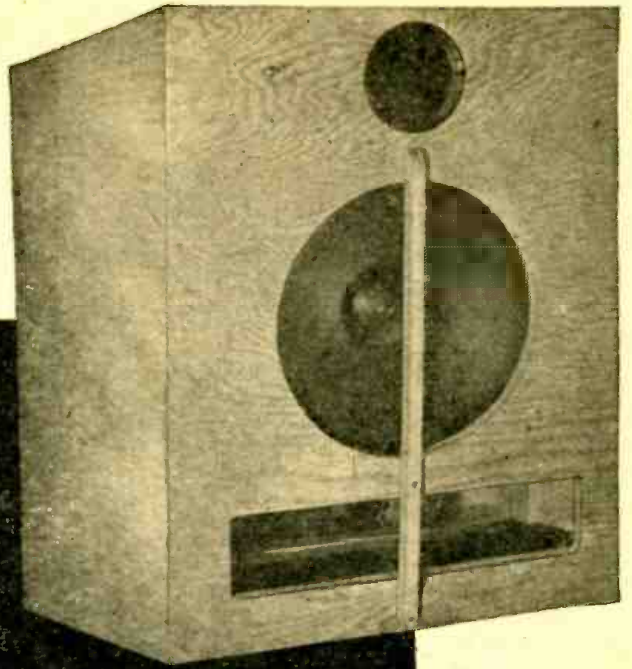

The speaker cabinet. Position and comparative sizes of vent and speaker hole are clearly shown here.

most disturbing element in any system is distortion. This will be more apparent at the higher frequencies, so we limit the frequency response of the system till it is just sufficient to reproduce the material on hand. There is no advantage in using a system flat from 20 to 20,000 cycles to reproduce a shellac pressing. The high frequency noise and distortion would be unbearable. Neither could we use an inexpensive phono motor with this wide-range system without the rumble in the motor being very apparent. So-called permanent needles when worn cause a particularly annoying type of distortion, in addition to causing permanent damage to the records.

The response of an AM receiver need not be any wider than 40 to 5000 cycles for the average station when broadcasting network programs, and 30 to 9500 cycles is entirely satisfactory for the

only in these sources is the distortion low enough or the range wide enough to warrant this wide range.

In the reproduction of any record we must take into account the various recording characteristics and compensate the pickup accordingly. Standard shellac phonograph records are recorded with a "modified" velocity characteristic. Amplitude of the cutting stylus is held constant from the lower frequency limit to between three and eight hundred cycles, and modified constant-velocity above this crossover frequency provides a five to ten decibel boost at 8000 cycles. See Fig. 1.

This is done for the following reasons:

1. Due to widespread use of crystal type pickups, the manufacturers of records insert a high frequency boost to reduce the compensation necessary to flatten the playback equipment's response. This boost effects a considerable improvement in signal to noise ratio.

2. A large majority of the users of shellac pressings have equipment with serious attenuation of the higher frequencies and no means for the compensation thereof. As the figure shows, there is a falling-off at the low-frequency end of the audio spectrum. If the low frequency amplitude were not restricted, either overcutting would result or the level of the high frequencies would be below the noise level.

best AM stations when broadcasting local programs. Limiting the response to 9500 cycles is to suppress any 10-kc beats between other stations located 10 kc apart. For FM reception or transcription reproduction we can go the limit and provide response from 30 to 15,000 cycles, for

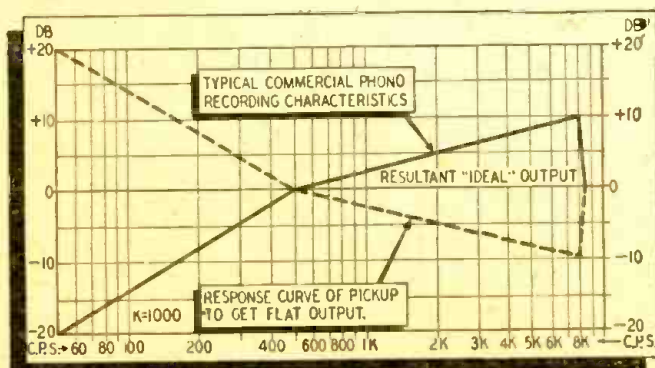

Fig. 1—Recording and response characteristics produce flat output.

PICKUP CHARACTERISTICS

If constant velocity records (without treble boost) are played back with a magnetic pickup the output will be flat with decreasing frequency down to the crossover frequency where constant amplitude begins. Since the magnetic pickup requires successively greater stylus motion at the low frequencies to maintain its output flat, and since the amplitude is held constant below the crossover frequency (300 to 800 cycles) we must provide an equalizer to compensate for this condition. Since practically all commercial records made in the last six or seven years have a treble boost, the magnetic pickup must be further compensated to *reduce* its high frequency response. Otherwise response from commercial records will be excessively brilliant. Fig. 2 shows the

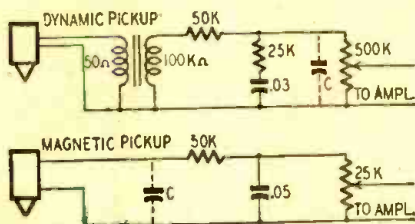

Fig. 2—Two suggested equalization circuits.

usual method of equalization. Constants are approximate and depend on the pickup and transformer, as well as the recording characteristic of the records being played. Condenser C is for treble attenuation. Its value may be anywhere from .002 to .02 μ f, depending on the pickup and transformer.

A crystal pickup has a *constant amplitude* characteristic. Its output voltage is a direct function of stylus motion independent of frequency up to its high-frequency cutoff point. For constant velocity recording (without treble boost) above the crossover frequency we would have to compensate for the decrease in stylus amplitude with frequency. This is in the order of six db per octave above the crossover fre-

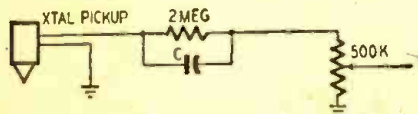

Fig. 3—Equalizer circuit for crystal pickup.

quency. To compensate the pickup for this would require considerable boost at 7000 cycles. However, commercial records insert treble boost at a rate of from two to about five db per octave above the crossover frequency, depending on the record. Thus for some records no high-frequency equalization is required and for others only a small amount. The customary method of compensating crystal pickups for commercial records is shown in Fig. 3. Reducing the value of C will reduce the amount of treble boost. For maximum boost C should be about .002 μ f. When playing records having considerable treble boost, C should be reduced in value to as low as 50 μ f. Transcriptions are recorded with more in-

volved response characteristics (generally they have considerably more treble boost than records) and the manufacturer of the pickup should be consulted for information on equalizers for Orthacoustic, NAB Standard, Columbia or other transcription characteristics.

THE AMPLIFIER

Now that we have a suitable flat source of music we wish to amplify it with as low distortion as possible. The easiest way to do so is to build a straightforward amplifier using triode tubes throughout. We can choose between 6A3, 6B4, 2A3, 45 for the output stage. These tubes should be arranged in push-pull, as the attendant cancellation of second harmonic distortion and supply-voltage hum is worthwhile, and reduces the first filter section requirements. Of course, beam tubes (6L6-6V6) can be used with feedback.

The most important purchase in connection with this amplifier is a good output transformer. It will make more difference than any other component. An output transformer may have a power rating of ten watts. This is somewhat deceptive as it is usually measured at some middle frequency, usually 400 or 1000 cycles. The same transformer may only be capable of transferring four watts at 30, and six watts at 12,000 cycles. This is a serious drawback particularly when we wish to boost the high and low frequencies. High-quality units are relatively inexpensive in comparison to the results they will produce.

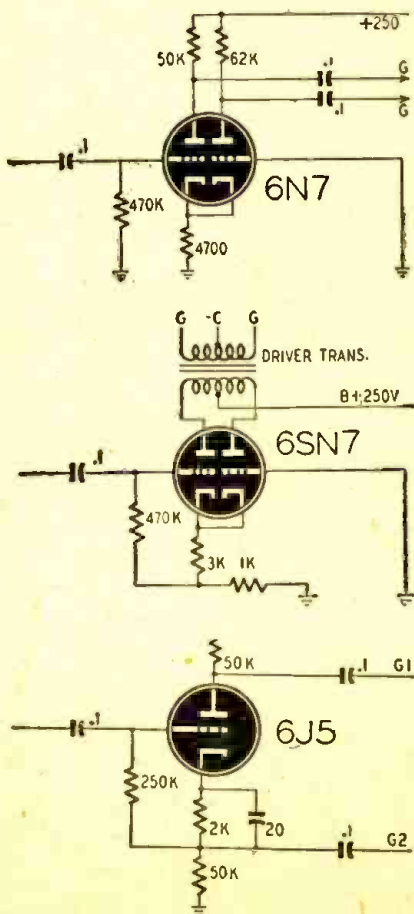

Fig. 4—Three self-balancing phase inverters.

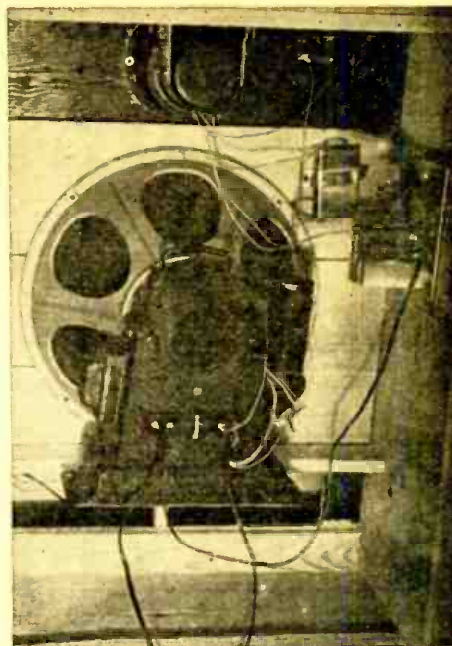

Photo B—Inside view of the speaker cabinet.

A high-quality output transformer for a 15-watt 6B4 amplifier can be obtained for \$15.00 or so.

An input transformer need not be used if class-A operation is desired, as a phase inverter is adequate. Fig. 4 shows several inverters which are degenerative and consequently self-balancing and of the low-distortion type. If class AB or AB₂ operation to obtain maximum power output is desired, an input transformer is needed to keep the resistance in the grid circuits of these tubes low in the case of a small amount of grid current being drawn.

Fixed bias is desirable as it allows greater power output with lower distortion. Fig. 5 shows a simple way to obtain it when your power transformer does not have a bias tap. A separate transformer winding is required. The rectifier may be a triode similar to those in the amplifier.

If you use an input transformer it is wise in the case of an inexpensive unit and essential for a high quality unit, to shunt feed the primary from the driver tube. This does not hold for push-pull drivers, as their d.c. plate current balances out in the output transformer.

Be sure to bypass all cathodes with large enough condensers to eliminate degeneration at low frequencies. It is wise to decouple every stage, both in the interest of low hum level and to eliminate the possibility of motor boating or unwanted interstage coupling.

One should, of course, use as good a speaker as possible and it should be baffled efficiently.

A bass reflex baffle offers many advantages, among which are improved bass response, higher sensitivity and cleaner high-frequency response. The distortion at low frequencies may be reduced greatly over the conventional open-back enclosure.

When a speaker is placed in an enclosure
(Continued on page 52)

UNIVERSAL 1-KW AMPLIFIER

Tuning Up and Adjustment Are Completely Described

THE average amateur starts out with what appears to be a good r.f. final amplifier design on paper and by the time that the rig is completed and all of the "bugs" ironed out, usually winds up with an entire-

ly different layout. Sometime later when the urge to try out a pair of the new pentodes, tetrodes or triodes, as the case may be, becomes unbearable, he is very much surprised and shocked to learn that, although the amplifier functioned perfectly with the previous tubes, it is again necessary to go through the entire "debugging" procedure with the new ones.

The author spent his spare time over a period of several months in an intensive experimental effort to develop a simple and stable high-power r.f. amplifier design which would be suitable for use with practically all types of pentode, tetrode and triode tubes. It was also felt desirable that the number of mechanical changes required when going from one type of tube to another should be reduced to the minimum. A multitude of arrangements were tried, some of which were good from a mechanical viewpoint but lacked stability when used with several different types of tubes; others had good electrical stability but were difficult to construct. As might be expected, the resultant design is a compromise between the various factors involved; the practical working model amplifier is described in this article.

As the photographs and drawings show, the unit is built up on a 17 x 13 x 3-inch cadmium-plated heavy-duty steel chassis and a 12x19-inch aluminum panel. The chassis is mounted spaced two inches from the aluminum panel, which also gives a two-inch spacing between the rear of the chassis and the back of the standard cabinet when the door is closed. The purpose of the offset type of construction is: 1. to permit a symmetrical layout of the parts on the top of the chassis; 2. to allow the plate tank coil to be electrically balanced with respect to ground. The center lines of the chassis and the center lines of the

Parmetal 66-inch metal cabinet coincide; therefore, the two "hot" ends of the tank coil are equidistant from ground when the cabinet door is closed.

This amplifier is designed to operate on the 3.5, 7, 14 and 28 megacycle amateur bands with practically any modern transmitting tubes such as the Eimac 100TH, 250TH, 4-125A or 4-250A; the Gammatron HK-54, HK-254 or HK-257B; or the Taylor TW75 or TW150. Using suitable tubes, the amplifier is easily capable of input powers up to 1,000 watts with excellent efficiency and stability. The only changes required when going from one type of tube to another are: 1. A filament transformer of the proper voltage and current capacity; 2. proper sockets for the tubes used; 3. incorporation of proper capacity and voltage rating neutralizing capacitors if the tubes are triodes.

GRID CIRCUIT ISOLATED

As shown in the under-chassis view photograph, the grid tank tuning condenser is mounted under the chassis. Experiments with previous amplifiers had convinced the author that much of

(Continued on page 57)

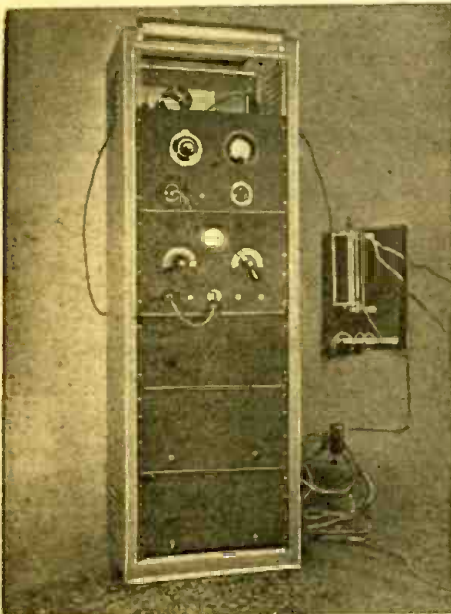

Amplifier is in the top section of this rack.

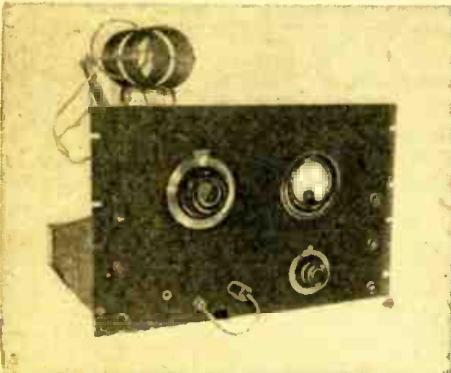

Closer view of the one-kilowatt final stage.



A rear view of the unit. Note swinging link.

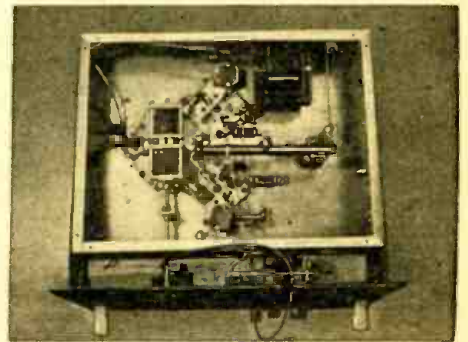

Grid tuning condenser is under the chassis.

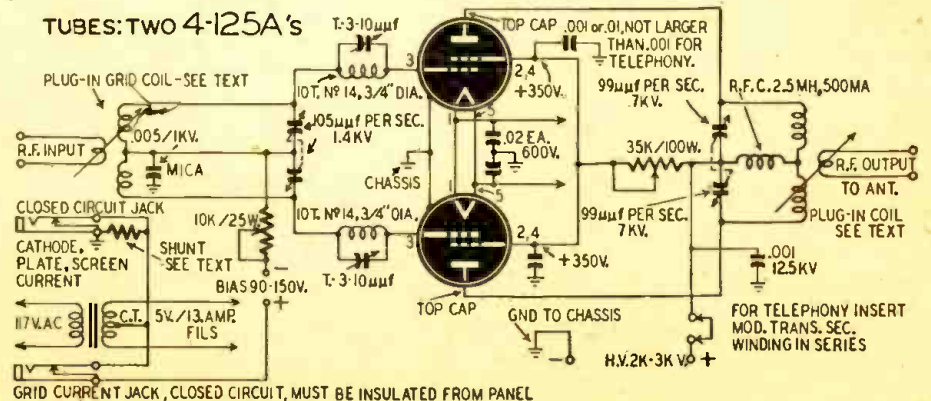

Circuit is designed to accommodate tetrodes, pentodes and triodes, with slight adaptations.

SERVICING MOVIE SOUND

Maintenance and Repair of Sound-on-Film Systems

"THE show must go on." This is an honored tradition in the entertainment world. Vaudeville and stage actors often work while ill or bereaved to preserve this tradition. Today it is the watchword in thousands of moving picture houses in all parts of the country, from the smallest neighborhood movie to the most palatial urban theater.

The local radio technician can help uphold this tradition, at a profit for himself. He is readily available when sound trouble occurs and has the equipment, spare parts and knowledge to make either a permanent or temporary repair usually in a matter of minutes. The break may thus be limited to an absolute minimum, thereby saving the theater prestige and money that would otherwise be lost in refunded admissions.

Any radio technician who intends servicing theater sound equipment—either routine or emergency—should first notify the business agent of any union under which the projection booth may be operated and obtain his permission to enter the booth for that purpose. He should also ascertain that his servicing the equipment would not violate the terms of any contract the theater may have with a service organization.

SOUND-ON-FILM SYSTEMS

When sound was first brought to the screen it was in the form of 16-inch wax recordings. For each reel of film a corresponding wax record was necessary for the sound. This system had many disadvantages. The principal one was that of synchronization between picture and sound. Proper synchronization was dependent on placing the reproducer needle accurately at the start mark on the record and the film start mark in the picture aperture. This insured that picture and sound started in synchronization. However, if any film had been damaged and removed, synchronization did not exist from that point to the end of the reel. It became common practice to replace any damaged film with an equal length of black film in an effort to maintain synchronization.

This system has been replaced with sound-on-film recording. In addition to other advantages, it insures perfect synchronization between picture and sound at all times because the picture and sound are both printed on the film.

The sound is recorded approximately nineteen frames ahead of the picture;

in projection this places at the scanning beam that point on the sound track which corresponds to the picture in the aperture at any given instant. The frequency and volume range that may be recorded on film is far greater than that possible with disc recording.

All sound-on-film may be broadly classified as variable-area, which is essentially an oscillographic trace of the signal currents (Fig. 1-a), or variable-density, which is a half tone photograph of the recorded sound (Fig. 1-b).

Both operate on the principle of modulating a beam of light, which is made to pass through the sound track and on to the cathode of the photoelectric cell. The photo-cell converts the light variations into electrical impulses whose wave form corresponds to the recorded sound. These impulses are very feeble and must be amplified many times before they are strong enough to operate the speakers.

THE SOUND HEAD

It is extremely important that the film move past the scanning point at a

uniform speed of *ninety feet per minute*. All traces of flutter or variations in speed must be absorbed so that it will not affect the movement of the film past the scanning point. This is accomplished by free-running loops on both sides of the scanning point. These loops absorb any flutter or sudden variations in speed. The film is pulled through by a constant speed sprocket (Fig. 2).

The rotary stabilizer or oil-damping wheel is used in later sound systems to
(Continued on following page)

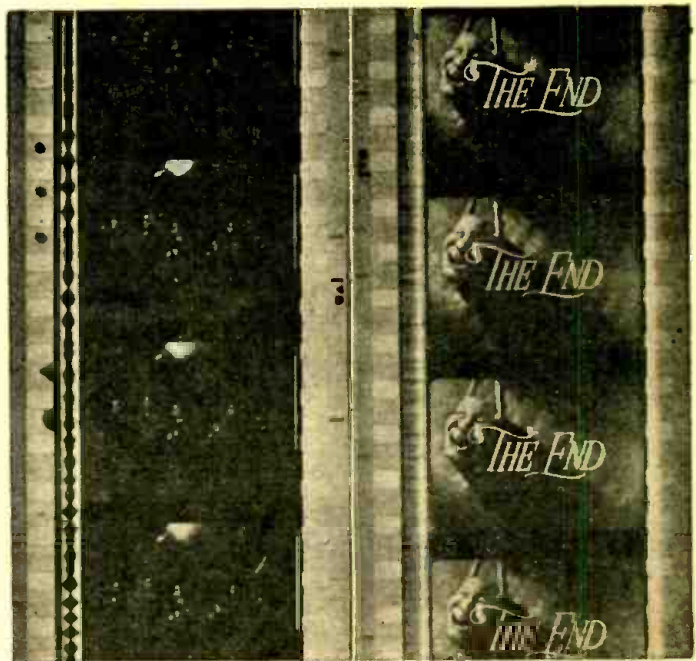

Fig. 1-a, left—Variable area; 1-b, right—variable-density strip

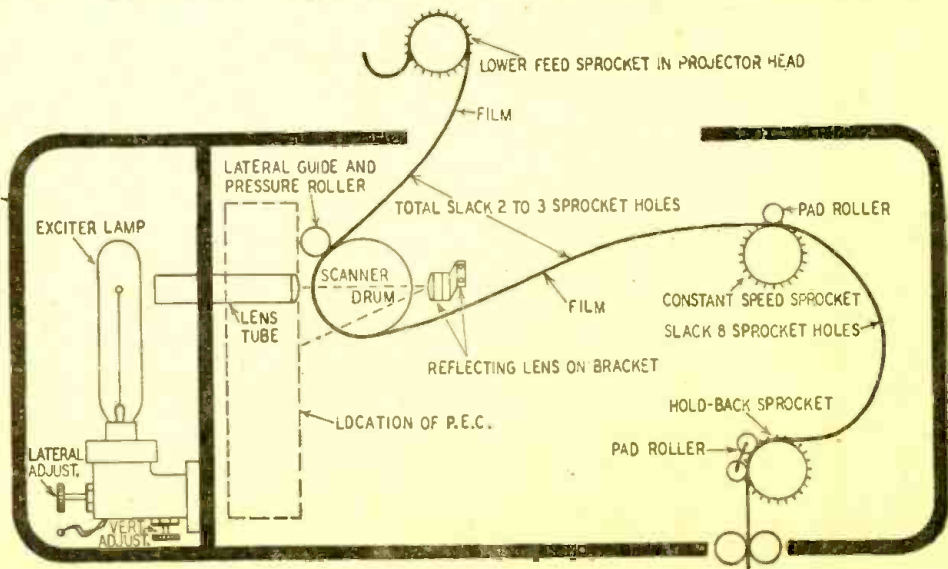

Fig. 2—Course followed by the sound film, showing how it is propelled and stabilized.

insure uniform film speed at the scanning point. This is simply an oil-damped flywheel which is not geared to the mechanism in any way, but is driven by traction between the film and the scanner drum, which is mounted on the same shaft with the damping wheel. Since this wheel is not geared to the mechanism, it is free of all variations in speed inherent to the mechanism.

The damping wheel should pick up from a dead stop to full speed—in two to three seconds. A peculiar gurgling distortion which lasts from one to ten seconds after changing from one machine to the other is usually caused by this wheel not having reached full speed when change-over is made. This is

which results in an even pull at the scanner. Mounted on the same shaft with the constant speed sprocket is a heavy flywheel, the inertia of which protects this shaft and its sprocket from flutter and variations in speed. Free-running loops are provided to isolate the scanner.

THE LIGHT SYSTEM

The exciter lamp and optical system should be adjusted so that it projects on the sound track a uniformly illuminated image approximately .084 by .0012 inch. Lateral and vertical adjustments are provided on the exciter lamp bracket, and it should be carefully adjusted so that it is in perfect align-

The second method of adjustment is known as the flicker test. A white card is placed between the film and reflecting lens. When the film is moved slowly, by hand, the frequency lines cause a definite flicker of light on the card. The lens is in focus when the lines appear to be stationary. If they appear to move up or down on the card, the lens tube should be adjusted.

In modern sound heads the lens tube is accurately adjusted for azimuth at the factory and it is not necessary to disturb this adjustment in order to focus the lens. This is not true in the older types because the lens tube is simply held in a clamp. If the locking screws are loosened the lens tube may be rotated as well as moved forward or backward. In fact it would be practically impossible to adjust the focus without rotating the tube slightly, and if any adjustments are made special care should be taken so that when the adjustment is finished the lens will be in focus and the image will be parallel with the frequency lines on the sound track.

If test film is not available, fairly accurate adjustments may be made by running any film with good sound recording and making adjustments for maximum high frequency response.

The lateral guide roller (Fig. 2), should be adjusted so that the scanning beam does not strike the frame lines or sprocket holes. The adjustment may be checked by running Academy Buzz Track film (which has a silent sound track with a low-pitched buzz recorded on each of the sound track border lines). Turn the adjusting screw clockwise until the buzz track can just be heard, then turn in the opposite direction, counting turns and fractions of turns, until the opposite side of the buzz track, which is a different frequency, can be heard. Turn the screw clockwise again half as many turns and fractions of turns as was required to bring the beam from one side of the

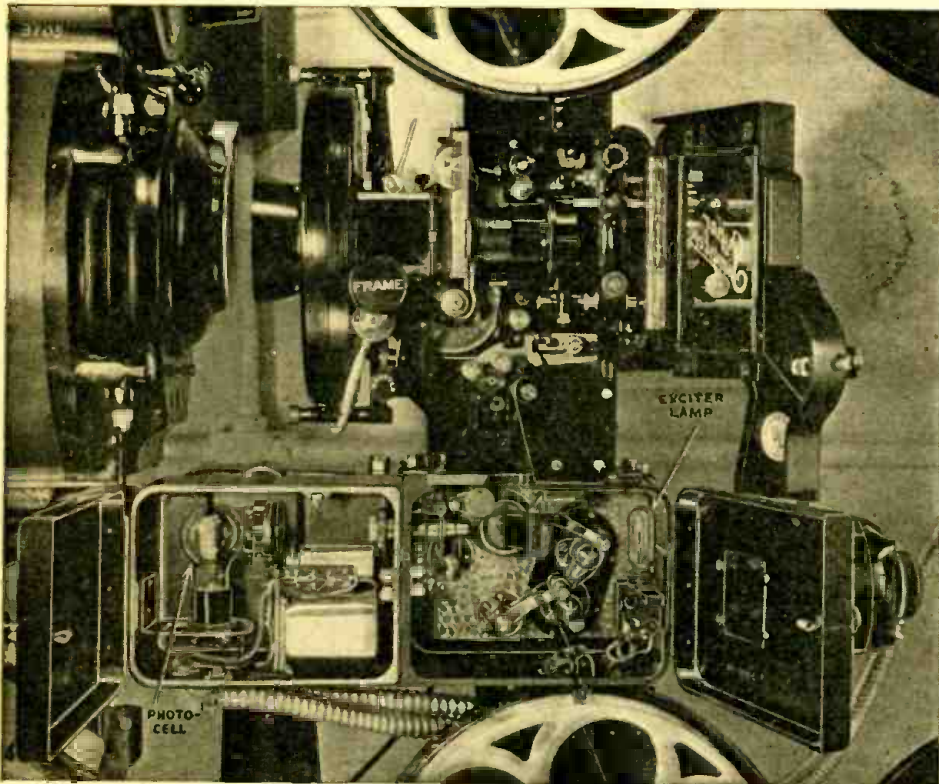

Light travels in a straight line from exciter lamp to photocell in this type of projector.

caused by a worn or improper adjusted guide and pressure roller (Fig. 2). The obvious remedy is replacement or adjustment of this roller to insure proper traction between film and scanner drum.

The drum may be spun by hand to determine if it runs freely. The run-out should be smooth with no jerky or sudden stops. The deceleration time (from normal speed) is between thirty and sixty seconds. If it is much less than this or if the stop is jerky or sudden the bearings should be cleaned and inspected. The scanner drum should also be inspected for end play. If end-play exists the film will weave in its motion past the scanner, resulting in the light beam being modulated by the framing lines or sprocket holes. To remedy, remove the damping wheel and reverse one of the spring washers provided to absorb end play, or add another washer.

In the older sound systems the film is pulled through a sound gate by the constant speed sprocket. This sound gate exerts a slight pressure on the film

ment with the optical system. The volume and frequency response will be seriously affected if the inside of the glass envelope is blackened from use, or if the filament sags. In either case the lamp should be replaced and proper adjustments made.

The sound head must be clean. Tests show that a film of oil or dirt on any part of the optical system will seriously affect the high frequency response. The lens, mirrors, etc., should be thoroughly cleaned with lens tissue; all other parts of the sound head may be cleaned with a soft cloth.

Unless it is definitely known that the optical system is out of focus, no adjustment should be made. If adjustment is necessary, one of two methods, both using Academy 8000-cycle test film, may be used:

Thread the test film in the machine and—with the machine running—adjust the lens tube until maximum response is obtained from the amplifiers. This may be observed aurally or with an output meter.

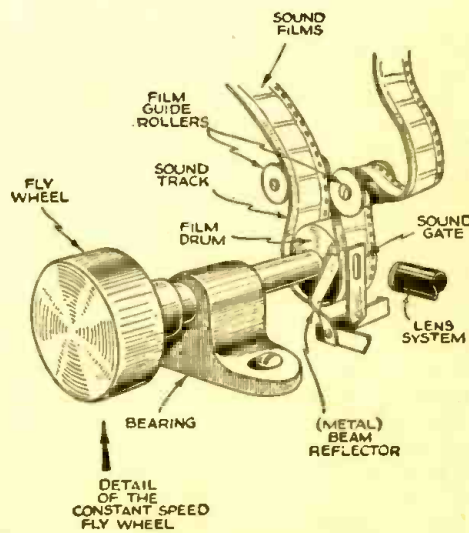

How lens, sound gate and mirror are placed.

track to the other. This centers the beam on the sound track.

If Buzz Track film is not available
(Continued on page 59)

TELEVISION FOR TODAY

Part VI — Contrast and Gain Control Systems

IN the standard radio sound receiver, volume is controlled by the volume control. In a television receiver, a comparable control is the contrast control and the intensity of the image is dependent upon its setting. Unlike the volume control, however, the position of the contrast control is usually in the grid or cathode circuits of the video i.f. amplifiers and very seldom at the input to the amplifiers following the detector, the point where most volume controls are located. Incidentally, another name for the contrast control is intensity control.

The action of the contrast control is simple. By varying the gain of the two or three stages to which it is attached, it controls the amplification supplied to the video signal. The more negative the bias of an amplifier, the lower its gain. With variable- μ tubes, the extent of control is very wide and the amplification factor may be varied over wide limits with only a slight effect on distortion. With sharp cut-off tubes, greater gain is possible, but the range of linear operation is restricted and distortion is readily produced.

Two simple methods of obtaining contrast control are indicated in the circuits of Fig. 1 and Fig. 2. In the former

illustration, the power supply is designed so that a small negative voltage is developed across the 150-ohm (5-watt) resistor. This voltage is then applied across the 30,000- and 50,000-ohm resistors, with the variable 50,000-ohm resistor functioning as the contrast control. This negative voltage is fed to the 1852 mixer and 1852 1st video i.f. amplifier. Two 500,000-ohm decoupling resistors serve their usual function of isolating each circuit to prevent undesirable interaction. The .005- μ f condensers complete the r.f. (or i.f.) path for the incoming signals.

The use of 1852 sharp cut-off tubes may appear to be a direct contradiction of a preceding statement until a closer inspection of both cathode circuits reveals 40-ohm unbypassed resistors. These partially counteract changes in input capacitance with changes in plate current, but they also serve to extend the E_c - I_p characteristic curves sufficiently to obtain limited remote cut-off properties. The advantage of this combination over an 1853 variable- μ tube is the higher G_m available with the 1852. The unbypassed cathode resistor reduces the G_m somewhat, but its overall gain remains higher than the 1853.

The second method of obtaining con-

trast control is given in Fig. 2. Both tubes are subject to a variable bias—in addition to small fixed biasing resistors—from the common 2,000-ohm potentiometer. The fixed cathode resistors set the minimum bias for each tube, while the additional bias serves for control.

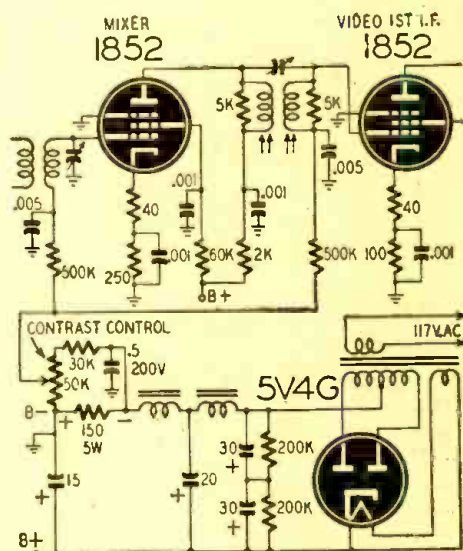
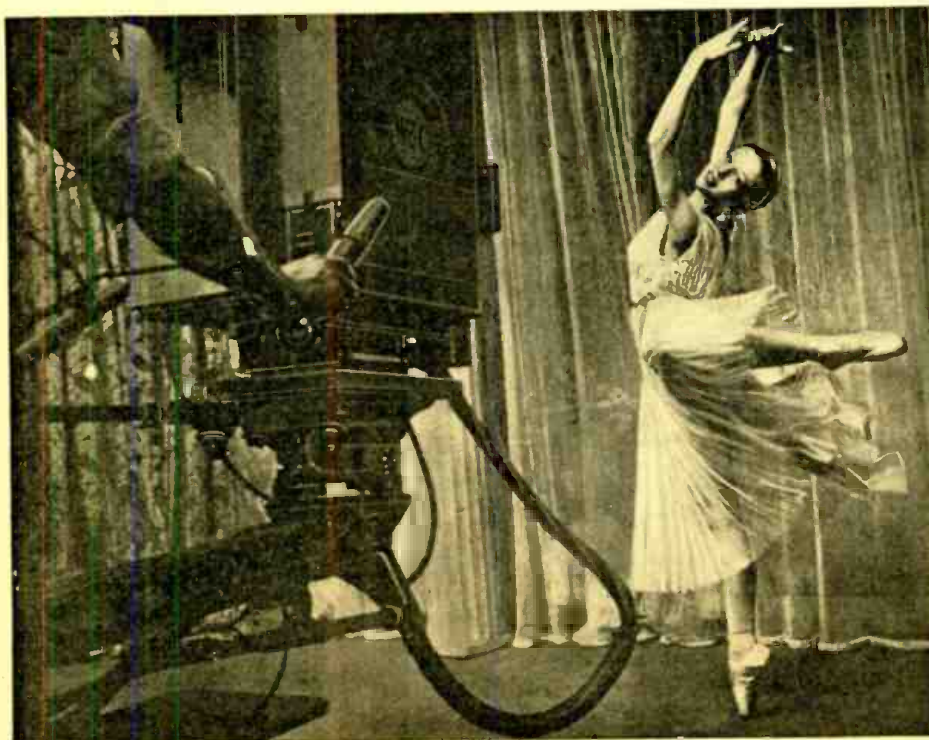

Fig. 1—Contrast control in Meissner receiver.

Designers seldom attempt to control more than three stages because of the possibility of introducing distortion in tubes where the level of the amplifier signal is high. The practice of including the mixer among the controlled stages has become common because of the separation of the oscillator and mixer operations. When both are within one envelope, the possibility always exists that a change in bias will produce a change in oscillator frequency. With the oscillator functioning as a distinct unit, this limitation is removed.

A final word about the contrast control. It controls the intensity and, indirectly, the contrast between light and dark values in the image. If the image is made intense, the difference between the bright and the dark portions of the picture will increase, which means that the overall image contrast likewise increases. On the other hand, a decrease in the setting of this control lowers the contrast ratio. Since the dark level of the image, where details are no longer distinguishable from each other, is relatively fixed, we see that the control is concerned mainly with increasing or decreasing the intensity of the brighter section of the image. It is as though one end of an elastic were held fixed, while

(Continued on page 56)



Studio lighting, camera work and direction are all important to the image in the receiver.

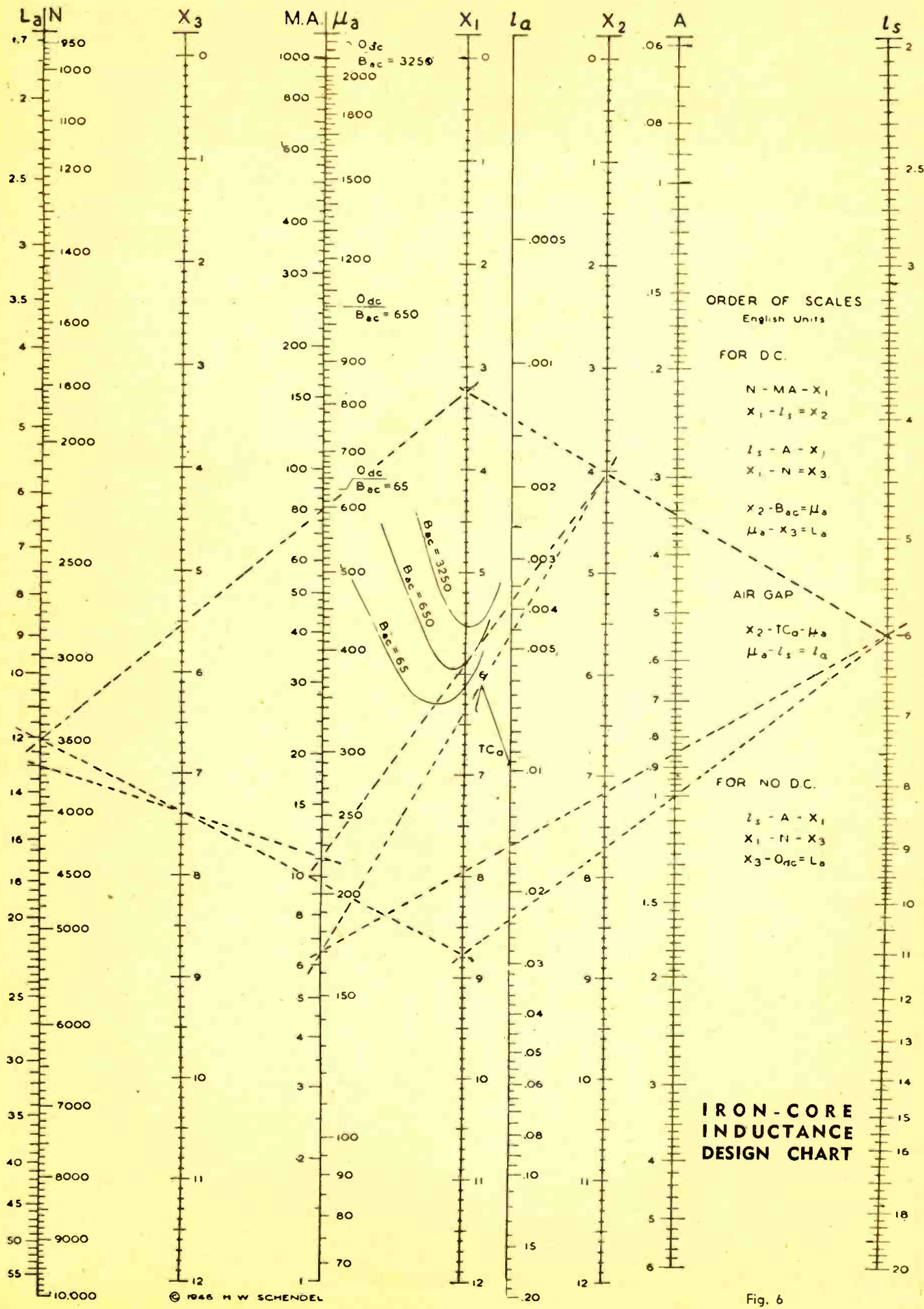

© 1946 H. W. SCHENDEL

Fig. 6

COILS, CORES AND MAGNETS

Part II—Reactor and Transformer Measurement and Design

FILTER chokes or reactors, audio frequency chokes, and audio transformers come under the classification of iron-core inductances. The unit of inductance is the henry. A coil has an inductance of one henry if a current changing at the rate of one ampere in one second induces one volt in it.

Basically inductances are the same as electromagnets and use cores like the relays described in the first part of this article. The essential difference is that inductance is the main consideration. This in turn depends on the permeability of the steel or alloy.

Considerable care is required in rewinding good grade audio devices but it is a comparatively simple matter to rewind filter chokes and obtain approximate original characteristics. If a unit is rewound with original size wire, with

about the same number of turns, and close attention given the size of air gap, if any, no trouble should be encountered. *When an air gap has been used its size is extremely important.* In some cases a change of .001 inch in air gap total length will cause a 50 percent change in final inductance. Generally speaking it is better to err slightly oversize rather than undersize.

Much valuable information on rewinding, including a copper wire table, appeared in articles in the Aug.-Sept., October, and December 1942, and the September 1943 issues of RADIO-CRAFT.

To rewind an iron-core inductance for other than original conditions or to design one for some specific purpose involves several factors.

Windings of iron-core coils carrying only a.c. have an inductance which varies in relation to the induced flux in

a manner similar to the variation of the d.c. permeability obtained from Fig. 1, which appeared last month. Push-pull output transformers in which the d.c. effects cancel and interstage transformers which have the d.c. blocked from

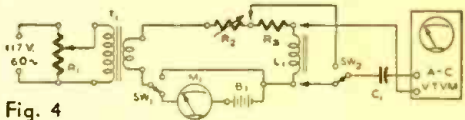

Fig. 4

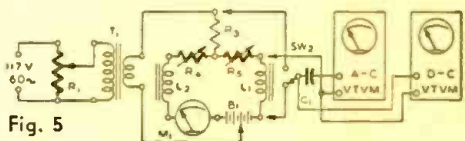

Fig. 5

- R1—500-ohm, 100-w rheostat
- R2—D.c. rheostat
- R3—Non-inductive shunt resistor
- R4,5—Two similar rheostats
- C1—1-uf (or more) paper condenser
- Sw1, 2—S.p.d.f. switches
- L1—Iron-core inductance (under test)
- L2—Iron-core inductance (like L1)
- T1—Power transformer (heavy duty)
- M1—D.c. milliammeter for range needed
- B1—Battery, adjustable-voltage with center tap

their windings are examples of the simple a.c. class.

Most iron-core inductance windings carry both a.c. and d.c. simultaneously—a.c. superimposed on d.c. As either of these may be varied in magnitude it is easy to see there would be an almost endless number of conditions, each resulting in a different inductance. The inductance rating of any device is accurate *only when the test conditions are the same as the normal load conditions.*

Curves may be prepared showing the a.c. flux density ($B_{max-a.c.}$) versus a.c. permeability ($\mu_{a.c.}$) for various values of d.c. in the winding. Such curves prepared from test data on a special test core are called *incremental permeability curves.*

Due to the factors explained in connection with d.c. magnetization curves as well as other factors—eddy-current insulation, stacking factors, core shapes and sizes, and other characteristics of laminations—separate permeability curves are needed for each core design. The curves, when prepared from data obtained directly from a definite working design, using a specified steel or alloy, are called *apparent permeability curves* (μ_a). They indicate the actual permeability (not theoretical) which the design appears to have under selected working conditions.

An air gap is seldom used when the inductance is used only on a.c. except in such devices as fluorescent lamp and sunlamp ballasts. Lamp ballast design

(Continued on page 72)

SYMBOLS	ENGLISH UNITS	C.G.S. UNITS
M.M.F. (MAGNETO MOTIVE FORCE)	= NI=RØ (IN AMPERE TURNS)	= 0.4πNI=RØ (IN GILBERTS)
R (RELUCTANCE)	= $\frac{MMF}{\phi} = \frac{NI}{\phi} = \frac{l}{\mu A}$ 0.313 FOR 1 CU. IN. OF AIR	= $\frac{MMF}{\phi} = \frac{0.4\pi NI}{\phi} = \frac{l}{\mu A}$ 1. FOR 1 CU. CM. OF AIR
Ø (MAXWELLS. FLUX. OR LINES OF FORCE IN ANY MATERIAL)	= $\frac{NI}{R} = \frac{3.19\mu NIA}{l}$	= $\frac{0.4\pi NI}{R} = \frac{0.4\mu NIA}{l}$
Ø (SAME AS ABOVE BUT FOR AIR)	= $\frac{3.19NIA}{l}$	= $\frac{0.4\pi NIA}{l}$
P (PERMEANCE)	= $\frac{\phi}{MMF} = \frac{\phi}{NI} = \frac{3.19\mu A}{l}$	= $\frac{\phi}{MMF} = \frac{\phi}{0.4\pi NI} = \frac{\mu A}{l}$
NI (AMPERE TURNS FOR ANY MATERIAL)	= $\frac{HØl}{BA} = \frac{Øl}{3.19\mu A}$ = AMPERES X TURNS	= $\frac{HØl}{0.4\pi BA} = \frac{Øl}{0.4\mu A}$ = AMPERES X TURNS
N (AMPERE TURNS FOR AIR)	= $\frac{Øl_a}{3.19A}$	= $\frac{Øl_a}{0.4\pi A}$
l (LENGTH—l _s —STEEL—l _a —AIR)	= INCHES=CM X .3937=2.54 CM	= CM=INCHES X 2.54=39 INCHES
A (AREA)	= SQ. IN.=SQ. CM. X .155=6.45 SQ. CM.	= SQ. CM.=SQ. IN. X 6.45=155 SQ. IN
B (NORMAL INDUCTION IN ANY MATERIAL)	= $3.19\mu H = \frac{\phi}{A} = \frac{M.M.F.}{l_a + l_s}$ = MAXWELLS/SQ. IN.=GAUSSSES X 6.45	= $\mu H = \frac{\phi}{A} = \frac{M.M.F.}{l_a + l_s}$ = MAXW./SQ. CM.=MAXW./SQ. IN X 0.155
B (MAGNETIC INDUCTION IN AIR)	= $3.19H = \frac{\phi}{A}$ =MAXWELLS PER SQ. IN	= $H = \frac{\phi}{A}$ = GAUSSSES
H (MAGNETIZING FORCE)	= $\frac{NI}{l} = \frac{B}{3.19\mu}$ =NI PER INCH LENGTH = OERSTEDS X 2.02	= $\frac{0.4\pi NI}{l} = \frac{B}{\mu}$ =OERSTEDS=GILBERTS/CM LENGTH = NI PER IN. LGTH X 0.495
μ (PERMEABILITY FOR ANY MAT'L)	= $\frac{B}{H}$	= $\frac{B}{H}$
μ (FOR AIR)	= 1	= 1
μ _a (APPARENT AC PERMEABILITY)	= $\frac{10^8 l_a}{3.19N^2 AK_1}$	= $\frac{10^8 l_a}{0.4\pi N^2 AK_1}$
La (APPARENT INDUCT. IN HENRIES)	= $\frac{3.19N^2 \mu_a AK_1}{10^8 l} = \frac{N^2}{10^4 (3.19\mu_a A + 3.19A)}$	= $\frac{0.4\pi N^2 \mu_a AK_1}{10^8 l} = \frac{0.4\pi N^2}{10^8 (\mu_a A + A)}$

MISC. FORMULAE

$$L_a = \sqrt{\frac{Z^2 - R_a^2}{4\pi^2 f^2}} = \frac{0.159\sqrt{Z^2 - R_a^2}}{f} \text{ OR, IF } R_a \text{ IS SMALL} = \frac{0.159Z}{f}$$

$$B_{ac} = \frac{10^8 E_{rms}}{4.44 f AN K_1} \quad E_{rms} = \frac{4.44 N \phi_{max}}{10^8} \quad \phi_{max} = \frac{10^8 E_{rms}}{4.44 f N} \quad N = \frac{10^8 E_{rms}}{4.44 f \phi_{max}} = \frac{10^8 E_{rms}}{4.44 f AB_{ac} K_1}$$

$$Z = \sqrt{X_L^2 + R_a^2} \quad X_L = 2\pi f L_a \quad Z = \text{IMPEDANCE IN OHMS} \quad f = \text{CYCLES/SEC.} \quad \pi = 3.1416 \quad R_a = \text{APPARENT RESISTANCE IN OHMS} \quad X_L = \text{INDUCTIVE REACTANCE IN OHMS} \quad K_1 = \text{STACKING FACTOR}$$

Symbols and equivalent English and C.G.S. units of common magnetic terms and formulas.

BEAT-FREQUENCY OSCILLATOR

An Excellent Instrument for the Advanced Serviceman

THE type of audio-frequency oscillator described in this article consists essentially of two high-frequency oscillators, the alternating voltage outputs of which are mixed, i.e., added together and rectified, the resultant being an alternating voltage the frequency of which is the difference between the frequencies of the high-frequency oscillators.

Audio-frequency oscillators have many uses, such as measurement of frequency response of an amplifier or a.f. section of a receiver, signal for locating rattles, squeaks and buzzes in radio cabinets and auditoriums (includ-

loudspeaker and microphone response. An accurately calibrated variable-frequency oscillator can be used as a source for measurement of inductances and capacities by resonance methods. (In later articles it is hoped to describe auxiliary equipment and procedures for some of the above).

This particular beat-frequency oscillator has a number of constructional and circuit features making it very useful for the experimenter, radio serviceman, teacher and amplifier enthusiast.

CONSTRUCTIONAL FEATURES

The entire job is very compact, the case measuring only 10 x 7 x 7 inches. The small size is due mainly to the employment of only four tubes (one each 6K7-GT, 6J8-GT, 6V6-GT and 6X5-GT). Bantam type tubes are employed but there is enough room for full size "G" types—a 5Y3-G rectifier was used in one version. Controls are only 3 in number: Zero set, Tune (frequency control) and Volume.

Ordinary radio parts are used throughout except that a slight modification is required of the one-gang condenser if the instrument is to be most useful.

With the exception of the 2000-ohm filter, all resistors are of the carbon type. Ordinary shielded coils in cans 1½ x 1½ x 3 inches high, are the only ones used. No modification is necessary

except that a few small condensers and resistors are squeezed inside the cans to facilitate shielding.

Probably the weakest part is the output transformer, although here again the sacrifice of some volume enabled fair results to be obtained.

CIRCUIT DETAILS

The 6K7-GT (which can be replaced by 6U7-G or 6D6) is employed as a fixed frequency oscillator using an electron-coupled output circuit so that signals applied to the plate from an external source will have little or no effect on the oscillator frequency. It is highly desirable in the design of beat-frequency oscillators that there be as little coupling (or energy transfer) as possible between the tuned circuits, otherwise waveform distortion and locking-in occur when low output frequencies are required. Locking-in means that the two high-frequency oscillators jump into synchronism so that no output beat signal is produced.

The variable-frequency oscillator consists of the triode portion of the 6J8-GT—here the circuit is very similar to that of a conventional superhet—electron coupling being provided in the hexode portion of the tube.

Production of reasonably good wave form requires that at least one oscillator output be free from harmonics and that no overload occurs in the output stage.

By having the fixed frequency oscillator barely oscillating, that is, working at low signal level, its wave form is fairly pure, a plate-to-ground condenser discriminating against any harmonics that might be produced.

Inverse or negative feedback is employed over the output stage to reduce any distortion produced by the 6V6. Theoretically the amount of feedback varies with the setting of the volume control in the circuit shown, an effect which would cause a slight change in frequency response between low and full volume. However the change is a very minor one indeed, as the output is provided with an almost constant resistive load consisting of a 10,000-ohm resistor and a 0.1 microfarad fixed condenser.

To prevent too great attenuation of the lower frequencies the cathode bypass condenser was made unusually large—100 µf being used.

Space was saved by omitting the usual power choke and employing a

(Continued on page 66)



The beat-frequency oscillator is compact and easily carried around.

ing ordinary rooms), alternating voltage source for measuring impedance of a loudspeaker, microphone, pick-up or cutting head. They also form part of the equipment for measurement of

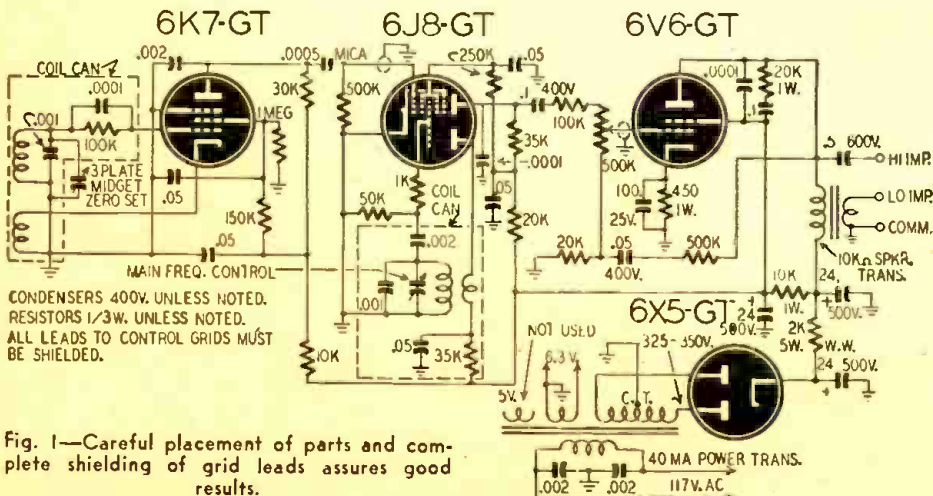
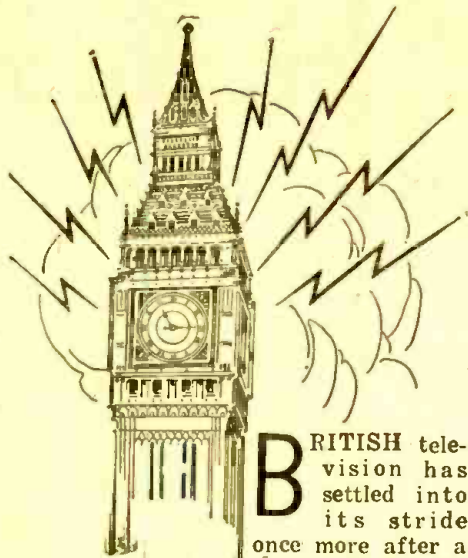

Fig. 1—Careful placement of parts and complete shielding of grid leads assures good results.

TRANSATLANTIC NEWS

From our European Correspondent, Major Ralph Hallows



BRITISH television has settled into its stride once more after a six-and-a-half years' sign-off dur-

ing the war and the period immediately following its end. Though many of the programmes come from the studio, outside broadcasts—or O.B.'s—are frequent. Almost every interesting event, sporting or otherwise, which takes place in or near London is broadcast for the benefit of televiewers. Arrangements which make such broadcasts possible may be of interest to American readers.

The heart of London is "piped" with a special coaxial cable devoted entirely to television. Starting at the Alexandra Palace, where the television station stands on high ground to the north of the city, the cable is so routed that it serves good vantage points for most of the important events in the life of the capital. Numbers of tapping-in places are provided on the cable and others can be arranged quickly if required.

The British Broadcasting Corporation has two complete mobile television

outfits, each of which consists of three large trucks of much the same shape and size as single-decker buses. One of these contains a complete control-room, with sound and vision monitoring arrangements and fade-in controls for two *emitrons*. The *emitron* is the British version of the super-iconoscope television camera. Each *emitron* has 1000 feet of flexible cable and can be used that distance from the control van.

Normally power is obtained from the lighting mains by tapping in. This is not always feasible, for parts of London still have d.c. and in other parts a.c. supplies are not of standard voltage and frequency. Where the mains supplies are unsuitable, the second van, containing generating equipment, is brought into use.

The third van, seen in the accompanying photograph, contains a complete medium-powered sound and vision transmitter. It has an antenna which can be raised to 80 feet by means of ladders extending on the "fire-escape" system. The transmitter truck is used when the scene of a television O.B. is too distant to allow tapping in on the coaxial cable. It extends the range of O.B.'s to 15-20 miles from the Alexandra Palace station. Sometimes transmissions are received direct at the Alexandra Palace by means of a small antenna fixed above the main broadcasting array; but this is often found to be impracticable for various reasons. In such cases the transmissions from the truck are received at a substation situated on the heights of Highgate and relayed to the Alexandra Palace by means of the coaxial cable mentioned, which runs close to the substation.

The results are extremely satisfactory. An extension of the London coaxial cable is planned. Soon a second television broadcasting station will be at work in the Birmingham area and that will be followed by other main stations in different parts of the country. All will be inter-linked by cable or by radio and the larger ones will have their own O.B. outfits. It will thus be possible before long to make vision broadcasts from London of events occurring all over Britain. Smaller relay stations will also take their programmes from one or other of the big fellows.

The modulation system, by the way, is the reverse of that used in the United States. With us 30 percent carrier gives black and 100 percent white. The sync pulses are "blacker than black" taking the carrier down to zero. There are many who think that we should have ensured better definition had we adopted the American method. It is certainly a pity that we decided on vertical polarization when the London station was erected in 1935. The superiority of horizontal polarization in the matter of auto

ignition interference was not then realized and I suppose that vertical was chosen because it makes the transmitting antenna problem so much more simple. It certainly would be no easy matter to devise and erect a horizontal array giving fairly uniform field strength in a service area of circular shape.

A RUSSIAN GIANT

The Russians have just announced that a new high-powered station, Soviet Latvia, is nearly completed and will start transmitting very soon on 582.9 kc. The power rating of the station is not given, but it is stated that it will be powerful enough to cover most of Europe. I hear on good authority that the power output will be 500 kw, with more in reserve when required. Soviet Latvia should be heard in America at night this winter. It will probably continue

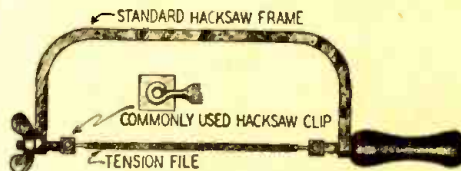

The tension file is a scroll-saw for metal.

working until 2 a.m. G.M.T., or 9 p.m. E.S.T. on most nights of the week. Strictly speaking, Russia is within her rights in operating the station on that frequency for it was allotted by the Lucerne Plan to Latvia and Tunis. It was, though, laid down that both of these stations should be of low power and should provide purely local services. The Russian announcement follows hard on the heels of one by the B.B.C. that it would start its new highbrow program on September 29th on 582.9 kc. As Soviet Latvia would certainly interfere after dark, another channel will have to be found—and that's no easy matter in Europe nowadays!

STANDARDIZED SCREWS

It's good to hear that there is a movement on foot for the adoption of a common standard of screw threads by Britain and the United States. I forget how many million dollars the difference in standards cost during the war, but I recall that the figures were astronomical. But I can speak with feeling of the bad language and the waste of time that result from losing a nut off an American radio or electrical part and being unable to find any British nut that will take its place. I'd be glad if we could do some further common standardizing with wire gauges and I'm sure that that goes too for most radio fans in both countries. If you read one of our constructional articles or we

(Continued on page 67)

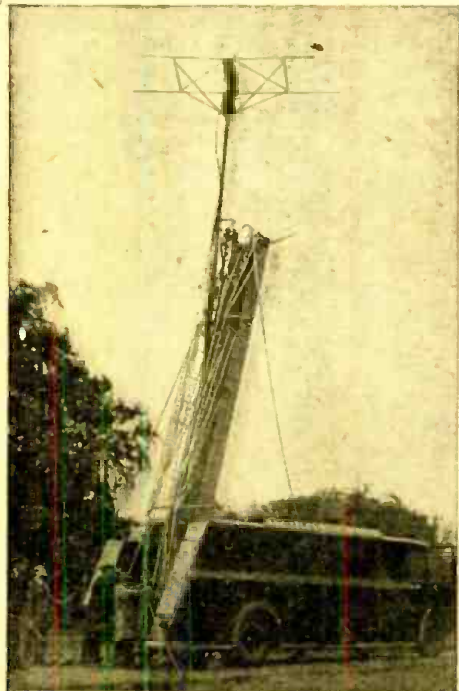

The BBC television "van" with extensible antenna which increases the range to 20 miles.

THE POSTWAR RADIOS

Telechron Musalarm

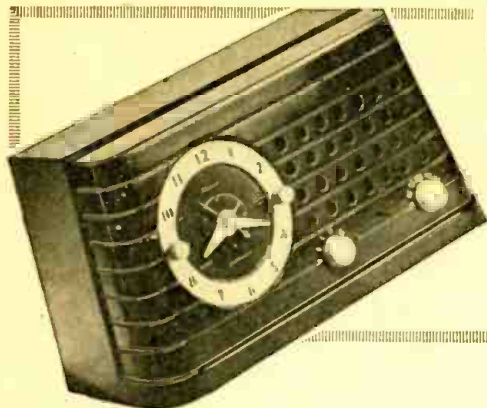

THE new Telechron Musalarm combines the best features of a compact radio and a self-starting electric alarm clock. These features make the set equally useful in the kitchen or in the bedroom. When the alarm is set for a particular time and the receiver is tuned to a favorite radio station, the user may be aroused from deep slumber by the crooning voice of the announcer on the Early Bird program. The Little Woman may want to set the alarm for her favorite soap opera. In this way, she can go about her housework without having to turn on the radio in time for the program.

alarm set to go off in seven to ten minutes after the set has been automatically turned on. This alarm continues to sound until the ALARM SET knob is pressed.

The clock begins to run when the line cord is plugged into a 110 to 120-volt, 60 cycle, a.c. line. If it is desired to have the set turned on in time for a favorite program, the ALARM-OFF-ON switch is turned to the ALARM position and the ALARM SET knob is turned to the program time. The receiver is tuned to the desired station. When the time arrives, the clock movement actuates a switch that turns on the radio. After a

The alarm may be used by merely setting the ALARM SET knob to the desired time. When the time arrives, the alarm will sound with sufficient volume to be heard above the sound of the radio.

A t.r.f. circuit is used in the receiver. A 12SG7 r.f. amplifier is followed by a 12SQ7 diode detector, a.v.c. and first a.f. stage. A 50L6-GT power amplifier and a 35Z5-GT rectifier complete the tube line-up.

Permeability tuning is used in the grid and plate circuits of the 12SG7. The set is tuned by sliding the ganged powdered iron cores in or out of the coils. The tuning mechanism is shown in the photos. The grid circuit uses a 140 to 170- μ f trimmer condenser connected across the coil. The plate coil uses a 270 to 275- μ f trimmer connected in series with a 430- μ f fixed condenser. The lead to the detector diode plate is connected at the junction of these two condensers. This type of coupling minimizes the loading effect of the diode, thus improving the selectivity of the circuit. The detector diode load consists of a 47,000-ohm resistor connected in series with a 1-megohm volume control. The a.v.c. diode is connected through a 2.2-megohm resistor to the junction of the volume control and the 47,000-ohm resistor. A.v.c. voltage is applied to the grid circuit of the r.f. amplifier.

The triode section of the 12SQ7 is a contact-biased first a.f. amplifier resistance-capacity coupled to the 50L6-
(Continued on page 55)

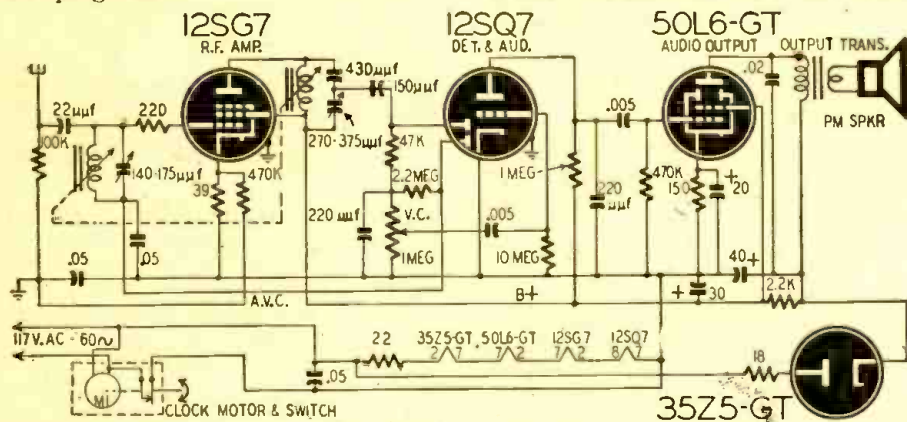

This radio is enclosed in an attractive brown bakelite cabinet, 10 $\frac{1}{4}$ inches wide by 4 $\frac{1}{4}$ inches deep by 5 $\frac{1}{4}$ inches high. A 3 $\frac{1}{2}$ -inch clock, with a Telechron movement, is included in the cabinet. It is equipped with an auxiliary buzzer

short time, the auxiliary alarm sounds, unless the ALARM SET knob is depressed at the time that the adjustment is made.

To operate the radio manually, the ALARM-OFF-ON switch is turned to ON.

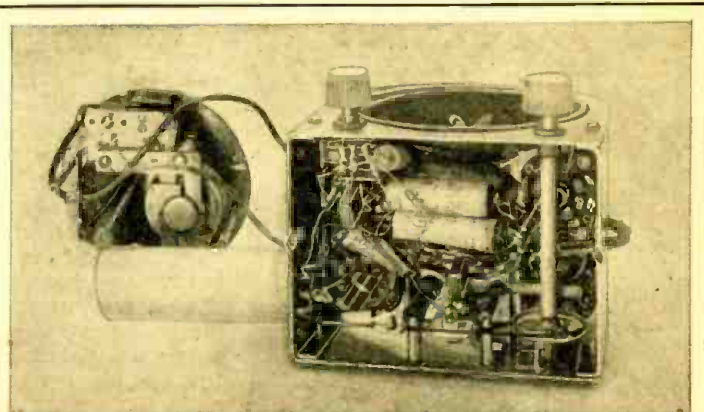
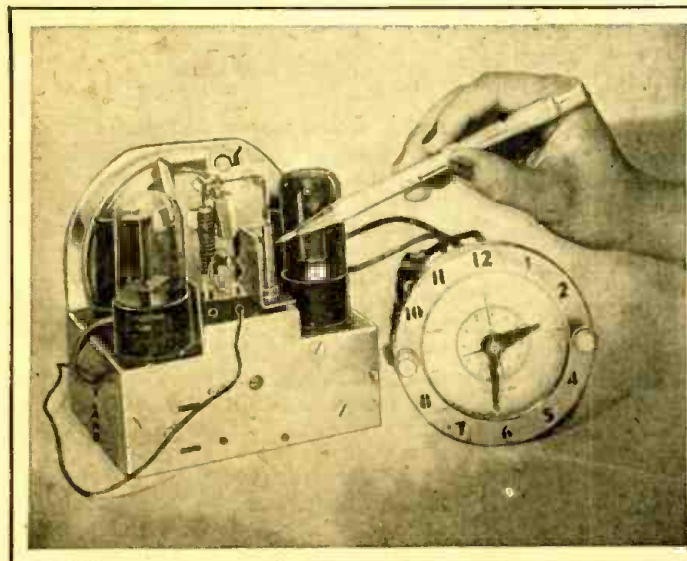

Left—Back-chassis view of radio and face view of clock. Bucket-in-the-well permeability tuning device is well shown in this and in under-chassis view above where the tuning shaft and pulley can be seen.

SOUND ENGINEERING — No. 25

This department is conducted for the benefit of RADIO-CRAFT subscribers. All design, engineering, or theoretical questions of general interest on PA installation, sound equipment, and audio amplifier design will be answered in this section. No circuit diagrams can be supplied by mail, all answers being printed in order of their receipt.
(Note: when questions refer to circuit diagrams published in past issues of technical literature, the original, or a copy of the circuit should be supplied in order to facilitate reply.)

PRE-AMPLIFIER

The Question

I am enclosing stamped self-addressed envelope and circuit diagram (Fig. 1) of a pre-amplifier I wish to build. It is actually an old single stage unit, rebuilt, with separate power supply. I wish to

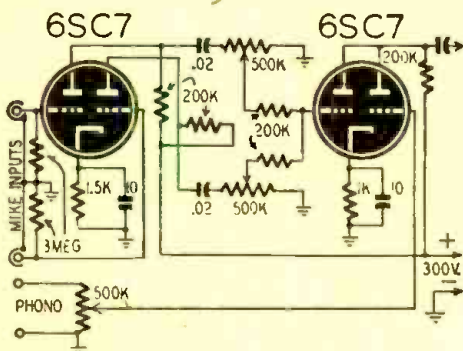

Fig. 1—Original circuit of a pre-amplifier.

use the old power supply with the new unit.

The new unit is to feed into the phono jack of my present amplifier which uses a 1612 in the first stage. Will you kindly have your Sound Department check part values on enclosed diagram and finish output circuit, to feed former phono input?

RALPH LEBRUN
Geneva, New York

The Answer

I am sorry that questions to this department cannot be answered by mail. They can only be answered through publication in this section. A corrected cir-

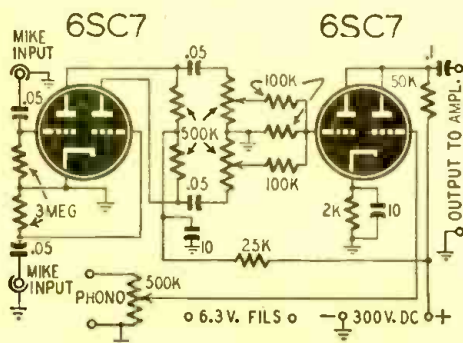

Fig. 2—Circuit of Fig. 1 with improvements.

cuit diagram of the type of pre-amplifier you are interested in is indicated in Fig 2. You will note that six major changes have been incorporated, which will insure satisfactory operation. The cathode resistor and by-pass condenser in the first stage have been eliminated to avoid excessive hum and noise pick-up. The mixer circuit has been altered to keep inter-action between controls at a minimum. In the circuit indicated, approximately 2-db change will be noted in the level of one microphone circuit when the remaining "mike" control is varied from minimum to maximum. Your original circuit produced a change of approximately 6 db. The bias of the second 6SC7 has been increased to enable this stage to handle 1 volt input adequately without introducing excessive distortion. A decoupling resistor has been inserted between the two stages to avoid possibility of motor-boating. The plate load of the first stage has been increased from 200,000 ohms to 500,000 ohms to provide increased gain and to limit plate current as the stage is operating under a "no bias" condition. The coupling condensers between stages have been increased from .02 to .05 μ f to provide a better low frequency response.

MIDGET AMPLIFIER

The Question

I intend to build the Midget Amplifier as shown on the enclosed diagram (Fig. 3). But, I am not sure about the voltage ratings of the condensers and wattage ratings of the resistors. Also, the two 20 μ f units, 10 μ f unit, and the 40 μ f unit. Must they be electrolytic condensers? I am under the impression that the two 20 μ f units are bypass condensers.

Please send me a complete parts list giving the wattage of resistors and voltage rating of condensers. Also, I would like to know if this amplifier would handle an 8-inch PM speaker as well as a 3- or 4-inch. Inform me whether the high frequency cut is an ordinary 0.5 megohm tone control, or whether it is a special control.

Thanking you kindly.

DEAN HORN
Columbus, Indiana

The Answer

The voltage rating of the condensers and the wattage rating of the resistors follow:

Condensers		Resistors	
40 μ f	—200 v	500,000 ohms	— $\frac{1}{2}$ watt
20	— 25 v	250,000	— $\frac{1}{2}$ watt
20	— 25 v	25,000	— 1 watt
10	—150 v	3,000	— 2 watt
0.1	—200 v	1,000	— 1 watt
0.1	—200 v	200	— 2 watt
.003	—200 v	50	— $\frac{1}{2}$ watt

The power output of the amplifier will be approximately 2 watts. This should be adequate to operate an 8-inch speak-

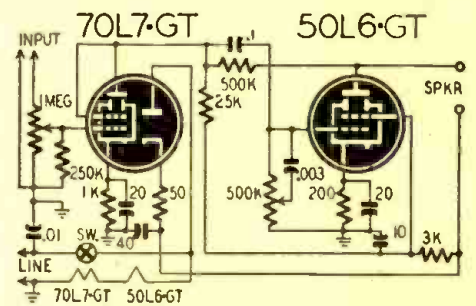

Fig 3—The 2-tube Midget Amplifier circuit.

er. However, a 3- or 4-inch speaker, if operated at low levels, will probably provide better frequency response. The high-frequency control may employ an ordinary $\frac{1}{2}$ -meg potentiometer. One with an audio grid taper will probably provide smoother high-frequency cut-off action.

TRANSFORMER DATA

The Question

Will you kindly tell me what should be the a.c. RMS voltage of the two plate transformer windings for the Direct-Coupled Recording Playback Amplifier described in the November 1940 issue of RADIO-CRAFT? Also, I would like to know the current rating for the winding supplying the plates of the 5U4-G rectifier tube.

WARREN E. HAIGHT
Wilmington, Delaware

The Answer

The loaded a.c. RMS voltages of the transformer windings together with their indicated current carrying capacities are listed below:

1. High Voltage Secondary—380 volts each side of center tap at 250 mils.
2. Bias Secondary—187 volts each side of center tap at 250 mils. The voltage and current ratings of the remaining windings also follow:
5U4G filament—5 volts at 3 amp.
5V4G filament—rated at 5 volts at 2 amp.

(Continued on page 63)

WORLD-WIDE STATION LIST

AT PRESENT the Australians and Russians seem to be the best dx catches one can find on the shortwave bands; both being very well received. The Aussies are best on VLG on 9.580 megacycles and VLC6 on 9.615 megacycles. The time is 9 to 10 am; 10:15 to 10:45 am; 11 am to noon for the Australians, and 5:15 to 5:30 am; 8:30 to 9:50 am; 11 am to noon for the Russians. Moscow is heard on several frequencies, but 11.88 megacycles seems to be best for reception on the east coast. Times of transmission are 6:45 to 8 am and 6:30 to 7:30 pm.

ZOY is a government-owned station on the Gold Coast of Africa, which operates with a power of 1.5 kw in the 41-meter band, and with 5 kw in the 61-meter band. Their schedule is daily except Sunday, at 10:55 am to 1:40 pm, EST. Most of the programs are in English and include Gold Coast news, talks, and music in English. The 41-meter or 7.295-megacycle frequency is badly QRM'ed by the 40-meter amateur cw band; but the other frequency is fairly well received here on the east coast. Verification reports are welcomed and a letter of VERI is sent out to listeners who furnish accurate reports on recep-

tion of ZOY. It takes about two months to obtain a reply to your report, so be patient while waiting for a reply and do not think they have forgotten it. The address is P.O. Box 250, Accra, Gold Coast Colony.

HER7 in Switzerland has been heard testing on 17.784 megacycles with a new transmitter. We have received one report on their transmission from 10:05 am to noon. Further reports on this transmitter would be greatly appreciated by your editor. Other Swiss transmitters are heard on 7.380 megacycles from 3:10 to 3:30 pm and 6:30 to 8 pm and on 9.185 megacycles from 7:15 to 8 am. These are both beamed to North American listeners and are well received on this side of the big pond.

Radio-Dakar is very well received here on 11.714 megacycles about 3:30 pm, week days. Complete information on this station was given in the last issue of RADIO-CRAFT, including frequencies and schedules. It is well worth trying for. Radio-France and the BBC are both showing their usual pep at this time of the year, and may be heard almost any time on several frequencies.

A report has been received on HOXB in Panama, on a frequency of 11.810

megacycles. They would like reception reports, which may be sent to Station HOXB; Box 1335; Panama City, Republic of Panama. Sorry but we do not have the frequency or schedule of this station. Please let us hear what you know about it.

Radio Luxembourg is heard on 6.090 megacycles on Sundays, 2:30 to 6 pm; Monday to Friday, 2:30 to 4:30 pm; and Saturday in English from 2:30 to 4:30 pm and in French from 4:30 to 6 pm. ZFY in Georgetown, British Guiana, is heard relaying the BBC at 5:45 pm on 6.000 mc. KU5Q on Guam, in the Marianas, is heard on 7.645, 9.280, and 9.670 mc most of the day and night. Reception is very good on the west coast and is fairly good on the East Coast.

Signals from Vienna, Austria, are heard from about 11 pm until about 7 pm the following day. The frequencies are 7.315 and 6.250 (best reception) and 12.00 megacycles. SUV in Cairo, Egypt, is heard irregularly, relaying programs to the armed forces about 7 pm; and later in the evening as point-to-point communication. The frequency in use at present is 10.060 megacycles.

All schedules are Eastern Standard Time

Freq.	Station	Location and Schedule
2.500	WWV	WASHINGTON, D. C.: U.S. Bureau of Standards; 6 pm to 8 am.
2.880	GRC	LONDON, ENGLAND;
3.228	HDZ	RIOBAWBA, ECUADOR; Thursdays, 9 pm.
3.310	YVIRO	TRUJILLO, VENEZUELA; 5 to 9:30 pm.
3.340	YUD3	DELHI, INDIA; 11 to 11:45 am.
3.370	YVIRT	MARACAIBO, VENEZUELA; 5:30 to 10:30 pm.
3.380	YV5RY	CARACAS, VENEZUELA; 9:30 am to 10:30 pm.
3.390	YV4RK	MARACAY, VENEZUELA; 6 to 10:30 pm.
3.400	YV5RW	CARACAS, VENEZUELA; 5:30 am to 10:30 pm.
3.420	YV2RC	MARIDA, VENEZUELA; 6 to 9:30 pm.
3.440	YVIRU	MARACAIBO, VENEZUELA; 7 to 9:30 pm.
3.460	YV4RP	VALENCIA, VENEZUELA; 8 to 9:30 pm.
3.480	YV4RQ	PUERTO CABALLO, VENEZUELA; 5 to 9:30 pm.
3.490	YV3RS	BARQUISIMETO, VENEZUELA; 4:30 to 9:30 pm.
3.500	YV5RX	CARACAS, VENEZUELA; 6:30 am to 10:30 pm.
3.500	COCX	HAVANA, CUBA; heard evenings.
3.510	YV6RC	BARQUISIMETO, VENEZUELA; 6 to 9:30 pm.
3.530	YV5RS	CARACAS, VENEZUELA; 5:30 am to 10:30 pm.
3.914	ZQP	LUSAKA, RHODESIA; 10:30 am to 1 pm.
3.935	HC5EH	CIUDAD CUENCA, ECUADOR; 6 to 10:30 pm.
4.040		PONTA DEL GADA, AZORES; 4 to 6 pm.
4.105	HCJB	QUITO, ECUADOR; 6 to 10:30 pm.
4.600	HHCA	PORT-AU-PRINCE, HAITI; 7:30 to 9 am; 5 to 9:30 pm.
4.750	YVIRV	MARACAIBO, VENEZUELA; 6 to 9:30 pm.
4.760	YV5RV	LA GUAIRA, VENEZUELA; 5 to 9:30 pm.
4.770	YVIRY	CORO, VENEZUELA; 4 to 10 pm.
4.780	YV4RO	VALENCIA, VENEZUELA; 4:30 to 9:30 pm.
4.785	HJAB	BARRANQUILLA, COLOMBIA; 5 to 11 pm.
4.810	YVIRL	MARACAIBO, VENEZUELA; 6:30 am to 11 pm.
4.815	HJBB	CUCUTA, COLOMBIA; 5 to 10 pm.
4.825	HJEO	CALI, COLOMBIA; 7 to 11 pm.
4.840	YVIRZ	VOLERA, VENEZUELA; 4:30 to 9:45 pm.
4.855	HJCA	BOGOTA, COLOMBIA; 6 to 10 pm.
4.865		BELEM, BRAZIL; 5 to 7 pm; 8 to 9 pm.
4.880	HJFH	ARMENIA, COLOMBIA; 6 am to 10 pm.

RADIO TERM ILLUSTRATED



"A Good Conductor"

Freq.	Station	Location and Schedule
4.890	YV5RM	CARACAS, VENEZUELA; 5:30 to 10:30 pm.
4.895	HJCH	BOGOTA, COLOMBIA; 6 to 10 pm.
4.920	CR7BO	LOURENCO MARQUES, MOZAMBIQUE; Sundays, 11 am to noon.
4.920	YV5RN	CARACAS, VENEZUELA; 6 am to 10:30 pm.
4.925	HJAP	CARTAGENA, COLOMBIA; 6 am to 1 pm; 5 to 10 pm.
4.945	HJCW	BOGOTA, COLOMBIA; 6:45 am to 11:15 pm; 4 to 6 pm; 7 pm to 11:15 pm.
4.950	VQ7LD	NAIROBI, KENYA; noon to 2 pm.
4.955	HJCC	BOGOTA, COLOMBIA; 10 am to 2 pm; 5 to 11 pm.
4.965	HJAE	CARTAGENA, COLOMBIA; 4 to 10:30 pm.
4.965		ADDIS ABABA, ETHIOPIA; 11:30 am to 12:30 pm.
4.975	HJAG	BARRANQUILLA, COLOMBIA; 9 am to 11 pm.
4.990	YV3RN	BARQUISIMETO, VENEZUELA; 6:30 am to 10:30 pm.
5.000	WWV	WASHINGTON, D.C.: U.S. Bureau of Standards; frequency, time and musical pitch; broadcasts continuously day and night.
5.400		BANDOENG, NETHERLANDS INDIES; early mornings.
5.440		MOSCOW, U.S.S.R.; 8 am to 6 pm.
5.580	OAX1B	PUIRA, PERU; 6 pm to midnight.
5.750	PZX3	PARAMARBO, SURINAM; 6 to 8:45 pm.
5.815		MOSCOW, U.S.S.R.; 11 am to 6 pm.
5.875	HRN	TAGUCIGALPA, HONDURAS; 8 to 10 am; 6 to 11 pm.
5.885	ZRK	CAPETOWN, SOUTH AFRICA; 11:45 pm to 1:30 am; 10 am to 4 pm.
5.890		MOSCOW, U.S.S.R.; 8 pm to 6 am; 8 am to 4:45 pm.
5.895	OAX4Z	LIMA, PERU; 4:30 to 11:30 pm.
5.910	XGOA	CHUNGKING, CHINA; 4 am to ?
5.940	OAX4V	LIMA, PERU; 6 pm to midnight.
5.947	HH2S	PORT-AU-PRINCE, HAITI; 11 am to 1 pm; 5:30 to 8:30 pm.
5.960		MOSCOW, U.S.S.R.; 11 am to 6 pm.
5.960	FG8AA	POINTE-A-PITRE, GUADELOUPE; 11:30 am to 12:45 pm; 6 to 7:30 pm.
5.968	HVJ	VATICAN CITY; 11 am to noon; 1 to 3 pm.
5.970	VONH	ST. JOHNS, NEWFOUNDLAND; 10 am to 2 pm; 3 to 10 pm.
5.985	LRSI	BUENOS AIRES, ARGENTINA; 7 to 10 pm.
6.000	ZFY	GEORGETOWN, BRITISH GUIANA; 5:45 to 7:45 am; 9:45 to 11:45 am; 2:15 to 7:15 pm.

(Continued on page 60)

RADIO DATA SHEET 341

GAROD MODEL 6AU-1

LINE VOLTAGE: 105-125 volts, 50-60 cycles, a.c.-d.c.

POWER CONSUMPTION: 30 watts.

TUNING RANGE: Broadcast: 540 to 1650 Kilocycles (180 to 555 meters).

TUBES: The tubes used, and their func-

tions, are as follows:

- 6SS7 r.f. amplifier
- 12SA7 converter
- 6SS7 i.f. amplifier
- 12SQ7 detector, a.v.c. and audio amp.
- 50L6GT beam power amplifier
- 35Z5GT rectifier



ALIGNMENT PROCEDURE:

Should it become necessary at any time to check the alignment of this receiver, proceed as follows:

- (1) Set the Signal Generator to 455 kc and connect to the grid of the 6SS7 r.f. amplifier, or to the stator lug on the rear section of the variable capacitor. Connect the signal generator ground lead to a -B point underneath the chassis. Connect a suitable output meter across the speaker voice coil connections. First turn the volume control to the maximum position. Turn the variable capacitor to the extreme clockwise position.
- (2) Adjust the trimmers located at the top of the first and second i.f. transformers for maximum output as indicated on the output meter.
- (3) Loosely couple the signal generator lead to the loop and set to 1650 kc.
- (4) With the variable capacitor set at the extreme clockwise position, tune in the 1650 kc signal by means of the oscillator trimmer on the variable capacitor (front section).

- (5) Set the signal generator to 1500 kc and turn the tuning control so that this frequency is indicated on the dial. Adjust the antenna trimmer on the variable capacitor (rear section) for maximum output. No other adjustments are necessary.

INSTALLATION:

The Model 6AU-1 is complete in every detail for efficient and immediate operation. A self-contained loop antenna is included, which will give excellent results in most locations. Due to the directional properties of the loop, it may be advantageous to turn the receiver to the left or right in noisy locations for maximum signal and minimum noise. A best position for reception can always be found. In unfavorable locations where distant reception is required, a well-constructed outside antenna may be used, and connected to the green wire labeled "Ant." at the rear of the loop.

CONTROLS:

The left-hand knob is the volume control and On-Off switch. The right-hand knob is the station selector tuning control, which selects the desired station along the slide-rule dial, the frequency of which is indicated by the pointer.

CAUTION:

If this receiver is operated on d.c. (Direct Current), it may be necessary to reverse the line cord plug to obtain the correct polarity. Objectionable hum or noise may also be eliminated on a.c. operation by reversing the line cord plug.

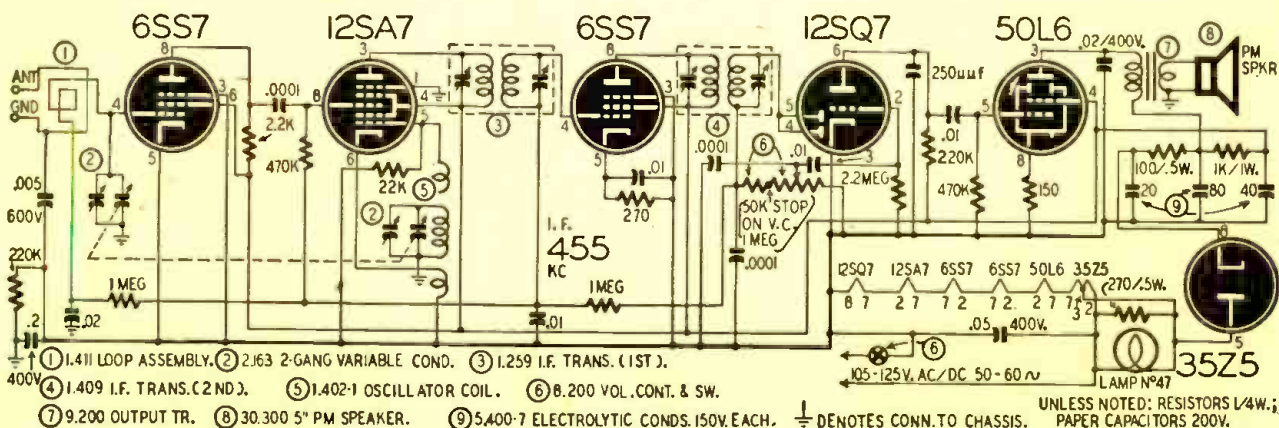
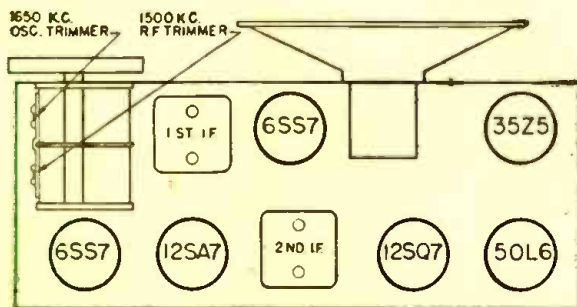

RADIO-ELECTRONIC CIRCUITS

TRANSMITTER MONITOR

Here is a circuit of a transmitter monitor that I have found useful for monitoring c.w. and radiotelephone transmissions.

The heterodyne principle is used. A 6K6-G electron-coupled oscillator is designed to operate at a frequency close to that of the transmitter. Regulated voltage on the plate and screen grid and a high-C tank circuit are used to insure adequate frequency stability. The 40-meter coil is wound on a 1-inch form with 20 turns of No. 22 enamel wire tapped at the sixth turn from the bottom.

The output of the oscillator is coupled to the suppressor grid of a 6SK7. The control grid of the 6SK7 is connected to a short antenna to pick up the signal from the transmitter. The 6SK7 mixes the signals from the oscillator and transmitter and applies the difference frequency to the i.f. amplifier section of a superhet receiver.

The receiver is turned ON with the b.f.o. in operation. The transmitter is keyed and the frequency of the monitor adjusted until a beat note is heard in the receiver. The monitor is now tuned to a frequency that will beat with the transmitter fundamental to produce a heterodyne equal to the receiver's intermediate frequency.

To use the monitor: the standby switch of the receiver should be altered so that the i.f. and a.f. sections of the receiver are in operation at all times. Initial adjustments on the monitor are made with the receiver in its standby position.

DOUGLAS K. VANDERWATER,
Belleville, Ontario

(Note: Coils may be wound for other frequencies but the monitor will probably work just as well by beating either the fundamental or harmonic of the oscillator with the fundamental or harmonic of the transmitter. The monitor will work as long as the heterodyne difference frequency of the two signals is equal to the receiver i.f.—*Editor*)

VOLTAGE REGULATOR

Here is a circuit of an electronic voltage regulator that I constructed for laboratory experiments.

A 15,000-ohm resistor stabilizes current through the VR-105 which biases the cathode of the lower half of the 6SN7. Both halves of the 6SN7 are

RADIO-CRAFT welcomes new and original radio or electronic circuits. Hook-ups which show no advance or advantages over previously published circuits are not interesting to us. Send in your latest hook-ups—RADIO-CRAFT will extend a one-year subscription for each one accepted. Pencil diagrams—with short descriptions of the circuit—will be acceptable, but must be clearly drawn on a good-sized sheet.

used as d.c. amplifiers which amplify any voltage fluctuations due to load variations. The amplified variations are applied to the grid of the 6L6 in the form of bias changes. The plate resist-

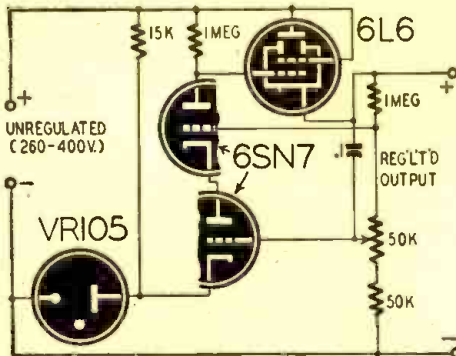

ance of the 6L6 varies with the bias, causing the voltage drop across the tube to rise or fall to keep the output voltage constant for varying loads.

The 0.1 μ f condenser is used to increase the effectiveness of control with rapid load changes. The 50,000-ohm potentiometer may be used to give a reasonable range of almost perfectly regulated output voltages.

PFC. H. W. MERRIHEW,
Camp Cambell, Ky.

NOVEL POWER SUPPLY

During the recent shortage of miniature B batteries, I designed this unit to power a camera-type portable radio.

The vibrator was made by altering a high-frequency code buzzer. The armature was removed and replaced by an old razor blade that had been ground to shape. The free end of the armature was weighted by a 1/4-inch nut soldered to one side. A silver breaker point was

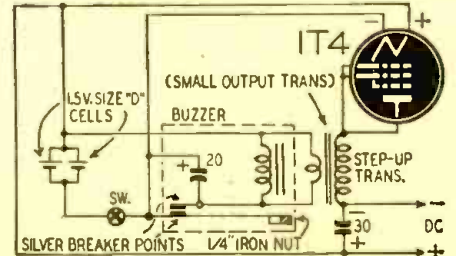

fastened to the armature opposite the fixed contact.

A small output transformer was connected with its secondary in the low-voltage circuit. The high-impedance primary is connected in a half-wave rectifier circuit using a 1T4 tube. Two electrolytic condensers filter out the hum and vibrator hash. Two standard flashlight cells, connected in parallel, supply the primary power.

This unit supplies 40 volts with an 8-ma load. The high-voltage leads from the transformer should be reversed to determine best connection.

FRED W. BURDON,
St. John, N. B., Canada

115-VOLT D.C. RECEIVER

Here is a simple receiver that was constructed aboard ship as an auxiliary h.f. receiver. Standard two- and three-winding coils are used in the r.f. and detector circuits. A 15-henry choke was inserted in the plate lead to the detector to remove all traces of commutator hash.

Filament voltages may be supplied from a six-volt battery or from a line dropping resistor.

JAMES R. YOUNG,
Los Angeles, Calif.

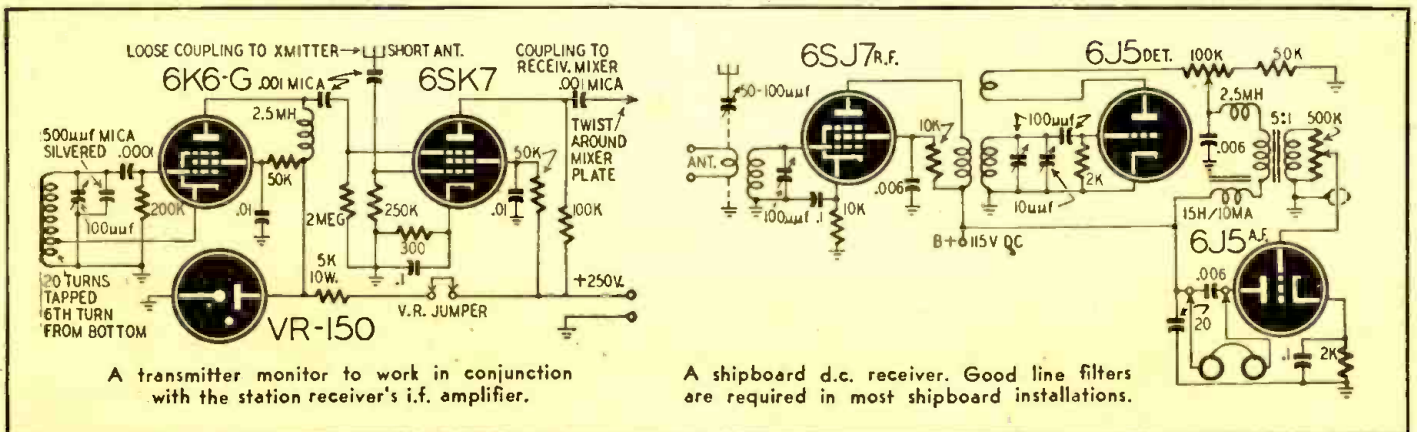

A transmitter monitor to work in conjunction with the station receiver's i.f. amplifier.

A shipboard d.c. receiver. Good line filters are required in most shipboard installations.

NOW AVAILABLE FOR IMMEDIATE SHIPMENT!

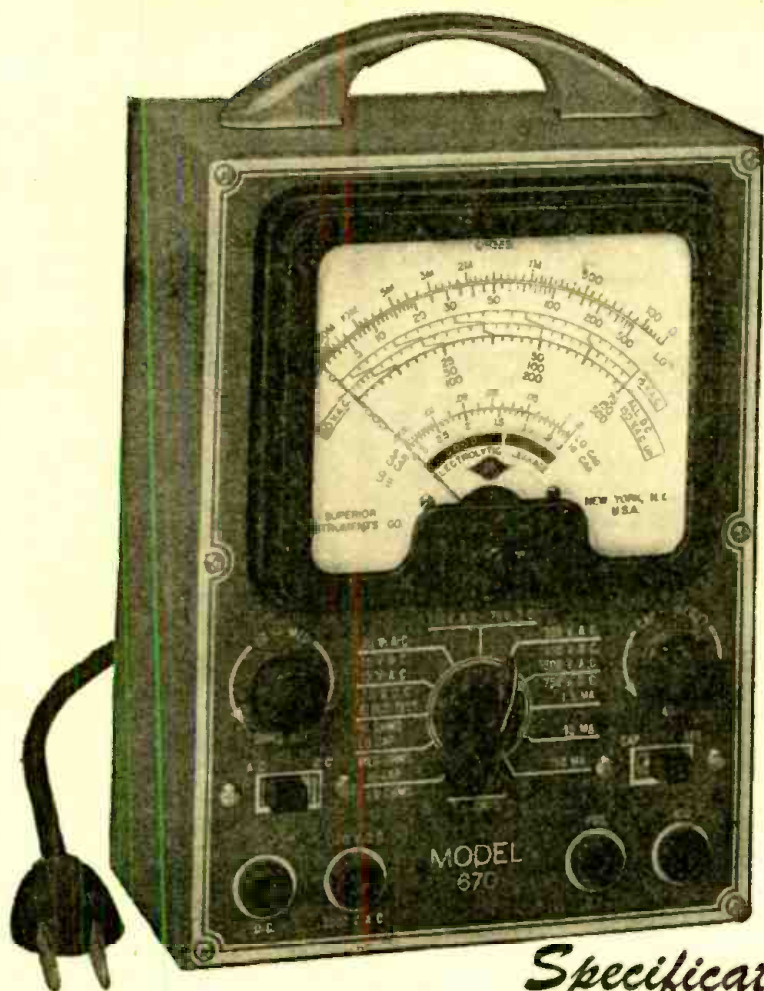

The New Model 670
SUPER-METER

A Combination
VOLT-OHM MILLIAMMETER
plus **CAPACITY REACTANCE**
INDUCTANCE and
DECIBEL MEASUREMENTS

Added Feature:

The Model 670 includes a special **GOOD-BAD** scale for checking the quality of electrolytic condensers at a test potential of 150 Volts.

Specifications:

D.C. VOLTS: 0 to 7.5/15/75/150/750/1,500/7,500 Volts
A.C. VOLTS: 0 to 15/30/150/300/1,500/3,000 Volts
OUTPUT VOLTS: 0 to 15/30/150/300/1,500/3,000 Volts
D.C. CURRENT: 0 to 1.5/15/150 Ma. 0 to 1.5 Amperes

RESISTANCE: 0 to 500/100,000 ohms 0 to 10 Megohms
CAPACITY: .001 to .2 Mfd. .1 to 4 Mfd. (Quality test for electrolytics)
REACTANCE: 700 to 27,000 Ohms 13,000 Ohms to 3 Megohms
INDUCTANCE: 1.75 to 70 Henries 35 to 8,000 Henries
DECIBELS: -10 to +18 +10 to +38 +30 to +58

The Model 670 comes housed in a rugged, crackle-finished steel cabinet complete with test leads and operating instructions. Size 5½" x 7½" x 3".

\$2840
NET

Model 670P

The Model 670P is identical to the Model 670 described in detail except housed in a hand-rubbed, portable oak cabinet complete with cover.

The Model 670P comes complete with test leads and all operating instructions.

\$35⁷⁵
NET

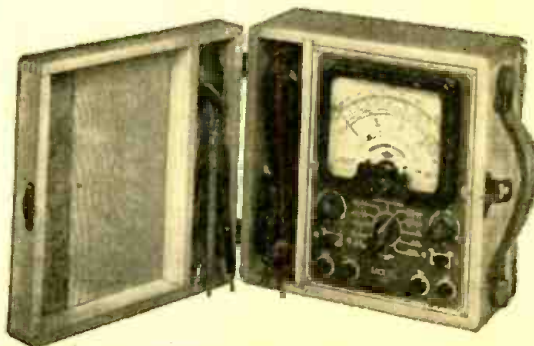

Please place your order with your regular radio parts jobber. If your local jobber can not supply you, kindly write for a list of jobbers in your State who do distribute our instruments or send your order directly to us.



SUPERIOR INSTRUMENTS CO.

Dept. R 227 FULTON ST., NEW YORK 7, N. Y.

TRY THIS ONE

VIBRATOR KINK

Here is a kink that saved me a lot of time and trouble. My automobile radio developed an open center tap on the primary of the vibrator transformer and I was unable to obtain a replace-

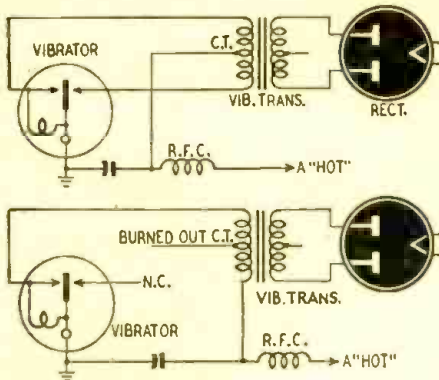

ment. The normal push-pull power input was converted to a single-ended input without noticeably affecting the operation of the radio. The diagram is self-explanatory.

BOB MELVIN,
Berkeley, Calif.

(Note: It may be necessary to add more filter to the output of the rectifier to compensate for the reduced input frequency. Additional chokes and by-pass condensers may be required in stubborn cases to prevent the low-voltage from radiating vibrator "hash."—*Editor*)

BATTERY ELIMINATOR

Here is an a.c.-d.c. battery eliminator for use with battery receivers. The circuit uses a 117Z6-G so that it is not necessary to use a transformer or line dropping resistor. No provisions were made for filament supplies as the

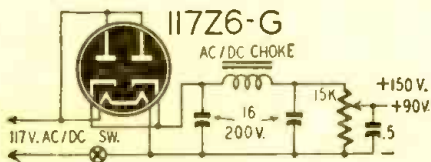

added cost of filter condensers and resistors was excessive. A No. 6 dry cell is much cheaper and will last almost indefinitely because the filament drain seldom exceeds 0.5 ampere, and runs usually from 0.2 to 0.25 ampere in most four-tube battery portables.

J. R. BLUNDIN,
Mt. Carmel, Penna.

TUBE SHIELDS

The cap from a burned out fluorescent lamp starter makes an excellent shield for the miniature button-base tubes like the 1R5, 1T4, 6J6 or 6AK5. If the tube has the exhaust tip on the top, it may be necessary to cut a 5/8-inch hole in the top of the cap.

HARRY KUNDIAT,
Garwood, N. J.

RADIO-CRAFT wants original kinks from its readers, and will award a one year subscription for each one published. To be accepted, ideas must be new and useful. Send your pet short-cut or new idea to RADIO-CRAFT today!

SIX-VOLT RECTIFIER

In some instances, the filament of a 35Z5 or 45Z5 will burn out, leaving only the pilot lamp tap in good condition. Instead of discarding such tubes, they should be saved for they may be used in circuits requiring a small rectifier tube with a 6-volt filament. Connect a 6-volt filament winding across the pilot lamp tap of the tube. The cathode is connected to the filter network. This kink is useful in a low-voltage; low-current power supply.

C. LEVAL,
Englewood, N. J.

USING OLD VIBRATORS

Defective vibrators from battery-powered radios may be used for many purposes around a radio shop.

The bottom of the unit is removed by inserting a screw driver under the rolled edge and bending it outward so that the "works" may be removed. Photo A shows the parts of the vibrator.

The sponge rubber lining may be inserted between tube shields (as

shown in Photo C) to prevent annoying rattles that are caused by vibration. The smaller disc will be useful in replacing worn or misplaced chassis shock absorbers.

The "can" may be used as a container for knobs and other small parts by removing the handle. If angle brackets or spade lugs are attached, the can may be used as a coil shield (Photo B).

H. LEEPER,
Canton, Ohio

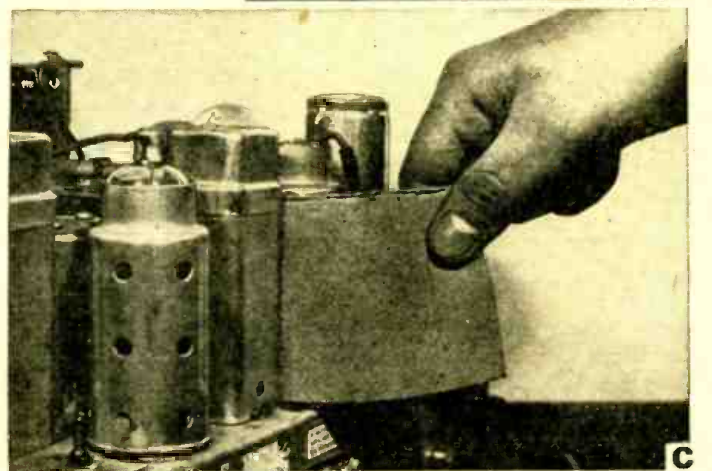

**MOST-
OFTEN-
NEEDED**

RADIO DIAGRAMS

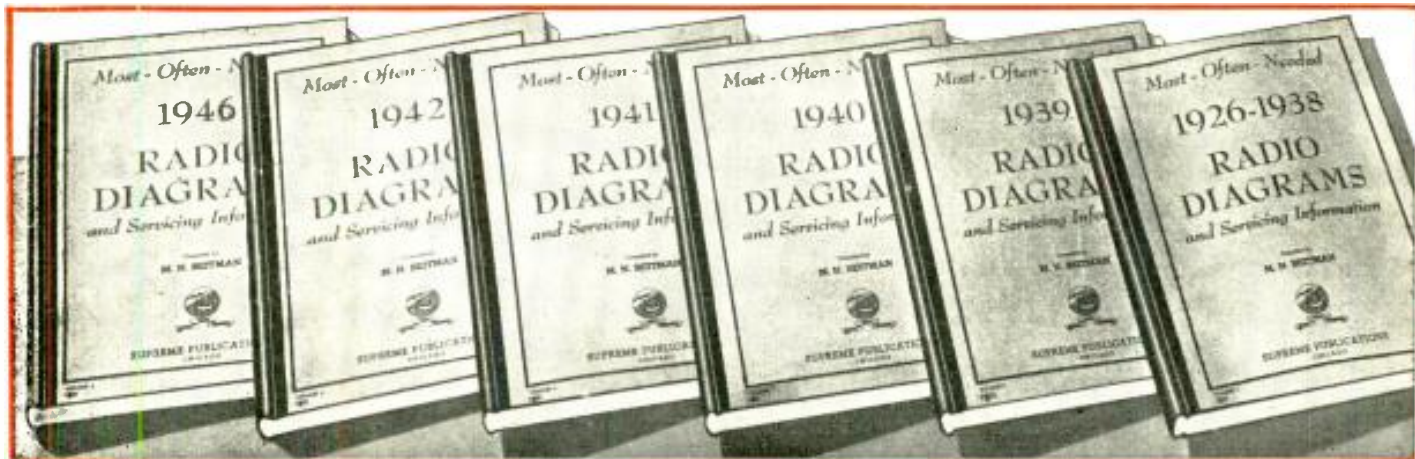

Covering 1946, 1942, 1941, 1940, 1939, & 1926-1938
SUPREME PUBLICATIONS LOW-PRICED DIAGRAM MANUALS

**Most Popular
Models Made by:**

R.C.A., Zenith,
Philco, Sears, Fada,
Emerson, Belmont,
Detrola Radio,
United Motors,
G.E., Westinghouse,
Arvin, Majestic,
Stewart-Warner,
Admiral, Delco,
Stromberg-Carlson,
Western Auto,
Sparton, Motorola,
Wards, Gamble,
and many others.

You can simplify and speed-up all radio repairs with Supreme Diagram Manuals. Service radios faster, better, easier, save money and time, use these *most-often-needed* diagram manuals to get ahead in radio servicing. At unbelievable low cost (only \$2 for most volumes) you are assured of having in your shop and on the job, diagrams and essential repair data on 4 out of 5 sets you will ever service. Every popular radio of every make, from old timers to new 1946 sets, is included. Clearly printed circuits, parts lists, alignment data, service hints are the facts you need to improve your servicing ability. Save hours each day, every day, let these six volumes furnish diagrams for 80% of all sets you will service. See picture of manuals above. Each volume has between 192 and 240 pages, size 8½ x 11 inches, each with index. Manual style binding. See coupon below for prices.

Guarantee

All manuals sent on 10-day trial basis. You must be entirely satisfied or your money will be refunded.

*Supreme
Publications*

(In business 13 years)

Other Practical Radio Manuals



RADIO SERVICING COURSE-BOOK

Let this complete 22-lesson radio course help you get ahead in radio servicing. Learn new speed-tricks of radio fault finding, case histories of common troubles, servicing short-cuts, extra profit ideas. Servicemen use this low-price radio training to brush-up and study new servicing methods. Reprinted in 1946, with latest facts. Complete 22 lessons, with self testing questions, index. Large size: 8½x11 in. **\$2.50**
 A bargain in radio training. Price only.....



Compiled by M. N. Beltman, radio engineer, teacher, author & serviceman.

SAVE HOURS ON EVERY JOB

Be ready to make repairs in minutes instead of hours. You will be called upon to fix hundreds of models listed in these easy-to-use manuals. Tackle each job with the needed help found on every page in these handy service manuals. Greatest bargain in diagram books. Send your order today. Use these manuals this week.

SIMPLIFIED RADIO SERVICING by COMPARISON



New, revolutionary different Comparison technique permits you to do expert work on all radio sets. Most repairs can be made without test equipment or with only a simple meter. Many point-to-point, cross-reference circuit suggestions locate faults instantly. Covers every radio set—new and old. This new servicing method presented in manual form, size 8½x11 inches, 84 pages. Over 1,000 practical hints. 24 large trouble-shooting blue-prints. Charts for circuit analysis. 114 tests using a 5c resistor. Price, only..... **\$1.50**



NO RISK TRIAL ORDER COUPON

SUPREME PUBLICATIONS, 9 S. Kedzie Ave., Chicago 12, ILL.
 Ship the following manuals: (Satisfaction guaranteed or money back)

- ★ ★ STEWART-WARNER MANUAL 50c
 - ★ ★ ARVIN DIAGRAM MANUAL 50c
 - ★ ★ GENERAL-ELECTRIC MANUAL 50c
- 64 pages of popular circuits. Size: 5½ x 8½ inches

- 1946
 - 1942
 - 1941
 - 1940
 - 1939
 - 1926-1938 @ \$2.50
- PRICED AT ONLY \$2.00 EACH**
- Radio Servicing Course @ \$2.50
 - Simplified Radio servicing @ 1.50
 - Stewart-Warner Manual @ .50
 - Arvin Diagram Manual @ .50
 - General-Electric Manual @ .50
 - Record Players and Recorders 1.50

RECORD PLAYERS & RECORDERS MANUAL
 Just what you need to repair quickly thousands of automatic record changers, manual players, phono pick-ups, wireless oscillators, recorders, and combinations. Hundreds of mechanical and electrical diagrams. Instructions for adjustment and repair. Most popular units of all makes. 128 large pages, 8½x11 in. Price, postpaid, only..... **\$1.50**

I am enclosing \$..... send postpaid.
 Send C.O.D. I am enclosing \$..... deposit.

See Your Radio Jobber or Send Coupon →

Name:
 Address:

PA Systems

Public Address is a field of great potential profit to the serviceman. This is the first of a series of articles designed to increase your profit from this source.

by C.G. McProud

Using the Oscillograph for Distortion Measurement



Can you tell the difference between the original and the distorted wave? The original wave is the one on the left. The distorted wave is the one on the right.

The output of a radio receiver is not always a pure sine wave. It may be distorted in many ways. It may be distorted in amplitude, in which the frequency characteristic of the original signal is distorted. It may be distorted in phase, in which the relative phase relationships between the various components of the signal are distorted. It may be distorted in frequency, in which the relative frequency relationships between the various components of the signal are distorted. It may be distorted in any or all of these ways. The oscillograph is a valuable tool for measuring distortion. It can be used to measure the amplitude, phase, and frequency distortion of a signal. It can also be used to measure the distortion of a radio receiver's output. The oscillograph is a simple and easy-to-use instrument. It is available in many forms and prices. It is a valuable addition to any radio service man's equipment.

DEVOTED ENTIRELY TO THE
RADIO SERVICEMAN

RADIO MAINTENANCE

AUGUST 1946

AVC CIRCUITS
FM TROUBLESHOOTING
TELEVISION RECEIVER FUNDAMENTALS
RECORD CHANGERS

A BOLAND AND BOYCE PUBLICATION

AVC CIRCUITS

BASIC TYPES AND THEIR CHARACTERISTICS

by PETER MARKANTER

The Radio Service Bench

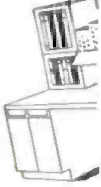

RECOMMENDATIONS FOR DIAL BELT REPLACEMENT

When a dial belt breaks in a radio receiver, it is usually necessary to replace it. The dial belt is a small, flexible strip of material that is used to hold the dial in place. It is made of a material that is resistant to heat and wear. It is usually made of a material called "dial belt" or "dial belt material". It is available in many forms and prices. It is a valuable addition to any radio service man's equipment.

RADIO SERVICEMEN

NEED THIS VALUABLE AID

TO REACH AND SERVICE TODAY'S VAST MARKET OF INSTALLATION AND REPAIR

A BOOM COMING... READ THESE VALUABLE ARTICLES ON:

- SPECIAL TEST EQUIPMENT
- TROUBLE SHOOTING PROCEDURE
- PUBLIC ADDRESS SYSTEMS
- ALIGNMENT TECHNIQUES
- and many other subjects

Are YOU prepared for the rush of radio service business that's starting right now? Are you familiar with every new kind of equipment, every up-to-date method, every development in servicing A-M, F-M and television? Today, new radios and equipment are rolling off production lines . . . old sets are needing more and more repairs. That's why you'll want to have every bit of information about what's new in radio maintenance at your finger-tips. That's why you'll want RADIO MAINTENANCE MAGAZINE! Here is complete, up-to-the-minute coverage of the entire radio service industry. Get a clear picture of basic maintenance principles and technique. Keep posted on all new products and procedures, presented and discussed by qualified on-the-job experts. Learn how to speed up your repair jobs . . . how to install new equipment efficiently . . . how to operate for easier, bigger profits. Read how other radio service men solve all kinds of problems in their shops. Subscribe today to RADIO MAINTENANCE, the magazine that's directed 100% to the radio service man . . . yes, published especially for YOU!

RADIO MAINTENANCE MAGAZINE RC-11
460 Bloomfield Avenue, Montclair, N. J.
Please enter my subscription as follows:

For 12 Issues at \$2.00 NAME _____
For 24 Issues at \$3.00 OCCUPATION _____
 CHECK ENCLOSED CITY _____
 BILL ME LATER ZONE _____ STATE _____



ONE ISSUE FREE IF YOU ENCLOSE PAYMENT

CALRAD "hard-to-get" RADIO VALUES!

WEBSTER RECORD CHANGER

Model 56

Complete

\$25⁹⁵

each

Built to last. Fast change cycle. Simple, fool-proof operation. Automatic shut-off. Feather light needle pressure. Longer life for records. Quiet running Webster 4 Pole motor-cushion mounted.

Webster Model 50 . . ea. **\$19.95**

TWO GANG SUPERHET VARIABLE CONDENSERS

Cut Oscillator Section Standard Capacity.

1³⁵ each



T-17B MICROPHONE



Made of durable plastic. Complete with 5 ft. rubber coated cord and plug PL-68. Press-to-talk button. Can be used with most radio sets as home broadcaster mike for entertainment.

\$1⁸⁵ each

SUPPLY IS LIMITED! ACT QUICKLY

BRAND NEW

Weston Volt Ohmmeter MODEL 663

Complete with carrying case and leads List \$71.50

\$39⁵⁰

Limited Quantity

Special

AC PHONO MOTOR

60 cycles, 115 volts with Turntable and Standard Make Crystal Pickup.



\$5⁹⁵

SIGNAL CORPS DUAL HEADSETS

8000 ohms high impedance, with two rubber ear cushions, cord and in-phonc plug, individually boxed. List Price \$12.50.

\$1⁸⁵

each



BRAND NEW WILLARD #20-2 2 VOLT STORAGE BATTERY

Used in General Electric model #530 charge A PACK portables. Suitable for all Farm Radio Sets. Individually boxed. List Price \$8.95.

\$3⁹⁵

Special each



5 Tube Super AC-DC PARTS KIT

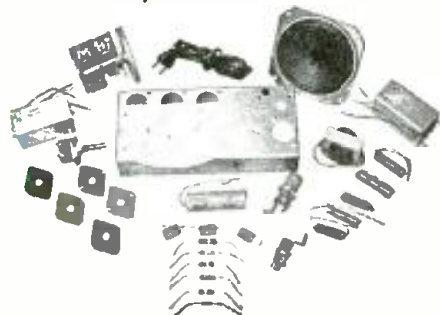

Kits include: Stamped Chassis—Dynamic Speakers—Output Transformer—Volume Control and Switch—2 Shielded I.F. Coils—Antenna and Use Coils—Two-kank Super Variable—Tretal Sockets—20 x 20 Mfd 150 Volt Filter—5 Tubular Condensers—3 Mica Condensers—6 Resistors—6 ft. AC Cord and Plug—Circuit Diagram

While They Last **\$8.95 ea.**

Lots of 6 **\$50.00**



TURNER CRYSTAL MIKE

With 100 ft. Shielded Mike Cable

\$6⁹⁵ each

SPECIAL!

Make any record player wireless with brand new TWO-TUBE PHONO OSCILLATOR KIT



Operates as far as 100 feet from a radio and can be used with Automatic Record Changers, Players or Microphone.

Uses 1-12SH7 and 1-12J6 Tubes. Complete with tubes. Supplied in kit form with "easy-to-follow" instructions for assembly. Complete with all parts, instructions and tubes

\$4⁹⁵ net

VARIABLE CONDENSERS

Single Gang 440 MMfd Variable Con. **95c ea.**



Dual Speed 110,110 Mfd Variable Con. **95c ea.**

Dual Speed 170,170 Mfd Variable Con. **95c ea.**

Dual Speed 170,170 Mfd Variable Con. **95c ea.**

V.M. TWO POST RECORD CHANGER



This Record Changer is a well-made mechanism, will play either 10-in. or 12-in. records. The pickup uses a crystal cartridge. Size 14 in. x 14 in. Packed 2 to a factory-sealed carton, factory guaranteed.

CARTON OF 2 **\$35.00 Special \$18.95**

4 Prong, 6 Vo. Universal AUTO VIBRATOR



Choice of Electronic or Utah. Individually boxed. Fits 80% of all replacements.

\$1²⁵ each

- Push Pull 6L6 Shielded Output Transformer 30 Watt Peak, to 2-4-8-8-16-250 and 500 ohm line. \$3.45 each. Lots of 12—\$3.25 ea.
- Push-Pull Input Transformer, 1000 ohm plate to push pull 6L6—\$1.10 ea. Lots of 12—\$1.00 ea.
- Midget Universal Output Transformer, push pull plate to 2-4-8-8-10-16 ohm voice coil. 95c ea. Lots of 10—85c ea.
- 10 Watt Large Universal Output—\$1.35 ea. Lots of 10—\$1.20 ea.
- Single Pentode Midget Output—for 50L6, 6V6, 6F6, etc. 55c ea.
- 50 Mill Filter Choke 300 ohm—65c ea. Lots of 10—60c ea.
- 75 Mill Filter Choke 250 ohm—95c ea. Lots of 10—85c ea.
- 100 Mill Filter Choke 250 ohm—\$1.10 ea. Lots of 25—\$1.00 ea.

- ### DYNAMIC AND P.M. SPEAKERS
- 4 in. 450 Ohm Dynamic \$1.75 ea.
 - 4 in. P.M. Heavy Slug \$1.50 ea.
 - 5 in. P.M. Heavy Slug \$1.55 ea.
 - 6 in. P.M. Heavy Slug \$2.25 ea.

- ### TUBULAR ELECTROLYTIC CONDENSERS
- 10 Mfd. 50 Volt—21c ea.
 - 25 Mfd. 50 Volt—24c ea.
 - 50 Mfd. 50 Volt—28c ea.
 - 100 Mfd. 50 Volt—35c ea.
 - 16 Mfd. 150 Volt—25c ea.
 - 20 Mfd. 150 Volt—29c ea.
 - 24 Mfd. 150 Volt—30c ea.
 - 30 Mfd. 150 Volt—32c ea.
 - 50 Mfd. 150 Volt—35c ea.
 - 10 Mfd. 450 Volt—39c ea.
 - 20 x 20 Mfd. 150 Volt—43c ea.
 - 30 x 20 Mfd. 150 Volt—47c ea.
 - 40 x 20 Mfd. 150 Volt—55c ea.
 - 50 x 30 Mfd. 150 Volt—65c ea.

- ### FINEST QUALITY MIDGET MICAS
- .001-.0001 .005-.00005 } \$5.00 per 100
 - .002-.00025 .006-.0005 } \$40.00 per 1000
 - Astatic Low Pressure, Curved Arm, Crystal Pickup with Sapphire Stylus Permanent Needle, has cartridge which replaces LP6-LP21-LP25. \$3.50 each. Lots of 10—\$32.50.
 - 456 K.C. Antenna, Oscillator and R.F. Coils. 25c ea.
 - 456 K.C. I.F. Coils Input & Output, medium size can. 59c ea.
 - Kit of 50 Assorted Bakelite Knobs for 1/4" shaft, with set screws. \$2.50 per k.t.
 - Midget Ceramic Trimmers—3-30 mmf—6c ea.
 - Rubber Sheathed "Mike" Cable, shielded, single Conductor, 100 ft. for \$5.95; 500 ft. for \$25.00.
 - Single Bearing Midget Condenser 14 plate—100 Mfd 50c ea. 10 Watt Wire Wound Resistors, your choice of sizes, 25 Ohm to 25,000 Ohm—20c ea. \$17.50—100.
 - Buffer Condensers (Famous Make) .005, .01, .02, 1700 Volts—19c each. Lots of 50—15c each.
 - Signal Corps Telegraph Keys. Lots of 10—60c ea. Lots of 50—50c ea.

MAIL ORDERS FILLED:

25% Deposit, Balance C.O.D., F.O.B. Los Angeles. Orders Under \$10.00 Please Remit in Full. References—Bank of America, Santa Monica & Vermont Aves., Los Angeles, Calif.

CALIFORNIA RADIO & ELECTRONICS CO.

Dept. No. C. 711 No. Vermont Ave., Los Angeles 27, California

MONITOR *Crystaliner*



A NEW SIGNAL GENERATOR FOR THE SERVICE MAN

FINGER-TIP CONTROL. Hundreds of exact frequencies instantly selected. No confused dial to read. No band switch. I.F., Broadcast, Shortwave, and Ultra Hi Frequencies with or without 400 cycle note.

TEMPERATURE COMPENSATED. All signals are crystal-controlled—not merely crystal-monitored. No stabilizing warm-up period. Laboratory accuracy the moment the set starts to oscillate. Frequency accurate to 0.1%. Output approximately 10 volts—enough signal to line up most I.F.'s by merely connecting to antenna post. No variable condenser to wear or coil to age. Frequency remains constant as the ageless crystal itself.

*Fast
Accurate
Dependable*

YOUR JOBBER HAS THEM IN STOCK **\$5750**



MONITOR PRODUCTS CO.

815 FREMONT AVE., SOUTH PASADENA, CALIF.

TECHNOTES

BALKY HY-75'S

When the HY-75 is used in high frequency circuits, it will sometimes go out of oscillation for no apparent reason. This is usually caused by poor connections between the grid and plate lead wires and their respective caps.

If oscillation failure is due to this source, it can be remedied by holding a hot soldering iron on the caps until the joint is resoldered. Too much heat should not be applied; it may crack the glass or loosen the cap from the tube.

RICHARD L. PARMENTER,
Middleboro, Mass.

CONDENSER POLARITY

A 10- μ f condenser with a 450-volt rating overheated when connected into a receiver's filter circuit. Since the condenser it was replacing had been shorted, suspicion naturally fell on the circuit. The circuit, however, seemed o.k. A new condenser was tried—this unit did not overheat. Furthermore, the B voltage jumped from 200 to 270. The defective condenser was tested, but checked perfect. Close inspection, however, revealed that negative and positive markings had been incorrectly inscribed at the factory. The lead from the external condenser envelope, which is commonly negative, was labeled positive in this case.

S. HELLER,
Bronx, N. Y.

MANTOLA R-255 CHANGER

If the tone arm on this automatic record-changer swings too far, or not far enough, over, the fault may lie in the copper sleeve's not being held tightly enough by the adjusting screws. To remedy, move the tone arm gently, without forcing, to one end. If it is dropping too far *inside* the record, move it as far as it can go *towards* the record. If it is dropping too far *outside* the record, push arm as far as possible *away* from the record.

If the adjusting screws (located under changer base, on the tone arm assembly) are loose, seize the arm at its base and force it slightly in the direction in which it has already been moved. If the screws are tight, loosen them before adjusting the arm. A slight rotation of the base produces a much greater change of position in the tone arm, so do not move the base very much. When the arm is found to drop in the proper place, tighten the adjusting screws.

Difficulty may be encountered in making adjustments when the record-changer remains in its cabinet, since the base of the pick-up may have shifted when the adjusting screws are tightened. To remedy this condition, the changer should be removed from its cabinet and adjusted on the work-bench.

S. HELLER,
Bronx, N. Y.

SILVER

"VOMAX"

*Proved Best
and...
Cheapest*



Thousands upon thousands of "VOMAX", the truly universal vacuum-tube volt-ohm-milliammeter . . . in service today in ranking laboratories ranging from the U. S. Bureau of Standards on through the roster of radio's elect . . . bought by Veterans Administration and other school training programs . . . consistently selected by America's top-profit service organizations . . . conclusively prove it is the best. "VOMAX" is also the cheapest . . . not only because the best is always cheapest in the long run . . . but in first cost, too! Increasing production in response to increasing demand enables us . . . despite continually increasing material costs . . . to hold its price down.

"VOMAX" alone gives you the profit-priceless ability to measure every voltage in radio servicing . . . at meter resistance so astronomically high it does not upset measured circuits . . . 24 d.c. voltage ranges 0 through 3000 volts at 51 and 126 megohms input resistance . . . 6 ranges 0-1200 volts a.c., a.f., i.f., r.f. to over 100 megacycles at 6.6 megohms honest input resistance . . . decibels from -10 through +50 . . . resistance from .2 ohms through 2,000 megohms . . . direct current from 50 microamperes through 12 amperes. No other instrument at any price gives you all that "VOMAX" does. Its value is unequalled . . . it's the standard of comparison . . . the overwhelming choice of those "in the know" . . . is radio's outstanding buy . . . at only \$59.85.

"SPARX" DYNAMIC SIGNAL TRACER

Next to the universal volt-ohm-milliammeter . . . "VOMAX" is the ideal universal d.c. through u.h.f. meter . . . what the radio service profession most needs is a good dynamic signal tracer. Ability to trace the signal through every successive receiver circuit reduces "trouble-shooting" to basic fundamentals . . . banishes forever the hard-to-service "roughies" . . . turns loss jobs into quick profits. Designed by radio's only International Grand Prize winner, "SPARX" is the aural-visual signal tracer you have been clamoring for. Not only does "SPARX" trace r.f., i.f., a.f. signals from 20 cycles to over 200 megacycles . . . it is your shop test-speaker as well. It also tests microphones, phono pickups, P.A. amplifiers, speakers . . . registers presence or absence of d.c. and a.c. operating voltages, too. With new raadar crystal diode probe, 3-stage 65 db. gain a.f. amplifier, ground-insulating transformer power supply and PM dynamic speaker, it's the instrument you've dreamed of . . . like all SILVER instruments will earn its cost in no time at all. Yet "SPARX" costs you only \$39.90



"904" LABORATORY CAPACITANCE RESISTANCE BRIDGE

Not only does Model 904 C-R Bridge cover the tremendous range of 1/4 mmfd./ohm up through 1000 mfd./megohms . . . give you truly laboratory accuracy in measurement of capacitors and resistors . . . provide 0-500 volts continuously variable built-in d.c. polarizing voltage for electrolytic and other capacitors . . . give power factors measurement 0-50% . . . but it brings something quite new to radio measurements. With Model 904 C-R Bridge you can at last measure capacitance of any type of condenser . . . air, paper, oil, electrolytic, ceramic . . . with d.c. operating voltage applied during measurement! Think what this means in increasing your efficiency . . . in finding those "intermittents" which cause so much trouble . . . in speeding your work and increasing your profits. Measuring capacitors and resistors to ±3% laboratory accuracy . . . matching "VOMAX" and "SPARX" in size, post-war style, top quality components and construction . . . it's the same amazing bargain at only \$49.90 net as "VOMAX" . . . value which has forced 500% expansion in our plant facilities in less than one year.

And

See these "must" instruments . . . and new SILVER amateur transmitters, receivers, kits, parts which were sensations at the 1946 Trade Show at your favorite jobber. Act fast . . . demand continues far in excess of supply . . . for SILVER products are the profit tools used by your smart competitors. Send postcard for new post-war catalog.

**SEND FOR FREE CATALOG of what's
new in post war Receivers, Transmitters,
factory built, or Kits and Parts**

OVER 35 YEARS OF RADIO ENGINEERING ACHIEVEMENT

McMurdo Silver Co., Inc.

1249 MAIN STREET • HARTFORD 3 • CONNECTICUT

Be sure to buy it from . . .

RADIO PRODUCTS SALES CO.

1237 Sixteenth Street
Denver 2, Colorado



Not only does Model 904 C-R Bridge cover the tremendous range of $\frac{1}{4}$ mmfd./ohm up through 1000 mfd./megohms . . . give you truly laboratory accuracy in measurement of capacitors and resistors . . . provide 0-500 volts continuously variable built-in d.c. polarizing voltage for electrolytic and other capacitors . . . give power factors measurement 0-50% . . . but it brings something quite new to radio measurements. With Model 904 C-R Bridge you can at last measure capacitance of any type of condenser . . . air, paper, oil, electrolytic, ceramic . . . with d.c. operating voltage applied during measurement!

We recommend the truly laboratory Model 904 C/R Bridge at \$49.90 . . . besides you can't equal the Vomax at \$59.85 . . . not to mention the new SPARX, the hottest visual/aural dynamic signal tracer we've ever seen . . . at only \$39.90.



904 $\frac{C}{R}$ BRIDGE

Immediate Delivery

J. G. BOWMAN & CO.

8010 S. Cottage Grove Ave.

Chicago, 19 Illinois



PROMPT SHIPMENT

New Silver 904 C R Bridge.....	49.90
Silver "VOMAX" at only.....	\$59.85
"SPARX" Signal Tracer.....	39.90

904 $\frac{C}{R}$ BRIDGE

IN CALIFORNIA, ALL WESTERN STATES, and MEXICO

The Finest Service on the Finest Equipment

MAIL AND PHONE ORDERS OUR SPECIALTY

at
**RADIO TELEVISION
SUPPLY CO.**

1509 S. Figueroa St.
Los Angeles 15, Calif.

Phone: Richmond 9131—Cable Address: RATELCO



PROMPT SHIPMENT

New Silver 904 C R Bridge.....	49.90
Silver "VOMAX" at only.....	\$59.85
"SPARX" Signal Tracer.....	39.90

904 $\frac{C}{R}$ BRIDGE

MISSILE BACK-TRACKS RADAR BEAM

A beam-climbing missile, not quite perfected by the Germans at the end of the war, was capable of following back to its source a radar beam focussed on a plane or ship. It is possible that it was one of the "wonder-weapons" promised by Hitler to his people, which were to

win victory even after Allied forces had crossed the German border. A report issued last month by the U. S. Department of Commerce gives details of the weapon, together with other devices on which the Nazis were just a little too late.

IN TEXAS

**IT'S
Mission Radio Inc.**



In S.W. Texas and around San Antonio, everyone knows it's Mission Radio Inc. for the best in everything. We recommend the 904 C/R Bridge without reservation.

With Model 904 C/R Bridge you can measure capacitance of any type of condenser . . . air, paper, oil, electrolytic, ceramic . . . with d.c. operating voltage applied during measurement! Increase your efficiency . . . in finding those "intermittents" which cause so much trouble . . . in speeding your work and increasing your profits. Prompt shipment "904 C/R Bridge," \$49.90; "Vomax," \$59.85; "Sparx," \$39.90.

Immediate delivery on Vomax, 904 C/R Bridge. For anything in Radio, sound or parts write, phone or wire.

MISSION RADIO INC.

814 S. PRESA ST., SAN ANTONIO, TEX.

IN STOCK FOR

**IMMEDIATE
DELIVERY**



MODEL 904 C/R BRIDGE

With Model 904 C-R Bridge you can measure capacitance of any type of condenser . . . air, paper, oil, electrolytic, ceramic . . . with d.c. operating voltage applied during measurement! Increase your efficiency . . . in finding those "intermittents" which cause so much trouble . . . in speeding your work and increasing your profits. Prompt shipment "904 C-R Bridge," \$49.90; "Vomax," \$59.85; "Sparx," \$39.90.

ZACK RADIO SUPPLY CO.

1426 MARKET STREET
SAN FRANCISCO, CALIF.

STANDARD ELECTRONICS DIST. CO., INC.

1497 MAIN, BUFFALO 2, N. Y.

With Model 904 C-R Bridge you can measure capacitance of any type of condenser . . . air, paper, oil, electrolytic, ceramic . . . with d.c. operating voltage applied during measurement! Increase your efficiency . . . in finding those "intermittents" which cause so much trouble . . . in speeding your work and increasing your profits. Prompt shipment "904 C-R Bridge," \$49.90; "Vomax," \$59.85; "Sparx," \$39.90.

904 $\frac{C}{R}$ BRIDGE

SILVER

904 C/R BRIDGE

(LABORATORY CAPACITANCE)
(RESISTANCE BRIDGE)

\$49.90

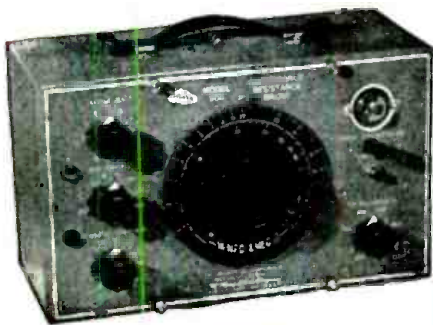

Order **NOW** for
IMMEDIATE SHIPMENT
from **CONCORD**

Depend on CONCORD for prompt shipment of your Silver 904 C/R Bridge—and for every requirement in Radio and Electronic Parts, Equipment and Supplies. Use the Convenient coupon below to order your Model 904 Bridge for shipment at once.

The Silver 904 C/R Bridge is just one of scores of latest model testing and measuring instruments of every type, for every radio purpose, you will see listed in the great, new, complete CONCORD catalog. PLUS the most comprehensive stock of guaranteed Radio and Electronic Parts and Equipment offered in years! Radio Sets—Phono-Radios—Test Equipment—Parts for all Radio and Electronic use—for repair, maintenance, building, experimenting—Tools—Amplifiers—Amateur Gear—Kits and Supplies—thousands of items—see them in the new CONCORD catalog. Check the coupon below for your FREE copy.



CONCORD
RADIO CORPORATION
LAFAYETTE RADIO CORPORATION
CHICAGO 7 ★ ATLANTA 3
901 W. JACKSON BLVD. 265 PEACHTREE ST.

Concord Radio Corporation,
901 W. Jackson Blvd. Dept. 116,
Chicago 7, Ill.

Please ship at once, enclose Silver Model 904 C/R Bridge, as checked below. Please include FREE copy of new complete Concord Catalog.

I enclose \$49.90 in full payment. Please ship express collect.

I enclose \$12.50 deposit. Please ship C.O.D. for balance of \$37.40 plus transportation charges.

Please also send me FREE copy of new complete CONCORD Catalog.

Name

Address

Town State

HARRISON HAS IT!

SILVER

904 C/R Bridge \$49.90



Also the "Vomax" and other Silver products. Send your orders to Harrison for earliest delivery of any make and model of test equipment!

HAM HEADQUARTERS
Since 1925!



HARRISON RADIO CORPORATION

9 WEST BROADWAY • NEW YORK CITY 7

PHONE—BARclay 7-9654 • EXPORT DEPT.—CABEE—"HARRISORAD"

[JAMAICA BRANCH—172-31 Hillside Ave.—REpublic 9-4102]

Radio Equipment Distributors

709 SOUTH MAIN ST.

LOS ANGELES 14
CALIFORNIA

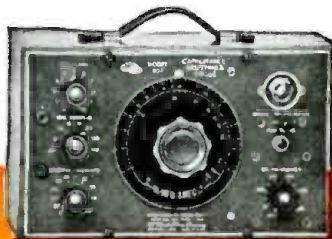

904 C/R BRIDGE

PROMPT SHIPMENT

New Silver 904 C R Bridge.....	49.90
Silver "VOMAX" at only.....	\$59.85
"SPARX" Signal Tracer.....	39.90

The Overton Electric Co., Inc.

522 JACKSON

TOPEKA,
KANSAS



904 C/R BRIDGE

PROMPT SHIPMENT

New Silver 904 C R Bridge.....	49.90
Silver "VOMAX" at only.....	\$59.85
"SPARX" Signal Tracer.....	39.90

McDonald Brothers

963 Union Ave.,
Memphis 3, Tenn.

LABORATORY CAPACITANCE
RESISTANCE BRIDGE

With Model 904 C-R Bridge you can measure capacitance of any type of condenser . . . air, paper, oil, electrolytic, ceramic . . . with d.c. operating voltage applied during measurement! Increase your efficiency . . . in finding those "intermittents" which cause so much trouble . . . in speeding your work and increasing your profits. Prompt shipment 904 C-R Bridge, \$49.90; Sparx, \$39.90; Vomax, \$59.85.

904 C/R BRIDGE

FISCHER DISTRIBUTING CO., INC.

222 FULTON ST., N. Y.

LABORATORY
CAPACITANCE
RESISTANCE
BRIDGE

With Model 904 C-R Bridge you can measure capacitance of any type of condenser . . . air, paper, oil, electrolytic, ceramic . . . with d.c. operating voltage applied during measurement! Increase your efficiency . . . in finding those "intermittents" which cause so much trouble . . . in speeding your work and increasing your profits. Prompt shipment "904 C-R Bridge," \$49.90; "Vomax," \$59.85; "Sparx," \$39.90.

904 C/R BRIDGE

METROPOLITAN *Guarantees Delivery from Stock!*

McMURDO SILVER INSTRUMENTS



Model 905
"SPARX" DYNAMIC
SIGNAL TRACER

Frequency range from 20 cycles to over 200 megacycles
NET \$39.90



Model 904
CAPACITANCE
RESISTANCE BRIDGE

1/4 mmfd/ohm through 1,000mfd/-megohms 0-50% pow.-er factor
NET \$49.90



Model "Vomax"
VACUUM TUBE
VOLTMETER

One of the finest test instruments of its type
NET \$59.85

SUPERIOR INSTRUMENTS



Model 670
SUPER-METER

Combination Volt-Ohm-Milliammeter plus Capacity Reactance Inductance and Decibel Measurements.
NET \$28.40



Model 450
TUBE TESTER

Tests all tubes up to 117 volts. Speedy operation assured by newly designed rotary switch which replaces conventional snap, toggle or lever action switches.
NET \$39.50



Model 650
SIGNAL GENERATOR

Improved AC-operated—generating RF frequency from 100 Kc to 105 Mc. Audio modulating frequency is 400 cycle pure sine wave. Three-step ladder-type alternator
NET \$48.75

RADIO CITY PRODUCTS INSTRUMENTS



Model 322
DYNOPTIMUM
TUBE TESTER

Simple operation—only 4 switches used. Special noise test for tubes that otherwise test "good." Counter model
NET \$41.50
Portable model, 322P
NET \$45.50



Model 802N
COMBINATION
TUBE & SET TESTER

DC Voltmeter 0 to 1000 at 1000 ohms per volt. AC Voltmeter 0 to 1000 DC Milliammeter 0 to 1000. Ammeter 0 to 10. D.B. Meter—8/15/15 to 29/29 to 49/32 to 55 decibels
NET \$59.50



Model 668
VACUUM TUBE VOLT-
OHM CAPACITY METER

DC-VTVM from 0 to 6000 volts. AC-VTO from 0 to 6000 volts. VTO direct reading from 0.1 ohm to 1000 meg. 0 ohms to 1000 megohms. Capacity 0 to 2000 units.
NET \$73.01

The New B-45 SIGNAL GENERATOR

Self-modulated—provides a highly stable signal. Generates R.F. frequencies from 150 Kc. to 50 Mc. on Fundamentals and from 11 Mc. to 50 Mc. on Harmonics. R.F. is obtainable separately or modulated by the Audio frequency. Television, AM & FM speedily aligned. Modulation accomplished by grid-blocking action which effectively aligns amplitude and frequency modulation as well as television. Direct-reading—all calibrations are etched on the front panel.

Complete with shielded test lead, self-contained batteries and instructions.
NET \$27.75

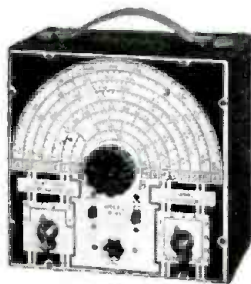

Waterman Pocket-size Oscilloscope	\$55.00	Superior 600 Combination Tube & Set Tester	62.50
Dumont 274 Five-inch Oscillograph	99.50	RCP 461-P Sensitive Multi-Tester	42.63
Supreme 543-S Multi-Tester	24.75	RCP 664 Electronic Multi-Tester	45.00
Supreme 589 Tube & Battery Tester	48.95	RCP 705 Signal Generator	49.50
Supreme 568 Vacuum Tube Voltmeter	63.50	RCP 663A VT "Billionsaire"	92.51
Supreme 546 Oscilloscope	89.75	Monitor Crystalliner Signal Generator	37.50
Superior CA-11 Signal Tracer	18.75	Shallicross 630 Wheatstone Bridge	75.00
Superior 400 Electronic Multi-Tester	52.50	Shallicross 637 Kelvin Wheatstone Bridge	100.00

Write for our FREE 1947 Catalog—Complete line of test equipment

Metropolitan ELECTRONIC & INSTRUMENT CO.

Dept. C, 6 MURRAY STREET
NEW YORK 7, N. Y., U. S. A.

Cable Address: METRONICS
Phone: BARclay 7-5556

STAN-BURN RADIO & ELECTRONICS
558 CONEY ISLAND AVE., BROOKLYN, N. Y.
1697 BROADWAY, NEW YORK CITY

LABORATORY CAPACITANCE RESISTANCE BRIDGE

With Model 904 C-R Bridge you can measure capacitance of any type of condenser . . . air, paper, oil, electrolytic, ceramic . . . with d.c. operating voltage applied during measurement! Increase your efficiency . . . in finding those "intermittents" which cause so much trouble . . . in speeding your work and increasing your profits. Prompt shipment "904 C-R Bridge," \$49.90; "Vomax," \$59.85; "Sparx," \$39.90.

904 C/R BRIDGE

NORTHWEST RADIO & ELECTRONIC SUPPLY CO.
204 S. 10th ST., MINNEAPOLIS 2, MINN.

With Model 904 C-R Bridge you can measure capacitance of any type of condenser . . . air, paper, oil, electrolytic, ceramic . . . with d.c. operating voltage applied during measurement! Increase your efficiency . . . in finding those "intermittents" which cause so much trouble . . . in speeding your work and increasing your profits. Prompt shipment "904 C-R Bridge," \$49.90; "Sparx," \$39.90; "Vomax," \$59.85.

904 C/R BRIDGE

A GERMAN BRAINWAVE

Use of brain waves to manage an artificial leg was the hope of German scientists, an Air Materiel Command Technical Intelligence team learned from questioning the scientists at the Aeronautical Research Institute of Munich.

Brain waves are the records of changes in electric potential that accompany brain activity. Electrical changes always accompany nerve impulse. The electrical currents are a by-product and except from the heart's surface, are extremely weak. Amplifiers are needed to detect and measure them.

The German artificial leg had electro-mechanical devices wired to the cut nerve endings in the patient's stump. The German investigators believed that galvanic electricity flowing along the nerves would supply the power impulses and that these could be controlled mentally, manipulating the leg according to the wishes of the owner. The galvanic electricity is the direct current which is a by-product of nerve impulses.

The amputee would employ varying degrees of concentration on the theory that mental intensity would act like a rheostat, controlling the amount of nervous electricity and moving the leg in the manner desired.

How the Germans expected these weak, microvolt currents to power a leg without an unbearably heavy and bulky amplifier is not stated in the announcement made here today. Neither is there any mention of how the Germans expected to keep the nerve endings in the stump from dying and becoming useless as a source of current.



YOUR FREE COPY IS READY!

**The Complete, New
25th Anniversary Lafayette Catalog
of Radio and Electronic Equipment**

**SPECTACULAR RADIO VALUES!
— HUNDREDS OF CRITICAL PARTS —**

Choose the parts you want from our complete stock of over 10,000 guaranteed-quality items. Whatever your needs, supply them from this single, dependable source at money-saving prices. *Lafayette!*

— THE LATEST IN HAM GEAR —

Here is the greatest selection of nationally-known communications equipment: Hallicrafters, National, Hammarlund, R.C.A., Meissner, transmitting tubes, tools and a host of others. Select a "Build-It-Yourself-Kit" and build a complete radio set.

This valuable 144 page catalog offers you the latest, largest line of top-quality *radio parts, amplifiers, test equipment, ham gear, tools, radio sets, phono-radios and other types of electronic equipment and accessories.* Page after page of post-war radio developments —plus a special bargain section that lists hundreds of surplus and standard-make radio and electronic parts at slashed-price Lafayette economy. Be one of the first to receive this big, new Lafayette Catalog. It will save you time and money. Rush coupon below today for your **FREE** copy!

LAFAYETTE RADIO

STANDARD PARTS—LEADING BRANDS

Complete line of famous-make radio and electronic equipment of the highest quality. Included are the latest developments. All items are shipped out the same day your order is received. That's Lafayette's famous *Super-Speed Service.*

RADIO WIRE TELEVISION, INC.

100 SIXTH AVE., NEW YORK 13, N. Y. 110 FEDERAL STREET, BOSTON 10, MASS. 24 CENTRAL AVENUE, NEWARK 2, N. J.

LAFAYETTE RADIO, Dept. JK-6
100 Sixth Avenue, New York 13, N. Y.

Rush my **FREE** copy of the big, new LAFAYETTE CATALOG.

Name.....

Address.....

City.....Zone.....State.....

Paste On Penny Postcard!

MAIL TODAY!

ONE OF OUR MOST IMPORTANT ANNOUNCEMENTS IN 19 YEARS OF PROVEN LEADERSHIP IN TRAINING PROFESSIONAL RADIO MEN:

Here it is! *Your First Practical Step Toward a Good Paying Career in TELEVISION*

CREI Introduces a Streamlined

Home Study Course

in Practical

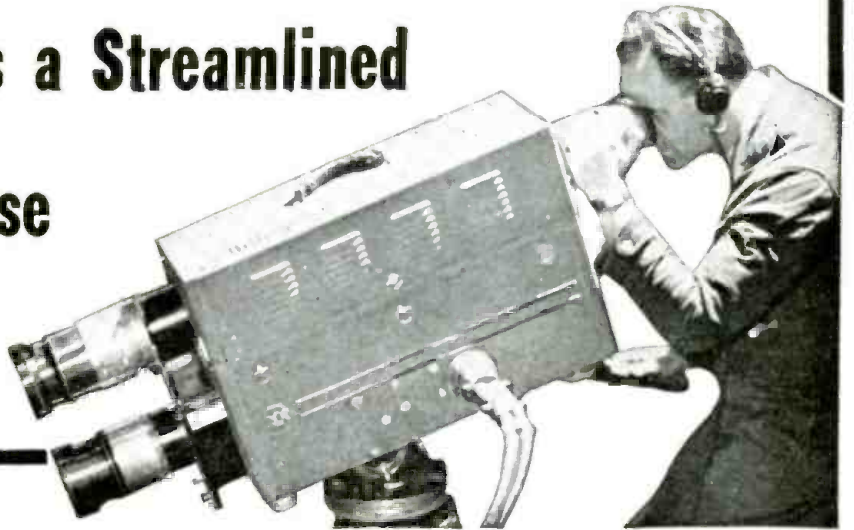

Television

ENGINEERING

AVAILABLE NOW—FOR THE FIRST TIME!

Here's Your Chance to "Get in on the Ground

Floor" of Television Opportunities

Don't say, "I never had a chance!" Prepare NOW for the good paying jobs awaiting trained television engineers and technicians. Be in a position to command a "key" job in the growing TELEVISION Industry by preparing now with the type of thorough, practical TELEVISION Engineering training that the industry requires. The new CREI TELEVISION Engineering course is (1) A complete well-coordinated course of

study that covers the entire field of practical TELEVISION Engineering, (2) Presented in CREI'S professional and proven home study form, (3) Prepared by CREI'S experienced staff, based on actual experience in our own TELEVISION Studios and Laboratories, plus years of close contact with leaders in television development. Here's your opportunity to be prepared for television well ahead of competition, if you start NOW!

CAPITOL RADIO ENGINEERING INSTITUTE

16th and Park Road, N. W.

Dept. RC-11,

Washington 10, D. C.

JUST OFF THE PRESS!

MAIL COUPON for Complete Free Details and Outline of Course

If you have had professional or amateur radio experience and want to prepare for opportunities in TELEVISION, let us prove to you we have the training you need to qualify. To help us intelligently answer your inquiry—PLEASE STATE BRIEFLY YOUR BACKGROUND OF EXPERIENCE, EDUCATION AND PRESENT POSITION.



CAPITOL RADIO ENGINEERING INSTITUTE RC-11
16th and Park Road, N. W., Washington 10, D. C.

Gentlemen: Please send me complete details describing the new CREI home study course in Practical Television Engineering. I am attaching a brief resume of my experience, education and present position.

Name

Street

City Zone State

Occupation

I am entitled to training under the G.I. Bill.

Member of NATIONAL HOME STUDY COUNCIL—NATIONAL COUNCIL of TECHNICAL SCHOOLS—and TELEVISION BROADCASTERS ASSN.

**RADIO STORES
SELLING.....**

**RADIO
CRAFT**

**IN YOUR
HOME TOWN**

ALABAMA

Decatur
Radio & Tele. Sup. Co.
717 Bank St.
Montgomery
Teague Hardware Co.
200 Commerce St.
Tuacaloosa
Allen & Jamison Co.

ARIZONA

Phoenix
Radio Specialties & Appl. Co.
401 W. Jackson St.

ARKANSAS

Fort Smith
Packard Radio Co.
205 Garrison Ave.
Little Rock
Southern Radio Supply
409 West Third St.

CALIFORNIA

Bakersfield
Bakersfield Radio Supply
2808 Chester Ave.
Hollywood
Yale Radio Electric Co.
6616 Sunset Blvd.
Long Beach
Fred S. Dean Co.
969 American Ave.
Los Angeles
General News Agency
326 West 5th St.
Papal Bros.
2639 E. 4th St.
Radio Television Supply Co.
1509 S. Figueroa St.
Oakland
Electric Supply Co.
149 12th St.
Radio Margo
7415 Mac Arthur Blvd.
Sacramento
E. M. Kemp Co.
1115 R. St.
San Bernardino
George H. Bagley Co.
1216 D St.
San Diego
Western Radio & Electric Co.
San Francisco
1415 India St.
Associated Radio Dist.
1251 Folsom St.
San Francisco Radio & Supply Co.
1284 Market St.
San Jose
Frank Queument Wholesale Radio
156 W. San Fernando St.
Santa Ana
Radio & Television Equip. Co.
207 Oak St.

COLORADO

Denver
McGee Radio & Elect. Co.
1330 Broadway
Radio Products Sales Co.
1237 16th St.

CONNECTICUT

Bridgeport
Coastal Radio Service Co.
1559 Stratford Ave.
R. C. Seel & Co., Inc.
84 Elm St.
L. N. Waldhaus
187 Pequonneck St.
Hartford
R. G. Seel & Co.
317 Asylum St.
New Britain
United Radio Supply
53 E. Main St.

DISTRICT OF COLUMBIA

Washington
Capitol Radio Wholesalers
2120-14 St., N.W.
Intercommunications Co.
2027 Nichols Ave. S.E.
Kenyon Radio Supply Co.
2214 14th St., N.W.
Sun Radio
938 N.W. F St.

FLORIDA

Jacksonville
Radio Parts Co.
712 Main St.
Thurow Distributors, Inc.
806 Main St.
Miami
Thurow Distributors, Inc.
420 S. W. 8th Ave.
Orlando
Thurow Distributors, Inc.
131 South Court St.
St. Petersburg
Welch Radio Supply
408 9th St. So.

Tallahassee

Thurow Distributors, Inc.
213 E. Tennessee
Tampa
Thurow Distributors, Inc.
115-117 So. Franklin St.
West Palm Beach
Thurow Distributors, Inc.
209 No. Olive St.

GEORGIA

Augusta
Prestwood Electronics Co.
727-29 Reynolds St.
Macon
Guy White Radio
654 Mulberry St.

ILLINOIS

Danville
Allen Electric Co. Radio Supply
109 N. Hazel St.
Decatur
York Radio Distributing Co.
801-805 N. Broadway St.
Chicago
Allied Radio Corp.
833 W. Jackson Blvd.
American Parts, Inc.
610 W. Randolph St.
Concord Radio Corp.
901 W. Jackson Blvd.
Lake Radio Sales Co.
615 W. Randolph St.
Newark Electric Co.
323 W. Madison Ave.
Radio Shack
630 W. Randolph St.
Radelek Company
601 W. Randolph St.

East Moline
C. L. Swanson Radio Laboratory
933 15th Ave.
Springfield
Harold Bruce
303 E. Monroe
W. Frankford
Radio Hospital
1107 E. Main St.

INDIANA

Anderson
Seybert's Radio Supply
19 E. 12th St.
Evansville
Castrup's Radio Supplies
1014 W. Franklin St.
Montoux Auto & Machine Co.
517 Locust St.
Hammond
Stanton Radio Supply
521 State St.
South Bend
Commercial Sound & Radio Co.
528 E. Colfax Ave.

IOWA

Burlington
Union Supply Co.
4th & Washington Sts.
Council Bluffs
World Radio Labs.
Dubuque
Boe Distributing Co.
498 N. Grandview
Sioux City
Dukes Radio Co.
114 West 4th St.
Power City Radio Co.
513 7th St.
Sioux City Radio & Appliance Co.
313 Fifth St.

KANSAS

Pittsburgh
Pittsburgh Radio Supply Co.
103 N. Broadway
Topeka
Acme Radio Supply
516 Quincy St.
Wichita
Interstate Distributors, Inc.
1236 E. Douglas
Radio Supply, Inc.
1125-27 E. Douglas

KENTUCKY

Lexington
Kentucky Radio Supply Co.
519 Georgetown St.
Radio Equipment Co.
377 East Main St.

Louisville
Peerless Electronic Equipment Co.
912-914 So. Second St.
Newport
Apex Distributing Co.
506 York St.

LOUISIANA

Lafayette
Radio-Electronic Supply
1419-21 Cameron St.
Monroe
Hale & McNeil
301 Pine St.

New Orleans

Radio Parts, Inc.
807 Howard Ave.
Walther Bros. Co.
714 Howard Ave.

MAINE

Bangor
Radio Service Laboratory
45 Haymarket Sq.
Portland
Maine Electronic Supply Corp.
13 Deer St.

MARYLAND

Baltimore
Henry O. Berman Co., Inc.
12 E. Lombard St.
D & H Distributing Co.
31 E. Lee St.
Royal Radio
941 Penna. Ave.
Wholesale Radio Parts Co., Inc.
311 W. Baltimore St.

MASSACHUSETTS

Boston
Hub Cycle & Radio Co., Inc.
596 Commonwealth Ave.
Sager Electrical Supply Co.
201 Congress St.
Lawrence
Hatry & Young of Mass., Inc.
639 Essex St.
Melrose
Meirose Sales Co.
407 Franklin St.
New Bedford
C. E. Beckman Co.
Commercial St.
Springfield
Springfield Radio Co., Inc.
405 Dwight St.
Worcester
Radio Electronic Sales Co.
48 Chandler St.
Radio Maintenance Supply Co.
19-25 Central St.

MICHIGAN

Ann Arbor
Purchase Radio & Camera Shop
605 Church St.
Berkley
The J. M. Morel Co.
1949 Woodward Ave.
Detroit
M. N. Duffy & Co.
2040 Grand River Ave.
Hershel Radio
3249 Grand River Ave.
Radio Supply & Engineering Co., Inc.
129 Seiden Ave.
Flint
Radio Tube Mds Co.
508 Clifford
Shelton Radio & Appliance
2914 North Saginaw St.
Jackson
Fulton Radio Supply Co.
707 S. Blackstone St.
Lansing
Electric Products Sales Co.
427 E. Michigan Ave.
Muskegon
Industrial Electric Supply Co.
1839 Pack St.
Saginaw
Orem Distributing Co.
801 E. Genesee Ave.
Radio Parts Co.
234 S. Second St.

MINNESOTA

Duluth
Northwest Radio
109 E. First St.
Minneapolis
Law Bonn Co.
1211 LaSalle Ave. So.
Northern Radio Laboratory
3927 East Lake St.
Ron's Radio Supply
4001 Bryant Ave. So.
Missouri
Cape Girardeau
Suedakum Electronic Supply Co.
902 S. Sprigg St.
Springfield
Harry Reed Radio & Supply Co.
833-37 Boonville Ave.

MONTANA

Butte
Geo. Steels & Co.
126 W. Broadway
Great Falls
Geo. Lindgren Co.
109 Central Ave.

NEBRASKA

Omaha
Alco Radio, Inc.
411 Cumins St.
All-State Distributing Co.
2857 Farnam St.

Omaha

H. C. Noll Co.
2226 Harney St.
Omaha Appliance Co.
18th & St. Mary's
Radio Equipment Co.
2820-22 Farnum St.

NEW HAMPSHIRE

Concord
Evans Radio
18 N. Main

NEW JERSEY

Bridgeton
Joe's Radio Shop
67-69 S. Pearl
Newark
Radio Wire Television, Inc.
24 Central Ave.
Variety Electric Co.
601 Broad St.
Passaic
Nidisco Passaic, Inc.
205 Madison St.
Red Bank
Bradleys Radio Service
Newman Springs Rd.
Trenton
Allen & Hurley
25 South Warren Street
Carl B. Williams
25 S. Warren St.

NEW YORK

Albany
E. E. Taylor Co.
465 Central Ave.
Binghamton
Broome Dist. Co.
221 Washington St.
Brooklyn
Electronic Equipment Co., Inc.
1460 Bushwick Ave.
Green Radio Distributors
482 Sutter Ave.
Hornbeam Distributing Co.
1639 Bedford Ave.
Buffalo
Buffalo Radio Supply
219 E. Genesee St.
Dymas, Inc.
2929-31 Main St.
Genesee Radio & Parts Co.
205 E. Genesee St.
Elmira
Fred C. Harrison Co.
108 W. Church St.
Jamaica
Harrison Radio Corp.
172-31 Hillside Ave.
Norman Radio Dist.
94-29 Merrick Road
Peerless Radio Dist. Co.
92-32 Merrick Rd.
Radio Dealers' Service & Supply
Co.
172-24 Jamaica Ave.
Middletown
Roskin Bros., Inc.
23 W. Main St.
Mount Vernon
Davis Radio Dist. Co.
66-70 E. 3rd St.
New York City
Federated Purchaser, Inc.
80 Park Place
Grand Central Radio, Inc.
124 E. 44th St.
Harrison Radio Corp.
12 West Broadway
Harvey Radio Co.
105 W. 43rd St.
Highbridge Radio Television &
Appliance Co.
340 Canal St.
Niagara Radio Supply Corp.
160 Greenwich St.
Radio Wire Television, Inc.
100 Sixth Ave.
Poughkeepsie
Chief Electronics
104 Main St.
Rochester
Masimo Radio & Electric
Equipment
192-196 Clinton Ave., N.
Syracuse
Broome Dist. Co.
912 Erie Blvd. E.
Stewart W. Smith, Inc.
325 East Water Street
Syracuse Radio Supply
238-40 W. Willow St.
Watertown
Boscon Electronics, Inc.
108 Lincoln Bldg.
White Plains
Westchester Electronic Sup. Co.
333 Mamaroneck Ave.

NORTH CAROLINA

Charlotte
Henry V. Dick & Co., Inc.
311 E. 5th St.
Goldboro
Signal Radio Supply
124 S. James St.
Wilmington
Gregory Radio Co.
223 North 7th St.

See Other Side For Additional Listings

<p>Fargo Radio Equipment Co. 624 2nd Ave. No.</p> <p>OHIO</p> <p>Cincinnati Chambers Radio Supply 1104 Broadway Holub & Hoeg 500 Reading Rd. Radio & Refrigeration Supply 1220-6 Jackson St.</p> <p>Cleveland Northern Ohio Labs. 2073 West 85th St. Radio Surplus Co. 648 Prospect Ave. Strong, Carlisle & Hammond Co. 2801 St. Clair Ave. Winterradio, Inc. 1468 W. 25th St.</p> <p>Columbus Electronic Supply Corp. 219 North 4th St.</p> <p>Warren Radio Specialties 136 S. Pine St.</p> <p>Dayton Standard Radio & Elect. Prods. 135 E. Second St.</p> <p>Steubenville D. & R. Radio Supply 156 S. 3rd St.</p> <p>OKLAHOMA</p> <p>Oklahoma City Radio Supply, Inc. 724 N. Hudson, Box 597</p> <p>OREGON</p> <p>Portland Appliance Wholesalers of Oregon 600 N.W. 14th Ave.</p> <p>PENNSYLVANIA</p> <p>Altoona Hollenback's Radio Supply 2221 8th Ave. Kennedy Radio Supply 1500 Fifth Ave.</p> <p>Beaver Falls Reliable Motor Parts Co. 1700 7th Ave.</p> <p>Erie Jordan Electronic Co. 201 W. 4th St.</p> <p>Harrisburg D. & H. Distributing Co., Inc. 311 S. Cameron St.</p> <p>Lancaster Eshelman Supply Co. 110 N. Water St.</p> <p>Philadelphia A.G. Radio Parts Co. 3515 N. 17th St. Almo Radio Co. 509 Arch St.</p>	<p>Flanagan Radio Corp. N.E. Cor. 7th & Chestnut Sts. M & H Sporting Goods Co. 512 Market St. Radio Electronics Service Co. 7th & Arch Sts.</p> <p>Reading Geo. D. Barbey Co. 432 Walnut St.</p> <p>Scranton Broome Dist. Co. 26 Lackawanna Ave.</p> <p>Sharon Helges Bros., Inc. 73 Central Way</p> <p>York J. R. S. Distributors 646 W. Market St.</p> <p>RHODE ISLAND</p> <p>Providence William Dandreta & Co. Rogert Ave. Powell Radio Supply 49 Atwells Ave.</p> <p>SOUTH CAROLINA</p> <p>Charleston Radio Laboratories 215 King St.</p> <p>SOUTH DAKOTA</p> <p>Siooux Falls Power City Radio Co. 209 So. First Ave.</p> <p>United Radio Supply 211 W. 10th St.</p> <p>TENNESSEE</p> <p>Knoxville C. W. McClung & Co. Jackson Ave.</p> <p>Memphis Bluff City Dist. Co. 905 Union Ave. Shobe, Inc. 1117 Union Ave.</p> <p>Nashville Frost Electric Inc. 1922 West End Ave.</p> <p>TEXAS</p> <p>Amarillo Amarillo Electric Co. 418 W. 10th Ave. R & R Electronic Co. 412 W. 10th St.</p> <p>Dallas All-State Dist. Co. 2405-07 Ross Ave. Southwest Radio Supply 1820 N. Harwood</p> <p>Fort Worth Ft. Worth Radio Supply Co. 1201 Commerce The Electronic Equip. Co. 301 E. 5th St.</p>	<p>Houston R.C. & L.F. Hall 1015 Caroline St. Sterling Radio Products Co. 1602 McKinney</p> <p>Laredo Radio & Electronics Supply Co. 1219 Lincoln St.</p> <p>Lubbock R. & R. Supply Co., Inc. 706 Main St.</p> <p>Port Arthur Lapham Radio Co. 309 1/2 Proctor St.</p> <p>San Antonio Tom Hopkins Radio 324 Macgockches St. R. L. Ross Co. 118 Seventh St. South Texas Radio Supply Co. 445 E. Commerce</p> <p>Tyler Radio Service Supply Co. 111 University Place</p> <p>Waco The Margis Co., Inc. 1305 Austin Ave.</p> <p>UTAH</p> <p>Ogden Ballard & Carter Co. 203 24th St.</p> <p>Salt Lake City D'Loughlin's Radio Supply Co. 113 East Broadway Radio Supply Co. 45 East 4 South Standard Supply Co. 531 So. State St.</p> <p>Norfolk Ashman Distributing Co. 807 Granby St. Radio Parts Dist. Co. 128 W. Olney Rd. Radio Supply Co. 711 Granby St.</p> <p>Salem Richie Radio Supply 306 E. Main St.</p> <p>Staunton Southern Electric Corp. 14 E. Johnson St.</p> <p>WASHINGTON</p> <p>Bellingham Waitkus Supply Co. 110 Grand Ave.</p> <p>Seattle Harper-Megee 960 Republican St.</p> <p>Spokane Columbia Electric & Mfg. Co. P.O. Box 1441 S. 123 Wall St.</p>	<p>Tacoma C. & G. Radio Supply Co. 714 St. Helens Ave. A. T. Stewart Co. 743 Broadway Wible Radio Supply 909 Tacoma Ave.</p> <p>WEST VIRGINIA</p> <p>Clarksburg Trenton Radio Co. 791-93 W. Pike St.</p> <p>East Charleston Hicks Radio Supply 10 Virginia St.</p> <p>Parkersburg John A. Cox Radio Supplies 554 7 St.</p> <p>Wheeling General Distributors 21 10th St.</p> <p>WISCONSIN</p> <p>Appleton Valley Radio Distributors 518 N. Appleton St.</p> <p>Hudson J. H. Larson Co. 109 Walnut St.</p> <p>Madison Satterfield Radio Supply Inc. 326 W. Gorham St.</p> <p>Manitowac Marris' Radio Company 115 N. 10th St.</p> <p>Milwaukee Acme Radio Supply Corp. 510 N. State St. Central Radio Parts Co. 1723 West Fond Du Lac Ave. Taylor Electric Co. 112 N. Broadway</p> <p>Racine Standard Radio Parts Co. 1244 State St.</p> <p>WYOMING</p> <p>Casper Golden Power Oil & Supply Co. 260 S. Center</p> <p>Cheyenne Houge Radio & Supply Co. 2008 Carey Ave.</p> <p>CANADA</p> <p>Radio Supply Co., Ltd. Grd. Floor McLeod Bldg. Edmonton, Alberta Electronic Supply Co. (Ottawa). Ltd. 244 Slater St. Ottawa, Ont. Hygrade Radio, Ltd. 673 Homer St. Vancouver, B. C.</p>
--	--	--	--

DEALERS: If you are not receiving RADIO-CRAFT, please ask for our Special Consignment Proposition.

HOW DOES THE SIGNAL GET THROUGH?

THERE is a time in the life of Mr. Serviceman when every repair seems to settle down to a faulty component or broken wire and work loses attraction because it offers no new experience.

Presently a job turns up which withstands all his efforts. Simple as it looks the fault persists. Mr. Serviceman, who believed that radio had no more problems in store for him, puts away test leads and soldering iron and starts with paper and pencil.

For instance, a set has a defective volume control. Not that it does not regulate up to full volume nor is it noisy. It simply does not cut out entirely. In the minimum position, a strong signal still comes through, far too loud to listen to a local at night.

Of course, Mr. Serviceman at once replaces the volume control with a new one. . . . The fault remains, the new volume control does not cut out either. Now he checks both volume controls for resistance from slider to grounded end, in minimum position. It shows zero. As a countercheck he grounds the center terminal directly. The signal still comes through.

If he thinks the signal passes by some obscure way to the grid of the first a.f. amplifier tube—he is right.

Let us consult the diagram of the receiver and solve the puzzle.

Figure 1 shows the volume control located in a diode-triode circuit. The modulated r.f. voltages developed across the i.f. transformer secondary cause a flow of electrons from the cathode to the diode plates in the tube on every r.f.

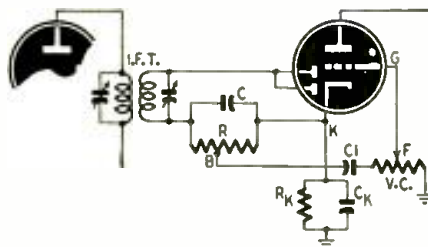

Fig. 1—Components of the mysterious circuit.

half cycle. The electrons charge up capacitor C and a potential varying with the modulation amplitude appears across resistor R. Part of this a.f. voltage is tapped off resistor R and coupled to the volume control through capacitor C1. The same a. f. voltage exists then between the cathode and the tapping point B, and between the cathode and

the top of the volume control V.C. (K-V.C. is equal to K.B.).

If the slider of the volume control is at the top position, all the a.f. voltage between point F and cathode is fed to the grid. As the slider moves to ground less and less of this voltage is tapped off and the input drops to zero if the slider reaches the "ground" position—but only if the ground has the same potential as the cathode. Since the cathode by-pass capacitor Ck has a low reactance at a.f., it puts ground and cathode practically at the same potential.

Now Mr. Serviceman should guess from this what happens if Ck is open. He may take the soldering iron again and replace the capacitor. A higher capacity value would do no harm.—Zygmunt Hof.

Three members of a Nebraska farm family, arrested for operating an illegal radio station, brought forward the unusual defense that they were using the ether to "spread the gospel." The station, which was heard and located by the Federal monitor station at Grand Island, July 25, broadcast from 12:15 to 1 p.m. daily, carrying religious music, sermons and talks against tobacco and alcohol.

NEW ARMY MINE DETECTORS!

RECEIVERS—TRANSMITTERS—COMPONENTS

MORE SUPER-SPECIAL BUYS!!!

CATHODE RAY TUBES BRAND NEW!!

MADE BY NORTH AMERICAN PHILLIPS CO.

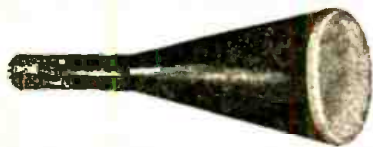

Tube Type	Approx. List	Your Cost
3BP1	15.00	3.95
3FP7	27.00	5.35
5BP1	20.00	4.95
5BP4	27.00	5.95
5CP1	45.00	4.95
5CP7	48.00	6.00
5FP7	32.00	4.95
5JP2	48.00	13.50
5LP1	41.00	8.00
837	2.80	1.50
872A	7.50	3.50
705A	22.50	7.50
241B-WE	85.00	50.00
861	155.00	95.00
MAGNETRON 10cm		
Jan. 2J32	List 200.00	\$35.00

PULSE AMPLIFIER



Signal corps type BC409. Designed for 115 volts. AC 60 cycles. Component parts worth several times the price of this unit. Slightly used. Following are a few of the items that make up the unit.

1-304TL (Elmac). 3-2 mfd. 4,000 W.V. GE Pyranol condensers. 1-3200 volt 150 MA power transformer. 1-Varlac 5 amps. General Radio type CU 200. 1-5 volt 26 amp. Hi. transformer (for 304 TL). 1-2.5 volt 10 Amp. Hi. transformer (5000 volt insulation). 1-1 mfd. 1000 volt GE Pyranol. 1-2 mfd. 1000 volt GE Pyranol. **\$59.50**

BC-312 RECEIVER

Superhet with 2-r.f.; 1-1st det; 2-i.f.; 2 audio; CW & RF osc. and other stages. Frequency coverage: 1500 kc-18,000 kc in 6 bands. These sets are in perfect condition. Complete with tubes **\$59.50**



I-F Crystal filter for BC-312, BC-342. Resonant at 470 kc. Crystal included **\$6.95**

BX-4 Battery box used with the BC-178 Receiver-transmitter. Will hold 2-#6 1 1/2 volt dry cells; 4-22 1/2 v. "B" batteries; 1-4 1/2 v. "C" batteries. Ideal for a portable test unit or **\$1.25** a set

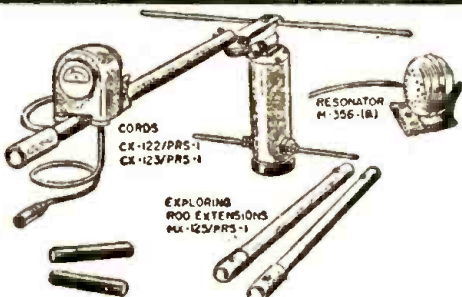

New/AN/PRS-1 Mine Detectors

For detecting metallic and non-metallic materials by indicating either aural or visual means or both. SET CONSISTS OF:
A. Detector head, antenna and reflector, meter and housing (illust.). B. Exploring rod extensions. C. Amplifier assembl. AM32/PRS-1 complete with tubes. D. Bag for carrying amplifier on back. E. Headset HS-30-B. F. Carrying case for storage and transportation of unit. Operates from two 45v; one 6-volt; one 3-volt battery (batteries not incl.). Worth approximately \$175. Complete unit with tubes **\$27.50**

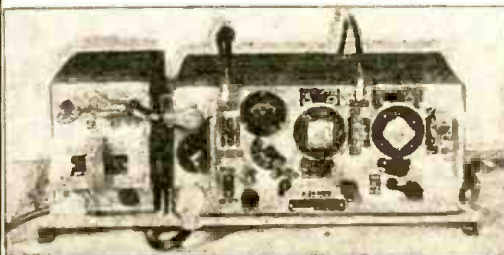

NEW COMPLETE TRANSMITTING AND RECEIVING SETS **\$68.50**

No. 19—Mark I-II-III Tank, made by Zenith & Emerson, lend-lease Russia. Trans. 6 tubes 807 final, grid mod. tel. 2 to 8 meg. cont. var. Includes 80 & 40 m. bands. Receiver 6-tube Super-Het. Also included intercom. 8v. 3 control boxes. 3 Comb. head phones & mikes; power supply, dynamotor, 12-volts. Ideal for mobile or marine. Also includes ant. variometer. Shipping weight in crates 300 lbs. (& spare set of tubes). THESE UNITS ARE NOT KNOCK-DOWN SETS. THEY ARE COMPLETELY ASSEMBLED AND READY TO OPERATE! MANY SPARE PARTS INCLUDED.

NEW USN NAVY MODEL RAK-7 SHIP RECEIVER

15 kc to 600 kc. 6-tube receiver with: AVC-Band pass filter—Audio filter—Noise limiter—Precision tuning with a Vernier dial—Voltage regulated power supply, with three tubes, for 60 cycle, 115 volts. Can be battery operated. Complete with spare parts box weighing 73 lbs., spare tubes and inst. book **\$69.50**



C-D Condenser Special. 4000 mfd @ 30 vdc. Listed at \$13.50 released for **2.40**

New ARC-5 Superhet receivers

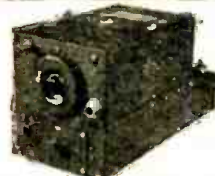

Tubes (included) 3-12SK7; 1-12K8; 1-12SR7; 1-12AG. Range: (Specify freq. desired) 190-550 Kc; 1500-3000 Kc; 3-6 Mc; 6-9.1 Mc. Power: 24-28 VDC. Complete with remote control unit and Dynamotor. **\$32.00**

New ARC-5 Transmitters: 25 watts CW; 15 watts phone. Tubes (included): 2-1625; 1-1629; 1-1626; 1-6200 Kc crystal. Range (Specify frequency desired): 5-8 Mc; 8-1.3 Mc; 1.3-2.1 Mc; 3-4 Mc; 4-5.3 Mc; 5.3-7 Mc; 7-9.1 Mc. Power: 24-28 VDC. Modulator unit; (with tubes) 1-1625; 1-vR150; 1-12J5. Remote control with key. Less Dynamotor **\$54.50**
Transmitter-Dynamotor extra **\$16**



HI-VOLT plate transformer, made by Amertran, 115v - 60 cycle input. Secondary is 6200v - ct - 700 m.a. Specially priced **\$39.95**
6 Hy. 700 M.A. Choke **\$7.95**



TRANSMITTING CONDENSERS

A. Cardwell type TC-300-US. 300 mmf max. .2" spacing between plates. Ruggedly constructed. List value of **\$40.50**. Our new low price **\$9.85**
B. Johnson type 500D35. Maximum cap. 500 mmf, min. 35 mmf. .08" spacing, 3500v. Listed at \$11.75. **\$4.75**
Lowered to



HI-VOLT plate transformer: 1/2 wave rectification 115v-60c/3200v @ 150 mils. Made by Kenyon **\$9.95**

U.H.F. Receiver, from SCB-268. Tunes from 201-210 mcs. Has 15 tube superhet circuit. Uses 6 acorn tubes in RF; 4 6SK7's in I-F stage designed for 20 mc. with 2 mc bandwidth. Designed for use on 155v/60c. New low price. Complete with 15 tubes **\$21.95**



HANDSETS — WHILE THEY LAST! Famous TS-13 push-to-talk handset with 50-ohm mike and 200-ohm phone. 1 each PL-55 & PL-68. Selling brand **\$5.95** new for

LARGE stock of 400 cycle fila., plate, H V scope, etc., transformers. Send for list.

SEND FOR FLYER

All merchandise guaranteed. Mail orders promptly filled. All prices F.O.B. New York City. Send Money Order or Check. Shipping charges sent C. O. D. Send for Flyers.

COMMUNICATIONS EQUIPMENT CO.

131-C LIBERTY ST., NEW YORK CITY 7, N. Y.
TELEPHONE WH 4-7658

SILVER BUTTON MICA CONDENSERS

stud. mtg. (Erie/Centralab.) 175-180-185-245 - 335 - 360 - 370 mmfd - 400 vdc each **\$.05**
lots of 100 **4.50**
lots of 1000 **37.50**
minimum order \$1.00

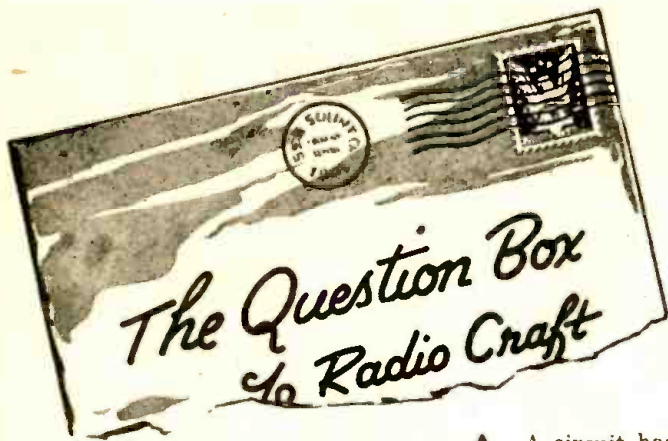

The Question Box is again undertaking to answer a limited number of questions. Queries will be answered by mail and those of general interest will be printed in the magazine. A fee of 50c will be charged for simple questions requiring no schematics. Write for estimate on such questions as may require diagrams or considerable research.

PHONO AMPLIFIER

Q Please print a diagram of a phono amplifier using a 56 and 2A5. I plan to use the amplifier with a 250-volt power supply.—C.J.M., USN, Great Lakes, Ill.

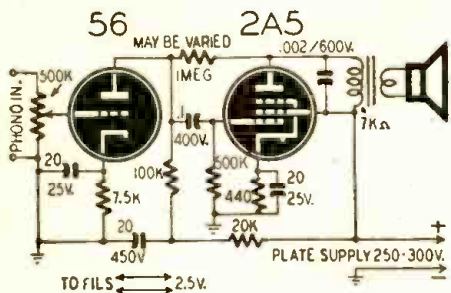

A. The diagram shown is as specified. The cathode biasing resistor and condenser may be eliminated by grounding the cathode and connecting the return side of the grid resistor to 20 volts negative bias. The output of the amplifier is 4.5 watts with cathode bias and 4.8 watts with fixed bias.

RECORDING AMPLIFIER

Q I would like a circuit of a recording amplifier using a 6SJ7, 6SQ7 and a 6L6, designed to mix the output of a mike and phono pickup. Please include inverse feedback from the output stage to improve the fidelity. I am planning to use a 4-ohm magnetic recording head, and would like to have provision made for aural and visual monitoring.—F.W.H., Philadelphia, Penna.

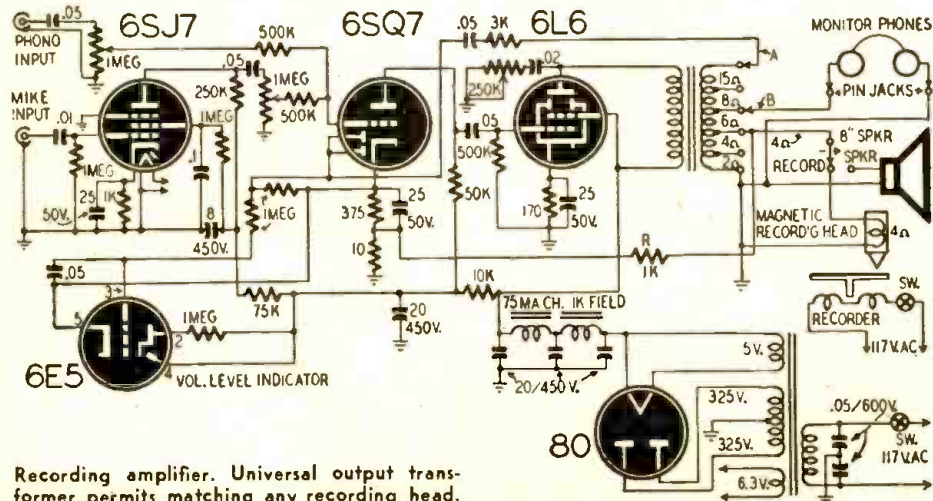

Recording amplifier. Universal output transformer permits matching any recording head.

PHONO AMPLIFIER

Q Kindly print a diagram of a small a.c.-d.c. phono amplifier using a 6SF5 and a 32L7.—P.S.W., Canal Winchester, Ohio.

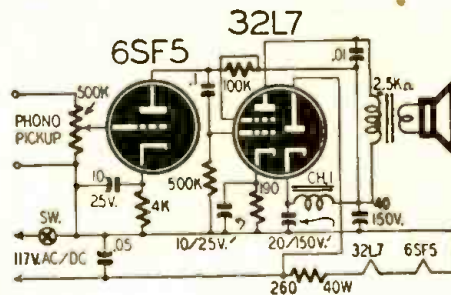

A. The diagram shown has been prepared for you. The same circuit may be used with a 6C5 or 6J5 voltage amplifier coupled to 25A7. If the latter tubes are used, cathode bias resistors will have to be changed to 4000, 6000 and 600 ohms respectively for 6J5, 6C5 and 25A7.

PILOT H-11 CONVERSION

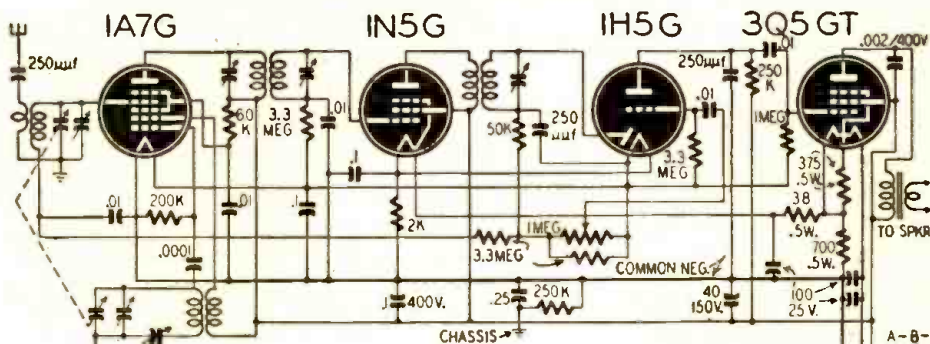

The Pilot H-11 converted to a 3-way portable.

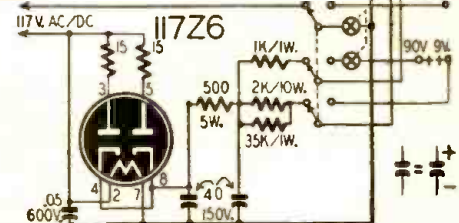

Q I have a Pilot Model H-11 battery set and would like to add a 117Z6 as a rectifier to supply A and B voltages.—W.R.R., Jamaica, N. Y.

A. A diagram for converting the Pilot to three-way operation is shown. A 3Q5 has been substituted for the 1C5 as it will perform better in an a.c.-d.c. set. A common negative return has been used for general safety when operating from an a.c. line.

A PRECISION INSTRUMENT

(Continued from page 19)

self admirably to extension of its range through the "vernier" effect upon P1 of adding R4, R4a into circuit to cover from 10 to 1000 μ f or megohms.

Voltage for operation of the bridge itself is supplied through special transformer T1 connected to the horizontal bridge arm junctures. Balance is indicated by the absence of voltage across the vertical bridge arm junctures (ground and arm of S1) indicated by the 6E5 electron-ray tube, with the null voltage amplified by the 6SN7GT triode to its left in Fig. 1. Indicator sensitivity is controlled by potentiometer P2.

The power transformer provides heater voltage to the three tubes, and has its high voltage secondary connected as a whole to the 5Y3GT rectifier tube used as a half-wave rectifier. Filtration is a simple problem in this type of instrument, while such use of an essentially standard power transformer and rectifier tube permits obtaining something over 500 volts d.c. output simply and easily. For operation of the amplifier and indicator tubes this is cut down to 200 volts by the voltage divider R10, R10a. The full 500 volt d.c. output of the power supply appears across extra-heavy potentiometer P3, with any panel-calibrated portion of this voltage from 0 to 500 volts obtainable from its arm for application to the capacitor—or resistor—under test through filter resistor R9, PUSH TO POLARIZE button switch S4, and isolating-current limiting resistor R5. C5 through C5f are all 8 μ f, 350 working volt electrolytic capacitors. C5d, C5e and C5f in series are the filter input capacitor of 1050 volts rating for the 500 volt circuit voltage—ample safety indeed against line surges. Voltage distribution across them, as well as across C5a, C5b and C5c is held constant and capacitor life is prolonged by shunt resistors R7a, R7b and R10b, R10c and R10d.

Switches S2, S2a shift the function of the 6E5 indicator tube from that of a bridge balance (null) indicator over into a two-range milliammeter with resistor shunts R11 and R12 yielding 0-10 and 0-100 ma ranges. The 6E5 connected across one or both of these resistors in series with the internal d.c. polarizing voltage source and the specimen under test provides a milliammeter which may not be burned out like the ordinary meter movement if a short-circuited condenser is inadvertently tested.

"Where extremely precise measurement of the leakage current through capacitors under test may be required, a more accurate indicator than the 6E5 is preferred. The milliammeter in any conventional volt-ohm-milliammeter may be employed for such precise measurement. It is merely necessary to connect such milliammeter between the capacitor under test and the black jack of the bridge. The meter should be short circuited for all except leakage current measurements, for its resistance can upset power measurements."



ROTARY SWITCH

Single gang, 6 pole, 3 position, shorting switch, 1 5/16" dia. with 1/2" shaft dia. Threaded bushing 3/8" long and 3/8" shaft.

5B3984 39¢

ANTENNA LOOPS



For battery and midget sets or portables. Replaces antenna coil; satisfactory pickup, excellent selectivity. Inductance slightly higher than necessary, permitting removal of turns for adjustment. 4 1/4" x 8".

C16450 48¢



10H 40MA. CHOKE

Extremely compact highly efficient choke well suited for auto radio receivers and AC/DC radios. Also excellent filter chokes for other receivers and amplifiers. 1 5/16" x 1 1/4" x 1 1/4". Unshielded strap type mounting.

C1601 46¢

Midget Electrolytic

Midget dry electrolytic will handle any job requiring an electrolytic capacitor. Polarity clearly indicated. Bare wire leads. Easily replaces larger capacitors. Cap. Mfd 20-20. DC-WV 150. 3/8" x 2 in.

C3153 60¢



L PAD

8 ohms, safely rated at maximum dissipation of 25 watts. Has continuous range from .5 to 30 dB attenuation in 10% steps. Last 10% affording infinite attenuation. Flatted shaft extends 5/16" from standard 3/8" bushing. Dia. 1 1/2", 1 3/8" deep.

5B2095 . 59¢

CONCORD
RADIO CORPORATION
LAFAYETTE RADIO CORPORATION

CHICAGO 7 ATLANTA 3
901 W. Jackson Blvd. 265 Peachtree Street

RADIO PARTS

SETS • AMPLIFIERS

COMPLETE
CONCORD
CATALOG
FREE!

Revised! Up-to-the minute! Listing the newest, the latest and best in RADIO PARTS, RADIO SETS, AMPLIFIERS, AMATEUR GEAR, ELECTRONIC EQUIPMENT, SUPPLIES and ACCESSORIES! Hundreds of items for every Radio and Electronic need—Condensers, Resistors, Transformers, Tubes, Test Equipment, Tools and Repair Replacement and Maintenance Parts of every kind. All standard top quality, nationally famous makes, are fully represented in the great new Concord Catalog. Complete lines including new and hard-to-get parts and equipment at latest O.P.A. prices or lower. Thousands of items—and complete stocks ready for immediate shipment from CHICAGO or ATLANTA. Your copy of the new Concord Catalog is ready now—FREE! Mail the Coupon below.

SEE . . .

Complete showing of ham gear, equipment, supplies and accessories for amateurs, engineers, servicemen, soundmen, retailers.

SEE . . .

the first peacetime Concord line of modern Radio Sets and Radio Phonograph Combinations—featuring a host of new, approved post-war developments...richer tone quality...super-selective tuning and reception...high fidelity...new modern design cabinets.

SEE . .

the thrilling new MULTIAMP Add-A-Unit Amplifiers, an entirely new revolutionary development in amplifier engineering with sensational new flexibility, power, fidelity and economy—EXCLUSIVE WITH CONCORD!

All in the new complete Concord Catalog . . . mail the coupon now.

Mail This Coupon Now!

CONCORD RADIO CORPORATION
901 W. Jackson Blvd.
Dept. RC-116, Chicago 7, Ill.

Yes, rush FREE COPY of the comprehensive new Concord Radio Catalog.

Name

Address

City State

NOW..

A complete line of

**OHMITE
RESISTORS**

LITTLE DEVIL

Insulated
Composition Resistors

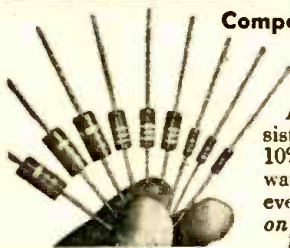

$\frac{1}{2}$, 1,
and 2 Watts
A new Ohmite resistor. Tolerance $\pm 10\%$. Resistance and wattage marked on every unit. Available only from Ohmite Distributors.

BROWN DEVIL

Vitreous Enameled Resistors



10 and 20 Watts
A favorite with radio servicemen. Tolerance $\pm 10\%$. Hard vitreous surface protects the wire from mechanical damage. Uniform winding prevents "hot spots."

DIVIDOHM

Adjustable Vitreous Enameled Resistors



10 to 200 Watts
Has a narrow strip of exposed wire along one side to provide a contact surface for the adjustable lugs. Ideal for quickly securing odd values of resistance. Sturdy... dependable.

Send for Catalog No. 18 and new Bulletin 127, for full information about these and other Ohmite resistors.

OHMITE MANUFACTURING CO.
4896 Flournoy St., Chicago 44, U. S. A.



Be Right with ..

**OHMITE
RESISTORS**

SOUND SYSTEM IMPROVEMENT

(Continued from page 21)

closure of this type, the back wave of the speaker is added in phase with the front wave through the port in the cabinet, which adds to the acoustic power obtainable at low frequencies. As a matter of fact, the radiation from the port exceeds the radiation from the cone at very low frequencies. This increases the low-frequency response, extending it approximately an octave lower, while at the same time more heavily damping the frequencies above this point. This tends to smooth out the response from the lower limit up.

Damping material is placed in the baffle behind the speaker to absorb the back wave. If this were not done, it would reflect from the back and cancel some of the higher frequencies emerging from the cone. This would give rise to very uneven high-frequency response. The overall effect is an enormous improvement in the bass and a clean high frequency response.

The baffle in Photos A and B was built for an 18-inch speaker, but this type of baffle works its wonders on any size speaker. Fig. 6 gives the dimensions for all standard size speakers. The enclosure should match your individual speaker. The dimensions given are approximate and there are two ways to vary the box's resonant frequency.

The easiest method is to vary the port size by placing a book over part of it while feeding several volts of 60-cycle a.c. into the speaker voice coil from a filament transformer. When the

proper size is arrived at, a piece of wood may be screwed over part of the port inside the box. The right position is where the greatest amplitude appears at 60 cycles.

The more difficult method is to move the back of the baffle in or out of the box until the desired result is obtained. For the 15 and 18-inch speakers it would be desirable to use a 30 or 40-cycle source for adjusting the baffle. The source should be a high-quality audio oscillator, with low distortion.

For AM or shellac pressing reproduction, a single speaker with response up to 5000 or 7500 cycles will be adequate. For FM or transcription reproduction,

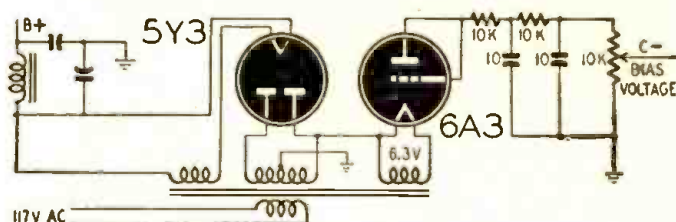

Fig. 5—Simple bias supply which works from the power transformer.

better results can be obtained with a dual speaker system, with a small high-frequency speaker added to extend the range of the larger unit. Several coaxial units are available, ranging in price from \$30 to over \$250.

Photo C shows a Jensen 18-inch low frequency speaker, a 14-inch speaker and a Jensen C3 tweeter. This combination is capable of reproducing the entire range from 30 to over 15,000 cycles.

The best place for a speaker in any room is in a corner facing the longest diagonal of the room. In this position

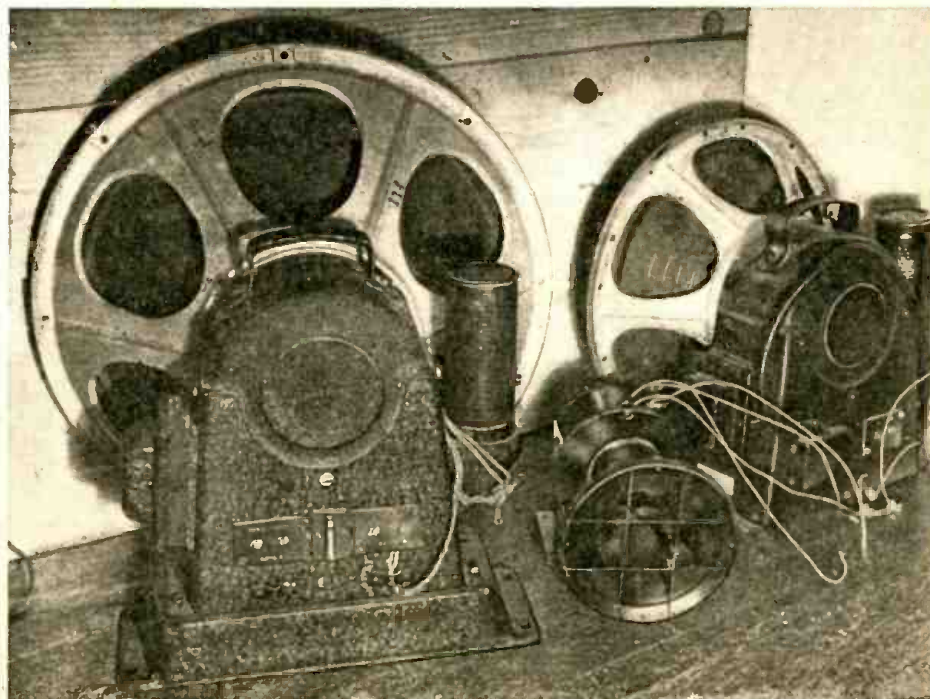
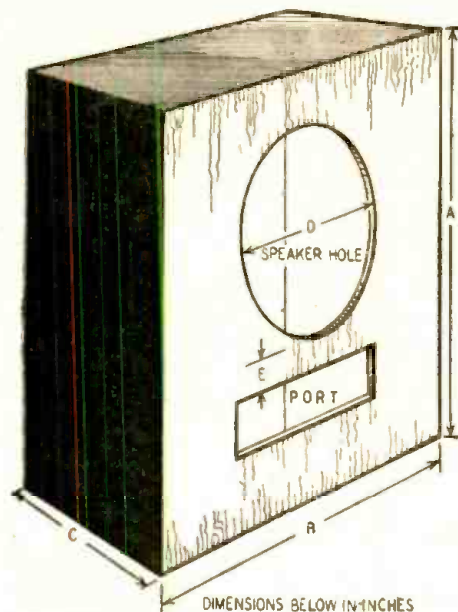

Photo C—A combination of speakers to provide high fidelity from 30 to 15,000 cycles.

the enclosure is best able to match the room's acoustic impedance. Remember to place the speaker far enough from the turntable so acoustic feedback will not occur from mechanical coupling at low frequencies.

Don't ruin records with worn needles. A regular steel needle will play one side of a 12-inch disc and should not be used further, as it will develop a pronounced flat spot with a sharp cutting edge which will tear up the next record.



DIMENSIONS BELOW IN INCHES

S	A	B	C	D	E	PORT
8	24	18	11	7	3	1/2 AREA OF SPEAKER HOLE "D"
10	28	22	12	9.5	3	"
12	31	24	13	11	3.5	"
15	34	26	14	13.5	4	9/16
18	40	27	14	16	4.5	5/8

*S COLUMN SHOW SPEAKER DIAMETERS

Fig. 6—Correct dimensions of speaker baffle (The first column "S" is diameter of speaker).

It will also allow the pickup to chatter in the groove, giving rise to a particularly obnoxious type of distortion.

It is a good investment to purchase a pickup with a built-in permanent stylus. The pressure on the record of these units is usually less than the replaceable-needle types. There is much less acoustical chatter, the hiss is lower and the sapphire stylus is kinder to your records.

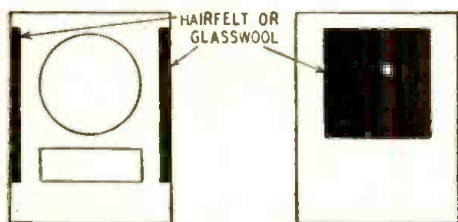

Suggested placement of sound-absorbing areas.

In the case of transcriptions, it is necessary to use a light-weight pickup, preferably with sapphire or diamond needles. The one greatest cause of surface noise on records is dust. They should be stored in dustless envelopes. If they get dusty, wash them in water. A dusting brush, which can be purchased in any record shop, is a good investment.

HARRISON HAS IT!

ALL STANDARD LINES!

- **RECEIVERS**
HALLICRAFTERS—HAMMARLUND—
NATIONAL—CARDWELL—RME—
COLLINS—PIERSON
- **TRANSMITTERS**
TEMCO—HALLICRAFTERS—
COLLINS—MECK—ABBOTT
- **TEST EQUIPMENT**
SUPREME—TRIPLETT—WESTON—
HICKOK—PRECISION—RCA—
JACKSON—SIMPSON—GE—
DUMONT—RCP—etc.
- **AMPLIFIERS**
BOGEN—THORDARSON—MASCO—
BELL—EASTERN—WEBSTER—etc.

● **PARTS**
All good makes—Harrison has it!
Complete stock.

More and more new models are
NOW IN OUR STOCK for

IMMEDIATE DELIVERY

Get **YOURS SOONER!**

Send your order to Harrison, NOW!

COAXIAL RELAY

Constant 52 ohm impedance. Throws antenna line from receiver to transmitter. Handles 750 watts of RF. Has three connectors for PL-259 Plugs, 115 Volt AC coil. Price Bros. model 6350 **\$7.35**
Same, with additional NC and NO contacts to control receiver. ECO, etc. Model 6351 \$8.33

ROTARY COAXIAL COUPLING

52 ohm constant impedance slip ring coupling. Made for Signal Corps by Lapp. to feed rotary antenna. Head, 1 1/2" dia. machined from brass. Copper feed line 7/8" dia. Is 51" long. Coaxial sockets at each end. HSS **\$7.75**

COAXIAL CABLE

RG-8/U. 52 Ohm impedance. FB for feeding beams, etc. Handles a KW with high efficiency. New, perfect cables.
110-foot length with two PL-259 coaxial plugs. Total list price \$39.281
HSS **\$4.98**

65-foot length with one plug. List \$22.59
HSS **\$3.45**

Cut to size in one piece within -0% to +20% of length ordered. Full measure!

Jan Type	Impedance	O. D.	1-100'	100' and up
RG-8/U	52 Ohms	.405"	9c	6c
RG-11/U	75 Ohms	.405"	10c	7c
RG-13/U	74 Ohms	.420"	14c	10c
RG-39/U	73 Ohms	.312"	11c	8c
RG-58/U	55 Ohms	.195"	8c	5c

HARRISON HAS IT!

HARRISON SELECT SURPLUS

Your assurance of good, usable, guaranteed materials at sensationally low prices — **TOP VALUE ALWAYS!** Come in and browse through our large HSS Department.

RECHARGEABLE POWER PACK



One of the most sensational HSS values ever offered! This modern, Navy accepted pack will save space, weight, and money. Ideal for portable transmitters, receivers, test equipment, remote controls, etc.

Only 3 lb., 10 oz., complete! 1 1/4" x 3 3/8" x 6 1/2". Delivers — 135 volts at 20 ma in continuous Military duty or 30 ma, or more, in intermittent Amateur service; 67 1/2 volts at 5 to 8 ma; 1.5 filament or 6.3 heater,

bias, and microphone voltages.

NON-SPILL storage battery can be recharged over and over for a penny or two. Brand new, with fully charged battery, and instructions. Complete, ready to use **\$5.50**

SPARE BATTERY
6 volt.
Fully charged.
\$2.00

BATTERY CHARGER
Noiseless. Selenium rectifier type, to trickle charge these or any other small batteries.
110 Volt AC **\$2.97**

BC-406 15 TUBE UHF RECEIVERS

Been getting such FB reports from our customers about these swell Signal Corps Radar receivers that we just had to get more for you!

Six acorn tube RF circuit, tuned to 205 mc; four IF stages; Thordarson heavy-duty power transformer delivering 350 volts at 145 ma; four choke and oil condenser filters; 115 volt, 60-cycle operation; chassis 10 1/2" x 25 1/2" in metal case. Slightly used but fully guaranteed.

Complete with tubes: 5—954, 1—955, 4—6SK7, 2—6SJ7, 2—6N7, 1—5T4.

Instructions and diagrams for easy conversion to a hot 10 (also 6 and 2) meter superhet receiver are included. Parts alone are worth much more than our **\$19.98** low HSS Price.....

OIL CONDENSERS

1 mfd. 5000 Volt. With stand-off insulators \$3.95
2 mfd. 1000 Volt. Compact round type. Mounts in 3/4" hole. FOUR for \$2.34

HSS TUBES

Brand new, per feet. 805—\$5.75. 3E29 (829B) — **\$4.79**

MAIL ORDERS?

Certainly! Just list everything you want (items in this ad, or any ad, magazine, or catalog) and include remittance.

Vy 73 de

Bill Harrison, W2AVA

HAM HEADQUARTERS
Since 1925!



HARRISON RADIO CORPORATION

9 WEST BROADWAY • NEW YORK CITY 7

PHONE—Bardoy 7-9634 • EXPORT DEPT.—CABLE—HARRISONRAD

[JAMAICA BRANCH—172-31 Hillside Ave.—REpublic 9-4102]

HERSHEL'S LOW PRICED SPECIALS

Famous
for low prices
and quick delivery

DYNAMOTOR—6 or 12 V



500 VDC at 160 MA Mounted on box with circuit breakers, relays, interference filter and two 10' cables. Army Surplus. **\$9.95**

- 6.3V. 6A. 110 V-60 cy. Fil Trans **\$1.49**
- 28V. 2A 110 V-60 cy. Trans. **\$1.29**
- 30 mc Silver Slug Tuned single I.F. in can . **.29**

TRANSMITTER & RECEIVER



A 24 tube unit that may be easily converted to 144 mc transmitter and receiver. Supplied less power transformer and tubes. **\$14.95**

- Oil filled paper condenser 1MFD 600 w.v.d.c. **.39**
- Oil filled paper condenser 1MFD 1000 w.v.d.c. **.69**
- Tubes VR 150 **.49**
- Tubes 955, 9004 **.65**
- 1T4, 3Q4, 3S4 6SN7, 12H6, 12SH7. **.49**
- 200 W. 75M ohms Bleeder **.49**
- 100W 2500 ohms Bleeder Var. **.49**
- Johnson 25W proclin sockets, 4 prongs **.39**
- 3000 WVDC .002 Mica 2.5 Amp. 300 KC **.89**

HERSHEL RADIO CO.

20% DEPOSIT WITH ALL C.O.D. ORDERS
6249 GRAND RIVER, DETROIT 8, MICH.

Headset Headquarters CANNON-BALL



is unusually sensitive. For clarity of tone, dependable performance, quality at a fair price, choose the Cannon-Ball Guaranteed Headset you like best. Folder R-11 illustrates complete Cannon-Ball line of efficient Headsets.

Scientifically Built
Heavy bar magnets greatly increase their efficiency.

Write
C. F. CANNON COMPANY
SPRINGWATER, N. Y.

RADIO-CRAFT PAYS \$3 for good Radio Cartoon Ideas. Artistic work is not needed—just send us a rough sketch or verbal outline.

THE TELE-THEATRE

(Continued from page 13)

of the actors on the stage of the Theater Guild, and showed this performance on the television screen of the Broadway Theater. This, then, was the first time in history that two theatres were connected together by means of television. The results were quite satisfactory. What has been done on a small scale here, will be done on a tremendous scale in the very near future by the instrumentality, which I now term the "Tele-Theatre."

Imagine a special building, erected in the City of New York, for the sole purpose of supplying the entire country with its daily theatre program—not, mind you, motion pictures, which are a "canned" product, but an actual theatrical performance just as it is being produced at the exact time on the New York stage.

In order to do so, I visualize a building which will have a series of stages, grouped around a central shaft or pit. There will be stage 1, stage 2, and as many stages as required. The idea of the multiplicity of stages is, that I propose to move the actors rather than move the scenery. At the present time it is necessary for the actors to go behind or before the curtain, when scenes are shifted; which is awkward and always takes up an amount of time for which

the public in the future will not stand.

In the central pit we have the stage director at the top of a skeleton steel structure with his assistant technical directors. Stage No. 1 is lit up and the orchestra located immediately beneath the director starts to play. Below the orchestra are a "battery" of television transmitters. Microphones are located in the wings in strategic positions. Television transmitters are connected to a wire network radiating to all parts of the country, just as the wire network transmits radio broadcast programs to the different radio stations in the country now. (Note: This was written before the invention of the co-axial cable, which probably will be used instead of wire lines. H.G.)

In Boston, Chicago, Atlanta, San Francisco, and hundreds of other points, we will have local theatres where, for 50c, audiences are assembled nightly to see the latest Broadway production. Instead of 1,500 or 1,600 people seeing the "Follies," five or ten million people will view them nightly, for one week, or for as long a time as the show is put on by the producers. Immediately the undertaking becomes tremendously lucrative, because millions now support a production; whereas before only hundreds did so, at prices which only the rich can afford.

In the Tele-Theatre, we will, of course, have both sight and sound, and the audience will actually see and hear their favorite actors at the exact time when the production is being performed in New York. And, of course, it will even be possible to have the actors enjoy the applause, because microphones in the Tele-Theatre will pick up the sounds of the applauding audiences and convey the sounds back to New York; so the actors will have the satisfaction of the applause which is now missing, so much to their detriment, in motion pictures.

Naturally, there will be a number of Tele-Theatres in the larger cities, all supplied by the central theatre in New York; so that, if you wish to go out in the evening, you need not see a musical show if you do not wish to do so. You may, instead, see a "comedy" or "straight-drama" in another Tele-Theatre in your own town, because New York City will telecast a multiplicity of productions for the same evening.

I need not mention that the productions of the future will be on an unparalleled and prodigious scale, never approached before; for the simple reason that, when millions are to view the same performance, naturally it can be ever so much more elaborate.

And, to satisfy remote points such as the West Coast, duplicate performances must be put on later in New York, on account of the difference of time. Thus, for instance, a man in San Francisco will be seated at 8 o'clock (his time), which is 11 pm in New York, when the second performance for the West starts.

EASY TO LEARN CODE

It is easy to learn or increase speed with an Instructograph Code Teacher. Affords the quickest and most practical method yet developed. For beginners or advanced students. Available tapes from beginner's alphabet to typical messages on all subjects. Speed range 5 to 40 WPM. Always ready—no QRM.



ENDORSED BY THOUSANDS!

The Instructograph Code Teacher literally takes the place of an operator-instructor and enables anyone to learn and master code without further assistance. Thousands of successful operators have "acquired the code" with the Instructograph System. Write today for convenient rental and purchase plans.

INSTRUCTOGRAPH COMPANY

4701 Sheridan Rd., Dept. RC, Chicago 40, Ill.



AT LAST—A HANDY,
POCKET-SIZE

ELECTRICAL AND RADIO TROUBLE-SHOOTER

quickly and conveniently checks radios, motors, fuses, wall plugs, sockets, switches, irons, broilers, toasters and all other electrical appliances from 60 A.C. 90 D.C. to 550 volts A.C. or D.C.

Also distinguishes A.C. from D.C. Rigidly attached POCKET-CLIP permits tool to be carried like fountain pen. Comes with genuine LEATHER CASE which permits faster to be carried in tool kit. Instruction sheet with every tester. No C.O.D. shipments outside U. S. A.



\$1.00

ANY BOOK IN PRINT

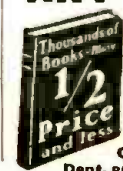

Delivered at your door. We pay postage. Standard authors, new books, popular editions, fiction, reference, medical, mechanical, children's books, etc. **Guaranteed savings.** Send for Clarkson's 1947 catalog. Write for our great illustrated book catalog. A short course in literature. The buying guide of 300,000 book lovers. The answer to your Christmas gift problem. Free if you write now—today!

CLARKSON PUBLISHING COMPANY
Dept. RC, 1257 So. Wabash Ave., Chicago, Ill.

PORTABLE A. C. AMMETER

Surplus New

WESTON MODEL 528



Dual Range 0-3 Amp. and 0-15 Amp. full scale for use on any frequency from 25 to 500 cycles. The ideal instrument for all commercial, industrial, experimental, home, radio, motor and general repair shop testing. Comes complete with a genuine leather, plush-lined carrying case and a pair of test leads. A very convenient pocket sized test meter priced at less than 50% of manufacturer's list.

Your cost ONLY \$12.50

MATCHING METERS

Surplus—New—Guaranteed

All meters are white scale in round, flush, bakelite cases unless specified otherwise.

- G.E. DO-41, 3 1/2" 0-200 microamp movement, special scale, with paper V.O.M.A scale @ \$6.00
- G.E. DO-41, 3 1/2" DC, 500 microamp. mvt., scale 20 KV, comp. with paper V-O-M sc \$4.95
- G.E. DO-41, 3 1/2" DC, 1.5 KV comp. with 1000 r/v ext. prec. resist. \$6.95
- G.E. DO-41, 3 1/2" DC, 2.5 KV comp. with 1000 r/v ext. prec. resist., bl. sc. \$6.95
- G.E. DO-53, 3 1/2" DC, square, 15 KV comp. with 1000 r/v ext. prec. resist. \$16.00
- G.E. DO-41, 3 1/2" DC, 1 MA. \$4.95
- G.E. DO-53, 3 1/2" DC, square, 1 MA mvt., 5000 ohm resist, 0-50 sc. \$3.95
- G.E. DO-53, 3 1/2" DC, square, 20 MA \$4.95
- G.E. DO-41, 3 1/2" DC, 80 MA \$3.95
- G.E. DO-41, 3 1/2" DC, 50 MA, bl. sc. \$3.95
- G.E. DO-41, 3 1/2" DC, 50 MA \$4.95
- G.E. DO-41, 3 1/2" DC, 80 MA \$4.50
- G.E. DO-41, 3 1/2" DC, 200 MA \$4.95
- G.E. DO-41, 3 1/2" DC, 100 MA \$2.50
- G.E. DO-41, 3 1/2" DC, 25 MA \$4.50
- G.E. DO-41, 3 1/2" DC, 1 Amp, black scale \$3.00
- G.E. DO-41, 3 1/2" DC, 200 Amp, with ext. shunt \$12.50
- G.E. AO-22, 3 1/2" AC, 5 Amp. movement, 50 Ampere scale, comes comp. with ext. current trans. By adding primary turns to the "donut" trans. the range of the meter can be made to 5-10-25&50 Amperes. AC diagram furnished \$7.00
- G.E. AO-22, 3 1/2" AC, 50 Amp self-contained \$4.50
- G.E. AO-22, 3 1/2" AC, 80 Amp self-contained, \$3.50
- G.E. AO-22, 3 1/2" AC, 15 volt bk. sc. \$4.50
- G.E. AO-22, 3 1/2" AC, 50 volts at 1000 cycles mtd. on metal angle bracket with 6' Tyrex leads & clips \$2.50
- G.E. AO-22, 3 1/2" AC, 150 volts \$5.50
- G.E. AO-22, 3 1/2" AC, 150 volts, black scale, \$4.50
- G.E. AO-25, 3 1/2" AC, sq. case, 150 volts. \$5.50
- G.E. AO-22, 3 1/2" AC, 300 volts \$8.00
- G.E. DO-46, 3 1/2" 400 Microamp 3 Volt AC mvt, self-contained rectifier, special scale \$5.50

Add sufficient money on parcel post orders, excess will be refunded.

MARITIME SWITCHBOARD

Worth 4-8217

336 Canal Street New York 13, N. Y.

THE POSTWAR RADIOS

(Continued from page 30)

GT power amplifier stage, which drives a 4-inch PM speaker.

The rectifier is a 35Z5-GT connected in a conventional half wave circuit working into an R-C filter consisting of a 2200-ohm resistor and the 70- μ f capacitor.

The tuning knob, 3/4-inch in diameter, is too small for tuning in any but local stations. These cannot be selected with a great degree of accuracy on the tuning dial calibrated at 55, 65, 80, 100, 130, 150 and 160. In each case, the last zero has been omitted so that 130 on the dial indicates the correct setting for receiving a station on 1300 kc.

HOME INTERCOMMUNICATOR

(Continued from page 17)

leads of T1, however, is inserted a resistor R6, and the by-passing switch S1 and one pair of relay contacts. S6 and another pair of relay contacts open or close the power supply B-minus connection to ground. When S1 and S6 and both circuits of the d.p.s.t. relay are open, the plate voltage on the tubes is removed and the filament voltage is cut down to approximately half normal value. This is the standby condition, and allows almost instantaneous use of the amplifier, but conserves tube life when idling. Using a 800-ohm resistor for R6, the idling filament voltage will be about 3.4 volts. R6 is a 20-watt wire-wound unit. This results in a warm-up period from idle condition to full gain of approximately five seconds. This waiting time, starting from cold tubes of the type described, is longer than fifteen seconds. Placing R6 in the transformer primary, rather than the proper value in the filament leads, avoids excessive heating of T1 under continuous operation, and eliminates all transformer hum while idling. (Transformer hum, (Continued on page 69)

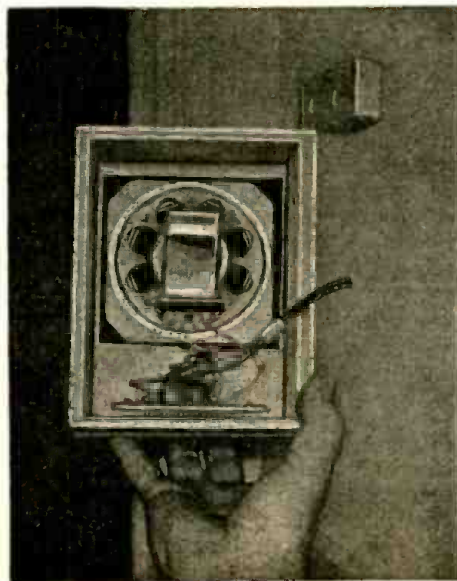

An interior view of one of the substations.

FREE! Send for it Now!

ALLIED'S Catalog of Everything in RADIO



LARGEST STOCKS QUICK DELIVERY

Send for your FREE copy of the handiest, most complete Buying Guide for Everything in Radio! Features thousands of radio and electronic parts, latest home radios, sound systems, amateur and builders' gear, servicemen's equipment, tools, books—world's largest and most complete quality stocks—at lowest prices! Fastest service; expert help!

OVER 10,000 ITEMS.....



Complete lines of all leading makes. Largest stocks of hard-to-get parts. Money-saving prices. Get everything you need from one dependable supply source.

AMATEUR GEAR.....



Earliest delivery on latest communications receivers. Time payment plan; trade-ins accepted. Headquarters for all ham and experimenter's needs.

HOME RADIOS.....



Large selection of exceptional home radios and phono-radios. Handsome new styles. Wonderful performance. Today's leading set values.

PUBLIC ADDRESS.....



Famous Ready-to-Use Sound Systems for every P.A. requirement. Everything in amplifiers, speakers, microphones, intercom and recording.

HANDY RADIO BOOKS.....



Radio Formulas and Data Dictionary of Radio Terms Radio Circuit Handbook Radio Builder's Handbook Simplified Radio Servicing Radio Data Handbook ALL SIX BOOKS No. 37-799...75c

Parallel Resistance and Series Capacitance Calculator, No. 37-960 25c R-F Resonance and Coil Winding Calculator, No. 37-955 25c

ALLIED RADIO

ALLIED RADIO CORP. 833 W. Jackson Blvd., Dept. L-LL-6, Chicago 7, Ill.

- Send FREE Radio Catalog
 - Send 6 Books No. 37-799
 - Send Calculator No. 37-960
 - Send Calculator No. 37-955
- \$..... enclosed

Name.....

Address.....

City.....Zone.....State.....

Variety . . .

VALUES!



Superior Signal Generator

Model 650

110-120 Volts 50 to 60 Cycles A. C. R.F. Frequencies from 100 Kc to 35 Megacycles. Harmonics from 25 to 105 Megacycles. Audio Modulating Frequency—400 Cycles

Pure Sine Wave. Distortion less than 2%. Uses a Hartley Excited Oscillator with a Buffer Amplifier.

Complete with coaxial cable, test leads and instructions **\$48.75**

SUPERIOR Model 670 Super-Meter

A Combination



VOLT - OHM MILLIAMMETER plus CAPACITY REACTANCE INDUCTANCE and DECIBEL MEASUREMENTS.

Complete with test leads and instructions **\$28.40**

1 TUBE RADIO KIT by "EASY-BUILT"



Battery operated, easy tuning, attractive wood finish cabinet. Complete with Tube, Coll. Battery, Headphone, Hardware and Base.

List Price \$4.98

Special **\$3.33**

PHONO MOTOR with TURNTABLE

60 Cycles, 115 Volts
\$3.95



Suitable for every phonograph instrument where low cost and dependable performance are required.

Federal Telco Selenium Rectifier replaces Rectifier Tube **99c each**

Tremendous Saving on By Pass Condensers! By Pass Condensers and Kit contains 100 Popular assorted types Normal Cost \$10.95 Special **\$6.75**

Filter Condenser Kits—23 assorted types—Value \$12.00 Special **\$8.75**

Permanent Tuner Assembly..... **\$2.35**

Dial Face Assortment 10 for **\$1.49**

Universal Replacement Loops 50c each

10 Watt Amplifier complete with tubes **\$22.75**

Neon Testers with Instructions List Price 50c ea. Special **29c**

Dial Condensers 25 ft. **29c**

Dumont 3" Scope **\$99.50**

HY-Q 75 Kit unassembled **\$9.95**

assembled **\$11.95**

Test Leads Superflex Pencil Type 75c

with Insulated Tip **\$1.00**

High Voltage-Heavy Duty **\$1.95**

10 or more sets of any assortment deduct 10%.

1 cell Bantam Handy Flashlite.

Precision tool, solid bar aluminum, small, powerful and durable. List Price **89c**

Dealer's Price **54c**

Fluorescent Desk Lamps. List Price **\$11.95**

Dealer's Price **\$6.95**

Write Dept. C11 for our FLYER
20% Deposit with order required.

Variety ELECTRIC CO., Inc.
601 Broad St., Newark 2, N. J.

TELEVISION FOR TODAY

(Continued from page 25)

the other end was stretched back and forth. Too great an increase in control will produce a thin, watery image; too low a setting will give a relatively dark image with little variation in light values.

AUTOMATIC GAIN CONTROL

In addition to the manual contrast control, many receivers incorporate automatic gain control. Its counterpart in present broadcast receivers, is a.v.c.; unlike conventional receivers, however, a.g.c. and the contrast control are almost invariably linked into one circuit in controlling the gain of the video i.f. stages. In addition, the problem of using the average level of the incoming signal to obtain the required biasing voltage for the a.g.c. is entirely different than what is encountered with a.v.c. To understand why, let us compare the signals of a sound broadcast with those transmitted for television. In the sound broadcast Fig 3, we see that the recti-

the lowest voltages. The engineer at the studio control panel regulates the average illumination of the video signal—in accordance with the script—by raising or lowering the average level of the video voltages generated by the scanning beam. He does this by inserting a d.c. voltage. The full video signal, then, contains the a.c. component and an inserted d.c. component. The word inserted is used because this value is generally adjusted by a human element, the engineer.

The video signal, in this form, modulates the carrier and is transmitted. Upon demodulation in the receiver, both these components reappear, together with an average d.c. value due to the carrier. The inserted d.c. voltage, acting with the average d.c. voltage from the carrier, makes it impossible to utilize this latter voltage for gain control, as with a.v.c. The inserted d.c. component varies with each scene and if we used it for a.g.c. the gain would fluctuate accordingly.

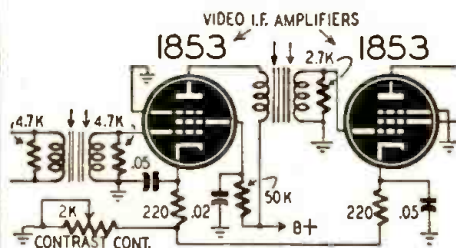

Fig. 2—A simple method of contrast control.

fied voltage consists essentially of two parts—the audio component and the d.c. component derived from the carrier. The d.c. voltage thus derived serves as the a.v.c. bias. (We are ignoring the i.f. ripple because this is always by-passed around the load resistor.)

But now examine the television carrier and its rectified voltage, shown in Fig. 4. This contains an a.c. (or varying) video voltage, an average d.c. voltage due to the rectification of the carrier (similar to the d.c. voltage mentioned above) and one additional component. It is this additional component that prevents us from using the average d.c. voltage just mentioned. And, strange as it may appear, this additional voltage is also d.c. in nature.

To determine the need for the latter component, let us briefly analyze any scene to be televised. In Fig. 5 we have two identical varying video voltages obtained from one line of an image scanned by the television camera. Note, however, that in Fig. 5-a the average value of the camera signal is low while in Fig. 5-b the average value is higher. In terms of the scene, this difference in average voltage level denotes that both scenes have the same actors, objects and scenery, but that one possesses a greater background or average illumination than the other. The scene with the greater illumination is represented by Fig. 5-a because with negative transmission, the brightest scenes have

CONTROL FOR THE GAIN CONTROL

The source for the regulatory a.g.c. voltage lies in the level of the synchronizing pulses, since it is current practice to raise each pulse to the same amplitude. As long as a carrier retains a fixed strength, the synchronizing pulses will attain the same level. Should the carrier amplitude decrease, due perhaps to atmospheric conditions in the path of transmission, then the strength of each pulse will likewise decrease. Here, then, is an excellent indication of changes in carrier amplitude. In conjunction with a relatively simple diode detector, the corresponding a.g.c. voltage may be readily produced.

The a.g.c. circuit, shown in Fig. 6, is employed in several G.E. sets. One half of the 6H6 is used for the video detector, the other half for a.g.c. In the a.g.c. circuit, we find R1, R2, R3, R4, and R5 with the 0.05-μf condenser connected between R4 and R5. Since the detector half of the 6H6 does not enter into the operation of the gain control circuit, it will be disregarded.

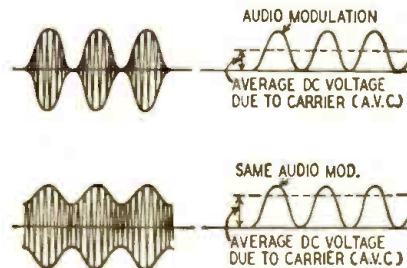

Fig. 3—Audio and d.c. components in carrier.

The modulated video signal is applied to the plate and cathode of the diode, and current flows whenever the plate becomes positive. The path of the current is from cathode to plate through R4, R2, (Continued on page 68)

UNIVERSAL 1-KW AMPLIFIER

(Continued from page 22)

the instability in high-power beam tetrode and pentode r.f. amplifiers may be due to *electrostatic* coupling between the grid and plate tank tuning condensers as well as electromagnetic coupling between the two tank coils. This point is frequently overlooked and many amateurs construct amplifiers in which only a few inches separate the "hot" tank condenser plates of the two circuits. When the grid tank condenser was placed under the chassis, all troubles from oscillation when using the 4-125As and the HK-257Bs disappeared *in spite of the fact that the grid coil is unshielded*. This arrangement also allows more room on top of the chassis for physically larger tubes such as the RCA 810 or Taylor T125.

Both the grid and plate coils are of the Barker and Williamson swinging-link type. Variable-coupling coils in both the input and output circuits of the amplifier give the unit extreme flexibility and permit the use of almost any exciter which will supply the minimum grid power requirements. The plate coil is a HD type conservatively rated at 1,000 watts; the grid coil is rated at 75 watts. The swinging link assembly is constructed as an integral part of the jack bar. When changing bands it is only necessary to remove and insert the plate coil—the swinging link coil is not disturbed. The adjustable grid coil link is constructed as a part of the plug-in grid coil assembly. In this unit, the link is removed with the coil when it is desired to operate on another frequency band. The grid condenser is a two-section type of 105 μ f per section maximum capacity, spacing 0.045 inch, peak voltage rating 2,000 volts. The plate condenser is also a two-section transmitting type of 99 μ f per section maximum capacity, spacing 0.175 inch, peak voltage rating 7,000 volts.

THE METERING SYSTEM

The milliammeter on the front panel is a 0-50 ma d.c. $3\frac{1}{2}$ inch General Electric type and was obtained from war surplus stock. It is connected into grid and plate circuits by means of the flexible coaxial lead and phone plug and the two jacks along the left bottom of the panel. When the plug is inserted into the jack at the right nearest the small tuning dial, the meter reads directly from the scale and indicates grid current. With the plug inserted into the jack at the left, the meter indicates plate current (or in this unit, the combined plate and screen currents) and the scale readings are multiplied by ten. This is accomplished by placing a suitable shunt across the *plate current jack terminals* which automatically converts the 0-50 milliammeter into a 0-500 milliammeter. About 1.8 ohms of Advance wire are needed. Adjust till meter reads 500 ma full-scale when compared with a standard meter.

The large four-inch dial is the plate

tank tuning control; the small dial is the grid tank tuning control.

TUNING-UP PROCESS

Adjustment and operation of the amplifier is simplicity itself. The unit should be perfectly stable and free from spurious radiations or parasites if the layout shown in the photographs and drawings is duplicated. To place the amplifier in operation:

1. Put the two 4-125A tubes in their sockets and connect the primary of the filament transformer to the 110 volts, 60 cycles a.c. line. Using a good quality a.c. voltmeter, with a scale of *not over 25 volts*, check the filament voltage of each tube in turn *right at the filament terminals of the tube socket*. If the filament voltage is high or low, as compared with the manufacturer's specifications, take steps to correct the condition. The use of a Variac or other voltage-adjusting device is a practical necessity when working with expensive transmitting tubes. The tubes not only will last much longer when operated at the proper filament voltage, but better *r.f. efficiency* will be obtained.

2. With a co-axial line or twisted pair, connect the output link of your exciter to the adjustable link of the amplifier grid coil. Adjust the grid coil link for minimum coupling. *Do not apply plate and screen voltage*. Insert the milliammeter plug into the jack at the right. Connect the proper fixed bias voltage in series with the grid return as shown in the schematic diagram.

3. Apply r.f. excitation to the grid circuit link coil. Rotate the grid tank tuning dial and watch the milliammeter. Grid current will be indicated when the grid tuning control is adjusted to resonance with the excitation frequency. If no grid current or too low a grid current reading is obtained at resonance, move the link toward the center of the coil and carefully retune the grid circuit for maximum grid current indication. When the grid current is of the value specified for the plate voltage in use, carefully "peak" the grid tuning control and leave it alone. NOTE: Unless the r.f. driver stage regulation is very good, the grid current will drop slightly after the plate and screen voltages are applied. After the amplifier is in operation, the link coil may be readjusted to give proper grid current reading with the plate and screen voltages applied.

4. Leave the grid circuit alone. Remove the plug from the grid current jack and insert it into the plate current jack. Connect a 110 volt, 100- to 200-watt lamp across the terminals of the plate circuit swinging link coil to act as a dummy antenna. The plate voltage should be reduced to approximately 1,000 to 1,500 volts for the preliminary tune-up procedure. This may be accom-

(Continued on page 71)

USEFUL XMAS GIFTS



\$4 COMPLETE

PAY ONLY \$1 A MO.

for AUTO MECHANICS

AUDELS AUTO GUIDE explains in detail with illustrations and diagrams for better service the whole subject of auto mechanics: Basic principles—Construction—Operation—Service—Repair, Handy Size, Easily understood. NEW FLUID DRIVE, HYDRAULIC SHIFT AND DIESEL ENGINES FULLY COVERED. Over 1700 pages—1540 illustrations showing inside views of modern cars, trucks and buses with instructions for service jobs. This standard book saves time, money and worry for operators and mechanics. Step up your own skill! with the facts and figures of your trade. Audels Mechanics Guides contain Practical Inside Trade Information in a handy form. Fully Illustrated and Easy to Understand. Highly Endorsed. Check the book you want for 7 days' Free Examination.

Send No Money. Nothing to pay postman.

CUT HERE MAIL ORDER

AUDEL, Publishers, 49 W. 23 St., NEW YORK 10, N. Y.

Please send me postpaid for FREE EXAMINATION books marked (x) below. If I decide to keep them I agree to mail \$1 in 7 Days on each book ordered and further mail \$1 monthly on each book until I have paid price. Otherwise, I will return them.

- AUTOMOBILE GUIDE, 1700 Pages . . . \$4.
- REFRIGERATION & Air Conditioning, 1280 Pgs. . . 4.
- OIL BURNER GUIDE, 384 Pages . . . 1.
- POWER PLANT ENGINEERS Guide, 1500 Pages . . . 4.
- PUMPS, Hydraulics & Air Compressors, 1658 Pgs. . . 4.
- WELDERS GUIDE, 400 Pages . . . 1.
- BLUE PRINT READING, 416 Pages . . . 2.
- SHEET METAL WORKERS Handy Book, 389 Pgs. . . 1.
- SHEET METAL PATTERN LAYOUTS, 1100 Pgs. . . 4.
- AIRCRAFT WORKER, 240 Pages . . . 1.
- MATHEMATICS & CALCULATIONS, 700 Pgs. . . 2.
- MACHINISTS Handy Book, 1600 Pages . . . 4.
- MECHANICAL Dictionary, 968 Pages . . . 4.
- DIESEL ENGINE MANUAL, 400 Pages . . . 2.
- MARINE ENGINEERS Handy Book, 1280 Pages . . . 4.
- SHIPFITTERS Handy Book, 272 Pages . . . 1.
- MECHANICAL DRAWING COURSE, 160 Pages . . . 1.
- MECHANICAL DRAWING & DESIGN, 480 Pgs. . . 2.
- MILLWRIGHTS & Mechanics Guide, 1200 Pgs. . . 4.
- CARPENTERS & Builders Guides (4 vols.) . . . 6.
- PLUMBERS & Steamfitters Guides (4 vols.) . . . 6.
- MASONS & Builders Guides (4 vols.) . . . 6.
- MASTER PAINTER & DECORATOR, 320 Pgs. . . 2.
- GARDENERS & GROWERS GUIDES (4 vols.) . . . 6.
- ENGINEERS and Mechanics Guides
 - Nos. 1, 2, 3, 4, 5, 6, 7 and 8 complete . . . 12.
- Answers on Practical ENGINEERING . . . 1.
- ENGINEERS & FIREMANS EXAMINATIONS . . . 1.
- ELECTRICIANS EXAMINATIONS, 250 Pages . . . 1.
- WIRING DIAGRAMS, 210 Pages . . . 1.
- ELECTRICAL DICTIONARY, 9000 Terms . . . 2.
- ELECTRICAL POWER CALCULATIONS, 425 Pgs. . . 2.
- HANDY BOOK OF ELECTRICITY, 1340 Pages . . . 4.
- RADIOMANS GUIDE, 914 Pages . . . 4.
- ELECTRONIC DEVICES, 216 Pages . . . 2.
- ELECTRIC LIBRARY, 12 vol., 7000 Pgs., \$1.50 vol.

Name _____

Address _____

Occupation _____

Employed by _____ R. C. F.

18 YEARS IN RADIO



**GET THIS
New CATALOG
By This Old Firm**

Latest developments in radio and electronic parts and devices, newest ham gear, gadgets for experimenters, bargains in war surplus items.

**FREE
TO YOU**

Mail the coupon below and get this new catalog FREE.



BURSTEIN-APPLEBEE CO.,
1012 McGee, Kansas City 6, Mo.

Send me FREE catalog advertised in
Radio Craft

I AM _____
STATE CONNECTION IN INDUSTRY _____
NAME _____
ADDRESS _____
TOWN _____ STATE _____

WIRELESS PHONO OSCILLATOR

NO LICENSE REQUIRED
Transmits recordings from phono pickup or voice from mike to radio without use of wires up to 500 ft. Neatly Designed.
Complete Kit with tubes.....\$5.75
Above Kit assembled and tested.....\$6.95
Immediate delivery.

CONSTANT ELECTRIC

112 Cornelia Street Brooklyn 21, N. Y.

New Radio-Electronic Patents

By I. QUEEN

MODULATION STEP-UP

Frank H. Slaymaker, Rochester, N. Y.
Patent No. 2,403,245

This method greatly increases the percentage of modulation of an r.f. carrier. Mobile units such as tank transmitters must operate at very low percentages of modulation due to requirements of portability. For example, in a tank it is possible to include a large loop which creates the r.f. field. Within this field, the operator carries about with him a small loop and portable modulating apparatus. The small loop modulates the r.f. by absorption. Due to the necessarily simple audio equipment possible, the percentage of modulation is very low.

In this invention, the r.f. amplifier is biased

so that the modulated portion of the carrier coincides with the lower portion of the r.f. tube characteristic. In this way only the modulated portion is present in the output circuit as shown. This corresponds to 100 percent modulation. The

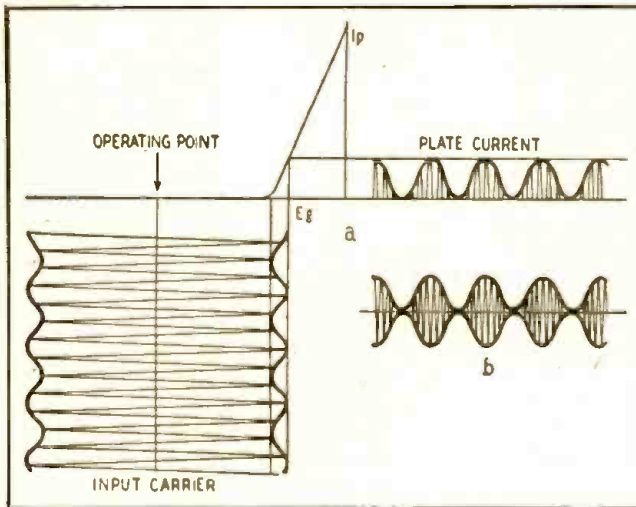
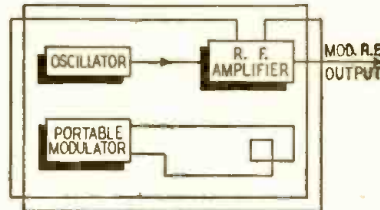

steeper the Eg- I_p curve, the greater the modulated output. Due to fly-wheel action in the plate tank, the half-waves become symmetrical as shown in b.

It is evident that the distortion creates harmonics of the original r.f. oscillation. This is an advantage since it is possible to produce 100 percent modulation and multiply the frequency in the same stage to reach the desired high frequency. As long as the modulated portion of the radio-frequency envelope falls on the linear portion of the Eg- I_p curve, no troublesome modulation distortion is introduced at the various harmonics.

You Can Now SIGNAL TRACE with a "Pencil"*

PROVAC

featuring **EDIPROBE**
*Pencil-thin RF probe



The PROVAC electronic vacuum tube volt-ohmmeter permits the laboratory engineer and radio service technician to measure every voltage required in the design laboratory and radio servicing.

Measure R.F. with the same ease as measuring D.C. with the latest development in R.F. probes. It is no longer necessary to guess at which point the signal stops.

DC Ranges: 0 to 3-10-30-100-300 and 1,000 volts. All ranges have a constant input resistance of 11,000,000 ohms. Accuracy 3% ±

AC Ranges: 0 to 10-30-100-300 and 1,000 volts. Sensitivity: 1,000 ohms per volt. Accuracy 5% ±

Electronic Ohmmeter Ranges: 0-1,000 ohms, 0-10,000 ohms, 0-100,000 ohms, 0-1 megohm, 0-10 megohms, and 0-1,000 megohms.

R.F. Voltage ranges 0/3-10-30-50 Volts to be measured on 100 Volt range.

Bridge Amplifier Circuit Meter individually calibrated for use with set of test leads, signal tracer probe and batteries.

Features of the EDIPROBE

- Smallest R.F. probe made.
- Frequency range 40 Cycles to over 100 Megacycles.
- Effective circuit loading: 3 mmf. and 1 megohm.
- Can be used as an output meter.
- Can be used for measuring decibels.
- Checks condensers for open circuit.
- Works with any standard V.T.V.M.

PROVAC Model ED 100 \$5950 VTVM Model 100 \$5250 EDIPROBE \$985 (with EDIPROBE) (without probe) (RF Probe)

Jobbers and dealers write for exclusive Territory Distribution. Orders addressed to us will be credited to your nearest dealer.

Write Dept. RK for FREE Technical Manual

ELECTRONIC DESIGNS, Inc.

IRVINGTON, NEW YORK



CONTROL SYSTEM

James W. Conklin, Indianapolis, Ind.
Patent No. 2,403,053

Control equipment such as for controlling temperature, generally relies upon a d.c. voltage to deflect a galvanometer and thus operate the control mechanism. However, d.c. cannot be conveniently amplified, so a.c. must be used to obtain sensitivity. In general, therefore, the quantity to be controlled, such as heat, velocity, etc., is converted into an equivalent a.c. which must be rectified and filtered. Since this a.c. is usually of low frequency, it requires a large filter capacitance. This results in appreciable and undesirable time delay.

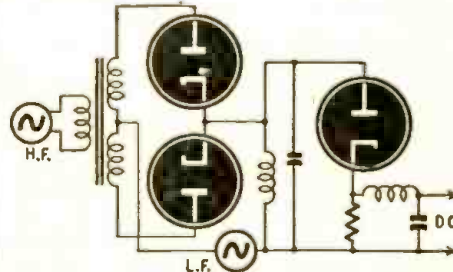

In this method, the a.c. control signal works into a balanced modulator, and does not appear in the output. A high frequency of about 10,000 cycles is applied in push-pull through a transformer. The output of the modulator is tuned to one of the side-bands, which being of relatively high frequency does not require large filter capacitance after rectification. Therefore, the time lag is eliminated.

100 Watt Vasco Soldering Iron	\$3.50
JAN 6AK5 Tubes	1.95
Midget 100 MMFD Variable Condenser	.79
5-inch PM Speaker	1.77
300 Ohm Amphenol twin lead per 100 ft.	2.90
75 Ohm Amphenol twin lead per 100 ft.	2.00

Send for our Surplus Bulletin

DOW RADIO
1759 E. Colorado Pasadena 4, Calif.

SERVICING MOVIE SOUND

(Continued from page 24)

this adjustment may be made by running any film with sound recording and adjusting so that frame line flutter will be heard at one extreme and sprocket hole hum at the other. The roller should be centered between the two in the manner described above.

All pad rollers (Fig. 2) should be adjusted so there will be a clearance equal to two thicknesses of film between them and the sprockets on which they run.

The sprocket teeth should be inspected and the sprocket replaced if they show signs of wear. Since the sprocket teeth wear on only one side it is often possible to reverse the sprocket end for end, which places the opposite side of the teeth against the film while pulling, thus increasing the useful life of the sprocket.

(A second article will appear in an early issue)

FM radio is in a quandary in which many stations are transmitting their full allotted time to audiences which approach the vanishing point, said T. R. Kennedy of *The New York Times* last month. Cause of the paradox is the "moving upstairs" of the transmitters, pursuant to FCC order, while most of the present receivers receive only low-frequency FM transmissions.

"THE HOUSE OF A MILLION RADIO PARTS AND TUBES"

for the Amateur, SWL, Service and Sound Men

M #450 Superior Tube Tester	\$39.50
P.B. 100 Superior Volt-OHM-Milliammeter with 6 D.C. Volts—5 A.C. Volts—3 D.C. Current—3 Resistance 5 Output Meter—3 Decibel Ranges. Complete in black wooden carrying case	28.40
Weston #665 Type #1 Volt-OHM Milliammeter. The Analyzer for all round work	58.50
Vomax (Silver) Model #900 V.T. V.M. and Visual Signal Tracer and Analyzer	59.85
Fix up a portable Tester for auto-radio service with the following Meters at very low cost: G.E. 0-50 D.C. AMP., 2½" and G.E. 0-30 D.C. Volts, 2½". Both for	6.95
Make your own Volt-OHM-Milliammeter Unit. G.E. 3½" Foundation Meter	6.95
Attention amateurs! Here is a Meter for your use: 0 to 1 Standing Wave Meter, has 0-1 ma. movement. Used to check Feeder, and for the Field Strength Meter	4.95

SPECIAL . . . R.M.E. #45 Receivers

Send your QSL or SWL card to W-8-E-S-N, Lee R. Kemberling, Sales Manager, for the latest Ham Bargain Bulletin.

Lifetime
SOUND EQUIP. CO., Dept. 23
911-913 JEFFERSON AVE., TOLEDO 2, OHIO

Install an aerial the new way—

the **VERTROD** way



EASIER!
FASTER!
BETTER!



As MODERN as 4 wheel hydraulic brakes—compared to the old mechanical brakes.

VERTROD'S—20 models cover all wave reception...
FM—AM and Television.

VERTROD—vertical models beautify buildings—eliminate poles—
Insulators—filters—lightning arrester—climbing.

VERTROD—the most scientific antenna yet evolved.

The VERTROD way (with patented features) is the MODERN way. At most radio shops. Write for folder 411

VERTROD CORPORATION

60 EAST 42nd STREET · NEW YORK 17, N. Y.

A LABORATORY QUALITY OSCILLOSCOPE For the Service Man . . .

Portable, sturdy, compact—the CRO-5A is an ideal unit for rapid, accurate, high quality service work. Check the utility and features which you have always wanted in the instrument on your bench.

- For better laboratory and production testing . . .
- For routine Service work . . .
- For studying any variable which may be translated into electrical potentials by means of associated apparatus . . .
- Designed with tubes for maximum amplification with minimum noise . . .
- Exceptionally stable trace even under adverse power line variations . . .
- Frequency response—essentially flat from 20 cycles to 350 KC . . .
- Completely self-contained . . .

Write to General Electric Company, Electronics Department SRC-6407, Syracuse 1, New York.



CRO-5A

GENERAL ELECTRIC

177-E2

LET THIS "AUTOMATIC TEACHER" show you exactly how to repair over 4800 RADIO MODELS without expensive test equipment!

SAVE TIME—SAVE MONEY!

Ghirardi's RADIO TROUBLESHOOTER'S HANDBOOK is the ideal manual to show you exactly how to repair radios at home in spare time—quickly and without a lot of previous experience or costly test equipment. It contains MORE THAN 4 POUNDS OF FACTUAL, time-saving, money-making repair data for repairing all models and makes of radios better, faster and more profitably than you may have thought possible!

NOT A "STUDY" BOOK

RADIO TROUBLESHOOTER'S HANDBOOK can easily pay for itself the first time you use it. You don't have to study it. Simply look up the Radio you want to repair and go to work. No lost time! Clear instructions tell exactly what the trouble is likely to be—EXACTLY how to fix it. Actually, this big 744-page manual-size HANDBOOK brings you factual, specific repair data for the common troubles that occur in practically every radio in use today—for over 4800 most popular models of Home and Auto-radio receivers and Automatic Record Changers of 202 manufacturers! In addition, there are hundreds of pages of helpful repair charts, tube charts, data on tuning alignment, transformer troubles, tube and parts substitution, etc., etc.—all for only \$5 (\$5.50 foreign) on an UNRESERVED 5-DAY MONEY-BACK GUARANTEE!



Get a Complete RADIO-ELECTRONIC SERVICE EDUCATION AT HOME—WITHOUT AN INSTRUCTOR

TEST INSTRUMENTS—TROUBLESHOOTING REPAIR

A. A. Ghirardi's big 1300-page MODERN RADIO SERVICING is the finest, most complete instruction book on Radio-Electronic service work for either the novice or the professional Radio-Electronic serviceman—*bar none!* Read from the beginning, it is a COMPLETE COURSE IN SERVICING by the most modern methods. Used for reference, it is an invaluable means of brushing up on any servicing problems that puzzle you.

Gives complete information on all essential service instrument types; how they work (with wiring diagrams), when and why to use them; how to build your own; preliminary trouble checks; circuit and parts analysis; parts repair, replacement, substitution; obscure radio troubles; aligning and neutralizing; interference reduction—and hundreds of other subjects including How to Start and Operate a Successful Radio-Electronic Service Business. 706 self-testing review questions help you check your progress EVERY STEP OF THE WAY. Only \$5 complete (\$5.50 foreign).

MONEY-SAVING OFFER!

While the present limited supply lasts you can get BOTH big books—radio's most famous complete Modern Service library totaling over 2040 pages—at a bargain combination price. See coupon.



5-DAY MONEY-BACK GUARANTEE

MURRAY HILL BOOKS, Inc.
Dept. RC-116, 232 Madison Ave., New York 16, N. Y.

Enclosed find \$..... for books checked, or send C.O.D. (in U.S.A. only) for this amount plus postage. If not fully satisfactory, I may return the books at the end of 5 days and receive my money back.

MODERN RADIO SERVICING RADIO TROUBLESHOOTER'S HANDBOOK \$5 (\$5.50 foreign)

Special MONEY-SAVING COMBINATION
Both big books for only \$9.50 (\$10.50 foreign)

Name

Address

City and Dist. No. State

(Please print or write plainly)

"BORROW" THESE BOOKS for 5 full days. Money refunded if you don't like them!

WORLD-WIDE STATION LIST

(Continued from page 32)

Freq.	Station	Location and Schedule
6.000	XEBT	MEXICO CITY, MEXICO: 8:45 am to 12 am.
6.005	CFCX	MONTREAL, CANADA: 7 am to 11:15 pm.
6.005	HP5K	COLON, PANAMA: 7 am to 3 pm; 7 to 11 pm.
6.005	VE9AJ	EDMONTON, CANADA: midnight to 2 am.
6.007	ZRH	JOHANNESBURG, SOUTH AFRICA: 11:00 to 2 am except Saturdays.
6.010	GRB	LONDON, ENGLAND
6.010	CJCX	SYONEY, NOVA SCOTIA: 5 pm to midnight.
6.018	HJCX	BOGOTA, COLOMBIA: 7 to 8 am; 2 to 11:15 pm.
6.023	XEUW	VERA CRUZ, MEXICO: 7 am to 12:45 am.
6.023	FZI	BRAZZAVILLE, FRENCH EQUATORIAL AFRICA: 4 to 8 pm; midnight to 1:30 am.
6.025	IRF	ROME, ITALY: 7 to 8:15 am; 12:30 to 6 pm.
6.028	ZRH	MOSCOW, U.S.S.R.: 5:45 to 9:30 pm.
6.028	ZRH	JOHANNESBURG, SOUTH AFRICA: 11:45 pm to 1:30 am.
6.030	CFYP	CALGARY, CANADA: 7:30 am to 1 am.
6.030	HP5B	PANAMA CITY, PANAMA: 6 to 11 pm.
6.030		BERLIN, GERMANY: 2 to 3 am; 4 am to 1 pm (from Russian sector).
6.035	GWS	LONDON, ENGLAND
6.037	OLR2B	PRAGUE, CZECHOSLOVAKIA: 4:30 pm to 7 am.
6.040	WRUW	BOSTON, MASS.: Central American beam, 8:30 pm to 1 am.
6.040		ALGIERS, ALGERIA: 12:30 to 6 pm.
6.040		RANGDON, BURMA: 8:15 to 9:45 pm; 1:15 to 2 am; 6:45 to 8:15 am.
6.040	COBF	HAVANA, CUBA: 8 am to 11 pm.
6.045	XETW	TAMPICO, MEXICO: 7:45 am to 12:45 am.
6.060	WCBN	NEW YORK CITY: Mexican beam, 6:30 pm to 1 am.
6.070	GRR	LONDON, ENGLAND: Central American beam, 8 to 10:15 pm.
6.065		TETUAN, SPANISH MOROCCO: 5 to 6:15 pm.
6.070	CRFX	TORONTO, CANADA: evenings till after midnight.
6.080	WLWK	CINCINNATI, OHIO: South American beam, 7:30 pm to 12:15 am.
6.080	CKFX	VANCOUVER, CANADA: 9:30 am to 3 am.
6.090	GWM	LONDON, ENGLAND.
6.090	LYRI	BUENOS AIRES, ARGENTINA: 5:45 to 7:15 am; 5 to 9 pm.
6.090	ZNS4	NASSAU, BAHAMAS: 7:45 to 8:30 am; 11:30 am to 1:30 pm; 4 to 10 pm.
6.090	CBFW	MONTREAL, CANADA: 7:30 am to 11 pm.
6.095	XRRR	PEIPING, CHINA: 4 to 11 am.
6.095	ZYB7	SAO PAULO, BRAZIL: 4:30 to 10 pm.
6.100	VUD7	DELHI, INDIA: 8:30 to 10 pm.
6.105	PRE9	FORTALEZA, BRAZIL: 3:30 to 6:15 pm Mondays; 3:30 to 8:35 pm other days.
6.110	GSL	LONDON, ENGLAND: Near East beam, 11 pm to 12:30 am; Italian beam, 11 pm to 12:30 am.
6.120	W00W	NEW YORK CITY: European beam, midnight to 3:15 am.
6.120	KRHO	HONOLULU, HAWAII: Oriental beam, 4 to 9:45 am.
6.122	HP5H	PANAMA CITY, PANAMA: 7 am to 11 pm.
6.125	GWA	LONDON, ENGLAND.
6.128	XEUZ	MEXICO CITY, MEXICO: 3 pm to 12:30 am.
6.130	CHNX	HALIFAX, NOVA SCOTIA: 7 am to 11 pm.
6.130	COCD	HAVANA, CUBA: 7 am to 10 pm.
6.130	VPD2	SUVA, FIJI ISLANDS: Sundays, 1 to 5 am; other days, 3 to 4 pm.
6.135	AFRS	MILAN, ITALY: 11:30 am to 4:30 pm.
6.145	HJDE	MEDELLIN, COLOMBIA: 4 to 10:30 pm.
6.150	GRW	LONDON, ENGLAND.
6.150	CJRO	WINNIPEG, CANADA: 9 to 11 pm.
6.150		BELGRADE, YUGOSLAVIA: 1 to 6 pm.

RESISTORS IS OUR BUSINESS

Which means that your orders for
**1/2—1—2 Watt
CARBON & WIRE-WOUND
RESISTORS**

Will be filled from stock
The same day we receive them
That's a fact!

LEGRI S COMPANY

846 Amsterdam Ave., New York 25, N. Y.
Phone: ACademy 2-0018

Freq.	Station	Location and Schedule
6.155	EQB	TEHERAN, IRAN: 9 am to 2:30 pm; 8 to 8:30 pm
6.155	TIRH	SAN JOSE, COSTA RICA: 9:30 pm to midnight
6.155	CS2WD	LISBON, PORTUGAL: 4:30 to 7 pm
6.160	HJCD	BOGOTA, COLOMBIA: 7 pm to 8 am; 4 to 11:30 pm
6.160		MUNICH, GERMANY: midnight to 3 am
6.160	CBRX	VANCOUVER, CANADA: 6 am to 3 am
6.165	GWK	LONDON, ENGLAND
6.165	HHCM	PORT-AU-PRINCE, HAITI: 5 to 8:30 am; 11 am to 2 pm; 5 to 9 pm
6.165	HER3	BERNE, SWITZERLAND: 8:30 to 10 pm
6.180	LRM	MENDOZA, ARGENTINA: 5:15 to 10 pm
6.190	HIIA	SANTIAGO, DOMINICAN REPUB. LIC: 4 to 5 pm
6.198	HJCT	BOGOTA, COLOMBIA: evenings till 11:30 pm
6.200	YV6RD	CIUDAD BOLIVAR, VENEZUELA: 5 to 9:30 pm
6.205	CP5	LA PAZ, BOLIVIA: 6:15 to 10:45 pm
6.205	FK8AA	NOUMEA, NEW CALEDONIA: 2:30 to 4 am; 4:30 to 5 am
6.230		MOSCOW, U.S.S.R.: noon to 6:25 pm; 7 to 9:45 pm
6.235	HRD2	LA CEIBA, HONDURAS: 7:30 to 10 pm
6.240	HJCF	BOGOTA, COLOMBIA: 5 to 11 pm
6.243	HIIN	CIUDAD TRUJILLO, DOMINICAN REPUBLIC: 4 to 10:30 pm
6.280	HCJB	QUITO, ECUADOR: 6 to 10 pm
6.315	HIIZ	CIUDAD TRUJILLO, DOMINICAN REPUBLIC: 4 to 9:30 pm
6.330	COCW	HAVANA, CUBA: 7 am to 10 pm
6.345	HEI2	BERNE, SWITZERLAND: 12:40 to 1:40 am; 6:20 to 7 am; 1 to 5:15 pm
6.345	COKG	SANTIAGO, CUBA: 4 to 11 pm
6.357	HRPI	SAN PEDRO SULA, HONDURAS: 6 to 7:30 am; 6:30 to 10:30 pm
6.370	CSX	LISBON, PORTUGAL: 3:30 to 7 pm
6.455	COHI	SANTA CLARA, CUBA: 7 am to 1 am
6.465	TGWB	GUATEMALA CITY, GUATEMALA: 8 am to noon; 6:30 pm to 1 am
6.485	HI2T	MONSIGNOR NOUËL, DOMINICAN REPUBLIC: 4 to 10:30 pm
6.510	CP40	COCHABAMBA, BOLIVIA: 7:30 to 10 pm
6.620	TG2	GUATEMALA CITY, GUATEMALA: 6 to 11 pm
6.720	PMA	BANDONG, NETHERLAND INDIES: 5:30 to 9:30 am
6.715	ZLT7	WELLINGTON, NEW ZEALAND: 4:25 to 4:45 am
6.750	JVT	TOKIO, JAPAN: to U.S. at 2 to 8 am
6.760	YNDS	MANAGUA, NICARAGUA: 8 to 10 am; 5 pm to 12 am
6.770	CP49	LA PAZ, BOLIVIA: 7 to 9 am; 11 am to noon; 6:30 to 9 pm

(Continued on page 62)

Production of electricity from atomic piles is expected within the next eighteen months, scientists of the Oak Ridge Laboratories state. Electricity will be produced for experimental purposes only, not on a commercial basis.

THE YEAR'S BIGGEST OFFER

10 lb. Radio Parts Assortment

A "find" for the radio serviceman. Hundreds of valuable radio parts, including coils, resistors, trimmer condensers, lugs, transformers, switches, hardware, etc.

Only **\$2.95**

Write for radio parts circular

RANDOLPH RADIO STORES
609 W. Randolph St. Chicago 6, Ill.

ELECTRONIC VOLT-OHMMETER

\$11.85

110 VOLTS AC 20 RANGES

POSTPAID

0/5/10/50/100/500/1000/5000 volts DC and AC. 0-1,000,000.000 ohms in six overlapping ranges. Sensitivity: over MILLION OHMS per VOLT on 5 volt range.

Complete kit includes all component parts, tubes, punched and drilled chassis and beautifully enameled panel. Easily assembled and wired.

Special slideback circuit developed during war by scientist at the California Institute of Technology gives amazing sensitivity and flexibility while completely eliminating necessity of batteries and expensive meter. Each instrument is individually calibrated. Dial scale over nine inches long!

In addition to performing the usual volt-ohm functions, this instrument easily measures these voltages: SUPPLY, RET OSCILLATOR, AVC, AFC, TRUE GRID BIAS AT THE GRID, BIAS CELLS without affecting the circuit. Measures the exact leakage resistance of INSULATION, TUBES, CONDENSERS. It can be used with a signal generator for SIGNAL TRACING.

STERLING ELECTRONIC COMPANY

106 N. Sierra Bonita Ave., Dept. 2, Pasadena 4, Calif.

RADIO-CRAFT for NOVEMBER, 1946



A. A. Ghirardi, Radio's most famous teacher

I'll make it easy for you to

LEARN RADIO

at home...in your spare time

FOR BEGINNERS! No Previous Training Needed

I'll PROVE that my famous 972-page RADIO PHYSICS COURSE book can teach you basic Radio-Electronics quicker, easier and AT LESS COST than any other book or course. I'll PROVE it gives exactly the training you need to learn Radio-Electronics RIGHT. And I'll PROVE you'll be pleasantly surprised how quickly it helps you understand subjects that other training makes seem too difficult for beginners. Mail the coupon today. If you're not more than satisfied after reading the COURSE for 5 full days, send it back. EVERY CENT of your money will be cheerfully refunded. No questions will be asked. You cannot lose!

..and for
ONLY \$5.00
FOR THE COMPLETE TRAINING!

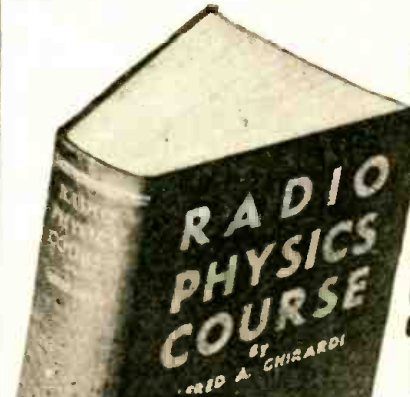

36 COURSES IN ONE
472 data-packed pages
508 clear illustrations
856 self-test review questions that make self-checking easy

GHIRARDI EXPLAINS EVERY DETAIL CLEARLY AS A-B-C

EVERYTHING ABOUT RADIO, SOUND, ELECTRICITY, ELECTRONICS: Radio Broadcasting Systems; Sound, Speech and Music; Electron Theory; Electric Current; Electrical Units; Ohm's Law; Resistance; Electrical Circuits; Batteries; Electro-magnetism; Electro-magnetic Induction; Inductance and Inductors; Capacitance and Condensers; Alternating Current Circuits; Electric Filters; Electrical Measuring Instruments; Electro-magnetic Radiations; Radio Transmission; The Broadcasting Station; The Receiving Station; Elementary Study of the Vacuum Tube; Vacuum Tube Detector & Amplifier Action; Tube Characteristics; Radio-Frequency Amplification; Superheterodyne Receivers; Tuning and Tuning Coils; Audio Amplification; Battery & Electric Operated Receivers; Auto-Radio; Aircraft Radio; Phonograph Pick-ups; Public Address Systems; Short-Wave Receivers; Photo-Electric Cells; Television; Testing and Servicing; Sound Motion Pictures—and dozens of other subjects.

NO OTHER COURSE LIKE IT

"I'd already taken a \$150 course, but since reading Ghirardi's RADIO PHYSICS COURSE book, I put the other one away," writes Gerard Champagne of Montreal. "RADIO PHYSICS COURSE is the real book I need because it teaches so clearly."



9 OUT OF 10 RADIO MEN SAID: "Here's the Way to Learn Radio RIGHT!"

Ghirardi's RADIO COURSE book is more widely used for home study, by U.S. Signal Corps and Navy Schools and by more schools and colleges than any other book of its kind. Also, it is more widely endorsed by the very men who are engaged in radio work for a living. On an actual survey among 817 radio leaders, 724 of them—9 OUT OF 10!—picked Ghirardi's famous training as their first choice—AT ANY PRICE! And remember, these men are tops in the fields of radio-electronic servicing, aviation radio, broadcasting, engineering, designing and instructing! No matter what phase of Radio-Electronics you plan to enter, you'll need the basic training this famous course gives you FIRST! And, this most complete training on the market comes to you all in one convenient big, handsomely bound book. Starting with Basic Electricity, it takes you step by step through the entire field. Everything is made crystal clear. You go ahead as fast as spare reading time permits. No lessons to wait for. Many students have completed it in a few weeks—and an amazingly high percentage of them are now successful Radio-Electronic experts! The complete cost is only \$5 postpaid. Actually you don't risk a cent! Our 5-Day Money-Back Guarantee is your absolute protection.

5-DAY MONEY-BACK GUARANTEE

Murray Hill Books, Inc., Dept. RC-116,
232 Madison Ave., New York 16, N. Y.

Rush a copy of Ghirardi's 972-page RADIO PHYSICS COURSE BOOK on your money-back guarantee offer. \$5 enclosed (\$5.50 foreign), or send book C.O.D. for this amount plus postage (no foreign C.O.D.'s). It is understood I may return the book after reading it for 5 days for full refund if not more than satisfied.

Name

Address

City & Dist. No. State

COMPLETE BASIC RADIO-ELECTRONIC TRAINING IN ONE BIG VOLUME

SMASH VALUES

IN

ELECTRONIC & COMMUNICATION SUPPLIES

Order Today

Immediate Delivery



CW3 RECEIVER Wilcox (used for Aircraft monitoring) a fixed fro. receiver (1900 KC to 16500 KC) xtal controlled—superhet with BFO and AC power supply; 110V, 60cy—makes a beautiful ham receiver with a converter. Complete with add. set of tubes and one set of coils \$32.95



MODULATION TRANSFORMER. Modulation transformer perfect for inputs up to 300 watts—150 watts of audio and screen winding... \$4.95
W.E. driver transformer Class B will match any class B grids from 6L6. Perfect match for above transformer \$3.95

PIONEER GENEMOTOR High Power on Wheels Pioneer Genemotor delivers 500V @ 160 mills—completely filtered—has relays and magnetic circuit breakers in specially constructed casing. The job that will deliver watts to that mobile rig. Specially priced... \$13.95

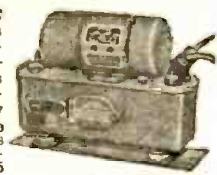

PLATE TRANSFORMER. 6200 Volt CT-700 mills, 110V, 60 Cy, tapped primary 2 KVA Amertran. A few left at \$29.95
SWINGING CHOKE. Langrevin Swinging Choke—9/60 henries, 400/50 mills. DC resistance, 72 ohms \$12.75
Antenna change over relay, Leach type 1357 DE-13F-DPDT—plenty of spacing—mounted on low-loss bakelite \$2.50
Quantity orders on any of the above items invited.

ALL PRICES F.O.B. OUR WAREHOUSE
NEW YORK CITY, NEW YORK

Exportable address:

MICROWAVE—New York
• Write for latest bulletin SRC

NAGARA RADIO SUPPLY
160 Greenwich St., New York 6, N. Y.
Brooklyn Green 9-7993

a Sensational TERMINAL Value!

PRECISION WIRE WOUND RESISTORS IRC - SHALLCROSS - MADISON

For Meter Multipliers, High Fidelity Amplifiers and other applications where 1% tolerance is required.



OHMS

1,000

4,000

10,000

20,000

25,000

40,000

50,000

80,000

90,000

100,000

200,000

35¢ EACH

3 FOR \$1.00

.5 megohm 75¢ each, 3 for \$2.00
1.0 megohm 95¢ each, 3 for \$2.50

METER SPECIALS!

G.E. 3 1/2" Round

0-20 Microamperes

Scale calibrated 0-100, Net **9.95**

DeJur 3 1/2" Round

0-200 Microamperes, Net

6.95

Minimum order \$2.00. No C.O.D.'s

We pay postage anywhere in U.S.A.

TERMINAL

Radio Corporation

85 CORTLANDT ST. N. Y. 7, N. Y.
WOrth 2-4415

WORLD-WIDE STATION LIST

(Continued from page 61)

Freq.	Station	Location and Schedule
6.850	YNOW	MANAGUA, NICARAGUA; 8 am to midnight.
6.980		MOSCOW, U.S.S.R.; 5:45 to 6:25 pm; 7 to 9 pm; 11:15 to 11:45 pm.
6.980	F08AA	PAPÉETE, TAHITI; Fridays and Saturdays, 10 to 11:30 pm.
7.008	YNBH	MANAGUA, NICARAGUA; 6 to 10 pm.
7.010	XPSA	QWEIYANG, CHINA; 11:30 pm to 1 am; 5 to 16 am.
7.018	YNWW	GRANADA, NICARAGUA; 1 to 10 pm.
7.080	HI2A	SANTIAGO, DOMINICAN REPUBLIC; 10 am to 1:30 pm; 4:30 to 8:30 pm.
7.100		BISSAU, PORTUGUESE GUINEA; 5 to 5:30 pm.
7.120	GRM	LONDON, ENGLAND; Australian beam, 1 to 3:45 am; New Zealand beam, 1 to 3:45 am.
7.140		VIENNA, AUSTRIA; midnight to 2 am; 6 to 8 am; 10 am to 4:30 pm.
7.153	XGOY	CHUNGKING, CHINA; 6:30 to 10:30 am.
7.160	HCIBF	QUITO, ECUADOR; 6:45 to 11 am; noon to 2 pm; 5 to 11 pm.
7.160		VIENNA, AUSTRIA; midnight to 2 am; 6 to 8 am; 10 am to 8:30 pm.
7.190	JCPA	CAIRO, EGYPT; 3 pm to 7; 10:30 pm to midnight; 2 to 3 am.
7.210	FGY	DAKAR, FRENCH WEST AFRICA; 1:15 to 1:45 am; 2 to 2:30 am; 1:45 to 4:25 pm.
7.215	FG8AH	POINTE-A-PITRE, GUADELOUPE; 6 to 7:30 pm.
7.215	VLQZ	BRISBANE, AUSTRALIA; on at 6:15 am.
7.205	EAQ	MADRID, SPAIN; heard 9:30 to 10 pm.
7.220	JCKW	JERUSALEM, PALESTINE; 10:30 pm to 3 pm.
7.220		SINGAPORE, MALAYA; 11:30 pm to 1:30 am.

Order from LAKE!

You'll Make No Mistake!

RADIO Cabinets & Parts



NOW Available

Postwar
2 Post

RECORD-CHANGER

With luxurious brown leatherette portable case 15" L x 15" W x 10" D. Latest electronic developments make this modern record-changer the finest on the market today!

Changer—\$19.00 Cabinet for same—\$8.95

Also blank table cabinets of walnut veneer in the following sizes, with speaker opening on left front side. (Note: 7" has center speaker grill.)

#1	8 1/2" L x 5 1/2" H x 4" D	\$1.95
#2	10 1/4" L x 6 3/4" H x 5" D	\$2.75
#3	13 1/2" L x 7 3/4" H x 6 1/4" D	\$3.25
#7	10 3/4" L x 7" H x 5 1/2" D	\$2.50

*Speaker Opening in center of front side.

All types of radio cabinets and parts are available at Lake's lower prices. A large stock is listed in our catalog.

SERVICEMEN—RETAILERS
Join our customer list today.

Order our New Catalog Today!
Get on our mailing list!

Dept. C

LAKE RADIO SALES CO.

615 W. Randolph Street, Chicago 6, Ill.

PEN-OSCIL-LITE

Extremely convenient test oscillator for all radio servicing; alignment. • Small as a pen • Self powered • Range from 700 cycles audio to over 600 megacycles u.h.f. • Output from zero to 125 v. • Low in cost • Used by Signal Corps • Write for information.

GENERAL TEST EQUIPMENT

38 Argyle Ave. Buffalo 9, N. Y.

Specializing in the design and Assembly of
Physics Demonstration Apparatus, Electronic
Equipment and Special Test Equipment. Consulting
Service on Applied Physics and Electronics.

CARLOCK LABORATORIES

of

Applied Physics and Electronics

Clinton

Mississippi

Save Time, Earn More on Radio Repairs— with the FEILER "Pro" Signal Tracer....!

Servicemen! Here's the new
ELECTRONIC "STETHOSCOPE"
that gets to the heart of
radio trouble in a flash!

Thousands Sold! Pays for Itself!

Cut your service time on tough repair jobs to minutes with the Feiler Signal Tracing Analyzer! Just "listen in" on or "look at" the signal as it progresses through the circuit—isolate and locate trouble in just minutes! Traces trouble at First Grid, R.F., I.F., Audio; tests parts and locates faults. Features: High Impedance Isolation Network; R.F. vacuum tube voltmeter circuit provision for visual indication of R.F. voltages; Output meter provision; Headphone connection; Full 5" PM Speaker; 1" dia. bakelite probe with 3 ft. cable; handsome brown-finished metal case with carrying handle. Requires only 3 economical long-life batteries for self-contained, portable use. A professional instrument for the serviceman who wants the best at a moderate price. Complete with valuable Radio Service Guide.



ONLY

29⁹⁵

Model TS-2 Signal Tracing
Analyzer, complete with 3
vacuum tubes (less batteries)

IMMEDIATE DELIVERY

Place your order with your regular parts jobber. If he can't supply you, write for name of nearest local jobber stocking this instrument—or send your order to us direct.

FEILER

FEILER ENGINEERING CO.

803-B MILWAUKEE AVE., CHICAGO 22, ILLINOIS

SOUND ENGINEERING
(Continued from page 31)

6.3-volt heater winding for the 6L6G output tubes—2 amps.

The remaining 6.3-volt winding is rated at 3 amps.

If you have any difficulty in locating a transformer with these secondary voltages, you might be able to construct one yourself or possibly have it built in accordance with the following manufacturing specifications:

Transformer Core—1½ x 2¼-inch Transformer Grade.

Primary—218 turns of No. 19 wire. Electrostatic Shield.

High-Voltage Secondary—1520 turns center-tapped No. 30 wire.

Bias Secondary—750 turns center-tapped No. 30 wire.

5-volt 3-amp. winding—10 turns center-tapped No. 16 wire.

6.3-volt 3-amp. winding — 13 turns center-tapped No. 16 wire.

5-volt 2-amp. winding — 10 turns center-tapped No. 18 wire.

6.3-volt 2-amp. winding — 13 turns center-tapped No. 18 wire.

The high voltage winding should be insulated from other windings and core to withstand 1750 volts RMS 60 cycles. The bias winding should withstand 1500 volts. The 5-volt 3-amp winding should withstand 2,000 volts.

HUM PICKUP, LINE IMPEDANCE

The Question

I am operating a sound moving picture system in an auditorium and have considerable trouble with hum at the loud-speaker and boominess. The room is not treated acoustically but some portable machines that have been operated there give satisfactory results.

The output of the amplifier (push-pull 2A3's) is coupled to the line through a "2A3 P-P to 500-ohm" transformer. The line is made up of a pair of No. 14 flexible wires, twisted, with heavy insulation, and is about 250 feet long. It terminates in the primary of a 500-ohm-to-voice-coil transformer. The line is unshielded and the speaker, when plugged in at the amplifier, shows no sign of hum. The amplifier is well grounded. The monitor speaker, a pm dynamic, shows lots of hum also when the main speaker is coupled to the other end of the line.

I am at present experimenting with the input end, photocell lines, etc., to see how much hum is originating there.

In connection with the output end, I would like to know how the impedance of an audio frequency line may be computed. Have tried feeding the line with and terminating it in 250-ohm transformers but did not get as good results as with 500-ohm terminations.

GEORGE F. SWARTZ
San Francisco, Calif.

The Answer

The excessive boominess you mention is undoubtedly caused by an extended
(Continued on page 64)

Mr. Radioman—

*What are
your
Qualifications?*

EMPLOYERS ARE CHOOSEY!



PREPARE FOR HIGH-LEVEL EMPLOYMENT WITH THESE CLEVELAND INSTITUTE HOME STUDY COURSES . . .

1. **Mathematics for Radio and Communication Engineering.**
2. **Advanced Course in Radio Communication Engineering.**
A college-level Radio Engineering Course.
3. **Master Course in Radio Communication.**
Covers fundamentals of Radio and includes complete preparation for FCC Commercial License Examinations.
4. **Specialized Television Engineering.**
Including post-war Television Techniques.

All Courses Include

The Remarkable Workbooks of Instructional Aids, prepared by the instructing staff of Cleveland Institute.

Choose the course best suited to your needs—Start with the section you are qualified to enter—Use the economical CIRE "Pay-As-You-Go Plan."

Write for descriptive folder • No obligation

CLEVELAND INSTITUTE OF RADIO ELECTRONICS

Successors to

NILSON RADIO SCHOOL
Founded 1939

SMITH PRACTICAL RADIO INSTITUTE
Founded 1934

RC-11 TERMINAL TOWER, CLEVELAND 13, OHIO

Approved for Veteran Training Under "G-I Bill of Rights"

(MAIL THIS COUPON)

Cleveland Institute of Radio Electronics, RC-11 Terminal Tower, Cleveland 13, Ohio.
Gentlemen: Please send information about your home study courses in Radio Electronics.

NAME

ADDRESS

CITY

ZONE STATE

I desire training in

I have had experience in broadcasting servicing

operating mfr. CAA Army-Navy

amateur other

I am a High School Grad. College Degree

Check here for Veteran Enrollment Information.

PREPARED ASSORTMENTS

GUARANTEED FIRST QUALITY

100	1/3 Watt Resistors All Insulated	\$2.98
100	1/2 Watt Resistors All Insulated	3.98
100	1 Watt Resistors All Insulated	4.48
50	2 Watt Resistors All Insulated	3.98
50	200 Volt Paper Condensers	2.48
50	Mica Condensers	2.98
50	Dry Electrolytic Filter Condensers	6.75
10	25 ft. Rolls Hookup Wire—Ass't'd colors	1.98
10	Volume and Tone Controls—No Switches	1.98
100	R. Spagetti and Vinylite98
10	Colls I.F., H.F. Ant. and Osc.	3.98
20	Wafer and Ceramic Band Switches	3.98
20	Auto Suppressors	2.98
50	Electrical Wiring Devices, Plugs, Tabs, Bases, Elements, Fuses, etc.	5.00

SEND FOR TRUTONE COMPLETE RADIO AND ELECTRICAL LIST

Terms: 25% deposit required with order. Balance C.O.D. Merchandise sent prepaid if full remittance accompanies order.

TRUTONE PRODUCTS CO.,

303 W. 42nd St. Dept. C New York 18, N. Y.

When writing advertisers, please mention that you saw it in RADIO-CRAFT.

MINE DETECTORS

YOU CAN NOW BECOME A PROSPECTOR—HERE IS ONE OF THE WAR'S TOP SECRETS: **ARMY MINE DETECTORS**

NEW, in original cases; portable. Will detect METALLIC and NON-METALLIC objects. Very sensitive; using 955 tube in detecting head. Two-tube amplifier using two 1N5GT; headset; or microphone; also 150 micro meter. Power supply—3 45v, 1 6v or 2 3v batteries. Complete with instructions. See "How Mine Detectors Work" in July, 1946, Radio-Craft. Shipping weight 108 pounds. F.O.B. N.Y. **\$17.50**
Special, less batteries.

SEND ORDER TO **HIGHBRIDGE RADIO-TELEVISION AND APPLIANCE CO.**

340 Canal Street New York 13, N. Y.

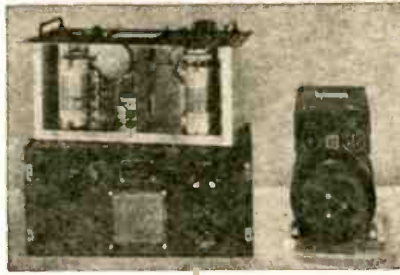
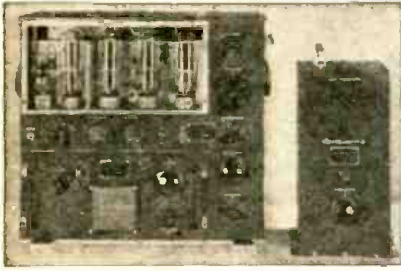

General Electric 150 Watt Transmitter—Brand New! Due to the drastic reduction given us on the cost of these units by the Government, we are now able to place these transmitters on sale for only \$67.60!!! These units certainly will not last at this price so get your order in immediately. This unit consists of Transmitter complete with tubes, seven plug-in tuning units which cover the entire frequency range, antenna tuning unit, and dynamotor. All cables and plugs along with Army Instruction Manual, and also instruction booklet on how to convert to 110V AC, are included with this stupendous buy. Don't forget the price exclusive of transportation charges is only \$67.50 while they last.

Here is a set adaptable for all amateur, experimental, marine, aircraft, police, and mobile applications. A 7-tube receiver featuring an RF stage, four double-tuned 455 KC iron-core IF transformers, 2 audio stages, and a beat frequency oscillator for CW reception. The transmitter employs a calibrated crystal oscillator, a buffer amplifier, and a pair of RK-75 tubes in the final amplifier stage. The transmitter plates are supplied by a 500V 160 MA dynamotor which operates from a 6 or 12 Volt automobile battery. The frequency range is 3760-5825 KC. Circuit diagrams are furnished. These units are priced at \$39.95, complete with set of 13 tubes and crystal. The dynamotor which must be used, if it is not desired to use 110V AC, is \$15.00 additional.

ANOTHER NEW ADDITION TO OUR ARMY SURPLUS LINE!

General Electric RT-1248 15 tube transmitter-receiver with TERRIFIC POWER (20 watts) on any 2 instantly selected, easily pre-adjusted frequencies from 435 to 500 Megacycles. Transmitter uses 5 tubes including a Western Electric 316 A as final. Receiver uses 10 tubes including 2-955's as first detector and oscillator, and 3-7H7's as IF's, with 4 slug-tuned 40 MC. IF transformers, plus a 7H7, 2-7E6's and 2-7F7's. In addition unit contains 6 relays designed to operate any sort of external equipment when actuated by a received signal from a similar set elsewhere. Originally designed for 12 volt operation, power supply is not included, as it is a cinch for any amateur to connect this unit for 110V AC, using any supply capable of 400V DC at 135 MA. The ideal unit for telephone use as in a taxicab, or for any kind of remote control applications, as with drone airplanes. Supplied with 15 tubes in original factory packing. Priced at only \$29.95. 10% less if ordered in quantities of two or more.

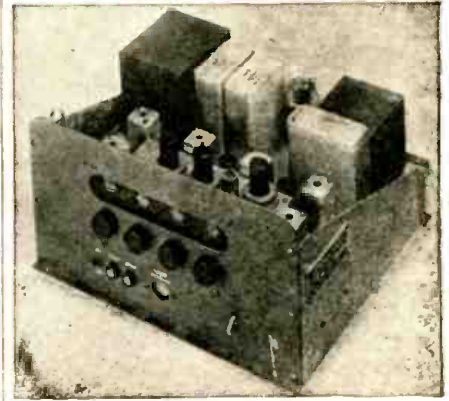

15 tube beautifully built Signal Corps Receiver is one of the most sensitive sets ever manufactured. It operates directly from 110V60 Cycles. Has two tuned RF stages, tuned converter and oscillator, five IF stages, using iron core IF's, a diode detector, tuning eye, and a two stage amplifier that will drive a speaker or phones. Easily converted from its 155 to 212 MC. band to any desired frequency. This 15 tube receiver cost the government about \$700, but is priced to sell now for only \$39.95.

famous for

GREAT VALUES

OUTSTANDING OFFERINGS OF NEW KITS

H-101 Five Tube Superheterodyne Kit

Small Bakelite cabinet approximate size 9"x5"x6", complete parts except wire and solder for the construction of a standard superheterodyne receiver using 50L6, 35Z5, 12SA7, 12SQ7, and 12SK7. A simplified circuit diagram included in this kit enables any one with a slight knowledge of radio to construct a highly efficient receiver. **\$10.75**
Price not including tubes

H-105 Automatic Record Changer Kit

Consists of 1 Automatic Record changer, single post; 1 Portable leatherette cabinet for above; 1 Crystal pick up; 1 5" P.M. and output transformer; 1 complete kit of parts including tubes but excluding wire and solder, to construct a 3-tube amplifier using 1-50L6, 1-35Z5, and 1-12SQ7. Price complete **\$36.95**

All prices are F.O.B. New York City.

Write for our new catalogue showing new test equipment, tubes and a large variety of new replacement parts. We ship anywhere in the U.S.A.—promptly.

RADIO DEALERS SUPPLY COMPANY

135 LIBERTY ST., NEW YORK 6, N.Y.

SOUND ENGINEERING

(Continued from page 63)

low-frequency response in the entire reproducing system. If other machines operate satisfactorily in the same auditorium, you undoubtedly can correct the trouble with your particular machine, by reducing the low frequency response of either the amplifier or the loud-speaker.

The hum may be picked either by the long unshielded line, particularly if it runs parallel to some power line carrying high currents, or, the coupling transformer at the speaker may be picking up hum from some hum-producing equipment on the stage of the auditorium. The fact that no hum is noticed in the monitor speaker when the auditorium speaker is connected directly at the amplifier, indicates that the hum is not being produced at the input end of the amplifier. An increase of hum in the PM speaker (at the amplifier) when the stage speaker is connected at the remote end of the line, clearly indicates that the line circuit is involved in the hum pickup. You can check if the speaker coupling transformer is picking up the hum by orienting the speaker while it is on the stage to see if the hum is reduced. If not, I suggest that you either shield the line or re-locate it so as to keep it away from high-current-carrying power lines.

The impedance of a terminated audio

Free Radionic Catalog



RADIONIC EQUIPMENT CO.

170 Nassau St. Dept. 1011. New York 7, N. Y.

Please send me a FREE copy of your 1947 Catalog. I understand it has thousands of items illustrated, described and priced and will be a great help to me in my search for "hard-to-find" radio equipment.

Name

Address

City State

frequency line may be checked with a power output level indicator. This device should be connected at the remote end of the line and adjusted so that maximum transfer of power takes place. The impedance setting of the indicator shows the proper terminal impedance.

The impedance of a non-terminated line is a function of its distributed capacity, inductance, d.c. resistance and insulation characteristics. For rough approximations, the impedance of a line should be at least twenty times its d.c. resistance. The distributed capacity of the line should have a capacitive reactance, at the highest frequency which the line is to transmit, of at least ten times the impedance of the source. The 250-foot line that you describe should be suitable for impedances ranging from 25 to 250 ohms, if 10,000 cycles is the upper frequency limit of transmission, or 25 to 500 ohms, if 5,000 cycles is the upper frequency limit.

The fact that you did not get as good results with 250-ohm terminations should not lead you to any false conclusions. The 250-ohm termination may have added some undesirable high frequency response in the system, and possibly provided less pleasing results. On the other hand, the 500-ohm transformers may have been much more efficient.

MAGNETOSTRICTION PICKUP

(Continued from page 16)

rants record performance beyond these limits—when such recordings can be obtained.

The pickup coils are so small they are not affected by magnetic fields that may exist around a phonograph motor or associated power lines. This factor reduces pickup hum to a negligible degree. The pressure on the needle point is only 0.7 ounce. This tends to reduce record wear and surface noise.

The TM pickup has a low output impedance, making it necessary to employ a coupling transformer between the pickup and the grid circuit of the amplifier. A high-quality transformer, correctly matched to the pickup and input grid circuit, will make it possible to take advantage of the high-fidelity recordings and transcriptions that are currently available.

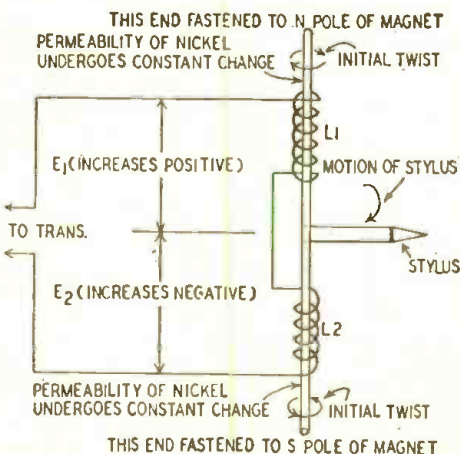

Fig. 2—Diagram of magnetostriction pickup.

A Handy SALESKIT FOR RADIO SERVICEMEN

A real saleshelp exclusively for Radio Servicemen... the Jensen Phonograph Needle Saleskit is just the thing for demonstrating fine needles. What's more, Jensen needles augment your work, assure full, clear tone of the instruments you repair, make all records sound better.

Colorful, convenient, compact... the Saleskit slips easily into your pocket. Take it on service calls. It contains 3 Jensen Concert Needles retailing at \$1 each and 3 Jensen Genuine Sapphire Needles at \$2.50 each.

Available NOW at your jobber. WRITE TODAY for complete details and our better than usual discount to servicemen.

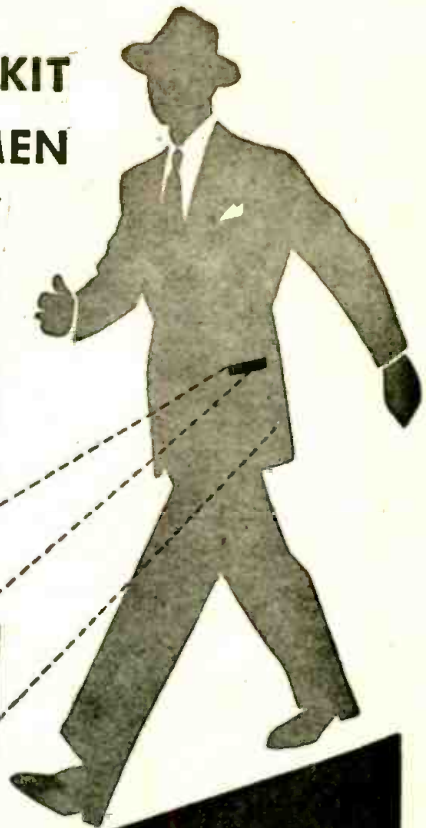

JENSEN INDUSTRIES, INC.
327 SOUTH WOOD STREET
CHICAGO 12 ILLINOIS

HAM SPECIALS

From Ham Headquarters

Order	Net Price
— Panoramic Adapter (PCA2)	\$99.75 Ea.
— Cabinet: 24 1/2" Wide, 29 1/2" Deep, 7 1/2" High, Gray Crackle Finish. Ideal for Transmitter	90.00 Ea.
— Choke: 300 MA. Swing 9-19 Henry. Smooth 11-Henry	7.50 Pr.
— Choke: 2 1/2 M.H. R.F.C.	.19 Ea.
— Code Oscillator: Complete with Speaker, Telegraph Operated, MS-700	9.95 Ea.
— Coil Assembly: R.F. from Army Receiver BC-224M	.75 Ea.
— Condenser: 12 Lx1 Mfd. 600-Volt Tobe Metal Case, Bath Tub	.49 Ea.
— Condenser: .5 and .2 Mfd. 600-Volt Bath Tub	.19 Ea.
— Condenser: 2 Mfd. 600-Volt Solar DC Aluminum Can, Oil Filled	.89 Ea.
— Condenser: 100 MMF. Midret Variable	.50 Ea.
— Condenser: 2 Mfd., 1000-Volt, Oil Filled, Rectangular Type	1.50 Ea.
— Condenser: 10 Mfd., 1400-Volt, Oil Filled, Rectangular Type	0.75 Ea.
— Condenser: 10 Mfd., 1000-Volt, Oil Filled, Rectangular Type	0.75 Ea.
— Condenser: 3 Mfd., 2000-Volt, Oil Filled, Rectangular Type	.50 Ea.
— Condenser: 50 MMF.	3.25 Ea.
— Condenser: 8 Mfd., 600-Volt C.D. Oil Filled	2.40 Ea.
— Condenser: .001 Mfd., 5000-Volt Oil Filled	.75 Ea.
— Condenser: 6 Mfd., 600-Volt Oil Filled	.99 Ea.
— Condenser: 3x3 Mfd., 600-Volt Oil Filled, Rectangular Type	1.50 Ea.
— Converter: Gonsett 4-tube supplied for either 10 or 6-Meter Band	39.95 Ea.
— Crystals: IN27 Sylvania Diode	.50 Ea.
— Handy Talkie: Complete with Batteries, 3885 K.C. Frequency	49.50 Ea.
— Chassis: for Handy Talkie	10.00 Ea.
— Insulator: 3" Feed Through	1.00 Ea.
— Meter: Westinghouse 2" D.C. MA. 0-10-25-50-100-150-200-250-300-400-500	3.50 Ea.
— Meter: Burlington, 2" A.C. 0-150	2.25 Ea.
— 2" Round	3.50 Ea.
— Meter: Time Hour 110-Volt 60-Cycle	3.50 Ea.

Order	Net Price
— Mike: Breast Mike	1.95 Ea.
— Mike: T17B Carbon Hand Mike	2.50 Ea.
— Plug: PL-55 Army Type Plug (100-Lots - \$25 Ea.)	.35 Ea.
— Receiver: BC-42 Frequency 200 to 500 KC-1500 KC-20 MC as is	60.00 Ea.
— Relay: D.P.D.T. 6-Volt D.C. Coil	1.75 Ea.
— Leach 1/4" Silver Contact	.12 Ea.
— Shield: 6C4 Tube Shield	.12 Ea.
— Transformer: 5.3 M.C. I.F. Iron Core Interstage	.49 Ea.
— Transformer: 5.3 M.C. I.F. Iron Core Diode	.49 Ea.
— Transformer: G.E. Modulation-200 Watts for 811s to 813	6.00 Ea.
— Transformer: 2.88 M.C. I.F.	.29 Ea.
— Transformer: Filament, 6.3 Volt at 1 3/5 Amps Small Round	1.20 Ea.
— Transmitter: BC-223 Frequency 2000 to 3000 K.C.	25.00 Ea.
— Transmitter and Receiver: BC-1335 F.M. Ideal for 10 Meter Mobile Operation 6 or 12-Volt Input 2 1/2 Watts Output. Dimensions 12 1/2" Long, 13 3/4" Deep, 6 3/4" High. Ready to go with Telephone Headset and (3) Crystals for 10-Meter Band	53.00 Ea.
— Trimmer: Air, 15 Mmf.	.25 Ea.
— Trimmer: 3-30	.15 Ea.
— Wire: Bronze Stranded Wire (250 Ft. Rolls) Heavy	3.50 /Rl.

Mail Orders Promptly Filled
Amateurs to Serve You
(20% Must Accompany All C.O.D. Orders)
Write Dept. RC
W6SCQ—W6UXN—W6NAT—
W6VHZ—W6VIW
WRITE FOR FREE BULLETIN 29

Radio Products Sales Company

238 WEST 15TH STREET
LOS ANGELES 15, CALIFORNIA
Prospect 7471

You Should Have An **OLSON**
PANEL LAMP
TOOL

for easy installation and
removal of all size
panel lamps

No
C.O.D.'s

The slickest tool yet offered to the
Radio Service Man. Made of live
rubber, with two size openings
so that any bulb will fit. No more
fumbling to get at a burned-out lamp.
No more squirming to install a new one.
Put a couple in your kit!

New Fall Catalog is off the press.

Write for your free copy

OLSON RADIO WAREHOUSE
73 E. MILL ST., DEPT. 53, AKRON, OHIO

Send me _____ Panel Lamp Tools at 25c ea.
I enclose \$ _____

NAME _____
ADDRESS _____
CITY _____ STATE _____

25¢
POSTPAID

MAIL TODAY

This offer good only in U. S. A.

BEAT-FREQUENCY OSCILLATOR

(Continued from page 28)

2000-ohm 5-watt resistor instead. Large filtering condensers and the extra filtering for the 6V6 screen also help. Ground returns are made to the No. 1 pin of the associated tube, all No. 1 pins being connected directly to the chassis by a short length of thick copper wire.

The plan view (Fig. 2) shows the general layout, with two tubes at each end (note the separation of 6K7 and 6J8) with a small vertical (40 milli-ampere) power transformer in between.

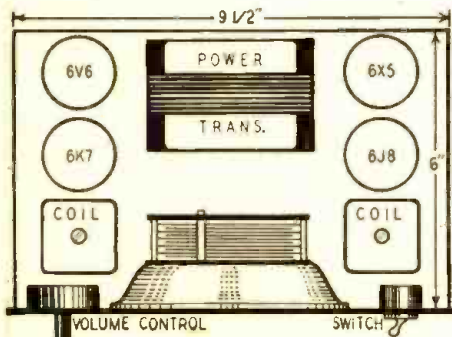

Fig. 2—The above layout should be followed.

Before any parts are mounted, the grid leaks and condensers must be connected inside the coil cans, the 6J8 triode decoupling arrangement also going inside a can if there be room. Chassis depth is

only 2 inches, though this can be increased to 2 3/4 inches if bantam tubes are used.

The main variable condenser moving plates are filed away at the end which first meshes, as shown in Fig. 3, and the fixed plates are shifted farther from the shaft. The idea is to have only a very, very, slow increase in capacity at first. Half the moving plates are to be removed—usually they can be pulled out without much trouble.

The front panel is of Masonite with a crackle-black finish. A bracket going right across the back of the panel carries the dial, dial drive and variable condenser. Four thick metal-braid leads run from the condenser to the chassis.

The dial drive consists of a large pulley on the condenser shaft with a quarter-inch diameter spindle fitting in a hollow bolt in the lower right-hand end of the panel. To provide a good grip for the dial cord, a strip of adhesive tape is wrapped around the end of the spindle.

The zero-set 3 plate condenser must be shielded by a screen of steel, brass or copper.

ADJUSTING THE OSCILLATOR

If the oscillator fails to produce a sound when a PM speaker or a pair of phones is connected to the output there may be several explanations. In-

correct polarity of one or more feedback coils (the plate windings) may prevent oscillation, one test for lack of oscillation being the absence of a negative voltage on the innermost grid of the tube concerned.

Another possibility is that the frequency difference of the oscillators may be so high that the sound is inaudible. This is the usual fault and is due to the small .001 μ f condensers having incorrect values. Try shunting one of them at a time by .0001, .0002, and .0003 μ f condensers. As a last resort a trimmer or padder condenser may be needed, but that is very undesirable as they do not stay put sufficiently and cause bad drifting especially when the weather varies.

ADJUSTMENTS FOR QUALITY

Once the oscillator is working, the next step is to obtain good wave-form by reducing the shunt resistor between the 6K7 screen and chassis. Try shunts of 1, .5, .25, .1 meg., etc., until oscilla-

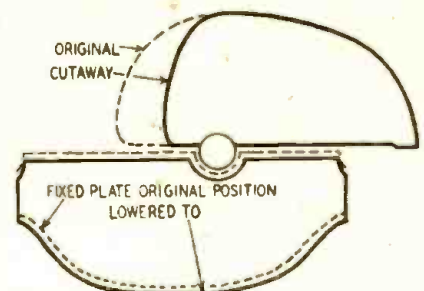

Fig. 3—How the condenser plates are shaped.

tion stops. Then connect in the smallest standard size that allows operation. This adjustment should be made at a fairly high frequency, say around 1000 or 2000 cycles and is facilitated if a cathode-ray oscilloscope is at hand to observe the waveform. Now the oscillator tuning control should be manipulated to determine the lowest possible frequency that can be produced. If locking-in occurs at too high a frequency, it may be due to imperfect grounding of coil cans, insufficient screening around gang, presence of r.f. in the output (cured by shielding of 6V6 together with a .00025- μ f condenser from 6V6 plate to chassis) or an open by-pass condenser somewhere. Reduction in size of the 6K7 coupling condenser from .0005 to .0002 μ f (or smaller) may help keep the circuits independent.

The particular oscillator shown had a wooden case and provided frequencies lower than 10 cycles per second. When a metal case is used, even lower frequencies can be obtained but care in shielding and wiring layout is most important. Frequency response of the output can be adjusted slightly by varying the capacities of the four condensers associated with the 6V6.

Calibration is best performed against an already calibrated oscillator by means of Lissajou figures on an oscilloscope, but other methods such as by beats and by bridges are also possible. Very accurate calibration at 20, 30, 45, 60, 90, 120, 150, 180 cycles can be obtained from an accurate 60-cycle supply.

TRANSATLANTIC NEWS

(Continued from page 29)

one of yours reference must be made to a comparative table of wire gauges before the inductors can be wound, for your B. & S. and our S.W.G. are quite different. I remember once winding a large solenoid with No. 30 wire as per instructions and wondering why there was not room on the former for all the turns. Then I realized that No. 30 was B. & S., equivalent to our No. 33.

BIG POSSIBILITIES

Two recent American developments have made a big impression on technical folk over here. These are the subminiature tubes and the system of painting connections with silver solution instead of using wires. I have heard of engineers who are contemplating special trips to the U.S.A. to investigate just these two things. What hurts me more than I can tell is that I got the idea of painting connections on radio panels about 20 years ago. I spent a lot of time and a good deal of money in buying and trying out every kind of metallic paint I could lay hands on. The only result of all that work was the discovery that most of them were pretty good insulators!

THE TENSION FILE?

Is the tension file available in your country? If it is, I can recommend it as a very handy tool for the radio workshop. As the drawing shows it is a round file about one-sixteenth inch in diameter, made with a knob at each end. To use it you fit it into an ordinary hacksaw frame by means of a pair of special clips and tighten it up just like a hacksaw blade. You then have what is to all intents and purposes a metal fretsaw. With the tension file you are not confined to cutting along straight lines, as you are with a hacksaw. You can cut curves, or even turn corners at a sharp angle. In fact the tool enables one to do a thousand and one neat shaping jobs which were previously almost impossible in the average amateur workshop. In England the files are obtainable in three different cuts, coarse, medium and fine.

NEW RADIOS

New radios are slow in coming along. Our radio industry shut down on the manufacture of domestic radios in September, 1939. Result is that the vast majority of the radios in use in Britain today date from 1938 or even earlier. There is no large supply on the market yet, for the government insists that a big percentage of those produced should be earmarked for export. Most of the sets in the shops are small and simple types which show little advance on pre-war designs. One reason is shortage of both components and materials, owing to the need of wood, plastics, metals and labor to erect and equip the houses now being built to replace some of the millions destroyed during the war. However, we are promised better things in the fall!

"TAB"

That's A Buy



CRYSTALS MTD QUART'D 2 to 10 mc's ACTIVE OSC'S LOW TEMP DRIFT. each .85 FOUR FOR \$3.00

DC-9 CRYSTAL 1000KC VACUUM STD'S ± 10 cyc's \$5.95

100KC CRYSTAL STD'S 7.20

Pioneer Instrument Autosyn Bendix

CK-5&AY101-D Paired Transmitter & Recv. New Govt. Insipid. for telemetering or remote signalling. Operates 24-28 Volts 400 cycles or 18-24 volts 60 cycles. Complete with all gearing. Govt. cost over \$100.00. "TAB" special \$2.95.



JAN 1625 new Beam (807) 85c @ 2 for	\$1.55
GE 440A/2C40 RCA Lighthouse tube (\$11)	6.95
GE 1841/1K60 RW.H.V. Rect (\$2.75)	1.95
GE 8AC7 JAN new 4 for	3.00
5CP1 & Socket \$7.50; 3BP1 & Socket	3.95
WE 368AS Tube UHF 20 watt to 1700mc's new	7.95
WE 368A Tube UHF 20 watt to 1000mc's new	5.95
WE 717A Door Knob Tube new	1.95
WE 307A RF. Pent. (L.P.\$13)	5.95
WE 330A RF. Pent. (L.P.\$24)	6.95
JAN 805/700-VT143 (L.P.\$11)	4.95
4G5/6U5 Ray Tubes (1.55) 75 @ 2 for	1.00
RCA 2V3G JAN H.V. C-Ray Rect. 16500V	1.25
JAN 872A New S/C Inap. \$3.75 @ 2 for	7.00

New W.E. Beachmaster Amplifier Navy Parts	
W.E. Dynamic microphone D-1734D-A	\$ 9.95
W.E. Dynamic microphone Cartridge	3.95
W.E. Dynamic microphone Transformer Input	2.00
W.E. 250watt Trumpet & Nine Drivers	125.00
GE Vacuum Condr 50mfd/16000V Z-600	3.95

957 Acorn JAN new (L.P.\$3.00)	\$1.25
RN215 Raytheon new (L.P.\$24.30)FW 500V/15A	7.95
VR150 JAN new (L.P.\$2.80) 75 @ 2 for	1.30
RCA 9002 JAN new (L.P.\$2.00) 65c. 2 for	1.25
RCA 30 JAN (L.P.\$1.20) .65 @ 2 for	1.10
RCA 187G JAN (L.P.\$2.80) \$1.50 @ 2 for	2.50
HCA12 Sweep Ckt. scope conversion kit	18.00
McElroy AN/GSC-T1 code practice set	22.50
Crystal Rectifier Test set TS-26BU	18.00
Polineman Q322 magnetic ckt bkr. DP 10amp	2.95
Heineman Q322 magnetic ckt bkr. SP @25amp	2.95
Air-Filter fiber-glass Cart' 8x6 1/2x3/4; 3 for	1.00

EICOR DC dynamotors new G'd Overseas packed-Anisp. HI-ef.	
Imp 12V/3A or 24V/4A. output 500V/50ma. Input same. output 275V/110ma & 12V/3A	
"TAB" SPECIAL EACH UNIT \$1.95 OR Both units (2) with filter \$3.49. Wgt. 9 lbs. 7 1/2" Lx2 1/2" H 1 1/4" W. Each Conservatively rated.	

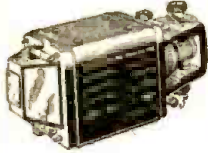

Switch A1H4 10A/125V DPST Rotary	\$ 5.79
Multi-switch 3pole 3pos six gang (\$7.39)	1.75
Multi-switch 1pole 11pos three gang (\$3.12)	.75
Multi-switch 1pole 11pos two gang (\$2.29)	.59
Multi-switch 3pole 3pos two gang (\$2.78)	.79
Ceramic-switch 3pole 3pos two gang (\$2.95)	.89
Ceramic-switch 1pole 12pos one gang (\$2.25)	.79
Switch A1H4 Toggle 15A/125V "Und APP"	.89
Daven attenuator "D" 5000ohm 10B/20pos	1.45
Daven attenuator "DTP" 5000ohm 60B/30pos	5.90
Daven attenuator "DT" 600/600 20pos	4.95

Condr oil A'VX 1510. 0.5mfd/1500WVDC Two for	\$ 1.15
Condr oil CD-TLA. 2mfd/600WVDC Two for	.79
Molded .01mfd/600WVDC-100 for \$7.50. 1000	30.00
Russ & little fuses 3AG/250ma. 48 for	1.00
Weston MTR-10+6DB 500/600 ohm L	3.95

Punched chassis 16 1/2" Lx6 1/2" Wx3 1/2" H Xmitter	\$ 3.35
Punched chassis 19 1/2" Lx13 1/2" Wx2 1/2" H Pwr Sup	.65
GE 3 Cond Tinsel "S3" new rubber cable 100 ft	2.49
Navy Res Trunk 12" x 2 1/2" x 1 1/2" used L.N.	3.95
Mallory NF1 Radio noise filter 57c @ 2 for	.98
Condr 25mfd/1000VAC wkg. new. 3 for	.75
GE oil 0.1mfd/1500WVDC 85; 0.1mfd/3000WVDC	1.25
0.1mfd 7500WVDC \$4.50; 0.25mfd 3000WVDC	2.95
0.1mfd 1500WVDC M/Tubulars. 10 for	1.50
0.2mfd 600WVDC M/Tubulars. 10 for	1.10
Condr mica .001mfd 2500V Test \$3.40. 2 for	1.00
Condr mica .001 or .002mfd 8000V (L.P.\$2)	3.90
Condr Mica CD .005mfd/6000VAC (L.P.\$12) 2 for	1.49

Transformers & Chokes New G'Insp all 115V/60 cy Pri	
Transformer C-Ray 4000V/2ma shielded GE	\$3.95
Transf 1600V/2ma. 2 1/2V/1.75A. GE	3.00
Transf 1600V/2ma. 2 1/2V/1.75A. 6.3V/0.6A GE	2.95
Transf Bias Sec 00.80.70V at 1 amp GE	2.95
Rectifier GE cu-Oxide FI 50V/5amp	2.95
Tnsf Fil 6.8V/4V/10A. 6.3V/0A. 5V/3A. 5V/3A	3.95
Tnsf P 2000VCT/250ma. 5V/3A. Cased GE	6.95
750VCT/250ma \$3.25; 800VCT/270ma	3.95
Tnsf P&S 1500VCT/170ma \$4.95; 6.3V/8A	1.85
Auto Trans 115.180.170.180V/1.0.1.78 Amp	1.65
Two 6.3V/3A. 7V/14A. 5V/8A. 5V/3A. GE	5.95
W.E. Tnsf 115V/60cy pri 5V/26A sec 15000V ins	4.50

Raytheon cased 840 VCT/110ma.530VCT/21ma. 5V/3A. 5V/3A. 6.3V/1A. 6.3V/3A. HV Ins (\$25)	\$ 2.50
Two for \$4.50; Five for \$10.00. 25 for \$45.00	
GE 10hy/250ma/100ohm choke	1.65
Thordarson 8Hy/150ma/200ohm. two for	1.94

Kenyon 115V/60cy pri 5V/60A sec HV. Ins.	\$7.95
Kenyon Pwr trans BC412 C-Ray tube A1 & P 2500V	5.95
Thord III-FI PPL6L output 3800 pri. tap sec	3.00
Choke GE 10Hy/250ma/110ohms. two for	2.80
Kurman adj 1000 cy AC source New G'1	.97
TBY Headsets & microphone with plug (L.N)G1	3.95
Vitreous Res. 1500 ohm 25W Tap at 7500. 3 for	1.00
IRC WW Resistor 10000 ohms 40W sq. 85 2 for	1.05
Sockets Amphinol SSTN octal 11P. 25 for	1.50
Sockets Amphinol 49R58 octal Ceramic. 10 for	1.00
Socket Amphinol 49-SS11L Normal Ceramic 3 for	1.00
Socket Johnson 50W. no. 211B (\$1.00) 2 for	1.63

RCA 808 JAN-CRC New G'd Fil 7.5V/4Amp. Plate 1500V/200 Watts Rated 140 Watts output each "UHF"	
(List \$7.75) "TAB" Price \$2.70 @ 2 for \$5.00	
Johnson UX sockets #224 (60c) 2 for	.49
GE&Wst 807 JAN (LP \$2.75) 1.35 @ 2 for	2.50
GE&Ray 955 JAN (LP \$2.85) .65 @ 2 for	1.25
VT127A/100TS UHF 100 watts 2 for	7.50

Socket RCA Diheptal & Adj Ring (\$7.00)	\$1.15
Socket Eby Miniature HF mica B & Shield 4 for	1.00
Socket National 7 Ironk Ceramic XC-75; 4 for	1.00
Socket National 5 Ironk Ceramic XC-5; 4 for	1.00
Socket National Octal Ceramic CIR-B; 4 for	1.00
Socket Hammarlund ACORN UHS900; 4 for	1.00
Resistors Kit 100B 1/2W 50 to 2 inck	2.50
Condr Kit 400 Silvermica 50 for	2.00
Voi controls Kit AB-J 50 to 1 meg; 10 for	2.50
Butterfly UHF Condr with 703 socket (SD5)	3.95
Cord SJ Hvt-duty 10 ft ext'nion M&F plugs	1.00

WE 200 microamps 3 1/2" Rd blk case	\$ 4.95
Shimston one ma 3 1/2" Rd blk case	3.00
Hallitifiers MO&XTAL HV-4 units BC610 (\$39)	2.95
Weston 476 Nq 3" B'C 15VAC	4.25
Weston 506 Rd 2 1/2" B'C 250ma DC.	3.95
Westchse elapsed time indicator 115V/60cy	4.50
GR Variac 200 CU new G'Insp	13.95

W.E. Crystal IN21-22-23-26 Lead sealed 4 for	\$1.50
W.E. Time delay relay 115V/5 amp cts 30 sec	1.49
Condr oil new G'Insp 18mfd/400WVDC We 2 for	2.35
Condr 0.5mfd/600WVDC Bathub. 3 for	1.00
Condr 10mfd/800WVDC (2/2.5mfd&5mfd) 2 for	2.50
Condr 2mfd/2000WVDC (1/2.4-5.5mfd) 2 for	5.00
Condr 3mfd/330VAC/1000WVDC GE. 2 for	2.50
Condr 2mfd/2000WVDC WACD. 2 for	4.25
Condr 3mfd/2000WVDC 2 for	5.00
Condr 10mfd/860VAC/2000WVDC GE (\$22)	2.70
Condr 15mfd/860VAC/2000WVDC GE (\$29)	3.90
Condr 2mfd/12500WVDC Westchse (\$210)	25.00
Condr 1mfd/25000WVDC Westchse (\$505)	75.00
Condr 4mfd/1500WVDC oil ins'tors. 2 for	4.00
Condr 6mfd/1500WVDC oil ins'tors. 2 for	5.00

"TAB" Special

Navy TBY portable ultra HI-Freq. 28 to 80 mc's transceiver Voice & CW Spot calibrated, including crystal calibrator, all tubes, adj. ant; phones, mike, carrying case \$36.00 each. Two for \$58.00. Additional spare parts. Vibrator supply. Trunk. Antenna, manual and other spares \$25.00.



Raytheon-866A filament transformer 115V 60c pri. 2.5 Vct 11A Sec and Two new RCA 866A tubes \$5.90 With Millen caps and sockets \$7.00 Raytheon Transformer only \$3.25

TRANSFORMER HIGH VOLTAGE new 115 & 203v 50/60 cy 110V. CT/212ma Collins mfged Chicago Trans. \$4.95

\$2 Min. orders FOB N.Y.C. Add Postage all orders and 25% deposit. Whitehall 3-3557. Send for catalog 300. Speciallists In International Export. School, College & Industrial trade. Buy thru "TAB" and save.

"TAB", Dept. RC11, 6A Church St., New York 6, N.Y., U.S.A.

CRESCENT Automatic RECORD CHANGER



Model C-100

- Physical Size: 15 3/4" x 12 1/2"
- Plays Twelve 10" or Ten 12" Records
- Noiseless
- Child-proof Mechanism
- Crystal Cartridge
- Reject Button
- Finished in Neutral Beige Crackle

RECORD CHANGER ONLY **\$1795**
Your Cost Each

LEATHERETTE BASE AS ILLUSTRATED
Above—Model H-100

Brown Finish, Made to Fit Model C-100 Record Changer, 6" High, with Grille for 5" Speaker. **\$4.25 ea.**

Orders are now being accepted for immediate delivery—no waiting. Terms: 2% check with order. Or 25% deposit, balance express C.O.D.

PM SPEAKERS

4" Alnico (5) PM Speaker	\$1.39 ea.
5" Alnico (5) PM Speaker	1.49 ea.
6" Alnico (5) PM Speaker	1.89 ea.

PHONO AMPLIFIERS

1-Tube Phono. Amplifier	\$2.35 ea.
3-Tube Phono. Amplifier	4.50 ea.

TUBULAR ELECTROLYTICS

100-MFD-25 V.	\$.22 ea.	10-MFD-450 V.	\$.29 ea.
10-MFD-50 V.22 ea.	16-MFD-450 V.39 ea.
20-MFD-150 V.22 ea.	10-10-MFD-450 V.59 ea.
30-MFD-150 V.29 ea.	20-20-MFD-150 V.29 ea.
40-MFD-150 V.39 ea.	30-20-MFD-150 V.39 ea.
50-MFD-150 V.45 ea.	40-30-MFD-150 V.45 ea.
8-MFD-450 V.25 ea.	50-30-MFD-150 V.59 ea.

HOLLANDER RADIO SUPPLY CO.

549 West Randolph Street Chicago 6, Illinois

TELEVISION FOR TODAY (Continued from page 56)

and R3 back to the cathode by way of the secondary of the I.F. transformer. As a result of the current flow, a voltage is developed across R4 with the polarity indicated. Since the incoming video signal has a negative picture phase the plate reaches its greatest positive value at the blanking and synchronizing pulses. The greatest current flows at this moment and develops the greatest voltage across R4. The video portion of the signal drives the diode plate only slightly positive and results in a relatively small amount of current flow.

The voltage that appears across R4 is the a.g.c. voltage. It is applied from grids of the tubes to be controlled through the filter composed of R5 and the 0.05- μ f capacitor. The filter has a relatively long time constant ($T = RC = 0.0005$ sec.), existing for about 10 horizontal lines. With this time constant, the 0.05- μ f capacitor, which is effectively across R4, charges to the peak value of the voltage across the resistor and retains this charge for a relatively long time. However, the peak voltage across R4 is determined by the syn-

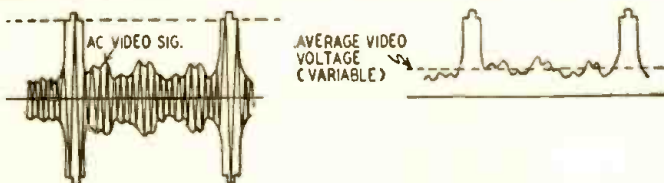

Fig. 4—Modulated television carrier and rectified video signal.

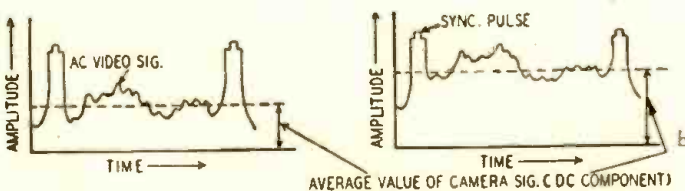

Fig. 5—Two identical video signals may differ in brightness only.

chronizing pulses of the video signal. Hence, the condenser charges to this peak voltage and then discharges so slowly that the rapid variations due to the smaller image voltages are ineffective and never reach the grids of the controlled tubes. Only changes in the level of the synchronizing pulses are effective at the preceding tubes. This is the desired action because, with constant carrier signal strength, the peak pulse voltages are also constant. With no signal arriving at the receiver, no voltage is developed across R4.

The plate of the a.g.c. diode and the grids of the controlled tubes are negatively biased by a voltage obtained from the negative side of the power supply. This voltage is in addition to the negative a.g.c. voltage and represents the minimum fixed bias on the tubes. There is -30 volts between the end of R1 and the grounded side of R3. Approximately 13 volts appear across R1, leaving the remaining 17 volts for R2 and R3. Rotation of the center arm of R2 will permit adjustment of the amount of negative voltage placed on the diode plate and on the controlled tubes' grids. In this way the amount of a.g.c. voltage fed back to the grids can be controlled. In addition, the d.c. negative bias of the grids may be altered, resulting in more or less gain for the video signal passing through the set. With greater gain, a stronger video signal is applied to the grid of the picture tube and a greater degree of contrast is obtained.

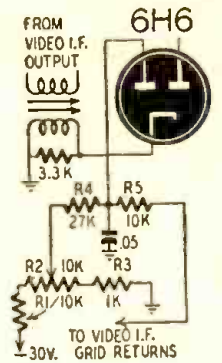

Fig. 6—A gain control.

CORRECTION

No wire sizes were given on the coil table of the Signal Generator, on page 778 of the August issue. A revised coil table with wire size is:

Band (kc)	Turns	Tap	Wire size
100-300	500	150	30 enamel
300-900	180	45	28 enamel
900-2700	46	10	28 enamel
2700-8100	17	3	28 enamel
8100-24000	5.2	1.4	26 enamel

A 2.5 millihenry r.f. choke, tapped between the first and second pies from the bottom may be used to cover the 100-300 kc band.

We are grateful to Mr. L. Donovan, of Bronx, N. Y., for calling our attention to the omission of wire sizes.

YOUR ELECTRIC DRILL Has 100 Other Uses

when used with K-Jax attachments
METAL SAWING . . . SHEARING
RIVETING ATTACHMENTS

Dept. R. Write for illustrated circular

K-JAX, 2600 Canton St., Dallas, Texas

HOME INTERCOMMUNICATOR
(Continued from page 55)

although slight in a good unit, can still be objectionably loud in the quiet of a bedroom at night.)

S1 and S6 are ganged with S4 and S7 in the form of a four-pole two-position lever action positive type twitch. S7 makes or breaks the 6.3 volt leads to the pilot light. The function of S4 will be treated in the following paragraph.

In each substation is located a double-pole single-throw switch in the form of a spring-return push button. These switches are normally open. When closed, one side completes the relay coil energizing circuit, thus closing both pairs of relay contacts. This, in turn, applies B voltage to the amplifier and brings the filament voltage up to normal level. The other side of the substation push-button switch connects the substation speaker voice coil to the amplifier input, through S4. This connection by-passes the regular voice coil leads and the master station selector switch S3, thus allowing the substation to call the master station even though the latter's power switch is "off," and the selector switch is set to the wrong position. If the ensuing conversation is of any length, the master station operator may set the station selector switch properly and throw his power switch to "on," thus relieving his fellow conversationalist of the duty of holding in the push button. When the master station power switch is turned "off" upon completion of the conversation, S4 is returned to position.

The other side of the substation
(Continued on page 70)

LAST MINUTE SPECIALS!

Iron Cord Sets, 6 ft., fine quality	Each	
G. E. Wire with plugs		\$0.42
Extension Cord Sets, 7 ft. with 3-way cube tap		.41
Excellō Automatic Iron, 1000-watt		7.25
1-Burner Hot plate		2.40
Steam Electric Iron		8.48
Dominion Electric Room Heater		5.90
Electric Heat Pads, 3-heat control		3.30

ELECTRIC COFFEE MAKER SET

Consists of a beautiful Electric Coffee Maker Stove, 8-cup Glass Coffee Maker, Attachment for Grilling, also Attachment for Making Toast... 6.85 (O.P.A. Retail Price \$9.98 each)

Write for illustrated literature featuring other merchandise.

2% discount for payment with order, otherwise shipped C.O.D. net.

SHEFFIELD RADIO & APPLIANCE CO., INC.

916 W. Belmont Ave., Dept. D Chicago 14, Ill.

Build Your Own *The Finest In Radio Kits*



JUST WIRE IT

All Parts Are Mounted

ATOMIC HEATER & RADIO CORPORATION

DEPT R.C.

104 PARK ROW

NEW YORK 7, N. Y.

The design, engineering and materials simplify construction and insure excellent reception and tone.

Cabinet is beautiful example of craftsmanship, made of choice veneer.

Tubes Required: Two 12SK7, One 12SA7, One 12SQ7, One 35L6, One 35Z5.

YOUR COST WITHOUT TUBES, \$15.80

Terms—10% Deposit with Order, Balance C.O.D.

Immediate Delivery

HOW TO PASS Commercial Radio Operators' FCC LICENSE EXAMINATIONS...

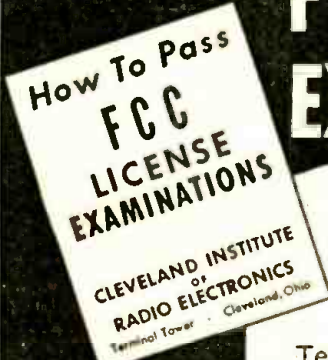

FREE BOOKLET

Tells you the Government requirements for all classes of commercial operator licenses.

Tells where to apply for and take the examinations, examining offices, scope of knowledge required, extracts from FCC Rules and Regulations, extracts from FCC Study Guide and Reference Material, approved way to prepare for FCC examinations, positive method of checking your knowledge before taking the examinations.

Don't Delay—Write Today!

Edition Limited—Mail Coupon Before Supply Is Exhausted

CLEVELAND INSTITUTE OF RADIO ELECTRONICS

Successors to

NILSON RADIO SCHOOL, Founded 1939

SMITH PRACTICAL RADIO INSTITUTE, Founded 1934

RC-11 TERMINAL TOWER

CLEVELAND 13, OHIO

APPROVED FOR VETERAN TRAINING UNDER G. I. BILL OF RIGHTS

MAIL THIS COUPON

CLEVELAND INSTITUTE OF RADIO ELECTRONICS

RC-11 TERMINAL TOWER, Cleveland 13, Ohio

Gentlemen: Please send your FREE Booklet, "How To Pass FCC License Examinations."
(Note: This Booklet does not cover examinations for Amateur License)

NAME I have had experience in broadcast-
ADDRESS ing servicing operating
CITY STATE mfg. CAA Army-Navy
amateur other

Check license desired:
Radiotelephone 1st. Class 2nd Class
Radiotelegraph 1st Class 2nd Class

I now hold these licenses I am a High School Grad. College Grad. with degree
If a War Veteran, check here

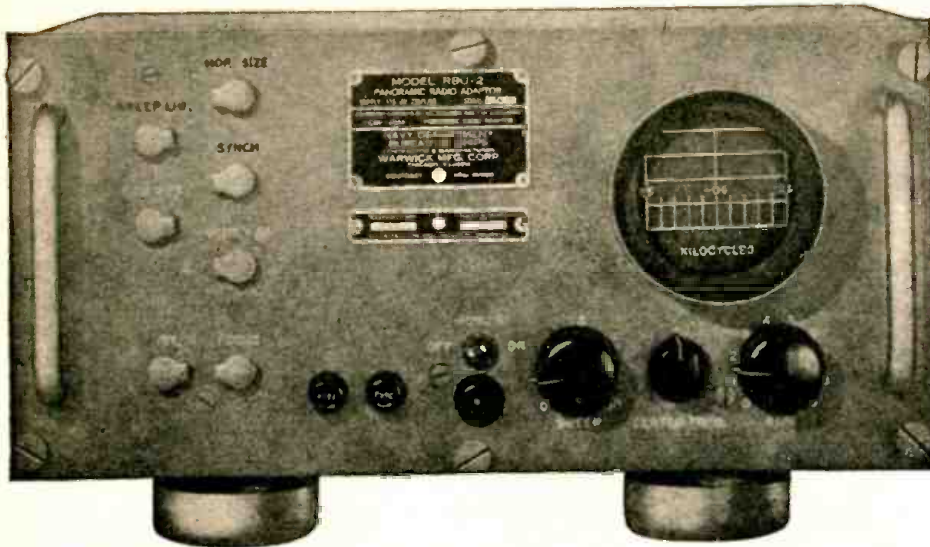

Navy Panoramic Adaptors!

The Panoramic Adaptor tells you at a glance what is going on over a wide area of the band. When attached to your receiver, the adaptor will visually indicate whether there are signals present within the area covered. It will show the relative frequency of each signal, relative signal strength, the type and percentage of modulation. This Navy unit was built to rigid specifications without consideration of cost. It will allow you to locate "holes" in crowded bands, detect weak signals, and contribute generally to the improved operation of your station. The RBV-2 covers a continuous band of frequencies 100 Kc. wide. Operates on 115/230 V.A.C. 50/70 cycles. New and packed in original crates. Tropicalized.

PRICE ONLY **\$94.50**

F.O.B. Chicago

ARMY WALKIE - TALKIES!

The BC-322 is a complete, portable radio communication set. It is light enough to be strapped on the back and powerful enough for dependable voice transmission over a range of 10 to 20 miles. Frequency band 52 to 65 Mc. These sets are new in original crates. The low price includes tubes, handset, telescopic antenna, batteries and battery adaptor, and carrying case. \$75.00 F.O.B. Chicago. Model BC-222 has two bands but otherwise the same as the BC-322. Frequencies from 28 to 38 Mc. and 38 to 52 Mc. These sets have been in service but have been renewed by the Government. New batteries. No carrying case.

PRICE ONLY **\$45.00**

F.O.B. Chicago

Government Termination Material

Condensers	Transformers
Resistors	Volume Controls
Spaghetti	Vibrators
Switches	B-L Selenium
Transmitting	Rectifiers
Tubes	Dial Light
Wire-Cable	Assemblies
Relays	Whip Antennas
Tube Sockets	

WELLS SALES, INC.
4717-J W. Madison St.
Chicago 44, Ill.

USE COUPON BELOW FOR COMPLETE INFORMATION

WELLS-SALES, INC., 4717-J West Madison Street, Chicago 44, Illinois

Please ship.....for which \$.....is enclosed

Please mail free Amateur Radio Circular.

Please send prices and information on the following items:.....

NAME

ADDRESS

SPECIALS

Recvr tube grid clip—pkge of 16	25c
Acorn tube grid clip—pkge of 20	25c
Insulated spring plate cap (2x2; 807) pkge of 4	60c
20,000 ohm WW Pots—longshaft; pkge of 4	\$1.00
20,000 ohm WW Pots—screw driver adjust; pkge of 2	45c
5,000 ohm WW Pots—screw driver adjust; pkge of 2	85c
2,000 ohm WW Pots—screw driver adjust; pkge of 2	40c

Send check or M.O., include postage

GREENWICH SALES CO.

59 Cortlandt Street New York 7, N. Y.

Do you need BINDING POSTS?



The XL PUSH POST with its Spring Action assures Constant Contact and quick connection.

Manufactured in All Aluminum Type M at 12c each.

Aluminum Body, Bakelite Top Type B1 at 15c each.

Types CP or NP. ALL BRASS—STAINLESS STEEL SPRING & FIN. PROVEN by 240 HR. SALT SPRAY TEST as NON-CORROSIVE at 28c each.

Manufacturers and Dealers Liberal Discounts

X. L. RADIO LABORATORIES

420 West Chicago Ave., Chicago 10, Ill.

RADIO BOOKS BY MAIL

OVER 125 TITLES IN STOCK

SAME-DAY SHIPMENT ON 98% OF ALL MAIL ORDERS. Books of nearly all radio publishers. If you don't know price, send deposit and we'll ship C.O.D.

SEND STAMP FOR CATALOG to **EDITORS AND ENGINEERS, Ltd.**
1305 Kenwood Road • Santa Barbara, California

HOME INTERCOMMUNICATOR

(Continued from page 69)

speaker voice coil is grounded to a water pipe, as is No. 6 pin of the amplifier connecting plug. The water pipe system cannot be used as one of the relay leads as well as a return for the audio signal because of the coupling between the two circuits when the relay circuit is closed. This interaction would cause intolerable distortion.

CONSTRUCTION DETAILS

The 9¼ by 7 by 2-inch chassis was built for the job of 22 gage galvanized sheet. A metal chassis front was provided for mounting the controls and speaker so that the cabinet front could be made an integral part of the box. A standard chassis and panel could have been used. The usual precautions in separating the input circuit from the rest of the amplifier should be followed. The power and interstation leads enter the master set through chassis-mounted connectors so that the amplifier may be easily detached for servicing.

The chassis and panel layouts are clearly shown in the photographs. The power transformer is mounted in the lower right hand corner of the chassis. R6 is mounted on two of the transformer bolts, as is the two-prong plug assembly for the power-line connector. The relay is located between T1 and the panel. Immediately to the left of the power transformer the rectifier tube and the triple-unit electrolytic filter condenser can be seen. Next in line is the power tube, with the 6C6 farthest to the left. Between the two amplifier tube sockets, and near the back edge, is the socket for the seven-prong plug terminating the interstation wiring. The input and output transformers are located under the speaker.

Looking at the panel front, the power and talk-listen switches are located to the left, with the pilot light between. The volume control is positioned below the pilot light. The station selector is mounted directly below the speaker. Both of the latter two controls are positioned below the chassis top. The arrangement described gives a convenient layout with minimum lead lengths.

Ordinary bell wire was used for the interstation leads, the maximum voltage handled being 16 volts in the relay circuit. By shopping around, seven different insulation colors were obtained, providing color-coded leads. Some ingenuity will be required in getting the leads hidden in partitions, closets and the attic, but no special precautions need be observed except to keep the relay wires separated slightly from the others when this can be done easily. The use of bell wire keeps the cost of this part of the installation to a minimum. Connection blocks were inserted at strategic points as indicated in the wiring diagram. Transformer T4, which is a door chime transformer rated at 16 volts output, was installed in a closet, with a line cord switch as S8.

UNIVERSAL 1-KW AMPLIFIER

(Continued from page 57)

plished by means of the Variac or by means of a 200 watt, 110 volt lamp wired in series with the high-voltage transformer primary together with a switch for shorting out the lamp resistance for normal operation.

5. Apply the reduced plate and screen voltage and quickly tune the plate tank for minimum plate and screen current indication on the milliammeter. Adjust the coupling between the plate coil and the output link circuit until the combined plate and screen currents are about 200 to 250 milliamperes. Watch the color of the 4-125A plates at this current indication: they should be a dull orange in color and should be of equal brilliance. If the plate colors are not of equal brilliance, this indicates that one tube is either receiving inadequate excitation or is being loaded too heavily. It is sometimes necessary to move the center connection of a grid coil one way or the other before equal excitation to the two tubes is obtained.

6. If amplifier operation appears normal with excitation and reduced screen and plate voltages applied, momentarily remove the r.f. excitation from the input circuit and watch the plate and screen current milliammeter. If the fixed bias is sufficient, the plate and screen currents should drop to a very low value or zero. If the plate and screen current rises when the grid excitation is removed, insufficient fixed bias is being applied to the grids, the amplifier is oscillating, or there are parasitic oscillations taking place at some frequency far removed from the resonant frequency of the plate and grid tuned circuits. The grid current should indicate zero. If grid current is indicated when the r.f. excitation is removed, this is a sure sign of oscillation in the amplifier. If no grid current is indicated but the plate and screen currents rise when the r.f. excitation is removed, the trouble is almost certain to be insufficient fixed bias voltage.

7. Now, with the r.f. excitation removed, adjust the fixed bias voltage so that the total plate and screen currents are approximately 100 to 150 milliamperes. Rotate the grid and plate tank tuning condensers throughout their scales; at the same time watch the plate and screen current milliammeter. The current indication should remain constant. If it does not, parasitic or spurious oscillation may be taking place.

8. If there was a change in plate and screen current as discussed in step 7 above, adjust the trimmer condensers of the two parasitic traps under the chassis until the plate and screen currents remain constant at any setting of the plate and grid tank tuning condensers.

9. Connect the antenna to the output link, re-apply r.f. excitation to the grids and apply the full plate and screen voltage. Tune the grid and plate tank cir-

Famous LUCY Receiver (KIT FORM)



All Original Parts
Shipping weight 4 lbs.

- Used by Paratroopers
- Used by U. S. Secret Service
- Used by Land and Sea Forces

Now available to you for the first time
Small, compact, ultra-efficient. No drilling or punching required. Complete wiring diagram supplied.

- Uses 6 Miniature Tubes—1R5, 1L4, 185, 3 IT's in a superhet circuit.
- 2 BAND COVERS 2-12 Megacycles.
- Requires 90 Volts B and 1½ Volts A Battery.
- Iron Core (456 k.c.) I.F. Transformers.
- B.F.O. for CW Reception.
- CABINET INCLUDED.

6 TUBES INCLUDED
(Less Phones & Hookup Wire)

20% Deposit with Order—Include Postage

YOUR COST
\$19⁹⁵

KELVIN ELECTRONICS

76 CORTLAND ST.
NEW YORK 7, N. Y.

uits as before and adjust the antenna loading for a combined plate and screen current of 300 to 400 milliamperes. Readjust the coupling between the r.f. excitation source and the amplifier grid circuit to give the proper grid current required for full power input operation.

10. If the operation of the amplifier now appears to be normal, the screen and control grid power dissipation should be checked before prolonged operation has taken place. The screen dissipation may be calculated by measuring the screen currents from the two tubes and the voltage applied to the screens. The power dissipation will be equal to $E_s I_s$, where E_s is the screen voltage and I_s is the total screen current. The total screen dissipation should not exceed the values given in the 4-125A operating conditions charts.

The grid dissipation is calculated from the following expression:

$$P_g = E_{emp} I_g$$

Where P_g = Grid dissipation

E_{emp} = Peak positive voltage

I_g = d.c. grid current

The grid dissipation for the 4-125As must not be allowed to exceed 3 watts per tube.

As the tables issued by the manufacturer show, the maximum plate dissipation per 4-125A tube for c.w. telegraph operation is 125 watts; for radio-telephone operation, the maximum plate dissipation per 4-125A tube is 85 watts. This means that at 100% modulation with a sustained sine wave, the plate dissipation will reach 125 watts per tube and, therefore, for radio-telephone operation, with normal efficiency, the plate power input will be limited to slightly over 700 watts per pair of 4-125As. On c.w. telegraph operation, however, the full input of 1,000 watts may be used.

Plate voltages up to 3000 may be
(Continued on page 77)

CRABTREE'S
WHOLESALE RADIO
2608 Ross Ave.
DALLAS 1 TEXAS

MORE SMASH BUYS at National Radio Distributors

IMMEDIATE DELIVERY

The Famous National Radio Kits



ALL PARTS MOUNTED.
Ready for easy wiring.

New & improved A.C./D.C. Superhet, featuring latest Post-War engineering, including beautiful modern design brown plastic cabinet, built-in loop antenna & new Alnico speaker. Uses 12SA7.

12SK7, 12SQ7, 50L6, & 35Z5 tubes.	
Price (Complete with cabinet)	\$11.95
Lots of 50 or more (Complete with cabinet)	10.95
Kit of 5 matched tubes for above	4.25
4 Tube A.C./D.C. T.R.F., built-in loop antenna & Alnico speaker. Price (Complete with cabinet)	10.95
Lots of 50 or more (complete with cabinet)	10.25
Kit of 4 matched tubes, for above (12SK7, 12SQ7, 50L6 & 35Z5)	3.50

GLO-IRON

The safe, cordless plastic toy that actually GLOWS in Sparkling Red through its translucent body.

Features smooth-steel ironing base & On-Off switch. Complete with battery & Bulb.



Absolutely brand new & different, will delight the youngster's heart!

Individually & attractively boxed.

List Price \$1.29
Your Net (in dozen lots) Each78

Write for New Catalog.

It's Free.

National Radio Distributors

1029_R E. 163 St., New York 59, N. Y.

The BUY of a LIFETIME

U. S. SIGNAL CORPS **5 Meter** ONLY \$3⁴⁹
SHORT WAVE XMTRS. }
(72.2 Mc)

Complete with Tube... BRAND NEW

One 1½ volt dry cell and 67½ volts of B operates it. Just attach di-pole, key or mike, connect the batteries and it's ready to use. Signal Corps spec wired with silvered wire, mica condensers, and precision resistors. Highly stable circuit with Lo-Loss silvered inductance. (Adjustable paddler.) Schematic supplied. Converts easily to walkie-talkie and Ham bands. Weighs less than a pound. Shipped by express only. No C.O.D.'s. No Parcel Post. A sacrifice at only \$3.49. Postal or express money order or certified check.

NEWARK SURPLUS MATERIALS CO.

324 Plane St., Dept. C, Newark 2, N. J.
SEND STAMP FOR GIANT CATALOG!

SRI for radio and electronic SPECIALS!



CONSTANT OUTPUT AMPLIFIER

Automatic Gain Control for PA systems or transmitters. **\$59.50**

- ★ Increases effective output power.
- ★ 38 db Amp. gain—600 Ohm input and output.
- ★ Prevents blasting and raises low levels automatically.
- ★ Fine all-around pre-amplifier.
- ★ Eliminates gain riding.
- ★ Complete with tubes and instruction manual.

TELESCOPIC ANTENNA

12' 10" extended—for receiver and transmitter— $\frac{7}{8}$ " dia. base threaded base stud mounting—plated steel. **\$2.75**

SENSITIVE HEADSETS

HS23—8000 Ohm impedance, with ear cups, leather band, extension cord. **\$2.59**

DYNAMOTOR—P103A

6 v. and 12 v. d.c. input—500 v. d.c. @ 224 Ma. output. Complete with relays, filter, fuses. **\$13.75**

WRITE NOW

For FREE catalog of 1001 different items. All equipment of highest quality, made to rigid government specifications at a fraction of cost. All items brand new and guaranteed. Bargain bulletins also mailed each month.

Terms 25% Deposit

Balance COD (No other way)

Write: Dept. R.C.-23

SURPLUS RADIO, INC.

2-54 148th STREET
WHITESTONE, N. Y.

COILS, CORES AND MAGNETS

(Continued from page 27)

must permit sufficient current to flow through the ballast for normal operation, make available enough starting voltage, yet limit the current to a safe value at all times.

Most inductances having d.c. in the windings have an air gap in the magnetic circuit. This is to increase the apparent permeability over that available without an air gap. The length of air gap which results in highest permeability and likewise highest inductance for the particular current conditions in the windings is called the *optimum air gap*.

Optimum air gap may be computed by proper application of the normal d.c. magnetization curve and the incremental permeability curve for a given steel and core. The procedure is rather lengthy and will not be presented here. The average experimenter would probably find it faster to use a test circuit and obtain apparent inductance, apparent permeability, and optimum air gap simultaneously.

Circuits suitable for measuring inductance, determining apparent permeability and optimum air gap, are shown in Figs. 4 and 5. The Fig. 4 circuit is suitable for low and zero direct current. D.c. saturation of the transformer core is eliminated with the Fig. 5 circuit but the circuit has the disadvantage of requiring two similar chokes.

In either circuit the d.c. is first adjusted to the normal working condition. R4 and R5, Fig. 5, must be so adjusted that no d.c. flows through R3. This can be determined by a d.c. v.t. voltmeter across R3. Sufficient a.c. voltage is applied to give the working values across

Come to the famous

COYNE TRAINING SHOPS

where you "learn by doing"



TRAIN FOR RADIO-ELECTRONICS IN A FEW WEEKS

Prepare For A Good Job Now With A Lifetime Future!

Trained Radio-Electronics men needed now. They will be needed too in the years to come. Don't be caught napping. Get a Radio training now and be ready. Learn by Doing. Free employment service for life after graduation. Many earn while learning. If you are short of money, ask about my Student Finance Plan. Now added Training in Industrial Electronics and Electric Refrigeration. We are also equipped to train those who qualify under G. I. Bill. We also have facilities for men with physical disabilities whether due to war or other causes. Fill in and mail coupon for details.

SEND COUPON FOR FULL DETAILS

B. W. COOKE, Dir., Radio-Electronics Div.,
COYNE ELECTRICAL SCHOOL
500 S. Paulina St., Dept. 86-8H, Chicago 12, Ill.
Send Big Free Book; also details about Coyne Part-Time Employment and Student Finance Plan.

Send G. I. Bulletin Physical Disability

NAME.....AGE.....

ADDRESS.....

CITY.....STATE.....

WE'VE GOT EVERYTHING in RADIO PARTS



WALSCO HARDWARE RACK

Contains over 2000 Electronic and Electrical Hardware Items

Permanent steel rack, complete with 40 screw top jars. Contains essential hardware such as screws, bolts, washers, nuts, trimouts, various springs, lugs, clamps, grommets, rubber feet and bumpers, snap hole plugs, rivets, eyelets, etc. NO. 1035

16⁵⁰



RESISTOR KITS

Assortment of 100 — $\frac{1}{2}$, 1 and 2-watt resistors. **1.49**

TYPICAL RESCO VALUES!

NOKORODE SOLDERING PASTE 1-lb. Can 49c	G. E. GLYPTAL VARNISH Can 10c
10' COIL ROSIN CORE SOLDER 9c 10 for 75c	12" PORCELAIN INSULATORS 3c 10 for 25c
6' AC CORD AND PLUG 19c 10 for 1.75	10-WATT ASSORTED RESISTORS 15c 10 for 1.35
MICA CONDENSERS HIGH VOLTAGES 15c 10 for 1.35	Screw Terminal Strips 2-11 CONNECTOR Ass't of 10 49c
Tube Adapters for Hard-to-Get Tubes 29c 10 for 2.50	Volume Controls — Ass't Values & Sizes 19c 10 for 1.75

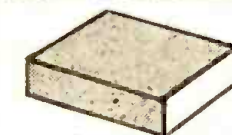

CHASSIS

All sizes for all purposes. If the size you want isn't in stock, our Metal Shop will make it in 48 hours.

10 x 23 x 3—1.86	10 x 17 x 3—1.50
17 x 14 x 3—2.40	7 x 13 x 2—.99
7 x 17 x 3—1.23	13 x 5 x 3—.99
13 x 7 x 4—2.64	

And Many Other Sizes In Stock

JUST OFF THE PRESS!

SPECIAL BULLETIN OF VALUES ON RADIO PARTS AND EQUIPMENT

Send for Yours Today!

Radio Electric SERVICE CO. OF PENNA., INC.

7TH AND ARCH STREETS. PHILA. 6, PENNA.
Branches at 5133 Market St. and 3145 N. Broad St.,
Phila. Also in Wilmington, Del., Easton, Pa., Allentown, Pa.

L1, as measured by an a.c. v.t. voltmeter. Connecting it across R3 will give the voltage drop due to the a.c. flowing through L1.

The optimum air gap may now be found by varying the gap length until the a.c. voltage across R3 reaches a minimum with the a.c. voltage and direct current across L1 held to the working values. For Fig. 5 the air gaps must be the same for L1 and L2 and both varied simultaneously.

INDUCTANCE FORMULAS

The apparent inductance of L1 in henries will be $L_a = .159 \times$

$$\sqrt{\frac{(R_3 E_L)^2}{E_R^2} - R_a^2} \cdot \frac{1}{f}$$

where R3 = d.c. resistance of voltmeter shunt in ohms, E_L = a.c. volts across L1, E_R = a.c. volts across R3, f = a.c. test frequency, and R_a = apparent resistance of L1. (R_a consists of the d.c. resistance plus resistance effects due to core losses. The latter are very low in good-grade laminated cores.) Usually R_a is small compared to the inductive reactance of the coil and could be omitted, simplifying the formula to

$$L_a = \frac{.159 R_3 E_L}{f E_R}$$

Because L1 and L2, Fig. 5, are in parallel, L_a must be multiplied by 2 to obtain the value for L1.

Knowing L_a, the apparent permeability can be found to be

$$\mu_a = \frac{3.19 N^2 A K_1}{2 l L_a}$$

where l = length of core in inches, A = area of core in square inches, N = number of turns in coil, and K₁ = stacking factor (usually about .9).

The a.c. flux density in lines per square inch will be

$$B_{ac} = \frac{10^8 E_{rms}}{4.44 f N A K_1}$$

where E_{rms} = a.c. voltage across L1 and other symbols as before.

To simplify calculations for average cores an Iron-Core Inductance Design Chart has been constructed in Fig. 6. The symbols at the scale headings may be identified from the previous text. The multiplying scales X₁, X₂, X₃ are used to obtain readings.

The Inductance Design Chart is constructed to automatically allow a .9 lamination stacking factor. O_{ac} points, and the B_{ac} and TC₁ turning curves were prepared from data on 29 gauge (.014-inch) steel laminations having properties similar to those on Curve 1, Fig. 1, which appeared last month. These properties were taken as an average. Some steels will give more inductance, others less. Now points and turning curves may be constructed for steels and cores with other characteristics. The balance of the chart would remain unchanged.

The previous B_{ac} formula may be used to assist in selecting one of the B_{ac} turning curves or O_{ac} points on the chart.

Values of B_{ac} may be less than 65 for some interstage a.f. transformers and smoothing chokes while for some output transformers and swinging or input chokes it may go well beyond 3500. Turning curve TC₁ is used to obtain air gap length for all values of B_{ac}.

USE OF THE CHART

Assume we have a core like Fig. 3 (last month's issue) to be used for a smoothing choke. The core is 1 inch wide and stacked 1 inch high using 29 gauge (.014-inch) steel laminations, making

the area (A) = 1.0 square inch. The entire core has uniform cross-sectional area (each of the two outer legs have one-half the area of the center leg). The core length (average length around each window as indicated in Fig. 3) l_c = 6.0 inches. Window is 1/2 x 1 1/2 inch. B_{ac} = 650 will be satisfactory and there will be 80 ma d.c. in the windings. The problem is to find the maximum inductance, L_a, in henries, and the optimum air gap, l_a, in inches.

The more turns the greater the inductance but wire size, allowable re-

THE SECRET'S OUT! The New and Spectacular ACA-100DC AMPLIFIER

Is Ready For Delivery!

DESIGNED BY A. C. SHANEY



A revolutionary development in amplifiers cleverly designed to defy obsolescence and amazing in its performance. New circuits, new materials and new processes are actually combined in this one amplifier to produce the most satisfying musical amplifier the world has ever known. If you are one of those discriminating persons for whom nothing less than the best is a disappointment, you are one for whom the ACA-100DC was designed. Send for technical literature.

AMPLIFIER CORP. of AMERICA

398 Broadway, New York 13, N. Y.

A. C. Shaney's FM-AM AMPLIFIER MANUAL is still available at 25c

Electricity

Capacity range: 350 to 35,000 watts; 115 to 660 volts A.C., 50 to 800 cycles; 6 to 800 volts D.C.; combination A.C.—D.C. types.

FOR RADIO AND ELECTRONIC APPLICATIONS

ONAN ELECTRIC GENERATING PLANTS supply reliable, economical electrical service for electronics and television applications as well as for scores of general uses. Driven by Onan-built, 4-cycle gasoline engines, these power units are of single-unit, compact design and sturdy construction. Suitable for mobile, stationary or emergency service.

Model shown is from W35 series; 2000 to 3500 watts, powered by Onan two-cylinder, water-cooled engine.

D. W. ONAN AND SONS

2434 Royalston Avenue
Minneapolis 5, Minn.

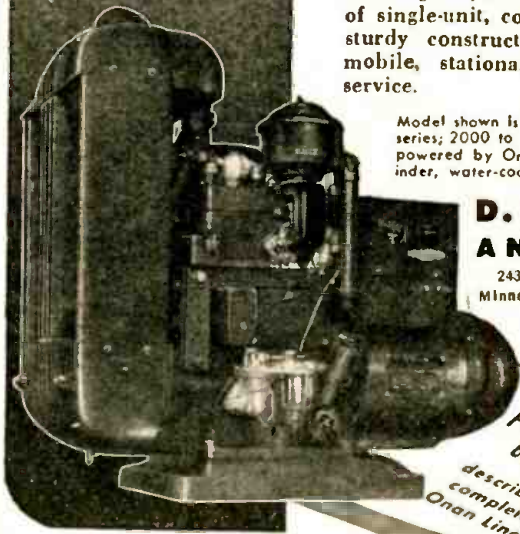

Write For Folder 690 describing complete Onan line



NEW TINYPOCKETSIZE RADIO!

Slips in your pocket or purse! WT. ONLY 1/4 lb. Complete READY TO PLAY as shown with self contained phone for personal use. Beautiful black silver plastic case. Has patented fixed CRYSTAL-SLIDE TUNING DIAL. NO TUBES. BATTERIES OR ELECTRIC PLUG-IN REQUIRED. USUALLY RECEIVES LOCAL BROADCASTS without outside aerial wires.

GUARANTEED TO WORK when connected and used according to instructions. Can be used in homes, offices, hotels, cabins, in bed after hours, etc. (cash, money order, check) and pay postman \$2.99 plus delivery fees on arrival or send \$3.99 for postpaid delivery. IDEAL GIFT FOR CHILDREN OR ADULTS Alike! Get your PA-KETTE RADIO NOW for real enjoyment. Foreign orders \$5.00 U.S. Cash.) Pa-Kette Electric Co., Dept RC-11, Kearney, Nebraska

Send Only \$100

The
SIGNALER
\$24.95



A Different, Positive Radio Tester

The New Dynamic SIGNALER is revolutionary... accurate... and quicker and easier to use! The SIGNALER puts out a continuously varying audio signal from 5000 cycles to well above short wave bands, including FM. Insert a signal at any point in the circuit. Start at the plate of the output tube. Proceed from plate to grid of every stage. Locate by lack of signal output, the defective stage... accurately and rapidly. Complete isolation from AC Power Line. No complicated dials to fuss with! An output jack and variable gain control do the trick. Use one probe for all tests... audio, intermediate, and frequency. Used with an output meter, the SIGNALER is the most modern, efficient way of servicing the most complicated radio circuits. Complete with special jack, lead, and probe, plus thorough, easy-to-understand instructions.

MAIL THIS ORDER FOR QUICK DELIVERY

ELECTRONIC PRODUCTS CO.
662 Monroe Ave. Rochester 7, N. Y.
Please send the following immediately. I understand my money will be refunded if I am not completely satisfied.
 Signaler Set Tester @ \$24.95
 Check or Money Order enclosed Send C.O.D.
Name.....
Address.....
City..... State.....

ELECTRONIC PRODUCTS CO.
662 Monroe Ave. Rochester 7, N. Y.

**RADIO PARTS
SOUND SYSTEMS
ELECTRONIC
APPARATUS**

**Depend on
RADOLEK**

Radolek's big Free Profit Guide Catalog and Profit Bulletin supplements keep you abreast of the rapidly changing radio situation. Buying from Radolek means greater values, better service and more profits. Make Radolek your buying headquarters.

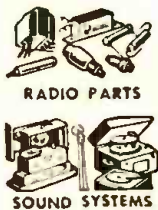

RADIO PARTS
SOUND SYSTEMS

FREE CATALOG

Large Stocks
Fast Service

SEND TODAY!

RADOLEK CO., Dept. C-120
601 W. Randolph St., Chicago 6, Ill.
Please send your FREE Profit Guide Catalog.
Name.....
Address.....

SAVE AT RADOLEK

COILS, CORES AND MAGNETS
(Continued from page 73)

sistance and window area will limit the number. Wire size and coil dissipation watts may be computed as outlined for electromagnets. If the coil resistance is too great larger wire may be used.

A fairly reliable method is to select a wire, allowing 750 to 1250 circular mils per ampere. A wire table and a few computations will show that 3500 turns, No. 32 enamel wire, would go in the window and have a resistance of about 250 ohms.

This information may now be applied to the Inductance Design Chart, Fig. 6. The column headed "Order of Scales" indicates the function of certain groups of scales and under each function is given the order in which the scales are read at each setting of a straightedge. Mistakes will be prevented by writing down the reading for each scale.

Using the group of scales "FOR D.C." set a straightedge from 3500 (no. of turns) on N to 80 (no. of milliamperes) on M.A. and read 3.23 on X₁; From 3.23 on X₁ to 6 (lgth. of core, inches) on l_c and read 4.02 on X₂; Next from 6 (core lgth.) on l_c to 1 (core area, sq. in.) on A and read 8.78 on X₁; From the 8.78 on X₁ to 3500 (no. of turns) on N and read 7.38 on X₂; From 4.02 previously obtained on X₂ over the B_{ac} = 650 curve and read 222 on μ_a; From 222 on μ_a to 7.38 previously obtained on X₂ and read 13 on L_a, the apparent inductance in henries.

The optimum air gap may be found by using the "AIR GAP" group of scales. From 4.02 found above for X₂ over the point of the TC. curve read 170 on μ_a; From 170 on μ_a to 6 (core lgth.) on l_c and read .0153 on l_a, the total

**OSCILLOSCOPE
FOUNDATION KIT**
5 INCH

Consisting of Case, Chassis, two shelves (right & left), tube shield and bracket, front panel, screen window frame, handle, plastic window socket, with 5CP1 Cathode Ray tube—Special



\$18.95

- 2x2 Tube \$1.00
- Socket for 2x2 Tube25
- H.V. Condenser .5 Mfd 2000 V 1.95
- KIT, without Cathode Ray tube 11.95
- 5CP1 Cathode Ray tube only 7.40
- Tube shield and bracket only 1.98

**Highbridge Radio-Television
and Appliance Co.**

340 CANAL STREET NEW YORK 13, N. Y.



**WHOLESALE
RADIO-ELECTRONICS
PARTS DISTRIBUTOR**

**IMMEDIATE DELIVERY
FROM STOCK ON
TEST EQUIPMENT**

- WATERMAN OSCILLOSCOPE**
S-10-A Pocket Size \$55.00
- G.E. 3" OSCILLOSCOPE**
Model CRO-3 A \$79.50
- DUMONT OSCILLOSCOPE**
274 Five-Inch \$99.50
- McMURDO SILVER 904 Capacitance**
Resistance Bridge \$49.90
- McMURDO SILVER "VOMAX"**
Vacuum Tube Voltmeter \$59.85
- R.C.P. 448 Pocket Multitester \$24.50
- R.C.P. 424A Volt-Ohm-Milliammeter \$29.50
- R.C.P. 322 Tube Tester \$41.50
- R.C.P. 461 AP Sensitive Multitester \$43.50
- R.C.P. 664 Electronic Multimeter \$45.00
- R.C.P. 322 P Tube Tester (Portable) \$45.50
- R.C.P. 668 Vacuum Tube Volt-Ohm Capacity Meter \$74.50
- R.C.P. 665 A.V.T. Volt-Ohmmegger Insulation Tester \$94.50

KIT ASSORTMENTS

- 100 Ass't—1/2 Watt Resistors—Insulated \$1.95
- 100 Ass't—1 Watt Resistors—Insulated \$2.50
- 100 Ass't—2 Watt Resistors—Insulated \$2.95
- 20 Ass't—Volume Controls \$2.45
- 6-25 Ft. rolls Hookup Wire (ass't colors) \$1.25
- 20 Ass't Auto-Radio Suppressors \$2.45

PHONO AMPLIFIER

3-tube, A.C.-D.C. — Completely Wired. Ready to Operate. Uses 50L6-35Z5-12SQ7
\$3.75
(less tubes)

MAIL ORDERS FILLED PROMPTLY



509 ARCH STREET
PHILADELPHIA 6, PA.
LOmbard 3-0513

length of the air gap, in inches. (See Fig. 3.)

Although not a part of the problem let us suppose there is no d.c. in the windings. What will be the inductance? For this we use the "NO D.C." group of scales. To proceed set a straightedge from 6 (lgth. of core) on l_1 to 1 (area of core) on A and read 8.78 on X_1 ; From 8.78 on X_1 to 3500 (no. of turns) on N read 7.38 on X_2 ; From 7.38 on

O_{ac}
 X_2 to _____ point on μ_s and read 37
 $B_{ac} = 65$

on L_s , the apparent inductance in henries. If B_{ac} is nearer 650 than 65, the L_s would be over 60 henries. No air gap would be used. Instead, the laminations would be interleaved as on any transformer.

TRANSFORMERS, SWINGING CHOKES

Audio frequency and output transformers are designed mainly on the basis of inductance of the primary winding, making the design problems similar to chokes except that secondary windings follow regular transformer procedure for impedance and turns ratios needed. Inductance values range from 2 to 50 henries and more, the higher inductance values giving better low frequency response, especially when used with tubes having high plate resistance.

Swinging chokes are often desirable when the load varies widely. The main difference between a swinging and smoothing choke is that the former, though designed for high d.c., has a shorter than optimum air gap. This shortened air gap lowers the inductance considerably at high d.c. loads and increases it at low d.c. loads when compared to a choke designed for high d.c. only.

The Fig. 6 chart is useful only for rough design of a swinging choke. Select the wire for the maximum d.c. ma and assume some value for turns to fit on the core. From the chart determine L_s at maximum d.c. and multiply the value found by 0.58 for the actual minimum swinging choke inductance. If this figure proves to be unsuitable try again using new values for turns or core.

After suitable values have been found for the maximum d.c. use all of them except that in place of the maximum d.c. ma substitute a value only 10 percent of the maximum d.c. ma and find the length of optimum air gap from the chart. Multiply the length as found by 2.6 to find the total air gap length to use for the swinging choke. Inductance ratio between maximum and 10 percent of maximum d.c. will be about 4 to 1. A shorter air gap would increase the ratio but would decrease the inductance at maximum d.c.

A handy reference chart of conversion factors and formulas (see page 27) shows some unusual variations. Unidentified symbols are explained in the text.

Acknowledgement is given Allegheny Ludlum Steel Corporation, United States Steel Corporation, and American Rolling Mill Company for information on electrical steels.

Presenting **The New Improved**
JFD REMOTE-O-CABLE REPLACER

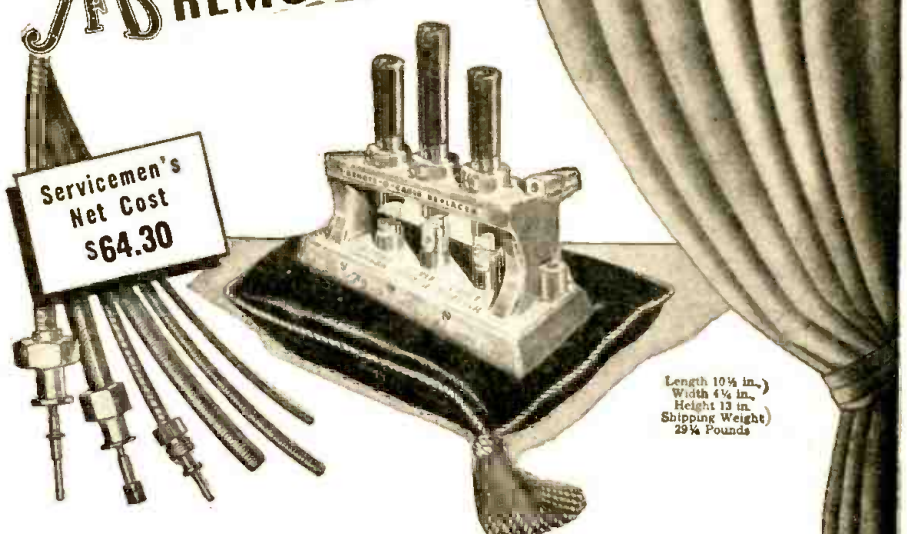

Servicemen's
Net Cost
\$64.30

Length 10 1/4 in.,
Width 4 1/2 in.,
Height 13 in.,
Shipping Weight
29 1/2 Pounds

**The Most Efficient Auto Radio Tuning
Cable-Servicing Machine in Use Today!**

Completely redesigned to meet MODERN Servicing requirements, the NEW JFD REMOTE-O-CABLE REPLACER is a vital necessity in the workshop of every auto-radio serviceman.

1. SWEDGES SHAFTING TO PREVENT UNRAVELLING.
2. CUTS SHAFTING TO EXACT LENGTH
3. REPLACES OLD FITTINGS ON NEW SHAFTING
4. CASING GROOVE MAKES CUTTING EASY

J.F.D. MANUFACTURING CO., 3111 FT. HAMILTON PKWAY, BRONX, N.Y.

Look at Our Specials at Lower Prices!

Aircraft Receivers

6 tubes: 3-12SK7, 1-12SR7, 1-12A6, 1-12K8; Range 190-550 Kc (Specify freq. desired) 1.5-3mc; 3-6mc; 6-9, 1mc; power 28VDC, mfd. by Western Elec., etc. Ship. wt. 19 lbs. Original cost \$90.23.
YOUR COST **\$12.95**
 (Complete with tubes)

Army Aircraft Receivers BC-946-B

Broadest band from 520 to 1500 Kc, tube complement: 3-12SK7, 1-12SR7, 1-12A6, 1-12K8; can be used with 24 V dynamotor supplying A & B power; can be converted to AC or DC or 32 volt sets; 3 stages of IF used, Uses 3 gang condenser.
YOUR COST **\$12.95**
 Each
 Complete with tubes and schematic.

Dynamotor DM-32A

To match receiver; input 28VDC; output 250 V; original cost \$33.95. Ship. wt. 5 lbs
Your Cost ea. **\$4.95**
 Lots of 10 ea. **3.95**



Signal Corps Radio Receiver

BC-341-B 2 tube set—1-12SQ7; 1-12C8; original price \$18.75; ship. wt. 5 lbs. **Your COST** (less tubes) .. **\$3.95**



3 1/2" G. E. AUTOMATIC TIME METER

60 cycle 110 volts. This time meter consists of a cyclometer driven by a telechron synchronous motor. Connect to an electric circuit; it will measure and indicate the number of hours, tenths of hours or minutes that the circuit is in use. Ship. wt. 6 lbs. list \$17.00.
YOUR COST **\$4.95**

SUPREME FOUNDATION METER

40 Micro Amps. 20,000 ohms per volt. 4 1/2" square. Manufactured by Supreme Instruments Corp.
Each **\$8.95**

plus shipping charges
DEPT. D

→ ARROW SALES, INC. ←

59 W. HUBBARD ST., CHICAGO 10, ILL.
Telephone: Superior 5575

MILO

Your "Q" for Quality

A MILO SPECIAL

SIGNAL CORPUS. TEST SET

(Brand New)

- CHECKS CONTINUITY OF CIRCUITS
- TESTS FOR AC-DC
- TESTS RESISTANCE
- CHECKS CAPACITORS AND FUSES
- OTHER USES
- PRICE INCLUDES EXTRA SET OF TUBES — TEST LEADS — INSTRUCTIONS



\$3.95

complete

A Sensational New Development in the Radio Parts Field

FEDERAL SELENIUM RECTIFIER

for:

- CONSOLE RADIOS
- AC-DC PORTABLES
- VIBRATOR POWER SUPPLIES
- INTERCOM POWER SUPPLIES
- REPLACES MOST RECT. TUBES

Orders

6 to 49 **99c** Ea.

Orders

of 1 to 5 **\$1.09** Ea.

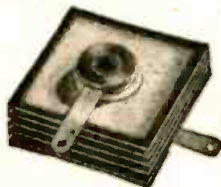

Quotations on larger quantities gladly furnished.

FEATURES

REPLACE TUBE and SOCKET; REQUIRE LESS SPACE; FACILITATE SMALLER CABINET DESIGN; PROLONG LIFE OF SET; GIVE IMMEDIATE RECTIFICATION

Schematic Applications with every order. Milo has complete stocks of nationally known IRC, AEROVOX, B & W, NEWCOMB, THOR-DARSON, MEISSNER, TUNGSOL, WESTON, SUPREME, etc.

If not rated, 20% with order, balance C.O.D. Dept. RC

MILO

Radio and Electronics Corp.

200 Greenwich St., N. Y. 7, N. Y.

BEekman 3-2980-1

(Cable Address) "MILOELECTRO NEW YORK".

COMMUNICATIONS

A SUGGESTION AND COUNTER-SUGGESTION

Dear Editor:

I wish to make a suggestion that will make your magazine very popular, I think. I have had occasion to cut out many of your articles for future use and have been annoyed to find the article continued for one or two columns in the rear of the magazine.

To remedy this aggravation I suggest that each article be complete in itself and any leftover space be dedicated to advertising. Also to refrain as much as possible from putting two articles back to back.

HAROLD LEJUZ,
Long Island City, N. Y.

(Many suggestions as to better makeup have been made to RADIO-CRAFT. These range from a proposal to keep

all the advertising in a separate section to the suggestion that *all* articles be backed up with solid advertising. Due to mechanical difficulties not less than the fact that no change would please everybody, it seems impossible to accede to any of these requests.

The satisfactory solution of the problem is to file the magazine *intact*. Then obtain a small card-file box and a pack of file-cards at the five-and-ten-cent store. Write down the names of interesting articles and file alphabetically under subjects. Thus it will be possible to turn up in a minute all the articles on a given subject, not only in RADIO-CRAFT but in other magazines, or even in books and publications not at the moment in your possession.—Editor)

WHAT IS A RADIO SERVICEMAN WORTH?

Dear Editor:

Have just read the August issue of RADIO-CRAFT. I have never written anything before but since reading, "Servicemen are honest," page 774, would like to say: Down here in Texas, a serviceman would starve to death at the prices Mr. Roth suggests. Just yesterday I had to pay 58c per box of 10 pilot lights. If I figure right this is 5.8c each, and 10c retail is not much profit if you have to take the chassis out of the cabinet, which you have to do in most midgets. He states you can replace a filter bank for \$1.50. A three-section filter (when you can get them) costs you 9c here. And that "clean up and realign" for 50c takes the cake! I charge \$2.00 for b.c. sets and \$3.00 for allwave, and don't think it's a penny too much. I

for one haven't spent the money I have, as well as 18 years experience, to work for nothing. I think anytime a man has devoted his time and money for special training, equipment, etc., and can restore a radio to its original performance he should be paid a fair amount for his labor. My estimate on the job mentioned would—assuming the tubes to be valued as stated—be \$9.25 plus \$1.00 for pickup and delivery. I don't think this is an unfair price, and neither do I have any complaints on high prices.

Have read nearly every issue of RADIO-CRAFT for 15 years—a great magazine. I am not writing this to get under anybody's skin, but to quote conditions in our part of the country.

J. F. SNEED,
Waco, Texas

RADIO TERM ILLUSTRATED



Suggested by: Gus Britzman, Houston, Mo.
"Plate Supply"

UNIVERSAL 1-KW AMPLIFIER

(Continued from page 71)

used for c.w. telegraphy; for telephony, however, plate voltages from 2200 to 2500 are recommended. Although the author has successfully operated the 4-125As with plate voltages as low as 1000 volts, such low-voltage operation is not recommended as the efficiency and power gain of these tubes drops off sharply as the voltage is decreased below 2500 volts.

Adequate cooling must be provided for the envelopes and seals of the 4-125As where medium or full input power is applied to the tubes. A small inexpensive blower or fan will usually be sufficient to move the two or three cubic feet of air per minute required for cooling of the stem structure. Better cooling efficiency can be obtained by directing the stream of air upward through the holes of the Johnson type 275 socket and the ceramic base of each tube.

List of Parts

CONDENSERS

- 1—Variable condenser, 2-gang, 99 μ f per section, 7000 volts peak, 0.175 inch spacing. Johnson Type 100DD70 or equivalent.
- 1—Variable condenser, 2-gang, 105 μ f per section, 2000 volts peak, 0.045 inch spacing. Johnson Type 100FD20 or equivalent.
- 1—Fixed condenser, mica, .005 μ f, 1000 volts d.c.
- 1—Fixed condenser, mica, .001 μ f, 12,500 volts d.c.
- 2—Fixed condensers, mica, 0.01 μ f, 1000 volts d.c., or fixed mica condensers, .001 μ f, 1000 volts d.c. See schematic.
- 2—Fixed condensers, paper, 0.02 μ f, 600 volts d.c.
- 2—Adjustable trimmer condensers, mica (or air), 3 to 30 μ f.

COILS, ETC.

- 1—Complete set (80, 40, 20 and 10 meters) Barker and Williamson 75 watt plug-in, adjustable link type inductors. B. & W. Type JVL.
- 1—Complete set (80, 40, 20 and 10 meters) Barker and Williamson 1000 watt plug-in, swinging link type inductors. B. & W. Type HDVL.
- 1—Jack bar—swinging link assembly for above HDVL inductors.
- 1—R.f. choke, 2.5 mh., 500 ma.
- 2—Parasitic trap inductors—10 turns No. 14 enameled wire $\frac{1}{8}$ -inch diameter, pulled out to form a coil $1\frac{1}{2}$ inches long. Self-supporting.

RESISTORS

- 1—Fixed resistor, 35,000 ohms, adjustable, 100 watts.
- 1—Fixed resistor, 10,000 ohms, adjustable, 25 watts.

OTHER PARTS

- 1—Filament transformer, primary 110 v.a.c.; secondary 5 v.a.c., c.t. 13 amperes.
- 2—Closed-circuit jacks (for grid and plate milliammeter connections).
- 2—Eimac 4-125A beam tetrode transmitting tubes.
- 2—Special ceramic sockets for above tubes. Johnson Type 275.
- 1—Milliammeter, $3\frac{1}{2}$ -inch diameter, 0-50 ma. d.c.
- 1—High-voltage coupler, ceramic, $\frac{1}{4}$ to $\frac{1}{2}$ -inch shaft.
- 1—Coupler, insulating type, $\frac{1}{4}$ to $\frac{1}{2}$ -inch shaft.
- 1—Dial, direct drive, 0-100 clockwise over 180°, 4 inches diameter.
- 1—Dial, direct drive, 0-100 clockwise over 180°, 2 $\frac{1}{4}$ inches diameter.
- 1—Phone plug, bakelite shell.
- 1—Standard aluminum panel, 12 $\frac{1}{4}$ x19x $\frac{1}{8}$ inches, black crackle finish. Parmetal Type 6681.
- 1—Standard steel chassis, 13x17x3 inches, cadmium plated finish. Parmetal Type C-4536.
- 2—Chassis mounting brackets. Parmetal SB-713.
- 1—Cabinet for complete transmitter. Parmetal Type "A" rack, 61 $\frac{1}{4}$ x19-inch panel space, No. ER-225.

SPEED UP REPAIRS WITH THESE G-C AIDS!

G-C is HEADQUARTERS for RADIO PARTS and SERVICE AIDS



All Types of Radio Cements, Chemicals, Coil Dopes, Compounds



FREE STEEL CABINET



SPEEDEX Wire Strippers Alignment Tools Ne-O-Lite Testers

G-C leads the field in supplying Radio - Electronic Manufacturers and Service Men with Parts, Tools, Radio Cements, Chemicals and Compounds. Insist on Genuine G-C Quality.



Dial Cables, Dial Belts, Packaged Hardware, Cabinet Repair Kits

ORDER FROM YOUR JOBBER—SEND FOR G-C CATALOG



GENERAL CEMENT MFG. CO.
ROCKFORD, ILLINOIS

At Last!

A PRACTICAL

RADIO

MERCHANDISING

PLAN

for Service Engineers

SEE PAGE 2

SURPLUS SPECIALS

5" Cathode Ray RCA Tubes	\$5.00
G.E. 4mf 2000 v Oil Condensers	2.00
Eimac Transmitting 15 E Tubes	1.50
W.E. 436 A Range Amplifiers	12.50
New RCA DP 12 Direction Finders	100.00
Other Surplus Bargains—Write	
TIRET ELECTRIC COMPANY	
47-46 Vernon Boulevard, Long Island City I, N. Y.	

"SINGER" TUNER!

Makes any amplifier into a 5- or 6-tube superhet. radio. Completely wired & ready to operate.



\$7⁹⁵

(LESS TUBES)

Uses 12SA7—12SQ7—12SK7

"SINGER" PHONO AMPLIFIER!

3-tube AC-DC completely wired & ready to operate.

\$2⁹⁵

(LESS TUBES)



Uses 50L6—35Z5—12SQ7

"SINGER" RECORD PLAYER!

Includes:

3-tube amplifier, tone control, 5" speaker, fine motor, crystal pickup, handsome cabinet.



\$19⁹⁵

(LESS TUBES)

Completely Wired & Ready to Operate

IMMEDIATE DELIVERY!!

25% Deposit Required With Order

N. J. INDUSTRIAL CO.

11 HILL ST.

NEWARK 2, N. J.

NEW CATHODE-RAY TUBES

5CP1's in original sealed cartons, \$7.95 each. 12 pin diheptal socket for 5CP1 when bought with tube, 45c each; otherwise, 90c each. New 5CP1 steel shields, cadmium plated, 85c each. Include shipping postage in your money order. 5CP1—6-lb.; shield, 3-lb. New 954, 955, 956 and 957 Acorn tubes in original cartons, not sealed, 89c each. Postpaid in U. S. Write for free electronic bargain list.

OHMEYER ENGINEERING LABS.

Fairview Blvd. Dept. K Hempstead, N. Y.

INDEX TO ADVERTISERS

The Quality

RADIO KIT

available at a Record Breaking Low Price

sensationally reduced below O.P.A. ceiling price

MODEL S-5P



Improved superheterodyne circuit, built-in loop antenna, PM Alnico speaker, streamlined airplane dial, wide tuning range, 550Kc-1600 kc, 6 tubes (including rectifier 115V-AC-DC 12SK7 IF) 12SA7 converter, 12SQ7 Det. and 1st audio 50L6GT

output and 35Z5GT rectifier, brown bakelite cabinet.

Complete Kit less tubes **\$10.95**

Tubes available (prices on request)

Also Available Phono Kits Model RP-3 **23.95**

Radio Phono Kit Model RP-S5 **34.95**

Portable Radio Phono Kit Model RP-SSP **31.95**

Portable Battery Kit Model P13-4 **15.95**

Record Changer Kit Model RC-3 **39.95**

(ALL KITS SUPPLIED LESS WIRE & SOLDER)

Write for Descriptive Catalog M

RADIO KITS COMPANY

120 CEDAR STREET
NEW YORK, N. Y.

IMMEDIATE

Delivery from Stock!



New Model 670 SUPERIOR SUPER-METER

Combination VOLT - OHM MILLIAMMETER plus CAPACITY REACTANCE INDUCTANCE and DECIBEL MEASUREMENTS. GOOD -BAD Scale for checking quality of electrolytic condensers at test potential of

150 volts. Complete

\$28.40



New Model 450 SUPERIOR TUBE TESTER

Speedy operation assured by newly designed rotary selector switch. Tests all tubes up to 117 volts, including 4.5, 6.7, 7L, Octals, Locals, Bantam Junior, Peanut, Television, Magic Eye, Hearing Aid, Thyatron, Single Ended.

Floating Filament, Mercury Vapor Rectifiers, etc., also pilot lights. Complete... **\$39.50**

Write Dept. C-11 for FREE 1947 catalog.

ATLAS ELECTRONICS COMPANY

11 Edward M. Morgan Pl. New York 32, N. Y.

COIL KIT

Matched superhet: 1st I.F., 2nd I.F., Osc. and Loop. With circuit diagram.

Postpaid In U.S. **\$1.95**

Plus SW 6-18 Mc. Ant. & Osc. Coils \$2.45

C-B MANUFACTURING CO.

412 West 37th Street New York 18, New York

Alden Products Co.	70	Modern Technical Book Co.	79
Allied Radio Corp.	55	Monitor Products Co.	40
George Brodsky		Rogers & Smith Advertising	
Almo Radio Co.	74	Murray Hill Books, Inc.	60, 61
E. L. Brown Co.		Harry P. Bridge Co.	
Amplifier Co. of America	73	N. J. Industrial Company	77
Sternfield-Godley, Inc.		National Radio Distributors	71
Arrow Sales, Inc.	75	Burke & Wayburne Advertising Agency	
Sander Rodkin Adv. Agency		National Radio Institute	1
Atlas Electronics Company	78	Van Sant, Dugdale & Co.	
Bass & Weber Co., Inc.		National Schools	9
Atomic Heater & Radio Corp.	69	The Mayers Co.	
W. Montague Pearsall		National Union Radio Corp.	2
Audel Publishers	57	Hutchins Advertising Co., Inc.	
Grant & Wadsworth		Newark Electric Co., Inc.	11
Bell Telephone Labs	Inside Back Cover	Charles Brunelle Co.	
N. W. Ayer & Son		Newark Surplus Materials Co.	71
Bowman, J. G.	42	Wm. N. Scheer Advertising Agency	
Buffalo Radio Supply	64	Niagara Radio Supply	62
International Advertising Ag.		Burke & Wayburne Advertising Agency	
Burstein-Applebee Co.	58	Northwest Radio & Electronic Supply Co.	44
Frank E. Whalen Adv. Co.		Ohmeyer Engineering Labs.	77
C-B Manufacturing Co.	78	Ohmite Manufacturing Co.	52
California Radio & Electronics Co.	39	The Fensholt Co.	
Bass & Weber Co., Inc.		Olson Radio Warehouse	66
Cannon, C. F.	54	Jessop Advertising Co.	
M. J. Werner Adv.		Onan & Sons, D. W.	73
Capitol Radio Engineering Institute	46	Graves and Associates	
Henry J. Kaufman & Associates		Opportunity Adlets	79
Carlock Laboratories	62	Overton Electronics Co.	43
Clarkson Publishing Co.	54	Pa-Kette Electric Company	73
Smith, Benson & McCure Co., Inc.		Arrow Advertising Agency	
Cleveland Institute of Radio Elecs.	63, 69	Radio Corporation of America	Inside Front Cover
Kenneth Kolpein Adv.		J. Walter Thompson Co.	
Communications Equipment Co.	49	Radio Dealers Supply Co.	64
Borough Advertising Co.		H. J. Gold Co.	
Concord Radio Corp.	43, 51	Radio Electric Service Co.	72
E. H. Brown Advertising Ag.		David Zibman Adv.	
Constant Electric	58	Radio Equipment Company	43
Cord Electrical Supply Co.	54	Radio Kits Co.	78
Rea Fuller & Co.		Bass & Weber Co., Inc.	
John A. Cox	79	Radio Maintenance	38
Coyne Electrical School	72	Shappe-Wilkes Adv. Agency	
McJunkin Advertising Agency		Radio Products Sales Co.	42, 65
Coyne Electrical School	12, 79	Barton A. Stebbins Adv. Ag.	
Phil Gordon Agency		Radio & Television Supply Co.	42
Crabtree's Wholesale Radio	71		
DeForest's Training, Inc.	7		
MacDonald Cook Co.			
Dow Radio	58		
Editors and Engineers, Ltd.	70		
Electronic Designs, Inc.	58		
Bass & Weber Co., Inc.			
Electronic Products Co.	74		
Feldman, Lefler, Inc.			
Federal Telephone & Radio Corp.	Back Cover		
Rickard & Co., Inc.			
Feiler Engineering Co.	62		
George Brodsky Adv.			
Fischer Distributing Corp.	43		
General Cement Mfg. Co.	77		
Turner Adv. Agency			
General Electric Company	59		
Maxon, Inc.			
General Test Equipment Co.	62		
Suzanne Hayman			
Greenwich Sales Co.	70		
Bass & Weber Co., Inc.			
Harrison Radio Corp.	43, 53		
Altomari Advertising Agency			
Hershel Radio Co.	54		
Hugh Allen Advertising			
Highbridge Radio-Television & Appl. Co.	63, 74		
Sternfield-Godley, Inc.			
Hollander Radio Supply Co.	68		
Turner Advertising Agency			
Instructograph Company	54		
Turner Advertising Agency			
International Resistance Co.	4		
John Falkner Arndt & Co., Inc.			
J. F. D. Manufacturing Co.	75		
Bergman-Jarett Co.			
Jensen Industries, Inc.	65		
Alan D. Parsons Adv.			
Kelvin Electronics Co.	71		
Sternfield-Godley, Inc.			
K-Jax	68		
Lafayette Radio	45		
Reiss Advertising Agency			
Lake Radio Sales Co.	62		
Sander Rodkin Adv. Agency			
Legri S Company	60		
Cromwell Advertising Agency			
Lifetime Sound Equipment Co.	59		
The Miller Agency Co.			
McDonald Brothers	43		
McGraw-Hill Book Co., Inc.	79		
McMurdo Silver Co., Inc.	41		
Edward Owen & Co.			
Maritime Switchboard	55		
Metropolitan Electronic & Inst. Co.	44		
Bass & Weber Advertising Agency			
Mid-America Co.	3		
E. H. Brown Advertising Agency			
Milo Radio & Elec. Corp.	76		
Burke & Wayburne Advertising Agency			
Mission Radio, Inc.	42		

RADIO SCHOOL DIRECTORY—See Page 80

American Radio Institute	
Sternfield-Godley, Inc.	
Baltimore Technical Institute	
Candler System Co.	
Rand-Reis Adv., Inc.	
Commercial Radio Institute	
Electronics Institute, Inc.	
Howard House	
N. W. Ayer Co.	
Lincoln Engineering School	
Buchanan-Thomas Adv.	
Melville Radio Institute	
Seidell Adv.	
RCA Institutes	
Tri-State College	
Clem J. Steigmeyer Adv.	
United Radio Television Institute	
Western Radio Institute	
YMCA Trade & Technical School	
Cecil & Presbrey	

Radionic Equipment Co.	64
Bass & Weber Co., Inc.	
Radolek Company	74
Turner Co.	
Randolph Radio Stores	61
Sheffield Radio & Appliance Co., Inc.	69
Sander Rodkin Advertising Agency	
Sprague Products Co.	10
Harry P. Bridge Co.	
Sprayberry Academy of Radio	5
Harry P. Bridge Co.	
Stan-Burn Radio & Electronics	44
Standard Electronics Dist. Co.	42
Sterling Electronic Co.	61
Superior Instruments	35
Bass & Weber Co., Inc.	
Supreme Publications	37
Henry H. Teplitz Adv.	
Surplus Radio Inc.	72
Bass & Weber Co., Inc.	
"Tab" Technical Apparatus Bldrs.	67
Bass & Weber Co., Inc.	
Terminal Radio Corp.	62
Regent Adv. Agency	
Tiret Elec. Co.	77
Triplett Electrical Instrument Co.	8
Westen Adv. Agency	
Truone Products Co.	63
Terrill Belknap March Assoc.	
Variety Elec. Co.	56
Bass & Weber Co., Inc.	
Vertrod Corporation	59
Bass & Weber Co., Inc.	
Wells-Sales, Inc.	70
Turner Advertising Agency	
X.L. Radio Laboratories	70
Zack Radio Supply Co.	42

BOOK REVIEWS

TEACH YOURSELF RADIO COMMUNICATION, by E. M. Reid. Published by David McKay Co. for English Universities Press, Ltd. Stiff cloth covers, 4½ x 7 inches, 176 pages plus index. Price \$1.00.

This book is a simplified radio text prepared for the reader with little or no previous knowledge of the subject. Although written on an elementary plane, the author presupposes a knowledge of simple algebra for complete understanding of the material.

It is well illustrated with a number of diagrams and drawings which help to present radio theory in an interesting manner. It discusses, briefly, the fundamentals of practically all types of components and circuits that will be encountered in a radio receiver or transmitter.

The reader of American radio publications will notice, immediately, the slight difference in the style of drawings and in terminology that will mark the book as being "distinctly British," in its presentation. This difference in terminology is bound to be slightly confusing to the American radio beginner who is accustomed to calling a plate a plate, and the "electron bottle" a tube. Overlooking these difficulties in terminology, this book is a good text for the radio beginner.

RADAR — RADIOLOCATION SIMPLY EXPLAINED, by R. W. Hallows. Published by Chapman and Hall, of London, England. Soft cloth covers, 5 x 7½ inches, 136 pages plus 4-page index. Price, approximately \$1.50.

The author of this text held the post of Chief Instructor in Fire Control (Radar) during the war and it was one of his duties to prepare easily understood material on radar for radar operator trainees. Clearly illustrated and concisely written, without resorting to mathematics or highly technical terms, this book is based on this basic training material that was prepared for radar operators.

The opening chapters deal briefly with the definition and applications of radar. An interesting analogy of radar, using sound echo ranging, helps the reader to understand just how radar works and what may be expected of it.

Chapters four through twelve are devoted entirely to fundamentals of radar. Chapters seven through ten are particularly interesting in the discussion of the cathode ray tube and how it may be employed as a stopwatch for measuring the time interval between the transmitted pulse and the arrival of the echo.

Chapters 11 and 12 are devoted to the antenna systems used in radar and are well illustrated with drawings showing the directional beam transmitting and receiving characteristics of these

(Continued on following page)

OPPORTUNITY AD-LETS

Advertisements in this section cost 20 cents a word for each insertion. Name, address and initials must be included at the above rate. Cash should accompany all classified advertisements unless placed by an accredited advertising agency. No advertisement for less than ten words accepted. Ten percent discount for less than ten words accepted. Ten percent discount for less than ten words accepted. Ten percent discount for less than ten words accepted. Objectionable or misleading advertisements not accepted. Advertisements for December, 1946, issue must reach us not later than October 23, 1946. Radio-Craft • 25 W. B'way • New York 7, N. Y.

BARGAINS—TUBES—PARTS, ETC. RADIO-ELECTRIC LABS., 715 North 7th Street, Lake City, Minnesota.

FOR SALE LARGE QUANTITY NITRY PANEL METERS. E. N. Goodman, 10 E. 23 St., New York City, A1 4-2954.

"RADIOBUILDER"—PARTS, DATA, SAMPLE FREE. Laboratories, Box I-b, San Carlos, California.

BUILD YOUR OWN RADIO 5 TUBE SUPER HET KIT complete with tubes and walnut cabinet using 50L6-3525-128A7-128K7-128SQ7. Easy to wire. Your cost \$16.95. McGee Radio Co., 1330 Broadway, Denver, Colo.

MAGAZINES (BACK DATED)—FOREIGN, DOMESTIC, arts, books, booklets, subscriptions, pin-ups, etc. Catalog 10c (refund). Cleverone's, 863 First Ave., New York 17, N. Y.

AMATEUR RADIO LICENSES, COMPLETE CODE and theory preparation for passing amateur radio examinations. Home study and resident courses. American Radio Institute, 101 West 63rd Street, New York City. See our ad on page 80.

CORRESPONDENCE COURSES AND SELF-INSTRUCTION books, slightly used. Sold, Rented, Exchanged. All subjects. Satisfaction guaranteed. Cash paid for used courses. Complete information and 92-page illustrated bargain catalog free. Write—NEILSON COMPANY, Dept. 2-39, Chicago 4.

RADIO TUBES, PARTS WHOLESALER. BULLETIN 3c. Henshaw Radio Co., 3313 Delavan, Kansas City, Kansas.

WE REPAIR ALL TYPES OF ELECTRICAL INSTRUMENTS, tube checkers and analyzers. Hazelton Instrument Co. (Electric Meter Laboratory), 140 Liberty Street, New York, N. Y. Telephone—B'arclay 7-4339.

In W. Va. and Eastern Ohio
it is the **JOHN A. COX RADIO SUPPLIES**
FOR THE BEST OF EVERYTHING IN
RADIO
Send For Free Buying Guide and Tube List. Special
MaGulre Record Changer. Net \$25.61
JOHN A. COX
554 Seventh Street Parkersburg, W. Va.

RADIO-ELECTRONICS



**CYCLOPEDIA
RADIO
ELECTRONICS**

LEARN AT HOME

A complete, easy to understand, reference-instruction book.

"Cyclopedia of Radio and Electronics"

1946 EDITION

Standard radio, high-frequency and UHF, public address and sound, television, phototubes, industrial electronic tubes, and applications. Acoustics; Automatic Tuning; Beam Power Tubes; Biasing; Broadcast Transmitters; Contact Rectifiers; Cold-cathode Tubes; Electrostatic Heating; Facsimile; Frequency Modulation Receivers; Gas-filled Tubes; Ignitrons; Induction Heating; Klystron Tubes; Load Lines; Microphones; Oscillators of all types; Oscilloscopes and uses Phase-shift Control; Rectifier Relaxation Circuits; Resonators; Saturable Reactor; Signal Generator; Superheterodynes; Thyristors; Time Constants; Transit Time; Tuning Indicators; Velocity Modulation, etc. **764 PAGES, 1400** headings, 600 illustrations, tables, and graphs. **ONLY \$6.00** if C.O.D. plus postage fee.

MONEY BACK GUARANTEE.

JOIN OUR NEW TECHNICAL BOOK CLUB — FREE

Members receive current literature, guidance on all book problems, premiums. No obligation. **ALL BOOKS:** Technical, Chemistry, Physics, Plastics, REFRIGERATION, AIR CONDITIONING, Building Construction, **ELECTRICITY, RADIO, TELEVISION, ELECTRONICS,** Automobiles, Mathematics, Woodworking, Homecraft, Business Language, Farming, Sports, Photography, etc.—**WRITE FOR FREE LITERATURE,** please specify subject.

MODERN TECHNICAL BOOK CO.
Dept. M # C, 55 West 42nd St., New York 18, N. Y.

Please send me _____ copies **CYCLOPEDIA OF RADIO AND ELECTRONICS** Enclosed find \$ _____
 check cash money order. Please send C.O.D. (plus postage). If I am not fully satisfied I may return the book within five days for refund.

NAME _____
ADDRESS _____
CITY _____ ZONE _____ STATE _____

NOW—A REALLY HIGH-POWERED—

Radio Engineering Library



NOTE:
The Library comprises a selection of books culled from leading McGraw-Hill Publications in the radio field.

- especially selected by radio specialists of McGraw-Hill publications
- to give most complete, dependable coverage of facts needed by all whose fields are grounded on radio fundamentals
- available at a special price and terms

THESE books cover circuit phenomena, tube theory, networks, measurements, and other subjects—give specialized treatments of all fields of practical design and application. They are books of recognized position in the literature—books you will refer to and be referred to often. If you are a practical designer, researcher or engineer in any field based on radio, you want these books for the help they give in hundreds of problems throughout the whole field of radio engineering.

- 5 VOLUMES, 3319 PAGES, 2289 ILLUSTRATIONS**
1. Eastman's **FUNDAMENTALS OF VACUUM TUBES**
 2. Terman's **RADIO ENGINEERING**
 3. Everitt's **COMMUNICATION ENGINEERING**
 4. Hund's **HIGH FREQUENCY MEASUREMENTS**
 5. Henney's **RADIO ENGINEERING HANDBOOK**

10 days' examination. Easy terms. Special price under this offer less than books bought separately. Add these standard works to your library now; pay small monthly installments, while you use the books.

10 DAYS' FREE EXAMINATION—SEND COUPON

McGraw-Hill Book Co., 330 W. 42nd St., New York 18
Send me Radio Engineering Library, 5 vols., for 10 days' examination on approval. In 10 days I will send \$2.50 plus few cents postage, and \$4.00 monthly till \$26.50 is paid, or return books postpaid. (We pay postage on orders accompanied by remittance of first installment.)

Name _____
Address _____
City and State _____
Company _____
Position _____ RC 11-46

I Guarantee this Book will

Earn You

5 TIMES

ITS COST!



Or It's Yours FREE!

Here's a book that will make money for you. Let me prove it with one of the greatest satisfaction guarantees in technical book history. **COYNE TROUBLE SHOOTING MANUAL** is 4 great books in 1. 610 large pages packed with over 600 valuable wiring diagrams, plans, etc. Shows you new methods for shooting trouble on motors, appliances, refrigerators, automotive devices, air conditioning and diesel equipment.

SEND NO MONEY

Here's my sensational offer—Fill in and mail the coupon below. Send no money. Look the book over 7 full days **FREE**—then decide if you want to keep the book. If you keep the book you can pay \$9.00 cash or send \$3.00 after 7 days and \$3.00 a month until \$9.96 is paid. And further I **GUARANTEE** that the book must earn 5 times its cost in one year or I'll refund every cent you paid and you keep the book **FREE**. You can't possibly lose on an offer like that—the book must pay its cost 5 times over or your money is refunded. **Offer Limited—Act Now! Send 7-day trial coupon today!**

B. W. COOKE, Dir., COYNE ELECTRICAL SCHOOL, Dept., 86-T2
500 S. PAULINA STREET, CHICAGO 12, ILLINOIS

Send me the **COYNE TROUBLE SHOOTING MANUAL** for 7 days **FREE** examination. After 7 days I'll either return the book and owe nothing or send \$3.00 and \$3.00 per month until \$9.96 is paid or I'll pay cash price of \$9.00. You agree to refund my entire payment if this book does not earn 5 times its cost in one year.

NAME _____ Age _____
ADDRESS _____
TOWN _____ Zone _____ STATE _____
 IF YOU WANT BOOK sent C.O.D. (you pay postman \$9.00) check here. Same satisfaction guarantee or your money back.

RADIO SCHOOL DIRECTORY

PREPARE NOW FOR SKILLED JOBS IN RADIO AND ELECTRONICS

CAREERS in RADIO

INTENSIVE COURSES—Thorough, technical education for progressive men and women.

1. **RADIO TECHNICIAN**—The MRI General Course. Includes F.M. & Television. Prepares for FCC Broadcast Licenses.
2. **RADIO & TELEVISION SERVICING**—Prepares for employment as Repairman on Standard Broadcast, F.M. & Television Receivers.
3. **RADIO COMMUNICATIONS**—Prepares for FCC Operators' License. Leads to position as Merchant Marine or Flight Radio Officer; Commercial Operator.
4. **FUNDAMENTAL RADIO MATHEMATICS**—The MRI Preparatory Course. Required pre-training for students lacking a basic mathematical background.

MELVILLE RADIO INSTITUTE
45 W. 45th St., N. Y. 19, BR 9-5080
"The Radio School Managed By Radio Men"

Licensed by the State of New York

MELVILLE RADIO INSTITUTE
45 West 45th St., New York 19, N. Y.

GENTLEMEN: RC

Send me FREE information about your school.

Name.....

Address.....

MAIL THIS COUPON NOW

RADIO COURSES

Servicing, Broadcast Engineering, Commercial Operating, Television

Individual Laboratory Work!
Learn by Doing!
Day and Evening Classes

Approved by the Maryland State Department of Education and the Veterans' Administration.

Free to Vets—Textbooks, Tools, Test Set.

Write for Bulletin

Baltimore Technical Institute

1425 EUTAW PLACE — DEPT. C.
BALTIMORE 17, MARYLAND

RADIO COURSES

- RADIO OPERATING • CODE
- RADIO SERVICING — ELECTRONICS
- REFRIGERATION SERVICING

Personal Counselling Services for Veterans
Write for Latest Trade & Technical Catalog

Y.M.C.A. TRADE & TECHNICAL SCHOOLS
4 W. 64th Street New York City

RADIO ENGINEERING!

VETERANS can complete work here in shortest possible time. Courses also in Civil, Electrical, Mechanical, Chemical, Aeronautical Engineering; Business Administration, Accounting, Secretarial Science. 3rd year. Enter Jan., Mar., June, Sept. School now filled to capacity. No applications can be accepted until further notice.

TRI-STATE COLLEGE 24116 College Ave. ANGOLA INDIANA

COMMERCIAL RADIO INSTITUTE

A radio training center for twenty-six years.

RESIDENT COURSES ONLY

Broadcast, Service, Aeronautical, Television and Marine telegraphy classes now forming. Literature upon request. Veteran training. Classes now forming for mid-year term, Feb. 1st. Entrance exam. Jan. 13. Dept. C, 38 West Biddle St., Baltimore 1, Md.

ELECTRONICS

Electronic Technician Training Course. Qualify for Radio Communication (Commercial Government License); Radio Repair Service; or be an Industrial Electronic Technician. Register now for new classes starting every four weeks. Approved under G. I. Bill of Rights. Residence day and evening school. Write to **ELECTRONICS INSTITUTE, INC.** 21 HENRY, DETROIT 1, MICH.

LEARN

RADIO—TELEVISION—FM

Complete courses in all phases given in both day and evening classes.

Veterans accepted under G.I. bill
United Radio Television Institute

225 Halsey Street Newark 2, N. J.

LEARN RAPID RADIO SERVICING

Send for Free Information: "3 Ways to Learn Radio." Approved for Training Veterans.

WESTERN RADIO INSTITUTE
1457 Glenarm, Denver 2, Colo.

BOOK REVIEWS

(Continued from page 79)

antennas. The two concluding chapters discuss briefly the war and probable peacetime applications of radar.

The book is illustrated with eight full-page photographic plates, mostly showing standard radar apparatus, as well as the excellent drawings already mentioned.

While definitely not an engineering treatise, this book will enable the read-

er to secure a good background on the operation of radar and its many applications in war and peace. Teachers will find the drawings especially useful in helping to get certain hard-to-explain ideas across to their students.

ELEMENTARY ENGINEERING ELECTRONICS, with Special Reference to Measurement and Control, by

LEs Correspondence Courses in **RADIO and ELECTRICAL ENGINEERING**

ELECTRICAL ENGINEERING Get good grasp of wide electrical field. Prepare yourself, at Low Cost, for secure future. Modern, simplified, you can understand quickly. **RADIO ENGINEERING** Extra fine course in radio. Sub-Radio Engineering (no address, photo-electric work). Trains you to be super-service man. Real vacuum tube technician. Servicemen needed badly. Diploma on completion. Tuition \$25, either course. Deferred payment plan. **FREE** Get copies of school catalogs, student magazines, complete details. **SEND NOW!**
LINCOLN ENGINEERING SCHOOL Box 931C-93 Lincoln, Nebr.

RADIO

RADIO Technician and Radio Communications courses. Register now for new classes starting first MONDAY of each month. Day and Evening Classes.

AMERICAN RADIO INSTITUTE
101 West 63rd St., New York 23, N. Y.
APPROVED UNDER GI BILL OF RIGHTS.



RCA INSTITUTES, Inc.

Offer thorough training courses in all technical phases of **Radio and Television**

DAYS—EVENINGS WEEKLY RATES

VETERANS: RCA Institutes is approved under G. I. Bill of Rights

For Free Catalog Write Dept. RC-46

RCA INSTITUTES, Inc.

A Radio Corporation of America Service
75 VARICK STREET NEW YORK 13, N. Y.

HOW TO MAKE MONEY

BY MAIL Easy way to start new or expand present occupation. Extraordinary plain, simple skill, know-how. Opportunity success operating plan. No loans needed. Sure results, sure profits. Write today for **FREE** astonishing particulars.

HOWARD HOUSE, Melrose 76-26 Massachusetts

SHORT CUT **CODE SPEED**
Be an Expert

Learn to be a Telegraph or Radio Operator. Thousands of men needed. Intensely interesting work—good pay. Learn at home or wherever you are, quickly, easily, with the famous Candler Code Speed System. Book of Particulars Free.

FREE BOOK
CANDLER SYSTEM CO.
Dept. 3-M, Box 928, Denver 1, Colo.

Andrew W. Kramer. Published by The Instruments Publishing Co., Inc. Stiff covers, 4½ x 8 inches, 340 pages. Price \$2.00.

This book, of thirty-four chapters, begins with a simple explanation of the electron theory and the nature of electricity. With this as a background, the author explains the principles of operation of the various electron tubes in commercial use today.

The text of the book is confined to electronics in industry and does not touch the radio aspects of the field. As each tube type is discussed, the author provides interesting drawings to illustrate the operation of the basic circuit and to show how it may be applied to perform various control or metering operations.

The operational functions of vacuum tubes not fully understood by the average reader are clearly explained by mechanical analogies. This is particularly true of the operation of the thyatron whose operation is clarified by comparing the tube to a non-return fluid valve. Eleven step-by-step drawings are used to illustrate the operation of this tube.

This book will serve as a guide to students, engineers and maintenance men who desire an understanding of the many electronic principles and applications in industry today.—R.F.S.

The Eye That Never Closes

You are looking at a thermistor — a speck of metallic oxide imbedded in a glass bead hardly larger than a pin-head and mounted in a vacuum. The thermistor was developed by Bell Telephone Laboratories to keep an eye on the amplification in long-distance telephone circuits.

When a thermistor is heated, its resistance to electric current changes rapidly. That is its secret. Connected in the output of repeater amplifiers, it heats up as power increases, cools as power decreases. This change in temperature alters the resistance, in turn alters the amplification, and so maintains the desired power level. Current through the wire at the left provides a little heat to compensate for local temperature changes.

Wartime need brought a new use for this device which can detect temperature changes of one-millionth of a degree. Bell Laboratories scientists produced a thermistor which could "see" the warmth of a man's body a quarter of a mile away.

Thermistors are made by Western Electric Company, manufacturing branch of the Bell System. Fundamental work on this tiny device still continues as part of the Laboratories program to keep giving America the finest telephone service in the world.



BELL TELEPHONE LABORATORIES

EXPLORING AND INVENTING, DEVISING AND PERFECTING FOR CONTINUED IMPROVEMENTS AND ECONOMIES IN TELEPHONE SERVICE



Type 403D2625

by Installing Federal's Miniature Selenium Rectifier—in AC-DC home radio receivers to replace rectifier tubes

HERE'S A REAL OPPORTUNITY for the progressive service man — a chance to make extra money and do a better job. For Federal's new, miniature Selenium Rectifier is more than just a substitute for a tube. It's the modern way to give old sets new performance — gives them instant starting without warmup, makes them run cooler, last longer—replaces 29 different rectifier tube types.

Only 1¼ x 1½ x 5⁄8 inches, it fits anywhere, with just a few simple soldered connections and minimum circuit changes. Once installed, it's in for the life of the set. It withstands overloads from defective electrolytic condensers, and is practically unbreakable.

This miniature Selenium Rectifier gives the same performance that has made Federal "Center-Contact" Selenium Rectifiers the standard of the industry.

HERE'S HOW YOU CAN DO THE SAME
 By installing Federal's Miniature Rectifier in place of a tube, you earn from \$1 to \$2 extra per set serviced. Ten sets a day gives you \$60 a week (or more) added profit.

Replaces these 29 different rectifier tubes:

5T4	5Y3	6Y5	25Z6	50Y6
5U4	5Y4	6Z5	35W4	50Z7
5V4	5Z4	12Z5	35Z3	117Z3
5Z3	6X5	7Y4	35Z4	117Z6
5W4	0Z4	12Z3	35Z5	OY4
5X4	80	25Z5	35Z6	

FREE—eight page service bulletin telling how to install this rectifier in AC-DC radio sets. Miniature Selenium Rectifiers now available in standard packages of 12, with window poster and mailing pieces. Send check or money order for \$12.00* for 12 rectifiers in display carton and complete sales accessories. Write to Dept. F863
*excludes State and City use and sales taxes



Federal Telephone and Radio Corporation

In Canada:—Federal Electric Manufacturing Company, Ltd., Montreal.
 Export Distributors:—International Standard Electric Corp. 67 Broad St., N.Y.C.



Newark 1,
 New Jersey