

HUGO GERNSBACK, *Editor*

RADIO CRAFT

**ROBOT
TELEVISION TANK**

SEE PAGE 410



APRIL

1945

25¢

CANADA 30¢

RADIO-ELECTRONICS IN ALL ITS PHASES

MEMO TO *Purchasing Dept.*

For postwar, recommend we standardize on Solar's hermetically-sealed, patented special twist-prong base Type DY electrolytic. They're properly protected against moisture.

E.M.

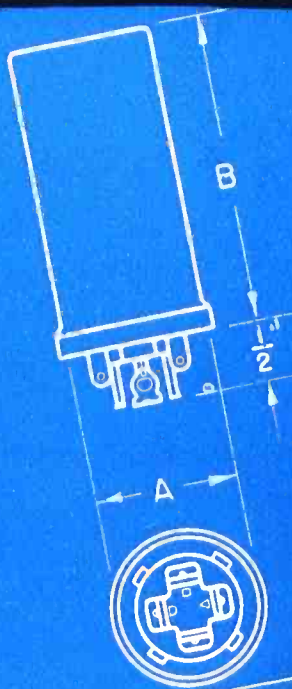

ENGINEERING
SPECIFY
Solar
DEPARTMENT

LEADING MANUFACTURERS
EVERYWHERE

PART NO.	SOLAR PART NO.	CAPY MFD.	WKG. VOLTS	DIMENSIONS		DRAWN	DATE
				"A"	"B"		
51 B50-1	DY-61	20+20	150	1"	2"	<i>E.O.H.</i>	1/4/45
51 B50-2	DY-92	20+20	450	1"	3-3/8"	<i>M.</i>	DWG. No. 51 B50
51 B50-3	DY-94	10+10	450	1"	2-1/2"	<i>J.C.</i>	ISSUE
51 B50-4	DY-132	15+10+20	350-350-25	1"	2-1/2"		
51 B50-5	DY-141	10+10+20	450-450-25	1"	3"		

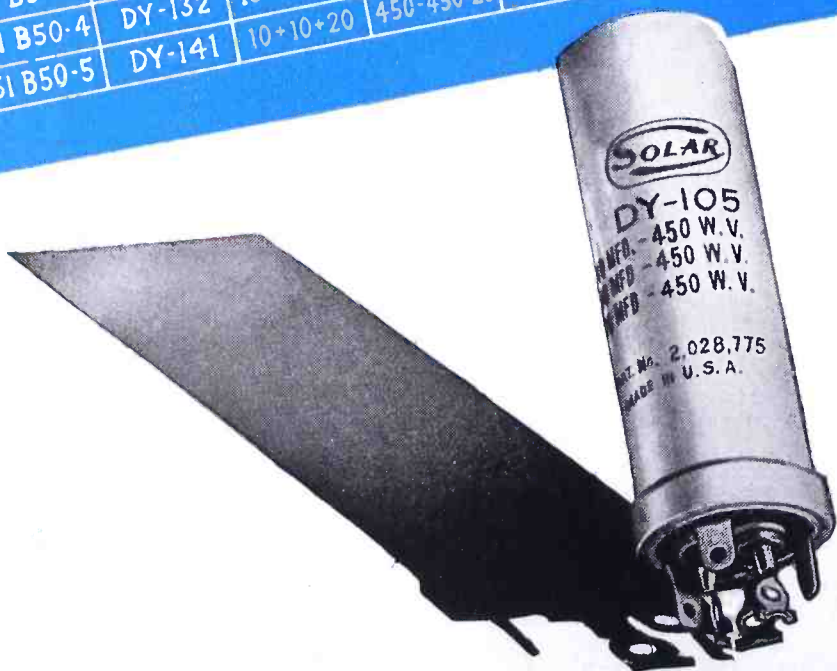

Prominent engineers consistently show their preference for Solar Capacitors. Solar pledges continued production of superior quality capacitors to merit that preference. Solar Capacitor Sales Corporation, 285 Madison Avenue, New York 17, N. Y.



CAPACITORS &
ELIM-O-STATS



* Hands that
Capture the
Future

*
FOR THE RADIO OF TOMORROW

War-trained hands . . . fingers educated in accuracy and speed . . . guided by new facts wrested from the widening frontiers of electronics research . . . hands that will create unsurpassed values in "Detrola-built" Radio Receivers . . . Television Receivers . . . Automatic Record Changers, and other electronic instruments.

KEEP YOUR EYE ON DETROLA

DETROLA RADIO

DIVISION OF
INTERNATIONAL DETROLA CORPORATION
BEARD AT CHATFIELD • DETROIT 9, MICH.

KEEP ON BUYING AND KEEP THOSE WAR BONDS



**JUST OFF
THE
PRESS!**

The new ELECTRONIC ENGINEER'S REFERENCE MANUAL now makes available to the practical engineer all the essential up-to-the-minute facts about electron tubes and related parts. More than 900 types of Receiving, Transmitting, Cathode-Ray and Photo Tubes are described—with physical specifications, characteristics, typical operat-

ing conditions, basing diagrams, war-time substitution chart and other data. All this and more in one handy quick-reference book of 146 pages that you can tuck in your pocket. Note ring binding which makes the pages lie flat when book is open. Price \$1.00 from your N. U. Distributor. National Union Radio Corporation, Newark 2, New Jersey.



I Will Show You How to Learn RADIO by Practicing in Spare Time

I Send You
6 Big Kits
of Radio Parts

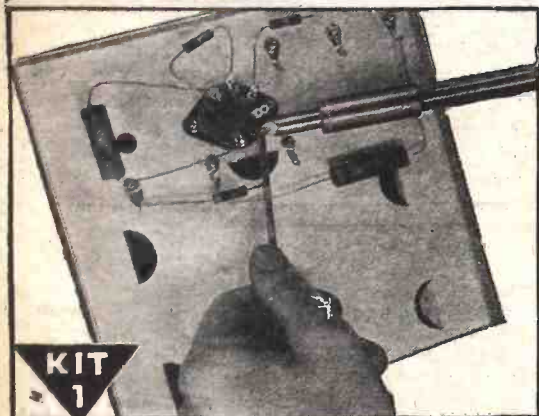

KIT 1

I send you Soldering Equipment and Radio parts; show you how to do Radio soldering; how to mount and connect Radio parts; give you practical experience.

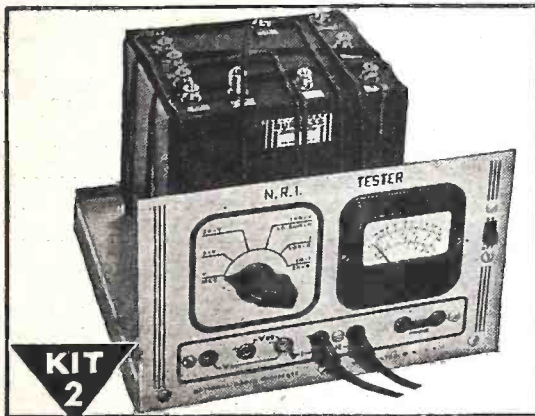

KIT 2

Early in my course I show you how to build this N.R.I. Tester with parts I send. It soon helps you fix neighborhood Radios and earn EXTRA money in spare time.

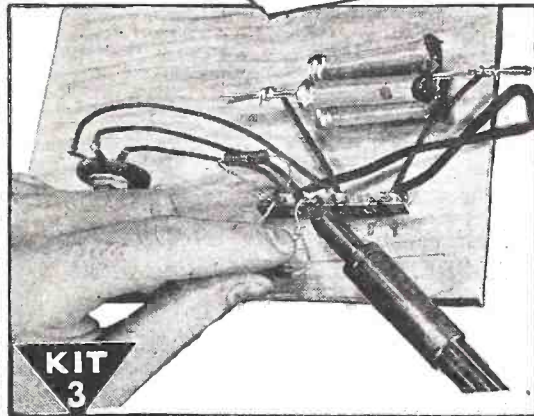

KIT 3

You get parts to build Radio Circuits; then test them; see how they work; learn how to design special circuits; how to locate and repair circuit defects.

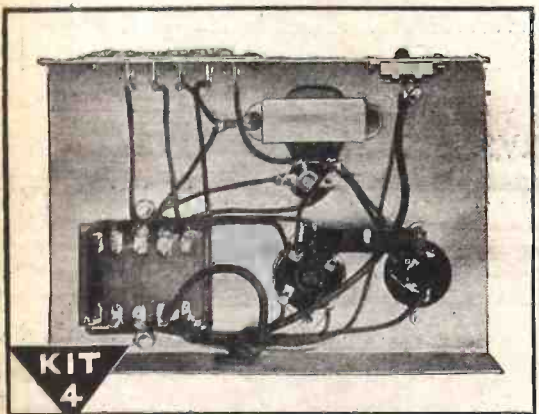

KIT 4

You get parts to build this Vacuum Tube Power Pack; make changes which give you experience with packs of many kinds; learn to correct power pack troubles.

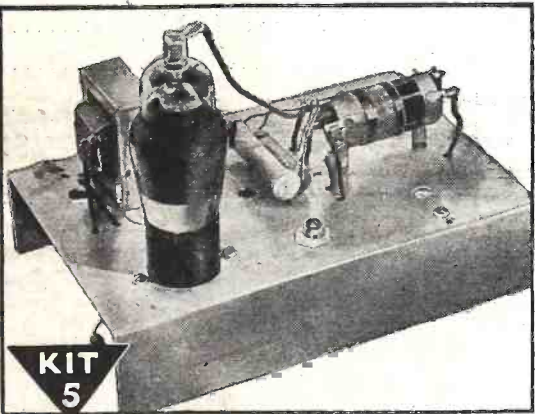

KIT 5

Building this A. M. Signal Generator gives you more valuable experience. It provides amplitude-modulated signals for many tests and experiments.

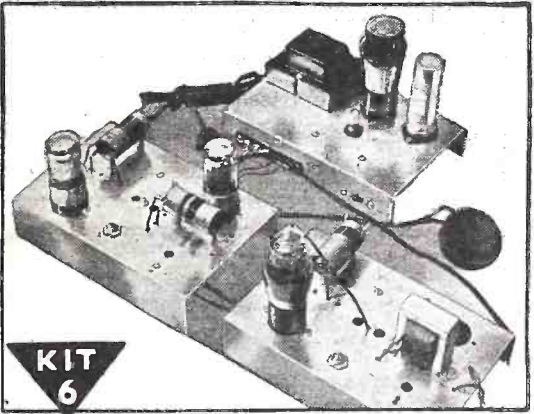

KIT 6

You build this Superheterodyne Receiver which brings in local and distant stations—and gives you more experience to help you win success in Radio.

I Will Train You at Home - SAMPLE LESSON FREE

Let me send you facts about rich opportunities in Radio. See how knowing Radio can give you security, a prosperous future. Send the coupon for FREE Sample Lesson, "Getting Acquainted with Radio Servicing," and my FREE 64-page book, "Win Rich Rewards in Radio." See how N.R.I. trains you at home. Read how you practice building, testing, repairing Radios with SIX BIG KITS of Radio parts I send you.

Future for Trained Men Is Bright in Radio, Television, Electronics

The Radio Repair business is booming NOW. There is good money fixing Radios in your spare time or own full time business. Trained Radio Technicians also find wide-open opportunities in Police, Aviation, Marine Radio, in Broadcasting, Radio Manufacturing, Public Address work, etc. Think of the boom coming when new Radios can be made! Think of the backlog of business built

up in all branches of Radio! Think of even greater opportunities when Television, FM, Electronics, can be offered to the public! Send for free book now.

Many Beginners Soon Make \$5, \$10 a Week EXTRA in Spare Time

The day you enroll I start sending EXTRA MONEY JOB SHEETS to help you make EXTRA money fixing Radios in spare time while learning. You LEARN Radio principles from my easy-to-grasp Lessons—PRACTICE what you learn by building real Radio Circuits with Radio parts I

send—USE your knowledge to make EXTRA money in spare time.

Find Out What N.R.I. Can Do for You

MAIL COUPON for Sample Lesson and my FREE 64-page book. It's packed with facts about opportunities for you. Read the details about my Course. Read letters from men I trained, telling what they are doing, earning. Just MAIL COUPON in an envelope or paste it on a penny postal. J. E. Smith, President, Dept. 5DX, National Radio Institute, Pioneer Home Study Radio School, Washington 9, D. C.

OUR 31st YEAR OF TRAINING MEN FOR SUCCESS IN RADIO

Good for Both - FREE

MR. J. E. SMITH, President, Dept. 5DX
National Radio Institute, Washington 9, D. C.

Mail me FREE, without obligation, Sample Lesson and 64-page book, "Win Rich Rewards in Radio." (No salesman will call. Please write plainly.)

Age

Name

Address

City Zone ... State4FR



**My Radio Course Includes
TELEVISION • ELECTRONICS
FREQUENCY MODULATION**

RADIO CRAFT

▼ AND POPULAR ELECTRONICS ▼

Incorporating
SHORT WAVE CRAFT TELEVISION NEWS
RADIO & TELEVISION

MEMBER
AUDIT BUREAU OF CIRCULATIONS

HUGO GERNSBACK, *Editor in-Chief*
FRED SHUNAMAN, *Associate Editor*
I. QUEEN, *Editorial Associate*
ELMER FULLER, *Shortwave Editor*
A. PASCALE, *Production Manager*
G. ALIQUO, *Circulation Manager*
JOHN J. LAMSON, *Advertising Director*
ALFRED STERN, *Promotion Manager*

IN THE NEXT ISSUE

Repairs On Electrical Clocks
Ratings of Sound Apparatus
An Introduction to Ham Radio
Receiver for 32-Volt Plants
Some Vistas of Postwar Radio

Published by Radcraft Publications, Inc.
Publication Office: 29 Worthington Street,
Springfield 3, Mass.

Editorial and Advertising Offices: 25 West
Broadway, Tel. RE2-9690, New York 7, N. Y.
Chicago Advertising Office: Radio-Craft, 520
North Michigan Avenue, Tel. Superior 7306,
Chicago 11, Ill.

Cleveland Advertising Office: 405 Erie Bldg.,
Cleveland, Ohio. Burdette Phillips, Manager.
Tel. Main 9645.

Los Angeles Advertising Office: 606 South
Hill Street, Los Angeles 14, Calif. Ralph W.
Harker, Manager.

New England Advertising Office: 411 Lafay-
ette Street, Salem, Mass. Claude C. Smith,
Manager.

San Francisco Advertising Office: 582 Market
St., San Francisco 4, Calif. Ralph W. Harker,
Manager. Tel. Garfield 2481.

RADIO-CRAFT is published monthly on the
25th of the month preceding that of date;
subscription price is \$2.50 per year in U. S.
(In foreign countries, 75c additional per year
to cover postage; Canada, 50c additional.)
Special rates for members of the Armed Forces
in U. S., or those addressed by A.P.O. or F.P.O.
mail, \$2.00. Entered at the post office at
Springfield as second-class matter under the
Act of March 3, 1879. All communications
about subscriptions should be addressed to:
Circulation Manager, Radio-Craft, 29 Worthing-
ton St., Springfield 3, Mass.

Notice of CHANGE of ADDRESS should
reach us at least one month in advance. When
ordering a change, please furnish an address
stencil impression from a recent wrapper if
you can. Address changes cannot be made
without the old address as well as the new.

Foreign Agents

London—Atlas Publishing and Distributing
Co., Ltd., 18 Bride Lane, Fleet St., London,
E.C. 4.

Melbourne—McGill's Agency, 179 Elizabeth
St., Australia.

Text and illustrations of this magazine are
copyright and must not be reproduced without
permission of the copyright owners.
Copyright, 1945, Radcraft Publications, Inc.

Contents

April, 1945

Volume XVI, No. 7

The Radio Industry Replies	407
Radio-Electronics Monthly Review	408

ELECTRONICS

V.H.F. Radio Range	by Raymond Lewis 411
Future Aspects of Television	by Dr. Lee DeForest 412
Radar Principles	by R. L. Smith-Rose 414
The Visie-Talkie	by Grego Banshuk 416
Radar, Bats and Supersonics	by Dr. Robert Galambos 421
Automatic Meter Reader	443

WAR-TIME RADIO

Robot Television Tank	by Hugo Gernsback 410
Tank Communications	415
An Army Wire Tester	445
Featherweight Radio Masts	446

RADIO TRAINING

Transitron Oscillators	by Fred Shunaman 419
Speech Amplifiers, Part VII	by Robert F. Scott 423

TEST INSTRUMENTS

A Signal Tracer and Multitester	by Harold T. Glenn 418
Test Oscillator	by Homer Davidson 447

SERVICING

Voltage Divider Design	by Jack King 420
------------------------------	------------------

CONSTRUCTION

Carrier Communicator	by Bob Melvin 426
----------------------------	-------------------

DEPARTMENTS

World Wide Station List	by Elmer R. Fuller 428
New Radio Electronic Devices	434
Radio-Electronic Circuits	436
Try This One!	438
The Question Box	440
Available Literature	442
Progress in Invention	by I. Queen 444
Technotes	457
"Why Not?"	459
Communications	460
Book Reviews	463



ON THE COVER

A television-controlled robot tank is the subject of our cover this month. The heavy turret of this vehicle carries a television pick-up in place of guns. Continually revolving, it gives a view of the terrain around as well as straight up, thus permitting full control from a place of safety.

"...BUT, HOGARTH, THE FOLKS
BACK HOME MUST GIVE UP THINGS—
BE A PAL AND LET ME BORROW
YOUR ECHOPHONE EC-1"



ECHOPHONE MODEL EC-1

(Illustrated) a compact communications receiver with every necessary feature for good reception. Covers from 550 kc. to 30 mc. on 3 bands. Electrical bandspread on all bands. Six tubes. Self-contained speaker. 115-125 volts AC or DC.



ECHOPHONE RADIO CO., 540 NORTH MICHIGAN AVE., CHICAGO 11, ILLINOIS

SPRAGUE TRADING POST

A FREE Buy-Exchange-Sell Service for Radio Men

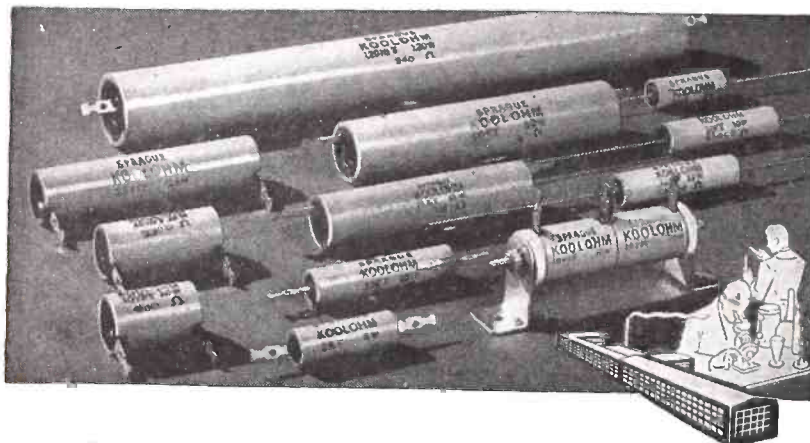

You Can Get KOOLOHMS Now!

At last, greatly expanded production is beginning to match even the tremendous war equipment demand for Sprague KOOLOHM Resistors. As a result, we have been delivering good quantities of 5- and 10-watt sizes in all ranges to Sprague distributors—and hope soon to make a similar announcement, both with regard to KOOLOHMS in other sizes and to many of the previously unavailable Sprague Capacitor types.

As always, we'll appreciate it if you ask for them by name!

WANTED IMMEDIATELY—A 1V tube. State condition and price. Wm. A. Plees, Whitehall, Mich.

AM INTERESTED in Radio and wish to buy parts. Send list and prices. R. H. Guyer, Hotel Monterey, W. Palm Beach, Florida.

WANTED FOR CASH—Any or all Rider's Manuals 1, 2, 3, 4, 5, 6, 8, and 10. Radio Service Lab., Box 150, Washington, Iowa.

IF YOU APPRECIATE the Sprague Trading Post service, we know we can count on you to ask for SPRAGUE Capacitors and SPRAGUE Koolohm Resistors by name whenever you buy. They will not let you down!

WILL TRADE—3 2-gang var. condensers medium size, approximately 365 mmfd. and 2 456 kilo air core I.F. trans. (in cans). Want 110 v. a-c phonomotor and turntable. Horace Helgeson, R.F.D. 3, Newark, Ill.

URGENTLY NEEDED—Supreme V-O-M and tube tester or analyzer. Must be A-1. Joseph Barron, 22 Pemberton St., Waterbury 4, Conn.

FOR SALE OR TRADE—Copies of QST, 1938 to 1943, and 39 copies of Radio mag. Want test equipment. F. Helm, 192 Jefferson St., Brooklyn, N. Y.

FOR SALE OR TRADE—Photo enlarger, 3 1/4 x 4 1/4 Agfa camera with flash and other photographic equipment. Want automatic record changer or other radio equipment. W. F. Griffin, Jr., 4 Proctor Court, Bowling Green, Ky.

WANTED — Power pack for Majestic radio No. 90; also 3 inch Supreme or Dumont oscilloscope. Marine Electric & Radio Service Sta., 201 Monroe St., Mobile, Ala.

TUBES FOR SALE—Several thousand used tubes, including many of the older types, magic eye, etc. Urgently need test equipment of all kinds and Rider manuals. Beattall Radio & Electronics Co., 88 Cortlandt St., New York 7, N. Y.

WANTED—203A or 303A tube in good working condition; also 276A or 376A. D. M. Decker, Deckerville, Mich.

FOR SALE—Tubes; 6—01-A, 1—12A (used, but working), 1—31. Also brand new Radiart vibrators No. 5331 and No. 5420-P, both for \$4.50. R. L. Odell, 502 12th St., Tell City, Ind.

WANTED—Echophone EC-1 or Sky Buddy receiver; also all 15 amp. tubes and Rider manuals. R. C. Fish, 419 Ludlow St., Lawrenceburg, Ind.

URGENTLY NEEDED—35L6 tube, new or used. Will offer 80, 45, 71A, 27, 24, or new 12SQ7GT in exchange. Donald Dove, 504 Elbon Ave., Akron 6, Ohio.

URGENTLY NEEDED—Sig. generator and late model V-O-M, R.C.P. or Triplett preferred. Robert Martin, 2844 LaViere St., Jacksonville, Fla.

WANTED—Small table model or combination radio, set Rider manuals, and the following tubes; 1A7, 50L6, 35L6, 35Z5, 25Z5, 12SA7, 25Z6, 50Y6, and 6AF6. Must be new and boxed. I. Weiner, 547 E. 30th St., New York 16, N. Y.

WANTED—78 r.p.m. 110v a-c phonograph turntable and motor. W. L. Thiel, 96 Westbury Blvd., Hempstead, N. Y.

FOR SALE OR EXCHANGE—Triplett No. 1230 battery operated sig. generator, 6 bands, in original case but without batteries. Will trade for 35 mm. camera or what have you? E. Gursh, 1481 Shakespeare Ave., Bronx 52, N. Y.

FOR SALE—National FB7A receiver, complete with power supply, 3 pr. coils and speaker, \$25. Am interested in U.S. postage stamps and coins. Fred Humphrey, 117 N. 20th St., Philadelphia 3, Pa.

WANTED—Late model sig. generator. C. W. Thompson, 6326 Repton St., Los Angeles 42, Calif.

WANTED—RCA jr. voltohmmyst, with complete instructions. Must be like new. W. B. Cox, RT. 3, Anson, Texas.

FOR SALE OR TRADE—Superior channel analyzer, recording discs, Jackson radio lab. rack; Monarch motor hand tool; C-D BN capacitor bridge; Weston 301 0-5 DC meter; V-O-M foundation meter; 3 Readrite meters and Bulova 21 j. wrist watch. Want late oscillator, Rider manuals, and 6—110 v. P.A. system. Byron Radio Shop, Byron, Ill.

WILL TRADE—Howard preselector No. 650 (tunes 540 to 43,000 KC) for late tube tester. Also have tubes to trade for rim drive phono. motors. Herbert H. Friedman, 520 Crockett St., Beaumont, Texas.

WANTED—1500 henry choke, RCA stock No. 9838 or equivalent. Ocelotron Laboratory, 2 Sherwood Terrace, Yonkers 4, New York.

NOTICE!—Please write plainly and describe your equipment accurately when sending advertisements for THE TRADING POST. This will help simplify our job of handling a tremendous number of ads every month—and will assure prompt, accurate presentation of what you have to sell or what you want to buy.

WANTED — G.T.C. Porta-Power Model "U" or equivalent, to convert 110 v. AC to 15 v. DC, 200 MA and 90 v. DC, 13MA for 4 tube 1 1/2 v. portable. S. Manville, 189 East 18th St., Brooklyn, N. Y.

WILL TRADE—DK-3 transceiver, slightly used, for all-purpose tester in good working order. G. L. Wood, R-1, Box 43, Jacksonville, N. C.

WILL SWAP—Good Shick electric razor for V-O-M or what have you? Lt. H. McLean, C.A.A.F., Childress, Texas.

WANTED—Crystal pickup of good quality. Must have cartridge. Arthur Domico, Box 46, Bisbee, Arizona.

WILL SWAP—Two hundred popular radio tubes, meters, and mis. equipment for Rider manuals—need all volumes. Bob Korellie, 2312 South Fern St., Arlington, Virginia.

FOR SALE OR EXCHANGE—Parts from Philco No. 65, including power transformer, condenser block, variable condenser, coils, and speaker with output transformer. Salvatore Lonigro, 52 Willowdale Ave., Montclair, New Jersey.

WANTED AT ONCE — Perforated type wireless code tapes for instructograph. J. Cavanagh, 92 Ocean St., Providence 5, Rhode Island.

URGENTLY NEEDED—For war industries training program, Hallcrafters' SX-24, S-20R or SX-25 receiver. Edward Kuligowski, 192 N. Henry St., Brooklyn 22, N. Y.

WILL TRADE—Eight transformers. Want Rider manuals from 1930 up, and small speakers. C. M. Rebelein, Kiester, Minn.

URGENTLY NEEDED—1000-ohm portovolt V-O-M. Frank Prezyna, Cowlesville, New York.

WANTED—Superior channel analyzer, No. 1230 sig. generator, dynamometer or similar instruments. Geo. H. Morse, Aerial, Alta., Canada.

WILL TRADE—Hammarlund Comet-pro 8-tube short-wave receiver, a-c band spread, speaker in cabinet, coils for 10, 20, 40, and 80 meter bands, for standard broadcast portable receiver, AC-DC and battery. Herman Fischer, 626 Carlton Ave., Brooklyn 17, N. Y.

URGENTLY NEEDED—New and good used radio tubes—1 to 25 of each type—for new radio shop. Milton Graham, 2321 Davis St., Charlotte, N. C.

FOR SALE—G.T.C. Porta power 1 1/2 v. bak. audio transformers, chokes, and 6—01A, 3—46, 3—83, and 2—1G1 tubes. Edwin T. Larason, Martinsburg, Ohio.

WANTED—Copy of operating chart for Simpson tube checker No. 393. Robert Grimm, 208 Crescent Bend, Macon, Mo.

WANTED — RCA television receiving chassis, less power supply. Walter Mordes, 854 Driggs Ave., Brooklyn, N. Y.

URGENTLY NEEDED—Late model all wave sig. generator. Michael Kopulos, Three Hills, Alberta, Canada.

FOR SALE—Telegraph sending machine (bug), chrome-plate, \$16.75; black crackle base finish, \$14.75. L. F. Sechman, 16 O'Meara St., Winnipeg, Man., Canada.

WANTED FOR CASH—Hallcrafters' Sky Buddy or Echophone EC-1. C. H. Miller, 2221 Ave. D., Kearney, Nebr.

FOR SALE—17-tube Meissner television receiver No. 10-1153, less cabinet and tubes, 1940 model. Also 1941 Echophone commercial receiver, No. EC-1. Both in good condition. Lester T. Grove, 400 White Horse Pike, R. D., Egg Harbor, N. J.

WANTED—Carborundum Co. crystal detector No. 30, in perfect condition. State price. Lee B. Walroth, Davenport, Nebr.

URGENTLY NEEDED—Professional recorder and turntable, preferably 16" over-head cutter, either dual or single speed (78 r.p.m.) Priority rating available. Lakewood High Radio Club, Lakewood High School, cor. Bunts and Franklin Aves., Lakewood 7, Cleveland, Ohio.

FOR SALE—2A3 Thordarson amplifier, 15 watt, with excellent Jensen speaker and 100' cable. Berg Henninger, Beloit, Kans.

YOUR OWN AD RUN FREE!

For over two years now, the Sprague Trading Post has been helping radio men get the materials they need or dispose of radio materials they do not need. Literally thousands of transactions have been made through this service. Hundreds of servicemen have expressed their sincere appreciation of the help thus rendered.

Send your own ad to us today. Write PLAINLY—hold it to 40 words—or less—confine it to radio materials. If acceptable, we'll gladly run it FREE OF CHARGE in the first available issue of one of the five radio magazines wherein the Trading Post appears every month.

HARRY KALKER, Sales Manager

Dept. RC-45 SPRAGUE PRODUCTS CO., North Adams, Mass.
Jobbing Sales Organization for Sprague Electric Company



SPRAGUE CONDENSERS KOOLOHM RESISTORS

T.M. REGISTERED U. S. PATENT OFFICE

Obviously, Sprague cannot assume any responsibility, or guarantee goods, services, etc., which might be exchanged through the above advertisements

Here is the one quick practical way to

REALLY LEARN RADIO • ELECTRONICS and TELEVISION



SPRAYBERRY RADIO TRAINING

Gives you Both



**..YOU GET
A COMPLETE
RADIO SET**

BE A TRAINED TECHNICIAN

There's only one *right* way to learn Radio Electronics. You must get it through simplified lesson study combined with actual "shop" practice under the personal guidance of a qualified Radio Teacher. It's exactly this way that Sprayberry trains you . . . supplying real Radio parts for learn-by-doing experience right at home. Thus, you learn faster, your understanding is clear-cut, you acquire the practical "know how" essential to a good-paying Radio job or a Radio business of your own.

A Bright Future

Now's the right time to start training. Because Radio is surging forward, expanding at a rapid pace . . . with the promise of spectacular opportunities in Television, Frequency Modulation, Industrial Electronics . . . in the vast Radio Service and Repair business. When you train with Sprayberry, you need no previous experience. The Course starts right at the beginning of Radio, even shows you how to make spare time profits while learning.

I'll Show You a New, Fast Way to Test Radio Sets without Mfg. Equipment

The very same Radio parts I supply with your Course for gaining pre-experience in Radio work may be adapted through an exclusive Sprayberry wiring procedure to serve for complete, fast, accurate Radio Receiver trouble-shooting. Thus, you do not have one cent of outlay for manufactured Test Equipment, which is not only expensive but scarce. In every respect, my training is practical, complete . . . tested and proved for results. It will give you the broad, fundamental principles so necessary as a background, no matter which branch of Radio you wish to specialize in.

MAIL COUPON NOW !

JUST OUT! FREE! HOW TO READ RADIO DIAGRAMS AND SYMBOLS

. . . a valuable new book which explains in simple, non-technical English how to read and understand any Radio Set Diagram. Provides the quick key to analyzing any Radio circuit. Includes translations of all Radio symbols. Send for this FREE book now while supply lasts and along with it I will send you another big FREE book describing my Radio-Electronic training.

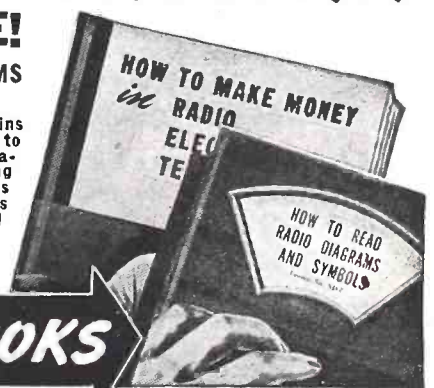

GET FREE BOOKS

SPRAYBERRY ACADEMY OF RADIO
F. L. Sprayberry, Pres.
Room 2045
Pueblo, Colorado

Please rush my FREE copies of "HOW TO MAKE MONEY IN RADIO, ELECTRONICS and TELEVISION," and "HOW TO READ RADIO DIAGRAMS and SYMBOLS."

Name Age

Address

City State

Tear off this coupon, mail in envelope or paste on penny postcard.



Skilled fingers check every connection before this Meissner electronic equipment leaves Mt. Carmel, Ill., its destination —“Somewhere with the Armed Forces.” This “precisioneering” may make the difference between a successful military operation or a defeat, and Meissner’s “precision-el” are working for victory.

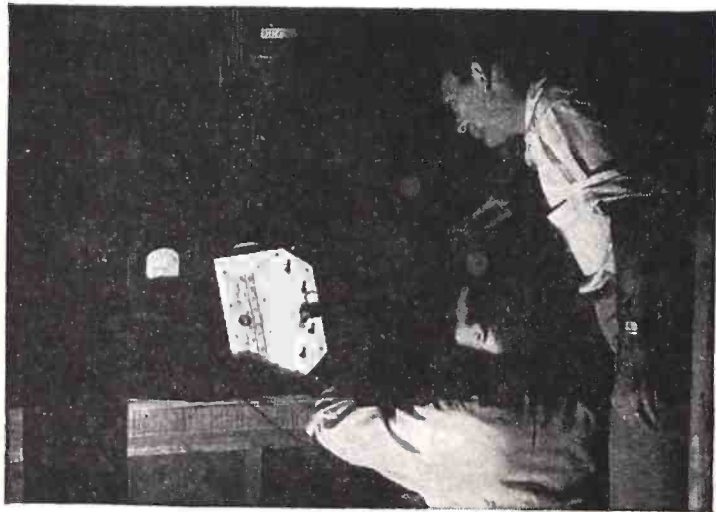

Precision testing in Meissner Laboratories proves the precision quality of the work of Meissner “precision-el.” It means new highs in performance when you specify Meissner precision-built electronic equipment for your product.



Concentration on the production of finer electronic equipment is characteristic of the men and women of Meissner. This devotion to quality production makes “precisioneering” out of even the most routine jobs — gives even greater skill to technicians like these.

THIS IS PRECISIONEERING by Mt. Carmel’s famed “Precision-el”

Precisioneering isn’t just another word for precision quality. It means that pride and skilled craftsmanship are represented in every product. To the men and women of Meissner, precisioneering means that they are maintaining the same high standards of workmanship that earned them the name “precision-el”—highest standard of an exacting industry.

To you, the users of Meissner precision-built electronic equipment, it means that these precisioneered products give you added quality, greater dependability.



“Step Up” Old Receivers!

These Meissner Ferrocart I. F. input and output transformers are getting top results in stepping up performance of old worn receivers. Special powdered iron core permits higher “Q” with a resultant increase in selectivity and gain, now available for frequency range 127-206. Ask for numbers 16-5728 input, 16-5730 output. List \$2.20 each.



MEISSNER

MANUFACTURING COMPANY • MT. CARMEL, ILL.

ADVANCED ELECTRONIC RESEARCH AND MANUFACTURE
Export Division: 25 Warren St., New York; Cable: Simontrice

RADIO-CRAFT for APRIL, 1945

PREPARE NOW FOR THAT BETTER JOB IN

RADIO ELECTRONICS



Above: Working on experiments Nos. 1, 2, 3, 4—after receiving Kit No. 7.

DeForest's Training is an effective, interesting stepping-stone toward good jobs, good pay. By actually using Radio parts and assemblies to build experiments described in your Loose-Leaf Lessons, you "LEARN-BY-DOING"—by using Home Movies to bring Radio's fundamentals to life in your own home, you "LEARN-BY-SEEING." You get BOTH features with DeForest's.

BUILD THIS "SUPER-HET"

DeForest's unique "Block System" makes assembling this Superheterodyne and many other Radio-Electronic circuits—simple and easy. In fact, you work out—

... 133 INTERESTING EXPERIMENTS USING THESE RADIO PARTS

PREPARE FOR A FIELD RICH IN PRESENT AND FUTURE OPPORTUNITIES

JUST CONSIDER—in the U. S. there are around 50 million Home Radios, 7 million Car Radios—900 Broadcast Stations—6,000 Police Transmitters—30,000 Retail Radio Outlets and 1,000 Radios and Radio Parts Manufacturers. Think of the number of TRAINED men needed in a field THIS SIZE! Then—think of the expanding fields of "FM" Radio, Motion Picture Sound and other new and interesting branches of the Electronics industry. Isn't it reasonable to believe that TREMENDOUS FUTURE OPPORTUNITIES exist for TRAINED men and women? Can't you see yourself climbing the ladder of success toward a Good Pay Job, or in a Sales and Service Business of your own in this newer, expanding industry? GET THE FACTS about this great field of Radio Electronic opportunities! MAIL THE COUPON—Now!

SEND FOR BIG FREE BOOK

Write today for DeForest's BIG, FREE BOOK, "VICTORY FOR YOU!" See what the growing Radio-Electronic field offers you—and How DeForest's prepares you at home in your spare time without interfering with your present job. Get complete facts about DeForest's exclusive "A-B-C" combination of home training advantages that includes (A) the use of 8 big kits of Radio parts and assemblies, (B) the use of a genuine DeVry Movie Projector and 12 reels of training film revealing hidden circuit actions, (C) 90 well-illustrated loose-leaf lessons prepared under the supervision of Dr. Lee DeForest, often called the "Father of Radio"—PLUS an effective EMPLOYMENT SERVICE that has long-established contacts with many employers. You "LEARN-BY-SEEING" ... you "LEARN-BY-DOING" ... you GET RESULTS AT HOME...the modern DeForest's Way. You be the judge.

"LEARN-BY-DOING" AT HOME!

With Standard Radio Parts furnished by DeFOREST's, you construct and operate 6 different types of Radio Receiving circuits—a Radio Telephone—Public Address System—Electric Eye devices—Wireless Microphone—Light Beam Transmission and many other projects—all in YOUR OWN HOME. Set up your own Electronic Laboratory. Enjoy this fascinating way to learn.



LEARN BY SEEING—AT HOME!

DeForest's Home Movies Help You Learn Faster—Easier at Home

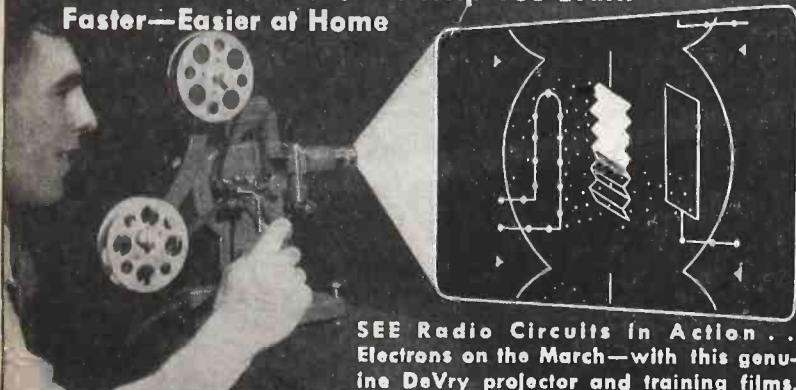

SEE Radio Circuits in Action... Electrons on the March—with this genuine DeVry projector and training films.

DeFOREST'S

Training also offers instruction in Motion Picture Sound Equipment, FM Radio and Television

E. B. DeVry, President
DeFOREST'S TRAINING, INC.
2535-41 North Ashland Avenue, Dept. RC-B4
Chicago 14, Illinois, U. S. A.

Please send me your "VICTORY FOR YOU" book and KIT FOLDER, FREE.

Name..... Age.....

Address.....

City..... State.....

- If under 16, check here for special information,
- If a veteran of World War II, check here.

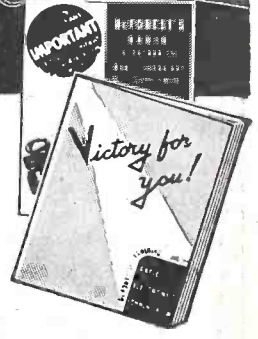

DeFOREST'S TRAINING, INC.
CHICAGO 14, ILLINOIS

Centralab STANDARD, MIDGET AND ELF *Radiohms*

● For more than two decades the name CENTRALAB on a volume control has been a synonym for QUALITY.

The long wall-type resistance sector, the smooth performance and the satisfactory operation of these controls are in no small measure responsible for the fame of Centralab. Whether for original equipment or replacement always specify

CENTRALAB Radiohms



Centralab

Division of GLOBE-UNION INC., Milwaukee

Producers of VARIABLE RESISTORS — SELECTOR SWITCHES — CERAMIC CAPACITORS,
FIXED AND VARIABLE — STEATITE INSULATORS — SILVER MICA CAPACITORS

MAKE MORE MONEY

IN Radio TELEVISION & ELECTRONICS

Now!

GET THESE 2 BIG BOOKS

FREE!

You men already in Radio know how great the demand is for trained, experienced servicemen, operators and technicians. You know how fast the field is growing and how important it is to keep up with developments — F.M. Receivers, Electronics and Television. You know, too, a fellow cannot learn too much about any industry for **REAL SUCCESS**. Whether you have experience or are merely **INTERESTED** in radio as an amateur, you must recognize the **WONDERFUL OPPORTUNITY** right within your grasp to cash in on your natural abilities. Make them pay dividends. Get into the **EXPERT RADIO SERVICE FIELD**. Be an F.M. and **TELEVISION specialist—OWN A BUSINESS OF YOUR OWN**, if you prefer. Fill out and mail the coupon below for all the details of our plan.

Get the Latest Inside Information—Short Cuts—Trade Secrets by

Here's Just a Few of the Interesting Facts you Learn with the **FREE MANUAL**.

1. Routine for diagnosing Radio Troubles.
2. Preliminary Inspection of Receivers.
3. How to Check Power Supply.
4. How to Identify Various Stages of Receiver.
5. How to Trace the Circuit and Prepare Skeleton Diagram.
6. How to Test and Measure Voltages.
7. How to Test Speaker in Audio Stages.
8. How to Test Detector, I.F., R.F., and Mixer Stages.
9. Complete Reference Table for Quickly Locating Receiver Troubles.

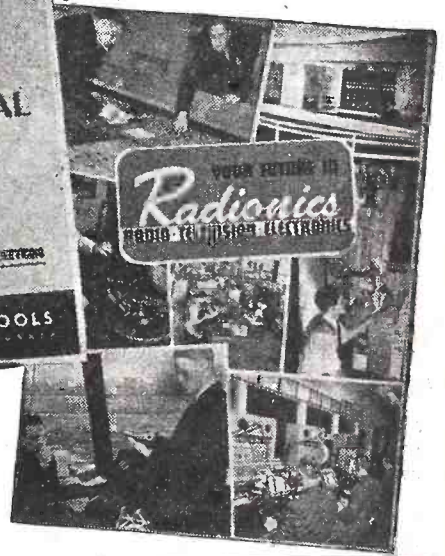
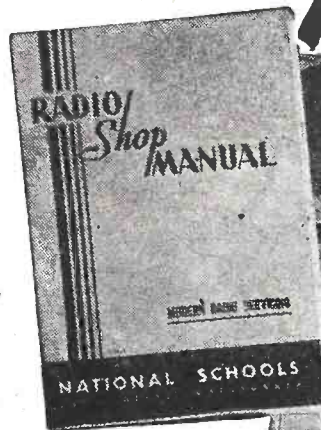

SHOP METHOD HOME TRAINING

FROM A REAL ESTABLISHED RESIDENT SCHOOL
Now the famous National Schools brings its exclusive Shop-Method of training right into your own home. You can learn the most up-to-date, approved projects, systems and circuits step by step in your spare time. This is the sound practical training you want and need—the development of experienced instructors working with thousands of students right in shops, **NEW F.M. broadcast studios and experimental laboratories of NATIONAL SCHOOLS**—one of the most advanced trade educational centers in the world.



National Trained Men Now Making the Best Money in History

The real value of National training shows up on the quick progress our men make on the job.

Incomes that seemed fantastic only a short time ago are now being reported by National graduates. And this is only a sample of what the future holds for the **MAN WHO KNOWS RADIO, ELECTRONICS, F.M. TELEVISION** and allied subjects. National is proud of the progress its graduates are making all over the world. Read the facts—the actual proof in the books we send you **FREE**.

LEARN BY DOING

Work with Real Experimental Equipment Furnished without Extra Cost as Part of Your National Training

Experience is the best teacher. You learn by experience with the exclusive National Shop-Method of Home Training. In the course of your study you actually build various types of receivers—a powerful superheterodyne, a signal generator, an audio oscillator and others—You make tests and conduct experiments that *show you the why and how of things*. You understand what makes the various elements of electronics operate because you actually see them work for you. Not only do you gain marvelous experience by this method of learning but you receive valuable equipment you will use on the job in the practice of your profession as an electronics expert. *Mail the coupon* and learn what this means to you.

Send the Coupon and prove to yourself what **YOU can do in RADIO!**

Be Sure Of Your Success And Security After The War

Don't let your post-war ambitions lag. Don't let **YOUR** future depend on others. Build a career for yourself. Never in all history has the returning serviceman, or war worker been confronted with such a great future if he reaches out and grasps it **NOW**. Here is a new world opening before you. Get ready now while you are still in uniform—while you are on your war job. Then you can soon step into an essential, well paid position or, with little capital, **GET INTO BUSINESS FOR YOURSELF**. It isn't a bit too soon to start now. Radio men are vitally needed. Fill out and mail the coupon immediately and examine the **NATIONAL SHOP METHOD HOME TRAINING COURSE** carefully, without obligation.

FREE LESSON INCLUDED

Examine the exclusive National Shop Method of Home Training. See for yourself how sound and practical it is. Be convinced that you can learn Radio, Electronics, Television—quickly and easily in your spare time. You can't tell until you try. This trial is **ABSOLUTELY FREE**. Fill out the coupon immediately while you are thinking about it and drop it in the mail at once.

Mail the coupon here for the books that tell you the complete story of the marvelous new system of training in Radio, Electronics and Television. Learn the facts of this exclusive shop-method of home training. See for yourself! **DECIDE FOR YOURSELF!**

This is the **MODERN SYSTEM OF TRAINING**; it matches the rapid progress constantly being made in Radio, Television and Electronics. It is **TIME TESTED**, too. National Schools has been training men for more than a third of a century. It is the very same training that has helped thousands to more pay and greater opportunity.

You owe it to yourself—your future—to read the book "Your Future in Radio, Electronics and Television"—**FREE** to you when you send in the coupon.

NATIONAL SCHOOLS

LOS ANGELES 37, CALIFORNIA EST. 1905



MAIL OPPORTUNITY COUPON FOR QUICK ACTION

National Schools, Dept. 4-RC
4000 South Figueroa Street, Los Angeles 37, California.

(Mail in envelope or paste on penny post card)

Mail me **FREE** the books mentioned in your ad including a sample lesson of your course, without obligation. I understand no salesman will call on me.

NAME AGE.....

ADDRESS

CITY STATE

Include your zone number



"HE WAN'STA KNOW
WHY THEY CALL THIS
THA' PACIFIC
THEAYTER"

Fine instruments produced in volume with quality first to last.

Triplet



ELECTRICAL INSTRUMENT CO.
BLUFFTON, OHIO

The Radio Industry Replies

IN the February, 1945, issue RADIO-CRAFT went on record and stated editorially its belief that this would be a long war.

RADIO-CRAFT had voiced in the September, 1943, issue the belief that if we had extraordinary good luck, the war might be over by the end of 1946. It is felt that this was an optimistic forecast. Even with Germany finally out of the struggle, the war with Japan would still tax the efforts of the radio industry severely.

Another belief was that radio manufacturers would not be permitted to build huge quantities of radio and television sets for the public consumption until Germany is completely out of the war. Even that would not mean the end of hostilities in Europe.

Another belief was that as long as the Japanese war is in progress, facilities of all radio manufacturers would be so heavily taxed that the civilian radio output for radio sets would be moderate. Even the termination of the war with Japan would in RADIO-CRAFT'S opinion not bring full-scale civilian radio set manufacture immediately. RADIO-CRAFT believed that civilian radio sets are not just around the corner and that radio manufacturers should stop publicizing fantastic post-war radio sets calculated only to hurt the industry in the end.

RADIO-CRAFT felt that in as much as these beliefs were its own, the magazine should ask the leaders of the radio industry for their individual opinions pertaining to the above.

The expressions from a number of the foremost leaders of the radio industry follow:

"War Will Have Little Bearing on Receivers"

FOR CROSLY, I have on numerous occasions talked down the fantastic illustrations and descriptions about post-war radios and major appliances, and both J. H. Rasmussen, our General Sales Manager, and myself have appeared on a number of programs and have written various articles trying to get people to be realistic about what could properly be expected in the way of new developments immediately following the war.



As president of the Radio Manufacturers' Association I have had Theodore R. Sills and Company, Publicity Agents for RMA, get out a number of articles which have had very wide publicity on this same subject.

We in the radio industry are all tied up on war contracts and have had practically no time for post-war thinking.

Our war products are in the areas not covered by domestic receiving sets and much that has been created during the war will have little bearing on domestic receivers.

On frequency-modulation there has been some accomplishment, but on television, in my opinion, outside of tube development and a few other items, little has been accomplished during the war in adding to the store of information available before.

I agree with you that all of

this dramatic presentation on the part of artists and designers, not only on radios, but on kitchen cabinets, homes and major appliances, has caused the public to expect more than they will get and hence develops sales resistance.

THE CROSLY CORPORATION,
R. C. Cosgrove,
Vice-President & Gen'l Mgr.

"Let Us Not Sell Ourselves Short"

WE at Emerson Radio & Phonograph Corporation want to congratulate *Radio-Craft* for the splendid editorial in its February issue regarding some of the exaggerated claims that have been made for post-war radio and television. We have always felt that it is a mistake to talk about "fantasy" radios for the reason that such talk arouses the question of probably obsolescence in the minds of prospective customers.

As you have so aptly pointed out in your editorial, the resumption of civilian production of radios is still a long way off. As the war with Japan draws to its climax, *the needs for radio and electronic equipment will increase rather than diminish.*



Moreover, when the radio industry has finished its war job and the *War Production Board* finally lifts its restrictions on civilian output, there will be a period of transition during which the supply of raw materials will

continue to be tight. The shortages created by four to six years of war will not disappear overnight.

During this period of transition, radio manufacturers, as well as producers in other fields, will probably find it expedient to resume production on the same models that were offered to the public just before the war, with whatever improvements that can be made without delaying too long the flow of goods to the consumer. We have no doubt that within the next decade or so our most extravagant dreams will come true—but they will be realized through evolution, not revolution. Meanwhile, there are millions of Americans who are waiting to buy what the radio industry will have to offer immediately after victory is won. Let us not sell ourselves short.

EMERSON RADIO
& PHONOGRAPH CORP.
Charles Robbins,
Vice-President

"Win War First — Post-war Radios Second"

OUR hopes are still running high for an early end to the war in Europe but we are not going to let our hopes influence our actions. Our first business is to produce for the armed forces and this we are doing. We will continue to go all-out on production of *Motorola Handie Talkies, Walkie Talkies, Radar* and other military FM equipment until we are definitely advised that we may turn our efforts to peacetime production of radios and radio-telephone equipment.

Furthermore, we are not making any definite predictions as to when Victory will be won nor how soon thereafter radios and other badly needed electrical appliances will once again return to dealers' shelves. After our magnificent break-through at Saint Lo, too many optimistic statements were given as to when the

war would end, by those who should have known better. The letdown which followed and, later, the bitter realization that the war in Europe would not be over quickly, exerted so many deleterious effects it must not be repeated.

Two ways have been listed by General Eisenhower to win the war. "Either with lots of man-



power and little material or . . . overwhelming supplies of material and a minimum of our precious boys' lives . . ." Naturally, we prefer the latter way, which is why we will make no promises and hold out no hopes for a definite date on which production of civilian radios will be resumed.

This does not mean that we are not looking forward to getting back into our normal stride, but it does mean that we are following the quickest way we know to help bring victory on the battle front.

Only one thing I will predict. In our production and development of military radio-radar equipment, for which we received the Army-Navy "E" production award five times, we have learned many important things in electronics and in radar-radio engineering. When peacetime production of radios is resumed, our new line of AM and FM Radios will include many of these wartime improvements. Our dealers will be able to offer the finest radios anywhere and their sales

(Continued on page 424)

POSSIBILITIES for the future development and expansion of television into many new fields were outlined by Lewis M. Clement, vice-president in charge of research and engineering, the Crosley Corporation, when he addressed the Men's Club at Middletown, Ohio, last month.

"In the future, television, to be commercially successful, must provide a service to the public and revenue to station owners. It is admitted that advertising by television is many times more effective than by radio, as the merchandise can be shown and demonstrated without stopping the program to make a commercial announcement.

"Automobiles can be shown and demonstrated under all conditions, on the road, over the proving ground course, etc. Electric stoves can be demonstrated in actual kitchens and clothing can be shown to great advantage in stores, hotels, theaters, etc.

"It is conceivable that an operator in a control room may be able to control a bat-

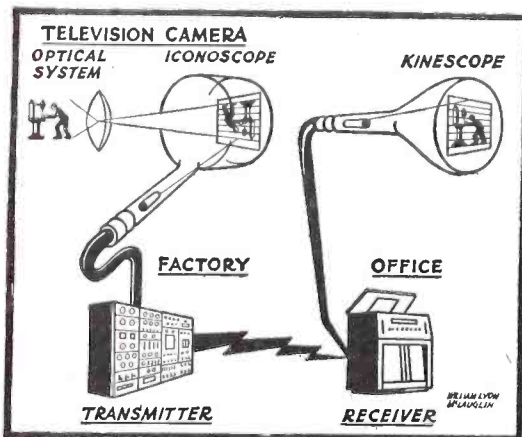

tery of lathes, punch presses or other machines. Floormen can be dispatched to load and unload machines at the direction of the dispatcher in the television control room.

"Since the television eye can be placed in a furnace, in a cold room, under water, or in fact, anywhere, television is likely to find application in processing, manufacturing, and industrial operation. It is possible to use television in the dispatching of trains, ships, aircraft, by placing the pick-up eye at the desired location and the receiver at the dispatcher's office.

"Television will be an important adjunct to theaters. Sports events and events of national or local importance can be shown on theater screens. Theater television chains will obtain rights for important events and will provide ringside seats for the audience at an extra charge.

"Receivers will produce useful pictures in normally-lighted living rooms. It will not, therefore, be necessary to sit in a dark room to enjoy a television program. Receivers for home use have been built which project the image on a screen and produce a picture 18" x 24". The brilliance is sufficient so that it is not necessary to turn off the floor lamps in a normal living room. It is generally believed that a 7" x 9" picture is the minimum size that will be satisfactory in the home, even in a table type set.

"For a projection type of receiver in which the brilliant image on the end of a 5" tube is projected on a screen by means of a reflective optical system, a 15" x 20" or 18" x 24" picture is believed to be as large as will be required.

"Experience has shown that the proper viewing distance of a television or motion picture image is between four and eight times the height of a picture. Thus, for a 7" picture, the viewing distance should be 2½ by 5 feet; for an 18" picture, 6 to 12 feet, and for a normal motion picture screen of 15 feet in height, 60 to 120 feet."

Radio-Electronics

Items Interesting

PUBLICATION of a 388-page Supplement and a 360-page Master Index in the seized enemy chemical patent abstracting program has just been announced by Alien Property Custodian James E. Markham. This was undertaken voluntarily by the Chicago Section of the American Chemical Society and the Science-Technology group of the Special Libraries Association.

The complete publication provides ready access for American chemists and businessmen to some 8,000 seized United States chemical patents, the bulk of which were issued to Germans. Covered are such broadly diversified fields as sanitary and agricultural chemistry, metals and alloys, heavy and fine chemicals, foods, oils and fats, textile and leather processing, explosives, and plastics.

A description of a number of these seized enemy patents relating to radio and electronics was published in last December's *Radio-Craft* under the title, "Alien Enemy Patents."

A MAGNET which supports itself in air above a super-cooled lead plate has recently been reported by a member of the USSR Academy of Science, according to a *Science Service* account last month.

The probable explanation is that the magnetic field of the magnet sets up incessant induction currents in the lead, which, in turn, repel the magnet. This ability is manifested in a ferro-nickel magnetized bar one centimeter long.

In the experiment, the lead plate had been cooled to 269 degrees below zero Centigrade, approximately four degrees above absolute zero. When the tiny magnet was thrown on the plate it bounced into the air and remained floating until the temperature of the plate rose three degrees, when it settled on its surface.

This action is dependent upon the very low temperature to which the lead was subjected. Scientists have known for years that at very low temperatures the electrical resistances of some metals drop very greatly. When cooled to this condition the metal is said to be superconductive. Lead becomes super-conductive at 266 degrees below zero Centigrade, and mercury at 269 degrees. A current started by an electromotive force in a superconductive lead ring continues to flow for hours after the starting force is removed.

MINIATURE tubes will result in smaller home radios, according to a paper read by Messrs. Kelly and Green of the Radio Corporation of America at the recent convention of the Institute of Radio Engineers.

Tubes developed during the war, state the authors of the paper, complete the necessary complement for the home receiver, which can now use the small "bottles" from rectifier to output tube. The space saving over modern midgets may be as much as 40 per cent, it is estimated.

RADAR and other electronic devices to permit safe automobile driving even in fog so heavy the driver cannot see the road, are the objects of experiments by British motor car manufacturers.

Sir Miles Thomas, chairman of the industry's Public Relations Committee, speaking last month about the automobile of the future, declared:

"Safe driving even when it is impossible to see the road is indeed a possibility.

"Curb beacons, operating with dashboard receiving sets, will guide drivers in fog."

This would mean that motorists would be employing the blind-landing technique used to bring planes on to an airfield in the dark.

The driver would have some method, either by a system of lights or buzzers, of knowing whether he was "too far left" or "too far right."

"In addition," added Sir Miles, "a buzzer would call the driver's attention to a change in traffic lights ahead.

"Another possibility is the use of miniature radiolocation sets, which would guide the motorist in a similar way."

PRAISE from the new head of the FCC for the movement against objectionable advertising blurbs in radio news programs was reported last month by the *St. Louis Post-Dispatch*. According to the report, Paul Porter, chairman of the Commission, complimented the *Post-Dispatch* as a "representative of the public in taking the lead in questioning program standards."

Pointing out that the FCC has no authority over the content of programs, he stated that the commission had received complaints from listeners about the excessive use of commercialism in newscasts.

"Unquestionably," said Mr. Porter, "the ingenuity of broadcasters has developed a kind of new dimension in the reporting of news, starting with the accounts of the spectacular broadcasting of the Austrian 'Anschluss' seven years ago. In rural areas particularly a large segment of the population depends primarily on radio for news. This is both a great opportunity and a great responsibility, and the *Post-Dispatch*, for one, has recognized that.

"The issue is whether radio stations will cry out advertising wares indiscriminately in news broadcasts or temper them in good taste. Listeners, as our mail shows, are becoming disturbed by the increasing trend to the former practice. If public-sentiment mediums are successful in getting the radio industry to impose voluntary standards in the broadcasting field, then these mediums will have performed a fine service to listeners and broadcasters alike."

NECESSITY of increasing receiver tube production to 3,000,000 per month was impressed on the Industry Advisory Committee at a meeting last month with Army and Navy representatives. Military demands are still increasing due to emergency programs, battle losses and the increasing number of electronic devices used, it was stated.

Monthly Review

to the Technician

INTERNATIONAL understanding was seen by Brigadier General Sarnoff as television's contribution to future peace, in a speech accepting the Wendell Willkie memorial "One World" award. General Sarnoff, who received the award for his expansion of radio as a medium of popular education and entertainment, his work on the final reparations settlement in 1929 and his contributions to television, spoke at the "One World" dinner on the anniversary of Willkie's birthday, February 18.

"Let there be no doubt that the world eventually will have international television," said General Sarnoff. "It will be a new educational force with a double appeal to eye and ear, put at man's disposal by science, to give him a new and more intimate understanding of his neighbors. Pictures are an international language. They convey clearer and quicker impressions than words spoken in a foreign tongue, or written in a foreign language. Nations will then see themselves as others see them, for the world is destined to go sight-seeing by radio. People everywhere will understand, as never before, how freedom functions in democracies.

"Radio's great role in the establishment and perpetuation of peace," General Sarnoff said, "is found in the fact that science has given to the essential Freedoms the wings needed to reach people everywhere—simultaneously. Because of science," he said, "Europe's relation to America is no longer the 'detached and distant situation' that George Washington noted in his farewell address.

"Today, radio and the press are inseparable in the defense of freedom of speech and expression. Liberty is the watchword. To this end, America must have more powerful and effective international broadcast programs to serve a world at peace. We must have sufficient world-wide radio circuits to carry news and pictures freely to and from all corners of the earth.

"To the Four Freedoms, I would add a Fifth—Freedom of Science," said General Sarnoff. "It is essential to the maintenance of world unity. Political and social limitations and expediencies must not fetter the application of scientific knowledge, nor stop the quest for it. Man must be free to think; free to conduct research, free to develop his ideas—free to invent and to produce."

CHARLES F. BURGESS, chemical engineer and founder of the Burgess Battery Co., died last month in Chicago. His age was 72.

Mr. Burgess was Professor of Chemical Engineering at the University of Wisconsin for many years, resigning in 1913 to become a manufacturer. Among his many inventions were an electrolytic process for the purification of iron, a building brick which would float—weighing only one-fifth as much as the ordinary type—a large number of processes in connection with dry cells, and inventions in the iron-alloy field. He took out more than 40 patents in the course of his life.

TRANSMITTERS waging active radio war against Nazi Germany and her remaining satellites are rapidly increasing in number, according to an RCA report last month. Twenty-three short wave transmitters have been sent overseas during the past 23 months, the report says, and three more will be shipped within the next thirty days. The transmitters are of the powerful 50,000-watt RCA 50-SW type.

First to "invade" the Axis and satellite nations, with words for weapons, short wave radio transmitters helped to pave the way for the physical invasion now in progress. Keeping up a constant bombardment of news, education, and counter-propaganda that is heard and felt around the world, they are helping now to consolidate Allied gains and facilitate further Allied victories.

First of the list of 23 to be installed was a transmitter purchased by the Brazilian government for Radio Nacional, government-operated station at Rio de Janeiro, which went on the air during the winter of 1942-43. The installation was supervised by John Dawson, RCA field engineer.

Next came Radiodiffusion Nationale Belge (the "Voice of Free Belgium") at Leopoldville, in the Belgian Congo, and Radio Brazzaville, operated by the French National Committee for Liberation, in Brazzaville, French Equatorial Africa. These transmitters went on the air in the spring of 1943, Leopoldville preceding the Free French station by about a month.

Rectifier, audio, and control circuits of the RCA 50-SW are much like those developed for the RCA 50-E Standard Broadcast Transmitter. The radio-frequency circuits, however, are naturally quite different, since the requirements of international broadcasting present problems that are not ordinarily encountered in domestic medium-frequency transmitters.

The inclusion of two separate and complete R.F. channels is a feature of the 50-SW which experience has proven very valuable as a means of quickly setting up or changing frequencies to any point in the range from 6 to 22 megacycles. The transmitter is laid out with power supply and modulator units in the center, so arranged that they may be switched to either of the R.F. channels.

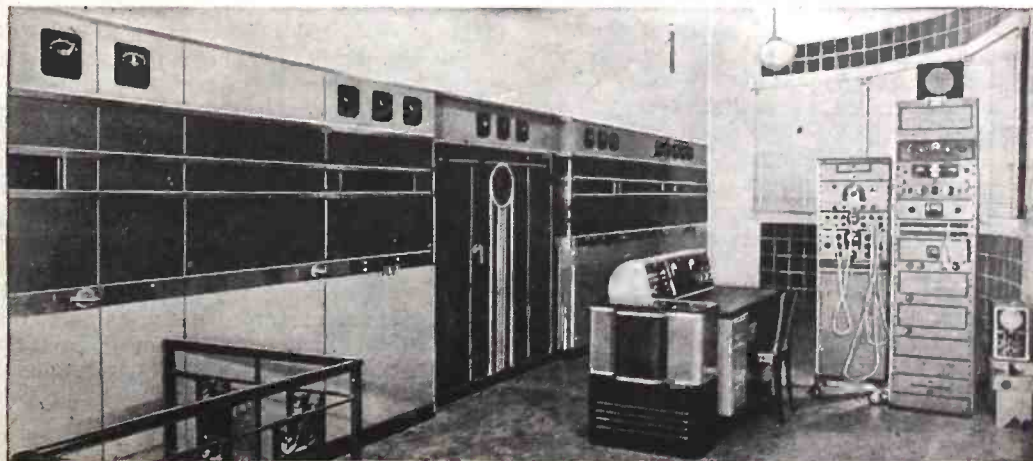

The 50,000-kilowatt transmitter is along the wall at left, the control desk at center.

DIATHERMY under jungle conditions was described by Paul von Kunitz, former chief engineer of WINS, New York, in an interview last month.

Mr. Kunitz, on duty with the OWI in Algeria, was informed that diathermy treatments would be beneficial in treating internal injuries received some time ago while erecting a station in Africa. Having no machine at hand other than the OWI's 50,000 kw transmitter, he put it to work. Two tin pie plates, attached to plywood panels, were connected to the end of the rhomboid antenna used by the station. The plates were held against the patient's back and chest by Italian prisoners of war.

"Not only were the results excellent," reported Mr. Kunitz, "but I could hear clearly every word of the OWI programs beamed to Germany and Italy during the treatments."

LEGISLATION to make group libel over radio broadcast stations a misdemeanor and to make broadcasters and stations subject to prosecution in such cases, was introduced last month in the Ohio Senate, according to a *Radio Daily* report.

The measure defines group libel as "A malicious publication by writing, printing, picture, effigy or other representation, or by any form of radio broadcasting, which tends to expose persons designated, identified or characterized therein by race or religion to hatred, contempt, ridicule, or obloquy, or tends to cause such persons to be shunned or avoided, or to be injured in their business, profession, or occupation."

TWO DEALERS who sold combinations of radio parts which could readily be assembled into receiving sets were suspended by the *War Production Board* last month, it was announced by R. A. McGovern, WPB regional manager for the New York City district.

Doing business as the Radio Dealers Supply Co., the two partners sold 118 of these radio combinations during the period from July 1 to the end of October, 1944, although WPB's general limitation order L-265 states that combinations of various radio component parts may be sold to purchasers only on certification that they will use the parts in their business of radio service and repair to replace defective parts in receiving sets.

Mr. McGovern states that Radio Dealers Supply Co. was familiar with the terms of L-265 and has admitted the violation, as a result of which consent order C-262 was issued today and remains in effect until December 31st of this year. Under the terms of C-262 the company can sell combinations of electronic components only to a government department.

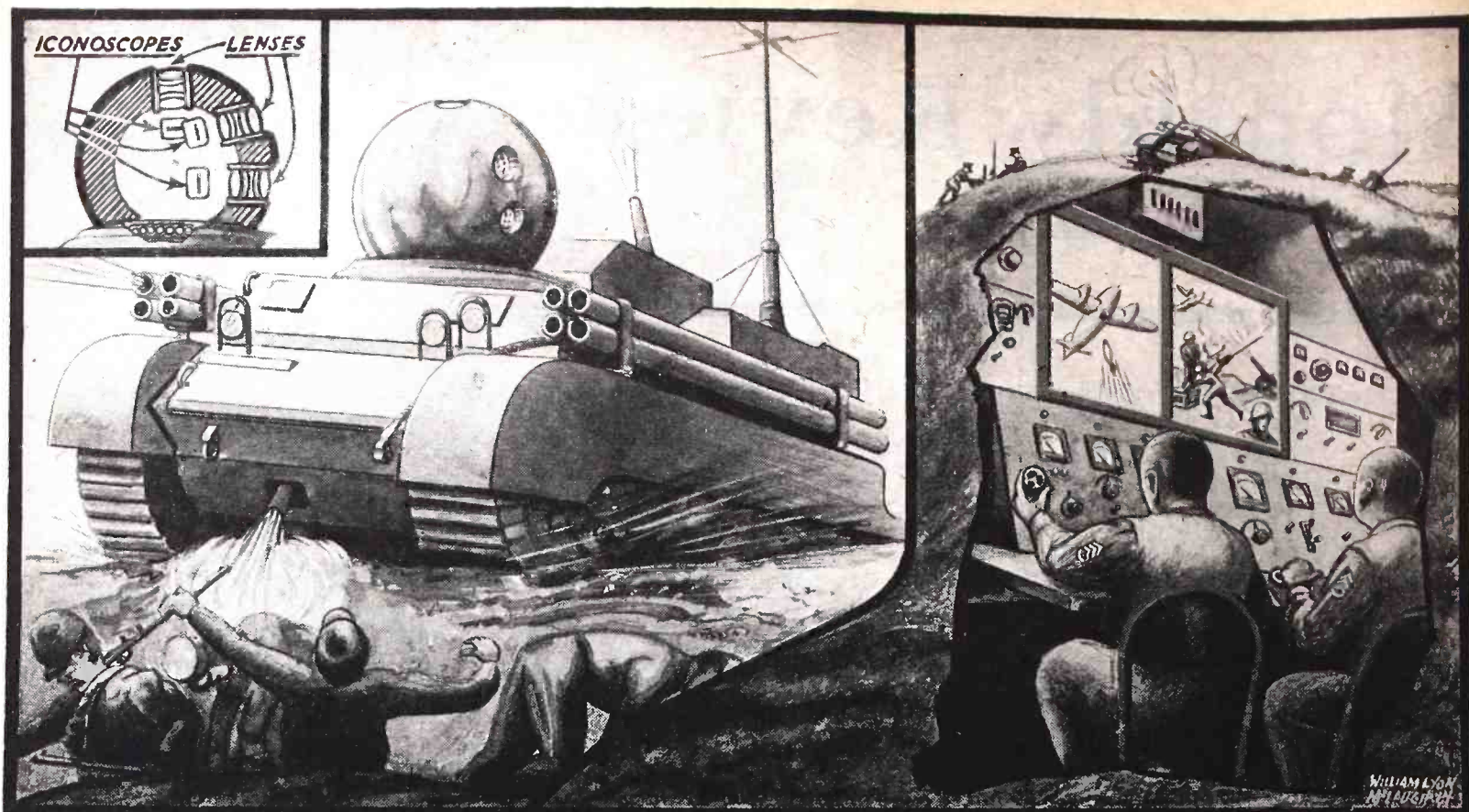

Left—The television-controlled tank in action. Round turret is a very heavy revolvable ball of toughest armor steel with a wall more than ten inches thick. This turret revolves continually, giving the television eye a 360-degree vision. In the top there is another lens so that overhead planes may be spotted. Insert shows arrangement of recessed lenses and iconoscopes and ball bearings of the revolving turret. Our cover shows a variation of the turret. At right, the remote control board from which the tank is directed. Operators continuously watch the two screens. The left one shows what the tank sees through its upper eye. The right-hand screen gives the view in a horizontal plane. Thus the operators are enabled to conduct the tank from the safety of their dugout just as if they were actually inside it.

COVER FEATURE:

Robot Television Tank

By HUGO GERNSBACK

THE United States has been very fortunate in the present war. The casualties suffered by our men in all branches of the services have been remarkably small compared to other nations. This has been particularly true in the war with Japan where our losses have been all out of proportion to the Japanese killed. The main reason for this is not so much the quality of our armament as the quantity. Army publications and military experts admit frankly that we have only a very few arms that are superior to the enemy's. Our airplanes, tanks, guns and other armament are not always as good as the enemy's, and the only weapon in the small arms field which is superior to theirs is the Garand rifle. These are facts that may easily be checked and are not the writer's opinion.

In tank warfare, up to very recently we had nothing as good as the German Tiger tank which raised so much havoc among our troops on the Western front. The armament of our own best tanks was woefully inadequate and in many cases the German type of bazooka raised fearful havoc among our tanks. That we have won battles, as military experts see it, was simply because we had more tanks and won through by sheer numbers, but not by quality.*

It has always been the policy of the American Army not to sacrifice soldiers in any action—particularly during an offensive action. But by massing a superior weight of

inferior armament, the enemy still exacts a heavy price from us at present. Even with the European war finished—which may take an appreciable time—there remains Japan to be reckoned with. Here we have a foe far more blood-thirsty and cunning than even the Germans. Cocoanuts lying under trees, but filled with explosives, the new so-called "castration" mine, and other nasty tricks are being evolved right along by the Japs.

In our December 1943 issue I spoke of expendable tankettes which are easy to manufacture, cost little, and can be expended without sacrificing lives. They are radio controlled and are supposed to clear the mine infested road or terrain without killing our men. This suggestion was made by me long before the Germans started using almost identical radio tanks, but so far we have done nothing to put such sacrificial tanks into use.

The robot television tank illustrated on the cover of this month's issue is another proposed idea to safeguard the lives of our men. These tanks are also radio controlled. There is not a living being inside the robot. To operate such a tank from a distance, the operators at headquarters must however know where it is going. Obviously it cannot be directed once it is out of sight of the distant control operator. Up to very recently a remotely-controlled tank was not feasible. Now that television has sufficiently advanced, it becomes a rather simple matter to

direct a tank—or a number of tanks—several miles right into the enemy's positions without sacrificing a single life. These television controlled tanks can be turned into a mighty powerful weapon if produced not only in sufficient quantities but also built to survive battle conditions. In the first place, such tanks must be much better protected than our present types, which are too vulnerable. For that reason it will be noted that the television tank has a much better tread protection consisting of very heavy steel plate armor—a steel apron—which protects the fragile treads in front, side and rear. The armament of the tank can take many forms. It can have the usual anti-aircraft guns, if desired, or it can be equipped with armor-piercing cannon, or as shown on our cover it can also be rocket firing if this should be desired.

The television element is housed in a shell-proof turret made of case-hardened steel, which can withstand everything but the heaviest enemy shells. The twin television transmitter is housed deep enough within the solid steel turret that only a direct hit right on the lenses will put out of action. This is a remote possibility because the lenses are located from 10 to 12 inches inside of the solid steel turret and a shell would have to squarely hit into the recesses. This would only happen once in a great while and it would have to be a very lucky shot to accomplish it.

The television tank is operated by remote control, by well-known means which

(Continued on page 437)

V.H.F. Radio Range

Improved Service with 125-Megacycle System

By RAYMOND LEWIS

THE Civil Aeronautics Administration of the United States Department of Commerce is installing a system of very-high-frequency radio ranges throughout the airways. They will operate in the band extending from 119 to 126 megacycles. Several different types of VHF range are planned; the four-course aural range; the two-course visual range; the combined visual and aural range consisting of two visual and two aural legs and the omnidirectional range.

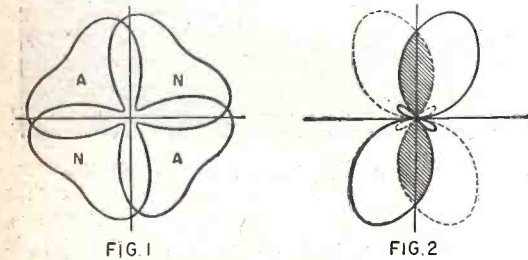

Fig. 1—Field of a VHF aural loop antenna. Fig. 2—Field pattern, 2-course visual range.

Two basic reasons underlie this change-over from low frequency range operation to the very high frequencies. Geographic separation on the low frequencies has not prevented serious interference, especially after dark, from reflected signals skipping over hundreds of miles. The result has been a complete saturation of available low frequencies at a time when the demand for new facilities is increasing.

The second reason has been instabilities of the low frequency range resulting in multiple and bent courses, course swinging and extreme sensitivity to atmospheric interference such as static. Most of these shortcomings have been overcome on the VHF, while new problems created by the transition have been of lesser importance.

The theoretical horizontal field pattern of the four course VHF range is shown in Fig. 1. It is composed of a modified clover leaf which has concentrated the maximum signal energy near the "on-course" position. This has been made possible by the adoption of a five loop Alford system. The Alford loop has largely eliminated the vertical sensitivity of a horizontal dipole. Alternate transmissions are made along each pair of loops, while the fifth remains connected to

the transmitter through a phase shifting network which keeps it 180° out of phase with the field produced by the other four loops. The usual A or N is heard to identify respective quadrants, while the overlap forms the continuous "on-course" signal. Similar to the low frequency range, but of a sharper character, a cone of silence exists over the center of the range antenna. As a positive identification of this orientation point, the 75 mc. Z marker is still important.

An important requirement on the VHF's is that a constant field of polarization exists for all points of the A and N pattern. Variations in received signal strength with a changing angle of incidence are considerably greater with a vertically polarized wave than with horizontally polarized waves. Pure horizontal polarization is definitely superior to vertical polarization.

The compact VHF antenna system eliminates the 125-foot five-tower low frequency Adcock stations. The most practical tower structure for VHF has been between 20 and 30 feet with a 30 to 45 foot counterpoise, with the antenna located a half-wave above the counterpoise. While an increase in the effective coverage can be obtained by raising the height of the tower, the introduction of multiple lobes due to reflection from the ground, with the resulting surges, fades, course discontinuities, and false cones-of-silence, nullifies the usefulness of the range as an aid to navigation. The antenna is fed by concentric copper transmission line separated by ceramic insulators in a nitrogen filled conduit.

The two-course visual range and the visual legs on the four-course VHF range will operate in much the same manner. The theoretical field pattern is seen in Fig. 2. A pair of diagonally opposite corner radiators and a center radiator comprise a complete antenna system for a two course range. The four-course range is similar to the two course range since it uses a common center radiator and two pairs of corner radiators, one set for each type pair of legs. The antennae used for the visual indication are excited 180° out of phase by side-band energy. This energy is caused by modulation of the carrier frequency by a 90 and 150 cycle signal simultaneously, but from which the carrier frequency itself is suppressed. The center element is used to radiate the side bands and the carrier frequency. The



The 22-foot tower station and transmitter house for a very-high-frequency radio range.

energy from the center tower and the corner elements combine vectorially to produce the clover leaf pattern. On one side the 90 cycle modulation predominates, while on the other side the 150 cycles predominates. At their point of intersection the two modulations are equal, forming an "on-course" signal. In the on-course area there is a 1020 cycle tone, keyed in two different characters. This tone is separated in the receiver output by an appropriate filter and gives an aural

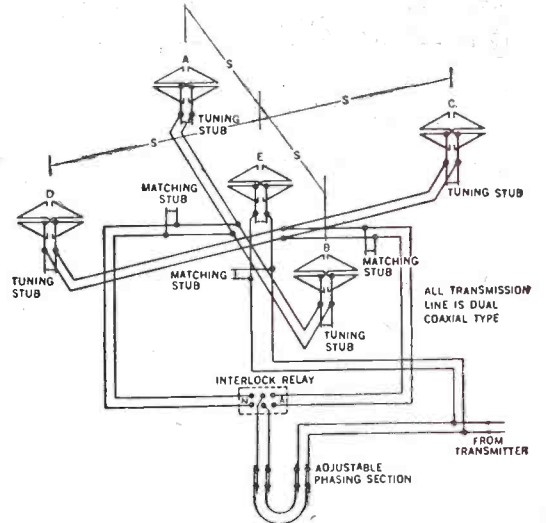

Method of feeding 5-loop radio range antenna.

identification whether the plane is approaching or has passed the station. The principal difference between the visual and aural range is the substitution of the keyed A and N signal for the tone modulation.

The aircraft receiver for use on the aural and visual VHF range is a conventional design. It has separate output circuits for the 90 and 150 cycle signals and for the keyed tone frequencies and voice. The 90-

(Continued on page 453)

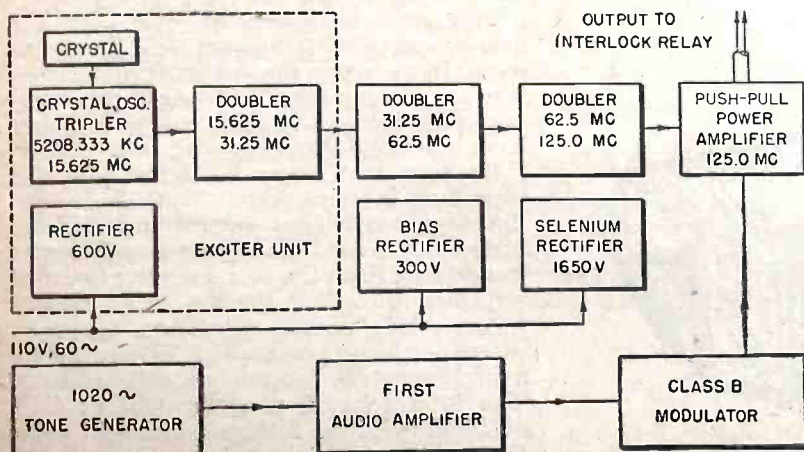

Block diagram showing complete detail of the 125-mc transmitter.

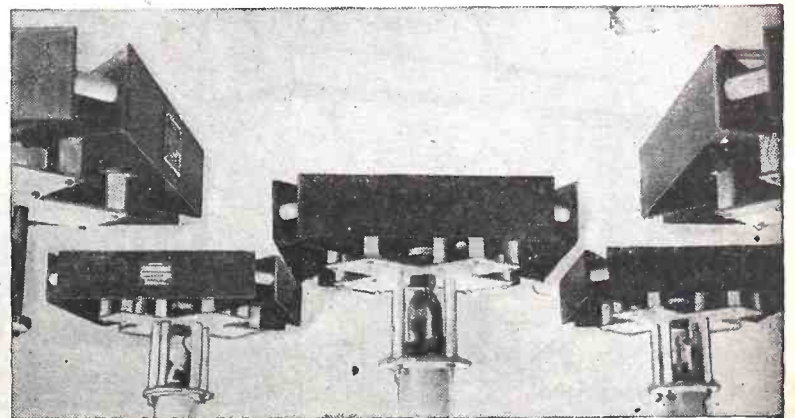

All photos courtesy CAA

The above close-up of the five-loop antenna system shows a great difference in size as compared with low-frequency transmitter systems.

Future Aspects Of Television

By DR. LEE DE FOREST

BEFORE Pearl Harbor television in and around New York had convincingly demonstrated that, after long, brave years of scientific research and technical development, it was actually ready to make its public bow. Its latest refinements, the 525-line picture, removal of blackheads, freckles and flashes of dizziness, had convinced hundreds of viewers that we had at last reached the longed-for stage of development when advertising sponsors could be hopefully invited to invest in television program time. They could even look at transmitted color pictures.

During these three years of war, despite the imperative demands made on all research laboratories and engineers, some further progress has been made, just how much is not fully known. But the clever adaptation of the Schmidt reflector-telescope principle has brought acceptable sized projection pictures measurably nearer the home and the theatre. Advocates of far advanced new standards, pictures of 630 or 840, or even greater numbers of lines (the latter especially for 3-color transmission) have been emphatic in crying the obvious advantages of such post-war standards, even arguing

the wisdom of postponing the renewal of public television for one or two years after V-day, to enable the construction of new or the renovation of existing tele-casting transmitters, and the manufacture of a sufficient number of the new type receivers to meet the overwhelming public demand for the greatly improved television which they foresee.

A sagacious and just-minded Federal Communications Commission, however, seems inclined to go along with the majority of television interests who strenuously advocate a V-day resumption of television employing the pre-war standards with such proven improvements as might then be actually ready to send down the production lines.

The Commission however agrees that space in the ether "upstairs" must be assigned, to enable the never-satisfied laboratory pioneers to work out new—even radically new—ideas which may be introduced as improved standards in years to come. There seems no sound objection to the idea that such improved methods of television transmission and reception can be gradually introduced, without in any way interrupting the daily, nightly flood of television programs. Exactly this gradual transformation



Dr. Lee de Forest, "The Father of Radio"

is occurring today, as FM transmitters, sending out the identical programs as their larger A.M. associates, enable the public to gradually shift from their old to newly-purchased radio receivers, but only as they feel the urge to discard the old for the more costly new.

Thus in, say, five years hence, alongside of a 60 megacycle tele-casting transmitter we may see erected an additional array of smaller "bays", radiating on 600 megacycles a 630-line (or an even finer-grained picture in 3 colors) both on the same program. Thus those of the then vast audience who desire something decidedly finer and more captivating on their enlarged viewing screens—and are willing to pay for the improvement—need not be for a single night without this indispensable television program. The makers will exchange sets, for a price.

This gradual evolution will work hardship on no one. The broadcaster will promptly obtain increased audiences, larger revenues from his advertisers; the set manufacturers a renewed demand for the improved receivers; the public greatly enhanced home enjoyment.

So much for the technical aspects of the near future of this new magic, Radiovision. I have the greatest confidence that the many remaining engineering and servicing problems will be, for the most part, neatly solved. These are in the hands of skilled and highly trained experts. As the home-returning troops disband we shall find tens of thousands of additional helpers already trained in the new intricacies of ultra-high-frequency and radar techniques. And thousands more fresh from the air-craft industries, who are already eager to learn of this fabulous new thing, television, of which they have heard and dreamed.

Be sure that some problems will still plague us in this soon-awakening dawn—that of ghost images, intervening shadow-casters, auto-spark plug smears and similar iconoclasts. Even the ever-growing flocks of airplanes, threading the low skies, will at times induce fleeting profanity—especially where our picture comes long distances over a link, or several, of automatic relay stations. The local telecast program will at least avoid many of the flickers which will afflict the aerial networks' product, and I predict that for a long time to come our most satisfactory entertainment will originate close at

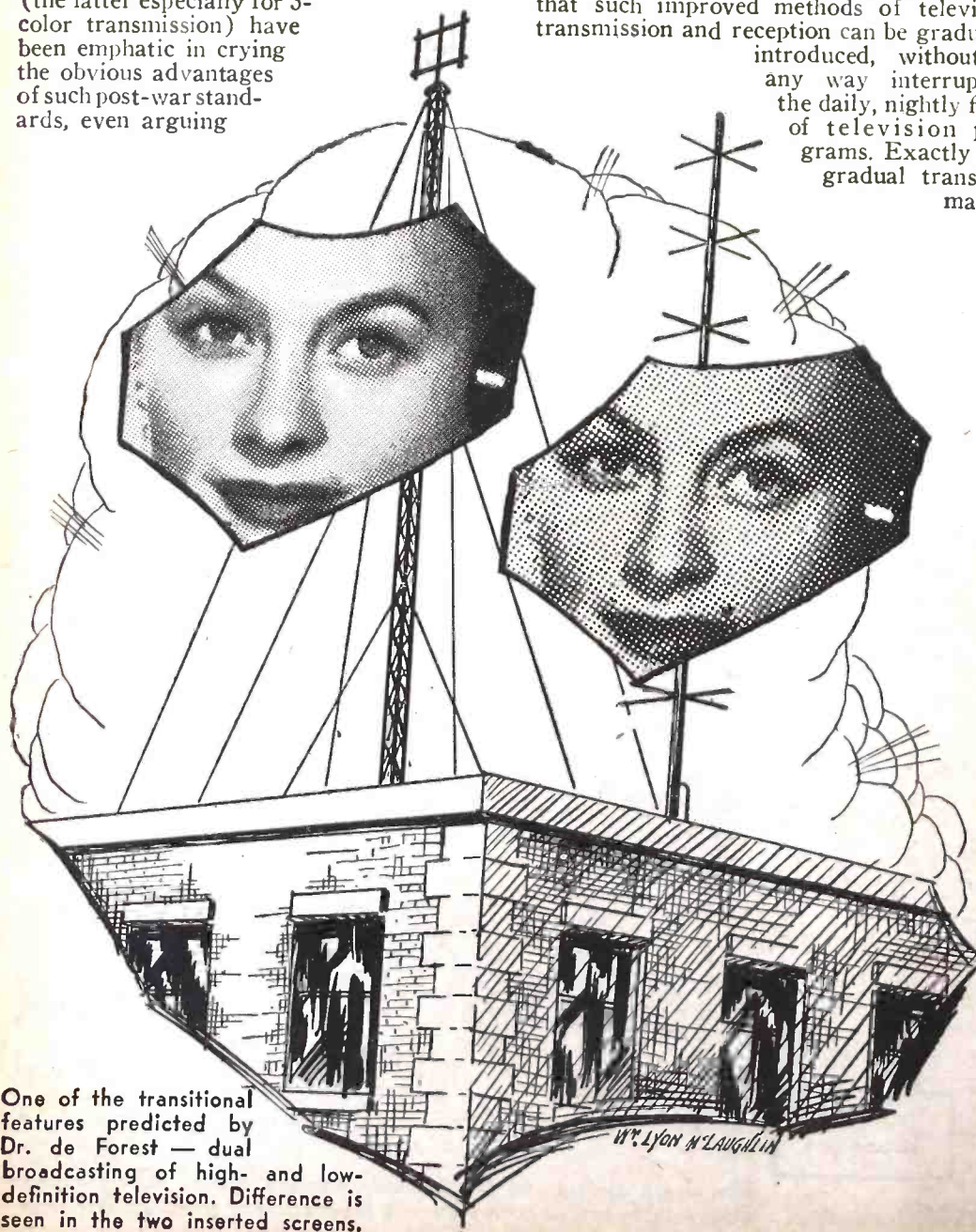

One of the transitional features predicted by Dr. de Forest — dual broadcasting of high- and low-definition television. Difference is seen in the two inserted screens.

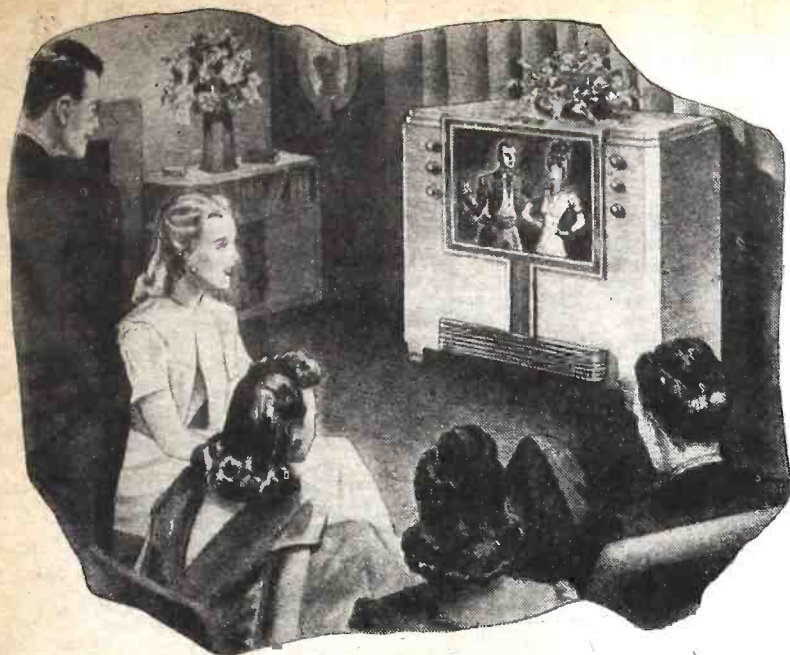

Large-screen television can be viewed with complete freedom from strain. . . in sharp contrast to the effort required to view a small screen.

hand (except as it comes to our transmitter in a tin can from some distant television film studio.)

No—the main problems still facing our young “pride and joy” are, and will remain, economic ones.

Here in America television, like radio, must needs earn its own keep, pay for itself. Here then comes the old problem: how to sustain television programs of sufficiently high quality to arouse sufficient public interest to build up an adequately large audience to induce enough sponsors to buy sufficient high-priced program hours to make the show self-supporting?

We have, most of us, simply shrugged shoulders and assumed that the televisors who will erect our transmitters will possess financial resources, or backing (and dogged determination), to continue to grind out first-class nightly programs, for an indefinite period, probably years long; while John Q. Public decides—one here, one there—to invest several hundred dollars in a kinescopic gadget, until hundreds of thousands of those strange consoles are in nightly employment in every large-sized community. The three or four pioneer telecaster organizations extant today are optimistic enough, and sufficiently courageous, to avow that they can and will carry on until their utopia shall arrive. Moreover the orders already on the books of four or five manufacturers of tele-transmitters is good proof that there are lots of other broadcasting—or would-be broadcasting—institutions willing to similarly carry on. Radio, they say, did just this. It grew up in 10 years from a cats-whisker, headphone shoestring, to be one of the richest paying gold-mines in industrial history. Once an acorn—now mightiest among oaks. “O.K.—let’s go”!

But calm yourselves, brother optimists. Twenty-four years ago we were unused to etheric miracles. The very wonder of hearing human voices and music through the air, without wires, fired us to pay first \$20, then \$200, for a questionable parlor adornment, beside which we could sit and listen to an expanding universe. Thus our audience grew from zero by leaps and bounds, until sponsors realized in very few years that the radio broadcast was the best paying form of advertising in sales history. Radio set manufacturers mushroomed everywhere, and most made huge profits (some by the blue-sky route). Early programs were relatively cheap—by today’s standards almost costless. In less than four years these programs began to pay upkeep and show attractive profit, until today the Radio Broadcasting Industry is one of our fabulously wealthy American wonders.

But today conditions are basically unlike those obtaining in the early ’20’s. Today our public has become spoiled. We have altogether different standards as to what to expect, what to demand in the way of radio-borne and picture-theatre entertainment. *Not now will satisfy* such cheap and simple programs as sufficed to build up broadcasting to a richly paying institution. Not long will television gazers be satisfied with the half-hour close-ups or the simple little dramas by ill-trained aspirants for screen or radio fame. For a brief season of novelty, until the public mind becomes again accustomed to this new miracle, yes. But such ephemeral interest will not build up, nor meet the demands of program sponsors for sustained and continuing gigantic nightly audiences.

The televisors must early begin to conceive and execute programs of such compelling interest that the public will demand receivers, more and better television receivers, in insatiable demand. They must demand large projected images too—the 8 x 10 picture cannot long endure. Eyestrain and its utter inadequacy for much more than close-ups will prevent its sale in the hundreds of thousands. Even if multitudes of small-screen sets are cheaply sold, they will—as the months pass—be seldom (not nightly) turned on.

We have therefore two requirements, un-

deniable and inevitable, which must be satisfied before television audiences will satisfy the sustaining sponsors: (1) really interesting programs, long sustained; (2) projected pictures. The first demands large and sustained financing by the telecasters; the second, expensive receiver instruments—from a problematic minimum of \$200 to five times that figure.

It is this latter requirement which is most menacing. On its solution depends the success of the entire American television entity. Because not for indefinitely long periods will the Telecasters be able, or willing, to continue to stay deeper and deeper in the red.

Can the post-war public be expected then to buy outright sufficient quantities of projection-type receivers to build up sponsor-paying audiences before the Telecasters tire of holding the bag? I don’t believe they will. Economists predict after the war a quick flash of prosperity, followed by a prolonged period of deflation. If this latter strikes before the required millions of good television receivers have been sold, they won’t be sold—not for years.

But don’t lose heart! This future need not be dark—quite the contrary. The solution of the audience build-up problem has already been found, in pre-war Britain. There the manufacturers of television re-

(Continued on page 439)

Among the problems to be solved are those of interference. Ignition from automobiles, electrical apparatus and even low-flying airplanes can break up a television image.

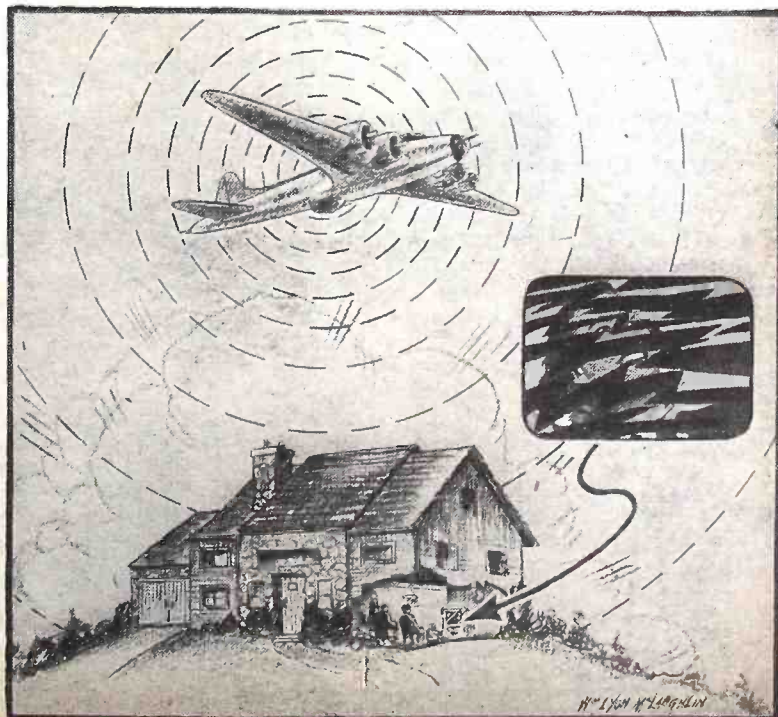

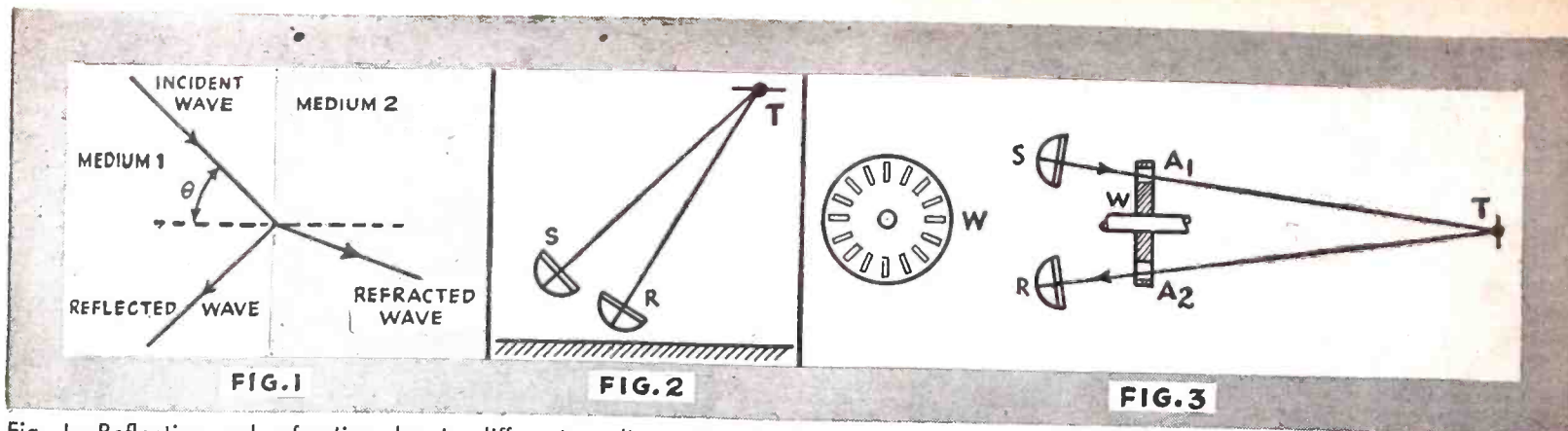

Fig. 1—Reflection and refraction due to different mediums. Fig. 2—Position of a target can be determined by this means, but not its distance or range. Fig. 3—This method of measuring speed of light can be applied to distance measurement if light speed is known.

RADAR PRINCIPLES

By R. L. SMITH-ROSE, D.Sc., Ph.D., M.I.E.E., F.I.R.E.*

RADIOLOCATION or Radar may be described as the art of using radio waves for the detection and location of an object, fixed or moving, by the aid of the difference of its electrical properties from those of the medium adjacent to or surrounding it. An intrinsic feature of the art is that no co-operation whatsoever is required of the object being detected. It is in this particular sense that radiolocation, as it was formerly known, differs from the long-established practice of radio direction-finding. The technique of direction-finding is confined to the determination of the direction of a primary source of radio waves. The source of the radio waves may be on the one hand an illicit sending station, the position of which it is required to determine; on the other hand, it may be a friendly radio beacon transmitter for the use of ships or aircraft fitted with direction finders to assist the navigator in determining his own position.

The new art of radiolocation, however, requires no such co-operation, on the part of the object under examination; the latter, be it aeroplane, ship, building or human being is merely required to reflect or scatter some of the radiation which reaches it from a radio transmitter forming part of the whole Radar installation. The detected object is thus merely a source of secondary radiation which results from its being illuminated, as it were, by the incident radiation from the primary sending station. With this definition of the subject with which we

are concerned, we may now proceed to an explanation of the fundamental principles forming the basis of this new application of radio waves.

When electric waves, of whatever length, impinge on the boundary separating two media of different electrical properties, the path of transmission of the waves is altered; some of the wave energy passes across the boundary, but in doing so its path is bent or refracted; another portion of the wave energy is turned back from the boundary and forms the reflected portion of the waves on the same side as the incident waves (see Fig. 1). The relative magnitudes of the reflected and refracted waves depend upon the electrical properties of the media on the two sides of the boundary, the angle of the incidence (θ in Fig. 1), and the frequency or wave length of the waves. If these quantities are known, the reflecting power of the surface of separation of the two media can be calculated; and in many practical cases, this calculation is made easier by the fact that the first medium is air under normal atmospheric conditions, when its electrical conductivity is very small and its dielectric constant is approximately unity. If the second medium is a sheet of copper, of which the conductivity is very high, nearly all the incident energy in the arriving waves will be reflected; this is the result of the re-radiation from the conduction currents set

energy passing into the medium to form the refracted waves.

From these considerations it is seen that reflection of radio waves is caused at a discontinuity or boundary between two media, and when waves in air strike a surface, which may be either a metallic conductor or an insulating medium, the waves are reflected in some degree by the surface. If this surface is smooth in the sense that it is free from irregularities of a size approaching the wave length, then the reflection is of the specular type such as we meet with in light waves; and in such cases if the waves impinge normally on the surface, they will be reflected back along the original direction towards the source of the incident waves. If the surface is not sufficiently smooth the reflection will take place in various directions, or the incident waves are scattered, as it is termed; and in this case only a portion of the reflected or scattered energy is returned along the path of the incident waves.

LIGHT WAVE MEASUREMENTS

It is thus easy to understand how light reflected from solid or liquid media enables us to see the existence of these objects, and Fig. 2 illustrates the manner in which a searchlight enables a target—aircraft or cloud—to be seen by an observer situated at R, who can then determine its bearing and angle of elevation. This is an art which is well known and has been practiced for a long time; but it suffers from one serious drawback; this simple combination of a searchlight and an observer does not enable the distance of the target to be determined.

In order to make this valuable addition to the observation, it is necessary to interrupt or modulate the beam of light in such a way that the time of transit of the waves between the source and target and then back to the receiver may be determined. This important addition to the technique of visual observation was actually made as long ago as 1849 by Fizeau in his classical experiments to measure the speed with which light waves travel. Fizeau used a mechanical method of measuring the time of transit of an interrupted beam of light over a return path about three or four miles long. At that time, the distance was accurately measured and so the velocity of the waves determined; but if, as is the case nowadays, a knowledge of the wave velocity is assumed, then the length of a path with a reflector at its end can be determined.

A possible arrangement of this method of determining the distance of a reflecting object by the aid of light waves is illus-

(Continued on page 454)

* National Physical Laboratory (Great Britain)

Fig. 4—How radio pulses or modulated beams (P_1 - P_4) can be used to determine the distance of a target T from sending and receiving aeriels A_1 and A_2 , by measuring the time taken for a pulse to travel from A_1 to the target and return to the receiver, A_2 .

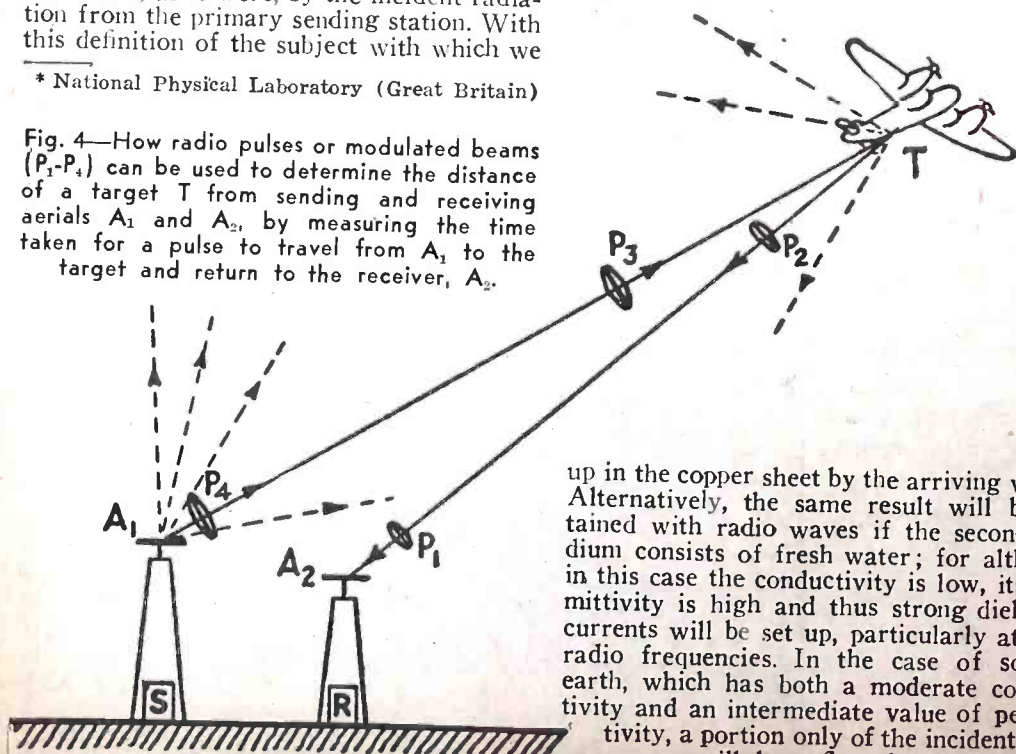

up in the copper sheet by the arriving waves. Alternatively, the same result will be obtained with radio waves if the second medium consists of fresh water; for although in this case the conductivity is low, its permittivity is high and thus strong dielectric currents will be set up, particularly at high radio frequencies. In the case of soil or earth, which has both a moderate conductivity and an intermediate value of permittivity, a portion only of the incident wave energy will be reflected, the remaining

Tank Communications

Design Features Render New Equipment More Effective

TANK warfare is decisive in the present struggle. Not even the airplane is as effective a winner of battles or taker of territory. This was conclusively demonstrated at the beginning of the war in Poland and France, later in Africa and now on the East Front. For full effectiveness, the tank arm must work in close co-ordination with the air arm as well as the artillery.

Communication is thus more vital to the

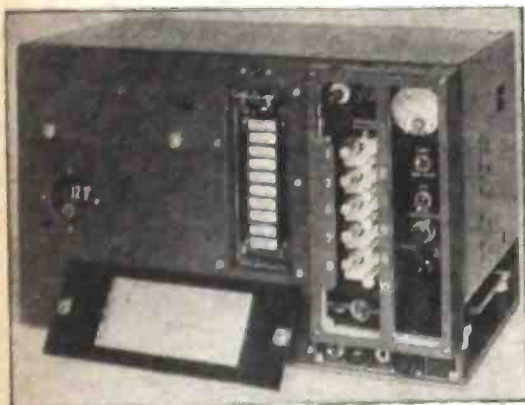

Fig. 1—The BC-604 radio transmitter. Crystals are seen stacked in holders near center.

tank than to any other weapon of the services. Radio equipment to provide contact between mobile units and between tanks and fixed positions such as headquarters or artillery emplacements, must be highly efficient to permit the tank arm to realize its full potentialities. Standardization, versatility, freedom from interference and jamming, and simplicity; these have been the design considerations which have resulted in the present tank radio.

Standardization is especially required in combat apparatus, to keep down the number of replacement parts. The tank radios here described were designed by Bell Laboratories. They are put out in four basic units, a transmitter (BC-604) receiver (BC-603) interphone amplifier (BC-605) and a mounting common to all these units, and to which combinations of them can be attached. By selecting from these units, three standard sets are made up: the SCR-508 which includes a transmitter and two receivers; the SCR-528, a transmitter and one receiver; and the SCR-538, a radio receiver with an interphone amplifier.

Usefulness of the sets is extended by special interphone control boxes installed at points in the tank out of reach of the radio set. Each control station has jacks for microphones and a headset, a volume control and a switch. The switch is set normally at RADIO, and permits the listener to hear anything received on the tank receiver. When a switch on the transmitter is turned to INTERPHONE, the officer at the transmitter can talk to the interphone stations. They can reply by pressing the TALK switch on their microphones.

The RADIO-INTER switch on the control boxes is normally set at RADIO. Only in battle emergencies may the person at the remote station switch it to INTERPHONE. When this is done, the radio is automatically switched off.

Versatility is provided by this multiple-station hook-up. The tuning system is also exceedingly versatile, making available ten frequencies at any one time, out of a large selection. A compartment in the upper left-hand corner of the transmitter (Fig. 1) carries all the crystals which may be needed. The ten required for the current operation are taken from this compartment and plugged into sockets in the vertical compartment to the left of the control panel, which—after a brief tuning operation for each crystal—provides push-button selection of any of the ten frequencies.

FREQUENCY MODULATION

Frequency modulation adds both to versatility and simplicity. A lower noise level and greater freedom from interference is obtained, as well as less complicated circuits in the transmitter. A further simplification in the system of modulation made the usual electron-tube modulating circuit unnecessary, further reducing the number of parts and reducing maintenance.

Simplicity is seen in the control panel as well. At the left is the series of push-buttons mentioned. To the right of them are the ON-OFF switch, the RADIO-INT switch, and two others, which with the meter at the top are used only when tuning or servicing the transmitter. There is also a switch for changing the microphone circuit gain to take care of the noise level difference between tanks and the relatively quiet command cars.

The receiver, shown in Fig. 2, also uses push-button control for ten frequencies, and may be tuned manually as well. The set requires a brief pre-tuning to each of the ten frequencies before the commencement of a mission, after which push-button con-



Fig. 2—The BC-603 receiver. Lamp above volume control lights when signals are received.

ontrol alone can be used till the crystals are changed. The receiver incorporates a speaker and two headset jacks. Controls other than tuning include the OFF-ON switch, volume control, a beat-frequency oscillator switch (the beat-frequency oscillator is used in tuning up) a SQUELCH switch, to reduce volume at the headset when no signal is being received, and a sensitivity control.



Fig. 3—Crystal and mounting used in the BC-604 transmitter.

The headset switch has a RADIO-INT position, which set on INT disconnects it from the receiver, so that only interphone signals are received. The speaker is attached directly to the receiver output and is not affected by the switches. The interphone is equivalent to the voice amplifier of the transmitter, and is installed as a separate unit only in sets which do not include a radio transmitter.

Push-button control for transmitter and receiver depends on crystals for frequency control. Considerable work on the part of Bell Laboratories resulted in a crystal only about seven-millimeters square and less than a millimeter thick. The temperature coefficient is zero within the operating range.

(Continued on page 441)



Communications with command post, artillery and other tanks—all are equally important.

THE VISIE-TALKIE

By GREGO BANSHUK, I.R.A.; R.S.V.P.*

WE PRESENT what is undoubtedly the biggest development in television up to now—the *Visie-Talkie*. As its name implies, it is a portable television handset over which you can also talk at a distance. A counter-part of the Walkie-Talkie and the Handie-Talkie, now something new—vision—has been added. Of importance is the development of *non-scanning television* which will simplify television to a greater extent than has been possible up to the present. The Visie-Talkie is described exclusively in this issue of *Radio-Craft*.

It was a memorable morning on February 1, 1945 that the Editor-in-Chief of *Radio-Craft* called me into his sanctum. The air seem electrified and there was a notable tension in the office. The Chief asked me to sit down and much



Keystone Photo

The Visie-Talkie is extremely simple to operate. Merely by opening the little door, the set begins functioning. Ordinary dry cells are used for power.

to my surprise handed me a cigar, which I immediately took with suspicion, because usually he doesn't hand out cigars, at least not during wartime. The Boss glared at me without a word for several long seconds as if he were searching my soul and then he delivered the following ultimatum in a high-pitched voice, eyeing me fiercely, now and then pounding the desk in front of him in great animation.

"Look here, Grego" he began in high strident tones, "this television business has exasperated me no end. The road the radio and television engineers are now pursuing is all triple-plated nonsense. The present television apparatus is no more television than Leonardo da Vinci's airplane was in the middle ages. Sure enough, we transmit and receive impulses which we later translate into light, but at what a cost! We have to scan at the transmitter and scan at the receiver. The correct word should not be scan but *scat*. I have talked myself hoarse for thirty years trying to get engineers to forget all about the silly scanning and I have vainly pointed out to them that animal vision,—far better than present-day television,—gets along very nicely without any scanning. Two billion years ago when the first creatures began roaming this earth, equipped with the animal eye—that was *television* and so far none of your engineers have been able to duplicate the

*International Radio Association; Radio Society Veteran Physicists.

animal or human eye. Take your own eye and what do we find? The eye is equipped with a lens the same as your television transmitter, *but where is the scanning apparatus?* There isn't any. The light impulses fall on the retina which has the so-called *visual purple*, then there are a number of so-called rods and cones. These are connected by means of nerve conductors through the optical nerve with the human brain. Scientists now know that we see by electro-chemical means.

"Now then, it should be possible to duplicate, or at least approach the optical elements of the animal eye and translate all this into a modern up-to-date non-scanning television.

"But damn it all, your engineers will have nothing to do with it, so it is about time that *Radio-Craft* did something to show the television people what really can be done. I have here a number of sketches illustrating how the problem can be solved. I have slaved long and laboriously on it and I have worked out all the theoretical elements as you will see when you inspect

the sketches for which a Potent has been applied, to safeguard this revolutionary invention. You will notice that I am using as the transmitter an electro-chemical layer spread over a special disk of plastic into which thousands of fine wires have been



Keystone Photo

The Visie-Talkie can be used by anyone—no radio knowledge is required. It works on centimeter wavelengths, and has a range of about 5 miles.

TRANSMITTER

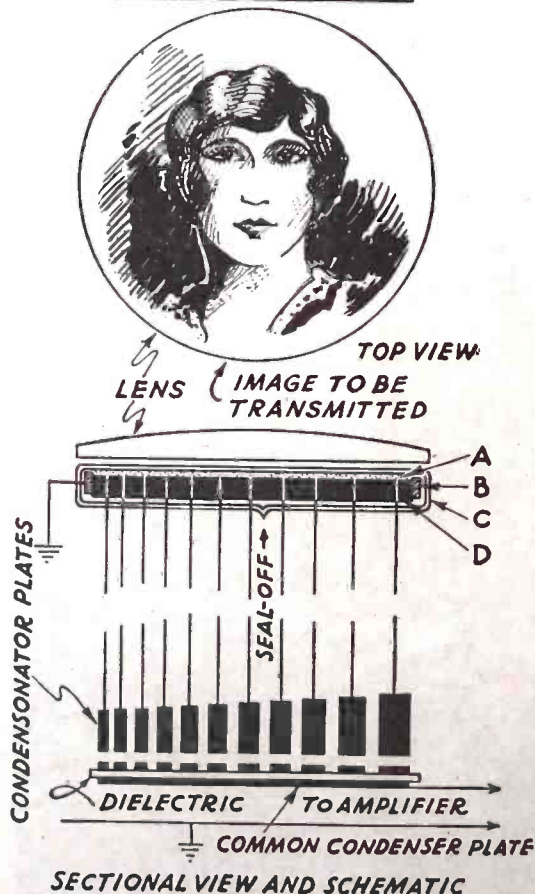

Simplified view of transmitter tube. A—Electro-chemical (photo-electric) layer; B—Ends of collector ring; C—Glass tube envelope; D—Plastic block in which wires are imbedded. Below, the Condensator.

embedded, leaving only the ends of the wires projecting.

"The end of each wire in turn goes to a new instrument which I call the *condensator*. This condensator is made up of different sizes of tinfoil or other material and in this manner each wire connects with a sort of condenser, *each having a different capacity from that of the next one*. There is a common return for the opposite plate as shown in the diagrams. Thus each wire has a different potential charge from the other. By a simple special means shown in my plans, each electrical impulse therefore is preserved and transmitted, because *each wire end modulates the condenser circuit in its own way*.

"This is made possible by development of a new plastic, which has a minus dielectric constant of very high absolute value. Thus the thousands of fine wires can be bunched very close together with no more effect on each other than if they were an inch or more apart. You will note that the lines are of different lengths, and that they are further end-loaded with special ceramic condenser-type units. These have the effect of tuning each wire to a slightly different natural frequency. In the Condensator a variable-frequency oscillator sweeps the gamut of the frequencies of these tuned leads, and is modulated in amplitude according to the strength of the light falling on the part of the chemical layer connected to the wire tuned to each



Hellmich Photo

Left—The Visie-Talkie closed for carrying. Right: Chief elements of the Visie-Talkie are: A—Television receiver. Recessed Shadow-box and ground-glass screen is visible. B—Television transmitter with lens. C—Microphone. D—Sound control. E—Visual control. F—Power switch. G—Telephone Receiver. H—Extension Antenna.

Here I draw a merciful curtain over what transpired during those eventful 60 days that followed.

I need not tell you how difficult the work was, but once I got the hang of the Chief's Visie-Talkie I picked up enthusiasm as my assistant and I went on with the work. Sure enough, the scheme worked out just as imagined by the big Boss. In about 40 days we actually had results and could see each other in the crude laboratory model. By this time the Old Man had produced the general mechanical design of the Visie-Talkie also and we galloped nicely along on the home stretch.

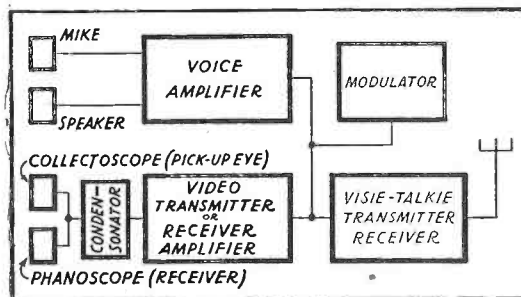

Simplified block diagram of the Visie-Talkie.

On account of the great importance of the invention we worked behind locked doors all the time. We had been admonished never to leave the plans out in the open and we had a big burglar-proof safe in the laboratory where the drawings were always safely cached whenever we had to be absent. This was not often, because most

part of its cycle. The condenser units are also discharged as the beat frequency oscillator passes their frequency, by an adaption of fairly conventional means,

"The complex wave thus produced is both amplitude and frequency modulated. The frequency modulation sets the position of the exciting area in the image—the amplitude modulation, the strength of light falling on that area. Thus without scanning, we are able to transmit in a single super-complex wave the necessary impulses, fixing both position and strength of light to permit us to transmit an image.

"At the receiver we have a similar means, only reversed. Here we have a fluorescent gas in a special tube so that each wire end has a different potential; therefore it gives rise to a varying luminosity—either intense or weak, with all the other light intensities in between. As each condenser plate at the receiver works on a different frequency we therefore reproduce the same mosaic, or pattern, from the original light impulses transmitted at the transmitter. This gives us a complete television image at the receiver, without any scanning whatsoever. The amplifier circuits making all this possible are shown in a diagram in my drawings.

"Now then," bellowed the Chief while pounding the desk in front of him, "I have worked out all of the theoretical considerations for you. Take the drawings along, study them carefully, and if there is anything you don't understand don't hesitate to call on me for further illumination of the problem."

Here there was an ominous pause. Then the big Boss, lighting a huge black cigar, scowled fiercely at me, took a deep breath and said:

"And I want a complete set of models in exactly 60 days—or else." With that he threw the sheaf of drawings and instructions at me and I scampered out.

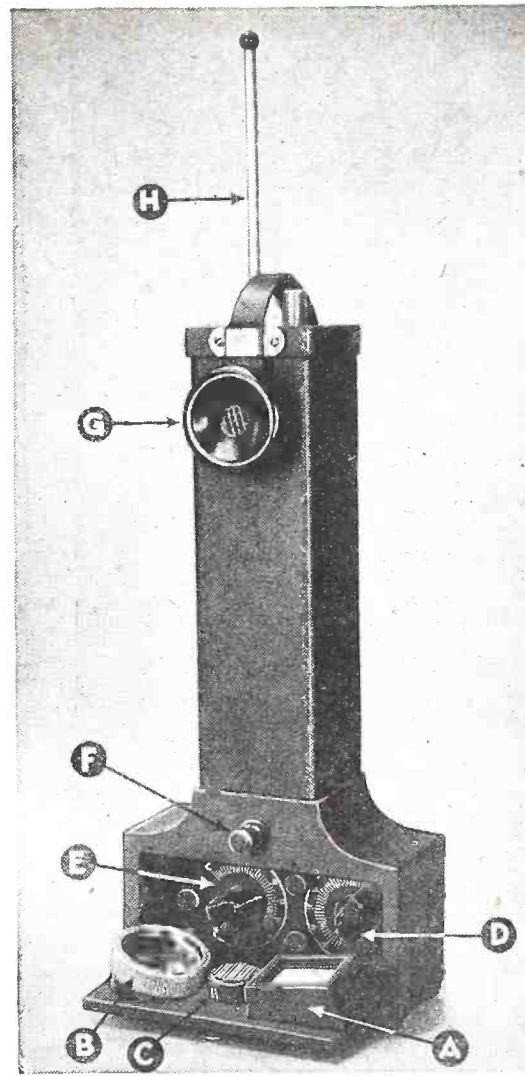

Hellmich Photo

of the time we slept in the laboratory and took turns on the cot provided for the purpose. During the last few remaining days we put the finishing touches to the Visie-Talkie and we even found a way to project the received image on its ground-glass screen in full natural colors, just as is done by the human eye. This was a little wrinkle which my assistant and I threw in for good measure.

There was also the little matter of static which we had to take care of so that the image would not flicker from static bursts from nearby automobiles and other man-made static annoyances. This problem we finally licked on the very last day.

Came the big moment when I marched triumphantly into the Big Chief's office and placed the now completed Visie-Talkie on his desk. My assistant stayed in the outer office and when the Old Man picked up the set (which automatically turns on the current when you open its little door) my assistant started to talk and his image and voice came over perfectly, much to the Chief's delight.

"I knew it was easy to do it," said he, "and now we have something that we can show these half-baked television engineers and teach them a non-scanning television lesson. As I figured it, the Visie-Talkie can be marketed for \$29.85 a pair, in the post-war period. There'll be millions in it!"

The big Boss beamed his full satisfaction and he must have been particularly happy, because he gave me two cigars, one for myself and one for my assistant. This was indeed mighty praise from the Great One. He insisted on keeping the two instruments on his desk and his parting statement was that he was much pleased that I came through exactly on the dot of the 60th day. As I backed my way out of his office I could not help noticing the historic date on his big wall calendar. It read:

APRIL 1st.

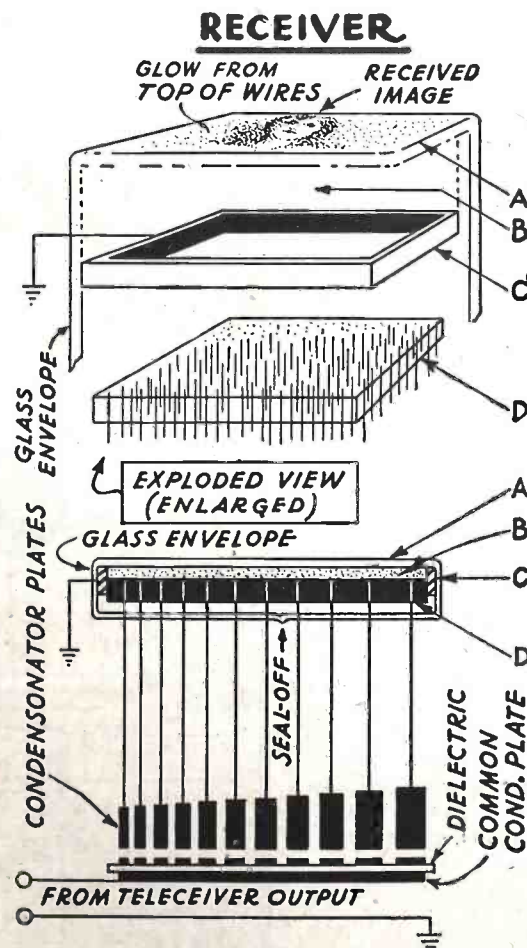

Exploded and cross-section views of Visie-Talkie receiver. A—Fluorescent screen. B—Fluorescent gas layer. C—Collector ring. D—Plastic block with imbedded wires.

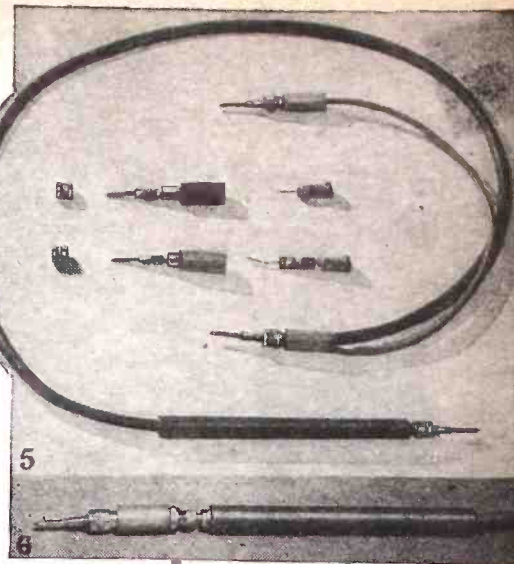
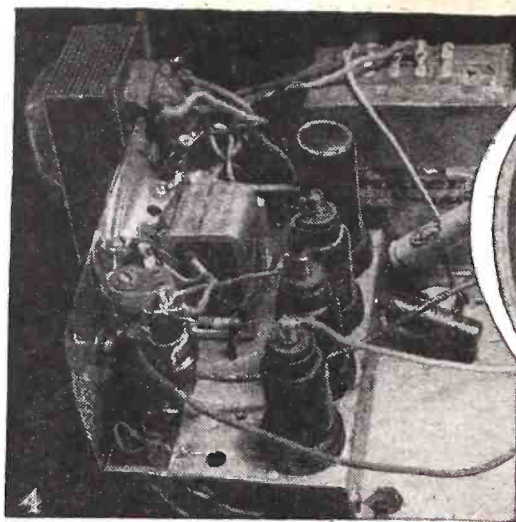
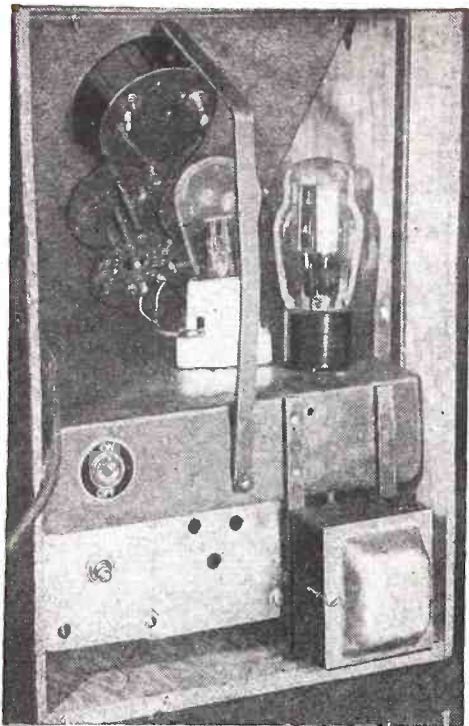

Photo 1—Interior view of the Signal Tracer.

Photo 4, above—Under-chassis view of tracer. 5 and 6 Construction of the signal prods.

A Signal Tracer and Multitester

By HAROLD T. GLENN

SEVERAL recent articles in *Radio-Craft* have inspired me to build my own signal tracer. As is usually the case now-a-days, parts specified were not immediately available. I did, however, have a two-stage TRF midget receiver on hand with a burnt-out 25Z5 rectifier which looked promising. From the demand for 25Z5's many such receivers must be laying around.

As I wanted more than just a signal tracer I decided to substitute a 60 Ma transformer with an 80 rectifier to provide a small power supply for other testing work I wanted to carry out. The tester as it now stands contains a signal tracer with an R.F. and A.F. pickup as well as an A.F. output for application to any audio section of a radio under test. It also contains a Volt-Ohmmeter and a condenser tester. Some future day I expect to add a Vacuum Tube Voltmeter.

The tester is housed in a sloping front cabinet made of 3/4-inch plywood, 12 1/2 inches high, 11 inches deep and 9 inches wide. The front straight drop at the bottom is 4 inches. This allows for a sub base with the tracer under it. The front panel is made of masonite 9 x 12 inches.

When the tracer is used as an A.F. generator, a tuned coil and condenser is connected to the grid of the 6K7 by means of a SPDT switch located at the back of the tester, and an aerial is connected to the aerial pin jack in the front of the receiver. The available A.F. signal can now be

applied to any audio tube grid or plate of the set being tested. If the receiver's audio section is OK the signal will appear in the receiver's loud-speaker. If not the probe can be moved from tube to tube and the trouble isolated.

THE R.F. TUNER

In order to avoid controls the regular 2-gang tuning condenser was removed and an old oscillator padder condenser inserted across the secondary of a regular TRF coil. The padder was adjusted to a strong local station and once set need never be readjusted. This assures a signal at all times in the A.F. output jack.

The untuned 6J7 is wired as a biased detector. This gives much more gain than the diode circuits mostly used for detectors. It handles the signal very well without overloading.

As one of the photos show, another 6K7 was tried, to boost the R.F. gain. The oscillation problems were difficult to surmount and most of the extra gain was lost

(Continued on page 448)

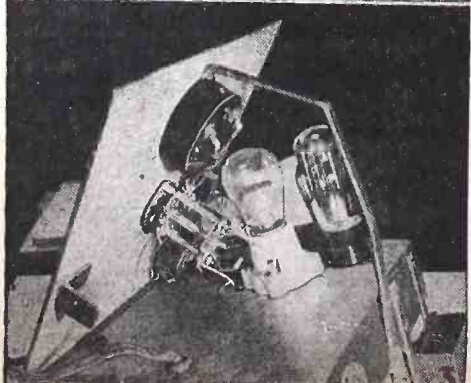
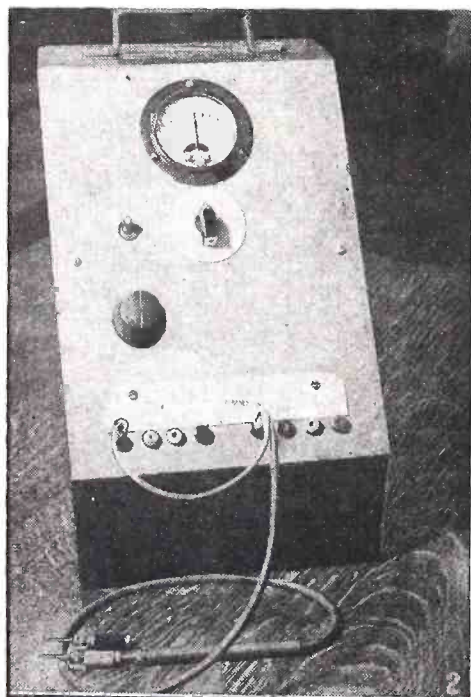
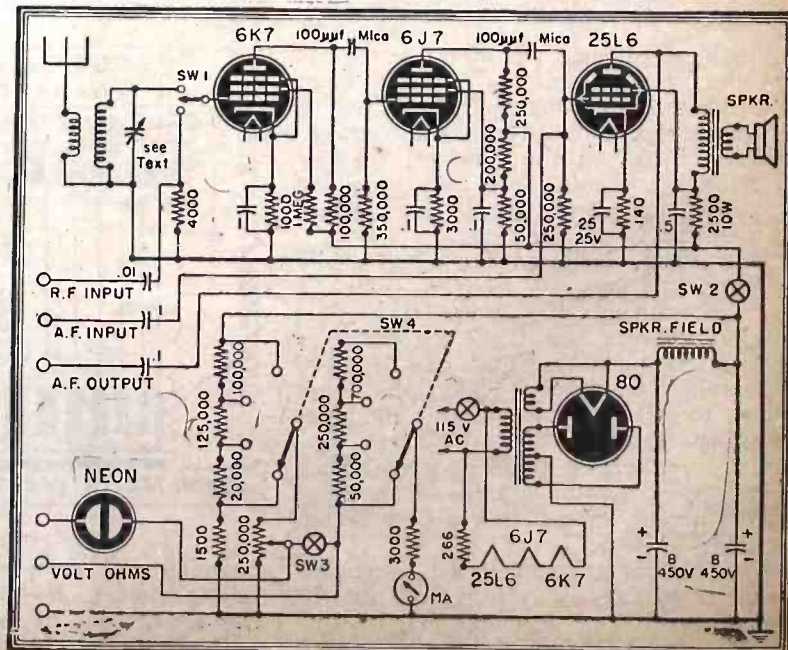

Photo 2, left—Exterior view of the instrument. Photo 3—This back-panel view shows the neon-tube condenser checker. Right—Schematic diagram of the complete tracer and multitester.



Transitron Oscillators

Negative resistance oscillators have special advantages

OSCILLATORS as commonly used in signal generators, the mixer stage of superheterodynes, generators of audio tones, frequency meters, and other electronic devices, have serious defects. The ideal oscillator would maintain absolute frequency in spite of changes in the supply voltage or load; would not "drift" in frequency because of changes in tube temperature; would produce a pure,



Fig. 1—Typical negative resistance circuit.

harmonic-free output; and would preferably have a two-terminal coil, without taps or tickler windings.

These desirable features have not yet all been realized in any one instrument. The negative-transconductance Dynatron and Transitron oscillators approach the ideal more nearly than any others.

All oscillating circuits depend on the phenomenon (inexactly) called *negative resistance*. A "negative resistance" is a circuit component which acts in the opposite manner to a resistance. If the voltage across it is reduced, current through it rises. An increase in voltage across it causes a reduction in current. A resistance absorbs power from the circuit—a "negative resistance" supplies power to the circuit in which it is inserted.

A circuit which contains a negative resistance—such as that of Fig. 1—may be made to oscillate. A slight increase of voltage across NR (such as might be caused by battery fluctuations) will cause still further increase till the whole battery voltage is across it. Another slight change—necessarily in the downward direction this time—will continue till the whole voltage is across LC. In practice the fields built up across the coil L and the charges produced in the condenser C reverse the current or voltage immediately it reaches one extreme

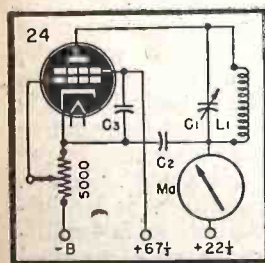

Fig. 2—The Dynatron oscillator. This circuit uses the secondary emission phenomenon to produce the negative resistance.

or the other and the circuit oscillates at the natural frequency of LC. (A detailed description of oscillation is given in the article, *Electron Power Pack*, in the August 1944 *Radio-Craft*.)

THE DYNATRON OSCILLATOR

The negative resistance, or power-generating device, may be an electron tube. A circuit using such a device was first discovered in 1918 by A. W. Hull, and named by him the Dynatron oscillator. The circuit is seen in Fig. 2. It consists of a type 24 tube with the screen operated at a higher voltage than the plate.

By FRED SHUNAMAN

When an electron strikes the plate of a tube, several more electrons may be jarred loose by the force of the impact. The Dynatron is a special circuit in which advantage is taken of this *secondary emission*.

Consider a circuit like that of Fig. 2, in which the grid may be set at zero voltage or a little below, and the screen at (for example) 70 volts. A milliammeter in the plate circuit will show us the effects of changing the plate voltage. At zero plate voltage, very little plate current will flow—due only to those electrons attracted by the positive screen which have passed through its meshes with such speed as to reach the plate by their momentum.

If the plate voltage is raised in small steps, the plate current increases accordingly, as more attractive force is exerted on the electrons which approach it. The rising voltage also increases the velocity with which the electrons strike the plate. As we approach a voltage around 10, the numbers of electrons knocked out of the plate increases, and the plate current actually starts to fall instead of increasing as the voltage increases. We have a negative resistance. The electrons are attracted to the more positive screen, and reduce the plate current. As the plate voltage is still further raised, drawing the electrons toward it with greater velocity, a point may be reached when the number of electrons knocked loose exactly equals the number reaching the plate, and the current drops to zero. Further increase in voltage causes the current to reverse. As the plate voltage approaches that of the screen, the current again rises rapidly and at slightly above screen voltage reaches an almost steady state, taking most of the electrons emitted by the cathode. Fig. 3 is a plate voltage vs. plate current curve of a typical screen-grid tube. Any slight change in the voltage across the combination LC of Fig. 2 will cause a change in the plate current which will drive the voltage still further in the same direction as the original change, thus setting up stable oscillations.

DYNATRON VS. TRANSITRON

The Dynatron, with its milliammeter connected in the cathode instead of the plate circuit, is a very reliable oscillator. It is only necessary to adjust it to a fixed value of cathode current to assure correct frequency in spite of changes in the supply voltage or other variations which might cause another type of oscillator to depart far from the frequency to which it was calibrated. The Dynatron output is low in harmonics, almost a pure sine wave being obtainable under certain conditions.

In spite of these advantages, the Dynatron did not become popular. This was because of its dependence on secondary emission, a very uncertain phenomenon which varies widely from tube to tube, and with increasing age in any one tube. It is used to some extent in laboratory work, but the electron-coupled oscillator displaced it where slightly less accuracy and a much higher harmonic content could be tolerated.

A newer type of negative-transconductance oscillator might have become more

popular in much commercial and experimental apparatus had not the war intervened. First described in 1935 by E. W. Herold, it was neglected till 1939, when it was again brought out into the light and given the name *Transitron*. Its action depends on the relation between the effects of the screen and suppressor grid of a pentode on the screen current. If these two voltages are correctly chosen, increasing them both together will decrease the screen current, while decreasing them will increase it.

The circuit action can be seen with the help of Fig. 4. Screen and suppressor are

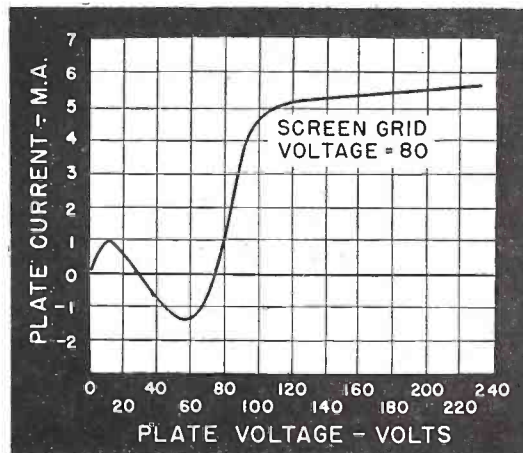

Fig. 3—"Dynatron kink" of a tetrode tube.

connected with a condenser so large that its reactance at the frequency of oscillation is low. A moderately high voltage is placed on the screen, a negative voltage on the suppressor and a low positive voltage on the plate. Now a sudden increase in the screen voltage will also increase the suppressor voltage. At its former low voltage it was turning practically all the electrons which approached it back to the screen. As its voltage rises it permits more electrons to go through to the plate, thus reducing the screen current. A sudden decrease of screen voltage would drive the suppressor more negative, turning back more electrons and increasing the screen current. *The screen circuit of the tube becomes a negative resistance.*

It is desirable that the cathode current be practically constant, if changes in screen voltage are to be faithfully reflected in screen current. This can be assured by keeping the control-grid slightly negative, thus reducing the effect of changes in the screen-

(Continued on page 439)

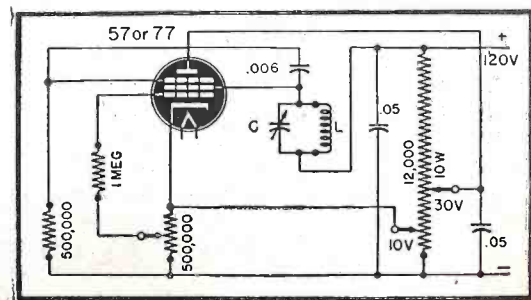

Fig. 4—Circuit of a Transitron oscillator.

Voltage Divider Design

By JACK KING

THE design of a voltage divider is a fundamental thing. First, we may start out with a basic circuit such as that shown in Fig. 1. The amount of current that flows through the load R is equal to E/R . The current is the same in all parts of a series circuit, but note that the voltage drops need not, necessarily, be the same. The voltage across R1 in Fig. 1 is,

$$E_{R1} = IR_1$$

The voltage across R2 is,

$$E_{R2} = IR_2$$

The sum of the drops equals the source voltage,

$$E = E_{R1} + E_{R2}$$

Let us return, for the moment, to another simple circuit. This circuit is shown in Fig. 2. The current flowing into a terminal equals the current flowing out of the terminal, according to Kirchoff's First Law. In Fig. 2, suppose we have 10 milliamperes flowing through R1 and 10 through R2. The total current through 1 or through 2 (the common terminals for R1 and R2) will be 20 milliamperes. As current flow is proportional to resistance, (assuming constant voltage) we see that making R1 lower than R2 in ohmic value in Fig. 2 will mean that more current will flow in R1 than in R2. The opposite also holds true, of course, that if R2 is made lower than R1 that the greater amount of current will flow in R2, since current always takes the path of least resistance.

With the above fundamental concepts thoroughly understood, we can take another step forward. Referring to Fig. 3, let us make the assumption that R3 is very high in value, so high in fact that the amount of

current flowing in it can be neglected for practical purposes. Then, the voltage drop across R1 will be due primarily to the current flowing through R1 and R2 in series. As these values of R1 and R2 are changed, the voltage drops across R1 and R2 are changed. The voltage across R2 will also be the voltage across R3. In view of the fact that we have assumed R3 to be high in value, we are primarily interested not in current flow but in voltage drops in this circuit, or in *voltage divider* action. Let's refer, now, to Fig. 4. This is one of the most commonly encountered circuits in radio work. Yet surprisingly few men have ever stopped to think about its basic action, having more or less taken it for granted for years. As the arm of the voltage divider is moved from its resting point at the center in the sketch to a point nearer point X, the amount of resistance between Z and X is reduced. This means that R1 in Fig. 3 is reduced. At the same time, the resistance in shunt with the load is raised in value (equivalent to raising the value of R2 in Fig. 3). Since the total value of R1 + R2 is constant, increasing R2 results in a lowered voltage drop across R1. More voltage is then available for the load R3 and R2. That is,

$$E = E_{R1} + E_{R2}$$

Therefore, $E_{R2} = E - E_{R1}$

VOLTAGES AND AMPLIFICATION

In an audio grid circuit, where the voltage divider would be termed a *volume control*, the current is unimportant and the voltage of greater importance. In a receiver power sup-

ply we are interested not only in current flow and voltage, but also in power. In an R.F. stage we may be dealing with signal voltages and impedances, but in whatever circuit we encounter, the basic idea of voltage division will come into the picture. Let us, for purposes of illustration, take the case of an R.F. amplifier tube which is feeding into a tuned plate tank circuit. This is shown in Fig. 5. This is a very simple form of voltage division. The tube supplies a signal voltage to the tank circuit. We may assume the cathode by-pass condenser C1 has zero impedance and that the plate return by-pass condenser C2 does have some impedance. The amount of signal current that flows through the tank impedance which appears between terminals 1-2 is governed not only by the source potential furnished by the tube, but also by the voltage drop across Z2. If Z2 is a high impedance, due to the fact that the radio has developed a defect, the voltage drop will be high and less voltage will be available for Z1, assuming that special effects such as oscillation and regeneration do not play a part in the action. Assuming that Z2 is low and normal, the amount of voltage across Z1 will be dependent on the impedance value of Z1, and a larger voltage division will result; a greater voltage will be built up across Z1 as Z1 is made larger in ohms. This is important in understanding why we can get maximum voltage amplification in an amplifier stage by using a high plate load resistance. In Fig. 2, suppose R1 is the tube plate resistance and R2 the resonant resistance of the plate load; increasing R2 will decrease the amount of current drawn from the source. The voltage across R1 will go down because of less current flow in R1 ($E_{R1} = I \times R1$) and the relative voltage across the load will rise.

Suppose, however, that we want maximum power in the load. Then, the values of R1 and R2 must be equal. This concept is fundamental and applies whether the design is that of a power supply or of an audio output stage which supplies audio instead of D.C. power to a speaker load.

THE POWER PACK DIVIDER

In a radio we may have plate voltages of 250 volts and screen grid voltages of 100 volts. Suppose that we have a number of tubes which draw various values of plate and screen currents. In series with the cathode of each tube we may assume that we have a biasing resistor R_k . A typical stage is shown in Fig. 6. The grid is made negative with reference to the cathode because of the voltage across R_k which is a D.C. voltage. Let us assume the screen current is 1 milli-ampere and that the plate current is 4 milli-amperes. These figures are only assumed and reference should be made to a manual to determine actual currents. The total current in the cathode circuit will be 1 plus 4 or 5 milliamperes. This is equal to .005 ampere. (Divide milliamperes by 1,000 or move the decimal point three places to the left.)

Now, suppose we want a bias of 10 volts on the tube. The drop across the resistor R_k will be 10 volts and the value of R_k is,

$$R_k = \frac{E_{Rk}}{I_k} = \frac{10}{.005} = \frac{10,000}{5} = 2000 \text{ ohms.}$$

We know that if we make the *bleeder current* through R1 high in comparison with the
(Continued on page 450)

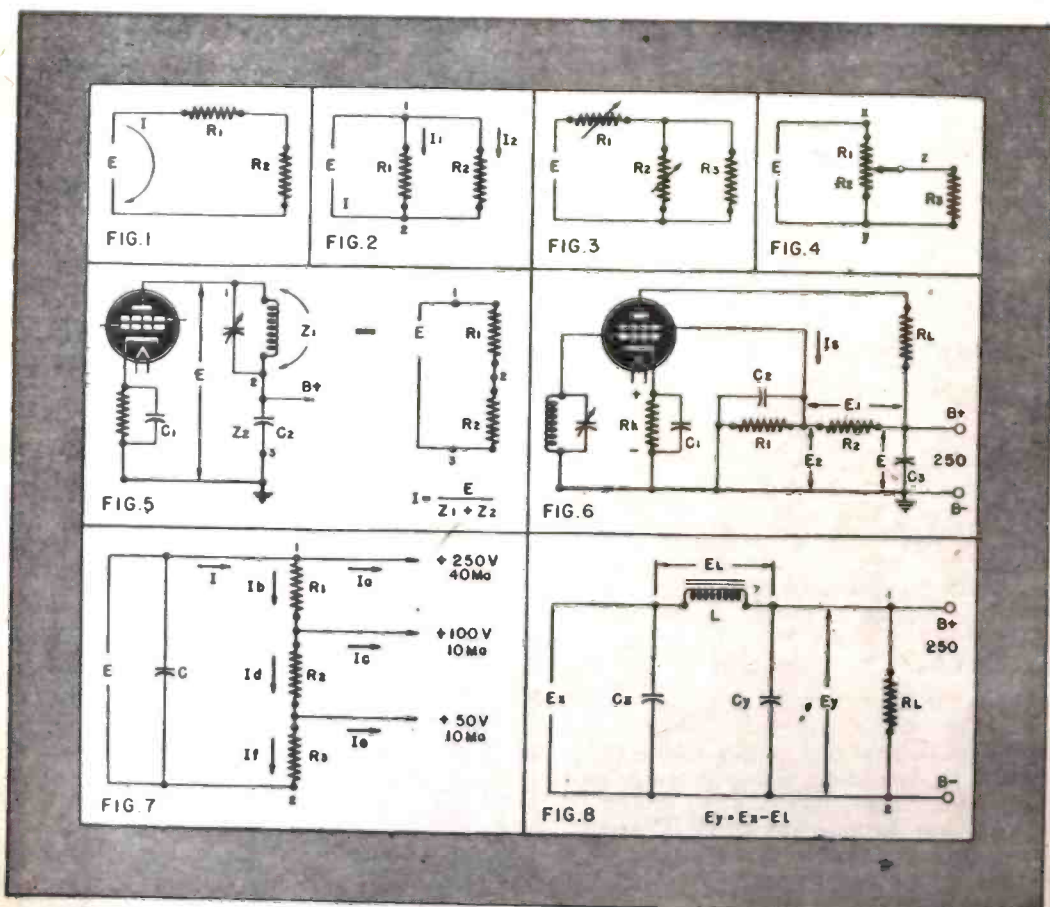
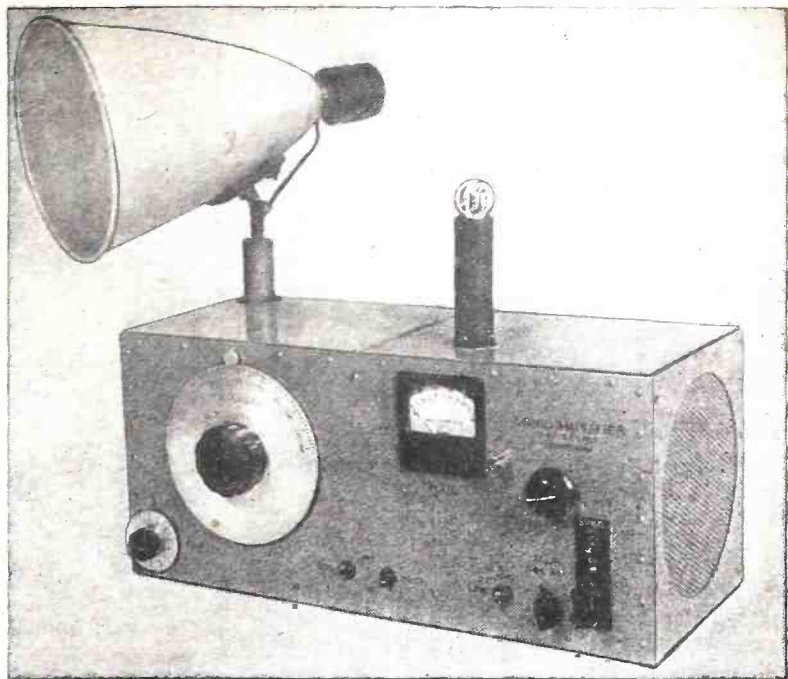

Fig. 1—Basic divider circuit. Fig. 2—The parallel connection. Fig. 3—R1 and R2 are the bleeders. Fig. 4—A common radio circuit. Fig. 5—An R.F. divider. Fig. 6—A standard bleeder such as may be found in practice. Fig. 7—Another bleeder. Fig. 8—Voltage drops.

RADAR, BATS and SUPERSONICS

By DR. ROBERT GALAMBOS
University of Rochester, N. Y.



Photos Courtesy Cruft Laboratory, Harvard University

The tuned amplifier. The large horn is actually a microphone. Speaker grille is at right of cabinet. Means for using a recorder are provided.

TO the readers of *Radio-Craft*—interested chiefly in electronics as it applies to human problems—it may seem strange to find an article on bats. If anything is far removed from radio tubes and circuit diagrams, certainly it is this odd mammal which flies by night. Yet electronic advances have been instrumental in finally solving a puzzler which for 150 years defied the best of scientific brains. The problem is, simply: How do bats avoid obstacles in the dark? As they cruise about in the warm summer night, how do they keep from hitting trees, fenceposts, the sides of houses, etc.? Under these conditions there may be moon and starlight to see by, but even this small quantity of light is absent in the caves deep in the earth where bats are known to spend the winter. Yet they almost never bump into walls or other objects as they fly about in utter and total darkness. Despite the saying "blind as a bat," these animals can see fairly well. But it is obvious that their eyes can be of no use when there is absolutely no light to see by.

The first attempt to solve this problem was made in 1794 by the Italian naturalist Lazzaro Spallanzani. He and his colleagues performed certain fundamental experiments verified by every succeeding investigator. The bat, like man, has 5 primary senses: sight, touch, smell, taste, and hearing. So Spallanzani eliminated each one of these senses in turn, to see if it made any difference to the flying bat. Blinded bats, bats covered with varnish, bats with nostrils stuffed up, and bats with tongues cut out—all of them, in the experimental room, avoided branches and threads with astounding precision and accuracy. But bats with their ears plugged up were helpless. They flew erratically, collided with the walls and other objects, and behaved as if with no knowledge whatever of where obstacles lay. Therefore, the scientists of 150 years ago argued, the bats directed themselves by ear.

BATS "SEE" WITH THEIR EARS

Now, this would suggest that they hear sounds by which they direct themselves. To anyone who has observed bats flying, this does not seem reasonable. Flying bats rarely make sounds audible to man, and they perform beautifully in a sound-proof room, in silence. Do they, then, produce sounds we cannot hear, and guide themselves by echos which to us are completely inaudible?

It was with this question in mind that Dr. D. R. Griffin and the author approached Prof. G. W. Pierce at the Cruft Physics Laboratory at Harvard University. Prof. Pierce is a specialist in supersonic sounds and has pioneered in the development of many widely used electronic devices. Dr. Griffin and the author are biologists, with little training in electronics, and we found Dr. Pierce happy to lend us equipment for detecting and recording sounds in the frequency range above the 20,000 cycle upper limit of the human ear. These instruments are described in detail below.

Bats were set free to fly in a room in which a supersonic detector was located.

We found these flying bats to be producing a constant stream of short cries in which frequencies around 45,000 cycles were most intense. When we plugged up the ears, the cries continued much as before, but the bat could not avoid obstacles (we used a barrier of steel wires), and was as likely as not to crash into a wall. When we taped the mouth shut, leaving the ears untouched, the cries were greatly diminished in intensity, and all the animals floundered about, bumped into whatever lay ahead of them, and behaved exactly as if their ears were plugged.

From these experiments an obvious conclusion can be drawn: the flying bat produces supersonic cries in its voice-box; these cries enter the space through which the animal is about to fly, and are scattered by objects lying in the direction of flight; some of the scattered sound returns to the ears of the animal as an echo and is interpreted as coming from an obstacle. The animal then changes its line of flight so as to travel only through space from which no echos are received. The bat thus locates objects at a distance by the echos they produce—an ingenious method which work amazingly well.

THE FREQUENCY SPECTRUM

The probing signal used by the bat contains frequencies between about 30,000 and 70,000 cycles in which, as stated above, frequencies around 45,000 cycles are most intense. The cry is of very brief duration—between .005 and .01 second. The astonishing feature about the cry is the variation in its rate of production. Bats which are on a wall, preparing to take off, produce 5 to 10 cries per second. As they cruise about, they produce about 30 cries each second. And when an obstacle looms ahead, the rate rises to as high as 50 or 60 for brief periods

while the animal is accurately exploring the area for a safe fly-away. On general principles, many echos, 50 or 60 per second instead of 30, would give much more precision in locating objects, and this seems to be exactly what the bat has found out by long experience.

TECHNIQUE OF HEARING TESTS

The critical reader may ask at this point for proof that the bat hears the supersonic cry it produces. The fact that bats with plugged ears can't avoid obstacles is a partial answer, but an even better one can be supplied. We have been able to show by the so-called *cochlear potential technique*—based on the minute electrical currents set up in the ears of an animal by sounds it hears—that bats ears give responses up to 98,000 cycles. This is in contrast to cats and dogs, which give responses only up to about 35,000 cycles. These and other facts make it fairly certain that the ears of bats are very delicate and accurate receptors for supersonic sounds.

Incidentally, the cochlear potential technique just mentioned is made possible only by electronic devices, and represents the most powerful tool possessed by students of animal hearing. Just 15 years ago, two psychologists from Princeton University, Drs. Wever and Bray, placed a wire on the inner ear of a cat and connected it

(Continued on following page)

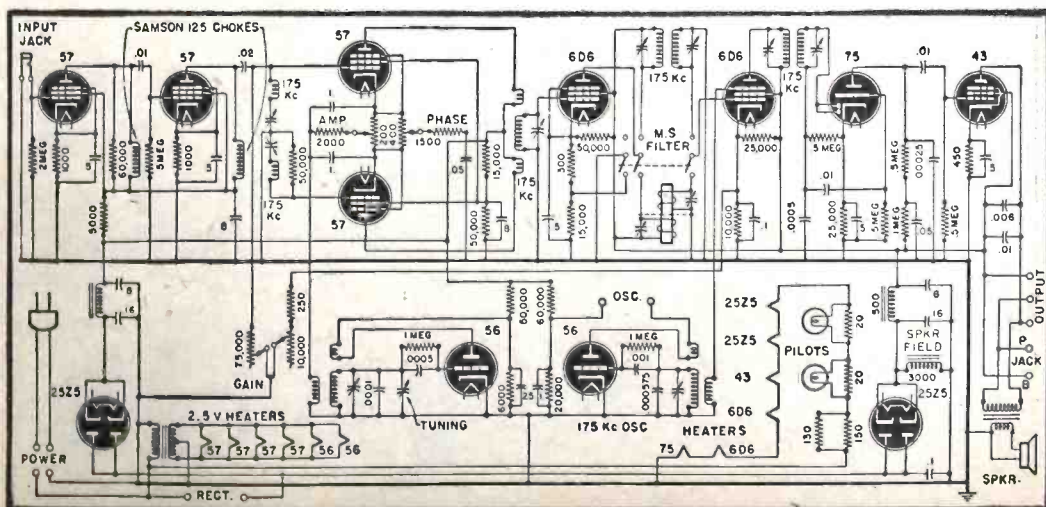

Fig. 1—Balanced circuit and magnetostrictive filter are features of the sonic amplifier.

(Continued from previous page)

through an amplifier to a loud-speaker. They discovered that tones from a violin or the spoken voice were converted in the ear into electrical waves accurately reproducing the frequency and phase relations in the sound wave. The inner ear, or cochlea, thus acts as a sensitive microphone of remarkable fidelity. Plotting its characteristics—frequency response, gain, linearity, etc.—in various animals has occupied workers in many laboratories, and the accumulated information has contributed enormously to our understanding of how the ear works.

RADAR'S REAL INVENTOR

The sonic mechanism of the bat is strikingly similar (as those interested in aviation will recognize) to the radar system being employed with such stunning success in the U. S. Air Forces' deadly night fighter plane. Both the animal and the radar equipped night flier emit a probing signal and possess delicate receiving devices for detecting and interpreting echos. The bat uses sound, which of course travels relatively slowly at a rate of some 1100 feet per second, while the electromagnetic waves in radar travel at the speed of light. But the flying bat doesn't pass through space fast enough to require the speedy return of echos so essential for the airplane. And certainly the bats' method gives the animals an amazingly accurate and delicate method for locating obstacles. It may be considered strange that this method was not recognized and used long ago. One of the reasons may be that few knew of this amazing faculty possessed only by the little-known animal.

The entire field of supersonic sounds in nature has received very little attention from biologists, mostly because the electronic devices needed for research in that field have not been readily available. Man's ears serve as sound-receivers only up to about 20,000 cycles, and this limitation has long prevented the search for, and the study of, sounds in the supersonic range. The bat is the only animal which has been studied with any degree of thoroughness in this regard. But other small mammals, like shrews, mice, and rats are known to be responsive to supersonic sounds, although there is as yet little inkling that these have any particular importance for them. Insects, on the other hand, produce supersonics as they chirp, but whether they hear them is questioned. Finally, the birds—and especially the night-flying owl—have had little or no attention so far as supersonic production or reception is concerned. If the author may venture a prediction, it is that we shall see,

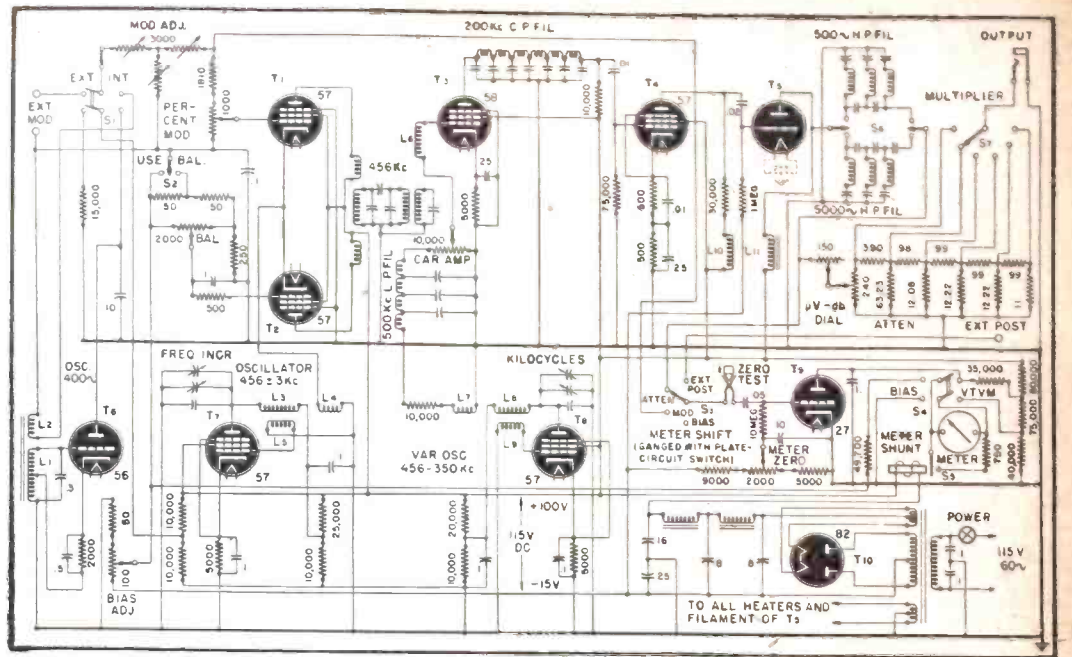

Fig. 2—Beat-frequency generator supplying signals from one to one thousand kilocycles.

within the next 20 years, much research along these lines, aided by electronic apparatus such as used in the foregoing experiments; some of which is described below.

THE SELECTIVE AMPLIFIER*

The amplifier here described has been built for use, primarily, in the frequency range between 1,000 and 100,000 cycles per second. For rapid tuning over a wide range the superheterodyne principle is attractive. Difficulties are encountered in designing superheterodynes for use with signal frequencies as low as one, or even ten, kilocycles, since the signal frequency is the difference between oscillator and intermediate frequencies. Overloading of the intermediate stages by the oscillator can, nevertheless, be avoided in large part by utilizing a balanced modulator for the first detector and thus eliminating the oscillator frequency from the intermediate circuits.

Fig. 1 is a diagram of an amplifier constructed on this principle. The chassis of a small A.C.-D.C. broadcast receiver was used; this accounts for the type of filament and B-supply.

*This material is from the paper, "Apparatus for Acoustic Research in the Supersonic Frequency Range," by Atherton Noyes, Jr., and G. W. Pierce, which appeared originally in the January, 1938, issue of the *Journal of the Acoustic Society of America*, and is reproduced by kind permission of the authors and the Society.

Cathodes of the balanced detector tubes (3 and 4) are fed by the oscillator (5). Relative detector bias of the two tubes is controlled by the 200-ohm potentiometer. This controls the amplitudes of the oscillator frequency plate currents in the primaries of the balanced output transformer; phase control of these currents—for balance—is controlled by the 400-ohm potentiometer. The circuits for balancing amplitude and phase are practically independent of each other.

The detector tube grids are grounded at the intermediate frequency through the two series resonant circuits shown. This prevents serious unbalance due to differences in grid-filament capacity of the two tubes and keeps any stray voltages of intermediate frequency off the signal grids.

THE MAGNETOSTRICTIVE FILTER

A switch in the plate circuit of the first I.F. permits choice of either a straight 175-Kc. I.F. transformer or a magnetostrictive filter for coupling to succeeding stages. A fixed oscillator (tube 6) is set about 1 Kc. from the filter frequency so that, as the tuning oscillator is varied, a very sharply peaked audible response is obtained about 1,000 cycles away from zero beat, and on one side only of zero.

The set is calibrated in terms of this peaked response; the tuning dial of the variable oscillator then reads the signal frequency directly. When less selectivity is desired—as in reception of voice-modulated supersonic signals, the ordinary tuned I.F. transformer is switched in.

The filter was constructed very simply. The primary and secondary circuits of a 175-Kc. transformer for a midget broadcast receiver were shielded from each other by a 1/4-inch thick metallic vane closing the coil can transversely. Through a hole centrally located in this vane passes the nichrome vibratory rod; the length of the rod is such that it vibrates in its third harmonic mode of longitudinal vibration at 175 Kc. The coils are located at the third harmonic nodal points, one quarter wave length from the ends of the rod.

The receiver is sensitive to a 1-microvolt signal and essentially flat over practically its whole tuning range, though the coupling impedances of the first two stages are such as to cause a decrease in sensitivity below 5 Kc. This is desirable to avoid howling due to acoustic feedback at low tuning fre-

(Continued on page 441)

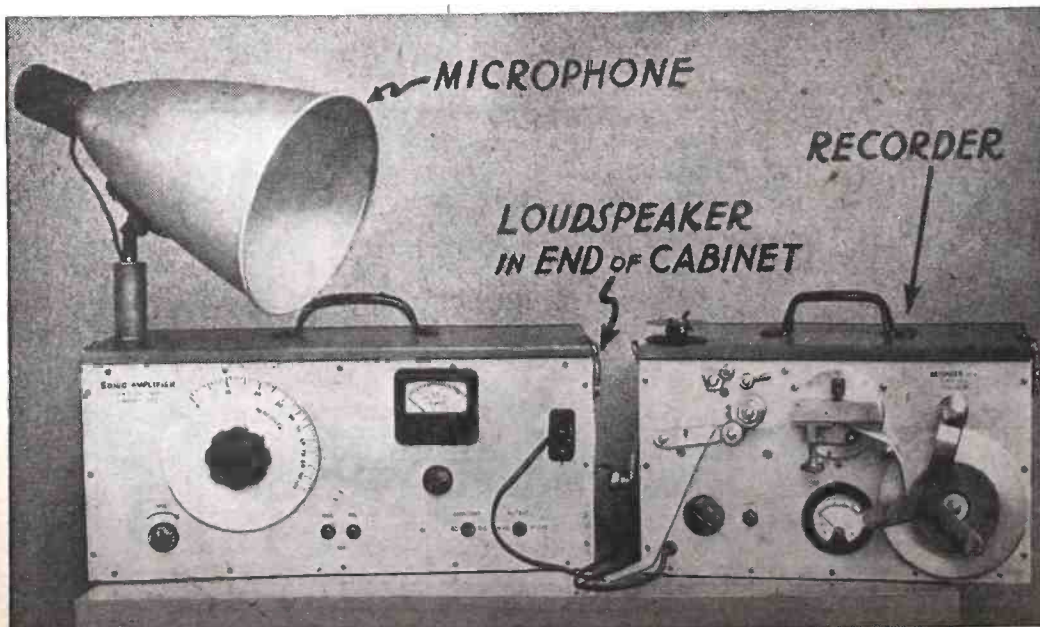

Supersonic amplifier of Fig. 1, hooked up with a tape recorder for study of bats' signals.

SPEECH AMPLIFIERS

Part VII—Equalization and Compensation

By ROBERT F. SCOTT

THE human ear responds differently to sounds of different frequencies and intensities and compensates for losses in high- and low-frequency gain which are common in most all types of audio amplifiers. It is necessary, for satisfactory listening, to compensate for these deficiencies in man and electronic device. The frequency response characteristics of an amplifier may be altered to suit the most critical listener. Any method used to control the frequency response of an amplifier is commonly called a tone control. It is often referred to as "Tone Compensation" or "Tone Equalization."

In the early days of radio when the art of audio amplification was not as fully developed as it is today, practically every set reproduced every note with a sort of boominess to which everyone became accustomed. When the audio systems of radios were improved the listeners did not always appreciate the improvements but preferred the abundance of bass notes which were prevalent in the older sets. This is still the manner in which many persons select a new radio receiver, purchasing the set which emphasizes the bass notes to the greatest extent.

Two distinct types of tone controls are used in radio and public address systems. These types are non-resonant and resonant systems.

CONDENSER-TYPE TONE CONTROLS

We have learned from previous study of amplifier characteristics that loss of the low frequencies in the resistance coupled amplifier is due to the capacitive reactance of the coupling condenser. Highs are attenuated due to the capacitive reactance of the stray and tube inter-element capacities.

The most common of tone controls works by virtue of a condenser connected from the plate of one of the tubes to ground. This added capacity serves to attenuate the highs and a portion of the middle-range notes. This system only gives an "apparent" boost of the low notes due to the decrease in the intensity of the balance of the audio range. This common circuit is shown in Fig. 1. This illustration shows the condenser shunting the plate circuit of a vacuum tube. It will be noted that the variable resistor in the circuit is employed as a means of manual control. When the entire resistor is in the circuit, the condenser has little or no effect upon the response. As it is progressively shorted out of the circuit, attenuation of the highs becomes increasingly noticeable. Maximum attenuation of the highs may be calculated from the equation

$$\frac{\text{Gain (normal)}}{\text{Gain with shunting cond.}} = \frac{1}{\sqrt{1 + (R_{eq}/X_s)^2}}$$

where

$$R_{eq} = \frac{R_c}{1 + \frac{R_c}{R_g} + \frac{R_c}{R_p}}$$

R_c = plate load resistance.
 R_g = grid leak resistance of following tube.

R_p = plate resistance of tube.
and X_s = reactance of shunting condenser in ohms at the frequency selected for measurement.

BASS ATTENUATION CIRCUITS

From the equation, it will be seen that attenuation of the highs is a function of the plate resistance and that—with all coupling and tone control constants being equal—attenuation will be greatest with a pentode tube, slightly less with a high- μ triode and still less with a low- μ triode.

Although less commonly used, there is a non-resonant circuit which gives apparent treble boost. This is accomplished by attenuating the low frequency notes. The low frequency response of an amplifier depends upon the size of the interstage coupling condenser and the losses will vary inversely as the size of the condenser and the frequency. This "treble boosting" circuit is shown in Fig. 2. A small condenser is placed in series with the coupling condenser and the grid of the following stage. If this condenser, C, is made much smaller than the regular coupling condenser, the bass will be sharply attenuated. In order to exercise manual control over this attenuation, a variable resistor, R, is included in the circuit.

Fig. 3 is the equivalent circuit of Fig. 2.

We note that the output of the first stage appears as E_o across the grid side of C_c . This voltage is applied to the network consisting of the control resistor R, condenser C and the grid-leak resistor, R_g . This network, at low frequencies, acts as a voltage divider with a portion of the signal voltage being dissipated in the impedance formed from the reactance of C paralleled by R. The voltage drop across this section is E_1 and the remaining voltage is applied to the grid of the following stage across the grid resistor. At high frequencies the losses are negligible because the reactance of C is quite small and may be considered as a short circuit.

The ratio of loss in signal voltage to the voltage appearing upon the grid is equal to the ratio of the equivalent resistance formed by combining the reactance of C in parallel with the resistance of R, to the value of the grid leak resistance.

In the circuits previously discussed, it will be noted that the apparent boost in one end of the audio spectrum results from cutting the response at the opposite end of the range.

The circuit in Fig. 4 is used to compensate for the apparent loss of high frequency notes when sound is being reproduced at an audio level lower than that of the original. This is due to one of the peculiarities of the human ear. In this circuit, the treble notes

are actually boosted without a sacrifice of the bass response. This boosting feature is practical only when the reproducing device is set at a level where the sound is being reproduced at a level lower than full output. It will be noted that a small condenser, C, is connected between the "hot" side of the volume control and the movable arm. Assume that the volume control has a value of one-half megohm (500,000 ohms) and the condenser has a capacity of .0005 mfd. When the control is set for half-volume, there will be 250,000 ohms on each side of the arm. Hence, one-half of the available audio voltage is dissipated in the portion of the potentiometer between the "hot" side and the arm. This percentage of voltage loss will be equal for all frequencies. With the condenser in circuit, the reactance is low at the high frequencies and will practically shunt the high notes around the portion of the control which is in the circuit.

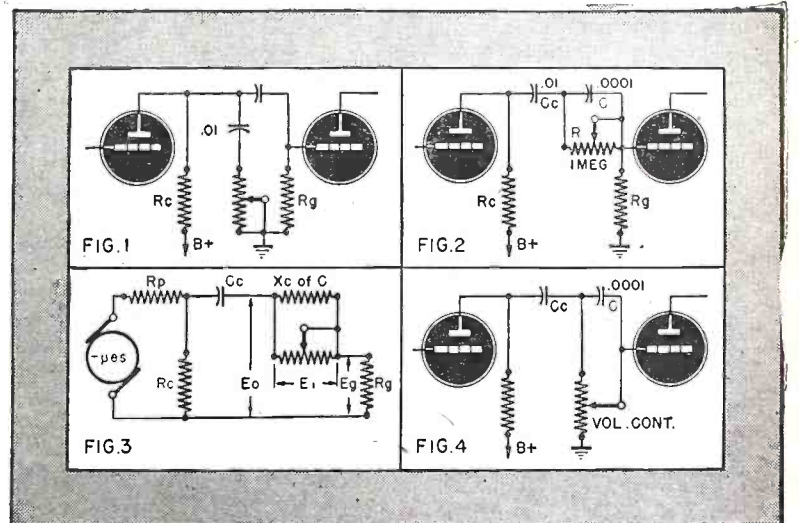

Fig. 1—The standard "tone control" or high-note attenuator. Fig. 2—A high-note accentuator. Fig. 3—Equivalent circuit of Fig. 2. Fig. 4—Tone compensator, maintains level of high notes at low volume settings.

REACTION VS. FREQUENCY

Let us consider the reaction of this circuit at 5,000, 1,000 and 100 cycles. We know that at any frequency, with the condenser paralleling a portion of the volume control, there will be a voltage drop across the equivalent resistance formed from this combination. Calculating the equivalent resistance for the previously named frequencies with the volume control set at the halfway mark (250,000) we find:

at 5,000 cycles, $X_c = 63,700$ ohms and $R_{eq} = 50,765$ ohms
at 1,000 cycles, $X_c = 318,000$ ohms; $R_{eq} = 139,964$ ohms
at 100 cycles, $X_c = 3,180,000$ ohms; $R_{eq} = 231,778$ ohms

The values of R_{eq} at the various frequencies are indicative of the voltage drops at these frequencies. For a more pronounced gain at high frequencies, a different value of C must be employed.

A very versatile control which makes possible apparent boost in the high or low frequency ends of the spectrum depending upon the setting of the manual control appears in Fig. 5. This combines the features of the circuits in Figs. 1 and 4. The control resistor is a one-megohm potentiometer while C1 and C2 are .01 and .0005 mfd. condensers
(Continued on page 441)

efforts will be backed up by a powerful advertising campaign through the major national magazines, metropolitan newspapers, our expanded outdoor road sign program and painted bulletins.

GALVIN MFG. CORPORATION,
Paul V. Galvin, *President*

"Civilian Radio Not Just Around Corner"

THANKS for your chance to mix in on an open forum about the immediate responsibilities of the radio industry. God knows they are plenty, and we ought to stop and take a look at them. In



the first place, I go along with you when you say that a "realistic view, based on sober facts, should be taken for the next five years. . . ." But, I part company with you when you say that the industry as a whole has given the public a "fantastic" view of what's to come, or that it has set up a lot of improbable and unlikely models—the promise of which can't be met.

True, some have undoubtedly gone too far and may, possibly, have "rocked the boat" slightly. Few but have seen the error of their ways, however, and long since stopped "confounding the public with post-war claims which are not likely to be fulfilled for years."

You know and I know that real radio engineers and developers—the kind of people that have been in it as long as we have—never take "no" for an answer. Most of the sets that are being promised will be an actuality some day soon—are, in fact, actualities in test labs right now. I know that their general distribution will be strictly limited by world conditions, but the fact remains that most of them can and will be delivered just as soon as conditions permit.

Certainly the public will expect, and be able to get, vastly improved performance from their post-war radios. That I know, because here at Hallcrafters we have squeezed many years' normal development work into the comparatively few years since Pearl Harbor. Many of these improvements will be immediately available and equally desirable to peace-time users of Hallcrafters' equipment.

At Hallcrafters, we have already explored the upper reaches of the higher frequencies and have developed quantity-built receivers to a degree of radio perfection never dreamed of a few years ago. I don't think that any of the things we have come up with in this war are in the "Su-

THE RADIO INDUSTRY REPLIES

(Continued from page 407)

perman" classification or that they can be called "dream sets." They are actual, technological improvements in radio that we will be able to offer the public just as soon as war demands permit. So, why not tell that public what's going on—within the limits of military security, of course?

All of the radio manufacturers you know—and you know them all—are engaged 100% in war work, and they are going to stay that way just as long as they are needed. Meanwhile let's tell the people that we're not standing still, that just as soon as we can we'll tell them about the war-born improvements and give them the best that can be built.

You ought to know that it is the nature of the industry, the very nature of the subject, to be imaginative, to be unlimited and uninhibited—to take a chance, to say "maybe it can be done" and then proceed to do it.

I, too, saw the survey placing radios in sixth place. A few days later I saw one placing them in second place. In my opinion, radios will be well up towards the head of the list in public preference during the post-war period, and for many years to come. Nothing else, to my knowledge, offers so much in the way of entertainment, news and information—all highly desirable to a vast majority of the people—at such relatively low cost.

Certainly civilian radio sets are not just around the corner—but when that corner is reached, our sets will be just as good as we say they are, and will do all of the tricks we claim for them. Radio is like that. It knows no bounds. At least we haven't found those bounds yet at Hallcrafters—and we're still looking, still exploring.

THE HALLCRAFTERS
COMPANY,
Bill Halligan, *President*

"Should Adopt a Sound and Realistic Attitude"

RADIO-CRAFT'S editorial—"Awake, Radio Industry!" takes a realistic view of the war, of predictions dealing with the



resumption of civilian radio production and of the radio manufacturers' responsibility.

It is not important that one agree or disagree with Mr. Gernsback's opinion as to when the war in Europe will end and as to when the Japanese war may end . . . what is important is that the industry make a very real contribution by way of war production to help end it and that they place a "check" on any tendencies to make enthusiastic promises relating to post-war products.

It seems to me that at least the leaders within the radio industry have been quite realistic and that the confusion that exists in the public's mind and the expectancy of some "great electronic radio" has been fostered by outside advertisers.

Certainly manufacturers' engineering departments have their feet on the ground in most cases and yet it is true that in the past eighteen months too many pages in the magazines and too many newspaper articles have been printed that fan the public's imagination and that lead them to believe that a "miracle radio" would be theirs in the immediate post-war era.

We see no need to oversell in print today. We believe that fundamentally the public's desire to possess a Frequency Modulation Radio, plus the public swing to radio-phonographs with automatic record changers constitutes adequate public demand and thereby a sizable post-war market for the industry.

As for surveys that measure the public's first, second and third preference for post-war products, it seems to me that there is still great confusion. For that reason, we have made our own unbiased check on this market problem and additionally, we have made an intelligent effort to gauge as accurately as possible the extent of the sellers' market that will immediately follow resumption of civilian production.

The radio industry, manufacturers, distributors and retailers should adopt a sound and realistic attitude and should reflect that kind of opinion in all of their contacts with the public. Any other course creates problems that we, as an industry, must ourselves solve later.

MAJESTIC RADIO CORP.,
E. A. Tracy, *President*

"They Cried 'Wolf' Too Often"

THERE is no question but that the radio manufacturers have cried, "Wolf" too often, particularly with the publicity put forth by some manufacturers regarding the post-war dream models of radios.

Of course, we agree that there will be some technical advances

in the radio field, particularly with regard to Frequency Modulation, which we class as a real stepping stone in the advancement of radio transmission and reception. We quite agree that the publicity promising great and radical changes in home radio receivers is misleading to the public and that it will hurt the sale of home radios in the immediate post-war era.

We are also of the opinion that there will be some government control in the production of home radios and we think that some civilian radio production



will be permitted after the defeat of Germany. The extent of that civilian production will depend entirely upon the needs of our armed forces in the continuing war with Japan.

We, of course, are looking forward to the day that civilian radio production will again be permitted. We do not believe it should be permitted, however, until the needs of our armed forces have been fully met and there is material and manpower available which is not adaptable to the production of any other type of government equipment.

JOHN MECK INDUSTRIES,
Harry Byrne,
Sales Manager.

"All Out War Effort"

THROUGHOUT the year 1944, the radio industry continued its all-out war effort and increased its total production in terms of dollars by 20% to approximately \$2,700,000,000, as compared with the preceding year. Measured in physical terms, the increase in production was even greater, for the Army and Navy received the benefit of lower costs on my pieces of equipment as the year progressed, and greater efficiency and production short-cuts were developed.

National security requirements make it impossible to tell in detail of the radio industry's contribution to victory at this time. When the whole story is revealed, however, it will be found that radar, with its almost supernatural powers, was one of the most decisive weapons in the hands of our Army and Navy. The development of this equipment in collaboration with Army and Navy scientists and its manufacture on a mass produc-

tion basis represent the greatest single achievement in the history of the radio industry. It is a source of satisfaction that Philco, through its research laboratories and production lines, has been able to play a leading part in providing these weapons for the United Nations.

There has been no production of civilian radio receiving sets since early in 1942 and the needs of the public for new equipment are constantly growing more acute. Of the 59,000,000 receivers in use in homes, offices, and automobiles in 1942, thousands are



Underwood & Underwood

going out of service daily due to obsolescence and shortages of tubes and other repair materials and a scarcity of technical service men in many areas. It is estimated that the pent-up demand for radio receivers at the present time amounts to between 20,000,000 and 25,000,000 units as compared with the industry's all-time high production of 13,100,000 sets in 1941. When the nation's war needs are met, the radio industry and its distributors and dealers should be assured of several years of active, profitable business.

PHILCO CORPORATION,
John Ballantyne, *President*

"You Are Somewhat Pessimistic"

I HAVE before me your editorial for the February issue of *Radio-Craft* and I am glad of the opportunity to express my views in this matter.

In the first place, I believe you are somewhat pessimistic as to when the industry will return to civilian production. It is true that we were all over-optimistic

last year when we felt that the war would come to an early end, but when we had the temporary setback on the western front, every manufacturer quickly forgot about post-war radios. Although some of us feel that there is a bare possibility to have some production of civilian radios in 1945, we are not giving this a thought for the time being, until the green light again will be



PILOT RADIO CORPORATION,
Isidor Goldberg, *President*

given by the Government agencies. In any event, I don't quite agree with you that it might take years before we will return to normal operations.

You say that even if the wars will be over a vast quantity of radio equipment will be required by the Navy and by the Armies of Occupation and that, comparatively speaking, only small quantities of civilian goods will be manufactured. You seem to lose sight of the fact that an enormous productive capacity has been created in our industry and that the radio manufacturers can well take care of both the Armed Services and large domestic requirements. It will be necessary to do something about our domestic requirements in the near future, because the shortage of properly functioning home radios in the United States is becoming a very serious matter and will become progressively worse from now on. Undoubtedly, the Government will give some serious consideration to this urgent matter by perhaps using similar methods to those which the British Government had applied in Great Britain, because it is just as important a problem for the morale of our people as other questions of public morale with which the Government is confronted.

I agree with you wholeheartedly when you mention the fantastic statements that some of

our radio manufacturers made a year ago as to what the public should expect immediately after the war. Fortunately, most manufacturers have recognized this mistake and have stopped this short-sighted kind of advertising. As you say in your editorial, it began to build up a great deal of sales resistance, because the public was inclined to think that it should wait for these super-electronic gadgets which would come with every radio set after the war.

The radio art has made great strides since the outbreak of the war, but most important will be the tendency towards better quality of component parts and workmanship.

"A Long and Difficult War"

WE at Stromberg-Carlson are fully in harmony with the thoughts expressed in your editorial, "Awake, Radio Industry!"

With two of my sons in the Navy and one in the Marine Corps, I realize keenly that this will be a long and difficult war. The Japanese fanatics must see their military forces completely subdued. Here in this country we still cannot realize the great distances and the tropical hazards that are so perplexing in maintaining communications. War is a wasteful business and we are going to have to produce lots of radio and telephone equipment for the Pacific theater of war right up to the time when the last shot is fired.

Here at Stromberg-Carlson we feel that we made outstand-



ing good FM radio receivers and phonograph combinations before the war. No doubt, our prewar models will be a standard of comparison for a number of our competitors when they come to design their postwar models. Naturally we will do what we can to improve on our prewar designs in appearance, in convenience for the user and in reliability. But when it comes to tone and performance and downright enjoyment we think the best prewar sets were very good sets indeed and we deplore the publicizing of ethereal "dream models" which all too often are impractical and which have the effect of making consumers dissatisfied with anything they can buy after the war.

STROMBERG-CARLSON Co.,
Wesley N. Angle, *President*

"Not in Full Accord"

WE are not in full accord with Mr. Hugo Gernsback's views. Although the editorial is forceful, and expresses sound thinking, we nevertheless believe that radios similar to types to those manufactured prior to



the war will appear on the market within six months after the defeat of Germany, since we will not be required to utilize all of our facilities for our fight with Japan.

Of course, the buying public should be made to realize that they will not be able to purchase new types of radios for a long time to come, and that the types of radios manufactured prior to the war are highly satisfactory.

TEMPLESTONE RADIO MFG. CORP.,
Oscar Dane, *President*

Radio Thirty-Five Years Ago

In Gernsback Publications

FROM the April, 1910, issue of MODERN ELECTRICS:

- Policing the Ether, by James M. Murdock.
- French Wireless Cars.
- Calculation of Condenser Capacity, by H. W. Secor.
- Curious Frequency Meter.
- The Burke Wireless Bill.
- Variometer for Amateurs, by M. H. Hammerly.
- How to Receive and Send at the Same

- Time, by Hallam Anderson.
- An Automatic Restoring Electrolytic Detector.
- How to Make Glass (Antenna) Insulators.
- Improved (Silicon) Detector.
- The Duplex Aerial.
- A Complete Amateur Equipment, by Ernest Brennecke.
- Winder Duplex Aerials.
- Interesting items in the advertising pages: William J. Murdock Co. of Chelsea,

Massachusetts, advertised their bare-wire double-slide tuner.

Franklin Electric Novelty Manufacturing Co. of New York disclose their new tubular variable condenser.

The book, "Wireless Telephone," by H. Gernsback—first book on the subject in print—was advertised in this issue.

The Electro Importing Company (E. I. Co.) of New York advertised their new patented Plastic Slider used on tuning coils of which hundreds of thousands were used.

HOW TO TEST A RADIO IN 2 MINUTES OR LESS!

Want to repair radios for neighbors and friends? Or, if you are a radio serviceman, do you want to learn how to diagnose radio troubles and fix sets TWICE AS FAST and TWICE AS PROFITABLY—without a lot of costly, hard-to-get test equipment?

Of course you do—and Ghirardi's RADIO TROUBLESHOOTER'S HANDBOOK is just the book that will make it possible for you to do it—for a total cost of only \$5. Send coupon on opposite page.

"IT'S THE BEST OUT OF 20" SAYS CHIEF ENGINEER

F. S. Bailey, Chief Engineer, Radio Operator's School, Brownsville, Texas, gives this endorsement of Radio-Electronics greatest basic training book: "We find Ghirardi's RADIO PHYSICS COURSE the best of 20 or more books we have tried . . . both as a complete course in Radio Physics and for all other branches including broadcasting. It is giving our students the VERY BEST FOR THEIR MONEY." Order now—use coupon on opposite page!

HOW MUCH Should Good Radio-Electronic Training Cost?

The answer is that the best basic Radio-Electronic Training that money can buy NEED NOT COST YOU MORE THAN \$5 complete. Ghirardi's RADIO PHYSICS COURSE BOOK (see advertisement on opposite page) is as complete as any book or course AT ANY PRICE—and far more complete than most. It is much easier to learn from—and it is the basic training most widely endorsed by radio experts themselves. Money-back guarantee. You cannot lose! Send coupon TODAY!

The Background of

ELECTRICAL JUST OUT! SCIENCE



THE SOUL OF AMBER, a sparkling new book by Alfred Still, will provide hours of pleasurable reading—and acquaint you fully with the entire brilliant history of Electricity in human terms. The "Soul" of amber is, of course, Electricity, and this fascinating

book follows its development from its earliest beginning associated with the superstitions of fire dancers. A. A. Ghirardi says . . . "It is the liveliest, most fascinating and informative story of Electricity I have ever read." 274 pages. Price \$2.50. See coupon on opposite page.

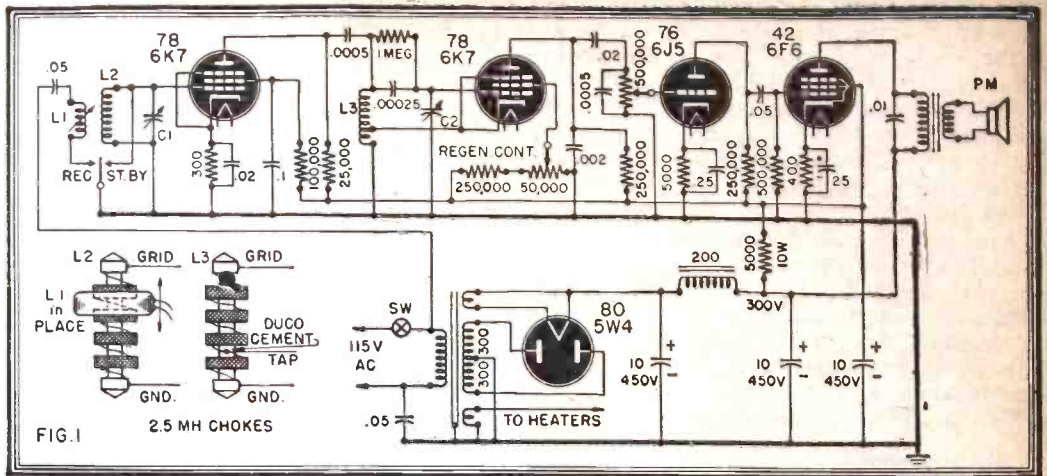

Fig. 1—Coils for the 200-kc. receiver are constructed from 2.5-millihenry R.F. chokes.

Carrier Communicator

By BOB MELVIN

VERY good "wired wireless" results are obtainable with the simple equipment described here. I have been experimenting with these circuits for some time, using approximately 200 Kc. as carrier. Communication has been carried on a distance of 6 blocks in a crowded residential district of Berkeley, and undoubtedly greater distances are easily possible. Either phone or C.W. signals may be transmitted.

The receiver, shown in Fig. 1, uses a regenerative detector, one stage of R.F. and two stages of audio. It is built on a 7 x 7 x 2 chassis in a plywood cabinet with masonite panel.

The receiver has sufficient sensitivity, considering the high static level of the power lines. High selectivity is obtained when it is in an almost-regenerating state. The tuning is broad when non-regenerating. The R.F. stage minimizes trouble due to frequency shifting as a result of ever-changing load on the power lines.

During periods of transmission, the receiver is silenced by throwing the switch from "receive" to "stand by." This switch is mounted on the regeneration potentiometer. The coil L1 is 50 turns of No. 24 to 30 wire, simply scramble-wound on a temporary paper or glass tube, just big enough to fit over the pies on the 2.5-MH choke. All other coil constants are given in the diagram. The turns of L1 are cemented together and then slipped over L2, its posi-

tion being changed until best results are obtained.

A transmitter for both C.W. and phone is drawn in Fig. 2. B is a 6.3-volt bulb used as an R.F. indicator. It is fed from a single turn around the tank coil. The center tap on the tank is adjusted for maximum brilliancy of the bulb. "Ch" is a 100 M.A. modulation choke. If an audio amplifier is already available, Fig. 3 may be used. The regular output transformer is connected to terminals "A.F." to feed the large output transformer T1 in the figure. A modulation transformer or large class-B audio unit should be used in this circuit, as the currents are very heavy, and the bigger your transformer is the better.

Coils for either transmitter may be wound on a 3/4-inch diameter coil form (salt box). If an actual salt box is used, be sure to moisture-proof it with a couple of coats of insulating varnish, or by dipping it in melted paraffine wax. Coil L3 is made by winding 2 1/2 inches of No. 20 wire on the salt box, tapping every 5 turns. L1 is 4 or 5 turns of hook-up wire wound on top of L3 so that it can be varied to suit line conditions. L2 is one turn around the form just below L3, and is the indicator light circuit.

All the circuits shown are straightforward and use standard parts, many of which may be found in the junk-box. I am very pleased with my carrier current results and hope some of you experimenters will join me.

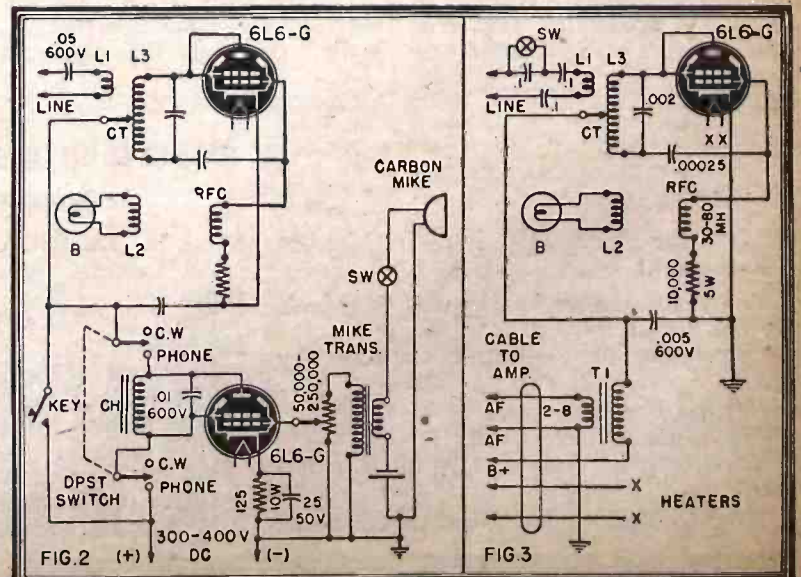

Fig. 2—The 6L6 modulator and transmitter circuit complete. Fig. 3—A suitable hook-up for use if an audio amplifier is available as modulator. Values for all coils are supplied in the text.

MAKE MONEY REPAIRING RADIOS

AND OTHER ELECTRONIC EQUIPMENT

TELLS YOU EXACTLY WHAT TO DO... EXACTLY HOW TO DO IT

If you like to repair radios at home in spare time, Ghirardi's RADIO TROUBLESHOOTER'S HANDBOOK offers you a new, fast way that makes the work easy—without a lot of previous experience or scarce, expensive test equipment. Or, if you are a professional radio man, it helps you repair two sets in less than the time you'd normally take for one. It is the ideal book for training new helpers, for substituting tubes and parts in these days of shortages, for repairing cheap sets quickly and profitably—in short, for repairing radios better, faster and more profitably than you may have thought possible.

4 LBS. OF FACTUAL, TIME-SAVING, MONEY-MAKING SERVICE DATA

RADIO TROUBLESHOOTER'S HANDBOOK isn't a "study" book. It rolls up its sleeves and goes to work for you the minute you get it. It can easily pay for itself the first time you use it! Simply look up the make, model, and the trouble symptom of the Radio you want to repair . . . and go to work. No useless testing! No lost time or motion!

The HANDBOOK'S clear instructions tell you exactly what the trouble is likely to be . . . and EXACTLY how to fix it. Actually, this big, 4 pound, 744-page, manual-size HANDBOOK brings you factual repair data for practically every radio in use today—over 4,800 individual makes and models!

In addition, there are hundreds of pages of helpful repair charts, tube charts, data on tuning alignment, transformer troubles, tube and parts substitutions, color codes, etc.—all for only \$5 (\$5.50 foreign) on an ABSOLUTE 5-DAY MONEY-BACK GUARANTEE.

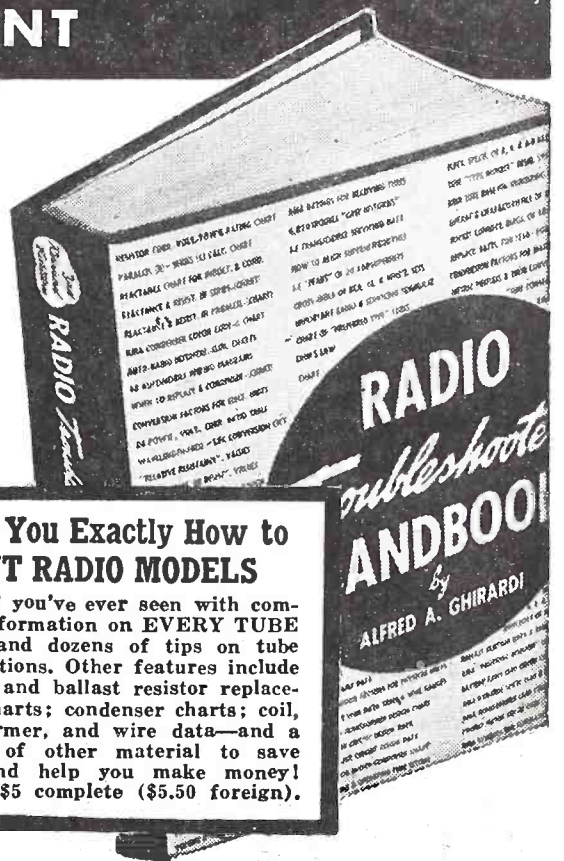

This "Automatic Teacher" Shows You Exactly How to REPAIR OVER 4,800 DIFFERENT RADIO MODELS

Over 400 pages of the RADIO TROUBLESHOOTER'S HANDBOOK include specific common Trouble Symptoms, their causes and Remedies for practically every Radio Receiver in use today. IN ADDITION, there are hundreds of pages including i-f alignment peaks for over 20,000 superhets; a big data section on i-f transformer troubles—and the most up-to-the-minute TUBE

CHART you've ever seen with complete information on EVERY TUBE TYPE and dozens of tips on tube substitutions. Other features include plug-in and ballast resistor replacement charts; condenser charts; coil, transformer, and wire data—and a wealth of other material to save time and help you make money! ONLY \$5 complete (\$5.50 foreign).

COMPLETE BASIC RADIO-ELECTRONIC TRAINING

▼ FOR BEGINNERS \$5

All the Basic Science of Radio-Electronics in One Big 3½ lb. Book—No Monthly lessons to Wait for

(\$5.50 foreign)

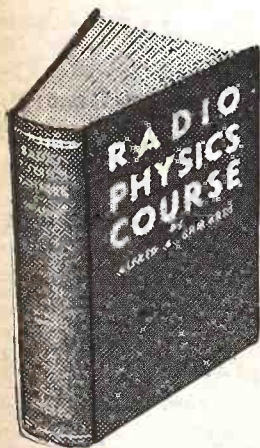

36 COURSES IN ONE

Easily worth \$50 or more if broken into "course" form and sent to you in monthly lessons.

Train NOW for the most interesting of all post-war futures—RADIO-ELECTRONICS! Ghirardi's 972-page RADIO PHYSICS COURSE BOOK gives you all the basic training you need—at a price you can afford to pay! Actually, this big book has started more people in Radio-Electronics than any other book or course. It is more widely used for home study—and more widely used in U. S. Signal Corps and Navy Schools and in civilian schools and colleges than any other book of its kind.

NO OTHER COURSE LIKE IT!

Ghirardi's RADIO PHYSICS COURSE book with its 500 illustrations and 856 self-testing review questions makes it surprisingly easy for you to learn at home without an instructor. Nothing is omitted, nothing condensed. Everything is made as easy as A-B-C. Ask any radio man! You'll be amazed how quickly you'll master the subjects that other courses and books make seem very complicated. Begin today! Examine this truly great book for 5 full days—and get every cent of your money back if not more than satisfied. You cannot lose!

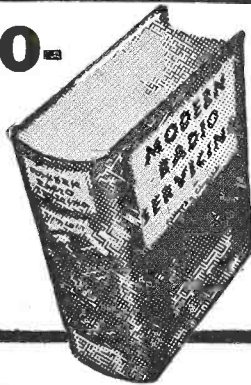

EVERY CONCEIVABLE SERVICE SUBJECT

Explains circuit and operation of all types of essential service instrument types; How and When to use them; How to build your own; Preliminary trouble checks; Troubleshooting; Repairs; Obscure radio troubles; Aligning and neutralizing; Auto and Marine Radios; Interference reduction; AVC and QAVC circuits, etc., etc.

LEARN PROFESSIONAL RADIO SERVICE WORK at home without an instructor!

Study now for a good job as a professional Radio-Electronic Service Expert. It's easy to learn from Ghirardi's big 1300-page profusely illustrated MODERN RADIO SERVICING book that costs you only \$5 complete. This one big book covers all phases of the work! Explains all necessary test instruments . . . even how to build your own if you prefer; how to troubleshoot all makes of radios, analyze electronic circuits, test components, make adjustments, repairs, etc., etc.—all step-by-step. Even explains how to start a successful Radio-Electronic Service Business of your own. Sold separately for \$5 (\$5.50 foreign), or, see MONEY-MAKING COMBINATION OFFER in coupon.

5-DAY MONEY BACK GUARANTEE

Technical Division, MURRAY HILL BOOKS, Inc., Dept. RC-45, 232 Madison Ave., New York 16, N. Y.

Enclosed find \$..... for books checked; or send C.O.D. (in U.S.A. only) for this amount plus postage. If not fully satisfactory, I may return the books at the end of five days and receive my money back.

- RADIO TROUBLESHOOTER'S HANDBOOK \$5 (\$5.50 foreign)
- MODERN RADIO SERVICING \$5 (\$5.50 foreign)
- RADIO PHYSICS COURSE \$5 (\$5.50 foreign)

THE SOUL OF AMBER \$2.50 (\$2.75 foreign) (See opposite page)

Special MONEY-MAKING COMBINATION: Both Modern Radio Servicing and Troubleshooter's Handbook, \$9.50 for the two (\$10.50 foreign)

Name

Address

City & Dist. No. State

(Please print or write plainly)

World-Wide Station List

Edited by ELMER R. FULLER

SPRING! and the advent of better receiving conditions is now at hand. The higher frequencies will stay open longer at night, and will be more consistent from day to day. According to the scientists of the world, we are in the midst of a cycle of sun spots which have a wide effect on the action of radio waves; and it will be a few years before conditions are again at their best.

Our Allied Armies are moving so fast nowadays that it is difficult to report to you on the stations being operated by the Signal Corps. They are springing up all over the world faster than we can keep track of them, even in our weekly reports. We sure hope that they will soon be in every capital and country of our enemies; and we will be especially happy the night we hear a W call from the Tokyo transmitters.

We still have time to read a few more reports each week, so why not send your listening results to us? Every one helps to keep our station list in the most up-to-date manner! With the coming season, you should have more than ever to send. Also we have a surprise for every regular contributor; and from what I hear from our present observers, it is worth receiving. All schedules are Eastern War Time.

Freq.	Station	Location and Schedule	Freq.	Station	Location and Schedule	Freq.	Station	Location and Schedule
9.095	—	ANGOLA; new station on at 3:45 to 4:30 pm.	9.640	GVZ	LONDON, ENGLAND; heard at 2:30 am in Pacific service.	9.690	GRX	LONDON, ENGLAND; North American beam, 5:15 to 10:15 pm.
9.120	—	BALIKPAPAN, BORNEO; 6 to 7 pm.	9.646	XGOY	CHUNGKING, CHINA; East Asia and South Seas beam, 7:35 to 9:40 am; North American beam, 9:45 to 11:40 am; European beam, 11:45 am to 12:30 pm; East Asia and South Seas beam, 12:30 pm to 1:45 pm.	9.693	JIE2	TAIHOBU, FORMOSA.
9.125	HAT4	BUDAPEST, HUNGARY; not heard recently.				9.700	WRUS	BOSTON, MASSACHUSETTS; Central American beam, 7:30 to 2 am; North African beam, 1:30 to 3:45 pm; 4 to 7:15 pm.
9.130	HI2G	CIUDAD TRUJILLO, DOMINICAN REPUBLIC; 10 pm.	9.650	DJW	BERLIN, GERMANY.	9.700	WRUW	BOSTON, MASSACHUSETTS; European beam, 6:30 to 8 am.
9.270	COCX	HAVANA, CUBA; heard at 1 am.	9.660	—	LONDON, ENGLAND; heard at 8:19 pm.	9.700	KNBC	SAN FRANCISCO, CALIFORNIA; Oriental beam, 5 to 9 am; East Indies beam, 1 to 3:45 pm.
9.31	PJY9	CURACAO, NETHERLANDS WEST INDIES.	9.670	WRCA	NEW YORK CITY; Brazilian beam, 8 to 11:30 pm.	9.705	—	FORT DE FRANCE, MARTINIQUE; heard at 6:30 pm.
9.360	CBFX	MONTREAL, CANADA; 7:30 am to 11:30 pm.				9.720	PRL7	RIO DE JANEIRO, BRAZIL; 4 to 9:45 pm.
9.410	—	LONDON, ENGLAND; South American service.				9.730	XGOA	CHUNGKING, CHINA; 1:30 to 2:40 am; 6:30 to 10 am.
9.440	FZI	BRAZZAVILLE, FRENCH WEST AFRICA; off at 7:45 pm.				9.735	CSW7	LISBON, PORTUGAL; heard 9 to 10 pm.
9.445	—	LONDON, ENGLAND.				9.735	CXA15	MONTEVIDEO, URUGUAY.
9.465	TAP	ANKARA, TURKEY; heard at 1 and 4 pm in French and English.				9.750	WLWRI	CINCINNATI, OHIO; European beam, 7 am to 11 pm.
9.480	—	MOSCOW, U.S.S.R.; 8:10 to 8:50 pm.				9.750	KCBF	LOS ANGELES, CALIFORNIA; South America beam, midnight to 2 am; Oriental beam, 5 am to 1 pm.
9.490	KRCA	SAN FRANCISCO, CALIFORNIA; Oriental beam, 5 to 10:45 am.				9.760	DKSA	"DEUTSCHER KURZWELLEN SENDER ATLANTIK".
9.490	WCBX	NEW YORK CITY; Brazilian beam, 5 to 11:30 pm.				9.785	OTC	LEOPOLDVILLE, BELGIAN CONGO; relays BBC evenings.
9.490	—	LONDON, ENGLAND; European service.				9.800	DKSA	"DEUTSCHER KURZWELLEN SENDER ATLANTIK"; heard at 2:30 pm.
9.500	XEWW	MEXICO CITY, MEXICO; 9 am to 3 pm.				9.825	GRH	LONDON, ENGLAND; heard at 9:50 pm.
9.510	TAP	ANKARA, TURKEY; 1 to 2 pm.				9.835	—	"HUNGARIAN NATIONS RADIO"; 1:15 to 1:30 am.
9.510	GSB	LONDON, ENGLAND; heard at 2 pm and 1 am.				9.855	KWIX	SAN FRANCISCO, CALIFORNIA; New Guinea beam, 5 to 6:45 am.
9.520	—	COPENHAGEN, DENMARK; last heard at 8 to 11 pm.				9.855	WNRA	NEW YORK CITY; European beam, 6:30 to 9 am; 2:15 to 11 pm.
9.525	—	LONDON, ENGLAND; European service.				9.897	WBOS	BOSTON, MASSACHUSETTS; European beam, 2:30 to 5:15 pm; 7:15 to 11 pm.
9.530	WGEO	SCHENECTADY, NEW YORK; European beam, 4 to 5:15 pm; South American beam, 6 pm to midnight.				9.897	WLWLI	CINCINNATI, OHIO; North African beam, 7:15 to 11 pm.
9.535	JZI	TOKYO, JAPAN; heard at 2 and 11:30 pm and 3 am.				9.897	KROJ	LOS ANGELES, CALIFORNIA; New Guinea beam, 3 to 4:45 am; 2 to 4:30 pm; Alaska beam, noon to 1:45 pm.
9.535	—	BERN, SWITZERLAND; 9:30 to 11 pm to North America.				9.930	SVM	ATHENS, GREECE; heard 2 to 7 pm.
9.538	—	"RADIO SHONAN" AT SINGAPORE; heard at 7:30 am.				9.930	DKSA	"DEUTSCHER KURZWELLEN SENDER ATLANTIK"; heard at 2:30 pm.
9.540	VLG2	MELBOURNE, AUSTRALIA; 8:30 am and 11 am.				9.950	—	NBC IN LONDON, ENGLAND; no sked followed.
9.540	DJN	BERLIN, GERMANY; evenings till about 11 pm.				9.958	HCJB	QUITO, ECUADOR.
9.540	VE9AI	EDMONTON, CANADA; heard about 10 pm; no sked.				10.000	WWV	WASHINGTON, D. C.; U. S. Bureau of Standards.
9.550	—	LONDON, ENGLAND.				10.005	—	"VOICE OF FREE ARABS"; 2:15 to 2:30 pm.
9.550	GWB	SAN FRANCISCO, CALIFORNIA; Oriental beam, 1:20 to 4:45 am; Hawaiian beam, noon to 1:15 pm.				10.040	—	BERLIN, GERMANY; heard evenings till 11 pm.
9.550	KGE1	MEXICO CITY, MEXICO.				10.050	SUV	CAIRO, EGYPT; heard calling New York Sundays.
9.555	XETT	MOSCOW, U.S.S.R.; 6 to 6:45 pm; 7:40 to 8:30 am.				10.065	—	CAIRO, EGYPT; heard afternoons.
9.560	DJA	SAN FRANCISCO, CALIFORNIA; Oriental beam, 7 to 9:45 am.				10.080	—	MADRID, SPAIN; heard calling New York.
9.565	—	SAN FRANCISCO, CALIFORNIA; South American beam, 7:45 pm to midnight; Oriental beam, 12:15 to 4:45 am.				10.130	HH3W	PORT AU PRINCE, HAITI; 1 to 5 pm; 7 to 11:30 pm.
9.570	KWIX	SAN FRANCISCO, CALIFORNIA; Oriental beam, 7 to 9:45 am.				10.169	—	"STATION PARIS"; PARIS, FRANCE; press or to NBC and CBS, often at noon and 6:30 pm.
9.570	KWID	SAN FRANCISCO, CALIFORNIA; South American beam, 7:45 pm to midnight; Oriental beam, 12:15 to 4:45 am.				10.220	PSH	RIO DE JANEIRO, BRAZIL; evenings.
9.580	GSC	LONDON, ENGLAND; North American service; 5:15 pm to 12:45 am.				10.290	DJC	BERLIN, GERMANY; no sked known.
9.580	VLG	MELBOURNE, AUSTRALIA; 10:15 to 10:45 am.				10.338	HE04	BERN, SWITZERLAND; North American beam, 3:45 to 4:15 pm except Saturdays; to South America, 7:30 to 9 pm.
9.590	WLWO	CINCINNATI, OHIO; South American beam, 7 pm to 1:15 am; European beam, 4 to 5:45 pm.				10.350	LQA5	BUENOS AIRES, ARGENTINA; 7:15 to 7:35 pm.
9.590	—	SAN JOSE, COSTA RICA; heard at 7 to 7:30 pm.				10.400	YPSA	SAN SALVADOR, EL SALVADOR; heard evenings.
9.595	—	ATHLONE, IRELAND; heard at 5:10 to 5:30 pm.				10.543	DZD	BERLIN, GERMANY; South American beam, 6:50 pm to midnight.
9.600	XAEW	MEXICO CITY, MEXICO; heard late afternoons and evenings.				10.620	KES3	SAN FRANCISCO, CALIFORNIA; Hawaiian beam, 7 pm to 1 am.
9.600	GRY	LONDON, ENGLAND.				10.780	SBB2	STOCKHOLM, SWEDEN; about 11 am or noon.
9.608	ZRL	CAPE TOWN, SOUTH AFRICA; 10 to 11:45 am.						
9.610	ZYCB	RIO DE JANEIRO, BRAZIL.						
9.610	DXB	BERLIN, GERMANY; North American beam, 5:50 pm to midnight.						
9.615	VLG6	MELBOURNE, AUSTRALIA; heard at 8:30 and 11 am.						
9.615	TIPG	SAN JOSE, COSTA RICA; heard at 9 pm.						
9.615	XERQ	MEXICO CITY, MEXICO; heard at 7:25 pm.						
9.625	XGCA	CHINA; 7 to 8:45 am.						
9.625	—	LONDON, ENGLAND; South American service.						
9.630	CBFX	MONTREAL, CANADA; heard off at 12:06 am.						

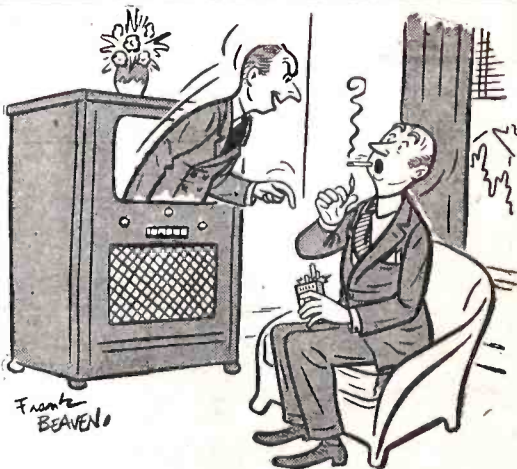

Suggested by: Maurice Goudreau, Montreal Quebec, Canada

"Got a cigarette, Bud?"

MURDER BY RADAR?

Among the various items on the antiquity and true authorship of Radar, the following was submitted by a correspondent who found it in *The American Weekly*, January 14, 1945:

"Vigilantes were organized and soon tracked down Radar Davis, a youth with a criminal record, as a suspect. He confessed killing McGee, Mrs. Henderson and W. E. Stanley, a farmer, as well as committing dozens of robberies."

The crimes referred to were committed in the spring of 1929, at which time "Radar" must have already been current for a number of years. Possibly some etymologist will look up the case of Radar Davis, and tell us how the name was derived?

Simplified...but Complete!

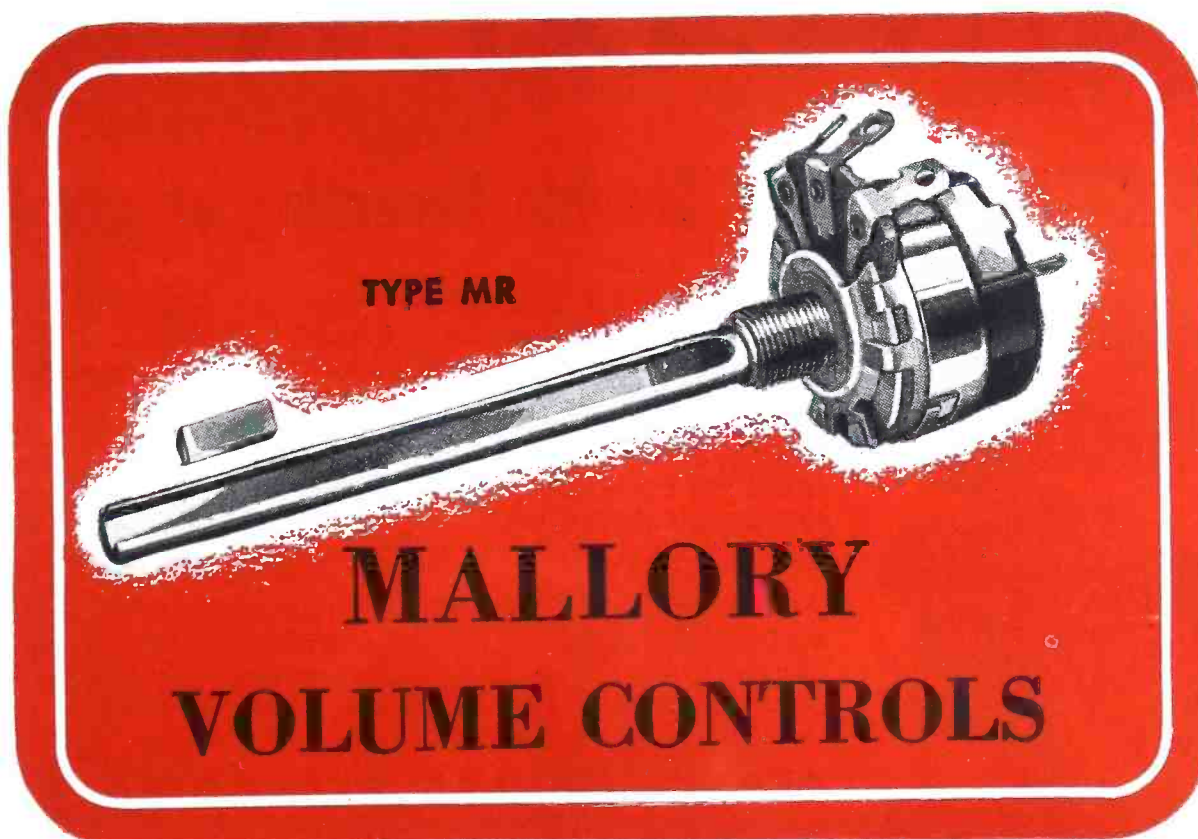

Replace Both Large and Small Controls

The perfect size for every application!



Precision-built like a fine watch!



Rugged strength for years of service!



The A-C switch that snaps on and stays on!



THIS Mallory Volume Control is one of a popular, streamlined group that embodies every practical short cut possible to keep your inventory *down* and *simplify* your service work. Only 16 controls are needed for approximately 85% of all your replacement needs! That's because of Mallory plug-in shafts which, used in conjunction with Mallory controls, replace nearly any volume control ever made—*duplicate* them exactly, mechanically and electrically!

The A-C switch on this control doesn't need disassembling—just snap it on and it *stays* on! The control itself gives you quiet operation and gradual increase or decrease of volume. And as for Mallory plug-in shafts, they just *can't* pull or twist loose.

Your Mallory distributor will help you select a simple kit of shafts and controls that will answer nearly all of your service problems. No other line gives you such complete coverage on so small an inventory investment!

P. R. MALLORY & CO., Inc., INDIANAPOLIS 6, INDIANA



More than ever—
ALWAYS
INSIST ON

P. R. MALLORY & CO. Inc.
MALLORY
APPROVED
PRECISION PRODUCTS

VIBRATORS • VIBRAPACKS* • CONDENSERS
VOLUME CONTROLS • SWITCHES • RESISTORS
FILTERS • RECTIFIERS • POWER SUPPLIES

ALSO MALLORY "TROPICAL"® DRY BATTERIES, ORIGINALLY DEVELOPED BY MALLORY FOR THE U. S. ARMY SIGNAL CORPS, NOT PRESENTLY AVAILABLE FOR CIVILIAN USE.

*Trademark

ALDEN

for Graphic Recording of any kind

OUR YEARS OF EXPERIENCE, and cumulative skills, in the designing and production of RADIO COMPONENTS, are now being used in making equipment which covers **the entire field of FACSIMILE.**

Actual service, as found in war and communication work under all conditions, has given a PRACTICAL quality to our equipment which, under ordinary conditions, would not have been obtained in years of engineering with limited application.

ALDEN PRODUCTS COMPANY is manufacturing practically ALL TYPES AND SIZES of facsimile and impulse recording equipment—using all the varied recording mediums: Photographic Paper, Film, Electrolytic Paper, Teledeltos, and Ink.

ALFAX IMPULSE RECORDING PAPER

By "COVERING THE ENTIRE FIELD," we mean

1. Some of our equipment has been used for the transmitting and receiving of photographic pictures of reasonably high resolution (such as the war pictures now appearing in the news).
2. Continuous Recorders—of the type whose value has been proven on National and International news service circuits—are now on their way to the Orient, to be used for the receiving of the so-called "picture" languages.
3. Also, through the use of ALFAX (the first high-speed black and white permanent recording paper), HIGH-SPEED Signal Analysis Equipment has been made possible for various laboratories and Government Departments. Other equipments have employed Teledeltos Paper for message work and other purposes.
4. The ability of ALFAX Paper and ALDEN Machines to record impulses AS THEY OCCUR, without the inertia problems of many previous methods, has made possible other recorders at various speeds (including slow). They will record a whole day's history of related phenomena, with time indicated, and often—with self-calibrated linear reference marks for ready interpretation.
5. ALDEN Tape Recorders (recording medium, ink)—have been designed to operate with a minimum of trouble and adjustments, and have PROVED MOST SATISFACTORY in day to day service.

ALDEN PRODUCTS COMPANY

117 North Main Street

BROCKTON (64J), MASSACHUSETTS

.....

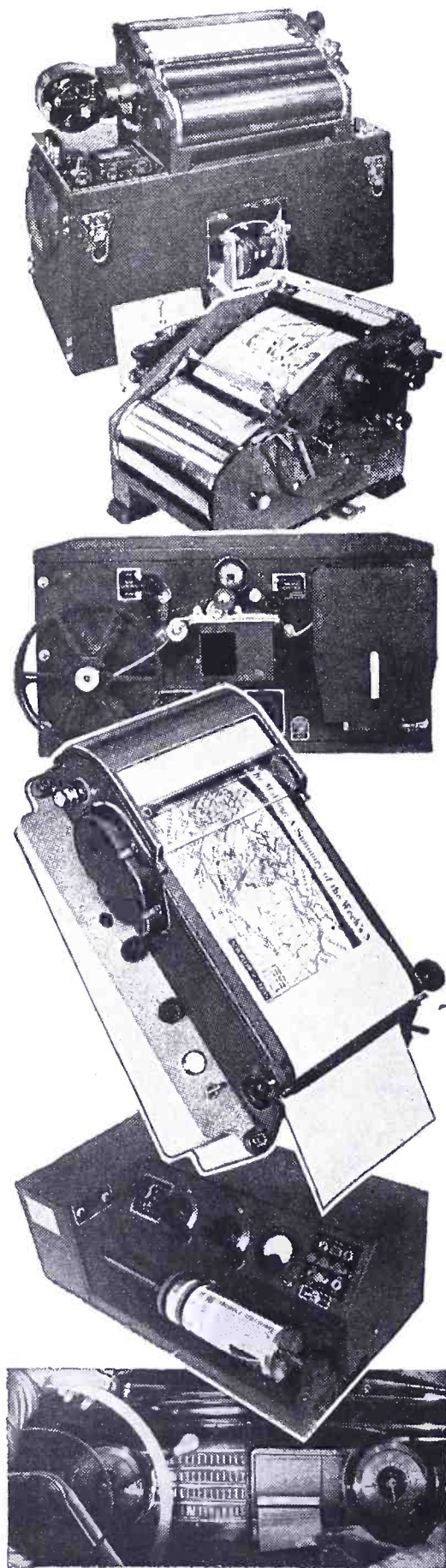

RECHARGEABLE 1½V CELL

AN interesting feature in rechargeable flashlight cells is seen in the one illustrated. Made by the B. F. Goodrich Co., it has a patented device to prevent spilling of liquid, no matter what position the flashlight is held in. The cone-shaped deflector shown in the drawing prevents the solution from reaching the vent cap, even if the light is held in an upside-down position. This is necessary, as the vent must have an opening for the escape of gases.

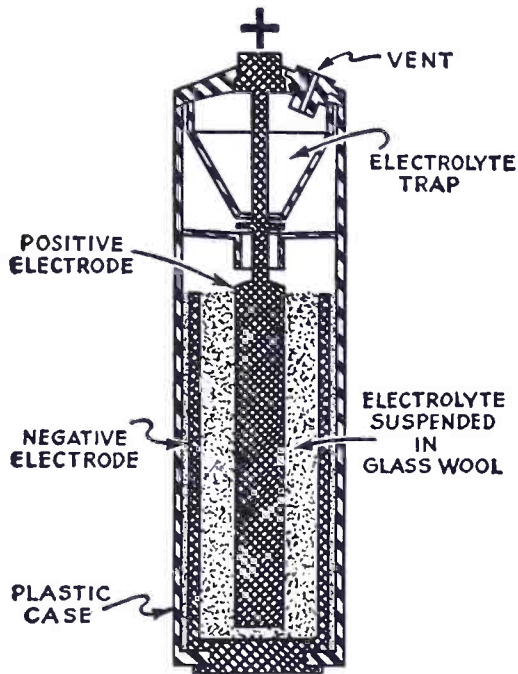

The cell is enclosed in a plastic container, which, being transparent, permits examination of the liquid level. This is supposed to just saturate the glass wool used as packing between the electrodes. To check the level, the cell is shaken sharply, with the familiar down-swing of a clinical thermometer. This drives the liquid up into sight. If a little is then visible in the measuring chamber, the supply is sufficient. If not, distilled water is added with a dropper.

Cells of the wet type are especially useful in industrial plants, ships, mines, etc., where large numbers of flashlights are used constantly. The cost of constant renewal and the annoyance and danger of dimming lights is avoided by periodic recharging of the storage cells. The cell is not as useful to individuals who make only rare use of their flashlights, as a recharge every month or so is necessary, even if the light is not used.

The cell operates with a special 1.6-volt, 0.6-ampere lamp, which operates approximately three hours on a single charge. The storage-cell feature of almost full brilliancy for practically the full period of the discharge is another advantage of this type of cell. Once the lamp starts to dim, it goes out entirely within 5 to 15 minutes. This is in sharp contrast to dry-cell operation, where maximum brilliancy is obtained during only a small fraction of the total period of use.

SERVICE NOTE FOR AK-37

These sets may start off with a loud howl while the tubes are warming up. Soldering a 50,000 ohm, ½ watt resistor from plate to cathode of the 27 detector will cure this.

I find this also applies to the Philco 511.

ERNEST F. JOHNSON,
Jonesboro, Tenn.

THE STANDARD
OF QUALITY
FOR A THIRD
OF A CENTURY

HICKOK
INSTRUMENTS

Electronic and Radio Service Equipment



Volt-Ohm-Milliammeter

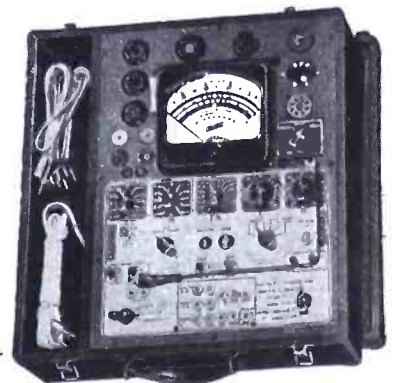

All-Purpose
Tube and Set Tester



Signal Generators



Oscillograph

● HICKOK Instruments have long been known as the ultimate in scientific development. Illustrated here are but 4 of our 36 leaders in the Radio Service field. Thousands of Radio Service men have preferred HICKOK Instruments because of their unusual accuracy and dependability.

HICKOK pioneered in Dynamic Mutual Conductance Tube Testing Equipment. In the field of Signal Generators, Traceometers, Vacuum tube Voltmeters, Oscillographs, Zero Current Testers, Volt-ohm-milliammeters and Industrial Analyzers the name HICKOK is assurance of excellence.

PRECISION CALIBRATED • LASTING ACCURACY

**THE HICKOK ELECTRICAL
INSTRUMENT COMPANY**

10531 Dupont Avenue

Cleveland 8, Ohio

GET ABOARD! . . .

IRC's NEW "CENTURY LINE"



**16 POPULAR TYPES
WITH FIXED SHAFTS**

**56 UNIVERSAL TYPES
WITH TAP-IN SHAFTS**

**100 ALL-PURPOSE CONTROLS THAT WILL CARE FOR BETTER THAN 90%
OF ALL YOUR SERVICE NEEDS! THIS MEANS BETTER DELIVERY, SMALLER
INVENTORY, MORE PROFIT THROUGH FASTER TURNOVER. ASK
YOUR PARTS JOBBER ABOUT THE NEW IRC CENTURY LINE TODAY.**



**8 CLUTCH TYPES
WITH FIXED SHAFTS**

**2 SPECIALS
FOR POWER USE**

**7 DUALS WITH
FIXED SHAFTS**

**11 SPECIALS FOR
SPECIFIC USES**



The IRC "Century Line" was developed because wartime restrictions and critical material shortages made it impossible to produce in sufficient quantity all of the exact duplicates, plus the many special controls which are in demand. The controls included in this streamlined version are all of the same high IRC quality for which

the entire industry has always shown preference. Extreme care based on exhaustive study of sales records and set designs makes this "Century Line" the kind a busy service man would choose for himself. All numbers in the Century Line are available for urgent civilian replacement needs under L-265 priorities.

INTERNATIONAL RESISTANCE CO.

DEPT. 25-D • 401 N. BROAD ST. • PHILADELPHIA 8, PA.

IRC makes more types of resistance units, in more shapes, for more applications than any other manufacturer in the world.





The system dispatcher communicating with an emergency truck crew. Supervisor using two-way radio from the scene of an emergency.

Two-Way Radio Speeds Transportation

A NEW and important field for two-way civilian radio is that of transportation maintenance systems. Pioneer in the use of radio for this work is Philadelphia Transportation Co., which has installed two-way FM radio between its central station, 28 service supervisors' cars and six emergency trucks.

Supervisors are the line officers of a transit system. Each is assigned to one or more routes over which he maintains constant watch to keep cars and buses on schedule. When a traffic jam, fire, accident or other cause halts or delays any of the vehicles under his command, he acts to resume regular service as quickly as pos-

sible. By quick action he can often prevent a small local delay from paralyzing an entire route.

Unlike the older radio communication systems, the equipment is of the frequency modulation type, but heretofore has been largely one-way from dispatchers to supervisors. The new two-way installations are also frequency modulated, similar to modern military communication equipment. Frequency modulation eliminates much of the static and local electrical interference, thereby making it possible to get clear reception in downtown industrial areas.

The central 400-watt station sends out signals of sufficient strength to be picked

up anywhere in the Philadelphia area. The 25-watt portable transmitters have an assured coverage of about five miles. To bring in the signals from the portable transmitters, four receivers in different sections of the city relay their messages over telephone wires to the dispatcher's office.

By means of the new radio facilities the dispatcher may hold two-way conversations with any of the radio equipped vehicles or may talk to all simultaneously. It is also physically possible for supervisors and emergency units within range to talk directly to each other with corresponding saving of time and rapid clearing of transportation snarls.

New Thinking Machine Is Horizontal

SEVERAL differential analyzers, "thinking machines," have been described in *Radio-Craft* and other magazines recently. The cut shows the latest type, General Electric's approach to the differential analyzer.

This wizard machine, consisting of an interconnected system of shafts, motors and gears, employs mechanical elements for addition, subtraction, multiplication and division, and electro-mechanical elements for more complex functions. Practically all of the gears and couplings are removable and must be set up in a different arrangement for each new problem.

According to scientists, almost any physical phenomenon can be expressed in terms of differential equations. Since this analyzer is fundamentally a tool permitting rapid solution of such equations, it can be used to solve many problems of an important nature whose correct answers were until now only guessed at.

Most important element of this new analyzer is a polaroid photoelectric system of unique design. Fourteen of these highly sensitive devices are installed on the machine, thus permitting the accurate, speedy solution of differential equations requiring as many as fourteen simultaneous integrations.

Differential analyzers of a type similar to the G-E device were first developed by Dr. Vannevar Bush, formerly of Massachusetts Institute of Technology. Later the

Moore School of the University of Pennsylvania and M. I. T. made modifications and further improvements. When General Electric began construction of its analyzer, it patterned the mechanical part largely after those already in existence, adding

some unique features of its own development. Most important of these was the photoelectric follow-up system used with the integrator. This improved the performance of the analyzer by attaining a shorter solution time with a greater degree of accuracy.

By making use of such mechanized mathematics, engineers have been studying many complex physical problems, a great number of which are related to the war. Applications made of the machine so far have included such problems as radar, hydrodynamic flow, rotating machinery, airplane

stresses and speed governors. According to engineers, continuous availability of it in the future will result in greater knowledge and better understanding of many technical problems which were hitherto unsolved and for all practical purposes unsolvable.

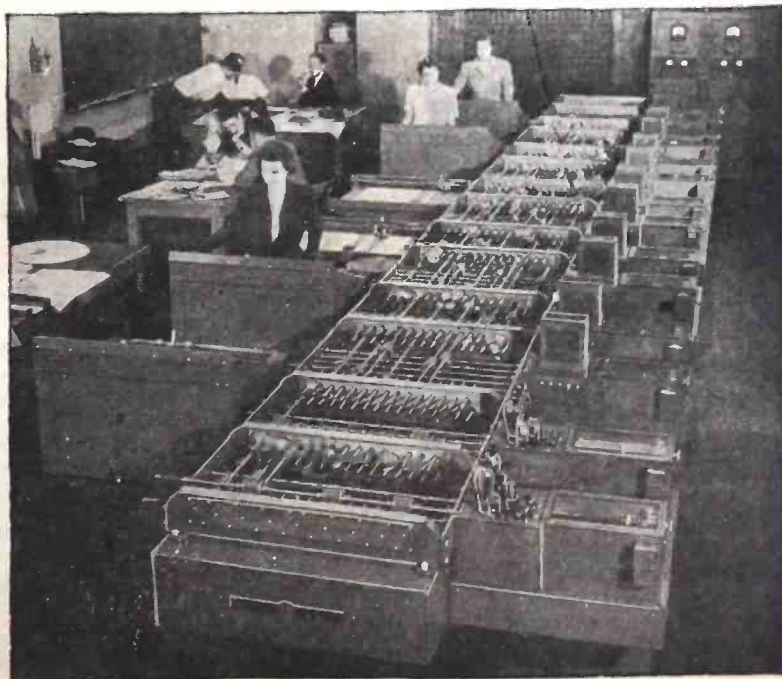

New Radio Electronic Devices

NARROW LEVER KEY

Federal Telephone and Radio Corp.
Newark, New Jersey

A NEW lever key only 7/16" wide is now being produced for control purposes in electronic and communications equipment where small size is important.

Though narrower than any other existing key, this reduction in size has been accomplished without any sacrifice in versatility, as the 18-spring capacity permits more than 500 possible switching combinations. Over-all design simplification has resulted

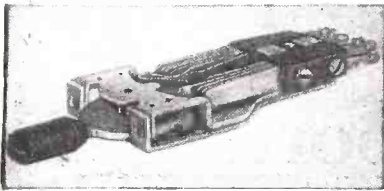

in a more rugged, dependable device.

Designed for one- or two-way, locking or non-locking operation, the entire key assembly is held together by a single screw to facilitate disassembly. The spring pile-up mounts on one side of the two-piece pressed steel frame, with all front position springs in one group and all back position springs in another.—*Radio-Craft*

PLASTIC CLIP

Commercial Plastics Co.
Chicago, Illinois

THE clip, known as CPC 1051, is made from a special formulated ethyl cellulose plastic, and is particularly popular in radio, aircraft and other multiple wiring applications. This is primarily due to the "Rolled Edge" feature which, regardless of vibration, prevents wear on the wire insulation held in place by the clips, thus preventing short-circuiting so common with metal clips. The resiliency of the ma-

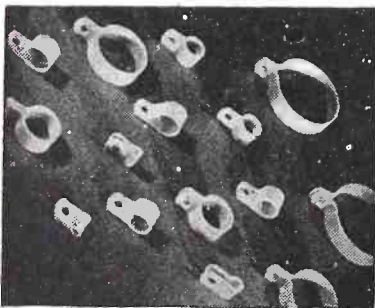

terial itself seems to accentuate this feature.

A saving in man-hours is realized in the use of these clips as they are non-conductors of electricity and consequently, require no insulation. The clips have great fatigue and impact strength, as well as a wide range of temperature resistance, and have excellent dimensional stability.—*Radio-Craft*

GROUND RESISTANCE TESTER

Associated Research, Inc.
Chicago, Illinois

A MUCH greater range of low and high ground electrical resistance testing is provided by the new Model 255 Vibroground, manufactured by Associated Research, Inc., 231 South Green St., Chicago 7, Ill. While it gives accurate readings for all ground conditions, it is particularly adapted to arid or wet regions or where extremes of dryness or moisture are found.

Protection of life and property by installation and maintenance of adequate ground connections is so important as to make a dependable ground resistance tester essential equipment in all fields where grounding is essential.

The new Model 255 Vibroground has four ranges 0-3, 0-30, 0-300, 0-3000 ohms. It comes complete with self-contained



power supply which eliminates hand cranking. With its direct readings no calculations are necessary. Reverse readings are unnecessary and polarization errors cannot occur. The design also excludes strays from high potential networks, D.C. ground currents, or any A.C. commercial frequencies, and other sources encountered in plant or field.—*Radio-Craft*

MOBILE RECTIFIER UNIT

W. Green Electric Co.
New York, N. Y.

THE Green mobile rectifier unit for magnetic testing is a power supply unit which has a continuous capacity of 1500 amperes D.C. with proportionately higher rating for intermittent operation. The output voltage is adjustable in eight steps from one to six volts. A fan-cooled selenium rectifier assembly is the heart of the unit. Deep "rain-proof" louvres at each end provide for air intake and exhaust.

D.C. output terminals on each side, also the control panel, are located in recesses in the cabinet

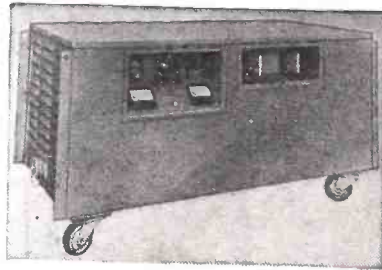

walls. The control panel is equipped with fan starting switch, push buttons for main contactor control, voltage adjustment switch, pilot lamp, visual and audible overload warning signals, voltmeter and ammeter.

Three-phase, 440-volt, 25-cycle power supply is brought to the Green unit through a 25-foot cable which plugs into a weatherproof receptacle at one end of the rectifier unit's cabinet.—*Radio-Craft*

AUDIO CHANALYST

Radio Corporation of America
Camden, New Jersey

THE new Audio Chanalyst, RCA Type 170A, is comprised of several self-contained testing sections or "channels" and can be used to test any point of any sound system from microphone to speaker, serving in emergencies as a bridging unit to substitute for the defective section of an inoperative amplifier.

The Audio Chanalyst contains a calibrated high gain amplifier useful for signal tracing, tube checking and gain measurements. It supplies its own test signal from a built-in Beat Frequency Oscillator, which can be operated by an internal auxiliary sweep circuit for checking multiple speaker installations and other work for which it is adapted.

The famous VoltOhmyst is included as one of the channels and it has been modified for flat, linear measurement of audio frequencies.



An impedance tester and a high-speed Electronic Indicator add to the unique testing facilities of the Audio Chanalyst, as various combinations of its channels can be used for different applications in audible and visual testing.—*Radio-Craft*

CIRCUIT BREAKER

Littelfuse Inc.
El Monte, Calif.

THIS new circuit breaker is relatively free from the effects of extreme high and low temperatures.

The actual trip temperature of the new breaker without flow of current is 350° F., ambient temperature. This outstanding resistance is accomplished by new bi-metal design.

There is, of course, a clear distinction between operating and ambient temperatures. The high differential between operating and breaking temperatures is a distinguishing characteristic of this circuit breaker.

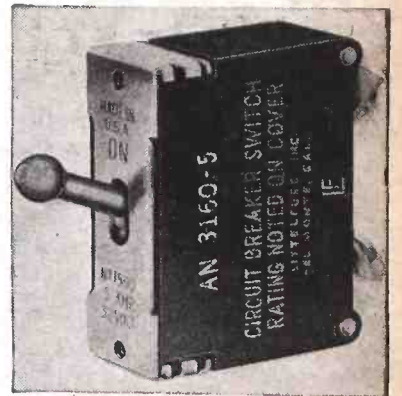

In the Littelfuse, the bi-metal is used as the finger that pulls the trigger. No appreciable mechanical load is exerted on the bi-metal as it trips the breaker. A new degree of dependability and uniformity of performance is obtained.

While primarily designed for military uses—aircraft, tanks, ships, landing craft, etc.—its high time lag well adapts it to protection of motors and other equipment having high starting surge currents.—*Radio-Craft*

LOUDSPEAKERS

Permoflux Corporation
Chicago, Illinois

A complete new line of loudspeakers has been engineered to cover the entire size range from 2 to 15 inches. Speakers are true dimensioned and diaphragms are graduated in 1/2-inch steps up to and including 7 1/2 inches with other standard sizes up to 15 inches.

The line will provide ample power handling capacities from 1 to 20 watts and is designed to give acoustical output in 2 d.b. steps. A new magnetic alloy which provides an actual magnetic efficiency of at least three times that of pre-war type magnets, results in considerable weight savings.

All speakers are completely dust-proof with metal parts rust-proof finished.—*Radio-Craft*

What you do with your money can wreck you (and your Uncle Sam)



BUY, BUY, BUY! Foolish people are doing it, *overdoing* it. But sensible folks know that with every needless purchase—or every time you patronize a black market or buy above ceiling—you do your bit to force prices up all along the line. That's the way inflation gets a boost.



IT CAN HAPPEN HERE—again! Today, with fewer goods in the stores while incomes are high, the danger of inflation is greater than ever. Inflation is always followed by depression. What can you do to head off another depression? Buy nothing you do not really—*really*—have to have . . . today.



SAVE, SAVE, SAVE! That's the way to make America good for the boys to come home to. Pay up debts, put money in life insurance, savings bank, War Bonds. Every cent you save now helps to keep prices down—and when the war is won you'll have use for that nest egg you've laid away.



A HOME OF YOUR OWN, a better farm, a real vacation, something to retire on—these are things worth saving for. Store up your money now while prices are high. There's a time to splurge and a time to save: today, while money's coming in, is a good time—the *right* and patriotic time—to **SAVE!**

4 THINGS TO DO to keep prices down and help avoid another depression

1. Buy only what you really need.
2. When you buy, pay no more than ceiling prices. Pay your ration points in full.
3. Keep your *own* prices down. Don't take advantage of war conditions to ask more for your labor, your services, or the goods you sell.
4. *Save.* Buy and hold all the War Bonds you can—to help pay for the war, protect *your own* future! Keep up your insurance.



Radio-Electronic Circuits

VOLT OHMMETER

(Figure 1)

This VOM has been built into a 9 x 8 x 4 box and gives accurate readings over a wide range. For best results resistors should be wire-wound and accurate, though 1-watt carbons will work.

The same input terminals are used for volts, ohms or milliamperes. For volts, a switch closes the desired range circuit: 10, 100 or 1000. For milliamperes, a single-pole and two double-throw switches are necessary, the desired one being closed. The shunts depend upon the meter resistance, and may be wound by cut-and-try methods. I used a 0-1 milliampere meter, but others can be used by changing the voltage resistors. Shunts always have to be calibrated with the meter used.

Three ohms scales are available. For these circuits two double-throw and a single-throw switch are required.

PAUL KIRCHBAUM,
Upper Sandusky, Ohio.

(If a 4000 ohm resistor is used instead of the 5000, and a series variable resistor of 1000 ohms added as a zero adjuster, aging

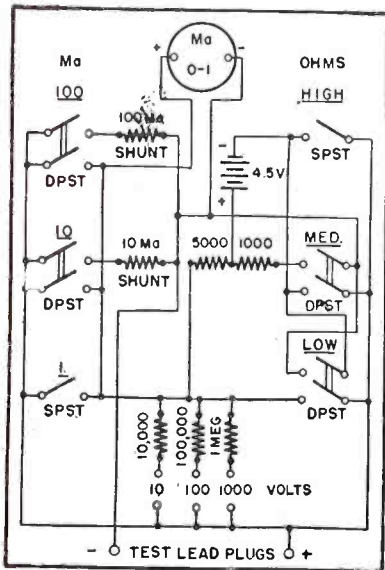

(Figure 1)

batteries will be compensated for.—Editor)

(Figure 3)

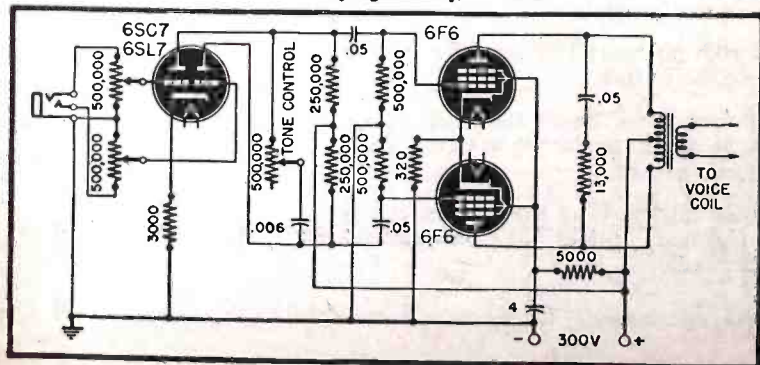

Radio-Craft welcomes new and original radio or electronic circuits. Hook-ups which show no advance on or advantages over previously published circuits are not interesting to us. Send in your latest hook-ups—Radio-Craft will extend a one-year subscription for each one accepted. Pencil diagrams—with short descriptions of the circuit—will be acceptable, but must be clearly drawn on a good-sized sheet of paper.

OUTPUT CIRCUIT

(Figure 2)

If you have an extra power transformer you can convert it to an output transformer. Connections may be made as shown.

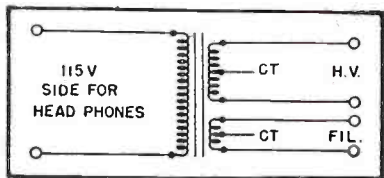

(Figure 2)

The high-voltage side makes a good impedance match for a 1A5 type tube and similar types, either singly or in push-pull. The filament winding matches any universal type dynamic speaker voice coil. The primary winding may be used for head phone reception.

GILBERT RUST,
Evanston, Ind.

P.A. AMPLIFIER

(Figure 3)

I use this amplifier circuit in connection with my crystal pickup. With a well-baffled 12-inch speaker, the power is ample and the tone excellent. My crystal pickup has three tabs or lugs, one of which is grounded to the case. Two-conductor shielded wire, with the crystal case grounded to the shield, is connected to the dual control.

I use a conventional power supply, an 80 rectifier with capacity-input filter consisting of 16 MFD on each side of a 1500-ohm speaker field.

If response is too "brilliant" a little by-passing on the input will bring it down. No cathode by-passing or de-coupling is necessary except on the 6F6 screens.

WESLEY MARSHALL,
Long Beach, Cal.

SUPER-REGENERATOR

(Figure 4)

The R.F. section uses a center-tapped coil tuned by a two-gang variable condenser. Standard short-wave coils may be tapped for the job. This is modulated by the low-frequency section which uses either a center-tapped choke coil or the secondary of a push-pull transformer (primary shorted out). A 110-volt AC-DC power supply may be used, the tubes being lit by a small bell transformer.

This circuit may be used as a modulated set tester oscillator by lowering the oscillations of the low frequency stage until it becomes audible. This may be done by increasing the size of the grid condenser and resistor.

FRANCIS MARION BLACK,
Sugarland, Texas.

(Mr. Black especially mentions that the primary of the push-pull transformer used should be shorted out. However, in some sets and with some transformers, better operation may possibly be had with the primary open.—Editor)

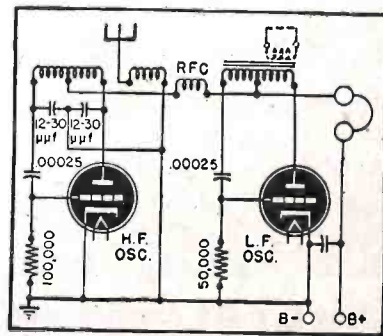

(Figure 4)

POWER SUPPLY

(Figure 5)

I had the pleasure of building the one-tube portable described on page 100 of the November issue. I made the following improvement on it. Instead of a tickler with the loop, I connected plate and RFC leads to the secondary of an antenna coil (without using the primary).

I know the set was designed as a portable, but because of the battery shortage, a small power supply may be interesting. The choke is a junked output transformer. Resistors are 1- or 2-watt carbons.

ANTHONY OETTINGER,
New York City.

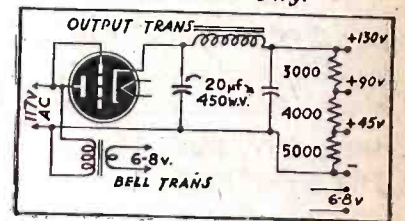

(Figure 5)

HOME BUILT P.A.

(Figure 6)

At our summer resort last year the children decided to put on a concert for a war charity. It was up to me to see that their voices would fill the hall.

I had a small two-tube amplifier in my shop to which I added a pre-amp. The entire outfit worked out very well, with enough volume to fill the crowded hall.

Two inputs were used as shown, each operating without interfering with the other. The problem of microphones was overcome as follows: I used two six-inch PM speakers with matched output transformers along the stage and ran the primaries through shielded leads to the inputs. By keeping the two mike speakers at an angle with the output speaker, no acoustic howl resulted.

L. H. DANIELS,
Toronto, Canada.

(Figure 6)

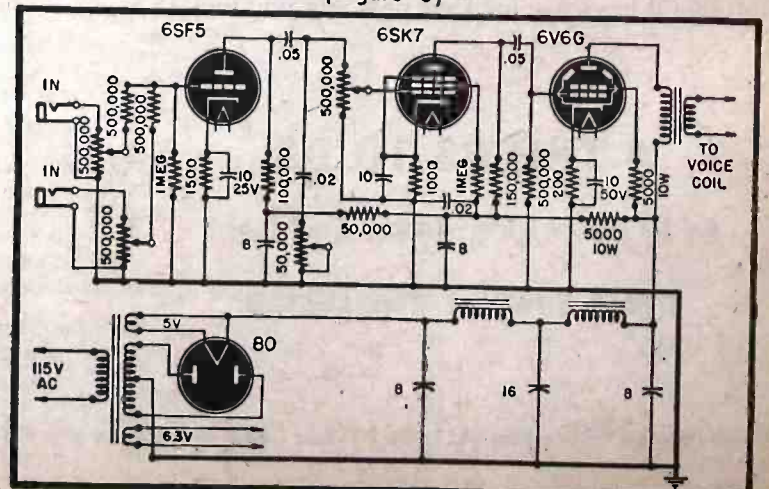

ROBOT TELEVISION TANK

(Continued from page 410)

the radio engineering fraternity has at its disposal today. There is no new problem whatsoever on that score. The operator, several miles back at headquarters, sees on his screen exactly the terrain over which the Robot Tank will travel. Not only does he see the road in front of the tank, but inasmuch as the television transmitter turret constantly revolves in a complete circle, the operator therefore can see in all directions within a few seconds, which is more than a human being in a tank can do. Consequently the operator knows exactly not only the terrain but what obstacles there are to overcome, such as opposing troops, gun emplacements, machine gun nests, etc. The control operator therefore has the choice of using gunfire or otherwise making attacks on such positions or enemy troops as required by our general plan of offense.

In case the road is mined it is of course possible that the Television Tank may be blown up and put out of action, but there will be no loss of lives and similar tanks that follow will get through without damage from mines.

The Television Controlled Tank can be used in spearhead actions for piloting other tanks in break-through offensives, in destroying heavy gun emplacements, in fact to do everything that a man manned tank can do—and do it not only better but without any loss of life.

There will again be made the old objection that a radio controlled tank can be made inactive by radio waves sent out by the enemy. As I have pointed out in these articles for several years, there is little chance of this happening because there are many different ways (many of which have been patented and which have been proven eminently successful) that make it impossible to have the enemy interfere with his radio impulses. The same thing pertains of course to television impulses as well, which can also be channelled in such a way that enemy radio interference will not be of much account.

Finally it should not be forgotten that it is also feasible to operate the Robot Television Tank by manpower during emergencies whenever it may be necessary for salvage purposes, or when such tanks have to be brought up from the rear, when radio control is of course unnecessary. In such a case one or two men may pilot them. But once in the danger zone there is then no reason for the men to continue occupying the Television Tanks.

There are many other military uses for these tanks. I will only mention one. These tanks can be filled with several hundred (and if larger with several thousand) pounds of high explosives. In these cases the Television Tanks are steered to bridges or strong points, etc., where they are blown up. There are of course many other uses for these tanks, unnecessary here to disclose.

World's biggest radio receiver is said to be the installation at Radio Receiving Central, Riverhead, Long Island. More than 7,000 tubes are kept in continuous operation. Heat from the tubes alone keep the equipment dry and stable in operation. The station management says this "high-frequency heating" saves more than 2,800 gallons of fuel oil per season.

Immediate Shipment!

RADIO PARTS and ELECTRONIC EQUIPMENT from CONCORD

What do you need in radio and electronic parts or equipment? If you think it's hard to get—if you need one or a hundred—order from CONCORD, by mail, by wire, by telephone. Our shelves are loaded with top-quality merchandise, nationally-known brands, complete assortments. Our radio technicians are prepared to work with you and expedite special requirements.

Tell us what you need. We can probably supply it from our huge stocks—and ship it to you at once.

GET IT QUICKLY—from CHICAGO or ATLANTA



CONCORD is geared to present-day demands for fast service. Government, Industry, and Institutions—the biggest names in America—have discovered that they are more likely to get what they want from CONCORD, and get it sooner. Two huge shipping warehouses, one in CHICAGO and another in ATLANTA, are ready to fill and ship your orders immediately, no matter how large or small, no matter where you are located.

FREE! NEW 64-PAGE "Book of Values"

This big 64-page showing of available now parts for radio and electronics will be ready about April 1st. It offers thousands of hard to get parts at substantial savings. Includes new 1945 Revised Listings of standard lines of Condensers, Transformers, Resistors, Test Equipment and other essential radio parts. Rush coupon for FREE COPY—mailed to you as soon as printed.

Typical Values Available Now!

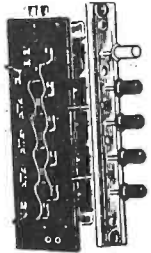
Money-saving prices on the four parts listed below are typical of thousands of unusual values offered by Concord.

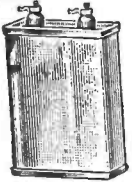
 <p>Push Button Switch, 4 Sections, each 8 pull double throw, with release button as illustrated. 5B4029 Specially priced, 89c</p>	 <p>Full Wave Vibrator Transformer, 6 Volts. Input—250 Volts. 60 MA. Output C.T. 5B5000 Specially priced, 79c</p>
 <p>I. R. C. type CS Dual Potentiometer 2500 ohm and 25 ohm. 5B2007 Specially priced, 49c</p>	 <p>Cornell-Dubilier type TjL6040, 4 mfd. 600 volt DC wkg. oil filled condenser. 5B3015 Specially priced, \$1.49</p>

CONCORD RADIO CORPORATION

Lafayette Radio Corporation

265 Peachtree Street
ATLANTA 3, GA.

901 W. Jackson Blvd.
CHICAGO 7, ILL.

RUSH FOR FREE 64-PAGE "Book of Values"



CONCORD RADIO CORPORATION
901 W. Jackson Blvd., Dept. RC-45
Chicago 7, Illinois

Please send me a FREE copy of the "Book of Values" of radio and electronic parts and equipment as soon as it's off the press.

Name.....

Address.....

City..... State.....

TRY THIS ONE!

B-F OSCILLATOR

It will be noted that the circuit in this oscillator is extremely simple and the parts consist of an old I.F. transformer, a .0001 mfd. condenser and tubes which is, or can be used as a triode. None of the values given are at all critical and a variety of tubes may be used.

In this particular installation a 6J5 which has seen better days gives excellent results. The I.F. transformer should tune to approximately the I.F. of the receiver in use and after being installed, may be tuned to give a suitable note and output. It never needs to be re-adjusted as the tuning is usually so sharp in a broadcast-type receiver that the note may be varied quite easily by de-tuning slightly.

In this particular case there was so much output from the oscillator that it was not necessary to couple to the second detector of the receiver at all, in which case the .01 mfd. condenser may be dispensed with, a short lead about an inch long serving to give plenty of coupling.

If the tube used has a suppressor-grid, it may be left floating and a screen-grid may be tied to the plate. The color code shown applies only to the particular I.F. transformer that was used, but a quick continuity test with an ohmmeter or batteries and head-set will show the different sides of the transformer, as the red lead will always go to B plus.

A. A. WICKS,
Edmonton, Alberta, Can.

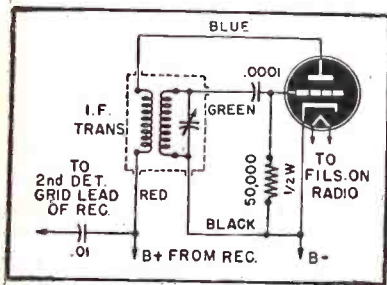

IMPROMPTU SHIELD

When in need of a tube shield, one can easily be made up as shown. Simply take a piece of thin copper foil and fasten together with brass paper fasteners. Connect ground strip to one of these fasteners.

A shield of this kind can often be worked into very small space, and may stop oscillation when nothing else is effective, especially in cases of tube replacement. Do not forget an excellent connection to ground or chassis.

JACK BUCHANAN,
Calgary, Alberta.

Radio-Craft wants original kinks from its readers, and will award a seven-month subscription for each one published. To be accepted, ideas must be new and useful. Send your pet short-cut or new idea in today!

AUTO RADIO BENCH

The writer built and equipped a bench for auto set testing and found that such work can be greatly speeded up in this way. I converted mine from a worn out cylinder-type washing machine.

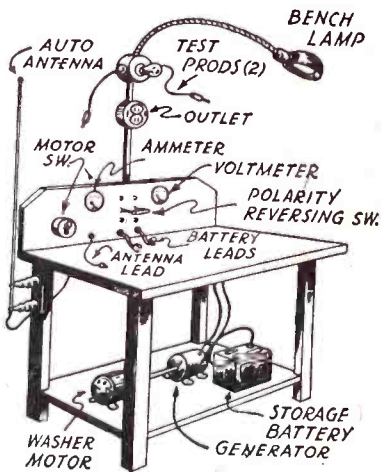

The washer was stripped down to the angle iron frame and the motor board removed, a full width 7/8-inch shelf replacing it. The top was made in like manner, both being fastened with flat head stove bolts. The washer motor was placed on the shelf and connected to an old auto generator by 1/2-inch coupling (flexible).

My ammeter came from an auto dash, and my voltmeter from an old "A" eliminator. The battery can be a used one, one too weak to start a car being satisfactory for a radio. Accessories consisting of lamp and outlets may be added. A polarity reversing switch also comes in handy (see sketch).

E. E. YOUNGKIN,
Altoona, Penn.

"NO KINK" KINK

SWL's who are troubled by twists, kinks and snarls in their headset cords can now obtain relief. A non-inflammable plastic, electrical appliance cord cover is now available in various colors in most electrical supply houses. They come in three-foot lengths.

This cord cover has a 1/4-inch diameter, but it may be made smaller and the length increased if it is stretched and slightly heated.

Besides being efficient, a neat appearance is given to the headset cord.

FRS 104,
Goshen, N. Y.

LOOP RADIO

This receiver works very satisfactorily without external antenna, and may be used for short waves as well as broadcast.

The antenna coil is an old variometer from an early set, its grid coil being tapped every three turns. An alligator clip is used to change from one tap to another.

Two 1 1/2-volt flashlight cells in series supply the filament, a midget 67 1/2-volt portable battery being used for the plate. The loop consists of 20 turns wound around the cabinet, which is 9 1/4 by 5 1/2 by 3 1/2 inches, one end going to the grid leak. The other end may be connected to an external antenna if desired. The plate coil connections should be reversed if the set fails to oscillate.

WILLIAM F. WOODHAM,
Dale Marby Field, Fla.

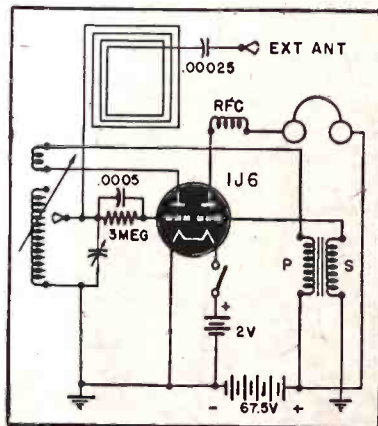

SIGNAL TRACER

For servicing intermittent receivers this tracer is a great help. With S2 open, the prod touched at any R.F., I.F. or A.F. plate will determine conditions in that stage. Closing S2, the circuit becomes an A.F. oscillator to test audio stages.

Since it works on batteries, it is portable and safe for use with A.C.-D.C. receivers.

R. SCOTT HERBERT,
Westfield, N. J.

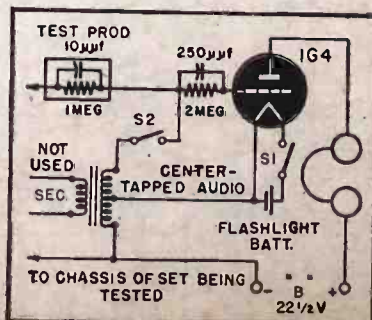

POTENTIOMETER

Some time ago I had need for a 10-watt potentiometer but could find none available. I made the following substitute from a 10-watt voltage divider.

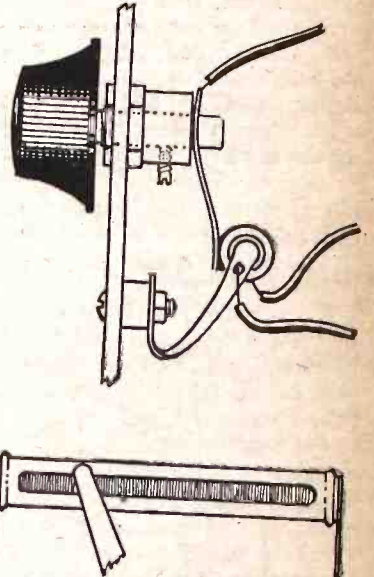

From an old Atwater-Kent model 40 radio, I removed the outside mounted potentiometer, using the case, knob and wiper. As shown, the wiper (of springy metal) moves across the turns of the voltage divider. The result is a smooth variation of resistance throughout the entire range. Adjust the wiper to make good contact yet little friction.

DEAN SPEIDEL,
St. Louis, Mo.

PRESELECTOR STAGE

I built this circuit, using the oscillator section of the tube to provide regeneration. As can be seen, the hexode works with full plate and screen voltage at all times, so that when regeneration is brought into play, gain and selectivity become very high.

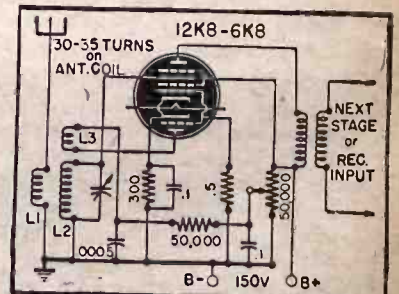

My coil was on a 3-inch form, but a standard broadcast plug-in might be better. Output coil is an I.F. transformer tuned to 570 Kc.

The circuit works very well on both the high frequencies and broadcast band. Proper shielding is desirable.

STIG W. HANSON,
Charlotte, N. C.

FUTURE ASPECTS OF TELEVISION

(Continued from page 413)

ceivers (mostly, by the way, projection, 18 x 24-inch screen type) finding wide sale demand for such costly sets almost non-existent, sensibly began to *rent* such instruments, at rates reasonable both for their lessees and themselves—an average charge of 10 shillings sixpence (about \$2.10) per week, as I am informed. The result: tens of thousands of such sets in use within a brief period after programs became fair, and the sets available.

B.B.C. (British Broadcast Co.) furnished advertisementless programs, paid for by the annual tax collected by the Post Office from all users of the television service. Needless to say, such programs left much to be desired, even as the B.B.C., government sponsored (and censored) radio fare could never be classed as a banquet in comparison with the best of our ad-supported American programs.

Yet notwithstanding this handicap, the British policy of television set rentals had succeeded before the war in abundantly proving that television audiences could be built up to very large dimensions quickly—incomparably faster than would be possible by time-honored outright sale methods (including, of course, time payments).

Here in America therefore it would appear as plain good sense on the part of the manufacturers of television receivers to be willing to assume their share of the cost of audience build-up process. If our television receivers are made available on, say, a graduated (\$2 per week minimum) rental basis, signed up for an initial quarterly period (plus a reasonable installation fee), I venture to say that a hundred householders will step up to the rental offices, to one who would sign up for a \$200 to \$400 televiser instrument, one-third cost down with purchase order.

This plan will entail no terrific cash investment on the part of the set manufacturer, *hoping* (as must now the television broadcaster) that some not too distant day his audience may attain such dimensions that Mr. Advertiser will step up and finance the costly nightly program. No, because in one year or 18 months (depending on the quality of the instrument) the manufacturer will have his investment returned in rental; and thereafter be in receipt of continuing revenues, rapidly growing larger—less only nominal servicing costs.

(To be continued in our May issue)

FM QUALITY VS. STATIC

Quality of workmanship has much to do with an FM radio receiver's freedom from interference. This news, which may come as a shock to some who have been boosting FM as "static-free" (apparently in all cases) is the result of tests conducted co-operatively by the Society of Automotive Engineers and the RMA. Performed on six sets, the tests indicated that ignition noise roughly equal to the strength of the carrier would not seriously harm reception. Most important result of the experiments was the discovery that the best receiver tested would tolerate three times as much interference as the average, while the worst one was knocked out with an interference level only *one-tenth* that which prevented satisfactory reception on the average receiver tested.

PORTABLE POWER PROBLEMS

THIS MONTH—UNITED AIR LINES' RADIO SIGNAL TEST



DIRECTIONAL INTENSITY of radio signals from all United Air Lines transmitter stations is measured at intervals with portable Field Strength Test Meters, powered by Burgess Industrial Batteries. Control of exact radiation from transmitters maintains perfect communication between ground and flight crews, assuring safe, accurate guidance of planes into airports.

TEST METER records full volt intensity of radio signals, showing how far and in what direction radiation extends from a specific antennae or station. Burgess Industrial Batteries are the standard of quality for commercial uses—they meet every requirement in the operation of test and control instruments. Production of industrial batteries is severely limited today by war needs, and the types you require may not be immediately available. *Burgess Battery Company.*



KEEP YOUR RED CROSS AT HIS SIDE!

BURGESS BATTERIES

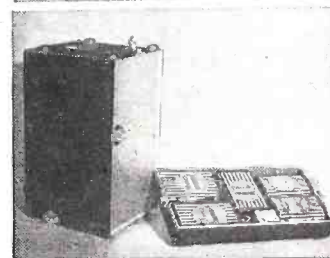
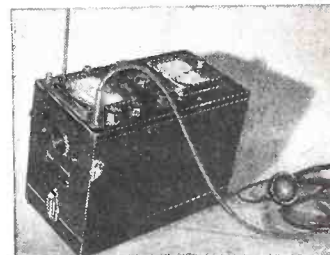

TRANSITRON OSCILLATORS

(Continued from page 419)

suppressor on the total space current.

The Transitron's frequency stability is equal to that of the Dynatron. In purity of wave form it also approaches its older rival. In other features it is far superior to the older circuit. The range is enormous—a single oscillator may cover frequencies from a few cycles per second to more than 60 megacycles by simply changing plug-in coils. Since it operates with a single untapped coil, it should be especially adaptable to multi-band superheterodyne receivers and short-wave experimenters.

Other and more practical advantages of the Transitron will be described in early issues of *RADIO-CRAFT*, in connection with special ap-

plications of the circuit. It is our intention first to publish an article on a Transitron signal generator. If readers discover any other interesting uses for the circuit, *RADIO-CRAFT* will be pleased to publish any that may be of general interest, paying for them at regular rates. Let us see what you can do with the Transitron!

The American Association of Engineers announces a campaign to distinguish technologists from technicians.

Miss M. E. McIver, national secretary of the association, at 8 S. Michigan Ave., said: "Technologists are professionals, and technicians are their assistants, or non-professionals."

THE QUESTION BOX

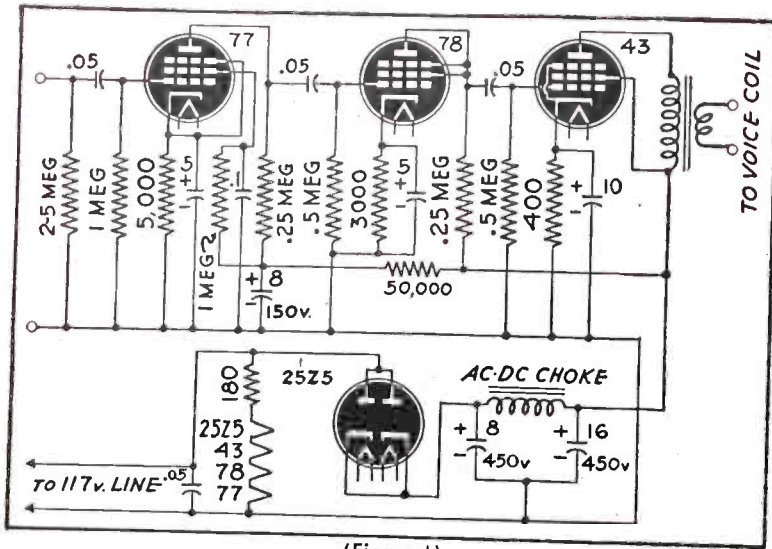

(Figure 1)

AC-DC AMPLIFIER

(Figure 1)

? I need an A.C.-D.C.-operated audio amplifier to be used in connection with low level inputs. The final amplifier is to be a 43. Please print a schematic of such a circuit. — H.N.B., Muncie, Ind.

A. We are showing a three-stage amplifier. Sufficient gain should be developed by this amplifier for your purposes. The power output will be practically a watt. If more output is required, you may use the 25Z5 in a voltage-doubling circuit, provided, of course, that A.C. is available.

BATTERY SET

(Figure 2)

? Please give me specifications for building a two-tube battery-operated radio using a 32 and a 33. Coil sizes would be appreciated. — R.J., Caledonia, Ont.

A. A regenerative detector followed by a resistance-coupled A.F. amplifier is illustrated. Coils may be wound on 1½-inch forms. One should have 18 turns of No. 24 spaced to cover 1½ inch for L₁ and 6 turns No. 30 for L₂. The other coil should have 9 turns spaced to fill 1 inch for L₁ and 5 turns for L₂, the two being interwound, from the ground end. CH is an audio choke or the secondary of an audio transformer.

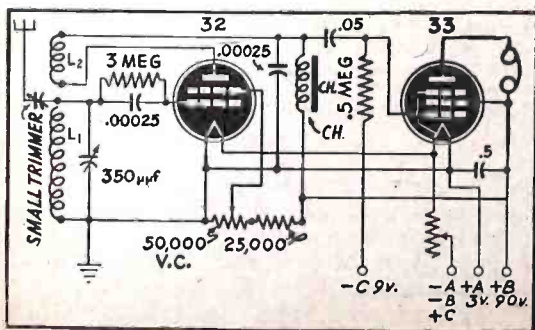

(Figure 2)

TONE CONTROLLED A.F.

(Figure 3)

? I have a 6V6 audio amplifier which I wish to convert to push-pull. The first stage at present uses a 6F5. Also, please add an effective form of tone control (separate bass and treble). — L.D., Troy, N.Y.

A. A tone control is incorporated into the first stage. The parallel circuit is tuned to a low frequency and as less resistance is used, the bass response rises. As more resistance is shunted across the condenser, the treble response improves.

To eliminate the push-pull transformer, a phase-inverter 6N7 is used.

3-CHANNEL AUDIO

(Figure 4)

? I wish to build a three-stage amplifier utilizing three separate inputs with mixers: phono, guitar, microphone. The output stage is to use push-pull 6L6's. Good fidelity is required.

— M.J.G., Folencroft, Ga.

A. Two of the inputs are connected to a 7F7 and the low level input to a 6SQ7. The 6A6 is a phase inverter which is required for push-pull. The bias cells for the input stages may conveniently be Mallory cells or small flashlight batteries.

We are including three 50,000-ohm filter resistors to avoid possibility of feedback due to high gain.

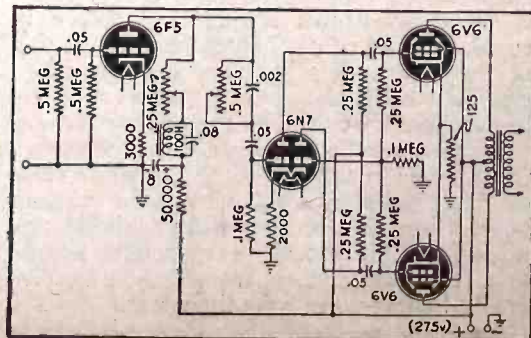

(Above, Figure 3; Right, Figure 4)

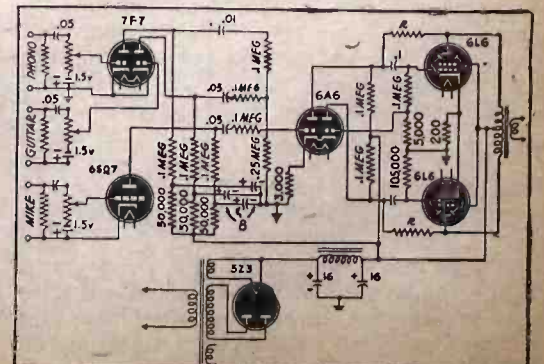

The Question Box is forced to discontinue answering questions until further notice. We have had great difficulty in securing skilled labor for this work, and in many cases recently have been forced to refund remittances. We will continue to print questions of general interest till those already answered and on hand have been exhausted or till we are again able to handle questions for readers.

WAVETRAP TRIMMERS

? I would like a clearly defined description of the purpose of a "Wave Trap Trimmer" and a 600 Kc. trimmer; also if they have anything to do with the short-wave bands. — P. V. C., Montreal, Canada.

A. The so-called wave-trap trimmer is a circuit tuned to the I.F. frequency. It absorbs signals near that frequency, such as certain code stations, which might otherwise reach the I.F. section and be amplified there. The 600-Kc. trimmer is the padding condenser described fully in the article. *The Trucking Problem* in the November issue of *Radio-Craft*. It is used to compensate for the fact that the oscillator coil is smaller than the R.F. coil, and to spread out the tuning in the oscillator circuit in spite of it.

HEADPHONES

(Figure 5)

? Please give hookup for eliminating speaker when desiring to listen to phones. — C.E.C., Tampa, Fla.

A. A simple circuit for this purpose is drawn. When a phone plug is inserted a 6-ohm resistor is placed across the secondary instead of the speaker. Its power

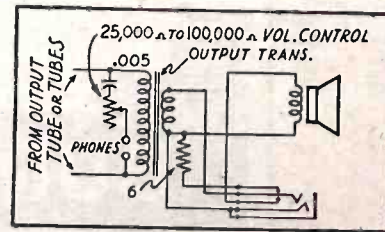

(Figure 5)

dissipation should equal that of the speaker.

The phones are connected so

that no D.C. passes through them, and a volume control is provided. A simpler but less satisfactory circuit is also shown.

An article on this subject (*Radio Headphone Circuits*) appeared in the March issue of *Radio-Craft*.

E.C. CRYSTAL OSC.

(Figure 6)

? Please show the circuit of an electron-coupled crystal oscillator which I can use for signal generator calibration, etc. I have a 6.3 volt supply and a "B" of up to 250 volts. — S.G., Bronx, N. Y.

A. You will have ample output from a 6F6 crystal oscillator as shown. The circuit LC is tuned to approximately the crystal frequency.

You may find that with a 6F6 tube, it is hard to get the crystal to oscillate, especially if—as is usually the case—a crystal of 455 or other intermediate frequency is used. In such case, a condenser between plate and grid is useful. A 10-mmfd. mica condenser or

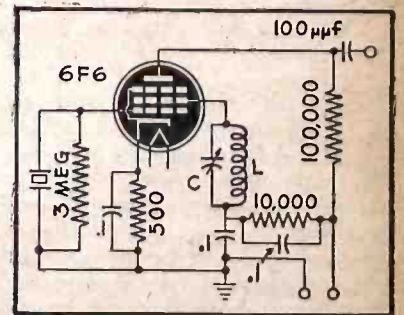

(Figure 6)

just two pieces of insulated wire twisted together will do.

The output appears in the plate circuit and there will be almost no reaction on the oscillator. You can experiment with the plate and screen-grid voltage required. A lower voltage will heat the crystal less and provide greater stability.

RADAR, BATS AND SUPERSONICS

(Continued from page 422)

quencies. It has sometimes been found necessary to plug in a speaker the high frequency of which has been suppressed, when using the apparatus at high gain for frequencies as low as one or two kilocycles. The terminals marked "Jack" are for this purpose, or to connect the output to a tape recorder or other indicating apparatus if required.

SIGNAL GENERATOR CIRCUIT

The signal generator utilizes a beat-frequency oscillator to obtain the tuning range of 1 to 100 Kc. necessary. The diagram is seen in Fig. 2. Each component oscillator is variable, one through a 100-Kc. range and the other through a range of plus or minus 3,000 Kc. for fine adjustment of the output frequency. Modulation, which may be supplied by a built-in 400-cycle oscillator or from an external source, is impressed on the output of the quasi-fixed oscillator by a pair of balanced modulator tubes operating at a fixed bias difference. One volt across 3,000 ohms is required for 100% modulation.

The output attenuator makes available known voltages ranging from one-half microvolt to one volt. A pair of high-pass filters serve to eliminate the modulation frequency from the output, while passing freely the modulated carrier. Other filters eliminate the oscillator frequencies and harmonics of the beat frequency from the output.

A built-in vacuum-tube voltmeter may be switched across the output attenuator for measuring carrier amplitude. Its microammeter may be used as a D.C. voltmeter for checking the bias on the modulator tubes. An automatic electromechanical lock prevents the switching of this meter unless a protecting shunt is on, and also protects the meter from current surges during the warming-up period.

A sensitive voltmeter is necessary for measuring the voltage developed by a sound-sensitive device. The need was met by construction of a microvoltmeter tunable over a range of 10 to 100 Kc., with an indicating meter whose readings may be either proportionately or logarithmically related to the input voltage.

SPEECH AMPLIFIERS

(Continued from page 423)

respectively. When the control is at position "T", there is a gain of the treble notes as described for Fig. 4. When in position "B", the full value reactance of C1 is effective in shunting the highs to ground, thus causing an apparent boost in the bass. Potentiometer, R2 is employed as a volume control.

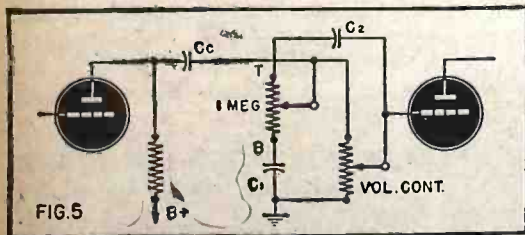

Other types of tone compensators utilize resonant circuits to increase the bass boost. These call for more careful engineering, and will be dealt with at some length in the next article in this series.



WE WILL REPROCESS YOUR DEAD

RADIO TUBES

BY THE LATEST METHOD
OPEN FILAMENTS, MICROPHONICS
AND SHORTS CLEARED!

30-Day Guarantee
All Tubes Are
Tested Before
Shipping

50^c
EA.

1 Volt and 3 Q-5
\$1.00
Services and
Charges Approved
By O.P.A.

Flashed, Exploded or Open Cathodes,
Broken Glass and Prongs
REJECTED AND NOT RETURNED

Send List with Order — C.O.D. ONLY

RADIO TUBE REPROCESSING SERVICE

662 MONROE AVE.

ROCHESTER 7, N. Y.

Free!



RADIO &
ELECTRONIC
TEST
EQUIPMENT
AVAILABILITY
BULLETIN

Contains detailed descriptions of
models we're now making.

We manufacture Volt-Ohm Milliammeters,
Insulation Testers, Signal Generators and
Tracers, Industrial Analyzers, Voltage Test-
ers, etc.

SUPERIOR INSTRUMENTS CO., Dept. 188
227 Fulton St., New York 7, N. Y.

RADIO Wholesale REPAIR

THIS IS THE ANSWER
TO YOUR RADIO REPAIR TROUBLES!

Just SEND us the SET via Railway Express.
We REPAIR and RETURN. You ADD MARK-
UP AND DELIVER. That's all there is to it.

- Complete Stocks—We can fix 'em all
- 90 day guarantee
- Prompt service
- OUR LOW PRICES mean more Markup for you.

Send that set to

SHEFFIELD RADIO CO.

918 Belmont Ave., Chicago 14, Ill.

★ BUY AN ★
EXTRA WAR BOND

TANK COMMUNICATIONS (Continued from page 415)

Engineering was also required in designing a mount for such delicate crystals which would be reliable under tank conditions. The crystal and mounting are seen in Fig. 3.

All units are designed to operate on either a 12- or 24-volt battery. A dynamotor supplies the high voltages required. Like the

transmitter and receiver units they plug into the standard base, and are held down by shock-absorbing mounting screws. Fig. 4 shows a complete SCR-508 radio set.

Acknowledgement is made to Bell Telephone Laboratories for all photographs used in this article, as well as the basic material from which the story is written.

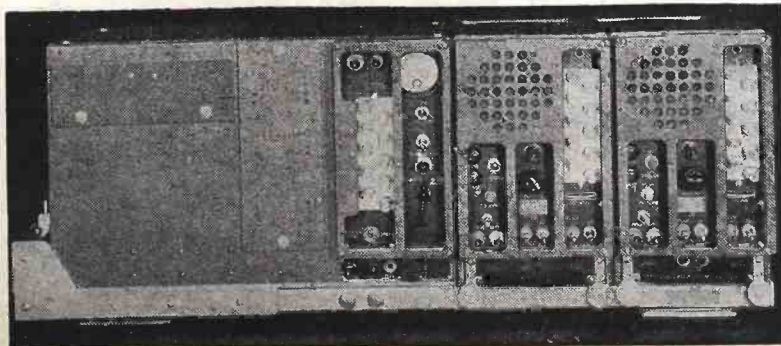

The SCR-508 radio set
is composed of two
transmitters and one
receiver, mounted on
a universal rack.

MR. RADIOMAN—
Here's How CREI Training
Can Prepare You for a Better
Job and Secure Career in
RADIO-ELECTRONICS



CREI Offers A Planned Program of Home Study in Practical Radio-Electronics Engineering That Equips You To Cope With Current and Post-War Technical Applications and Problems and Helps to Assure You of a Secure, Profitable Post-War Future.

Right now is the time to put your *own* post-war plans in effect! The alert radioman will not wait until post-war technical improvements actually arrive . . . or wait until thousands of new men enter the field . . . before preparing himself with the necessary technical training to assure himself a good job in the post-war fields of Radio-Electronics.

CREI home study courses are constantly being revised and kept up-to-date with the rapid developments in the industry. What do you know today about U.H.F. circuits, cavity resonators, wave guides, Klystrons, Magnetrons and other tubes? U.H.F. as well as all other basic principles of modern, practical radio-electronics engineering are covered in CREI home study courses. Now is the time to equip yourself with the necessary modern technical knowledge to step ahead of competition into the important, career jobs in radio-electronics engineering. You learn not only *how* . . . but *why!* Easy-to-read and easy-to-understand lessons . . . each student having his personal instructor . . . corrections, criticisms and suggestions on each lesson examination . . . these are only a part of the successful CREI method of training for which thousands of professional radiomen have enrolled since 1927.

Investigate CREI home study training now, and prepare for security and happiness in the coming New World of Electronics! Write for all the facts today.

● **WRITE FOR NEW, FREE 36-PAGE BOOKLET**

If you have had professional or amateur radio experience and want to make more money—let us help you qualify for a better radio job. TELL US ABOUT YOURSELF. so we can intelligently plan a course best suited for your needs.—PLEASE STATE BRIEFLY YOUR BACKGROUND OF EXPERIENCE, EDUCATION AND PRESENT POSITION.



CAPITOL RADIO ENGINEERING INSTITUTE

Home Study Courses in Practical Radio-Electronics Engineering for Professional Self-Improvement

Dept. RC-4, 3224—16th St., N. W. WASHINGTON 10, D. C.

Contractors to U.S. Navy—U.S. Coast Guard
—Canadian Broadcasting Corp.—Producers of
Well-trained Technical Radiomen for Industry

Available Radio-Electronic Literature

Manufacturers' bulletins, catalogs and periodicals.

A NEW SERVICE FOR RADIO-CRAFT READERS: In order to save your time, postage and incidental work in writing a number of letters to different manufacturers to secure the various bulletins offered, proceed as follows:

On your letterhead (do not use postcards) ask us to send you the literature which you designate. *It is only necessary to give us the numbers.* We will then send your request directly to the manufacturers, who in turn will send their bulletins or other literature directly to you.

130—JOHNSON—IN WAR AND PEACE.

Issued by the E. F. Johnson Co. A collection of advertisements which have appeared recently in American trade journals, and which tell the story of Johnson activities and products. In conjunction with the latest Johnson General Products Catalog No. 968, describing their line of radio-electronic products.—*Gratis.*

131—IT WAS A TUBE THEY WANTED. (Amperex Electronic Products Co.)

A decorative booklet describing the part played by electron tubes in the global war, and the part played by the company in supplying such tubes.—*Gratis.*

132—VARIABLE WIRE-WOUND RESISTORS. (American Standards Association)

Standards and specifications for low-operating-temperature wire-wound resistors. Details of material and workmanship; methods of sampling, inspection and tests; packaging, packing, etc., are included as well as the more fundamental requirements.—*Price 40c.*

133—ELECTRONIC DICTATION.

Issued by the Dictaphone Corporation. An eight-page booklet describing an improved dictating recorder, also adaptable to other office uses.—*Gratis.*

134—SPRAGUE DRY ELECTROLYTIC CAPACITORS. (Sprague Electric Co. Catalog No. 10)

A 28-page book covering the company's

complete line of dry electrolytic condensers. Well illustrated.—*Gratis.*

135—RAYTHEON VOLTAGE STABILIZERS.

Published by Raytheon Manufacturing Co. An eight-page booklet describing a line of stabilizers. These are of the non-electronic type using saturable cores and partially-resonated windings.—*Gratis.*

136—MODERN PRECISION, a quarterly issued by the Leeds and Northrup Co.

A large (10½ x 15 inch) 20-page publication carrying descriptions of Leeds and Northrup apparatus, with short items interesting to users. The issue reviewed (Summer, 1943) carried a number of articles on the Micromax recording pyrometer.—*Gratis to interested parties.*

137—AUDIO DEVELOPMENT COMPANY. Catalog of audio apparatus.

Includes input, output, plate, power, filament and auto-transformer units, with a large line of impedance transformers. Jacks, plugs and replacement cords are also advertised, as well as key switches and jack panel assemblies. — *Gratis to interested parties.*

138—INSULINE CATALOGUE, 1944.

A complete catalogue of the company's line of radio hardware, fittings, accessories, tools and other products. The catalogue runs to 45 pages, and was accompanied by two smaller ones, describing Insuline metal products (chassis, cabinets, etc.) and ICA antennas, respectively.—*Gratis.*

139—ALLEGHENY LUDLUM MAGNETIC CORE MATERIALS, Technical Bulletin EM-11, Allegheny Ludlum Steel Corporation.

A 28-page booklet giving the magnetic characteristics of various types of the company's steel sheets. These are largely in the form of charts, showing permeability curves, core loss characteristics against current density and against frequency, and BH curves, with some text material. Also received was Bulletin EM2, containing data on magnetic core design, and EM3, a catalog of transformer laminations made by the company.—*Gratis*

140—CENTRALAB SILVER MICA CAPACITORS, a 4-page leaflet issued by Centralab.

Describes a new line of miniature oil-impregnated silvered-mica condensers. Complete specifications are given and the dimensions are illustrated with working drawings.—*Gratis*

141—ELECTRONIC TUBES FOR INDUSTRY, a quick-selection chart. Issued by General Electric Co.

A 10½ x 16 inch-folder containing brief technical data on Phanatrons, Thyratrons, Pliotrons, Ignitrons, Kenotrons, Glow Tubes, Ballast Tubes and Phototubes, as well as vacuum capacitors, vacuum gages and vacuum switches.—*Gratis*



Suggested by: Marguerite Muchmore, Encinitas, Calif.

"I know you can't hear me very well sir, but there's been a little trouble at this end."



Ground-base receiving and recording unit of electronic flight recorder. Count the tubes.

AUTOMATIC METER READER

READING a meter is a process which affects all of us in some way every day. The meters on our dashboard, the gas meter, the meter on our tube tester, all must be interpreted quickly and with no difficulty.

Engineers of Consolidated Vultee Aircraft Corporation have recently developed an electronic device which can "read" and record more than 80 instrument indications per minute! This recorder was especially created to help test pilots to obtain accurate performance data on new airplanes. For this purpose, a transmitter is installed in the plane and a receiver unit is retained at a ground radio station in connection with appropriate recording apparatus.

When the airplane takes off, instrument indications (which provide vital data as to airspeed, direction of flight, engine revolutions, etc.) are conveyed to a high-speed scanning switch mechanism. Each indication modulates an alternating current in conformity with its range, producing an audio frequency signal which is superimposed on an R.F. carrier for transmission.

The receiver unit, which is synchronized with the airplane equipment, picks up the signal, and a suitable recording mechanism is actuated. In this way it is possible to study the performance of new planes. Before the development of this Convair flight recorder, it was necessary to take engineering observers on each test flight. This often proved unsatisfactory because even the most skilled observer could not record more than a half dozen indications per minute. Also, in the unfortunate event of an accident, engineering data which might have given a clue as to the cause of the mishap would be destroyed.

Accuracy to within 1% of the original gage readings is obtainable. Therefore, the course of a robot bomb could be traced, for example, making each succeeding bomb more accurate. In postwar America, it may be possible to accomplish commercial flying without assistance of pilots or crew. For example, a jet-propelled mail plane, equipped with radio controls and a flight recorder, could be flown by ground person-

RIDER VOLUME XIV COVERS 1941-42 RECEIVERS

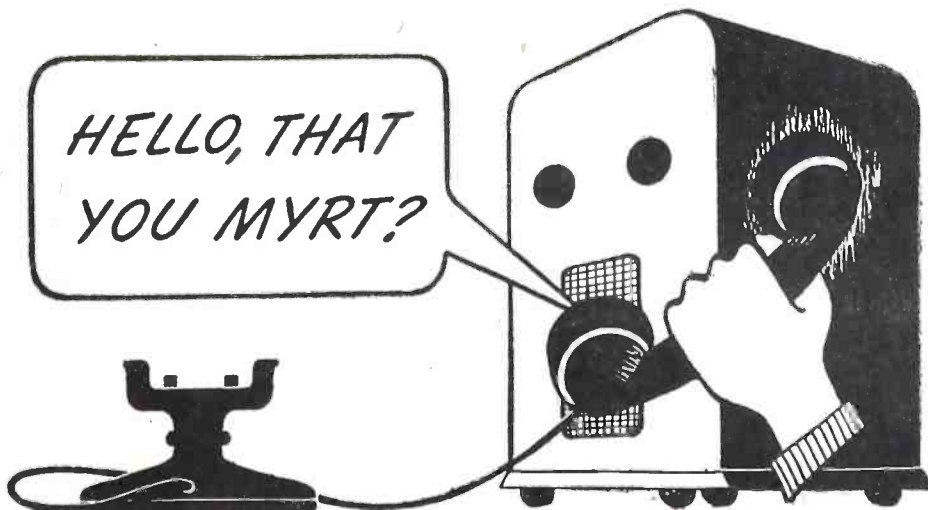

One of the first programs I carried as a new radio, four long years ago, was that of "Fibber McGee" saying "How's every little thing?" Of course he was talking to "Myrt" and not to me, though I felt fine at that time.

But if he asked me now! After the way I've been worked since 1941 I'd lay down and quit if it weren't that I have my war job to do. And there are no newer receivers to take my place. But I'm not the only one—most of my

contemporaries are wheezy, or lying quiet in repair shops right now.

It's a good thing Rider Manual Vol. XIV came out recently. It enables radio servicemen to diagnose the ills of we 1941-42 receivers quickly, easily and accurately. That gets us out of shops and back into homes where we're needed.

If you can't get immediate delivery on Volume XIV from your jobber please be patient—paper restrictions, you know.

RIDER MANUALS (14 VOLUMES)	
Volumes XIV to VII	12.50 each volume
Volume VI	9.50
Abridged Manuals I to V (1 vol.)	15.00
Automatic Record Changers and Recorders	7.50
OTHER RIDER BOOKS YOU NEED	
The Cathode Ray Tube at Work	4.00
Accepted authority on subject	4.00
Frequency Modulation	2.00
Gives principles of FM radio	2.00
Servicing by Signal Tracing	4.00
Basic Method of radio servicing	4.00
Servicing Superheterodynes	2.00

The Meter at Work	2.00
An elementary text on meters	2.00
The Oscillator at Work	2.50
How to use, test and repair	2.50
Vacuum Tube Voltmeters	2.50
Both theory and practice	2.50
Automatic Frequency Control Systems	1.75
—also automatic tuning systems	1.75
A-C Calculation Charts	7.50
Two to five times as fast as slide rule	7.50
Hour-A-Day-with-Rider Series—	
On "Alternating Currents in Radio Receivers"—	
On "Resonance & Alignment"—	
On "Automatic Volume Control"—	
On "D-C Voltage Distribution"—	1.25 each

JOHN F. RIDER PUBLISHER, INC. 404 FOURTH AVE., N.Y. 16, N.Y.
 Export Division: Rocke-International Corp. 13 E. 40th Street New York City Cable: ARLAB

RIDER MANUALS *are complete* IN 14 VOLUMES

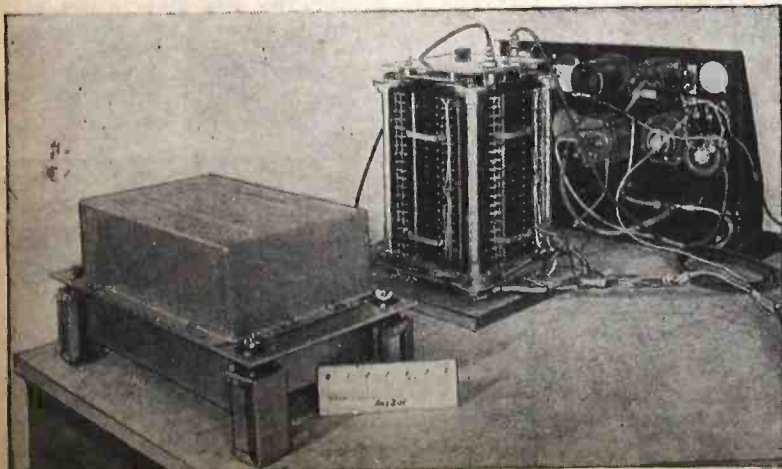

Here is the automatic flight recorder's transmission unit, with a suitable array of instruments, ready for mounting in an airplane. Despite its complex appearance, it is small (scale is 6 inches). The total weight is 55 pounds.

nel. The same method could be used to test experimental planes with exposing a test pilot to danger.

ATOMIC particles of an apparently new type were reported recently to the Soviet Academy of Sciences by Professor Artem Aliachnian, Armenian Scientist.

The new particle has about the same mass as a proton, ionizes air at a faster rate than other known particles, and has a different penetrating power.

The new particles were discovered in cosmic rays at an altitude of 11,000 feet on Mt. Alagez in the Caucasus.

Using a different psychological approach to break down sales resistance of possible customers, Sonotone urges that you "Learn to Read Lips and Aid Your Hearing" in one of three advertisements, currently appearing in New York newspapers. Persons with or without hearing aids are invited to the Sonotone building, to a lip-reading class for a free demonstration.

One Central Source FOR Everything in RADIO and ELECTRONICS



LARGEST STOCKS
•
COMPLETE SERVICE

REPAIR and REPLACEMENT PARTS AVAILABLE without priority



Centralized here are today's *largest and most complete stocks* under one roof. Over 10,000 items from all leading manufacturers . . . for the Armed Forces, Radio Training, Laboratories, Industry, Service Replacements. Our experienced staff *simplifies procurement—expedites delivery.*

R. F. Resonance and Coil Winding **CALCULATOR**
No. 37-955
Postpaid **25c**



6 Radio Books for 75c

Dictionary of Radio Terms. No. 37-751	10c	Radio Data Handbook. No. 37-754	25c
Radio Circuit Handbook. No. 37-753	10c	Radio Builders Handbook. No. 37-750	10c
Radio Formulas & Data Book. No. 37-752	10c	Simplified Radio Servicing. No. 37-755	10c
All Six Books No. 37-799 75c			

Write for Quantity Prices

ALLIED RADIO CORP., Dept. 2-D-5
833 W. Jackson Blvd., Chicago 7, Ill.

Please send following books (. . . enclosed)

FREE Guide 37-750 37-752 37-754
 37-751 37-753 37-755
 Calculator No. 37-799 (All 6 Books)

Name
 Address
 City State

ALLIED RADIO

Progress In Invention

Conducted by I. QUEEN

MOISTURE MEASUREMENT

Patent No. 2,362,344

THIS circuit accurately measures the moisture content in soils, soaps, grains, paper, etc. Electrical conductivity methods fail where changes in salt concentration are present. The inventors, Leonard D. Bayer, Raleigh, N. C. and Byron T. Shaw, Columbus, O., use a sensitive bridge to measure the heat conductivity which depends upon moisture content.

For soil measurements, X, the unknown arm of the bridge is composed of No. 40 enameled copper wire wound on glass or bakelite tubing. Arm A may be of 7 ohms resistance, B a variable in shunt with 200 ohms, and C about 200 ohms. Meter M_1 measures battery current into the

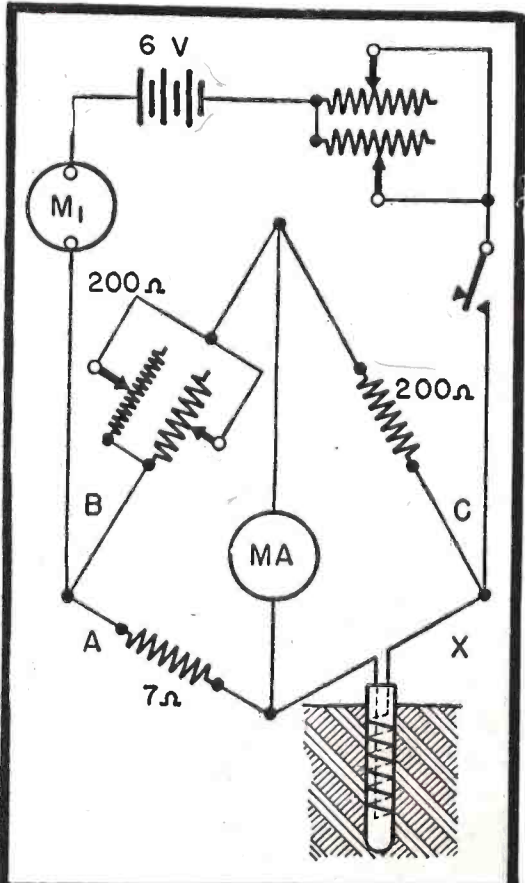

bridge and MA is used to indicate balance. Sufficient current is passed through the bridge to cause a slight temperature rise in Coil X. Only this resistance will increase with temperature, since the others are of manganin. If the moisture content of soil or other material is great, heat will be conducted away rapidly and only a small unbalance will be present. If only a small amount of moisture is contained in the medium, the temperature and resistance rise of the coil is correspondingly greater. MA therefore indicates directly the degree of moisture and may be calibrated in temperature.

HARMONIC GENERATOR

Patent No. 2,364,756

A SYSTEM which requires transmission on harmonically related wave lengths (such as amateur radio) has heretofore used multiplier stages to reach the desired harmonic. This results in tuning complications and multi-stage doublers. Walter van B. Roberts of Princeton, N. J., has discovered that if a momentary pulse is delivered to the amplifier, the same excitation is available regardless of the order of harmonic. By using one pulse per cycle of fundamental the same power is applied at the amplifier grid at all harmonics. The pulse generator functions as follows: A high grid-leak, R periodically blocks the tube, but when plate current finally flows, regenerative

actions induces a high positive potential on the grid so that saturation is reached. When the plate current levels off it produces a high negative

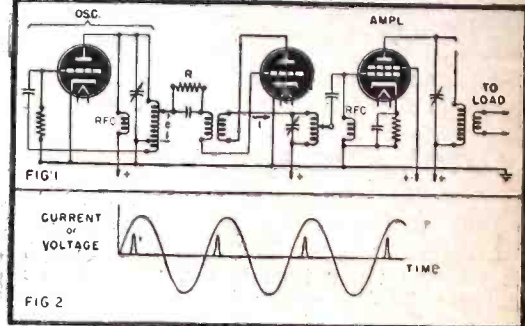

potential on the grid, rapidly cutting off plate current, thereby producing pulses. The circuit is shown in Fig. 1, and the triggering effect of the pulses in Fig. 2. These pulses of current are made to traverse the harmonic tank L, C, keeping it in oscillation and supplying excitation to the grid circuit of the final amplifier, which may thus be operated at any multiple of the fundamental oscillator's frequency.

VARIABLE LOAD SUPPLY

Patent No. 2,364,761

IN some cases of extreme load variation, it is desirable that a power pack supply either a high voltage at low current or a low voltage at high current. O. H. Schade, of West Caldwell, N. J., has designed a power supply system for such purposes. Two power supplies are in series: E_1 which has, for example, an output of 150 volts at 100 M.A.; E_2 which supplies about 450 volts at 1 M.A. At light loads E_2 is mainly effective in supplying the high voltage. As the load increases, E_2 drops quickly until it becomes smaller than E_1 so that

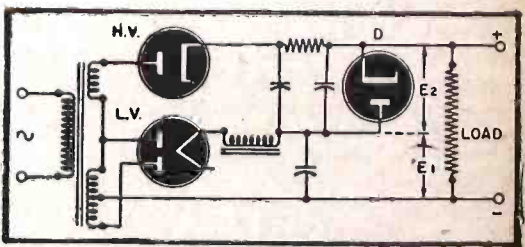

the diode D conducts, shorting out E_2 . E_1 then supplies the low voltage at high current.

DETECTOR CIRCUIT

Patent No. 2,361,616

THIS circuit overcomes previous limitations of diode detector circuits and provides greater selectivity and sensitivity. A diode detector usually loads the circuit, while an infinite impedance type does not provide sufficient AVC. The new detector, developed by Frederick C. Everett, Brecksville, O., uses an inductance in the cathode circuit. The two diode plates are excited by this inductance rather than the tuning circuit, so that the latter is not loaded. One plate is used for AVC, the other as detector. The latter voltage is also reflexed back to the control grid for A.F. amplification.

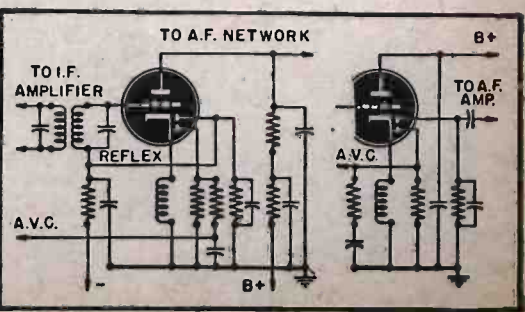

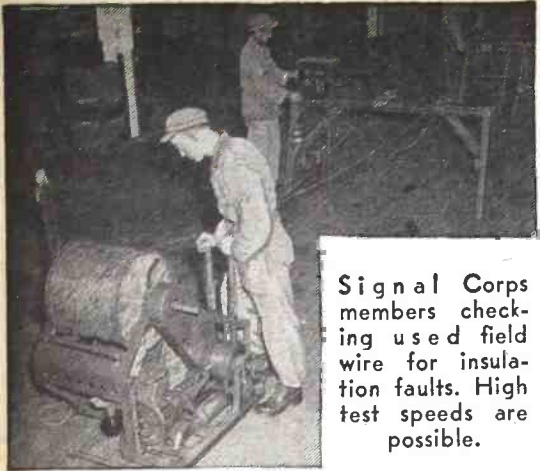

Signal Corps members checking used field wire for insulation faults. High test speeds are possible.

AN ARMY WIRE TESTER

AS a result of the ingenuity of several members of the Signal Corps in the European theatre, there has been developed a high speed and extremely accurate device for testing salvaged field wire. Using this instrument it is possible to locate pin-holes in the insulation, discover whether rubber tape has been used under the friction tape in an otherwise perfect appearing splice, etc. The apparatus is divided into three components, a motor-driven reel for winding the wire, a trough-shaped spark-testing electrode through which the wire passes, and a control box containing switches, dynamotor,

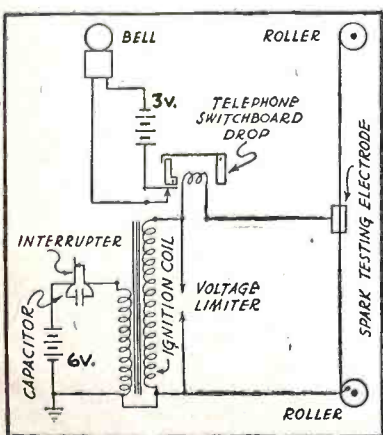

Schematic of the speedy insulation tester.

spark coil, and telephone switchboard drops. When a fault is encountered, the drop on the test box falls, causing a bell to ring. Up to 100 feet per minute may be tested. To obtain a relatively short distance between conductors of the wire being tested and the testing electrode, the latter was made from an angle iron $1\frac{1}{2}'' \times 1\frac{1}{2}''$, approximately 16" long. The wire is then passed along the base of the V formed by the angle iron. Guides are used at both entering and exit ends of the electrode to properly position the wire during the spark test and prevent damage to equipment when splices or knots are encountered.

In operation, 6 volt D.C. is stepped up by

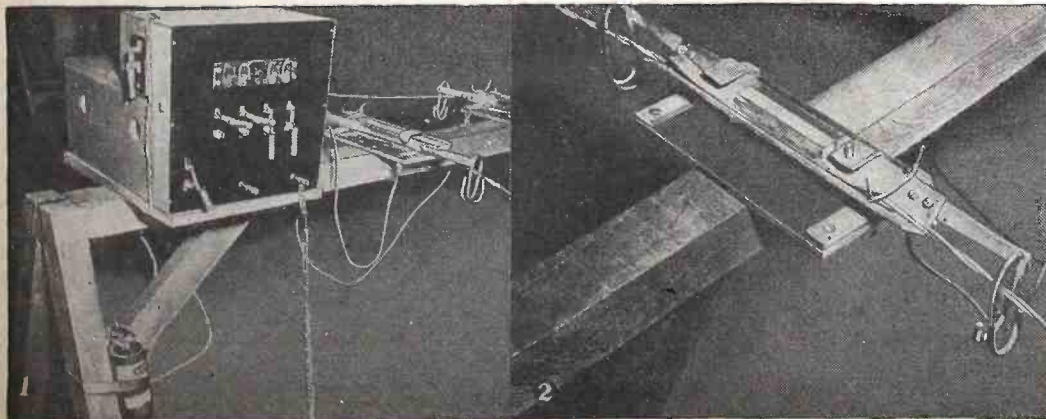

1—Apparatus is contained in box at left. 2—Close-up of the actual test electrode.



WE'VE GOT THOSE HARD TO GET RADIO PARTS!

QUICK SERVICE!

Our central location in the heart of the nation makes it possible to give you quicker service.

In these days of scarcity we have done everything possible to bring you the best in radio parts and equipment. In spite of existing shortages we have made available thousands of items as shown in our printed circulars.

We are determined to give you the same quick service on "hard-to-get" parts as thousands have enjoyed in the past. Because parts move so rapidly these days we intend to continue our policy of publishing an up-to-date list of merchandise every two or three months.

As additional equipment is released, we will be the first to have it. If you are not on our list to receive our flyers—mail the coupon today.

Sincerely,
Leo F. Meyerson
W9GFQ

WE SPECIALIZE IN HALLICRAFTERS

Service men all over the world are learning that the name "Hallicrafters" stands for quality in radio equipment. For many years we have been one of the country's largest distributors of Hallicrafters—"the radio man's radio." We have Hallicrafters available for immediate delivery on priority. For full particulars, write us today.

WHOLESALE RADIO LABORATORIES

**744 WEST BROADWAY
COUNCIL BLUFFS, IA.**

SEND FOR OUR LATEST FLYER TODAY!

You'll be surprised at the many hard-to-get parts we've been able to get for you fellows. Mikes, pickups, multimeters, meters and many other items. They're yours as long as they last. Send for latest flyer. It's full of merchandise you've been trying to get! Stocks won't last long, so write today.



OUR LATEST GET-ACQUAINTED OFFERS

TUBE AND CIRCUIT REFERENCE BOOK

Here's a handy reference book that meets the demand for simple, easy to understand data on substitution of radio tubes. Contains valuable technical information on tubes and circuits. It's a guide you'll refer to time and again. Send for your copy today! Only 10c post-paid.

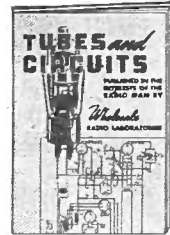

TUBE-BASE CALCULATOR ONLY 25c

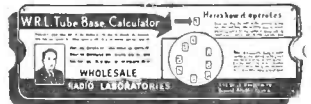

Here's just the calculator you've been looking for! Tells you quickly, tube characteristics that enable you to substitute available tubes for those hard to get. Only 25c. We pay shipping expense.

Giant Radio Reference Map - 15c



Time zones, amateur zones, short wave stations. Other valuable information. Printed in colors; size $3\frac{1}{2} \times 4\frac{1}{2}$ ft. Send 15c to help with packing and mailing.

Mail Coupon Today

Wholesale Radio Laboratories RC-4
744 West Broadway
Council Bluffs, Iowa

- Send your Reference Book, "Tubes and Circuits." Here's my 10c.
- You bet I want a Tube-Base calculator. 25c is enclosed.
- Ship me your radio map. 15c is enclosed for packing and mailing.
- Send your free flyer of hard-to-get radio parts.

Name

Address

Town State.....

Since the ignition coil used had no built-in vibrator for interrupting the primary circuit to develop the necessary high voltage in the secondary, a set of distributor points were mounted in the end of a salvaged dynamotor which had its high voltage winding burned out. To adapt the dynamotor to this use, the high voltage commutator and brush holders were removed and a single lobe cam for opening the breaker contacts was installed in place of the commutator. The dynamotor is operated from the same six-volt storage battery used to energize the ignition coil.

The illustrations give a clear idea of how the apparatus operates.

Twenty-one major advertising agencies have added television directors to their staffs.

DEALERS

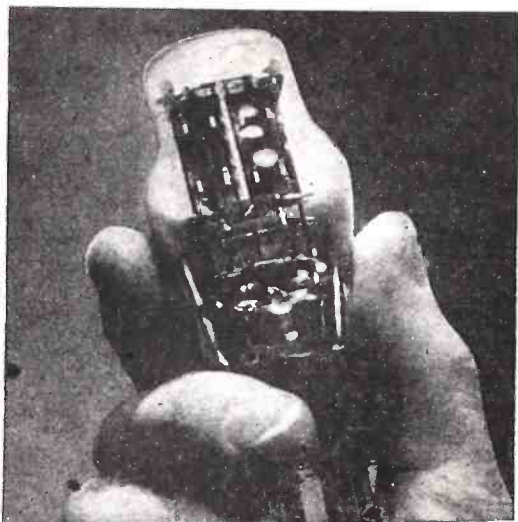

STOP! don't
throw it away!

Let **RTS** reprocess
your dead

RADIO TUBES

NEW Scientific Process

**REACTIVATES THORIUM
CONNECTS OPEN FILAMENTS
CLEARS SHORTS and
MICROPHONICS**

(NOT the old "flash" trick)

MINIMUM ORDER 6 TUBES

SEND NO
CASH

50¢
EA.

C. O. D.
ONLY

Prices approved
by O.P.A.
1 volt & 3-Q5
\$1.00

30-Day Guarantee

Every tube fully tested in
checkers & sets before playing

Send itemized list with order

Make sure glass, base & prongs are in-
tact... flashed, exploded or open ca-
thodes **REJECTED** and **NOT RETURNED**

RTS RADIO TUBE SERVICE CO. INC.

6805 20th Avenue, Brooklyn 4, N.Y.

446

Featherweight Radio Masts

MOLDED plywood, used during this war for many things unheard-of in peacetime, may solve the amateur's postwar antenna problem. The "ham" needs an aerial mast high enough for modern micro-wave techniques, light enough to be erected by one or two men, and cheap enough to buy without making too great inroads into funds set aside for electronic equipment.

The masts shown here are made from tubular molded plywood, somewhat reminiscent of the "conductor pipe" or "down-spout" masts used by a few pre-war hams. The impregnated plywood is far stronger than the old galvanized pipe, of course. Reports from one area where wind velocities went to more than 95 miles per hour during a hurricane indicated definitely that a properly-erected plywood aerial is practically windproof.

These masts can be constructed as high as 90 feet, and illustrations of shorter ones are shown on the page. Designed for use with long rhombics, they have been checked for a maximum pull of 10,000 pounds; and built for UHF arrays, tests with 300 pounds at the head—far more than the weight of any ordinary short-wave antenna—have been successfully passed.

As for weight and size, a 55-foot mast

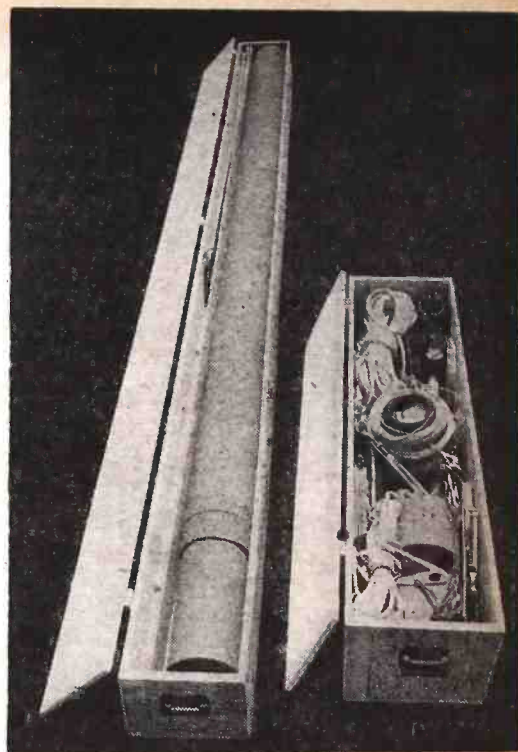

The Plytube mast and all accessories can be packed for shipment in these two boxes.

weighs only 200 pounds packed for shipping. The sections telescope into each other to pack in sections not more than 12 feet in length. Since all parts of the mast and

equipment are re-usable, they are especially adapted to experimental work, as one mast can be erected a number of times in different locations.

Old-timers of the 160-meter days can remember when an amateur's chief ambition was to have the tallest mast. The era of short waves and sky-wave reflections made masts less important than other features of the station. With the coming UHF and micro-waves, the mast again regains its old position as the chief factor in increasing a transmitting station's range.

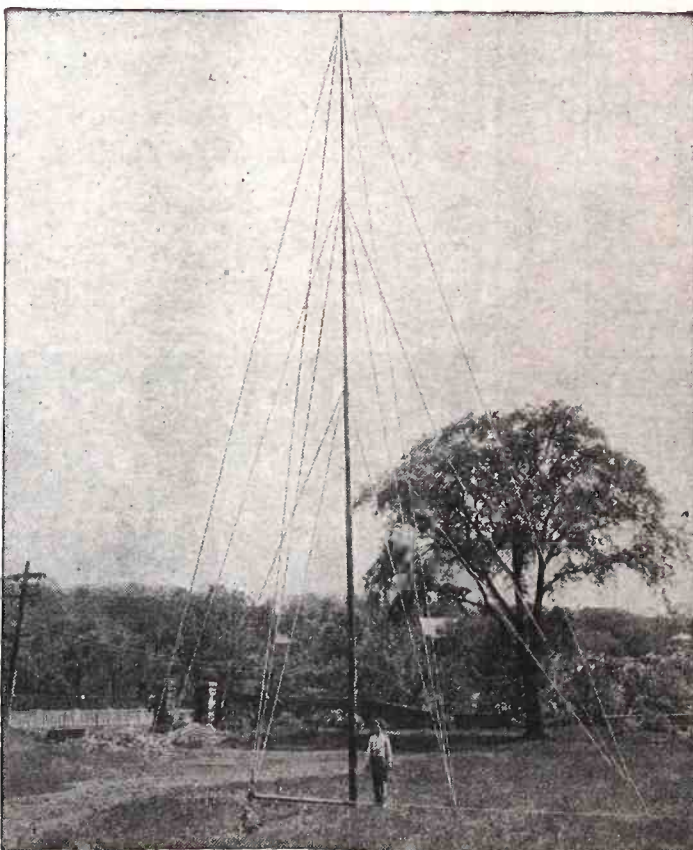

Above is a 75-foot mast, erected and guyed to stand a 125-mile-per-hour wind. At right is a mast in process of erection. A single man can raise a 55-foot antenna by means of the boom and tackle. If masts are more than 55 feet high, two men are required.

(Photos courtesy Plymold Corporation)



TEST OSCILLATOR

By HOMER DAVIDSON

THIS signal generator was especially built for the radio beginner to be used in aligning radio broadcast receivers. The frequency coverage is from 1500 Kc. to 550 Kc. approximately. It can be used as a standard calibrating oscillator. The electronic indicator is used as an A.C. output meter.

The oscillator section consists of an elec-

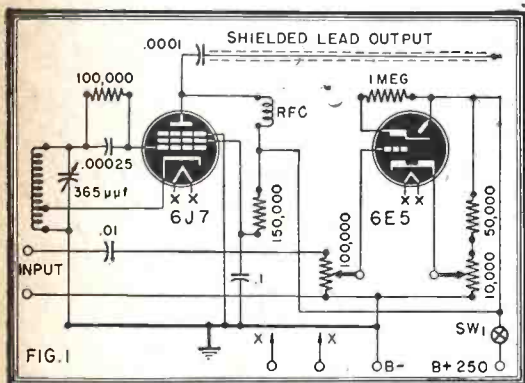

Schematic of the simple signal generator.

tron coupled oscillator using a 6J7 pentode. About 142 turns of number 28 enameled wire was closely wound on a 1¼ inch diameter form. This coil was tuned with a 365 mmfd. variable tuning condenser. A tap was made at the 47th turn from ground. It connected directly to the tube cathode.

A grid resistor of 100,000 ohms and a fixed mica capacitance of .00025 mfd. was used. The tuned circuit was placed to the left-hand side of the chassis with the .00014 tuning condenser fastened to the panel.

The output of the standard oscillator was taken off of the pentode plate. A small radio frequency choke supplied a load for the plate and offers high impedance to R.F., eliminating it from the power supply. The coupling condenser of .0001 mfd. is in series with the output shielded lead. Be sure and bring this output lead out of the right-hand side of the metal cabinet. The shielding runs clear to the plate and is grounded directly at the tube base. This lead is about three feet in length with two alligator clips.

A resistance of 150,000 ohms was used to drop the screen grid voltage. This resistance could be variable if desired, to control the oscillator. It is shunted by a 0.1 by-pass condenser.

The input of the electronic indicator is a pair of tip jacks, into which can be inserted leads. These are connected to the plate of the output tube and chassis of the receiver being aligned or otherwise tested. A blocking condenser is used to keep the receiver's high voltage off the 6E5 grid. Input signal can be varied with the 100,000-ohm control, according to the strength needed to close the "eye."

When using this small electronic indi-

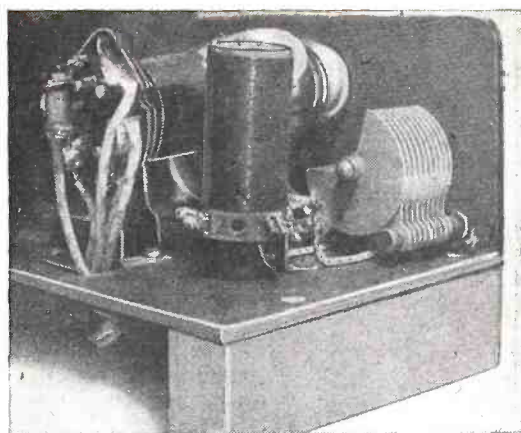

Photograph shows coil, condenser and 6E5.

cator be sure there is some means of rectifying the R.F. voltage. A detector stage such as a 6H6 could be added ahead of the 6E5 if needed. For alignment hook up the indicator after the second detector.

The whole chassis was made of brown masonite with pine box wood supports. The front panel was constructed of the same material. The panel was 5 inches wide, 4½ inches high. The wood-masonite chassis was 5 inches wide, 3½ inches deep, and 1 inch in thickness. This material was used because it is very easily handled and easy to work with.

A few extra attractions could be added to this instrument if desired. The detector tube ahead of the indicator (previously suggested) would make it usable as a signal tracer, for it would then indicate in R.F. circuits. A variable resistor could be used in the oscillator output to cut down the signal. Plug-in coils would make it possible to use the oscillator on the intermediate frequencies as well as on short wave.

FIX ANY RADIO

Amazing New Invention

**Simplified
Radio
Servicing
by
Comparison
Method**

Find radio faults with a new simplified method. Repair radios in minutes instead of hours. Revolutionary, different **Comparison** technique permits you to do expert work almost immediately. Most repairs can be made without test equipment. Simple point-to-point, cross-reference, circuit suggestions locate faults quickly and easily.

**COMPLETE
\$1.50
ONLY
SPECIAL OFFER
READ THE DETAILS**

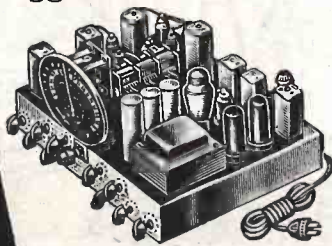

New 1945 Edition

**REPAIR ANY RADIO
IN MINUTES — NO TESTERS NEEDED**

Learn how to locate the source of trouble in any radio without equipment. Make needed tests, measure voltage, trace the signal, by using only a resistor, small condenser, and a crystal detector. Inject signals without any signal generator. Test parts by the new Comparison method. Test tubes without equipment. Repair any radio expertly following illustrated, simplified plans. Improve your radio servicing ability. Examine and apply the plan for 10 days without obligation or risk. Send coupon today.

Learn trouble-shooting short-cuts; find any radio fault with ease. Follow the tests shown on 16 large circuit blue-prints. Over 1,000 practical repair hints. Hundreds of simplified tests using a 5c resistor and any filter condenser. Introductory material for beginners and to serve as review for experienced radio men. Several chapters on test equipment. Complete plan in manual form, 64 job-sheets, size: 8½ x 11 inches. Sold on *no risk* trial. Money-back guarantee.

SUPREME PUBLICATIONS

328 S. Jefferson St. Chicago 12, Illinois

Ship postpaid the new complete Simplified Radio Servicing by **COMPARISON Method** manual for 10 days' examination. I am enclosing \$1.50, full price. I must be entirely satisfied or you will refund my total remittance.

NAME:

ADDRESS:

It's
SMART

to use our



INSTRUMENT REPAIR SERVICE

Testing instruments, worth their weight in gold! Can't take chances . . . gotta get 'em serviced RIGHT! Here's where we shine . . . all makes repaired by experts!

BUT—Please, before shipping, let us know make, model and serial number, age of instrument, and what seems to be the trouble. Then we can steer you straight. . . .

AUTHORIZED SUPREME SERVICE STATION

BURLINGAME ASSOCIATES

SERVICE DIVISION 23

11 Park Place New York 7, N. Y.

IMMEDIATE DELIVERY RADIO PARTS

Here are needs for every serviceman and sound man—put up in handy kit forms—to give you a wide assortment of everyday wants—at a small cost.

- 1M—1,000 piece hardware assortment—a "must" in every service shop—anything you might need . . . \$1.86
- 1C—100 piece By-pass condenser assortment—all popular numbers—from .0001 to .1 . . . \$5.55
- 2R—100 piece rubber-grommet assortment . . . \$1.23
- 3P—100 padders & Trimmers . . . \$4.92
- 4W—2# package assorted hookup wire . . . \$1.50
- 5R—100 carbon resistors, 25 1 watt, 75½-watt . . . \$2.94
- 6R—100 1/3 watt, insulated resistors color coded . . . \$2.94
- 7V—25 assorted volume controls . . \$6.45
- 8L—50 assorted 2 watt resistors . . \$2.58

Write for our latest bulletin listing hundreds of necessary items for the radio and soundman.

20% deposit required on all C. O. D. orders of \$25.00 or more accompanied by payment in full, will be shipped prepaid. DON'T FORGET L-265 certificate.

LIFETIME SOUND EQUIPMENT CO.

P.O. BOX 834 TOLEDO 1 OHIO, U.S.A.

SIGNAL TRACER AND MULTITESTER

(Continued from page 418)

in reducing voltages and adding bias in order to stop the oscillation. The output was very little better than with one R.F. stage. As it now stands the one untuned 6K7 and untuned 6J7 provide enough gain to trace the signal from the grid of the first tube right on to the detector, from which point the probe is shifted to the audio input jack and the signal traced right on the loud-speaker.

The use of such a tester is a revelation to one who has never used a signal tracer. Oscillation can be traced right down to the offending tube by bringing the probe somewhere in the neighborhood of the tube plate prong. Hum and noise can be picked up just as easily. Loss of gain can be isolated right to the offending stage and many times to the very part.

A real set of test prods made as the photos show will prevent any detuning of the circuit under test. If the parts are available the shielded test probe shown will prove a valuable addition to the tester. Use 30 inches of microphone cord and bring the end of the shield out in a phone tip which is to be inserted in the ground jack. When testing the grid circuit of the first tube the ground tip should be removed from the ground jack to increase the signal strength, as the shield acts as a small condenser by-passing some of the R.F. energy to ground.

The small capacity tip is made by turning or grinding down a small phone-tip jack in a lathe or grinder until it is just a thin shell. Cut the end off to fit the length of the insulator of the phone tip (See Photo). Insulate the turned surface of the jack with wax paper and wind on 50 turns of wire from an old transformer secondary. Fasten the wiring by painting the coil with dope. Test the assembly for continuity to be sure you have no short. There must

be no direct connection; only a small capacity coupling between the coil wire and the jack should exist.

When cutting off the end of the jack to fit the space within the insulated phone tip, the gripping jaws will slip out. To hold the assembly together solder the jaws and the end of the jack together.

The A.F. tip probe was made by cutting off a phone jack and soldering a 50,000 ohm resistor to the end of the jack and the inside gripper jaws. The photo is self explanatory. When using the tester only one such probe is necessary if the tester ground and the set chassis are connected together with a jumper. The same probe can then be used for all voltage and resistance tests by using it without the tips, which are easily put on and removed.

THE VOLT-OHMMETER SECTION

As we had a power supply the tester could be adapted to many more uses. It is a handy Volt-Ohmmeter, also a condenser and continuity tester. My only transformer had a 2½-volt filament winding so I selected tubes which could be wired in series with a line cord resistor. Other tubes can be used in their places if they have the same current drain. Any tubes of similar type can be substituted if you can supply 6.3 volts on the filament winding. If so you can do away with the line-cord resistor.

The voltmeter has 4 ranges: ½, 25, 150 and 500 volts, which are selected by the 4 positions of the gang wafer switch (to the right in diagram). The lowest range was selected for ohmmeter work only. The resistor values given are for my 2,000 ohm-per-volt meter, which has a resistance of 47 ohms. For a 1 Ma. meter these values should be halved.

The ohmmeter uses the same pin jacks

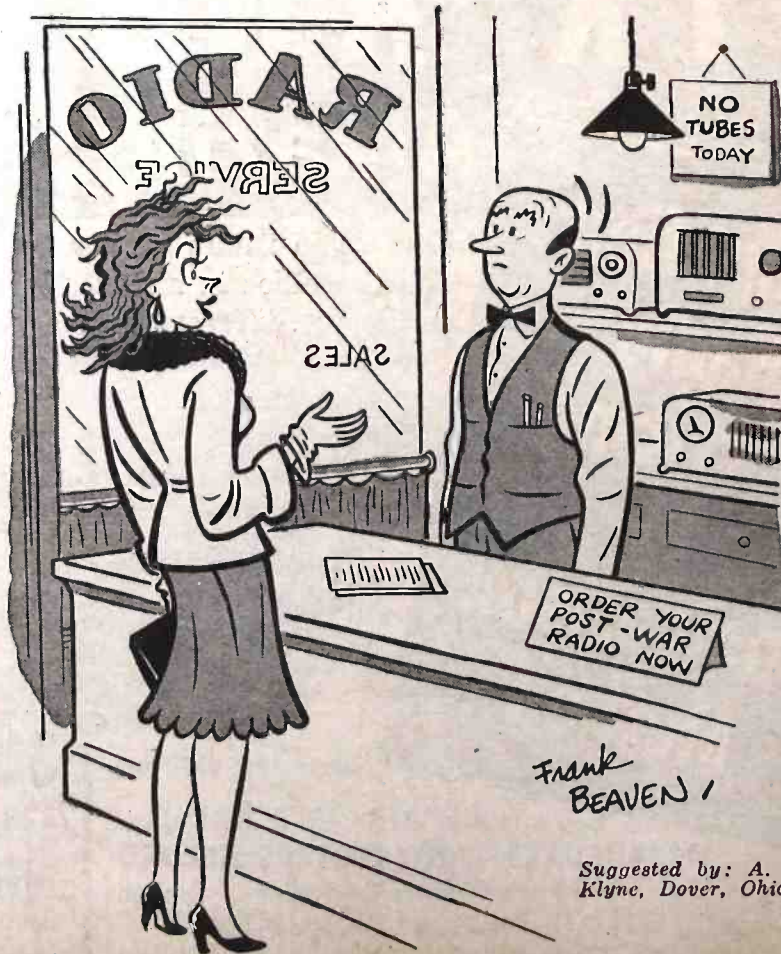

Suggested by: A. B. Klyne, Dover, Ohio.

"Give me one of those short 'wave sets' I hear so much about; my hair is a mess."

that are used for the voltage tests. The gang wafer switch which selects the voltage range also operates a voltage divider on the second wafer when the switch No. 3 on the front panel is thrown. This switch may be combined with potentiometer R. The voltage divider was constructed to give a full scale reading on the meter of each of the ranges with the exception of the 500-volt scale. The adjustment of the pot. R is for the full-scale adjustment. The circuit is arranged so that the same voltmeter jacks are used and the test prods are in parallel with the meter. Shorting the prods shunts all the current away from the meter, which reads zero on a dead short. The scale can be calibrated with a known set of resistances. If a sensitive meter is used values of resistances from 1 ohm to 2 meg. can easily be read. The voltage available at the jacks can be used for experimental purposes while the meter reads the voltage actually supplied.

The ohmmeter provides a very accurate condenser tester, especially for the 25 and 150 volt electrolytic condensers. This is the only tester I have seen capable of testing the leakage and capacity of the low voltage electrolytics. The range switch is thrown to the proper range, let us say 25 volts and the voltage divider switch turned on. Adjust the meter for full scale deflection and insert the test leads in the ohmmeter jacks. The prods now have 25 volts DC across them which can be placed across the electrolytic, watching the polarity as usual. The meter needle will dip on the charge and return to almost full scale if the condenser is good. Discharge by shorting the condenser leads. The meter needle will read zero on a shorted condenser and will not dip on an open-circuited condenser as the prods are applied.

For 150 and 450 volt filters and continuity tests the prod is changed to the neon tube jack which is No. 3 on the front panel, and the range of voltage is selected as before by the wafer switch. The two-watt neon bulb was purposely left inside of the tester where it is dark so that very small leakages and small capacities will be much easier to see.

As 25 volts will not light the neon tube such low voltage condensers must be tested as above. The meter test is just as good as the neon test if not better and can be used for the higher voltage condensers.

INVISIBLE CODE MACHINE

With the aid of two small pieces of cotton you can have with you at all times a code practice oscillator with any tone or note you desire.

Just place the cotton in ears fairly tight. Now for that loud earphone effect: with a little use of the lips and vocal cords just say your dit-dit-dit-dah. By shutting out the world you can have the privacy that helps you to concentrate, plus that loud in-the-head sound.

By utilizing the time riding on trains and busses or at odd moments in the noisy factory you can speed up your code work—it helps you till you get to your set at home.

L. E. BROSTROM,
Rock Island, Ill.

(While this was not sent in for the April issue, it seems singularly appropriate for this month. Personally, we would not care to take a chance on being seen in the street-car [for instance] with eyes fixed straight forward and pronouncing—even semi-audibly—"dah-dah-dit" or similar expressions. The sanity of radiomen is already too suspect for that!—Editor)

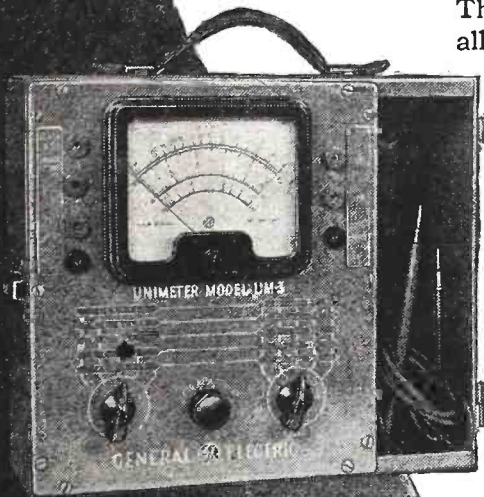
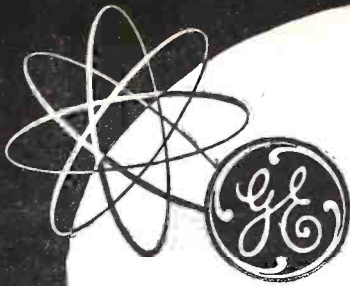

UM-3 GENERAL ELECTRIC

177-D2

UNIMETER

This unit fulfills an extremely important need for general utility portable service equipment. It has wide range coverage for both a-c and d-c measurements of voltage, current measurements on d-c and the popular ranges on resistance.

The UM-3 is designed to clearly indicate all the functions which aid in the prevention of application of high voltages when preparing for current or resistance measurements.

Other G-E units for better servicing include: Tube Checker TC-3, Unimeter UM-4, and Oscilloscope CRO-3A.

For details write: *Electronics Department, General Electric, Schenectady 5, New York.*

Electronic Measuring Instruments

AN AMAZING TOOL!

The Burgess Vibro-Tool PUTS PERMANENT IDENTIFICATION MARKS ON INDUSTRIAL MATERIALS—files, chisels, hammers, etc. . . . and grooves soft metals.



On the production and assembly lines, in the tool-room or for superintendents and inspectors, Vibro-Tool saves time, money and trouble, in quickly cutting identifying numbers on production parts; engraving names on identification

disks; engraving trade-marks or other insignia on finished goods; writing names of persons or departments on tools or other equipment; cutting cloth patterns; engraving names or designs on glass; cutting rubber patterns, gaskets, etc. Even hard steel easily marked by using our special V-3 Tantalum Carbide Point. Tool uses vibration principle. 120 vertical strokes per sec.; 60 cycles, operating from 110V. AC. outlet.



Portable: weighs only 1 lb. Price complete \$7.50, for carton containing tool and ordinary needles. Special needles, cutting points and other accessories available at reasonable extra cost.

Available on AA-5 Priority within 30 days after receipt of order.

RADIO ELECTRIC SERVICE CO. of PA.

701 ARCH STREET PHILADELPHIA 6, PA.

— BRANCHES —
PHILADELPHIA:
3145 N. Broad St., 5135 Market St.
ALLENTOWN, PA.:
1042 Hamilton St.
CAMDEN, N. J.:
513 Cooper St.
WILMINGTON, DEL.:
219 W. 8th St.

EVERY ELECTRICAL WORKER NEEDS THIS ELECTRICIANS 1945 HAND BOOK

For Everyday Help On The Job!

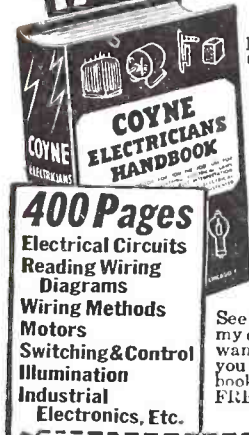

Brand new... up to the minute. Contains over 5,000 electrical facts—wiring diagrams—essential electrical formulas—latest code rules, tables, charts and wiring methods. Includes Industrial Electronics data. It's a gold-mine of practical, down-to-earth help and ideas to save you time and money. A book every Electrical Worker can use every day. Pocket size, 4 1/4 by 7 inches, flexible leatherette cover to stand hard usage.

SEE IT FREE!

See this book FREE for 7 days at my expense. If you decide you don't want to keep it, send it back and you owe nothing. If you keep the book you pay only \$2.75 after 7 days' FREE examination.

FREE TRIAL COUPON

H. C. LEWIS, President
Coyne Electrical School, Dept. 45-T2
500 S. Paulina St., Chicago 12, Ill.

I want to see the New Coyne Electricians Handbook. Send me a copy for 7 days' FREE examination. If after 7 days I do not want the book I will return it and owe you nothing. If I keep it I will pay \$2.75 within 7 days and the book is mine.

NAME _____ Age _____
ADDRESS _____
TOWN _____ Zone _____ STATE _____

If you prefer to pay postman cash price shown above on delivery, check here. Same FREE examination & money back guarantee.

LAKE Radio Cabinets & Parts

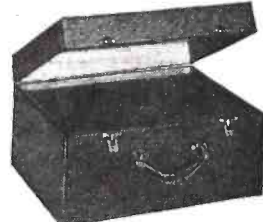

Portable Phonograph case, of sturdy durable plywood, in handsome brown leatherette finish. Inside dimensions 16 1/2" long, 14" wide, 9 1/2" high. Has blank motor board. As illustrated above, specially priced at **\$6.95**

Also blank table cabinets of walnut veneer in the following sizes, with speaker opening on left front side: (Note: 7" has center speaker Grill.)

#1	8 1/4"	L	x	5 1/2"	H	x	4"	D	\$1.95
#2	10 1/4"	L	x	6 3/8"	H	x	5"	D	\$2.75
#3	13 1/2"	L	x	7 3/8"	H	x	6 1/4"	D	\$3.25
#7	10 3/4"	L	x	7"	H	x	5 1/2"	D	\$2.50
#8	17"	L	x	9"	H	x	9 3/4"	D	\$4.50
#9	21"	L	x	9 1/4"	H	x	10 1/2"	D	\$5.50

*Speaker Opening in center of front side. Cabinets available in Ivory color and Swedish Modern. Write for prices.

POWER TRANSFORMERS

4, 5, or 6 Tube—6.3V at 2 amp.	50 Mill Power Transformer	\$2.45
7, 8, or 9 Tube—6.3V at 3 amp.	70 Mill Power Transformer	\$2.65

All types of radio parts available in today's market can be obtained at Lake's money-saving prices. Write For Our Free, New Illustrated Catalog!

LAKE RADIO SALES CO.
615 W. Randolph Street Chicago 6, Ill.

Headset Headquarters

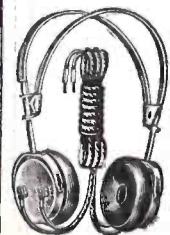

Folder R-4 illustrates complete line of Guaranteed

CANNON-BALL HEADSETS

Beautifully designed. Light in weight. Efficient. Reproduce with clarity and good volume. Write

C. F. CANNON COMPANY
SPRINGWATER, N. Y.

VOLTAGE DIVIDERS

(Continued from page 420)

screen current that any fluctuation in the screen current will have only a small effect on the voltage drop across R2. The voltage across R2 is,

$$E = I_b R$$

THE BLEEDER CURRENT

If we want a bleeder current 10 times that of the screen grid, I_b will be 10 Ma. and to have a 100-volt drop across it,

$$\frac{E}{R} = .01, \text{ and } R = 10,000\Omega.$$

The value of ten times the screen current for the bleeder current through R1 is only an arbitrary choice, and actually in circuit design we might set up the circuit and only install R1 if necessary. Or, we might find that the value of bleeder current could be reduced to five times the screen current or even to two or three times. The exact amount would depend on the circuit conditions. Voltage division is just part of the picture of voltage divider design. We may also run into voltage regulation.

Assuming a 1 Ma. screen current through the circuit for the screen grid of the tube, and a current of 10 Ma. through R1, the total current through R2 in Fig. 7 will be 11 Ma. We know that the voltage between screen grid and ground is to be 100 volts, for our example, and the source voltage E is 250. Then, 250 minus 100 gives 150 volts as the drop across R2. The current through R2 is .011 ampere and the voltage across R2 is 150, so that:

$$R2 = \frac{E_{R2}}{I_{R2}} = \frac{150}{.011} = \frac{150,000}{11} = 13,600 \text{ ohms}$$

approximately.

In this circuit, two things may commonly happen to change the voltage on the screen. If, for any reason, the screen current goes down, the amount of screen current flowing in R2 will be reduced and the voltage drop across R2 will go down. This would tend to raise the screen potential, but as the screen voltage across R1 rises, more current tends to flow in R1 and accordingly there is a tendency for the series current through R2 to rise, which again in turn tends to raise the voltage across R2. The rise in voltage across R2 reacts on the circuit in such a way as to leave less voltage for R1, so that the effect of R1 is to make the circuit stabilize, providing voltage regulation.

A RADIO VOLTAGE DIVIDER

In a radio receiver, we may have several tubes which are connected to a common power supply. The plates and screens may be fed through a voltage dividing network, as shown in Fig. 7. Suppose we label the currents alphabetically. Then, in Fig. 7, the total current drawn from the source will be, $I = I_a + I_b$; $I_b = I_c + I_d$; and $I_d = I_e + I_f$

where I = total current
 $I_a, I_b, I_c, I_d, I_e, I_f$ indicate the branch currents shown by arrows in Fig. 8.

We may know, for example, that a certain number of tubes will draw the currents indicated in Fig. 7. The currents will be shown approximately by a tube chart or tube manual for typical operating voltage values.

Assuming that we have the values in Fig. 7, the total current drawn by the tubes is 60 Ma.

Suppose we assume a bleeder current of 10 milliamperes. Some other value may be chosen, but on the basis of experience, a fair estimate is about 10% of the total current. 10% of 60 would be 6 Ma., but for simplicity in explaining the action we can take a round figure such as 10 milliamperes. Accordingly, the total current taken from the source is 70 ma. or .07 ampere. The bleeder current flows through R1, R2 and R3. Only the bleeder current will flow in R3. In R2 and R1, in addition to the bleeder current, we will have 10 ma. through R2 and in R1 we will have the current of I_b plus the bleeder current and I_c . This means that the current in R2 will be 20 Ma. and in R1 it will be 30 Ma.

We know that the voltage across R3 is to be 50 volts. Then,

$$R3 = \frac{50}{.01} = 5000 \text{ ohms}$$

The power dissipated in R3 is,

$$P = \frac{E^2}{R} = \frac{50 \times 50}{5000} = \frac{2500}{5000} = .5 \text{ watt}$$

A resistor rated at 1 watt could be used in the circuit, allowing a 100% safety margin. The value of R2 is,

$$R2 = \frac{100 - 50}{I_b + I_r} = \frac{50}{.02} = 2500 \text{ ohms.}$$

The power in R2 is,

$$P = \frac{E^2}{R} = \frac{50 \times 50}{2500} = \frac{2500}{2500} = 1 \text{ watt.}$$

A 2-watt resistor would be used here. The value of R1 is,

$$R1 = \frac{E_{R1}}{I_b} = \frac{150}{.03} = 5000 \text{ ohms.}$$

PLATE NEUTRALIZATION



Suggested by: Albert A. Mueller, Sioux Falls, S.D.

The power in R1 is,

$$P = \frac{E_{R1}^2}{R_1} = \frac{150 \times 150}{5000} = \frac{22,500}{5000} = 4.5 \text{ watts}$$

Assuming a field coil of 1,000 ohms is used in series with the load, as shown in Fig. 8, and remembering that the total current is 70 Ma., the input voltage, r.m.s., across the input filter condenser is,

$$E_x = E_x + E_L$$

$$\text{and } E_L = .07 \times 1000 = 70 \text{ volts}$$

$$\text{then } E_x = 250 + 70 = 320 \text{ volts}$$

These figures and formulas are very simple and indicate only in a rough way the fundamental principles; the actual design on an engineering basis is extremely complicated, according to how deeply you want to go into it. Many beginners make the mistake of assuming that a circuit design can be sketched out; in many instances such "design" yields fairly satisfactory results and the equipment may work, but whether it works efficiently and properly is something else again—depending on what your standards of performance are. The design of a precision communications receiver, for example, cannot be compared with the design work involved in an "engineering" laboratory where the engineer hooks up a couple of condensers, parts of various types and lo and behold has a midget receiver. For the amateur experimenter, comparatively crude engineering work is sufficient, enough of such work to make the apparatus function, but no one, unless he has had ample theoretical training and practical experience, should attempt to "design" a radio on a real engineering basis.

TWO-WAY LIFEBOAT RADIO

A new transmitter-receiver for use in lifeboats can be operated by non-skilled men and will be equipped for two-way manual radio telegraph and radio telephone, also automatic radio telegraph transmission. The radio telephone will enable occupants of lifeboats so equipped to maintain communications between lifeboats. The transmitter-receiver will operate on the International distress frequency of 500 KC and on the high frequency adopted by the air-sea rescue program to permit an effective tie-in with this undertaking and provide the maximum of rescue capabilities.

The transmitter-receiver is operable entirely by the use of a hand powered generator which permits unlimited operation without the use of batteries. The unit is entirely waterproof and embodies the use of balloon and kite antennas enabling an average transmitting range ten times that obtainable with the present lifeboat transmitter on 500 KC and a range above a thousand miles when used on the high-frequency band.

Bureau of Standards tests on over-age batteries now being released by the military and available to civilian purchasers indicate that most types of good quality cells will give 80 to 90 per cent of the output of new cells after six months' storage. In the smaller types of batteries such as are used for portable radios, however, the drop is greater, and such cells may be only 60 to 70 per cent efficient.

HALLICRAFTERS ★ HALLICRAFTERS



COMPLETE STOCKS

I have in stock some Hallicrafters receivers available for immediate delivery on priority and the following parts without priority: meter rectifiers \$1.95, transmitting tubes, transformers, resistors, condensers, panels, headsets, etc. Your orders and inquiries invited.

RECEIVER HEADQUARTERS for the Nation

BEFORE the war Bob Henry served the amateurs as the world's largest distributor of communications receivers.

Now Henry Radio is Hallicrafters receiver headquarters for the Nation at war. Hallicrafters Receivers can be supplied on AA-1 priority. I can usually supply SX28As at \$223.00, S-39s at \$110.00, SX-25s at \$94.50, and PM-23 speakers at \$15.00 at once. It takes longer to supply other models.

Soon, it is hoped, non-priority orders can be filled and Bob Henry can become again Hallicrafters headquarters for the nation at peace.

I have stores at Butler, Missouri, and at 2335 Westwood Blvd., Los Angeles 25, Calif.

Your orders and inquiries are invited.

Bob Henry, W9ARA
HENRY RADIO SHOPS

Butler, Mo. and Los Angeles, 25, Calif.

"WORLD'S LARGEST DISTRIBUTOR OF COMMUNICATIONS RECEIVERS"



SPEED UP REPAIRS WITH THESE G-C AIDS!



FREE
STEEL
CABINET

G-C DIAL BELT KITS

Exact replacement woven fabric belts. Easy to install—no stretching—no adjustments—a perfect fit everytime. Kits come with 25, 50, 100, 200 or 300 belts.



G-C AUTOMATIC
WIRE STRIPPER

Strips insulation from all types of wire. Does the job instantly, easily, perfectly. An ideal tool for radio men, electricians and sound men.

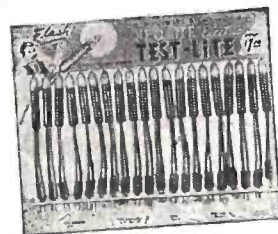

G-C NE-O-LITE

New improved design. Useful hundreds of ways. Tests AC and DC lines, DC polarity, fuses, etc. You can't afford to be without this handy all-purpose trouble shooter.

Order From Your Radio Parts Jobber
ALWAYS ASK FOR G-C PRODUCTS



GENERAL CEMENT MFG. CO.

ROCKFORD, ILLINOIS

PATENTS—TRADE MARKS

Booklet concerning Inventions & Patents Form "Evidence of Conception" with instructions for use and "Schedule of Government and Attorneys Fees"—Free
LANCASTER, ALLWINE & ROMMEL
Registered Patent Attorneys

436 Bowen Bldg.

Washington 5, D. C.

A convention by radio—the first in history—is projected for the 38th annual meeting of the Virginia Federation of Women's Clubs. WRNL of Richmond, Virginia has made arrangements to carry the convention in three 30-minute programs on April 10, 11 and 12. A state-wide network will broadcast it to all areas to be covered.

NATION-WIDE
MAIL ORDER
DISTRIBUTORS
SINCE 1928



RADIO AND ELECTRONIC DEVICES

For...

TRADE... INDUSTRY...
COMMUNICATION...
PUBLIC UTILITY...
VOCATIONAL AND
EXPERIMENTAL
APPLICATIONS

BURSTEIN-APPLEBEE CO.

1012-14 MCGEE ST.
KANSAS CITY 6, MISSOURI

LEARN ABOUT THE GREAT OPPORTUNITY FIELD

ELECTRONICS!



THE PRACTICAL BOOK FOR
RADIO and ELECTRICAL MEN

7 DAYS FREE TRIAL

Brand new! Practical! Simplified! THE quick, easy way to get a knowledge of Electronics—greatest of all job opportunities.

SEND NO MONEY! SEE OFFER IN COUPON!

Big new 400 page manual on Electronic work. Handy for job use—full of easy-to-follow diagrams. Radio men, Electricians, Mechanics—build on your present knowledge to get a better job! Send coupon TODAY!

FREE with Manual! 1 yr. Personal Counsel by mail on your Electronic problems from Coyne staff. ALSO FREE—1 year subscription to Coyne Technical News.



H. C. LEWIS, Pres.,
COYNE ELECTRICAL SCHOOL
Dept. 45-71, 500 S. Paulina St., Chicago 12, Ill.
Send me postpaid your big new manual, ELECTRONICS for the Radio Man and Electrician. I'll either return book within 7 days or send \$4.95 in full payment.

NAME.....
ADDRESS.....
CITY.....STATE.....
OCCUPATION.....AGE.....

YOUR NEW FREE CATALOG IS READY FOR YOU!

Radionic's Catalog No. 26 lists hard-to-get radio parts! • Helps you fill your radio and electronic needs. • All parts are available for immediate shipment • All are highest quality. • All are exceptional values.

SEND TODAY FOR YOUR FREE COPY TO

RADIONIC EQUIPMENT CO., Dept. 2A
"CHANCELLOR" PRODUCTS
170 NASSAU STREET, NEW YORK 7, N. Y.

Rivets in Radio

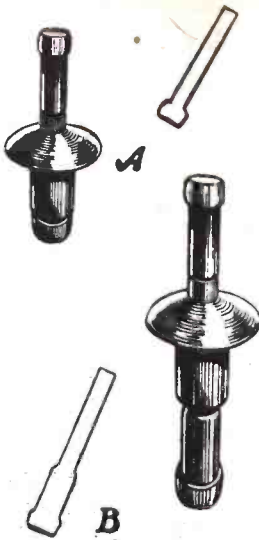

Top: Hollow type blind rivet. Plug A drops out. Bottom: Self-plugging type. Plug B remains in rivet.



Fastening an output transformer to speaker.

MANY of the discoveries and improved methods discovered during the war are expected to revolutionize post-war radio. With eyes fixed on the big discoveries, radiomen tend to overlook the fact that many of the smaller routines and methods will be as greatly improved and modified. One technique borrowed from aviation may well be the use of blind rivets.

Blind rivets, used extensively in aircraft construction for hard-to-get-at places, are headed by one man from one side of the job—no bucking up is needed. These rivets are made in two types, hollow and self-plugging, with either brazier or counter-sunk heads.

For radio repair work, the hollow rivet is especially applicable. Because of unusual tolerances, this rivet does not require exact hole drilling in the material to be riveted. Assembled at the plant, it consists of an aluminum stem inserted into this hole and extending above and below the rivet. The top of the stem is notched in such a manner

that it fits securely into the specially designed guns. The bottom of the stem has a factory-formed head, larger than the rivet shank. In application, the rivet and stem are placed in the material hole, and the stem top is inserted into the gun head. The pulling force of the gun draws the stem against the rivet shank, forcing the shank to spread and clinch into the material with a clinching force of from 300 to 600 pounds. Then the stem breaks into two parts, both parts falling free of the rivet and leaving a tightly clinched hollow rivet.

Radio repair shops already using hollow rivets report that they are quick, dependable, inexpensive for such installations as fastening tube sockets, transformers, name plates, loud-speaker shields, parts to chassis, lid hinges on portables—almost any place where fastening is required. They report that these rivets do not bend, dent, mar or otherwise damage radio chassis and materials; finish up neat and smooth, giving a workmanship-like appearance to the job.

"COPPER MAN" SUBS FOR AVIATORS

General Electric has joined the robot-builders. Their "Copper Man" here illustrated is not able to wield a soldering iron or wire up sets, as might have been expected. Neither is the first of a group of electronic warriors for hand-to-hand fighting against enemies of mere flesh and blood. The Copper Man is merely a "test pilot" for artificially-heated garments.

In the development of electrically warmed clothing and blankets for fliers and their implements, cold chamber testing is so vital that it was thought highly desirable to develop a mechanical device that would simulate the human body. The device duplicates almost exactly the human temperature system and provides the perfect scientific answer to the problem of testing electrically warmed flying suits, gloves, shoes and blankets at low temperatures without inflicting suffering and danger on humans.

General Electric's Copper Man is 5 feet 10½ inches tall and has a copper "skin" 1/16 of an inch thick. He loses his handsome copper luster, however, when put into actual operation, as he is at the N.R.D.G.A. convention. He is overcoated with a black ebony finish used to increase the radiation of heat. A complicated system of electric wires is connected with separate areas of the copper head, torso, hands and feet.

It is necessary for the body to generate sufficient heat with which to keep warm. The temperature of different parts of the human body varies considerably. For instance, the face and hands which are normally more exposed may vary over a wide

range of temperature without harm or discomfort, whereas the torso must be kept at an about uniform temperature. The marvel of the Copper Man is that he has been so wired and circulated that he practically reproduces the varied heat of different parts and members of the body. His body has been divided into 15 areas, the amount of energy to each area being, subject to individual control.



V.H.F. RADIO RANGE

(Continued from page 411)

and 150-cycle frequencies are passed through band-pass filters. The individual outputs are then rectified and the D.C. applied to opposite coils in a zero-center meter. This meter will deflect to one side or the other, depending upon whether the 90- or 150-cycle signal is stronger. When "on-course" it will remain in a vertical position. The visual leg makes possible much more accurate flying of a range, since deflections on the course being flown are more rapidly apparent.

The VHF range antenna installation is smaller than the low frequency range. For this reason they are less expensive to install. Field tests have also shown that favorable results may be obtained with lower power, with a consequent reduction in the cost of station installations. In the preliminary report it was estimated that the VHF stations will cost about one-fifth that of the low frequency stations. The VHF transmitters are crystal controlled and designed to deliver 300 watts to the antenna.

The compact size of the VHF ranges have enabled field tests heretofore impractical. Some of the difficulties which were encountered and overcome in this preliminary work have greatly simplified installations for regular flying.

Considerable care must be taken in VHF design and installation to avoid the formation of spurious secondary courses as a result of minor lobes in the antenna pattern. It was observed that both the three-element and the five-element pure horizontally polarized arrays are economical and easy to maintain. While the three-element array was simpler to adjust than the five-element system, the latter gave slightly sharper courses. Slight quadrant reversals appear in the cone-of-silence area with the five-element system which are not present with the three-element system. The five-loop system (using either 3 or 5 elements) was the most desirable VHF range tested. The three-element system was best for aural flying because of the lack of quadrant reversals in the cone of silence.

The omnidirectional or all-direction VHF range will register the bearing of an airplane on an instrument in the cockpit. This latest device has been developed by the Technical Development Division of the Federal Airways Service of the CAA. It is now going through final testing.

The new range will send course signals in all directions from the station. It is also equipped for voice, but will have the advantage of being practically free from static. In actual flight, the pilot can select any desired compass course by setting a pointer on a 360 degree compass type dial. So long as he maintains the course, a vertical pointer on another dial—usually the standard cross-pointer instrument used for instrument landings—remains centered. Deviations are indicated to right and left up to 10 degrees maximum on the dial.

Should the pilot go far off course, despite continual instrument indication of his flight path, he can determine immediately his bear-

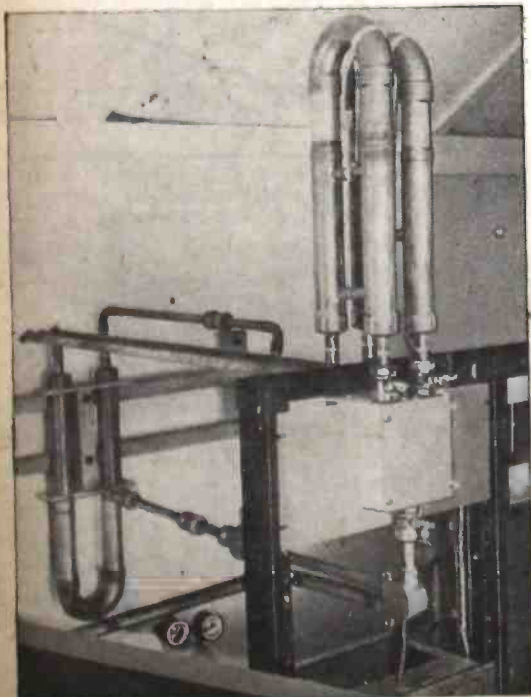

Phasing network—125-megacycle radio range.

ing to any station within receiving range by centering the vertical pointer and reading the bearing on the scale of degrees. He can also take bearings on two or more stations and obtain a radio fix. The effective coverage of these ranges will be about 50 miles at 1,000 feet, increasing to 100 miles at 10,000 feet. Results obtained in the development of the range have been so promising that the CAA has designed the VHF ranges now being installed so that they can be converted to the new type easily and inexpensively. This type of air navigation facility makes it possible for the private pilot of a small airplane, with nothing more than a radio receiver, to navigate by radio anywhere in the country.

When the VHF range system is installed nationally it is anticipated that a variety of reflecting objects will be encountered. Should they seriously distort the pattern or cause multiple courses it may be necessary to resort to specially shaped space patterns. In such cases the two course radio range permits greater flexibility than the four course range.

SHORT circuits often result because of the common habit of pulling electric fixture plugs out of the wall receptacles by the cord. The wire loosens bit by bit, eventually shorts and blows the fuses.

Tighten up the screws in the plug, then pour in melted sealing wax until all wires are covered. Sealing wax for the purpose may be obtained from the tops of old "B" batteries. The wax will anchor the wire ends securely and double the trouble-free life of the extension cord.

LAMPHOUSE ANNUAL,
New Zealand.

ELECTRICITY

● for Radio and Electronic Applications

ONAN ELECTRIC GENERATING PLANTS supply reliable, economical electric service for electronics applications as well as for scores of general uses.

Driven by Onan-built, 4-cycle gasoline engines, these power units are of single-unit, compact design and sturdy construction. Suitable for mobile, stationary or emergency service.

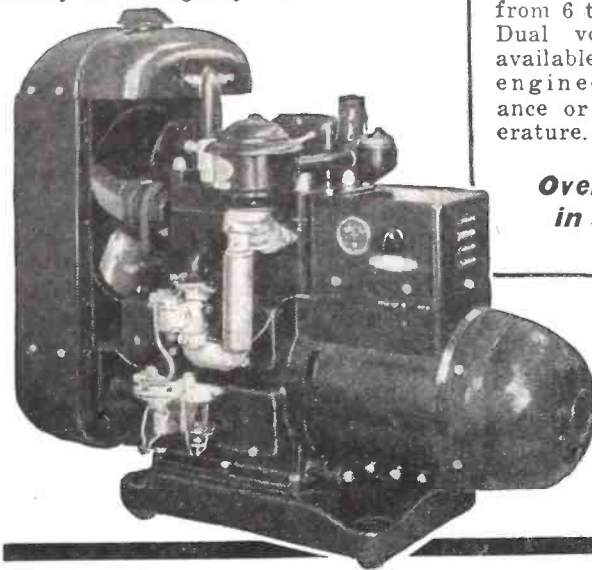

Model Shown is from W2C series, 2 and 3-KW, 60-cycle, 115 volt; powered by water-cooled, 2-cylinder engine.

D. W. ONAN & SONS 2414 Royalston Ave.,
Minneapolis 5, Minn.



Models range from 350 to 35,000 watts. A.C. types from 115 to 660 volts; 50, 60, 180 cycles, single or three-phase; 400, 500, and 800 cycle, single phase; also special frequencies.

D.C. types range from 6 to 4000 volts. Dual voltage types available. Write for engineering assistance or detailed literature.

**Over 250,000
in service**

LEARN RADIO-ELECTRONICS TELEVISION, SOUND SYSTEMS, ETC.

"Learn by Doing" 12-WEEKS Training IN COYNE SHOPS

Train now for a good job and a peace-time future in Radio-Electronics. Free employment service after graduation. Earn while you learn. If short of money, I'll finance your training.

Send coupon today for all details. H. C. Lewis, Pres., Radio-Electronics Div., Coyne Electrical School, Dept. 45-8H, 500 S. Paulina St., Chicago 12, Ill. Send Free Book and details of "Pay-After-Graduation" plan.

NAME _____
ADDRESS _____
CITY _____ STATE _____

Guaranteed Rebuilt Radio VIBRATORS—\$1.00 ea.

Send old vibrator. For very prompt delivery, enclose remittance and return postage. We rebuild any make or kind of vibrator or relay. Vibrator packs rebuilt also. Send your old vibrator to BEST VIBRATOR CO., Box 5802-Z, Cleveland 1, O.

● **Ted McElroy**
World's Largest Manufacturer of Wireless Telegraphic Apparatus
COMPLETE CENTRAL OFFICE EQUIPMENT
McElroy Manufacturing Corp.
82 Brookline Avenue • Boston, Massachusetts

The United States is producing more Radar and radio equipment than all other nations together, stated R. C. Cosgrove, president of the Radio Manufacturers' Association and General Manager of the Crosley Corporation in a recent interview.

OHMITE RESISTORS

*for accurate
trouble-free*

SERVICE

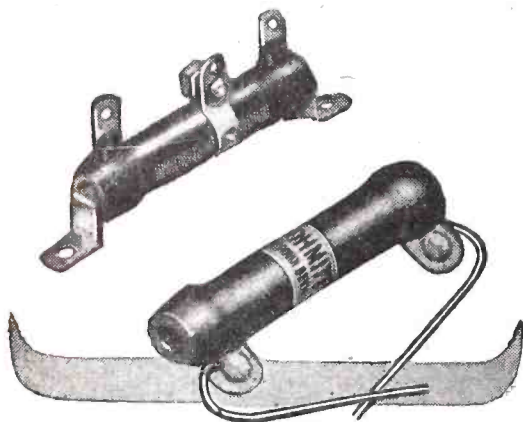

Time-proved, battle-proved, service-proved... Ohmite Brown Devils and Adjustable Divid-ohms are used today in critical war equipment. After Victory . . . these dependable units will again be the favorite of radio servicemen who want and use the best for resistor replacements.

For information about these and other Ohmite Resistors, write for Stock Unit Catalog 18.

SEND FOR HANDY OHM'S LAW CALCULATOR

Figures ohms, watts, volts, amperes—quickly, accurately. Solves any Ohm's Law problem with one setting of the slide. Send only 10c in coin for handling and mailing. (Also available in quantities.)



OHMITE MANUFACTURING CO.
4895 Flournoy Street • Chicago 44, U.S.A.

Be Right with **OHMITE**
RHEOSTATS • RESISTORS • TAP SWITCHES

RADAR PRINCIPLES

(Continued from page 414)

trated in Fig. 3. As before, light from a source S is transmitted to a target at T whence some of it is reflected back to a detector or receiver at R. In front of both S and R rotates a disc or wheel W, with an even number of radial apertures in it, so that the beam of light is alternately interrupted and allowed to pass. With the disc stationary the outgoing and incoming beams pass through the corresponding slots at the end of a diameter. As the disc is rotated and its speed gradually increased, some of the light which has passed through a slot A_1 in front of S will be cut off, because

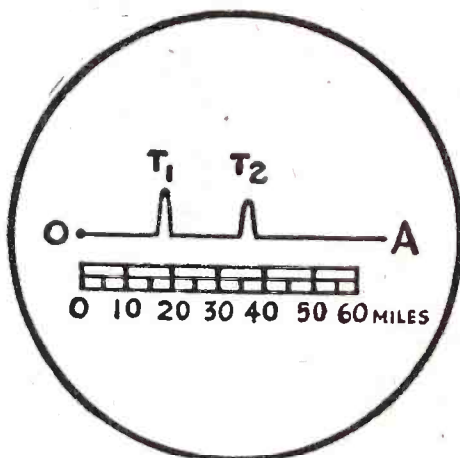

Fig. 5—C-R tube screen. Peak farthest from O is caused by echo from more distant target.

by the time it has traversed A_1TA_2 the corresponding slot A_2 will have moved round through a small angle. As the rate of rotation of the disc is increased, a speed will be reached at which the returning light will be cut off by the portion of the disc between the slots. As the speed of the disc is further raised the light will again be perceived at R, since while the light is traversing the path A_1TA_2 , the disc will have rotated through an angle equal to that separating adjacent slots. Hence from an observation of the speed of the disc under these conditions, and assuming the velocity of the waves, the distance A_1T can be determined. From this type of measurement and the associated observations of the angular directions of the reflector T in both the horizontal and vertical planes, the position of T in three-dimensional space becomes known.

This, in essence, is the fundamental principle of radiolocation as it is practised today. The writer is not aware to what extent, if at all, it became practicable to use it with light waves, but in any case, its use in this way would be severely limited to ranges normally detectable by the human eye under conditions of darkness and the occurrence of clear weather. Furthermore, in typical circumstances, the time intervals to be measured are very small—about 10 microseconds per mile—and the consequent practical problems involved in the rotation of the disc at the required speed are not easily solved.

ELECTRIC WAVE REFLECTIONS

Radiolocation, or Radar, makes use of the longer electric waves in the radio-frequency portion of the spectrum. A complete station consists of a combination of a transmitter and receiver. The transmitting or sending portion emits radiation over a broad arc in the approximate direction it is desired to explore. When this radiation strikes an object having an appreciable

conductivity or dielectric constant, some of the energy is reflected or scattered back towards the receiver which is installed moderately close to the transmitter. If the latter emits the radio waves in short trains or pulses, the time of transit of these to the reflecting target and back to the receiver can be measured, by displaying the received signals on the screen of a cathode-ray tube. The arrangement is indicated schematically in Fig. 4, where successive pulses $P_1P_2P_3P_4$ have been emitted from the sending aerial A_1 , the first two pulses having already reached the target and been reflected back towards the receiving aerial A_2 . It is now required to determine the time of transit of any one of the pulses over the path A_1TA_2 .

The pulses of radio-frequency oscillations arriving at the receiving aerial are suitably amplified and rectified, and then applied to the vertical deflecting plates of a cathode-ray tube. If the horizontal deflecting plates are connected to a suitable time-base circuit operating in synchronism with the pulse generating circuit in the transmitter, then for a fixed distance A_1TA_2 , the received pulses will appear superimposed on one another as vertical deflections from the horizontal time-base. If furthermore, the time-base is made to start its deflection from the left-hand side of the screen at the same instant as the pulse of radiation leaves the sending aerial, then the distance along the time-base from its origin to the position of the pulse displayed on it is a measure of the length of path A_1TA_2 . The type of picture obtained on the screen of the cathode-ray tube is illustrated in Fig. 5, in which the line OA represents the time-base which is locked to the transmitter in such a way that the length OT_1 represents the time taken by an emitted pulse to arrive back at the receiver after reflection from a target T_1 . As we know that the velocity of radio waves is substantially 186,000 miles per second, the scale of the time-base can be graduated in miles, so that the distance of the target T_1 is seen to be about 19 miles.

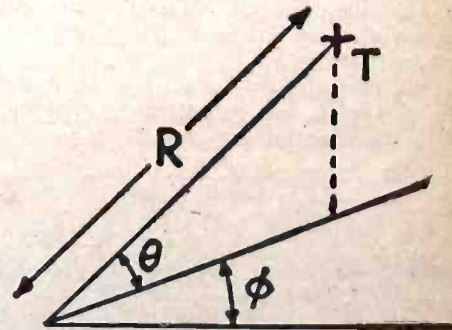

Fig. 6—Target position determined by range, R, angle of elevation, ϕ , and its bearing, θ .

A second received pulse is seen at T_2 returned from another target at a range of about 35 miles. If one or both of these targets are moving, their changes in position are indicated by the movement of the pulses along the base-line on the screen of the cathode-ray tube towards or away from the point O.

The amplitude of the pulse on the tube is proportional to the strength of the received signal, so that this naturally increases as the target from which the echo is returned approaches the receiver. When other conditions remain the same, the amplitude of the echo is also a measure to some extent of the reflecting properties of the target, for example, its size; and an experienced observer may be able to guess the nature of

the target from the echo pulse seen on the tube screen.

This measurement of the distance of the reflecting body responsible for the echo signals must be supplemented by a determination of the direction of arrival of the waves in both the horizontal and vertical planes, before the actual position of the reflector in space is completely known. These measurements can be made by well-established methods for observing the bearing or azimuth (θ in Fig. 6) and the angle of elevation above the horizontal (ϕ , Fig. 6). The first observation can be made by rotating the receiving aerial, which may at certain wave lengths be a horizontal dipole, about a vertical axis until the amplitude of the corresponding pulse decreases to zero; it is then known that the bearing is in line with the direction of the dipole. Alternatively, a pair of fixed aerials at right angles to one another can be used, connected to the field coils of a radio goniometer in the usual manner of a direction finder. Rotation of the search coil to the signal minimum position again enables the bearing to be determined.

The angle of elevation of the arriving waves can be measured by comparing the amplitudes of the voltages induced in two similar aerials mounted one above the other at a known distance apart, depending upon the wave length in use and the range of angles of elevation it is desired to cover. This technique has been used for many years past by several investigators for measuring the angle of arrival of radio waves over long-distance communication paths, and it is directly applicable to the problem now under discussion. If the reflecting object being observed is an aircraft, then a knowledge of the range R and elevation ϕ (Fig. 6) enables the altitude at which the craft is flying to be determined. If the object of interest is a ship, then the angle of elevation is negligible, and the

range and bearing determine its position.

The above considerations all apply to the use of wave lengths of the order of, say, 5 to 50 meters, for which the dimensions of the aerials are such as to make it impracticable to obtain very concentrated beams of radiation by the use of local reflectors. If, however, much shorter wave lengths are used, then it becomes possible to arrange what is, in effect, a radio searchlight, but with the addition of the facility for determining distance. This type of equipment was used, for example, in 1931 in the radio telephony system which was set up for operation across the Straits of Dover between England and France, using a wave length of 18 cm. and parabolic reflectors about 10 ft. in diameter. A combination of transmitter and reflector constructed on these lines, and moved together in both vertical and horizontal planes, is analogous to the searchlight and observer depicted in Fig. 2. When this type of radiolocation set is trained on the target to give the maximum deflection of the received pulse, the azimuth and elevation can be read off the horizontal and vertical scales, respectively, while the range of the target is observed from the position of the pulse along the time-base on the screen of the cathode-ray tube.

This is the principle of the modern radiolocation set, in the development and exploitation of which so much technical and operational effort has been devoted in the past five years or so. The story of its success, and the technical details of its development must await description for the time being; but there is no doubt that the early establishment and use of Radar stations has contributed very materially indeed to both our defensive and offensive operations at various stages of the present war.

Reprinted by special arrangement from *Wireless World* (London) February 1945.

NEW INDUSTRIAL OSCILLOGRAPH

For aircraft engine manufacturers, electric power companies and research laboratories, a new self-contained industrial electronic oscillograph which records characteristics of electrical phenomena lasting as little as a fraction of a millionth of a second is announced by Westinghouse Electric and Manufacturing Company.

An instrument of the cold cathode type, the electronic oscillograph is capable of recording single electrical transients with respect to time, or two electrical phenomena with respect to each other, such as voltage versus current, in the form of diagrams produced by two pairs of electrostatic deflecting plates disposed at right angles to one another. The cathode of the tubes is energized from a 50 Kv D.C. rectifier with a control to correct for line voltage variation. The beam is normally blocked by a target. An impulse synchronized with the phenomena will trip the relay which bends the beam around the target so that it will strike the fluorescent screen or film below.

The new streamlined unit consists of the oscillograph proper in front of the cabinet and the cabinet proper which houses all energizing and control circuits. Energizing terminals are enclosed except one bushing connected to the source of synchronizing impulse. Concentrating coils, beam current meter, and leak valve control the intensity and size of the trace on the film. Deflecting coils move the zero position of the beam so as to use the whole area of the exposed film for the record.

In addition to the fluorescent screen for direct observation, the instrument contains a

stationary film holder taking a standard film for recording electrical phenomena lasting 1/1000 of a second or less, and may be operated with a rotating film drum for phenomena lasting from 1/1,000 to 1/10 of a second. A photoelectric control which makes it possible to take an oscillogram in one revolution of the drum, regardless of speed, eliminates the possibility of superimposed waves.

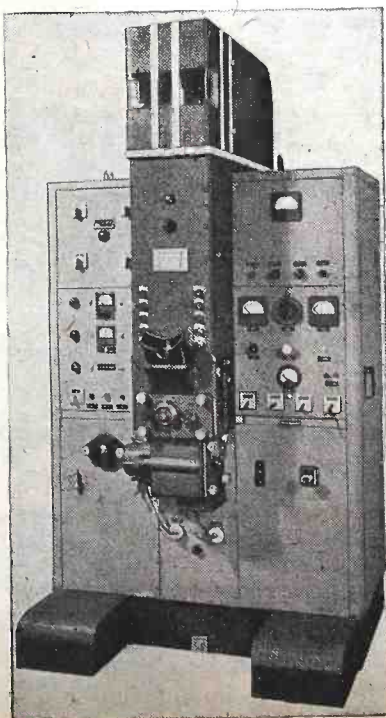

RADIO-CRAFT for APRIL, 1945

4 STANDARD TYPES
of Amperite Regulators replace over 400 types of AC-DC Ballast Tubes now in use. Amperites are real REGULATORS... have patented Automatic Starting Resistor which prevents initial surge and saves pilot lights... Ask Your Jobber.

AMPERITE

THE *Simplest* WAY TO REPLACE **BALLASTS**

WRITE FOR REPLACEMENT CHART
AMPERITE CO. 561 BROADWAY, NEW YORK, N. Y.

new!
DE LUXE BINDER

Preserves Your **RADIO-CRAFT** BACK ISSUES *Permanently*

ONLY \$1.50

HOLDS 12 ISSUES

PROTECT your back issues in this new beautiful De Luxe Binder, tailor-made to fit 12 issues of RADIO-CRAFT.

Start now to keep your magazines clean, fresh-looking for instant reference—instead of lying around helter-skelter, torn, dog-eared and soiled... very likely lost. This DeLuxo binder is attractive enough to dress up your living room library shelves.

Well-constructed, finished in simulated Morocco leather, rich russet brown with gold embossed lettering and design on front and back. 9" x 12½" with 1½" back.

No punching of magazines necessary. Just slip your RADIO-CRAFT magazines through a metal strap built into the binder. In a jiffy they are in place and overlastingly protected.

5-DAY FREE TRIAL

The De Luxe Binder is guaranteed to more than satisfy. If not, return within 5 days and your money will be cheerfully refunded. Sent postpaid in U.S. on receipt of \$1.50. (Canadian and Foreign \$1.75.)

RADIO-CRAFT
25 West Broadway, New York, 7, N. Y.

RADOLEK

Radio-Electronic Service Parts

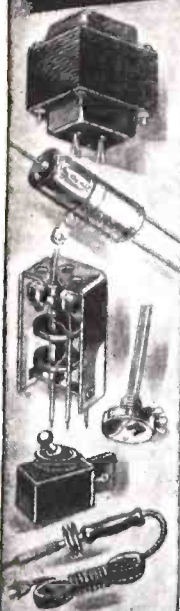

Large stocks assure the finest and most complete selections of all available items at lowest prevailing prices. Thousands of active buyers depend on us for their entire Radio repair and replacement requirements. Because we understand service problems, every order is expedited for delivery in double quick time. Everything we do is planned for convenience and satisfaction to our customers. You will find it profitable to make Radolek your buying headquarters.

FREE BUYING GUIDES

Because of existing conditions we keep our customers right up to the minute on available merchandise by releasing supplements frequently instead of sending our regular Big Profit Guide once a year. Send the coupon now to get these Free Buying Guide Supplements as they are issued.

FREE!



FAST SERVICE!

RADOLEK CO., Dept. C-101
601 W. Randolph St., Chicago 6, Ill.

Please send FREE Buying Guide Supplements

NAME _____

ADDRESS _____

ORDER FROM RADOLEK

LEARN ELECTRICITY

12 WEEKS SHOP TRAINING



"LEARN BY DOING" IN COYNE SHOPS

Electricity offers you opportunities for the best jobs today — with a real peace time future. "Learn by Doing," on real machinery. Earn while learning. Right now I'm offering extra training in Industrial Electronics at no extra cost. Lifetime employment service after graduation. Get all-around practical training at Coyne in 12 weeks. If you are short of money I'll finance your training. Mail coupon now for Free Book. We have facilities for men with physical disabilities. If you have a physical disability of any kind check coupon below for details.

H. C. Lewis, President, COYNE ELECTRICAL SCHOOL
500 S. Paulina St., Dept. 45-78, Chicago 12, Illinois

Send free book and all details. Send physical disability plan.

NAME _____

ADDRESS _____

CITY _____

ZONE _____

STATE _____

50/50 RIBBON SOLDER

4000 lbs. .020 x 1/4" 1 lb. Rolls
1500 lbs. .020 x 1/8" 2 lb. Rolls
500 lbs. .012 x 1/8" 1 lb. Rolls

Low Price — Immediate Delivery

BOX 41 C/O RADIO-CRAFT

25 West Broadway New York 7, N. Y.

CAPACITY BRIDGES

A regrettable error occurred in Fig. 5 of the article by the above name in the February issue. The lead containing the .05 condenser which is shown connected to the ray-control electrode of the 6E5 should be attached to the grid of that tube instead. As the circuit now stands, there is no way of applying signal voltage to the tube. The 500,000-ohm resistor is simply connected between ray-control electrode and target of the 6E5 in conventional style.

ACCURATE COMPARISON BRIDGE

The Comparison Bridge illustrated offers a simple, compact and accurate instrument for high-speed measurement of capacitance, resistance and inductance. It is entirely self-contained and operates from a 50-60 cycle, 105-125 voltage source. L, C and R may be

bridge measurements, 60, 1,000 and 10,000 cycles. The first is taken from a section of the filament transformer. Selection of three output levels from the oscillator is possible. With an amplifier gain control, the bridge sensitivity is controlled by the operator. As

By means of a vacuum-tube oscillator circuit and a bridge (in the output) in which the unknown resistor, inductor, or capacitor is balanced against a standard, this bridge provides accurate and simple measurements.

Diagram courtesy
Freed Transformer Co.

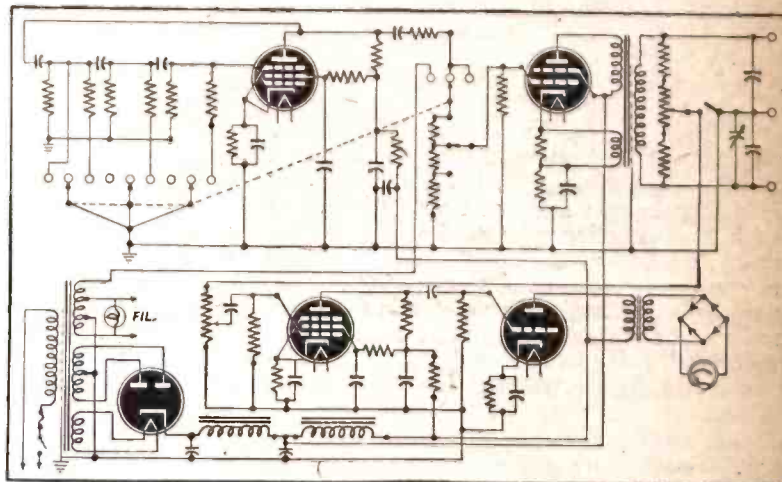

measured with a precision ranging from .5% to 10%, and this range may be further extended to 20%.

The comparison bridge system of measurement gives laboratory accuracy under factory conditions. Its quick and simple operation makes it particularly useful for high speed precision testing for manufacturers of resistors, condensers and coils by semi-skilled factory personnel as well as in laboratories.

The unit consists of an A.C. bridge, an oscillator and a vacuum-tube voltmeter. The oscillator is of the R-C type which maintains a constant frequency under all conditions. Three frequencies are available for

the sensitivity is increased, the bridge control is manipulated until a very sharp and distinct balance is obtained.

The vacuum-tube voltmeter circuit consists of a high gain unit, the output of which feeds a rectifier type voltmeter. Visual indication offers a great advantage over aural detection, especially near the null point, where little is left for the imagination.

The range of measurements in which comparison may be made with this particular unit is: capacitors, from 25 MMF to 20 MF; inductors, 5 microhenries to 500 henries; resistors, 10 ohms to 5 megohms. The percentage difference between standard and unknown is given by a calibrated dial when the bridge is balanced.

PLEASURE EQUIPMENT NOW IN THE SERVICES

The yachtsman's radiophone has gone to war. The midget Western Electric 8-watt radio transmitter which formerly enabled the small boat owner to keep in touch with the Coast Guard, land telephone system and other radio-equipped vessels is now installed aboard a Merchant Marine training ship.

Photograph courtesy
Holmes I. Mettee



TECHNOTES

SOLDERING HINTS

A primary of a power transformer (tapped) used as an auto-transformer to either raise or lower the voltage by means of a two-way switch will help keep your iron at suitable temperature. Always use a rosin core solder for fast and clean work.

The victory solders have a low tin content and require more heat. It is wise to double check such connections visually and mechanically.

Insulation on wires should be pushed back, not stripped so that after soldering it may be put back into place. Wax-filled pigtail condensers should be soldered extra quickly to prevent wax melting. In fact, all successful soldering is QUICK soldering.

SUBSTITUTE CONTROL, PHILCO 70

The dual volume control in a Philco 70 may be substituted as shown in the diagram. Wire together the IF and RF cathodes to the single volume control through a 150-ohm resistor. Also connect a 200-ohm resistor to voltage divider terminals formerly going to cathode-bias side of old volume control.

Now add a 3000 ohm resistor in antenna

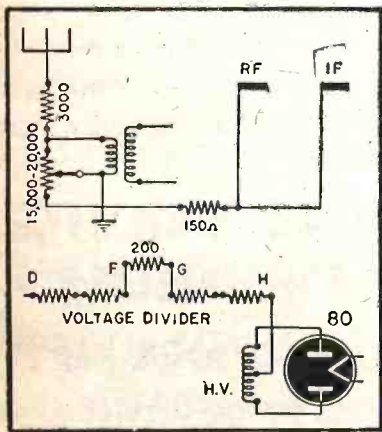

circuit to improve action on loud signals. The three fixed resistors may be $\frac{1}{3}$ watt.

GERALD EVANS,
Ola, Arkansas.

GE KL7M AUTO SET

Complaint: Intermittent.

Check connections in the magnetic core antenna. First remove the shield. Resolder terminal lugs of the coil, making sure that no strands of wire contact the shield.

W. R. CLAYSON,
Verlo, Sask.

6A8 FOR 6SA7

Take grid connection off base, extend this lead through hole in chassis to a grid cap for 6A8. Change wire from No. 6 to No. 8 lug, leaving No. 6 blank. Socket is then ready for 6A8. This worked fine on model 6C17 Truetone Auto Set.

CROSLEY 515

When tuning crackling noise is caused by loose tuning-shaft bearing, use a flat piece of tin $\frac{1}{2}$ -inch wide, 3 inches long and bolt at each end to inside of chassis. The middle of the strip pressing, in spring fashion, on the shaft makes a better electrical connection.

FRED P. STEINMETZ,
Chandler, Ind.

EMERSON BA-199

In several occasions I have encountered a buzz on Emerson BA-199 or BA-201. This was found not due to defective filter condensers in the power supply.

The trouble may be corrected by replacing the .25 MFD 100-volt by-pass condenser on the 6C6 cathode with an electrolytic 5 to 10 MFD rated at 50 volts.

TED HANNAH,
Seattle, Wash.

SEMI-BLOWN 35Z5'S

In the November issue of RADIO-CRAFT you have an article on semi-blown 35Z5's (page 115).

The author goes to the trouble of putting a 20- to 25-ohm resistor between pins 2 and 3 on the socket and then sends a card to the customer telling all about it. Here is a much simpler way.

I take 25 ohms of wire off an old volume control and wind it around the tube base, fastening it on with masking tape and soldering one end to tube pin 2 and the other end to tube pin 3. This means when the tube does give out entirely there are no change-backs to be made.

ED. GRIMSHAW,
No. Andover, Mass.

150-MA TUBES

When an A.C.-D.C. set with low drain (.15 amp.) type tubes come into the shop I always install a 50-ohm resistor in series with the filament circuit if no external resistance is already present. This prevents sudden surges from burning out scarce tubes.

When a 35Z5 with open pilot section comes in, I use a shunting resistor as others have suggested in RADIO-CRAFT with the following change: I solder the resistor to the tube prongs close to the base, using a disc of cardboard to insulate from the chassis. When a new tube becomes available the old one is removed and the new one inserted. No leads have to be unsoldered to go "back to normal."

GERALD W. BENEDICT,
Montpelier, Vt.

(An even better system of handling the open 35Z5 is described in the note above, from Ed. Grimshaw of North Andover, Mass.—Editor)

REWIRING HINT

Wartime shortages often require replacement or rewiring of sockets. Here is a method of keeping track of the wires when doing the job.

Color code eight small alligator clips: brown—1, red—2, etc. As the wires are unsoldered from the socket pins, they are held with the proper coded clip, that is, brown for No. 1, etc. After the new socket is mounted, it is very easy to find the proper wires.

ROBERT H. CLOVER,
W. Sacramento, Calif.

AIRLINE 62-196

Breakdown of .02 600-volt condenser from plate of 6F6 to chassis. Replace with two .05 600-volt units in series.

FRED P. STEINMETZ,
Chandler, Ind.



10,000 PARTS immediately available on priorities.

SAME-DAY SERVICE

Trained expeditors fill your order the day we receive it.

SINCE 1922 we have been known as reliable and responsible jobbers, wholesalers and manufacturers, of radio and electronic equipment.

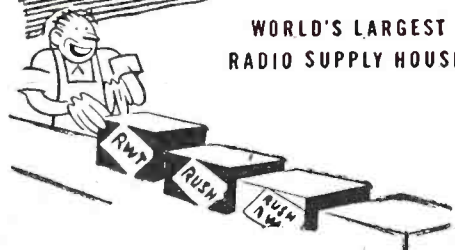

WORLD'S LARGEST RADIO SUPPLY HOUSE

Originators and Peacetime Marketers of the celebrated

Lafayette Radio

Write today for our bargain flyers and special bulletins.



**TECHNICAL
PERSONNEL
WANTED**

ELECTRONIC ENGINEERS!

War - Winners Today, Post-War Builders Tomorrow!

Leaders in NATIONAL UNION RADIO CORPORATION'S staff of engineers, scientists and technicians have brought us far out in front in the electronics industry. We have a research laboratory and two manufacturing plants in Newark, N. J., and a manufacturing plant near Philadelphia, Pa. We invite you to consider your opportunities with us for professional advancement, stimulating, friendly associations, and a future with promise.

NATIONAL UNION NEEDS:

SENIOR TUBE ENGINEERS: These men MUST have actual experience with radio tube manufacture. The pay and opportunities are commensurate with your ability.

COMMERCIAL ENGINEERS: Engineers interested in developing electronic tube applications, who may represent us among radio manufacturers upon occasion.

QUALITY CONTROL MEN AND WOMEN: Here you need an interest in the practical application of statistical and/or engineering procedures to many factory processes.

TEST EQUIPMENT ENGINEERS: Men experienced with meters or electronic test equipment to work either as TEST EQUIPMENT DESIGN ENGINEERS or as MEASUREMENT LABORATORY ENGINEERS.

JUNIOR ENGINEERS—MEN AND WOMEN: Do you have a college degree in Physics, Electrical Engineering, Chemical Engineering, Mechanical Engineering, Mathematics or Chemistry? This company offers an opportunity for young, ambitious graduates to assume responsibilities and to exercise initiative.

FOREMEN AND ASSISTANT FOREMEN: Men experienced in radio or radio tube manufacture to supervise exhaust, stem or grid operations.

TECHNICIANS, CIRCUIT MEN: Have you been a radio ham, or have you built or repaired radios? Have you studied radio in the Services? We need men who can read circuit diagrams and do wiring and construction.

WOMEN!

We have a number of fine young women engineers with us now. We need more. If you have a degree in Electrical Engineering, Chemical Engineering, Mechanical Engineering, Physics, Chemistry or Mathematics and are seeking career opportunities, investigate.

If you have thorough training in your field, as evidenced by job experience in radio or allied industries, or by a college degree—if you have ambition, initiative and resourcefulness—if you have the ability to inspire your co-workers, then

Phone or Write

DR. L. GRANT HECTOR

Director of Engineering

NATIONAL UNION RADIO CORPORATION

Plane St. at Raymond Blvd.

Newark 2, New Jersey

WMC RULES OBSERVED

WANTED

RADIO LICENSED AMATEURS

thoroughly familiar with all types of parts, tubes, meters, test equipment, receivers, transmitters, etc. Permanent position; excellent salary; splendid opportunity for some one residing in metropolitan New York area.

SUN RADIO & ELECTRONICS CO.

212 Fulton Street

New York 7, N. Y.

ELECTRICAL and RADIO ENGINEERS RADIO TECHNICIANS

For Design, Development and Production Work. Post-war Opportunity. Also Openings for Mechanical Draftsmen, Junior and Senior Designers.

ALLEN D. CARDWELL MFG. CORP.

81 Prospect St.

Brooklyn

Wanted ENGINEERS

Radio

* Electrical

Electronic

* Mechanical

* Factory Planning

Materials Handling

Manufacturing Planning

Work in connection with the manufacture of a wide variety of new and advanced types of communications equipment and special electronic products.

Apply (or write), giving full qualifications, to:

R.L.D., EMPLOYMENT DEPT.

Western Electric Co.

100 CENTRAL AV., KEARNY, N. J.

*Also: C.A.L.

Locust St., Haverhill, Mass.

Applicants must comply with WMC regulations

FIELD SERVICE ENGINEERS

For Domestic and

Foreign Service

Must possess good

knowledge of Radio

Essential workers need release.

HAZELTINE CORPORATION

58-25 Little Neck Parkway

Little Neck, Long Island

RADIO RECOGNIZED

Radio has arrived at last! A report from London states that the Wireless Section of the Institute of Electrical Engineers of Britain will henceforth be known as the Radio Section.

To enable the change, the formal ruling describing the section was modified to read that "the section shall include within its scope all matters relating to the study, design, manufacture or operation of apparatus for communication by wave radiation, for high-frequency and electronic engineering or for electrical recording or electrical reproduction of sound."



ENGINEERS

Are You Concerned With YOUR POST WAR FUTURE ?

The Federal Telephone & Radio Corporation, the manufacturing unit of the International Telephone & Telegraph Corporation with its multiple business activities extending to all parts of the civilized world, will accept applications from experienced men for immediate employment with almost limitless post war possibilities. These positions should interest those with an eye to the future and whose interest lies in forging ahead with this internationally known organization whose expansion plans for post war are of great magnitude covering all types of radio & telephone communications. Advancement as rapid as ability warrants. Majority of positions are located in the New York area!

We need the following personnel! Men with long experience or recent graduates considered.

- ENGINEERS
 - ELECTRONICS
 - ELECTRICAL
 - RADIO
 - MECHANICAL
 - CHEMICAL
 - TRANSFORMER DESIGN
- SALES AND APPLICATION ENGINEERS
 - PHYSICISTS
 - DESIGNERS
 - DRAFTSMEN
 - TOOL DESIGNERS
 - TECHNICAL WRITERS

Look Ahead With Federal!

If inconvenient to apply in person, write letter in full, detailing about yourself, education, experience, age, etc., to Personnel Manager.

FEDERAL TELEPHONE & RADIO CORP.

39 Central Avenue

EAST NEWARK

NEW JERSEY

WANTED

TRANSFORMER & SMALL ELECTRIC MOTOR MEN

ENGINEERS DESIGNERS DRAFTSMEN TECHNICIANS

For war time and post-war design and development of intricate, specialized, hermetically sealed transformers, and special purpose fractional h.p. motors.

Write, giving details about age, experience, past salaries to

SPERRY

GYROSCOPE COMPANY, INC.
RESEARCH LABORATORIES
STEWART AVE. AND CLINTON RD.
GARDEN CITY, NEW YORK

Transmitting or Receiving

RADIO STATION TECHNICIANS

MEN AND WOMEN

for Point-to-Point International Radio-communications Stations in the United States.

Applicants must possess at least Second Class Commercial Radiotelegraph Operator's License.

Essential workers need release statement.

Apply weekdays except Saturdays between 10 am and 3 pm

or write

PERSONNEL DEPARTMENT

R.C.A. COMMUNICATIONS, Inc.

64 BROAD STREET
NEW YORK 4, N. Y.

?? WHY NOT ??

Have you ever asked yourself, "Why can't I have this or that gadget on a radio? Why aren't programs made to fill such and such a need?" If so, you are a charter member of the *Radio-Craft* "Why Not" club. Send us your "Why Not's" on all subjects—serious or screwball, practical or idealistic. We will pay \$1.00 for every one we believe will interest the readers of *Radio-Craft*.

You can get the idea from the "Why Not's" printed below. Send in as many as you like. One dollar will be paid for each one printed.

Why not arrange *Radio-Craft* and other magazines so the useful information is on one side of the page and the advertising on the back side of the page?

Many people, including myself, cut out useful articles and keep them in some sort of a scrap book. In many cases, where it is necessary to paste articles in a book, good material on the back of the page is destroyed.—*Jens C. Jensen, Camp Pinedale, Calif.*

(It is not possible to do this economically in magazines, for many reasons, such as ads smaller than one page that must be run; continuations of many articles in rear of magazine; stories received late, which must be included, etc., etc.—*Editor*)

Why not have one main radio for each home, and a number of portable "slave" radios tuned to an intermediate frequency that could be set so it would not interfere with any neighbor?

Then each room could be equipped with a "slave" radio controlled by the main installation, and you could have music in any room at any time.—*R. W. Anderson, St. Catherines, Ont.*

Why not have a radio which could quickly be turned into a low-power amplifier? I use mine in conjunction with a 5-tube short-wave set. By throwing two switches my other radio becomes an amplifier, to give me increased volume.—*Louis Margolis, Los Angeles, Calif.*

(Any radio with jacks for a phonograph pickup can be used as an amplifier without internal changes.—*Editor*)

Why not have a radio with a switch and rheostat knob to control the brilliancy of lights in a room? Pushbuttons for colored lights could also be included on the panel. Then for a weird mystery story the lighting could be turned down to resemble candles; for different atmospheres colors could be added as required. This would create greater interest in the story or other form of entertainment.—*Walter Zatorsky, Winnipeg, Canada.*

Why not have a large number of our "maintenance and repair" tubes built double-ended during the war period? So many tubes are identical but have different bases that it would be handy if we could (for instance) turn an octal tube upside down and have its local corresponding number.—*Eric Leslie, New York City.*

Why not have a knob to turn the loop antenna used in so many sets? This screwy arrangement of always reaching around behind the set is driving me nuts. Yet if I don't turn the loop I don't get reception at its best.—*Wm. Kreichbaum, Lebanon, Penna.*

(Many sets in the late 20's were equipped with loop controls.—*Editor*)

OPPORTUNITY AD-LETS

Advertisements in this section cost 20 cents a word for each insertion. Name, address and initials must be included at the above rate. Cash should accompany all classified advertisements unless placed by an accredited advertising agency. No advertisement for less than ten words accepted. Ten percent discount six issues, twenty percent for twelve issues. Objectionable or misleading advertisements not accepted. Advertisements for May, 1945, issue must reach us not later than March 28, 1945.

Radio-Craft • 25 W. B'way • New York 7, N. Y.

USED 1619 TUBES. A 6L6 WITH 2.5V FILAMENT. List \$4.50. Perfect substitute for 47, 2A5 and 59. Ten for \$6.50 postpaid. Cash with order. In U.S. only. City Radio Company, 504-6 E. Washington, Phoenix, Arizona.

UNIVERSAL MIDGET TOOLS: DANDY SIXTEEN Piece Set: Midget Pliers, Diagonal Cutters, Four Midget end Wrenches, Needle-nose Pliers, Screwdriver, Six Punches and Chisel, Round File Midget Crescent Wrench, \$14.85. Immediate Delivery. Remit Today. Catalogue Free With Order. DEALERS TOOL SUPPLY, 1527 Grand Ave. RC, Kansas City, Missouri.

CORRESPONDENCE COURSES AND SELF-INSTRUCTION books, slightly used. Sold, Rented, Exchanged. All subjects. Satisfaction guaranteed. Cash paid for used courses. Complete information and 92-page illustrated bargain catalog free. Write—NELSON COMPANY, Dept. 2-39, Chicago 4.

USED CORRESPONDENCE COURSES AND TECHNICAL Books Bought, Sold, Rented. Catalog Free. Educational Exchange, Henager, Alabama.

WANTED FOR CASH—LATE MODEL TUBE TESTER. Prefer roller chart type. All replies answered promptly. Jerome Null, Woodsboro, Maryland.

LARGE AND VARIED STOCK OF PANEL METERS and multi-range meters. Panel meters 3 1/2-inch round war-standard. Specify ranges you want and ask for quotation. Many D.C. instruments without priority. Good supply of critical types on priority. HATRY AND YOUNG, Hartford, Connecticut.

MAGAZINES (BACK DATED)—FOREIGN, DOMESTIC, arts, booklets, subscriptions, pin-ups, etc. Catalog 10c (refunded). Cicero's, 863 First Ave., New York 17, N. Y.

"100,000 POST-WAR JOBS ABROAD"—SOUTH AMERICA, Asia, Africa. How, When and Where to apply. 15,000-word copyrighted forecast—\$1.00. Return for refund in 7 days if not satisfied. Pacific Industrial Research Bureau, 202-X Studio Building, Portland 5, Oregon.

RADIO TUBES, PARTS, CONDENSERS, FREE BARGAIN lists. Potter, 1314 McGee, Kansas City, Mo.

RADIO REPAIR—LOCATE SIMPLE RADIO TROUBLES although inexperienced. Mail 25c for copy of "Minor Radio Troubles" to RADIO SERVICE, Box 311, Benton Harbor, Mich.

BUILD RADIO, COMPLETE KIT WITH TUBES, \$10.95, details. Radio, 9418b Avenue "A", Brooklyn, N. Y.

FOR SALE—FIVE (5) GENERAL RADIO MODEL 483F output meters. Attn. Mr. Schwanbeck, D. W. Onan & Sons, Minneapolis 5, Minn.

Radio Servicemen:

RADIO PARTS — TUBES

BARGAIN PRICES—NO PRIORITIES

King P.M. Speakers, 4 or 5 inch \$1.19
King 450 Ohm Speakers, 4 or 5 inch 1.49
Filter Cond. 20-20 Mfd., 150 V.39
By-Pass .600 V. .01, .02 Mfd., .06, .05, .107
A.C. Cord and Plug Set, 6 ft.29
Resistor Kit—50 ass't'd 1/3 to 1 watt99

Write Today for Bargain Bulletin

RADIO DISTRIBUTING CO., Pasadena 18, Calif.

Attention Radio Servicemen

Many hard to get items.
Send post card for new price list.

JOHN A. COX
WHOLESALE RADIO SUPPLIES

557-7th Street, Parkersburg, W. Va.

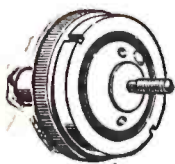

"WONDER" ELECTRIC BUTTON

Most interesting electrical apparatus ever discovered. Make your own Telephone Amplifier

Detectophone. Transmit your voice or music to distant rooms. Perform hundreds of fascinating experiments. So tiny it can be concealed in dozens of places. Send \$1 now for button and free 5,000 word instruction booklet with 50 illustrated experiments. SPECIAL OFFER 6 buttons and booklets sent postpaid for \$5. Write now to

BUCK MFG. COMPANY North Aurora, Illinois

Construction permits have been granted by the FCC for the construction of six new portable-mobile stations for experimentation directed toward improving railroad communications equipment. The stations, which are to be operated by the Halstead Traffic Communications Corporation, will use FM, AM and facsimile. Initial experiments will be conducted on the New York Central railroad, using frequencies from 116,450 to 161,775 Kc. with maximum authorized power of 10 watts.

Communications

HOW DO YOU LIKE RADIO-CRAFT?

RADIO-CRAFT asked for opinions on a highly critical letter from F. C. Nolle. Our readers responded with enthusiasm, and below are printed some of the more interesting letters on the subject.

CATERS TO THEORISTS

Dear Editor:

Several contributors to the February Mail Bag expressed my views exactly. Before entering the service I looked to your magazine (then *Radio and Television*) for solutions to many of my troubles and problems. Your "Hints and Kinks" were especially helpful. When you changed the title I think you also started changing the contents. Ever since, it seems you have been straying away from the radio servicemen, while catering more and more to the theorists.

It is my personal opinion that these theorists are in the minority, and that you could do more good by printing practical information that we all can use.

LEWIS R. WALLACE,
Camp Crowder, Mo.

C. H. SPERRY,
Los Angeles, Calif.

now catering to the radio novice and non-technical reader—no doubt they represent the largest part of your reading public at the present time—but I am interested in the type of magazine published prior to the war.

Your articles appear to me to be sketchy and incomplete, which is satisfactory for popular descriptions of electronic devices and radio news articles, but unsatisfactory for technical, construction and servicing articles which I desire.

Why not print less articles but what you do print make complete with enough technical information to satisfy the student, experimenter and serviceman. At the present time I am reading magazines three or more years old to satisfy my craving for good material.

(*Radio-Craft* is keenly aware of its imperfection, but is somewhat bewildered by criticism such as the above. We are tempted to use the time-honored reply "Make up your minds!" Either the paper is moving toward the tyro or away from him—toward an industrial-technical line or away from it—but surely not both at once?)

Readers will do *Radio-Craft* and themselves [we hope] a service by criticising one copy of the magazine, going through it article by article, and suggesting what they would not have published, what they like as it is, what they would have had more of or presented differently. Possibly also you would like some subjects not now printed in the magazine.

We can use the information thus acquired to print material wanted by the majority of our readers. If the reader sending in a criticism will state his occupation and the nature of his interest in radio, it will make it easier for us to evaluate his criticism.—*Editor*)

THE TECHNICAL SLANT

Dear Editor:

I was much disappointed in last three issues, the articles are veering over to the technical—industrial; only of passing interest, to be read and cast aside. We poor tyros and amateurs are out.

I was glad to notice a protest from a Mr. A. W. Mann. Why not cut down on some of these long-winded articles? There's one thing about a "Newsstand" copy, you can see from the index if you care to spend the quarter on it.

WM. A. PLEES,
Whitehall, Mich.

WRITTEN FOR NOVICES

Dear Editor:

I heartily agree with the sentiments expressed by F. C. Nolle of Vallejo, California, in his letter to the editor. You are

WE NEED THE ARTICLES ON ELECTRONICS

Dear Editor:

What do we, the readers, think of the suggestions in "The Mail Bag?"

The communication from F. C. Nolle of Vallejo was a good letter and made several points. I agree we could use dope on inverter circuits, inverse feedback, etc. As he says: As soon as one of your theory projects gets under way—bingo, something else takes its place!

So Mr. Breedlove is tired of electronics! Then let him go back to bowling! We need electronics. Need it as you put it. We don't always want the present and the past—a good look ahead is often valuable.

About the covers: Does Mr. Foss buy the magazine for the cover or the dope inside? I like the covers. They are not flashy, but attractive. From every angle I believe an attractive cover makes an attractive magazine.

As a whole, I like the paper. Colorful,

entertaining and educational, but, like everything else, it can be improved.

May I suggest: A little more space and a little more theory on FM; actual "how and why" in receivers. We have had some very good dope, but only a dabble now and then. Remember we cannot now experiment to learn, so we must get our knowledge through reading and study.

I like the Electronic puzzle squares—kinda remind one to brush up occasionally. I have a hard time keeping my radio slide rule in condition. A few radio theory problems help.

Record Changers—swell!

My main suggestion: Not much discussion about an object or device, but—How is it made? Why is it made that way? How to repair it?

ROBERT H. BRAND,
San Anselmo, Calif.

FOR SALE HARD-TO-GET ITEMS

All items are brand new, except where indicated. ALL are in PERFECT WORKING ORDER. In many cases, the parts alone total more than the price we are asking. Satisfaction guaranteed or your money back. ORDER FROM THIS PAGE. Use our convenient coupon. Include sufficient extra remittance for parcel post charges, otherwise order is sent express collect. Any excess will be refunded. All C.O.D. shipments require 20% deposit. No C.O.D. shipments on orders for less than \$5.00. If full remittance accompanies order deduct 2% discount. Send money order, certified check, or new U. S. stamps. No C. O. D.'s to foreign countries.

THE MAGIC ELECTRIC WELDER

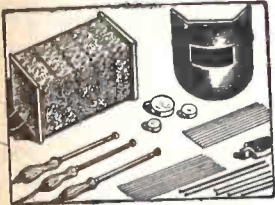

Here is one of the most compact, practical welders we have ever seen. Anyone can use it for shop, farm and home repairs. WELDS, BRAZES, SOLDERS, CUTS ALL METALS. ANYONE CAN OPERATE IT. Repairs steel, cast iron, aluminum, brass, copper, bronze, etc. Complete with power unit, flame and metallic arc attachment. Carbons, flux, rods, mask included. Just plug it in any electric outlet. 110 volts AC or DC. For hobbyist or professional.

GET IN ON THE GREAT WELDING BOOM. This fine set quickly teaches you welding. Low cost to operate—about 5c an hour. COMPLETE SAFETY is assured. No fumes with this outfit. SET COMES COMPLETE—nothing else to buy. Used by the U. S. Navy, American Tel. & Teleg. Co.; Eastman Kodak Co., Bell Laboratories, etc. BRAND NEW OUTFIT. Guaranteed for one year. Simple instructions with each set. ITEM NO. 158 YOUR PRICE \$19.95

WESTERN ELECTRIC BREAST MIKE

This is a fine light-weight aircraft carbon microphone. It weighs only 1 lb.

Mike comes with breastplate mounting and has 2-way swiveling adjustment so that it can be adjusted to any desired position. There are 2 woven straps; one goes around neck, the other around chest. Straps can be snapped on and off quickly by an ingenious arrangement.

This excellent mike can be adapted for home broadcasting or private communication systems. By dismantling breastplate, it can be used as desk mike.

Comes complete with 6-foot cord and hard rubber plug. Finished in sherdized plate, non-rustable. THIS IS A BRAND NEW MIKE. IT HAS NEVER BEEN SOLD AT SUCH A LOW PRICE BEFORE. ORIGINAL LIST PRICE \$15.00. Shipping weight, 2 lbs.

ITEM NO. 152 YOUR PRICE \$2.55

POWERFUL ALL-PURPOSE INDUCTION MOTOR

IDEAL FOR EXPERIMENTERS—101 USES



Sturdily constructed to precision standards, this self-starting shaded pole A.C. induction motor is powerful enough for a number of uses. Some of these are: Automatic Timing Devices, Current Interrupters, Electric Fans, Electric Chimes, Window Displays, Photocell Control Devices, Electric Vibrators, Small Grinders, Buffers and Polishers, Miniature Pumps, Mechanical Models, Sirens, and other applications.

Consumes about 15 watts of power and has a speed of 3,000 r.p.m. When geared down, this sturdy unit will constantly operate an 18-inch turntable loaded

with 200 lbs. dead weight—THAT'S POWER! Dimensions 3" high by 2" wide by 1 1/2" deep; has a convenient mounting stud; shaft is 3/16" long by 3/16" diameter and runs in self-aligning oil-retaining bearings. Designed for 110-20 volts, 50-60 cycles, A.C. only. Shp. Wt. 2 lbs.

ITEM NO. 147 YOUR PRICE \$2.50

LIMITED QUANTITIES! PROMPT SHIPMENTS!

It's Easy to order—Clip Coupon—Order from This Page—No Catalog Sent. MAIL TODAY—NOW!

HUDSON SPECIALTIES CO.

40 West Broadway, Dept. RC-4-45, New York 7, N. Y.

I have circled below the number of the items I'm ordering. My full remittance of \$..... is enclosed (if include shipping charges) is enclosed. (NO C.O.D. ORDERS UNLESS ACCOMPANIED WITH A DEPOSIT.)

OR my deposit of \$..... is enclosed (20% required), ship order C.O.D. for balance. NO C.O.D. ORDER FOR LESS THAN \$5.00. (New U. S. stamps, check or money order accepted.)

Circle Item No. wanted 147 152 158

Name

Address Please Print Clearly

City State

Send remittance by check, stamps or money order; register letter if you send cash or stamps.

A SECTION FOR EVERYBODY

Dear Editor:

I have been a Radio-Craft reader for the past 15 years and have continually noticed letters from the readers advancing ideas as to the form your publication should take, a request by you that other readers say what they think of this or that idea, and have finally decided to put in my two cents worth.

In the first place, some of your issues are so devoid of interest (as are some of the readers' letters) that they can be looked through, laid down and forgotten. Others are worth keeping for their information for years to come. This brings me to the point of the readers' letters.

One man—a serviceman—wants all servicing and latest equipment discussed; an amateur wants shortwave sets; the experimenter wants U.H.F. and television articles and the beginner wants a combined radio course and simple articles. Oh yes, and then there is the engineer who wants them technical and packed with formulas so no one else can understand them.

Now this should give you an idea as to how to build your magazine. Every one of these people read your magazine and every one is entitled to a section of it printed to cover his interests. At the present time your magazine seems to be half advertising and half articles, and I suppose that due to the paper shortage you cannot make it any bigger in size. But I suggest that when the day comes that you can make it larger that it be increased in size enough so each issue can have a section devoted to each class of readers interests—and advertising too—how we love to read the ads!

Oh yes, and one more thing. No doubt the majority of your addicts live in places where either A.C. or D.C. power lines exist, but there are a few of us who do not and have to do our work with battery packs and such. For heaven's sake, keep shoving in a few experimental articles, and such that can be monkeyed around with by those of us who haven't the large power available for the more elaborate experiments.

L. J. WELSFORD,
Shepard, Alberta.

WHY THE ONE-TUBERS?

Dear Editor:

Having been a reader of your magazine for the past fourteen years, I have both bricks and bouquets for it. I realize that it is impossible to even try to please every Tom, Dick and Harry, but please, must you have such constant repetition of these one tube blooperdynes? I grant that they are perhaps grand things for the beginner, but there are so many diagrams in existence now, why waste such good space? Wouldn't it be better to devote that space to such things as test equipment, training in theory and of course new equipment and new service techniques as soon as they can be released to the public?

WILBUR T. MORRISON,
New York, N. Y.

THINKS MAIL BAG BEST

Dear Editor:

I am a present subscriber to your magazine and always will be. I think it is tops and read it from cover to cover.

The first place I turn to is the "Mail Bag Section." I enjoy reading the feuds between

(Continued on following page)

FOR SALE HARD-TO-GET ITEMS

All items are brand new, except where indicated. ALL are in PERFECT WORKING ORDER. In many cases, the parts alone total more than the price we are asking. Satisfaction guaranteed or your money back. ORDER FROM THIS PAGE. Use our convenient coupon. Include sufficient extra remittance for parcel post charges, otherwise order is sent express collect. Any excess will be refunded. All C.O.D. shipments require 20% deposit. No C.O.D. shipments on orders for less than \$5.00. If full remittance accompanies order deduct 2% discount. Send money order, certified check, or new U. S. stamps. No C. O. D.'s to foreign countries.

ULTRA MAGNET

LIFTS MORE THAN 20 TIMES ITS OWN WEIGHT

LITTLE GIANT MAGNET

Lifts 5 lbs. easily. Weighs 4 oz. Made of ALNICO new high-magnetic steel. Complete with keeper. World's most powerful magnet ever made. The experimenter and hobbyist will find hundreds of excellent uses for this high quality permanent magnet. Measures 1 3/4" x 1 1/2" Shp. Wt. 9/2 lbs. ITEM NO. 159 YOUR PRICE \$1.50



GENUINE MICROPHONE TRANSMITTERS

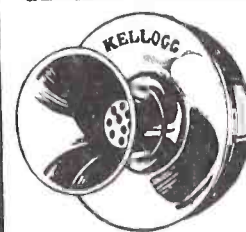

These are regular "telephone transmitters" of the type used on wall telephones. Taken from a large telephone supply company's overstock, these fine mikes offer a grand opportunity to obtain a splendid unit for little more than the price usually asked for a simple "microphone button".

The amateur experimenter and telephone mechanic will find a variety of uses for these excellent microphones. They work perfectly on 2 dry cells.

Can be used on P.A. systems for voice transmissions, in call systems and intercommunications sets. With telephone receivers (radio headphones will do) they may be made into short-line telephone circuits, such as house-to-house or farm-to-farm phone lines. You can use them to talk through your own radio, or as concealed dictaphone pick-up units for listening to conversations in a distant room or building. The telephone mechanic will find them useful replacements on battery-operated rural telephone lines. THESE ARE GENUINE TRANSMITTERS. MADE BY KELOGG, WESTERN ELECTRIC AND STROMBERG-CARLSON, excellent in appearance and operation. A remarkable value, and one seldom offered in these times. Shp. Wt. 1 lb. ITEM NO. 160 YOUR PRICE \$1.50

AMAZING BLACK LIGHT!!

Powerful 250-Watt Ultra-Violet Source



The best and most practical source of ultra-violet light for general experimental and entertainment use. Makes all fluorescent substances brilliantly luminescent. No transformers of any kind needed. Fits any standard lamp socket. Made with special filter glass permitting only ultra-violet rays to come through. Brings out beautiful obnoxious hues in various types of materials. Swell for amateur parties, plays, etc.; obtain unique lighting effects. Bulb only. Shp. Wt. 2 lbs.

ITEM NO. 87 YOUR PRICE \$2.45

WATTHOUR METER

Completely overhauled and ready for immediate service. Designed for regular 110-volt, 60 cycle 2-wire A.C. circuit. Servicemen use it in their shops to check current consumption of sets, soldering irons, etc. Keeps costs down. If dismantled, the parts alone would bring the price. The elaborate gear train could be used as a counter on machines of various kinds. Simple to install: 2 wires from the line and 2 wires to the load. Sturdily constructed in heavy metal case. 8 1/2" high, 6 1/4" wide. 5" deep. Westinghouse, G. E., Ft. Wayne, Sanganam or other available make. Shp. Wt. 14 lbs.



ITEM NO. 33 YOUR PRICE \$5.95

LIMITED QUANTITIES! PROMPT SHIPMENTS!

It's Easy to Order—Clip Coupon—Order from This Page—No Catalog Sent. MAIL TODAY—NOW!

HUDSON SPECIALTIES CO.

40 West Broadway, Dept. RC-4-45, New York 7, N. Y.

I have circled below the numbers of the items I'm ordering. My full remittance of \$..... is enclosed (if include shipping charges) is enclosed. (NO C.O.D. ORDERS UNLESS ACCOMPANIED WITH A DEPOSIT.) OR my deposit of \$..... is enclosed (20% required), ship order C.O.D. for balance. NO C.O.D. ORDER FOR LESS THAN \$5.00. (New U. S. stamps, check or money order accepted.) Circle Item No. wanted: 33 87 159 160

Name

Address Please Print Clearly

City State

Send remittance by check, stamps or money order; register letter if you send cash or stamps.

无线电知识

1700
ANSWERS



TO YOUR HARDEST PROBLEMS

1178 Illustrations
1000 Pages
130 Tables — 105 Graphs

GET THE ANSWERS NOW!

Here, in one big volume, you'll find all the time saving answers to your radio problems . . . and time saved is **MONEY EARNED**. Written in easily understood language, yet accurate enough for an engineer. Completely revised and cross indexed for quick reference, this handy reference book for your tough jobs covers radio transmission and reception, public address systems, television, photocells and data on their important parts. It's a book you'll always use. And . . . it's only **\$5.00**

ANOTHER TIME SAVING BOOK!
ELECTRICAL AND RADIO DICTIONARY. Over 3800 definitions of technical words and terms used in all branches of radio and electricity. 300 Pages—550 Illustrations. **\$2.50**

GATEWAY PUBLISHING COMPANY
53 W. Jackson—Dept. RC-4
Chicago 4, Ill.

Clip This Coupon NOW

- Send me the new Drake Cyclopedia IMMEDIATELY.
- And the 300 Page Radio Dictionary.

Name

Address

City State

ALEXANDERSON HONORED

Dr. E. F. W. Alexanderson, who recently received the Edison award for his work in electricity and radio, has been honored by his native country. He was awarded the Cedergren gold medal on February 9 last by the Royal Technical Institute of Sweden.

Presenting Dr. Alexanderson for the award, which was made by Martin Kastengren, Swedish Consul General, Harry Stockton of Harvard University stated:

"One of the outstanding characteristics of Dr. Alexanderson is the fact he is unafraid of difficulties and frequently does the seemingly impossible.

"It was around 1904 that Reginald Fessenden requested General Electric to build an alternator for a frequency—not of 60 cycles per second, nor of a few hundred cycles per second—but 100,000 cycles per second," Mr. Stockman said. "Everyone knew that such an alternator could not be designed, but Dr. Alexanderson seemed unaware of the fact, so he just went ahead and designed it. His alternator was tested in 1906 at Brant Rock in Massachusetts and became a great success. On Christmas eve of 1906 the Alexanderson alternator went on the air with voice transmission, and to those operators on ship and shore who happened to get this transmission in their ear-phones, it meant the advent of broadcasting.

"This must not lead us to believe that the alternator is the only invention credited to the genius of Dr. Alexanderson, for there are 300 General Electric patents taken out in his name, covering a vast field of electrical engineering applications. Roughly speaking Dr. Alexanderson has taken out a new patent every seventh week over a period of 40 years.

(Continued from previous page)

servicemen concerning licensed and unlicensed repairmen. Perhaps it may be a good idea to be a licensed repairman; I wouldn't know because I am not licensed. I do have a diploma for completing my radio course and also a diploma for completing an appliance course. I have been in appliance service for years and never had a callback or any calls for a license.

I suggest we call all this license feuding off and get together and form some kind of "Radio Servicemen's Association," thus enabling us to get together and help each other out. Let the president be a man with about ten or twenty years of radio experience behind him.

Anybody have any nominations? How about Mr. Hugo Gernsback?

GEORGE ANGLADO,
Gordon Johnson, Fla.

THE MAGNETIC RECORDER

Radio-Craft has received a number of queries on the article, "A Magnetic Recorder" by Warren M. Davis, which appeared in the January issue. Most of the queries were in regard to certain details of the coil winding. We sent the inquiries to Mr. Davis, and received this reply:

Dear Editor:

The three windings on the oscillator coil are wound in the same direction; it is not important how the terminals of the secondaries are connected in the circuit.

The secondaries are layer wound, one over the other, at the plate end of the oscillator coil. The erase coil is wound on a 1/8-inch insulating tube capable of withstanding the wear of the wire passing through the center of the coil. It may be connected to the No. 2 secondary with a twisted wire or shielded auto antenna lead.

I would be glad to give any inquiries you care to forward to me my personal attention as far as possible. I have already answered a number of letters in response to the article, also furnished two readers with recording wire.

You may be interested to hear that I have just completed another recorder that compares favorably with any commercial machine; it could be built in any workshop where a metal lathe is available.

WARREN M. DAVIS,
North Hampton, N. H.

RADIO SERVICE AT HOME

By ED CARTER

(A little note on servicing as seen by the five-year-old.)

My Daddy fixes radios;
A service man, you know . . .
The people bring them in to him.
He has to make them go . . .
He tunes them up and tests the tubes
And checks the dial light—
And then he settles down to work
And stays up half the night.
He touches this and wobbles that
And mutters 'neath his breath . . .
And then sometimes he swears so bad
It scares ME half to death . . .
And sometimes, too, he makes them squawk
And screech and scream and roar . . .
I shove my fingers in my ears
And scamper out the door . . .
I wish he'd give it up, I do—
It's driving him insane . . .
And if he doesn't stop, I fear
He'll be a rattle brain!

Index to advertisers

Alden Products Co.	430
Allied Radio Corporation	444
Amperite Co.	455
Audel & Co.	466
Best Vibrator Co.	453
Buck Mfg. Co.	460
Burlingame Associates	448
Burgess Battery Co.	439
Burstein-Applebee Co.	452
Cannon Co., C. F.	450
Capitol Radio Eng. Institute	442
Cardwell Mfg. Corp., Allen D.	458
Centralab	404
Concord Radio Corporation	437
Cox, John A.	460
Coyne Electrical School	450, 452, 453, 456
DeForest Training, Inc.	403
Echophone Radio Co.	399
Federal Telephone & Telegraph	459
Gateway Publishing Co.	462
General Cement Mfg. Co.	451
General Electric Co.	449
Hazeltine Corp.	458
Henry Radio	451
Hickok Elec. Inst. Co.	431
Hudson Specialties	461
International Detrola Corp.	395
International Resistance Co.	432
Lake Radio Sales Co.	450
Lancaster, Allwine & Rommel	451
Lifetime Sound Equipment Co.	448
Maedel Publishing House	463
Mallory & Co., Inc., P. R.	429
McElroy, T. R.	453
McGraw-Hill Book Co.	463
Meissner Mfg. Co.	402
National Radio Institute	397
National Schools	405
National Union Radio Corp.	396, 458
Ohmite Mfg. Co.	454
Onan & Sons, D. W.	453
Opportunity Adlets	460
Personnel Help Wanted	458, 459

RADIO SCHOOL DIRECTORY
Page 464

- American Radio Institute
- Candler System
- Capitol Radio Engineering Institute
- Commercial Radio Institute
- Lincoln Engineering School
- Melville Radio School
- Radio-Television Institute
- RCA Institutes
- New York Y.M.C.A.
- Tri-State College

RCA Communications	459
Radcraft Publications, Inc.	455
Radio Corporation of America	Back Cover
Radio Distributing Co.	460
Radio Electric Service	449
Radio & Technical Division	
Murray Hill Book Co.	426, 427
Radio Tube Reprocessing Service	441
Radio Tube Service	446
Radio Wire Television	457
Radionic Equipment Co.	452
Radolek Company	456
Raytheon Mfg. Co.	Inside back cover
Rider Publisher, Inc., John F.	443
Sheffield Radio Co.	441
Solar Capacitor Sales Corp.	Inside front cover
Sperry Gyroscope, Inc.	459, 465
Sprague Products Co.	400
Sprayberry Academy of Radio	401
Sun Radio & Electronics Corp.	458
Superior Instruments Co.	441
Supreme Publications	447
Triplett Elec. Instrument Co.	406
Western Electric Co.	458
Wholesale Radio Laboratories	445

BOOK REVIEWS

COYNE ELECTRICAL-RADIO TROUBLE SHOOTING MANUAL, prepared by the Staff of the Coyne Electrical School, Chicago. Stiff leatherette cover, 9 x 11 inches, 612 pages. Price \$8.00.

This large book of the trouble-shooters' manual type is designed to be of use to the person working with electricity whether in radio, automotive electrical installations, alternating or direct current, wiring, or even in connection with refrigeration and air-conditioning. It will be of especial value to shops which work in two or more branches of the art, and to specialists in one of these lines who find it necessary to have a certain amount of knowledge and facility in related work.

The first 38 pages are devoted to electrical trouble shooting and reading electrical diagrams. There is then a 30-page section of wiring diagrams, including bells, relays, telephones, meters and house wiring circuits.

Direct Currents are next treated. The section includes diagrams and explanatory material on D.C. motors, generators, windings and control circuits.

A larger section (134 pages) deals with alternating-current apparatus, including principles and circuits, transformers, single-phase and polyphase motors, motor starters and controllers. The largest section of the book (241 pages) is that on radio and television. Beginning with radio principles and circuits, it continues through tubes and receiver components, receivers and controls, sound and P.A. systems to such electronic devices as photo-cells. Television systems and transmitters have a chapter each, and the remainder of the section deals with servicing and trouble shooting. A radio-electric dictionary closes the book.

ELECTRICAL DRAFTING; Applied to Circuits and Wiring. By D. Walter Van Gieson. Published by McGraw-Hill Book Co. Stiff cloth covers, 5½ x 8 inches. Price \$1.50.

Textbooks on engineering drawing often relegate drafting as applied to electrical circuits to a few pages or even paragraphs. While this is no doubt proportional to the importance of the subject in relation to the whole field, it is not sufficient for the student whose only interest in draftsmanship is electrical diagrams, with the major emphasis on circuit work.

Circuits, the author points out, are of the first importance in any drawing of electric or electronic apparatus. Every piece of electrical equipment, even a simple bell, must have a controlling circuit. The function of the detailed wiring plan as a pattern for the wiring installation need hardly be stressed.

The treatment of purely electronic apparatus is limited, only two chapters being devoted to communications, radio and television, though parts of other chapters are useful to the electronic student. There are some interesting pictorial and wiring drawings of radio apparatus, as well as ordinary schematics. The symbols used are all of the pre-coordination type, and those used in the pictorials seem to date back to 1926. With these minor blemishes, the material is useful and interesting.

SECRET WEAPON, by K. K. Doberer. Published by Practical Press Ltd. (Britain). Stiff cloth covers, 5 x 7½ inches, 160 pages. Price 6 shillings sixpence.

The book opens with a short item on the fear of secret weapons and the probable causes of such fear. It then goes on to describe secret weapons of the past—including a few frauds—those of the present and possible future weapons. There are 26 short chapters, each dealing with some formerly attempted, presently projected or theoretically possible means of military offense or defense.

Strangely enough, electronic or radio means as secret weapons are absent, though the use of infra-red rays in radar-like devices is mentioned. No mention of radio control is made even in connection with rockets, which are considered important enough for three chapters.

The book is especially interesting as a review of European military methods, intrigue and espionage. It is related that the French, after laboriously reconstructing "Big Bertha" from theory and observers' reports, discovered that they already had the plans for the giant gun stolen 30 years before! In another instance, a tank flame-thrower, news of which had leaked out inconveniently, was explained away by the German General Staff as a device for extinguishing incendiary bombs. The bombs were apparently to be put out by spraying them with benzine or high-test gasoline!

SOUL OF AMBER—The Background of Electrical Science, by Alfred Still. Published by Murray Hill Books. Stiff cloth covers, 6 x 8½ inches, 274 pages. Price \$2.50.

This is the most human book which has been written on the history of electricity in the past several years. The general tendency is to suppose that such books must necessarily be incomplete, superficial and weighed in favor of picturesque individuals as against their prosaic but more important contemporaries. Readers who come to the book with this thought will be pleasantly surprised. While the author's central idea is to show the development of modern methods of thought in scientific pursuits, his coverage of the physical facts of discovery is surprisingly complete. How many have heard of Jean Paul Marat as an electrical writer? Yet his *Researches on Electricity*, published in 1782, was in some respects important, particularly in combatting the rising popular tendency to attribute an electrical origin to all natural phenomena not clearly understood.

A large number of other individuals and items are drawn into this history of the progress of human thought as applied to electricity. The references which appear at the end of each chapter stimulate further study, and should be of assistance to any worker interested in original approaches to electrical science.

The subject of electronics is not covered—only one chapter being devoted to the period after Faraday. This is not entirely a misfortune, as the reader is left with the hope that a second volume may be written on the "Soul of Amber" in its electronic incarnation.

NOW—A REALLY HIGH-POWERED— Radio Engineering Library

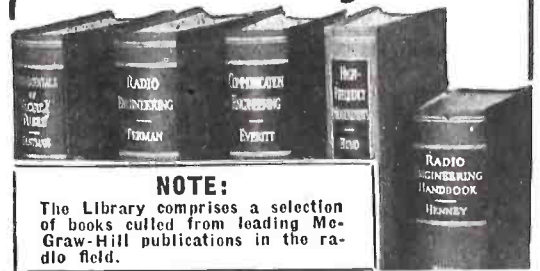

NOTE:

The Library comprises a selection of books culled from leading McGraw-Hill publications in the radio field.

- especially selected by radio specialists of McGraw-Hill publications
- to give most complete, dependable coverage of facts needed by all whose fields are grounded on radio fundamentals
- available at a special price and terms

THESE books cover circuit phenomena, tube theory, networks, measurements, and other subjects—give specialized treatments of all fields of practical design and application. They are books of recognized position in the literature—books you will refer to and be referred to often. If you are a practical designer, researcher or engineer in any field based on radio, you want these books for the help they give in hundreds of problems throughout the whole field of radio engineering.

5 VOLUMES, 3319 PAGES, 2289 ILLUSTRATIONS

1. Eastman's FUNDAMENTALS OF VACUUM TUBES
2. Terman's RADIO ENGINEERING
3. Everitt's COMMUNICATION ENGINEERING
4. Hund's HIGH FREQUENCY MEASUREMENTS
5. Henney's RADIO ENGINEERING HANDBOOK

10 days' examination. Easy terms. Special price under this offer less than books bought separately. Add these standard works to your library now; pay small monthly installments, while you use the books.

10 DAYS' FREE EXAMINATION—SEND COUPON

McGraw-Hill Book Co., 330 W. 42nd St. New York 18

Send me Radio Engineering Library, 5 vols., for 10 days' examination on approval. In 10 days I will send \$3.00, plus few cents postage, and \$3.00 monthly till \$24.00 is paid, or return books postpaid. (We pay postage on orders accompanied by remittance of first installment.)

Name
Address
City and State
Company
Position RC-4-45

MATHEMATICS FOR RADIO

Two volumes, prepared for home study. Book I (314 pp.) covers the algebra, arithmetic, and geometry; Book II (329 pp.) covers the advanced algebra, trigonometry, and complex numbers necessary to read technical books and articles on radio.

MAEDEL PUBLISHING HOUSE Room 117
593 East 38 Street, Brooklyn, New York

Send me MATHEMATICS FOR RADIO AND COMMUNICATION as checked below. I enclose payment therefor with the understanding that I may return the book(s) within 5 days in good condition and my money will be refunded.

Name

Address

- Book I at \$3.75 plus 6c postage
 Book II at \$4.00 plus 6c postage
 Books I and II at \$7.75 postage prepaid

Foreign and Canadian prices 25c per volume higher

RADIO SCHOOL DIRECTORY

PREPARE NOW FOR POST-WAR RADIO AND ELECTRONICS

MAKE a place for yourself in a new world of radio and electronics—a world in which revolutionary electronic developments will require highly specialized technical knowledge. Take a good course now to fit yourself for a good paying job. The training you need can be supplied by one of the schools advertised in this publication.

RADIO-TELEVISION ELECTRONICS

offer ever-increasing post-war opportunities for trained men and women. R-T I courses prepare you by combining theory with practical laboratory experience.

Consideration given to Veterans eligible for training under the G.I. Bill. Day & Evening Sessions. Apply daily 9-9, Sat. 9-2. Request Information.

Radio-Television Institute

480 Lexington Avenue, N. Y. 17 (46th St.)
PLaza 3-4585 Licensed by N. Y. State

RADIO ENGINEERING

DEGREES IN 27 MONTHS

EX-SERVICE MEN can complete work here in shortest possible time. Special Prep. Dep't. Also REFRESHER COURSES. Courses also in Civil, Electrical, Mechanical, Chemical, Aeronautical Engineering; Business Administration, Accounting, Secretarial Science. Tuition, living costs low. 62nd year. Cosmopolitan student body. Enter Mar., June, Sept., Jan. Catalog.

TRI-STATE COLLEGE 2445 College Ave. ANGOLA, INDIANA

COMMERCIAL RADIO INSTITUTE

A radio training center for twenty-four years.

RESIDENT COURSES ONLY

Pre-Induction, Broadcast, Service, Aeronautical, Television and Marine telegraphy classes now forming for June 18. Literature upon request. Veteran training.

Home Study Course in Mathematics

Dept. C., 38 West Biddle St., Baltimore 1, Md.

RADIO

Courses Qualifying for Service Technician • Laboratory Technician (Electronic Television) Communications Operator Register Now for New Classes Starting 1st Monday of each Month. Day and Evening Classes.

Consideration Given To Veterans Eligible For Training Under G.I. Bill.

AMERICAN RADIO INSTITUTE

101 West 63rd St., New York 23, N. Y.

RADIO-TELEVISION ENGINEERING & SERVICING

Now Training Veterans Under "G.I." Bill Prepare now for profitable career! ENTER AT ANY TIME. Residence school classes in Radio-Electronics Engineering, Broadcast & Television Engineering and Servicing. Write for FREE Booklet

Capitol Radio Engineering Institute Dept. RC-4, 3224 16th Street, N. W., Washington 10, D. C.

See Big Ad. Page 442

RADIO ELECTRONICS

Intensive training in Airline, Merchant Marine, Press Communications, Electronics, Television. Co-educational. FREE booklet.

VETERANS: Request FREE copy, G.I. bill of rights

"A Radio School managed by radio men." 45 W. 45th St., Dept. RC, New York 19, N.Y.
MELVILLE RADIO INSTITUTE

RCA INSTITUTES

Offer thorough training courses in all technical phases of

Radio and Television

DAYS—EVENINGS WEEKLY RATES

VETERANS: RCA Institutes is approved under G. I. Bill of Rights

For Free Catalog Write Dept. RC-45

RCA INSTITUTES, Inc.

A Radio Corporation of America Service 75 VARICK STREET NEW YORK 13, N. Y.

Correspondence Courses in RADIO and ELECTRICAL ENGINEERING

ELECTRICAL ENGINEERING Get good grasp of wide electrical field. Prepare yourself, at Low Cost, for secure future. Modern, simplified, you can understand quickly.
RADIO ENGINEERING Extra fine course in radio, publication address, photo-electric work. Trains you to be super-service man, real vacuum tube technician. Servicemen needed badly. Diploma on completion. Tuition \$25, either course. Deferred payment plan.
FREE Get copies of school catalogs, student magazines, complete details. SEND NOW!
LINCOLN ENGINEERING SCHOOL Box 931C-74 Lincoln, Nebr.

SHORT CUT CODE SPEED Be an Expert

Learn to be a Telegraph or Radio Operator. Thousands of men needed. Intensely interesting work—good pay. Learn at home or wherever you are, quickly, easily, with the famous Candler Code Speed System. Book of particulars Free.
Candler System Co., Dept. 3-D, Box 928, Denver 1, Colo.

Pre-Induction RADIO COURSES

for Civilians and those entering Military Services. New classes now starting for men and women.

- RADIO OPERATING • CODE
- RADIO SERVICING — ELECTRONICS

New York Y.M.C.A. Schools 4 W. 64th Street New York City

BEAUTY AND BROADCASTING

NUMEROUS changes in personnel from male to female have occurred during the war emergency, in various industries from "Rosie the Riveter" to weatherwomen, postal truck drivers, streetcar "conductresses," "motorwomen," female "icemen" and taxi drivers. Women are operating road-grading equipment, and even working as train washers and baggagemasters. But to WISE, Asheville, North Carolina, famed mountain resort, goes the distinction of being the only broadcasting station in the United States with three women as radio engineers. An experimental television station in Chicago is manned by women.

The engineering staff at WISE has as its chief engineer a former New York stage actress. The nation's first woman chief radio engineer—charming, but unassuming Miss Madeline Halleuth, a native of Scarsdale, New York. In addition to her technical abilities, she has splendid voice-appeal as announcer. As chief engineer, she speaks the language of crystal-controlled frequencies, water-cooled transmitting tubes, condensers, coils, and carries her position with the ease of a veteran radio technician.

The other two women at WISE are only 19 years old. Miss Faye Beard of Bryson, City, North Carolina, chic and charming enough to be a model as well as an engineer, started experimenting with radio when only 16 years old. She built a two-tube radio receiver then; and now has four cousins in radio and radar work in the war. Miss Beard is capable of talking the language of radio engineering, has a license from the Federal Communications Commission to operate a broadcasting station, having studied at the N.Y.A. radio night school in Asheville; and has been with WISE since December 1942. Miss Bettie Freeman of Morganton, North Carolina, who is also licensed and received her training through the same channels, and carries the same distinction, has been with WISE since January 1943.



The results of World War II in the future development of our country's industries can be credited then, not only to our nation's leading men, but to these first ladies of the land, whose ingenuity, perseverance, and ability will carry them through this emergency of manpower shortages to the days of the postwar future, when these same women will become established factors in the radio industry and other fields of industrial endeavour.—S.R.W.

BOOK REVIEWS (Continued from previous page)

PROCEEDINGS OF THE FIRST ANNUAL CONFERENCE of the Television Broadcasters Association. Published by the Association, New York City. 8½ x 11 inches, 223 pages, mimeographed. Heavy paper covers. Price \$2.00.

The first conference of the nation's television is an important event to radio in general as well as to television itself. As such, it is fitting that a report of the meeting be circulated beyond the membership itself. The Proceedings give a full account of the meeting, with verbatim reports of all panel sessions, speeches and discussions.

Since the greatest stress was placed on the commercial and promotional aspects of television, the greater part of the material is devoted to these angles. The seven panel reports were: Advertisers, Manufacturers,

Producers, Theatres, Publications, Talent and Broadcasting. Exception was the technical session at which the country's chief television experts answered questions proposed by delegates, as well as a few individual addresses.

Other than panel reports and technical sessions, a symposium, "Television Programming," by John F. Royal, Robert L. Gibson, and Thomas H. Hutchinson, and addresses by Commander William C. Eddy, Harold S. Osborne, E. W. Engstrom and Dr. W. R. G. Baker, were delivered and are reported in full.

A 36-volt storage battery, built by Willard Storage Battery Company, for use in walkie-talkies, gyro controls, etc., weighs only six ounces.



The Greeks gave us a word for it . . . now we give it to you

WHEN Sperry first developed its velocity-modulated, ultra-high-frequency tube, the word "KLYSTRON" was registered as the name of the new device.

This name — from the Greek, as coined by scientists of Stanford University — is an apt description of the bunching of electrons between spaced grids within the tube.

"Klystron" is a good name. So good, that it has come into widespread use as the handy way to designate *any* tube of its general type,

whether a Sperry product or not.

This is perfectly understandable. For the technical description of a Klystron-type tube is unwieldy, whether in written specifications, in conversation, or in instructing members of the Armed Forces in the operation of devices employing such tubes.

These conditions have prompted many requests from standardization agencies—including those of the Army and Navy—for unrestricted use of the name Klystron. In the public interest, Sperry has been glad to

comply with these requests . . .

From now on, the name KLYSTRON belongs to the public, and may be used by anyone as the designation for velocity-modulated tubes of any manufacture.

Sperry will, of course, continue to make the many types of Klystrons it now produces, and to develop new ones.

On request, information about Klystrons will be sent, subject to military restrictions.

SPERRY GYROSCOPE COMPANY, INC. GREAT NECK, N. Y.

Division of the Sperry Corporation



LOS ANGELES • SAN FRANCISCO • NEW ORLEANS
HONOLULU • CLEVELAND • SEATTLE

GYROSCOPICS • ELECTRONICS • RADAR • AUTOMATIC COMPUTATION • SERVO-MECHANISMS

**NEW EDITION
NOW READY**

Audels RADIOMANS GUIDE

Includes **TELEVISION
AND ELECTRONICS**

LARGER - MORE COMPLETE - 914 PAGES - 633 ILLUS - WIRING DIAGRAMS - PHOTOS

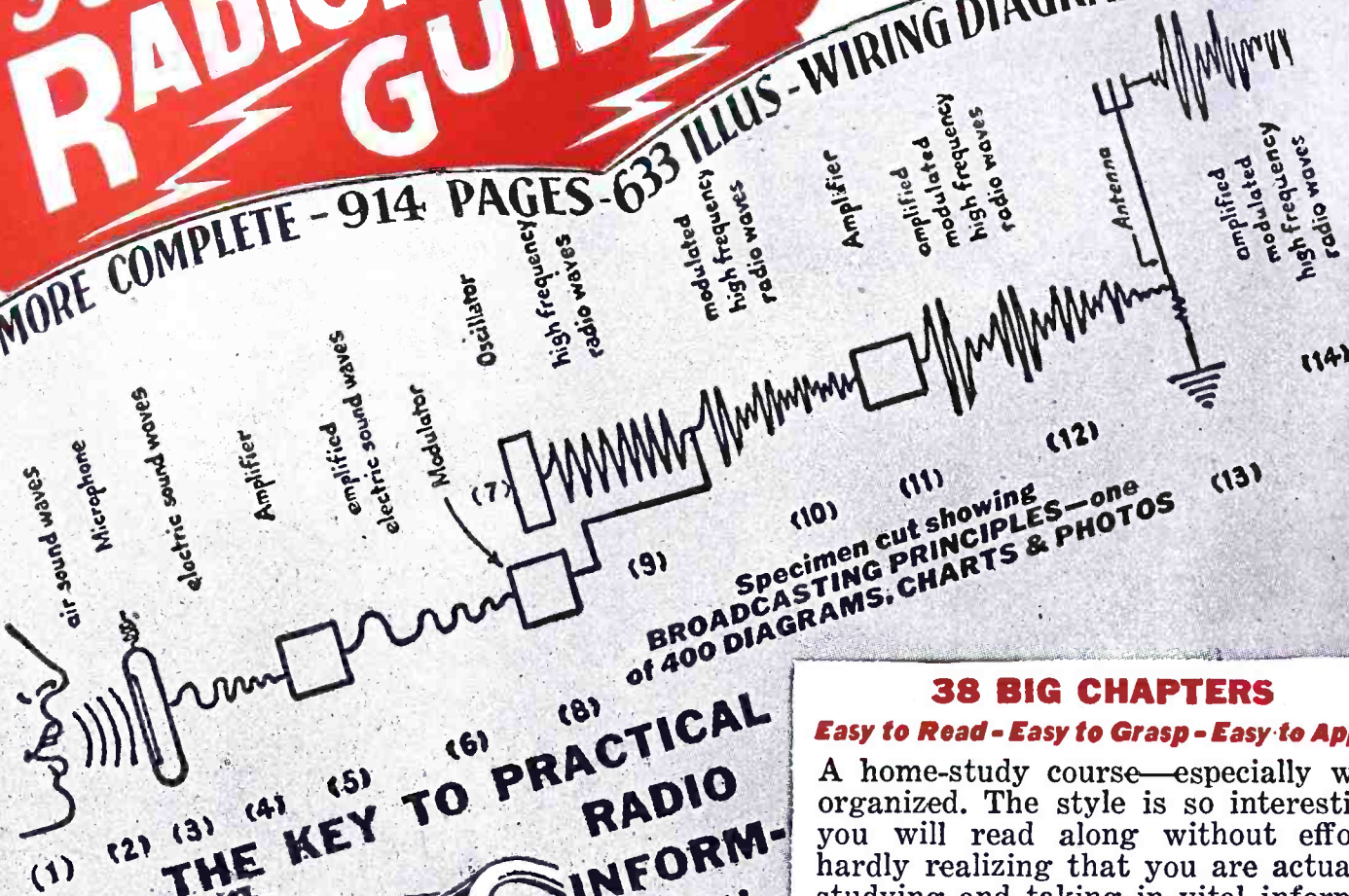

**THE KEY TO PRACTICAL
RADIO
INFORMATION**

It gives you in usable form pointers on radio, including frequency modulation, television, etc. Also valuable inside information for Aviators, Marines, Commercial Operators and Technicians, Servicemen and Students.



**Q AND A
UNIQUE
QUESTION
and
ANSWER
METHOD**

Highly Endorsed

**1001 RADIO FACTS AND FIGURES
A Complete Library In One Book**

AUDELS RADIOMANS GUIDE gives authentic Principles and Practices in Construction, Operation, Service and Repairs. Covers clearly and concisely radio fundamentals—Ohm's Law—Physics of sound as related to radio science—Measuring instruments—Power supply—Resistors—Inductors—Condensers—Transformers and examples—Broadcasting stations—Radio Telephony—Receivers—Diagrams—Construction—Control Systems—Loudspeakers—Antennas—AutoRadio—Phonograph Pick-ups—Public Address Systems—Aircraft and Marine Radio—Radio Compass—Beacons—Automatic Radio Alarms—Short Wave—Coil Calculations—Testing—Cathode Ray Oscillographs—Static Eliminations—Trouble Pointers—Underwriter's standards—Units and tables. REVIEW QUESTIONS—READY Reference Index.

38 BIG CHAPTERS

Easy to Read - Easy to Grasp - Easy to Apply

A home-study course—especially well organized. The style is so interesting you will read along without effort, hardly realizing that you are actually studying and taking in vital information. Audels Radiomans Guide gives you just the right amount of mathematics required to cope with radio problems successfully. You can solve, with the aid of this extraordinary book, practically every radio problem that comes up. At your finger tips is a complete index for instant use.



7 DAYS' FREE TRIAL

THEO. AUDEL & CO., Publishers
49 West 23rd Street, New York 10, N. Y.

Mail AUDELS NEW RADIOMANS GUIDE for free examination. If O. K. I will send you \$1 in 7 days; then remit \$1 monthly until \$4 is paid. Otherwise I will return it.

\$4

COMPLETE

\$1

PAY ONLY

1 MO.

Name
Address
Occupation
Reference

**MAIL THIS
COUPON
TODAY**

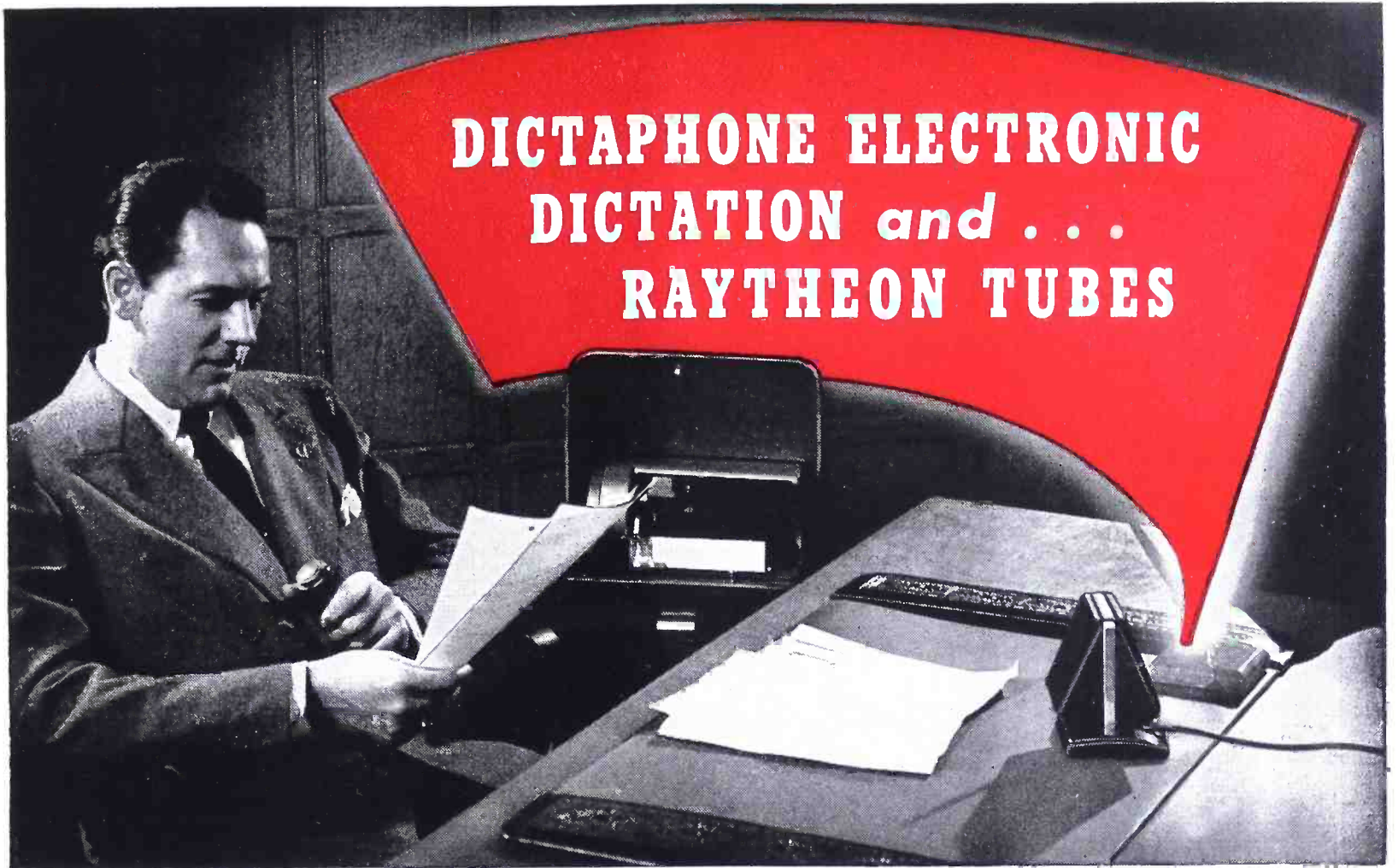

**DICTAPHONE ELECTRONIC
DICTATION and . . .
RAYTHEON TUBES**

● If you're a radio serviceman or engineer, you'll appreciate the ingenuity and development work which produced this new Dictaphone Electronic Dictating Machine which is available for essential uses. And if you're a busy executive, as well, you'll praise it as an aid to getting things done more easily, more quickly and more conveniently. Not only does it record dictation, but over-the-desk conversations and both ends of phone-calls too!

Raytheon high-fidelity tubes used in this remarkable new machine consistently deliver clear, realistic reproduction and give long, dependable performance...just as they will in the future for this and an infinite variety of other electronic devices.

When peace comes, Raytheon tubes will be more readily available. And they'll be even finer than Raytheon's pre-war tubes,

for their design and construction will have been proved by the toughest test of all—the acid test of battlefront performance. We can promise, too, if you're a serviceman or dealer, that the Raytheon tube line will be the most *beneficial* line for you to handle. After Victory it will pay you to switch to Raytheon high-fidelity tubes!

Increased turnover and profits . . . easier stock control . . . better tubes at lower inventory cost . . . These are benefits you will enjoy after the war as a result of the Raytheon standardized tube type program, which is part of our continued planning for the future.



**Raytheon
Manufacturing Company**

RADIO RECEIVING TUBE DIVISION

Newton, Massachusetts • Los Angeles
New York • Chicago • Atlanta



Listen to
"MEET YOUR NAVY"
Every Saturday Night
ENTIRE BLUE NETWORK
Coast-to-Coast
181 Stations

RAYTHEON
High Fidelity
ELECTRONIC AND RADIO TUBES



All Four Divisions Have Been Awarded
Army-Navy "E" with Stars

DEVOTED TO RESEARCH AND MANUFACTURE OF TUBES FOR THE NEW ERA OF ELECTRONICS

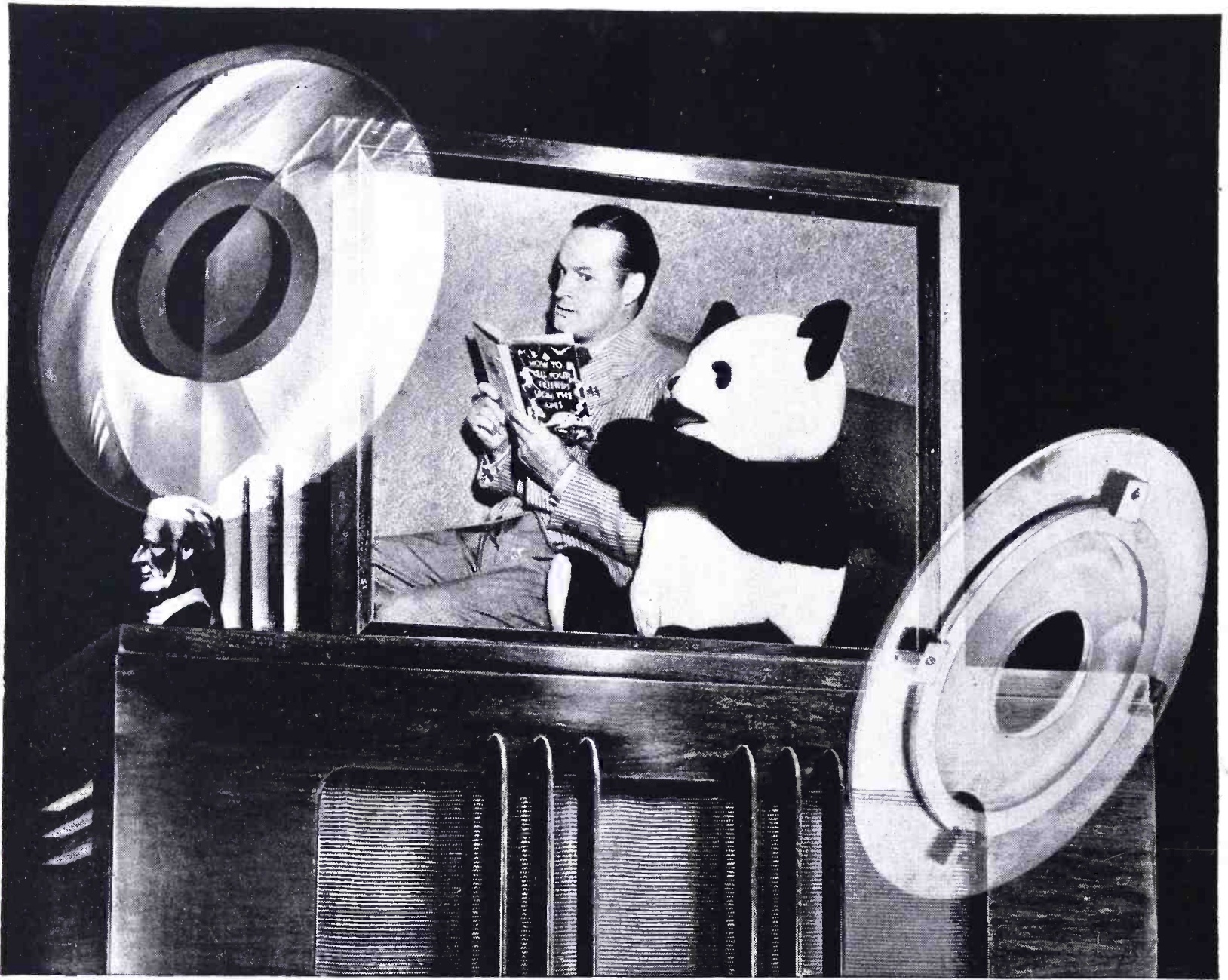

RCA Laboratories model with an 18 by 24-inch screen showing how Bob Hope may appear on future home television.

New Projection Television - Bob Hope's face "big as life"

Can you picture Bob Hope on television . . . seeing his face *big as life*—right in your own living room?

Well, you will—for now, thanks to RCA research, all limitations on the size of home television screens have been removed.

RCA Projection Television sets can have 18 by 24-inch pictures, or for that matter, pictures as large as the screen in a "movie" theater!

When you tune in an NBC television broadcast you'll almost think the actors are in the same room with you—and trust NBC, America's No. 1 network in sound broadcasting, to bring you the best in television entertainment.

This revolutionary improvement was achieved in RCA Laboratories by development of an entirely new reflector and lens, shown in phantom above. This lens, of inex-

pensive plastic, is 8 times as efficient for the purpose as the finest optical lens.

When you buy an RCA radio, phonograph or television receiver—or any other RCA product—you receive the benefit of the latest research development of RCA Laboratories. It is this *plus value* which is your assurance of lasting satisfaction.

The widespread public recognition of this plus value has given to RCA world leadership in the radio, phonograph, television and electronic art.



Dr. D. W. Epstein with a projection television tube, reflector and lens unit. Here the image on the end of the tube hits the reflector, is corrected by the lens, projected to the screen, then enlarged . . . making possible larger and clearer television than ever before.

RADIO CORPORATION of AMERICA

PIONEERS IN PROGRESS

