

HUGO EFFENSBACK, Editor

RADIO CRAFT

▼ AND POPULAR ELECTRONICS ▼

SKY RADIO
BLANKETS
ENEMY
SEE PAGE 334

MARCH

1944

25¢

CANADA 30¢

RADIO-ELECTRONICS IN ALL ITS PHASES

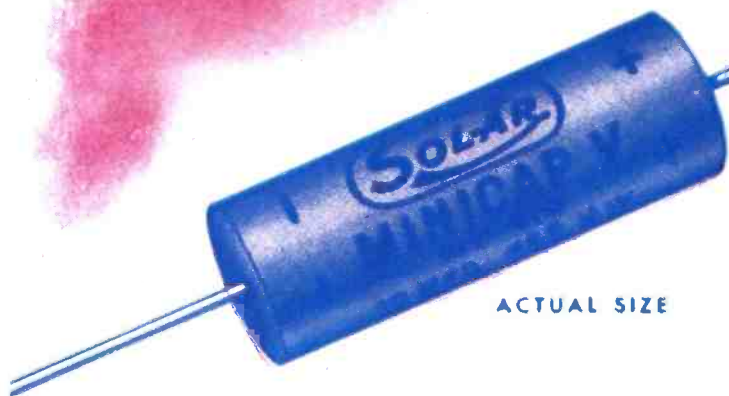

Meet the **NEW**
 "MIDGET
MINICAP"

TINY ELECTROLYTICS BY Solar

**10
 CAPACITY AND
 VOLTAGE
 RATINGS**

These replacement Capacitors are dry electrolytics of *very small diameters*. They fit!

They are built to American War Standards. Their dependability is guaranteed by Solar's "Quality Above All". And they make for peace ... your peace of mind!

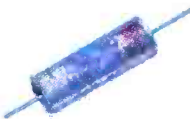

25 VOLTS WORKING

25 Mfd.
 PART NO. MV-2525 List Price \$.60
 Diameter 9/16" Length 2 1/4"



100 Mfd.
 PART NO. MV-25100 List Price \$.85
 Diameter 3/4" Length 2 1/4"



50 VOLTS WORKING

10 Mfd.
 PART NO. MV-5010 List Price \$.55
 Diameter 9/16" Length 2 1/4"



150 VOLTS WORKING

20 Mfd.
 PART NO. MV-220 List Price \$.75
 Diameter 11/16" Length 2 1/4"



20 + 20 Mfd. Negative Common
 PART NO. MV-2020 List Price \$1.30
 Diameter 13/16" Length 2 1/4"



250 VOLTS WORKING

20 Mfd.
 PART NO. MV-2520 List Price \$1.00
 Diameter 13/16" Length 2 1/4"



450 VOLTS WORKING

10 Mfd.
 PART NO. MV-410 List Price \$.85
 Diameter 13/16" Length 2 1/4"



10 - 10 Mfd. Negative Common
 PART NO. MV-41010 List Price \$1.40
 Diameter 1" Length 2 1/4"



40 Mfd.
 PART NO. MV-440 List Price \$1.75
 Diameter 1-5/16" Length 3 1/4"



NOTE: Government regulations prohibit the former practice of supplying metal mounting straps with these capacitors. However, the small size and light weight of Minicap "Vees" make them truly "self-mounting."



CAPACITORS

SOLAR CAPACITOR SALES Corp., 285 MADISON AVE., NEW YORK 17, N. Y.

SOLE NATIONAL DISTRIBUTORS OF SOLAR CAPACITORS TO THE JOBBING TRADE

FREE Lesson in Radio

Gives You a Real Start Toward Understanding These Subjects

With 31 Photos, Sketches, Radio Drawings

- How superheterodyne Circuits work
- How to remove tubes, tube shields
- Three reasons why Radio tubes fail
- Electrodynamic loudspeaker:
 - How it works
 - Replacing damaged cone
 - Recentering voice coil
 - Remedies for open field coil
- Output transformer construction, repair
- Gang tuning condenser:
 - Construction of rotor, stator
 - How capacity varies
 - Restraining dial cord
 - Straightening bent rotor plates
- I.F. transformers—
 - What they do, repair hints
- How to locate defective soldered joints

GETTING ACQUAINTED WITH RECEIVER SERVICING

- Inside story of carbon resistors
- Paper, electrolytic, mica, trimmer condensers
- How condensers become shorted, leaky
- Antenna, oscillator coil facts
- Power transformer: construction, possible troubles
- Installing power cord
- Troubles of combination volume control, on-off switch
- Tone controls
- Dial lamp connections
- Receiver servicing technique:
 - Checking performance
 - Testing tubes
 - Circuit disturbance test
- Isolating defective stage
- Locating defective part

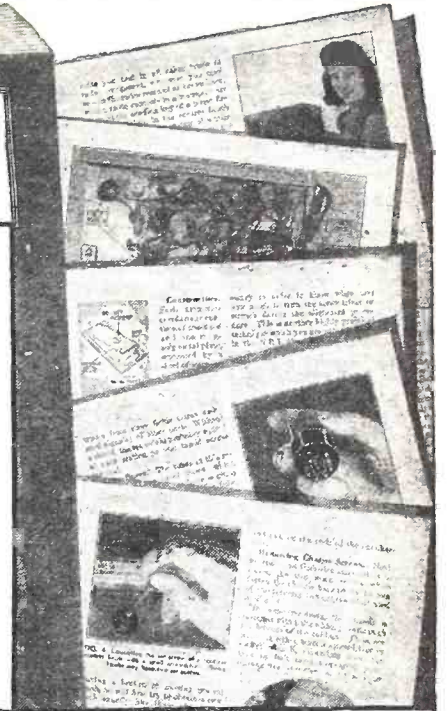

See For Yourself How I Train You at Home to BE A RADIO TECHNICIAN

More Radio Technicians and Operators Now Make \$50 a Week Than Ever Before

I will send you a sample Lesson, "Getting Acquainted with Receiver Servicing," to show you how practical it is to train for Radio at home in spare time. It's a valuable lesson. Study it—keep it—use it—without obligation! And with this Lesson I'll send my 64-page illustrated book, "Win Rich Rewards in Radio." It describes many fascinating jobs Radio offers, explains how N.R.I. trains you at home for good pay in Radio!

Big Demand Now for Well-Trained Radio Technicians, Operators

There's a big shortage today of capable Radio Technicians and Operators. Fixing Radios pays better now than for years. With new Radios out of production, fixing old sets, which were formerly traded in, adds greatly to the normal number of servicing jobs.

Be Ready to Cash in on Good Pay Jobs Coming in Television, Electronics

Broadcasting Stations, Aviation and Police Radio, and other Radio branches are scrambling for Operators and Technicians. Radio Manufacturers, now working on Government orders for Radio equipment, employ trained men. The Government too needs hundreds of competent civilian and enlisted Radio men and women. And think of the NEW jobs that Television, Electronics and other Radio developments will open after the war.

I Trained These Men



\$200 a Month in Own Business
"For several years I have been in business for myself making around \$200 a month. I have N.R.I. to thank for my start."
ARLIN J. FROEH,
NER, 300 W. Texas Ave.,
Goose Creek, Texas.



\$5 to \$10 Week in Spare Time
"I am engaged in spare time Radio work. I average from \$5 to \$10 a week."
THEODORE K. DUBREE, Horsham, Pa.

First Lieutenant
"I cannot divulge any information as to my type of work but N.R.I. training is coming in mighty handy."
RICHARD W. ANDERSON
(Address omitted for military reasons.)



Chief Operator Broadcasting Station
"Before I completed your lessons, I joined Station WMPC, where I am now Chief Operator."
HOLLIS F. HAYES, 327 Madison St.,
Lapeer, Michigan.



Many Beginners Soon Make \$5, \$10 a Week EXTRA in Spare Time

The moment you enroll for my Course I start sending you EXTRA MONEY JOB SHEETS that show how to earn EXTRA money fixing Radios. Many make \$5, \$10 a week EXTRA in spare time while still learning. I send you SIX big kits of real Radio parts. You LEARN Radio fundamentals from my lessons—PRACTICE what you learn by building typical circuits like those illustrated on this page—PROVE what you learn by interesting tests on the circuits you build.



EXTRA PAY IN ARMY, NAVY, TOO



Men likely to go into military service, soldiers, sailors, marines, should mail the Coupon now! Learning Radio helps Service men get extra rank, extra prestige, more interesting duties, MUCH HIGHER PAY. Also, prepares for good Radio jobs.

Mail Coupon for Free Lesson and Book

The opportunity the war has given beginners to get started in Radio may never be repeated. So take the first step at once. Get my FREE Lesson and 64-page, illustrated book. No obligation—no salesman will call. Just mail coupon in an envelope or paste it on a penny postal.—J. E. SMITH, President, Dept. 4CX, National Radio Institute, Washington 9, D. C.

You Build These and Many Other Radio Circuits With Kits I Supply!

By the time you've conducted 60 sets of Experiments with Radio Parts I supply—have made hundreds of measurements and adjustments—you'll have valuable PRACTICAL experience.

You build this SUPERHETERODYNE CIRCUIT containing a preselector oscillator-mixer-first detector, i.f. stage, diode-detector - a.v.c. stage and audio stage. It will bring in local and distant stations. Get the thrill of learning in spare time while you put the set through fascinating tests!

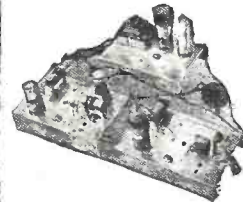

You build this MEASURING INSTRUMENT yourself early in the Course, useful for practical Radio work on neighborhood Radios to pick up EXTRA spare time money. It is a vacuum tube multi-meter, measures A.C., D.C. and R.F. volts, D.C. currents, resistance, Receiver Output.

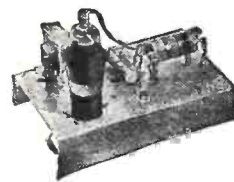

Building this A.M. SIGNAL GENERATOR will give you valuable experience. Provides amplitude-modulated signals for test and experimental purposes.

GOOD FOR BOTH 64 PAGE BOOK FREE

J. E. SMITH, President, Dept. 4CX, National Radio Institute, Washington 9, D. C.

Mail me FREE, without obligation, Sample Lesson and 64-page book, "Win Rich Rewards in Radio." (No salesman will call. Write plainly.)

Name AGE

Address

City State 4FR

Have you a friend or pal who is interested in Radio? Write his name and address below and I'll send him my book, "Win Rich Rewards in Radio." We will not mention your name unless you request it.

Name

Address

City State 4CXA





"RADIO'S GREATEST MAGAZINE"

HUGO GERNSBACK, *Editor-in-Chief*
 FRED SHUNAMAN, *Associate Editor*
 G. ALIQUO, *Circulation Manager*

IN THE NEXT ISSUE

Giant Radio Motor Torpedo
 Raysonde—Sky Transmitter
 FM Walkie-Talkie for WERS
 Causes of Audio Distortion
 Electronics and Ordnance
 Calibrating the Generator

Published by Radcraft Publications, Inc.
 Publication Office: 29 Worthington Street,
 Springfield 3, Mass.
 Editorial and Advertising Offices: 25 West
 Broadway, New York 7, N. Y.
 Chicago Advertising Office: Radio-Craft, 520
 North Michigan Avenue, Chicago 11, Ill.

RADIO-CRAFT is published monthly, on the
 25th of the month preceding that of date; sub-
 scription price is \$2.50 per year in U. S. (In
 foreign countries, 75c additional per year to
 cover postage; Canada, 50c additional.) Special
 rates for members of the Armed forces
 in U. S., or those addressed by A.P.O. or
 F.P.O. mail, \$2.00. Entered at the post office
 at Springfield as second-class matter under the
 Act of March 3, 1879. All communications
 about subscriptions should be addressed to:
 Circulation Manager, Radio-Craft, 29 Worthing-
 ton St., Springfield 3, Mass.

Notice of CHANGE of ADDRESS should
 reach us at least one month in advance. When
 ordering a change, please furnish an address
 stencil impression from a recent wrapper if
 you can. Address changes cannot be made
 without the old address as well as the new.
 Foreign Agents

Foreign Agents

London—Atlas Publishing and Distributing
 Co., Ltd., 18 Bride Lane, Fleet St., London,
 E.C. 4.

Melbourne—McGill's Agency, 179 Elizabeth
 St., Australia.

Text and illustrations of this magazine are
 copyright and must not be reproduced without
 permission of the copyright owners.
 Copyright, 1944, Radcraft Publications, Inc.

Contents March, 1944 Volume XV, No. 6

Editorial: The Big News.....by Hugo Gernsback 329
 Radio-Electronics Monthly Review..... 330

ELECTRONICS

Magnetic Current.....by Fred Shunaman 332
 Industrial Electronics, Part I.....by Raymond F. Yates 335
 A Precise "Treasure" Locator.....by R. M. C. Greenridge 337
 "Madame Curie" and Electronics.....by Hugo Gernsback 338
 Electronics Speeds Ordnance.....by S. R. Winters 340
 Lamps Measure Power..... 349
 Are Radio Symbols Wrong?..... 351

WARTIME RADIO

Sky Radio Blankets Enemy.....by Hugo Gernsback 334
 An FM Walkie-Talkie?.....by Dean S. Edmonds, Jr. 341
 Electronic Life Detector.....by Leslie W. Orton 342
 City QRM and Invasion Radio..... 364

SERVICING

Electronic Circuit Checks.....by R. E. Altomare 343
 A Serviceman to His Son.....by Eugene M. Conklin 362
 Modernize the Ancient Radio.....by William B. Miller 345

RADIO TRAINING

Maintaining FM.....by Jules M. Kleinman 344

CONSTRUCTION

Fluorescent Radio Tubes?.....by L. E. Shepard 346
 The "Plastic" Radio.....by Irving Minton 347
 A "Post-War" 2-Tube.....by Homer L. Davidson 348

DEPARTMENTS

World-Wide Station List.....by Elmer R. Fuller 350
 New Radio-Electronic Devices..... 354
 The Question Box..... 356
 Radio-Electronic Circuits..... 358
 Try This One!..... 360
 Available Radio-Electronic Literature..... 366
 Technotes..... 379
 The Mail Bag..... 380
 Book Reviews..... 383

ON THE COVER

Assistance to invasion by expendable transmitters
 parachute-dropped over occupied territories is the
 cover theme this month. Compact broadcast sta-
 tions descend over invaded areas to transmit mes-
 sages of relief to the public and instructions to
 fighters of the underground. Another type of radio
 invasion unit—a public address system—is not pic-
 tured on our cover, but is illustrated on page 334.



HEY MAC— GET IN ON THIS!

SERVICE MEN...

KEEP SENDING THOSE LETTERS!

"Bill Halligan says that all the contest entries he's received so far have been swell—he wants *more* letters tellin' about actual experiences with *all* types of Radio Communications equipment built by Hallicrafters including the SCR-299!"

RULES FOR THE CONTEST

Hallicrafters will give \$100.00 for the best letter received during each of the five months of November, December, January, February and March. (Deadline: Midnite, the last day of each month.)

For every serious letter received Hallicrafters will send \$1.00 so even if you do not win a big prize your time will not be in vain.

Your letter will become the property of Hallicrafters and they will have the right to reproduce it in a Hallicrafters advertisement. Write as many letters as you wish. V-Mail letters will do.

MILITARY REGULATIONS PROHIBIT THE PUBLICATION OF WINNERS' NAMES AND PHOTOS AT PRESENT... MONTHLY WINNERS WILL BE NOTIFIED IMMEDIATELY UPON JUDGING.

BUY MORE BONDS!



hallicrafters RADIO

THE HALLICRAFTERS CO., MANUFACTURERS OF RADIO AND ELECTRONIC EQUIPMENT, CHICAGO 16, U. S. A.

RADIO-CRAFT for MARCH, 1944



Radiotelephones

**WEAPONS OF WAR...
INSTRUMENTS FOR PEACE!**



The great mobility of modern warfare demands instantaneous and constant contact between all fighting units. Radio communications are indispensable weapons in any military operation. . . . Hallicrafters built SCR-543 (illustrated) is a low powered transmitting and receiving unit. When mounted in a scout car it dashes virtually into the jaws of the enemy to direct artillery fire and carry out similar communications duties. Designed and built to be operated by combat soldiers as easily as by highly trained radio personnel.

Peacetime will find the use of radiotelephones expanding to meet the needs of transportation—MARINE, AVIATION, RAILWAY and AUTOMOTIVE . . . assuring greater safety, efficiency and pleasure.

MARINE-TYPE RADIOTELEPHONE SCR-281 — another Hallicrafters built unit has gone to war! This radiotelephone installed in coastal and harbor vessels is performing vital ship-to-ship and ship-to-shore war duties. Because of its extreme simplicity it can be operated by even the most inexperienced personnel . . . just as easily as an everyday telephone!

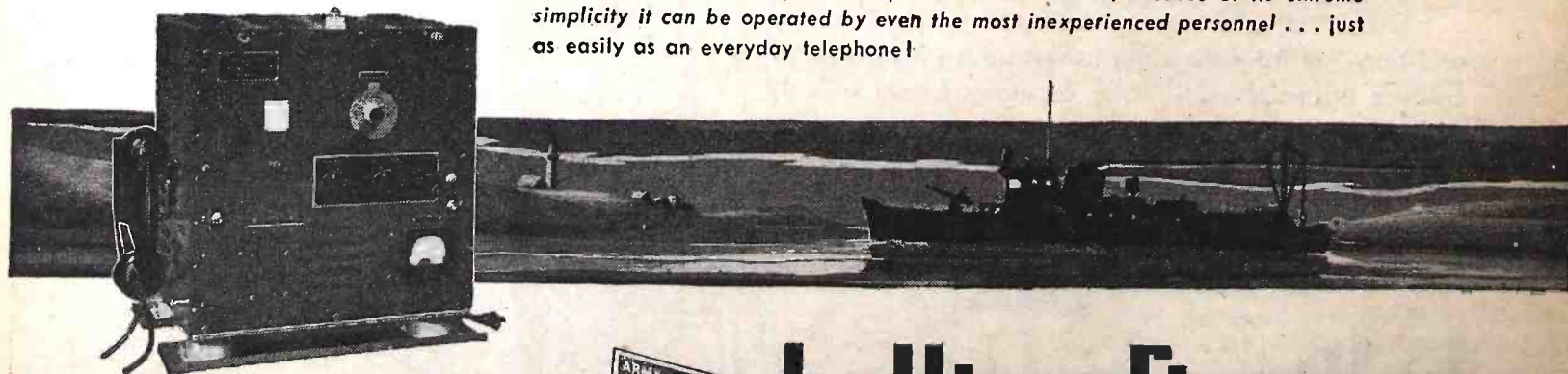

BUY MORE BONDS!



hallicrafters RADIO

THE HALLICRAFTERS CO., MANUFACTURERS OF RADIO AND ELECTRONIC EQUIPMENT, CHICAGO 16, U. S. A.

HERE IS YOUR SUCCESS CHANCE

BE A

RADIO-ELECTRONIC TECHNICIAN!

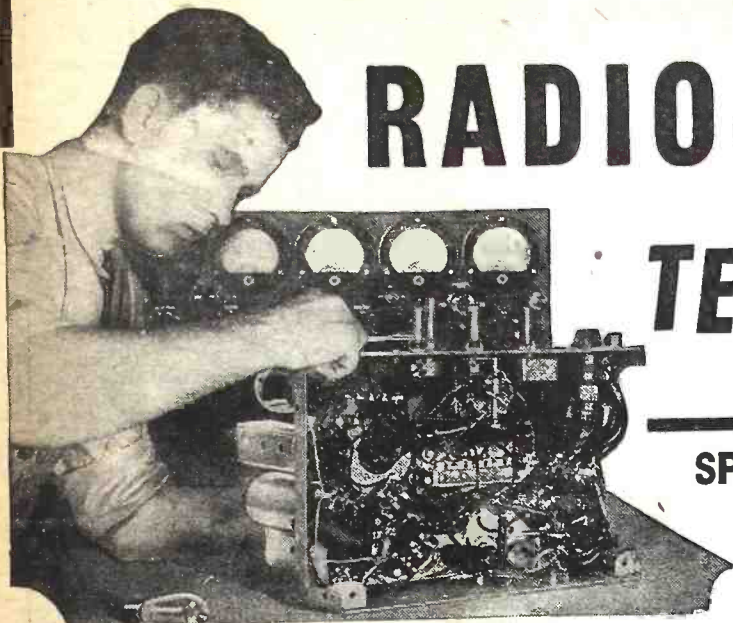

**SPRAYBERRY TRAINS YOU
QUICKLY FOR WAR
AND PEACETIME WORK**

**IF YOU REMAIN A
CIVILIAN OR ENTER
MILITARY SERVICE . . .
Radio Training Will
Enhance Your Future!
• READ THESE LETTERS •**

One Job Nets About \$26.00

"Since last week I fixed 7 radios, all good-paying jobs and right now I am working on an amplifier system. This job alone will net me about \$26.00. As long as my work keeps coming in this way, I have only one word to say and that is 'Thanks to my Sprayberry training' and I am not afraid to boast about it."—ADRIEN BENJAMIN, North Grosvenordale, Conn.

**Sprayberry Graduate Wins
Out in Army Test**

"Since I completed your elegant Course in Radio I have been drafted into the Army and put into the Signal Corps. I had to compete to get the job I now hold and as a result of my training with you, I made the best grade and got the job. The point I am driving at is if it hadn't been for your thorough course in Radio I would probably be peeling potatoes now. I recommend your training to all because it is written in language that the average layman can understand."—ARCH PLUMMER, JR., Fort Meade, Md.

**Student Makes \$15.00 to \$20.00
A Week in Spare Time**

"After starting your Course I began doing minor radio service jobs and I want to say that I have been flooded with work. So much so that I have had to neglect my lessons. I want to say your training has done a great deal for me. I am making \$15.00 to \$20.00 a week in spare time. Even so, I'm going to go back to my studies and finish the Course."—SANFORD J. CHICOINE, Whitley, Ontario, Canada.

**You Do Practice-Giving Experiments
with Real Equipment**

The offer I make you here is the opportunity of a lifetime. It's your big chance to get ready for a wonderful future in the swiftly expanding field of Radio-Electronics INCLUDING Radio, Television, Frequency Modulation, and Industrial Electronics. Be wise! NOW is the time to start. No previous experience is necessary. The Sprayberry course is short, intensive, and interesting. It starts right at the beginning of Radio. You can't get lost. It gets the various subjects across in such a clear, simple way that you understand and remember.

**You Get a Dual-
Purpose Radio Set**

I supply you with Radio Parts which you use to gain pre-experience in Repair work. These same Parts are used for testing and for Signal Tracing, etc. I make it easy for you to learn Radio Set Repair and Installation Work . . . by practical, proved, time tested methods. I teach you how to install and repair Electronic Equipment. Your success is my full responsibility.



**Prepares You for a Business of Your Own . . . or
Good Radio Jobs**

My training will give you the broad fundamental principles so necessary as a background no matter what branch of Radio you wish to specialize in. Soon you'll be qualified for a good paying job in one of the nation's Radio plants doing war work OR a business of your own. If you enter the Army, Navy, or Marines, my training will help you win higher rating and better pay. Let me prove what Sprayberry training can do for you.

JUST OFF THE PRESS!

**"How to Test and Repair Radio
Sets Without Meters"**

Developed in the Sprayberry laboratory, this instructive volume tells about an amazingly simple, yet efficient method for Radio troubleshooting and repair without use of regular equipment made scarce due to war. Send for this free book now while the supply lasts and along with it, I will send you another big free book describing my Radio - Electronic training. Mail coupon.

**YOURS FREE
THESE TWO
VALUABLE BOOKS!**

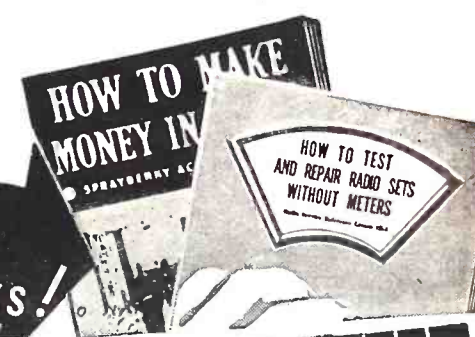

SPRAYBERRY ACADEMY OF RADIO
F. L. Sprayberry, Pres.
Box 500TC,
Pueblo, Colorado.
Please rush my FREE copies of "HOW TO TEST AND REPAIR RADIO SETS WITHOUT METERS" and "HOW TO MAKE MONEY IN RADIO."

Name Age

Address

City State

Tear off this coupon, mail in envelope or paste on penny postcard.



NOW! BECOME A MONEY-MAKING RADIO SPECIALIST

OUR ROVING PHOTOGRAPHER VISITS MT. CARMEL ...WHERE ELECTRONICS IS KING!

A thousand miles from New York—more than 200 from Chicago—is a little city of 7,000 that's very much in the news these days. For Mt. Carmel, Illinois, is the home of the Meissner Manufacturing Company. And Meissner's laboratories are humming with great electronics secrets, its shipping platforms busy with precious cargoes destined for the far corners of a fighting world. Meissner is *in* the news, because it's *making* news!



Pleasant Smile, Skilled Fingers: The whole industry's talking about Meissner's gilt-edged personnel. And here's one of the reasons why every Meissner product is a quality product.



Precision-EI Is The Word: So trained and alert are the workers, so slight the turnover, that the envious in the industry are already calling Meissner personnel... "Precision-EI" ... and the term fits like a glove!



This Is Mt. Carmel... and what a station for a city of its size! But wise heads say it's a hint of big things to come as Meissner daily rises in stature as one of the world's most progressive companies in one of the world's most progressive fields... *Electronics!*



This Is The Meissner Plant—(at least a portion of it)—where hundreds upon hundreds of workers continue the kind of production records that long ago won for them the famed Army-Navy "E" with star.



Here's the Perfect Manual For Your School Contacts!

Yes—168 pages of helpful, factual material—liberally illustrated with charts, radio formulae, schematic circuit diagrams, and pictorial wiring diagrams. Soundly based on Meissner's vast and unexcelled experience in this field. There's construction data on 22 kits for building radio receivers and adapter units, with operating instructions and servicing data on over a dozen complete assemblies, including F-M receivers, phonograph-recorders, and radio equipment. Ideal for beginner or advanced student. Price, only 50c postpaid anywhere in the U.S.A. (75c in Canada.) Send for your copy today.



MEISSNER

MANUFACTURING COMPANY • MT. CARMEL, ILL.

ADVANCED ELECTRONIC RESEARCH AND MANUFACTURE

RADIO-CRAFT for MARCH, 1944

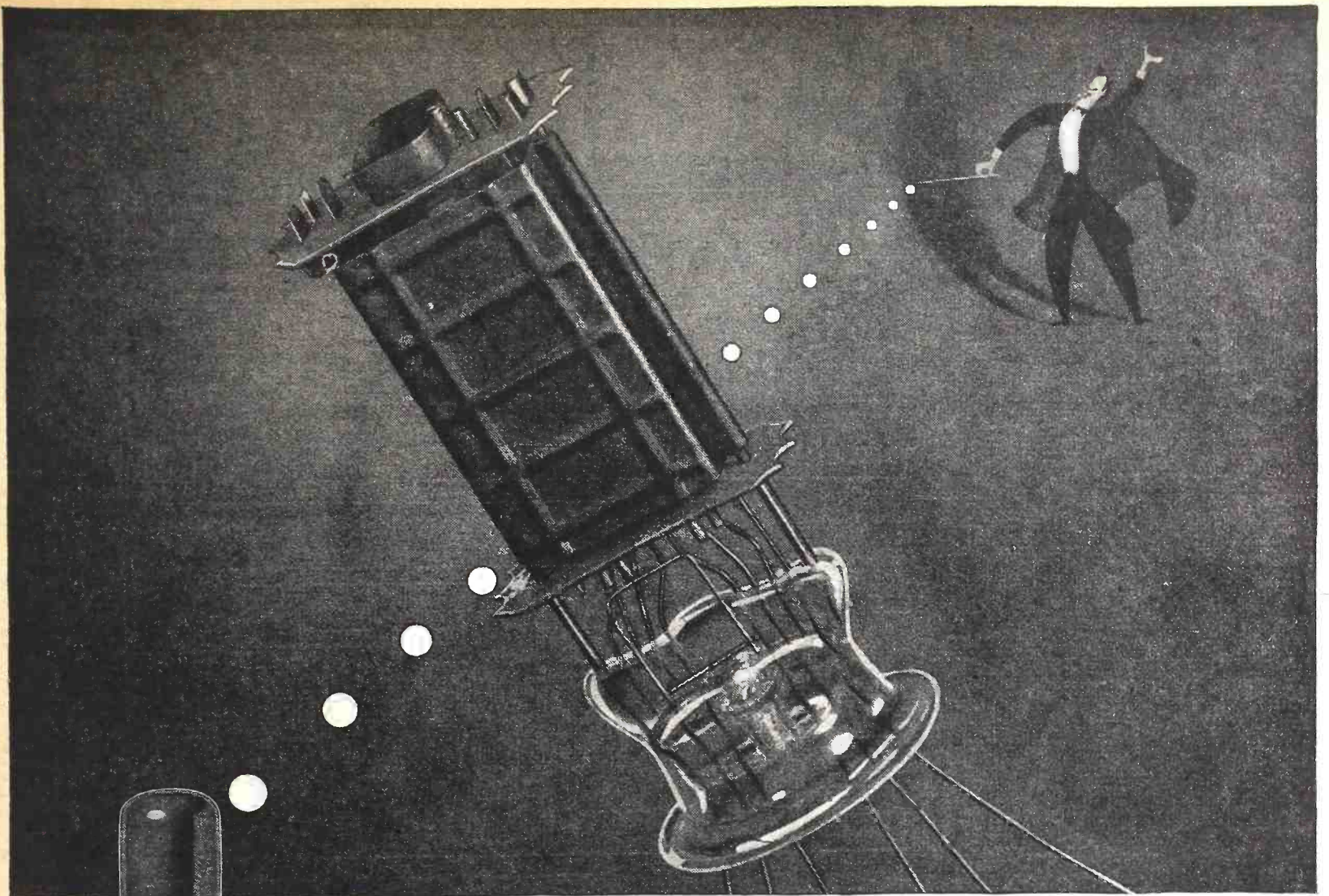

Metal Magic!



Long ago National Union engineers had to strike out for themselves in search of new metals, alloys and coatings. The extremely high temperatures employed in tube making—brazing, for example, at 2 to 5 times the heat customarily used—ruled out the use of metals common to most industries.

For this reason and for others peculiar to the needs of tube manufacture, there has come from the nation's electronic tube laboratories a whole new group of metals and combinations of metals. Here are special alloys for filaments, coils, grid wires, getters, electron guns and many

other uses. And as these metals have provided characteristics not previously available, they have literally pulled wonders out of the magic hat of electronics.

In metallurgy, as in other sciences related to tube making, National Union is helping to push back the frontiers of electronic knowledge. This research is helping, also, to provide for service engineers a broad, profitable post-war franchise. *Count on N. U.* to be ready with better tubes for every important service need.

NATIONAL UNION RADIO CORPORATION, NEWARK, N. J.
Factories: Newark and Maplewood, N. J., Lansdale and Robesonia, Pa.



NATIONAL UNION
RADIO AND ELECTRONIC TUBES

Transmitting, Cathode Ray, Receiving, Special Purpose Tubes • Condensers • Volume Controls • Photo Electric Cells • Panel Lamps • Flashlight Bulbs

SPRAGUE TRADING POST



A FREE Buy-Exchange-Sell Service for Radio Men

"MIGHTIEST
MIDGETS OF ALL"



SPRAGUE Atoms

Sprague Atoms meet practically every dry electrolytic capacitor replacement need. Play safe! Use them universally on every job. Ask for them by name!

FOR SALE—Readrite 0-5 amp. AC meter; Pioneer genemotor; 2 Dodge 12V generators (1 stripped); 1 D.B. mike transformer; many back issue magazines and older type radio tubes. Write for list. Harry Kay, Rt. 2, Box 255, Imlay City, Mich.

WANTED—Communication receiver such as Ecophone, Sky Buddy, or what have you? Cash. Rush information. A/S David L. Fayman, Class 43-C8, 318th CTD (air crew), U.S.A.C., Logan, Utah.

WANTED—A Morris coil winder in 1st class condition with all accessories. Cash. Lloyd L. Melton, Electric & Radio Shop, State Hospital, Norwalk, Calif.

WANTED—Record player with a 6- to 10-watt amplifier and speakers. John Bennett, Uncasville, Conn.

FOR SALE—Practically new: 2 AC amp. meters, 1-3 amps. and 1 to 10 amps.; 2 AC voltmeters, 0-150 AC volts and 1 to 15 AC volts; 1 DC voltmeter 0-150 DC volts. Sell all 5 for \$20 or separately @ \$5 ea. AC meters No. 831. DC No. 221 (3 1/2" faces). Brian Bailey, 1004 Ave. H., Brownwood, Texas.

WANTED—Will swap radio parts or cash for 8 to 16mm movie projector. Jim Larson, Shelby, Mont.

WANTED—Hallcraft's Sky Traveler, used or new. Sgt. Frank S. Zuzga, Btry. "D", 514th AAA Bn., Fort Bliss, Texas.

FOR SALE—Hartman converter, 6V DC to 110V AC with ant. & grd. plug, \$10. 2 fil. transformers, heavy-duty 6 to 8V; 2 ditto, 1 to 30 volts with switch; 1 tube tester trans. 1-30V taps. Choice \$2.50. 5 SW vernier dials, 100-1 ratio, new, 25c. Want test meters. W. F. Onder, Rt. 1, Box 389, Kimmswick, Mo.

WANTED—Signal generator in good condition. Cash. R. Davis, 7 Buffalo St., Attica, N. Y.

FOR SALE—Clough-Brengle graphoscope with a three inch tube (same as new model 127). \$80. Morris Radio Service, Box 243, Raceland, Ky.

FOR SALE—Pioneer dynamotor 6V input, 320V output at 135 mills. Used, but in splendid condition, \$25. One Turner 34X crystal microphone, \$27.50. Radio Service Co., P. O. Box 109, Fayetteville, N. C.

WANTED URGENTLY—Hallcraft's S-29 receiver (new or used) or similar portable communication receiver. Cash. Cpl. James W. Gish, 15373156, A.P.O. 30; A Btry., 197 F.A. Bn., Camp Atterbury, Ind.

FOR SALE—Weston milliammeter No. 280 0-750 DC; Readrite RF & IF oscillator with output meter; Readrite analyzer with 3 meters, DC meter is 1000 ohms per volt. Like new. C. M. Cryslar, 308 Berger Place, New Castle, Pa.

FOR SALE—12- to 18-watt recording and motion picture sound amplifier used only very few hours. Write for details. Also Shure crystal mike, almost new; G-I recording and play-back unit, no amplifier; 200 mil. 6.3V power trans. like new. L. E. Milholland, 248 East 40th St., Norfolk, Va.

FOR SALE OR TRADE—SW5 National receiver complete with coils and AC power supply. 1st Lt. J. H. Ziglinski, Co. "A", 303 Sig. Opn. Bn., Fort Ord, Calif.

NEEDED URGENTLY—Supreme No. 561 oscillator for use in repairing air patrol eqpt. Cash. Carl's Radio Shop, 5103 Fleet Ave., Cleveland, Ohio.

FOR SALE OR SWAP—Janette Rotary converter CA20, 12V DC to 110V 60-cycle AC, like new, \$25. Want new or used oscillator coil for 59T5 Motorola; 35Z5GT tubes; electrolytics; Supreme diagrams Vol. 2-3-4-5; also alarm clocks in any condition. Don's Fix-It Shop, 1122 Elm St., Decatur, Ind.

SWAP OR SELL—One Dumont 164 oscilloscope in perfect condition. Reiss Public Address Systems, 7629 E. Jefferson, Detroit 14, Mich.

FOR SALE OR TRADE—4-3 1/2' aluminum Lifetime trumpets; 2 heavy duty PM driver units; 2 "Y" connector; 1 Webster Chicago 6V 20-watt amplifier with built-in turntable; 1 hand mike; 2-12" aluminum projectors with crows feet; 2-10" aluminum projectors; 2-2500 ohm 10" Operadio speakers; 1 crystal mike stand; 1-extra 33 1/3 and 78 RCA turntable; 1-12" 700 ohm speaker; 1-813 tube, used 150 hrs.; Controls; 8 mfd. condensers; and other radio parts. Trumpets and PM units are new. Want Springfield 30-06 rifle or best cash offer. G. Archer, 607 E. Auglaize, Wapakoneta, Ohio.

FOR SALE—Superior model No. 1200 V-O-M in good condition, \$20. Panel mounting. F. E. Fralick, Box 222, Salem, Oregon.

NEW TUBES FOR SALE—6Q7GT; 6SQ7GT; 2-6SK7GT; 6J7GT; 6SQ7; 2-6SK7. 40% off list. Also, new Vibroplex bug, \$12.50; code practice oscillator built in metal box with PM speaker and 117L7GT, \$12.50. Also misc. parts. Geo. Maxey, 174 Taurus Ave., Oakland 11, Calif.

WANTED—Cash for copy of revised instruction booklet on Simpson No. 220 Rotoranger modernized to check bantam and 117V tubes. P. P. Miglin, 846 West Drive, Woodruff Pl., Indianapolis 1, Ind.

WILL TRADE—Seven vols. set Civil Engineering books, unused, cost \$30. Want V-O-M or V-O in good cond. Howard F. Buck, 82-05 81st St., Jackson Heights, N. Y.

WANTED—Tube tester in good condition, any make, with phono motor. Cash. Martin Redlich, Pullman, Wash.

FOR SALE—New (in factory carton) Meissner factory-wired analyst with tubes, No. 9-1025, \$100 cash. Stranded copper 7/22 aerial wire, 1c ft. Also some new tubes. Write for list. E. A. O'Connell's Radio Shop, Westfield, N. Y.

Important Notice!

We discourage offers to buy or sell anything beyond the O.P.A. ceiling prices, and will not knowingly accept such ads for the Sprague Trading Post. Buyers and sellers please cooperate by reporting infringements.

WANTED—Three communications receivers, Sky Buddy or equal, for cadet training at Army Air Base. Cash. Capt. R. I. Ellis, Post Communications Office, GAAF, Greenwood, Miss.

WANTED—Supreme No. 560 vedolyzer and No. 561 signal generator. All letters answered. Earl G. Meyer, 3101 Ready Rd., Flat Rock, Mich.

FOR SALE OR TRADE—2 Hoyt ammeters. 0-8 and 0-10 DC amps. What have you? J. L. Roberts, Howard, Kans.

FOR SALE OR TRADE—One 211-C xmitting tube, perfect cond. Also about 100' mike cable. Need 4, 5, or 6 tube power transformers or what

have you. George Miller, 520 West 124 St., New York 27, N. Y.

WANTED—Code practice oscillator for 110V AC or DC. R. E. Hartman, Dakota, Ill.

WILL SWAP—7B3, 7B7, 6P5GT, 80, 46, 1N5GT, 5Y4, 6SK7, 6SA7, 6SQ7, 6L6G tubes for 6A8, 1A7GT, 1H5GT, 5Y3GT, or any 12, 35, or 50 volt types. 10 to 80 of above types in sealed cartons available. Domingue Radio, Houma, La.

WANTED—Pioneer power plant 350 watts AC, 200 watts DC. New or used. Pvt. Louis De Marco Jr., & ASN 3119431, 56th T.G. Sqd. 561, Class 19, Keesler Field, Miss.

WANTED—Capehart Deluxe turn-over record changer, also Capehart radio-phonograph. Spot cash for new or used models. Clark Music Co., 416 S. Salina St., Syracuse, N. Y.

WANTED—Supreme tube tester. Describe fully. Edward Vjneski, Mount St., Box 176, Tiltonsville, Ohio.

WANTED—Complete set Rider manuals. R. B. Donovan, Lovington, Ill.

FOR SALE OR TRADE—Amperite velocity mike; American dynamic mike; compl. RCA 20-watt sound system with Aerodynamic mike; spray gun; misc. items; books; first 5 Gernsback service manuals, etc. Write for list. Want test eqpt., tubes, etc., to set up shop. H. W. Schendel, 518 W. Main St., Sparta, Wisc.

FOR SALE—One A.T.R. 110 V. DC to AC inverter, 150 watts, new vibrator. Used approx. 30-45 days—very good cond. John S. Elvan, 333 W. 26th St., New York, N. Y.

WANTED—Model VI McMurdo Silver Masterpiece radio. Will sell a 4 amp. charger, new rectifier. Paul Capito, 637 W. 21 St., Erie, Pa.

WANTED—Cash for good sig. generator, any make or model, preferably AC. Ray Stewart, 807 Howard St., Bridgeport, Ohio.

URGENTLY NEEDED—Tube tester to complete eqpt. in new company. John M. McGarry, Dalton, Mass.

WANTED—Small used radios, chassis, testers, meters, up-to-date tube testers, eqpt. and tubes. Will pay cash. Radio Electronics Service Co., 301 Front St., Hempstead, N. Y.

YOUR OWN AD RUN FREE!

Send us your Sprague Trading Post advertisement today. We'll be glad to run it free as part of our special wartime advertising service to the radio profession. WRITE CAREFULLY OR PRINT. Hold it to 50 words or less. "Equipment for Sale" and "Wanted" advertisements of an emergency nature will receive first attention. Different Trading Post ads appear regularly in RADIO RETAILING-TODAY, RADIO SERVICE-DEALER, SERVICE, RADIO NEWS and RADIO-CRAFT. Please do not specify any particular magazine for your ad. We'll run it in the first available issue that is going to press. Sprague, of course, reserves the right to reject ads which, in our opinion, do not fit in with the spirit of this service.

DEPT. RC-43 SPRAGUE PRODUCTS CO., North Adams, Mass.

SPRAGUE CONDENSERS KOOLOHM RESISTORS

Obviously, Sprague cannot assume any responsibility, or guarantee goods, services, etc., which might be exchanged through the above advertisements

THE BIG NEWS

. . . . An astonishing and breath-taking discovery—Pure Magnetic Current—has been made. Where will it take Radio and Electronics?

HUGO GERNSBACK

IN the midst of the greatest war in history, the biggest scientific news of the day is the announcement made last month of the discovery of *Pure Magnetic Currents*. Nothing anywhere nearly as exciting has happened since Heinrich Hertz in 1887 demonstrated electro-magnetic waves in free space—the forerunner of wireless and radio today. According to *The New York Times*, the new discovery may be ranked with the principle of the dynamo by Michael Faraday 113 years ago.

The epochmaking discovery is the result of researches made over a span of several years by Professor Felix Ehrenhaft, the well-known Viennese physicist, now a refugee in this country.

While the inter-relation between electricity and magnetism has been recognized since the days of Oersted, magnetism was always considered as static. We could conduct electricity for miles and miles over wires, and even through space by means of radio waves, but when it came to magnetism, we could not make it flow, as electricity flows. Indeed, the most powerful magnet in the world could not do much useful work over a distance of one foot of free space. We knew, of course, that the electrical current would set up a magnetic field around (outside) the wire over all of its length, but here again the magnetic field is stationary and it does not flow along the wire from one point to another. Now Professor Ehrenhaft has demonstrated to the satisfaction of many scientists that there also exists a free pure magnetic current similar to the electric current. That is the big news of 1944.

For over 700 years most of our magnetic thinking traveled along a single well-worn groove. It was Peregrius who at that period stated, "Magnetism has direction, but no motion. Only electricity can move." In other words, you can take an ordinary compass needle, oil it a bit and place it on the surface of water. The magnetic needle will turn till it comes into a north-south direction. Then its motion stops. The needle will not move or travel to the north or to the south. Scientists agreed with this view, but nothing much further was done about magnetism until Ehrenhaft made his noteworthy experiments, upsetting our entire conception of electro-magnetism and all that goes with it.

Ehrenhaft now says, "Electricity and magnetism represent an indivisible pair. It can be said that the unification of the field theory has been indicated here in an experimental way, and electricity and magnetism may have to be expressed in the future by one symbol only."

He discovered that electricity and magnetism are the selfsame force in every respect and not two different forces, which text books have always taught us.

Now we find, as has been discovered by a bright young child, if it takes off its left woolen mitten and turns it inside out, that it will fit the right hand, too—an astonishing discovery, no doubt, to the child.

But Professor Ehrenhaft went much further. He cites four new principles, to wit:

1. Sensitive experiments show that in a geo-magnetic field, small particles of ferro-magnetic substances move as simple magnetic poles in opposite directions. If sufficiently small, they become magnetic ions. These ions can be generated by applying friction, by chemical means, or by light, just as electric ions can be created.

2. If two ends of a piece of pure soft iron are immersed in acidulated water, hydrogen is evolved. Now magnetize the same piece of iron north and south and a mixture of hydrogen and oxygen is evolved from the poles.

3. Circulation of positively or negatively charged gas bubbles and solid bodies in opposite directions in the same plane around the constant magnetic field—reversing their direction of circulation with the reversal of the magnetic field—in the same manner as a single north or south pole would circulate around the electric current.

4. In a solution of copper sulphate, colloidal particles of copper move upwards or downwards in a spiral path, in a constant magnetic field, ending their motion on the magnet's pole faces. Microscopic small particles of chromium, manganese, nickel or iron move upwards or downwards in spirals or parts of spirals in gas of atmospheric pressure around the constant vertical magnetic field. This proves that the particles carry simultaneous electric and magnetic charges.

More recently Ehrenhaft succeeded in decomposing water with a permanent magnet, just as in the classic experiment of the year 1800, scientists decomposed water with the electric current. (Continued on page 378)

Radio Thirty-Five Years Ago

In Gernsback Publications

FROM the March, 1909, issue of MODERN ELECTRICS:

Talking Dynamos and Transformers, by the *Berlin Correspondent*.

Increased Sensitivity of Electrolytic Detectors.

Wireless To and From Trains.

A Microphone Detector, by *Alfred P. Morgan*.

Wireless Association of America—Letter by *Dr. Lee DeForest* exhorting all the then radio amateurs regarding wholesale

HUGO GERNSBACK

Founder

Modern Electrics	1908
Electrical Experimenter	1913
Radio News	1919
Science & Invention	1920
Radio-Craft	1929
Short-Wave Craft	1930
Wireless Association of America	1908

interference with governmental wireless stations and predicting that Congress will be asked to pass legislation requiring licenses for all transmitting stations.

Radio-Goniometer of the Bellini-Tosi System, by *A. C. Marlow*.

Wireless Telegraphy by *Melville Eastham and O. Kerro Luscomb*.

An interesting contribution by *Henry Heim, Jr.*, regarding communication between amateurs using an arc lamp as a detector.

Editorial, by *H. Gernsback* commenting on *Dr. DeForest's* letter and suggesting the use of only short aerials for transmission in order to cut down interference.

Radio-Electronics

Items Interesting

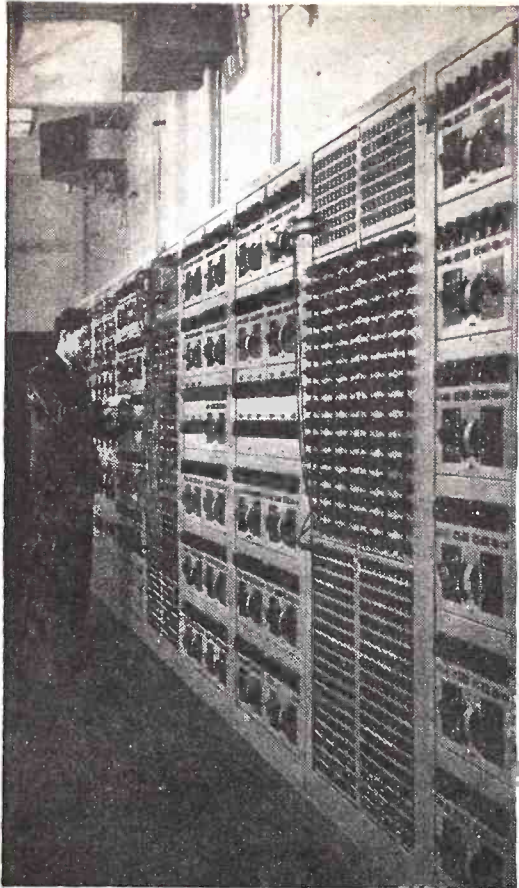

Just a section of the big calculating board.

CUT-AND-TRY has been carried to its ultimate in the new and improved A.C. calculating board recently installed by Westinghouse at East Pittsburgh, according to a report from that company last month. Every experimenter knows how often, when constructing a new piece of apparatus, laborious calculations can be saved by setting up a trial job, taking voltage and current measurements, then making the necessary adjustments.

Westinghouse engineers, faced with highly complicated power circuits, do not attempt to go through the time-consuming process of mathematical calculation to learn the conditions in these circuits. Instead, with the new board, they can set up a "model" of the circuits, with the vol-

tages, currents and phase angles of a number of voltage sources absolutely measurable, and the possibility of creating artificial distribution networks of known resistance, inductance and capacity.

The new calculating board thus makes it possible to solve complicated power-system problems much more readily than on previous calculators. Simulating a total of 18 power sources, it can be electrically divided in any desired manner for the simultaneous solution of two small problems or can be operated as a single unit for a large-system study. Dial-type switching for resistor-reactor circuits facilitates setting and checking of network impedances. Generator units have independent voltage and phase-angle controls that simplify adjustments. Instruments have scales that are read directly in power-system quantities instead of requiring the application of multipliers, necessitating interpolation.

TRAGIC CRASHES which leave the dead strewn on mountainsides or scattered in the path of a plummeting plane will soon be a thing of the past, Dr. Lee DeForest told reporters in Chicago last month. Electronics, in the form of the terrain altimeter, will keep the pilot informed of the distance between him and the ground directly below his plane. Present devices show his altitude above sea level, and are no protection against mountain ranges or cliffs that may rise above his line of flight. Thus, while his altimeter may show him a comfortable 3,000 feet above ground, he may be flying headlong into a mountain which rises 4,000 feet above sea level.

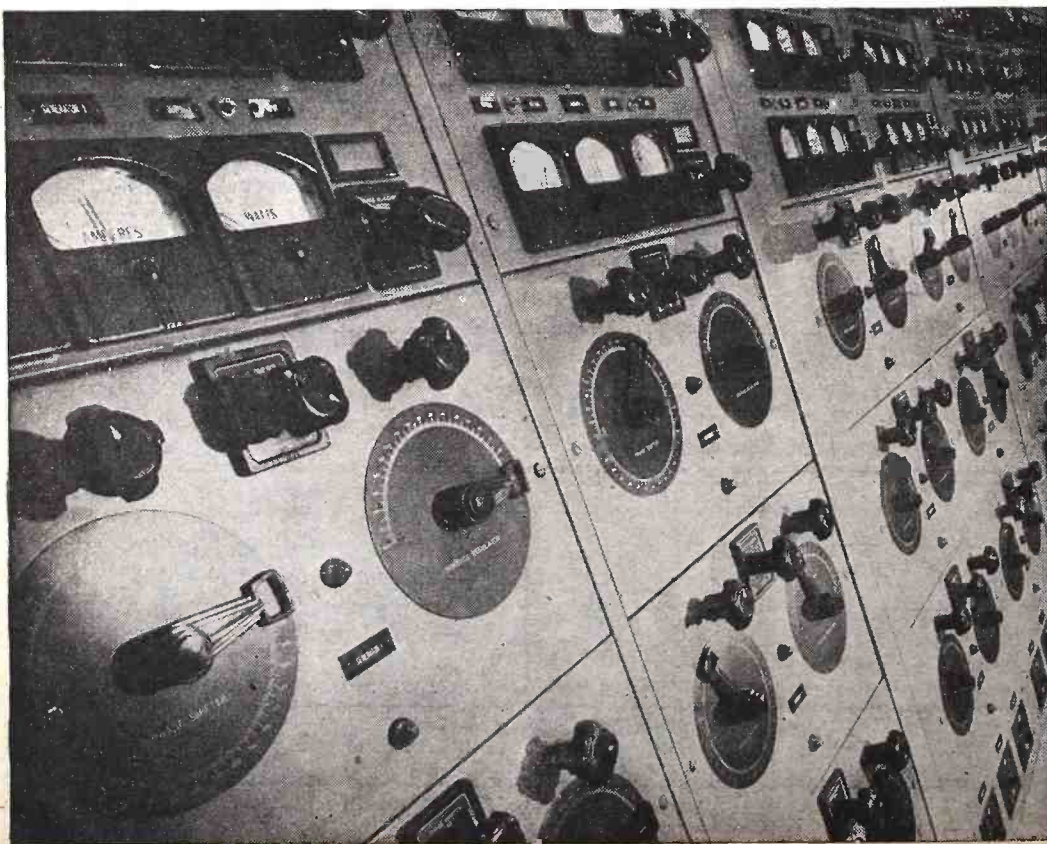

Close-up view of some of the controls on the board which calculates "impossible" problems.

Seventy years old, sturdy Dr. DeForest is as active now as when he unfolded to the world the scientific wonders of radio and electronics with his third-element vacuum tube.

He predicts that television sets will flood the markets within a year after the war.

Postwar uses of radar will be of great benefit to transportation and will save millions of lives, DeForest declared. Collisions of ships at sea and planes in the air would be virtually eliminated with radar detection devices, he said.

"A pilot, for example, when radar is completely developed, would have a silhouette of the terrain beneath him and before him, and the dangers of blind flying and landings in fog and at night would be lessened," the inventor said.

The smaller radar units, those weighing 15 pounds, can be foreseen for use in civilian planes, DeForest said. He also predicted the use of radar units to assist in automobile travel.

"Radar would signal the approach of another car and the turns in the road," he explained.

DeForest stopped briefly in Chicago on his way home from Washington. He had just completed talks with government officials on his terrain altimeter, which is his latest invention.

IMAGINATION is the only limit to the use of the vacuum tube, declared Dr. Walter R. G. Baker, head of General Electric's Electronics Department. "The magic electronic tube that levels elevators in skyscrapers, counts traffic, controls the flow of power in electric furnaces—the tube that even now is working miracles for American industry in great sprawling factories rushing arms production, in railroad, knitting mill, fruit-packing house and printing plant—will double and triple its industrial deeds in the future. The money the electronic tube will save, the burdens it will lift, the inventions it will stimulate, no man can foresee. The tiny electron, partner of business in a thousand ways, is mobilized to gigantic tasks set by industry's power machinery."

Dr. Baker believed there was little question that the advantages offered by frequency modulation will render obsolete the 60,000,000 broadcast receivers now in American homes.

Continuing with the prediction that television will be a large factor in post-war business, but that its full development was not to be expected as soon as many had been led to believe, he pointed out that broadcasting both by sight and sound represents a mass entertainment market, and possibly may be the greatest use of electronics in the home.

"Electronics is not going to make obsolete your home, your household equipment, and your way of living," he said, "but it is going to make that home a finer place to live in and is going to make you a happier person."

Monthly Review

to the Technician

ACTION against interference by diathermy and other medical devices was asked by the convention of FMBI (Frequency Modulation Broadcasters, Inc.), held in New York last month. Congress was asked to so amend the Communications Act that these devices would be subject to the same prohibitions against interfering with other services that now apply to radio transmitters operating for communications or entertainment purposes.

It was pointed out that although diathermy apparatus transmits very effectively, there is at the present time no legal way of preventing a diathermy outfit from jamming essential services, or preventing the reception of programs intended for entertainment. The Federal Government has recognized the radio-transmitter nature of these machines by its action in requiring that all diathermy apparatus be registered as a war measure for national security.

TWO CHANGES beginning February 1, 1944, were announced in the standard frequency broadcast service of the National Bureau of Standards.

One is the addition of a new radio frequency, 2500 kilocycles per second, at night. The other is omission of the pulse on the 59th second of every minute. The entire service is described here. It comprises the broadcasting of standard frequencies and standard time intervals from the Bureau's radio station WWV near Washington, D.C. The service is continuous at all times day and night, from 10-kilowatt radio transmitters. The services include: (1) standard radio frequencies, (2) standard time intervals accurately synchronized with basic time signals, (3) standard audio frequencies, (4) standard musical pitch, 440 cycles per second, corresponding to A above middle C.

IDENTIFICATION of atoms in ultramicroscopic particles of matter no larger than 1/100,000 of an inch in diameter can be accomplished quickly and accurately for the first time by a revolutionary new tool of science—the electron micro-analyzer—developed experimentally by Dr. James Hillier of RCA Laboratories.

The new instrument, according to information released by RCA last month, promises to go far toward overcoming one of the great barriers to the accumulation of knowledge about the infinitesimally small particles of matter of which all things are made. Information vital to the solution of many practical problems in the physical, chemical, and biological sciences can be obtained.

"The vital question: 'Of what particular atoms, or chemical elements, are these different particles of matter constructed?' can be answered by the electron micro-analyzer," Dr. Hillier explained. "For the first time, the scientist, using this new instrument, will be able to determine the chemical constituents of a particle weighing only 10^{-15} , or 1/1,000,000,000,000,000, grams.

And, more important still, he will be able to see the relationship of the particles to the rest of the specimen under examination."

In operation, the micro-analyzer uses an "electron needle" of extraordinarily fine focus to knock other electrons loose from their parent atoms in the specimen, measures the amount of energy lost by the incident electrons in the process, and thereby reveals the specimen's chemical content.

"With the new instrument, the image of the specimen may be observed by means of an electron microscope, which is incorporated as a part of the micro-analyzer, and a selection made of the exact portion to be analyzed," Dr. Hillier said. "Then by manipulation of a few controls, a photographic exposure is made of what we call the 'electron velocity distribution.'

"This results in a series of small marks on the photographic plate, each one of which indicates by its position the presence of a chemical element in the specimen. Thus, with one exposure, information is obtained that would have required weeks or months to obtain by present indirect methods, which too often result in failure."

In explaining how the instrument works, Dr. Hillier pointed out that in the table of chemical elements each atom, or element, is differentiated from another by the number of electrons surrounding the atom's nucleus. The electrons are arranged around the nucleus in "shells," he added, and it is known how much energy, or voltage, is required to knock holes in the shells of different atoms.

"In the micro-analyzer," he continued, "the electrons of the 'needle' that strike the selected area of the specimen are all moving with the same velocity, say 50,000 volts. After they have passed through the specimen area, some of the electrons—the ones that struck atoms traveling with less velocity, or energy.

"The next thing of importance in micro-analysis is the fact that the energy loss suffered by the speeding electron is different for each chemical element. What's more, the differences are large enough to be easily distinguished by a method of measuring electron velocities. If, for instance, one of the energy losses shown is 298 volts, we know that a carbon atom has been struck; if it is 400 volts, the element is identified as nitrogen, and so on."

Dr. James Hillier and Vladimir Zworykin study the action of the new micro-analyzer. Latest addition to the increasing number of electronic aids to chemistry, the instrument can identify particles of microscopic size.

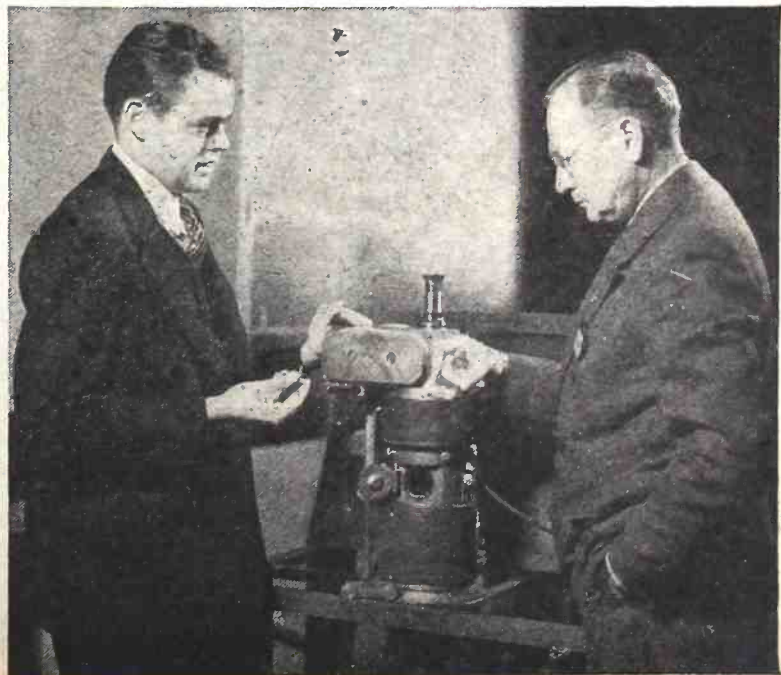

ELECTRON Microscopy has brought to light a virus-like organism never before found in the human blood-stream, it was reported last month at the first meeting of the Electron Microscopy Society of America.

Dr. Gregory Schwartzman, who made the discovery, reports that the virus belonged to the group known as "pleuropneumonia-like microorganisms." They have never been associated with any human disease, though considered responsible for certain diseases of animals. They are then found in the victim's brain.

The discovery that these organisms, which cause fatal diseases in animals, are also to be found in the human blood-stream has caused speculation as to whether they may not play a part in the evolution of human diseases whose causes have until now been a mystery.

Dr. Schwartzman also showed on the screen the first microphotographs ever made of the virus which causes that type of meningitis known as "lymphatic choriomeningitis." Other forms of meningitis are caused by bacteria.

FMBI, the Frequency Modulation Broadcasters, Inc., met in annual convention in New York January 27 and 28. This important gathering attracted

more than 600 delegates and visitors. Membership in FMBI increased from 72 at the beginning of the meeting to 108 before it had ended, and now includes practically all the important figures in the industry.

Previous plans to issue an FM booklet for the public were confirmed by the meeting. Other matters considered were standards of minimum performance in FM receivers, use of a common tower by several FM licensees and relay or rebroadcast stations.

A suggestion that at some future date a common carrier might be licensed as a telephone and telegraph company to operate FM (or television) relay stations was made by F. K. Jett of the FCC. There was considerable discussion as to the advantages of relay as against rebroadcast stations in given positions. Wire vs. wireless transmission came in for its share of discussion as well. It was pointed out by Major Armstrong that many points at which it was desirable to erect FM stations or relays were not served by wire lines. For example, there was little wire in the mountains of New England, and wires in the mountainous parts broke every winter.

Magnetic Current— Discovery of the Age?

By FRED SHUNAMAN

Electrical science may well be on the verge of a new era; an age in which magnetism will duplicate or exceed the advances of current electricity. The action of magnetic particles in a strong field, movement of electrically-charged bubbles of gas spirally around a magnetic field set up in a liquid, and above all, the decomposition of water by magnetism, prove that some new thing has been discovered. How important such discoveries are, and what their effects may be, only the future can tell.

THE greatest advance in science since Oersted discovered that electricity and magnetism are interrelated, may well have been heralded by Dr. Felix Ehrenhaft, when he announced at a recent meeting of the *American Physical Society* that he had proved experimentally the existence of magnetic current.

Magnetism has always been the mysterious twin sister of electricity. It is known that an electric current is invariably accompanied by a magnetic field, and that electricity can be produced with the help of magnetism—as in the ordinary dynamo. Yet practically nothing is known of the nature of magnetism itself.

Our present concepts on magnetism, as Dr. Ehrenhaft pointed out to the Society, are based on experiments which probably originated with the ancient Chinese, and were formulated for the modern world by the philosopher Peregrinus in 1269. Peregrinus found that a magnet floating on water directs itself in a North-South direction, but does not move, once it has assumed its North-South position. Fig. 1. From this arose the theory that magnetism has direction, but no motion.

THE EHRENHAFT CONDENSER

Ehrenhaft, like Peregrinus, makes his experiments with magnets, but uses sub-microscopic particles of iron, nickel, antimony, manganese or chromium, which, in the form of powder, are inserted between the plates of a "magnetic condenser." (See Fig. 2.) This condenser is a gap between the ends of two iron rods 8 millimeters in diameter. The gap is 2 millimeters wide. Spools of wire are placed around the rods, permitting them to be strongly magnetized in either direction. Thus the field in the magnetic gap can be changed at will. The poles can also be connected to a source of D.C., and a voltage applied in the manner of an ordinary electric condenser. Electrostatic or magnetic fields, or both together, can thereby be set up across the gap.

When a minute amount of the finely powdered metals mentioned above are placed in the exact center of the lower electrode and the magnetic field applied, some of these particles move toward the upper plate, while others remain at rest. If the small metal dust particles are suspended in the air between the two faces of the condenser, application of a magnetic field will

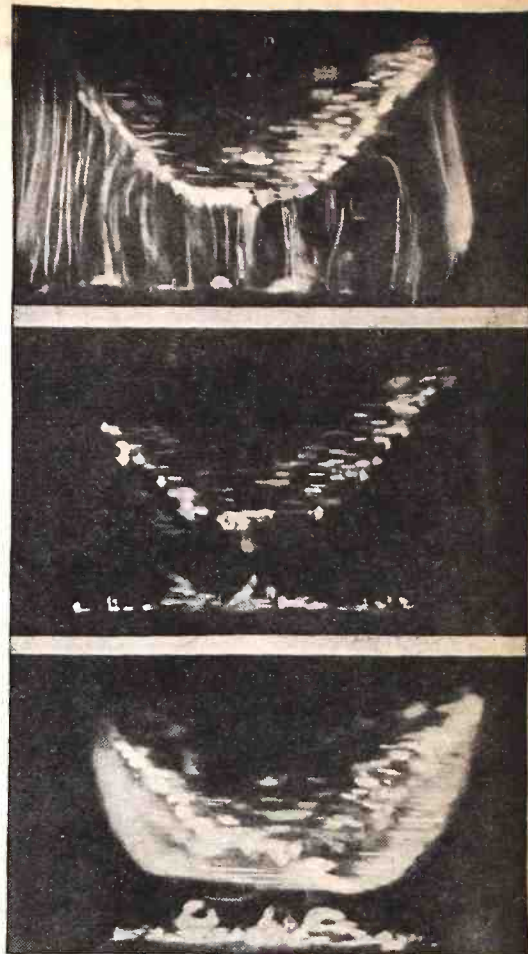

World-Wide Photos

Electrically-charged gas bubbles in a liquid between the poles of a magnet, move in a way similar to magnetic "lines of force."

cause some of them to move toward the North face, others toward the South face.

The obvious conclusion is that these particles must be magnetically charged, some with North and some with South magnetism. To persons who have been brought up in the orthodox theory, this is hard to believe. We have been taught that if an ordinary bar magnet is broken, each of the broken pieces will be a perfect magnet, with its own North and South pole. (Fig. 3.) This is known as Maxwell's experiment, and from it he concluded that if the magnet were still further broken, a whole series of smaller and smaller magnets would be formed, and that each of these would have its North and South pole, even if the whole magnet consisted of only one molecule of iron.

Dr. Ehrenhaft believes that his experimental work proves that such is not the case—that small particles may have unit polarity—may be magnetically charged either North or South. If, in the condenser experiment, each of the microscopic bits of magnetic dust had been a true magnet, complete with North and South poles, they should have aligned themselves with the magnetic field, but certainly should not have moved away from the pole on which they were resting. It is hard to explain that by any other theory than that of the unipolar magnetic particle, a pure North pole or one with South polarity only.

EFFECTS IN LIQUIDS

Another striking example of the magnetic current is the movement, under the influence of a magnetic field, of small particles of such metal as nickel in liquids. The Ehrenhaft condenser, submerged in liquid, has the same effect on these small particles that it has in air. Furthermore, on reaching one or the other of the poles, the magnetic particles are deposited in a

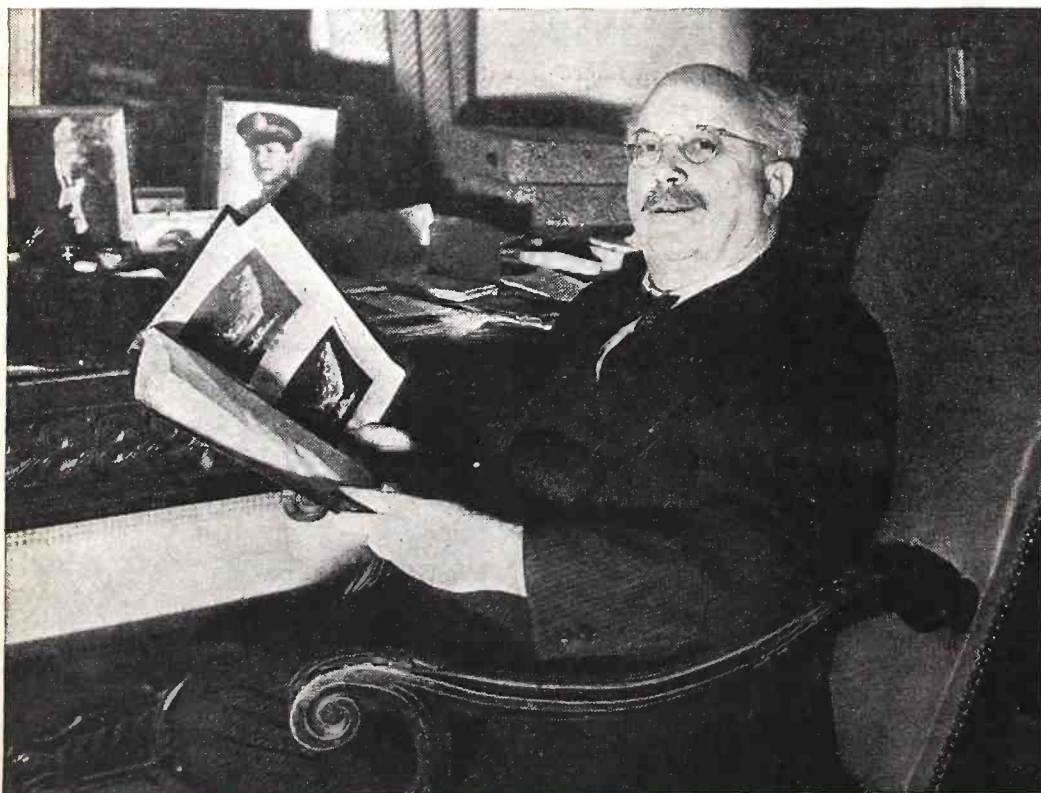

Dr. Felix Ehrenhaft, looking over some photos of recent experiments with magnetic current.

manner similar to that of electroplating. To avoid possible electric effects, the poles of the magnet were electrically short-circuited during this experiment. The result might be called "magnetopating," rather than electroplating.

If small particles are subjected to a strong electric charge while moving in the magnetic field, their course becomes a spiral. They circulate around the magnetic

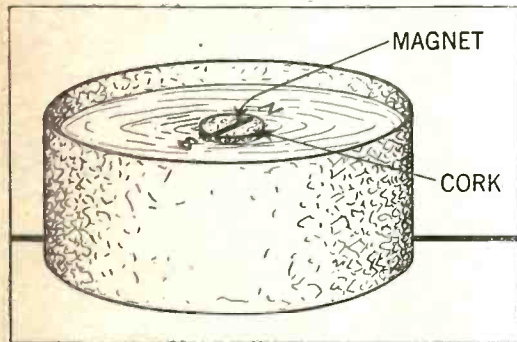

Fig. 1—This experiment convinced Peregrinus that magnetism had no tendency to flow, and fixed our ideas on the subject for 800 years.

field, much as magnetic "lines of force" are supposed to revolve around a conductor carrying electric current. See Fig. 4. Says Ehrenhaft, "In the same way the constant electric current is surrounded by magnetic force lines closed in circles, the constant magnetic current is surrounded by electric force lines closed in circles."

"MAGNETOLYSIS" OF WATER

A further experiment produces effects not previously discovered in the whole history of magnetism. The ends of a horse-shoe shaped electromagnet of plain Swedish iron were inserted into acidulated water. Chemical action released bubbles of hydrogen. The iron was then magnetized, and instead of pure hydrogen, the gasses released contained from 2 to 12% of oxygen. Fig. 5.

The water is actually decomposed by the magnet, as it can be decomposed by an electric current. While oxygen is released from both ends of the magnet, the larger amount comes from the North pole.

The same experiment, repeated with a permanent magnet, resulted in a weakening of the magnet by about 15% over a 24-hour period. This is very significant. If decomposing water reduces the strength of a magnet, it is only reasonable to suppose that the magnetic must be the cause of such decomposition.

A further point adduced in favor of the

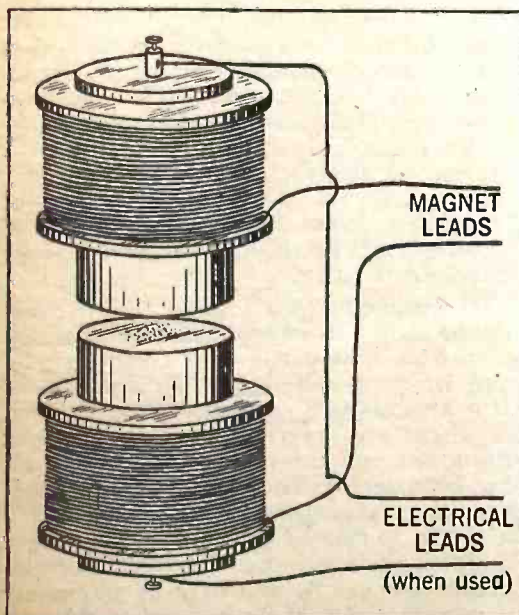

Fig. 2—The Ehrenhaft condenser. Magnetic or electric fields may exist between its faces.

new theory of magnetism is that it is possible to magnetize sub-microscopic particles with light or friction. Every experimenter knows how simple it is to produce a uni-polar electric charge on such a body as a piece of glass, paper or hard rubber. Particles placed between the plates of the Ehrenhaft condenser, if irradiated with light, begin to move toward one pole or the other.

IS THE PROBLEM CRACKED?

If the experiments just described have been correctly observed and interpreted, magnetism is shown to have many of the attributes formerly supposed to belong exclusively to electricity. Small particles may be "charged" to a single polarity, North or South. They may be thus charged by some outside influence such as light. Unit

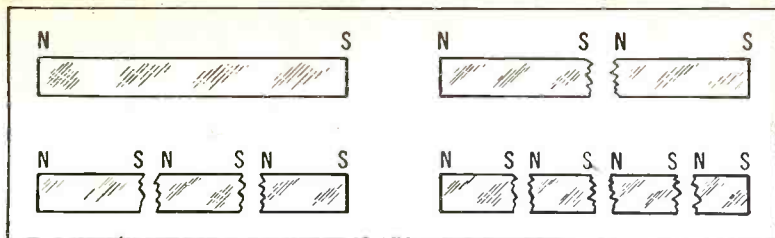

Fig. 3—Maxwell's experiment. If an ordinary magnet is broken in two, each half is a magnet. This caused the belief that unipolar magnets cannot exist.

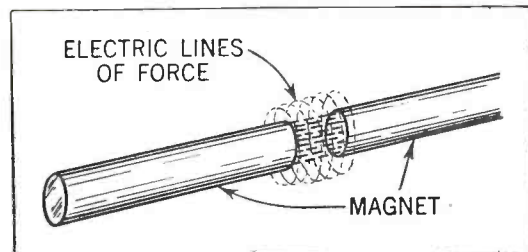

Fig. 4—Small electrically charged particles revolve around a magnetic field as do "lines of force" around a wire carrying electricity.

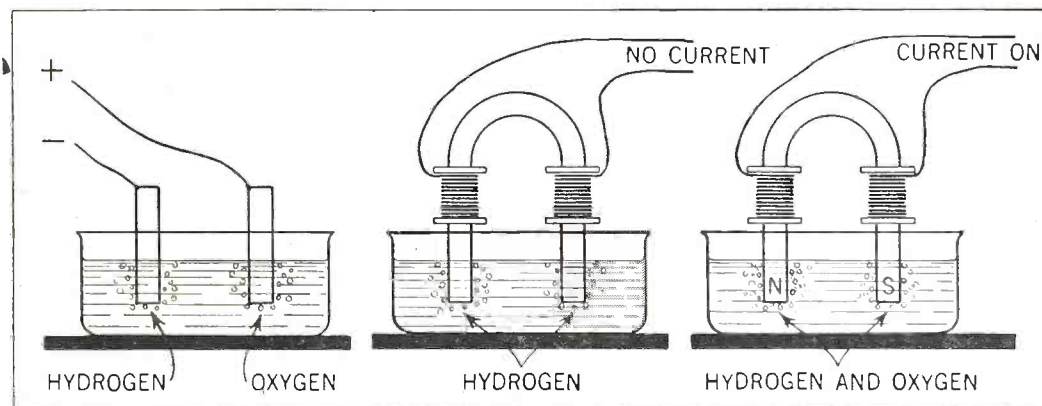

Fig. 5—Left, ordinary electrolysis of water. Center, bubbles of hydrogen rising from both ends of the iron rod. When magnetized, right, both oxygen and hydrogen rise from the poles.

poles placed in a magnetic field tend to move toward the pole of opposite magnetic polarity, and electrostatic charges revolve in closed circles around the "magnetic current," as do magnetic "lines of force" (charges?) around an electric current.

Our preservation of an almost complete ignorance of magnetism through all the startling advances in current electricity and electronics is one of the great marvels of

modern science. It would not be surprising if some one should at last crack this problem. Dr. Ehrenhaft believes that he has done so, and has proposed experimental proof that "Electricity and magnetism are an indivisible pair. The unification of the field theory has been indicated in an experimental way, and electricity and magnetism may have to be expressed in the future by one symbol only."

What Others Say

William L. Laurence, in "The New York Times":

Professor Felix Ehrenhaft, noted Vienna physicist, presented before the American Physical Society, a set of his latest experiments, which he said provided for the first time experimental proof of the existence of pure magnetic current.

The presentation of the experiments, illustrated with lantern slides, created a sensation among the prominent physicists present. They said that if the experiments described by Professor Ehrenhaft could be corroborated by others they would mark one of the greatest revolutions in modern science, to be ranked with the discovery of the principle of the dynamo by Michael Faraday 113 years ago.

Just as Faraday's discovery marked the ushering in of the age of electricity, it was pointed out, so this discovery of Professor Ehrenhaft, assuming the correctness of his results, would mean the ushering in of a new era in technology based on currents of magnetism. It would mean, one leading physicist said, that we would double the possibilities for building machines—for every electrical machine now in existence

we would be able to build a machine utilizing magnetic instead of electric current.

Willy Ley, in "PM":

When Faraday once demonstrated the principles of the electric current, a woman asked him: "But, professor of what USE is all this?"

Faraday, without looking up from his demonstrations, shot back: "Madam, what use is a new-born baby?"

We now know of what use electric machinery is, but the same question might be asked again now. And the answer would also be the same. Because a new basic discovery has been made recently, and while one cannot say precisely just what will come of it there can be little doubt that it is important.

It seems, after all this, that magnetism and electricity are but two manifestations of the same thing. The importance of this discovery is so great that it cannot be expressed in words. We'll get a completely new theory of electricity and electric phenomena. And as regards practical aspects: we may get "magnetic" equivalents of everything electrical which we have. And more.

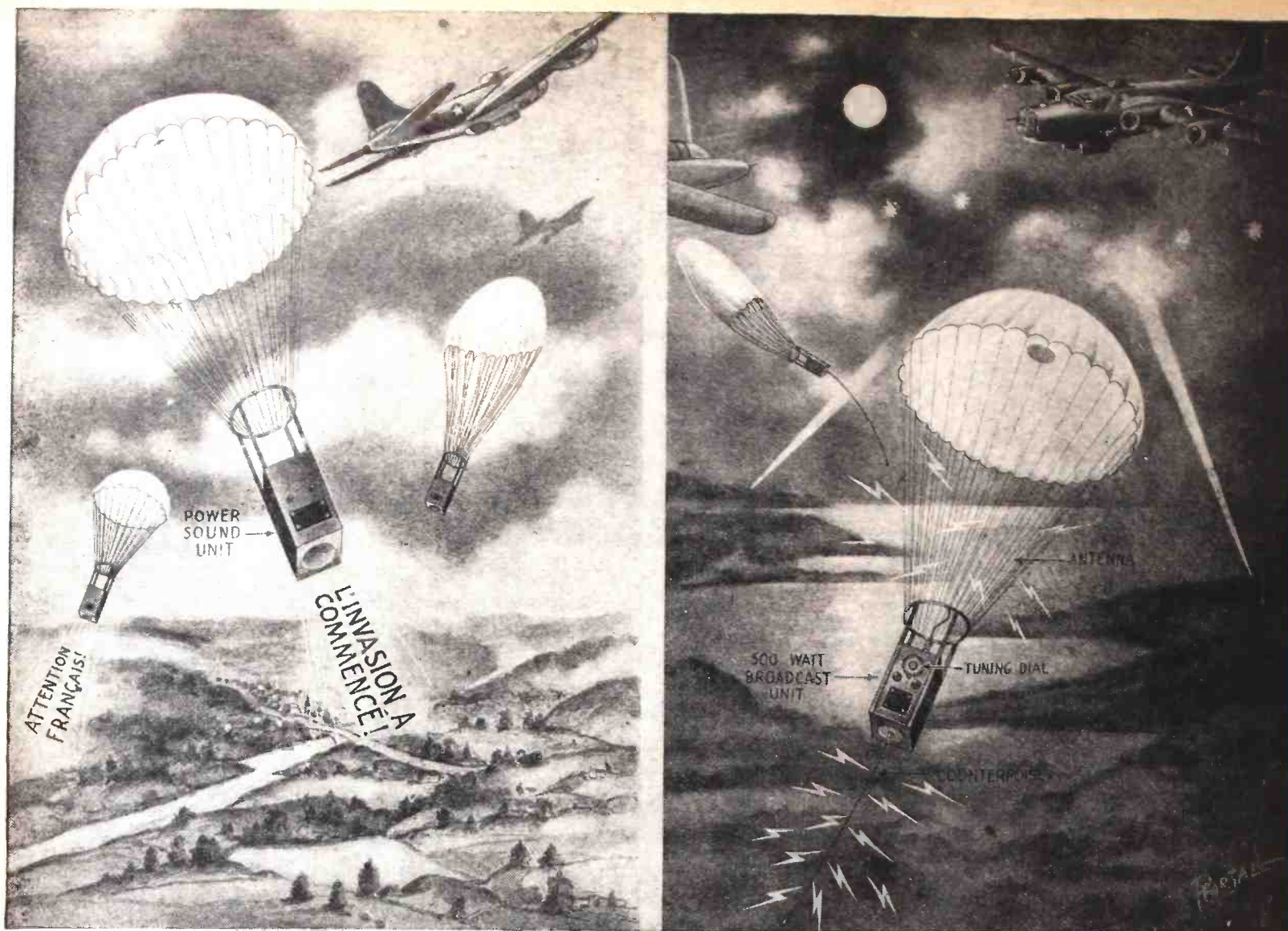

(COVER FEATURE)

Sky Radio Blankets Enemy

By HUGO GERNSBACK

THE present war has brought forth many new techniques in warfare and many other new and surprising ones will be originated before the war is brought to a successful conclusion.

This war has also shown that during an invasion the population is easily panicked, and very frequently this hampers the invasion forces. During the invasion of France and the Low Countries, the demoralized population, as a rule, tried to get out in the open and started their trek away from the invasion forces. Much needless hardship, casualties and senseless killing of non-combatants was caused in this manner.

In the United Nations' future invasions, in Europe and in Japan and elsewhere, it is often of great importance that the population should be informed when the invasion has been started and that the people be instructed what to do. At certain times military strategy requires that the population stay where it is; in other instances where a town is to be shelled it is necessary to inform the inhabitants to evacuate immediately, if large casualties are not to result.

Naturally the enemy does not concern himself about such details, particularly where occupied country is concerned, and the ruling military are not likely to give the occupied population much notice or comfort. For that reason the Allied Nations must do so themselves.

Several means are open for them to do this. They can either use existing broadcast facilities and warn the population over their

regular radio receivers, or otherwise shower the towns to be occupied with leaflets from the air. These two methods leave much to be desired. Frequently it is not possible to receive Allied broadcasts in occupied territory because the enemy may "jam" the usual broadcast wave lengths, making Allied transmissions almost impossible to be heard. If the Allies use short-wave frequencies, they know in advance that this will not be very effective because the population is under a death penalty if they use short-wave receivers, or listen to short-wave broadcasts.

Communication is never more important than at the moment of invading occupied country. Instructions to the populace and directives to guerrillas or underground groups may be of great strategic importance at such moments. This article suggests an effective method for communicating with these friends and activating our potential allies.

Leaflets are not very effective either because the people know that this is coupled with large hazards; the occupation authority is stern in this respect and will often execute those who pick up Allied leaflets and hand them around.

A different method in spreading important information to the populace of occupied territories is shown on our front cover, as well as the accompanying illustrations on this page.

The means concerns itself with launching over the occupied territory *expendable* radio means which can either be in the form of a floating broadcast station, or by direct sound method.

Let us first consider the radio broadcast method. It has been suggested at times that a fairly strong broadcast station be set up in a bomber which can then broadcast to the population within a radius of from 50 to 100 miles. This method is not too good because an airplane during war conditions cannot circle too long over a city without being shot down. Furthermore, too many airplanes will be required to cover even a fair-sized territory.

The method which I suggest is, as mentioned above, an expendable broadcast station. This then would be a compact radio unit weighing not more than 200 pounds. It is attached to a regulation parachute and is discharged—preferably at night—over the towns and cities where the best result can be expected. The cost of these units is not too great and the units are constructed in such a manner that once they have achieved their purpose, they are no longer needed and can be destroyed by the enemy if necessary. Or, if desired, when the unit

(Continued on page 366)

Industrial Electronics

PART I—ELEMENTS OF CONTROL

By RAYMOND F. YATES

ELECTRONICS was unknown in industry twenty years ago. It was not till 1930 that the electron tube as an industrial device started on the "road to fame," with a few more or less obvious applications. By 1935 it had definitely taken its place among the tools of industrial control. The war has stimulated the invention of many new electronic devices and applications, some of which will not become known till after peace is declared.

The future of this young science is bright—so bright indeed that the intelligent young man may well plan a career in this fabulous new field, with every assurance that rich rewards will come to him who excels.

Before we come to grips with the matter of practical application, the design of circuits, etc., it might be well to first review the list of physical forces upon which electronic operation may be based. The cornerstone upon which the major weight of industrial electronics rests is the sensitivity of certain electronic circuits to small changes in (1) capacitance, (2) inductance and (3) resistance. These are basic elements of control, as we shall soon see.

Let us take the matter of capacitance as an example and see how mechanical measurements of great accuracy and extremely small extent may be made by the use of a measuring contact in mechanical connection with the movable plate of a condenser as shown in Fig. 1. Any shifting of the measuring device will bring a movement of the condenser electrode which in turn alters the capacity of a special circuit made highly sensitive to such a change. Such a circuit is shown in Fig. 2. See also the "Vibration Transducer" in the October, 1943, issue of *Radio-Craft*. The mechanical displacement of the condenser electrode finally results in a current change. This principle is used a great deal in the measurement of thicknesses, where the material issuing from a machine may be of a dielectric nature. It has also been applied in the machine industry and holds a great deal of promise for future development.

When it is desired to continuously record the thickness of a conducting material (such as rolled sheet or ribbon) during the course of its manufacture, then the device shown in Fig. 1 is employed. In the one case, capacity is changed by the movement of the condenser plate and, in the other case, the capacity of the condenser is changed by the changing of the dielectric constant K. As an illustration, a parallel plate condenser has a capacity equal to

$$C = .0885 \frac{KA}{d} \mu\text{f}$$

where K=1 in air, A=area in square centimeters, d=distance separating plates in centimeters. A variation in d will also cause a change in C.

Should such a sensitive condenser be placed in a resonant circuit (such as those of Fig. 2), and a meter placed in the plate

lead of one of the tubes, the current flow will be extremely sensitive to even small changes in capacity.

The vacuum tube—with its ability to greatly amplify extremely small effects—has provided the engineer with a device that will permit him to create large effects with extremely small modifications or changes in physical, electrical and chemical forces. For instance, we find that vacuum tube circuits may be set up to record and amplify pressure, contraction, expansion, temperature, magnetostriction, magnetism, electrostatic attraction and repulsion, electromagnetic attraction and repulsion, ionization of gases and electrolytes, changes in electric conduction, vibration, humidity, moisture, barometric pressure, speed, light, frequency, sound, voltage, current, thermoelectrics, radiation of particles (cosmic, radium, etc.), transparency, etc. See Fig. 3.

Once the effects produced by these forces or conditions are detected by vacuum tubes, a trigger action becomes available. By amplification larger forces of control may

This article opens up a new series on Industrial Electronics by Raymond Francis Yates, known to our readers for his earlier writings on Popular Electronics. These new articles will deal with electronic control devices, heavy applications of electron tubes, measurements by electronic circuits, and the thousand-and-one other uses in mine, mill and factory.

be released. Thus by a beam of light merely interrupted, a 20,000 lb. ingot of hot steel in a rolling mill may be stopped dead in its tracks because of applied power released through the function of a photoelectric cell. Before the vacuum tube appeared, it was not possible to make such small effects control large amounts of power.

Electronic engineers not only use small physical impulses to control machinery, but hundreds of vacuum tube circuits are also employed in the electric power industry for special control. Such circuits are often employed in machine control. We find

(Continued on following page)

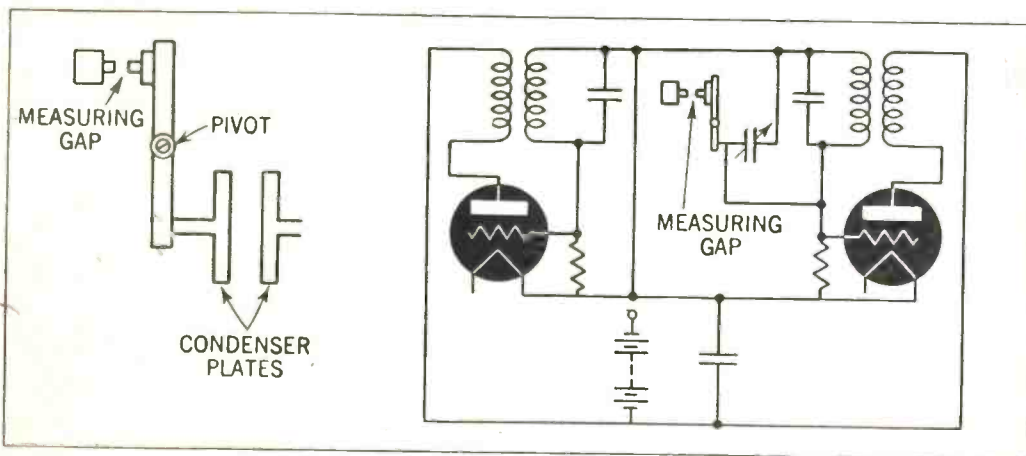

Fig. 1—How distance between two plates may be expressed by a slight change in capacity. Fig. 2—Simple electronic circuit for amplifying such effect to a measurable quantity.

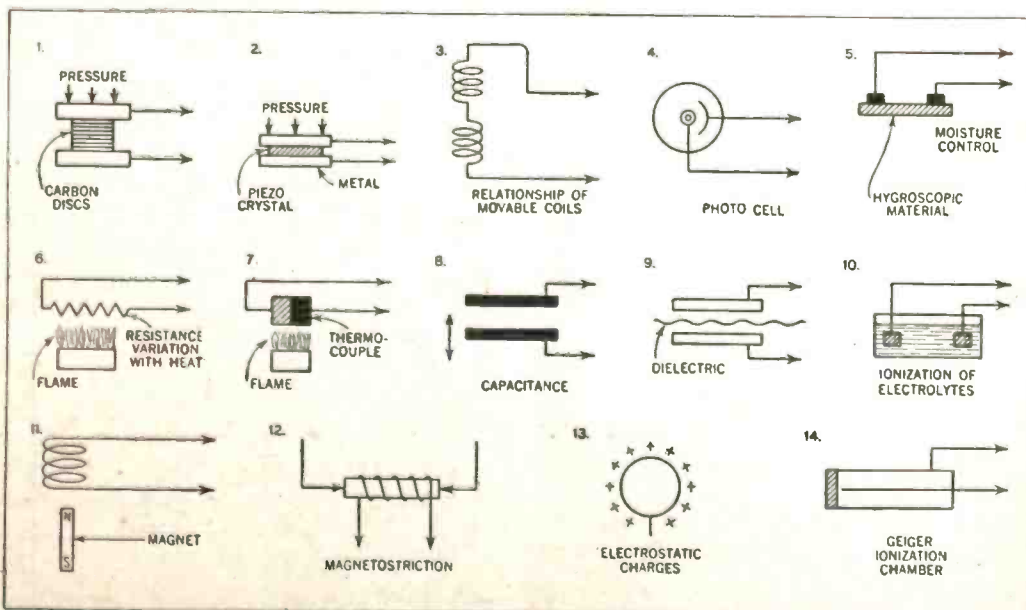

Fig. 3—Only a few of the possible electronic measurement circuits. Changes undetectable by other means are readily amplified until they can be measured on ordinary apparatus.

vacuum tubes of different characteristics serving in time interval control (as time delay relays, for instance) constant current devices, discriminator circuits, integration, differentiating, balanced reactance tube modulation, inverse cathode-coupled converters, synchronization and other circuits.

The industrial use of vacuum tubes had not progressed very far before engineers discovered ways and means of controlling temperature within very narrow limits. While many such circuits and methods have been employed, the diagram of Fig. 4 illustrated what is known as the bridge circuit for temperature control. Here a properly designed resistance thermometer forms the fourth arm of an A.C. resistance bridge. Its operation is based on the fact that the resistance of wires carrying electric current change their resistance with temperature, the resistance increasing with increase in temperature. This fourth arm is placed in the furnace the heat of which is to be controlled. When the bridge is balanced and the resistance unit in the furnace is at the correct temperature, there will be no voltage across the bridge. However, when the resistance unit in the furnace becomes overheated, the bridge will be unbalanced and this permits the vacuum tube to conduct current and operate the power relay.

Some idea of the extreme sensitivity of certain vacuum tube amplifiers (high gain) may be had from the fact that strain gages

made up of fine wires of special alloy are so sensitive that changes in their resistance caused by a slight flexing may be measured. Thus the degree of strain in an airplane or machine part may be accurately determined.

Still another system is shown in Fig. 5. A phototube receives a light impulse from a reflecting galvanometer connected directly to a thermocouple located in the furnace. As the beam swings around with an increase of current due to an increase of temperature it eventually strikes the photocell and current is generated. This varies the current through the 5-ampere gaseous triode by the so-called phase-variation method.

It will quickly and clearly be seen that in the final analysis a change in resistance is equivalent to a change in current flow and that vacuum tube circuits of many types may be made very sensitive to such responses. Thus process and machine control may at times be had by mechanically adjusted rheostats, pressure on carbon piles, changes in the conduction of electrolytes by addition of various substances, distortion of special resistance units (strain gages), etc.

The measurement of mechanical and hydraulic pressure and the control of machines through the use of special pressure-sensitive units is made possible by means of piezo-electric quartz crystals. Crystals

especially cut and ground will generate a small voltage when compressed (see 2 in Fig. 3). This principle is beginning to find many industrial uses. For one thing, ballistics experts have been employing such crystals in measuring the internal pressures inside large guns at the moment of explosion. The voltage generated by the crystals is impressed upon the grid of a vacuum tube placed in a suitable circuit. The amplified output reaches a meter calibrated in units of pressure.

Practically any kind of operating control may be exercised in mechanical, electrical or chemical processes, through the use of one or another of the devices or principles suggested in Fig. 3. Such control has been greatly simplified during the past few years by the appearance of hydraulic servo motors for lathes and other metal working machines, electromagnetically operated valves for fluids and gases, etc. At the present time a vast mechanism suitable for accessory equipment is growing up around the electron tube.

A wide variety of effects and forces may be used to cause current and voltage changes that may in turn be used as impulses for electronic control. This has been made possible not because of the control units in Fig. 3 being new. Most of the principles outlined diagrammatically there are as old as the hills. The fact constantly to be borne in mind is that the electron tube is extremely sensitive to slight changes. Extremely small electrical effects amounting to as little as a few thousand electrons a second may be amplified until sensible forces are set in motion. That and that alone is the crux of electronics.

The apparatus or principles outlined in Fig. 3 may be called the original impulse units. They set up the current changes that operate the associated tube and other circuits. Thus the two coils shown at 3 may be so employed that they will indicate the position of remote mechanism, etc. On the other hand, a hygroscopic material at 5 may absorb moisture which will lower its electrical resistance and permit more current to pass. Practical application has already been made of this fact.

We all know that when a magnet is moved in the vicinity of a coil of wire, that a current will be generated in such a coil. Engineers took advantage of this long ago in developing electromagnetic pick-ups for phonographs. Mechanical engineers have also employed the principle in detecting small movement and in vibration analysis on high speed machines such as turbine rotors. Some time ago, engineers employed the piezo-electric crystal in devising a vibration detection device that was used to explore machined surfaces of metal to indicate degree of finish.

One of the electronic devices to find rather wide industrial and commercial use during the past few years has been the so-called time-delay circuit. As an example of the more simple type of such circuits, we point to Fig. 6 where a simplified traffic control circuit is outlined. The car passes over a road pad which charges a condenser which in turn discharges through a neon light. The amount of delay is controlled by varying the size of resistor and condenser. Other circuits for such uses involve thyratron tubes. Practically any time interval, no matter how large or small, may be accurately measured out if the proper circuit components are employed.

So far, the photoelectric cell is more widely used in machine control than any other electronic device save perhaps the

(Continued on page 373)

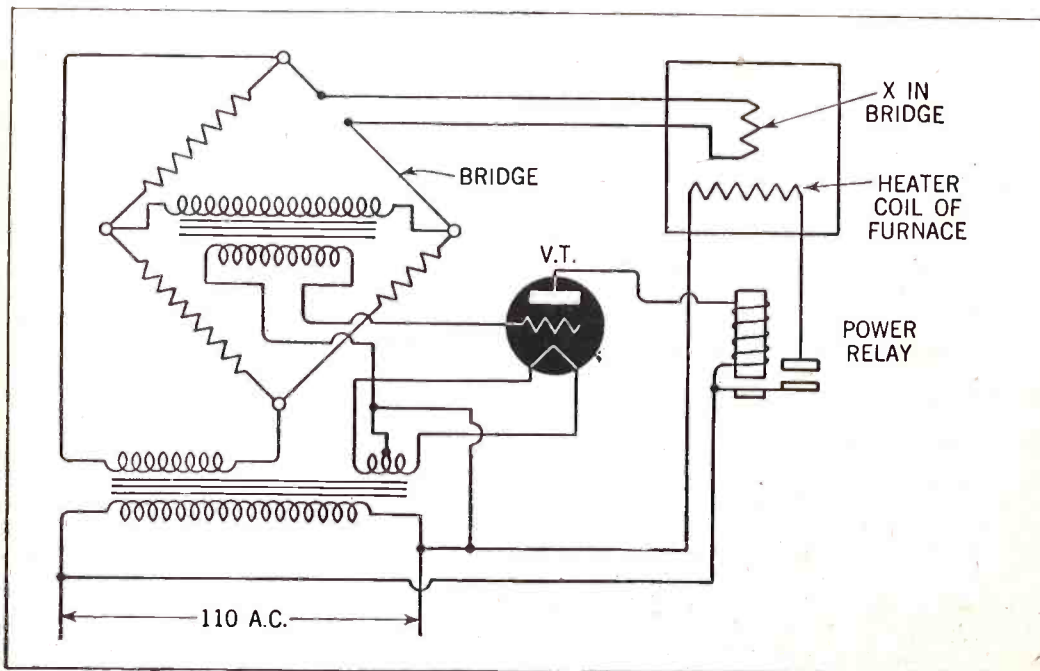

Fig. 4—Variations in the resistance of the furnace unit caused by heat unbalanced the bridge, supplying a signal which, amplified by the electronic tube, operates the relay.

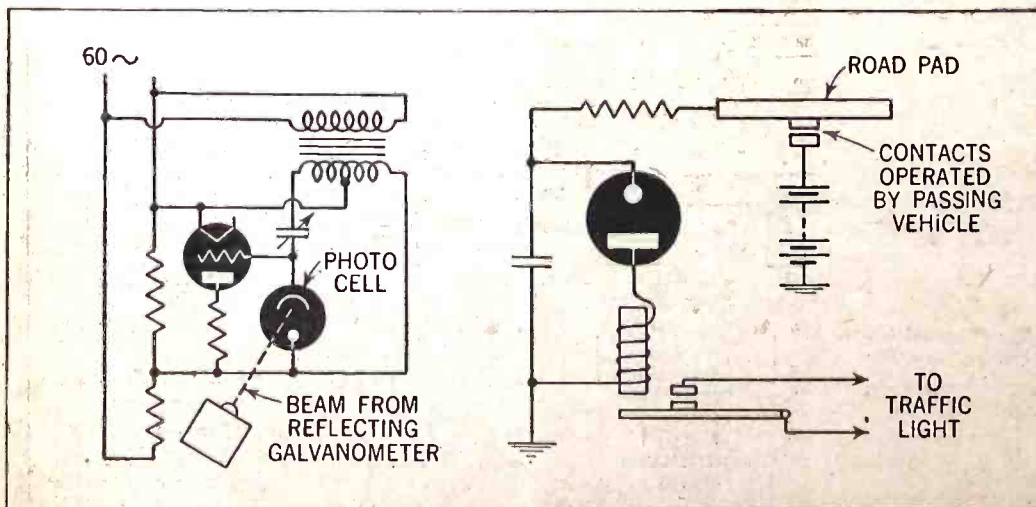

Fig. 5—This device permits amplifying weak signals from a reflecting galvanometer to a point where they can be caused to operate heavy apparatus. Fig. 6—Electronic traffic counter, employed in traffic light operation. Resistor and condenser supply desired delay.

A PRECISE "Treasure" LOCATOR

By R. M. C. GREENRIDGE*

IN THE maintenance of buried inter-city cables it is sometimes necessary to install, for protection against damage by lightning, copper shield wires above a cable already in the ground. Since these wires are placed by a plow, the precise route of the cable has to be determined so that the shield wires can be correctly positioned. It is also important to know the depth of the cable, so that damage to it may be avoided while installing the shield wires.

Irregularities in terrain make this depth vary; and the track left by the plow, which buried the cable, soon becomes obliterated, particularly in cultivated land and in swamps. Sometimes the path and depth have to be determined almost continuously over long distances. This can now be done electrically with a simple device which consists of coils that pick up a tone which has been applied to the cable sheath.

The principle is illustrated in Figure 1, where L is a wire carrying an alternating current. If a coil is held nearby, as in position x , so that the magnetic flux F generated by this current passes through its windings, voltage will be produced across the terminals of the coil and can be detected, after amplification, as an audible tone. If the coil is held in position y , however, with its axis perpendicular to the wire, the flux generates equal and opposite voltages in each half of the windings and no tone will be heard; also if the coil is held in position z , so that the windings are coplanar with the lines of flux, there will be no tone produced.

* Outside Plant Development, Bell Telephone Laboratories.

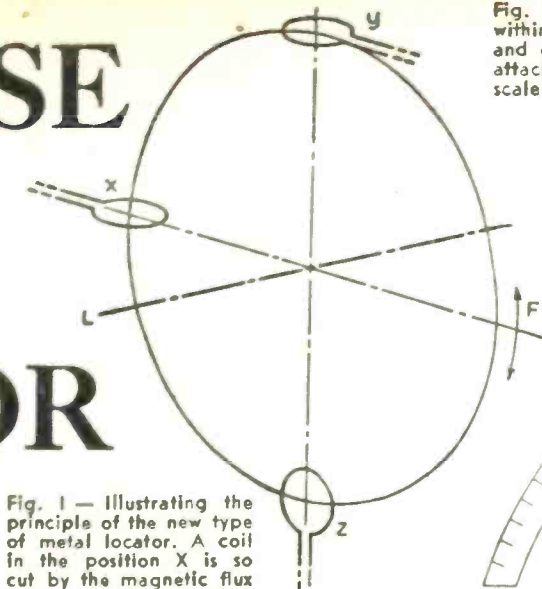

Fig. 1—Illustrating the principle of the new type of metal locator. A coil in the position X is so cut by the magnetic flux F , induced by an alternating current in the wire L , that a current flows in the loop. Loop Y , whose axis is perpendicular to the wire, and coil Z , coplanar with the lines of flux, receive no signal. A wire can be located to within an inch or two.

Construction of the device is shown in Figure 2. The locating coil A , the direction coil B and the depth coil C are mounted on a crossbar T attached to a vertical rod which supports a graduated scale S and has a spirit level L on its upper end. A handle H is used to position the apparatus by forcing the spike K into the ground. The selector switch w connects any one of the three coils to the amplifier and detector circuit, which is connected at x . A pointer P indicates the setting of the depth coil C and the shaft F , which slides vertically, permits leveling the apparatus.

The test current is generated by the buzzer of a 20C test set. One of its terminals is connected to the cable sheath at a pressure-testing valve and the other to a ground rod located from fifty to one hundred feet from the cable. Current flows along the sheath in both directions, and through earth to the ground rod. With the amplifier operating and earphones as

detector the selector switch is set on position a , and the apparatus carried across the path of the cable. When coil A comes directly over the cable, a null position (y in Figure 1) is reached and at this point the spike is pushed into the ground, thus locating coil A directly over the cable. By setting the selector switch at b and rotating the apparatus around the spike, the null point of coil B is found. In this position the horizontal bar on which coil C is located is at right angles to the path of the cable. Adjusting the sliding shaft then levels the device, after which the selector switch is set at c and the depth coil rotated on its

(Continued on page 376)

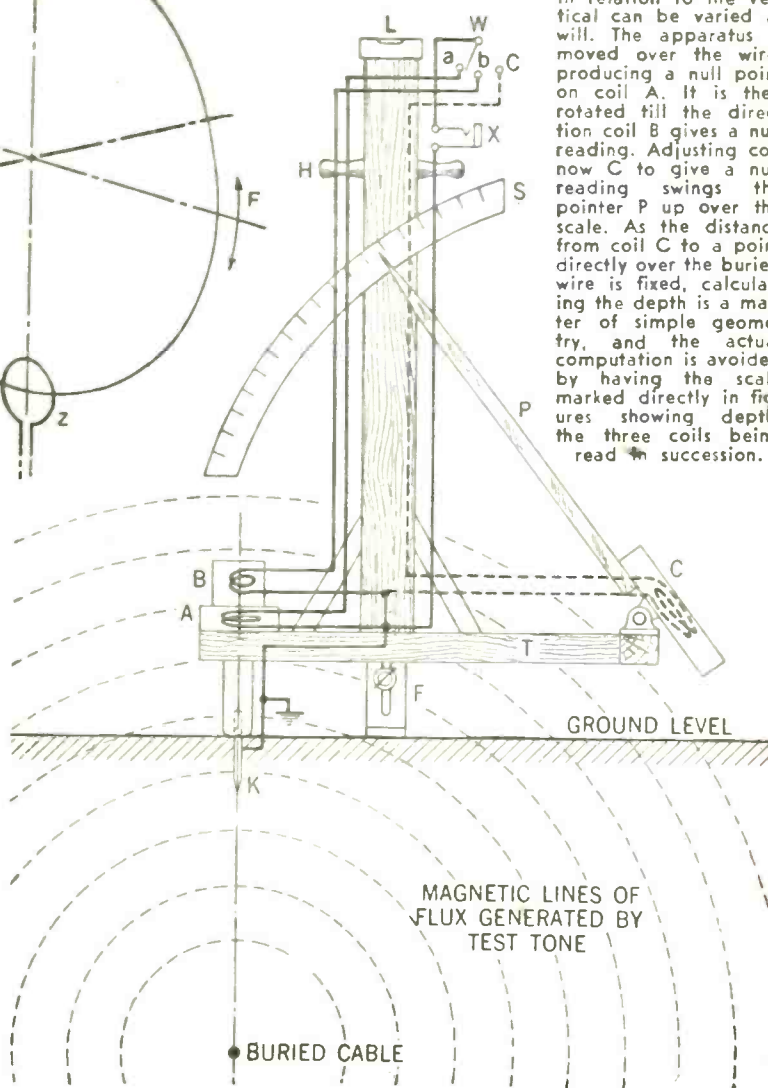

detector the selector switch is set on position a , and the apparatus carried across the path of the cable. When coil A comes directly over the cable, a null position (y in Figure 1) is reached and at this point the spike is pushed into the ground, thus locating coil A directly over the cable. By setting the selector switch at b and rotating the apparatus around the spike, the null point of coil B is found. In this position the horizontal bar on which coil C is located is at right angles to the path of the cable. Adjusting the sliding shaft then levels the device, after which the selector switch is set at c and the depth coil rotated on its

(Continued on page 376)

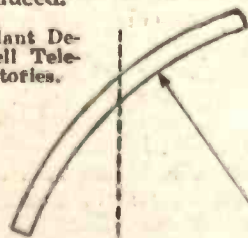

Fig. 3—If r is the radius of the cable, h the height of the coils above ground, l is the distance between coils and d the depth of the cable, d equals $\cot \theta - k$ where k equals $r + h$. In actual practice the scale is calibrated directly.

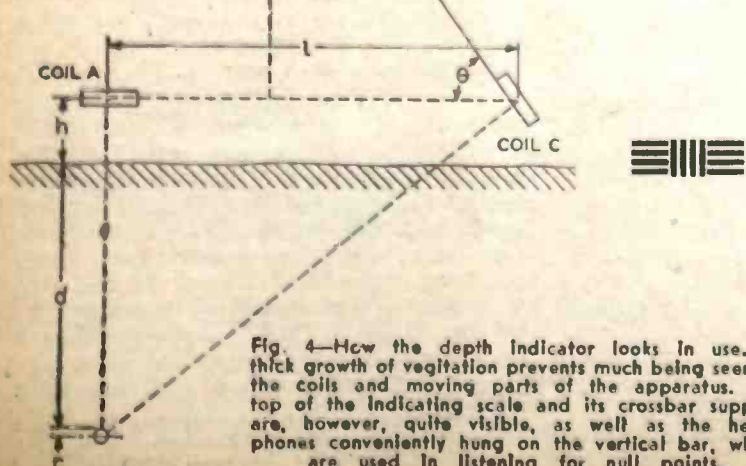
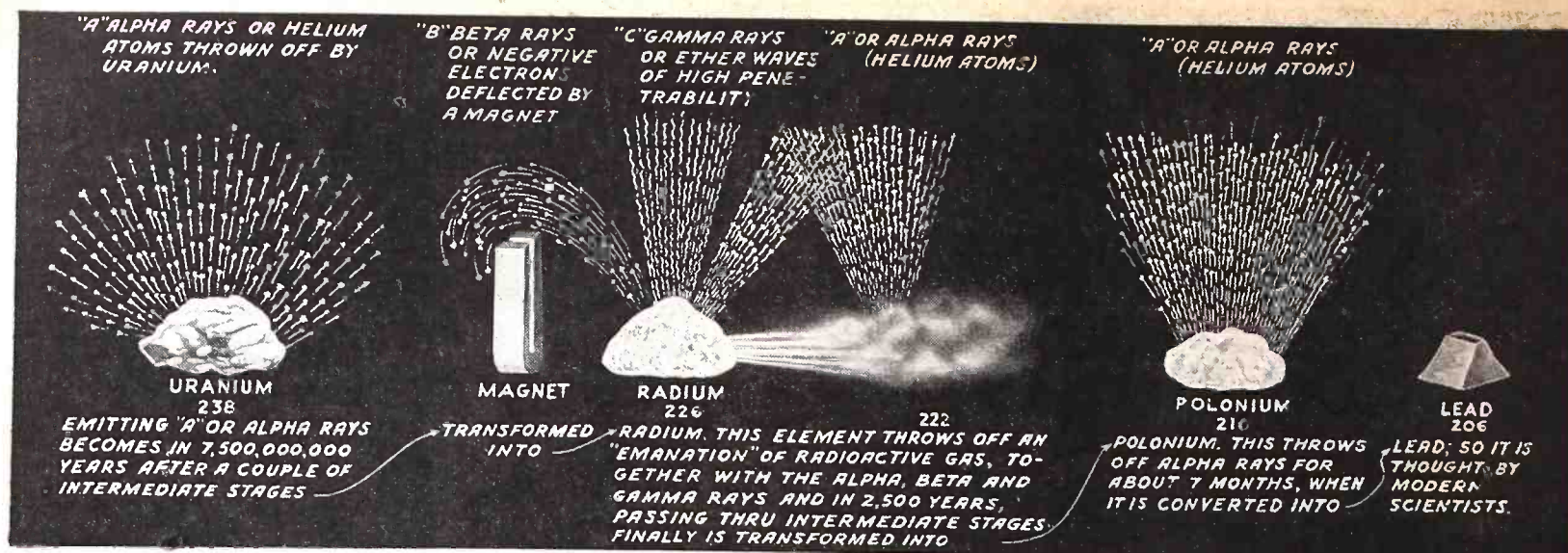

Fig. 4—How the depth indicator looks in use. A thick growth of vegetation prevents much being seen of the coils and moving parts of the apparatus. The top of the indicating scale and its crossbar support are, however, quite visible, as well as the headphones conveniently hung on the vertical bar, which are used in listening for null points.





This illustration shows how the element Uranium, according to the Curies, disintegrates into Radium, then to Radium Emanation, then Polonium and finally into lead at the end of its life.

"Madame Curie" and ELECTRONICS

By HUGO GERNSBACK

THE motion picture industry in the past has covered itself with glory when technical subjects were involved which had to be interpreted to the public.

Such pictures as "The Story of Alexander Graham Bell" and "Edison, the Man," come to mind. Usually the various film research departments did an excellent job in presenting the technical aspects of the various inventions without going into too many high technicalities.

After all, when the public sees a motion picture on the discovery of the telephone, or how electric light finally was perfected, it is quite obvious that the portrayal not only must give the whole story of the invention, but it must be technically correct and show its important uses too.

So when we witnessed the film presentation of "Madame Curie" the other day, we were in high hopes that the man in the street and the younger generation would be presented with a complete review of the wonders of Radium. We watched reel after reel of "Madame Curie" and were impressed with the profuse presentation of the many technical details on how Radium was discovered by the Curies. We see where the veteran scientist, Jaques Becquerel, calls the Curies into his laboratory to show them the first X-ray photographs ever made *without* X-rays and without electrical apparatus, but with a mysterious substance. In the screen version Professor Becquerel mentions that the substance was pitchblende. We smiled at this because in an article that Becquerel had once done for a Gernsback publication, he stated that all the early experiments were with the element uranium—the forerunner of Radium. We let this inaccuracy pass because the pitchblende tied in better with what followed in the picture, when we see the Curies working like Trojans in their cold laboratory—and outdoors as well—extracting Radium from the Austrian pitchblende. We watch them toiling over a large vat in which they melt the pitchblende. Later on we see them laboring over the fractional distillation of the valuable salts which later become Radium. We observe hundreds upon hundreds of evaporating dishes in which the liquids, pregnant with Radium, are evaporated to the tune of over 5,000

IN the recent film, "Madame Curie," the producers were concerned only with the bare outline of how Radium was discovered by the Curies, but the film completely failed to tell the public the many wonders of Radium in word and picture. This deficiency is pointed out in this article which describes the major, almost miraculous powers of Radium.

Because only a small number of technicians are aware of the unusual properties of Radium, which may play an important role in the future Radio and Electronic art, RADIO-CRAFT takes great pleasure in presenting this article.

different operations to yield Radium salts in the preliminary stage. Then at the end of the titanic labor, which took many years, we finally see a small porcelain evaporating dish glowing softly in the dark—Radium has been discovered.

Incidentally, the film producers had a lot of trouble to shoot this last scene, as Radium itself could not be used. After many trials an ordinary electric light bulb, arranged in a certain manner and covered with some water, was used to get the desired effect.

Now, then, the microscopic amount of Radium which the Curies finally isolated did not give a very heroic glow, which led to the exclamation of the young boy sitting behind us: "Gee, is that all?"

That was the first disappointment in the film, but nevertheless, the movie people were technically quite correct in their presentation of the glow. The very minute quantity of Radium could not give off a very strong glow.

But from here on the picture has no further technical presentation to make. It concerns itself only with the personalities of the Curies, and when the final fadeout came, we felt a distinct let-down, because we knew that the non-technical film audience would not get the slightest idea of what Radium was all about.

Having gone to so much trouble with all the other technicalities—which really were

not too important—in the first part of the picture, one would reasonably expect that now the public would be presented with the spectacular effects of Radium. Nothing like that happens, however.

Perhaps the man on the street knows that Radium IS used in medicine—but what does the average person know about it? In the motion picture Mme. Curie exhibits burns on her hands, obtained from handling the unknown substance, to a Paris physician, but outside of some high-faluting speculation on what Radium might be, and its great power, nothing else of importance transpires. It is also true that at the end of the picture, when 25 years after the discovery of Radium Mme. Curie is lecturing to the assembled great French scientists, some mention is made again of the healing power of Radium, but to the average listener it is all too vague and inconclusive. Too much class room lecturing.

When it is known that cancer has killed more people in the United States in 1943 than were killed on all the American fronts combined, we may be pardoned in saying that "Madame Curie" did not fulfill its main mission; that is, to instruct the masses on how cancer can be prevented if discovered early enough. Another hundred feet of film would have conveyed the message unmistakably. Here was an excellent chance to do so, but in this respect, too, the film missed the boat. It wasn't our thought that some ghastly cancer victim should be portrayed, but there are other early cancers and growths which do not look horrible when shown on the screen.

Several years ago, for instance, the writer had a large wartlike growth on the left index finger. He went to the Radium hospital, where the doctor in charge merely applied the so-called Radium bulb for five seconds to the growth. In less than ten days the growth* had vanished completely, never to come back. Cancer of the skin frequently is not something to view with horror. Often it looks like an ordinary large wart. It could easily have been portrayed in the film with a most important

*The Radium or Radio bulb is limited to precancerous lesions of the skin, particularly Keratoses.

(Continued on page 374)

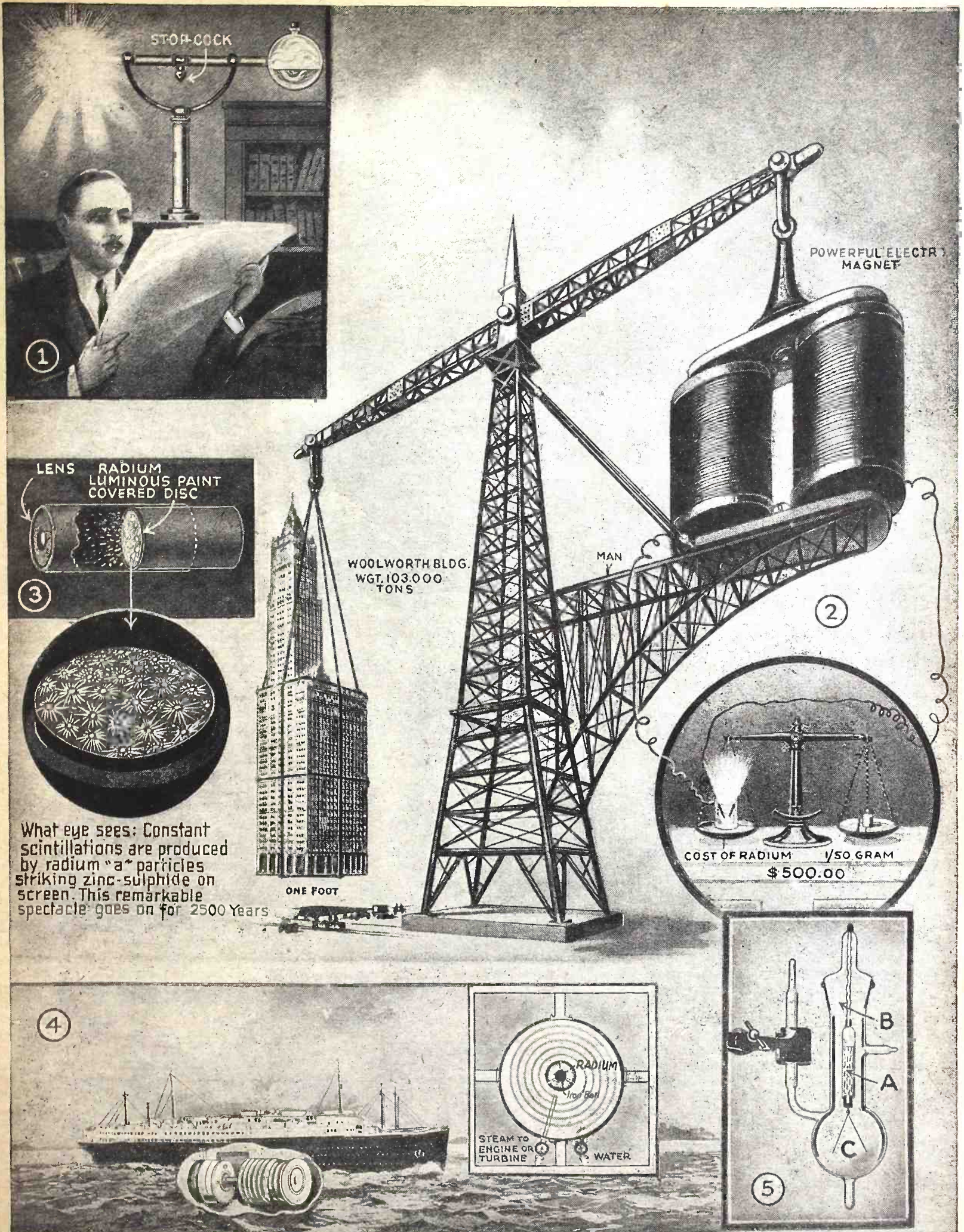

WOOLWORTH BLDG.
WGT. 103,000
TONS

ONE FOOT

COST OF RADIUM 1/50 GRAM
\$ 500.00

What eye sees: Constant scintillations are produced by radium "a" particles striking zinc-sulphide on screen. This remarkable spectacle goes on for 2500 Years

THE WONDERS OF RADIUM

1—Very soon after the element Radium had been isolated by the Curies, Professor Curie himself constructed the Radium Light which actually permits the reading of a newspaper six feet away. The device uses up nothing, except Radium, and will last for over two thousand years. 2—If we could harness it, the electrical energy developed by a mere speck of Radium, weighing one-fiftieth of a gram and costing five hundred dollars could lift the Woolworth building one foot off the ground. 3—The marvelous SPINTHARISCOPE, wherein we witness the actual destruction of miniature worlds. It shows one of the most spectacular effects of Radium. 4—A future ocean

greyhound being driven across the ocean with a minute speck of Radium weighing 15/100 of a gram at a cost of \$3750 which compares with the present one trip cost of \$12,000 for coal. 5—Professor Strutt's Radium "Clock." The glass vessel encloses a minute quantity of Radium, contained in the tube A suspended by a quartz fibre B. The Radium charges the gold leaves C with electricity as is done in an electroscope. The gold leaves C now diverge till they touch the metallic lining of the enclosing tube. This discharges the gold leaves, which collapse; then the action starts over again. Such "clocks" have been working for 35 years. The action will last 2500 years.

ELECTRONICS

SPEEDS

ORDNANCE



1—Fuses on moving conveyor enter the machine for inspection. X-rays are below the grenades, photo-tube above. 2—Holding a rejected fuse, the engineer points out its record.

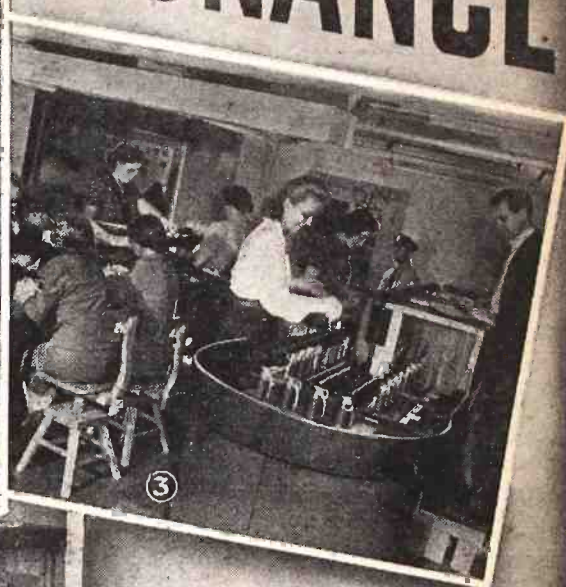

3—Fuses are coming from the X-ray machine, all ready for re-packing. 4—Only three minutes elapse from the time the grenades are unpacked until they are back in their cases.



SUBJOINING the predictable behaviour of a 100,000-volt X-ray machine with that of a photoelectric cell, the General Electric Company has designed automatic apparatus for certifying the correct amount of powder in the fuses of hand grenades. This device, the first of its kind in this country, automatically checks 4,000 fuses hourly, discarding those that might cause premature explosions on Allied battlefronts.

A grenade fuse, barely larger than a fever thermometer, and closely resembling same except that it is fashioned from metal, contains two powder charges and a slow-burning detonator. If, in making these weapons of war, too little powder is put in any of these elements, the grenade may explode as soon as the soldier releases his grip on the handle. The War Department divulges a few instances, in the early stages of this global conflict, of faulty hand grenades failing to explode. In a single reported instance the position of one of our soldiers was exposed and the American was killed by a Japanese sniper.

As "the arsenal of democracy," the U. S. Army has adopted numerous electronic devices and techniques to prevent faulty material from reaching Allied combat troops. Most of these secret weapons must remain just that until the enemy's "unconditional surrender," but the War Department censorship has lifted the veil of secrecy to let us see how the General Electric Company solved the problem of setting all hand-grenade fuses to explode at exactly the predetermined time.

A moving belt, carrying a row of sockets, was set up in the laboratory at Schenectady. A fuse was set upright in each of these sockets, permitting a perpendicular beam from a 100,000-volt X-ray machine to penetrate each fuse (in the same manner as Roentgen rays "look" into the recesses of the human body or penetrate a tightly welded piece of steel). Each fuse, subjected to the penetrating "insight" of the X-ray, reflects its glow on a fluorescent screen,

By S. R. WINTERS

above which is a photoelectric tube (popularly designated "electric eye"): If this fluorescent glow does not waver in its constancy, then the hand-grenade fuses pass inspection without incident. However, should a fuse contain an insufficient amount of powder, when it passes over the X-ray beam, this electric eye notes the variation in the fluorescent glow.

This light-intensity change, indicating not enough powder, is the signal for a 4-point alarm. Automatically, this near-human fuse inspector rings a bell, flashes a red light, stamps a dab of red paint on the faulty fuse (and to further malign the dud) its bad record is recorded graphically on a meter chart.

When the fuses arrive for inspection they are packed in wooden boxes, each containing 200. Within a period of three minutes, they have been unpacked, inspected by the combination of X-rays and electric eye, and are repacked in the same boxes, ready for shipment to the world battlefronts.

The tube-like fuses contain three sections—two for five-second timing and the third, a sort of firecracker, for causing detonation. Yet despite this intricate mechanism, the photo-electric eye "sees" to it that all three sections are filled with proper amounts of powder. Without this automatic device there would be no way of seeing inside of hundreds of thousands of fuses—potential hand grenades that are writing memorable chapters of heroism as they are being hurled by our soldiers to blast Japanese snipers out of jungle foxholes in the Southwest Pacific, and Germans from their rocky hide-outs in Italy.

As a check and double-check on a new machine of such uncanny performance the Ordnance Bureau of the War Department purposely manufactured a quantity of defective fuses to trick the automatic inspector. One bad fuse was inserted after each four good ones along the line of the mov-

ing belt. If the electronic eye failed to locate one of these defectives, the women operators were aware that the automatic machine itself had gone haywire and that the stoppage affected not more than the last four fuses. Testing, as it does, about 4,000 fuses an hour, the Ordnance Department reports that the device operates so efficiently that of 100 fuses it discards, nearly all, and sometimes all, have enough powder in them to fire a hand grenade. This, we are told, places the quality of the material in the hands of combat troops well beyond the usual margin of safety—a rejection of every fuse on the borderline of performance. That's why we repeatedly hear stories from the Southwest Pacific to the effect that our equipment is superior to that of the Japanese and in the skilled hands of our soldiers ultimate victory is vouchsafed.

Radionic devices, too, are insurance against duds in the fuses of American artillery fire. We are told that our shells explode virtually 100 percent, whereas in previous wars the rate was 100 explosions out of 125 shells. An artillery fuse contains from 70 to 120 parts. Each fuse has been described as like a clock without a main spring. The fuse functions because of the whirling action of the shell, 1,500 to 1,800 revolutions per minute. This centrifugal force actuates a pair of governors, whose motion drives the mechanism. These fuses vary in size from a large grape to a cantaloupe. To turn out millions of these artillery fuses—discarding the imperfect ones—there are novel automatic, photographic and shadowgraphic devices.

A woman worker picks up each finished fuse as it moves along the conveyor belt and places it, like a cap, over a tiny metallic head. She presses a button and this metal head spins the fuse, 1,800 revolutions per minute. Forthwith, on a glass immediately in front of this woman worker, there is flashed an oscillograph wave—a green line of light, as it were. The pattern of this

(Continued on page 382)

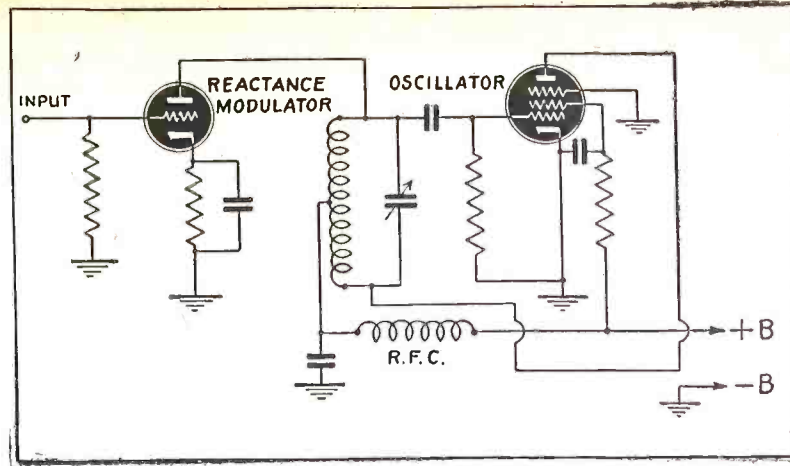
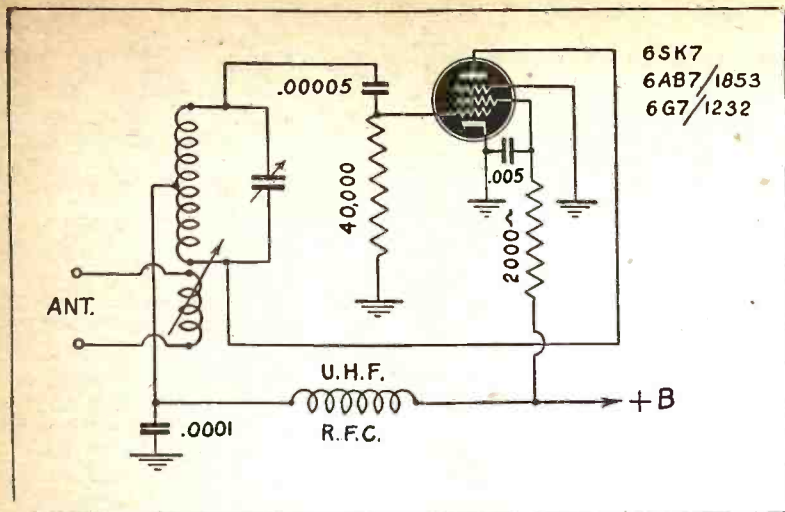

Fig. 1, left—The dependable Hartley oscillator transmitting system.
Fig. 2, above—How the modulator circuit, theoretically, might work.

AN FM WALKIE-TALKIE?

A Transmitter which can be adapted to mobile work

By DEAN S. EDMONDS, JR.

THE amateur experimenter, his ham station closed down and his parts supply restricted to little beyond the contents of his junk box, is looking about him for a field in which to work. In the W.E.R.S. he finds an opportunity for transmitter and receiver construction, but these are generally limited to some common type of plate modulated U.H.F. oscillator and a super-regenerative receiver of disgusting simplicity.

Let us look at the added attractions brought on the scene by the advent of F.M. Besides the interest of working with something new and different, F.M. systems have certain distinct advantages. The first is that of static elimination. While the requirements for small size and simplicity placed on the design of W.E.R.S. equipment by present conditions preclude the use of a limiter circuit, an F.M. discriminator-detector such as I am about to describe may be adjusted so as to cancel out much static and other broad-band interference.

The second advantage of an F.M. system is a great saving of hard-to-get parts at the transmitter. The usual W.E.R.S. transmitter is plate modulated by a single tube class A amplifier through a small modulating transformer or choke. A power supply is required not only to run the oscillator but also to deliver the necessary voltage and current to

the modulator. Heavier chokes and power transformers are needed when this extra current drawn by the modulating power tube is considered, and the modulation transformer or choke is an expensive, bulky, and hard-to-get item. In an F.M. oscillator, not only is every form of iron core inductance dispensed with (except, of course, in the power supply) but the reactance modulator tube draws no more plate current than an ordinary low-level voltage amplifier. Savings as high as 50% on total "B" current consumed may easily be effected, with a corresponding reduction in requirements for power supply components. Thus in size, cost, and power consumption, the F.M. transmitter has it all over its brother A.M. job of equal power output.

DISADVANTAGES OF FM

Two fairly serious disadvantages are inherent in an F.M. W.E.R.S. hookup, which must be overcome before such a system can be built and operated satisfactorily. Interference from adjacent W.E.R.S. channels has been found to cause enough trouble without making the situation still worse by the introduction of F.M. An F.M. transmitter, its carrier frequency being swept back and forth by an audio signal, requires a much greater band-width than an A.M. transmitter, even allowing for the latter's side bands.

If you want to use this system, you'll just have to put up with that drawback. In other words, if you're trying to sandwich stations in between each other with barely enough separation of channels to keep the squeals down to a tolerable extent, this article is not for you.

A second disadvantage of an F.M. hookup is the receiver. With A.M., the experimenter could always fall back on his favorite super-regen circuit for the U.H.F., as in the case of W.E.R.S. receivers. With F.M. there are no such common, simple, and obvious alternatives. The problem of getting a receiver of simpler and less expensive design than the big superhet.—complete with a couple of R.F. stages, several I.F.'s and a limiter or two—is a very serious one, and must be solved before the construction of a W.E.R.S. network using F.M. may be undertaken.

In the following description of an F.M. W.E.R.S. station the transmitter circuit has been thoroughly tested and has proven itself a reliable, non-critical, and generally trouble-free design. The receiver shown is principally a suggestion to the experimenter who wants a comparatively simple receiver especially for F.M. If you have a bit of spare time on your hands, some spare parts in your junk box and an opportunity for trying

(Continued on page 372)

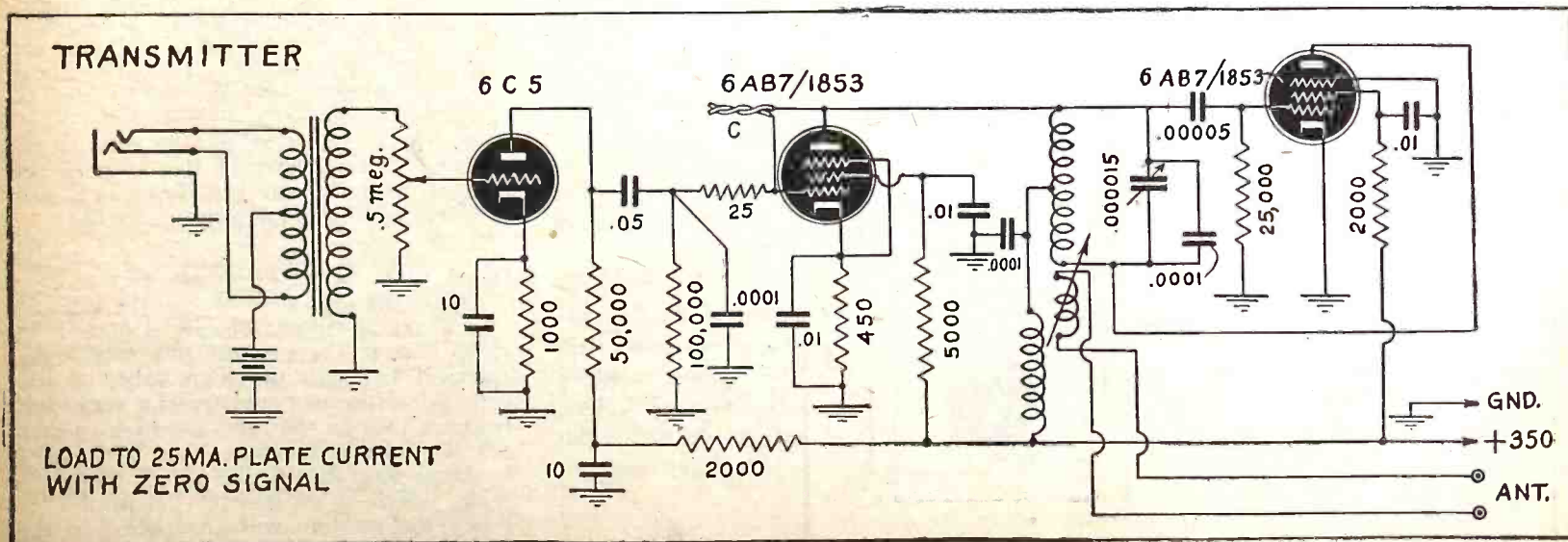

Fig. 3—Complete hook-up of the FM transmitter, showing the small feedback condensers

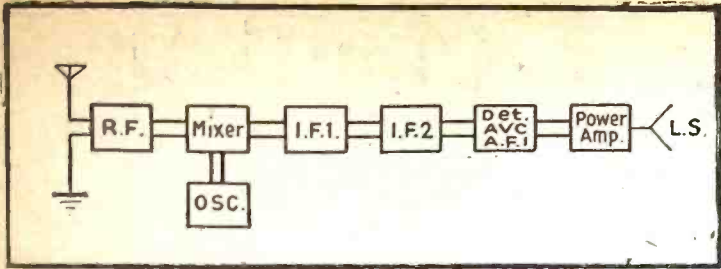
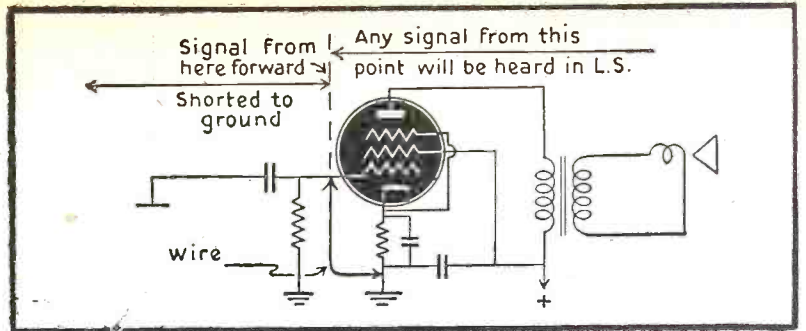

Fig. 1, above—Typical block diagram, used to show squelch points. Fig. 2, right—Effect of squelching in any given stage of a radio. Noise in a given stage can thus be quickly located.



Electronic Circuit Checks

PART II—STAGE SQUELCHING AND SIGNAL SUBSTITUTION

By R. E. ALTOMARE

If a receiver is afflicted with noise, regeneration and oscillation, or hum* not originating from the power supply, the use of the Analyzer or the Multimeter will avail us nothing. But there is a time-saving method to localize this type of trouble. Let us presume we have a case of noise in the typical receiver blocked in Fig. 1. Before proceeding, we must determine whether the noise actually comes from the receiver. This may be done by shorting the antenna terminal to ground (short the input terminals in the case of an electronic device and use an output meter). If the noise disappears, it is outside static, while if it persists, it may be due to some imperfect component in the receiver.

THE SIMPLEST INSTRUMENTS

Oddly enough, to use the system we are about to describe, the only testing apparatus required is a piece of wire, preferably terminated in clip leads, and a large paper capacitor of about $\frac{1}{2}$ mfd. capacitance. In this system, we mute, or squelch, each stage individually, thereby eliminating one stage at a time until we locate the faulty stage.

To illustrate the use of the system in the case brought up, we start by squelching or silencing every stage of the receiver except the last one. The accomplishment is even simpler than the description, since it is only necessary to short circuit the grid of the power tube to ground. As Fig. 2 will indicate, this prevents any signal originating in any stage before the power stage from being heard in the speaker. Hence, if the noise, which is an A.C. signal in nature, is native to the power stage, it will be audible in the speaker when previous stages are squelched. If the noise disappears, it will be necessary to proceed, one stage at a time, towards the antenna, until the critical stage is found. The critical stage that one which, when its grid is grounded, will fail to exclude the noise, though the following stage stopped the noise when its grid was grounded.

Thus, if in the block diagram of Fig. 1, the grid of the second I.F. stage had been grounded and the noise disappeared, and then when we grounded the grid of the first I.F. stage the noise persisted, we would have located the critical stage as the first I.F. amplifier. Apparently, we have saved much time, since we are now sure the noise is emanating somewhere between the grids of the first and second I.F. ampli-

fiers (control grids, of course). This means we will not waste time checking suspected parts in remote stages.

USING THE CONDENSER

By extending the system, we may even localize the noise further, reducing the local "sphere of trouble." Suppose we short the plate of the first I.F. amplifier to ground. Since the set is on, we ground the high voltage D.C. as well as the A.C. component (the noise signal). This is where our capacitor proves useful. If we ground the plate through it we short out (by-pass) the A.C. signal, including the noise, but since D.C. will not flow through a condenser it will remain unaffected.

If the noise disappears upon making this connection, we see that the "sphere of trouble" only extends from the grid to the plate of this stage. The tube itself is checked or replaced to make sure the trouble is not in it, and, travelling even further, we check the circuit associated with each element by grounding that element and noting the results. (Be sure to use the capacitor when a D.C. component also exists at that element.) In many cases it is feasible to short out isolated parts.

Some experienced trouble shooters use a simplified method of "squelching" before actually using the technique presented above. The faulty stage is localized very quickly by pulling the tubes out of their sockets one at a time, starting with the R.F. tube. When a stage is reached which stops the noise we may use this stage as the basis for further diagnosis as described above.

It should be borne in mind that an A.C.-D.C. receiver, or any device with a series filament string, will give dubious results with this method since the removal of a tube will, in effect, shut off the receiver.

It might well be pointed out that in grounding the control grids of Class AB2 or Class B power amplifiers, it is imperative

to use our capacitor, as it may preclude dangerously high currents. This system is never used in transmitter Class C amplifiers or high level oscillators as expensive parts may be damaged if a grid, which depends upon excitation from a previous stage to obtain bias, is robbed of this signal.

SIGNAL SUBSTITUTION

Modern radio and electronic equipment—being more complex in form—often require a more modern technique to properly locate trouble. Some ailments cannot be located easily by means of either the set analyzer-free point tester, or the volt-ohm-milliammeter. A splendid but simple illustration, is the case where a tuning condenser section has a shorted trimmer. No D.C. voltages will be influenced by this short circuit.

Therefore, the system of signal substitution has found wide application among some trouble shooters. We know that each stage of any piece of equipment has a definite function. Furthermore, each stage handles a definite type of signal which is of a particular frequency (or band of frequencies), amplitude and wave form. The audio amplifier stages handle the frequencies of the audio spectrum, and the I.F. stage amplifies the intermediate frequency only. If the receiver, blocked in Fig. 1, is a broadcast receiver, and its intermediate frequency is 465 Kc., the R.F. amplifier will be tunable and will cover from 550 to 1700 Kc. The same goes for the mixer input circuit. The oscillator will generate a radio frequency signal and will be tunable from 1015 Kc. to 2165 Kc. The I.F. amplifier peaks at 465 Kc.

If we are familiar with the functions of the stages involved, we may substitute the proper type signal at the control grid of any stage and note whether this stage passes or amplifies this signal. The system of signal substitution presupposes that we have signals of the proper type which we may select at will. It is also desirable to use an output meter.

(Continued on page 368)

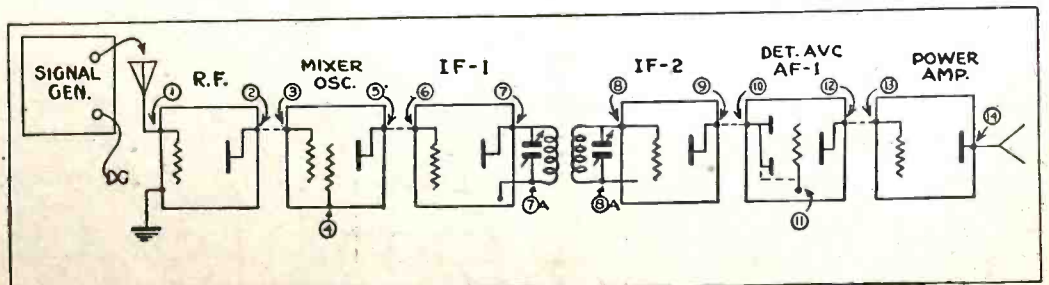

Fig. 3—Points at which a signal generator can be applied to localize circuit trouble. Many of the advantages of expensive signal-tracers can be realized by this easy method.

*Note: It is believed that when a receiver is afflicted with hum, time may be saved by going immediately to the power supply and checking the filter condensers first. The simplest check is to bridge the suspected filter condenser with a good one and listen for decrease of the hum level.

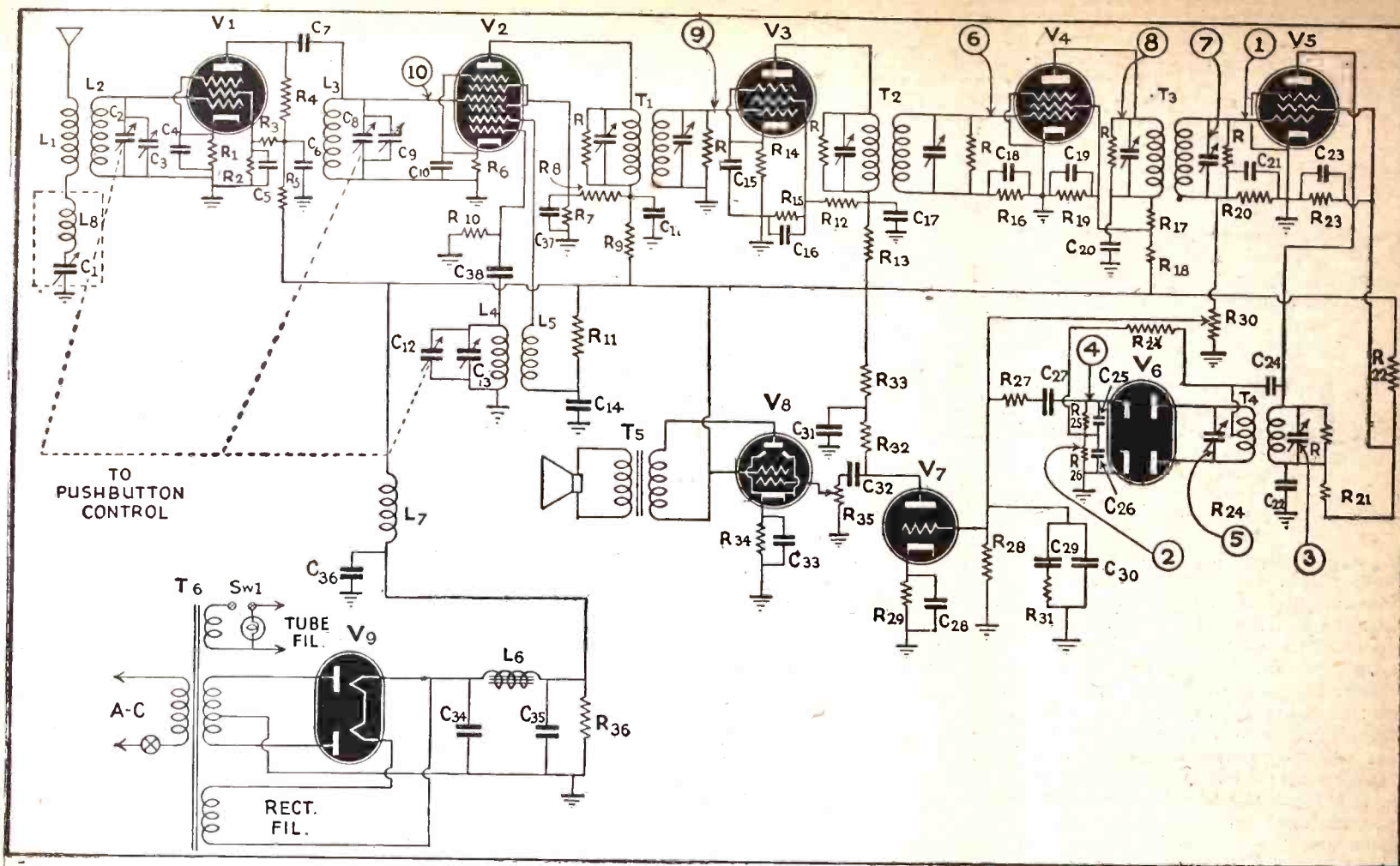

Fig. 1—The complete schematic diagram of a standard FM receiver. Several points referred to in the text are in numbered circles.

Maintaining FM

How to Adjust Discriminators, Limiters and Squelchers

By JULES M. KLEINMAN

IN the last installment we discussed in detail the theory behind the functioning of FM receiver circuits. It is the purpose of this installment to mention the pertinent points relative to maintenance and adjustment of these circuits. The author feels that this article may clear up many misconceptions on the servicing of FM receivers.

The test equipment required to satisfactorily maintain FM receivers should not present any problem to the experienced serviceman. The essential instruments required are an accurately calibrated vacuum tube voltmeter, preferably of the zero center scale type; an accurately calibrated signal generator, which should cover the FM band (40 to 50 mc.); and the other common instruments used to service AM receivers. If the serviceman is fortunate enough to have a cathode ray oscilloscope and a frequency modulated signal generator, quick and practically perfect results can be obtained. These are not absolutely required and good work can be done with the essentials listed.

In Fig. 1 is shown the schematic of a conventional FM receiver including the circuits that were discussed in the preceding article. We will assume that the I.F. of this receiver is 3.5 Mc., and that it is push-button tuned. We will follow through all of the adjustment and maintenance steps in such a manner as to make them applicable to any other FM receiver. An itemized list of the parts used in this receiver is given in chart 1. The use of each component part in its respective circuit is included for the convenience of the reader.

We will first discuss the adjustments necessary in an FM receiver.

ADJUSTING THE DISCRIMINATOR

As in AM we work from the detector back to the converter in alignment, the only instruments required to align the discriminator are a signal generator and a vacuum tube voltmeter which reads down to at least .5 volts:

- Set tuning dial of signal generator to 3.5 Mc.
- Connect "hot" lead of signal generator to grid of 2nd limiter V5 through a .01 ufd. paper condenser. (Point 1 on Fig. 1.)
- Connect "cold" lead of signal generator to chassis (gnd.) of receiver.
- Short out the oscillator section of V2 to prevent spurious beats in the mixer during alignment.
- Connect the diode plates of V6 together, so V6 will act like a simple half-wave rectifier.
- Connect the "hot" lead of the V.T. voltmeter to the negative side of R26 (point 2 on Fig. 1) and the "cold" lead to ground.
- Set the V.T. voltmeter range selector switch to the position that gives the lowest practicable reading.

- Feed just enough signal from the signal generator to the limiter grid to give a substantial reading. Note: The modulation switch of the signal generator should be in the off position during the entire alignment of the receiver.
- Adjust the primary trimmer of T4 at point 3 for maximum voltage indication on the V.T. voltmeter.
- Disconnect the lead across the diode plates of V6.
- Disconnect the "hot" lead of the V.T. voltmeter from point 2 and connect it to point 4 on Fig. 1. You will now be reading the total D.C. voltage across R25 and R26.
- Adjust the secondary trimmer (5) of T4 for zero voltage indication on the V.T. voltmeter.
- Swing the signal generator tuning dial to 3575 Kc. and note the voltage reading on the V.T. voltmeter; it should be negative.
- Swing the signal generator tuning dial to 3425 Kc. and note the voltage reading on the V.T. voltmeter; it should be positive, and the same value as in (m). Note: Checks (m) and (n) are made to indicate whether or not the discriminator is responding linearly to the plus and minus 75 Kc. deviation in frequency encountered. If the same voltage readings are not obtained in (m) and (n) all of the constants of the discriminator should be checked to determine the fault. This method is the simplest and most accurate for aligning the discriminator circuit if carried out systematically.

(Continued on page 369)

Fig. 2—A cathode-ray oscilloscope, with a frequency-modulated signal generator, may be used to considerable advantage in checking and adjusting FM receiver circuits. A good electronic voltmeter is also necessary.

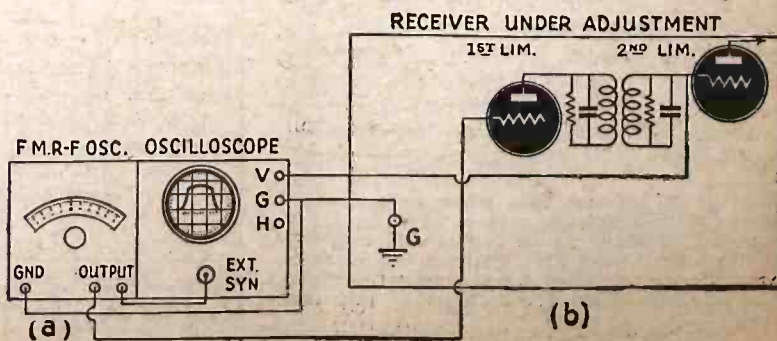

Modernize

The Ancient Radio

By WILLIAM B. MILLER

THE war, it is said, has crowded the normal progress of more than 20 years in radio and electronics, into the brief span since the beginning of hostilities. It has had an opposite effect on civilian radio. More than one family has dragged discarded sets from attic or cellar because of the failure of the modern radio, which of course used irreplaceable tubes. Some of these date back to 1933 or earlier.

Repairmen—and even skilled non-professional radio enthusiasts—are besieged with requests for modernization of these ancient boxes. In many cases such requests should be turned down. Sets that were not good when manufactured will be little better after a hasty "modernization." Attempts to make superheterodynes out of the still excellent RE-45 or similar jobs will fare little better.

There are many excellent old receivers which can be modernized with excellent results, even in this period of no parts, no tubes, no nuthin'! Cases have even been reported of hopeless old-timers with an excellent audio and being combined with the family midget, which had a burned-out 25L6. The hybrid radio was of course much better than either of its parents had ever been.

Any job, no matter how limited, must be well planned. Power supply is, perhaps, the most frequent stumbling block to modernization, as the older type tubes used 2.5 volt heaters and usually operated with only 180 to 200 volts on the plates. Modern tubes use 6.3 volt heaters and to secure the maximum performance plate voltages reach 315 volts in some cases.

An inexpensive filament transformer will take care of the heaters. A few changes will increase the voltage output of most power supplies considerably. If the filter system includes a choke as well as the speaker field a choke can usually be eliminated and additional or larger condensers used. Its removal will lower the D.C. resistance and increase the voltage by as much as 30 volts in some cases. If the speaker is to be replaced select one having a lower field resistance. Should the filter use a choke input, substitute condenser input, using a large condenser.

Another way to increase the output is to use an 84-6Z4 rectifier, provided the 6.3 volts are available for the heater. This tube has an internal drop of about 22 volts as compared with 60 volts for the 80 rectifier. Voltage dropping resistors will usually be found and can be lowered or eliminated to suit the needs, but be sure there is enough voltage on hand to warrant the use of newer tubes.

It is fairly easy to add a.v.c. to receivers not having it, provided the original circuit is straightforward and there is enough gain. The best way is to change the second detector to a duo-diode-triode such as the 6Q7 and use one diode plate for half wave detection and the other for a.v.c. Be sure and use blocking condensers between the low end of the a.v.c. fed coils and the tuning condensers in both R.F. and I.F. stages; .05Mfd, 100 v. is a good value.

To find the best values of resistance to use in an a.v.c. circuit, or in any circuit for that matter, substitute a variable resistor such as a Clarostat and vary it until the best results are obtained. An ohmmeter test of the Clarostat will then give you the correct value of fixed resistor to use. In T.R.F. sets, where a.v.c. is to be added, it is not always convenient to place the diode load between the detector tuning condenser section and ground. The method shown in the diagram is recommended. Tone controls, of course offer no problems and push-buttons are merely a mechanical job.

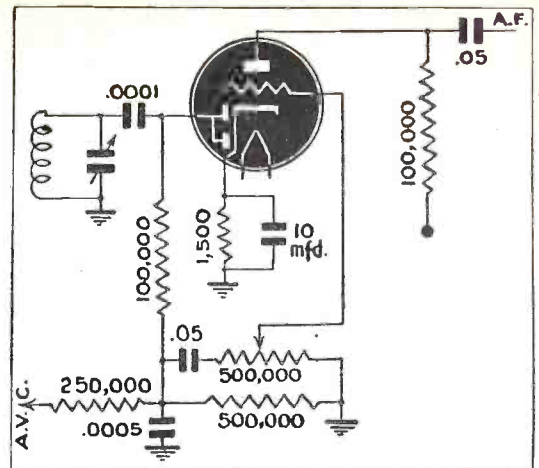

Circuit for adding a.v.c. to old receiver.

Iron core I.F. transformers will increase the gain of single stages considerably and if the work is done carefully and the set properly aligned the selectivity and gain will almost equal two stages of ordinary I.F. By using iron core transformers in a two-stage set the peaks can be slightly staggered, resulting in better fidelity with no loss of selectivity. Iron core antenna and R.F. coils make a world of difference in overall performance in any set.

MUSIC MAKES MORALE

INDUSTRIAL music is invariably a valuable factor in increasing production and stimulating morale, wherever properly and sufficiently used.

This conclusion is the result of a survey recently conducted by the War Production Board. The survey was conducted by the well-known conductor and composer, Wheeler Beckett. After an investigation of 100 war plants, he reports that music in the factory is immediately approved by the workers, and—a little later—greeted with equal enthusiasm by the management.

RCA figures indicate that more than 1,000 of the nation's leading war plants are equipped with sound systems. Probably about 50% of these were installed since July, 1942. Thus a new development appears on the American industrial scene.

The length of the programs given has a direct bearing on the step-up in morale and production, according to the WPB survey. All plants using music for more than one hour per shift reported good effects, 66% of this group claiming production increases of from 5 to 10%.

The investigation apparently did not go into the statistical elements as did that made by the Stevens Institute some months ago. No reports are given as to absenteeism, lateness and afternoon slump. Industrial music has been shown to be a powerful weapon fighting these hindrances to peak production.

The prime value of music in relation to efficiency was found to lie not in speeding up the workers to

greater efforts, but in relaxing unnecessary tensions and creating a pleasant atmosphere for work. Thus may be set at rest the fears of those employers who wished to have smart foxtrots playing continuously and felt that calmer selections might slow down production.

The survey also discovered that music can be used as successfully in noisy departments as in quiet sections; that the workers should be given some choice in the selection of numbers and not be permitted to get the idea that they are the guinea pigs in a production experiment; and that the use of the plant sound system for non-musical purposes alone usually justifies the expense of installing and keeping it up. These uses include paging, announcements, air-raid alarms, talks by visitors and management and radio broadcasts of news and speeches of national or local importance.



Electronic methods are used to produce the light seen in fluorescent lamps. The same electronic effects may be put to other uses than of simply producing light. Mr. Shepard describes a number of these, and his investigations open a vista of still further interesting experimental work.

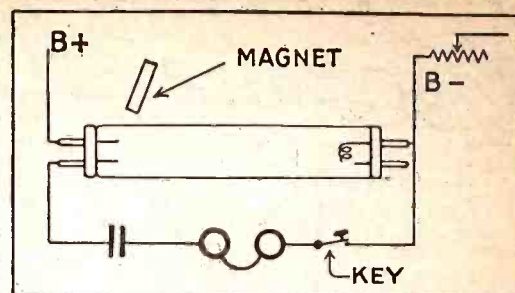
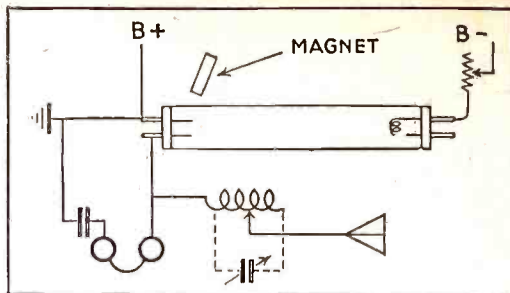

Left—How the fluorescent tube is hooked up as a diode detector, with a slider-tuned antenna circuit. Right—The same tube hooked up as an audio oscillator. Oscillation may be controlled by the magnet and by varying the resistor shown at B in the diagram above.

Fluorescent Radio Tubes?

Burned-out Lamps as Detectors and Oscillators

By L. E. SHEPARD

FLUORESCENT light tubes which have burned out filaments on either or both ends can be used as Diode Detectors and Audio Oscillators. The radio-electronic experimenter can have plenty of fun with some of the phenomenal characteristics which will manifest themselves when the inert gas of the tube is ionized by a source of D.C. potential.

All that is necessary to conduct these experiments is a few old burned out tubes, a pair of head phones, a small condenser (approximately .25 MF to 1. MF) and a home made tuning coil to tune in the desired frequency of the local station to be heard.

The end of the tube to which the negative D.C. is supplied, must have at least a part of the original filament still attached to the anchor wire which goes to the contact pin. The coating on this filament is the electron emitting material which is necessary to supply electrons. These electrons will be attracted to the positive end of the tube. At the end of the tube used for the positive, the original filament can be completely burned off. All that is necessary is the anchor wires in the tube, which act as plate or grid. A few typical circuits are shown. The source of D.C. can be any old "B" eliminator or a "B" power pack from an old radio set, provided that the current has been filtered to eliminate hum. A variable resistance of approximately 25,000 to 250,000 ohms, should be inserted in series with the circuit to control the current.

If tube should not start to glow when a voltage of about 250 volts is across it, it can be started by rubbing a dry rag from the positive end to the negative end. The static electricity thus created is generally sufficient to ionize the gas enough to start the current flowing. The resistance

should then be increased to lower the current through the gas and a steady glow is maintained. If the resistance is increased too much, there will not be enough energy to keep the cathode hot and the electronic emission will cease and only ionization of the gas will take place. Magnets applied near the ends of the tube while it is glowing will control any audio oscillations which may be present. A slight increase in light of the fluorescent material also may be noted when magnetism is applied near the negative electrodes.

The regular 20 watt and 40 watt tubes work very nicely. While glowing, a 20 watt tube will only have a potential of about 50 volts across it while the 100 watt will have approximately 100 volts. The current in the circuit will be 50 to 100 mils for a 20 watt and 100 to 200 mils for the 40 watt tube.

Various other experiments may present themselves, as the inert gases are affected by static electricity and magnetism. A circuit along these lines is shown.

The capacity of the condenser is not critical. Its only purpose is to block the direct current from the head phones.

If you should burn out an old tube on purpose and are lucky enough to have the filament and anchor wires burnt off completely, a magnet applied to the outside of the glass, will attract this filament to it. Then if the magnet is rotated in a circular motion, the filament which is held against the inside of the glass by the magnetic attraction from the outside, will have a scraping effect and dislodge the fluorescent material it touches. This will give a clear glass window to see through and the action at the electrodes can be noted.

If the tube should glow very dimly and not demodulate a R.F. signal, it probably is due to the fact that the filament has been burned completely off. It is only necessary that a small part of one filament be left. The end of the tube which has filament left connected, of course, is to be used as the negative end.

Waves from Bullets

Bullets—in the form of tiny drops of mercury—fired from two hollow, metallic radio tubes, like bullets from the barrel of a gun, make possible the generation of radio waves only a few inches long when these discharged mercury "bullets" collide with one another. The resulting waves are useful in radio communication.

The novel system, in which liquid metal drops are harnessed as an aid to ultra-short-wave radio, involves the use of one metallic tube charged with positive electricity, the other tube negatively charged. These tubes are positioned at such an angle that the positively charged drops of liquid metal collide with the negatively charged bullets. These opposing charges, naturally, neutralize each other and thus produce micro-radio waves.

Issuing from a pair of spaced nozzles, like water sprayed from a lawn sprinkler, these mercury bullets are fired in very rapid succession—a continuous train of waves being generated. After the positive and negative charges collide, with the relative impact of two oncoming railway trains, and are thus neutralized, they drop into a collecting pool from which mercury is fed to the firing tubes.

While the veil of secrecy is lifted sufficiently by an enemy country to permit seepage of details of this invention into the United States, our own American radio engineers are developing micro-radio waves as an ally in winning the war and as a challenging industry during the post-war period. The Japanese sneak-punch at Pearl Harbor was an impetus to radio science and the entire pattern of war strategy has been transformed by the micro-wave-radio technique. Radio progress, it is generally admitted, has been far-reaching and spectacular in the ethereal realm of these "finger-length" waves—where communication is effected over highly concentrated radio beams, acting like light waves.—S. R. W.

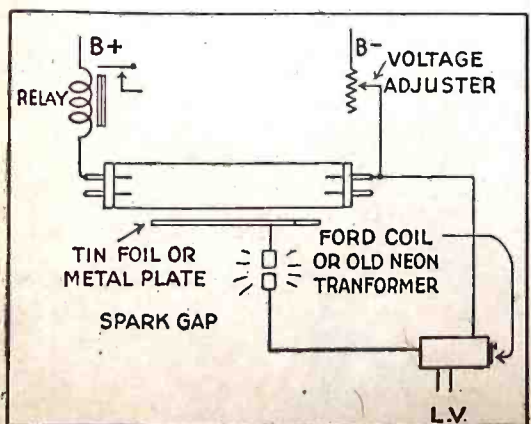

Left—An electronic relay. The high-frequency disturbance causes the gases in the tube to become ionized and current to flow in the external circuit, throwing the relay. Below—A different type of detector circuit.

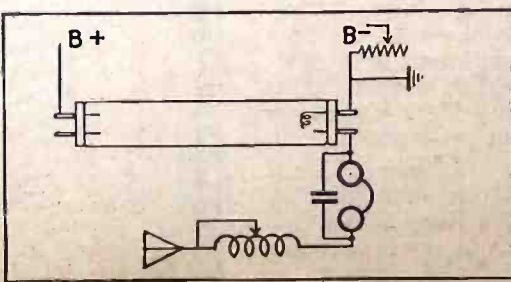

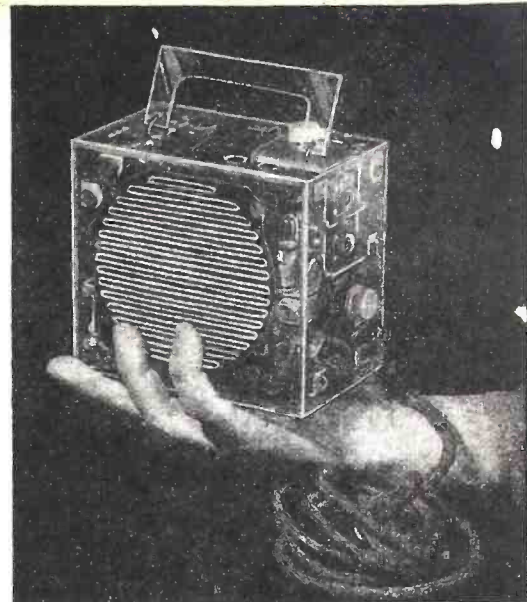
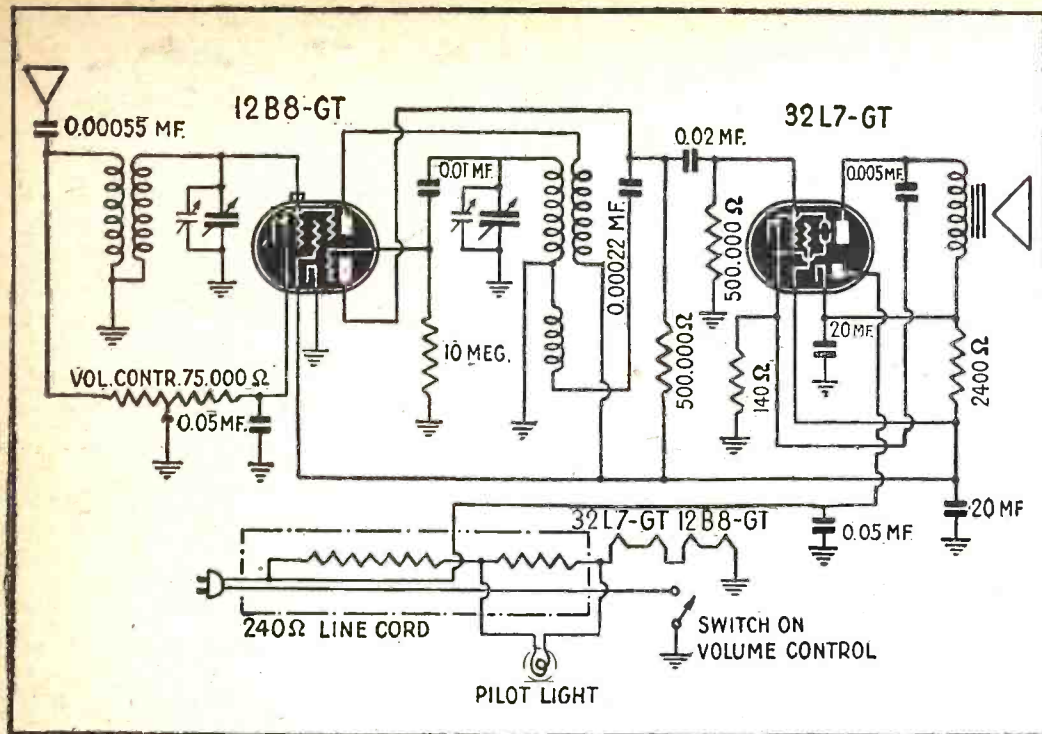

This plastic cabinet has a carrying handle of the same material. All the efficiency of the original radio has been preserved even though parts are much closer together than in the original miniature Emerson receiver.

THE "PLASTIC" RADIO

A two-tube receiver in an attractive plastic cabinet

By IRVING MINTON

I HAD one of the smallest old Emerson A.C.-D.C. sets which had been shelved because it had a badly cracked bakelite cabinet and was not working. One of the tubes was burned out and some connections in the wiring were broken. Because of this I decided to construct a still smaller set and to make it more attractive in appearance.

While browsing around in one of the radio shops I saw plastic panels which were very transparent and clear as glass. These panels, I was told, were easy to drill and cut. This material inspired me to carry out my purpose of constructing a personal receiver. I ripped the Emerson set apart in my spare time; saving the four-inch speaker, the two-gang variable condenser, the 75,000-ohm volume control and the two antenna and detector coils. As to the resistors and the tubular condensers and the tubes, I had no problem in obtaining them either from my personal supplies or what I was able to get in radio shops.

CONSTRUCTION DETAILS

I then made a chassis out of a small piece of aluminum sheet. It is difficult to get aluminum at the present time, but tin might solve the problem.

The dimensions of the chassis are 4½ inches long, 3 inches wide and 1 inch in height. On this I mounted the four-inch speaker and the small two-gang variable condenser. The two sockets for the tubes were placed close together to save as much space as possible. After mounting the speaker, the condenser and the tubes, there was ample space left to place the coils, tubular condensers and resistors.

Carefully following the circuit which is a regular A.C.-D.C. tuned radio-frequency receiver using only two tubes, a 12B8GT and a 32L7GT, I wired the set. The diagram shows the proper connections and parts used. In order to make the set very compact I had to place the volume control on the side of the cabinet and not

in front. The condenser was also placed so that the knob attached to the shaft of the condenser was on top of the cabinet. The photograph clearly shows the position of the two white knobs. Of course all the parts including the speaker were fastened to the chassis with small angles, screws and nuts.

THE PLASTIC CABINET

Now I proceeded with making the cabinet itself. The cabinet was made only after careful measuring and planning, taking into consideration the thickness of the plastic panels. Its measurements are 4¾ inches in width, 5 inches in length and 3 inches in depth. The panels are fastened together with small angle brackets. After the cabinet was completed I found that the chemical acetone would fuse the panels together. By using it I could have made the receiver much smaller. The front panel of the cabinet, which is 4¾ by 5 inches, has slots ⅛ of an inch wide and are directly in front of the 4-inch speaker. In order to get these slots on the panel I first pasted a piece of white paper on it with rubber cement and drew a circle four inches in diameter in the center of the panel. Then I penciled out the slots carefully and cut them out with a jig saw. When the slots were cut and the paper was removed I evened out the slots with a flat file.

The receiver also has a handle, as you can see from the photograph. This handle measures 4 inches in length and an inch and a half in height and is also cut out of plastic. It is fastened with two little rings to the center of the top of the case. The rings allow the handle to lie flat when not in use. The pilot light is placed inside the case, and when the receiver is turned on it illuminates the inside construction, and lights up the whole case.

I must add that the receiver is completely enclosed with plastic panels. This means that both the back and the bottom of the receiver are plastic-enclosed; alto-

gether six panels. In order to prevent these panels from warping when the tubes are lit, I cut square openings right behind the front of the tubes. On the side panels, which are close to the tubes I also made openings.

The receiver is decorative, has good volume and sharp tuning. It is very attractive because of its size and material.

NON-ELECTRONIC

Commander Eugene F. McDonald, head of Zenith Radio Corporation, always sees callers who have a new development to offer. Thus, when a man telephoned the other day to say he had a new type of hearing aid, McDonald made an appointment with him.

When the man came in he was wearing the device, and he took another one from his pocket so McDonald might examine it. "It was nothing but a little black plug of plastic that rested in the cavity of the ear, and a little black string hung down from the plug which could be put inside a man's coat or a woman's blouse," explained McDonald. "It was absolutely nothing but a black dummy plug."

He looked at the man to see if he was kidding him, or whether he was another nut, and told him the device didn't do anything.

"It's true this thing doesn't help one hear, but it makes you talk louder and more distinctly," explained the caller.

"Therefore I can hear better what you are saying. I've found that this badge of deafness helps because the minute you notice this black ear plug and the string you talk louder, hence I can hear better."

Commander McDonald does not plan to market this particular type of hearing aid, but he was thinking of hiring the man as a salesman.

—From June Provinces "The Chicago Sun."

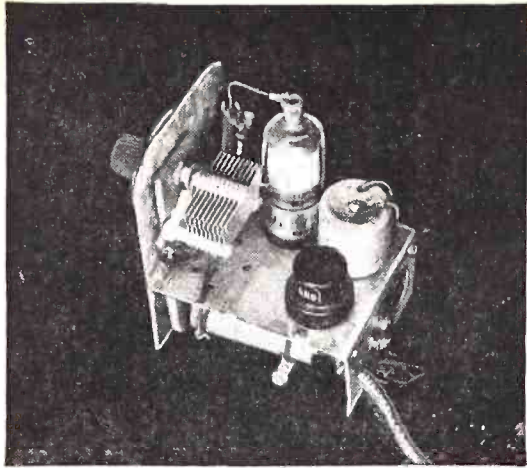

Right — Diagram of the "Post-War" radio and its 6H6 power supply. A regenerative detector-triode amplifier are combined in 1 tube. Left — Photograph of the little radio. Socket at rear of chassis is for the plug-in coils.

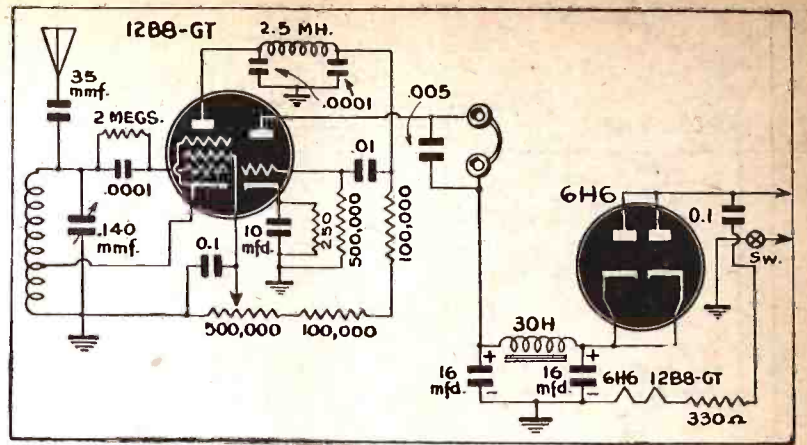

A "Post-War" 2-Tuber

A 12B8-GT Combines with a 6H6 Power Supply in This Radio

By HOMER L. DAVIDSON

It will be a great day when this global war comes to an end and post-war life will resume in all phases of industry. The hams will go back to the ether with their high- or low-powered rigs and radio-chatter will again fill the cans of the ardent short-wave listener. This little receiver is called a post-war experiment for several reasons. One reason is because during the period before the global war the electron tube (12B8-GT) was in its infancy and had many advantages due to its multi-electrodes. Another reason was that this receiver first went into action during the disastrous night of December the seventh, when, as you know, all hams' bands ceased, went dead.

The electron tube is an octal base 12B8-GT double purpose type with a pentode and triode section. The pentode amplifier section was converted into a regenerative detector, using the modified Hartley circuit. This section proved to be more satisfactory than the triode due to higher gain and by using the second grid to vary the regeneration. It has a varying potential controlled by a 50,000 ohm variable resistance located in the middle of the lower quarter of the front panel.

The triode section is a conventional audio amplifier. It is capacity-coupled to the 2.5 M.H. choke in the plate section of the detector circuit. A 250 ohm ½ watt carbon resistor with a 10 mfd. 25 volt electrolytic capacitor in parallel to ground biases the triode section. This dry electrolytic condenser prevents degeneration hum. A resistance of 500,000 ohms is connected from grid to ground.

The R.F. filtering section consists of two .0001 mfd. mica capacitors and a 2.5 millihenry shielded radio frequency choke. The first by-pass condenser by-passes the R.F. to ground with the help of the 2.5 M.H. choke. What R.F. may exist in the output of the choke is cancelled by the second condenser.

A plate load resistance of 100,000 ohms was soldered from R.F. choke to the source of "B" supply and connected also to this junction is another 100,000 ohm resistor in series with a variable 50,000 ohm resistance to vary the regeneration of the little post-war receiver.

The modified Hartley circuit consisted of a tapped solenoid inductance tuned with a variable capacitance of .00014 mfd. These coils were wound on old tube bases, though the standard form can be used. Since the

4 prong socket is mounted horizontally to the rear of the chassis, a 4 prong socket taken from a tube base does not protrude too far from the rear back panel. A grid leak of two megohms with a shunt condenser of .0001 mfd. connects directly to the grid cap and the other end of the rotor of the variable condenser. The small trimmer was mounted through a hole in the chassis so adjustment could be made with an insulated screw driver. This adjustment is not critical.

THE RECTIFIER SECTION

A halfwave rectifier using a small metal 6H6 double diode vacuum tube supplied enough plate and screen potential for the detector and audio stages. The pulsating direct current was filtered with a 30 henry choke and two parallel electrolytic paper condensers of 16 mfd. each. If hum still exists larger capacitance can be added in parallel with the other two condensers (although this won't be necessary). The two vacuum tube heaters were wired in series with a 330 ohm line cord resistor. If this is not available a 330 ohm wire wound resistor of 50 watts may be used. A small line filtering condenser is placed directly behind the on and off switch to eliminate line noises.

The panel layout is very simple as only two pieces of galvanized sheet metal are used. One of the panels consists of the base or chassis. It was laid out and drilled before being bent. One large socket hole is drilled or chiseled out and the 12B8-GT, 8 prong octal socket is placed ½ inch from the edge and two inches from the rear. This socket should be placed so that the variable condenser will open and close when the tube is inserted. Right behind this socket, ¼ inch from the rear edge, is the shielded R.F. choke. Only three holes are drilled for this choke, two for the flexible leads and one for the mounting screw. One large 4 prong socket hole is drilled along the back of the chassis so the coil will mount horizontally. Also placed beside this socket are holes for two phone jacks and a ⅜ inch hole for the line cord. A rubber grommet should be placed around the hole after the cord is inserted into position to prevent damage to the insulation. Two holes are drilled in the front panel. The variable

condenser is mounted 1½ inches from the top of the galvanized panel, centrally located. A small volume control with switch was placed under the chassis in line with the tuning control. All of the resistors and condensers are placed under the chassis.

Coils may be wound according to the wire size you have. The Hartley circuit makes them non-critical. Make the tap about a quarter of the way up for a start, then move it up or down till you get good control of regeneration with the 50,000-ohm potentiometer.

Here are a few don'ts: Do not solder the ground returns to the chassis but to an insulated common ground terminal. When using an external ground place a .1 mfd. condenser in series with the grounded terminal. Don't do a "sloppy" job of wiring! A good, clean job will always reward the constructor. Don't forget to check the wiring four or five times before plugging into the A.C.-D.C. power line. One wrong connection can destroy those precious vacuum tubes.

If the constructor does have a 12B8-GT tube on hand this receiver—even during the present war period—still has many advantages on the broadcast, police and foreign bands as they are still scattered through the ether. If tube cannot be obtained, save these plans until the post-war season is open and put all those extra dollars in War Bonds!

Anti-Noise microphones were carried by the NC-4, pioneer trans-Atlantic plane, as reported in the *Electrical Experimenter*, July, 1919: "A special feature of the telephone sets is the *anti-noise microphone*, which is so constructed that the engine noises are not heard. This is accomplished by having the back of the microphone open. The exterior sound waves strike the back as hard as the face of the diaphragm, and even though the operator cannot hear his own voice, the radio sets receive enough effect to modulate the transmitted wave.

"This single item has been the deciding factor in success or failure in long-distance transmission of telephone by airplane. It is easy enough for short distances to get communication with an ordinary microphone, but for long ranges it is impossible without the anti-noise transmitter."

(See also the inventor's letter, page 352.)

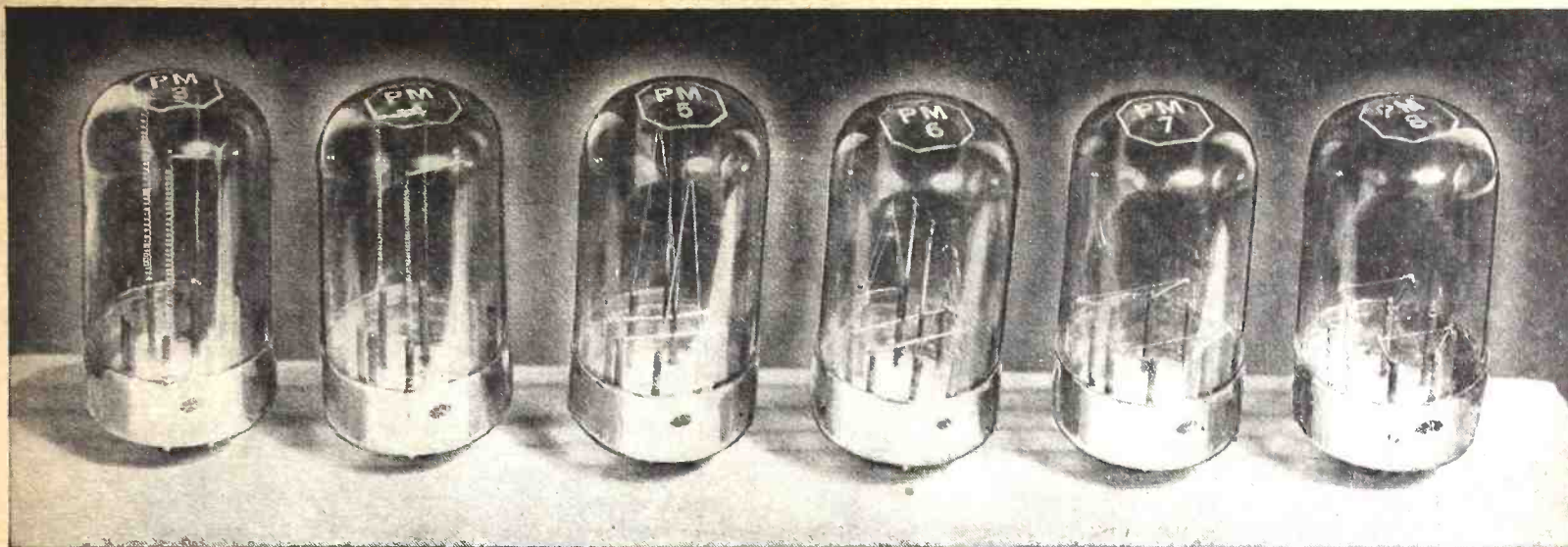

LAMPS MEASURE POWER

MEASUREMENT of radio frequency power has always been a difficult problem to the amateur and experimenter. The crude system adopted by many amateurs has been to insert a lamp into the tuned circuit, and to guess from the brightness and wattage rating of the lamp, what the power output of their transmitter might be. A slightly better system calls for measuring the current through the lamp with a thermocouple meter. Since the resistance of the lamp varies greatly at different degrees of brightness, and the voltage across it is usually not known, this method does not give much better results. A vacuum-tube voltmeter across a non-inductive resistor may be inserted into some circuits, but in others the extra capacity, resistance and inductance which would thus be introduced would throw the circuits off so far as to make its use impractical.

Sylvania has approached this problem from a new angle, with a series of Power Measurement Lamps. These lamps have two identical filaments in the same bulb. One of these filaments is connected into one of the leads of the circuit under study, and lights more or less brightly, according to the strength of the current through it. The other filament is connected to a variable power supply, which is adjusted till the two filaments are of equal brightness. As they must now be dissipating equal power, and as the measurement of the D.C. or low-frequency A.C. voltage and current supplied to the "control" filament is simple, the R.F. power in the circuit can be measured accurately.

Six of these Sylvania Power Measurement Lamps have been made available up to the present time. They are rated to measure power from 0.05 watt to 25 watts.

The range may be extended into the higher power region by using a dark glass filter for visual comparison of filament brightness. If a suitable photocell detector is available the useful range can be still further extended. It would not be advisable to operate above the maximum power or voltage listed since a permanent sag may be put in the filament if these values are exceeded.

Because of the high heat conductivity and small diameter of the filament material, the temperature and color will be constant for a given quantity of energy dissipated, regardless of whether the heat is liberated uniformly throughout the cross section as with D.C. or non-uniformly due to skin effect at ultra high frequencies. Power can

be measured at any frequency at which it is possible to couple the energy into the lamp filament. (Series tuning capacitance or resonant lines may be required.)

The high frequency resistance of the power lamp does not differ appreciably from the D.C. resistance up to the frequencies given in the characteristics, for due to the small wire size the depth of pene-

tration is greater, or at least equal, to the wire radius. When the lamps are used at a higher frequency where skin effect becomes a factor, the resistive component increases; but the power will be correctly indicated as the R.F. current will be less than the D.C. current, resulting in equal R.F. and D.C. I²R products (power values) and equal filament brightness.

Electronic "Wobble-Meter"

UNBALANCE of armatures can be located in $\frac{1}{8}$ to $\frac{1}{10}$ the time required for mechanical balancing with this dynetric balancing unit used by Westinghouse at East Pittsburgh. It is possible to precision balance armatures for 50 HP to 200 HP motors to 1/10,000 of an inch of linear movement. Last month, 1000 armatures were balanced on this machine.

The operator proceeds as follows when he balances an armature: (1) Places the shaft of the armature in floating bearings. (2) Connects the armature shaft to that of a motor driven sine wave generator. (3) Adds a known weight of molding clay to one end of the armature at the 0 reference point of the sine wave generator index wheel. (4) Rotates armature at 600 rpm. (5) Manually adjusts sine wave generator until the rotor is in phase with the stator.

at which point the armature is in balance with the machine. (6) Weight of metal necessary to bring one end of the armature in balance is read on the scale of the large instrument in center of panel. The horizontal movement of the armature, due to vibration, is transmitted by the floating bearings through a mechanical connection to an electrical coil whence it is electrically transmitted to electronic tubes which amplify the unbalance so it can be recorded by the instrument. (7) Sine wave stator index wheel indicates place on armature with respect to 0 reference point of the sine wave generator index wheel where the weight that was read on the instrument must be added to bring that end of the armature in balance. The operator then repeats these steps for balancing the opposite end of the armature.

Tedious work of balancing an armature is eliminated by this new invention of Westinghouse, which indicates the exact point at which weight must be added to the armature, and the amount of metal necessary to bring the shaft into perfect balance.

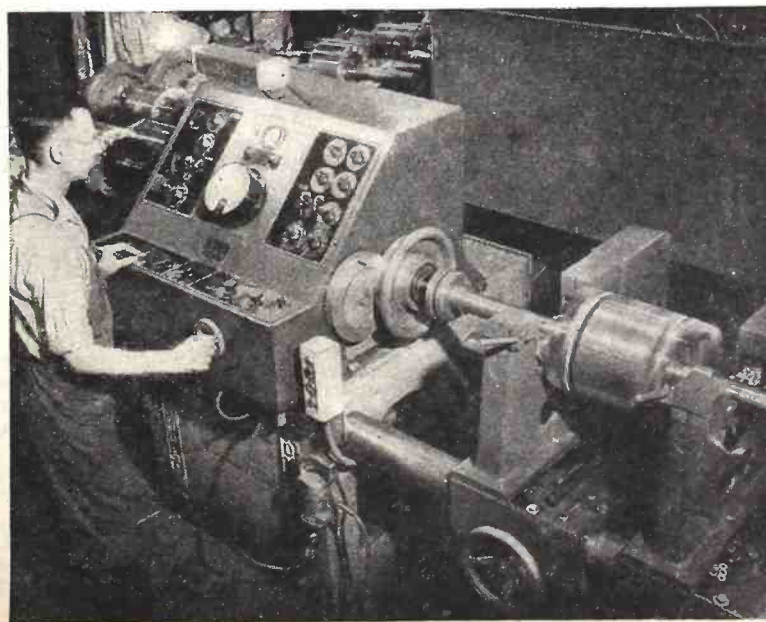

World-Wide Station List

Edited By ELMER R. FULLER

RECEPTION during the past month or two is not what we had hoped that it would be, and therefore little of importance has been heard by our observers. With the coming of spring, it is reported that we can expect better receiving conditions, and therefore more Dx should be heard. It is hoped that soon we will be able to publish a chart showing the receiving expectations for different frequencies at various times of the year.

Late in January, 2R011, in Rome, Italy was heard back on the air after a silence since September 8th of last year. It was heard from 5 to 6:30 pm daily. It is believed, however, that this transmitter may have been moved to Berlin, or other German locations, and is now being used from there. They sign on and off with a piano theme. The frequency now being used is 7.220 megacycles.

Station Debunk has returned to the air

on its old frequency of 10.380 mcs. but does not have any regular schedule. He has been heard on several occasions during the late afternoon and early evening. According to recent news releases, it is believed that all of these so-called Freedom Stations are located inside Germany.

Due to the shortage of paper, it now becomes necessary to limit the space devoted to this department, so we have decided to cut the station list by publishing one third of it each month. In this way a complete station list will be had in each quarter of the year. In the April issue we will publish the second third, with any major changes in the first third. In the May issue, the last third will appear with changes noted in the first and second third. In June we will start over again. It is hoped that this plan will meet with the approval of our readers until such time as the paper shortage is relieved.

The Bureau of Standards in Washington may now be heard at night on 2.500 megacycles, as well as 5.000 megacycles, 10.000 megacycles, and 15.000 megacycles as announced before. This gives a good frequency check on all parts of our short wave bands.

WKD and WQO in New York City, have been heard on several occasions recently, in communication with AFHQ in North Africa. These are point-to-point transmissions and are for the exchange of programs, data on receiving conditions, and press reports. The frequency is about 13.40 mcs. Other press stations in New York City are as follows:—

WBS, 7.355; WDJ, 7.565; WBG, 7.820; WOO, 8.660; WDL, 9.750; WRX, 9.905; WJQ, 10.010; WDO, 14.470; WCB, 15.580; WCW, 15.850.

All schedules below are Eastern War Time. STATION LIST FOR 2.5 to 9 megacycles, inclusive:

Mc.	Call	Location and Schedule	Mc.	Call	Location and Schedule	Mc.	Call	Location and Schedule
2.500	WWV	WASHINGTON, D. C.; U. S. Bureau of Standards; evenings.	6.04	COBF	HAYANA, CUBA; afternoons.	6.200	ZYC7	RIO DE JANEIRO; never heard, as yet.
2.926	GRC	LONDON, ENGLAND; North American Service, 7 pm to 12:45 am.	6.05	GSA	LONDON, ENGLAND.	6.20	GRN	LONDON, ENGLAND; 8:15 pm to 12:45 am.
3.30	YV10RX	CARACAS, VENEZUELA; afternoons and evenings.	6.060	WCDA	NEW YORK CITY; Mexican beam, 7:30 pm to 2 am.	6.2	YV5RN	CARACAS, VENEZUELA; early evenings.
3.470	YV7RB	VENEZUELA; relays YV5RA from 9 to 10:30 pm.	6.065	SBO	MOTALA, SWEDEN; European beam, 5:15 to 5:50 pm; North American beam, 9 to 10 pm.	6.220	—	"GUSTAV SIEGFRIED EINS"; 7:50 to 8 pm.
3.510	YV3RS	BARQUISIMETO, VENEZUELA; relays YV3RA evenings.	6.070	CFRX	TORONTO, CANADA; Sundays, 9 am to midnight; Monday to Friday, 7:30 am to 12:05 am; Saturday, 7:30 am to 12:45 am.	6.235	HRD2	LA CEIBA, HONDURAS; evenings.
4.020	—	PONTA DELGADA, AZORES; 6 to 8:01 pm.	6.080	WLWK	CINCINNATI, OHIO; European beam, 12:15 to 4:30 am; West South American beam, 8:30 pm to midnight.	6.243	HIIN	CIUDAD TRUJILLO DOMINICAN REPUBLIC; evenings.
4.107	HCJB	QUITO, ECUADOR; 7:45 to 10 am; 8 to 10 pm; daily except Mondays; Sundays, 9 am to 8 pm.	6.090	CBFW	VERCHERES, CANADA; daily, 7:30 to 11:30 am.	6.280	HIIZ	CIUDAD, TRUJILLO, DOMINICAN REPUBLIC.
4.70	ZQI	KINGSTON, JAMAICA; Sunday, 6:15 to 6:55 pm; daily, 6:15 to 7:15 pm.	6.09	ZNS2	NASSAU, BAHAMAS; Sundays, off at 10:05 pm.	6.330	COCW	HAYANA, CUBA; midnight to 1 am.
4.75	YV1RV	MARACAIBO, VENEZUELA.	6.095	OAX4H	LIMA, PERU.	6.345	HER4	BERN, SWITZERLAND; 9:30 to 11 pm daily except Saturday.
4.76	YV4RO	VALENCIA, VENEZUELA	6.105	HJFB	MANIZALES, COLOMBIA; 9 to 10 pm.	6.370	—	LISBON, PORTUGAL; home service, 4 to 8 pm.
4.765	HJFB	MANIZALES, COLOMBIA.	6.11	GSL	LONDON, ENGLAND; American beam, 5:15 pm to 12:45 am.	6.370	WKTM	NEW YORK CITY; European beam, 6 pm to 5 am.
4.77	YV1RY	CORO, VENEZUELA	6.120	WCRC	NEW YORK CITY; European beam, 12:15 to 2:45 am.	6.380	HIIX	CIUDAD TRUJILLO; DOMINICAN REPUBLIC.
4.78	YV3RN	BARQUISIMETO, VENEZUELA.	6.120	WKTS	NEW YORK CITY; European beam, 3 to 5 am; 8 pm to midnight.	6.385	HI9B	SANTIAGO DE LOS CABALLEROS, DOMINICAN REPUBLIC; 6 to 8 pm.
4.79	YV6RU	BOLIVAR, VENEZUELA; evenings.	6.120	—	BERLIN, GERMANY; North American beam, variable times.	6.405	TGQA	QUEZALTENANGO, GUATEMALA; 9 pm to 2 am.
4.82	YV5RN	CARACAS, VENEZUELA; evenings.	6.120	LRXI	BUENOS AIRES, ARGENTINA; "Radio El Mundo"; 9 to 12 pm.	6.440	HIIS	SANTIAGO DE LOS CABALLEROS, DOMINICAN REPUBLIC; 6 to 8 pm.
4.955	HJOQ	BOGOTA, COLOMBIA; evenings.	6.130	COCD	HAYANA, CUBA; 9 pm to 1 am.	6.47	COHI	SANTA CLARA, CUBA; afternoons and evenings.
5.000	—	WASHINGTON, D. C.; U. S. Bureau of Standards; Standards of frequency; time, and musical pitch.	6.130	XGOY	CHUNGKING, CHINA; East Asia and South Seas; 7:35 to 9:40 am; North American beam, 9:45 to 11:30 am.	6.480	TGWB	GUATEMALA CITY, GUATEMALA; 7 am to 8:10 pm daily except Sunday.
5.620	OAX2A	TRUJILLO, PERU; heard Sundays 7:30 to 8 pm	6.130	CHNX	HALIFAX, NOVA SCOTIA; Sundays, 8 am to 6:55 pm; Monday to Thursday, 6:45 am to 10:15 pm; Friday, and Saturday, 6:45 to 11 am.	6.715	ZLT7	WELLINGTON, NEW ZEALAND; daily at 5:30 or 6 am.
5.75	PZX	PARAMARIBO, DUTCH GUIANA; Friday, 7 to 7:30 pm.	6.140	WBOS	BOSTON, MASS.; European beam, 3:45 to 5:45 am.	7.000	WGEA	SCHENECTADY, N. Y.; Brazilian beam, 8:30 to 11:30 pm.
5.875	HRN	TEGUCIGALPA, HONDURAS; 7 pm to midnight; Sundays, off at 10:45 pm.	6.140	DXX	BERLIN, GERMANY; 7 to 8 pm.	7.014	CMZI	HAYANA, CUBA; 11 pm to 12:10 am.
5.88	—	CAPETOWN, SOUTH AFRICA; heard around midnight.	6.145	HJDE	MEDELLIN, COLOMBIA; 9 to 11 pm.	7.020	—	PONTA DELGADA, AZORES; heard Sundays 4 to 5 pm.
5.935	PJCI	CURACAO, NETHERLANDS WEST INDIES; 7:45 to 10:38 pm	6.150	CJRO	WINNIPEG, CANADA; 9 pm to 1 am.	7.02	—	MADRID, SPAIN; 5 to 7 pm.
5.980	VONH	ST. JOHNS, NEWFOUNDLAND; Sundays 8:30 to 10:30 am; 1:30 to 6 pm; other days, 6:30 to 10:30 am; 2:30 to 7:30 pm.	6.150	GRW	LONDON, ENGLAND; North American beam, 10:15 pm to 11:30 pm.	7.065	GRS	LONDON, ENGLAND
5.985	WKRX	NEW YORK CITY; European beam, 10 to 11:15 pm; 12:30 to 2 am.	6.160	HJCD	BOGOTA, COLOMBIA; 9 to 10 pm.	7.12	GRM	LONDON, ENGLAND; 8:15 pm to 4 am.
6.005	CFCX	MONTREAL, CANADA; Sunday, 7:30 am to 12 midnight; Monday to Saturday, 6:45 am to 12 midnight.	6.160	CBRX	VANCOUVER, CANADA; 10:30 am to 2:30 am.	7.180	—	"STATION DEBUNK"; 8:30 to 9 pm.
6.010	GRB	LONDON, ENGLAND; evenings.	6.165	HHBM	PORT AU PRINCE, HAITI; 7 to 10 pm.	7.185	GRK	LONDON, ENGLAND
6.010	CJCX	SYDNEY, NOVA SCOTIA; Monday to Friday, 7 to 11 am; Saturday, 6:45 to 11 am; Sunday, 8 to 11 am.	6.170	WCBX	NEW YORK CITY; European beam, 11:45 pm to 3 am.	7.205	BBC	LONDON, ENGLAND; For eastern beam, early mornings.
6.020	ZFY	GEORGETOWN, BRITISH GUIANA; evenings.	6.180	HJCX	BOGOTA, COLOMBIA; 7 pm to 12:15 am.	7.210	—	BERN, SWITZERLAND; heard at 9:30 pm.
6.030	CFVP	CALGARY, CANADA; Sunday, 10 am to 1:30 am; Monday, to Saturday, 8:30 am to 2 am.	6.190	DXG	BERLIN, GERMANY.	7.220	2R011	ROME, ITALY; 5 to 6:30 pm.
6.03	DXP	BERLIN, GERMANY; North American beam, evenings to 1:30 am.	6.19	HHBN	PORT AU PRINCE, HAITI; mornings; evenings.	7.230	GSW	LONDON, ENGLAND; North American beam, 10:15 to 11:30 pm.
6.040	WRUW	BOSTON, MASSACHUSETTS; European beam, 2:15 to 4 am; Central American beam, 7:30 pm to 2 am.	6.190	WGEO	SCHENECTADY, NEW YORK; 12:15 to 3:15 am; European beam.	7.230	KWID	SAN FRANCISCO, CALIF.; Oriental beam, 6:30 am to 12:45 pm.

(Continued on page 361)

Are Radio Symbols Wrong?

RADIO was cursed in its early days by hangovers from the electric industry, of which it is a direct descendant. Because the first electron tube was a slightly modified electric lamp, electron tubes continued to be made in the image of lamps for many years, in spite of the obvious disadvantages.

Diagrams of radio circuits also suffer from the heavy hand of tradition, according to D. S. B. Shannon (I.R.E., Great Britain). Writing in *Electronic Engineering*, he suggests that many improvements from the draftsman's viewpoint could be made in diagrams. His proposals for improvement would result in a revolutionary change in at least the appearance of standard schematics. Present radio diagrams have many advantages. Although it is possible to determine by examining a diagram whether it was drawn in the United States, Great Britain or continental Europe, the modifications are so slight that radiomen from any country in the world, no matter what their language, can understand each other clearly through the medium of the schematic. Nor is the regular diagram difficult for the engineer or experimenter to draw. He can turn out a perfectly understandable sketch even of a complicated circuit suitable for working up into a blueprint or a schematic for publication, in an hour or two.

The situation of the draftsman is not so happy. He may spend a day or more to produce a neat circuit layout from the rough hookup. In drawing the numerous details, each of which must be uniform with the others in the finished drawing, he is likely to note corners that might reasonably be cut. One of these time-wasting corners is the necessity of dropping the rule and picking up the compass whenever tubes, coils, and a few other symbols are to be represented. Another is the grid symbol. This is either a zig-zag line or a broken continuous line, which looks simpler, but actually takes more time to draw than the other. When there are several grids in a tube, such points become important.

A system of drawing which would drastically reduce the number of movements required in representing standard symbols, without reducing the clarity of the meaning, would be worth while, in spite of the natural prejudice felt toward anything new in appearance, believes Mr. Shannon. He therefore proposes a method of drawing diagrams which will cut down the number of motions required in drawing standard tube symbols by approximately one-half, as well as making notable savings in other line work, due to the complete abandonment of the compass. The system is illustrated in the schematic shown here. Above we have a diagram drawn in the conventional (English) manner. Below it is the same diagram drawn in "reformed" style. Startling as it is on first glance, and resembling the art of the cubist, it is absolutely straightforward and easy to read. As an example of the difference in the amount of work required, the triode-hexode first tube requires 38 pen movements in the old version, and only 22 in the reformed drawing.

The new symbols are not likely to be accepted immediately, in spite of the present tremendous shortage of draftsmen. Tradition is not easy to buck, and some of our American engineers could give Europe lessons in staid conservatism. There is, however, at present a movement to reconcile the symbols used by American communica-

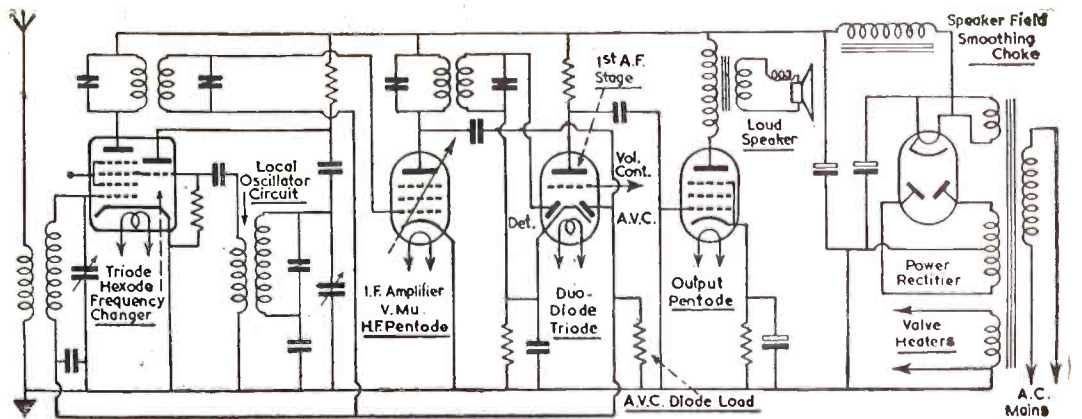

Standard drawing of a 5-tube super. Readers will recognize the English style at once.

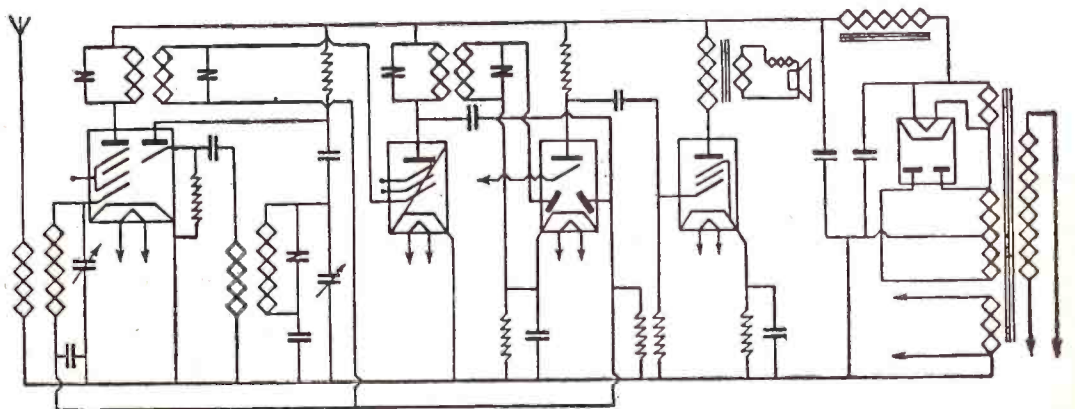

The drawing above, rendered in the Shannon style. Futuristic as it seems at first glance critical inspection shows it to be as easily read and straightforward as any schematic.

tions engineers with those used in industrial and power circuits. If that desirable end should be brought about, the body entrusted with the work might well consider a complete rationalization of the whole system of drawing schematics.

Since any standardization of symbols will bring changes in established signs, with a certain attendant confusion, it might be possible to introduce a thoroughgoing reform of present practices with little greater shock than is bound to ensue in any case.

Tiny Fluorescents Burn 6 Months for a Cent

NO larger than a marble, a new fluorescent lamp has been developed that operates with remarkable efficiency. It gives off more light than a quarter-watt neon glow lamp that consumes two and a half times as much power, according to Westinghouse engineers. For the first time, modern fluorescent lamp efficiency has been obtained in a miniature-size light source. Thirty of these tiny bulbs take no more energy than an electric clock. This economy adapts the new lamp to many military applications, where very little energy is available. Using energy from dry batteries, it might be used to mark a cache of supplies to be left unattended for months. It could also be used as a flashing lamp on life rafts. If available after the war for household use, the lamp could burn constantly for six months (to mark a staircase or keyhole) for about a penny's worth of electricity.

The lamp contains two spiral electrodes in a gaseous atmosphere. A discharge takes place when about 100 volts A.C. or 140 volts D.C. is applied across the electrodes. This creates an ultraviolet radiation that is retransformed (at high efficiency) into a green light—accomplished by the phosphor coating on the interior of the bulb. Other colors are possible, but green phosphors convert "black light" to visible light most efficiently. A tiny resistor in the lamp base stabilizes current flow after discharge begins

It is more than likely that lamps operating on this principle (in other colors and in slightly larger sizes) will be available following the war. They will be useful for marker purposes where low illumination with low energy consumption is desirable.

State police officers whizzing up and down the highways of Massachusetts in their patrol cars can now talk freely with their headquarters and with each other through the new FM system recently installed. It replaces AM equipment which had served the state police for many years, and makes possible complete coverage in every nook and cranny of the Bay State.

There are now 105 FM-equipped cars and seven 250-watt fixed transmitters situated on strategic hilltops throughout Massachusetts (also 25-watt transmitters on the islands of Martha's Vineyard and Nantucket). No car is ever beyond range of one of these fixed stations and, through it, can always contact police headquarters in a matter of split-seconds. Connecticut pioneered in establishing a similar FM set-up, and a number of other states, including Michigan, have also replaced their AM systems with FM. The use of FM police radio is common in hundreds of cities and towns all over the country.—*FM Broadcasters.*

Anti-Noise Mike Not New

Comment from the well-known inventor of the Miessner circuit

Editor, *Radio-Craft*

Your cover, illustrating the "Anti-noise Microphone" described on page 202 of the January issue of *Radio-Craft*, strikes a strangely familiar chord.

In 1916-17, while "Expert Radio Aide for Aviation" with the U. S. Navy, at the Naval Aeronautic Station, Pensacola, Florida, I developed anti-noise microphones employing the very same principle for use on aircraft with intertelephone and radio equipment. Magneto and carbon button types were both used with this "open back" principle, in which cancellation of undesired sounds was effected by equal and opposed sound pressures on the opposite sides of the diaphragm. These developments were described in my official reports to the Navy Department. These were very successful, but a parallel development of mine at the same time with a special type of speaking tube apparatus proved simpler and just as effective, if not more so, since it required no electrical circuits involving other components. At that time airplanes were limited to two airmen and the pilot-observer or pilot-student Airphone (as I called it) answered all the requirements perfectly. This indeed, is still used for pilot training. I obtained patent No. 1,418,388 on this invention on June 6, 1922.

In 1919, however, I continued my anti-noise developments, made numerous models, which I still have, and took hundreds of polar directional curves showing the noise-eliminating action of various types under various conditions.

Among these types was one designed for sound direction finding, and a standard telephone microphone modified to incorporate these anti-noise principles. The direction finder microphone has a directional characteristic exactly like a bi-lateral radio loop, with two broad maxima, and two very sharp minima points.

A third type has a unilateral directional response with but one maximum. On September 2, 1924, I obtained patent No. 1,507,081 on these microphones. The patent application preceding this patent got into an interference with a similar application of Pridham and Jensen (both then with the Magnavox Co.) and their company bought my application and put most of the claims in the Pridham-Jensen patent.

Later, while Consulting Engineer for Wired Radio, Inc. (1924) I continued these developments, not only with microphones, but also with loud-speakers of varying directional characteristics.

These researches were described in a series of three articles for *Radio Broadcast Magazine*, particularly in the September, 1926, issue, and this issue was reviewed in some detail by Carl Dreher in the March 1929 issue of the same publication.

In my published articles I pointed out the advantages and disadvantages of directional microphones and loud-speakers, especially the variation of directivity with frequency, which introduces a serious type of distortion that is hardly even known by the bulk of radio engineers today.

The anti-noise microphone described in *Radio-Craft* differs not one whit from my early developments in principle. It, as was mine, is operated in close proximity to the lips of the speaker so that the voice sound pressure variations are strong on one side of the diaphragm and much weaker on the

other, due to the difficulty experienced by these pressure waves in trying to diffract around the microphone to the opposite side of the diaphragm.

In the unilateral type a shield plate was included for the back side which however had an annular opening to the back side of the diaphragm near its edge. The result of this was to force sound waves approaching this back side to diffract around the edges of the back shield where they would split into two equal components, one operating against the back side of the diaphragm, the other against its front sides and thus neutralize one another.

As before, voice sounds, originating very close to the front side, were much stronger on that side of the diaphragm due to the "sound shadow" around the back side, so that the acoustic sensitivity was not much impaired. I still have the many polar type directional curves of these various transmitters in my files.

The direction-finding type has been used for submarine sounds.

BENJAMIN F. MIESSNER,
Morristown, N. J.

(See also page 348 for a short note on early use of the microphones described above.)

ELECTRONIC LIFE DETECTOR

(Continued from page 342)

age on the cathode with the result that the 56 grid is 12 volts more negative than the cathode.

The plate of the 56 is at a positive potential of 350 volts less the drop in the resistance R7 to earth. Therefore it is at a much higher positive potential than the grid or cathode of the same tube.

The result is that, with respect to the ground, the voltages applied to the 56 tube are approximately 63 volts positive to the grid; 75 volts positive at the cathode, and 275 volts positive at plate.

With respect to the cathode we find that the voltages are: Grid, 12 volts negative; plate, 200 volts positive.

As the voltage applied to the 56 tube is rather critical, a variable resistance, R2, of 10,000 ohms is included in the circuit.

Variation of this resistance automatically



"I haven't found any mines yet, but I've located one lira and a Roman hairpin."

changes the plate voltage of the 57 and the grid voltage of the 56. If the resistance is not correctly adjusted, distortion may result.

THE POWER SUPPLY

The building of the amplifier is simple and so long as a few elementary precautions are taken everything should be straightforward. The size of the chassis is not very important, and as no interstage transformers are included in the circuit, the layout may be arranged as conveniently as possible to the designer.

As readers will have observed, a power pack is used with the amplifier. A considerable length of strong flex should be kept in readiness for use with the apparatus in case of emergency. It is hardly likely that an electric supply will be available from the site of a bombed house, but it is probable that it may be obtained from a building in the immediate vicinity.

I have experimented with a rotary converter which operates from an auto-engine and supplies both A, B and C power, with considerable success. This, of course, abolishes the necessity of having a supply close at hand but in view of the fact that the majority of neighborhoods are now wired with electricity I have described the power pack apparatus.

The circuit diagram shows the wiring of this pack. From it readers will observe that the main transformer has two 2.5 volt filament windings, a 5 volt rectifier filament winding and a high voltage winding delivering 385 volts each side of the center tap. I recommend employing a transformer rated at 100 milliamperes.

The first choke in the power supply is really a speaker field wound to 800 ohms—it should not be higher. The choke L3 is a 30 henry, 75 milliamp. job.

The diagram shows the further details clearly so I will not describe them here.

When the apparatus has been constructed it may be fitted up in a stout box or case and, if required as a life detector, placed in a car and rushed to an incident.

OPERATING THE DETECTOR

Next extend the microphones and locator on their leads (which should be about ten feet or so in length, preferably armored—the armor being grounded). The two directional microphones should be placed so, as far as possible, they are at each side of the debris. Having placed the microphones carefully in position, switch on the apparatus. Now, using one microphone at a time, endeavor to locate sounds from amidst the wreckage. When a sound is heard on one microphone turn to the other one and endeavor to pick up the sounds from a different angle. When this has been done, it will be found possible to locate the approximate position of a trapped person by drawing a straight line out towards the sound from each microphone. The person should be under the position where the two lines, one from each microphone meet.

The locator may be used in cases where no sound is picked up upon the directional microphones, or when external noises make the use of the latter impossible.

\$23,000. WORTH OF HELP FOR YOU!

FOR BEGINNERS! NO PREVIOUS TRAINING NECESSARY

Here, in one big, 972-page volume that cost over \$23,000 in actual cash outlay before a single book was sold, you get complete basic Radio-Electronic Training at a cost to you of only \$5 complete. Think of it! \$23,000 worth of the finest, learn-at-home instruction—at a price so low you simply cannot afford to miss it! And remember: Literally hundreds of successful Radio men themselves state without reservation that you cannot get better, more complete basic instruction AT ANY PRICE. Actually, Ghirardi's famous RADIO PHYSICS COURSE book covers the scope of 36 courses. If it were broken into sections and sold in course form, you'd consider it cheap at \$50 or more!

LEARN RADIO EASIER... LEARN IT FASTER
... at a price you can afford to pay!

Ghirardi's RADIO PHYSICS COURSE book is acclaimed throughout Radio as the "biggest bargain" in easy-to-understand, complete, and fully modern Radio-Electronic Training. This same inexpensive book has given more people their start in Radio than any other ever published. It is more widely endorsed, more universally recommended by men who know Radio, who are in Radio themselves. Because of its sheer merit, it is more universally employed in U. S. Army Signal Corps, Navy, and civilian schools than any other book on the subject. Because it explains everything so clearly, it is more widely used for home study. Facts like these speak for themselves. They prove that you don't have to spend a lot of money to learn Radio-Electronics easily—and to learn it RIGHT!

Ghirardi's RADIO PHYSICS COURSE painstakingly explains everything in detail. Nothing is left out. Nothing is condensed. Over 500 specially prepared illustrations help you visualize every step. You don't need to wait for monthly lessons. All you need is a little spare reading time and a desire to get started right in any of Radio-Electronics' many branches—service work, aviation, military, broadcasting, manufacturing, television, and many others.

YOU DON'T RISK A CENT!

BEST OF ALL, you don't risk a cent. We'll gladly give your money back if, in 5 days, you are not absolutely convinced that this big book will teach you the fundamentals of Radio-Electronics EASIER, FASTER, and at LESS COST than any other book or course. That's how sure we are that it is the best in the field! You be the judge!

No previous study is necessary.

HERE'S PROOF!

"Ghirardi's RADIO PHYSICS COURSE is the handiest and easiest to understand of any Radio book we used in the Navy," writes C. A. Randall, Radio Technician 2nd Class, U.S.N.R.

"This book has really been my instructor. With its aid, I passed the Army Communications Cadet exam. It is virtually a radio encyclopedia." Pfc. Bernard Bragin, Scott Field, Ill.

"I cannot understand how you

could possibly publish a book that completely covers Radio and Electricity at such a low price. I only regret that I did not get my copy sooner." A. DeRossi, Serviceman.

"I have searched all over for a book on Radio which would completely cover the subject and still be easily understandable to a beginner. This is it!" Robert Becker, student.

WARNING! Paper shortages may make it impossible for us to continue meeting the tremendous demand for Ghirardi Radio Books. Order yours today while they are still available!

THE 3 GREATEST VALUES IN MODERN RADIO TRAINING

RADIO & TECHNICAL DIVISION,
Murray Hill Books, Inc., Dept. RC34,
232 Madison Ave., New York 16, N. Y.

Enclosed find \$..... for books checked; or send C.O.D. (in U.S.A. only) for this amount plus postage. If I am not fully satisfied, it is understood that I may return the books within 5 days and receive my money back.

- | | |
|--|---|
| <input type="checkbox"/> RADIO PHYSICS COURSE
\$5 (\$5.50 foreign) | <input type="checkbox"/> MODERN RADIO SERVICING
\$5 (\$5.50 foreign) |
| <input type="checkbox"/> RADIO TROUBLESHOOTER'S
HANDBOOK \$5 (\$5.50 foreign) | <input type="checkbox"/> SPECIAL MONEY-SAVING OFFER
"Modern Radio Servicing"
with "Troubleshooter's Handbook"
\$9.50 (\$10.50 foreign) |
| <input type="checkbox"/> Send FREE literature | |

NAME
ADDRESS
CITY & DIST. NO. STATE

Meet A. A. Ghirardi—the man who has started thousands of students on successful Radio-Electronic careers by making their training easy.

HERE'S HOW TO TEST A RADIO in 2 Minutes or less!

If you repair Radios for a living—or even if you only "tinker" with them occasionally—this big special wartime edition of Ghirardi's RADIO TROUBLESHOOTER'S HANDBOOK is the book for you! 744 manual-size pages contain a complete guide to diagnosing, locating, and quickly repairing practically every type of Radio receiver now in use. Simply look up the Trouble Case History data on the particular set you want to repair. Nine times out of ten, the Handbook will tell you just what is wrong and how to fix it in a jiffy! No extensive testing—no guesswork—no lost motion—more sets fixed per day!

Now contains 404 pages of case histories giving the common trouble symptoms, their causes and remedies for over 4000 receiver models. Also,

hundreds of additional pages on i-f alignment peaks for over 20,000 superhets—parts substitution data—tube replacement charts—and dozens of data sections, charts, etc., invaluable in service work. Only \$5 complete (\$5.50 foreign) on a 5-Day Money Back Guarantee.

Work Twice as Fast!

THE ONLY COMPLETE BOOK ON MODERN RADIO SERVICING

Ghirardi's 1300-page MODERN RADIO SERVICING is a hard-hitting, intensely practical volume worth its weight in gold to the busy serviceman. It is the only single, inexpensive course giving a thorough explanation of the workings of all Test Instruments; Receiver Troubleshooting Procedure; Circuit Analysis; Testing and Repair of Component Parts; Installation; Adjustment; Maintenance, etc. 708 illustrations, 720 self-testing review questions, 768 different topics. Only \$5 complete (\$5.50 foreign) on 5-Day Money-Back Guarantee Basis.

SEE SPECIAL OFFER IN COUPON

5-DAY MONEY BACK GUARANTEE

MAIL THIS NOW!

New Radio-Electronic Devices

SENSITIVE RELAY

Sigma Instruments, Inc.
Boston, Mass.

THE 4-a, illustrated, and all relays of the "4" series are designed to operate at low input currents, varying from a few milliwatts to a maximum of one watt. The normal rating of the single-pole double-throw switch circuit is 150 watts at 110 volts A.C. noninductive. However, when proper provision is made for it and when the input is 100 or more milliwatts, very much higher currents may be carried, and relays of this series capable of handling 20 amperes D.C. at 24 volts highly inductive have been made. Relays of this series are particularly suitable for use in aircraft or wherever vibration is a problem, having balanced springs

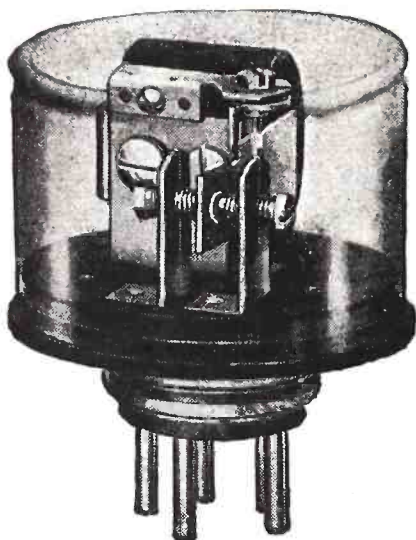

and armatures. For this class of service, inputs of at least 30 and preferably 50 or more milliwatts are recommended. Coils supplied where humidity is a factor will stand the severest tests without failure. Of low mass construction these relays are exceptionally fast-acting and can be made to "follow" pulsations occurring at a rate of several hundred per second. Relays supplied where precise adjustment is required are free from any observable remanence or retentivity effects and can be set for drop-out as high as 95% of pull-on voltage, a valuable feature on many applications.—Radio-Craft

VARIABLE FREQUENCY GENERATOR

Communications Measurements Laboratory
New York City

THE CML 1400, was developed by Communication Measurements Laboratory to fill the need for a versatile source of power, especially for engineers requiring test power at various loads through a wide frequency range. Research laboratories, and an increasing number of manufacturers in the electronics field find this Electronic Generator capable of delivering power with good regulation and waveform over a frequency range of 300 to 3500 cycles.

This electronic generator includes a variable-frequency oscillator, followed by several driver stages. The output stage em-

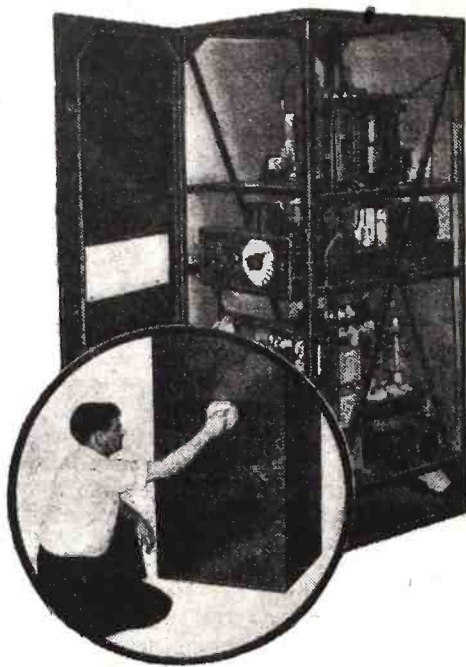

loys a pair of 833-A tubes in Class B. Because of the high impedance of such a power source, the regulation of generators of this type is quite poor, ordinarily. CML 1400 overcomes this difficulty by means of a special control circuit which maintains output voltage at a substantially constant level from no load to full load. Power output is 1400 watts at 120 volts R.M.S., with a load of unity power factor.

CML 1400 is especially valuable where Government specifications call for complete tests on the production line through a wide range of power frequencies. Aircraft radio installations can be tested in the plane, or serviced in the repair shop, without resorting to aircraft power supply and condensers.—Radio-Craft

"SELCO" POWER RECTIFIERS

Selenium Corporation of America
Los Angeles, Calif.

SEVEN disc sizes ranging from $\frac{3}{4}$ " to $4\frac{1}{2}$ " in diameter are available in these recently released power-type rectifier units. Mountings are standard, ample ventilation space being provided.

All the units are stated to be moisture proof and to have permanent characteristics. Assemblies with output up to 1000 amperes can be supplied.

Rectifiers are of the selenium type and are claimed to offer the advantages of high efficiency, high overload factor, unlimited life, maximum output per unit weight and advantageous temperature characteristics.

Selco rectifiers are available for bolt or stub mounting direct to equipment or with mounting brackets as per specs.—Radio-Craft

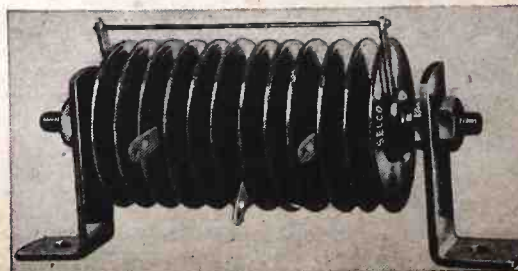

SMALL WIRE-WOUND CONTROLS

Clarostat Mfg. Co.
Brooklyn, N. Y.

A NEW space-saving wire-wound control, Type 43, is now available to manufacturers and government agencies subject to highest priorities covering wire-wound items. Ultimately, it will be a standard item for the trade generally.

This midget control measures only $1\frac{1}{8}$ inch in diameter by $\frac{9}{16}$ inch behind mounting surface. The bakelite body is completely enclosed by the dust-tight metal cap, of by the attached switch. The control virtually matches in both size and general appearance the well-known Clarostat Type 37 or midget composition-element control. The wire winding is curved and held in a concentric slot in the molded bakelite body. The alloy contact arm presses against the inside surface of the winding. The control is supplied with or without switch; in resistance values up to 10,000 ohms; linear tapers only; and is rated at $1\frac{1}{2}$ watts.—Radio-Craft



OIL CAPACITORS

Capacitrons, Inc.
Chicago, Illinois

THE new "EC" oil type Capacitrons are designed as standard components to replace many similar types of special capacitors used in the production of war equipment. They are being manufactured in several capacity ranges with D.C. working voltage ratings from 600 to 1,500 to meet U. S. Signal Corps and Navy specifications.

The new units are locked on the chassis by means of a solid nut and lockwasher through a single hole to clear the $\frac{3}{4}$ " x 16 threaded bakelite neck. The bakelite neck is lock-spun into the extruded, insulated metal container, making possible a 100% hermetic seal. Grounding of either insulated terminal is readily accomplished with a special groundlug. Dimensions of the 3 mfd. and 4 mfd. size units are $1\frac{1}{2}$ " in diameter by $4\frac{1}{2}$ " in height.—Radio-Craft

"THEN I'LL PUT IT THIS WAY—THE
JEEP AND YOUR **ECHOPHONE EC-1**
ARE BOTH REMARKABLE!"

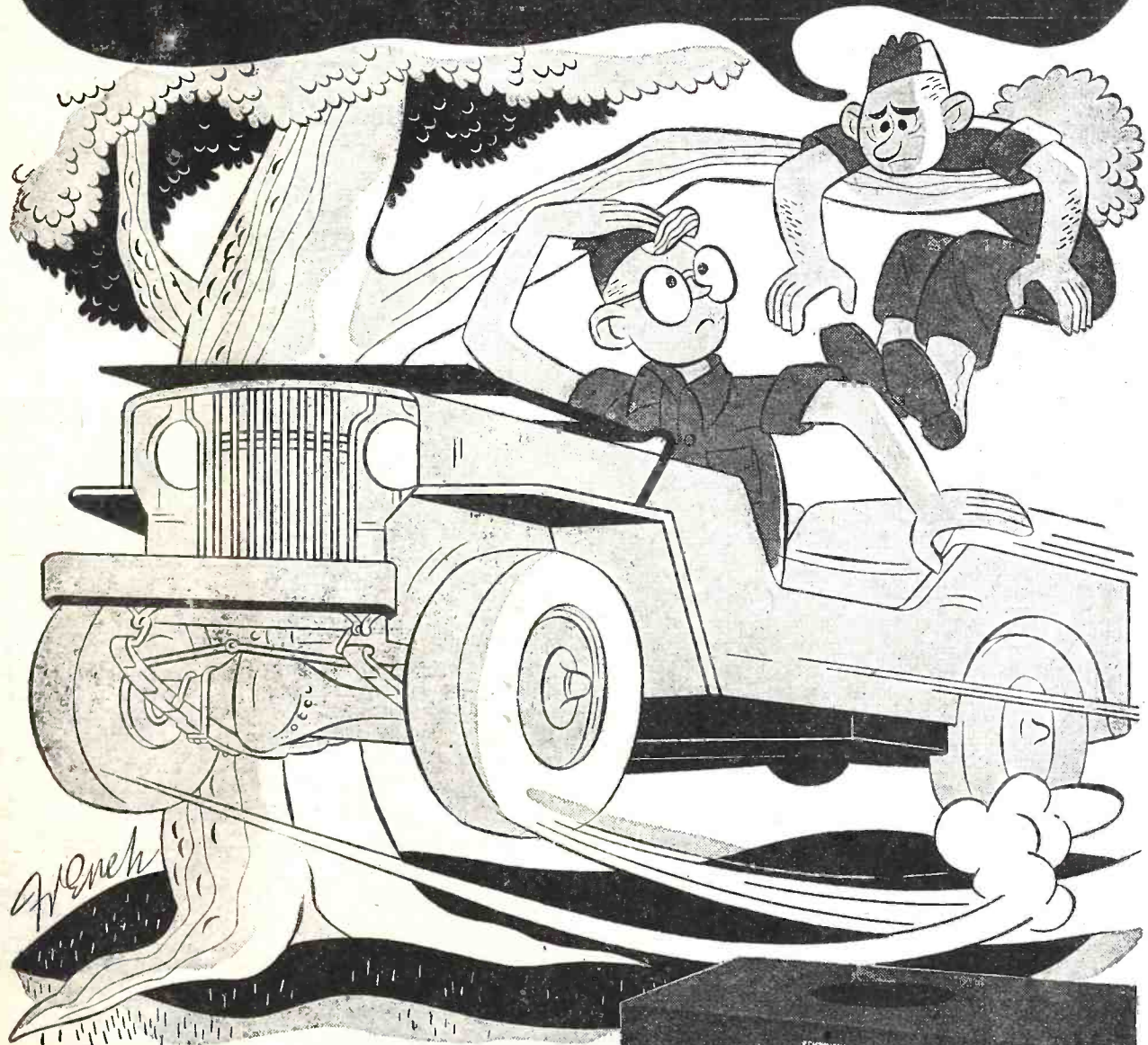

Echophone Model EC-1

(Illustrated) a compact communications receiver with every necessary feature for good reception. Covers from 550 kc. to 30 mc. on three bands. Electrical band-spread on all bands. Beat frequency oscillator. Six tubes. Self-contained speaker. Operates on 115-125 volts AC or DC.

Echophone Radio Co., 540 N. Michigan Ave., Chicago 11, Illinois



*"Why shouldn't I
buy it?
I've got the
money!"*

Sure you've got the money. So have lots of us. And yesterday it was all ours, to spend as we darn well pleased. But not today. Today it isn't ours alone.



"What do you mean, it isn't mine?"

It isn't yours to spend as you like. None of us can spend as we like today. Not if we want prices to stay down. There just aren't as many things to buy as there are dollars to spend. If we all start scrambling to buy everything in sight, prices can kite to hell-'n'-gone.

"You think I can really keep prices down?"

If you don't, who will? Uncle Sam can't do it alone. Every time you refuse to buy something you don't need, every time you refuse to pay more than the ceiling price, every time you shun a black market, you're helping to keep prices down.

*"But I thought the government put a
ceiling on prices."*

You're right, a price ceiling for your protection. And it's up to you to pay no more than the ceiling price. If you do, you're party to a black market deal. And black markets not only boost prices—they cause shortages.

"Doesn't rationing take care of shortages?"

Your ration coupons will—if you use them wisely. Don't spend them unless you have to. Your ration book merely sets a limit on your purchases. Every coupon you don't use today means that much more for you—and everybody else—to share tomorrow.

*"Then what do you want me to do
with my money?"*

Save it! Put it in the bank! Put it in life insurance! Pay off old debts and don't make new ones. Buy and hold War Bonds. Then your money can't force prices up. But it can speed the winning of the war. It can build a prosperous nation for you, your children, and our soldiers, who deserve a stable America to come home to. Keep your dollars out of circulation and they'll keep prices down. The government is helping—with taxes.

*"Now wait! How do taxes help
keep prices down?"*

We've got to pay for this war sooner or later. It's easier and cheaper to pay as we go. And it's better to pay more taxes NOW—while we've got the extra money to do it. Every dollar put into taxes means a dollar less to boost prices. So...

*Use it up . . . Wear it out . . .
Make it do . . . Or do without*



A United States war message prepared by the War Advertising Council, approved by the Office of War Information, and contributed by the Magazine Publishers of America

Radio-Electronic Circuits

ELIMINATOR WITH FILAMENT TRANSFORMER

The following diagram is for the construction of a simple "B" Eliminator. It was made almost entirely of used parts. It uses a type 1-V tube. A 12Z3 may be used if the 20-ohm resistor is cut out of the circuit. The parts are as follows:—

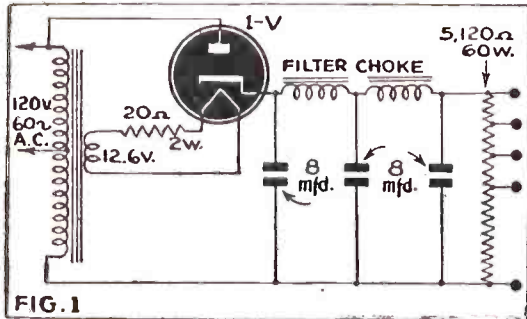

FIG. 1

- 1—Type 1-V or 12Z3 tube.
- 1—2-winding filter-choke (taken from a Model NR55 or NR56 Freed-Eisemann radio).
- 1—Push-pull output transformer (taken from Model 72 Majestic radio).
- 3—8 Microfarad, 300 or 350 Volt Electrolytic Condensers.
- 1—20-ohm, 2-watt resistor (taken from Model 73 Majestic radio).
- 1—5,120 ohm, 60-watt resistor

The push-pull output transformer works as an auto-transformer in this circuit. When the input voltage is 120, the output voltage is approximately 240. The secondary (which led to the speaker when the transformer was used as an output) is approximately 12.6 volts.

HENRY J. RUTOWSKI,
Detroit, Mich.

EXPERIMENTERS!

Radio-Craft is initiating a plan to overcome the bottlenecks created by the unavailability of many standard types of apparatus. The ingenuity of the American experimenter, technician and mechanic is hereby challenged to replace, rebuild or substitute unrepairable or unobtainable equipment.

Every month one project will be announced for the readers of this page to exercise their brains on. Radio-Craft will pay a

FIRST PRIZE OF \$5.00

for the best answer and one-year subscriptions for all others published.

PROJECT FOR THIS MONTH: Bottleneck No. 1—High-Resistance relays. As every technician knows these are impossible to obtain. How do our readers meet the problem thus posed? Send your solutions—construction, substitution, etc.

Suggestions from readers as to other bottlenecks are also welcome. What is your present pressing problem? If you want help with it, tell us so that we can all get to work on it.

"OLD PARTS" MASTERPIECE

This three-tube receiver is made entirely of junk-box parts. The R.F. choke is part of an I.F. transformer, and worked very well. The tickler has 40 turns and is wound over the secondary of the coil.

I was going to use a 6H6 tube as rectifier, but not having one, I used a 6K7 with all the grids tied to the plate. When used this way it supplies plenty of current for the two tubes.

Two old output transformers were used as filter chokes and any condensers from 8 mfd. up to 40 mfd., may be used.

The 40-watt, 110-volt lamp drops the voltage to about 6.5 volts per tube. This works all right, and I have had no trouble with tubes. The set is shown in Fig. 2.

A regenerative set is likely to have a little hum unless an antenna of at least 50 feet long is used. Don't ground the set, though, as it is grounded through the power line.

WILBUR LEMMONS,
Stonham, Colo.

(The set described above shows the possibilities of old parts. A little more attention to design might have resulted in better performance. For example, a cathode resistor of 2,000 or 3,000 ohms on the audio tube should improve quality and cut down the drain on the makeshift rectifier tube. For best results it should be by-passed by a condenser of at least 2 microfarads capacity. Another filter—preferably a resistor-condenser type—in the detector plate circuit would reduce the hum considerably.)

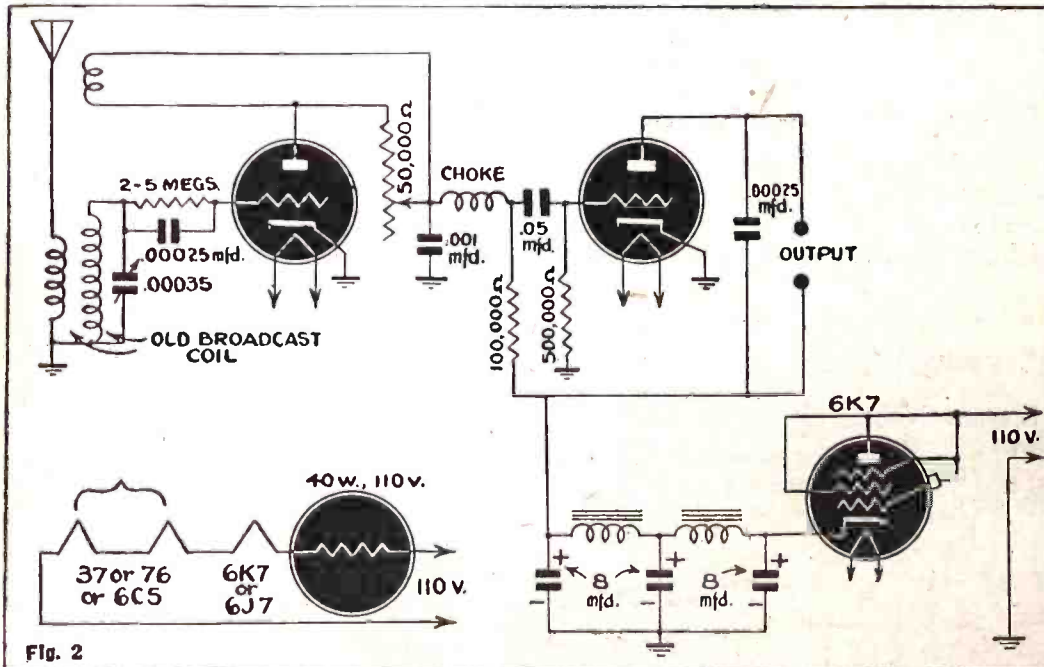

Fig. 2

A NEAT SHORT-WAVER

While there is nothing new about this circuit (a 2-tube regenerative short-wave set with a 1N5-G as grid-leak detector resistance-capacity coupled to a 1C5-G as audio amplifier), it has given me such good results I would like to call it to the attention of your readers. See Fig. 3.

It uses a 3-winding plug-in type of coil. I tried values of grid-leak ranging from 1 megohm to 5 megohms but found the 2 megohm best. The regeneration control is the usual 50,000-ohm potentiometer, used to vary the screen-grid voltage. I found no place on the dial where dead spots occurred and yet the control was not too "touchy."

The plate load for the 1C5-G was a filter choke salvaged from an old electric set. This tube adds greatly to the amplification and will operate a small PM or magnetic speaker on many strong stations.

I have received all continents on this, using only the coil covering the 17 to 41 meter bands. My antenna is 100 feet long, running northwest and southeast. Stations heard include Caracas, Rio, Colon, Havana, many stations in Central America, Mexico and the United States, England, Vichy, Berne, Rome, Moscow, French Equatorial Africa, Australia, Tokyo and Saigon.

The success I have had with the set is due, I think, to using good parts, and in experimenting with it till best results are attained. I have torn this one down and rebuilt it no less than six times.

GERALD A. CHASE,
Princeton, Ontario.

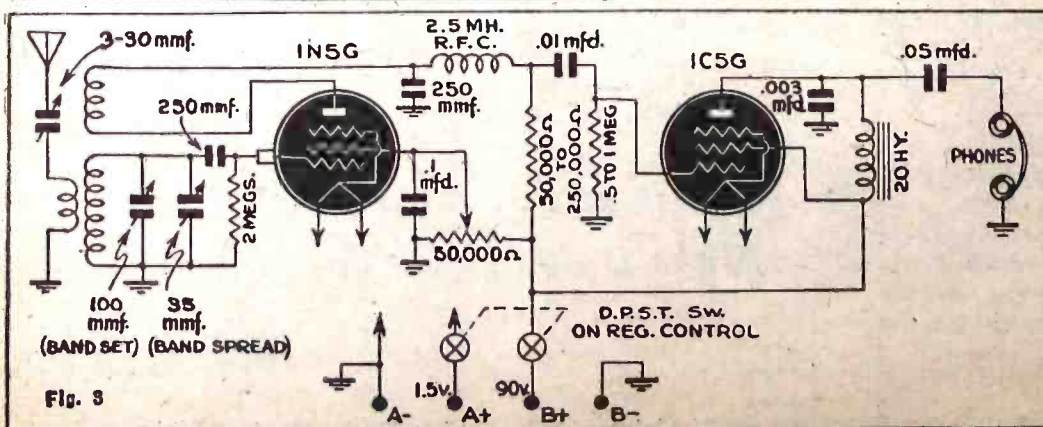

Fig. 3

RADIO-ELECTRONIC REFERENCE-ANNUAL

1943-1944

PARTIAL CONTENTS RADIO-ELECTRONIC REFERENCE ANNUAL

ELECTRONIC THEORY AND GENERAL PRACTICE

Is thoroughly covered in this book in easy-to-grasp language. Among the articles on this subject are: What You Should Know About Electronics—Electronic Tubes for Servicemen—The Electronic Solovox, its theory and action—and The Photoelectric Phonograph Pickup, the principles underlying its operation.

ELECTRONIC DEVICES YOU CAN BUILD

Among the interesting and easily constructed devices selected are the following: Compact Hearing Aid—Oscillex Automatic Key and Code Machine—Electronic Relays, Capacity and Light Operated, High Frequency Radiotherapy, a complete home apparatus—and many other timely types of electronic apparatus.

RADIO CONSTRUCTION

Many well-illustrated, how-to-do-it articles, such as: Phono Oscillators, several types, adapted to playing records through your radio with a simple record player—T.R.F. S's & a's—Superheterodynes—Power Packs for Portable Receivers, making it possible to use your battery portable on the electric light line—A two-tube Super Midget Amplifier, which is a palm-of-the-hand public address system—and many others.

SOUND AND RECORDING, including detailed instructions on constructing: High-Fidelity Amplifier—Exponential Horn with perfect reproduction down to 50 cycles—Electronic Expander-Compressor—Also the Robeson Technique—Semi-Pro Recording—Electronic Bass—and Treble-Expanding Circuits—Equalizers, etc.

TEST INSTRUMENTS

A complete line including: A Tube Checker with universal hookup; can check any tube regardless of the prong to which its elements are brought out—Compact Multitester; 18 ranges of voltage, current and resistance on an 11-point, 2-gang switch—A Three Tube Signal Tracer, capable of checking R.F., I.F., and audio circuits—A Condenser Analyzer which measures both capacity and checks leakage—and an Electron-Ray Voltmeter which dispenses with hard-to-get milliammeters, using a 6E5 tube instead.

SERVICING

Articles on servicing supply a multitude of methods and useful ideas, including: Dynamic Testing with Signal Generator—Modernizing a Test Set—Calibrated UHF Oscillator—And countless other hints for ironing out kinks in your servicing problems.

PUBLISHED BY
RADIO-CRAFT
25 WEST BROADWAY
NEW YORK, N.Y.



FREE—if you
subscribe now to



Are you asking yourself: "What's next in Radio and Electronics?" What mysterious inventions are brewing in radio research laboratories? What effect will these wartime secret inventions have on peacetime conditions? Will the scientists take me into new, unfamiliar fields, requiring special technical education? Or do I know enough to master whatever comes up?

Keep Posted With Radio-Craft

Radio is once again at the cross roads! . . . and so is everyone who is connected with it. All must become students again of a science that has experienced a marvelous rebirth through ELECTRONICS. The question about the near and distant future now racing through your mind will be answered step by step in the forthcoming issues of RADIO-CRAFT—the publication that stands alone in its prophetic vision and its practical help.

You Need This Free Reference Annual, Too!

But remember, you can't plan intelligently ahead—you can't grasp the new—until you have thoroughly mastered the tried and accepted present-day radio developments. And that is where the RADIO-ELECTRONIC REFERENCE ANNUAL comes to your aid. This fact-packed book is THE radio man's digest—compiled to save your time—to give you the meat of the craft's best effort. It's the spark that bridges the gap between the RADIO-ELECTRONIC WORLD OF TODAY and the COMING POST-WAR WORLD.

And think of it—you can get this indispensable reference work absolutely free and postpaid by subscribing to RADIO-CRAFT now—but you must act quickly as the war-paper shortage compels us to limit the printing of the REFERENCE ANNUAL and there are not enough to go around.

If you are already a subscriber we can extend your subscription so you can obtain a Free copy of RADIO-ELECTRONIC REFERENCE ANNUAL.

TIME LIMIT OFFER

RADIO-CRAFT WITH FREE COPY
RADIO-REFERENCE ANNUAL

1 Year \$2.50
2 Years \$4.50
3 Years \$6.00

RADIO-CRAFT for MARCH, 1944

Be sure to use coupon or mention Free Reference Annual when ordering.

CUT OUT AND MAIL

RADIO-CRAFT
25 WEST BROADWAY, New York 7, N. Y.

Gentlemen:

I want to take advantage of your Special Time Limit Offer for your RADIO-ELECTRONIC REFERENCE ANNUAL—1943-1944, which you will send me ABSOLUTELY FREE and PREPAID in connection with my subscription to RADIO-CRAFT and Popular Electronics for the period checked below. I enclose my remittance of \$.....

1 Year \$2.50 2 Years \$4.50 3 Years \$6.00
 This is a new order Renewal Extension

Name

Please print clearly

Address

City State

Postal Dist. No. (if any)
(Canadian and Foreign subscriptions 5c extra per copy. Send by International Money Order.)

RADIO-CONTROLLED BOMB

THE following is reprinted from the February 1st issue of "The New York Times":

"Like all the 'secret weapons' of which we have heard since the outbreak of war, the radio-controlled bomber of the Germans turns out to be no secret at all. It is nothing but an enlargement of the German winged, radio-controlled rocket bomb described by Mr. Churchill last year. Like other secret weapons it has not fulfilled expectations by reducing Allied military forces to helplessness.

"The general principle of controlling apparatus by radio goes back to the early days of what was once called 'wireless.' At the first electrical exposition held in this city over forty years ago Nikola Tesla maneuvered and blew up a model submarine in a tank by radio. There soon followed a score of German, American, English and French inventors who showed how engine-driven vehicles, torpedoes and ships could be steered by radio waves with never a man on board. Both the British and American Navies maneuvered obsolete crewless battleships under full steam in the same way and used them for target practice.

"Whether or not the new German bomber is as destructive as the Germans claim, it manifests a trend which goes back to the introduction of cannon. Ignite gunpowder and chemical energy is released. The mechanization of war, therefore, begins with artillery. Every improvement in mechanical engineering has been applied in battle. Troops are carried to the front in trains. Tractors have taken the place of horses, and steam engines the place of sails on battleships and cruisers. Now we have tanks, jeeps, trucks, planes—all engine-driven so that battles are fought by machines as well as by men. And the machines have become more and more automatic until at last a stage has been reached when the crewless bomber, remotely controlled, can be launched against an enemy. Who knows but some day, if war is not abolished, battles may be fought simply by more or less automatic machines?

"We have not yet reached that stage of military and naval evolution, but we are not far from it when a battleship is reduced to helplessness if turrets can no longer be turned or her steering gear is crippled or if Germany finds it impossible to launch enough planes to ward off an attack on Berlin. The writers of romantic scientific fiction have been telling us for years that wars will be bloodless because machines will do all the fighting, and the radio-controlled devices of the war lend some color to their fancies."

CORRECTION

An error which may be puzzling to many readers, appeared in the article, "Transmitters for FM," in the November issue. The lower end of the coil T_1 is shown directly attached to the high-voltage lead. Under these circumstances little or no R.F. could be applied to the grid of the lower tube through the condenser C_2 .

Removing the condenser between T_1 and inserting an R.F. choke in the B line, would be effective in transmitting radio-frequency voltage to C_2 . A better system would be to use a center-tap for the B supply in T_1 , together with a double-stator condenser, with the rotor grounded. This would put both ends of T_1 at an equal R.F. "distance" from ground.

WORLD-WIDE STATION LIST (Continued from page 350)

Mc.	Call	Location and Schedule	Mc.	Call	Location and Schedule
7.275	DXL25	BERLIN, GERMANY; 5:50 pm to midnight (except during air raids).	7.820	WKRD	NEW YORK CITY; European beam, 4:45 pm to 4:45 am.
7.290	DJX	BERLIN, GERMANY; variable times; North American beam.	7.86	—	CAIRO, EGYPT; late afternoons.
7.295	YSO	SAN SALVADOR, EL SALVADOR; "Voice of Democracy"; nightly at 7:55 pm.	7.950	—	ALICANTE, SPAIN; off at 6 pm daily.
7.32	GRJ	LONDON, ENGLAND; 12:15 to 12:45 am, North America beam.	8.000	—	"A E F RADIO IN ALGIERS"; heard at 4:15 pm.
7.565	WKLJ	NEW YORK CITY; North African beam, 8:15 pm to 5 am.	8.000	—	ATHENS, GREECE; heard 3 to 6 pm daily.
7.565	KWY	SAN FRANCISCO, CALIF.; 8:30 to 10:30 am daily, Sundays, 9:30 to 10:30 am.	8.030	FXE	BEIRUT-LEBANON (SYRIA); 1 to 4:30 pm.
7.575	WRUA	BOSTON, MASS.; North African beam, 4:45 to 7:15 pm; 7:30 to 11:45 pm.	8.035	CNR	RABAT, MOROCCO; heard Sunday 5 pm.
7.805	WRUL	BOSTON, MASS.; North African beam, 2:15 to 5:45 am.	8.04	COCL	HAVANA, CUBA.
			8.220	—	DAKAR, SENEGAL (French West Africa); off at 5:04 pm.
			8.484	XPSA	KWEIYANG, CHINA; 7:30 am to 12 noon.
			8.664	COJK	CAMAGUEY, CUBA; 5 to 6 pm; irregular.
			8.70	COCO	HAVANA, CUBA; daytimes.

Now You can Use



ALL OF THESE RADIO PARTS

to help You learn

RADIO

FASTER—EASIER AT HOME

YOU CAN BUILD 133 FASCINATING EXPERIMENTS

At home—in your spare time—you get real Radio experience with these many Radio parts and sub-assemblies. DeForest's handy "Block System" eliminates unnecessary mechanical work; the convenient clip connections save a great deal of time. Quickly build Radio circuits that work. Experiment with Photo-electric Cell "Magic," and scores of other fascinating projects. Little wonder learning Radio at home is so practical... so effective and so much fun—with this fascinating, DeForest's "Home Laboratory."

YOU ALSO USE "LEARN-BY-SEEING" MOVIES

Think of the pleasure as well as the help you can get from the use of this genuine DeVERY Motion Picture Projector and exciting Radio-TRAINING FILMS. You'll likely be surprised how much faster... easier... home movies can help you understand Radio. Here's a preferred training method of tomorrow—yours today. SEE the principles of what you're learning—in action, ANIMATED! Peer into moving parts otherwise hidden from the eye. You get this big home-training. Radio advantage—exclusively with DEFOREST'S. So act now! Mail the coupon today!



See how DeForest's fascinating SHOP-METHOD Radio Training at home can help you toward a good start in the Billion Dollar Radio Industry. Write for DeForest's BIG FREE book, "VICTORY FOR YOU," that has helped many to good-pay jobs in essential war industries; others to preferred Army and Navy classifications—and still others to interesting, profitable businesses of their own.

YOU GET "ALL THREE" WITH DEFOREST'S

Where else can you get such a combination of PROVED MAJOR Training features as—(1) ninety modern loose-leaf lessons prepared under the supervision of Dr. Lee DeForest, often called the "Father of Radio"; (2) the use of "learn by seeing" home movie films and a genuine 16 mm. DeVERY MOVIE PROJECTOR—and (3) eight big kits of "home laboratory" Radio parts to give you thrilling practical Radio experience.

See how you can prepare for a bright postwar future now—in your spare time at home—then get started toward a worthwhile Radio-Electronics job with the help of DeForest's effective, proved EMPLOYMENT SERVICE. If you are 17 or over, mail the coupon today for complete details. You be the judge. No obligation.



DEFOREST'S TRAINING, INC.

2535-41 N. Ashland Ave., Dept. RC-2, Chicago, U.S.A.

Please send me—FREE and WITHOUT OBLIGATION—illustrated book, "VICTORY FOR YOU," showing how I can prepare for Radio with your Home Movies and Laboratory Kits.

Name.....Age.....

Address.....

City.....State.....

DEFOREST'S
TRAINING, INC.
CHICAGO, ILLINOIS

PROVED THRU THE YEARS
SUPREME
BY COMPARISON

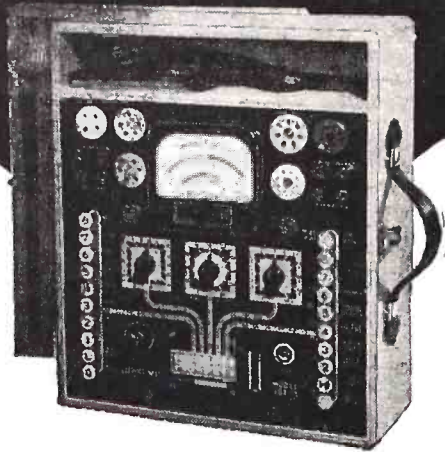

Model 504-A
Tube and Set Tester

Right now Supreme is 100% in war production. After Victory, you again can count on Supreme Testing Equipment for dependability, durability and ACCURACY . . . the same Supreme qualities which today are helping keep vital communications open on the battle fronts of the world.

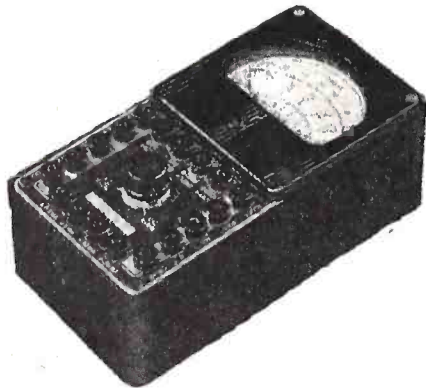

Model 542
Pocket Multimeter

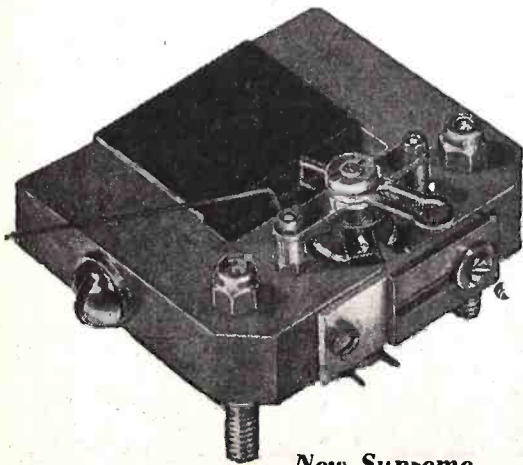

New Supreme
"Hairline Accuracy"
Meter

SUPREME

SUPREME INSTRUMENTS CORP.
GREENWOOD, MISSISSIPPI, U. S. A.

A Serviceman to His Son

By EUGENE M. CONKLIN

Dear Son:

I see by the paper that almost everyone is contemplating post-war conditions even before the present conflict is written off the books. While this may be a bit of "wishful thinking," it can't do any harm and it might do a spot of good if the radiomen did give a little serious consideration to radio-servicing in the post-war days to come.

I think you'll agree that the greatest stumbling block, to date, has been the complete lack of *esprit de corps* prevailing in the service industry before the war. "Dog eat dog" sums up the amount of co-operation between service operatives in the matter of setting up a "decent and livable" payment scale for the customer. Servicemen were afraid to band together, fearful lest another operative chisel in on their legitimate sphere of operations.

Lack of professional pride helped the mess along considerably. Rightly or wrongly our servicemen have never attempted the professional approach. Among themselves they might whisper a bit defiantly perhaps that they were on the same par with the medico, the legal luminary and other professional men. Wasn't it true that repairing a sick radio required as much ability as performing a repair job on an ailing patient? Alas and alack, such thoughts stayed put well below the surface.

The war has changed all this. Servicemen have been forced willy-nilly to mingle with one another in an attempt to exchange vital components, information about "old-time radios"; share and share alike has been the wartime rule. The wall has been broken down. Will it be reconstructed after the war so that once again servicemen will be at each other's throats?

That's the sixty-four dollar question. For my money based on confabs with servicemen all over my area, the handwriting on the wall spells an end to friction within the industry, provided certain basic changes are made.

First of all, some form of licensing is inevitable. We've discussed before, you and I, the belief that state boards should be set up to conduct examinations for all existing radio shop operatives as well as those who, after the war, wish to enter the service end of the game. Now a suggestion comes along that all men who were conducting service-shops before entering the service, or during the war, should be examination exempt. The only ones to take such exams would be the newcomers.

Radiomen know that their ranks will be swollen by youngsters having Signal Corps experience or its equivalent, who want radio servicing as their career. It may be true that television and FM will mean increased business for the serviceshop, sufficient to absorb these newcomers. But there will be a transition period of a year or so before production can be resumed on a scale large enough to warrant any such

"prosperity barometer" readings for the service profession as a whole.

And it's this transition period that is going to spell trouble with a capital "T." Servicemen back from armed force duty will find it tough sledding perhaps until the many new wonders of radio are actual every day affairs. In general, it's a situation that will take a whale of a lot of downright serious thinking through.

About the only double header improvement to emerge from this conflict is elimination of house calls and stepping up of labor charges to a one fifty or two bucks an hour level. There never should have been house calls in the first place except on a double or increased charge basis of say three dollars an hour. Doctors do this—servicemen should too. If a set weighs 500 lbs., chances are a trucking company lugged it in the house—and they certainly can lug it out again to the serviceshop.

Flat rate servicing is another brain child that should have been kicked out long ago. Doctors do not charge flat rates for fixing you up, the fee depends upon what's wrong with your innards. The day you catch a medico tossing in a brain surgery for the same price as a diagnosis of indigestion caused by an over-consumption of hamburgers—will be THE day!

You asked about record sales. They certainly are jumping and I thought you'd like the inside story—so here goes. A couple of new ideas tried out by two of the local record vendors were in no small part responsible, though some of the Binghampton merchants had a hand in it too.

First of all, there is the tie-up with all music teachers in the community. The store sells each music instructor on the idea that pupils will learn to play the piano, trumpet or what have you more readily if said pupils can hear over and over again recordings by famous orchestras or instrumentalists. For example, a student of the piano takes home along with his sheet music some records of Ray Noble, Fats Waller, Alex Templeton. A trumpet student takes home records of Harry James. The teacher purchases these records outright from the store, and either loans or re-sells at exact price the recordings to the youngsters as the need arises.

Another stunt being used is to form a "Record of the week club." Members buy two records weekly, they may be popular or classic. A local committee, consisting of



"Meet me at the same lamp post tomorrow, Fifi—the boss is whistling."

well-known musicians, head of local musical organization, etc., recommends twenty releases monthly—half popular, half classical or folk music. Recommendations are posted in the dealer's window and reproduced in weekly newspaper display ads. Members buy records for three months, on this basis, then get a free selection of records amounting to ten per cent of their purchases as a bonus.

Dealers living in neighborhoods near training camps, are suggesting that soldiers, sailors, marines, or WAC's send phonograph records as gifts to the folks or sweethearts back home. Soldiers can send a recording of "Put Your Arms Around Me Honey" to their sweethearts, who can play it again and again during the ensuing year. The dealer helps make record selections, wraps and mails for the serviceman.

By the same token, dealers are suggesting that civilians send records to their boys and girls in domestic camps. These lads and lassies can have them played on the victrola in the camp relaxation rooms, at USO lounge or in canteens. Records on hand at such places never meet the demand; and servicemen who "tote" their own recordings (gifts from home) are mighty popular with the other inhabitants.

Another natural is the contest where entrants give their favorite popular, or classical tune and tell why in one hundred words or less. Maybe they like "Good-night Sweetheart" because the band played it at the first school dance. Or perhaps it is "Rhapsody in Blue" because they heard it in a restaurant on a wedding night. Best submissions are printed sans identifying names, and win for their submitter a choice of recordings, perhaps a recording of the same number they wrote about.

These little stunts, quite simple all of them, but never thought of when the dealer was busy going after bigger game, had given record sales quite an "uplift" in this community, and when you come back you are going to find records a far more important part of the business than it was pre-war.

Your loving Dad

WAVE OF THE FUTURE

"The development and use of radio waves that resemble light waves in some respects, and which can be formed into beams and made to do things that cannot be done with light," points out William C. White of the General Electric Company, "will be part of the contribution to be made by the science of electronics toward better living when the war is over."

As one of numerous applications of the new radio waves, Mr. White explained how they can penetrate clouds, smoke, fog, and storm, and thus become a great aid in the navigation of ocean liners and air-craft.

"Navigation of ocean liners is in many ways based on vision, which, in turn, is based on the use of light and sight," he pointed out. "The steering of a proper course is largely a matter of noting position of shoreline, lighthouses and buoys. Avoidance of collision is also largely based on seeing. But night reduces the effectiveness of these aids to navigation and fog almost renders them useless.

"Radio beams of the newer high-frequency waves will provide a method of locating aids to navigation, as well as locating obstacles when these cannot be seen. Navigation of aircraft will be aided also.—S.R.W.

RADIO-CRAFT for MARCH,

RADIO SETS ARE "COMMANDO-TOUGH"

RADIO sets are ordinarily considered relatively fragile — thus they deserve to get gentle handling. World War II has produced a radio set that combines sturdiness with ability to take all kinds of abuse, according to Westinghouse engineers. Communication is absolutely essential for Allied troops storming an enemy shore—they must have tough radio transmitters and receivers. In those critical moments no equipment can be given the careful treatment its inherent fragility commands.

Radio sets go overboard into the surf along with the men—in a matter of minutes, they are dragged ashore and are set up to transmit vital information. Those war radios must be insensitive to wide tem-

perature ranges and must operate satisfactorily in the Arctic or in the tropics. Furthermore, since the sets are sometimes flown to front-line positions, light weight is very important. Combining lightness with super-strength is the designer's task.

Engineers have produced a super-tough war radio and have given it performance flexibility without unduly complicating its operation. It has two degrees of selectivity, automatic volume control, a beat-frequency oscillator for continuous-wave reception, an output limiter and a noise limiter. All frequency-determining components have been temperature compensated. For easy field servicing, all parts are readily accessible once the outside cover is removed.

Get into RADIO ELECTRONICS TELEVISION now!

Prepare for the future. Get ready now for an interesting career in Radio, Electronics and Television, the gigantic industry now known in its entirety as R-A-D-I-O-N-I-C-S. The Field of Today and Tomorrow!

SHOP METHOD HOME TRAINING

BY A REAL, ESTABLISHED TECHNICAL TRADE SCHOOL GET READY FOR YOUR OPPORTUNITY... IT'S HERE! Radio technical men are needed everywhere; afield in action, and at home in industry! Trained men are needed in the Army, Navy and Air and Signal Corps, Government Defense Service and Civilian fields. Now, in answer to repeated demands for Trained Radio Technicians, National Schools has extended its famous Shop Methods so you can qualify right at home. You can quickly prepare to be of greatest service to your country and yourself. Yes, right at home, in your spare time. National's time-tested plan of Home Training will definitely establish you, in a short time, so you can hold a good job in this fascinating field. Furthermore, you become equipped for an even bigger career in the years of reconstruction after the war.

BIG OPPORTUNITY FOR NATIONAL GRADUATES

For 38 years National Schools has trained ambitious men for Top Pay trades. Squarely behind you are the modern, completely-equipped Training Shops of National where we pre-test and prove every instruction sent to you. Training in your home is comparable to actual laboratory practice.

GET ON THE TECHNICAL FRONT

Unique training facilities give you Home Training based on Resident School Shop principles—methods not available from any other source. To our knowledge. You'll be amazed when you receive our Free Lesson and full details. MAIL THE COUPON TODAY!

FREE LESSON and OPPORTUNITY BOOK

Mail Coupon for new Opportunity Book which gives full details about the big future of Radio Electronics and Television, and how you can qualify. Also, Free Lesson to demonstrate how easy you can learn. No obligation.



— THE START TO SUCCESS COUPON

More than 50,000,000 Radios in use. More than ever before, because of the shortage of new equipment, they must be serviced. Over 800 Broadcasting Studios employ trained Radio Technicians. Electronics, a whole new industry, based on Radio principles, is growing at an amazing pace. Television, too, will soon need its own corps of trained men. Get READY NOW. Here is your opportunity to get into a permanent field of fascinating and profitable employment.

MILITARY SERVICE

Prepare for Radio Service in Army and Navy. In U. S. Gov't. service you install, operate and maintain most technical equipment such as secret ultra-high frequency apparatus to locate airplanes, submarines, etc. Get promotion in rank and increased pay almost from the start.



KEEP PRESENT JOB WHILE LEARNING

Regardless of previous education or age you can Train for Radio. Continue your present job. Earn while you learn. If subject to Military Service, all the more important that you get pre-training.



RADIO EQUIPMENT INCLUDED

You receive modern experimental apparatus.

NATIONAL SCHOOLS

Los Angeles California

ESTABLISHED 1905



MAIL OPPORTUNITY COUPON FOR QUICK ACTION

National Schools, Dept. 3-RCR (Mail in envelope or 4000 So. Figueroa, Los Angeles, 37 Cal. paste on penny postal) Mail me FREE, without obligation, one Lesson and Opportunity Book, with full details about how I CAN become a RADIO Technician.

NAME _____ AGE _____
 ADDRESS _____
 CITY _____ STATE _____
 Include Your Zone Number

TUBE PULLING
MADE EASY

SYLVANIA SERVICEMAN SERVICE

by
FRANK FAX



THIS gadget makes it easy to pull radio tubes of the "Lock-in" type. And only 25 cents buys it.

Here's how it works:

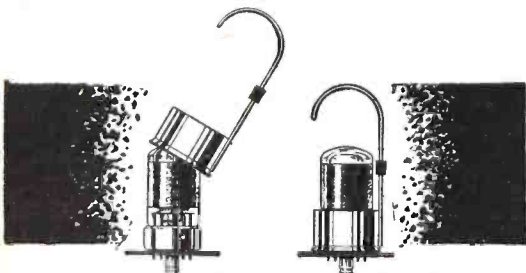

Slip the rubber bushing, packed with the Puller, over the handle to $\frac{1}{2}$ -inch from the collar. Then insert the Puller over the "Lock-in" tube. Push it down so that the collar grips the tube base shell firmly.

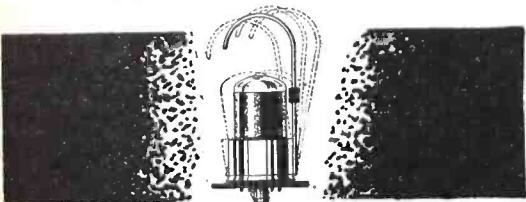

Push handle sideways, or rotate, until a *snap* indicates unlocking of the "Lock-in" pin. Do not lift up on the Puller until the tube is unlocked. After the unlocking, the tube can be lifted without any trouble.

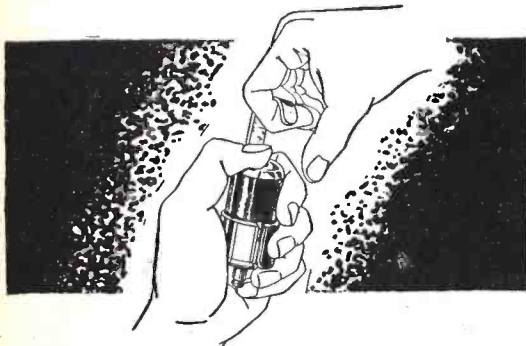

To release tube from Puller, hold the curved handle with one hand, push down firmly on top of the tube with thumb of other hand, holding open end of the Puller toward the palm so that the released tube does not fly out.

If your jobber does not have this item in stock, write to FRANK FAX, SYLVANIA, EMPORIUM, PA.

SYLVANIA
ELECTRIC PRODUCTS INC.
RADIO DIVISION • EMPORIUM, PA.



CITY QRM AND INVASION RADIO

HOW will high powered mobile radio stations serve Allied military forces when invasion armies enter large, congested cities on the European continent? How will the operating efficiency of mobile receivers and transmitters be affected by the electrical shielding effect of steel buildings, over-head trolley wires, and electric railway lines?

Some interesting conclusions were reached in a test recently made with modern high-power radio equipment in an area which offers the most adverse conditions imaginable—the Chicago loop.

Two of the U. S. Army Signal Corps' famous SCR-299 mobile radio transmitters were assigned to the Third War Loan Bond Drive on State Street, Chicago. It was proposed by the Army that these units would be set up in operating condition and also a radio set, SCR-543, would be installed on the ground floor of the Marshall Field department store, and communication be maintained between all three units for the two weeks during the bond drive.

F. A. Franke, Harold Rensch and William Blinoff, engineers of the Hallicrafters Company, manufacturers of the SCR-299 and 543, were assigned to assist the Signal Corps in the technical arrangements of this program. The Army personnel assigned to this detail, while unfamiliar with these particular radio sets, were experienced radio operators and after a short training course conducted by the Hallicrafters engineers, were experienced veterans in servicing, tuning and adjusting these complicated sets.

After considerable study of available frequencies for the demonstration, the engineers decided that an operating frequency of 3,510 kilocycles held the most promises for reliable communication, and the equipment was set up to function on that frequency. The noise level created by street cars, motors, automobiles, etc., was almost unbelievable in its intensity. It was amazing that the signals received between the SCR-299's were powerful enough to over-

ride this noise level completely and provide uninterrupted communication.

The transmitters and receivers are both operated from a 15 foot whip antenna and, likewise, the Radio Set SCR-543 installed at Marshall Field's. The SCR-543 is a medium-powered transmitter and, to provide communications between it and other radio sets, a novel arrangement was developed by the Hallicrafters engineers. An antenna was run from the roof of Marshall Field's down through the center court, and the lead passed within a few feet of vertical transmitting antenna of the Radio Set SCR-543. It was in no way attached to the radio set proper, and this lead carried out the transmitting signal to the top of the building and then reradiated it to the other equipments. Receiving signals, likewise, from the other transmitters, were fed into the receiver. The lead was in no way directly connected to the Radio Set SCR-543.

With this arrangement, signals to and from the SCR-543 were unbelievably strong and the results obtained while in this completely steel cage of the building were similar to those obtained when operating in open country.

The conclusion drawn from this demonstration was that, with proper choice of transmitting and receiving equipment and proper operating frequency, it is possible to provide reliable radio signals between any given points in a congested metropolitan area. Army authorities are convinced that no European city can produce electrical interference to compare with the area used.

Men theoretically flying at a simulated height of 38,000 feet (in special de-compression chambers) are now being X-rayed to determine why pilots suffer from "bends" and less-understood pains while in the stratosphere.

Surprising large bubbles in the bloodstream have been shown up by electronic apparatus.

FLASHTRON CONTROL UNIT

The Flashtron is a unique type of electronic switch whose actuating circuit can be of the single circuit (simple contactor) type while double circuit control suitable for reciprocating action is accommodated. Involving negligible current in the actuating circuit, it may be operated from super sensitive primary actuating elements of many types. The speed of response is within a half cycle (of 60 cycles line frequency). Its output circuits accommodate the alternate energizing of loads, within the range of the instrument, which may be connected to it. These might be motors for valve control, blower fans, or other motor driven power control elements. They also may be other types of electrical leads.

Flashtron incorporates two grid controlled rectifier tubes. Each of these tubes controls power to separate output circuits, through suitable transformers, is such that only one circuit is operating at a given instant and one of the circuits is always functioning (Patent No. 2,208,235).

In service an actuator or primary sensitive element (Bourdon tube, thermostat, etc.) with its electrical contacts is connected to the grid circuit of one of the tubes of the Flashtron. The output circuits are connected to a suitable bi-directional motor or other reciprocal control (valve, etc.). When the contacts of the actuator approach the closed position, the tube releases power to its output circuit, operating the motor or control in a given direction. The change in direction immediately reflects its action to the actuator, opening the contacts and restoring the first tube to a non-operating condition. The second tube is then functioning, which changes the direction of operation, and the cycle repeats itself. The valve is constantly re-set to the desired position in exact response to the primary sensitive element which is actuating the Flashtron.



A typical application is the controlling of steam pressure. A Bourdon tube is fitted with a pair of contacts to operate the Flashtron at a pre-set pressure. The output circuits are connected to a bi-directional motor operating a steam valve. Control of pressure is so perfect that there is practically no movement of the motor or valve except to compensate for differences in boiler pressure or lead.

The Flashtron operates with and supplies to the output terminals 115 volt, 50-60 cycle current. It should be noted that one of the actuator connections is at ground potential which simplifies the primary sensitive element. The potential applied to these contacts does not exceed 15 volts RMS, .001 ampere.

NOW WESTON MODEL 785 INDUSTRIAL CIRCUIT TESTER!



Tests Insulation and Cable Covering Resistance Values as Well!

With this new, compact unit which fits into the spare compartment and connects into the ohmmeter circuit with a pair of leads, Model 785 now provides for resistance measurements up to a value of 900 megohms. Thus the broad range coverage of this versatile maintenance tool now is as follows:

DC VOLTAGE . . . 0-1/10/50/200/500/1000 volts — 20,000 ohms per volt. (*5000 volt range with external multiplier.)

AC VOLTAGE . . . 0-5/15/30/150/300/750 volts — 1000 ohms per volt.

DC CURRENT . . . 0-50 microamperes, 1/10/100 milliamperes, 1 ampere and

10 amperes (*ranges above 10 amperes with external shunts).

AC CURRENT . . . self-contained ranges 0-5/1/5/10 amperes (*higher ranges with an external current transformer).

RESISTANCE . . . 0-3000, 0-30,000, 0-300,000 ohms, 0-3 megohms, 0 to 30 megohms (self-contained batteries). 0-900 megohms (*with compact Model 792 Resistance Tester shown in illustration).

**Extra equipment on special order.*

For complete facts on Model 785 write Weston Electrical Instrument Corp., 599 Frelinghuysen Ave., Newark, N. J.

WESTON Instruments

HALLICRAFTERS ★ HALLICRAFTERS ★

LET'S ALL PITCH IN!

WE CAN all help win this war by selling our government the communications receivers and equipment they need quickly and in sufficient quantities.

That is the reason I pay *highest cash prices* for used communications equipment.

When this war is over you will be in the market for new equipment and by taking advantage of my offer to purchase your present equipment at highest cash prices you will be in a position to buy new and better equipment than you now own.

Write, telephone or telegraph me description of your used communications receivers, transmitters and parts of standard make; you will be paid cash immediately without bother or red tape. I am particularly interested in *Hallcrafters*.

I also have a store at 2335 Westwood Blvd., West Los Angeles, Calif.

Bob Henry, W9ARA
HENRY RADIO SHOP
BUTLER, MISSOURI

COMPLETE STOCKS

I have large stocks of receivers available for immediate delivery on priority and the following parts without priority: meter rectifiers \$1.95, meters, tubes, transformers, resistors, condensers, panels, chassis, etc. Your orders and inquiries invited.

"WORLD'S LARGEST DISTRIBUTOR OF COMMUNICATIONS RECEIVERS"



MULTIPLE UTILITY

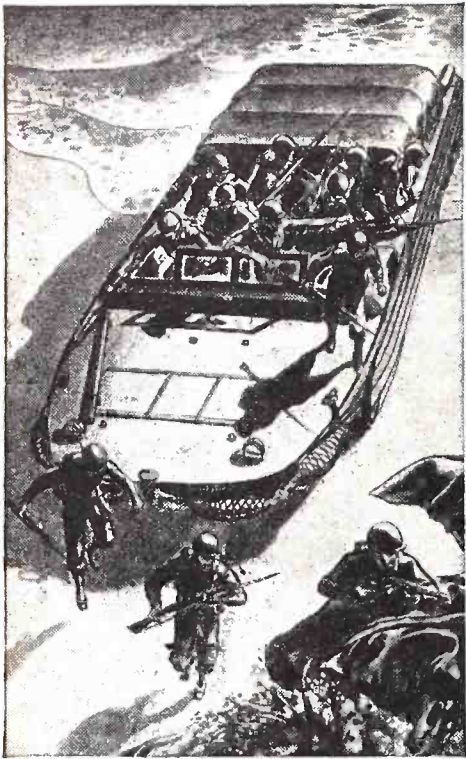

MULTIPLE utility is one of the many outstanding features that makes General Electric SERVICE TESTING EQUIPMENT practically pay for itself in added service. Sturdy, compact . . . designed for hard every-day use, this new line offers a wide choice of portable, accurate apparatus for maintenance and testing work in the field or service shop.

G-E unimeters, tube checkers, audio oscillators, oscilloscopes, condenser resistance bridges, signal generators—all give radio service men and service dealers rapid, dependable equipment for testing radio and electronic circuits and component parts.

While these sturdy, shock-resistant units are now in production primarily for the Armed Forces, they may be purchased on priority if you are engaged in war work. After victory, of course, the full line will again be available to everybody. . . . *General Electric, Schenectady, New York.*

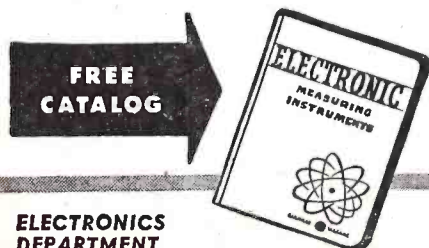

**ELECTRONICS DEPARTMENT
GENERAL ELECTRIC CO.
Schenectady, N. Y.**

Please send, without obligation to me, the General Electric Testing Instrument Catalog, R-3 (loose-leaf), for my information and files.

Name _____
Company _____
Address _____

GENERAL ELECTRIC
177-C3
Electronic Measuring Instruments

Available Radio-Electronic Literature

Manufacturers' bulletins, catalogs and periodicals.

A NEW SERVICE FOR RADIO-CRAFT READERS: In order to save your time, postage and incidental work in writing a number of letters to different manufacturers to secure the various bulletins offered, proceed as follows:

On your letterhead (do not use postcards) ask us to send you the literature which you designate. *It is only necessary to give us the numbers.* We will then send your request directly to the manufacturers, who in turn will send their bulletins or other literature directly to you.

108—TECHNICAL EDUCATION NEWS, published periodically by the McGraw-Hill Book Co. in the interest of Technical Institutes, Terminal Junior Colleges and War Industry Courses.

A 16-page magazine, carrying informative items on soon-to-be-released McGraw-Hill books and books recently published, as well as the occasional general article on technical training subjects. There are also personal-interest stories of McGraw-Hill authors.

The stories on new books are longer than the average book review, and a better opportunity of estimating their contents is thereby given. A selected list of McGraw-Hill technical books appears on the back cover.—Gratis to interested parties.

109—ELECTRONICS—What It Is and What It Means to the Printing Industry. General Electric Co.

A 7-page booklet (8½ x 11-inch pages), which begins with a general description of electronic action, as applied to rectifier tubes, and proceeds to specific detail on the application of these tubes in the printing industry. Gasoline engine analogies are used to make rectifier action clearer, and the action of the phototube is explained.

Electronic devices in the printing industry are next described. Sheet counters, web-break detectors, safety devices, mat dryers, speed regulators, and the color-register

control are mentioned, and the part played in each by electron tubes is featured.

The booklet is excellently illustrated with 24 cuts, most of which are half-tones.—Gratis.

110—CENCO NEWS CHATS, a periodical issued by the Central Scientific Co., Chicago.

Devoted chiefly to cataloging latest Cenco products, with considerable informative material on each. The issue reviewed also included a biographical sketch of Professor Dayton C. Miller, an editorial, a page of photographs and a cartoon.—Gratis.

111—DRY ELECTROLYTIC CAPACITORS, AND DIMENSIONS FOR RADIO-FREQUENCY THERMOCOUPLE CONVERTERS, American War Standards, issued by the American Standards Asso.

Dry Electrolytic Capacitors sets forth the specifications for home receiver replacement electrolytics, covering capacitance, leakage current, power factor, temperature ratings, overload voltage and life, as well as mechanical requirements, mounting hardware, insulating compound, marking, etc. The thermocouple bulletin is a side and top plan of a thermocouple unit designed for the range of 120 Ma. to 10 Amp. inclusive.

Price. Capacitors, 20 cents; Thermocouples, 10 cents.

SKY RADIO BLANKETS ENEMY (Continued from page 334)

touches the ground, it automatically is destroyed by fire or otherwise.

The *modus operandi* is as follows:

A large transport plane flying at night over a large city, for instance, will discharge a dozen or more of these 500-watt broadcast units. Before they leave the transport plane, the tuning dials are set and locked in such a manner that the broadcasting will be done on from three to six different wave lengths. These are the normal broadcast wave lengths on which the particular population usually tunes in on their regular broadcast frequencies, in order to listen in lawfully to the various radio broadcasts of their territory.

By using a number of broadcast units, the entire city will be completely blanketed so that *anyone* who listens will, without any doubt, get the message that the Allies want the city to hear.

The units are discharged from the transport at a height of about 25,000 feet. The parachutes will require anywhere from 18 minutes to 24 minutes to strike the ground, depending on the type of chute used, as well as weather conditions. This gives sufficient time for the broadcast, because the messages are usually short and no long-winded propaganda is necessary for an invasion. For instance, the message that the invasion has commenced, or that the population should either remain in the city (or evacuate), and other military information, is given in short

crisp sentences. The message is recorded on either the new cellophane tape or a magnetic wire recorder is used. The message is repeated over and over until the broadcast unit finally hits the ground.

The most important point to remember is that these units are powerful and of a strength of about 500 watts. This gives the same effect as if you had a 500-watt broadcast station right in your backyard! *Therefore the recorded voice will come in on the average radio set like a thunderous voice of doom, so loud that it will blanket any other radio program that might be on the air at the time.* It will completely obliterate distant broadcast stations, and that is the only purpose of the scheme. In the end the effort will be worthwhile and the moderate cost of the few transmitters is cheap for the purpose which they achieve. More important, the Allies will not lose valuable lives because no one can get hurt, and it is doubtful even that the transport which discharges the broadcast units will be much molested at night and at a height of 25,000 feet.

It may be asked: "How can you put a 500-watt broadcast unit into a weight of 200 pounds?"

The answer is that it must be remembered that this is an *expendable broadcast unit*. Its total life is about 30 minutes. Consequently, everything in the set is designed for this purpose; everything that goes into

it is naturally as light as it can be made. We have already valuable experience in this line with meteorological Radio-Sonde transmitters which weigh only a few pounds and are sent into the stratosphere. In our 500-watt broadcast unit, we overload all the tubes to three or four times their normal capacity. That means that we get an enormous gain in output. We can in this fashion increase the plate current in the output enormously simply because the unit has such a short life. We also get the maximum power out of the batteries which are to operate the unit.

Amateurs many years ago learned that a remarkable increase in power and transmitting efficiency could be obtained by disregarding manufacturers' tube ratings. So-called 5-watt tubes were loaded to 50 watts. But the amateur never lived, who, to increase his transmitting efficiency, loaded his tubes and other equipment to a 20-minute life expectancy. Needless to say, fantastic increases of power may be expected from such loading, and this is the secret of our great power with equipment of such moderate size and weight.

The illustrations show how the broadcast waves are radiated. Instead of using the ordinary 'chute guide lines, we substitute stranded wire. This gives us the antenna. For the counterpoise, we use a phosphor-bronze flexible wire, weighted at the end to steady it. The broadcast frequency will not "wander" too much with this arrangement and should therefore remain fairly fixed and steady. Within the broadcast unit, we have the record with the message, which weighs only a few pounds and is of not much consequence as far as weight is concerned.

If we do not wish to use a radio broadcast unit for certain reasons, we have the alternative of using a Power Sound Unit, as is also illustrated. The working of this is parallel to the radio unit, except that the broadcasting is done by *direct sound waves*, just as any public address outfit would do. In this case, too, the power sound unit is also "loaded" to full capacity. In other words, it is forced far beyond its normal rating, because in this case also its total life is only less than half an hour. For that reason, the tubes and the output are forced to just below the burnout point.

The power sound unit, as well as the 500-watt broadcast unit, both have timing mechanisms. Thus, in the case of the power sound unit, it does not commence the blasting of the message until it reaches a point about 3,000 or 4,000 feet up—then continues to repeat it in a stentorian voice so loud that people indoors can hear it clearly. As the unit descends further down, its voice becomes still stronger by the second until finally everyone in the neighborhood will have little trouble in hearing the intended message.

I have dwelt in this article only on the more obvious features of the idea. There are a number of technical details in both methods that must be worked out, and experience will teach exactly how to obtain the maximum results from either outfit.

It goes without saying that each of the two methods must use recordings in the language of the populace for whom the message is intended. For the French occupied territory, the language would be French; in China, it will be Chinese, etc.

Yes, some of the units will be shot down if there are enemy fighter planes around. That is to be expected. During war one cannot expect to get 100% results from any means and that holds true for this scheme as well.

It should, however, prove a valuable adjunct for our forces.

Over 100 Different Numbers in...

RADIO TUBES!

That's right, over 100 different tube numbers available and coming in every day. Here are some of those critical tubes you've been looking for. Join our list of preferred customers and write to us today. Radio tubes for Ray Guns, Phonographs, and all types of coin-operated machines.

All Numbers are subject to Prior Sale!

NET PRICES

0Z4	1.65	78	.90	12SQ7	1.00
1Q5GT	1.65	6K7G	1.15	12SQ7GT	1.10
2A3	2.00	6N7/GT	1.65	24A	.90
3Q5GT	1.65	6Q7/GT	.90	25L6GT	1.15
5Y3/GT	.75	6SK7	1.05	26	.75
6A7	1.00	6SQ7	1.05	27	.70
6A8	1.35	6SQ7GT	1.15	35/51	1.00
6C5	1.15	6V6GT	1.15	37	.90
6D6	1.00	6Z4/84	1.10	42	.90
6F6	1.15	7A8	1.35	43	1.10
6H6/GT	1.15	7B7	1.35	50L6GT	1.10
6J5	.95	7F7	1.65	56	.85
6J5GT	.95	83	1.35	57	.95
76	.95	84/6Z4	1.10	11Z6/GT	1.65
77	.95	12SK7GT	1.10		

We Have Many Other Tube Numbers! Every order subject to prior sale.

WPB LIMITATION ORDER No. L265 makes "Supplier's Certificate" mandatory with each order.

ALL SHIPMENTS EXPRESS C.O.D. DO NOT SEND CHECK OR MONEY ORDER. ONLY MAIL ORDER BUSINESS ACCEPTED!

Chicago Novelty Company, Inc.

1348 Newport Avenue

Chicago 13, Illinois

The Model 610-B

MEG-O-METER

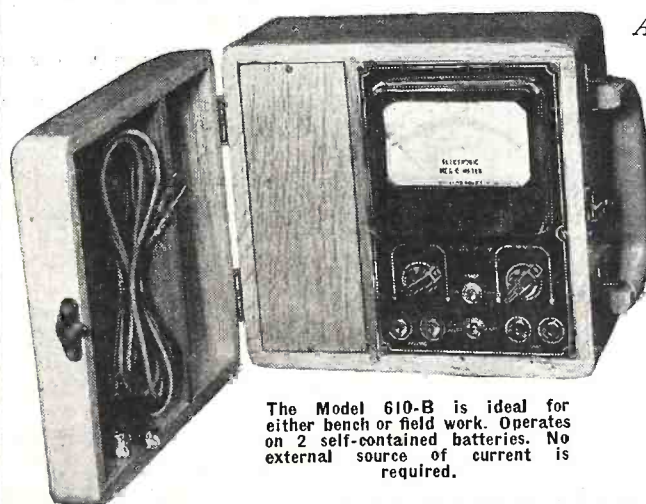

The Model 610-B is ideal for either bench or field work. Operates on 2 self-contained batteries. No external source of current is required.

A New, Battery-operated

INSULATION TESTER!!

Instantaneously measures the exact leakage of all insulation from zero up to

200 MEGOHMS

At a Test Potential of **500 VOLTS D.C.**

Supplied by built-in battery and vibrator power supply.

3 RANGES:

0—20,000 OHMS.

0—2 MEGOHMS.

0—200 MEGOHMS.

SPECIFICATIONS

***NO HAND CRANKING**—The 500 VOLT POTENTIAL is made instantly available by simply throwing a front panel Toggle switch.

***DIRECT READING**—All calibrations printed in large easy-to-read type enabling exact determination of leakages from 0 to 200 Megohms. In addition, the Megohm scale is also subdivided into BAD (0 to 1 Megohm), DOUBTFUL (1 to 3 Megohms), GOOD (3 to 200 Megohms) sections. The BAD Section which indicates the danger point is printed in red.

*The instrument is housed in a heavy-duty Oak portable cabinet. *Meter movement—a 4½" 0 to 200 Micro-ampere sensitive meter guarantees extremely accurate readings on all ranges.

MODEL 610-B comes housed in a beautiful, hand-rubbed Oak cabinet complete with cover, self-contained batteries, test leads and instructions. Size 9½" x 8½" x 6". Shipping weight, 16 pounds.

\$62⁵⁰

Price

SUPERIOR INSTRUMENTS CO.

DEPT. R, 227 FULTON STREET, NEW YORK, 7, N. Y.

Centralized... to
Serve You Efficiently!

LARGEST and MOST
COMPLETE STOCKS

of RADIO
AND ELECTRONIC
EQUIPMENT

Under One Roof

FREE
most complete
up-to-date
BUYING
GUIDE

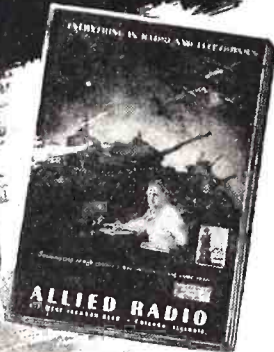

REPAIR and
REPLACEMENT
PARTS
AVAILABLE
without priority

Save time—
Call Allied First

The world's largest
stocks are centralized
in this single arsenal

of supply. Over 10,000 items from all leading manufacturers . . . for the Armed Forces, Radio Training, Research Laboratories, War Industries and Service Replacements. Our experienced staff helps speed delivery. Save time—simplify procurement—call ALLIED first! Thousands do.

Write, wire or phone Haymarket 6800.

6 Radio Books for 75c

Dictionary of Radio Terms. No. 37-751 10c
Radio Data Handbook. No. 37-754 25c

Radio Circuit Handbook. No. 37-753 10c
Radio Builders Handbook. No. 37-750 10c

Radio Formulas & Data Book. No. 37-752 10c
Simplified Radio Servicing. No. 37-755 10c

All Six Books No. 37-799 . . . 75c

Write for Quantity Prices



ALLIED RADIO CORP., Dept. 2-C-4
833 W. Jackson Blvd., Chicago, Ill.

Please send following books (.....c enclosed)

FREE 37-750 37-752 37-754
 Buying 37-751 37-753 37-755
 Guide No. 37-799 (All Six Books)

Name.....

Address.....

City..... State.....

ALLIED RADIO

ELECTRONIC CIRCUIT TESTS (Continued from page 343)

THE SIGNAL GENERATOR

A signal generator which continuously covers the radio frequencies required, and which may be modulated or unmodulated, is desirable. In addition, the audio modulating frequency should be available separately. This frequency is usually 400 cycles, which is recommended by the Institute of Radio Engineers. This frequency is also used to modulate the R.F. signal at about 30% modulation.

As regards the output meter, while this is to be recommended, it is not always on hand, so for purposes of illustration, we will use the loudspeaker.

This receiver is dead and all of the systems previously described give us dubious information as to the source of trouble. Let us now observe the diagram of Fig. 3. A signal generator is available.

Since it is advisable to proceed from the power stage backward, tune the signal generator (S.G.) "on" and allow to warm up. Switch S.G. to "A.F." position and advance audio control fully clockwise. Connect the return lead to the chassis. Now, with the chassis upside down, connect the hot S.G. lead to point No. 13 of Fig. 5, the power amplifier control grid. A loud 400 cycle note should be heard in the speaker, whereupon we may advance (towards antenna) to the control grid (No. 11 in diagram) of the Det-AVC-AF1 tube. Again, a 400 cycle note should be heard. We should also determine if any gain exists.

We now come to the detector diode and may ask if we should set our S.G. to give an R.F. signal. Since the function of any detector is to rectify and filter, either an A.F. signal or a modulated R.F. signal of any frequency should be rectified by the diode. So we might have tried A.F. first and then switched the S.G. to the I.F., modulated, of course.

THROUGH THE I.F. STAGES

Apply a modulated 460 Kc. signal to the grid (point No. 8) of the second I.F. amplifier. The 400 cycle note should be heard in the speaker, if this, and all following stages operate correctly. Keep in mind the 400 cycle A.F. modulates the radio frequencies in the S.G. and the detector of the receiver demodulates, or separates, them again, getting rid of the unwanted R.F. and passing the 400 cycle A.F. on to the speaker.

We can go on this way until we reach the antenna, or until no signal is forthcoming from the speaker when the proper signal is substituted at the input to the stage.

When working on the mixer or R.F. grid, the receiver dial must be tuned to the same frequency as that of the S.G., 1000 Kc. being a commonly used frequency. We may feed both the I.F. of 460 Kc. and the frequency to which the dial is tuned to the mixer grid (No. 3). The mixer should pass both frequencies. If it passes the I.F. and not the R.F., look for a non-operative local oscillator.

A further check on a dead local oscillator is to apply an unmodulated signal to point No. 4, the oscillator grid. If this signal is 460 Kc. more than the station to which the dial is tuned, the station should be heard while this artificial signal is being applied.

Note that connections have been made to control grids thus far. This should always be done in alignment, since the input impedance of the control grid is comparatively high and little loading on the signal

generator results with no consequent change in S.G. frequency. For test purposes, it is often advantageous to connect our S.G. lead directly to a plate. Due to the comparatively low plate impedance, we never use this connection for alignment. If the S.G. in use does not have a small blocking capacity, it is well to use one externally to prevent application of the high voltage from the plate to the attenuator of the S.G.

In practice, application of a 460 Kc. modulated I.F. to point No. 8 of Fig. 3 may produce a 400 cycle note, whereas application of the same signal to point No. 5 produces no output. Some time may now be saved by connecting the S.G. lead to point No. 7 through "C." This will show if the trouble is in the plate and coupling circuit from points No. 7 to No. 8, or lies in the tube circuit itself (again we assume the tube was checked for obvious defects).

Continuing our example, if it was determined that no signal was getting through point No. 7, we could remove our ground clip from the chassis and connect to point No. 8a, setting the hot S.G. lead back to point No. 8. We now have applied a signal directly across a tuned circuit. Likewise, we may make connection across points No. 7 and No. 7a.

MAGIC SIGNAL GENERATOR

Signal substitution has many ramifications. The above described procedure is simple enough in the cozy confines of a serviceman's shop but, as one can see, it requires an S.G. and constant retuning and manipulation of the S.G.

What we need is a magic signal generator; one which will change to the frequency you want without even rubbing Aladdin's lamp. Some fighting men are taught to use such a device, and presumably are supplied with one.

This magic device may be a multi-vibrator, which is nothing more than a motor-boating 2 stage audio amplifier, and has the property of generating harmonics, often up to the 200th. If we connect the output of the MVB to any grid of a receiver, a signal should be supplied to that grid, amplified, and heard in the speaker. This is an extremely quick check on any stage of most electronic equipment.* The author makes use of a small size MVB, powered with a 67½ volt Minimax, and using the type XXB tube.

"Square-wave" generators also put out signals with many harmonics, and a more symmetrical wave-form than the MVB. This advantage, however, is realizable chiefly in work with a cathode-ray oscilloscope.

Even simpler than the electronic multi-vibrator is the mechanical MVB. This has been used by many radio service men and consists essentially of a high frequency buzzer. One can be made from a few hundred turns of wire wound on an armature with a spring contact for make and break or an old code-practice buzzer may be found. Operation can be had with a single flashlight cell. A commercial unit is mounted in a pencil size holder with clip. This device works by virtue of the sparks produced. Hertz proved to us long ago that sparks produce radio waves with an unusually broad frequency characteristic.

The operation of the mechanical vibrator is not as positive as the electronic multi-vibrator, but comes in handy where speed is essential.

*The subject covering the use of the MVB in servicing is too wide in scope to be covered here.

I.F. TRANSFORMER ALIGNMENT

In aligning the I.F. transformers it should be remembered that the bandpass of these transformers is about 200 Kc., to accommodate the frequency swing, and in adjusting these stages this factor must appear as part of that adjustment:

- (a) Set the tuning dial of the signal generator back to 3.5 Mc.
- (b) Connect the "hot" lead of the signal generator to the grid of the 1st limiter V4 at point 6 in Fig. 1.
- (c) Connect the "hot" lead of the V.T. voltmeter to the grid of the 2nd limiter V5 at point 1 on Fig. 1. Note: At this point a negative voltage will be indicated. This is the voltage drop across grid-leak R20, and the attenuator of the signal generator should be turned up until this negative voltage appears.
- (d) Adjust the secondary trimmer (7) of T3 for maximum negative voltage reading on the V.T. voltmeter.
- (e) Adjust the primary trimmer (8) of T3 for maximum negative voltage reading on the V.T. voltmeter.
- (f) Swing the signal generator tuning dial to 3575 Kc. (maximum deviation frequency, plus) and note the voltage reading.
- (g) Swing the signal generator tuning dial to 3425 Kc. (maximum deviation frequency, minus). The voltage reading should be the same as in (f); if not, repeat steps (d) and (e). An error of .1% in the readings is allowable.
- (h) Leaving the V.T. voltmeter connected to the 2nd limiter grid connect the signal generator "hot" lead to the I.F. amplifier grid at point 9.
- (i) Adjust the primary and secondary trimmers of T2 as described in (d), (e), (f) and (g).
- (j) Connect the signal generator "hot" lead to the converter control grid at point 10.
- (k) Adjust the primary and secondary trimmers of T1 as described in (d), (e), (f) and (g). This completes the alignment of the I.F. transformers.

VISUAL ALIGNMENT

If the serviceman is fortunate enough to have at his disposal a good cathode ray oscilloscope and a frequency modulated R.F. oscillator that covers the desired 150 Kc. swing, visual alignment can be accomplished. These two units were put on the market by Clough-Brengle and RCA as one unit. A block diagram of how the unit should be connected to the receiver I.F. circuits for alignment is shown in Fig. 2. The output of the FM R.F. oscillator is connected to the external synchronizing terminal of the oscilloscope and to the grid of the stage ahead of the I.F. transformer to be aligned. The vertical amplifier of the oscilloscope is connected to the grid of the stage following the I.F. transformer to be aligned as shown at 2(b). With the deviation control on the FM R.F. oscillator set

at 75 Kc., and using a three-inch cathode ray tube, an image width of 1.5 inches on the screen would indicate a bandwidth of 150 Kc. This is shown in Fig. 3. By adjusting the primary and secondary trimmers of each I.F. transformer an image similar to Fig. 3 appears. Each transformer adjusted should produce the same bandpass pattern on the screen. This method will provide the most nearly perfect alignment, if followed through correctly.

ADJUSTMENT OF WAVE TRAPS

Wave traps are used in FM receivers for the same reason as in AM receivers; to eliminate image response:

- (a) Connect the "hot" lead of the V.T. voltmeter to the grid of the 2nd limiter V5 at point 1.
- (b) Remove the jumper shorting the oscillator section of the converter.
- (c) Set the signal generator tuning dial to 3.5 Mc.
- (d) Connect the "hot" lead of the signal generator to the antenna terminal of the receiver.
- (e) Adjust C1 for zero limiter grid voltage indication on the V.T. voltmeter. Any other wave trap that would be present in the receiver would be adjusted in the same manner.

PUSH BUTTON ADJUSTMENT

Regardless of the type of push button assembly employed, the following procedure can be carried out successfully:

- (a) Leave the V.T. voltmeter "hot" lead at point 1.
- (b) Set the signal generator tuning dial to the desired station channel.
- (c) Connect the signal generator "hot" lead to the antenna terminal of the receiver.
- (d) Loosen the push button tuning gang locking screw or screws.
- (e) Depress the push button that corresponds to the desired station channel.
- (f) Adjust the receiver tuning control gang to the desired channel and maximum voltage indication on the V.T. voltmeter. Note: If the dial pointer must be set off the correct channel number to obtain a maximum voltage, set the tuning dial exactly on some high frequency channel and correspondingly set the signal generator to this same frequency; then adjust the R.F. tank trimmers C3, C9, and C13, respectively, for maximum voltage.
- (g) After the maximum has been found swing the signal generator tuning control to 3575 Kc. and 3425 Kc., respectively, noting the voltage values; these values should not vary more than .1% for good accuracy and circuit tracking. If these values are off by any larger degree touch up the R.F. sections. Follow steps (a) through (g) for the additional push button on the receiver. If the receiver's R.F. sections are padded to spread the low end of the dial select some low frequency channel and adjust the padders for maximum limiter grid voltage. Thus alignment of the R.F. stages is completed.
- (h) Then tighten the push button locking screw.

CIRCUIT ADJUSTMENT

The squelch circuit is incorporated in the FM receiver to disable it during no-signal intervals. The following has been found to be the simplest method of adjustment:

- (a) Set the manual tuning dial of the receiver to some point where no signal is received.
- (b) Adjust the squelch potentiometer R30 (usually a screwdriver adjustment) to the point where the sensitivity hiss just disappears. Note: This should be done with the manual volume control advanced to maximum.
- (c) Depress a push button, and the signal should open up the squelch and come through the receiver. If not, R30 will have to be adjusted to some optimum setting which will allow opening of the squelch, with suppression of as much of the sensitivity hiss as practicable.

The procedures thus given apply to any (Continued on following page)

NOW'S Your Big Chance!



TURN YOUR EQUIPMENT INTO CASH—AT HIGHEST PRICES

Right now is when you can do your government a favor, and do yourself a favor at the same time! Communications equipment is needed... and I'll pay the highest cash price for that equipment you're not using. The government will get what they need, and you'll get cash—or trade-in credit—to buy the post-war super-equipment.

YOU'LL BE SET FOR NEW, BETTER RIGS WHEN THE WAR ENDS



I WANT HALLICRAFTERS

I'm especially interested in any Halli-crafter equipment you have, but will pay top prices for transmitters, receivers and parts of any make. Write today and tell me what you have. I'll quote you cash price by return mail.

Free!

GIANT WALL-SIZE RADIO REFERENCE MAP

Here's a gift from me that you'll surely want. I've printed a brand new reference map, with time zones, amateur zones, all standard broadcast stations, shortwave stations, systems four major networks—lots more information. Easily worth two dollars or more, but it's yours free! Send 15 cents to cover packing and mailing.

LEO-W9GFQ

Wholesale Radio Laboratories
744 W. BROADWAY, COUNCIL BLUFFS, IOWA

Complete Plans

For Building Useful and Practical Things at Home. Each issue of Popular Homecraft is crammed with plans for making such beautiful and useful things as: Furniture, Bird Houses, Lamps, Outdoor Garden Furniture, Candle Equipment, etc. Covers lathe work, tools, wood-working, leathercraft, copper. You'll find "how" to make almost everything from the pages of Popular Homecraft. Scores of drawings and photographs make every step simple as A B C. A real "How-To-Do-It" magazine.



Six Months' Trial \$1.00

Send \$1.00 today for trial six months' subscription. Money Back If Not Delighted.

POPULAR HOMECRAFT

937 Palmolive Building Chicago, Ill.

Trial 6 Months \$1.00

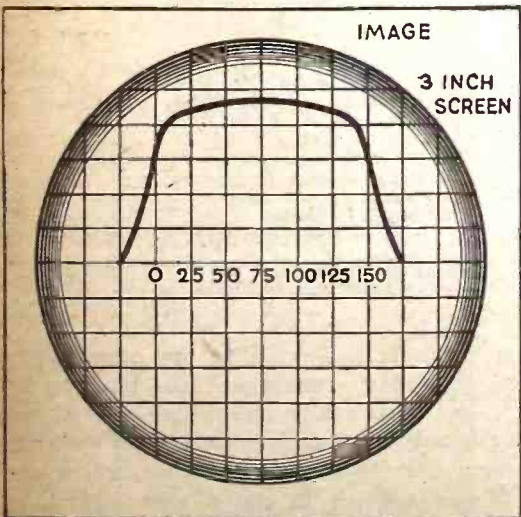
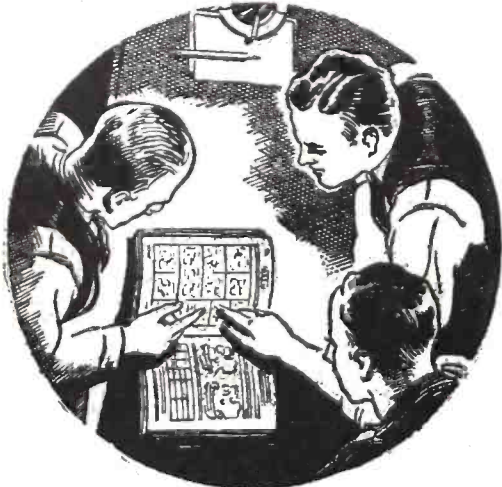

Fig. 3—Correctly adjusted FM discriminator curve. Bandwidth is a full 150 kilocycles.

AMPLIFIER MANUAL

By **A. C. SHANEY**

Chief Engineer, Amplifier Co. of America



**For the Layman, Serviceman
Recordist and Engineer**

Regardless of whether you are interested in the finest type of phonograph reproduction, high fidelity recording, sound-on-film applications, FM or AM programs, you will find invaluable information in this practical handbook. Written by the leading exponent of direct-coupled amplifiers who has spent more than 10 years improving and perfecting the famous Loftin-White circuit.

Explains the theory and practical application of:

- Variable Speed Non-Overloading Push-Pull Expansion
- Non-Frequency Discriminating Scratch Suppression
- Push-Pull Balanced Direct-Coupled Amplification
- Push-Pull High-Frequency Equalization
- Push-Pull Low-Frequency Equalization
- Push-Pull Volume Compression
- Automatic Volume Limitation
- Automatic Volume Control
- Calibrated V. U. Indicator
- Audio Spectrum Control
- Remote Control

If you are interested in the latest audio developments, you can't afford to be without this complete compilation of authentic articles on Direct-Coupled Amplifiers. 32 pages 8 1/2" x 11". Over 100 diagrams and illustrations.

Priced to Cover Cost of
Printing and Mailing **25c**

Send U. S. Stamps or Coin

AMPLIFIER CO. OF AMERICA

396 BROADWAY

NEW YORK, N. Y.

**300 WAYS
TO MAKE
MONEY**

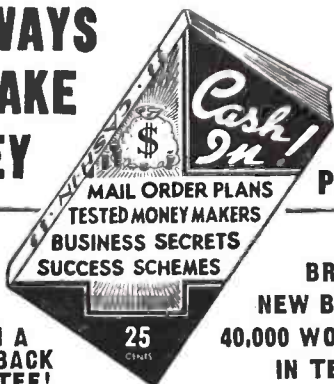

68
PAGES

25c
Per Copy

**SOLD ON A
MONEY-BACK
GUARANTEE!**

In "CASH IN" you get ALL the real money-makers—dozens of profitable tested mail order plans, confidential business secrets, dozens of practical tested formulas, successful tested schemes—actual experiences of men who have started on a shoestring—with less than \$10 capital.

Buyers of This Book Tell Us—

"Biggest value I've yet to see. Book is worth at least a dollar." S. Buda, B'klyn, N. Y.
"Your book is as good if not better than others selling at \$1.00."

George Brunet, Montreal, Can.
"CASH IN is the best value I have yet to see in the mail order field."

Lawrence Fox, Brooklyn, N. Y.
"CASH IN" contains only tested ideas covering every type of full-or spare-time enterprise—it's a "master-piece" in business ventures.
25c a copy postpaid. Send U. S. stamps or coin.

NATIONAL PLANS INSTITUTE
P.O. Box 26R, Station N
New York 23, N. Y.

MAINTAINING FM

(Continued from previous page)

FM receiver regardless of the complexity of design, and with a little common sense no difficulty whatsoever should arise.

GENERAL MAINTENANCE

There are only three circuits in the FM receiver which differ with those used in AM radios; the limiter, the discriminator and the squelch. The maintenance and servicing of the rest of the receiver is practically the same as in AM. We will mention some of the troubles arising in the three circuits segregated.

If noise comes through the receiver with the signal, the trouble will usually be traced to the limiter stage or stages. The following should be checked: R16 and R20 for change in value; C18 and C21 for open; R17, R18, R21 and R22 for changes in value. Regeneration sometimes occurs due to open plate and screen grid by-passes C19, C23, C20 and C32. Regeneration in the limiter can be detected by pulsating squeals

in the audio output. The troubles listed above have been the most common ones encountered.

Very little trouble is ever found in the discriminator circuit if it is properly balanced. Sometimes distortion arises due to an open, or short, or an intermittent in C24. A fringe on the audio sometimes occurs due to open R.F. by-passes C25 and C26 across the load resistors. Outside of these few cases the discriminator usually behaves itself.

If precision parts are used for R30, R31, C30 and C29 there is nothing to worry about from the squelch circuit. If the squelch takes hold too fast the value of C29 should be increased (or R31). If the squelch lets go too quickly on noise peaks the value of C30 should be increased to allow a longer discharge period for C29. Improper adjustment is biggest fault with this circuit and as the parts are few, it is comparatively simple to correct.

CHART I

Function of Component Parts of Fig. 1

VACUUM TUBES

- V1—R.F. amplifier
- V2—Pentagrid converter
- V3—I.F. amplifier
- V4—1st overload limiter
- V5—2nd overload limiter
- V6—Discriminator
- V7—1st A.F. amplifier
- V8—Power A.F. amplifier
- V9—Full-wave rectifier

RESISTORS

- R1—R.F. amp. cathode bias
- R2—R.F. amp. screen-grid bleeder
- R3—R.F. screen-grid dropping
- R4—R.F. amp. plate load
- R5—R.F. amp. plate filter and decoupling
- R6—Converter cathode bias
- R7—Converter screen-grid bleeder
- R8—Converter screen-grid dropping
- R9—Converter plate filter and decoupling
- R10—R.F. oscillator grid leak
- R11—R.F. oscillator anode grid dropping
- R12—I.F. amp. screen-grid dropping
- R13—I.F. amp. plate filter and decoupling
- R14—I.F. amp. cathode bias
- R15—I.F. amp. screen-grid bleeder
- R16—1st limiter grid leak
- R17—1st limiter plate dropping
- R18—1st limiter screen-grid dropping
- R19—1st limiter screen-grid bleeder
- R20—2nd limiter grid leak
- R21—2nd limiter plate dropping
- R22—2nd limiter screen-grid dropping
- R23—2nd limiter screen-grid bleeder
- R24—Discriminator cathode return R.F. filter
- R25, R26—Discriminator load
- R27—1st A.F. grid series resistor
- R28—1st A.F. grid leak
- R29—1st A.F. cathode bias
- R30—Squelch sensitivity control
- R31—Part of squelch time constant filter with (C29 and C30)
- R32—1st A.F. amp. plate load
- R33—1st A.F. amp. plate filter and decoupling
- R34—Power A.F. amp. cathode bias
- R35—A.F. volume control (manual)
- R36—Power supply bleeder
- R—I.F. transformer damping

TRANSFORMERS

- T1—1st I.F. converter to I.F. amplifier
- T2—2nd I.F., I.F. amplifier to 1st limiter
- T3—3rd I.F., 1st limiter to 2nd limiter
- T4—Discriminator; 2nd limiter to discriminator
- T5—A.F. output
- T6—Power supply

MISCELLANEOUS

- S1—Off-on switch
- P—Pilot light

CONDENSERS

- C1—Part of series wave trap (L8)
- C2—R.F. amplifier tank tuning
- C3—R.F. amplifier tank trimmer
- C4—R.F. amplifier cathode by-pass
- C5—R.F. amplifier screen-grid by-pass
- C6—R.F. amplifier plate by-pass
- C7—D.C. blocking, R.F. coupling plate to converter control grid
- C8—Mixer section tank tuning
- C9—Mixer section tank trimmer
- C10—Converter cathode by-pass
- C11—Converter plate by-pass
- C12—R.F. oscillator tank tuning
- C13—R.F. oscillator tank trimmer
- C14—R.F. oscillator plate by-pass
- C15—I.F. amplifier cathode by-pass
- C16—I.F. amplifier screen-grid by-pass
- C17—I.F. amplifier plate by-pass
- C18—1st limiter grid leak by-pass
- C19—1st limiter screen-grid by-pass
- C20—1st limiter plate by-pass
- C21—2nd limiter grid leak by-pass
- C22—2nd limiter plate by-pass
- C23—2nd limiter screen-grid by-pass
- C24—D.C. blocking
- C25, C26—Discriminator load R.F. by-passes
- C27—Part of frequency correcting network (with R27)
- C28—1st A-F amplifier cathode by-pass
- C29—Part of squelch time constant network (with C30 and R31)
- C30—Part of squelch time constant network (with C29 and R31)
- C31—1st A.F. amplifier plate by-pass
- C32—D.C. blocking A.F. coupling 1st A.F. plate to 2nd A.F. grid
- C33—Power A.F. amplifier cathode by-pass
- C34, C35—Power supply filters
- C36—D.C. supply bus R.F. by-pass
- C37—Converter screen-grid by-pass
- C38—Converter grid leak

COILS

- L1—Primary antenna transformer
- L2—R.F. amplifier tank (secondary of antenna transformer)
- L3—Mixer section tank
- L4—R.F. oscillator tank (primary)
- L5—R.F. oscillator tank (secondary)
- L6—Filter choke (power supply)
- L7—D.C. bus R.F. choke
- L8—Part of wave trap (with C1)

The vital service rendered by radio in the swift and accurate dissemination of news from global battlefronts and in its complete coverage of the United States with valuable win-the-war publicity was praised by George W. Healy, Jr., OWI domestic director, speaking at a luncheon tendered in his honor by the NAB last month. No industry has responded bet-

ter to the call for aid to the government in the war emergency, declared Mr. Healy. "You really have done everything we've asked you to," he said. Relations between the OWI and the radio broadcasters are excellent, he stated, and added that much of the credit properly belongs to Philip Cohen, OWI radio chief.



HIGH EFFICIENCY results in **Sound National Defense** that is why **NATIONAL DEFENSE SOUND SYSTEMS** are equipped with **University Reflex HIGH POWER LOUDSPEAKERS UNIVERSITY LABS.** 225 VARICK ST. N. Y. C.

OPPORTUNITY AD-LETS

Advertisements in this section cost 20 cents a word for each insertion. Name, address and initials must be included at the above rate. Cash should accompany all classified advertisements unless placed by an accredited advertising agency. No advertisement for less than ten words accepted. Ten percent discount six issues, twenty percent for twelve issues. Objectionable or misleading advertisements not accepted. Advertisements for April, 1944, issue must reach us not later than March 18, 1944.

Radio-Craft • 25 W. B'way • New York 7, N. Y.

RADIO SERVICEMEN AND EXPERIMENTERS SEND for our giant radio catalogue. Save collars. United Radio Co. (1000P) Newark, N. J.

USED CORRESPONDENCE COURSES AND TECHNICAL Books Bought, Sold, Rented. Catalog Free. Educational Exchange, Henager, Alabama.

REVISED PLANS 18 CRYSTAL SETS (SW RECORD 5300 miles), with "Radiobuilder"—25c. Laboratories, 868-A Hampton, Hayward, Calif.

TECHNICAL BULLETINS

Technical bulletins give reliable information in easy-to-follow form, and save valuable time otherwise spent in laborious reading of numerous books. Every subject is treated briefly and concisely, yet completely. No complicated mathematics, chemistry, electricity, or theory. Each bulletin is written in simple language.

Each Bulletin consists of a set of large sheets, assembled in one packet, size 9 x 14 1/2"; weight 1/4 lb. Numerous illustrations, diagrams, charts to supplement text.

PRICE \$1.00 EACH POSTPAID
ORDER BY NUMBER

- D-111—DESIGNING AND BUILDING TRANSFORMERS
- D-112—DESIGNING ELECTRO-MAGNETS
- D-113—HOW TO DESIGN SOLENOIDS AND PLUNGER MAGNETS
- D-101—USING NICHROME RESISTANCE WIRE
- D-106—REWINDING ELECTRIC MOTORS
- D-144—ALTERNATING CURRENT CONTROLLED WITH EASILY MADE CHOKE COILS
- D-148—DESIGNING AND USING ELECTRIC RELAYS
- D-127—SMALL ELECTRIC LIGHT PLANTS
- D-134—ELECTRICAL EXPERIMENTS WITH SIMPLE MATERIALS
- D-131—MODEL MAKERS & INVENTORS GUIDE TO REMOTE-CONTROL SWITCHING
- D-137—ELECTRICAL METERS EASILY BUILT
- D-136—SMALL A.C. ARC WELDER CONSTRUCTION AND USE

Send Stamps, Cash or Money Order

TECHNIFAX

1917 S. STATE ST. RC-3-44 CHICAGO, 16, ILL.

DEPT. RC-3-44
TECHNIFAX 1917 So. State, Chicago, 16, Ill.

Enclosed find \$..... for which please send me postpaid the following Technical Bulletins:

Nos.

Name

Street and Number

City and State

RADIO-CRAFT for MARCH, 1944

HIGH-ALTITUDE BRUSHES

RADIOMEN have been puzzled by announcements of "high-altitude generator brushes." There seems no reason why a brush that operates at sea level should not work at 30,000 feet, as far as the earth-chained engineer is concerned. Radiomen and electricians used to aviation work were not surprised—many things happen at high altitudes, even to the apparently least susceptible components of radio and electrical apparatus. Commutator brushes were one of these—the life of an ordinary brush at high altitudes was only an hour or two. Sometimes they would disintegrate completely in a single flight at altitudes of 30,000 feet and above.

Research engineers, studying the phenomena of commutation in the stratosphere, found that the thin copper-oxide film normally present on the commutator surface at ground level is not maintained in the upper air. This oxide film acts as a lubricant for the brush face. Without it the carbons ride on raw copper and are quickly ground to dust at the high speeds at which aircraft generators turn. Absence of the film also decreases brush-contact resistance—this has an adverse effect on the electrical characteristics of the generator. High temperatures at which these commutators operate nullify conventional methods of lubrication.

Armed with this information research engineers were able to develop a special treatment for brushes that develops on the commutator the necessary oxide film as rapidly as it is worn away. Thanks to their research, airplane builders and operators now have new brushes that last one hundred hours in high-altitude flying. The resulting fiftyfold improvement in aircraft brush life is of great significance, not only now, but also in the high-altitude flying that is to come after the war.

MORSE CODE SPACING

ONE of those inter-office debates last week revolved around the correct spacing of the International Morse Code. What was the authority for it? Or did it depend on "old custom." No one seemed to know, and everybody we asked admitted that he had just taken the code for granted all these years.

Inquiry from the FCC reveals that there is definite authority for the spacing of the code characters, and that this authority is found under the heading, "Morse Code Signals," in the Telegraph Regulations annexed to the International Telecommunications Convention. The length and spacing of code characters is as follows:

1. A dash is equal to three dots.
2. The spacing between signals of the same letter is equal to a dot.
3. The spacing between two letters is equal to three dots.
4. The spacing between two words is equal to five dots.
5. When punching is used on the Wheatstone apparatus the spacing between two letters is equal to one "blank" and the spacing between two words is equal to three "blanks."

CORRECTION

An error appeared in Fig. 9 of the article, "Oscillators" (January, 1944, pages 208 and 209). The grid leak resistor, which should have run from the No. 1 grid of the mixer tube to ground, was omitted.

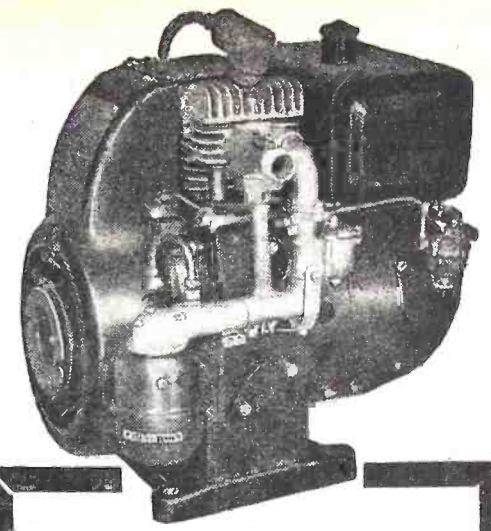

ELECTRICITY for Any Job Anywhere

ONAN GASOLINE DRIVEN ELECTRIC PLANTS provide electricity for communications work in locations where it is not otherwise available, and for emergency and standby service. Thousands of these sturdy, reliable plants are doing a winning job on all fighting fronts, in communications and other war tasks.

50 to 800 cycles, 110 to 660 volts, A.C.—6 to 4000 volts, D.C. Also dual A.C. and D.C. output types. Engines are air or water cooled.

Your inquiry regarding present or post-war needs will receive prompt attention.



D. W. ONAN & SONS
731 Royalston Ave.
Minneapolis, Minn.

SYLVANIA OPENS NEW PLANT

Sylvania has established an additional manufacturing unit at Dover, New Hampshire, it is announced by the Industrial Agent of the State Planning and Development Commission.

The plant, which occupies 250,000 square feet of space in two large buildings which are now the property of the city of Dover, will draw workers from within a 20-mile radius, populated by more than 100,000 people. The new factory is the latest of a large number which includes 3 in Massachusetts and 7 in Pennsylvania.

A new and important post-war job of radio will be airway traffic control, according to W. A. Burden, aviation assistant to the Secretary of Commerce.

DON'T WAIT!

—for those hard-to-get tube types. Complete all jobs immediately, and increase your weekly profits, with handy tube guide books that feature:

- ★ over 225 substitutions and change-overs
- ★ 8 substitutes for 12SA7
- ★ 6 substitutes for 50L6GT
- ★ 4 substitutes for 1A7GT
- ★ complete adaptor construction data
- ★ universal rectifier socket and adaptor

contained in the
**"RADIO TUBE
 SUBSTITUTION &
 CHANGE-OVER MANUAL"**

Price: \$1 per copy

and the new
**"RADIO TUBE
 SUBSTITUTION
 SUPPLEMENT"**

Price: 50 cents per copy

See your radio parts jobber,
 or write to:

OELRICH PUBLICATIONS
1627 So. Keeler Ave.
Chicago, 23, Ill.

for the set of two booklets, or the
 manual or supplement only.

Never Be Caught Without a JIFFY-NEON Electric Tester



This Neon Electric tester checks all Electrical Devices, Lines, Motors, etc., 110 volts to 550 volts!! A.C. or D.C.!!

TO CHECK FOR CURRENT—The test leads of the JIFFY WILL FIT into any standard outlet. "Live" line (110-550 volts) will cause Neon to glow.

TO CHECK IF CURRENT IS A.C. OR D.C. Both electrodes of the Neon Lamp light on A.C. Only one electrode lights on D.C.

\$1.25

POSTPAID

TO TEST FOR BLOWN FUSE. Connect the JIFFY across the fuse with the line load "on." If the fuse is defective the Neon will glow. The JIFFY will indicate if a motor, appliance, etc., is not operating due to an "open." With the current "on" and the JIFFY connected in series with the device under test, the neon will not glow if there is a "break" or "open" in the device under test.

Easy to check if line is 25 or 60 cycles or for grounded side of a line. Many additional uses will suggest themselves as you become familiar with this indispensable tool.

Order it Now! Postpaid

\$1.25

N. GRAY

160-22 97th St., Howard Beach, L.I., New York

AN FM WALKIE-TALKIE?

(Continued from page 341)

an F.M. W.E.R.S. network, perhaps this receiving circuit will give you something to start your experiments on.

THE TRANSMITTER

The R.F. section of our transmitter should consist of an oscillator of sufficient power working directly into the antenna. The various types which fill these requirements fall into two general classes: those whose tuned circuits consist of "lines" whose length determines the frequency of oscillation, and those employing one or more coil-condenser tank circuits for frequency control. The former are more efficient, but present great problems to anyone trying to frequency modulate them, and so, for our purposes, may be ruled out. Of the others, the good old Hartley circuit combines efficiency and high output with simplicity and reliability, and therefore seems the logical choice for our transmitter. A typical form of this circuit is shown in Fig. 1.

A coil of 3 turns ½ inch in diameter center tapped and used with a 15 mmfd. condenser such as the National UM15 works very well on 112 M.C., while slight improvement in output may be obtained by using a .0001 silver mica across the tuning condenser to decrease the L/C ratio. In this case the turns of the coil may be spread apart somewhat to keep the frequency in the 112 mc. range.

MODULATION METHODS

The problem of how to frequency modulate this oscillator now arises and, as a first step, we must ask ourselves, "If the frequency of the oscillator is to be varied, what controls this frequency?" The answer is, of course, the tuned circuit. Changing either the capacity of the tuning condenser or the inductance of the coil will change the resonant frequency of the circuit and hence the frequency on which the transmitter works. We have a choice of two methods of changing the capacity of the condenser at an audio rate. The first—that of actually varying, by electro-mechanical means, the capacity of a small condenser connected in parallel with the main tuning capacitance—would not only challenge the skill of many an experimenter and require hard-to-get parts, but would also defeat one of the advantages of using F.M. by requiring considerable audio driving power. The second consists of connecting one of the pentagrid mixers such as the 6SA7 or 6L7 in a special circuit which will vary the effective capacity across a tank coil by purely electronic means.

The author found that this circuit had several disadvantages. One trouble was that the design could be used only with tank circuits with one end grounded, which limited its use to electron coupled oscillators. Also the fidelity was lower than was desirable and the sweep that could be obtained without high distortion was very limited.

THE MODULATOR CIRCUIT

So far we have discussed only methods of modulating the effective tuning capacity. Looking at the tank coil, we may again dismiss mechanical methods of varying its inductance and confine ourselves to the electronic. And here we find a law about all inductances that gives us the perfect solution to the problem—namely that the value of the inductance of any coil varies inversely as the current drawn through it. This is a familiar fact to hams who have tried to overload their power supply chokes and still get hum-free output. It would seem, then, that if we pass an audio frequency current through our oscillator's tank coil, we would frequency modulate the oscillator therewith. And what do we find in the plate circuit of any ordinary voltage amplifier but just such an A.F. current? It would seem, then, that the circuit shown in figure 2 would represent a practical hookup for an FM W.E.R.S. transmitter. Note that the plate of the reactance modulator tube is connected to the grid end of the tank coil and that the half of this coil between the centertap where the "B" supply is inserted and said grid end forms the reactance modulator's plate load. While it would provide a greater frequency swing for a given audio input were the entire tank coil used as the modulator's load, the simplicity of this circuit far outweighs any such disadvantage, and a reasonably low level of audio input produces quite an adequate frequency sweep. The reason for using the grid-end of the coil to connect the modulator to is simply this: while similar results as far as frequency modulation would be obtained by connecting the modulator to either end, the fact that the oscillator draws its plate current through the one half of the tank coil would cause a slight amount of amplitude modulation to take place if the modulator likewise drew its plate power through the same half of the coil. This would decrease the efficiency of the oscillator by reducing the average power output somewhat.

A FEW CIRCUIT TRICKS

There is only one hitch in the circuit of Fig. 2: The oscillator stops oscillating as soon as the reactance modulator tube is in-

NURSING-BOTTLE RADIO

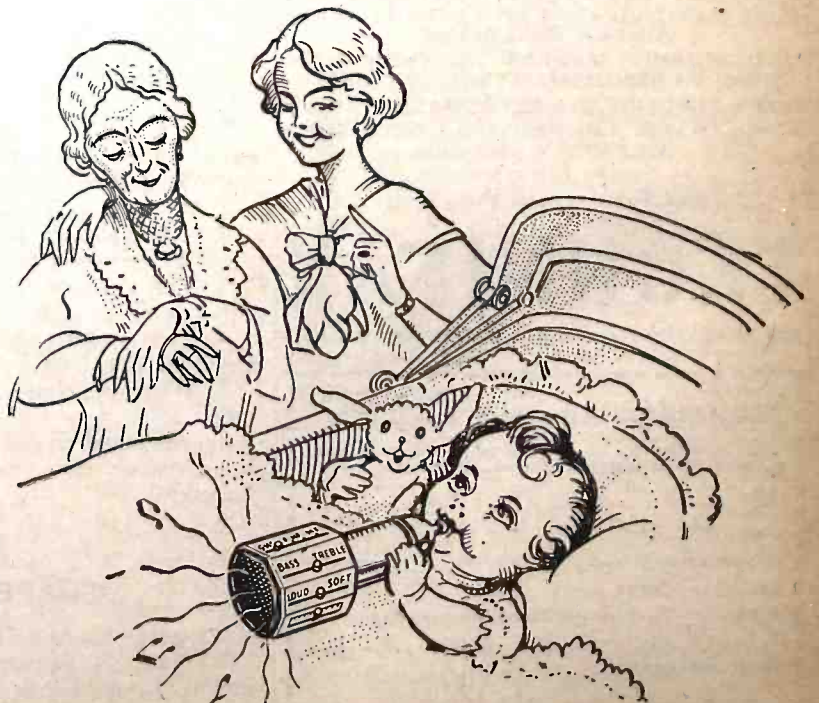

"We wanted the baby's musical education to start early."

serted in its socket. This is due to the fact that the stray capacities involved in the audio circuit, which is hooked into a U.H.F. circuit, load this last so heavily and reduce the tank circuit's "Q" to such an extent that the oscillator stops operating because it cannot make up for the losses with which the reactance modulator saddles it. The solution to this problem is a simple one. First, instead of using a triode, a high efficiency, low loss pentode such as the 6AB7/1853 should be used as the modulator tube. And secondly, a very small amount of R.F. feedback should be inserted between the plate and the grid of the reactance modulator. This provides a bit of regeneration on the frequency the oscillator is working on, and tends to make up for any losses placed on the tank circuit by the modulator.

These additions provide us with a highly efficient and thoroughly reliable F.M. transmitter circuit, which is shown in detail complete with parts values in Fig. 3. A 6C5 is connected as an ordinary voltage amplifier to give the output of the double button carbon mike a boost before it reaches the reactance modulator. This stage has a simple filter in series with its grid to prevent the R.F. which is fed onto it through condenser C from getting back into the straight audio circuits. Condenser C must be very small to feed back only a little of the U.H.F. and

keep the modulator from oscillating. A .00001 mfd. mica works very well, but it is even simpler and more economical to just twist a couple of lengths of well insulated hookup wire together for a length of 1½ to 2 inches and use that. The value of C is extremely non-critical and almost anything which will allow a little of the 112 mc R.F. to reach the modulator grid without letting plate voltage through will work perfectly.

The whole transmitter (exclusive of power supply, which need only supply about 50 Ma) may be built on a piece of sheet metal about 3" x 5" and tucked away in any convenient corner. After the author had tested this design, the completed unit was finally mounted under the chassis of a P.A. amplifier in some free space under the power transformer. The amplifier's power supply didn't even get slightly warmer when the extra load was placed on it, and a tap on the grid resistor of one of the low level audio stages provided a convenient source of audio voltage.

This is just an example of what this circuit may be adapted to and what a wide variety of audio sources the reactance modulator will work off of with completely satisfactory results. With other conditions tolerable, an excellent F.M. W.E.R.S. net may be set up using units like this for the transmitters.

INDUSTRIAL ELECTRONICS (Continued from page 336)

amplifying tubes invariably employed on photoelectric relays. Contrary to the generally accepted belief, such relays are used for far more important work than opening doors in restaurants or railroad stations. In a very large measure such cells, espe-

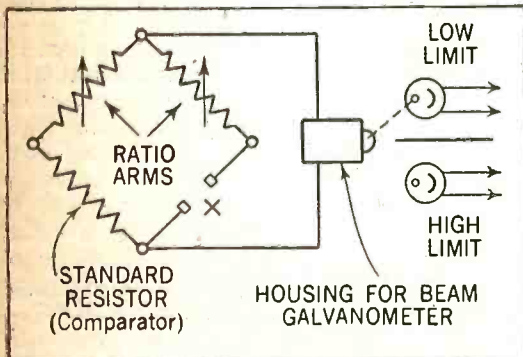

Fig. 7—A circuit for quick resistor checks.

cially when designed to respond to a wavelength comparable to that of the human eye, will do practically everything that the human eye will do—perhaps even more. Its response is instantaneous and, unlike the human eye, it is not troubled with "visual persistence" or the retention of a light impulse after the impulse has disappeared.

The widespread application of the photoelectric cell in industry is easy to understand. Of all the electronic devices, it is by far the most versatile. It is not only sensitive to the volume of light but intensity and color as well. Thus we find it used for color inspection, registration (as in printing colors), counting at high speed, beam control of punch presses and other danger machinery, etc. It is also able to detect many different conditions and classify various things. It may mechanically sort articles according to shade or according to condition of surface. The device has also successfully applied to mechanical measurements and is now extensively used for such purposes in the automobile industry.

The uses of the photoelectric cell appear to be limited only by the imagination of

the engineers who are called upon to make use of it. A very simple trick is illustrated in Fig. 7 for sorting electrical resistor units. Here a light beam galvanometer is employed and each resistor being tested is the "X" arm of a Wheatstone Bridge. When the bridge becomes unbalanced, the beam will swing one way or the other and flash upon one of the two photoelectric cells.

Due to the fact that such cells may be made extremely sensitive to very small light changes small differences in color, turbidity, transparency reflectivity, density, etc., may be quickly detected and accurately measured. Such changes may be so small that no device but the electron tube could possibly detect or use them. It is this inability to respond to infinitesimal effects which is the foundation of the widespread use of electron tubes in industry.

The electron tubes may be used as a switch which requires practically no power to throw, or as a control which will translate a two or three per cent increase in potentials in the order of millionths of a volt into the same (or a greater or lesser) increase or decrease of tens or hundreds of volts, involving kilowatts of power.

Succeeding articles will describe specific applications of vacuum tubes in measurement and control, and show how electronics can extend the usefulness of existing machines, cut production costs and increase efficiency.

NOW—A REALLY HIGH-POWERED— Radio Engineering Library

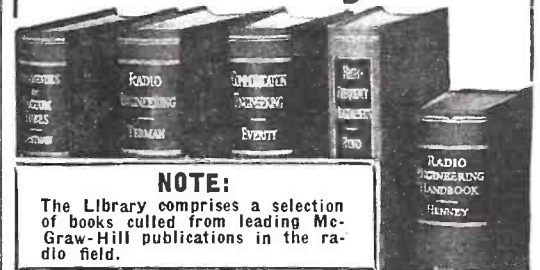

NOTE:

The Library comprises a selection of books culled from leading McGraw-Hill publications in the radio field.

- especially selected by radio specialists of McGraw-Hill publications
- to give most complete, dependable coverage of facts needed by all whose fields are grounded on radio fundamentals
- available at a special price and terms

THESE books cover circuit phenomena, tube theory, networks, measurements, and other subjects—give specialized treatments of all fields of practical design and application. They are books of recognized position in the literature—books you will refer to and be referred to often. If you are a practical designer, researcher or engineer in any field based on radio, you want these books for the help they give in hundreds of problems throughout the whole field of radio engineering.

5 VOLUMES, 3319 PAGES, 2289 ILLUSTRATIONS

1. Eastman's FUNDAMENTALS OF VACUUM TUBES
2. Terman's RADIO ENGINEERING
3. Everitt's COMMUNICATION ENGINEERING
4. Hund's HIGH FREQUENCY MEASUREMENTS
5. Henney's RADIO ENGINEERING HANDBOOK

10 days' examination. Easy terms. Special price under this offer less than books bought separately. Add these standard works to your library now; pay small monthly installments, while you use the books.

10 DAYS' FREE EXAMINATION—SEND COUPON

McGraw-Hill Book Co., 330 W. 42nd St. New York 18

Send me Radio Engineering Library, 5 vols., for 10 days' examination on approval. In 10 days I will send \$3.00 plus few cents postage, and \$3.00 monthly till \$24.00 is paid, or return books postpaid. (We pay postage on orders accompanied by remittance of first installment.)

Name

Address

City and State

Position

Company RC 3-44

RADIO AND ELECTRONIC DEVICES

BURSTEIN-APPLEBEE CO.
1012-14 McGee St. Kansas City, Mo.

New Accurate 10" Slide Rule

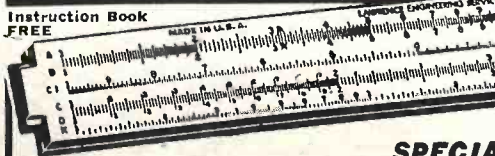

Instruction Book FREE

SPECIAL COMBINATION OFFER

Standard 10" Slide Rule and Instruction Book; Pocket Calculator for adding and subtracting up to 999,999; 6" Transparent Protractor and Graph Rule graduated in centimeters and inches. —ALL 3 for \$1.00 cash (\$1.10 Foreign) POSTPAID.

New "TRIG" 10" Slide Rule, with Pocket Calculator and Transparent Protractor. \$1.50 (\$1.60 Foreign) POSTPAID.

Magnifying Indicator



Enables you to do difficult calculations instantly without paper or pencil—multiplying, proportions, division, extracting roots, etc. Accurate, white composition face. Has standard A, B, C, D, CI and K scales.

For complete outfit, including slide rule, 28-page illustrated instruction book, carrying case, send 50c (60c Foreign). New "TRIG" 10" Slide Rule, with same six scales as above plus S, L, and T scales on Reverse of Slide for problems in Trigonometry; Gunmetal Finish indicator; complete instructions—\$1.00. Mailed postpaid. Satisfaction Guaranteed or money refunded. (See Special Combination Offer.) Order NOW.

HEWIG CO., Box H-143, Grand Central Annex, NEW YORK CITY

Short-Cut Mathematics

COMBINED WITH
Practical Mechanics Simplified

NEW 2-in-1 reading course! Now you can learn the speedy, simplified system of calculation used by draftsmen, engineers, accountants, "master minds" on the stage. Learn easy way to multiply 4 figures by 4 figures without using old-fashioned multiplication; add long columns of figures this lightning short-cut method. Learn horsepower, slide rule, micrometer, logarithms, wood measure, puzzles, etc., etc. Large illustrated volume complete with answers, only \$1 postpaid. Satisfaction or refund. Amaze your friends with your magic-like mental powers.

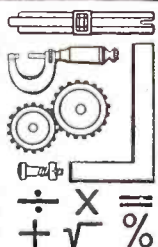

FREE Complete details... mail coupon TODAY!

NELSON CO., 321 So. Wabash, Dept. C-310, Chicago
Please send free details about "Short-Cut Mathematics and Practical Mechanics Simplified." No obligation.

Name _____
Address _____

PATENTS—TRADE MARKS

Booklet concerning Inventions & Patents Form "Evidence of Conception" with instructions for use and "Schedule of Government and Attorneys Fees"—Free
LANCASTER, ALLWINE & ROMMEL
Registered Patent Attorneys

436 Bowen Bldg. Washington, D. C.

GEOPHYSICAL PROSPECTING PRINTS (TREASURE FINDERS)

50¢ EACH

7 FOR

\$3.—

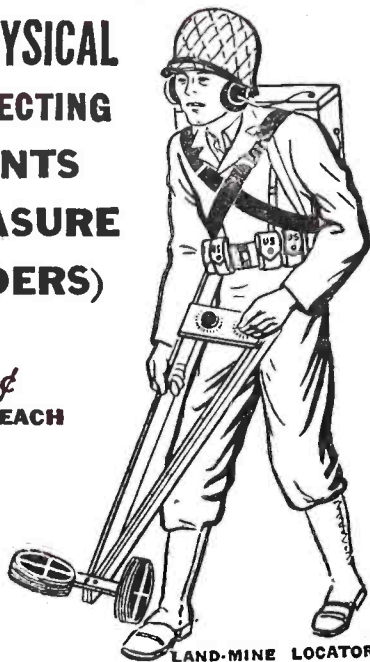

LAND-MINE LOCATOR

With any one of the modern geophysical methods described in the Blue-Print patterns, radio outfits and instruments can be constructed to locate metal and ore deposits (prospecting); finding lost or buried treasures; metal war relics; sea and land mines and "duds"; mineral deposits; subterranean water veins; oil deposits (under certain circumstances); buried gas and water pipes; tools or other metallic objects sunken in water, etc., etc.

- Folder No. 1. Radiolocator Pilot. Construction and use of 2 tube transmitter and 3 tube receiver. Reflected wave principle. Visual and aural signals.
- Folder No. 2. Harmonic Frequency Locator. Radiates low frequency wave to receiver. Aural signals.
- Folder No. 3. Beat Note Indicator. 2 oscillators. Visual and aural signals.
- Folder No. 4. Radio Balance Surveyor. Balanced loop principle. Modulated transmitter. Visual and aural signals.
- Folder No. 5. Variable Inductance Monitor. Inductance principle. Aural signals.
- Folder No. 6. Hughes Inductance Balance Explorer. Bridge principle. Aural signals.
- Folder No. 7. Radiodyne Prospector. Balanced loop principle. Very large field of penetration. Aural signals.

Each set of blueprints and instructions enclosed in heavy envelope (9 1/2" x 12 1/2"). Blueprints 22" x 34"; eight-page illustrated 8 1/2" x 11" folder of 50c instructions and construction data. Add 5c for postage

The complete set of seven folders \$3.00
Shipping weight 2 lbs. (add 25c for shipping anywhere in U.S.A.)

Send Stamps, Cash or Money Order to

TECHNIFAX

1917 S. STATE ST. RC-3-44 CHICAGO, ILL.

TECHNIFAX 1917 So. State, Chicago, Ill.

Enclosed herewith \$..... for which mail to address below:

Treasure Finder No. 1, 2, 3, 4, 5, 6, 7.
Complete set of seven folders.

NAME

ADDRESS

CITY STATE

RC-3-44

"MADAME CURIE" AND ELECTRONICS (Continued from page 338)

message—that any growth anywhere on the body should never be neglected, but immediately reported to a physician. This phase fitted eminently into the scope of the film.

What about the other wonders of Radium—wonders so spectacular that they lend themselves extraordinarily well to motion picture presentation? Nevertheless, the film "Madame Curie" completely and totally ignored them. Merely to show what can be done and to refresh the memories of technical men and older readers, and to impress those who are not up on their Radium, we present here a number of illustrations which we originated way back in 1915. The illustrations appearing here are adapted from those published in the September, 1915, issue of the ELECTRICAL EXPERIMENTER.

We hear so much about electronics in these days that frequently the fact that Radium is one of the original reasons for the electron is lost sight of. Indeed, Radium and its various rays and emanations are partly responsible for the electron theory. It took Radium to revolutionize science as well as the concept of the atom and it may be said that the real discovery of the electron dates back to about the time of the discovery of Radium by the Curies.

This is shown graphically in one of our illustrations which shows how uranium, the key element, is transformed into Radium till it finally disintegrates into what is believed to be lead. It shows also graphically how the Beta "B" rays—that is, the negative electrons—are deflected by a magnet.

Another of our illustrations shows the famed Radium "clock" invented by Professor Strutt. If undisturbed, it will run some 2500 years, the average life of Radium. This "clock," usually constructed entirely of glass, is the nearest approach to perpetual motion that we know. There are a number of them in various scientific institutions, some of the "clocks" already having run uninterruptedly for over 35 years without replenishing the Radium.

Another spectacular wonder of Radium is not that Radium can give out light by itself, but that if it is used in conjunction with certain Radium salts, we can even construct a beautiful and practical reading lamp. Why this was not shown in the film is inconceivable to us—all the more so because it was actually constructed by Professor Curie himself.

The illustration shows the construction of the lamp. It consists of two large glass bulbs, one having a solution of Radium salts, the other a small quantity of phosphorescent zinc sulphide. The two bulbs are connected by means of a glass tube, in the center of which is a stopcock. The lamp operates by placing it in a dark room. Then by opening the stopcock, the Radium emanation will travel from one bulb through the horizontal tube to the zinc sulphide. This illuminates the zinc sulphide crystals with such an inten-

sity that it is possible to read a newspaper six feet away from the bulb, as shown in the illustration. *Nothing is consumed, therefore such a lamp will last indefinitely.* Only the high cost of Radium so far has prevented the Curie lamp from coming into general use.

One of the really spectacular effects of Radium which would have been a marvelous adjunct in the film—particularly if made in technicolor—is the *Spinthariscopes*, invented by Sir William Crookes. In the original instrument, Sir William used a mere speck of Radium salt which was suspended over a zinc sulphide screen. A much more simplified version which we constructed and of which thousands were sold, can be made nowadays by any school boy. The quantity of Radium used is so small that it is almost nil, yet the spectacular effect still is had. We used a metallic lipstick holder, in one part of which we fitted a lens, as shown. This is focused by sliding it up or down, because the adjustment is critical. In the other part of the lipstick holder we cemented a paper disc coated with strong Radium luminous paint (easily obtainable before the war, but now restricted until the end of hostilities). The full effect of the spinthariscopes can only be had in total darkness. When the eye has become accustomed to the dark and the screen disc brought into focus, we behold a most extraordinary as well as astonishing spectacle in which *we actually witness the destruction of worlds on a small scale.*

We now watch the effect of the Radium *Alpha* particles as they continuously bombard the zinc sulphide atoms. This bombardment keeps up for 2500 years—longer than the simple apparatus can possibly last.

What we see with the eye is an amazing flickering as myriads of stars scintillate on a green background. So many thousands of collisions take place every instant that the eye is incapable of following them fast enough. It is an extraordinary spectacle and astonishing to those who have never seen the workings of the simple little instrument.

Another wonder of Radium, also completely lost sight of in the film, is the inherent power of Radium as it gives off a tremendous amount of heat for the whole of its 2500 years of life. Future man may

THAT WRIST-RADIO



"Henry. Henry-y-y! You come home this instant."

smile when he reflects how stupid humans of the present-day used coal to heat their houses when it gives only 5% of its actual energy when translated into steam, the rest being carried off as waste heat.

Consider that one of our not too large ocean greyhounds uses about 6,000 tons of coal for a single trip, costing about \$12,000 to \$14,000 to propel the steamship across the ocean. Let us also not forget the terrific amount of space required to cart the coal across the ocean and the extra energy needed to carry it. The same condition, of course, prevails if we use oil, which is a bit more economical, but not much.

In burning one gram of coal, only about 8,000 calories of heat are obtained. In this transformation, however, two and two-thirds grams of oxygen also are consumed, so that the two substances together give us only about 2,200 calories of actual heat.

Some day man will find it possible to obtain the key to Radium so that instead of requiring a wait of 2500 years to get all the heat out of it, we can release it in a few days. What will happen then? Simply this:

One gram of Radium develops 133 calories of heat per hour. Therefore, in 2500 years we get 2,900,000,000 calories of heat. If you consider the tremendous energy transformation of the latent power in Radium, it is found to be a million times greater than that furnished by the combustion of coal! This gives a small idea of the tremendous power stored in Radium.

One of our illustrations shows a future greyhound using Radium instead of coal. In order to make a one-way trip to Europe, we would require .15 (15/100) of a gram of Radium, which at today's prices is worth about \$25,000 per gram. Therefore a .15 gram would cost about \$3750, which compares with a price of \$12,000 for coal or oil! Radium, in other words, is almost four times cheaper than coal! On top of this we would gain tremendously by saving valuable space in the ocean liner which is now used for coal or oil; then, too, machinery for handling the coal or oil, manpower necessitated for all this, etc.

In our illustration we have shown a hypothetical boiler constructed in spherical form having a radius of several feet, and a small shell of steel or iron, with the Radium hung in the center of the boiler. Such a boiler would take up very little space and can be readily installed. The energy supplied by the Radium is distributed equally in all directions, and therefore the heating of the water in every part of the boiler is practically equal.

Radium would also be the ideal fuel for submarines, doing away with a lot of the cumbersome machinery now used, not to speak of the great load of weight which could better be used for torpedoes, and perhaps even airplanes.

Still another great wonder of the inherent energy of Radium is shown in a further illustration. Because Radium not only gives off heat but also electrical energy, we have in Radium a source of electrical energy not sufficiently appreciated even by many technicians. Our illustration makes this clear. A mere speck of Radium, weighing 1/50th of a gram, costing but \$500.00, in the 2500 years of its life gives off sufficient electrical energy to lift the entire Woolworth Building, weighing 103,000 tons!

While the illustration was merely made to demonstrate the inherent electrical power of Radium, it is nevertheless accurate, because during the 2500 years of its life, sufficient electrical energy is developed to actually perform the work as pictured.

Of course there is the hitch today of storing the energy. Even if we could trans-

form the electrical energy of Radium into direct current and charge a huge storage battery, the losses incurred over a long period of time would not give us much energy at the end of 2500 years. This again simply shows our lack of means, because we have not progressed technically to the point where we can utilize the inherent power of Radium. The fact remains, nevertheless, that if at some future date—and it will surely come—we take 1/50th of a gram of Radium and utilize its electrical power instantly through a huge electromagnet, the Woolworth Building, with all its 103,000 tons, could be lifted one foot above the ground, as pictured.

These, then, are the actual wonders of Radium that could readily have been shown in "Madame Curie," easily making it the film of the year. We hope and trust that one of these days some enterprising motion

picture producer will show what has been pictured here in a good educational two-reeler. We predict that the public will "eat it up."

USED Correspondence Courses
Complete HOME-STUDY Courses and self-instruction books, slightly used. Rented, gold, exchanged. All subjects. Satisfaction guaranteed. Cash paid for used courses. Full details & 84-page illustrated bargain catalog Free. Write now.
NELSON CO., 321 So. Wabash Ave., Dept. 210, Chicago, Ill.

Inventions Wanted
Patented or Unpatented
We have been successfully selling inventions, patented and unpatented, since 1924. Write us, if you have a practical, useful idea for sale.
CHARTERED INSTITUTE OF AMERICAN INVENTORS
Dept. 111, 631 Pa. Ave., N.W., Washington, D.C.

RADIO CIRCUIT MANUAL 1942

UP-TO-DATE OF GOVERNMENT SHUT-DOWN APRIL, '42

Complete, Correct, Compact

The Set You Are Looking For Is Here!

This Radio Circuit Manual has more listings than any other publication of its kind. Check for yourself on such makes as Lafayette, Emerson, Pilot, Philco, RCA, Stewart Warner. If time really means money to you then this completeness will save you many times the cost of the book. It is the greatest time-saver you can buy today.

No fumbling around! No turning over to another page! The big roomy pages of the Radio Circuit Manual contain everything on a single page. You will see not only schematics, but quick reference IF spot, parts lists, dial stringing, diagrams, tuning range and data, tube locations, voltage charts, trimmer locations, push button, set-ups, alignment notes, and procedures, record changer details, etc.

THE ONLY EDITED MANUAL PUBLISHED!

The diagrams are perfect. Every one was checked and rechecked to make sure of it. The printing is clear and distinct. It's a pleasure to use this manual.

The index is another feature you'll like. At a glance you can tell whether a model is the same as another. No hunting back and forth... it's right there. Big readable type numbers and model numbers help to spot quickly what you want.

Special charts on tube and battery interchangeability, lights, ohms law, color codes; also a special article on "The Methods of Substitution" by F. L. Sprayberry, to make your wartime service job easier.

If you like your service manual in handy form—so shaped that you can grab hold of it easily and store in small space... if you like a book that lies open flat so you don't constantly lose the place... then you will certainly appreciate the Radio Circuit Manual.

Everything relating to a model is on a single page. Mighty handy!

700 fact-packed pages. The actual page size is 10 x 12 3/4 inches.

\$10 EACH

Use this simple coupon for ordering the 1941 and 1942 Radio Circuit Manuals.

RADCRAFT PUBLICATIONS, INC.
25 West Broadway, New York 7, N. Y.

Gentlemen: Rush to me by return mail, the RADIO CIRCUIT MANUAL ordered below, which I understand are priced at \$10 each.

1941 Edition 1942 Edition

I enclose remittance to the amount of \$.....

Kindly send C.O.D.

Name (PLEASE PRINT CLEARLY)

Address

City Dist. No., if any State

(If remittance is enclosed, send in form of check or money order; register your letter if you send cash.)

LIMITED NUMBER OF 1941 MANUALS LEFT

Our 1941 RADIO CIRCUIT MANUAL—the first we ever issued—proved so popular that we cleared out most of them in a short time notwithstanding a large printing. However, during a recent inventory, we discovered a small number still on hand which we are disposing of quickly. This should be good news to anyone who failed to get the 1941 edition. After all, many 1941 models must be served today, and the 1942 edition won't help at all for the earlier models. The price of the 1941 edition is the same as 1942... only \$10 each

SOME ENGINEERS WE DON'T WANT AT NATIONAL UNION



Let's make it plain. There are a lot of engineers WE DON'T WANT. We have an outstanding group of engineering specialists who are GOING PLACES. They're thinkers, doers, practical dreamers. We're proud of them. WE DO WANT more engineers to join them but they have to be fellows who measure up. If you're not just trying to hit a high spot today. If you want to get into the exciting war work we're doing now and ride along on our great peace time electronic tube band wagon—THIS IS YOUR BIG OPPORTUNITY. We are adding to our staff engineers who specialize in

ELECTRONIC TUBES
PRODUCTION
DEVELOPMENT
MEASUREMENTS
PHYSICS
ELECTRICITY
TRANSMITTING TUBES.

Our laboratories in Newark, N. J., offer ideal working conditions. We prefer that you have a degree in electrical engineering, physics, chemistry or mathematics—your experience, however, may be sufficient.

Why don't you find out whether you're one of the engineers National Union DOES WANT. Write and tell us about yourself or Phone HUmboldt 2-5252, Ext. 72, for appointment.



NATIONAL UNION RADIO CORPORATION

50 Spring Street, Newark 2, N. J.



WESTERN ELECTRIC CO.

In PEACE
Source of supply for the
Bell System
In WAR
Arsenal of communication
equipment

NEEDS

ELECTRICAL TESTERS

MEN AND WOMEN

For Radio Transmitters & Re-
ceivers & similar equipment.

Young men and women who have been licensed radio amateurs preferred or those having a good technical knowledge of voice communication and trained in electrical testing of radio equipment are needed for inspectors and testers.

Release statement and
U.S.E.S. consent needed.

WRITE OR APPLY TO
C.R.L., DEPT. 4816

100 Central Ave.
Kearny, N. J.

Mon. through Sat. 8:30 a.m.-5:00 p.m.

RADIO

- . . . engineers
- . . . draftsmen
- . . . laboratory assistants
- . . . mechanical engineers
- . . . production men

A TOP-FLIGHT RADIO MANUFACTURER who is NOT in a manpower emergency wants to establish contact with top-flight radio men who, today, are NOT in a job hunting emergency.

WE ARE LOOKING AHEAD

to the postwar day when we can turn from the vital war work we now are doing and begin on the constantly growing bank of civilian production which is on our books.

LOOKING AHEAD, we want to add capable men as rapidly as they are freed from essential wartime work so they can fit themselves into our organization and be ready for responsible jobs when we get the "go" signal on major peacetime projects.

OR—IN CASES OF MEN WHO MUST REMAIN on essential war jobs for the duration—we want to establish contact and be acquainted to save time when a move can be made.

GOOD INCOME PLAN

wide-open opportunity, a sound future, pleasant surroundings in midwest location.

PLEASE SUPPLY FULL DETAILS in letter, including address and telephone number so our representative can get in touch with you for personal interview soon. Write Box 3-915, c/o RADIO-CRAFT, 25 West Broadway, New York 7, N. Y.

A PRECISE TREASURE LOCATOR

(Continued from page 337)

pivot for the null point. The reading on the scale, as indicated by the pointer, is the distance of the center of the cable below the surface. If r , Figure 3, is the radius of the cable, h the height of the coils above the ground, l the distance between the coils A and C, and d the depth of the cable, $d = l \cot \theta - k$ where $k = r + h$. By this formula the quadrant scale, s of Figure 2, can be calibrated for depth.

The depth indicator is usually handled by a group of three men. One operates the apparatus and another measures distances along the cable and places marker flags. The third member takes notes and carries the flags. The depth indicator is shown in use in Figure 4. In good going, where the

cable is buried to a depth of twenty-five inches or more, measurements are taken every fifty feet. White flags are placed every hundred yards or less to mark the path of the cable. In rocky terrain, or in places where washouts have occurred, measurements are made more frequently because in such locations the cable is apt to be at a relatively shallow depth. The depth at which the wires are plowed in is governed by the notes taken during the survey. The plowshare is raised, where possible, so that the wires will be buried at less than the normal depth of 16 inches below the surface of the ground.

As a check on the accuracy of the survey and also the guiding of the tractor and plow, test holes are dug at intervals to expose the wires and cable after the plow has passed. In most cases the two wires straddle the cable almost exactly and are about four inches distant on each side, but in some instances they are off center by two or three inches. As a result of the depth survey and the precautions during the plowing, damage to the cable is completely avoided.—From Bell Laboratories Record.

This Fast-Growing Company Needs—
ELECTRONIC TECHNICIANS

- ★ DEVELOPMENT ENGINEERS
- ★ INSPECTION ENGINEERS
- ★ PHYSICIST
- ★ ELECTRONIC EQUIPMENT TECHNICIANS
- ★ MECHANICAL DRAFTSMEN
- ★ AND OTHERS

A real opportunity for experienced men, particularly with well-balanced backgrounds in acoustics, broadcasting, frequency modulation, ultra high frequencies and special device circuits. Openings exist in designing, development and manufacturing of cathode ray, transmitting and general-purpose tubes; communications, electronic and precision test equipment. Excellent post-war possibilities.

In replying give age, draft status, technical education, training and experience; salary requirements, availability. Enclose photograph. Write direct to:

President

NORTH AMERICAN PHILIPS COMPANY, INC.

Dobbs Ferry, Westchester County, N. Y.

If working in essential industry at highest skill, please do not reply.

if treated in time

**cancer
can be
cured**

**Learn the danger signals!
Get early diagnosis and
prompt treatment. Delay is
dangerous! Enlist as a Vol-
unteer in the Women's Field
Army of your State and sup-
port its activities for Cancer
Control.**

If you are a resident of the Metro-
politan area of New York, write the
NEW YORK CITY CANCER COMMITTEE,
130 East 66th Street, New York 21, N. Y.

**AMERICAN SOCIETY FOR
THE CONTROL OF CANCER**
350. MADISON AVENUE, N. Y. 17, N. Y.

NEW "RADIO SLIDE RULE"

Latest and best of the recent group of paper "Radio Slide Rules" which now make it possible to calculate resistance, reactance and other factors entering into set design, practically without agony, is this Calculator, which makes it possible for the engineer and beginner alike to design single-layer solenoid coils with a simple setting of the rule.

Manufactured by Allied Radio Co., of Chicago, it will be found useful both by the experimenter and the professional radio-man.

Coils with an inductance of 0.1 to 1500 microhenries can be designed from this rule, which is marked to accommodate wire sizes from 11 to 35 in enamel-covered and 11 to 36 in S.S.C., D.S.C. and S.C.C. Wire sizes in D.C.C. run from 12 to 36. Coil forms from 1/2 to 5 1/2 inches in diameter are provided for, and lengths may be from 1/4 to 10 inches. The turns-per-inch may vary from 10 to 160.

A top window of the slider is set to give the required coil diameter and width, and the wire size and turns per inch are read off on the appropriate one of two scales below. Or conversely, the inductance may be decided on, and the correct length or diameter for a given wire size can then be found.

The reverse side of the scale is provided with a frequency-inductance-capacity scale, a setting of which shows the correct inductance for a given wavelength or frequency and the condenser at hand.

This coil winding calculator is priced at 25c, and may be obtained from the manufacturer or from *Radio-Craft*. Address letters to *Radio-Craft*, 25 West Broadway, New York 7, N. Y., and ask for the Allied Coil Winding Calculator.

**RADIO-ELECTRONIC
TESTERS
TECHNICIANS
EXCELLENT OPPORTUNITIES
IN A MAJOR POST WAR FIELD**

Openings available at our Research Laboratories and Electronic manufacturing unit. Leaders in the design and development of vital electronic equipment for the armed forces.

Essential workers need release statement.

Write, stating experience, education, draft status, salary requirements or apply to

SPERRY

GYROSCOPE CO., INC.

RESEARCH LABS. & ELECTRONIC
PLANT
STEWART AVE. & CLINTON RD.
GARDEN CITY, NEW YORK

RADIO WRITERS

Resident in the New York Metropolitan area. For part or full-time work on established radio magazine. Capable of writing articles on assigned radio or electronic subjects, expand or digest technical data, press releases, etc., or to carry on research work under editorial direction. Apply

Box 37, Radio-Craft

25 West Broadway, New York 7, N. Y.

WESTERN ELECTRIC CO.

In PEACE
Source of supply for the
Bell System
In WAR
Arsenal of communication
equipment

NEEDS INSPECTION ENGINEERS

For quality
control work.

Men or Women

Background required: Knowl-
edge of D.C., A.C. and elec-
tronic theory. High school with
some college background in
Physics and Mathematics or
radio school essential. Experi-
ence in amateur radio with
license desirable but not re-
quired.

To do inspection and test-
ing of radio and other
high-frequency equipment.

Release statement and
U.S.E.S. consent needed

Write or apply in person to
C.R.L., Employment Dept.

100 Central Ave.
Kearny, N. J.

Monday through Saturday
8:30 A.M. to 5 P.M.

Very Old (1900-1920) RADIO SETS and PARTS WANTED

Fair prices paid for radio sets and apparatus
manufactured from 1900 to 1920. We need only
one sample of each model. Write giving complete
description and your price. RADIO-CRAFT,
25 West Broadway, New York 7, N. Y.

"Radio Listeners' Guide"

Answering in non-technical language the ques-
tions that puzzle the home radio listener. Tells
how to determine and overcome causes of noisy
radio reception. Written by an interference expert
15 years in the field. \$1.00 Postpaid.
Quantity discounts to Radio Dealers

A. E. ROWE & CO., INC., Dept. R
660 Mission St. San Francisco, 5

LET'S GIVE



RED CROSS
WAR FUND

Continue
GIVING
so others can
continue
LIVING

New Knobs Are Attractive

THE problem of wartime scarcities is pri-
marily one of adaption—the old rule that
the one who can adapt is most likely to
survive was never truer than in radio indus-
try in the present period. An excellent ex-
ample of this adaption in some of the minor
essentials of radio is afforded by a new line
of knobs put out by
the Crowe Name-
plate Co., univer-
sally known as
manufacturers of
radio dials.

While dial and
knob styles have
shifted and swung
through the years,
there have been a
large number of
users of commer-
cial and laboratory
apparatus who
have stayed with
the old bakelite
fluted-grip knob
which the broad-
cast listener re-
members as a relic
of 1922, but which
was really old-time
standard apparatus
even at that date.
Faced by military
demands on Bake-
lite, this manufac-
turer combined the
old design with
new materials,
turning out knobs
to the satisfaction of the most conservative
customer.

Not only are old-type knobs produced in
the new plastic, but so also are a number
of new and streamlined types, a few of
which are shown in the illustration.

The material is known as "Croplastic."
Knobs made from it have slightly more
gloss than the older bakelite types. It seems
especially suited to color use, and some of

the knobs are striking in appearance.

The pointer on the "black bakelite" type
in the lower right corner is not metal,
but transparent plastic, with a hair line down
the center. This makes for much more ac-
curate alignment with scale markings than
was possible with the older metal pointer.

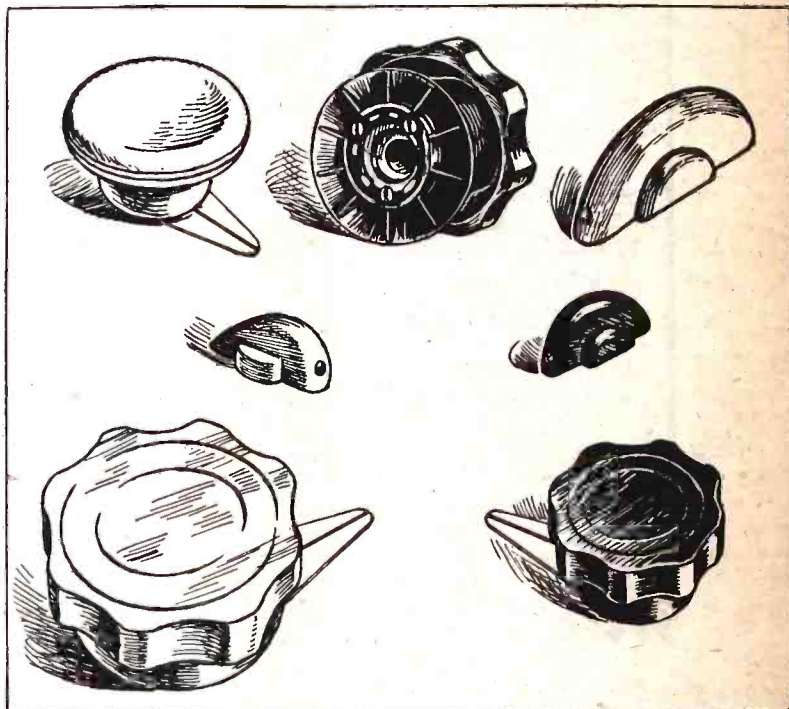

Transparent pointers may be removed and
an apron of material matching or contrast-
ing in color may be replaced. Thus similar-
colored knobs can be fitted up with con-
trasting-color aprons according to their
function on the panel or otherwise. The old-
er metal pointers are also provided where
needed for use on equipment where such
style is indicated, the mode of construction
facilitating such variation in style.

THE BIG NEWS

(Continued from page 329)

This to my mind, is sufficient and final
proof of Ehrenhaft's discovery, but we may
be sure that further proofs will come along
in quick succession from now on.

Of what use will be this new discovery
of pure magnetic currents? There comes to
mind the old story of Faraday when
he showed a lady visitor his crude experi-
ment where a suspended copper wire, dip-
ping into a circular doughnut-like vessel,
filled with mercury, was rotating around
a bar magnet. This was incidentally, the
first demonstration of the electro-magnetic
motor. The lady watched it attentively, then
asked, "But what good is all this?" To
which Faraday replied: "What good is a
new born child?" Similarly when Heinrich
Hertz first demonstrated his electric waves
in free space, no one could see anything
remarkable about it. Not until Marconi
came along, and using the selfsame means,
brought about wireless telegraphy on which
radio has been built today. So it is with
the new Magnetic Current. What will it
do? Where will it take us in the future?
No one today—not even the most versatile
inventor or scientist—can even dimly fore-
see the future of the great new discovery.
One thing, however, is certain; and, that
is, it will be tremendous and breathtaking.

Within fifty years, every present electrical
notion, every electrical appliance and ap-
paratus will be profoundly affected. Here
are a few thoughts which I give at ran-
dom.

Who will invent the first Magnetic Bat-
tery—a device through which magnetic cur-
rents will flow in sizable currents or
streams?

Who will invent the first Magnetic Am-
plifier?

Who will be responsible for the first
Magnetic-Vacuum Tube—a parallel to our
present electric vacuum tube? This tube
will probably emit not electrons as we now
visualize them, but magnetic ions.

Who will build the first Magnetic Gen-
erator?

The list can be lengthened indefinitely,
and what the results will be of all this, is
anyone's guess.

In the next few generations our pres-
ent concepts of radio and all that goes
with it, will have changed completely—so
completely, in fact, that we won't recog-
nize our present means which probably will
have gone into the discard.

The new child—Magnetic Current—has
been born. Now watch it grow into a lusty
and magic giant.

Technotes

..... FARNSWORTH MODEL BT-22

The dial pointer on this set tends to slip on the cable, apparently throwing the set out of calibration. A permanent remedy is to place a small piece of adhesive tape under the metal flange which clamps on the cable. I have used this on several of these sets.

..... FARNSWORTH BT-50, CHASSIS C-51

This 5-tube set has a small inside loop antenna. Low sensitivity seems to be a characteristic of the set. To increase the pickup, trace the loop to where it connects to the variable condenser. To this same point, solder a three-foot wire, which is permitted to hang down behind the receiver. A noticeable increase in signal strength will result.

MARION L. RHODES,
Knightstown, Ind.

..... OSCILLATION AT HIGH VOLUME

Noted an item regarding squealing of an RCA Model 95T1 when the volume control was turned up.

We have encountered this trouble in two different sets, one a 6-tube Philco table model, the other a 6-tube Admiral console. In each case it was found that the lead from the plate of the output tube passed very close to the prong of the oscillator grid at the base of the converter tube.

Simply moving this lead half an inch further away from the mixer tube base stopped the squeal. It was apparent that the squeal was a feedback of the audio component in the output plate lead through the capacity formed by the nearness of the lead to the converter tube base.

DALE F. ALDRICH,
Kansas City 3, Kans.

..... CANADIAN DEFÖREST, ROGERS

On the DeForest 6-tube battery chassis 9D661 (Rogers 9R661) the two 1P5M tubes and the 1A7 have the screen voltage supplied through a 10,000-ohm resistor.

A noticeable improvement in gain results from adding another 20,000 ohm resistor between the 1P5M's and the No. 4 pin on the 1A7. It will then receive its screen voltage through both the resistors. It will be necessary to use another bypass condenser since the resistor added isolates the original by-pass.

This chassis uses two 1C5 output tubes. By removing both these tubes and replacing with one 1Q5 the same performance will be obtained, with the added advantage of considerable battery saving, so important in war time. No circuit changes are required to use the 1Q5, as the bias for the two 1C5's is right for the single 1Q5.

LESTER D. ROGERS,
Bridgewater, Nova Scotia

..... ZENITHS WITH 6X5

A number of these models have a 6X5 on the same filament line as the other tubes, one side of the filament being grounded to chassis. Breakdown of the 6X5 is common.

I find that putting on another filament winding—usually 5 volts for an 80—is the best way to service such sets for a permanent job. Where this is not possible, I use another power transformer with separate windings for the rectifier filament and those of the other tubes in the receiver.

LLOYD GRIPE,
Syracuse, Kansas

..... HARD LOUD-SPEAKERS

One method of improving low-frequency response in old or hard diaphragms is to bathe the paper and spider and all moving parts in light oil. This should be done after the cone is carefully dusted and repaired for torn or loose places that cause rattling.

DAVID KELLERMAN,
Camp Davis, N. C.

(While we are passing this kink on for what it is worth, we would be extremely cautious about bathing a cone in oil, and suggest that the Serviceman try it out on a shop speaker which will be in constant use, and observe results for a month or two before using the method regularly.)

..... SIMPLEX MODEL DA

Complaint: Oscillation on high or low settings of the volume control; no oscillation on medium volume.

The A.V.C. tube shield had become corroded where it made contact with ground. Scraping the shield stopped the oscillation.

LELAND GARRISON,
Drakesville, Iowa

..... TRUETONE OR OTHER SUPERS

Receiver dead except two locals riding through in the middle of the B.C. band, neither on its proper frequency.

This was due to a broken wire in the oscillator grid coil. The set was a Truetone but could just as well have been any other receiver.

LELAND GARRISON,
Drakesville, Iowa

..... CORONADO 954 WELLS GARDNER 1A29

When poor tone and volume is apparent in these sets, check the voltage. You will find that it will probably be 60 V. low at the 5Y3 rectifier filament. Other voltages are proportionately low. Current check shows push-pull 6V6 output tubes drawing 20 Ma. too much current. The control grid voltage check shows about 10 V. too high, and coupling condenser shows a high-resistance leakage, which raises the grid voltage enough to cause the 6V6 tubes to draw more current than the rectifier can put out without a heavy drop in voltage.

Replace the coupling condenser and set voltages and performance will return to normal.

CYRIL SANNES,
Billings, Montana

..... GENERAL ELECTRIC H736

A common complaint of this set is distortion and mush. It sounds like leaky filters. The filament voltage resistor should be replaced as the pilot light section has a high resistance short.

EARL WASEM,
Greenville, Ill.

..... MOTOROLA 51X17

The set goes dead and the oscillator tube does not work.

The trouble can be traced to high leakage in the oscillator section of the tuning condenser.

Repair was made by replacing with a new tuning condenser.

EARL WASEM,
Greenville, Ill.

FOR SALE HARD-TO-GET ITEMS

All items are brand new, except where indicated. ALL are in PERFECT WORKING ORDER. In many cases, the parts alone total more than the price we are asking. Satisfaction guaranteed or your money back. ORDER FROM THIS PAGE. Use our convenient coupon. Include sufficient extra remittance for parcel post charges, otherwise order is sent express collect. Any excess will be refunded. All C.O.D. shipments require 20% deposit. No C.O.D. shipments on orders for less than \$3.00. If full remittance accompanies order, deduct 2% discount. Send money order, certified check, or new U. S. stamps. No C. O. D.'s to foreign countries.

THE MAGIC ELECTRIC WELDER

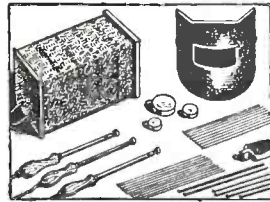

Here is one of the most compact, practical welders we have ever seen. Anyone can use it for shop, farm and home repairs. WELDS, BRAZES, SOLDER, CUTS ALL METALS. ANYONE CAN OPERATE IT. Repairs steel, cast iron, aluminum, brass, copper, bronze, etc. Complete with power unit, flame and metallic arc attachment. Carbons, fluxes, rods, mask included. Just plug it in any electric outlet. 110 volts AC or DC. For hobbyist or professional. GET IN ON THE GREAT WELDING BOOM. This fine set quickly teaches you welding. Low cost to operate—about 5c an hour. COMPLETE SAFETY is assured. No fumes with this outfit. SET COMES COMPLETE—nothing else to buy. Used by the U. S. Navy, American Tel. & Teler. Co.; Eastman Kodak Co.; Bell Laboratories, etc. BRAND NEW OUTFIT. Guaranteed for one year. Complete simple instructions with each set. **\$19.95**

ITEM NO. 158

YOUR PRICE

WESTERN ELECTRIC BREAST MIKE

This is a fine light-weight aircraft carbon microphone. It weighs only 1 lb.

Mike comes with breastplate mounting and has 2-way swiveling adjustment so that it can be adjusted to any desired position. There are 2 woven straps; one goes around neck, the other around chest. Straps can be snapped on and off quickly by an ingenious arrangement.

This excellent mike can be adapted for home broadcasting or private communication systems. By dismounting breastplate, it can be used as desk mike.

Comes complete with 6-foot cord and hard rubber plug. Finished in sherardized plate, non-rustable.

THIS IS A BRAND NEW MIKE. IT HAS NEVER BEEN SOLD AT SUCH A LOW PRICE BEFORE. ORIGINAL LIST PRICE \$15.00. Shipping weight, 2 lbs.

ITEM NO. 152

YOUR PRICE

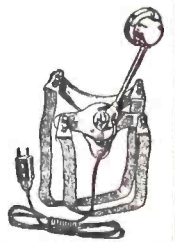

POWERFUL ALL-PURPOSE INDUCTION MOTOR

IDEAL FOR EXPERIMENTERS—101 USES

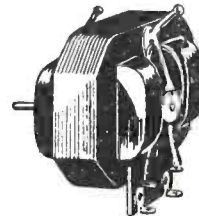

Sturdily constructed to precision standards, this A.C. induction motor is powerful enough for a number of uses. Some of these are: Automatic Timing Devices, Current Interrupters, Electric Fans, Electric Chimes, Window Displays, Photocell Control Devices, Electric Vibrators, Small Grinders, Buffers and Polishers, Miniature Pumps, Mechanical Models, Sirens, and other applications.

Consumes about 15 watts of power and has a speed of 2500 r.p.m. When geared down, this sturdy unit will constantly operate an 18-inch turntable loaded with 200 lbs. dead weight.

THAT'S POWER! Dimensions 3" high by 2 1/2" wide by 1 3/4" deep; 2 oiling spouts; has 4 convenient mounting studs; shaft is 7/8" long by 3/16" diameter, and runs in self-aligning oil-retaining bearings. Designed for 110-20 volts, 50-60 cycles, A.C. only.

ITEM NO. 161

YOUR PRICE

\$1.95

LIMITED QUANTITIES! PROMPT SHIPMENTS!

It's Easy to order—Clip Coupon—Order from This Page—No Catalog Sent.

(See Corresponding Ad. Page 380)

MAIL TODAY—NOW!

HUDSON SPECIALTIES CO.

40 West Broadway, Dept. RC-3-44, New York 7, N. Y.

I have circled below the number of the items I'm ordering. My full remittance of \$..... (include shipping charges) is enclosed. (NO C.O.D. ORDERS UNLESS ACCOMPANIED WITH A DEPOSIT.)

OR my deposit of \$..... is enclosed (20% required), ship order C.O.D. for balance. NO C.O.D. ORDER FOR LESS THAN \$3.00. (New U. S. stamps, check or money order accepted.)

Circle Item No. wanted **152** **158** **161**

Name

Address Please Print Clearly

City State

Send remittance by check, stamps or money order; register letter if you send cash or stamps.

FOR SALE HARD-TO-GET ITEMS

All items are brand new, except where indicated. ALL are in PERFECT WORKING ORDER. In many cases, the parts alone total more than the price we are asking. Satisfaction guaranteed or your money back. ORDER FROM THIS PAGE. Use our convenient coupon. Include sufficient extra remittance for parcel post charges, otherwise order is sent express collect. Any excess will be refunded. All C.O.D. shipments require 20% deposit. No C.O.D. shipments on orders for less than \$3.00. If full remittance accompanies order, deduct 2% discount. Send money order, certified check, or new U. S. stamps. No C. O. D.'s to foreign countries.

ULTRA MAGNET

LIFTS MORE THAN 20 TIMES ITS OWN WEIGHT

LITTLE GIANT MAGNET

Lifts 5 lbs. easily. Weighs 4 oz. Made of ALNICO new high-magnetic steel. Complete with keeper. World's most powerful magnet ever made. The experimenter and hobbyist will find hundreds of excellent uses for this high quality permanent magnet. Measures 1 3/4" x 1 1/2" Ship. Wt. 3/2 lbs.

ITEM NO. 159
YOUR PRICE \$1.25



GENUINE MICROPHONE TRANSMITTERS

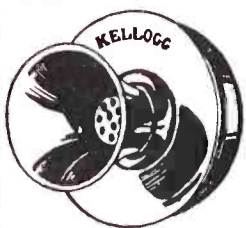

These are regular "telephone transmitters" of the type used on wall telephones. Taken from a large telephone supply company's overstock, these fine mikes offer a grand opportunity to obtain a splendid unit for little more than the price usually asked for a simple "microphone button."

The amateur, experimenter and telephone mechanic will find a variety of uses for these excellent microphones. They work perfectly on 2 dry cells.

Can be used on P.A. systems for voice transmissions, in call systems and intercommunications sets. With telephone receivers (radio headphones will do) they may be made into short-line telephone circuits, such as house-to-house or farm-to-farm "phone lines. You can use them to talk through your own radio, or as concealed dictaphone pick-up units for listening to conversations in a distant room or building. The telephone mechanic will find them useful replacements on battery-operated rural telephone lines.

THESE ARE NEW, GENUINE TRANSMITTERS, MADE BY KELLOGG, WESTERN ELECTRIC AND STROMBERG-CARLSON, excellent in appearance and operation. A remarkable value, and one seldom offered in these times. Ship. Wt. 1 lb.

ITEM NO. 160
YOUR PRICE \$1.50

AMAZING BLACK LIGHT!!

Powerful 250-Watt Ultra-Violet Source



The best and most practical source of ultra-violet light for general experimental and entertainment use. Makes all fluorescent substances brilliantly luminescent. No transformers of any kind needed. Fits any standard lamp socket. Made with special filter glass permitting only ultra-violet rays to come through. Brings out beautiful opalescent hues in various types of materials. Swell for amateur parties, plays, etc.; to obtain unique lighting effects. Bulb

only. Ship. Wt. 1 lb.
ITEM NO. 87
YOUR PRICE \$2.45

WATT HOUR METER

Completely overhauled and ready for immediate service. Designed for regular 110-volt, 60 cycle 2-wire A.C. circuit. Servicemen use it in their shops to check current consumption of sets, soldering irons, etc. Keeps costs down. If dismantled, the parts alone would bring the price. The elaborate gear train could be used as a counter on machines of various kinds. Simple to install: 2 wires from the line and 2 wires to the load. Sturdily constructed in heavy metal case. 8 1/2" high, 6 1/4" wide, 5" deep. Westinghouse, G. E. or other available make. Ship. Wt. 14 lbs.



ITEM NO. 33
YOUR PRICE \$4.95

LIMITED QUANTITIES! PROMPT SHIPMENTS!

It's Easy to order—Clip Coupon—Order from This Page—No Catalog Sent. MAIL TODAY—NOW!
(See Corresponding Ad. Page 379)

HUDSON SPECIALTIES CO.
40 West Broadway, Dept. RC-3-44, New York 7, N. Y.

I have circled below the numbers of the items I'm ordering. My full remittance of \$..... (including shipping charges) is enclosed (NO C.O.D. ORDERS UNLESS ACCOMPANIED WITH A DEPOSIT) OR my deposit of \$..... is enclosed (20% required) ship order C.O.D. balance NO C.O.D. ORDER FOR LESS THAN \$3.00. (New U. S. stamps, check or money order accepted.)
Circle Item No. wanted: 33 87 159 160

Name

Address Please Print Clearly

City State

Send remittance by check, stamps or money order; register letter if you send cash or stamps.

The Mail Bag

WANTS SOUND ON TAPE OR WIRE

Dear Editor:

I am one of your newsstand readers of the past seven years and have not found your magazine wanting in any way that I can see.

People do not seem to understand, or do not care to understand that to please everyone of your readers would take a volume of at least the thickness of a servicing manual every month and there just isn't the time or talent available as yet to fulfill such a request.

Personally, I am vitally interested in the art of recreating sound from some source that is inanimate in itself; consequently I devour every iota of information concerning sound on disk, sound on film, and the fast growing infant of sound on wire.

I was wondering if your monthly mail shows enough interest for you to publish running articles plus schematics on the above mentioned devices.

Also, is the old method of sound on a flat steel tape sufficiently aged to not be of any military value so that you might be able to publish data concerning the recording apparatus, amplifiers used in conjunction with same, methods of wiping records from tape, and finally reproducing of recorded material from tape.

I shall eagerly await future issues that you might see fit to publish anything in concerning my pet subjects, and sign off as one of your constant readers.

WILLIAM H. GIFFEE,
Platte City, Mo.

(Radio-Craft has published articles on the above subject from time to time, and hopes shortly, to publish one on a non-metallic tape system. If any of our readers have had interesting experiences with tape or wire recording, we would be glad to hear of it.—Editor.)

AN AUSTRALIAN SERVICE BENCH

Dear Editor:

This is a photo of my service bench. The large volumes on the bottom left hand shelf are bound copies of *Radio-Craft* dating from July, 1931, also many issues ready to be bound. The next shelf contains Service Manuals for Australian Radios. The instruments are left to right (top): Triplet model 1232 Signal Gen., Model 1260 Audio Osc., (bottom) model 1200-A Multimeter,

Valve and Circuit Tester, Triplet Model 1631 Signal Gen.

During the last year I have serviced many American Radios owned by members of the U.S.A. fighting services. The only source of Service Data for these sets are those printed in *Radio-Craft* and I feel that you should realize how valuable they are.

J. BRASSIL,
Mt. Isa, Queensland, Australia



LIKES OUR EDITORIALS

Dear Editor:

This is my first comment on your magazine since I have been a subscriber. At the present time I'm enjoying a furlough at home and have just finished reading the back issues.

The first article that catches my eye in any issue is Mr. Gernsback's Editorial. Then follow the articles on Electronics, Servicing, and Experimenter Departments. The latter interests me most of all, especially anything dealing with Short-Wave.

I, as many others, was heartily disgust-

ed with Mr. Esluk's letter in the November issue. Even including Mr. Bohr's (age 15) opinions, which trend with Mr. Esluk. It's the magazine's readiness to aid the Beginner as well as the technician that makes it so popular with its readers. Asking "silly" or "stupid" questions is the backbone of learning!

Keep this magazine as it is, because that's the way the "Radio-Youngster" likes it.

T/Sgt. H. L. AEIKER,
Henderson, W. Va.

OPPOSED TO GENIUSES

Dear Editor:

We have been ardent readers of *Radio-Craft* for several years and always manage to look in the Mail Bag section. We are thoroughly disgusted with the attitude taken by your young genius Edwin Bohr, on the subject, "Are Beginners Necessary?"

If this young wisecracker knows so damned much about radio and electronics, why does he bother to read any radio magazine at all? Speaking of magazines; why isn't he publishing one of his own for advanced engineers only?

In our opinion young Bohr has learned nothing more about radio than a few 64-dollar words and phrases. Much of our knowledge can be credited to *Radio-Craft*.

OREN WESTLING,
PHIL MACTAGGART,
VERNON BAXTER, JR.,
Minneapolis, Minn.

RADIO-CRAFT USED IN CLASS

Dear Editor:

Your department, Diagrams for the Radio Experimenter, has always interested me. In the April 1943 issue there appeared a diagram for a five-watt phono-amplifier, which I built. I wish to tell you that I am very much pleased with the result. The volume and tone are excellent and the hook-up is very economical, costing me under ten dollars.

I studied Radio for one year at the Curtis High School and became acquainted with *Radio-Craft* because our teacher gave numerous assignments in it. He had us write reports on an article in every issue. It made it necessary for everyone in the class to buy a copy. Undoubtedly, he is still giving this type of assignment.

JOHN HEIMBERGER,
Staten Island, N. Y.

PASSING PARADE OF RADIO?

Dear Editor:

Just a few lines to tell you how much I appreciate your magazine. I particularly enjoyed articles like your "Listening Post" and the short biography of Nikola Tesla.

Even up here in British Columbia I can bring in Radio Brazzaville quite well. I can get Australia, if I get up early enough. No trouble getting Tokyo and Moscow; London and Vichy come in fairly well, but Berlin is a tough one to get—but, then, who wants to listen to Berlin anyway!

Are you likely to give us diagrams for transmitters in forthcoming issues? Where could I obtain information as to the power output of short wave transmitters?

Also, it might be of interest to other readers as well to have you publish a passing parade of radio—a pictorial review, as it were.

ALAN PHILLIPS,
North Vancouver, B.C.,

STRAEDE APPRECIATED

Dear Editor:

Thanks for the article by Mr. Straede, telling about the inverse audio method, which appeared in the November issue.

I tried it on a Sonora P-7 chassis, and the improvement is very noticeable to the ear.

CLARE D. FOSTER,
Massillon, Ohio.

RADIO-CRAFT for MARCH,

HARRISON HAS IT!

FOR URGENT
WAR WORK—

HALLICRAFTERS

RECEIVERS AND
TRANSMITTERS

TUBES
CONDENSERS
RESISTORS
TRANSFORMERS

AND THOUSANDS OF OTHER
CRITICAL ELECTRONIC PARTS!

PURCHASING AGENTS—

Call upon us for your high priority requirements of equipment and components for your production and development work.

We usually have it in stock!

FOR THE
HOME FRONT—

CODE PRACTICE SET

Buzzer and key, heavily nickel plated, of single unit construction, mounted on wood base. Adjustable high frequency pitch. Complete with silk covered cord, in attractive box with code chart on cover. Works on one or two flashlight or dry cells.

Postpaid—\$2.45

6L6G First grade, \$1.37 ea.
meter tested, 3 for \$3.75
TUBES fully guaranteed postpaid

DYKANOL CAPACITORS

Cornell-Dubilier oil filled, hermetically sealed metal cased condensers. 4 mfd. capacity. Rated at 220 Volts AC working, will stand over 600 Volts D.C. Ideal for amplifiers, receivers, power packs, etc. (Filtering action equivalent to 12 mfd. electrolytic but with better safety factor, longer life). \$2.25 (3 or more shipped postpaid).

P. M. DYNAMIC SPEAKERS

5 inch, with output transformer to match single plate of 8000 ohms \$1.95

(Not Postpaid)

Immediate delivery of the above items, without priority, while quantities last. Place L-265 or V-3 certification on your order. SEND REMITTANCE WITH ORDER, TODAY! (Money back if not satisfied.)

HARRISON

RADIO CORPORATION

11 WEST BROADWAY

Phone WOrth 2-6276

NEW YORK CITY 7

MODEL
No. 1632

Signal
Generator

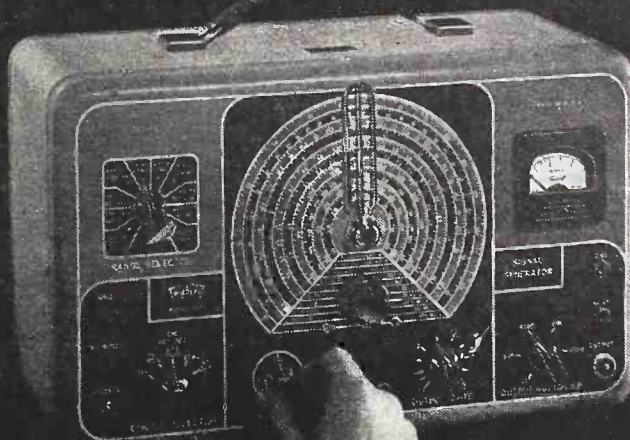

Continuous coverage—100 KC to 120 MC—
all frequencies fundamentals. New high frequencies for frequency modulated and television receivers. All coils permeability tuned. Litz wire wound against humidity with "high"-Q cement. This and other models will be available to you after the war.

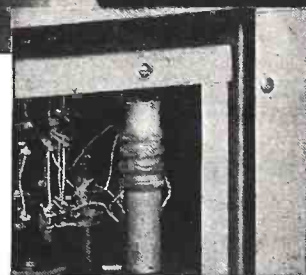

Triple shielding throughout. Steel outer case, steel inner case plus copper plating.



Triplet

ELECTRICAL INSTRUMENT CO.

Bluffton Ohio ★ ★ ★

RADIO-CRAFT for MARCH,

1944

381



Reach
for a...

● Yes, reach for a Dandee when you are making an electrolytic capacitor replacement these wartime days. The Aerovox Victory Line listings of Dandees take care of 90% and upwards of all standard electrolytic capacitor replacements, used singly or in combinations. Note these general-utility values:

VICTORY DANDEES

Aerovox Type PRS-V electrolytics. Individually tested. Extra-wax-sealed. Use singly or in multiples.

D.C.W.V.	CAPACITY
25	25 mfd.
50	10 mfd.
150	20 mfd.
150	20-20 mfd.
150	50 mfd.
250	20 mfd.
450	10 mfd.
450	10-10 mfd.
450	40 mfd.

● Ask Our Jobber ● ● ●

Ask about these Victory electrolytics. Order a supply to take care of rush jobs. Ask for latest Aerovox catalog—or write us direct.



AEROVOX CORP., NEW BEDFORD, MASS., U. S. A.

In Canada: AEROVOX CANADA LTD., HAMILTON, ONT.

Export: 13 E. 40 St., NEW YORK 16, N. Y. Cable: 'ARLAB'

ELECTRONICS SPEEDS ORDNANCE

(Continued from page 340)

electronic wave is a signal informing the girl whether the governors driving this apparatus are functioning well.

An Associated Press writer describes some of these fuses as being comparable, in size at least, to mosquitoes—metallic mosquitoes, if you please. Pursuing the analogy further, there is a hair-like metal proboscis, as if appearing in the act of penetrating one's hand with incisive effect. These fuses contain other equally tiny parts—fashioned to fit within the fineness of one thousandth of an inch. They, as the poet said of coming events, cast their shadows before—on geometrically lined charts.

Once completed, artillery fuses literally go through shimmying tests in preliminaries and as "tough-sledding" as going over Niagara Falls in the final check-up. The so-called jumbling test means rough-rolling in a barrel, to determine stability under combat conditions. Then the fuses are hurled upon concrete. They must withstand such terrific shocks from successively greater heights—otherwise their sensitive mechanisms are not sufficiently rugged. Ultimately, the fuses go through firing tests.

The electric eye, immune to many fluctuating conditions which beset the human element, is finding increasing uses as an automatic inspector in Navy yards, where X-rays are also employed to test critical material. Electronic equipment, free from the whimsies of the fickle-minded human factors, is stretching its shadow of performance all the way from the ordnance manufacturing plant to the battlefield—whether the combat troops are on planes, in submarines, on battleships, or in the mosquito-infested jungles of Bougainville.

More and more electronic devices will be used to inspect tens of thousands of war material parts—varying in size from an ant to an elephant. The methods of inspection number many hundreds—the army of military inspectors reaching tens of thousands, nearly half of that number being women. Meanwhile electronic instruments, which didn't exist before this war, are being introduced by the hundreds.

Government activity in radiocasting is now a public issue in Australia and New Zealand, according to recent press reports. The government of Australia owns and operates 28 national stations, and regulates over 100 privately-owned ones. Ownership and operation of all the 12 New Zealand radio stations is centered in the government.

The New Zealand broadcasters are split into two chains, the National Broadcasting Service and the Commercial Broadcasting Service. NBS follows the British style, while CBS is livelier, running more along American lines, even to the point of accepting advertising, which is refused by the NBS.

Demands for greater powers of regulation and control, made in a recent report of the standing committee for radio of the Australian Parliament, are being hotly contested. It is pointed out by opponents of greater government control that already the Postmaster-General (head of the radio set-up) is empowered to compel broadcast of material he supplies, or to prevent broadcast of items which he disapproves. This power does not exist in Great Britain and Canada, it is pointed out, and might become dangerous.



Our Headphones are used by the United States, Canadian, New Zealand and South African Governments as well as other Governments not directly in the war.

Headset Headquarters

Scientifically Built Heavy bar magnets greatly increase their efficiency.

Folder R-3 illustrates rugged, unusually sensitive, dependable Cannon-Ball Headsets.

Write

C. F. CANNON COMPANY
SPRINGWATER, N. Y.

Index to advertisers

Aerovox Corp.	382
Allied Radio Corp.	368
Amplifier Company of America	370
Audel & Company	Back Cover
Burstein-Applebee Co.	373
Cannon Company, C. F.	382
Chartered Institute of American Inventors	375
Chicago Novelty Co., Inc.	367
DeForest's Training, Inc.	361
Echophone Radio Co.	355
General Electric Co.	366
Gray, N.	372
Hallicrafters, Inc.	323, 324
Harrison Radio	381
Henry Radio	365
Hewig Co.	373
Hudson Specialties	379, 380
Lancaster, Allwine & Rommel	374
McGraw-Hill Book Co.	373
Meissner Manufacturing Co.	326
National Plans Institute	370
National Radio Institute	321
National School's	363
National Union Radio Corp.	327, 376
Nelson Company	374, 375
North American Philips Co.	377
Oelrich Publications	372
Onan & Sons, D. W.	371
Opportunity Adlets	371
Popular Homecraft	369

RADIO SCHOOL DIRECTORY Page 384

Candler System
Capitol Radio Engineering Institute
Commercial Radio Institute
Lincoln Engineering School
New York Y.M.C.A.
RCA Institutes

Radcraft Publications, Inc. 359, 375, 378
Radio & Technical Division of
Murray Hill Books, Inc. 353
Rowe and Co., A. E. 378
Solar Manufacturing Co.

Inside Front Cover
Sperry Gyroscope Co., Inc. 377
Sprague Products Co. 328
Sprayberry Academy of Radio 325
Superior Instruments Co. 367
Supreme Instruments Co. 362
Supreme Publications

Inside Back Cover
Sylvania Electric Co. 364
Technifax 371, 374
Triplett Electrical Instrument Co. 381
University Laboratories 371
Western Electric Co. 376, 378
Weston Instruments 365
Wholesale Radio Laboratories 369

(While every precaution is taken to insure accuracy, we cannot guarantee against the possibility of an occasional change or omission in the preparation of this index.)

BOOK REVIEWS

MATHEMATICS OF RADIO COMMUNICATIONS, by T. J. Wang. Published by T. Van Nostrand Co., Inc. Stiff leatherette-finished covers, 371 pages, 6 x 8½ inches. Price \$3.00.

A noticeable difference between this book and other radio mathematics is that it tends to present mathematical theory as such, leaving the application to specific radio problems in the hands of the user. The lists of problems on radio subjects, seen in other texts, are missing. This is deliberate on the part of the author, and he suggests a schedule, by means of which the subjects may be correlated with the stages of a course in electrical or radio theory.

The text matter is very clearly and simply presented. This feature will make the book valuable to independent students. Arrangement of the contents is strictly electrical, beginning with matter necessary to the student of simple direct currents and ending with such mathematics as is required in semi-advanced study of alternating-current circuits. The break with the customary embryological sequence of the standard text-book is, therefore, sharp. Graphical representation is introduced before algebra, simultaneous linear equations after quadratics. Logarithms appear in Chapter 16.

A full chapter is given to natural logarithms, which have a wide application in the radio-electronic field. Power functions and Fourier series are given a chapter each, and several chapters are devoted to calculus.

The student of radio-electronics will find this a book which preserves the simple style of the average radio mathematics text, but goes on to more advanced material than can be found in most other books written for the individual with no previous mathematical background.

FUNDAMENTALS OF TELEPHONY, by Arthur L. Albert. Published by McGraw-Hill Book Co. Stiff cloth covers, 5½ x 8½ inches, 374 pages. Price \$3.25.

The telephone man has always approached certain problems common to the wire and radio field with a different viewpoint from that of the practical radioist. For this reason, an elementary book written from his viewpoint is especially useful to the radioman.

Designed for the beginning student, the book starts out with D.C. and A.C. theory. Alternating current is presented in a manner somewhat easier for the beginner to understand than in certain other beginners' books which have appeared recently. The treatment is by no means oversimplified—it goes further than the average elementary work. The student is introduced to rectangular and polar vectors, and is encouraged to use the *i* operator.

The chapter on electric networks also goes further than elementary radio books usually do. Calculation of impedance in parallel circuits containing resistance, inductance and capacity, study of constant-voltage and constant-current circuits and calculations of mutual inductance are included. Power transfer, decibels and transmission losses are handled from the telephone point of view.

Another pair of chapters especially interesting to the radioman are the two on circuits with distributed constants and those with lumped constants. The importance of these subjects in telephony causes them to receive much more attention than in a work on radio. The chapter dealing with lumped constants is especially noteworthy, and may write finis to the old opinion that "nothing elementary has been written on wave filters." These two chapters cover more than 50 pages, and are well worth reading by any radioman who requires simple filter theory.

Other chapters deal with telephone transmitters (the author still insists that radio use of the word "microphone" to designate that instrument is a sort of corrupt practice), receivers, telephone sets, manual and dial systems, measurements, trouble shooting over telephone lines, and the telephone repeated, both one- and two-way types.

THE RADIO AMATEUR'S HANDBOOK, by the Headquarters Staff of the A.R.R.L. Published by the American Radio Relay League. Heavy paper cover, 6½ x 9½ inches, 480 pages, plus advertising section of 174 pages and index. Price \$1.00.

Standard reference annual of the amateur, experimenter, and no small number of engineers who find its well-tryed circuits a short-cut to results, the "Handbook" is with us again, in its 1944 edition.

The beginner as well as the established radioman is attracted to the Handbook. Because of its special approach, he is often enabled to grasp ideas not understandable in the orthodox texts. The Handbook might in fact be called a textbook in reverse. Fundamentally an exposition of technical advances made by its authors, all its theoretical features work back from actual practice. The chapter on antenna systems is an excellent example. It is obvious that the authors are not describing abstract ideas, but things they have built with their own hands. The result is a chapter which cannot be described as either theoretical or practical, but eminently understandable.

The "freeze" of amateur transmission is reflected in the Handbook, which differs less from its predecessors than any one issued to date. Some chapters appear to have been carried over intact. A notable exception is the "Tube Characteristics and Miscellaneous Data," which has been completely revised, with several new tables, and a complete index of transmitting and receiving tubes.

RADIO TUBE SUBSTITUTION and CHANGE-OVER MANUAL, by Robert T. Oelrich. Oelrich publications. In two 5 x 7 inch booklets, 20 pages each. Price \$1.50 for the two. (Manual \$1.00, supplement 50c.)

Two small booklets showing in tabular form, what socket changes are necessary to make changes from hard-to-get tubes to others presumably easier to obtain. Also shows what types may be substituted without changes.

TIME BASES (Scanning Generators), Their Design and Development, by O. S. Puckle. Published by John Wiley and Sons, Inc. Stiff cloth covers, 5½ x 9 inches, 204 pages. Price \$2.75.

The increasing importance of cathode-ray equipment has focussed attention on the circuits used to produce the "trace," or (usually) horizontal sweep. That a complete book can profitably be devoted to the subject has been abundantly proved by the author of this work.

The engineer—even the radio engineer—whose acquaintance with cathode-ray tubes has been of a casual nature, is likely to think of a time-base generator as a device to produce saw-tooth oscillations, and only on second thought to recognize the sinusoidal trace as a true time base. The polar coordinate time bases described may therefore be especially interesting as an almost-overlooked tool in certain types of study. Spiral and radial time bases are also described.

Treatment of circuits used to produce the scanning trace is exhaustive. Trigger circuits, blocking oscillators and inductive bases, multivibrators, transitron, relaxation and flip-flop circuits are described, among others.

Linearization of the trace and checking its linearity receives considerable attention, and is covered in a chapter of 28 pages. Synchronization of time bases is discussed in a shorter chapter.

There are six appendices, the largest of which, covering 22 pages, is devoted to the cathode-ray tube. Among other interesting points covered in the appendices are differentiating and integrating circuits, characteristics of gas-discharge tubes used in time-bases, and square-wave generation.

RADIO LISTENERS' GUIDE—An Aid to Better Reception, by Fred D. Rowe. Published by A. E. Rowe, Inc. Paper covers, 6 x 9 inches, 62 pages. Price \$1.00.

"Written Expressly for the Home Radio Listener," is printed on the front cover of this little book so no one could possibly mistake it as one for the technician, serviceman or student. The author gets down to the level of the reader of limited technical knowledge. He gives only as much information as is necessary for the listener to grasp what is responsible for good and bad reception.

The fundamentals of broadcasting and reception are stated in a few words. The reader is then led to identify noises and types of defective reception, to distinguish between hums, whistling, cracking, buzzing and fading, and to look intelligently for their causes. He is trained to separate in his mind what can and what cannot be overcome—what he can himself correct and what should be left to an experienced serviceman.

While the booklet seems to have been simplified almost to the point of absurdity, too many others have had the opposite fault, and it may be very useful to the home listener now that servicemen are absent in the services or overloaded with work.

Radio School Directory

TO OUR READERS—NOW IS THE TIME TO TAKE UP RADIO!

NOW, more than ever before America needs trained radio men. The Army, the Navy and the Air Force are continuously on the lookout for men who have had training in radio. Scores of war industries require radio men in various capacities throughout the country. There now is and there will be a great shortage of radio men for years to come. Reputable schools of Radio advertise to help you.

RADIO TECHNOLOGY



RCA Institute offers an intensive two-year course of high standard embracing all phases of Radio and Television. Practical training with modern equipment. Also shorter specialized courses in Commercial Radio Operating, Radio and Television Servicing, and Aviation Communications. For Free Catalog write Dept. RC-44.

RCA INSTITUTES, Inc.

A Radio Corporation of America Service
75 VARICK STREET NEW YORK 13, N. Y.



Correspondence Courses in
RADIO and ELECTRICAL ENGINEERING

ELECTRICAL ENGINEERING Get good grasp of wide electrical field. Prepare yourself, at Low Cost, for secure future. Modern, simplified, you can understand quickly.
RADIO ENGINEERING Extra fine course in radio, public address, photo-electric work. Trains you to be super-service man, real vacuum tube technician. Servicemen needed badly. Diploma on completion. Tuition \$25. either course. Deferred payment plan.
FREE Get copies of school catalogs, student magazines, complete details. **SEND NOW!**

LINCOLN ENGINEERING SCHOOL Franklin Stn., Box 61-C61
WASHINGTON, D. C. (Formerly at Lincoln, Nebr.)

COMMERCIAL RADIO INSTITUTE

A radio training center for
twenty-three years.

RESIDENT COURSES ONLY

Pre-Induction, Broadcast, Service, Aeronautical and Radio telegraphy classes now forming. Literature upon request.

Dept. C., 38 West Biddle St., Baltimore 1, Md.



Send for this FREE 52 page Book.

It shows that "crack" operators rely on something besides practice to develop their high speeds and proficiency. It explains the "knack" of sound-sense and sound-consciousness—the secret of speedy sending and receiving. Once you acquire these mental processes, reading code becomes almost second nature to you. The Candler System, endorsed by telegraph champions, will train you quickly to be a High-Speed Radio Operator or Amateur. If you want speed and proficiency—send for this revealing book now.

CANDLER SYSTEM CO.

Dept. 3C, Box 928, Denver, Colo., U.S.A.
And at 121 Kingsway, London, W.C. 2, England

Pre-Induction RADIO COURSES

for Civilians and those entering Military Services. New classes now starting for men and women.

- RADIO OPERATING
- RADIO SERVICING — ELECTRONICS
- CODE

New York Y.M.C.A. Schools
4 W. 64th Street New York City

HOW LOUD IS A RATTLESNAKE'S RATTLE?

How loud is a rattlesnake's rattle? That's what associates of J. L. Michaelson of the general engineering laboratory of the General Electric Company asked him recently when he showed them a three-foot, seven-inch rattlesnake he killed last summer at J. S. Apperson's camp on Tongue-mountain in the Adirondacks.

"The rattle sounded terribly loud, like

the rattle of one of those gourds in a Latin-American rhumba band," was his reply.

Coming from a prairie state where snakes are sometimes regular callers, Miss Della McClurkin, engineering assistant, was skeptical. Next day she fastened the snake's rattle to an electric vibrator which she had been using in testing metals for war material. The motor can vibrate samples as

rapidly as 10 million times in five hours. Nearby she placed a G-E sound level meter, which showed a reading of 64 decibels when the rattle was vibrated.

"The overall clatter of six typewriters or the rattle of dishes in the G-E cafeteria kitchen, each rate about 64 decibels," Walt Michaelson, laboratory authority on noises, told her. "In fairness to the snake, however, it should be pointed out that you placed the rattle close to the meter, whereas the other are over-all noises."



What Chance Have You . . . ? For A Secure Peace-Time Future in RADIO-ELECTRONICS

NOW is the time for ambitious radiomen to prepare for a secure engineering job after the war!

If you want peace and security after the war . . .
prepare for it now!

Your present job may last only as long as the war. After that, industry will face a complete readjustment as the country returns to peacetime normalcy and millions of men return from the Armed Forces. Then, once again, the choice jobs will go to those who have the ability and technical knowledge to qualify.

Opportunity is yours, but competition will be keen

The remarkable advancements being made in all branches of Electronics are creating opportunities you cannot afford to overlook. CREI training in practical radio-electronics engineering can give you a sound, technical knowledge, the result of a proven program for self-advancement. We can train you, as we have trained more than thousands of other experienced radiomen, for secure, good-paying positions. You can train in your spare time, without interference with your present work, at moderate cost . . . and you can start right now!

● WRITE FOR FREE 32-PAGE BOOKLET

If you have had professional or amateur radio experience and want to make more money—let us prove to you we have something you need to qualify for a better radio job. To help us intelligently answer your inquiry—PLEASE STATE BRIEFLY YOUR BACKGROUND OF EXPERIENCE, EDUCATION AND PRESENT POSITION.



CAPITOL RADIO ENGINEERING INSTITUTE

Home Study Courses in Practical Radio-Electronics
Engineering for Professional Self-Improvement

Dept. RC-3, 3224-16th St., N. W.
WASHINGTON 10, D. C.

Contractors to the U. S. Navy, U. S. Coast Guard—
Canadian Broadcasting Corp.—Producers of Well-Trained
Technical Radlomen for Industry.

COAST MANUFACTURERS UNITE

Sixty-odd of the leading electronic and component parts manufacturers of the Pacific Coast recently organized the West Coast Manufacturers Association.

Present objectives are: full utilization of existing manpower and manufacturing facilities of Western electronic industry; insuring complete information to Government bureaus, so that the area may make full contribution to the war effort; clarifying various Government regulations and rulings as they apply to members; securing uniform consideration on problems affecting regulation and termination of contracts, selective service, wage stabilization and other matters of mutual interest; distribution of mutual information on commodities and facilities among the membership.

RADIO-ELECTRONICS

HOME-STUDY COURSE

IN 3 BIG MANUALS

8½ x 11 in.
50 LARGE LESSONS
New 1944 Edition



M. Beltman, teacher and author of many books, directed this preparation. Instructions to help you study at home included in the narrow column on each page.



ONLY \$3.95
COMPLETE 3 VOLUMES
50 Lessons

GREATEST BARGAIN IN RADIO-ELECTRONIC TRAINING

Get a complete course of training in practical radio and electronics for less than the cost of a single book. The fifty large lessons, making up the course in 3 volumes, are simple to follow, easy to master and apply. Many drawings, examples, diagrams, and instructor's suggestions (in the side column, on each page) help you move along quickly and find learning interesting fun. Review questions at the end of each lesson permit you to check your progress. You enjoy learning important radio and electronic facts. In a surprisingly short time, you are ready to do highly skilled radio repairing, building of electronic equipment, or hundreds of other War-winning tasks in the growing Electronic and Radio industries.

MANY LESSONS ON RADIO REPAIRING

Volume 3, of the course, includes lessons, service hints, case histories, and trouble-shooting charts which will show you how to repair all radio sets quickly and easily. This material alone is worth many times the low price of \$3.95, for the complete 3-Volume course. Send no-risk order coupon today. Look over and use these lessons for 10-days without obligation. You have everything to gain—and nothing to lose.

These lessons will tell you all about

Meters, Microphones, Power Supplies, Test Equipment, Circuits, Oscillators, X-Ray Amplifiers, Facsimile, Photo-cells, Superhets, Television, Recording, Alignment, Detectors, Motor Control, Radio Servicing, Electronics in Industry, Gages, Radio circuits, Hints, Testing radio parts, Transmitters, Metal Locators, Operating, Frequency standards, Analyzers, Welding Controls, Tube testers, P.A., High-frequency heating, Beacons, FM, Tubes, and hundreds of other topics.

Lessons on all Phases of Electronics and Practical Radio

Let this authoritative, easy-to-understand, practical course pave your way into Electronics—the money-making field of the future. Prepare now. Use this training in your spare time to get ahead in a good War-job. Be ready to grab the opportunities in post-war Electronic developments. Let these lessons train you, serve as your teacher and guide, and give you the needed practical time-saving hints on the job. All topics completely indexed—all subjects easy to find. An educational value that cannot be duplicated at any time.

LIMITED QUANTITY

All three volumes of the Practical Radio and Electronics Course have just been printed. Although a large quantity of courses is on hand now, our bargain price will create a tremendous demand. Government (WPB Order L-245) paper limitation policies may prevent reprinting. Better order immediately for examination—no obligation.

SEND TRIAL ORDER COUPON TODAY

Supreme Publications

PUBLISHERS OF RADIO BOOKS, MANUALS, AND DIAGRAMS

328 South Jefferson Street

Chicago, Illinois

AMAZING OFFER

New, 1944, radio-electronic course of 50 large fact-packed lessons; covers every topic of radio and modern electronics; bound in three big manuals and sold complete at the unbelievable bargain price of only \$3.95, nothing else to pay. Now is your chance to take advantage of this amazing money-saving offer. Let this home-study course guide you quickly to an essential high-pay interesting job in a radio plant, or in electronic War industry, or help you open your own radio service shop, or aid you in getting higher rank in the Army. Learn radio and electronics to earn more money now; prepare for the after-the-war opportunities in Electronics and Radio.

THREE COURSES IN ONE

You will find this complete training of 50 large lessons is really three distinct courses covering (1) Practical Radio, (2) Applied Electronics, and (3) Radio Servicing. The lessons are clear, practical, interesting, easy to master and use. No special education or previous experience is needed. Notice in the illustration of the manuals (at the left) how the helpful explanations and remarks, in the narrow column on each page, serve as the teacher. These comments guide you over the hard parts, stress the more important points, show you how to perform many self-teaching experiments using any home-radio. There are hundreds of review self-testing questions, 427 drawings, pictures, diagrams, and service hints. These newly prepared lessons will teach you all about basic radio, transmitters, test equipment, radio servicing, and every topic of modern Electronics — photo-cells, X-ray, metal locators, FM, airplane beacons, recording, facsimile, welding controls, television, etc.

BE A RADIO-ELECTRONIC EXPERT

Train quickly, in your spare time and in your own home, for a well-paying interesting job in the expanding two-billion dollar radio-electronic industry. You begin with elementary principles and quickly progress to practical explanations of radio building, servicing, and all branches of Electronics. In these well written 50 lessons, experts from every field of electronics tell you important facts and knowledge which they gained during years of practical experience. These easy-to-follow, well illustrated lessons will give you the useful "know-how" needed to obtain and get ahead on the job. Send coupon today and examine all three volumes in your own home, without obligation.

POST-WAR OPPORTUNITIES IN ELECTRONICS

New electronic applications, devices, and accomplishments, not even imagined a few years ago, are now helping us win the War. Remarkable and unique new civilian uses of electronics and radio will result immediately after the War. The peace-time advancement in the radio-electronic industry will compare with the rise of the auto industry after the last war. Plan and prepare to be in the midst of this opportunity. Let this lowest priced, home-study course give you the needed training.

SENT ON TRIAL FOR 10 DAYS

Take advantage of our no-risk examination offer. Send trial order coupon. You will receive the complete 3-volume Course for 10-days use. Begin your radio-electronic study without cost or obligation. If you are pleased, the complete course of 50 lessons, in three large manuals, is yours to keep for only \$3.95, full price, otherwise it costs you nothing for the examination.

* **Money-Back** *
* **Guarantee** *
* You must be en- *
* tirely satisfied or *
* your money will be *
* immediately re- *
* funded. You are *
* permitted to make *
* full use of the *
* course for 10 days, *
* on a trial basis. *
* **Supreme** *
* **Publications** *

NO RISK TRIAL ORDER COUPON

SUPREME PUBLICATIONS, 328 S. Jefferson St., Chicago 6, Illinois
Ship the complete 3-Volume Practical Radio and Electronics Course for 10 days examination.

- I am enclosing \$3.95, full price, send postpaid.
- Send C.O.D. I am enclosing \$..... deposit.

I must be satisfied or you will refund my money in full

Name:

Address:

Audels RADIOMANS GUIDE

**1001 RADIO FACTS
AND FIGURES**

772 PAGES. 400 DIAGRAMS, CHARTS AND PHOTOS

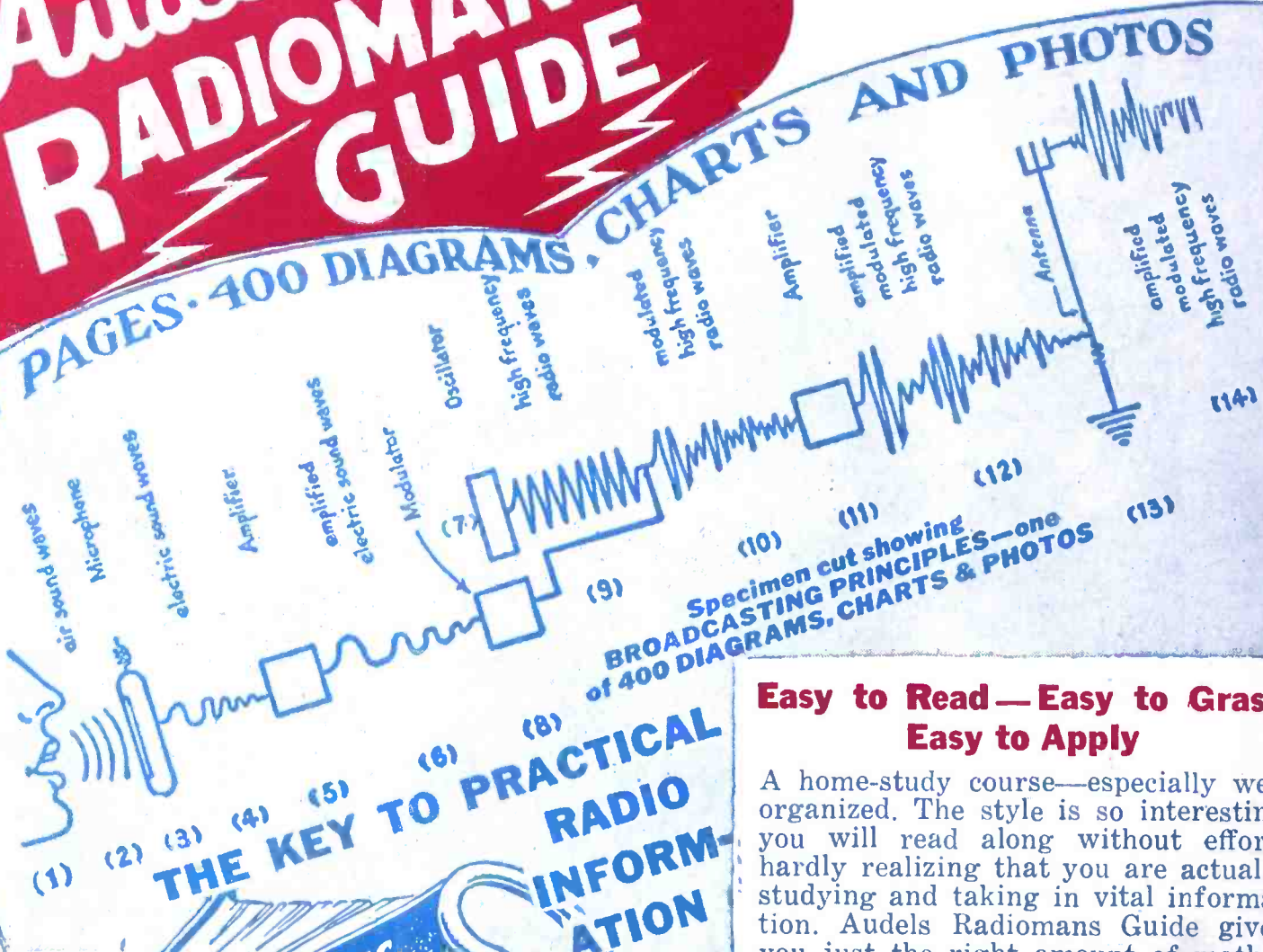

**THE KEY TO PRACTICAL
RADIO
INFORMATION**

It gives you in usable form pointers on radio, including frequency modulation, television, etc. Also valuable inside information for Aviators, Marines, Commercial Operators and Technicians, Servicemen and Students.



**Q AND A
UNIQUE
QUESTION
and
ANSWER
METHOD**

Highly Endorsed

**Easy to Read—Easy to Grasp
Easy to Apply**

A home-study course—especially well organized. The style is so interesting you will read along without effort, hardly realizing that you are actually studying and taking in vital information. Audels Radiomans Guide gives you just the right amount of mathematics required to cope with radio problems successfully. You can solve, with the aid of this extraordinary book, practically every radioproblem that comes up. At your finger tips is a complete index for instant use.



A COMPLETE LIBRARY IN ONE BOOK

AUDELS RADIOMANS GUIDE gives authentic Principles and Practices in Construction, Operation, Service and Repairs. Covers clearly and concisely radio fundamentals—Ohm's Law—Physics of sound as related to radio science—Measuring instruments—Power supply—Resistors—Inductors—Condensers—Transformers and examples—Broadcasting stations—Radio Telephony—Receivers—Diagrams—Construction—Control Systems—Loudspeakers—Antennas—AutoRadio—Phonograph Pick-ups—Public Address Systems—Aircraft and Marine Radio—Radio Compass—Beacons—Automatic Radio Alarms—Short Wave—Coil Calculations—Testing—Cathode Ray Oscillographs—Static Eliminations—Trouble Pointers—Underwriter's standards—Units and tables. REVIEW QUESTIONS—READY Reference Index.

\$4

**COMPLETE
PAY \$1
ONLY 1 MO.**

7 DAYS' FREE TRIAL

THEO. AUDEL & CO., Publishers
49 West 23rd Street, 10, New York

Mail AUDELS NEW RADIOMAN'S GUIDE for free examination. If O.K. I will send you \$1 in 7 days; then remit \$1 monthly until \$4 is paid. Otherwise I will return it.

Name _____
Address _____
Occupation _____
Reference _____

**MAIL THIS
COUPON
TODAY**