

RADIO'S GREATEST MAGAZINE

RADIO-CRAFT

with
**POPULAR
ELECTRONICS**
★

HUGO GERNSBACK, Editor

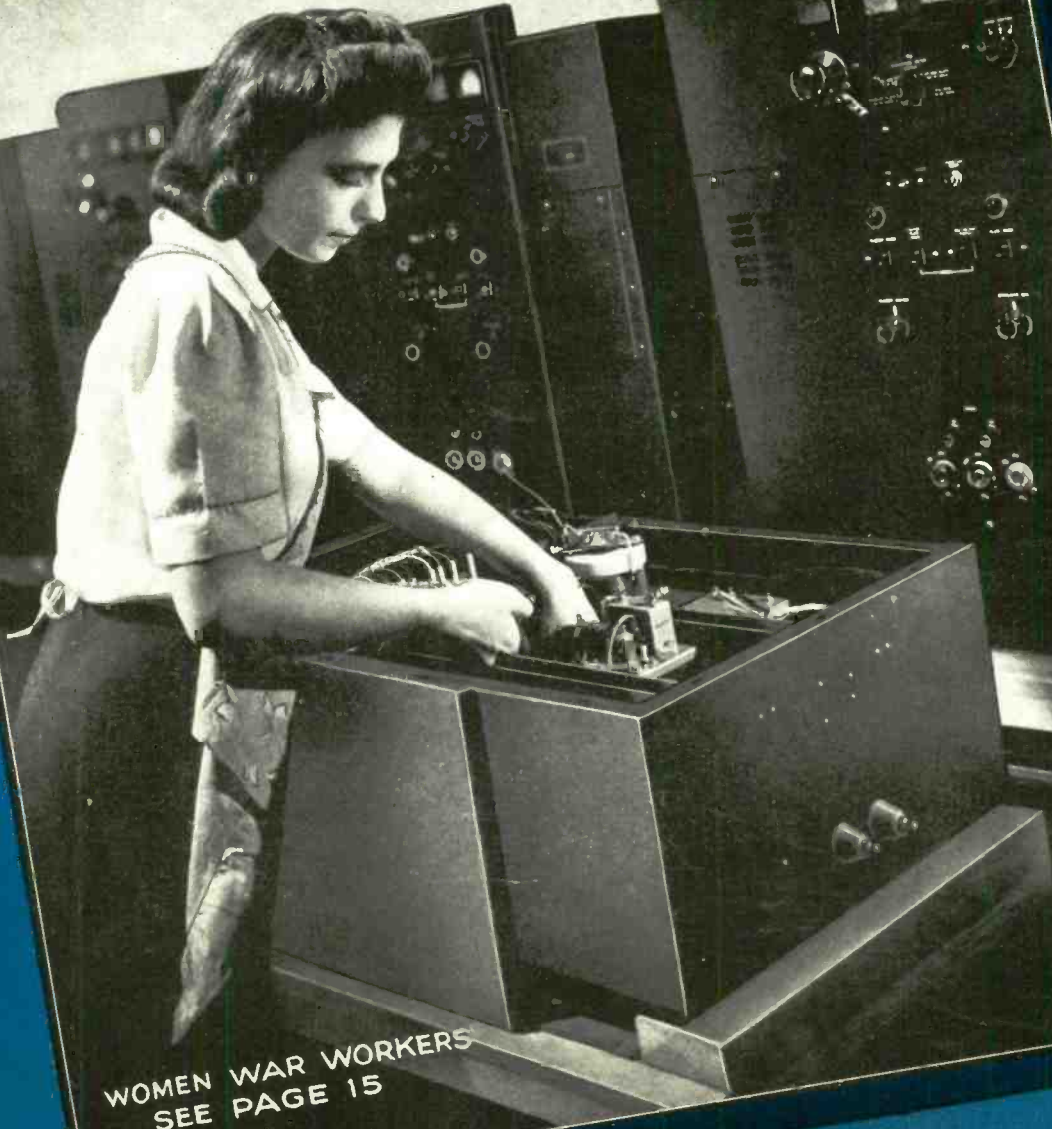

WOMEN WAR WORKERS
SEE PAGE 15

OCTOBER

25¢

CANADA 30¢

1943

OVER 100 ILLUSTRATIONS

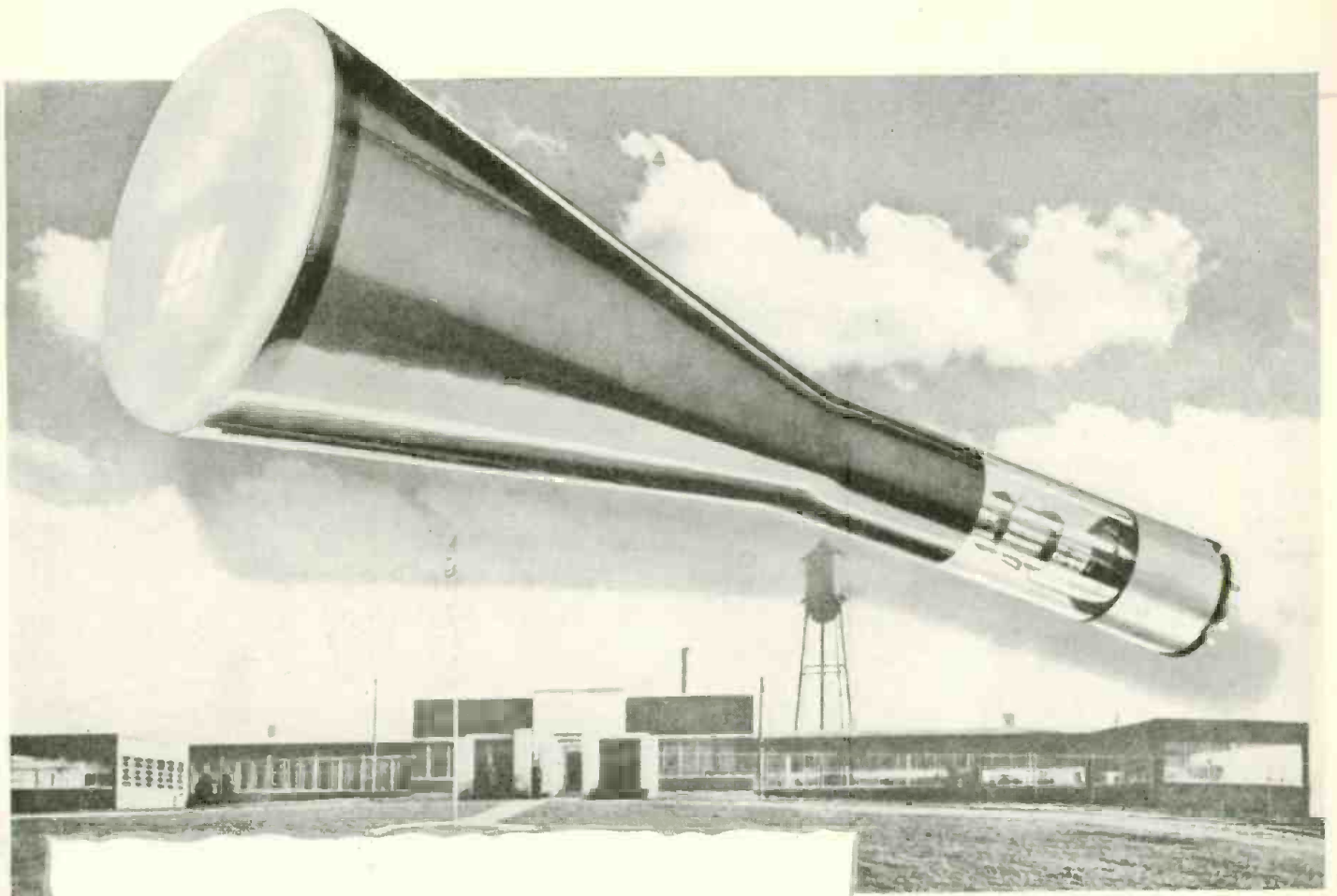

MEMO for Post-War Reference:

**NATIONAL UNION IS ONE
OF THE LARGEST PRODUCERS
OF CATHODE-RAY TUBES**

In our cathode-ray tube production record, now climbing upward week by week, we see the working out of plans made long ago. Here are the dreams of our engineers come true. Here is the model factory they planned and equipped especially for cathode-ray tube manufacture—one of the Industry's

largest. Here are the mass production machines they designed—built by this company's own equipment division. Here are the hundreds of skilled workers to whom they taught this special art of tube making that calls for the utmost precision and accuracy. Here are their laboratories with research continuing

at an even greater pace, as though their work had just begun. And here are the results of all this thought and effort—National Union Cathode-Ray Tubes by the carload. Today, enroute to those who need them most—our fighting forces! Tomorrow, destined to bring to millions of homes a marvelously improved kind of television with larger images, with greater sharpness, reality, at mass-market prices—and to thousands of factories many new precision testing and measuring devices.

Count on National Union for the things you'll need—tubes, test equipment, engineering data—to keep your post-war service in step with electronics progress.

NATIONAL UNION RADIO CORPORATION

NEWARK, N. J.

LANSDALE, PENNA.

NATIONAL UNION
RADIO AND ELECTRONIC TUBES





J. E. SMITH
President
National Radio
Institute
Established
29 Years

I WILL TRAIN YOU TO START A SPARE TIME OR FULL TIME RADIO SERVICE BUSINESS WITHOUT CAPITAL

I Trained
These
Men

I Trained
These
Men

You Build These and Many Other Radio Circuits With Kits I Supply!

By the time you've constructed 60 sets of Experiments with Radio Parts I supply—have made hundreds of measurements and adjustments—you'll have had valuable PRACTICAL experience!

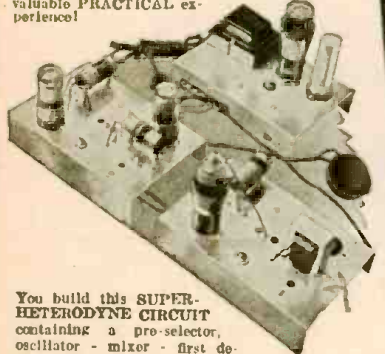

You build this SUPER-HETERODYNE CIRCUIT containing a pre-selector, oscillator - mixer - first detector, I. F. stage, diode-detector-a.v.c. stage and audio stage. It will bring in local and distant stations. Get the thrill of learning at home evenings in spare time while you put the set through fascinating tests!

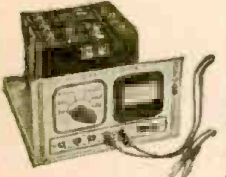

You build this MEASURING INSTRUMENT yourself early in the Course, useful for practical Radio work on neighborhood Radios to pick up EXTRA spare time money. It is a vacuum tube multimeter, measures A. C., D. C. and R. F. volts, D. C. currents, resistance, receiver output.

Building this A. M. SIGNAL-GENERATOR will give you valuable experience. Provides amplitude-modulated signals for test and experimental purposes.

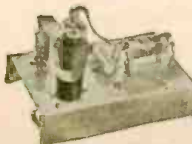

\$600 BEFORE GRADUATING, KITS HELPED



"From your Experimental Kits I learned how electricity worked, how to connect the three stages of a Radio together, also the practical basis for the operation of different parts of a set. I made about \$600 or \$700 before I graduated."—S. G. PIERSON, Box 71, Dry Creek, W. Va.

FREE TRIAL LESSON

I will send you FREE a Sample Lesson, "Getting Acquainted with Receiver Servicing," to show you how practical it is to train for a good pay Radio job at home in spare time. It's a valuable lesson. Study it—keep it—without any obligation whatsoever. Tells how Superheterodyne Receivers work—why Radio Tubes fail—how to fix Electrodynamic Loudspeakers and Output Transformers—how Gang Tuning Condensers work. Gives hints on L. F. Transformer Repair—how to locate defective soldered joints—Antenna, Oscillator Coil facts—Receiver Servicing Technique—dozens of other hints, facts, explanations, illustrated with 31 photos, sketches, drawings. Get your copy at once—mail the coupon NOW!

TRAINING MEN FOR VITAL RADIO JOBS

These Men Have SPARE TIME BUSINESSES



"I repaired some Radio sets when I was on my tenth lesson. I really don't see on my part how much for such a small amount of money. I made \$800 in a year and a half, and I have made an average of \$10 a week—just spare time."—JOHN JERRY, 1337 Kalamath St., Denver, Colorado.

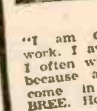

"I am engaged in spare time Radio work. I average from \$5 to \$10 a week. I often wished that I had enrolled sooner because all this extra money sure does come in handy."—THEODORE K. DUBREE, Horsham, Pa.



"I am doing spare time Radio work. and I am averaging around \$500 a year. These extra dollars mean just getting by difference between just barely getting by and living comfortably."—JOHN WASH, KO, 97 New Cranberry, Hazleton, Penna.

These Men Have FULL TIME BUSINESSES



"For several years I have been in business for myself making around \$200 a month. Business has steadily increased. I have N.R.I. to thank for my start in this field."—ARLIE J. FROEHLER, 300 W. Texas Ave., Goose Creek, Texas.

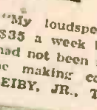

"My loudspeaker System pays me about \$35 a week besides my Radio work. If it had not been for your Course, I would still be making common wages."—MILTON I. LEIBY, JR., Tooton, Pa.



"I started Radio in the Marines in 1917. Later I started studying Radio with N.R.I. no matter how long he has worked in Radio. I now have my own business."—CHARLES F. HELMUTH, 18 Hobart Ave., Absecon, N. J.

The men above are just a few of many I have trained at home in spare time to be Radio Technicians. Today they are operating their own successful spare time or full time Radio businesses. Hundreds more of my men are holding good jobs in practically every branch of Radio, as Radio Technicians or Operators. Aren't these men PROOF that my "50-50 Method" of training gives you, in your spare time at home, BOTH a thorough knowledge of Radio Principles and the PRACTICAL experience you need to help you make more money in the fast-growing Radio industry?

More Radio Technicians Now Make \$50 a Week Than Ever Before

There's a big shortage today of capable Radio Technicians and Operators. Fixing Radios pays better now than ever before. With new Radios out of production, fixing old sets, which were formerly traded in, adds greatly to the normal number of servicing jobs. Broadcasting Stations, Aviation and Police Radio, and other Radio branches are scrambling for Operators and Technicians. Radio Manufacturers, now working on Government orders for Radio equipment, employ trained men. The Government, too, needs hundreds of competent civilian and enlisted Radio men and women. You may never see a time again when it will be so easy to get started in this fascinating field.

Be Ready to Cash In on Jobs Coming in Television, Electronics

Think of the NEW jobs that Television, Frequency Modulation, Electronics, and other Radio developments will open after the war! You have a real opportunity. I will train you to be ready to cash in when Victory releases the amazing wartime Radio developments for peacetime uses!

Many Beginners Soon Make \$5, \$10 a Week EXTRA in Spare Time

Right now, probably in your neighborhood, there's room for more spare and full time Radio Technicians. Many N.R.I. Students make \$5, \$10 a week EXTRA MONEY fixing Radios in spare time while learning. I send EXTRA MONEY JOB SHEETS that tell how to do it! My "50-50 Method"—half building and testing real Radio Circuits; half learning from easy-to-grasp, illustrated lessons—is a tested, proved way to learn Radio at home in spare time. Within a few months you can be ready to run your own Spare Time Shop, fix the Radios of your friends and neighbors—get paid while learning!

Extra Pay in Army, Navy, Too

Men likely to go into military service, soldiers, sailors, marines, should mail the coupon now! Learning Radio helps men get extra rank, prestige, more interesting duties, MUCH HIGHER PAY. Also prepares for good Radio jobs after service ends. Over 1,700 service men now enrolled.

Mail Coupon for Sample Lesson and 64-Page Book—Both Free

MAIL THE COUPON. I'll send you a FREE Lesson and my valuable, 64-page, illustrated book. They're packed with facts about Radio. You'll see snapshots and letters from men I trained, so you can know what N.R.I. did for others. You'll read a description of my Course—"50-50 Method"—Experimental Kits—Extra Money Job Sheets. You'll have my free lesson to keep. And you'll see many fascinating jobs Radio offers and how YOU can train at home. NO obligation—no salesman will call. If you want to JUMP YOUR PAY—Mail Coupon in an envelope or basket on Henry Postcard! J. E. SMITH, President, Dept. 3KX, National Radio Institute, Washington 9, D.C.

GOOD FOR BOTH 64 PAGE BOOK SAMPLE LESSON FREE

J. E. SMITH, President, Dept. 3KX, National Radio Institute, Washington 9, D. C.

Without obligating me, mail your Sample Lesson and 64-Page book. FREE. I am particularly interested in the branch of Radio checked below. (No salesman will call. Write plainly.)

<input type="checkbox"/> Radio Service Business of My Own	<input type="checkbox"/> Aviation Radio
<input type="checkbox"/> Service Technician for Radio Stores and Factories	<input type="checkbox"/> Operating Broadcasting Stations
<input type="checkbox"/> Spare Time Radio Servicing	<input type="checkbox"/> Army, Navy Radio Jobs
<input type="checkbox"/> Government Civilian Radio	<input type="checkbox"/> Operating Police Radio Stations
	<input type="checkbox"/> Operating Ship and Harbor Radio

(If you have not decided which branch you prefer—mail coupon for facts to help you decide.)

Name Age.....

Address

City State 4FR

HOW TO TRAIN AT HOME AND Win Rich Rewards in Radio

RADIO-CRAFT

with
Popular Electronics

★
HUGO GERNSBACK
Editor-in-Chief

FRED SHUNAMAN
Associate Editor

G. ALIQUO
Circulation Manager

Contents OCTOBER, 1943 Issue

VOLUME XV -- NUMBER 1

Editorial: U. S. Army Wants Radio Ideas ... by Hugo Gernsback 5
The Radio Month in Review 6

POPULAR ELECTRONICS

Popular Electronics, Part IX by Raymond F. Yates 8
Selenium Rectifiers 10
Phanatron 11
Vibrator Transducer 12
"Seeing-Eye" Phototubes 13
Now—Electronic Nails 14

WARTIME RADIO

Women War Workers (Cover feature) 15
Forecasts of Future Radio 16
Invasion 17

SERVICING

Locating Defects In Radio Receivers, Part I by D. B. Looney 18
RADIO SERVICE DATA SHEET:
No. 328 Philco Models 42-1008, 42-1009W, 42-1009M 20
The Care of Instruments by H. S. Day 22
Checking Power Supplies by Jack King 26

RADIO TRAINING

Radio Waves and Radio Antennas, Part II ... by Eugene P. Bertin 24

SOUND

Pick-Up Performance, Part II by Ted Powell 27
Electro-Guitar by Arnold Schutzman 28
Negative Feedback Pitfalls by J. T. Terry 30

CONSTRUCTION

Short-Wave Interflex by William F. Luebbert 31
4-Watt Amplifier by Charles Baker, Jr. 32
All-Round Bridge Analyzer by Robert Wolf 32

ATTENTION, READERS!

Commencing with the November issue RADIO-CRAFT will be presented to you in a new and improved dress.

New material and new features will continue to appear from month to month in the body of RADIO-CRAFT.

Watch for this issue of RADIO-CRAFT — your guide to the new age of Radio and Electronics.

DEPARTMENTS

RADIO SERVICE DATA SHEET (See Servicing) 20
Servicing Notes 23
The Listening Post 33
The Question Box 36
Radio Hook-ups 38
Radio Kinks 40
Latest Radio Apparatus 41
Mailbag 60
Book Reviews 63

★

Published by Radcraft Publications, Inc. Publication office: 29 Worthington Street, Springfield 3, Mass. Editorial and Advertising Offices: 25 West Broadway, New York City 7. Chicago Advertising Office: RADIO-CRAFT, 520 North Michigan Avenue, Chicago, Ill.

RADIO-CRAFT is published monthly, on the first of the month preceding that of date; subscription price is \$2.50 per year in U. S. (In foreign countries, 75c additional per year to cover postage; Canada, 50c additional.) Entered at the post office at Springfield as second-class matter under the act of March 3, 1879. All communications about subscriptions should be addressed to: Radio-Craft, 25 West Broadway, New York 7, N. Y.

Notice of CHANGE OF ADDRESS should reach us at least one month in advance. Be sure to give your OLD ADDRESS as well as the new, as without the old address we cannot find your name in our files.

★

Foreign Agents:

London—Gorringe's American News Agency, 9A Green St., Leicester Square, W. C. 2, England.

Melbourne—McGill's Agency, 179 Elizabeth St., Australia.
Dunedin—James Johnston, Ltd., New Zealand.

★

Text and illustrations of this magazine are copyright and must not be reproduced without permission of the copyright owners.

★

Copyright 1943 Radcraft Publications, Inc.

SCR-299

RIDES THE CREST OF THE INVASION WAVE!

To our troops fighting on all fronts, the SCR-299 Mobile Radio Communications unit is a familiar sight. It helped pave the way for the Allies in Africa and Sicily. In Africa alone it operated on five networks, including circuits from Oran to England, Casablanca, Gibraltar, Algiers and Accra.

Whether set up as a fixed radio station or used as a fast-moving mobile unit, the SCR-299 has done an excellent job transmitting commands while in action, no matter how difficult the conditions . . . thus proving that communications systems were adaptable to the "Blitz" tactics of modern warfare.

The World's Largest Exclusive Manufacturers of Short Wave Radio Communications Equipment

the hallicrafters co.

CHICAGO, U.S.A.

BUY
MORE BONDS!



CASH PRIZE CONTEST!

FOR RADIO MEN IN THE SERVICE!

"Write A Letter"

As you know, the Hallicrafters make SCR-299 Communications trucks. We are proud of our handiwork and proud of the job you men have been doing with them on every battle front.

RULES FOR THE CONTEST

We want letters telling of actual experiences with SCR-299 units. We will give \$100.00 for the best such letter received during each of the five months of November, December, January, February and March!

We will send \$1.00 for every serious letter received so even if you should not win a big prize your time will not be in vain.

Your letter will be our property, of course, and we have the right to reproduce it in a Hallicrafters advertisement.

Good luck and write as many letters as you wish. V-Mail letters will do.

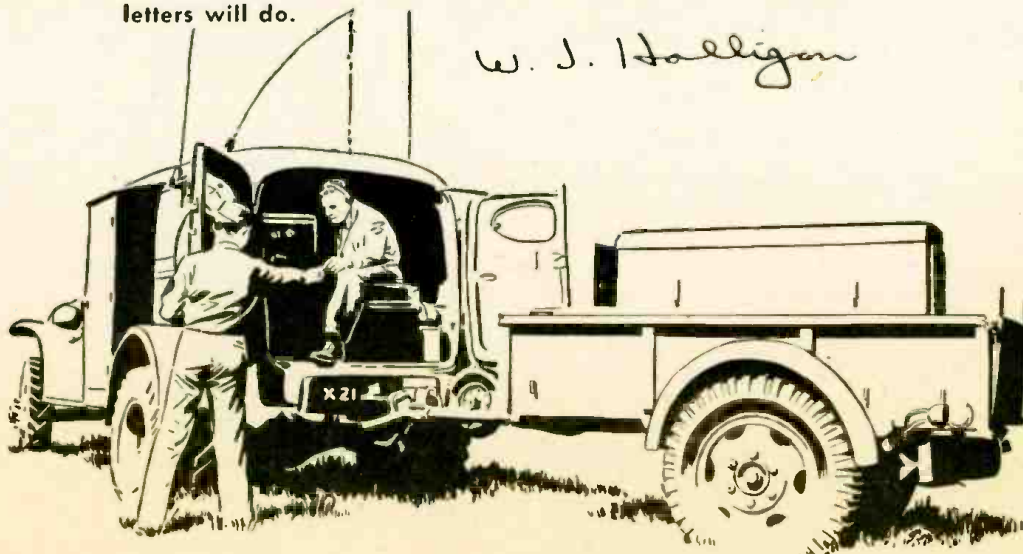

BUY MORE BONDS!



the hallicrafters co.
2611 INDIANA AVENUE, CHICAGO, U. S. A.
MAKERS OF THE FAMOUS SCR-299 COMMUNICATIONS TRUCK

RADIO-CRAFT

with

POPULAR ELECTRONICS

"RADIO'S GREATEST MAGAZINE"

U. S. ARMY WANTS RADIO IDEAS

By the Editor — HUGO GERNSBACK

... For a quicker Victory,
our armed forces require im-
portant radio inventions ...

IN THIS the most highly mechanized war of history, it has been demonstrated over and over, that the side that has the best technically equipped army wins most battles—and if it can keep the pace up will eventually win the war. It was so when Nazi Germany over-ran Poland, the Low Countries, and France, with losses to the German army that were relatively small and out of all proportions to the results achieved.

Now that the United Nations are technically better equipped than the Axis, the tide runs the other way and if we can maintain the accelerated pace, there is no question but that the Axis will go down in defeat.

It has further been demonstrated that each new efficient weapon that makes its appearance on the battlefield and on the fronts measurably shortens the length of the battles, and the length of the war as well. To put it in another way, the more technically efficient our armies become, *vis-à-vis* the Axis, the fewer casualties we shall have and the sooner the war will be over. These may all be platitudes that have been repeated often, but just as often are lost track of, because self-evident truths are frequently not heeded.

The writer has made the observation for many, many years that radio itself is a formidable weapon and is apt to be more formidable as time goes on. Indeed, it is much more formidable than the public appreciates, on account of the secrecy surrounding many new radio developments now in use, with many more to come. People are apt to think that the word "radio" means only communication during war times. How wrong this interpretation can be is best proven when the public was recently appraised of the role played by Radar during the present war; and—as everyone now knows—Radar has nothing whatsoever to do with communication, it detects hostile aircraft and surface vessels long before they are ever seen or heard.

In every past war it has also been demonstrated that all new weapons eventually bring forth counter-weapons. Thus, for instance, the airplane was countered with the anti-aircraft batteries. When in North Africa the United Nations' forces found that the retreating Nazis had sowed mines by the tens of thousands, to slow up the pursuing English 8th Army, as well as our own U. S. forces, we countered this by the so-called magnetic detectors—which were not magnetic at all—but really are radio metal locators such as have been described in *Radio-Craft* for many years back.

As long as the land mines were made of metal, little trouble was experienced in quickly locating and neutralizing them. But the Nazi land mines are no longer made of metal and that is where radio comes in. More of this below.

It will be of intense interest to radio technicians and inventors that last month the United States Army broke its long-kept silence of secrecy on a taboo subject—that is, a search for new war weapons and various urgently needed war devices.

The National Inventor's Council in Washington made public a list of U. S. Army requirements and, for the first time during this war, invited amateur and private inventors to put their native American ingenuity to work solving a number of specific problems. In giving the list below, it should be noted that it is only a partial list insofar as the writer evaluates the problems in question that pertain to radio. There are many other needed devices in the list, which obviously, not having any connection with radio, have not been mentioned. If you are interested in obtaining the entire list, you may do so by addressing the National Inventor's Council, Washington, D. C. The partial list follows:

- (1) A detector to locate non-metallic land mines.
- (2) A detector to spot unseen enemy soldiers approaching along jungle trails.

(3) A light (perhaps using infra-red rays), enabling soldiers to see objects at night, but being invisible to the enemy.

(4) An improved means of signalling the identity of land troops and friendly planes, and *vice versa*.

(5) A new method or methods of sabotage to be used by "friendly inhabitants within (enemy) occupied areas."

It is most interesting to note that of the total requirements, the needed inventions and ideas in which radio can (in the writer's estimation) be used in some way, leads the list.

The first item on the list is a non-metallic land mine detector. As stated above, as long as these mines were made of metal, it was child's play to detect them and dig them out of the ground so they could do no damage. Being aware of this, the Nazis not so long ago switched to non-metallic land mines which presumably are made out of wood, plastics or a combination of both. Now our armed forces are confronted with a new problem to find a reliable detector to search out these non-metallic land mines.

The problem need not be insolvable. It is almost certain that the new mines must have some metallic parts, even if minute. The first thought would be to get a much more sensitive radio metal locator that will locate a minute quantity of metal. Fortunately there are some devices that do this trick and which so far have not been employed. I refer only to one—the famous Hughes Balance. It will be found in many text books and it is incredibly sensitive to minute amounts of metal. To the best of my knowledge, an improved Hughes Balance has never been coupled effectively with modern radio instrumentalities in order to give it still greater sensitivity required for such field work. To be sure such a highly sensitive radio-balance-detector would also detect small pieces of metal, stray nails and bits of wire which the army sappers would have to dig for. This is very true and it is also true that it would slow the work of the men somewhat, but that is the price to be paid when many lives are to be saved.

Another approach to the solution of the problem might be high frequency radio currents which can be used for intense local heat applications. Land mines contain dynamite or TNT. Both can be liquefied at high temperatures. Experiments would have to be made to find out what happens when high heat is applied, which would probably dislocate the detonator; then after solidifying again, it is probable that the mine would not go off and would not have to be dug out of the ground at all.

I appreciate that these are only approaches to the problem and that quite a good bit of research work will have to be undertaken in order to finally solve the problem.

As for the improved means of signalling the identity of ground troops and friendly planes, and *vice versa*, there are no doubt many different radio ways by which this problem can be solved. It is certain that one of the best way will be by special centimeter short waves. These waves, as is well known, have optical properties and do not spread out far, and for this reason they are not received by the enemy too readily.

The problem of detecting and spotting unseen enemy soldiers is certainly also a radio problem. Here too we find that the enemy soldier as a rule carries a sufficient amount of metal on his body, including helmet and rifle, to make an excellent radio detecting target. There are a number of ideas which will immediately become apparent to some ingenious inventors and I hesitate to put too many hints in print, for the main reason that ideas in this category should remain secret for the duration. It is an intricate laboratory job and requires a number of excellent research men with imagination, but I have little hesitancy in predicting that this problem as well as the others mentioned in this article will be solved before long, through the instrumentality of Radio.

A Digest of News Events of Interest to the Radio Craftsman

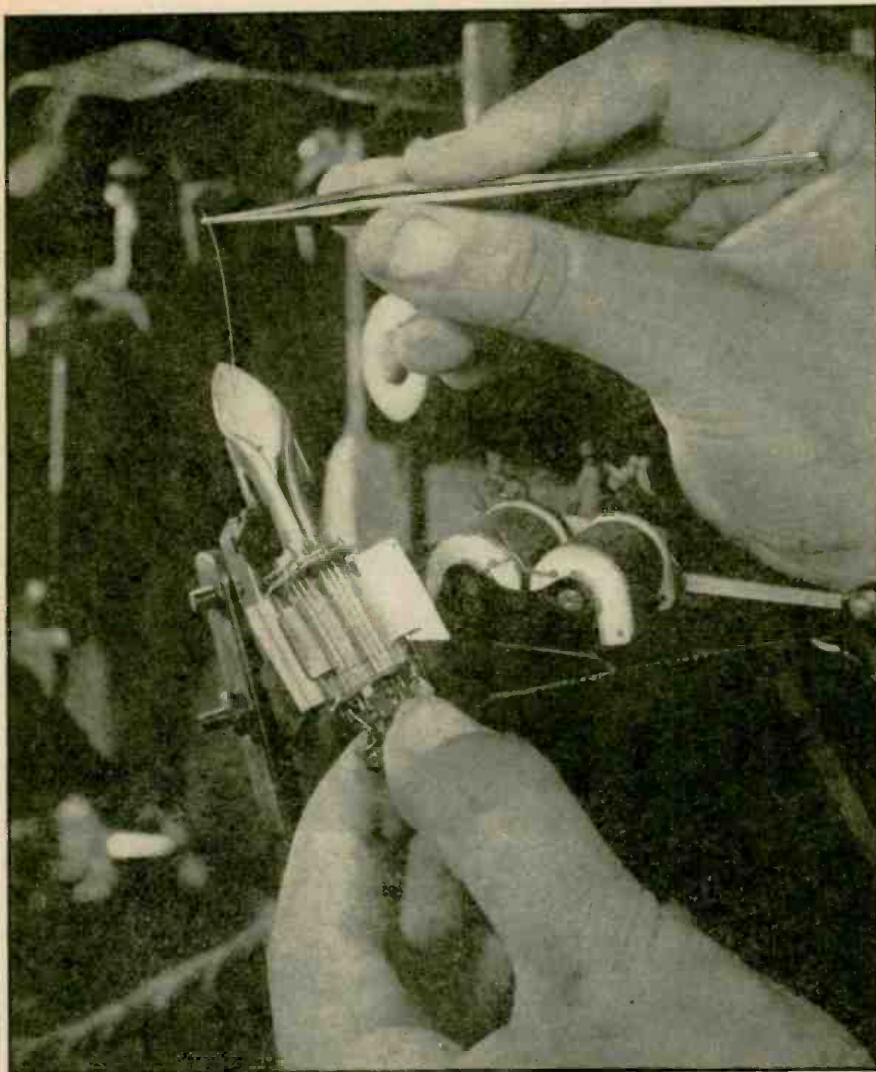

BOTTLENECKS in the manufacture of miniature tubes are being broken by the interesting device pictured above, according to information received last month from Tung-Sol, in whose plant it is now installed.

Called a "lily-jig" because of a fancied resemblance to a calla lily, it speeds up the operation of installing filaments in the delicate miniature tubes which are fast becoming one of the most important types manufactured today. The large number used in military work, together with the popularity of small A.C.-D.C.-battery portables, have caused these tubes to be put out in such numbers that older methods of manufacture have had to be streamlined to keep up.

One of the worst and most tedious bits of hand work in assembling these tubes was installing the filament. This more than hair-thin piece of wire, equipped with welding tabs, has to be inserted through a triangular hole in the top mica, slipped past a "damping bar," then down through the grid assembly and out through another hole in the bottom mica support. The clearance between tabs on the filament is only .007 inch. To make the job more interesting, the damping bar, which contacts the fila-

ment continuously to discourage vibration and microphonics, tends to throw it off center, prevent its passage, or entangle it in the grids.

The delicate and difficult task of positioning the filament to insert in the top mica support, coaxing it past the damper, urging it down the center of the assembly with encouraging taps of the tweezers, and getting it out the bottom hole, was a time-killer. Not only that, it was hard on the eyes and nerves of the operator. Girls especially trained for this highly-skilled job cracked up and had to be taken off.

Tung-Sol research workers decided that the bottle-neck must be broken, and the "lily jig," largely the work of Frank Kew, factory supervisor, and Joseph Bannon, factory engineer, was brought forth. The new and ingenious device saves the time of five operators on one shift alone, and it is estimated that in a year it will cut filament inserting time by 12,000 operator hours. The saving in mental strain is incalculable.

Operation of the "lily jig" is simple. It holds the assembly so that the filament slipping down the spathe of the "lily" finds itself properly positioned to enter the hole in the top mica support. It is now aided by vibration from an over-sized buzzer.

Where the operator used to help it along by tapping with a tweezer at the maximum rate of about 500 taps per minute, it now receives 3600 taps in the same time, and slides freely down past all obstructions and out the bottom opening.

FREQUENCIES in the order of billions of cycles per second, used in applications as yet undreamed of, were predicted by W. C. White, head of the electronics laboratories of General Electric, in an address to National Association of Music Merchants last month.

"Scientists," said Dr. White, "have found means of creating and controlling currents of such high frequencies that engineers have not as yet discovered uses to which this amazing development can be put.

"When they do," he predicted, "the discoveries may be so startling and revolutionary as to open great new fields to the science of electricity."

Dr. White further envisioned a great advance in the technical qualifications of the post-war public as a result of electronic training so many are now receiving in the Armed Services.

"Veterans of past military services," he said, "have had to catch up on all the advancements which took place while they were in uniform. Now the shoe is on the other foot. Thousands of these men have received fine radio technical knowledge in the armed services of this war, a training which they may never have found available in civilian life. The result is that the civilian will have to do the catching up. All this will contribute a great impetus to the entire radio industry."

DAVID GRIMES, one of the best-known of the pioneers of radio, and famous as the inventor of the reflex circuit which bore his name, was killed on Saturday, September 4th. The transport plane in which he was traveling crashed into a mountain in Northern Ireland. Mr. Grimes was 47 years of age. He was abroad on a special war mission.

Mr. Grimes served in the last war as chief radio officer at Kelly Field, Texas, when the use of radio communications in warfare was just beginning to assume importance. From June to December, 1918, he was Signal Officer attached to the British Air Forces at Aldershot and at Littlehampton, England.

After the war, he joined the American Telephone and Telegraph Company as a research engineer in telephony. In 1922 he established his own engineering organization to do research work on a consulting basis for a number of different companies. It was during this period that he invented the famous "Grimes Inverse Duplex circuit" that was used by many early radio amateurs in home-made receivers. From 1930 until 1934, he was License Engineer with the Radio Corporation of America.

Mr. Grimes joined Philco in 1934. In 1942 he was elected vice-president in charge of engineering. Under his direction, Philco established one of the first successful television relay systems. It was Mr. Grimes' belief that a network of similar relay links which beamed television programs through the air from one station to another 25 to 40 miles apart would make it possible to develop a nation-wide television service in a relatively short time.

CALL LETTERS for frequency modulation stations are to be changed to bring them into line with the regular 4-letter calls used by AM broadcasting stations, according to a recent report by the Federal Communications Commission. The new system will come into effect November 1.

This system of call letters for FM stations will replace the present combination of letter numeral calls (such as W47NY, W51R, etc.) presently used by FM broadcasters. In cases where a licensee of an FM station also operates a standard broadcast station in the same city, he may, if he so desires, retain his standard call letter assignment followed by the suffix "FM" to designate broadcasting on the FM band. Thus, if the licensee of a standard broadcast station with the call letters "WAAX" (hypothetical), also operates an FM station in the same location, he will have the choice of using the call "WAAX-FM" or he may, on the other hand, be assigned a new four-letter call—say, WXRI. Similarly, an FM broadcaster on the West Coast, who also operates a standard broadcast station "KQO," may, if he likes, use the call "KQO-FM" or he may be asked for a new four-letter call "KQOF" for his FM station. This choice will remain entirely with the FM operator.

Urged by FM Broadcasters, Inc., which had petitioned the Commission for a change, the new procedure will immediately affect some 45 FM stations now in operation, as well as all future licensees. Existing licensees have been instructed to select their new calls prior to Oct. 1 from the list available at the FCC of some 4000 four-letter unassigned calls.

If no request has been received from an FM licensee by Oct. 1, the FCC will, at its discretion, assign a new four-letter call to that station. It is recommended that FM operators who wish a new four-letter call list their first, second and third choices, and in the event two stations seek identical call letters the request first received by the Commission will be honored.

Under the existing system the first letter of an FM call, either K or W, indicated the geographical position of the station in relation to the Mississippi River, the number designation showed the frequency on which that station was operating and the last letter or letters gave a clue to the city from which the broadcast emanated. (FM stations are licensed in the 43,000 to 50,000 kilocycle band, on frequencies from 43,100 to 49,900 Kc., progressing by 200 kilocycle steps.) Thus the call K37LA indicates a station operating on 43,700 Kc. at Los Angeles; W53D, a station on 45,300 Kc. at Detroit, etc.

The Commission's decision to discard the combination of letter-numeral calls for FM stations arose out of several disadvantages and inherent limitations in the system based upon the past experience of FM broadcasters themselves, and the advisability of making the change while transmitter construction is halted because of the war.

Licensees of FM stations have found that the letter-numeral system is cumbersome and does not meet with general public acceptance. In addition, a change in frequency of an FM station under the old system involved a change in its call with consequent confusion to the listening public.

Finally, it was felt that as FM stations were licensed in more and more cities, it would become increasingly difficult to identify the station call with a particular city through the use of an initial letter or letters, as if call signs were allotted to two cities with the same initial letter there would be no means of distinguishing between them.



Underwood and Underwood

DR. LEE DEFOREST, the Father of Radio, celebrated his 70th birthday in the quiet of his Los Angeles home on August 26.

Dr. DeForest is still actively engaged in electronic research and development. His latest field is that of Radiotherapy, and some of his conclusions, presented in a recent *Radio-Craft* article, are at variance with the traditional concept that all effects of high-frequency current on the human system are due to heating.

The ability to think ahead of the crowd which has always marked his career is still his most distinguished characteristic. Nor is it confined to his researches in ultra-high-frequency physiotherapy. He is said to be currently working on a new military application of the electron tube, in which television and robot plane control will be so combined that an explosive-laden plane—a literal flying torpedo—can be directed unerringly to a distant target.

Celebrated as the inventor of the three-element electron tube upon which all radio development since its time has been based, his accomplishments in the field of broadcasting and related activities have often been overlooked. Yet he originated successful broadcasts at a time when the man in the street neither knew nor would have believed such a thing to be possible. His first successful tests were made in the summer of 1908, from the Eiffel Tower in

Paris. Beside initiating broadcasting, another tradition (which has been faithfully adhered to since) was established the first night the Tower station went on the air. The program consisted of *phonograph records*, which were received well by a number of French military radio stations near Paris. While DeForest was still enjoying his triumph, a letter was received from an engineer in Marseilles, confirming reception of every number. The name of the first DX listener has been lost, but he was the founder of a great fraternity.

In early 1910 the experiment was repeated in New York City. More than 50 people were said to have listened to America's original radio program.

Another "first" of DeForest's has remained with the radio constructor and experimenter through all the years since. It came from his work on the Audion in the old New York laboratory. DeForest found some difficulties in directing his two assistants in an experiment which called for the rapid change of a number of circuit connections. There was a certain confusion as to which should go where, and the inventor stopped for a minute to clear it up. "Put the green wire on the grid and the black on the ground," he said. "Write it on the wall somewhere so you won't forget. Green to grid, *always*, and black to ground!"

And green to grid, black to ground it has been to the present day!

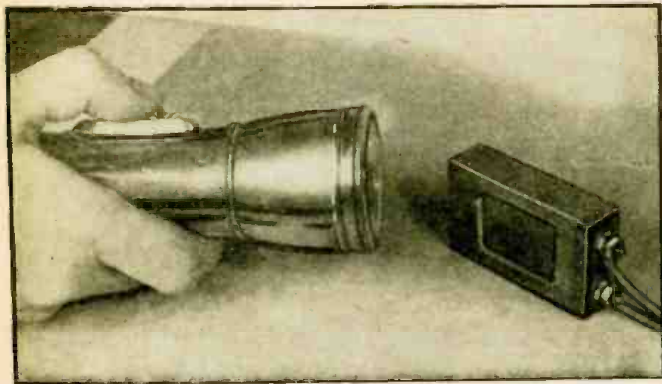

Photo A.—With an ordinary flashlight and a collection of photo-cells, the serious student can greatly expand his knowledge of photoelectricity.

PHOTOELECTRICS is so much a part of electronics—such a big and such an important part—that we shall continue with a discussion of this phase of the art. The emphasis here will be laid on the purely experimental side and we shall deal with experiments that may be conducted in the home laboratory.

It is assumed that the student has equipped himself with at least a selenium cell and a photo-voltaic cell. If at all possible a gaseous and vacuum type emissive cell should also be at hand. These are inexpensive nowadays, and may be had for a few dollars each from any one of a number of scientific supply houses. If the student anticipates a career in the electronics field, he will do well to thoroughly acquaint himself with the action of these cells. The actual use of these devices give him more toward training than the reading of reams of literature.

The first experiments should be extremely simple. How sensitive to light, for instance, is an ordinary selenium cell? We can get a pretty good idea of this by connecting a cell to a milliammeter and using a single candle for illumination. At least we know that one candle power only is available. (See Fig. 1). This is placed an inch or two from the cell and a reading of the meter can be taken. Then the candle can be moved away, an inch or two at a time, and further readings taken. An ordinary foot ruler is used to measure the distance between the cell and the light. If we wish to be really scientific, a graph may be drawn on cross-section paper showing the relationship between light intensity and distance. As the candle is moved away from the cell, the current curve will bend downward, until a zero point is reached. After that an electric lamp may be used in place of the candle. An ordinary flashlight of the beam type, as shown in Photo A, is excellent for use as a light source in experimenting with photo cells. In special experiments, the glass can be masked with black paper provided with a small hole in the center for the propagation of a small beam.

This simple but highly interesting and practical experiment may be tried with all four cells if they are at hand. This, more than anything else, will acquaint the experimenter with the relative sensitivity of the various types of cells.

SELENIUM PHOTO-EMISSIVE CELLS

If at all possible, the student should also include in his photoelectric experimental kit a selenium cell of the barrier type. This may be operated without a battery and will deliver as much as 100 micro-amperes at 100 foot candles. The cells are extremely rugged and long lived. Whereas crude,

* Application for Trade Mark Title, pending in U. S. Patent Office.

homemade cells may have an appreciable time lag, the commercial barrier cells, which may be purchased for as little as \$1.75 unmounted, have no appreciable lag and will respond to light changes having a frequency as great as 10,000 cycles. The generated voltage of such cells changes logarithmically with the illumination and shows .6 volts in direct sunshine. The construction of such cells is shown in Fig. 2, and is much like that of the selenium rectifier described elsewhere in this issue, the counter-electrode being so thin as to permit passage of light through it.

Another important fact concerning these cells, which are finding increasingly important commercial usage, is their low fatigue. This means that they do not readily show "tiredness" by a decrease in their self-generated current. Here, too, let it be pointed out that such barrier type, self-generating cells are not in any sense to be confused with the ordinary selenium cell even though a selenium compound is used as the active material. In the ordinary selenium cell, the element selenium is used alone in an annealed condition and, so far

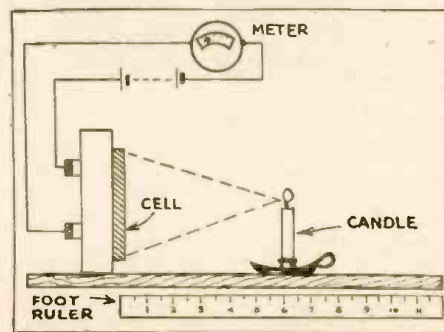

Fig. 1.—A simple set-up for measuring the emissivity per candle-power of ordinary photo-cells, and checking the effect of distance on light strength.

as is known, only a change of electrical resistance results when a light strikes the exposed surface. Thus is the current from a local battery connected to the cell permitted to flow in degree determined by the nature of the cell and the intensity of the impinging illumination. The selenium compound barrier cell, on the other hand, is a photoelectric generator.

MEASURING TIME LAGS

The simple experiment illustrated in Photo B can be used to roughly determine the degree of lag in the selenium cells and it may also be used in connection with high speed cells of the emissive types to produce musical pitches. It will be noticed that a sheet metal or heavy cardboard chopper disc is attached to the shaft of a small D.C. motor or a series wound motor used on A.C. In any event, a resistor should be placed

POPULAR

By RAYMOND F. YATES

in the motor circuit so that the speed may be changed.

The light source used in this experiment may be an ordinary flashlight of the beam variety. The glass of the flashlight is covered with a piece of black paper with a hole in it. This hole should be just the size of the slot or hole in the chopper disc so that a complete cut-off of light will occur when the spaces between the holes or slots are being covered.

The first experiment is tried with an ordinary selenium cell. When the motor moves at a low speed, a low hum should be heard in the selenium cell circuit through the agency of a pair of radiophones. As the motor speed is increased, a high point will eventually be reached where no sound at all will be heard. This represents the point at which the selenium cell fails to respond because of its so-called "inertia."

This inertia is present in some degree in all photoelectric cells save the high vacuum type. This has an inertia but it is so low as to be practically unmeasurable. It amounts to the transit time for an electron between the cathode and anode. The distance is small and electrons, under these conditions, may move as fast as 10,000 miles a second. Obviously, the time required for an electron to move 1/2-inch must be small.

The gaseous cells will have some time lag, due to the fact that electrons released from the photo-emissive surface collide with the gas atoms (argon, for example) on their way across the inter-electrode space. Ionization is thereby brought about and such cells operate on this principle, the ionized gas thereafter functioning as a conductor. The time lag here, however, is so small that there is some question as to the ability of the home experimenter to detect it.

By using a power amplifier and a powerful loudspeaker with this equipment, the experimenter may assemble a very interesting photo-electric siren with variable pitch.

COLOR-SENSITIVITY CHECKS

If the student will assemble a few pieces

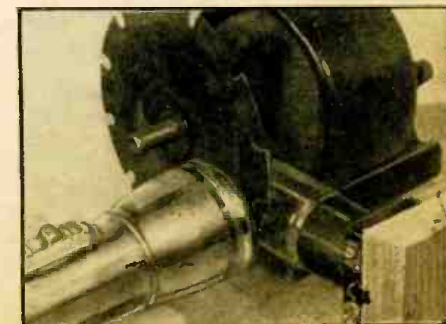

Photo B.—The flashlight used with a small motor and toothed disc to measure time-lag of photocells

ELECTRONICS *

PART IX—PHOTOCELL EXPERIMENTS

of colored glass or, better yet, a set of light filters from one of the scientific supply houses, many very edifying experiments may be conducted with the various photoelectric cells. In our first discussion of the theory of the photo-emissive cell, it was pointed out that it was not light intensity alone that counted but the wavelength of the light as well. Photoelectric response becomes increasingly greater as the wavelength of the light used as the exciting agent becomes shorter. Thus violet and ultra-violet light has an intense effect while red and infra-red have a minimum effect. Indeed—except in the case of especially designed caesium cells that may be made to respond to invisible infra-red rays—most cells will not provide a response at all. This may easily be determined by interposing red glass between the light source and the photo tube or device under examination. In every case, a meter reading is taken with each piece of glass. The set-up is shown in Photo C. Should the experimenter have some photographic filters at hand, these may be pressed into service as well. The worker will find that he may while away a number of evenings investigating the matter of photoelectric response-vs.-wavelength and he is bound to emerge from the work with greatly increased practical knowledge.

The drawing, Fig. 3, will supply the details of a filter experiment using pure infra-red rays which are utterly invisible although even the shorter of these waves may be felt in the form of heat. The experiment calls for an electric arc light which is known to produce a rich source of ultra-violet light as well as infra-red. The arc may be easily drawn either through the use of a lamp bank or through the employment of a heavy Nichrome (600-watt) heater unit, in series with two 3.8 inch carbons. A reflector must be used to concentrate the light of the arc so that a point of high intensity will be had.

Iodine dissolved in either carbon disulphide or alcohol will entirely prevent the passage of visible rays and very short rays but will permit the passage of infra-red rays. These rays will converge at a point beyond the bottle shown in the diagram and here the

cells being experimented with may be placed. Each cell should be tested for performance in what may be taken as pure infra-red rays. Most cells will show no response whatsoever. It is also interesting to see what effect is had with such things as paper, quartz, celluloid, mica, etc., in place of the iodine solution.

A bottle filled with water may also be used for a filter. In such a case only visible light will be permitted to pass, all infra-red being absorbed. The behavior of each cell should be noted with this filter also. Such work should prove fascinating to any experimentally inclined student.

AN EXPERIMENTAL PHOTOPHONE

The transmission of sound over light beams may easily be accomplished by the home experimenter if he will set up an arc

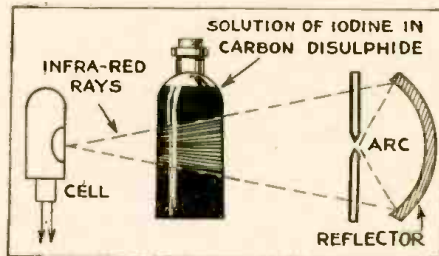

Fig. 3.—How apparatus is arranged for an experiment with infra-red light.

light and condensing lens as illustrated in Fig. 4. The photocell may be of the caesium gas-filled type which is, in turn, connected to an ordinary audio amplifier with the proper matching resistance in the cell input circuit. The point marked A in Fig. 4 shows where interruptions in the light beam should be made. This is at the point where the light waves cross each other. If an ordinary comb is run across the beam longitudinally, the light interruptions will be heard in the loud speaker. The attention of the experimenter is also drawn to the possibility of creating various musical and other sounds by painting wave forms on glass or celluloid. It will also be possible to mount a small mirror on one of the prongs of a tuning fork so that light

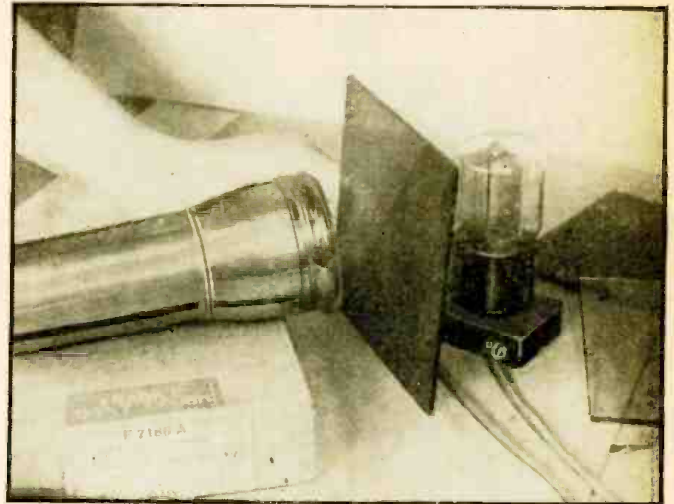

Photo C.—By using filters, the response of a photo-cell to different colors may be readily seen.

from the arc will strike it in such a way as to effect the reflection of the beam. Striking the fork will then produce a musical note of the frequency represented by the fork.

The transmission of speech via light beam has engaged the attention of many able experimenters. For this purpose, light beams may be modulated in the manner shown in Fig. 5. This transmitter is useful only for very short distances because of the weakness of the neon crater lamp used. Speech or other sound impressed on the microphone in the input circuit will cause fluctuations in the current reaching the neon tube. This, in turn, will create changes in light intensity which will be recorded by the photoelectric cell used to catch the emitted beam. This system is similar, in a measure, to that used in part of the moving picture industry for recording sound on film. A highly special and far more intense lamp is used in place of the neon bulb.

Greater distances may be covered by so arranging a slit (through which the light is made to pass) that a movable shutter attached to the armature of a magnetic speaker unit will chop the beam to a greater or less extent, depending upon the sound energy impressed upon the current passing through its coils. In such a case, the loudspeaker is simply connected to the output of an ordinary audio amplifier and a standard microphone used for the input. With such an installation, no limit need be placed on the power of the light beam employed, and in the case of an arc light, equipped with the proper optical accessories, considerable distances may be covered at night.

Still another photocell experiment is recommended for the more ingenious and patient student. If the proper kind of a photocell is available, relatively simple manipulation will demonstrate the actual relative velocity of photo-electrons released by the photo-sensitive surface of a cell. For

(Continued in page 43)

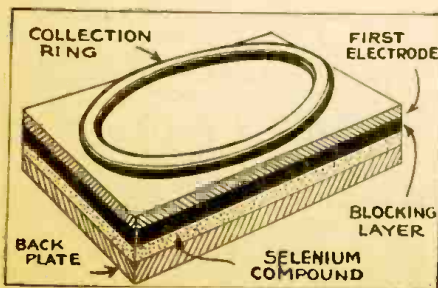
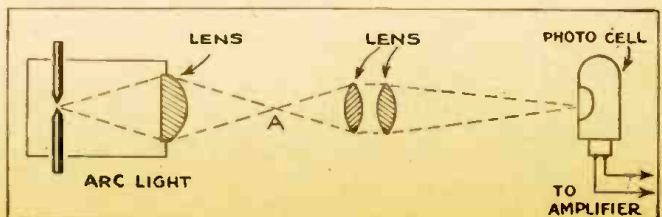
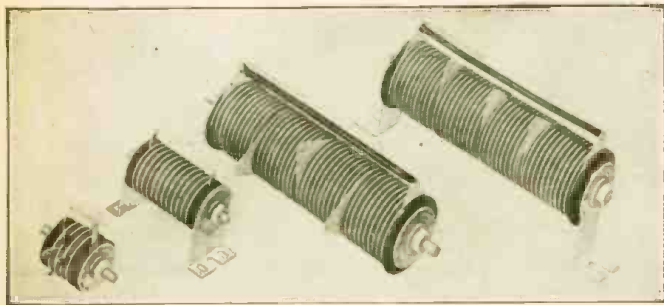

Fig. 2.—How a barrier-layer photoemissive cell is constructed. (See also, "Selenium Rectifiers".)

Fig. 4.—"Transmitter and receiver" for light-beam signalling. If the beam is carefully focussed, signals may be received for surprising distances by this means.





Courtesy General Electric Co.

Selenium, long known as the light-sensitive element, is now appearing in another role. Its characteristics have been found suited to the construction of dry rectifiers, a field long monopolized by the copper-oxide combination.

SELENIUM RECTIFIERS

SELENIUM has long been known to the radio-technician as a photo-electric element, out of which light-sensitive cells could be constructed. Only recently has it sprung into prominence as a rectifier material. Though its rectifying properties were discovered as long ago as 1883, it was not until copper-oxide cells had become common and research departments were stimulated into looking for other rectifying substances, that this feature of selenium was again noticed. Commercial cells were produced in Germany in the early '30's, and later in the United States.

In its construction, the selenium rectifier cell parallels the more familiar copper-oxide unit. It consists of a very thin film of selenium on a supporting plate, usually of iron or aluminum. As in the photoconductive cell, a special annealing treatment, or series of treatments, is given to the

in large quantities under the influence of an electric potential; and a semi-conductor, able to supply only small quantities of electrons, when subjected to electric pressure.

Between these two surfaces exists a so-called "barrier-layer" in itself an insulator, but which permits electrons to pass from the one conducting surface to the other. This layer is the surface created by the "forming" process.

The selenium layer is the semi-conductor in a selenium rectifier cell. The thin metal-alloy counter-electrode is the good conductor, and the barrier-layer between selenium and counter-electrode is produced by the forming process. The complete cell is shown in Fig. 2.

When placed in an alternating-current circuit, electrons can move readily from the counter-electrode while it is negative. As soon as sufficient voltage is applied they pass through the barrier-layer and the crystalline structure of the selenium, to the conducting metal on which it is supported. When the selenium layer is negative, due to the lack of free electrons in the material, few will flow through the barrier-layer to the counter-electrode.

While this theoretical explanation is not entirely satisfactory, it is the best advanced to date, and engineers engaged in practical design find it usable as a hypothesis.

Incidentally, the barrier-layer type of selenium cell has also been used as a light-sensitive device, as will be noted in another article in this issue. Employed in this manner, it is a true self-generating device, like a phototube, and does not depend on an external battery as did the old light-sensitive selenium cell. When used in this manner, the counter-electrode is sprayed on so thin as to be practically transparent, light passing freely through to the barrier layer.

RECTIFIER CHARACTERISTICS

Persons used to handling selenium in photo-sensitive cells will be interested to note that—even under strict mass-production conditions—absolute uniformity of product is impossible. The cells show slight individual variations, and manufacturers' data usually state that the figures given represent averages.

An important point to note in using these rectifiers is that, with fixed voltage, current increases with temperature. Leakage current in the reverse direction also increases with temperature. This necessitates a certain amount of care as to ambient temperature and rectifier loading, as otherwise increased current due to higher temperatures might cause still more heat, finally ending in destruction of the rectifier. The units are generally rated for satisfactory operation at

all temperatures between -50 and +50 degrees Centigrade.

When a selenium cell has not been used for some time, the leakage current will be high for a short time after operation begins. This phenomenon is the same as noted with electrolytic condensers. If the cell is in constant but not continuous use, the initially high leakage current drops down to normal within the first two minutes' operation.

The selenium cell acts as a capacity in the circuit. This has to be taken into account in high frequency application. An average figure for capacity is .02 mfd. per square centimeter, which appears as a shunt across the cell. At normal power frequencies effects due to this capacity are negligible, and this applies up to at least 2,000 cycles. At higher frequencies, capacity effects may have to be taken into consideration.

While selenium rectifiers will tolerate a considerable rise of temperature over the rated 50 degrees Centigrade, they should at all times be mounted in such a manner as to insure good ventilation and isolation from other heat-dissipating components in the same cabinet. The precautions taken for other types of metal rectifiers will be quite sufficient for selenium cells. If temperatures are likely to rise above normal, the working ratings should be reduced. (Normal ratings are usually predicated on an ambient temperature of 35 degrees Centigrade.)

Selenium cells stand up well under current overloads, the limiting factor being the resulting temperature rise. Seventy-five degrees Centigrade is the maximum. As it takes time for an overloaded rectifier to increase in temperature, short, heavy overloads are less dangerous than longer periods of lesser overloading.

The cells, as may be seen from the photograph, are stacked in units in practically the same style as older types of metal rectifiers, and will present no problems to the practical workman who has been used to installing and maintaining the older types of dry-plate units.

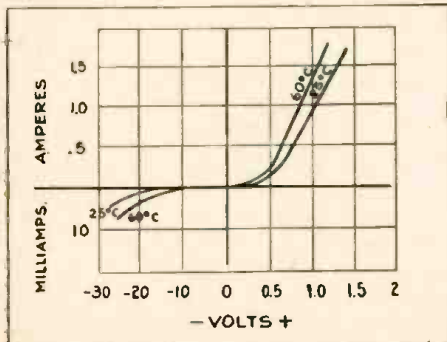

Fig. 1.—Forward and back current characteristics of an average selenium rectifier.

selenium to bring it to a crystalline structure, in which form only is it useful for rectifier applications. A low-melting-point alloy, known as the counter-electrode, is then applied in a thin layer to the surface of the selenium.

The film is then "formed" to produce the rectifying effect. After the forming process, details of which are not available from the various manufacturers, the resistance of the cell is relatively low in one direction and extremely high in the other, as can be seen in Fig. 1, which gives the electrical characteristics in both directions.

The problem of how metal rectifiers work is one that has not been solved. It is impossible to state just what action causes current to flow so much easier in one direction than the other. The theory which comes nearest to meeting common acceptance at present is that all such rectifiers depend on action between a surface which is an excellent conductor and can supply free electrons

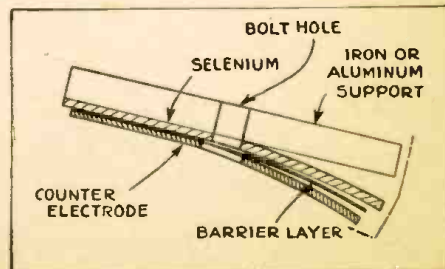

Fig. 2.—How the selenium rectifier is constructed; a breakdown view.

PHANATRON

Gas Rectifier Tubes

MORE than one radioist, unfamiliar with and a little awed at the word Phanatron, may find to his surprise that he has been using phanatrions (from the Greek *phaneros*, visible, referring to the glow when the tube is passing current) all his radio life. The 866 (later the 866-A), well-known to all hams, is an excellent example of this type of tube.

The Phanatron, then, is a simple mercury-vapor rectifier. Even this is hardly correct—some phanatrions use inert gas instead of mercury for their atmosphere. It would be better to state that a phanatron is a diode rectifier with a heated cathode and a gas or vapor atmosphere. The Serviceman will readily see that at least one receiver-type tube, the 83, can be classed in this group.

The mystic name has been reserved in the past chiefly for the larger rectifiers used in transmitters, and an average phanatron may have a plate voltage rating running from less than 100 to something over 14,000 volts, and supply currents up to 15 or 20 amperes.

The action of gas-filled and high-vacuum tubes is basically the same. When a high voltage is applied to the plate, electrons given off by the heated cathode drift across to it, forming the uni-directional output current. In a high-vacuum tube, each electron leaving the cathode has to buck all those which have already left and are on their way across to the anode. This space charge, so-called, resists the flow of current. As the number of electrons leaving the cathode is increased, so also is the space-charge, and consequently the internal resistance of the tube.

When an electron leaves the cathode of a gas-filled tube and gains speed on its way to the plate, it does not go far till it collides with an atom of gas. Usually, or at least often, an electron is knocked loose from the gas atom as a result of such collision, and two electrons speed on their way to the anode. The atom—now become an ion as a result of losing its electron—finds itself with a positive charge. It tends to move towards the cathode, but while doing so exerts an attraction on electrons ahead of it, tending to aid them on their course to the plate. Moving its ponderous bulk toward the cathode, it may pick up another electron before it gets very far, and again become a neutral atom till the next electron hits it. This may be repeated again and again before the ion finally reaches the cathode, as the steady rush of electrons tends to keep the positive ions more or less immobilized.

The space-charge of the high-vacuum tube does not exist in a phanatron, being neutralized by the positive field set up by the ion cloud surrounding the cathode. As a result, the internal resistance of phanatrions is very low, and does not vary greatly with large changes of current. Once there is a sufficient voltage difference between the plate and cathode to cause ionization

of the gas with which the tube is filled, it behaves very much like a short circuit, passing extremely large currents before the tube voltage drop begins to increase.

This voltage difference varies according to the gas used in the tube, and in the common mercury-vapor types, also according to the vapor pressure, which increases with the heat of the tube. In commercial tubes, the drop is seldom greater than 20 volts, and the minimum drop may be 5 volts.

Any user of rectifiers will see the great advantage of a tube whose resistance does not change materially with large variations in the load. There are disadvantages, however. Since the tube presents practically no resistance, should an external short develop, it will be put out of action. One of the first rules in dealing with a gas tube is: There must always be *sufficient external resistance* in circuit to keep currents to a safe level.

When currents become excessive, the internal voltage drop between cathode and filament rises. Electrons attain a greater speed on their path to the plate, and so do the positive ions moving toward the cathode. When their speed increases beyond a certain point, they bombard it in an ionic hailstorm, and the emissive cathode coating is rapidly stripped off. Thus currents must be kept down to a point where the voltage across the phanatron is not great enough to permit destructive acceleration of the positive ions moving toward the cathode.

Another cause of damage to the cathode coating is application of plate voltage before the filament is fully heated and the concentration of vapor is sufficiently great. Under such conditions, high acceleration of the positive ions is also possible and the cathode is again exposed to the ionic hail. For this reason provision must be made for turning on the filament voltage before the plate voltage is applied. The heating time may vary from about 30 seconds to as much as 5 minutes. The longer heating period is characteristic of big tubes with high-efficiency filaments built to make the fullest use of the power supplied to them. These filaments are slow-heating and heat-retaining.

A third cause of stripping of the emissive coating is failure to maintain vapor pressure. When mercury-vapor tubes are operated in low temperatures there may be difficulty in keeping a sufficient amount of the metal vaporized to prevent ionic bombardment. Too much heat, increasing the vapor pressure, may increase the tendency to arc-back (passage of current in the reverse direction). Where tubes are likely to be operated at high ambient temperatures, the peak inverse voltage ratings must be reduced. The ratings of the FG-166, for example, permit a peak anode voltage of 1500 with the tube operated between 20 and 60

(Continued on page 44)

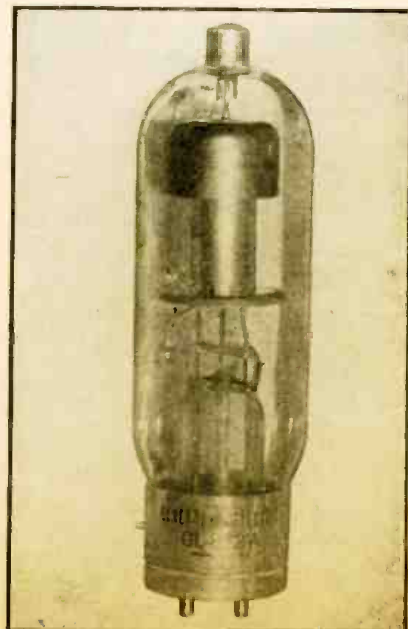
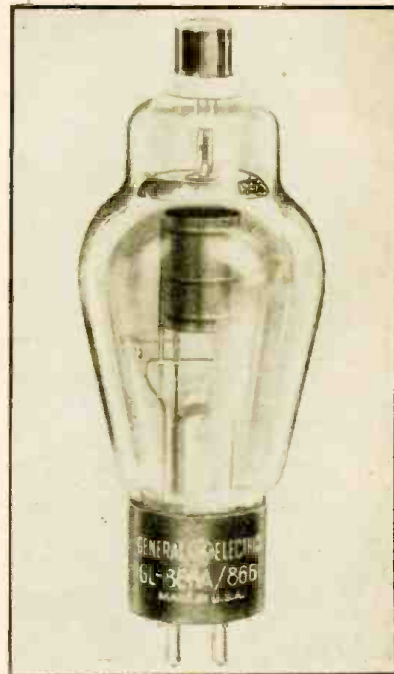
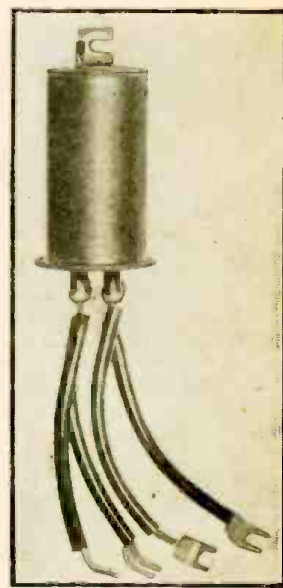
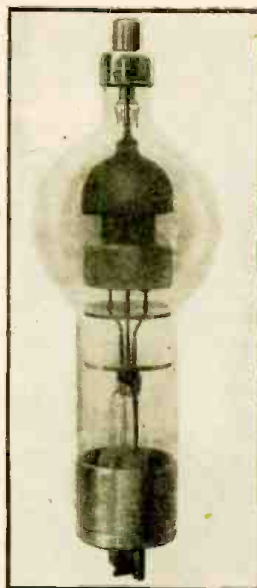

VIBRATION TRANSDUCER

For Use With Capacity Pickups

SEVERAL means are employed in the study of mechanical vibrations, which may be of an oscillatory nature covering frequencies from a few cycles to hundreds of kilocycles per second. Optical, electrical or mechanical methods are used. In the electrical methods the vibratory motions can be made to cause changes in resistance, capacity or inductance proportional to the mechanical displacement. The electrical methods produce a current of voltage that is an electrical counterpart of the vibratory motion, and the motion can then be studied by direct measurements of the current or voltage or by recordings on suitable meters or oscillographs.

A form of electrical circuit that will produce current changes proportional to small changes in capacity has been found by the

The essential parts of the circuit are shown in Fig. 1. Basically, it consists of two oscillators, A and B, isolated from each other as much as possible except for a coupling circuit consisting of two coils, L_1 and L_2 (which are tightly coupled to the tuning circuits of oscillators A and B, respectively), rectifier tube V_1 and D.C. meter M_1 . The condenser, C_1 , is stray capacity in the vacuum tube and meter and serves as a bypass for the high frequency current in the coupling circuit.

Oscillators A and B are made as nearly alike as possible and are normally operated so that they would oscillate at virtually the same frequency if the coupling circuit were not present. The coupling provided is adequate to cause the oscillators to synchronize, and within certain limits the normal fre-

same normal frequency, at which point no transfer of power is required; and if the oscillators were exactly alike, no current would flow. Actually, this condition is never realized, and the current drops to some minimum value greater than zero.

Further increases in capacity reduce the oscillator frequency below the normal frequency of the other one, and power will be transferred in the opposite direction to keep them synchronized. Thus, the current will again increase until the frequency has decreased below normal to the lower limit of the synchronizing band, the current will again reach a minimum value, and any additional capacity will make the oscillator drop out of synchronism.

The currents obtainable, the width of the synchronous band, and the shape of the current-capacity curve can all be controlled by proper choice of oscillator tubes, coupling constants and circuit constants in the coupling circuit. In the four curves of Fig. 2 only the arrangement of the tuning, tickler and coupling coils was changed.

For general use, a characteristic similar to curve IV of Fig. 2 was considered the best. The actual coil arrangement giving curve IV is shown in Fig. 3. Coil symbols refer to Fig. 4.

The actual transducer circuit now being used is a 60-cycle A.C.-operated unit shown in Fig. 4, the switch in the coupling circuit being added to provide a more flexible output circuit; otherwise it is not essentially different from Fig. 1. In this circuit, the input terminals are arranged so that the capacity pick-up device can be connected in parallel with either oscillator condenser or, where the pickup is designed to provide two capacities, one of which decreases as the other increases, each capacity can be connected to one of the oscillators, doubling the sensitivity of the unit.

Fundamentally, this circuit provides a D.C. current, and as its satisfactory operation requires low resistance in the coupling circuit, it is basically adapted for use with current-operated measuring and recording instruments of low impedance.

In many instances, it is desirable to measure or record the output of the transducer by means of a high impedance, voltage-operated device such as a cathode-ray oscillograph, or it may be necessary to amplify the output signal before it can be measured or recorded. In either event a voltage output is required. Therefore, a resistor R_3 of 1000 ohms was provided, so that in one position of the switch SW, the coupling circuit current will pass through it, making available at the output terminals a voltage proportional to the synchronizing current and having the same relationship to capacity variations as the current.

In actual operation the oscillators are adjusted so that they operate in the linear portion of the current-capacity curve, such as point A in Fig. 3, in which case a current of approximately 15 ma flows through the coupling circuit. This current, passing through resistor R_3 (Fig. 4), produces a potential difference of 15 volts across the output terminals. Since most amplifiers do not respond to D.C. potentials, this will not affect them in any way; only the changes

(Continued on page 46)

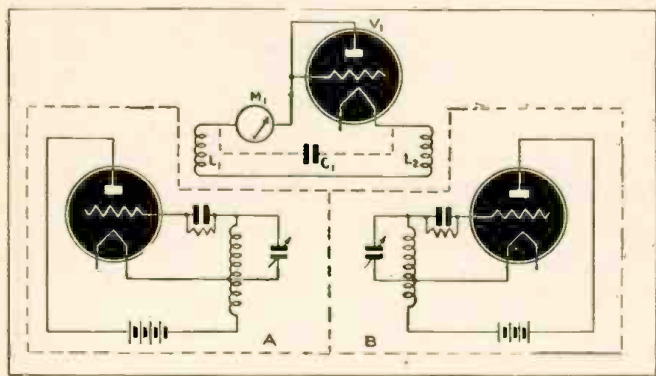

Fig. 1.—Fundamental circuit of the transducer. The two synchronized oscillators are unbalanced as capacity in the grid circuit of one is varied by the pickup device. Circulating current is thereby produced in the L_1, L_2 circuit, which is rectified and read on meter M_1 .

Bureau of Mines to be very sensitive and, at the same time, relatively free from interference by local electrostatic and magnetic fields.

A condenser microphone is used to vary the capacity of the circuit into which it is connected. This is the tuning circuit of one of a pair of synchronized oscillators, and the variations in capacity—not great enough to throw the two circuits out of synchronism—produce measurable effects exactly in proportion to the vibration causing them.

The Bureau has found a number of applications for this transducer in its metallurgical research. Among them are the measuring and recording of vibrations of specimens in the apparatus used for determining both high and low-stress-damping capacities, studies of the motion of large vibrating surfaces, and the measurement and recording of the elongation of specimens in dilatometers.

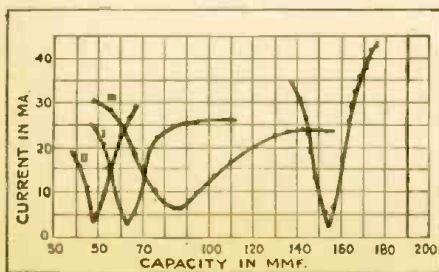

Fig. 2.—Several curves showing variation of synchronizing current with different coils.

quency of either oscillator can be changed and the two oscillators will still oscillate at the same frequency, even though the absolute value of the operating frequency might change somewhat.

What actually happens in such event cannot be explained by any simple theory, but it is enough to say that the normal uncoupled frequency of either oscillator can be changed over a considerable range above and below the normal frequency of the other and they will remain in synchronism. The really important feature is how the current in the coupling circuit varies as the oscillator tuning is changed. Figure 2 shows several curves in which the variation of current in the coupling circuit, as read on the meter, M_1 in Fig. 1, is plotted against change in capacity of one of the oscillator tuning condensers.

These curves were obtained from the transducer shown in Fig. 4, which unit will be described later. In general these curves closely resemble the so-called V curves between two alternators operating in parallel and a simplified explanation of the behavior of two coupled oscillators can be based on this analogy.

At values of capacity below the normal tuning value, one oscillator will tend to oscillate at a higher frequency than the other and power will be transferred from one to the other to maintain them in synchronism. Increasing the capacity causes the two normal frequencies to be more nearly equal, thus requiring a smaller transfer of power and decreasing the current. This will continue until the two oscillators have the

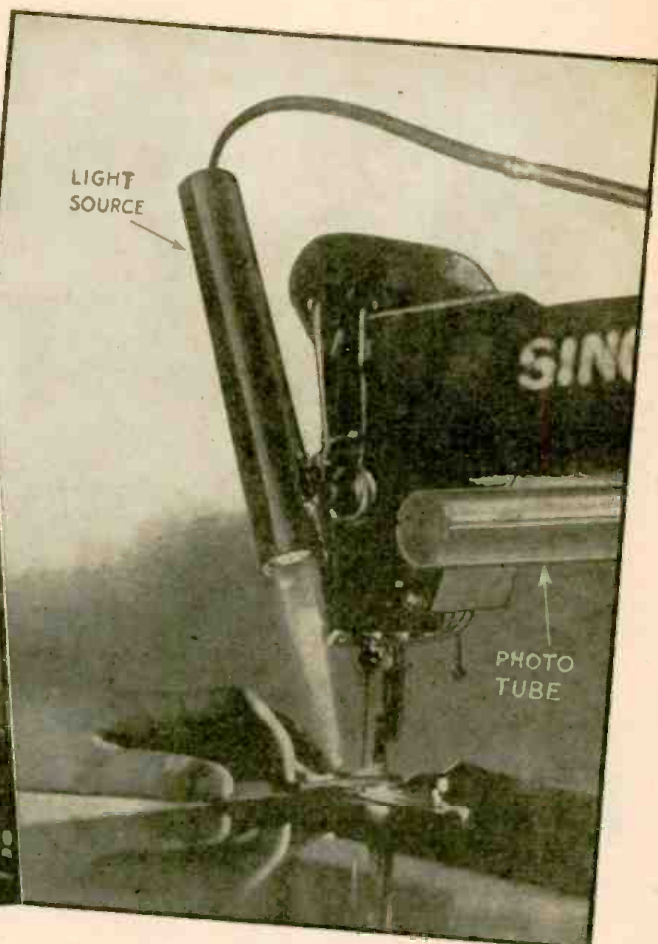

Left: a standard machine fitted with the electronic guard. Right, a closer view of the details of the "seeing-eye" device.

Photos by Wide World

"SEEING-EYE" PHOTOTUBES

THAT Seeing Eye of electronics, the phototube, has found a use in guiding sightless workers, as shown by the accompanying photographs.

A photo-electric relay, many of the parts for which were salvaged from pin-ball machines, has been built up for a safety guard, used on sewing machines by blind workers at the Illinois Industries for the Blind. This permits sightless operators to turn out work at nearly as great a speed as fully-sighted workers, and do it under conditions of perfect safety.

A beam of light from the lamp in the long tube at the left is focussed by a lens and turned down on the work at such an angle that the reflected ray from the level of the machine bedplate strikes the photo-

tube (right center), mounted under the head of the machine. If the operator's hand enters the beam of light, it is reflected from a point higher than the bedplate of the machine, and the ray misses the phototube.

The instant that light ceases to strike the tube, the relay goes into action, throwing the clutch and stopping the machine instantly. It will not start again until the operator depresses the foot-clutch.

In addition, the attachment has a two-tone buzzer which tells the operator that either the needle or the bobbin thread has broken.

The relay, which is contained in a case about as big as one of the smaller midget radios, is shown here controlling a high-speed machine, capable of making 4,500 stitches per minute, normally operated by skilled sighted workers.

EARTHQUAKES TO ORDER BY RADIO?

A NEW static-proof receiving system heralded a couple of months ago by an American tire company did not meet with a particularly excited reception by the technical press of this country. Static-killers have come up too often to be world-shaking news. In the case of this particular one, while absolutely no technical information was forthcoming, the description of its operation was so reminiscent of Lamb's famous noise-silencing circuit as to cause many to wonder whether its features were entirely new.

As would appear from the following, reprinted from the London *Daily Telegraph*, the announcement has been taken more seriously in some quarters, and has even been discussed in the British Parliament:

"Mr. Purbrick, the white-haired bespectacled M.P. for Walton, pursues with benign persistence his design of discomfitting the enemy by induction of earthquakes. He has already given the House of

Commons a laugh by suggesting that this might be accomplished by dropping a bomb down the crater of Vesuvius.

"Yesterday he gave it another by asking the Government to investigate

'the application in America whereby a neutralizer man-made electrical disturbance more powerful than the greatest storms of thunder and lightning can be reduced to a whisper,' and to 'consider the applicability of this method for the artificial promotion of seismic disturbances, volcanic eruptions, &c.'

"Mr. A. S. L. Young, a Government Whip, solemnly replied that further information was being sought, though the Government were advised that the device was unlikely to be of use as a generator of seismic or volcanic disturbances.

"The following exchange then ensued:

"Mr. Austin Hopkinson: 'Can the Hon. Gentleman explain the exact meaning of the phrase "neutralizer man-made electric disturbances"?'

"Mr. Young (apologetically): 'I am afraid that is beyond me.'

"Don't worry, Mr. Young, its beyond us, too."

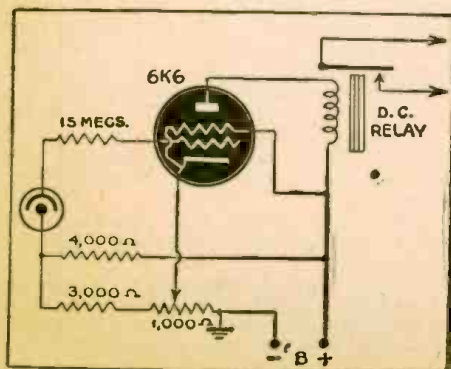

Schematic of the photo-cell unit.

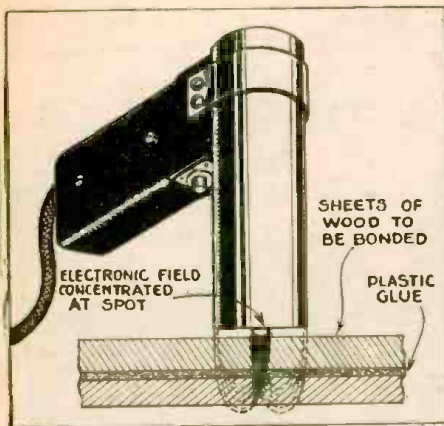

At the right is an illustration of how the new spot-gluer works, together with a photo of the hammer itself. The way the high-frequency field produces a "radio nail" is shown in the drawing above.

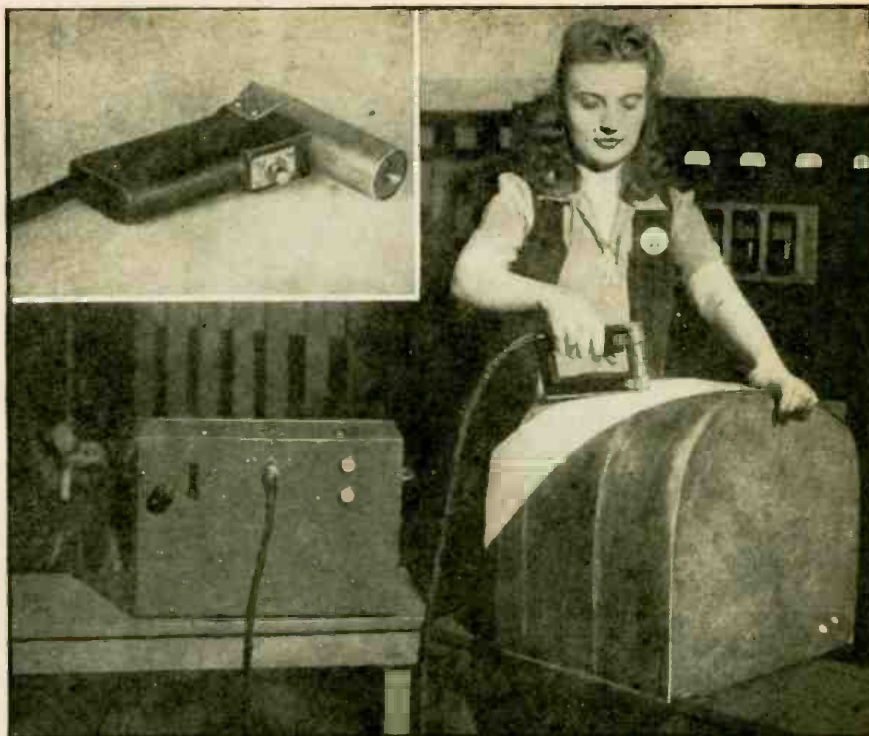

NOW—ELECTRONIC NAILS

TACKING of plywood, plastics and other industrial materials with "radio nails" is the latest development in electronics, according to a statement made last month by the Radio Corporation of America.

The so-called "radio nail" is a discharge of high frequency electric current which can be directed through a sheet of material, generating a quick and intense heat in its path. When two sheets of material are placed together with a coating of plastic glue between them, heat thus induced can be used to form a bond at the point of application.

Resembling a short-barreled automatic pistol or a narrow-based electric flatiron in the two styles thus far designed, the "gun" or applicator is connected by a cable

to a portable radio-frequency generator. Maneuverability is enhanced by the use of a principle which makes it possible to locate both electrodes in the "muzzle" of the gun, whereas earlier dielectric heating devices have required passage of the material to be heated between two electrodes.

In the spot gluer, a pin extending lengthwise down the center of the barrel forms one electrode, while the casing of the barrel is the other. In operation the muzzle is pressed against the material over the spot to be bonded and the current is applied by pressing the trigger. Since the material to be bonded is a better conductor than the air between the pin and the casing of the barrel, the current, following the line of least resistance, between the electrodes, follows a curved line

through the material.

Chief differences between the "radio hammer" and other radio-frequency dielectric heating devices, such as those already in use for permanent bonding of plywood, preheating of plastics, drying of textiles, and other operations, are the portability and maneuverability of the former, particularly advantageous in quick, temporary bonding of materials to prevent shifting during assembly.

One field of use now foreseen is in the fitting together of thin veneers in the manufacture of molded plywood aircraft parts.

Before assembly, such sheets are coated with plastic glue. They are then "laid up," one at a time, on a wooden mold, and each sheet is cut and trimmed to fit the mold
(Continued on page 43)

DEFOREST ON PHYSICAL EFFECTS OF U. H. F.

JUST prior to the publication of Dr. DeForest's article "Radiotherapy" in the August issue, there was a reference in the semi-technical press to possible physical effects of such high-frequency devices as radiolocators and the more powerful UHF radio transmitters. This was based on the reports of an investigation by Lt.-Comdr. L. Eugene Daily, of the U. S. Navy Medical Corps, published in the July issue of the *U. S. Medical Bulletin*.

Lt.-Comdr. Daily reported that certain personnel working in the field of such devices (within 3 or 4 feet of the transmitter) at times exhibited "a typical frontal headache . . . with occasional intra-ocular pain." These symptoms were never severe, and disappeared in one-half to one hour after exposure ceased.

In rarer cases a flushed feeling of the face and a heating of the hands when placed directly in the field, was observed.

Dr. DeForest, asked to comment on the

possible effects of such waves on the human system, replied as follows:

"Dear Mr. Gernsback:

Complying with your request of July 27th, I remark as follows regarding the physiological effects of these waves.

By virtue of their extremely short wave lengths, it is readily possible to concentrate their energy of these VHF ("very high frequency") waves in the form of a narrow beam, resembling that of a searchlight. Furthermore, existing transmitters radiate energy of the order of megawatts during the exceedingly brief intervals of each pulse. As a result, such radiation concentrates upon the living body standing directly in the beam and close to the source, a very intense manifestation of energy. The opposing, semi-conducting body transforms this radiant energy into heat, and also, doubtless produces some pronounced nervous disturbances.

The extent of this influence depends, of

course, on the intensity of the application and its duration. Without question, harmful effects will result from long exposure to the most intense radiation.

The symptoms mentioned in a recent *Naval Medical Bulletin* report resemble those experienced in the past by operators exposed for a considerable period to radiations from a high-powered ultra short-wave transmitter—"mild headaches, flushed faces, etc."—with the difference that in the focussed beams of locating apparatus the intense effect can be concentrated upon a limited definite area of the subject exposed thereto.

The whole subject is as yet so new, so little time has been yet afforded for investigation, that the full possibilities, therapeutic or harmful, cannot now be clearly stated. It is highly probable, however, that certain physiological benefits may be found resulting from judicious exposure to such decimeter electromagnetic waves, given suf-

(Continued on page 48)

WOMEN WAR WORKERS



From delicate operations on minute parts to work on large broadcast tubes, the women have proved themselves equal to, if not better than their male co-workers. The young lady at the right is giving the final checks to a Hallicrafters Communications receiver.



Women are taking their place in the technical world as well, as witness Miss Rita Carlin (above), new member of the Westinghouse engineering staff, or the highly skilled worker in the manufacture of high-vacuum tubes.

(Photos courtesy of Hallicrafters, Westinghouse and General Electric)

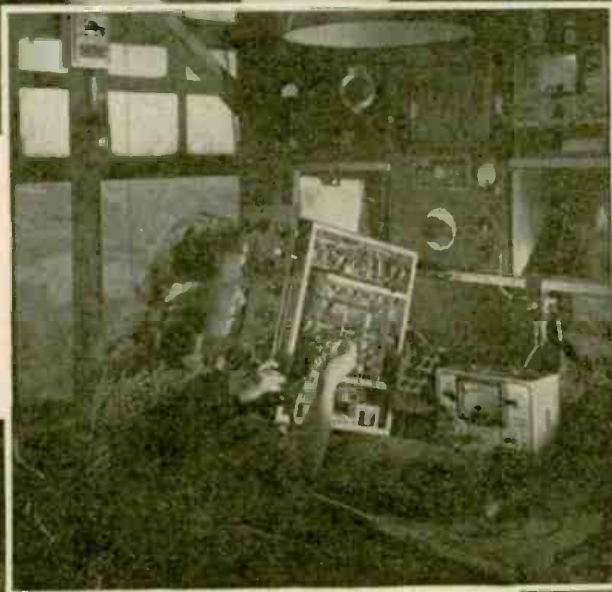

"America's problem of manpower is to become largely one of womanpower in the coming months" says a high official of the War Manpower Commission.

And the women of America are surging to solve that problem. Hardly a line of former male endeavor does not see new—and attractive—faces, as they pour in to fill the breaches in defense industries.

The women of our radio industry are no whit behind those in other occupations. Long considered best in the painstaking and delicate operations of tube manufacture, and established in many factories in such capacities as wireers, coil-winders and packers, as well as taking charge of test operations, they are now to be found in all branches of manufacture of radio transmitters, receivers and components.

On this page may be seen women in various ranks of radio construction, ranging from the new electronics engineer to the solderer. All are doing necessary work in the war effort, and on Surrender Day all will share in the credit for final victory.



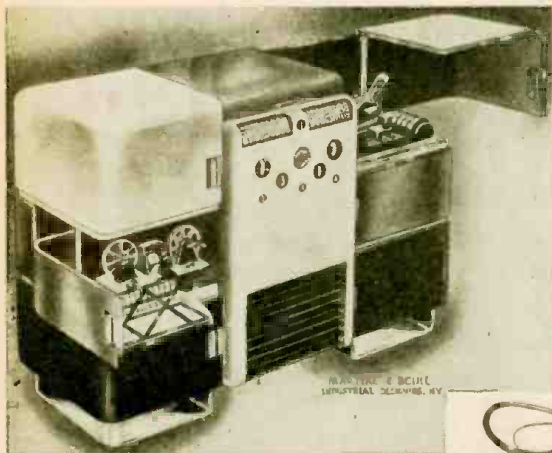

Courtesy Mechanix Illustrated

At the left, an ideal post-war receiver; at the right, a personal walkie-talkie of the same period.



Courtesy Kurz-Kasch Ltd.

FORECASTS OF FUTURE RADIO

WHAT some engineers want and expect in a post-war receiver was illustrated in the Great Christopher Crystal Gazers Model (printed in *Radio-Craft's* July issue). Priced at \$14.92 in honor of the discoverer of America, it had everything including the kitchen sink (with hot and cold running programs). All-way reception was provided for, ham sandwiches being the only thing that couldn't be tuned in.

The picture was circulated by Zenith, as a warning against too-extreme ideas and predictions about the "Radio of the Future." The warning was given immediate point by the action of one dealer, who sent in his check for two of the "new radios" and asked for delivery at the earliest post-war date. Whether he had a super-abundant sense of humor, or was simply so confused by post-war radio-electronic planners that he was ready to believe anything, has not

—up to this date—been made entirely clear.

Not all technicians are taking the conservative stand, as is evident on this page. More than one noted industrial designer has tried his hand on The Radio of the Future. Some have shown great caution, others almost equal audacity.

Possibly the most beautiful of these is the design made by Raymond Loewy for Admiral. Much is left to the gazet's imagination, but we suspect the flat knobs to right and left are tuning and volume controls, that the speaker is concealed behind the convex grill, center, and that the stops are band-shift switches, or possibly tone controls. The familiar push-buttons are seen, in two rows on this model. Another feature which adds to the beauty of the design is the pair of streamlined supports which lift the cabinet into the clear.

A more venturesome design is one created by Martial and Scull. Completely en-

closed in a handsome plastic cabinet, it is entirely made up of swinging sections, which move on pivots to conceal or reveal any part of the apparatus. Even the television screen folds down into the set when not in use.

With the screen up, we have television, with its accompanying sound from the speakers at the base.

The "main speaker for sound track recording" is not entirely clear, but apparently it is intended for "recordings." All the phonograph "records" on this receiver are of the sound-on-film type. Thus the same apparatus is used for a moving-picture machine which is also built into the cabinet. When television programs are dull, you can turn on your own home movies. A microphone for home recording is included.

Two things will interest the radioman and student of this receiver. One is that the machine seemingly contains nothing new. It consists of several devices "of the present" rolled together. The second point is that no radio apparatus appears. Presumably it is all contained in the flat section below the tuning apparatus. If so, such compactness is the most outstanding feature of the set.

Something more revolutionary is seen in the Kurz-Kasch "walkie-talkie" in its neat plastic case, about the size of a portable radio. As the designer is a plastic manufacturer, there is no detail on the radio end of this transceptor. Probably he did not even bother with this unimportant angle. The appearance of the cabinet is such that present-day designers of portable receivers may well profit by the example.

It is suggested that such a set would be found useful by plant executives, foremen on construction gangs, forest rangers, firemen and police.

Such use of small walkie-talkies was advocated in this magazine at the time the *Normandie* burned. The Editor said, in the issue of March, 1942:

"The idea I propose seems absurdly simple, but when it comes to protecting ships during war time—when seconds count—there must be instantaneous means of getting in touch with either the Police or the Fire Department. Waiting for someone to run across a deck and onto the dock means loss of valuable seconds. How much simpler then is the idea of equipping guards

(Continued on page 48)

Detailed drawing of the receiver shown at the top of the page. Television, radio, movies and recordings are all combined in one instrument.

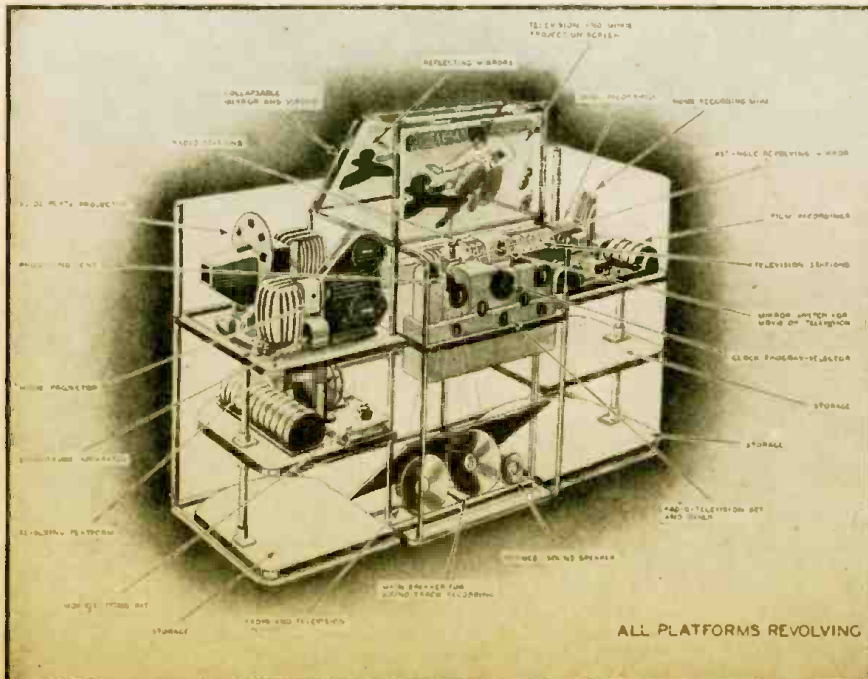



Official Navy Photo
Public address in the landing on Attu.

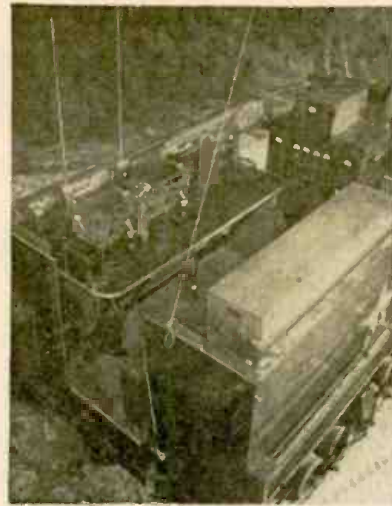

Above—The Hall-icrafter SCR-299, a typical truck-mounted radio of the type used in the advanced stages of an invasion.

Below — How the SCR-299 looks with its roof off. A completely equipped radio communications station on rubber wheels.

Photos courtesy Hallicrafters, Inc.



INVASION

THIS war is a war of motion as no other struggle has been. A war of motion is one of communication, and no one can question that radio is the chief factor speeding up the present struggle and making possible the exceedingly complicated maneuvers of mechanized divisions, often co-ordinated with aircraft.

The walkie-talkie—and now the handy-talkie—have been the most publicized of all means of radio communication used by the Armed Forces. This may be partly on account of the appeal of the name—partly because they make a good picture and have therefore been published in every magazine and newspaper in the country. Not the least of the reasons for the wide publicity they enjoy is their own very real utility, which causes them to be used for everything from an intercommunicator inside buildings to a medium-distance transmitter in landing operations.

It is during such operations as characterized recent invasions that the handy-talkie and walkie-talkie are at their best. Communications are short and direct, and they enable shock troops to keep in contact with each other and with divisional headquarters aboard ship. The invading division is by no means placing its sole dependence on these versatile sets. The whole range of electronic communications equipment, from the straight public address system to the old line telegraph, is used by the Division Signal Company, whose duty it is to keep up communications during the invasion.

The Signal Company may comprise a Radio Section, a Telephone and Telegraph Section, an Intercept Section, a Direction-Finding Section and repair, maintenance, service and construction sections. Any or all of these may put their special skills to work in any given operation.

As an amphibious Task Force approaches its objective, Naval Forces start bombarding the enemy beach. Air Force bombers and strafing fighters concentrate on the same spot. As the cannonading lifts, assault troops, kept in liaison by their Handy-Talkies, make the initial landing. Here, as was the case at Attu, the P. A. system may be called in to issue orders during the noise and confusion of hotly-resisted landing operations. Commands are under-

stood when they can be shouted at any desired volume, to get through in spite of the noise of battle. Visual signalling with flags, lamps and rockets or flares, may be used to help out the electronic apparatus, and the good signalman must be able to use a pair of flags as well as a key.

Larger sets than the walkie-talkies are used to keep in communication with the planes which support the attack from the air. These are set up at the Air Force ground headquarters and communications to and from planes are handled through them, the headquarters unit acting as a relay station for all messages.

It may be several hours or even days before the battle enters the second phase, and the troops begin to move inland. When this occurs, types and apparatus of signal communication change to meet the new conditions. Assault wire is laid between the beachhead or other headquarters and the command posts of the various assault battalions, and communications kept up by line telegraph or telephone. More powerful radios are used to extend the communications network. The large truck-mounted radios are now called into play. Completely self-contained with their own gas-driven power supply, these are medium-power which may quickly be put into action anywhere.

The cavalry guidon radio is used to maintain communications between jeeps or other vehicles and their temporary bases. This interesting set looks vaguely like the lance of the days of chivalry, and for a good reason—it was originally designed to fit into those cavalry stirrup boots used to carry the guidon, a small flag which is also a semi-signalling device.

With success, sufficient depth is gained to permit the establishment of regular combat communication headquarters. The long-range mobile headquarters station is now set up and operates for divisional and corps headquarters communications. It has a range of several hundred miles.

Assuming, as the invasion continues, that the mission in addition to establishing a beachhead, is to take a town some miles inland, Signal Corps special troops have their part to play. Special combat teams race for the nerve centers of the town as soon as it is entered by our troops. In-

cluded among them are two groups of Signal Corps soldiers: a telephone team and a radio team.

The telephone team has as its job the taking over of the local telephone plant, its rehabilitation if necessary, and its operation for our own use if possible. The Signal Corps telephone men have the job of utilizing existing telephone and telegraph communications. Should they not find such facilities, their job is to put up rapid pole-line construction for overhead wire, or of laying the special "Spiral-4" field cable.

This line, made in quarter-mile lengths, provides three telephone and four telegraph

(Continued on page 48)



Signal Corps Photo
The guidon radio, originated for the cavalry, but now used in almost all branches of the service.

LOCATING DEFECTS

A complete and exhaustive survey

By D. B. LOONEY*

A RADIO receiver is essentially an electrical assembly of tubes, resistors, condensers, coils, transformers, a loudspeaker, switches and connecting wires. A defect in any one of these parts or wires can cause receiver trouble.

To emphasize the large number of parts which make up an average radio receiver, let us take a census of the parts in the Philco Model 41-230 a.c. superheterodyne receiver for which a circuit diagram is shown in Fig. 1. Remember that a defect in any one of these parts can produce one or more receiver complaints:

- 7 tubes
- 18 resistors
- 31 condensers
- 19 coil windings
- 38 socket connections
- 136 connections of parts
- 249 items total.

But this total is by no means a true indication of the number of defects we can have in an average receiver. Take tubes, for instance—in a typical pentode tube there can be over two dozen defects.

In order to get a better picture of problems encountered in radio servicing, let us now consider in detail the various kinds of defects which can exist in each kind of radio part. We need not consider mechanical defects like broken or crushed parts, since they can be spotted readily during the initial inspection of the receiver for obvious defects.

VACUUM TUBE DEFECTS

A tube tester is an indispensable instrument for any radio serviceman. The following defects occur in tubes and are revealed by tube testers:

Low Emission. Inability of the cathode or filament in a tube to emit the normal number of electrons when heated is revealed

*National Radio Institutes, Washington, D. C.

by a low (BAD) reading on the meter of the tube tester.

Open Elements. Some types of tube testers will reveal open elements, but this defect can also be identified readily by the action of the circuit. An open filament is readily detected because the tube will feel cold when touched, and no filament glow will be visible. It is always wise, however, to check the tube in a tube tester, because an open in the socket or in a filament lead can cause the same symptoms.

Shorted Electrodes. These are readily detected either with a tube tester, by circuit action, by continuity tests with an ohmmeter, or by volt-meter tests.

Leakage between Electrodes. Cathode-to-filament leakage often occurs in heater-type tubes. The trouble is revealed by most tube testers, but is not in itself sufficient cause for discarding a tube. Cathode leakage does no harm when the cathode and filament are both grounded or at the same potential with respect to ground. Leakage is important only when the cathode is ungrounded.

Excessive Gas. A certain amount of gas is present in all tubes, and causes grid current to flow. Only in high-resistance grid circuits is gas objectionable, however. A voltage test across the grid resistor constitutes a satisfactory test for gas, assuming that the preceding grid-plate coupling condenser is not leaky. Gas is one defect not ordinarily revealed by tube testers.

SOCKET DEFECTS

Defects in tube sockets are sometimes visible on inspection, but more often a professional servicing technique is required to isolate the defect. It is quite important to realize that professional techniques are required to locate even simple socket defects such as the following:

Open Prong Contacts. Repeated insertion and removal of a tube from its socket may spread the prong contacts so much they no longer grip the tube prongs. Faulty material

used in the construction of a socket will cause the same trouble. When the defect cannot be detected visually, make a continuity check between the bottom end of the suspected tube prong and its socket contact.

Shorted Prong Contacts. Shorts can occur between adjacent contacts on a tube socket, particularly if a number of wires are grouped together on the contact lugs, or if there is excessive solder. This trouble can be suspected if noise occurs when the tube is wiggled in its socket. The remedy is rearranging of connections to the socket terminals.

Leakage. Dust or a conductive greasy film on the surface of a tube socket will provide a leakage path between socket terminals, with the trouble being most serious in the case of leakage between grid and plate terminals. Brushing the socket with a small, stiff round paint brush or a tooth-brush will clear up this trouble and also identify it by restoring receiver operation. Charring of the insulating material of a socket between the high-voltage plate terminal and other terminals may also cause leakage paths. Charred sockets should be replaced.

CONDENSERS (PAPER AND MICA)

The method of testing a condenser depends upon the nature of its defect and upon its capacity value.

Shorted Condensers. A short can occur in a condenser if a surge voltage punctures the dielectric, allowing the metal foil on each side of the dielectric to make contact. An ohmmeter will always reveal shorts in condensers. It is usually best to unsolder one condenser lead when making an ohmmeter test for a short in a part.

Leakage. This is the radio man's term for the condition whereby current "leaks" through a condenser due to a greatly lowered resistance between the condenser terminals. This lowered resistance may be the result of internal deterioration of the dielectric, or to an accumulation of conductive dirt on the surface of the condenser between the terminal leads. One condenser lead must usually be disconnected in order to make a leakage resistance check with an ohmmeter, because the leakage resistance value will be comparable to that of parts usually shunted across condensers.

There are many places in receivers where a small amount of condenser leakage is unimportant. An alert Radiotician will recognize these and not waste time checking leakage in such locations. As an example, leakage in a condenser shunted across a cathode resistor is relatively unimportant. In other positions even a small amount of leakage is bad; thus, leakage in a grid-plate coupling condenser can cause distortion and other troubles. An alert, properly trained radio serviceman never makes unnecessary tests.

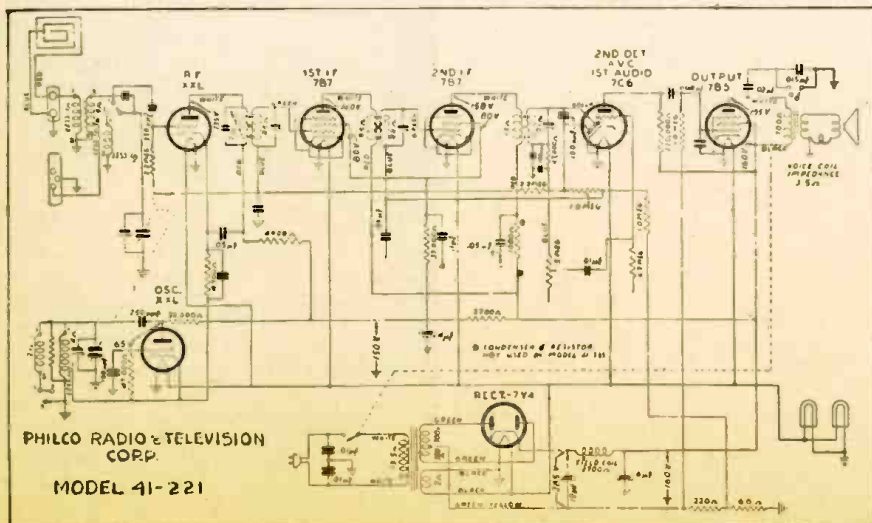

IN RADIO RECEIVERS

of troubles in radio components

PART I

Opens. These are common both in paper and mica condensers, and occur particularly at the point where the pigtail leads are bonded to the metal foil inside the condenser housing. The most practical test for open by-pass condensers is simply to shunt each suspected condenser in turn with a good one of approximately the same capacity while the set is in operation.

Condensers having larger values, say above .05 mfd., can be checked for opens by unsoldering one lead of the condenser and checking with the highest range of an ohmmeter. A momentary deflection of the meter pointer indicates that the condenser is not open. Absence of a deflection indicates an open, provided the condenser has sufficient capacity to make the meter pointer move. Actual capacity values of condensers cannot be checked with an ohmmeter, however.

An open can often be detected by wiggling each condenser in turn while the receiver is operating; noise will occur when the defective condenser is touched. Of course, the capacity test in a condenser tester will reveal an open.

CONDENSER DEFECTS (ELECTROLYTICS)

Electrolytic condensers perhaps require replacement more often than any other type of condenser used in radio equipment.

Wet electrolytic condensers become ineffective when not used for long periods of time. Modern dry electrolytics are much better in this respect, and will ordinarily give long life if not over-loaded by excessive voltage and not dried out by excessive heat. Nevertheless, voltage surges and unusual climatic conditions will cause dry electrolytics to become defective.

Opens. These are rare in electrolytics, but high-resistance joints can sometimes occur internally at the junctions between the foil strips and the contact lugs or terminal leads, due to corrosion. Substitution of a good condenser is perhaps the most practical way to check this.

Shorts. A short will occur in an electrolytic condenser if an excessive voltage of the correct polarity is applied, or if voltage of incorrect polarity is applied for any length of time. In a wet electrolytic, the short will probably heal, but in dry electrolytics it is invariably permanent. An ohmmeter will reveal shorts.

Leakage. All electrolytic condensers have a certain amount of leakage, which is equivalent to a resistance shunted across the condenser. The leakage resistance can be measured with an ohmmeter, and will have different values depending upon the polarity of the ohmmeter connection. The leakage resistance will be larger when the positive terminal of the condenser is connected to the positive terminal of the voltage source in the ohmmeter. This is the correct connection for a check of leakage. Be sure to discharge the condenser by shorting its

terminals before reversing ohmmeter leads.

An ohmmeter test gives only a general check-up of the condition of an electrolytic condenser. Better information can be obtained with a capacity tester, or by a simple substitution test. If connecting a good electrolytic in place of the suspected one clears up the trouble, you can be sure the defect has been located.

Poor Power Factor. A perfect condenser would theoretically have a power factor rating of zero, as compared to a power factor rating of one for a perfect resistor. Resistance in series with condenser capacity internally raises its power factor. A condenser with high power factor (approaching the characteristics of a resistor) dissipates energy just as a resistor does, and this produces heat in the condenser. This heat causes evaporation of the solution or chemical paste in the electrolytic condenser, raising the power factor still more and eventually drying out the unit entirely.

A condenser which feels hot to the touch is definitely drying out and has a high power factor. It should be replaced, because it will break down very soon due to the heat.

When you substitute a good electrolytic condenser and this clears up the trouble, you have identified the original condenser as defective.

TUNING CONDENSER DEFECTS

Gang tuning condensers in receivers are particularly susceptible to mechanical damage because they are usually entirely exposed and have moving parts. Their troubles are as follows:

Opens. The mechanical construction of a tuning condenser is such that an open in its circuit is extremely unlikely; if it does occur, it will be at the terminals and can readily be repaired by resoldering. Continuity tests between the connecting leads and the rotor and stator will reveal the trouble.

Shorts. Mechanical strain applied to the chassis during handling, warping of the frame of the gang tuning condenser, warp-

ing of tuning condenser plates, loosened mounting screws, accidental dropping of the chassis, or tampering with the gang tuning condenser can cause a short between the rotor and stator sections. You can usually identify such a condition by a scraping sound heard when the unit is rotated. To test for shorts electrically, the coil associated with the gang tuning condenser must be disconnected temporarily if it is connected between rotor and stator plates. Shorts usually occur over limited portions of the movable range. Flaky conductive materials, such as the metal plating applied to some condensers, can lodge between rotor and stator plates and cause shorts.

Leakage. The high-resistance range of an ohmmeter can be used to detect leakage in gang tuning condensers. The chief cause of this leakage is dust between the rotor and stator plates and on the insulating sections in the unit. The dust can be blown out or wiped out with a pipe cleaner of the type obtainable at any tobacco store.

Poor Contacts. High resistance at the wiping contacts in a gang tuning condenser or in the stator-mounting screws is rather difficult to measure with ordinary test equipment. If you suspect the existence of high resistance in series with a gang tuning condenser, watch for poor wiping contacts serving the rotor sections. This is a frequent cause of low sensitivity and poor selectivity, and also of r.f. oscillation. These three symptoms are thus a direct clue to poor rotor contacts in many cases.

TRIMMER CONDENSER DEFECTS

Both the air dielectric and mica dielectric types of trimmer condensers are fortunately reasonably free from trouble. Only in rare cases will they become open, shorted or leaky, and they then require testing like any variable tuning condenser. The mica type is subject to capacity changes as a result of changes in temperature or normal aging, but this is usually easy to recognize because it affects the alignment of the receiver. The mica dielectric can crack or

(Continued on page 50)

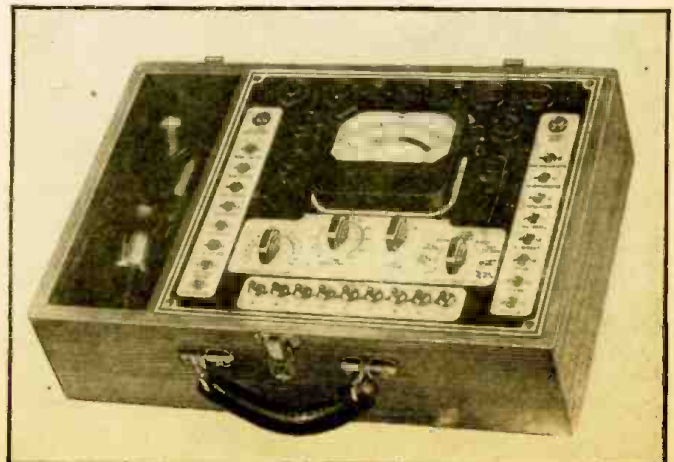

The instrument at the right combines a tube checker, voltmeter, milliammeter and ohmmeter. Such a multimeter is the trouble shooter's basic instrument for locating defective parts described in this article.

Courtesy Weston Electrical Instrument Co.



The Philco Radio-Phonograph Model 1008.

RADIO SECTION

The radio includes six (6) electric push-buttons for automatically tuning stations in addition to manual tuning; two tuning bands; two I.F. stages; variable tone control (combined BASS, and TREBLE); automatic volume control; push-pull pentode audio output stage with screen inversion; LOKTAL TUBES including the XXL noise-reducing converter tube; built-in, variable, low-impedance loop aerial and a twelve (12) inch dynamic speaker.

PHILCO TUBES USED: Nine: one 7C5, oscillator; one XXL, converter; two 7B7, I.F. amplifiers; 7C6, 2nd detector. 1st audio; 7C6, Phonograph pre-amplifier; two, 41 audio output, and a 6X5G, Rectifier.

AERIAL CONNECTIONS: The built-in loop aerial system is designed to operate without an outside aerial or ground and to give exceptionally sensitive receiving performance of stations on the standard and short wave frequencies. The outdoor aerial can be easily connected to the radio by inserting the plug attached to the transformer unit into the socket provided at the rear of the chassis.

PHONOGRAPH SECTION

The phonograph section of each model consists of an automatic record changer which plays twelve 10-inch or ten 12-inch records at one loading; the Philco Light-Beam Reproducer with a floating jewel needle which reproduces sound from a light beam; variable two speed motor (39½ and 78 RPM) with Neon speed indicator on turntable, and a phonograph amplifier stage for operation through the push-pull audio output tubes of the radio. Provisions are also provided on the automatic record changer and radio chassis for installation of the Philco Home Recording Unit.

ADJUSTMENTS FOR LIGHT BEAM REPRODUCER

To reproduce the sound from a record, the light beam of the reproducer must be carefully positioned on the light sensitive cell. otherwise the sound reproduction will be distorted, weak or, if the light beam is completely on or off the cell, the phonograph will be silent. If any of these conditions exist, the following adjustment procedure should be made with the power line voltage at 117 volts A.C.

A. ADJUSTING WIDTH OF LIGHT BEAM by pushing the lamp socket assembly into its holder until a clear image of the lamp filament appears on the light cell. The socket should then be slightly pushed in beyond this point until the rectangular spot of light is 5/30" in width. The socket assembly is now rotated so that the spotlight is vertical.

B. POSITIONING THE LIGHT BEAM on the light cell by turning the adjusting screw at the lower left side of the reproducer until the spot is half on the cell and half on the metal frame surrounding the cell.

C. ADJUSTING INTENSITY OF LAMP: When replacing the reproducer or lamp it may be necessary to readjust the light intensity. In this case the compensator is adjusted as

**PHILCO RADIO—PHONOGRAPH
MODELS-1008, 42-1009W, 42-1009M**

INTERMEDIATE FREQUENCY: 455 Kc.

TUNING BAND FREQUENCIES: 540 to 1720 Kc.; 9 to 15.5 Mc.

POWER SUPPLY: 115 volts, 50 or 60 cycle A.C.

ALIGNING R.F. AND I.F. COMPENSATORS

Connecting Aligning Instruments

VACUUM TUBE VOLTMETER: To use the vacuum tube voltmeter as an aligning indicator, make the following connections: Attach the negative terminal of the voltmeter to any point in the circuit where the A.V.C. voltage can be obtained. Connect the positive terminal of the vacuum tube voltmeter to the chassis.

AUDIO OUTPUT METER: Terminal No. 1 is provided on the loop aerial panel for connecting one lead of the audio output meter to the voice coil of the speaker. The other lead is connected to the chassis. When using these connections, the lowest A.C. scale of the meter must be used.

SIGNAL GENERATOR When adjusting the "I.F." padders, the high side of the signal generator is connected through a .1 mfd. condenser to the antenna section of the tuning

condenser. Connect the ground of the generator to the chassis.

When aligning the R.F. padders a loop is made from a few turns of wire and connected to the signal generator output terminals; the signal generator is then placed close to the loop of the radio.

When adjusting the radio outside the cabinet the loop aerial should be placed in approximately the same position around or near the chassis as when assembled.

After connecting the aligning instruments, adjust the compensators as shown in the tabulation. Locations of the compensators are shown in Fig. 3. If the indicating meter pointer goes off scale when adjusting the compensator, reduce the strength of the signal from the generator. Keep volume control of radio at maximum position.

Operations in Order	SIGNAL GENERATOR			RECEIVER		Special Instructions
	Output Connections to Receiver	Dial Setting	Dial Setting	Control Settings	Adjust Compensators in Order	
1	Amt. Section of Tuning Cond. with .1 mfd. Cond.	455 K.C.	Tuning Cond. Closed	Vol. Max. Bands Switch "Brdest"	35 35B 43A, 47A	
2	Loop Signal Generator	1720 K.C.	1720 K.C.	Bands Switch "Brdest"	14	Note A
3	Loop Signal Generator	1500 K.C.	1500 K.C.	Bands Switch "Brdest"	7A	
4	Loop Signal Generator	580 K.C.	580 K.C.	Bands Switch "Brdest"	8A	Roll comp. (8A) to "max." Recheck Operation No. 2
5	Loop Signal Generator	1720 K.C.	1720 K.C.	Bands Switch "Brdest"	14	
6	Loop Signal Generator	15 M.C.	15 M.C.	Bands Switch S.W.	14A, 8	Note B

follows: 1. Turn volume control on full and play a record. 2. While the record is playing, turn compensator 17 in the direction necessary to obtain the best operating point without distortion. By turning the compensator the strength of the pick-up output is increased or decreased.

D. INSTALLING NEW LAMP: There are two positions in which the lamp can be inserted. Ordinarily, either of these positions can be used. In some cases, however, due to the lamp filament being off center, the lamp must be

inserted in the position that gives the best center of the spot of light on the mirror.

NOTE A.—Dial calibration: In order to adjust the receiver correctly, the dial must be aligned to track properly with the tuning condenser. To do this, proceed as follows: Turn the tuning condenser to the maximum capacity position (plates fully meshed). With the condenser in this position, set the tuning pointer on the extreme left index line at the low frequency end of the broadcast-scale.

NOTE B.—Adjust padder (14A) to the second signal peak from the tight position. Roll padder (8) slowly to maximum on the first peak from tight position.

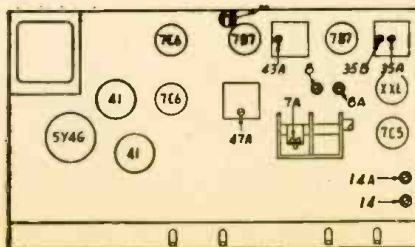

Top chassis view, showing locations of compensators and trimmers and tube layout.

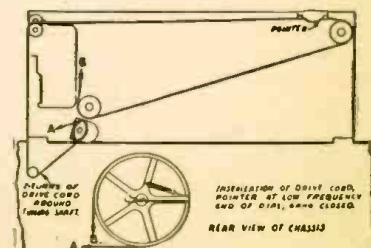

Installation of dial cords. Pointer is at low-frequency end of dial, tuning condenser all in.

Radio Service Data Sheet

328

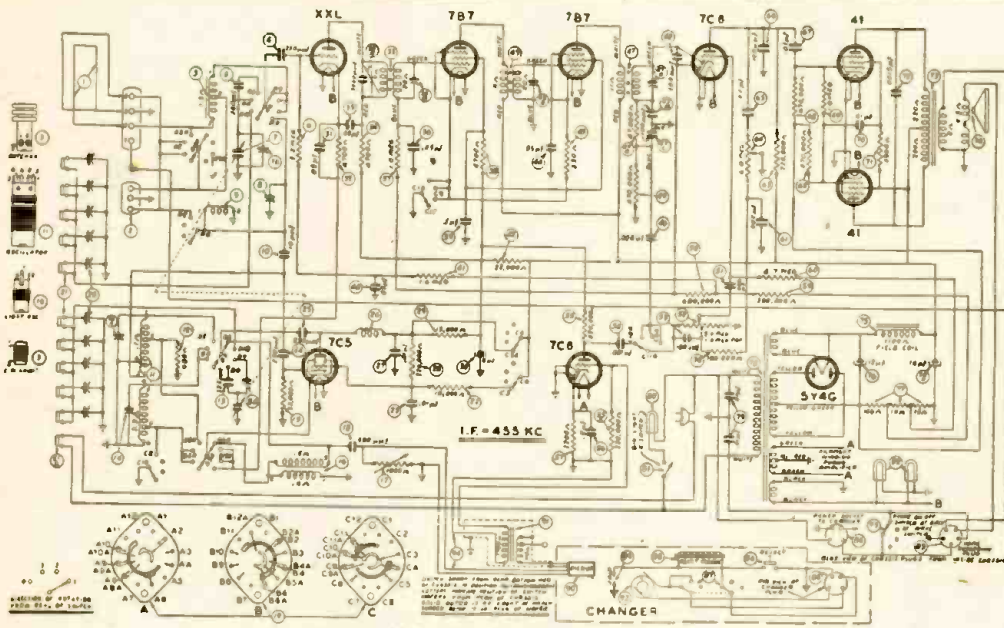

Fig. 1. Schematic Diagram, Models 42-1008, code 121; 42-1009, code 121

PARTS LIST

Schem. No.	Description
1.	Loop Aerial
2.	External Aerial Socket
3.	Aerial Transformer (Broadcast) Mtg. Clip
4.	Mica Condenser (250 mmfd.)
5.	Mica Condenser (360 mmfd.)
6.	Resistor (2.2 megohms)
7.	Tuning Condenser
8.	Compensator (Aerial—SW)
8A.	Compensator (Oscillator—580 K.C.) Part of 8
9.	Aerial Transformer (S.W.—)
10.	Mica Condenser (10 mmfd.)
11.	Oscillator Transformer (Broadcast—S.W.) Mtg. Clip
12.	Resistor (680 ohms)
13.	Mica Condenser (325 mmfd.)
14.	Compensator (Broadcast Oscillator)
14A.	Compensator (S.W. Oscillator) Part of 14
15.	Resistor (33,000 ohms)
16.	Light-Beam Oscillator Transformer Mtg. Clip
17.	Light-Beam Oscillator Control
18.	Mica Condenser (300 mmfd.)
19.	Band Switch
20.	Push-Button Compensator Assembly
21.	Push-Button and Power Switch Assem.
21A.	Push-Button Power Switch (Part of 21)
22.	Resistor (10,000 ohms)
23.	Condenser (.01 mfd., 400 volts)
24.	Mica Condenser (250 mmfd.)
25.	Mica Condenser (250 mmfd.)
26.	Oscillator Plate Choke
27.	Condenser (.01 mfd., 400 volts)
28.	Resistor (220,000 ohms)
29.	Resistor (15,000 ohms)
30.	Electrolytic Condenser (8-16 mfd.)
30A.	Electrolytic Condenser (16 mfd.) (Part of 30)
31.	Condenser (.05 mfd., 200 volts)
32.	Resistor (4700 ohms)
33.	Condenser (.05 mfd., 400 volts)
34.	Resistor (4700 ohms)
35.	1st I. F. Transformer
35A.	Primary Compensator (Iron Core) (Part of 35)
35B.	Secondary Compensator (Part of 35)
35C.	Condenser (3000 mmfd.) (Part of 35)
36.	Condenser (.05 mfd., 200 volts)
37.	Resistor (1 megohm)
38.	Resistor (4700 ohms)
39.	Condenser (.1 mfd., 400 volts)
40.	Condenser (.05 mfd., 200 volts)
41.	Resistor (1 megohm)
42.	Resistor (22,000 ohms, 1 watt)
43.	2nd I. F. Transformer
43A.	Secondary Compensator (Part of 43)
44.	Condenser (.05 mfd., 200 volts)
45.	Resistor (330 ohms)
46.	Condenser (.004 mfd., 600 volts)
47.	3rd I. F. Transformer
47A.	Secondary Compensator (Part of 47)
47B.	Condenser (100 mmfd.) (Part of 47)
47C.	Condenser (100 mmfd.) (Part of 47)
47D.	Resistor (47,000 ohms)
48.	Condenser (.100 mmfd.)
49.	Resistor (470,000 ohms)
50.	Resistor (680,000 ohms)
51.	Condenser (.006 mfd., 400 volts)
52.	Volume Control
53.	Mica Condenser (100 mmfd.)
54.	Condenser (.001 mfd., 600 volts)
55.	Resistor (220,000 ohms)
55X.	Resistor (220,000 ohms)
56.	Condenser (.2 mfd., 200 volts)
57.	Resistor (2200 ohms)
58.	Resistor (100,000 ohms)
59.	Resistor (330,000 ohms)
60.	Resistor (4.7 megohms)
61.	Condenser (.002 mfd., 600 volts)
62.	Resistor (470,000 ohms)
63.	Resistor (220,000 ohms)
64.	Tone Control

Schem. No.	Description
*65.	Condenser (.004 mfd., 600 volts)
66.	Mica Condenser (100 mmfd.)
67.	Condenser (.01 mfd., 400 volts)
68.	Resistor (479,000 ohms)
69.	Resistor (1 megohm)
70.	Condenser (.01 mfd., 400 volts)
71.	Resistor (3900 ohms)
72.	Condenser (.0015 mfd., 1000 volts)
73.	Output Transformer
74.	Speaker
75.	Field Coil (Replace Speaker 46-1528)
76.	Electrolytic Condenser (12 mfd., 475 v.)
77.	Bias Resistor (14, 15, 146 ohms)
78.	Power Transformer (115 v., 60 cycles)
79.	Line Filter Condenser (.01-01 mfd.)
80.	Record Changer Compartment Light
81.	Compartment Light Switch & Cable
82.	Pilot Lamp (Dial)
83.	Socket (Home Recording, on Chassis)
84.	Changer Power Socket (on Chassis)
85.	Power Cable & Plug (Record Changer)
86.	Reject Button (Record Changer)
87.	Select Switch (OFF-Automatic-Manual Record Changer)
88.	Reject Solenoid
89.	Electric Reel Trip (on Changer)
90.	Light Beam Reproducer
91.	Phonograph Input Transformer
92.	Motor (Record Changer, 115 v., 60 cy.)
93.	Phonograph Power Switch (Mounted on 19)
94.	Pickup Light Cable & Input Cable Assembly

*Condenser changed to .01 mfd., part No. 30-4572 in run 2nd chassis.

†Two types of speakers are used on these models. These speakers are interchangeable and will have the same part number, with the exception of a suffix number -4, -9 added to the part number. The cone assemblies, however, of these speakers are not interchangeable.

PUSH-BUTTON ADJUSTMENTS

Looking at the front of the cabinet, the second button on the left is adjusted by adjusting trimmer screws No. 1 and 2. The next push button by adjusting screws No. 3 and 4 and the remaining push buttons in order.

1. Press in "Off-On" push button, turn "Bands" knob to "Broadcast."

2. Set up a Model 070 Signal Generator near the receiver and connect a loop aerial (made from a few turns of wire 12 inches in diameter) to the high and ground output jacks of the signal generator. Turn the output controls to maximum and set the modulation control to "MOD. ON."

3. Manually tune in the station to be set up on the first push button. After doing this set the indicator of the 070 Signal Generator to the frequency of the station being received. As the indicator approaches the frequency of the station a whistle will be heard; leave the indicator at this point.

4. Turn "Bands" knob to "Push button" position. Using the insulated screw driver, turn the No. 2 "Osc." screw until the broadcast station identified by the signal generator is heard; at this point, turn the indicator of the signal generator away from the frequency of the station. Readjust No. 2 "Osc." and No. 1 "Ant." screws until the station is clearly and distinctly heard. The push button should then be adjusted properly to the station.

After setting up the first station the same procedure as outlined above is used for the remaining.

Tube	Radio Position	Phono. Position	D.C. Voltage
12 mf. elect. to ground	300	290	
16 mf. elect. to ground	215	195	
8 mf. elect. to ground	85	180	
95	90		
35	65		
210	190		
200	180		
210	190		
215	195		

TUBE SOCKET VOLTAGES

Tube	Radio Position	Phono. Position	D.C. Voltage
7C5 2nd Det.	3	2 1/2	
1st Audio	80	180	
7C6 Preamp.	2	19	
41 Output	215	190	
(Phase inverter)	75	175	
41 Output	2 1/2	45	
7C5 Osc.			
XXL 1st Det.			
7B7 1st & 2nd I.F.			
7B7 2nd I.F.			

D.C. voltages indicated at the tube elements in the diagram were measured with a 1000 ohms per volt meter; Philco Model 027, using the 300-volt scale. Line voltage 117 volts A.C. no signal being received—range switch broadcast.

Tube	Radio Position	Phono. Position	D.C. Voltage
7C5 Osc.	50	200	
7C5 Osc.	8	110	

The Care of INSTRUMENTS

By H. S. DAY*

SINCE instruments play such an important part in the maintenance of all types of electric equipment, the following observations cover not only their maintenance, but also the ways in which they should be used. Best results

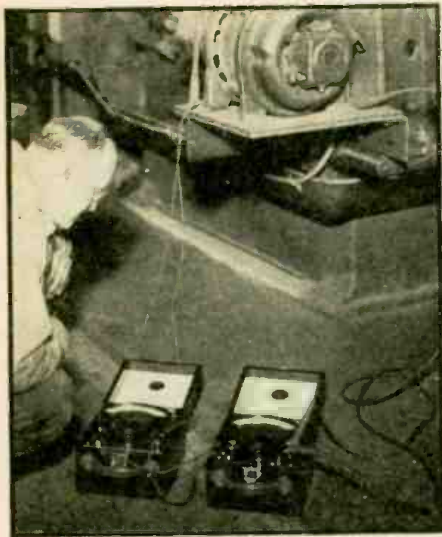

Fig. 1.—Portable meters properly placed for reading.

in the use of instruments depend upon the proper original selection. The accuracy desired and the cost are the two important factors in selection. Instruments should be chosen on the basis of obtaining the required accuracy at the least cost.

1. What accuracy is desired?
2. Should it be A.C., D.C., or both?
3. Should it be portable or for switchboard mounting?
4. Should it be indicating or recording?
5. What is the desired rating? The range should be such that the instrument reading is usually above one-third scale.

*Meter & Instrument Division, General Electric Company, Schenectady, N.Y.



Fig. 2.—DON'T put them here! Strong fields from the cables may ruin the calibration.

6. If a switchboard instrument is desired, should it be of the surface-mounting or semiflush-mounting type?

7. Can a standard instrument listed in the manufacturer's catalog be utilized in order to obtain lowest cost and best delivery?

8. *What effect will the instrument have on the circuit in which it is to be used?* For example, some applications require a voltmeter with high resistance for minimum current drain. Or, an ammeter may have to have a low volt-ampere rating if it is to be used with a through-type current transformer.

9. Conditions under which the instrument is to be used are important. Indoor or outdoor, humidity, or corrosive atmosphere may require special instruments.

When any question arises on the use of a specific instrument, it is recommended that the information be obtained from the manufacturer. Any request for information on instruments should be complete with all the information shown on the instrument nameplate—its rating, serial number, when the instrument was purchased, and a description of the special conditions under which the instrument is used.

SETTING UP FOR USE

1. Read manufacturer's instruction book carefully.
2. Instruments should be handled carefully to avoid all vibration or shocks which may injure the instrument bearings.
3. From the nameplate of the apparatus on which the measurement is to be made, estimate the value of the current, voltage, etc. to be measured.
4. If an instrument has more than one tap or range, make connection to the highest range first to avoid injury to the instrument.
5. Instruments should always be read when in their normal operating position; that is, portables should be in a level, horizontal position (see Fig. 1), switchboard types in a vertical position.

PORTABLE INSTRUMENTS

1. Metal benches should be avoided, as the instrument indication may be affected by the proximity of the metal.
2. Proper sized leads should be used. Terminals should be clean to avoid high contact resistances, particularly in the case of millivoltmeters used with shunts. Lead wires should extend away from the observer to avoid accidentally pulling the instrument off the table.
3. Whenever a shunt is used with a millivoltmeter to read current, always check to make sure the leads with which the instrument was calibrated are being used.
4. If external resistance multipliers are used, check both the serial number of the instrument and that of the multiplier to make sure of the correct combination.
5. The instrument zero setting should be checked. If the pointer is slightly off zero, reset to zero by adjusting the external zero shifter. Never try to compensate for a bent pointer by moving the zero shifter.



Fig. 3.—How NOT to carry valuable instruments. Meters are easily injured. They deserve attentive and very careful handling.

6. The instrument should not be used in strong fields, such as near cables or bus bars (see Fig. 2). Presence of a magnetic field which is affecting the reading of an instrument can be detected by turning the instrument (clockwise or counterclockwise), 90 degrees at a time, and taking a reading in each position. If a difference is noted in the readings, some stray field is present.

7. Unshielded instruments should not be placed close together, as the reading of one instrument may be affected by the magnetic field of the other.

8. When an ammeter or shunt is to be connected into a circuit, always connect it into the grounded side, if possible.

9. When a voltmeter is to be connected to a circuit, always connect the leads to the instrument *first*. This avoids loose leads which may be "hot." Be sure that voltmeter leads are properly insulated for the voltage to be checked.

10. Instruments, shunts, and leads should always be arranged in such a way that there is no danger of knocking them off the table or tripping over the leads; and if any high voltages are to be measured, the arrangement should be such that no one might accidentally touch the high-voltage equipment.

11. Whenever an instrument is to be connected to a current-transformer secondary, always short-circuit the transformer secondary terminal before the primary is connected in the circuit to avoid dangerously high voltages. *The current transformer secondary must be grounded.*

12. When a potential transformer is to be used, always make sure that the instrument is connected to the secondary, or low-voltage, side. *The potential transformer secondary circuit must be grounded.*

SWITCHBOARD INSTRUMENTS

Switchboard instruments should be mounted on panels in accordance with the manufacturer's instructions. Never mount a switchboard instrument on a panel until all other work on the panel is completed.

(Continued on page 50)

POST-WAR SURPLUS DANGER?

POST-WAR dumping of surplus radio parts need not be a serious threat to the trade if manufacturers and jobbers cooperate in maintaining price structures and brand reputations, points out Charley Golenpaul of Aerovox Corporation. While radio parts are now being produced in fantastic quantities, such parts are just as rapidly assembled into radio and electronic equipment for our armed forces. Much of that equipment will be used by our armed forces or placed in reserve after fighting ceases. Thus completed equipment, much of it of a vital military character, will hardly be dumped into civilian hands. Neither will it pay to break up discarded military equipment to salvage second-hand parts.

Nevertheless, the fact remains that radio parts are now being produced on a fantastic scale. No doubt there is some overbuying here and there. Considerable quantities of parts may be dumped by equipment manufacturers caught with over-supplies. What about this very real threat?

Golenpaul points out that a sharp distinction can be drawn between such surplus parts and regular items produced for the jobbing trade. Parts made for set or equipment manufacturers are usually not individually packaged. That is distinction No. 1. Loose goods are apt to be considered with suspicion.

Again, manufacturers' parts usually carry an entirely different part number or type designation to the confusion of the jobbing trade. That is distinction No. 2. Manufacturers can accentuate the discrepancy in type numbers or designations.

Still again, parts sold to manufacturers are protected by a blanket guarantee covering the initial buyer only. In other words, if such parts are resold to others as parts, the guarantee no longer holds. That is distinction No. 3. The lack of a guarantee on dumped goods is likely to be important to the buyer.

There is a further distinction, and that is the vintage of the crop. When were those dumped parts made? For whom? Were they ever used? Have they been taken from some broken-up assemblies? Or perhaps discarded as defective? Are they really good?

Of course if the buyer knows his radio parts thoroughly, he may pick and choose among dumped parts and get good stuff. It is a safe bet that radio experimenters, amateurs, laboratory workers, handymen and the like will have a holiday picking up those fine surplus parts originally made to the toughest wartime specifications and finally dumped at a ridiculous fraction of Uncle Sam's own cost. However, such trade is in a class by itself. Many of such items would not be purchased at normal prices.

It is normal trade that must be insured against the inroads of dumping. The serviceman, with a reputation at stake, and working with an adequate markup on the materials he uses, likewise the assembler of electronic equipment, the instrument maker, the maintenance man in the industrial plant may think twice before he takes a chance on a nondescript dumped part which comes unpackaged, carries a different type designation, and carries no guarantee whatsoever. He simply can't afford to gamble that way.

Our main job, said Golenpaul, is to win the war. But without detracting one iota from the all-out war effort, manufacturers can and must do a little thinking and planning as to how the post-war dumping situation can be met, by drawing that sharp distinction between regular and dumped goods.

SERVICING NOTES

... CROSLEY MODEL 127

Would break into oscillation and hissing hum after playing a short time. Move wire leading from A.F. transformer to grids of 47's from between socket terminals of the 27 detector and 51 I.F. screen terminal. By-pass low-voltage end of 2600-ohm resistor which supplies current to all screen grids on the set.

... SPARTON MODEL 410

This set has two type 183 tubes in the push-pull output stage. These were replaced with 45's by simply wiring the filaments in series. No change in bias was made.

Results were satisfactory, with excellent tone.

... SILVERTONE 4548A

The 6Q6-G went bad. No other 6Q6 available. A 6Q7 was used with excellent results.

Changes required: Take all connections off No. 4 prong of the 6Q6 socket. These are high voltage leads. Connect them together again and wrap some tape around them. Then connect No. 4 to No. 5 prong. These are the diodes of the 6Q7. Leave the wires connected to the No. 6 prong as they are. Neither the 6Q7 nor the 6Q6 has any connection to the No. 6 prong.

... G.E. E155 15-TUBE RADIO SET

When this radio receiver operates with fair volume on local stations, and weak on distance, check the 0.05-mf. bypass condenser in the grid circuit of the 1st I.F. coil. This condenser is quite difficult to find as it does not affect the plate voltage and unless a signal generator is used it would hardly be suspected. This condenser is marked T C 40 on the G.E. diagram.

THOS. R. DISSINGER,
Chicago, Ill.

... PORTABLE POWER PACKS

When converting a portable battery set to A.C. I use a 117Z6 with suitable choke and filter condenser for the "B" supply and use two of the regulation flashlight cells for the "A" supply. This involves disconnecting the former B-plus from the on-off switch and using that section of the switch for the A.C. line.

The original battery plug is cut off the cable. The two flashlight cells are hooked up in parallel as the "A" supply, the B-negative lead is attached to the ground of the new power supply and the "B" plus is soldered to a series or bleeder resistor to bring it to the correct voltage.

This method eliminates difficult filtering of the "A" supply and danger of blowing expensive 1.4-volt filaments.

S. P. JOHNSON,
Saginaw, Michigan.

... BUICK 980690

Set dead. Plate voltage appears intermittently in a.v.c. circuit.

There is a small green wire used as a coupling condenser in the R.F. stage. This seems to be wrapped too tight, as in some cases it shorts to the coil, which renders the set inoperative.

Place insulation between green coupling wire and coil windings.

WILLIAM PORTER,
Los Angeles, Calif.

... 1941 and 1942 PHILCO, ALL MODELS

Set dead, voltage may or may not be O.K. After checking all parts for defects, check all rubber insulated wires for shorting against chassis or metal parts. I have found this to be the trouble in several cases.

GEORGE WEISS,
Punxsutawney, Pa.

ATTENTION SERVICEMEN!

Do you have any Servicing Notes available which you would like to bring to the attention of the readers of *Radio-Craft*? If so, send them along and if they are published a six months' subscription to *Radio-Craft* will be awarded you. If your notes are illustrated you will be given a six-months subscription.

... PHILCO CAR RADIOS

Objectionable vibrator hash. Very often the soldering lug from chassis to filament connection on tube sockets make poor contact to chassis, causing hash. By making new ground connection the trouble can be eliminated.

V. M. DE ROO,
National City, Calif.

... GRAYBAR 320

Volume could not be controlled in this receiver, when volume control was turned half way up. Upon dismantling volume control it was found that resistance element (500 Ohm wire wound) was worn but intact, also a deep groove was worn in contact arm. Soldering a piece of copper over the worn part, restored uniform control again when receiver was placed in operation.

FRED HARTMANN,
Woodside, N. Y.

... G-E K-9

Very pronounced distortion, particularly on bass notes. This is not in the audio section, or in the receiver proper at all, but is caused by the cement holding the speaker cone to the frame cracking and coming loose.

Remedy is re-cementing with G.E. Speaker Cone Cement, although the complaint will arise again, and the only permanent cure is to fasten the cone to the frame with a circular metal ring, cut to fit right over the edge of the cone, and bolted securely to the frame.

J. A. REID,
Hamilton, Canada.

... HAMMOND SOLOVOX

This unit had very little volume and would fade out completely after being played for about an hour. Trouble was found to be caused by a high-resistance leak in the 0.15 mfd., 200-volt condenser used to bypass the grid bias voltage for the two 7A7 control tubes.

The 0.33 megohm resistor in the bias supply divider for the same tubes was found to have increased in value, further changing the bias.

Replace the condenser with a .05 and a 0.1 600-volt condenser (if you have no 0.15 in stock) and replace the resistor—if incorrect—with an accurately-measured 0.33 megohm unit.

KOEPKE SOUND SERVICE,
Junction City, Kansas.

RADIO WAVES AND

The Ionospheric Paths That

IN Part I of this series we learned about how a RADIATION FIELD consisting of an electrostatic and an electromagnetic component at right angles to one another were generated and "coupled to space" by the transmitting antenna. We also learned something of the physical nature of these waves. We are now ready to undertake a little investigation of the manner in which their propagation through space is affected.

Fig. 1* should not present too formidable

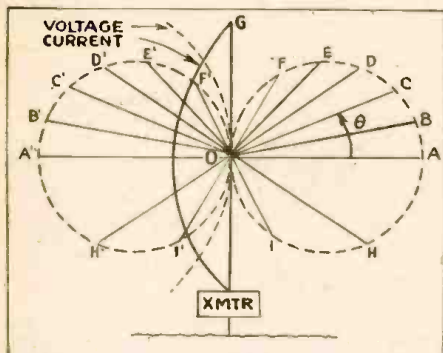

Fig. 1.—The famous "fly's eyes" diagram, representing the field around a vertical radio antenna.

an appearance to the reader who comprehended last month's installment. It is a simple half wave vertical antenna excited by a transmitter at its natural frequency so that the voltage and current relations will be as shown, and the radiation pattern will be a 3-dimensional toroid (or doughnut) such that any vertical cross-section of it will have somewhat the shape of a figure "8."

Now the reader will remember (I hope!) that such a radiator will radiate with maximum intensity along directions perpendicular to the wire, as OA and OA' (Fig. 1), while the intensity will be somewhat less in directions like OB and OB', still less in OC and OC', still less in OD and OD', OE and OE', in OF and OF', and practically zero in OG.

*Writer's Note: All figures so marked in this article contain a straight line representing a transmitting antenna, and the reader should imagine these figures rotated about this line as an axis through 360° to derive the full meaning of the diagram in our 3-dimensional space.

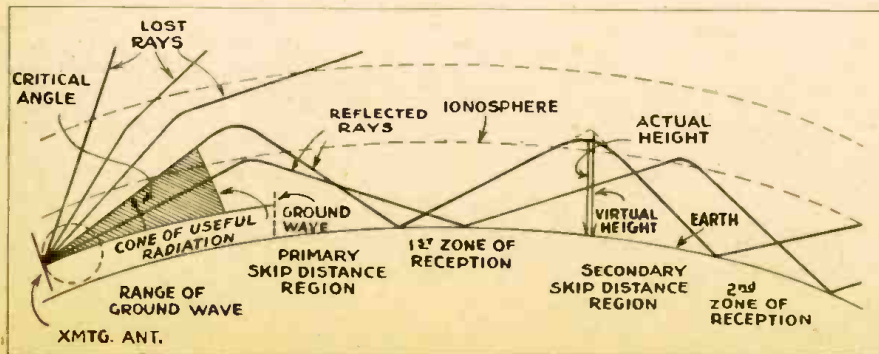

Fig. 2.—The path of a radio wave in the ionosphere. Illustrating skip distance and showing how distant reception is possible at a given point only if waves of the right length are used.

We shall not take time here to consider at any length what becomes of radiations emitted in directions like OH, OH', OI, and OI', i.e., into the Earth, although their importance is not to be minimized. Suffice it to say that they are either "absorbed" (this isn't a very good name for it, but it'll do) by the Earth, or reflected, or, as is generally the case, both.

Waves like OA and OA' are, of course, sent along the ground and are consequently referred to as GROUND WAVES. However, waves like OC or OC', for example, are radiated at an angle (θ) to the horizontal. Now θ is small, say, something of the order of 10° or 15°, for waves OB and OB'. Thus these are termed LOW-ANGLE WAVES. For OC, OC', OD and OD', the angle has a greater value with the result that these are known as MEDIUM-ANGLE WAVES. Similarly, OE, OE', OF and OF' are HIGH-ANGLE WAVES since for them, θ has a relatively large value.

GROUND WAVE PROPAGATION

Let us concern ourselves with waves like OA and OA'—the HORIZONTAL or GROUND WAVES.

These, as their name implies, go out from the transmitting antenna in all horizontal directions, staying in continual contact with the surface of the Earth. Could we see them from above, they would probably present an appearance somewhat like the waves created on the surface of a quiet pool when disturbed by a pebble, the transmitting antenna corresponding to the point at which the pebble enters the water.

As is to be expected these waves are continually encountering all sorts of conductors and semi-conductors as they progress—buildings, trees, fences, telephone, telegraph, and power wires, moist areas of ground, etc. etc. Each of these extracts a portion of energy from the wave as it passes with the result that it is attenuated far more rapidly than would be the case in the absence of these obstructions. A small portion of this lost energy is replaced by the very low angle waves directly above the ground wave, but this rarely amounts to much.

Let us consider just how this energy is "sapped" so effectively; for example, by a wire fence:

As the ground wave advances past the

PART II—HOW RADIO WAVES TRAVEL IN SPACE

fence, it induces a feeble current to flow in the fence—and a good thing it does, too; otherwise, how could we expect a current in our receiving aerials? Now:

(1) Some of this current is dissipated as heat (I²R loss) by virtue of the electrical resistance of the wire of the fence, and by the higher resistance of the damp

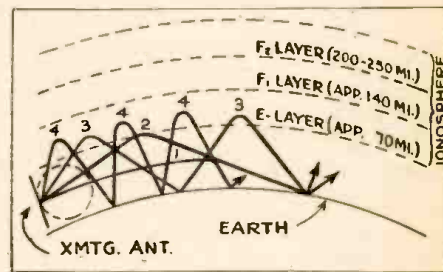

Fig. 3(a)—Average heights of the different layers in the ionosphere under normal daylight conditions.

ground wave is useful for communication purposes is restricted indeed, being dependable only about as far as 30 or 50 miles, or a little more.

(2) Some of the current leaks off through the fence posts and vines to ground, also constituting a total loss.

(3) As these feeble currents flow along the fence, they radiate an electromagnetic field of their own which will be 180° out of phase with the original field and which will therefore "buck" or cancel the original field to a degree dependent upon its own intensity.

One and two may be termed "absorption" or dissipation losses, while three is a loss due to "reflection."

In any event, we see that the region over which the ground wave is useful for communication purposes is restricted indeed, being dependable only about as far as 30 or 50 miles, or a little more.

How, then, is it possible to communicate over the entire planet? Let us equip ourselves with a general understanding of that part of the upper reaches of the atmosphere termed the IONOSPHERE, or (since its existence was suggested independently and almost simultaneously in 1902 by A. E. Kennelly in the United States, and Oliver Heaviside in England) the KENNELLY-HEAVISIDE LAYER.

NATURE OF THE IONOSPHERE

The planet on which we live is enveloped in a layer of air known as the atmosphere. The exact thickness of this layer is unknown with certainty but most authorities agree that it extends well over 200 miles above the level of the sea. However, the air at high altitudes exists in a far different physical condition than that here at the surface.

At the level of the sea, the atmosphere exerts a pressure of approximately 14.7 pounds per inch, or sufficient to support against the force of terrestrial gravity a

RADIO ANTENNAS

Radio Waves Must Follow

By EUGENE P. BERTIN

column of water some 34 feet high, or a column of mercury 760 mm. high. As we rise higher and higher into the air, we know that the air becomes thinner and thinner until we find our lungs laboring full tilt to keep our blood supplied with the now hard-to-get oxygen. At a height of several miles, it is impossible to breathe at all, and we must resort to artificial methods of oxygen supply. Finally, whereas at

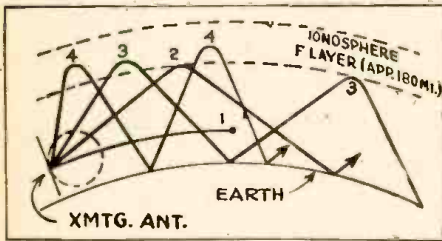

Fig. 3(b)—Under night conditions the lowest layer of the ionosphere is higher, and radio ranges longer.

sea level the pressure exerted by the air was 760 mm. of Mercury, at a height of 100 miles and above, the air exerts a pressure of but a small fraction of a millimeter of Mercury.

Thus we see that the air at the surface of the earth is DENSER than at greater altitudes. This can only mean that IN A GIVEN VOLUME OF AIR THERE ARE MANY MORE MOLECULES—THOUSANDS OF TIMES AS MANY as at very high altitudes. (Indeed, there are so many that were each molecule in a single cubic centimeter [1 cm. = app. 1/3 in.] of air at Sea Level (and at the temperature at which water freezes) turned into a grain of sand, there would be enough sand to fill a ditch a mile wide and three feet deep from New York to San Francisco.)

These countless millions of molecules are in rapid motion—constantly colliding with one another. When such collisions occur (and billions occur per cubic inch per second!) one or both of the colliding molecules may have one or more electrons knocked off their outer orbits, thereby becoming POSITIVE IONS and consequently liberating a number of FREE ELECTRONS. Also, it has been conclusively shown that

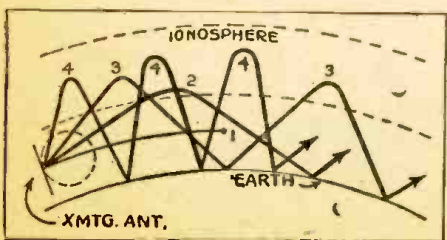

Fig. 4(a)—A rough idea of the propagation of waves at commercial broadcast frequencies.

the higher the temperature, the more extensive the ionization. This is because the molecules move more rapidly as the temperature rises thereby increasing the rate of collisions.

In addition to this, a number of other factors influence the process. Following is a table of energy received by the Earth in ergs per square centimeter per second from various agencies contributing to atmospheric ionization (an erg is the energy required to lift a mosquito's weight about 1/3 inch):

(1) Ultra-Violet Light from the Sun	28.35
(2) Meteors, during Meteor Shower (in AM.)	2.4
(3) Ultra-Violet Light from the Stars	0.014
(4) Cosmic Radiation	0.00031
(5) Meteors, Average for a normal day (A.M.)	0.00024
(6) Meteors, Average for a normal day (P.M.)	0.00012
(7) Ultra-Violet Light from the Moon	0.000044

Thus we see that due to collisions and to a number of external contributing factors (only the first of which, solar ultra-violet irradiation, need be considered), a given volume of atmosphere contains, in addition to the MOLECULES (or atoms) of the atmospheric gases, a number of POSITIVE IONS and FREE ELECTRONS.

WHERE THE IONIZED AREAS ARE

Now, strangely enough, it has been shown that the number of ions and free electrons in the air at or near the surface of the Earth is extremely small. This is largely due to the following considerations:

(1) The solar ultra-violet radiation which constitutes one of the two chief ionizing agencies, is largely absorbed in the upper layers of the atmosphere and, consequently, is very greatly diminished in intensity by the time it reaches the surface.

(2) Even though the process of ionization by collision is far more pronounced in the dense lower atmosphere, an ion cannot exist for more than a split instant in the lower atmosphere, because since the air is so dense, an ion would encounter some free electrons almost immediately upon being ionized, and these would therefore be removed from "circulation" by neutralizing the charge of the ion, returning it to its electrically neutral atomic condition.

But in the upper reaches of the atmosphere, conditions are different:

(1) Here the ultra-violet radiation from the sun is received at its full intensity during daylight hours so that ionization is extensive, and for every ion formed, one or more electrons are freed.

(2) These ions and electrons, and the many others formed by the normal collisions, can exist for relatively long periods (since an ion may go on a comparatively long time before approaching close enough to any free electrons to annex them) in the thin upper air.

The important facts to be derived from these seemingly irrelevant considerations are that although the free electron and ion density in the lower atmosphere is very low, in the upper atmosphere there is a region where it is very great. This is the IONO-

SPHERE, and but for its existence, long distance radio communication as practiced today would be an impossibility!

The Kennelly-Heaviside Layer is far more extensive in the daytime than at night. This is only to be expected since the Sun is one of the two chief factors contributing to atmospheric ionization. The best authorities generally agree on the following AVERAGE LAYER HEIGHTS* for normal conditions for the 3 main daytime divisions of the Ionosphere:

- (1) E Layer Approx. 70 miles
- (2) F₁ Layer Approx. 140 miles
- (3) F₂ Layer Approx. 200-250 miles

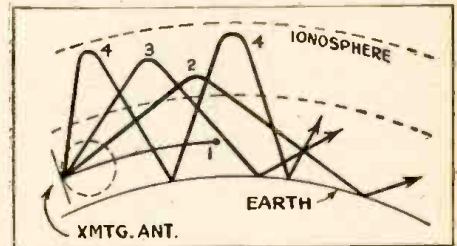

Fig. 4(b)—Conditions when shorter waves than those of 4(a) are used. Waves get farther in fewer jumps.

At night, when the Sun's powerful ionizing radiations are no longer a factor, the ions and free electrons in the E-Layer recombine extensively, leaving it rather ineffective for communication. Also the F₁ and F₂ layers appear to merge, leaving only one layer in the F region at a virtual height of approximately 180 miles.

The extent of ionization and layer height of the Ionosphere have been found to vary periodically in accordance with such factors as the rotational period of the Sun (approximately 26 days), the sunspot cycles (approximately 11 years), the transit of the Moon, various disturbances in terrestrial magnetic conditions, and several others of lesser importance. These cannot be covered in the scope of this article.

The Ionosphere must then be regarded as being highly variable.

The manner in which the Ionosphere affects long distance communication is by RETURNING TO EARTH by some not clearly understood process of REFLECTION or REFRACTION. RADIATIONS emanating from transmitting an-

*These are VIRTUAL heights. The meaning of this term will be explained later.

(Continued on page 56)

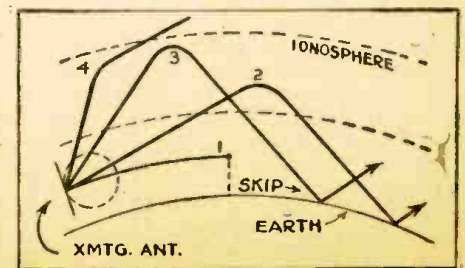

Fig. 4(c)—These are the short waves of the DX fan. One or two jumps takes them around the earth.

CHECKING POWER SUPPLIES

By JACK KING

THERE are several types of power supplies, but the types encountered most often are the half-wave rectifier systems in A.C.-D.C. sets and the full wave rectifier and power transformer systems in A.C. sets.

A typical half-wave rectifier arrangement is shown in Fig. 1. This circuit is widely used in many A.C.-D.C. sets. Frequently

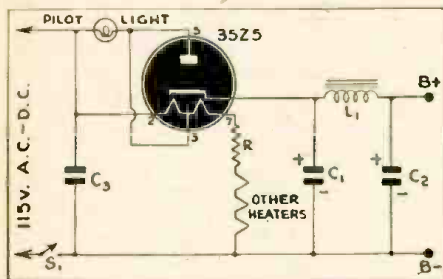

Fig. 1.—A standard half-wave rectifier, as commonly used in A.C.-D.C. receivers.

it is found that the pilot lamp fails. This failure may be due to opening of the part of the 35Z5 filament connected across the lamp. Common causes are tube aging and wear out, cathode to heater leakage in one of the other tubes or in the 35Z5 or any other defect which may cause the rectified current to rise to higher than normal level, such as excess current demand produced by a shorted filter.

Before replacing a burned out 35Z5 (when a replacement is obtainable) it is advisable to check the tubes carefully in an accurate tube tester and to check the filters with an ohmmeter. It is also a good idea to check for leakage in the condensers which connect to the grid and to the plate of the output tube, or output tubes, when servicing the power supply, since if a condenser connected from the output tube's plate to B-short circuits or leaks, or the grid condenser is defective, excessive tube and plate circuit current will flow, overloading the rectifier.

In Fig. 1, an overload due to breakdown in C2 will be limited by the resistance in L1, but as this resistance is seldom more than 500 ohms it isn't much protection. A breakdown in C1 will be more serious since the rectifier will, under such conditions, be working into a direct short circuit. This will "pop" the pilot lamp. When that happens, the filament current goes through the filament section across the lamp and overloads that section. Tube burnout may result.

AN AMMETER IN THE POWER LINE

Assuming the filters have been checked, and all points in this discussion are kept in mind, a ready test of the set may be made by using a power line ammeter. The relation between line voltage and current is shown in Fig. 2.

We may assume that the set under test is equivalent to a resistance, so that the current is equal to the wattage rating divided by the voltage. In most cases the line voltage is near 115 volts as an average. Other values of current for different voltages can easily be calculated, if the serviceman wishes to go to the trouble, and can

be plotted in graph fashion. This will enable the technician to determine the current when a set of given wattage rating is plugged in, most radios having a rating stamped on the chassis or indicated somewhere.

If the line current is too high, the set can be turned off and checked further, with the definite knowledge that something wrong needs to be corrected. This makes for precision servicing and conservation of time. Sets which are intermittent due to power supply defects or other troubles can be left on but not playing. When the ammeter shows a change the serviceman working on another radio can turn off the set on which he is working and check the set which is being warmed up. He can glance at the ammeter from time to time without having to listen to the first set. This idea is illustrated in Fig. 3.

A NUMBER OF TROUBLES

In some cases it will be found that the tubes check good in a tube tester, the filters are all right and there is continuity from the rectifier plate to ground or to one terminal of the on-off switch but that still the set refuses to play or light up. This may be due to a break in the line cord or an on-off switch which is defective and in need of replacement. The switch can easily be checked using an ohmmeter across the terminals when the set is *entirely disconnected* from the power line.

Tunable hum is a common cause of trouble and may be traced to C3 in the power supply of Fig. 1, or to C1 and C2 in Fig. 4. Line condensers can be best checked by cutting them out of the circuit and trying new ones. If the hum disappears it is clear that new condensers are needed.

We use an A.C. voltmeter to measure the voltage across the rectifier filament, and to test the voltage from plate to on-off switch. If there is no A.C. input voltage we must find the reason for the condition and correct it before we can expect to secure output D.C. voltage from the rectifier system.

The D.C. output voltage is measured with the plus side of the meter connected to the rectifier cathode and the minus side connected to the on-off switch. We are, in effect, checking the D.C. voltage across filter condenser C1 in Fig. 1.

FILTER EFFICIENCY FACTORS

If we use a blocking condenser in series with an A.C. voltmeter we can test the efficiency of the filter system. First the A.C. voltage across C1 is tested. Then the A.C. voltage across C2 is checked. This voltage, if the filter is working properly, will be much lower than the first A.C. voltage across C1. If that first voltage is 10 volts A.C. and the second voltage is 1 volt the ratio is 1/10 or .1 and the efficiency may be assumed to be 1-.1 or .9, which multiplied by 100 gives 90% efficiency.

As high an efficiency as possible is desired to keep the hum at a minimum level. However, C1 must not be too large if the peak current through the tube and rectifier life are not to be out of proper proportions. Low peak current and low capacity for C1 mean longer life for the tube, so a balance

between these two conflicting requisites must be worked out by the design engineer. Hence capacitance values should be the same as the original values whenever making replacements of parts in doing servicing work. A fairly safe rule to follow is that the capacity rating of condenser such as C1 and C2 should be equal to or slightly greater than the original values, with the same rule applying to the voltage ratings of the condensers. That is, the voltage of a new replacement condenser should be equal to or higher than the original voltage rating. This rule applies wherever the condenser may be located, in any circuit, in any set.

FIND BAD PARTS WITH A VOLTMETER

Referring to Fig. 4, a breakdown in C2 or C3 will be a common servicing trouble. The voltage output can be checked by connecting a D.C. voltmeter across C2. The A.C. voltage input can be tested by con-

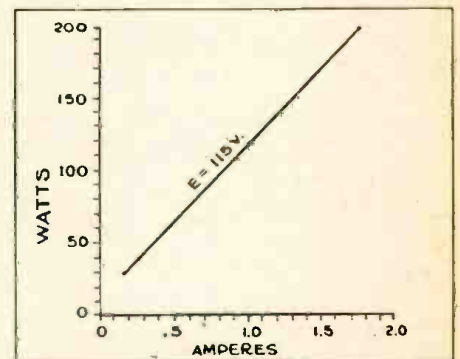

Fig. 2.—Watts-amperes chart for 115-volt supply. With this your ammeter becomes a wattmeter.

necting an A.C. voltmeter between the center tap of the winding which connects to the plates of the rectifier and one plate at a time. The voltage per plate is checked in this way. In a typical case it might be found that, under normal power supply conditions, the voltage per plate is 350 and the output voltage is 300, but this will vary according to the design of the receiver and its condition. If there is a breakdown in C4, R3 may burn out. C4 can be checked with an ohmmeter, and R3 can be tested with the ohmmeter. Or, a substitute for C4 can be installed, the voltage across it can be

(Continued on page 58)

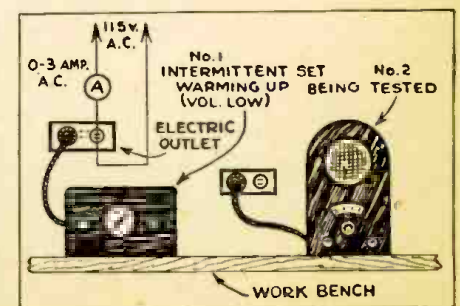

Fig. 3.—Don't fool with an intermittent. Let it play while you work on another receiver.

PICK-UP PERFORMANCE

PART II

By TED POWELL

SEVERAL distortion effects are developed by the turntable assembly itself. Some of these are not generally appreciated.

Vibration in the motor due to gears, bearings and A.C. introduce noise frequencies and their harmonics. These effects are noticeable as turntable "rumble", power-frequency hum or mechanical groaning or grinding noises. Turntable rumble can be heard even on some costly transcription type phono assemblies. It is difficult to eliminate with turntable assemblies designed as they are, especially with those using ball-bearings and gear drive. This trouble is still further aggravated in hi-fidelity amplifiers with genuine and not synthetic low-frequency response in the phono system.

A separately-mounted motor with rubber suspension mounting and a flexible-cable-on-turntable-rim drive would be an obvious solution to the gear hash, bearing noise and motor A.C. vibration hum problems.

The use of heavy adjustable taper-fit bronze bearings instead of the usual ball-bearings would eliminate the bearing grind and rumble problem. A noiseless ball-bearing is an impossibility from the very nature of its design and operation. A plain bronze bearing with a taper fit, if properly fitted, is practically noiseless even though nowhere efficient as the ball-bearing. Some manufacturers now use a single-ball pivot-bearing as a silent thrust bearing in turntable mounts.

SEVERAL CAUSES OF "WOW"

The other and more commonly recognized distortion effect developed by the turntable assembly is the one known as "wow". This is frequency-modulation distortion and is caused by variation of drive-motor speed. This speed variation is due to the variable turntable load which is caused by gear-tooth torque pulses and the variable modulation amplitude swing of the stylus. Obviously, the wider the amplitude of the modulation groove, the wider the stylus tip is swung, the more work has to be done to swing the stylus against the impedance of its mechanism. Therefore the transient load placed upon the turntable drive motor is greater. The result is the familiar and inevitable "wow" where the usual turntable assembly is employed.

The "wow" effect may be considered to be two-fold. The simple momentary reduction of turntable speed is the more obvious effect and the one responsible for the familiar wailing, smearing frequency modulation audio distortion. It is due to a sustained heavily-modulated section of the recording groove. There is also a higher frequency component effect called "hash" which is a true F.M. distortion effect. It is partly due to gear-tooth drive torque pulses and may also be partly due to higher frequency transient variable frequency and amplitude modulation groove loading upon the stylus mechanism and the turntable drive motor.

There seems to be no practical way out of this wow effect when simple direct motor drive is employed. No motor could possibly be designed to have an absolutely flat

R.P.M.-vs.-load characteristic under a transiently varying load when operating on its own. The use of massive turntables, mechanical types of governors and cable-on-turntable-rim drive will reduce such wow greatly but will not eliminate it. Such methods are bulky, heavy, costly and commercially impractical.

It might seem practical to resort to some sort of electronically stabilized turntable drive motor system. Mechanical stabilization methods have a serious limitation. No effective device could possibly have low enough mass to respond quickly enough to handle the higher-frequency oscillatory type turntable wow. Electronic stabilization is the logical solution.

TURNTABLE ASSEMBLY POINTERS

Care should be taken not to mount the turntable assembly on too thin a mounting board, otherwise a sound-board effect will take place and turntable rumble will be especially troublesome.

Setting the mounting board on rubber cushions may help isolate the pick-up arm from cabinet vibration generated by the loudspeaker, especially at the lower frequencies. Such rubber cushioning will also minimize a possible source of acoustic feedback and instability at low frequencies.

Setting the pick-up base and the turntable motor assembly on rubber cushions will tend to isolate the pick-up arm from the motor's gear, bearing and A.C. hum vibration noise and speaker cabinet vibration.

Where such rubber cushioning is resorted to, care must be taken not to set up mechanical resonance effects, otherwise the very trouble that is to be minimized may be exaggerated instead.

The motor frame and pick-up arm should be grounded. The under-side of the pick-up arm should be shielded by a light copper

screen. The motor A.C. leads and pick-up output leads should be well-shielded. A light copper shield should be inserted above the motor. This reduces the A.C. hum pick-up by the pick-up output leads.

If the pick-up's swivel bearings are properly adjusted and lubricated, mechanical wear and back-lash will be eliminated and a possible source of mechanical noise interference removed.

If the pick-up's cartridge is mounted by means of screws, the screw holes in the arm can be slotted out slightly to facilitate mechanical alignment of the pick-up cartridge. If the turntable height and pick-up arm height do not match up, the stylus cartridge can then be pivoted somewhat to set it parallel to the record disc and maintain proper stylus angle in the record grooves.

If a light pencil line is drawn down the long center-line of the pick-up arm and one across it at right angles directly over the stylus tip, a pair of cross-hairs will be set up which will simplify the optimum tangency tracking location for the pick-up's pivot base.

A turntable disc must run true. If it runs off-center or with a warp wobble, there will be variations in stylus pressure on the disc and a consequent variation in drive motor loading. This will result in slight wow distortion. Since there will be momentary increase and decrease in stylus pressure, there will also be slightly exaggerated stylus skating distortion at the pressure-decrease moments and stylus hiss and record groove wear at the pressure-increase moments.

A quiet and smooth-running drive-motor with high torque, silent gear-train and bearings and a true-running turntable are necessary, or mechanical noise and wow

(Continued on page 54)

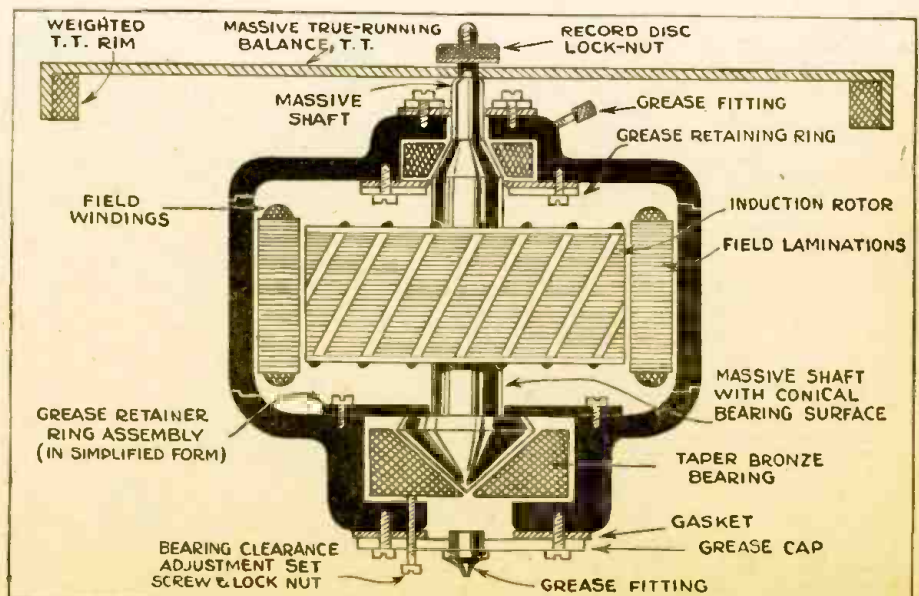
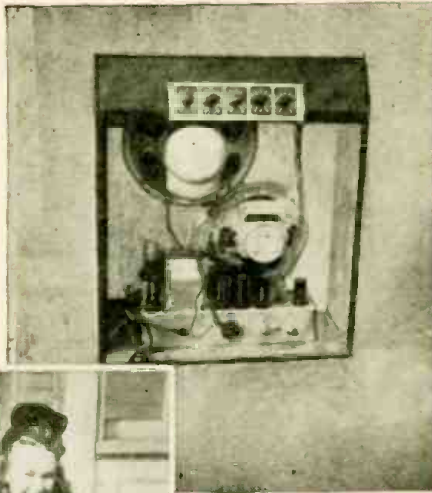

Fig. 1.—Ted Powell's idea of how an ideal turntable assembly might look. Massive table, solid bearings, all lend stability to the system.

How the completed instrument (and its operator) looks. Large for a portable, its improved quality compensates for lesser mobility.



ELECTRONIC musical instrument amplifiers for electric guitars have been described by the dozen, ranging from high quality down to "junk box" super-duper amplifiers. However they rarely finish the job by giving complete instructions on how to make the guitar, as well as the amplifier. Following are a few constructional suggestions founded on a sad experience of tedious experiments both with the amplifier and the pick-up device, simplification of the latter being the greatest obstacle.

The main objective is, of course, to produce an instrument that really looks and performs like a commercial article. The compromise between portability and power output is always a stickler, but when it's boiled down it will be found that an amplifier of the size shown is quite portable, with no sacrifice of tone or power because of a small junky chassis and speaker.

The guitar itself is made of solid birch or some other hard wood. A soft wood can be used and may be easier to work with but it is impossible to keep the dints out of it. A soft wood also tends to vibrate with the strings, causing extraneous pick-up of objectionable noises. The body is shaped roughly with a band saw and then sanded *very smooth* using a power sander except in tight corners, of course. If you do not have power tools don't let it bother you, for it is surprising how little it costs to have it done. There are two output plugs on the end of the instrument. The extra one is for use with an extra foot volume control, if desired.

WOODWORK AND FINISH

The finish should be a high grade varnish, two coats, rubbed down with rottenstone. If you don't feel capable of the job by all means have it done by a professional, as it is well worth the four dollars which it costs to get the mirror like finish. The fret markings are made carefully at right angles to the centre line of the instrument; the exact measurements of the frets may be copied from an ordinary Hawaiian guitar.

Masking or adhesive tape placed 1/16" apart on either side of the fret marking line produces a smooth, straight and well defined line when filled with a quick drying white enamel of fairly thick consistency. The markers for the "main" frets are small rhinestones taken from a dime store brooch and set in countersunk holes of the proper size with cement. The bridge should be made so that the tops of the strings are level, especially the third or "A" string, in order to avoid undesirable scraping and buzzing noises while playing. The "nut" at the other extremity should of course be bought with this point in mind. The tail piece to which the strings are anchored is made of a standard one cut down, drilled and bent to fit. The physical contours of the guitar may be altered to suit personal tastes as desired. This has no effect on the tone of the instrument. To complete the guitar a zipper fastened canvas case may be made, not forgetting a side pocket for the connecting cable and playing accessories.

THE ELECTRONIC PICK-UP

The pick-up device or unit is the heart of the instrument. It is the most interesting and neglected part in constructional articles. Its operation is based on the theory of magnetic lines of force inducing a current in a conductor moving through the magnetic field. In this case things are reversed; the conductor, which is in this case the coil, remains stationary and the magnetic field

**ELECTRO-
OLD SPEAKER MAKES**

By ARNOLD

moves in accordance with the disturbances caused by the steel strings vibrating in this magnetic field. The strength of the generated signal depends on.

- (a) Intensity of magnetic flux or field.
- (b) Size of wire in coil.
- (c) Proximity of the vibrating body, i.e. strings, to the magnetic field. It should be mentioned here that magnetized strings are NOT used.

The pick-up unit proper is constructed from a discarded 5" P.M. speaker having a fairly powerful magnet, usually of the new "Alnico" type and having a U shaped field extension, *not* a pot shaped one.

Shown in Fig. 1 is a diagram illustrating the relative positions of the pick-up magnet, strings and coil. A polished metal panel is used to cover the opening in the back of the guitar through which the unit is installed. It is easily accessible without removing the strings. Fig. 2 shows the shape of the speaker magnet and the relative position of the coil. The dotted lines show the portion of the speaker frame assembly which should be removed with a hacksaw. Use of a magnet of this shape (cylindrical) provides a particular advantage in that construction of the coil is reduced to simplicity itself.

CONSTRUCTING THE COIL

The coil is wound with the finest wire obtainable, No. 44 or better; wire obtained from the old faithful "Ford spark coil"

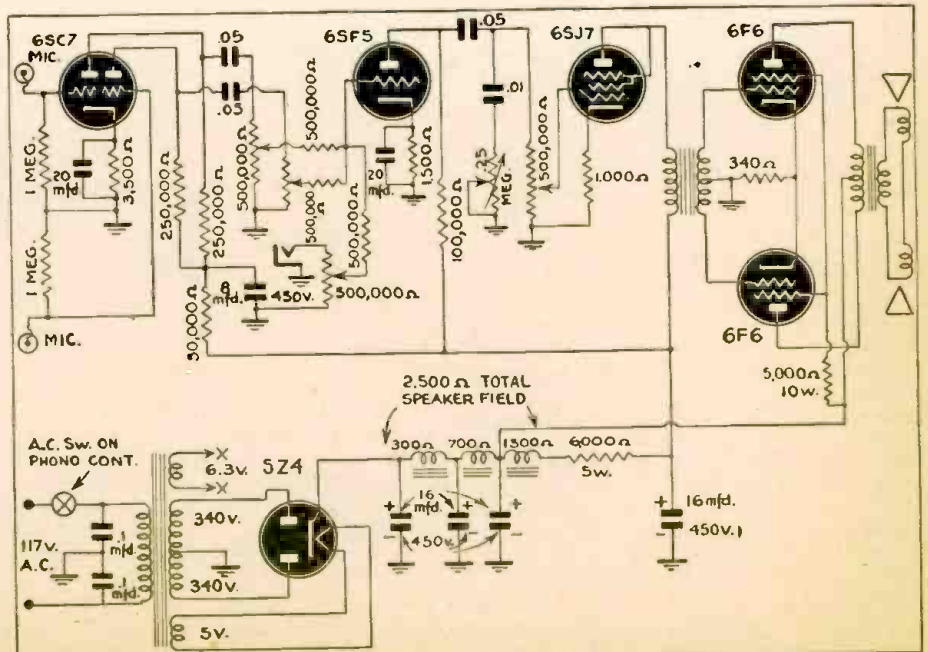

The guitar amplifier. Microphone as well as instrument pickup is provided, and the inputs can be mixed. The filter system is unusually thorough, obviating both hum and feedback. Note the two loudspeakers.

GUITAR

A STRING PICKUP

SCHUTZMAN

works quite satisfactorily in a pinch. The actual size of the coil will, of course, vary slightly with the actual speaker unit used by the individual. It is a simple cylindrical coil and measures approximately 2000 ohms. It slips over the magnet "M" Fig. 1 and should fill, as completely as possible, the gap between the magnet and the field extensions.

Small angles are soldered to the pole extensions "E" (Fig. 1) so that the whole unit may be securely bolted down with rubber cushioning washers.

In order to bring the magnetic field as close as possible to the strings, an auxiliary extension "X" (Fig. 1) is made. It consists of a rectangular piece of soft iron as highly polished as possible, $2\frac{1}{2}'' \times \frac{1}{4}'' \times 2''$. This is cemented in place on top of the magnet proper ("M" Fig. 1) at the point "Y-Y." Its size may vary slightly as it must project through the top of the guitar far enough to come as near as possible to the strings, without touching them, even at their greatest vibration.

Thus its size or height must vary according to the height of the bridge used.

The portion marked "A" in Fig. 1, which is the original voice coil extension, is sawed off, so that only about $\frac{1}{4}''$ of it remains. The top is filed smooth.

A special Alnico horse-shoe shaped magnet with special extensions and small high resistance coils gave no better results than the set-up shown and was much more difficult to construct. Even an ordinary head-phone with no changes made except to install a set of parallel extensions on the pole pieces worked fine.

Fig. 3 is a schematic of the hookup used for volume and tone control. Different tone control circuits may be used with equal results. Low resistance controls are essential to eliminate noise.

On completion the unit shown was given a comparative test by playing records of different artists through the phono input and mixing the guitar through one of the

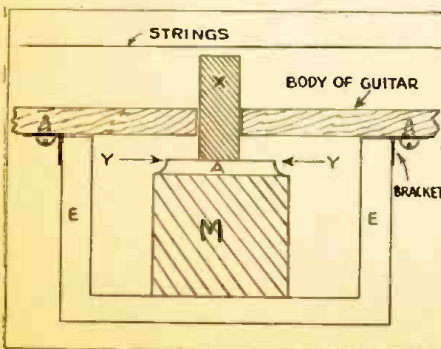
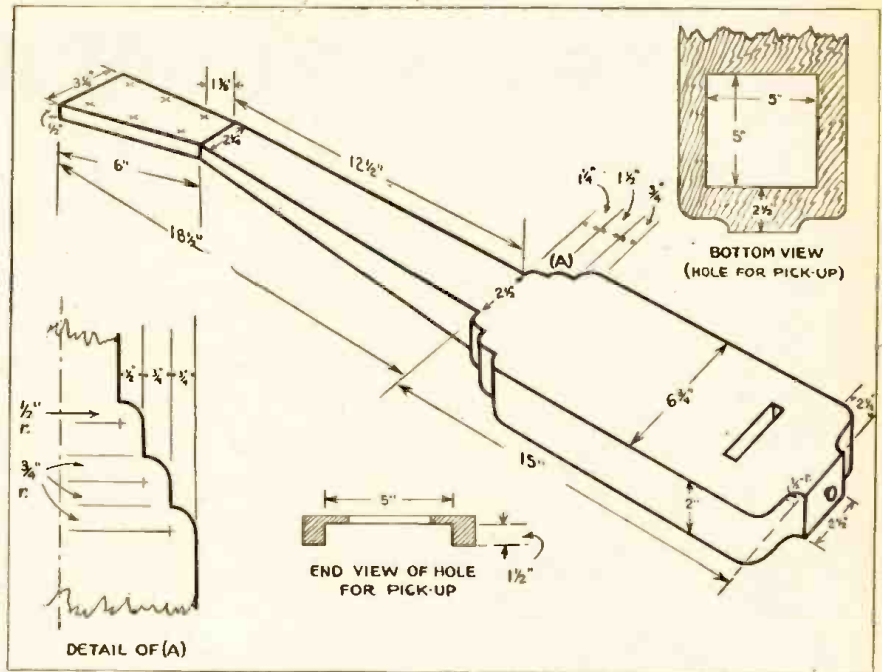

Fig. 1.—The unit in place under the strings.



Construction of the guitar body. This should be a simple matter for any handy workman, but it is worth noting that the impression made by the instrument will depend almost as much on its appearance as sound.

other inputs. This check of the tone quality as compared to that on different records proved the tone to be identical.

Moving the position of the pickup bodily nearer or farther away from the bridge, thus picking up the sound impulses at different points along the strings, produced no audible effect on the tone.

THE AMPLIFIER AND CASE

The amplifier is a standard set-up incorporating two high gain and one phono input. It can be made simpler if desired or more complicated as regards tone circuits, etc. It may even be reduced to one input for the instrument and made of junk parts. A phase inverter may be preferred.

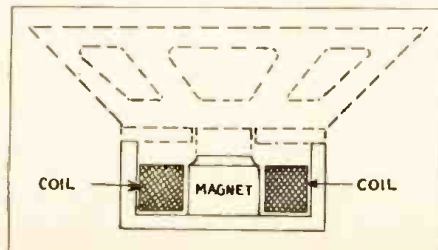

Fig. 2.—How a loudspeaker is cut down to make the magnetic pickup body.

In this rig a power of 12 to 14 watts is obtained in class AB1.

It is important to mount the driver transformer as far as possible from the power transformer to eliminate inductive hum pickup. It will be noted that in the picture they are mounted right next to each other. This resulted in quite a vicious hum which was eliminated very satisfactorily by turning the transformer for minimum hum pickup. The line bypass condensers were also found necessary in eliminating the last bit of hum and noise.

It will be noted that the tone and gain controls are not mounted on the chassis but on the cabinet. This has worked out very well and also is O.K. from an electrical standpoint. (Some musicians prefer the volume control on the instrument for "sew!" effects.—Editor) The cable to these controls is not shielded, and when tried it made no difference and so may be omitted.

The A.C. switch wires and tone control wire were run separately from the other side of the chassis. It is most important that two speakers be used to realize full power and tone. If you don't believe it at least try it and you'll find yourself using two. I cannot stress too much the importance of making a pictorial diagram, messy as it may be, of where every condenser and resistor goes in order to obtain a neat, trouble-free chassis. It's a lot easier to change a diagram than a 16 gauge chassis!

The case is made of plywood and covered with a good grade leatherette, black, put on with a paper stapling machine. The speakers are mounted on a board $\frac{1}{8}''$ smaller all around than the inside of the case so as to prevent resonant vibration.

Experimenting showed that the manner in which the different depths and brilliance of tone are obtained is due almost solely to the musical key in which the selection is rendered. Proper use of the tone control merely serves to modify the effect produced. One trial is all that is required to convince even the most doubtful soul. Most music for this instrument is written in sharp keys for easy playing. When changed

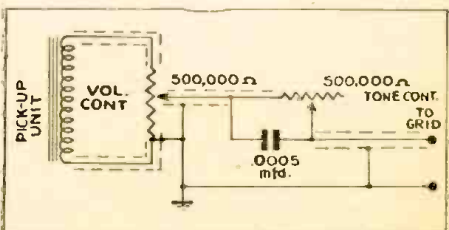

Fig. 3.—Tone and volume are adjusted by these two 500,000-ohm controls. Many musicians prefer them mounted on the instrument, which of course is quite feasible with this hookup.

to any of the proper flat keys the difference is really startling.

All that is necessary to duplicate professional artists is to use the same key and tuning.

This note on the musical side is just as important as the construction notes for no matter how painstakingly and well the instrument is made it cannot be made to perform as it should unless properly used.

NEGATIVE FEEDBACK PITFALLS

By J. T. TERRY

THE behaviour of a vacuum-tube circuit is radically affected by feeding back part of the output voltage into the input circuit. This has been done for some considerable time past, with and without intention. De Forest was not long in applying positive feedback to his three electrode "audion" to obtain a detector of high sen-

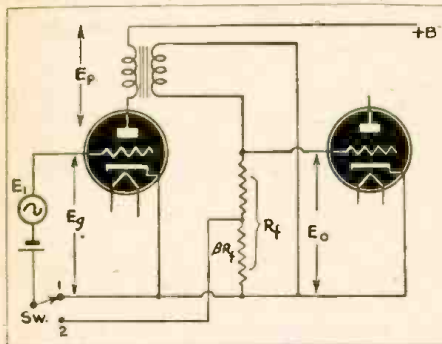

Fig. 1.—An experimental layout for determining negative feedback characteristics in an audio amplifier.

sitivity, or an oscillator. Negative feedback was also used, even in the infancy of radio (multi-stage amplifiers of the First World War embodied this feature).

It is usually held that the performance (especially the frequency/gain characteristic) of an audio amplifier is enhanced by

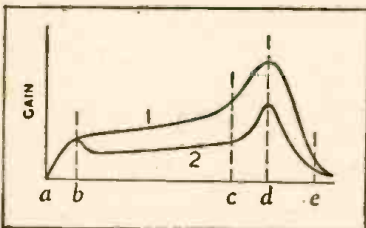

Fig. 2.—Response characteristics of the amplifier above, with and without negative feedback.

the provision of negative feedback. This belief is based on the usual analysis of negative feedback which assumes that in the absence of feedback the output voltage contains a distortion term D which is independent of the gain.

If a fraction of the output voltage E_o is fed back in any phase whatever, both gain and distortion are modified, such modification being easily calculated by the engineer for any given quantity and phase of feedback.

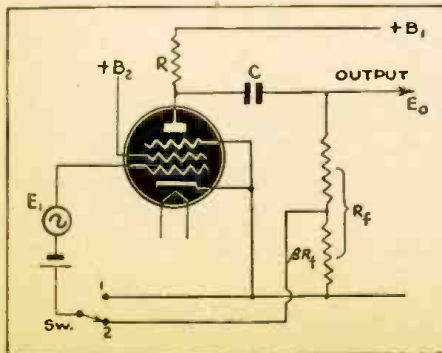

Fig. 3(a).—A practical resistance-coupled pentode amplifier, with negative feedback switch.

The difficulty lies in the varied sources of the distortion term D which it is rather rash, if expedient, to assume independent of the output voltage proper. This could at best be maintained about one of its parts, e. g., 60-cycle line hum, possibly about tube noise, certainly not about distortion arising in the grid circuit (grid current), in the mutual characteristic (bottom bend curvature) or in the plate circuit (non-linear behavior of plate resistance R_p and load impedance Z_L , the latter also varying in general with frequency). Only one factor has been cleared up so far, i. e., irregularities arising from changes in the amplification factor of individual tubes, due to arbitrary reasons. J. Peters has shown that the greatest improvement obtains when the stage or stages over which feedback is applied has a gain equal to ϵ ($= 2.718$ approx.).

For a start, it is necessary that the feedback should be truly negative. This does not mean pure negative feedback necessarily, but that the feedback voltage βE_o should contain a component 180 degrees out of phase with the applied input voltage E_i .

The β refers to that fraction of the output voltage which is fed back. This postulate is not quite as trivial as it may first appear, as the following example will demonstrate.

Consider a stage of voltage amplification with transformer coupling (Fig. 1). The switch S is arranged to apply feedback from the secondary of the transformer when in position 2. In position 1 no feedback is applied, and providing the resistance R_f of the potential divider is adequately high, a frequency/gain characteristic as sketched in the top curve of Fig. 2 is likely to result. It reveals a poor low-frequency response below b , a resonant peak at d then a falling off rapidly towards e .

Obviously this characteristic is associated with serious frequency distortion and the cure would seem to lie in applying negative feedback rather than redesigning the transformer. Suppose then that the switch (Fig. 1) is thrown into position 2. Assuming that the feedback potentiometer has been suitably connected (otherwise self oscillation is probable) the result will be disappointing, as is shown in the lower curve of Fig. 2. The gain is generally lower than before, but instead of a flatter characteristic it will be adorned by an additional "bump" at b , the obnoxious one at d still being present.

The simple truth is that neither below b nor at d does negative feedback occur. The coupling transformer is in effect a complicated network of mutual inductance, leakage reactance and shunting capacitances on primary and secondary. Thus near point d the transformer is effectively bypassed by the series combination of transformer capacity and resistance. Hence the output voltage is in quadrature with E_g at this frequency and feeding back a fraction of the former in the way shown does not provide negative feedback.

The hump at d is, if anything, increased relatively. Beyond d the load is likely to be capacitive on account of the primary shunt capacity and a small amount of negative feedback may obtain once more.

At the low frequency end below b , the plate load is small but inductive, hence the output voltage is again very nearly in quadrature with E_g ; so feedback would not be negative. As shown by the fall of the characteristic, it does become so above b . Incidentally, this is a resonance-like effect though no capacity is present; it might be put to good use in special circuit work where a low frequency "resonance" is desired without a bulky condenser.

The basic cure for the resonant rise in the frequency characteristic is not to use feedback, but to eliminate it by some known stratagem, such as a resistance shunt on the secondary. This would also modify the phase-frequency characteristic suitably and allow of negative feedback at any frequency above b .

Thus, it seems axiomatic that feedback can correct frequency distortion in voltage amplifiers if, and only if, the distortion is not due to series-resonance.

What tends to be overlooked is the question of how the distortion term D arises

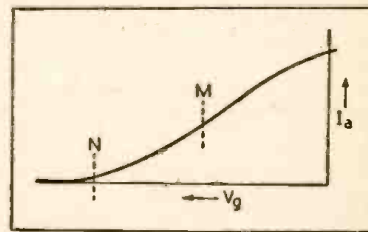

Fig. 3(b).—The grid-voltage vs. anode current curve of the pentode in Fig. 3 (a).

in the first place, and by what mechanism, if any, negative feedback may reduce it. As a simple example, consider the circuit of a resistance-capacity coupled amplifier with a pentode, as shown in Fig. 3 (a), switch S being in position 1. As is well known, the mutual or E_g/I_p characteristic

(Continued on page 53)

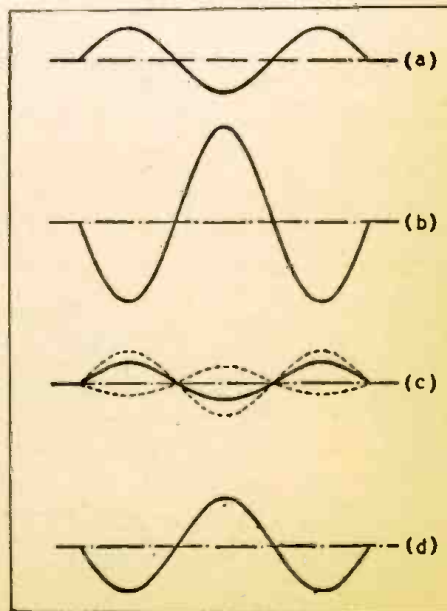

Fig. 4.—The distortion-reducing effect of negative feedback in the circuit of Fig. 3(a).

SHORT-WAVE INTERFLEX

Old-timers will be pleased to see the short-wave version of this old circuit, which dates back to 1925. Though the circuit here given is of the non-regenerative type, experimenters may also be interested in hooking up a short-wave Regenerative Interflex.

By WILLIAM F. LUEBBERT

THE long-scorned crystal detector is still unchallenged as the best from the standpoint of fidelity, in spite of all modern technical advances. All that is necessary to prove this is to hook one up to the input of a really good modern amplifier, and listen to a good local station. The improvement over a high-fidelity band expanding superhet, or even T.R.F. receiver, is striking, and one does not have to be a musician to appreciate it.

The crystal is well ahead from the standpoint of simplicity, too. No other detector is as cheap to build or as foolproof to operate. In spite of these facts, two things have kept the crystal out of common use. First is the troublesome and time-wasting process of getting the cat-whisker properly adjusted, and of keeping it so. Second, the crystal's lack of amplification limits its range to a few miles under most normal conditions.

The modern fixed crystal completely eliminates the first obstacle. A good fixed crystal requires less attention and adjustment than a vacuum tube.

Several attempts have been made to overcome the second difficulty. Some have been successful, others not. As already stated, adding a good amplifier makes the crystal a practical receiver for local stations. High, long aerials may increase its range to a hundred miles or more. The lack of selectivity in the ordinary crystal circuit is a further obstacle, and to gain distance without interference it is necessary to use vacuum-tube circuits with the crystal.

Among the most practical of such successful circuits were the Harkness Reflex and Hugo Gernsback's Megadyne and Interflex. The set I am about to describe is a modernized and considerably changed version of the famous Interflex. Though the Interflex was put out in three forms—straight, balanced and regenerative—I am following the original set.

On examination the schematic can be broken down into three parts—the crystal detector, audio amplifier (which includes both tubes), and the power supply. In my case the second tube was so hooked up that it could be used as an amplifier in connection with other experimental work. The set could of course be built in one unit if desired.

The crystal detector is hooked up in standard fashion, the only difference between it and any other being that instead of having a pair of phones and a phone condenser across the output it has the 500,000-ohm gridleak and the grid-cathode capacity of the tube. This manner of con-

necting a crystal detector to its audio amplifier deserves some attention. Instead of using a transformer with its attendant losses, the Interflex uses a direct coupling from the crystal to the audio grid. The only voltage present in the detector circuit is the signal voltage. The most important purpose of any coupling device is to isolate the plate voltage from the next stage, while letting the signal pass through. Therefore there is no reason here for using any coupling other than an ordinary piece of copper wire.

Construction of this set is too simple to warrant much discussion. If it is the builder's desire to hook it up all in one unit, the filaments may all be hooked in series and a line cord of approximately 200 ohms used. The condenser in the antenna circuit will be found useful in increasing selectivity. Some people are a bit puzzled by the low resistance of the first tube grid resistor, but if you remember it is an audio amplifier and not a detector, the resistance looks more like normal.

There are only three cautions to be impressed: 1—Keep all leads as short as possible. 2—Do not ground the set except as shown in the circuit diagram. 3—When using the additional power amplifier section be sure that the leads to it are properly connected. After you have finished the construction, it is wise to check the wiring at least twice to make sure you have no mistakes.

This set is a joy to handle—there are no tricky regeneration circuits to whistle and howl at you. There are no image interference problems as with a superhetero-

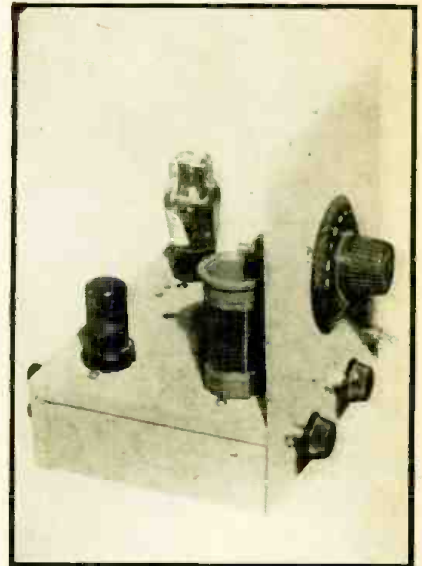

How the Interflex looks. Layout details of course be modified by constructors.

dyne, no distortion with strong signals as with condenser-leak detectors, and best of all, plenty of volume. It is a really fine high-quality set for either the fellow who is about to build his first A.C.-D.C. receiver or the experienced builder who wants to get the best possible short-wave set with the least cash outlay.

I would like to hear from those of you who build this set and how it works for you.

Address your letters to William F. Luebbert, c/o Radio-Craft, 25 West Broadway, New York 7, N. Y.

A list of the parts used in constructing this set follows:

Parts List:

- C1, C2—140 mmfd. variable
- C3—8 mfd., 35-volt electrolytic
- C4—.003 mica or good paper
- C5, C6—16 mfd. 250-volt electrolytics
- R1, R4—0.5 megohm, 1/2 watt
- R2—9000 ohms, 2 watts
- R3—0.25 megohm, 1/2 watt
- RL—Line cord resistor, 270 ohms
- L1, L2—Standard plug-in coils
- CH—Any good A.C.-D.C. choke
- V1—6F5 or 6SF5
- V2—25Z5 or 25Z6
- Amplifier:
- C7—10 mfd., 35-volt electrolytic
- C8—.005, (if required)
- R5—600 ohms, 2 watts
- RL AMP.—Line cord resistor, 300 ohms
- V3—25A6 or 43

If the set is built in one unit, with all filaments in series, the line cord should have a resistance of 200 ohms.

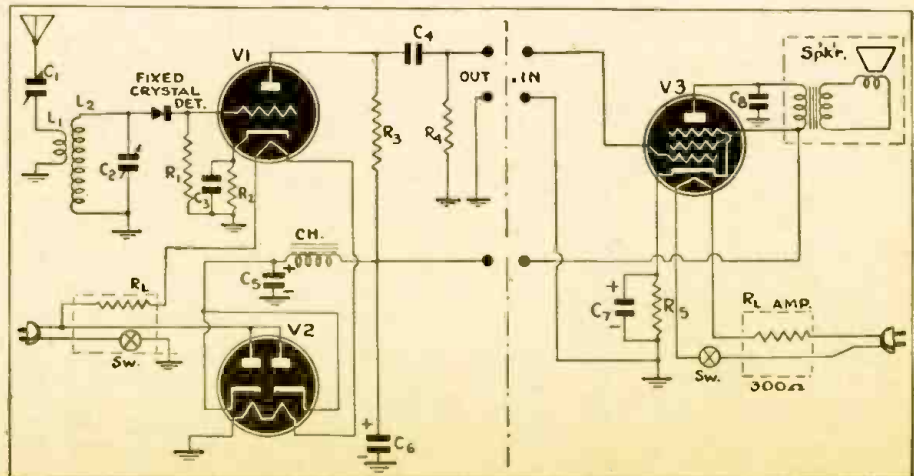

Schematic of the Short-Wave Interflex, with its semi-independent amplifier unit.

4-WATT AMPLIFIER

By CHAS. BAKER, JR.

A neat and easily built small amplifier is this one in the photo at the right. Versatile in application, it can easily be built from available parts. Performance, of course, will depend on just what is available, and on the care used in construction.



THE amplifier here has excellent fidelity when used with a well-baffled 10-inch speaker. It is shown removed from its cabinet, where it has of late been in use as a small phono sound system.

The two knobs on the front are volume and tone controls. Above them may be seen the input jack and indicator jewel. The input lead, as shown, is short and well-shielded to avoid hum pickup.

The chassis base, 7x4½x2 inches, was taken from an old kit, as were some of the other parts. The speaker field acts as one of the filter chokes.

This set may be used as a phone amplifier; with one of the new medium output dynamic or crystal mikes; or as a small set amplifier. I have used it to supply the "B" and heater voltages as well, when working with small receivers.

The amplifier is the result of considerable circuit and design in experimentation, in an attempt to build an economical but efficient amplifier. Metal tubes were available, so they were used, but of course their G or GT equivalent may be used. The power supply is quite conventional, and built large enough to supply extra power for equipment asso-

ciated with the amplifier. Any of the usual rectifier tubes might be substituted for the 5Z4, with an accompanying change in circuit design if necessary. Following is the parts list:

RESISTORS

- R1—1000 ohm 1 watt resistor
- R2—1 mex ½ watt resistor
- R3—250,000 ohm ½ watt resistor

- R4—100,000 ohm 1 watt resistor
- R5—250,000 ohm tone control
- R6—450 ohm 1 watt resistor
- R7—500,000 ohm volume control

CONDENSERS

- C1—10 mfd. 25 volt electrolytic
- C2, C4—.01 mfd. 400 volt condenser
- C3—8 mfd. 450 volt electrolytic (optional)
- C5—25 mfd. 25 volt electrolytic
- C6, C7, C8—16 mfd. 450 volt electrolytic
- C9—.002 mfd. mica condenser

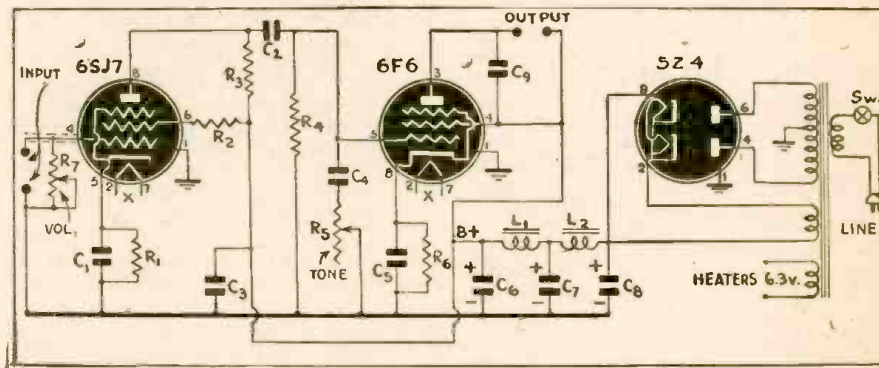

Schematic of the 4-watt utility amplifier. The two-section filter makes for hum-free reproduction

ALL-ROUND BRIDGE ANALYZER

By ROBERT WOLF

THIS simple parts checker is more useful than some expensive instruments. It was made entirely of parts from my own junk box, and calibrated by using known components.

The dial was made up as shown, but this is only an example, as with various resistors and condensers in the calibrating arm of the bridge, the dial is likely to differ from one instrument to another. If units close to the rated value are used, however, this specimen dial may serve as a valuable guide.

The inductors are a special problem. Two inductances of the same rating as to henrys, but with different resistances, will check altogether different. The best thing is to use inductors of as low resistance as possible. You cannot expect the same accurate results as on resistors or condensers, because the standard inductance and the one being measured are both combinations of resist-

ance and inductance. Both of them change their inductance due to the current flowing through them, too. This change in current flow depends on both the inductance and resistance of the inductor, so we have a flock of factors all getting in each other's way. In spite of this, the bridge is very useful for approximate checks on inductance.

Used as a resistance or capacity bridge, it is as accurate as any commercial bridge or "condenser analyzer" I have ever worked with.

To use the checker, the unknown part is put across the terminals marked X and the dial slowly rotated till the sound in the phones reaches its lowest point. For calibrating, the same process is followed. For example: To calibrate the C₁ scale various capacities from .001 to 0.1 are connected in at X and the dial marked at the correct

point of minimum hum in the phones for each size. All other scales are calibrated the same way.

I use a neon light across the 115-volt line, with a special pair of terminals for making quick short and open tests on condensers, but this feature is not a necessary part of the meter, though it is a convenience. The meter itself shows shorts and opens, as there is no balance on any part of the dial.

It is an ordinary filament transformer, with a secondary voltage of 6.3. For small condensers and large resistors, a much higher voltage would be better, though for inductance measurements the present voltage is best. Sometime I hope to have a tapped secondary, using about 50 or 60 volts for the condenser and resistor scale. Electrolytic condensers would have to be

(Continued on page 62)

THE LISTENING POST

Edited by ELMER R. FULLER

A LAST minute report—just received as we were going to press—says that LRX1, Buenos Aires, Argentina, has returned to the air on a frequency of 6.120 megacycles, after a long absence. They have been heard from 9 to 11 p.m., E.W.T.

Hams received during the past month by Bob Hoiermann of Alliance, Ohio were OA4D, ZP5AC and ZP3BA. They are all South Americans, and are usually heard from 8:30 to 9:45 pm. Their signal strength is low, but they are readable. We should like to have more of our readers listen for those amateurs who are still using the ether.

Reported to be on the air on Saturdays at 6:45 pm, is a station in Alaska. The broadcasts are irregular, but are reported to have been heard in New York State. This will be a good one to be on the watch for. A verification might be possible.

JLG+ uses a frequency of 15.105, and is

on the air at 6:20 pm with the news, and sometimes other programs, in English. The QRA of course is Tokyo.

Newly heard is station XBBH in Mexico City, Mexico, which broadcasts from 11:25 am to 12:45 pm, and sometimes is heard all day. Spanish is usually heard, and little more is known about him. If anyone has any other information, will he please drop me a card.

KWIX, in San Francisco, California, has joined the United Network, and may be heard from 8 pm to 12:45 am daily. The frequency used is 9:57, and the change was made about three weeks ago.

The station heard on 9835 mcs, has been identified as "Hungarian Nations Radio"; and is heard 2:15 to 2:27 pm and 7:15 to 7:27 pm. They usually speak in German.

Reports for the past month have been received from the San Francisco Chamber of Commerce; Gilbert Harris, Massachu-

setts; Adolph Umiker, New York; Nick Vangellow, New York; Bob Hoiermann, Ohio; and Radio Station WLWO of Cincinnati, Ohio.

We would like to receive reports from more of our listeners, as this is the only way we can determine if we are being of service to you. Let us know whether or not you like this department of *Radio-Craft*, and if you wish to have it continued in future issues. Many stations' schedules can only be checked by what we hear, and the only way for us to know, is for you to write to us. Please address me:—Elmer R Fuller, Listening Post Editor, RADIO-CRAFT, 25 West Broadway, New York City, 7. All correspondence will be acknowledged.

News broadcasts in English are the same as reported in last month's issue, so there is no need to repeat it again this month. Our station list has had some changes, as will be seen by looking over the following.

Mc.	Call	Location and Schedule	Mc.	Call	Location and Schedule	Mc.	Call	Location and Schedule
4.70	ZQI	KINGSTON, JAMAICA, Sundays, 6:15 to 6:55 pm; daily 6:15 to 7:15 pm.	6.080	WLWO	CINCINNATI, OHIO, 12:45 to 2 am.	6.190	WGEO	SCHENECTADY, NEW YORK; 12:15 to 2:10 am.
4.785	HJAB	BARRANQUILLA, COLOMBIA.	6.082	OAX4Z	LIMA, PERU. "Radio Nacional."	6.19	—	"GUSTAV SIEGFRIED EINS". Variable times of evening.
4.835	HJAD	CARTAGENA, COLOMBIA.	6.090	CBFW	VERCHERES, CANADA. Daily, 7:30 am to 11:30 pm in French.	6.210	—	"DEUTSCHER KURZWELLEN SENDER ATLANTIC". Evenings, variable times; thought to be anti-nazi station.
4.865	HJFK	PEREIRA, COLOMBIA.	6.09	ZNS2	NASSAU, BAHAMAS. Evening transmissions.	6.235	—	"GUSTAV SIEGFRIED EINS". Variable times of evening.
4.885	HJDP	MEDELLIN, COLOMBIA.	6.095	OAX4H	LIMA, PERU, "Radio Mundial."	6.480	TGWB	GUATEMALA CITY, GUATEMALA. 7 am to 8:10 pm daily, except Sunday.
4.905	HJAG	BARRANQUILLA, COLOMBIA.	6.098	ZRK	CAPETOWN, SOUTH AFRICA. Day and night transmissions.	6.485	HI2T	SAN FRANCISCO DE MACORIS, DOMINICAN REPUBLIC.
4.92	YV5RN	CARACAS, VENEZUELA. Evening transmissions.	6.11	GSL	LONDON, ENGLAND. American beam, 7 pm to 12:45 am.	6.700	TIEP	SAN JOSE, COSTA RICA; "La Voz del Tropico"
4.925	HJAP	CARTAGENA, COLOMBIA.	6.120	—	BERLIN, GERMANY. North American beam, variable times.	7.037	EAJ3	VALENCIA, SPAIN; 4 to 6 pm.
5.85	—	SANTIAGO, CHILE; 7:40 pm to midnight.	6.120	WKTS	12:45 to 1 am.	7.15	GRT	LONDON, ENGLAND. 10:45 pm to 12 midnight.
5.980	VONH-V	VONG ST. JOHNS, NEW-FOUNDLAND; 7:30 to 8:15 pm.	6.120	LRX1	BUENOS AIRES ARGENTINA. "Radio El Mundo," 9 to 11 pm.	7.171	XGOY	CHUNGKING, CHINA. East Asia beam, 7:35 to 9:55 am; 2:30-4 pm; European beam, 11:35 am to 12:30 pm; 4 to 5 pm; Asia-Australia-New Zealand beam, 6 to 6:30 am; East Russia beam, 6:30 to 7 am; Japan beam, 7 to 7:30 am; North American beam, 10 to 11:30 am.
5.44	—	MOSCOW, USSR. 6:48 to 7:25 pm.	6.12	—	"GUSTAV SIEGFRIED EINS". Variable times of evening.	7.230	KWID	SAN FRANCISCO, CALIFORNIA; 6:30 am to 1:05 pm.
5.875	TIGPH	SAN JOSE, COSTA RICA	6.122	ZFA2	HAMILTON, BERMUDA. Mondays, 7 to 7:45 pm.	7.230	—	ROME, ITALY. Day and night transmissions; news in English every hour.
6.005	CFCX	MONTREAL, CANADA. Sunday, 7:30 am to 12 midnight; Monday to Saturday, 6:45 am to 12 midnight.	6.130	COCD	HAVANA, CUBA; 7 pm to midnight.	7.250	KGEI	SAN FRANCISCO, CALIFORNIA, 1 am to 1 pm.
6.007	ZRH	JOHANNESBURG, SOUTH AFRICA. Evening transmissions.	6.130	CHNX	HALIFAX, NOVA SCOTIA. Sundays, 8 am to 6:55 pm; Monday to Thursday, 6:45 am to 10:15 pm; Friday, 6:45 am to 11 am; Saturday, 6:45 am to 11 am.	7.28	VLI9	SYDNEY, AUSTRALIA; Eastern North American beam, (English) 8 am.
6.010	CJCX	SYDNEY, NOVA SCOTIA. Monday to Friday, 7 am to 11 am; Saturday, 6:45 am to 11 am; Sundays, 8 am to 11 am.	6.145	HJDE	MEDELLIN, COLOMBIA. Evening transmissions.	7.290	DJX	BERLIN. Variable times, North American beam; news in English at 7 pm.
6.020	—	GEORGETOWN, BRITISH GUIANA. 7 am to ?	6.148	ZRD	DURBAN, SOUTH AFRICA. Day and night transmissions.	7.31	2RO19	ROME, ITALY. Day and night transmissions; news in English every hour.
6.02	—	"GUSTAV SIEGFRIED EINS." Variable times of evening.	6.150	CJRO	WINNIPEG, CANADA. 6 to 11 pm.			
6.030	HP5F	COLON, PANAMA. 11 pm to ?	6.160	CBRX	VANCOUVER, CANADA. 10:30 am to 2:30 am.			
6.03	DXP	BERLIN, GERMANY.	6.165	TILS	SAN PEDRO, COSTA RICA.			
6.030	CFVP	CALGARY, CANADA. Sunday, 10 am to 1:30 am; Monday to Saturday, 8:30 am to 2 am.	6.165	HER4	BERNE, SWITZERLAND. Canadian beam, 9 to 11 pm, except Saturday.			
6.04	COBF	HAVANA, CUBA. Relays CMBF.	6.170	WCBX	NEW YORK CITY; 11:45 pm to 3 am.			
6.070	CFRX	TORONTO, CANADA. Sundays, 9 am to 12 midnight; Monday to Friday, 7:30 am to 12:05 am; Saturday, 7:30 am to 12:45 am.						

(Continued on following page)

• LISTENING POST •

Mc.	Call	Location and Schedule	Mc.	Call	Location and Schedule	Mc.	Call	Location and Schedule
7.345	—	GUAYAQUIL, ECUADOR. 9 to 11 pm.	9.570	KWID	SAN FRANCISCO, CALIFORNIA; 3 to 6:15 am.	9.935	SVM	ATHENS, GREECE
7.495	—	CAIRO, EGYPT. 3:15 to 6 pm.	9.58	VLG	MELBOURNE, AUSTRALIA; Western North American beam, in English, 11 am.	9.97	HCJB	QUITO, ECUADOR. 6:45 pm.
7.565	KWY	PACIFIC COAST; 4:45 to 7:05 am; 8 to 10:30 am	9.580	GSC	LONDON. North American beam, 5:15 pm to 12:45 am.	9.98	—	FRENCH EQUATORIAL AFRICA. "Radio Club"; 9 to 10:20 am; 2 to 3:20 pm; 5 to 5:30 pm.
7.565	WKLJ	NEW YORK CITY; 12:45 to 1 am.	9.590	WLWK	CINCINNATI, OHIO; midnight to 9 am.	10.005	—	"VOICE OF FREE ARABS". Sundays, 3:15 to 3:30 pm. irregular.
7.575	WLWK	CINCINNATI, OHIO. 12:30 to 4:30 am.	9.59	WLWO	CINCINNATI, OHIO; 8:30 pm to midnight.	10.050	XBBH	MEXICO CITY, MEXICO. 11:25 am to 12:45 pm, at times all day; Spanish.
7.660	YNDG	LEON, NICARAGUA. 7:30 pm to ?	9.59	—	"VOICE OF FREE INDIA." 9 to 11 pm.	10.055	SUV	CAIRO, EGYPT. Afternoons; irregular.
7.820	WKRD	12:45 to 1 am.	9.59	—	"NATIONAL CONGRESS RADIO". 11:15 to 11:55 pm.	10.22	PSH	RIO DE JANEIRO, BRAZIL. 8:15 to 8:30 pm.
8.030	FXE	BEIRUT-LEBANON. 6:30 to 6:45 pm; irregular.	9.595	—	ATHLONE, IRELAND. "Radio Eireann." 7:10 to 8 pm.	10.250	XGAP	PEIPING, CHINA. 10 am to noon.
8.035	CNR	RABAT, MOROCCO.	9.615	TIPG	SAN JOSE, COSTA RICA; "La Voz de la Victor"	10.380	—	"STATION DEBUNK": Station of all free. 8:30 to 9:30 pm; says he is in the U.S.A.
8.484	XPSA	KWEIYANG, CHINA. 7:30 am to 12 noon.	9.620	—	VOICE OF FREE FRANCE. 4 to 5 pm; 9:45 to 10:15 pm.	10.445	—	MOSCOW, USSR. 7:40 to 8:20 am.
8.930	KES2	PACIFIC COAST; 6:15 am to 1 pm.	9.62	—	VICHY, FRANCE. North American beam, 9:45 pm.	10.543	DZD	BERLIN, GERMANY.
8.955	COKG	SANTIAGO, CHILE. Evening transmissions.	9.626	ZRL	CAPE TOWN, SOUTH AFRICA. Daylight transmissions.	10.610	ZIK2	BELIZE, BRITISH HONDURAS. 9 to 9:15 pm.
8.96	AFHQ	ALGIERS. 6:30 to 7:45 pm; irregular.	9.630	2RO3	ROME, ITALY; 6:30 pm to midnight.	10.620	CEC	SANTIAGO, CHILE. 7:30 to 8:15 pm; irregular.
9.04	—	FRENCH EQUATORIAL AFRICA. "Radio Club"; 9 to 10:20 am; 2 to 3:20 pm; 5 to 5:30 pm.	9.635	XGOY	CHUNGKING, CHINA. East Asia beam. 7:35 to 9:55 am; 2:30 to 4 pm; European beam, 11:35 am to 12:30 pm; 4 to 5 pm; North American beam, 10 to 11:30 am.	10.620	KES3	PACIFIC COAST; 1 to 6 am
9.125	HAT4	BUDAPEST, HUNGARY. 9:15 to 9:30 pm; 10:15 to 10:30 pm.	9.637	—	"GUSTAV SIEGFRIED EINS". Variable times of evening.	10.840	KWV	PACIFIC COAST; 2 to 4:30 am.
9.415	OAX4W	LIMA, PERU. "Radio America" 9 pm to midnight.	9.64	COX	HAVANA, CUBA. 1 to 11:15 pm.	11.145	WRUS	7:30 pm to 2 am
9.437	COCH	HAVANA, CUBA. Evenings.	9.64	KZRH	MANILA, PHILIPPINES.	11.145	WCDA	NEW YORK CITY; 5 to 6:45 pm.
9.465	TAP	ANKARA, TURKEY.	9.645	LLH	OSLO, NORWAY.	11.150	PRL8	RIO DE JANEIRO, BRAZIL. Afternoons and evenings except Sundays. Off at 11 pm.
9.47	JZHA	HONG KONG	9.645	—	"GUSTAV SIEGFRIED EINS". Variable times of evening.	11.37	—	CROATIAN FREEDOM STATION. 2:30 to 2:40 pm.
9.48	—	MOSCOW, USSR. 6:48 to 11 pm.	9.650	WCRC	NEW YORK CITY; 12:15 to 2 am.	11.470	—	AZAD MOSLEM RADIO; 9:30 to 9:45 am.
9.482	—	"GUSTAV SIEGFRIED EINS". Variable times of evening.	9.670	WNBI	NEW YORK CITY; 12:15 to 2 am; 4:30 to 6 pm.	11.470	—	"NATIONAL CONGRESS RADIO" (INDIA); 12:15 to 12:53 pm.
9.490	WCBX	NEW YORK CITY; 7:55 to 11:30 pm.	9.67	COCQ	HAVANA, CUBA. Evening transmissions.	11.470	—	"VOICE OF FREE INDIA"; 10 am to 12:05 pm.
9.490	KRCA	PACIFIC COAST; 1 am to 1 pm.	9.685	TGWA	GUATEMALA CITY, GUATEMALA. Night transmissions.	11.6	—	RUMANIAN FREEDOM STATION. 1:45 to 1:55 pm, 4:15 to 4:25 pm.
9.50—XEWV		MEXICO CITY, MEXICO. Evening transmissions.	9.69	LRAI	BUENOS AIRES, ARGENTINA; off at present time.	11.623	COK	HAVANA, CUBA; daily, 1 pm to 1 am; Sundays, 2 to 8 pm.
9.505	JLG2	TOKYO, JAPAN. 7:30 to 7:45 am; 8 to 8:45 am.	9.690	GRX	LONDON, ENGLAND. 10:45 pm to 12:45 am.	11.675	OPL	LEOPOLDVILLE, BELGIAN CONGO. 3:15 to 3:30 pm; 4:30 to 4:45 pm.
9.520	—	GENEVA, SWITZERLAND. 9 to 10:45 pm.	9.700	WRUW	BOSTON, MASSACHUSETTS; 11 pm to 2 am.	11.68	GRG	LONDON, ENGLAND. 5:15 to 7:15 pm.
9.52	DZD	BERLIN, GERMANY. North American beam; evenings.	9.7	—	FORT DE FRANCE, MARTINIQUE	11.70	HB5A	PANAMA CITY PANAMA.
9.523	ZRH	JOHANNESBURG, SOUTH AFRICA. Daylight transmissions.	9.720	PRL7	RIO DE JANEIRO, BRAZIL; "Radio Nacional"; 6 to 9:55 pm.	11.705	CBFY	VERCHERES, CANADA. 7:30 am to 11:30 pm.
9.530	—	BERNE, SWITZERLAND; U.S.A. beam, 9 to 11 pm except Saturday.	9.720	XGOA	CHUNGKING, CHINA. 7 am to 1 pm.	11.705	SBP	MOTALA, SWEDEN. 12 to 2:15 pm.
9.530	WGEO	SCHENECTADY, NEW York; 5:30 pm to midnight.	9.735	CSW7	LISBON, PORTUGAL.	11.705	CXA19	MONTEVIDEO, URUGUAY. Evenings.
9.530	WGEA	SCHENECTADY, NEW York; 3:30 to 6 am.	9.750	WCDA	NEW YORK CITY; midnight to 2 am.	11.705	—	FRENCH INDO CHINA. "Radio Saigon"; 8 am to 12 noon.
9.535	HER4	BERNE, SWITZERLAND. North American beam, 9:30 to 11 pm, except Saturdays.	9.750	—	ROME, ITALY. Day and night transmissions.	11.710	WLWO	CINCINNATI, OHIO. 6 to 9 am, 3:45 to 5:15 pm.
9.535	JZI	TOKYO, JAPAN. 2:15 pm; 7 to 9:30 pm; 7:30 to 7:45 am; 8 to 8:45 am.	9.755	—	DURBAN, SOUTH AFRICA. Day and night transmissions.	11.71	VLG3	MELBOURNE, AUSTRALIA; Tahiti beam, news in French, 1:55 am; British beam (English), 2:55 am; Pacific beam (Japanese) 3:30 am; New Caledonia beam (French) 4:30 am; Allied Forces in South Pacific beam (English) 5:30 am.
9.535	SBU	MOTALA, SWEDEN. 12 to 2:15 pm.	9.760	WKLJ	NEW YORK CITY	11.720	CJRX	WINNIPEG, CANADA. Noon to 4:30 pm.
9.540	VLG2	MELBOURNE, AUSTRALIA. 8 to 8:45 am.	9.780	—	ITALIAN UNDERCOVER STATION; variable times of evenings; sometimes afternoons.	11.72	HSP5	THAILAND.
9.543	XEFT	MEXICO CITY, MEXICO. Evenings.	9.835	—	HUNGARIAN NATIONS RADIO. 2:15 to 2:27 pm, 7:15 to 7:27 pm, speaks German.	11.72	PRL8	RIO DE JANEIRO, BRAZIL; "Radio Nacional"; nightly beamed to North America.
9.545	—	"GUSTAV SIEGFRIED EINS." Variable times of evening.	9.84	CR7BE	MOZAMBIQUE; News in English, 4:50 pm daily.			
9.545	—	KOMSOMOLSK, SIBERIA, USSR. 7:40 to 8:20 am; 10:15 to 10:30 am.	9.86	EAQ	MADRID, SPAIN.			
9.562	OAX4T	LIMA, PERU. "Radio Nacional" 2 to 8 pm, daily.	9.897	KROJ	LOS ANGELES, CALIFORNIA; 11 pm to 1:45 pm.			
9.565	JRAK	TOKYO, JAPAN. 7 to 9:30 pm.	9.905	WKRX	NEW YORK CITY			
9.57	KWIX	SAN FRANCISCO, CALIFORNIA. 8 pm to 12:45 am daily.						

(Continued on page 46)

YOUR MONEY BACK IN 5 DAYS

IF Ghirardi's big 972 page **RADIO PHYSICS COURSE** doesn't teach you **RADIO-ELECTRONIC** fundamentals **FASTER** and at **LESS COST** than any other book or course!



A. A. GHIRARDI
Radio's most widely read Author

THE MOST WIDELY USED TRAINING BOOK OF ITS KIND IN THE WORLD

Here, in a single, big 972-page volume, is a miracle of modern Radio-Electronic Training—sold at a small fraction of the price you might expect to pay—and backed with our 5-DAY MONEY BACK

GUARANTEE that makes you the sole judge of whether or not you want to keep it. *You cannot lose!*

NO PREVIOUS TRAINING REQUIRED

Everything that can be done to make learning Radio easy for you at home has been done in Ghirardi's **RADIO PHYSICS COURSE**. No previous training is required. All you need is a little spare reading time—and a desire to get started **RIGHT** for a profitable, interesting future in any of Radio's many branches, from Radio and Electronic Servicing, to Aviation, Military, Broadcasting, Manufacturing, Public Address, and others. There is no guesswork when you buy Ghirardi's famous **RADIO PHYSICS COURSE**. You **KNOW** you'll get complete, time-tested Radio-Electronic training and get it right **BECAUSE**:

1. *This same inexpensive book has given more people their basic training than any other ever published.*
2. *It is more widely endorsed*

- and recommended by men in Radio.*
3. *It is more universally used for home study, and more widely used in more U.S. Army Signal Corps, Navy, and civilian schools and colleges than any other.*

Would you want any better proof?

What other books and courses skim over, **RADIO PHYSICS COURSE** painstakingly explains in detail so that you cannot fail to understand clearly. It even contains over 300 pages devoted to the all-essential foundation knowledge of Electricity without which no Radio Training could possibly be complete or understandable.

MORE TRAINING FOR YOUR MONEY

Such features are highly important. They explain why thousands of civilians and men in the armed forces report that **RADIO PHYSICS COURSE** makes the study of Radio-Electronics easier, more interesting, and more genuinely helpful to them than any other book or course they've ever seen.

Actually, this famous volume gives you the scope of 36 different courses in one—packed into an easy-to-follow 972-page book with 508 clear illustrations, and 856 self-testing review questions—all for the price of only \$5 complete (\$5.50 foreign). Send for it today!

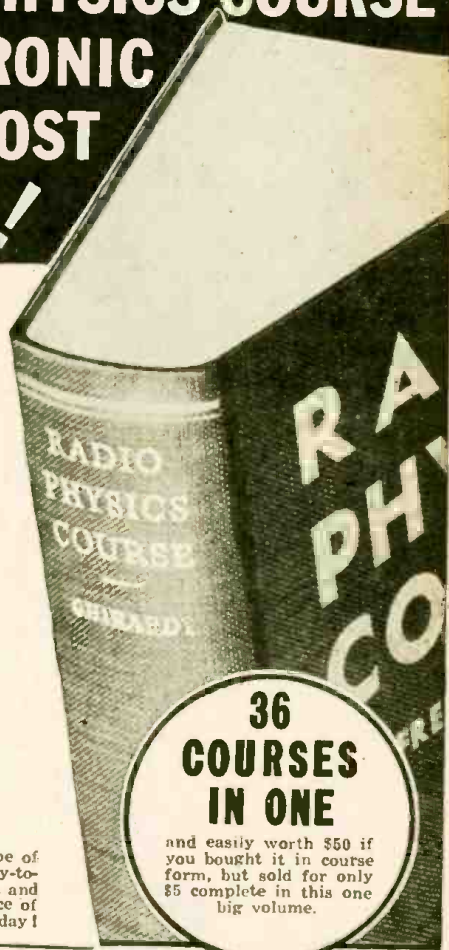

36 COURSES IN ONE
and easily worth \$50 if you bought it in course form, but sold for only \$5 complete in this one big volume.

NEW! Ghirardi's Wartime Guide for DIAGNOSING, LOCATING, AND REPAIRING RADIO RECEIVER TROUBLES (RADIO TROUBLESHOOTERS' HANDBOOK — Now in its 3rd Revised Edition)

Stop guessing on radio service jobs—stop wasting time **THAT ACTUALLY COSTS YOU MONEY!** . . . Here is the most important book any repair shop or individual can own during these war shortage days! Enables you to cut corners on jobs—cut troubleshooting and repair time **IN HALF**—train new helpers—repair cheap sets at a real profit—substitute available tubes and parts properly—

handle tough jobs in half the usual time—and much more.

COVERS 75 VITAL SUBJECTS

This new 3rd, Special Wartime Edition of Ghirardi's popular **RADIO TROUBLESHOOTERS' MANUAL** has been completely revised, greatly enlarged, and contains nine entirely new and additional sections of vital new material—including the finest, most up-to-the-minute tube chart you've ever seen.

Its 404-page Case History Compilation gives common trouble symptoms (their Causes and Remedies), for over 4,800 models of the 202 most popular makes of receivers—and that is just the beginning of the book's usefulness. 74 other big subjects include all the various kinds of information you need to help you repair more radios in less time and at better profit to you. Sold for only \$5 complete (\$5.50 foreign) on a 5-DAY MONEY-BACK GUARANTEE. Folder free.

JUST OUT!

GHIRARDI'S FAMOUS MODERN RADIO SERVICING

Another indispensable volume by Radio's best known technical author is Ghirardi's **MODERN RADIO SERVICING**—the only single text book covering modern radio testing instruments, troubleshooting, and repair procedure **COMPLETELY**. Actually, it is a 1300-page home-study course on the entire art of Radio repair, complete with 706 illustrations, and 720 self-testing review questions. Sold for only \$5 complete (\$5.50 foreign).

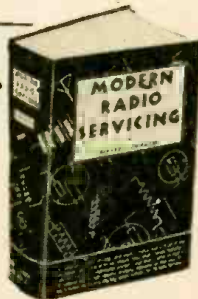

See Money-Saving Combination Offer in Coupon!

THE 3 GREATEST VALUES IN MODERN RADIO TRAINING

RADIO & TECHNICAL PUBLISHING CO., Dept. RC-103
45 Astor Place, New York (3), N. Y.

- Enclosed find \$ in payment for books checked below; or
- Send C.O.D. for this amount plus postage. In either case, if I am not fully satisfied, I may return the books at the end of 5 days AND RECEIVE MY MONEY BACK.
- Ghirardi's **RADIO PHYSICS COURSE** \$3.00 (\$5.50 foreign).
- NEW 3rd Revised Edition of **RADIO TROUBLESHOOTERS' HANDBOOK** \$5.00 (\$5.50 foreign).
- MODERN RADIO SERVICING** \$5.00 (\$5.50 foreign).

MONEY-SAVING COMBINATION OFFER!
 Troubleshooters' Handbook and Modern Radio Servicing at a special price of only \$9.50 FOR THE TWO (\$10.50 foreign).

Name
Address
City [Dist. No.] State

REPAIR ANY MAKE OF RADIO EQUIPMENT!

Prepare Now for a Good-Paying Job in the Radio-Electronic Field

THE QUESTION BOX

QUERIES

All queries should be accompanied by a fee of 25c to cover research involved. If a schematic or diagram is wanted please send 50c, to cover circuits up to 5 tubes; for 5 to 8 tube circuits, 75c; over 8 tubes, \$1.00.

Be sure to send the fullest possible details when asking questions. Give names and MODEL NUMBERS when referring to receivers. Include schematics of your apparatus whenever you have such. Serial numbers of radios are useless as a means of identification.

All letters must be signed and carry FULL ADDRESS. Queries will be answered by mail, and those of general interest reprinted here. Do not use postcards—postmarks often make them illegible.

No picture diagrams can be supplied.

Back issues 1942, 25c each; 1941, 30c each; 1940, 35c each.

Any issue, prior to 1940, if in stock, 50c per copy.

AN ELECTRIFIED SIGNAL TRACER

? There was a schematic diagram of a low-cost signal tracer in one of the summer issues of 1940. I would like to know what

sary is to use pin jacks for the taps, and to plug the phones directly into them. The neon tester was not so readily adaptable,

The original numbers which were printed with this schematic are given here for the benefit of those who have constructed the device, and would like to follow the circuit changes. Unfortunately for would-be constructors, the issue (August, 1940) is exhausted and no longer available.

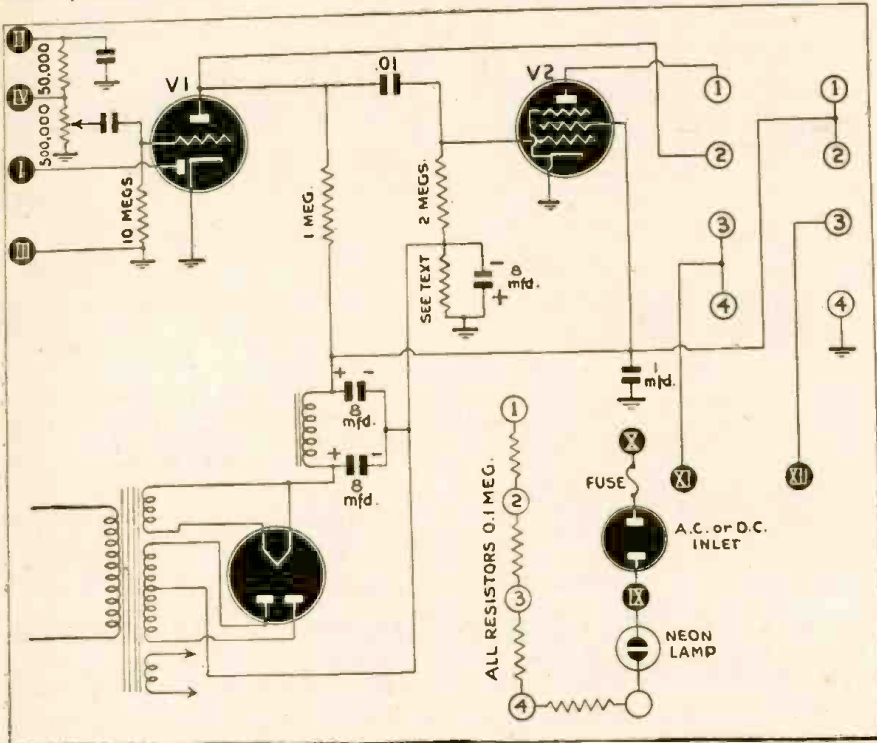

changes can be made to omit the 1D8-GT and the gang switch, substituting another tube or tubes and a small power transformer to take the place of the batteries. The tube cannot be obtained nor can batteries.—H.E.H., Youngstown, O.

and a slight circuit change had to be made.

It would be possible to hook this set up as A.C.-D.C. by using a 25Z5 or similar rectifier instead of the transformer and the one shown, which may be an 80, 84 or any other ordinary rectifier tube.

SIGNAL GENERATOR QUERY

? I have read Radio-Craft since I saw my first issue a year ago. I have been looking for an all-wave signal generator but haven't seen one that suits me. Could you print one in the Question Box in one of the next few issues?—E.L.M., Montreal, Canada.

A. I considered the Signal Generator described on Page 729 of the September, 1942, issue, an excellent signal generator. It is readily adaptable to all types of tubes, and the circuit is such that it can be made to oscillate readily on all wavelengths. If it falls short of your requirements in any respect, let us hear from you on its drawbacks, and we will try to find one more suitable.

PORTABLE BATTERY AMPLIFIER

? Will you please supply me with the diagram for a portable battery amplifier that will operate from a radio or phonograph? I prefer to use tubes like the 30, 33, 34 and 19.—P.E.R., Fordtown, Texas.

A. The required diagram is here printed. The number of tubes can be kept down by using type 19 tubes in both the inverter and power amplifier stages. This should give satisfactory volume with an average phonograph pickup.

The problem consists of breaking up the combination tube into a diode-triode and a pentode. Numerous combinations will work. You may use a 55 or a 2A6 with a 47 or 2A5, (or even a 59, to say nothing of using a 27 or 56 as the output tube). Six-volt tubes give a wide range of choice, as the diode-triode may be a 6R7, 75, 85, 6Q7, 6B6 or 7C6, and the pentode a 38, 41, 42, 89, 6F6, 6K6, 6G6, 6A4 or 7B5, or even some of the 6L6—6V6 family. It is only necessary to calculate the resistor marked "See Text" to give the proper grid bias for the tube chosen. This is of course obtained by dividing the correct grid bias as obtained from the tube manual by the sum of the screen and plate currents. A resistor of about 400 ohms will work for most of the tubes in this list.

A 6Q7 or one of its variants is to be favored for the first tube, as it works at zero volts bias, as provided by the circuit.

Getting rid of the switches is a simple matter, since the two important ones were connected to the phones. All that is neces-

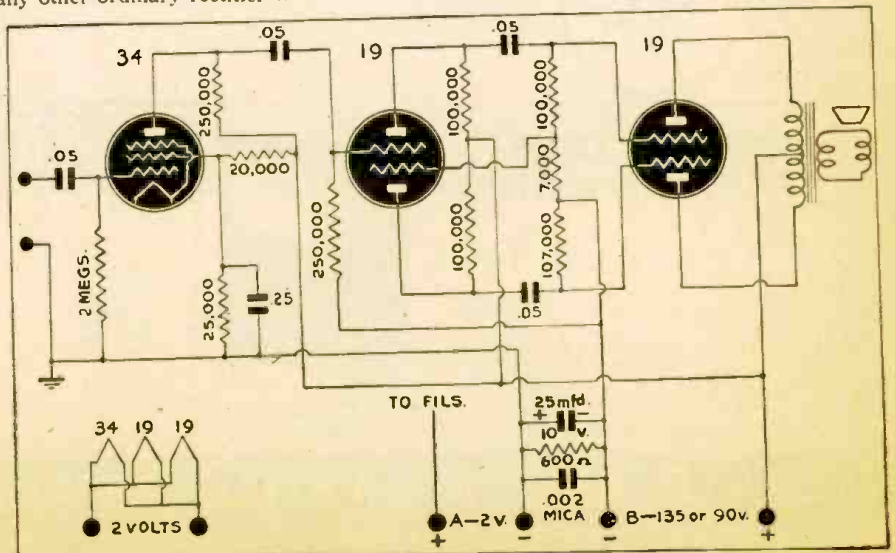

SPRAGUE TRADING POST

EXCHANGE — BUY — SELL

Your Own Ad Run FREE!

The "Trading Post" is Sprague's way of helping radio servicemen obtain the parts and equipment they need, or dispose of the things they do not need during this period of wartime shortages. Send in your own ad today—to appear free of charge in this or one of several other leading radio magazines on our list. Keep it short—50 WORDS OR LESS—WRITE CLEARLY, word it exactly as you would like it to appear—and confine it to radio items. "Emergency" ads will receive first attention. Address it to:

SPRAGUE PRODUCTS CO., Dept. RC-310
North Adams, Mass.

WANTED—Superior Channel Analyzer. Must be in good condition. Cash or swap parts. Ray Johnson, 966 Fort Wayne Ave., Indianapolis, Ind.

TUBE TESTER WANTED—Am in urgent need of up-to-date model, A-1 condition. Ray D. Loewen, Box 35, Inola, Okla.

URGENTLY NEEDED — Solar capacitor and resistance bridge analyzer; a model 560 Vedolyzer; and an Oscillator to match. Could also use a model 585 deluxe diagnostic, or any good 3" oscilloscope. Cash's Radio Service, Aldrich, Minn.

RECORDER WANTED — Professional or semi-professional model in good condition. State make, model, and equipment. Robert Woodburn, 915 E. Washington St., Iowa City, Iowa.

WANTED AT ONCE—Late model tube checker; good oscillator, any model; oscilloscope with tube. Fred L. Elliott, Bryan's Road Post Office, Maryland.

WANTED—Good tube tester and Rider's manuals, vols. 1 to 11. Give full description and price. Don Y. Yen, 343 Louis St., Rockford, Mich.

OSCILLOSCOPE WANTED—Will pay cash for late model scope, 9" DuMont, RCA, or other reliable make in good, serviceable condition. Zelna N. Cokes, 21 Barclay Ave., Portsmouth, Va.

CONDENSER TESTER WANTED—Must be in good working condition. I pay the price. Walter Kohler, Radio Service, Syosset, N. Y.

WILL TRADE—Want to swap Hallicrafter SX25 (with speaker) for test equipment and 12SA7, 12SQ7, 50LE, 35Z5 tubes. Martins Radio Service, Route 1, Gastonia, N. C.

FOR QUICK SALE—Hickok tube and set analyzer (1938) factory-converted for 112 V. tubes; Hickok AF-RF signal generator (1938); Aerovox line noise analyzer; aligning tools; loads of service and radio magazines; radio books; slide rule; a few parts and tools, all in 1st class condition. \$125 F.O.B. Utica takes it, or make an offer for part. L. W. Briggs, Radioman, Naval Radio Station, Cheltenham, Washington, D. C.

WANTED—Want Triplett Red Dot tube tester, model 1612 or 1613 or recent tube tester of other brand. Will consider tube VOM combination. Have for sale 1 Briggs & Stratton 1 h.p. gas motor in good condition, \$10. Clifford D. Lessig, Frenchtown High School, Frenchtown, N. J.

FOR SALE—Bogen Hi-Fi amplifier, PV20, 20-watts, list \$95; two Bogen professional recorders, 500 ohm Audak heads, compl. with cable, etc., list at \$485 each; four Jensen 12" A12PM speakers, list \$41 each; one 100-watt modified Bogen amplifier; one Vibroplex deluxe, new, with case; one TZ-40 tube; several thousand feet No. 18 rubber-covered wire, double conductor. Write for details or make offer. John H. Elrod, 1424 K St., N.W., Room 606 Washington, D. C.

WANTED—Rider chanalyst, Rider signalist, and Solar exam-meter. Make offer. The Radio Man, 1724 Central Ave., Middletown, Ohio.

FOR SALE OR TRADE—We offer long list of items including amplifiers (also theatre types); intercom systems; juke box; Tunzgar chargers and bulbs; trickle charger; motion picture projectors, misc. speakers, etc., etc. Write for complete list. Will sell for cash or trade for high-wattage amplifier equipment, mikes, recorders, speakers, and other PA equipment. Nightingale Sound Service, 434 Westminister Ave., Greensburg, Pa.

WANTED — For Civilian Defense unit: low-powered xmitter parts and u-h-f receiver parts. Also want General Industries RM-4 rim-drive recording motor or similar unit, new or used. Have for sale or trade: Cardwell condenser; Weston voltmeter, roto coil, etc., also hard-to-get tubes, condensers, transformers, speakers and other parts. Send list of what you can supply with price. Bill Benner, 145 S. Maple Ave., Webster Groves 19, Mo.

RADIO SHOP WANTED—Want radio shop in a medium-sized town. Need not be fully equipped, but would prefer one with good stock of tubes. State price. Duane Meyer, 1114 Court St., Beatrice, Nebr.

WANTED — Combined tube-tester and VOM, RCP model 803 or equivalent. State age, cond., price. R. E. Turner, 5016 13th Ave., Sacramento, Calif.

URGENTLY NEEDED — S19R EC1, or similar receiver. State price and condition. Private Don Edwards, Co. "D," A.S.T.B., North Camp Hood, Texas.

BADLY NEEDED—V.O.M., signal generator, and set of Rider's Manuals. Geo. H. Welch, 1235 So. Avolon, Alliance, Ohio.

WANTED—Volt-ohm-milliammeter, must be in first class condition. Elmer H. Neumann, 2906 E. 25th St., Vancouver, Wash.

EQUIPMENT FOR SALE — One Clough-Bregle CRA 3" scope, used about week, \$85; one Supreme 561 AF-RF signal generator (metered) push button frequency selector. A-1 condition, \$90 (late 1942); one Supreme Audolyzer #562 with vacuum tube voltmeter and ohmmeter, uses single probe line. A-1 condition, \$85 (late 1942). Will ship C.O.D. express. D. A. Dargie, P. O. Box 35, Joseph City, Ariz.

WANTED—Scott all-wave 15- or 23-tube chassis compl. with audio-amplifier and speakers, with or without cabinet. State price and cond. R. Cooper Bailey, P. O. Box 112, Richmond, Va.

WANTED AT ONCE—Tube tester in A-1 condition. Give full description and price. K.L.H. Radio Repair Service, P. O. Box 1002, Santa Fe, New Mexico.

WANTED—VOM, signal generator (battery-operated) and Rider's Manuals. State price, make and cond. in first letter. Wm. J. Schwallier, 514 9th St., Henderson, Ky.

FOR SALE—Supreme Audolyzer model 562. Write for details. J. O. Reese, Box 243, Franklinton, La.

WANTED—RCA voltohmyst, any condition. Ross McCann, Jr., 718 Live Oak, Menlo Park, Calif.

WANTED—Vacuum tube voltmeter, communications receiver, tubes and Rider chanalyst. Have radio parts, new FM converter, and cash. Wayne Storch, Beecher, Ill.

WANT TO BUY—New or used (provided in perfect working condition) Superior multi-meter model 1250. Name price. E. M. Brownlee, 36 St. Philippe St., Valleyfield, Quebec, Canada.

WANTED AT ONCE—Tube Tester and volt-ohm-milliammeter. Will pay cash. Victor S. Flynn, Machiasport, Me.

WANTED—Any pocket type VOM. State details and price. G. Thoden, R. D. 1, Box 117E, Asbury Park, N. J.

WILL BUY OR SWAP—Want Hickok Traceometer, model 155 and a tube tester. Have several VOM's. Write for specifications. Also have Stewart Warner comb. phono-radio-recorder—PA chassis-11-6T. Martin F. Klinger, Route 2, New Ulm, Minn.

WANTED — Will pay good price for RCA Voltohmyst. Prefer senior model. Ed's Radio Ray, 220 Grand Ave., Spencer, Iowa.

THIS HELPFUL BOOKLET FREE

Write today for your free copy of the Sprague "VICTORY LINE" FOLDER. Besides listing the various Sprague Atom electrolytics and the Sprague TC tubular Condensers now available for civilian service use under wartime restrictions, this Folder contains helpful data on how to use Victory Line Condensers in handling practically every replacement job. It tells you, for instance, how to replace 600 volt Capacitors with 450 volt types; how to use dries on wet electrolytic jobs, and much more. Rush a post card today for your free copy!



SPRAGUE
PRODUCTS CO.
North Adams, Mass.

SPRAGUE CONDENSERS AND KOOLOHM RESISTORS



Obviously, Sprague cannot assume any responsibility, or guarantee goods, etc., which might be exchanged through the above advertisements

Diagrams for

THE RADIO EXPERIMENTER

If you have a new Hook-Up, send it along; a pencil diagram will do. Be sure to include a brief description.

All diagrams and descriptions accepted and published will be awarded six-month subscription. Diagrams may be for receivers, adapters, amplifiers, etc. Send them to Hook-Up Editor, RADIO-CRAFT, 25 W. Broadway, New York City 7.

AN EFFICIENT FOUR-TUBE RECEIVER

I have been using this circuit on the short and long waves for quite some time. I am using manufactured coils.

The set seems quite tricky. The 27 detector works better than the usual 57 or some other pentode on the higher frequencies. I found that about 180-volts works better than about 300-volts.

The antenna condenser is not a trimmer, but a small variable, as it is easier to set for each band, and must be carefully set each time. However, it takes only a few seconds. The regeneration method works very well also.

This set works as well, if not better, than any T.R.F. receiver, and as good as some superhets.

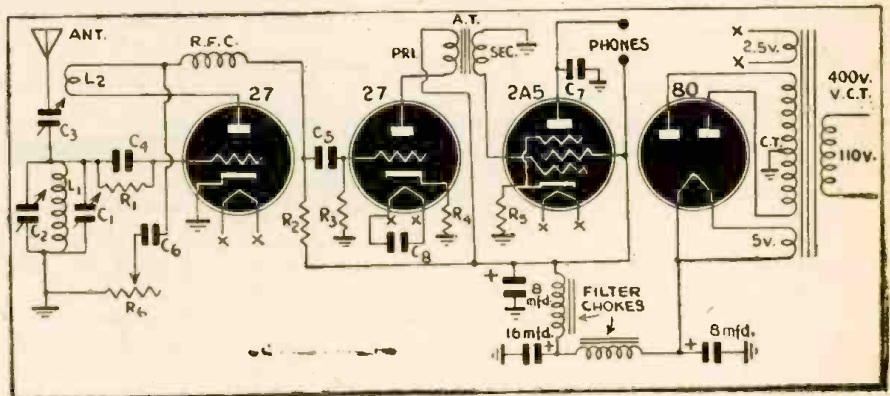

Parts List

CONDENSERS

- C1—250 mmf.
- C2—30 mmf.
- C3—15 mmf.
- C4—100 mmf.
- C5—.01 mf.
- C6—.001 mf.
- C7—.006 mf.
- C8—.01 mf.

RESISTORS

- R1—2 meg.
- R2—100,000 ohms
- R3—250,000 ohms
- R4—2,500 ohms
- R5—400 ohms
- R6—50,000 ohms

MISCELLANEOUS

- RFC—2.5 mh.

ROBERT J. MEAGHER,
W. Peabody, Mass.

1-TUBE A.C.-D.C. RECEIVER

Below is the diagram of a 1-tube A.C.-D.C. set that has been used by me for about six months. In about 25 nights I received over 200 S.W. stations from as far away as Little America.

The set uses a 6C8G as combined detector and rectifier. The tuning is by a variable condenser and plug-in coils. The set is used with phones or a small P.M. speaker.

LEO SILBER,
Springfield, Mass.

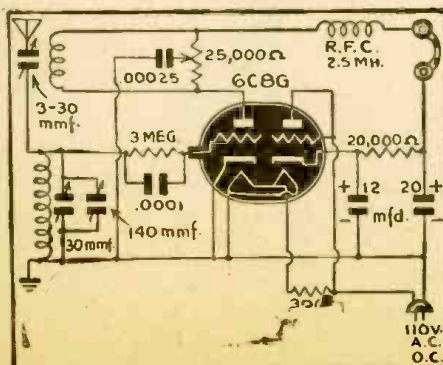

PHONO OSCILLATOR FROM A.C.-D.C. MIDGET

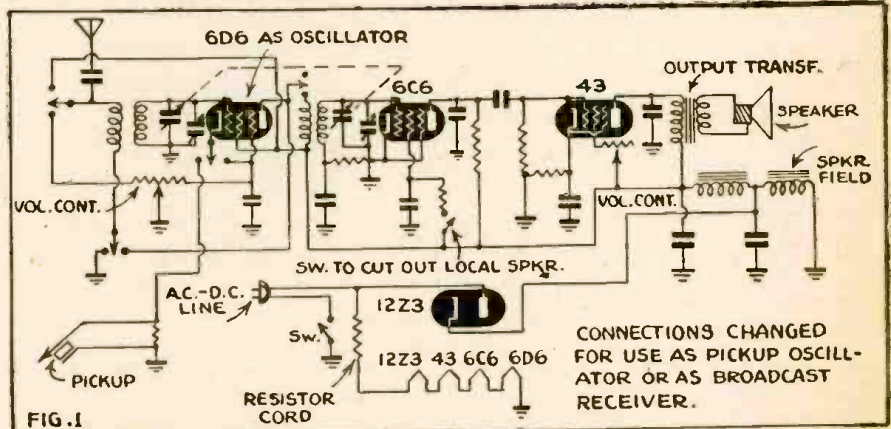

FIG. 1

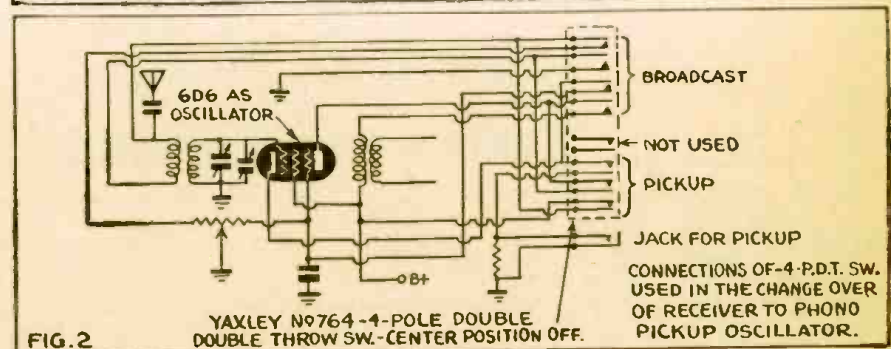

FIG. 2

I show here how I converted a four-tube A.C.-D.C. receiver into a phonograph wireless player, that works very well.

Figure 1 shows the circuit of the set after the revisions were made. Note the 4-pole double-throw switch that was inserted, and to which the pickup was attached.

With this arrangement the set can be used as a wireless player or as a broadcast receiver using its own audio end. When used as a wireless player it can be picked

up by other radios within the usual limited legal radius of such a player.

Figure 2 shows in detail how the switch was inserted into the circuit. This enables anyone having a turntable and a pickup, to make the few connections without difficulty.

It is of course not necessary that a radio like the one I have shown here be used. Any one similar to it can be used.

LLOYD F. BEHRENDT,
Milwaukee, Wis.

**ON
SEPT.
9TH**



Your Bond Selling Responsibilities Double!

Starting September 9th, your Government will conduct the greatest drive for dollars from individuals in the history of the world—the 3rd War Loan.

This money, to finance the invasion phase of the war, must come in large part from individuals on payrolls.

Right here's where YOUR bond selling responsibilities DOUBLE!

For this extra money must be raised *in addition* to keeping the already established Pay Roll Allotment Plan steadily climbing. At the same time, every individual on Pay Roll Allotment must be urged to dig deep into his pocket to buy *extra* bonds, in order to play his full part in the 3rd War Loan.

Your now *doubled duties* call for these two steps:

1. If you are in charge of your Pay Roll Plan, check up on it at once—or see that whoever is in charge, does so. See that it is hitting on all cylinders—and *keep it climbing!* Sharply

increased Pay Roll percentages are the best warranty of sufficient post war purchasing power to keep the nation's plants (*and yours*) busy.

2. In the 3rd War Loan, every individual on the Pay Roll Plan will be asked to put an *extra two weeks salary* into War Bonds—over and above his regular allotment. Appoint yourself as one of the salesmen—and see that this sales force has every opportunity to do a real selling job. The sale of these *extra* bonds cuts the inflationary gap and builds added post-war purchasing power.

Financing this war is a tremendous task—but 130,000,000 Americans are going to see it through 100%! This is their own best *individual* opportunity to share in winning the war. The more frequently and more intelligently this sales story is told, the better the average citizen can be made to understand the wisdom of turning every available loose dollar into the finest and safest investment in the world—United States War Bonds.

BACK THE ATTACK  **With War Bonds!**

This space is a contribution to victory today and sound business tomorrow by RADIO-CRAFT
RADIO-CRAFT for OCTOBER, 1943

RADIO KINKS

KNOBBS FROM BOTTLE CAPS

Sometimes especially in fixing up old or discarded sets, the serviceman needs a set of knobs. Sets of these can easily be made from plastic bottle caps, quantities of which can be found, in all colors and sizes, around the ordinary household.

All that is needed is a few empty thread spools and a strip of metal, such as clock spring or a steel from an old corset, about 1/4-inch wide.

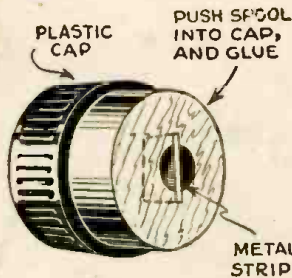

Simply trim the spool and cut it the size of the inside of the cap, then glue it in place. Cut a short piece of the metal strip and drive it into the spool across the hole, leaving enough space to fit the hole snugly to the control shaft of the set. The whole idea is illustrated in the diagram.

R. W. SOCKWELL,
Kellerville, Texas.

TRANSMITTER TUBE CHECKER

I have used this hook-up very successfully for testing the filament emission of 810's, though there is no reason it could not be used equally well with other types of transmitting tubes.

By using one or two brand new tubes as calibrators and setting the rheostat to read (say) 80 milliamperes, a fairly accurate test of filament emission can be made.

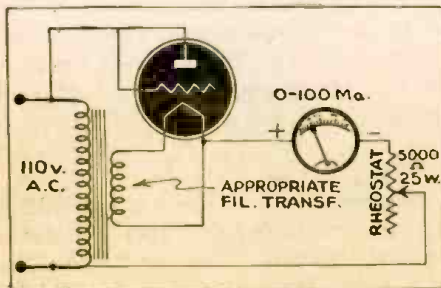

This tester has been very valuable in testing tubes which have been "rejuvenated" by running them at a slightly higher filament voltage and with no plate voltage, according to the maker's instructions.

J. G. WILKINSON,
Ottawa, Canada.

PILOT-LAMP REMOVING TOOL

Every radioman knows how difficult it is to remove pilot lamps from some of the places the set designers put them. I have contrived a gadget that gets some of them in such a simple way that it's almost unbelievable.

Anyone can make it—the sketch shows

Do you have any interesting and novel kinks which you would like to bring to the attention of RADIO-CRAFT readers? If so, send them in addressed to the Kink Editor. A seven-month subscription to RADIO-CRAFT will be awarded for each kink published.

how. It only takes an instant to get pilot lights out of many hidden-away places with this. I am working now on one that will reach around corners!

A. E. REDMOND,
Tacoma, Wash.

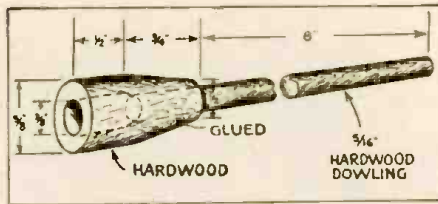

RADIO PARTS FROM SCRAP

The two sketches will show how I use discarded electrical and other material around the house for my radio fittings.

An old flexible lampstand makes an excellent holder for a microphone. It may be necessary to run a little lead. (also often

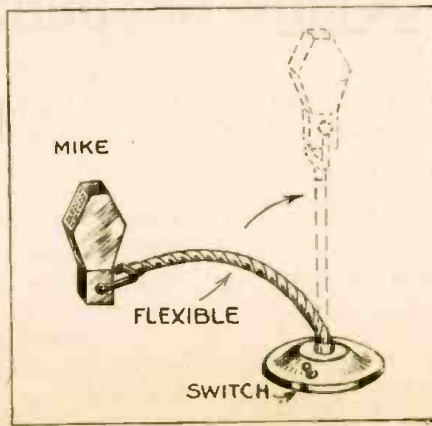

found around the house), into the base to give it extra weight.

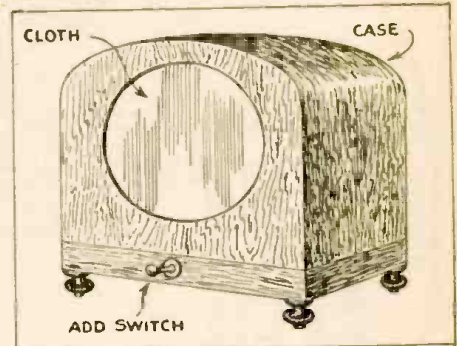

An old clock case was found to be an excellent cabinet for a small speaker.
RICHARD LANE,
Richmond, Va.

A CAPACITY METER

Recent issues of Radio-Craft have printed several circuits for determining the capacity of condensers.

I believe the simplest way is to use a 1,000 ohm-per-volt rectifier-type A.C. voltmeter in series with a condenser across the

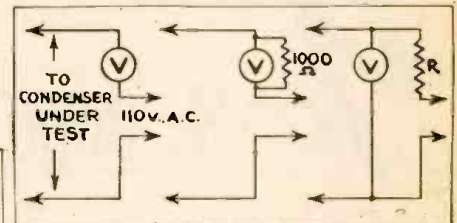

110-volt A.C. line, as illustrated in the diagram.

Though this system is not as accurate as the A.C. bridge, approximate capacities can be identified with more than enough accuracy for radio service work. The meter dial can be calibrated by using condensers of known capacity.

Capacities from .001 mfd. to 0.1 mfd. can be found with Circuit 1, and capacities from 0.1 mfd. to 10 mfd. with Circuit 2. Use Circuit 3 for condensers of larger capacity.

ALEX SEBESTYEN, JR.,
Nashville, Tenn.

TWO 80'S AS GOOD AS ONE 5Z3

I have a 6L6 amplifier with a 5Z3 rectifier tube which burned out. I could not get a new 5Z3.

I find that two 80's in parallel will work just as well, and without heating the plates.

I did not want to change the wiring of the amplifier, so made a small strip of bakelite with one tube base on the bottom and two sockets in parallel on the top.
STANLEY BOWERS,
Cedar Rapids, Ia.

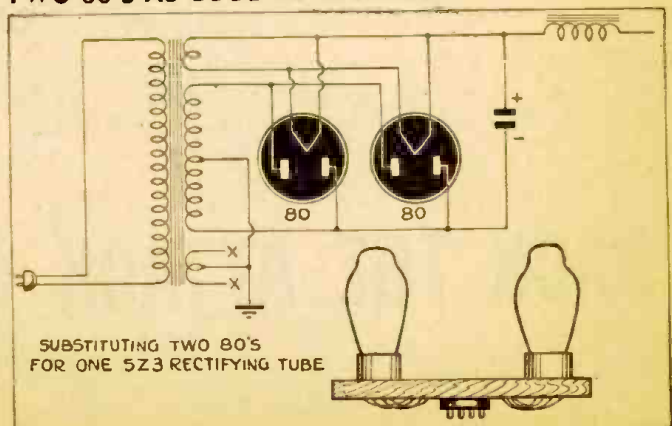

NEW COMPACT CONDENSER

A NEW type flat-disc ceramic condenser recently announced by Erie Resistor Corporation makes possible the attaining of capacities up to .006 mfd. or more in what would formerly have been unbelievably small space.

The condensers, called Disc Ceramicons, consist essentially of a stack of thin ceramic dielectric discs with silver electrodes fired on at high temperature. The secret of their remarkable capacity rests in the ceramic dielectric, a dielectric factor of over 100 being easily obtainable with some types of this material.

The method of mounting is ingenious, resulting in a saving of space while reducing the inductance of the condenser to a minimum.

The complete condenser at A is broken down into its various components. B is the metal shell in which the discs are mounted. C and D are the discs. As will be seen from

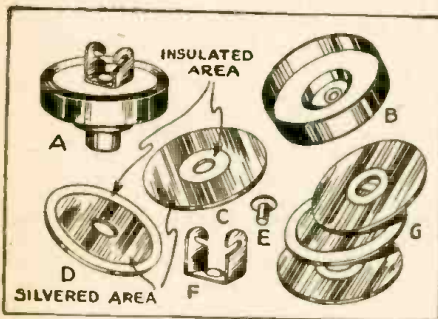

the drawing, C discs are silvered to the outer edge, with an insulating area at the center, while the D discs are silvered from the center to a point near the outside, leaving an unsilvered ring around the edge. The shaded portions are silvered, while those not shaded represent the insulating ceramic material of the discs. The discs are built up alternately on the center rivet E, which makes contact with the discs silvered to the center, while three strips of solder equi-spaced around the outside edge of the stack serve the triple purpose of holding the stack in line, making the electrical connection to one set of plates, and making connection to the metal container which forms one terminal of the condenser. The other terminal is the lug F.

These condensers are put out in two types. The standard Type 170 shown in the diagram is only 15/16 of an inch in diameter, with a maximum height of 3/4 of an inch.

The special dielectric makes for other advantages. Working voltages may be very high, and these minute units are furnished in 500-volt, 1000-volt and 1500-volt ratings. They also come in a wide range of temperature co-efficients, ranging from zero to plus 100 or minus 750 parts per million per degree Centigrade.

A second type, the 160, is put out in 500 working volt rating only. It is 3/4 inch in diameter, and has a screw for mounting, whereas the 170 is threaded for a mounting screw.

TUBE OUTPUT CUT TO NEW LOW

HOME receiver tube output will be cut to 1,500,000 in the next six months, according to latest WPB reports. The tubes to be produced, however, will be those A.C.-D.C. types in which the shortage has been most acute. Thus the limited production may be of a nature to actually ease the present shortage situation, in which one dead tube often keeps several others idle.



Keep 'Em Running FOR THE DURATION!

It is difficult to secure new Generating Sets or new Rotary Converters... Pioneer is devoting all of its resources toward winning the war... but we can, and will, help you keep your present equipment running for the duration.

Send your service problems, by letter, to Pioneer's Customer Service Department.

DYNAMOTORS · CONVERTERS · GENERATORS · DC MOTORS · POWER PLANTS
GEN-E-MOTORS

PINCOR Products

PIONEER GEN-E-MOTOR

CHICAGO, ILLINOIS · EXPORT ADDRESS: 25 WARREN STREET, NEW YORK CITY
CABLE ADDRESS: SIMONTRICE, NEW YORK CITY

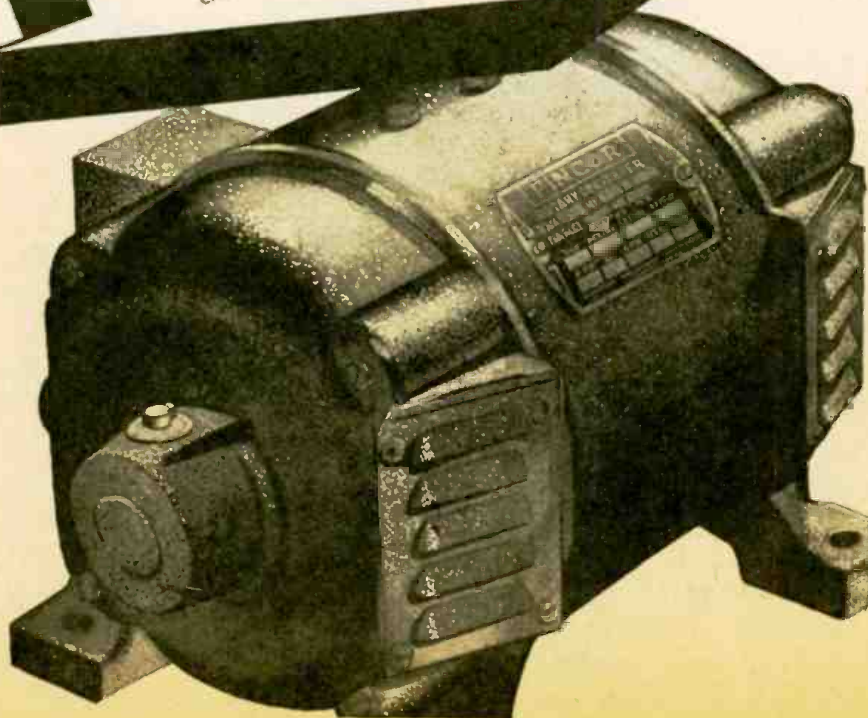

• LATEST RADIO APPARATUS •

TO DRAW YOUR OWN

SYLVANIA SERVICEMAN SERVICE

by
FRANK FAX



HERE is a new and improved little tool-of-the-trade — the Sylvania Symbol Guide.

Just the thing for radio men who draw their own circuits and diagrams.

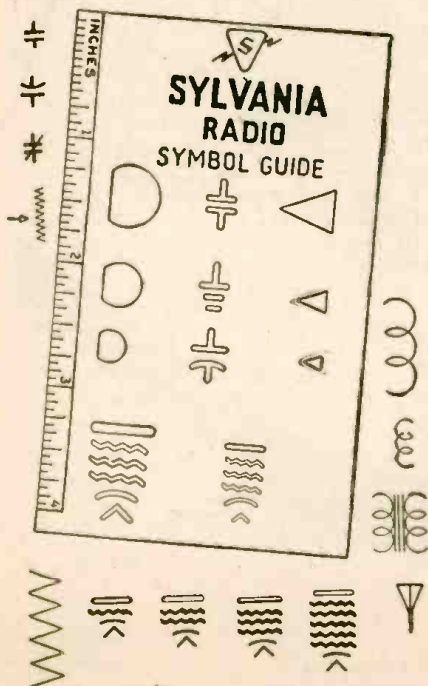

The new guide is made of transparent plastic so you can see your work while drawing. It comes in a heavy paper envelope and contains a complete set of working instructions. Price for this handy pocket tool is only 25 cents. If your jobber does not have one in stock, write to Frank Fax, Dept. RC-10, Sylvania Electric Products Inc., Emporium, Pa.

SYLVANIA

ELECTRIC PRODUCTS INC.
RADIO DIVISION

PANEL PILOT LAMPS

Gothard Manufacturing Co.
Springfield, Illinois

THIS new series of Gothard Pilot Lights is designed for grounded pilot light panels, and presents many noteworthy installation and maintenance features. Measuring approximately 2" in length, they mount on 1" centers permitting a number of units to be incorporated within a very small space.

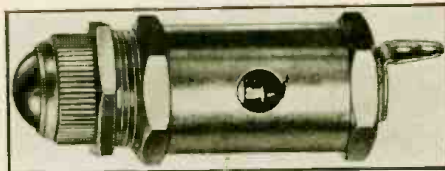

Body of hexagon design facilitates the use of a socket wrench in installation and, therefore, insures a solid mounting that will not work loose over a long period of operation. Bulb change is accomplished from the front of the panel without disturbing body mounting or wiring. The bulb automatically comes out when the jewel holder is unscrewed. Bayonet socket lamps (long or round) may be used. This Pilot Light is well ventilated for cool operation, and is available with either faceted or plain jewels.—Radio-Craft

TUBULAR OIL CAPACITORS

Aerovox Corporation
New Bedford, Mass.

THESE Type '26 capacitors are impregnated oil-filled with Aerovox Hyvol vegetable oil. This means smallest capacitor size and minimum weight consistent with safety in high-voltage operation. The capacitors are built with adequately insulated and matched sections of uniform capacitance, connected in series. Equal voltage stresses are maintained for all sections, with a uniform voltage gradient throughout the length of each capacitor. High-purity aluminum foil with a generous number of tab connectors provides high conductivity



with low inductive reactance. Capacitor sections are dried and impregnated under high vacuum in a closely-controlled long cycle. This eliminates voids and also provides for high insulation values and lower losses.

The case is of special laminated bakelite tubing, protected by a high-resistance insulating varnish for high dielectric strength and maximum safety from external flash-over. Long creepage path between terminals means an exceptionally conservative and safe rating for these units. Dependable operation and long service life is assured at

rated voltages and ambient temperatures up to 65° C.

The terminals are two-piece cast-aluminum end caps with bakelite-treated cork gaskets, which are locked in to provide leak-proof hermetic sealing. Caps are available with mounting feet for space-saving assemblies in series, parallel or series-parallel arrangements. Also obtainable with plain end caps.

This line is designed for X-ray, impulse generator and other intermittent D.C. or continuous A.C. high-voltage applications such as indoor carrier-coupler capacitors, test equipment and special laboratory work.—Radio-Craft

HIGH-VOLTAGE CAPACITORS

Industrial Condenser Corp.
Chicago, Illinois.

THIS new line of heavy-duty, high-voltage capacitors is intended for military applications. They are designed for continuous operation up to 150,000 volts working. The pictured 0.5 Mfd. unit is a 50,000 volt D.C. capacitor: it is 28 inches high and weighs 175 pounds. It is constructed for 24 hours continuous operation and total submersion in salt water!

These units can be used in surge and lightning generators. They are equipped with solder seal terminals for operation at highest altitudes and under the most humid conditions encounterable.—Radio-Craft



HIGH RESISTANCE CORES

Stackpole Carbon Co.
St. Mary's, Penna.

FOR applications calling for Iron Cores having high unit resistivity, a new special core material shows resistance of practically infinity. This is recommended for applications where a resistance of 150 megohms or greater is required, and where voltages do not exceed the breakdown value.

This Stackpole high resistivity material reduces leakage currents and their resultant noise troubles. Possibilities of voltage breakdown between coils and cores are also reduced. In applications using cup cores, the high resistivity core material avoids the necessity for heavy insulation on lead wires.

Other core types are regularly supplied for a wide variety of uses, and for frequencies to 175 megacycles and better.—Radio Craft

POPULAR ELECTRONICS

(Continued from page 9)

this experiment the collector plate (anode, that is) of the cell used should be fairly large and cannot be a mere vertical wire. It is also to be pointed out that the anode of the cell used should not be covered with a layer of alkali metal as often happens in the manufacture of such cells. Such a layer is photo-active; it will also release a few photo-electrons upon exposure to light, though in a lesser degree than the cathode. For all ordinary uses of the cell this is not an objectionable feature, but it will make this particular experiment impossible.

What we are trying to show here is experimental evidence (of a rather homely nature to be sure) in support of the photoelectric equation $h\nu = Ve$. To conduct the experiment, the positive potential on the collector is gradually reduced to zero with the aid of a potential divider. A tiny retarding potential is applied until the current as measured by a galvanometer is zero.

This can be done with a circuit like that of Fig. 7 in the August article. At this point, it can be shown that this potential is precisely the same for a given color of light quite apart from its intensity and that blue or violet light, as an example, will require a greater retarding potential. This proves beyond reasonable doubt that it is not the intensity of light

that counts in the velocity of the electrons released but the frequency of the light itself, the higher the frequency the greater the V_e of the released electrons.

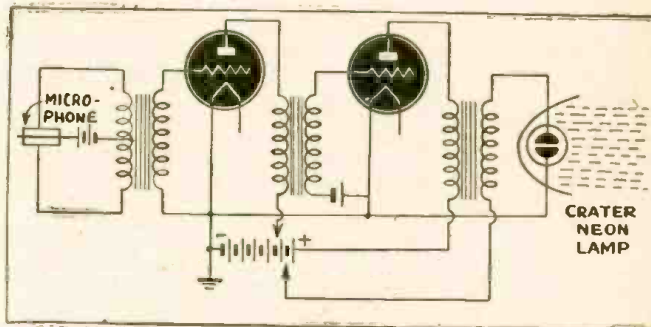

Fig. 5.—A modulated light-beam transmitter, or photophone. These phones are quite practical, and have been used to cover distances up to several miles.

NOW—ELECTRONIC NAILS

(Continued from page 14)

before the next is applied. To prevent shifting of the veneers during this operation, the conventional procedure is to tack each sheet in place with metal tacks or staples, which must be pulled out and reset as each successive layer is added to build up the preformed piece. The use of "radio nails" in place of metal fasteners will eliminate this tedious and time-consuming procedure.

In laying up veneers on a molding form, as well as in some other operations it may be desirable to advance the resin only enough to set the glue to a thermoplastic state—a sufficient bond to prevent accidental shifting the sheets while handling, but with enough flexibility to allow for necessary shifting when pressure is applied to effect the permanent bond.

To permit such variation in the degree of fastness or permanency of the original bond, the spot gluer is equipped with an electronic timer which can be set to control the interval of application. The spot gluer has an output of approximately 50 watts and an operating frequency of about 200 megacycles.

The new gun is largely the work of Joseph E. Joy, development engineer in RCA's Camden, N. J., plant, although others in the organization have participated.

The most powerful lightning strokes—those that split trees, shatter buildings, and create terrific noises—if they could be converted to usable electrical energy and sold at the usual rate would be worth less than half a dollar a dozen.

A strand of wire reaching from New York to Montreal, a distance of 469 miles, can be produced from a rod of tungsten 5½ feet long having a diameter slightly larger than a lead pencil.

WHEN THE LIGHTS
COME ON AGAIN...

MIRROR-TONE

MADE BY THE MAKERS OF AUDIOGRAPH

FOR *Entertainment* IN THE HOME

Life again will be reasonably carefree and happy. When that time comes MIRROR TONE Recreating Phonographs will be available again, to entertain you in your home with music more faithfully mirrored than you have ever known. Thus, the hard lessons of today's experience will be translated into tomorrow's enjoyment.

JOHN MECK INDUSTRIES
PLYMOUTH, INDIANA

PHANATRON

(Continued from page 11)

GENERAL ELECTRIC
PHANATRON TUBE FG-190

The FG-190 is an inert-gas-filled tube designed for use as a full-wave rectifier at low voltages.

TECHNICAL INFORMATION

These data are for reference only. For design information see the specifications.

GENERAL DESIGN

Number of Electrodes	3 Filamentary
Cathode Heater Voltage	2.5
Heater Current, amp approx	12
Heating Time, typical	5 sec
Tube Voltage Drop, volts	
Maximum	13
Minimum	5
Max Pick-up Voltage, either anode, volts	25
Net Weight, ounces approx	6
Shipping Weight, pounds approx	3
Installation and Operation	GEH-977

MAXIMUM RATINGS

Max Peak Inverse Anode Voltage, volts	175
Max Anode Current, amperes	
Instantaneous, 25 cycles and above	5
Instantaneous, below 25 cycles	2.50
Average	1.25
Surge, for design only	20
Max Time of Averaging Current, seconds	15
Temperature Limits, C	-20 to +50 Ambient

WESTINGHOUSE
WL-866A/866

MERCURY VAPOR RECTIFIER
GENERAL CHARACTERISTICS

Air Cooled Diode	
Filament Voltage (A-C)	2.5 volts
Filament Current	5 amperes
Filament Heating Time, typical*	30 seconds
Tube Voltage Drop (Approximate)	15 volts

MAXIMUM RATINGS

Crest Inverse Anode Voltage	
25-150 cycles (Maximum)	10,000 volts
Corresponding Condensed Mercury Temp. Range**	25-60° Cent.
Crest Anode Current, 25-100 cycles	1.0 ampere
Average or D-C Anode Current (Maximum)	0.25 ampere
Crest Inverse Anode Voltage	
25-1000 cycles (Maximum)	5000 volts
Corresponding Condensed Mercury Temp. Range**	25-70° Cent.
Crest Anode Current, 25-1000 cycles	1.0 ampere
Average or D-C Anode Current (Maximum)	0.25 ampere
Crest Inverse Anode Voltage, 25-150 cycles (Maximum)	200 volts
Corresponding Condensed Mercury Temp. Range**	25-70° Cent.
Crest Anode Current, 25-150 cycles	2.0 amperes
Average or D-C Anode Current (Maximum)	0.5 ampere
Maximum Time of Averaging Anode Current for above Ratings	30 seconds

TYPICAL OPERATING CONDITIONS

Typical Operation for 10,000 volt and 1.0

(Continued on following page)

degrees Centigrade (temperature of the condensed mercury), but a peak of only 800 volts if the temperature limit is extended upward to 70 degrees Centigrade.

Phanatron with an atmosphere of argon or other inert gas are free from temperature effects, but in spite of this advantage, most tubes use mercury vapor. The reason is that if an inert gas is used, there is a tendency for it to disappear during the life of the tube. Molecules of the gas disappear into the elements and walls. Because of this clean-up effect (so desirable in high-vacuum tubes) the life of an inert gas rectifier is shortened. Where voltages are low, enough gas can be put into the tube to allow for a certain amount of "clean-up."

Since these tubes give best service when used under steady-current conditions, they are not so commonly found in applications where high currents must be drawn over short periods. They can, however, be used in work where intermittent heavy currents may be drawn, and data for such use is given for all phanatron. When used under these circumstances, the same considerations of maximum (or instantaneous) and average current apply as in the case of such tubes as the Ignitron. The "averaging current time" is also applicable.

The characteristics of a number of representative phanatron are given in the tables.

DESCRIPTIONS AND RATINGS

	GL-266-B	GL-857-B	GL-872	GL-872-A	FG-104
General Design					
Number of Electrodes	2	2	2	2	2
Cathode Type	Filamentary	Filamentary	Shielded Filament	Filamentary	Indirectly Heated
Voltage	5.0	5.0	5.0	5.0	5.0 Volts
Current, approx.	30.0	30.0	10.0	6.75	10.0 Amperes
Transformer Watts, for design purposes			50	50	5
Heating Time, typical	1	1	.5	1/2	Minute
Tube Voltage Drop					
Maximum	20	20	20	20	20 Volts
Minimum	5	5	5	5	5 Volts
Net Weight, approx.	3 1/2	3 1/2	6	1/2	12 Pounds
Shipping Weight, approx.	9 1/2	9 1/2	3	3	3 Pounds
Installation and Operation	GEH-977	GEH-977	GEH-977	GEH-977	GEH-977
Maximum Ratings					
Maximum Peak Inverse Anode Voltage					
150 cycles or less	10,000	10,000	7,500	5,000	Volts
Corresponding condensed mercury temperature limits	25C-65C	25C-65C	10C-60C	25C-70C	Contin- Weld- uous Control Service Service
Type of cooling	Natural Ventilation	Natural Ventilation	Natural Ventilation	Natural Ventilation	
Maximum Peak Inverse Anode Voltage					
150 cycles or less	22,000	22,000	10,000	3,000 10,000 Volts
Corresponding condensed mercury temperature limits	30C-40C	30C-40C	25C-60C	
Type of cooling	Forced Ventilation	Forced Ventilation	Natural Ventilation	
Maximum Anode Current					
Instantaneous					
25 cycles and above, in-phase operation	20	20	5.0	5.0	40 16 Amperes
25 cycles and above, quadrature operation	40	40 Amperes
Below 25 cycles	2.5	12.8 8 Amperes
Average	1.25	6.4 4 Amperes
Average, in-phase operation	5	5	1.25 Amperes
Average, quadrature operation	10	10 Amperes
Surge, for design only	400	400	50	50	200 80 Amperes
Maximum Time of Averaging Current	60	30	15	15 Seconds
Maximum Time of Surge Anode Current	0.2	0.2	0.1	0.2 Second
Recommended Temperature, Condensed Mercury C	35±5	35±5	40±5	40±5	40 40
Temperature Limits, Condensed Mercury C	40-80 25-50

PHANATRON

(Continued from previous page)

ampere Crest Plate Ratings:

Single Phase Full Wave (2 tubes)	
A-C Input Voltage (RMS per tube)	3535 volts
D-C Output Voltage to Filter,	
approximately	3180 volts
Maximum D-C Load Current,	
Amperes (total)	0.50 ampere
Single Phase Full Wave Bridge	
Circuit (4 tubes)	
A-C Input Voltage (RMS per tube)	7070 volts
D-C Output Voltage to Filter,	
approximately	6360 volts
Maximum D-C Load Current	
(total)	0.50 ampere
Three Phase Half Wave (3 tubes)	
A-C Input Voltage (RMS per tube)	4080 volts
D-C Output Voltage to Filter,	
approximately	4780 volts
Maximum D-C Load Current	
(total)	0.75 ampere
Three Phase Double Y - Parallel	
(6 tubes)	
A-C Input Voltage	
(RMS per leg)	4080 volts
D-C Output Voltage to Filter,	
approximately	4780 volts
Maximum D-C Load Current	
(total)	1.50 amperes
Three Phase Full Wave (6 tubes)	
A-C Input Voltage	
(RMS per leg)	4080 volts
D-C Output Voltage to Filter,	
approximately	9560 volts
Maximum D-C Load Current	
(total)	0.75 ampere

NOTES

- * Before applying plate potential. Sufficient time must be allowed to bring the condensed mercury temperature to the recommended value.
- ** Operation at 40° Cent. ± 5° C is recommended.

ELECTRONIC DESK

A NEW type of testing device is the result of growing manpower shortage in all forms of skilled technical labor, taken together with the necessity of careful individual checks on all characteristics of critical cathode-ray tubes. Despite production schedules now running into the thousands as compared with dozens before the war, the vital characteristics of such tubes must still be critically checked before receiving the maker's OK. It is still a case of individual test. Percentage or spot tests mean little or nothing in dealing with products as critical as cathode-ray tubes.

Faced with this problem of individual and critical checkup on a mass testing basis, engineers of the Allen B. Du Mont laboratories set to work some time ago evolving a satisfactory production test procedure and equipment. It was realized from the first that while the equipment would have to provide for several dozen readings of as many different characteristics, which requirement heretofore called for a maze of laboratory equipment and hookups, the procedure now would have to be simple enough to permit operation by average girl workers.

The result is the Du Mont "electronic desk" test position. Several of these units are now installed in the Du Mont plants, checking up the daily production flow of cathode-ray tubes. For routine production



RADIO-CRAFT for OCTOBER, 1943

checkup, these units are operated by girls, but engineers too depend on these ingenious all-the-answers-at-a-glance test positions in checking up the characteristics of new tubes.

As its name implies, the "electronic desk" is a steel cabinet in the form of a modified flattop desk. An inclined platform supports the cathode-ray tubes which are plugged into their respective receptacles at the rear. Directly beneath the inclined platform or shelf is a battery of meters covering all required readings. Directly in front is the writing space, and beneath a drawer for paper, forms, pencils and so on. On either side of the writing space are more meters. Where the desk drawers would be there are switches and controls for the power supply which forms part of the test position and which provides all required voltages for the widest array of cathode-ray tube types.

Sitting at this comfortable "electronic

desk" the operator sets the various voltages for the given type tube or tubes. The operator now checks for brilliance, focus, deflection, leakage resistance and other characteristics—simply, quickly, positively. The readings are duly entered on the inspection sheets which cover each tube and provide a complete record of tube characteristics. The "OK" or any other notations are made directly on the face of the tube with a grease pencil.

Thanks to this new mass-testing technique, made possible by the ingenious "electronic desk," the Du Mont organization is enabled today to give each and every tube, despite production runs in the thousands, an even more thorough checkup than was the case a dozen years ago when Allen B. Du Mont personally checked a handful of tubes which daily came out of his garage laboratory.

Replace with **Meissner**
Universal Adjustable Coils

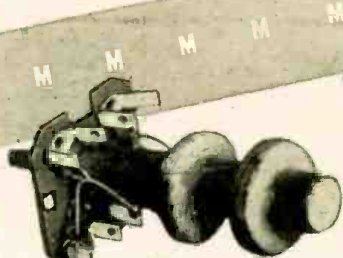

Adjustable R. F. Coil



Adjustable Oscillator Coil



Adjustable Antenna Coil

Meissner Adjustable Inductance Ferrocart (iron core) coils are designed to replace the Broadcast band coils in practically any receiver. When an antenna, R.F. or Oscillator coil requires replacement use a Meissner Universal Adjustable Coil.

Universal Adjustable Coils are continuously variable in inductance over a wide range. The coils will accurately "track" with the other coils in the receiver when properly adjusted. The exact inductance of the old coil is easily matched by a very simple adjustment regardless of the value of the tuning condenser.

Universal Adjustable Coils are available at your MEISSNER distributor.

Meissner
MT. CARMEL, ILLINOIS
"PRECISION-BUILT ELECTRONIC PRODUCTS"

COMPLETE CENTRALIZED SERVICE
on *Everything* in
RADIO AND ELECTRONICS



Use the New 1943 **ALLIED CATALOG**
Most Complete up-to-date Buying Guide
Free!

Allied SPEEDS SUPPLIES
for the Armed Forces... War Industries... Home Front

ONE quick, dependable central source of supply for all your Radio and Electronic needs . . . over 10,000 items for the Armed Forces, Radio Training, Research Laboratories, War Industries, and Service Replacement. Our large complete stocks speed delivery. Our experienced staff is ready to help you.

6 Radio Books for 75c

- Dictionary of Radio Terms. No. 37-751 **10c**
- Radio Data Handbook. No. 37-754 **25c**
- Radio Circuit Handbook. No. 37-753 **10c**
- Radio Builders Handbook. No. 37-750 **10c**
- Radio Formulas & Data Book. No. 37-752 **10c**
- Simplified Radio Servicing. No. 37-755 **10c**

Write for Quantity Prices

ALLIED RADIO CORP., Dept. 2-K-3
833 W. Jackson Blvd., Chicago, Ill.
Please send following books (.....c enclosed)
 FREE 37-750 37-752 37-754
1943 Catalog 37-751 37-753 37-755
 Send All Six Books

Name.....
Address.....
City..... State.....

ALLIED RADIO

VIBRATION TRANSDUCER

(Continued from page 12)

in voltage above and below the normal value will indicate on the oscillograph or pass through the amplifier.

The most important characteristics of a transducer of this type are:

1. Flexibility in sensitivity and characteristics of current-capacity curves.

5. Low background-noise level.

6. Freedom from interference from local magnetic and electromagnetic fields so long as their frequencies differ somewhat from the resonant frequency of the oscillator circuits.

In conclusion, this form of transducer possesses characteristics giving it many distinct advantages over other types of electrostatic devices, and its simplicity, flexibility, sensitivity, and freedom from shielding requirements make it a device that should be familiar to all investigators wherever mechanical vibrations are being studied.

Parts List for Reference

- C1—.001 mfd. mica
- C2—100 mmf. mica
- C3—.5 mfd., 400-volt paper
- C4—.02 mfd. paper
- C5—.01 mfd. paper
- C6—16 mfd., 450-volt electrolytic
- C7—16 mfd., 150-volt electrolytic
- R1—50,000 ohms, 1/2 watt
- R2—10,000 ohm potentiometer
- R3—1,000 ohms, 1 watt
- R4—75 ohms, 10 watts
- R5—1,000 ohms, 20 watts
- M1—0.50 ma.

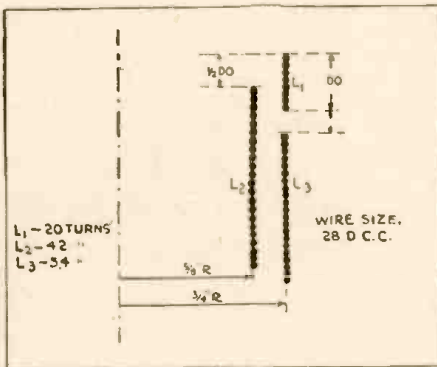
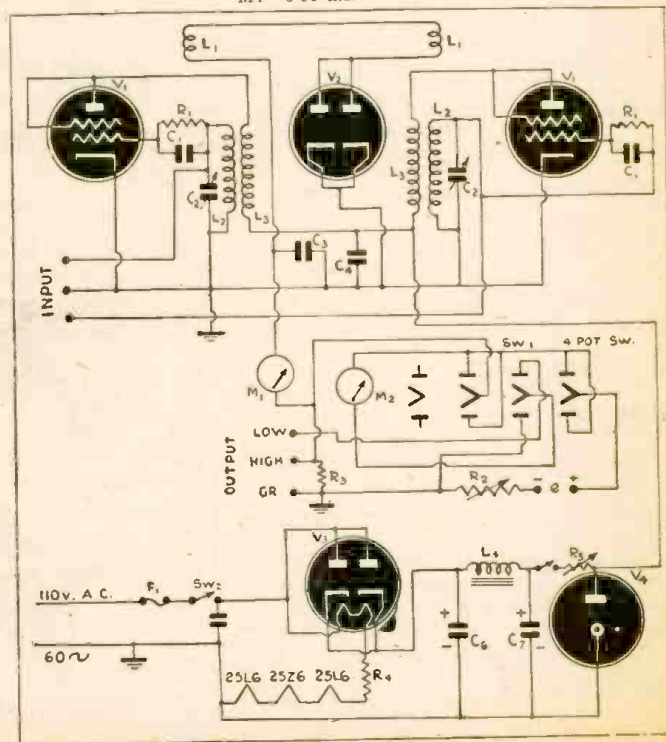

Fig. 3.—View of the coil in longitudinal section, showing placement for the best shape of current curve.

Fig. 4.—A practical model of vibration transducer, hooked up to operate on A.C. and D.C. A small battery, e, is provided as a source of "bucking voltage" to reduce initial current through the circuit to zero. It is adjusted by R2.



- 2. Simplicity in operation.
- 3. Substantially constant sensitivity over a range of frequencies from zero to several hundred Kc/sec.
- 4. Sensitivity that depends on absolute changes in capacity values rather than on percentage changes.

- M2—30-0-30 and 3-0-3 ma.
- V1—25L6-GT
- V2—25Z6-GT
- V3—25Z6-GT
- V4—VR-105/30

Condensed from an article by E. V. Potter of the Western Region office, U. S. Bureau of Mines, and reprinted by courtesy of *The Review of Scientific Instruments*.

THE LISTENING POST

(Continued from page 34)

Mc.	Call	Location and Schedule	Mc.	Call	Location and Schedule
11.730	WRUL	BOSTON, MASSACHUSETTS; 11:30 pm to 2 am.	11.760	TGWA	GUATEMALA CITY, GUATEMALA.
11.730	CBNY	HAVANA, CUBA	11.77—DJD		BERLIN, GERMANY. North American beam, evening transmissions.
11.73	KGEI	SAN FRANCISCO, CALIFORNIA. Evening transmissions.	11.775	MTCY	MANCHURIA.
11.74	HBJ	VATICAN CITY.	11.78	GVU	LONDON, ENGLAND. North American beam, 6:30 to 7 pm.
11.74	HP5Q	PANAMA CITY, PANAMA. Evenings to midnight.			

Mc.	Call	Location and Schedule	Mc.	Call	Location and Schedule	Mc.	Call	Location and Schedule
11.78	—	FRENCH INDO CHINA.	15.190	WKLD	NEW YORK CITY	15.21	WBOS	BOSTON, MASSACHUSETTS; noon to 5:15 pm; 5:30 to midnight.
11.785	OIX3	LAHTI, FINLAND. 9:15 am.	15.19	OIX4	LAHTI, FINLAND. North American beam; 9:15 to 9:45 am.	15.220	—	"VOICE OF FREE INDIA". 10 am to 12:05 pm.
11.790	HP5G	PANAMA CITY, PANAMA. 10:30 pm to ?	15.190	WKRX	NEW YORK CITY; 6:45 to 7 am.	15.220	—	AZAD MOSLEM RADIO; 9:30 to 9:45 am.
11.79	KGEI	SAN FRANCISCO, CALIFORNIA; 5 pm to 12:45 am.	15.195	TAQ	ANKARA, TURKEY	15.220	—	"NATIONAL CONGRESS RADIO". (INDIA); 12:15 to 12:53 pm.
11.8	DJZ	BERLIN, GERMANY	15.20	DJB	BERLIN, GERMANY. North American beam; 7 to 9:45 am; 5:50 to 6:30 pm.	15.230	VLG6	MELBOURNE, AUSTRALIA; Western North America, evenings; news at 1:10 am in English.
11.80	JZJ	TOKYO, JAPAN. 7 to 9:30 pm.	15.200	XGOY	CHUNGKING, CHINA. Asia-Australia-New Zealand beam, 6 to 8:30 am; East Russia beam, 6:30 to 7 am; Japanese beam, 7 to 7:20 am.			
11.805	COGF	MATANZAS, CUBA. Afternoon transmissions.						
11.81	2RO22	ROME, ITALY. North American beam, 8:30 pm to midnight.						
11.830	WCRC	NEW YORK CITY; 5:25 pm to midnight; 6 am to 5:15 pm.						
11.84	VLG4	MELBOURNE, AUSTRALIA; Asia beam (Chinese, English, Malay, Dutch) 6:15 am.						
11.84	—	MALAYA; "Radio Shonan"; controlled by the Japanese.						
11.845	—	VICHY, FRANCE.						
11.847	WGEA	SCHENECTADY, NEW YORK; 6:15 am to 5:15 pm; 5:30 pm to 11:30 pm.						
11.855	DJP	BERLIN, GERMANY						
11.87	VL12	SYDNEY, AUSTRALIA; British beam, (England) 2:55 am.						
11.893	WRCA	NEW YORK CITY; 5 to 8:45 am; 3 to 4:45 pm.						
11.900	XEW1	MEXICO CITY, MEXICO						
11.9	VLG9	MELBOURNE, AUSTRALIA; Asia beam (English) 10:15 am.						
11.910	WBOS	BOSTON, MASSACHUSETTS.						
11.910	2RO	ROME, ITALY. Day and night transmissions.						
11.935	—	"SUDETEN GERMAN FREEDOM"; 7:35 to 7:55 am; 12:15 to 12:30 am; other times.						
11.947	—	MOSCOW, USSR. 7:30 to 11 pm.						
11.970	FZI	FRENCH EQUATORIAL AFRICA; "Radio Brazzaville"; 3:45 to 4 pm; 11:30 pm to midnight; also heard with news in English at 7:45 pm to ?						
12.11	—	ALGIERS, NORTH AFRICA. 1 to 5:30 pm; "Radio France". 4:45 to 5:20 pm.						
12.115	ZNR	ADEN, ARABIA. 1 to 1:30						
12.130	DZE	BERLIN, GERMANY						
12.19	—	MOSCOW, USSR. 6:48 to 7:25 pm.						
12.210	TFJ	ICELAND. 7 pm; irregular.						
12.455	HCJB	QUITO, ECUADOR, "La Voz de los Andes" (The Voice of the Andes) in English daily at 8 am and 6 and 9 pm. At other times in Spanish.						
12.967	WKRD	7:30 to 7:45 am; 8:15 to 8:30 am; 5:45 to 6:15 pm.						
12.97	PPH	BRAZIL. 5:45 to 6:15 pm.						
14.925	PSE	RIO DE JANEIRO, BRAZIL. North American beam, daily 7 to 8 pm.						
15.13	KGEI	SAN FRANCISCO, CALIFORNIA; 1:15 to 2:15 pm.						
15.150	WNBI	NEW YORK CITY; 6 am to 4:15 pm.						
15.150	WRCA	NEW YORK CITY; 5 to 11:30 pm.						
15.155	SBT	MOTALA, SWEDEN. 12 to 2:15 pm; morning transmissions.						
15.170	TGWA	GUATEMALA CITY, GUATEMALA. Daytime transmissions.						
15.175	—	EL SALVADOR; 1 pm to ?						
15.190	KROJ	LOS ANGELES, CALIFORNIA; 3 to 4 pm; 4:15 to 5:45 pm; 6 to 7 pm.						

(Continued on page 64)

Get into *RADIONICS now

Learn

INDUSTRIAL ELECTRONICS TELEVISION & RADIO

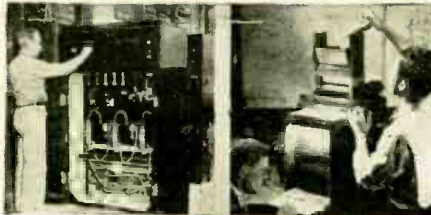

Out of the War is emerging the Age of Electronics, with immediate opportunity for you to enter America's new Industry.

*Radionics is a general term embracing industrial Electronics, Television and Radio. Electronics for harnessing the forces of industry, Television to bring the world's sights into the home, Radio with revolutionary improvements—these are developments that constitute a tremendous field. You can project yourself into this mighty field. You can become part of it. You can earn good pay as a Radionics Expert, with independence insured during and after the war. When the war ends, Radionics will boom even faster than now. But you can't successfully enter this field unless you have TRAINING. Let's speak plainly. You have the desire and you realize the tremendous future of Radionics. But you lack training. So here's the way to get into Radionics. Have National Schools train you right in your home.

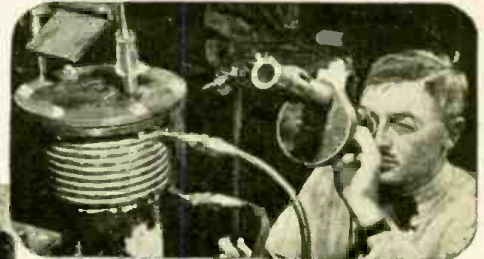

How you can qualify as a Technician in the fascinating field of RADIONICS—including Electronics, Television and Radio.

National is always in the lead. As industry advances, National offers training to fit. This was never more true than today. National's training covers all phases of Radionics. You learn by following fascinating lesson assignments, based on practical shop-laboratory methods. Instructors give you the same fundamental training that you would receive if you were actually in the school. It's an amazing extension of resident school training.

TESTED HOME TRAINING By PROVED SHOP-FIELD METHOD

For more than 38 years National Schools has trained thousands of men. Many graduates hold top positions in hundreds of leading industries. Unlike ordinary correspondence courses, National's Radionics Course is based on shop-practice, shop-tested, shop-routine training, adapted to Home Study. Replacing dry text books, fascinating Lesson and Experimental Assignments are provided. Instructors counsel with you. After the first few lessons, you are qualified to repair Home Radio Sets. Soon you master Communications and Sound Systems. Before you realize it you have practical knowledge of the "workings" of countless Electronics Controls and how Electronics is applied to Industry. When you graduate you are qualified to accept a job that should pay substantially more than you are now earning. This is a real opportunity for you.

New Opportunity Book, all about Radionics, and FREE lesson mailed without obligation. ESTABLISHED 1905



Mail This Coupon Today

FREE RADIONICS BOOK & LESSON

NATIONAL SCHOOLS, DEPT. RC-10
4000 SOUTH FIGUEROA, (Paste on a penny postal)
LOS ANGELES 34, CALIFORNIA

Send Radionics Book, Lesson and full details, post paid without obligation.

NAME _____ Age _____
ADDRESS _____
CITY _____ STATE _____

NATIONAL SCHOOLS of Los Angeles presents HOME TRAINING IN RADIONICS

TRAINING IS BROUGHT TO YOU. Every day some new development in Radionics takes place. National's instructors are always on the alert to study each new invention and weigh its advantages. The Course reflects this up-to-the-minute checking so that you as a student get the latest first. The more time you can devote to this training, the sooner you graduate. The Course is geared to your needs. You keep your present job while learning. Many students, soon after enrolling, earn extra pay by servicing neighbors' Radio Sets and working in established Radio Shops.

OHMITE

10 AND 20 WATT
**BROWN DEVIL
RESISTORS**

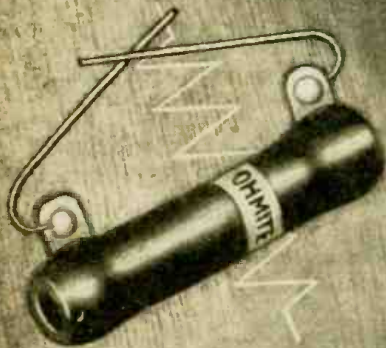

*For Dependable
Service in Electronic
Applications*

Long known for their dependable performance—Ohmite Brown Devil Resistors serve today in critical war applications—in radio communications and other electronic equipment. Their extra sturdy, wire wound, vitreous enameled construction insures permanent resistance. These same units will be ready to serve your peacetime needs after Victory is won.

Ohm's Law Calculator
Helps you figure ohms, watts, volts, amperes—quickly, easily. Solves any Ohm's Law problem with one setting of the slide. All values are direct reading. Send only 10c in coin. (Also available in quantities.)



CATALOG 18

Gives helpful information on Ohmite stock resistors, rheostats, chokes and tap switches for all types of applications. Free—Write for it.



Authorized Distributors
Everywhere



Ohmite Manufacturing Co.
4894 Flournoy, Chicago 44, U.S.A.

FORECASTS OF FUTURE RADIO

(Continued from page 16)

with portable transceivers, many models of which are now available. Some of these models, which do not weigh more than five pounds, can contact Police Headquarters or the Fire Department *instantly*, while the guard walks about the ship. This would mean two things—one, that the guards could communicate with each other; two, that the one stationed on the top deck could have radioed the alarm *instantly* to the Police or Fire Department. *Such Radio Guards should be stationed on all ships during war time.*

The antenna of the small transceptor concealed in the shoulder-strap. The outstand-

ing feature of this device is the handset, like that of a telephone, which is so blended into the cabinet as to almost escape notice.

More of these fanciful designs will be seen before the end of the war. If we can depend on our experience of predictions in the past, the new radios are likely to differ widely from ties: visions (crystal-ball or otherwise) of the prophets. The difference will be due chiefly to inventions and improvements on existing methods worked out during the war. These will not be made public until peace comes, and may be revolutionary enough to make some of our crystal-inspired designs look drab and uninteresting.

A conservative design by Raymond Loewy. Provisions for television is apparently regarded as a "must." One of the most attractive designs yet put forth.

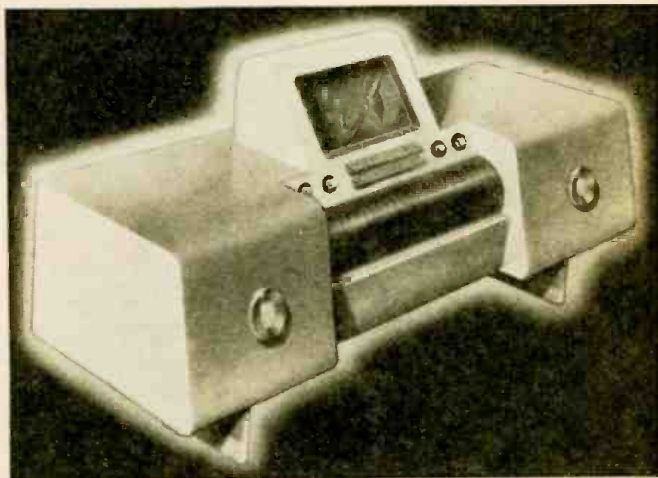

Courtesy Continental Radio and Television

INVASION

(Continued from page 17)

circuits. Messages are handled by carrier-current, and the lines are therefore untappable by an enemy, unless he were equipped with the electronic devices necessary to demodulate and unscramble the signals. Quarter-mile lengths may be connected by a simple "twist of the wrist" through the special coupling units provided.

The radio team has as its objective the local enemy radio station or stations. Its job is to take over the radio station, repair it if it is damaged, and put it back on the air for the use of American forces. The radio station is used for long-distance military communications and announcements to the local populace.

The establishment of powerful radio broadcasting and receiving stations for military purposes is an important part of the Signal Corps' responsibility. Ultimately our

forces will have a broadcasting and receiving station for military communications powerful enough to reach the United States, London, or any of the headquarters of the United Nations.

Direction-finding equipment, operated by Signal Corps personnel goes ashore as soon as possible after the beachhead is established. Direction finding is done by two radios set as far apart as possible. By tuning in on enemy stations the Signal Corps operators are enabled to compute, through triangulation, the position of enemy communications centers. After establishing the position of an enemy station, direction-finding signal men relay their information to artillery, which lays down a barrage at that point. The information also might be used to send out an air mission to bomb and strafe the enemy location.

DeFOREST ON PHYSICAL EFFECTS OF U. H. F.

(Continued from page 14)

efficient energy for the purpose. Certain definite precautions should be observed. It were clearly foolish for anyone to unnecessarily expose himself to such intense beams of radiation, possessing, as these do, excessive power of penetration.

Based on the now classic researches of Debye, working with much longer wave lengths—of the order of 1 to 5 meters—who 15 years ago investigated carefully the specific effects of such frequencies upon solutions of colloid and bacteria cultures of various degree of concentration, it is to be expected that similar specific effects will be observed when these much shorter waves are turned upon the biologists' test tubes. A

very interesting field of research here awaits us, not unfraught with possibilities in the medicinal field, possibly in the realm of malignancies.

It is even more probable that when that as yet unknown spectral region of the millimeter waves is explored, where rays or beams of pencil dimensions are obtainable, with power in the fractions of a kilowatt, very remarkable therapeutic, biologic and chemical effects may well be anticipated. The possibilities of employing such modalities in cancer research are surely not carelessly to be denied."

Very truly yours,
(Signed) LEE DeFOREST

POWER INCREASES APPROVED

The Federal Communications Commission, acting on the Report of its Committee on Critical Materials, announced last month that under certain conditions it would be in the public interest to grant applications for permits involving the use of idle equipment to increase power of 100-watt local channel standard broadcast stations to 250 watts, and for construction of new 100-watt or 250-watt local channel stations.

Applications for permits to construct new 100-watt and 250-watt local channel standard broadcast stations in cities or towns where no station is located at present and not located in metropolitan districts already served by radio stations, and applications to increase power of local channel stations to 250 watts may be granted upon a satisfactory showing that:

1. All required materials, except vacuum tubes, may be obtained without priority assistance.
2. Such applications involve no inconsistencies with the Commission's Rules and Regulations.
3. Such applications tend toward a fair, efficient and equitable distribution of radio service, are consistent with sound allocation principles, offer substantial improvement in standard broadcast service, and
4. Such applications are otherwise in the public interest.

Applications for local channel stations or changes in such stations which have been dismissed without prejudice pursuant to the policy announced April 27, 1942, may be reinstated for consideration in the light of the new circumstances upon submission of a petition within thirty days of this date showing (1) that such application is in conformity with the foregoing enumerated conditions; and (2) any and all changes with respect to facts and circumstances as represented in the original application.

Idle equipment already fabricated is to be used—including a total of 48 transmitters now believed to be in condition to begin broadcasting, ten with 100 watts, 38 with 250 watts, it was stated.

It is believed that tubes can probably be obtained from WPB for any transmitter licensed by the Commission, but licensing of new transmitters has been limited to the low power because tubes for higher powered transmitters are not available. Twenty-one transmitters ranging in power from 500 to 5,000 watts are on hand. Of the whole 69 reported, however, 13 are not completed. Another 51 are now under construction or in need of repair, and will probably be completed, but there again only those built for 100 or 250 watts will probably be licensed.

In addition to the tube shortage, it is held by the Commission that directional antenna would be required for new stations with more than the 250 watt power, and there critical materials would be called for.

Applications for 129 new stations are now on file, including 52 (41 of which are contested) for cities without any station at present. Forty of them request 250 watts power.

The FCC stated that it has been informed by WPB that clearance for construction of new buildings for these stations may be obtained "only when that agency (WPB) is satisfied that a direct contribution toward winning the war is clearly indicated."

The FCC Committee on Critical Radio Materials, on whose recommendation the policy was adopted, is composed of Commissioners Craven and Durr. A third member, George H. Payne, was on the committee till his term expired in July.

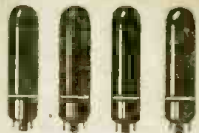

4 STANDARD TYPES
of Amperite Regulators replace over 400 types of AC-DC Ballast Tubes now in use.
Amperites are real REGULATORS... have patented Automatic Starting Resistor which prevents initial surge and saves pilot lights... Ask Your Jobber.

AMPERITE
THE *Simplest* WAY TO REPLACE
BALLASTS
WRITE FOR REPLACEMENT CHART
AMPERITE CO. 561 BROADWAY, NEW YORK, N. Y.

RADIO BATTERIES

FOR ALL TYPE

PORTABLES

\$5 COMPLETE COST INSTALLED

PERSONAL RADIO or CAMERA TYPE BATTERIES **\$2.25** ea

FLASHLIGHT BATTERIES **10c** ea

Include 50c for cost of packing and mailing if so desired.

THE CORTLANDT DISTRIBUTING CO.

72 Cortlandt St., New York 7, N. Y.
COMPLETE STOCK OF HARD TO GET BATTERIES & TUBES

BRING VICTORY SOONER
BUY WAR BONDS

HALLICRAFTERS ★

HALLICRAFTERS ★

LET'S ALL PITCH IN!

WE CAN all help win this war by selling our government the communications receivers and equipment they need quickly and in sufficient quantities.

That is the reason I pay *highest cash prices* for used communications equipment.

When this war is over you will be in the market for new equipment and by taking advantage of my offer to purchase your present equipment at highest cash prices you will be in a position to buy new and better equipment than you now own.

Write, telephone or telegraph me description of your used communications receivers, transmitters and parts of standard make; you will be paid cash immediately without bother or red tape. I am particularly interested in *Hallcrafters*.

I also have a store at 2335 Westwood Blvd., West Los Angeles, Calif.

Bob Henry, W9ARA
HENRY RADIO SHOP
BUTLER, MISSOURI



COMPLETE STOCKS

I still have large stocks of receivers, 2 1/2 meter equipment, meters, tubes, transformers, resistors, condensers, panels, chassis, and radio parts of all sorts. I sell and rent code teaching equipment. Your orders and inquiries invited.

"WORLD'S LARGEST DISTRIBUTOR OF COMMUNICATIONS RECEIVERS"



ACCURATE



UNFAILING accuracy for maintenance and testing work in the field or service shop is one of the many features of the new General Electric line of SERVICE TESTING EQUIPMENT. Designed in the famous G-E electronic laboratories, this line offers a wide choice of portable apparatus for radio service men, service dealers and others.

G-E unimeters, tube checkers, audio oscillators, oscilloscopes, condenser resistance bridges, signal generators—all give you rapid, dependable service for testing radio and electronic circuits and component parts.

These sturdy, shock-resistant units are now in production primarily for the Armed Forces. But they may be purchased on priority if you are engaged in war work. After the war, of course, the full line will again be available to everybody... *Electronics Department, General Electric, Schenectady, New York.*

FREE CATALOG

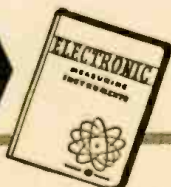

ELECTRONICS DEPARTMENT
GENERAL ELECTRIC CO.
Schenectady, N. Y.

Please send, without obligation to me, the General Electric Testing Instrument Catalog, R-1 (loose-leaf), for my information and files.

Name _____
Address _____
Company _____

GENERAL ELECTRIC
Electronic Measuring Instruments

THE CARE OF INSTRUMENTS

(Continued from page 22)

as any pounding or vibration may affect the instrument. The other general precautions given under *Portable Instruments* also apply equally to switchboard instruments.

PRECAUTIONS IN USE

1. Always try to have the instrument reading between $\frac{1}{2}$ and $\frac{3}{4}$ full scale. Never read below $\frac{1}{3}$ full scale if it can be avoided. (See paragraph 11 below.)

2. Never touch bare terminals or binding posts while an instrument is energized.

3. The instrument reading should be made from directly above the scale to avoid errors.

4. If a split-core current transformer is used with an ammeter, always make sure that the transformer-core joint is free from dirt which may introduce a considerable error in the reading.

5. To avoid temperature errors, instruments should never be used in extreme temperatures. Special temperature-compensated instruments can be supplied for these conditions.

6. Special instruments should be used to measure motor starting currents or welding currents. For example, the pointer-stop ammeter is ideal for checking motor starting current.

7. Clean the glass of an instrument by using a damp cloth. A dry cloth may induce a static charge on the glass and affect the instrument reading. If the instrument glass does become charged, it can be dispelled by breathing on the glass.

8. *Never slam the cover of an instrument.* Be sure that the nuts of the binding post are tight, even when the instrument is not in use.

9. If an instrument is overloaded or dropped or, if for any reason the accuracy is doubted, it should be checked against another instrument on several points before it is used again.

10. Tapping an instrument with the fingers will remove any slight stickiness. If the pointer movement is erratic, and if tapping causes appreciable movement of the pointer, the bearings may require attention and should be examined by a competent repair laboratory.

11. Instrument accuracy is always expressed in terms of the percentage of error at the full-scale point, so maximum accuracy is obtainable by keeping the reading as high on the scale as possible. This calls for the selection of a properly rated instrument. The accuracy of the readings is determined as follows: Assume that there are 100 scale divisions and that accuracy is one per cent of full scale. A scale reading of 100 means that the quantity measured contains 100 units plus or minus one per cent, or plus or minus one scale division; that is, the correct value lies between 99 and 101 units. However, while a scale

reading of 20 ($\frac{1}{5}$ of full scale) also has a margin of error of plus or minus one division, the error there is *five times as great*, or plus or minus five per cent.

How often an instrument should be calibrated depends on its use and the accuracy desired. If calibration standards and equipment are not available, instruments of nearly the same rating can be checked against each other. If wide discrepancies are noted, the instrument which obviously reads incorrectly should be checked by a competent laboratory or returned to the manufacturer.

COMMON TROUBLES—THEIR CAUSES

1. Unless a competent instrument mechanic is available for making repairs, it is recommended that the instrument be returned to the manufacturer or to some competent laboratory.

2. The following is a guide for finding some of the more common causes of trouble:

Sticky or Jerky Pointer:

Dirt on scale; pointer touching glass; dirt in air gap of moving element or damping magnet; damaged bearing.

Pointer Sticks to Stop:

Dirt or grease on pointer or stop.

Instrument Fails to Indicate:

Loose or dirty lead connection; poor soldered joint; open resistance spool; open armature; control spring or lead-in burned out.

Pointer Cannot Be Set at Zero:

Bent pointer or zero adjuster crank arm out of regulator slot.

3. If an instrument element is removed from the case in order to inspect for any of the above causes, extreme care should be taken not to get dirt and dust into the instrument and not to distort or damage any of the delicate internal parts of the instrument.

4. Instrument bearings should never be oiled.

STORAGE AND HANDLING

1. Instruments should be stored in a place free from dust, corrosive fumes, and excessive humidity.

2. An instrument should be slid into its carrying case, not dropped.

3. An instrument should preferably be transported face down, or up on one end, in order to remove the weight from the lower pivot.

4. If it is necessary to transport an instrument other than by hand, it should be carried in a padded container which will absorb shocks.

5. Do not carry more than one instrument in one hand. (See Fig. 3 for a horrible example.) If means have been provided for locking the moving element, this should be done before the instrument is transported.

BASIC DEFECTS IN RADIO RECEIVERS

(Continued from page 19)

flake, causing changes in capacity and eventual shorting of adjacent plates.

A change in capacity is one defect which cannot be located by simple meter tests; you must be able to recognize the effects of capacity changes on receiver performance.

FIXED RESISTOR DEFECTS

As a general rule, low-wattage units

(ranging from .1 watt to 3 watts) will be of the carbon or metallized type, and higher-wattage units will have wire-wound construction, oftentimes covered with a ceramic cement. You will occasionally encounter small 1- and 2-watt wire-wound resistors molded in a bakelite housing which resembles that of some carbon resistors, but these wire-wound units will rarely have more than about 5000 ohms resistance.

Resistors which crack or break in any way can usually be spotted visually, so we will concentrate here upon defects which can be located only by tests.

Opens. Overloading of a resistor by sending excessive current through it can burn out the resistance material or cause an open at the point where the wire lead makes contact with the resistance material. You can check for opens in resistors with an ohmmeter.

Shorts. A direct short between the two terminals of a resistor is not at all common. However, it is entirely possible for resistor leads to touch each other, to touch the chassis or touch other parts and give the same shorting effect. Also, resistors encased in metal can short to the metal case anywhere. When not visible to the eye, a short in a resistor can be located with an ohmmeter.

Changes in Resistance. Carbon resistors are particularly susceptible to changes in resistance whereas wire-wound resistors rarely change. Overloading of a carbon resistor or even continued use at normal temperatures will often cause a marked decrease in resistance, which increases the resistor current and overloads it still more. The resistance value can be checked with an ohmmeter in the usual manner. Remember, however, that carbon resistors are generally used at points where a great deal of variation in resistance value is tolerated or where the resistor is operated well under its rated wattage. Normally, variations as great as 20% in resistance value are entirely permissible.

VARIABLE RESISTOR DEFECTS

Variable resistors and potentiometers are far more subject to trouble than fixed resistors. Since they are mechanical in operation, we have wear in moving parts to consider. As a rule, the defect will be readily apparent because rotating of the control knob while the set is in operation will cause noise or intermittent operation. An open volume control will not provide proper control of volume even though it may permit partial transfer of the signal.

Opens. In both carbon and wire-wound controls, movement of the contact arm over the resistance element may eventually wear away the metallic or carbon deposit, or wear down the nichrome resistance wire, creating an open. Loss of spring tension in the movable arm may also give an intermittent or full open.

Wearing away of the resistance element reduces its heat-dissipating capabilities, so that a current-carrying control unit may be overloaded by normal current or momentary excessive current after it has worn down. This causes an open by burning out the resistance element. When the defect is not visible, an ohmmeter check will isolate the trouble.

Shorts. As with fixed resistors, shorts are not common. In units where the metal case is "hot" and an insulating bushing is used between the chassis and the mounting bushing of the control, a defective insulating washer or bushing will often create a short to the chassis. To locate a trouble of this sort, you usually have to unsolder all leads, then test between each terminal of the control and the chassis.

Change in Resistance. Wearing off of the carbon or metallized material in a variable resistor or potentiometer will cause the total resistance to increase, but this is not ordinarily of importance. The chief symptom in trouble of this nature will be noise. Manipulation of the control during the initial performance check should reveal this trouble, either by noise coming from the loudspeaker or by failure of the potentiometer to control volume or tone.

THE PEACETIME MEASURES OF REFLECTION AND DEFLECTION . . . WILL BE READ FROM

TRIPLETT

ELECTRICAL MEASURING INSTRUMENTS

WITH CONFIDENCE AND ECONOMY

THE TRIPLETT ELECTRICAL INSTRUMENT CO., BLUFFTON, OHIO

BACK UP YOUR BELIEF IN AMERICA...BUY WAR BONDS

HARRISON HAS IT!

FOR URGENT WAR WORK—

FOR THE HOME FRONT—

HALLICRAFTERS

CODE PRACTICE SET

RECEIVERS AND TRANSMITTERS

Buzzer and key, heavily nickel plated, of single unit construction, mounted on wood base. Adjustable high frequency pitch. Complete with silk covered cord. In attractive box with code chart on cover. Works on one or two flashlight or dry cells.

Postpaid—\$2.45

**TUBES
CONDENSERS
RESISTORS
TRANSFORMERS**

6L6G First grade, \$1.37 ea.
meter tested, 3 for \$3.75
TUBES fully guaranteed postpaid

DYKANOL CAPACITORS

Cornell-Dubilier oil filled, hermetically sealed metal cased condensers, 4 mfd. capacity. Rated at 220 Volts AC working, will stand over 600 Volts D.C. Ideal for amplifiers, receivers, power packs, etc. (Filtering action equivalent to 12 mfd. electrolytic but with better safety factor, longer life). \$2.25 (3 or more shipped postpaid).

AND THOUSANDS OF OTHER CRITICAL ELECTRONIC PARTS!

PURCHASING AGENTS—

P. M. DYNAMIC SPEAKERS

Call upon us for your high priority requirements of equipment and components for your production and development work.

5 inch, with output transformer to match single plate of 8000 ohms \$1.95
Magnavox, 10 inch, 16 ounce magnet! 6 ohm voice coil \$5.25
(Not Postpaid)

We usually have it in stock!

Immediate delivery of the above items, without priority, while quantities last. **SEND REMITTANCE WITH ORDER, TODAY!** (Money back if not satisfied.)

HARRISON
RADIO CORPORATION

11 WEST BROADWAY

Phone WOrth 2-6276

NEW YORK CITY 7

HERE IS YOUR SUCCESS CHANCE
BE A
**RADIO-ELECTRONIC
TECHNICIAN**

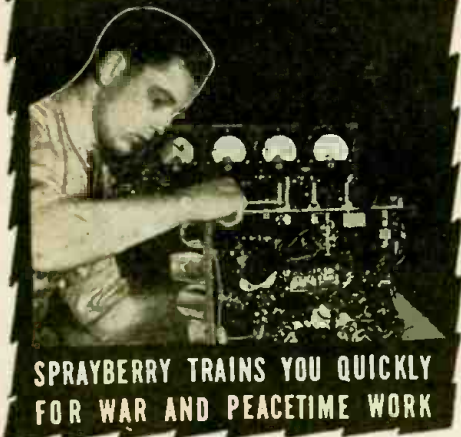

**SPRAYBERRY TRAINS YOU QUICKLY
FOR WAR AND PEACETIME WORK**

YOU LEARN IN EASY STEP-BY-STEP STAGES

No Previous Experience Needed

The offer I make you here is the opportunity of a lifetime. It's your big chance to get ready for a wonderful future in the swiftly expanding field of Radio-Electronics INCLUDING Radio, Television, Frequency Modulation, and Industrial Electronics. Be wise! NOW is the time to start. Aside from future considerations, just think of the IMMEDIATE possibilities in Radio during war time. They're tremendous! Best of all, it's easy for the beginner to get started through my quick, practical training.

**PREPARES YOU FOR A BUSINESS
OF YOUR OWN**

**... OR GOOD RADIO JOBS,
CIVILIAN OR MILITARY**

The Sprayberry course is short, intensive, and interesting. It starts right at the beginning of Radio. You can't get lost. It sets the various subjects across in such a clear, simple way that you understand and remember. I make it easy for you to learn Radio Set Repair and Installation Work - - - by practical, proved, time tested methods. I teach you how to install and repair Electronic Equipment, and give you the broad fundamental principles so necessary as a background no matter what branch of Radio you wish to specialize in. Soon you'll be qualified for a good paying job in one of the nation's Radio Plants doing war work. Or, if you enter the Army, Navy, or Marines, my training will help you with higher rating and better pay. Let me prove what Sprayberry training can do for you.



JUST OFF THE PRESS!

**"HOW TO TEST AND REPAIR
RADIO SETS WITHOUT
METERS"**

**YOURS FREE THESE
TWO VALUABLE
BOOKS!**



Developed in the Sprayberry Lab. oratory, this instructive volume tells about an amazingly simple, yet efficient method for Radio trouble-shooting and repair without use of regular equipment made scarce due to war. Send for this FREE book now while the supply lasts and along with it, I will send you another big FREE book describing my Radio Electronic training. Use coupon below.

MAIL COUPON

SPRAYBERRY ACADEMY OF RADIO
F. L. Sprayberry, President
620-K University Place, N. W., Washington, (9) D. C.

Please rush my FREE copies of "HOW TO TEST AND REPAIR RADIO SETS WITHOUT METERS" AND "HOW TO MAKE MONEY IN RADIO."

Name Age

Address

City State

(Mail in plain envelope or paste on penny postcard)

SIGNALLETTE

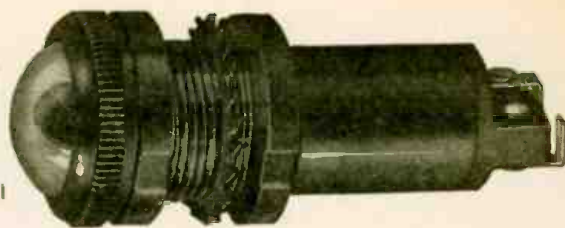

The lamp before installation in the switchboard.

BLACK-OUT requirements on modern fighting craft make demands on man and equipment such as were unknown in the last or other wars. The modern night-fighter shuns the daylight like an owl, or wears heavy dark glasses and seeks subdued light. His eyes are accustomed over a period of weeks or months to sight in what to the ordinary individual would be complete darkness.

Instruments aboard ship and plane must follow the same line. Signal lights (commonly used especially on aircraft) must not betray their position by any stray gleam. Neither may their indications weaken the super-sensitivity of the night-fighting pilot's eyes. Lights used for reading maps on board ship are calculated to give the maximum illumination on the subject for the least possible effect on the sight of the officer, who after studying his charts, must again go out to scan an inky sea for submarines or raiders.

The problem of an aircraft signal has been approached in a new way by Littelfuse, well known to radioists as manufacturers of instrument protective devices. Their contribution is a signal light without a light source! This little indicator, called Signaletto, flashes red, yellow, green or white, enabling the use of four Signalettes on the same board, each doing a different duty.

The secret of the Signaletto is that it operates by *reflected light* only. When "flashed" a pair of vanes—normally folded up like a butterfly's wings—flatten. The surface of the vanes is covered with a highly reflecting pigment which reflects any light which in the normal course of things may be on the instrument board.

Where complete darkness is essential, the vanes may be illuminated by ultra-violet light, the pigments being of such nature that they will glow when exposed to these rays.

The construction of the Signaletto is simple, as will be seen from the accompanying drawing. In its normal closed po-

sition, the two vanes A are close together. They are hinged on the pin B and connected with two links to the small iron armature C, which is held away from solenoid D by spring E. As spring E pushes the armature forward, the links cause the vanes to close.

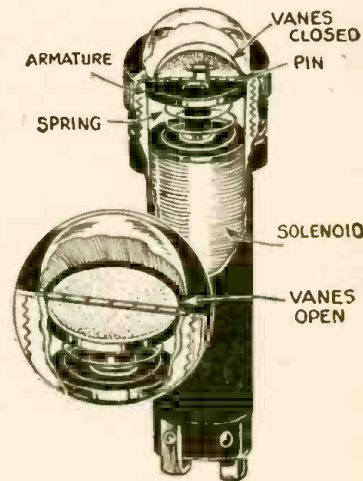

Breakdown of the Signaletto, showing open and shut position and principles of operation.

When current is passed through solenoid D, the armature and its plunger are rapidly drawn down to the coil, and the links pull the vanes apart, causing them to show a colored signal. Due to the depth of the vanes inside the unbreakable plastic cap, and to the fact that the black outside surface of the vanes are the only parts visible, when not energized the Signaletto shows dark at all times.

Secondary advantages, such as freedom from possible burn-out and therefore the necessity of carrying spares, superior mechanical strength and current economy, (the Signaletto uses only 2.25 watts) are factors which are expected to help popularize the Signaletto as a standard device.

DRAFTING GADGET

THE interesting little gadget pictured above should open a new era in home-drawn hook-ups. No longer will magazines such as *Radio-Craft*, recognize curved and scrawly hieroglyphs supposed to be radio symbols, connected together with wavy lines, the whole ensemble vaguely resembling a barbed-wire entanglement which has been subjected to inaccurate shell-fire! The experimenter and serviceman will be able to turn out schematics hardly distinguishable at first sight from the work of a radio draftsman (we hope!).

The device, which Sylvania sells for 25c, is a piece of heavy celluloid, in which holes of different shapes have been punched. By using the triangles and moving the guide down to the pencil point after each zig-zag, resistors of perfect form may be drawn. The incomplete circles permit drawing coils, the guide being slipped along between each loop, with the straight side against the pencil lead. Aerials can be drawn with the help of the larger triangle. The tube, condenser, etc., are self-explanatory.

With the help of a ruler and the Symbol Guide, any radioman can draw hook-ups that are easy to read and reflect credit on the amateur draftsman.

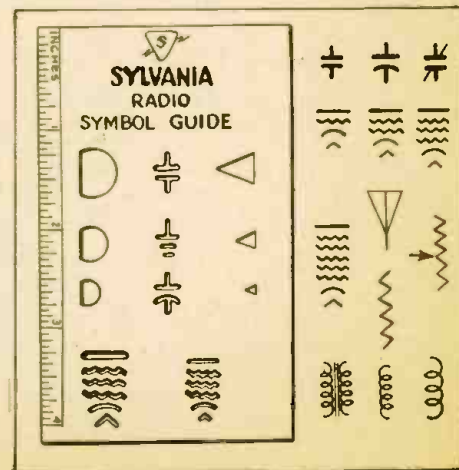

NEGATIVE FEEDBACK PITFALLS

(Continued from page 30)

of a pentode with load approximates less to a straight line than that of a corresponding triode circuit; in fact, as E_c gets less negative, the characteristic tends to flatten out. Thus, what happens when an operating point such as M in Fig. 3 (b) is chosen and a pure sine voltage E_i is applied to the input terminals of Fig. 3 (a) is roughly as shown in Fig. 4 (b): the output voltage

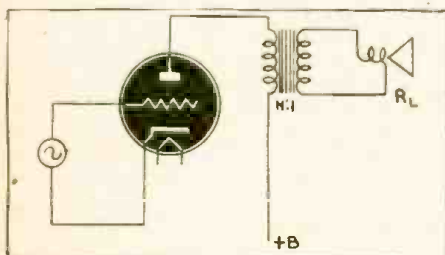

Fig. 5.—Distortion may occur where negative feedback can have no effect on it.

suffers amplitude distortion, its negative half cycles being flatter than the positive. This state of affairs is termed, "second harmonic distortion," as the output is practically equivalent to the sum of two sine voltages, one having the frequency of the input voltage, and a smaller one of twice that frequency.

Suppose now that we apply feedback by moving the switch S from position 1 to position 2. Assuming the blocking condenser to have negligible reactance compared with the resistance of the feedback potentiometer R_f , the feedback will be purely negative. The actual grid-cathode voltage will be the sum of the input voltage of Fig. 4 (a) and a fraction b of the output voltage of Fig. 4 (b). The resultant is drawn in Fig. 4 (c) and differs from the original input both in amplitude and form. In particular, the positive half-cycles are larger than the negative. On working it out you will see that this is exactly what is required to make the output voltage less distorted. This is indicated in Fig. 4 (d), showing an improvement over 4 (b) at the cost of reduced gain.

For negative feedback to reduce amplitude distortion, the distortion must be present at the input terminals of the feedback network, (which in Fig. 3 [a] are identical with the amplifier output terminals) and both the amplifying and feedback paths must be able to pass the correcting voltage freely.

As an example of distortion occurring at a point beyond the input terminals of the feedback network consider an output stage such as in Fig. 5 (a). It is conceivable that the loud-speaker impedance is nonlinear—that it draws a distorted current in spite of sinusoidal voltages in both primary and secondary of the output transformer. Feedback from either of these windings cannot combat this type of distortion.

Let us revert to Fig. 3 (a) for an illus-

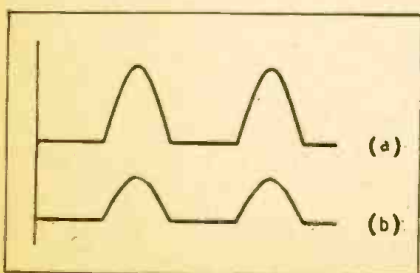

Fig. 6.—When grid bias is too high. Output curves.

tration of the third postulate for successful negative feedback. Suppose the grid bias be chosen too large, shifting the operating point to cut-off, say to N of Fig. 3 (b). The output voltage will then have the rectified appearance of Fig. 6 (a), and on applying negative feedback this is changed to Fig. 6 (b) with its smaller amplitude but practically identical waveform. This is due to the inability of the amplification path to amplify the negative half cycles of the input voltage, even though the feedback voltage does not affect them.

Assuming, however, that your amplifier satisfies the conditions already postulated, there is another case worthy of careful attention. It concerns the power output stage and frequency distortion. Briefly, the loud-speaker, being a complex electro-mechanical system, is subject to some form of resonance at several frequencies; most serious perhaps is the lowest one, usually around

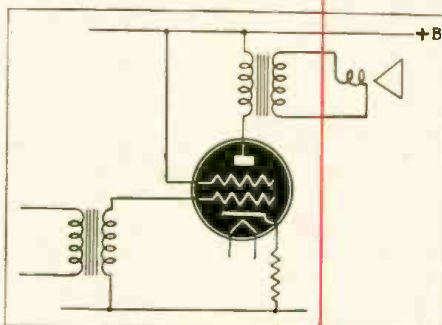

Fig. 7.—A degenerative current-feedback system.

100 c/s. The electrical impedance of the loudspeaker is then almost purely resistive, rising to several times its normal value, i.e., from 10 to about 100 ohms. The upshot

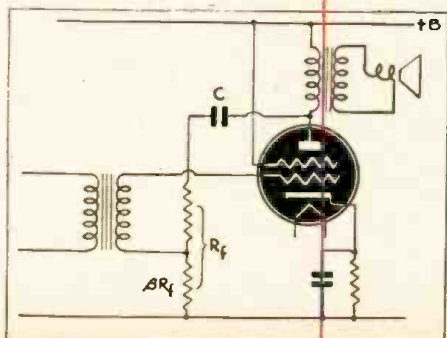
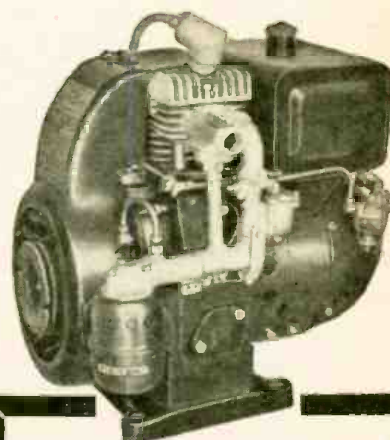

Fig. 8.—The amplifier of Fig. 7 with voltage feedback.

of this is that at the resonant frequency, the output power tends to rise many times, due to an undesired improvement in the transfer efficiency of electrical into mechanical power.

When a triode is used the load is matched to the tube; hence an increase in the normal load value will decrease the power available in the load and the "low-frequency boom" will be less serious than might be feared. In other words, a comparatively low plate resistance damps the

(Continued on following page)



ELECTRICITY for Any Job Anywhere

ONAN GASOLINE DRIVEN ELECTRIC PLANTS provide electricity for communications work in locations where it is not otherwise available, and for emergency and standby service. Thousands of these sturdy, reliable plants are doing a winning job on all fighting fronts, in communications and other war tasks.

50 to 800 cycles, 110 to 660 volts, A.C.—6 to 4000 volts, D.C. Also dual A.C. and D.C. output types. Engines are air or water cooled.

Your inquiry regarding present or post-war needs will receive prompt attention.

ONAN

ELECTRIC PLANTS

D. W. ONAN & SONS

726 Royalston Ave.

Minneapolis, Minn.

GUARDING COMMUNICATIONS WHERE THE GOING IS TOUGH!

SUPREME

TESTING INSTRUMENTS

The famous 504-A and other SUPREME Testing Instruments are on active duty in all parts of the world. Now more ruggedly built, more accurate and dependable than ever, SUPREME Instruments will be your logical choice when victory is won.



SUPREME INSTRUMENTS CORP. GREENWOOD, MISSISSIPPI

loudspeaker resonance electrically.

Power pentodes or beam tetrodes have the advantage of greater efficiency and sensitivity over triodes; but they tend to give greater distortion, partly due to the curvature in the mutual characteristic (see Fig. 3 (b) which produces amplitude distortion, and partly due to their high internal resistance, the latter being normally so high that there can be no question of matching the speaker. At resonance, speaker power will tend to rise with the resistance, producing very serious frequency distortion.

Negative feedback is thus called for. There are two basic ways of applying it, either as current or as voltage feedback. The former is readily achieved by leaving off the by-pass condenser across the self-bias resistor in the cathode lead (Fig. 7); while this reduces amplitude distortion, it will actually increase the frequency distortion,

for this step has the effect of increasing the plate resistance by a factor which varies directly with the fraction of output voltage fed back.

On the other hand, voltage feedback decreases R_p by the same factor and will thus look after both forms of distortion in pentode power stages. The outline of a suitable circuit is shown in Fig. 8; it forms the basis of handling pentodes in push-pull circuits. Note that the feedback potentiometer should have a high value compared with the reflected speaker resistance.

Thus you will see that in applying negative feedback to a circuit, it is necessary not only to make sure that the feedback is truly negative, and does not affect the operating point, but also that it can achieve your requirements in principle.

—*Wireless World (London)*

WWV AGAIN ON THE AIR

THE new WWV, Bureau of Standards frequency broadcasting station, opened last month at Beltsville, Md. This will be good news to many radiotechnicians who have used WWV for calibration purposes in the past.

Ten-kilowatt transmitters have been installed and additional frequencies and voice announcements added. The services now include: (1) standard radio frequencies, (2) standard time intervals accurately synchronized with basic time signals, (3) standard audio frequencies, and (4) standard musical pitch, 440 cycles per second, corresponding to A above middle C. The standard radio frequencies are 5, 10 and 15 megacycles. The service is continuous day and night.

TECHNICAL BULLETINS

Technical bulletins give reliable information in easy-to-follow form, and save valuable time otherwise spent in laborious reading of numerous books. Every subject is treated briefly and concisely, yet completely. No complicated mathematics, chemistry, electricity, or theory. Each bulletin is written in simple language.

Each Bulletin consists of a set of large sheets, assembled in one packet, size 9 x 13 1/2"; weight 1/4 lb. Numerous illustrations, diagrams, charts to supplement text.

PRICE \$1.00 EACH POSTPAID ORDER BY NUMBER

- D-111—DESIGNING AND BUILDING TRANSFORMERS
- D-112—DESIGNING ELECTRO-MAGNETS
- D-113—HOW TO DESIGN SOLENOIDS AND PLUNGER MAGNETS
- D-101—USING NICHROME RESISTANCE WIRE
- D-106—REWINDING ELECTRIC MOTORS
- D-144—ALTERNATING CURRENT CONTROLLED WITH EASILY MADE CHOKE COILS
- D-148—DESIGNING AND USING ELECTRIC RELAYS
- D-127—SMALL ELECTRIC LIGHT PLANTS
- D-134—ELECTRICAL EXPERIMENTS WITH SIMPLE MATERIALS
- D-131—MODEL MAKERS & INVENTORS GUIDE TO REMOTE-CONTROL SWITCHING
- D-137—ELECTRICAL METERS EASILY BUILT
- D-136—SMALL A.C. ARC WELDER CONSTRUCTION AND USE

Send Stamps, Cash or Money Order

TECHNIFAX

1917 S. STATE ST. RC-1043 CHICAGO, 16, ILL.

DEPT. RC-1043
 1917 So. State, Chicago, 16, Ill.
 Enclosed find \$..... for which please send me postpaid the following Technical Bulletins:
 Nos.
 Name
 Street and Number
 City and State

PICK-UP PERFORMANCE

(Continued from page 27)

will mar the phono system's performance.

NOTES ON THE STYLUS

The pick-up and especially its stylus and stylus mechanism are delicate precision instruments and should be treated as such. Rough handling will quickly ruin a pick-up's frequency response. The stylus should be lowered gently onto the recording disc groove and should be protected when not in use. When working on phono equipment, remove the stylus from the pick-up. If it is the permanent type, protect it with small pads taped about the pick-up arm.

Once set into its receptacle and used, a stylus should not be rotated or shifted in any way. When worn out, it should be discarded in such a way that it cannot be mixed up with new needles. Since the stylus is set at a pitch, its spherical tip becomes worn off into a semi-circular wedge-shaped form under the action of the protective abrasives which are deliberately mixed into the recording's plastic material. When the stylus setting is altered, a knife-edged cutting surface is presented to the record modulation grooves. It will gouge out the grooves for a few record disc revolutions till blunted down and will cause an increase

in needle hiss, groove wear, high-frequency cut-off distortion and will shorten the recording's useful life.

A stylus should be changed often if it is of the metal type and should not be used for too long a period if the permanent jewel type. In the long run it is mighty poor economy to over-play a stylus, especially the temporary metal type. The .003" spherical tip is set at the end of a thin tapering shaft. With wear, the tip increases in diameter and it gradually becomes too great for the groove width and begins to wear down the groove walls. This will cause subsequent normally-sized needles to skate excessively. Furthermore, a worn stylus tip's diameter begins to approach the size of the higher frequency modulation waves and it will proceed to chop off the peaks of these grooves. High frequency cut-off and distortion effects and stylus hiss will be the result and again, record life will be shortened.

RECORDS MAY CAUSE TROUBLE

A damaged recording should be discarded. If it is cracked, has badly worn grooves or is otherwise damaged, it will chew up the stylus tip. Then when a normal record-

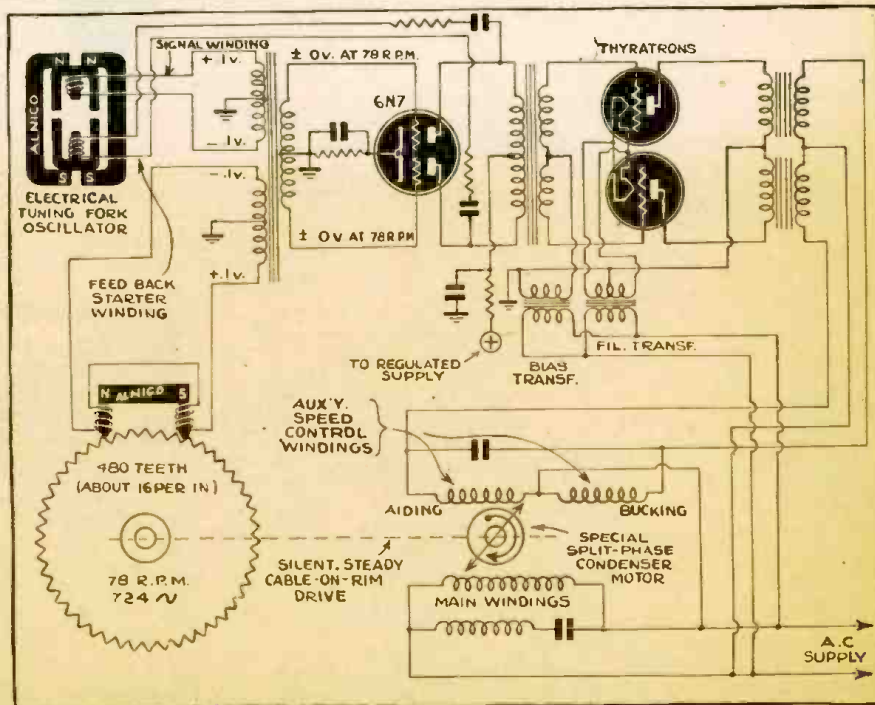

Fig. 2.—A proposed electronic speed-control system, using thyatrons to prevent speed changes.

ing is played off, the damaged stylus tip will proceed to ruin the good recording. If such a damaged recording must be played off and a standard metal stylus is used, the stylus should be discarded after the defective recording has been played.

Where the permanent type jewel stylus is involved, it is good policy not to use second-hand recordings which have been played off with various other types of needles, especially worn ones of the steel or alloy type. If a library of new recordings is gradually acquired and used exclusively with the one stylus, quieter operation, higher fidelity and longer useful record and stylus life will be obtained. This will result from the fact that smooth and uniformly-sized record grooves will at all times present themselves to the jewel stylus tip.

SUGGESTIONS TO MANUFACTURERS

Some of these suggestions are old stuff and some new. They are presented here for whatever practical use can be made of them.

1.—Make a chain of black-and-white squares about the record disc label so that it can be used as a convenient stroboscopic ring for checking the turntable R.P.M.

2.—Make two types of record disc material—one with the normal percentage of abrasive for protection against steel and alloy needles and one with less abrasive for silent play-back with polished jewel stylus type pick-ups.

3.—Manufacture test records with specially recorded passages of abruptly varying frequency and amplitude to check wow; blank groove sections for checking turntable assembly mechanical noise sources; audio oscillator created passages containing three simultaneous non-harmonically related odd-order frequencies in order to check intermodulation distortion aurally; a passage containing a sine-wave signal with a gradually changing frequency covering the frequency range in order to check the frequency range of the system; etc.

4.—Do not cut recordings with too wide a modulation amplitude swing when the recordings are intended for phono amplifier systems. While such recordings are "louder", this is a rather futile advantage where amplifiers are used since they usually possess much more gain than is required. Such overmodulation overloads the stylus mechanism and generates excessive frequency modulation, harmonic and intermodulation distortion as well as causing the pick-up head to radiate an annoying tinny mechanical singing of the recording modulations.

5.—Develop some sort of a low-viscosity protective lubricant to lengthen record disc groove and stylus tip life and reduce stylus hiss.

6.—Develop a "micro-groove" recording system using tiny recording grooves about .001" or .002" wide and extremely small, light-weight, low-inertia stylus and stylus mechanism. (The object would be to produce a super-fidelity phono system with a frequency response flat out to 20,000 cycles within 1 DB for F.M. transcription work.)

7.—Make a protective guard for pick-up stylus tips so that delicate stylus mechanisms would be protected against accidental damage.

8.—Scribe two silver or white cross-hair lines atop the pick-up head, one down the center-line and one at right angles to it and directly over the stylus tip so that the optimum location for the pick-up pivot base can be more readily obtained.

9.—Supply hi-fidelity pick-ups with shielded twisted-pair leads so that they can be readily used to feed modern hi-fidelity push-pull amplifiers.

10.—Shield the pick-up mechanisms by

"canning" them in aluminum or silver-plated copper shields; shield the exposed bottom sides of the pick-up arms with light silver-plated copper screens; shield the turntable motor leads and place a thin, silver-plated, copper shield over the turntable motor so as to reduce the A.C. hum pick-up at the stylus mechanism and output leads.

11.—Instead of using fine-wood veneering and ornamental metal finish inside the phono compartment housing the pick-up and turntable assembly, soundproof it with cloth padding and cover with ornamental velvet in order to minimize pick-up radiations and cabinet reverberation effects.

12.—Use nearer sound-proof mounting of cabinet, speaker, turntable motor, turntable mounting board, and pick-up base in order to reduce acoustic feedback and turntable assembly mechanical noise effects.

13.—Design a turntable motor with silent taper bronze or roller bearings, cable-on-

turntable-rim drive, and mechanical and electronic speed stabilization in order to minimize noise and wow effects on radio transcription equipment. See Fig. 1.

14.—Design turntables with massive rims in order to obtain more flywheel effect to reduce wow effects.

15.—Make the turntable end of the motor drive shaft more massive in order to eliminate whip action and shaft vibration effects under the stylus mechanism impedance reaction impulses against the record disc and turntable center-pin and thus reduce slight low-frequency cut-off and distortion effects.

16.—Make the turntable center-pin with a felt-padded lock-nut or else a split-expansion type center-pin with which to anchor down recordings on transcription type turntables to eliminate record disc lateral oscillation and radial slip and consequent small low-frequency cut-off and distortion effects.

(Continued on next page)

NEW RADIO-CRAFT LIBRARY BOOKS

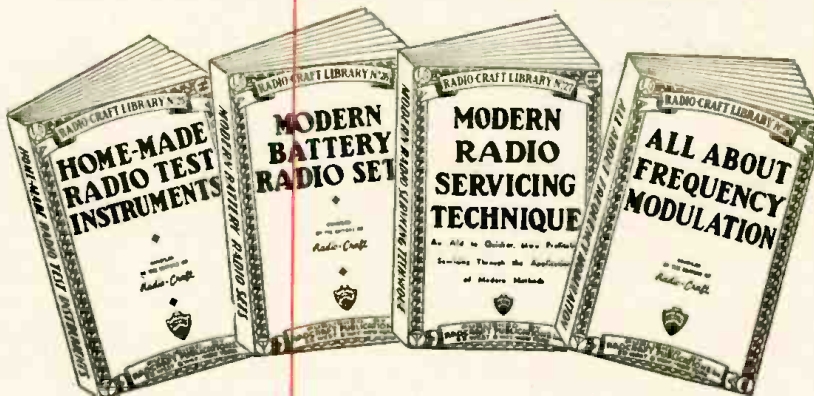

THE four latest books of our well-known RADIO-CRAFT Red Books—Nos. 25, 26, 27 and 28—recently published. These four books are all on timely subjects and we recommend every one of them to you strongly. Now, more than ever, radio education has become a burning question. If you are to be in the National Service; in the Army, Navy or Air Force—practical radio knowledge is of paramount importance. YOU CAN GET BETTER RATINGS AND ADVANCE QUICKER IF YOU HAVE A GOOD RADIO BACKGROUND. Conversely, if you are not with the armed forces, there is a whole of a job to be done at home. With more and more men going into the service, the demand for practical servicemen becomes greater each day. Therefore we say: PROFIT BY THESE UNIQUE BOOKS, WHICH ARE PRICED SO LOW THAT THEY ARE WITHIN THE REACH OF EVERYONE'S PURSE.

No. 25—Home-Made Radio Test Instruments
Outline of Contents: A Low-Cost Signal Chaser—Signal Tracer Test Unit—Simplified Practical Signal Tracer—A Home-Made Infinite Resistance Tube Checker—Build This Direct-Reading V-T Voltmeter—How to Make a Modern V-T Voltmeter—Measuring High Values of A.C. Voltage and Current With a Low-Range Meter—How to Make a Meter-Range Extender—How to Build a Practical Tube Tester and Set-Analyzer Adapter—The Beginners' Simple Volt-Milliammeter—Build This Simplified Neon-Type Test Unit—Midset Oscilloscope—How to Make and Use a Frequency Wobbler—Double Tracing Your Oscilloscope—Home-Made Frequency Modulator.

No. 27—Modern Radio Servicing Technique
Outline of Contents: Elementary Servicing Technique—Correct Procedure for the Servicing Beginner—Elementary Procedure for Servicing Radio Sets—A.F.C. Alignment Made Easy—Dynamic Servicing—Dynamic Testing Simplifies Servicing—Modern Receiver Test Requirements—Servicing Universal A.C.-D.C. Receivers—Servicing "Orphans" and Private Brand Sets—Emergency Servicing Without Test Meters—Servicing Coils—Servicing R.F. Coils—Servicing Oscillator Coils—General Information—RMA Transformer Color Code—What Causes Echo, Fading?—Radio Service Puzzlers.

SPECIAL SEND-NO-MONEY OFFER

It is not necessary that you send money with order. If you wish to take advantage of our C.O.D. plan, simply cut out the coupon, paste it on a post card and send it to us. Books will be sent to you immediately. All four books are listed uniformly at 50c each. No discount on less than three books. If you wish to take advantage of our special offer, ordering three books or more, we make an unusual low price to you as follows:

3 books—\$1.25 4 books—\$1.50

Do not fail to send coupon today!
RADIO-CRAFT PUBLICATIONS, INC.
25 West Broadway, New York 7, N. Y.

No. 26—Modern Battery Radio Sets
Outline of Contents: Beginner's 1-Tube High-Gain All-Wave Receiver—Beginners' Build This 1-Tube Loop Receiver—A "3-in-1" Battery Portable—An Easily-Built "Fluwellung Superregenerative" 2-in-1 "Card File" Battery Set—A 2-Tube Superhet. With Pentagrid Regenerative 2nd-Detector—The 4-Tube Superhet. Vacation Portable—The "Lunchbox 5" Battery Portable—"The Seafarer" Loop-Type Boat Radio Set—1-Tube Permeability Portable—An All-Purpose Portable—A Typical Commercial 3-Way Portable (Pilot Models X-1452 and X-1453)—Switch for Varying "C" Bias on Battery Radio Sets—Making a Simple Portable Aerial—Making a Pilot-Light Fuse—Old Auto Sets for New Cars—Using a Loop Portable in Cars—Quasi-Electric Soldering Iron—Lamp Bulbs as Resistors.

No. 28—All About Frequency Modulation
Outline of Contents: The ABC of F.M.—Frequency vs. Amplitude Modulation—Basic Facts About F.M. Broadcasting—Construction—Build This Practical F.M. Adapter—Audio Amplification—F.M. Audio Amplifier, Part 1—F.M. Audio Amplifier, Part 2—F.M. Audio Amplifier, Part 3—F.M. Service—Part 1, Antenna Installation and Service—Part 2, Receiver Alignment and Diagnosis—Part 3, Test Equipment for F.M. Servicing, Engineering—Part 1, The How and Why of F.M.—Part 2, The How and Why of F.M.—Theory and Design Considerations of R.F. and I.F. Coils in F.M. Receivers.

RADIO-CRAFT PUBLICATIONS, INC. 1043
25 West Broadway, New York 7, N. Y.
Gentlemen:
Rush to me by return mail, as per your special offer, the following books: (Check books selected.)
 No. 25 No. 26 No. 27 No. 28
I will pay postman \$1.00 (if two books are ordered), \$1.25 for three books, \$1.50 for four books. Plus a few cents postage and charges.
WE CANNOT SEND A SINGLE 50c BOOK C.O.D.

NAME _____
ADDRESS _____
CITY _____ STATE _____
 Save shipping and C.O.D. charges! Check here if you send cash with order. (Cash, U.S. new postage stamps, money order, check.) Foreign countries no C.O.D. Add 20% to all prices quoted.

**WESTERN
ELECTRIC CO.**

*"The Arsenal of
Communications Equipment"*

**NEEDS
ELECTRICAL
TESTERS
MEN AND WOMEN**

For Radio Transmitters & Re-
ceivers & similar equipment.

Young men and women who have been licensed radio amateurs preferred or those having a good technical knowledge of voice communication and trained in electrical testing of radio equipment are needed for inspectors and testers.

Persons in war work or essential activity not considered without statement of availability.

WRITE OR APPLY TO
C.A.J., DEPT. 891

**WESTERN
ELECTRIC CO.**

100 Central Ave., Kearny, N. J.
Mon. through Sat. 8:30 a.m.-3 p.m.

**300 WAYS
TO MAKE
MONEY**

Cash In! 68 PAGES

MAIL ORDER PLANS
TESTED MONEY MAKERS
BUSINESS SECRETS
SUCCESS SCHEMES

25c Per Copy

25 CENTS

BRAND NEW BOOK
40,000 WORDS
IN TEXT!

In "CASH IN" you get ALL the real money-makers—dozens of profitable tested mail order plans, confidential business secrets, dozens of practical tested formulas, successful tested schemes—actual experiences of men who have started on a shoestring—with less than \$10 capital.

Buyers of This Book Tell Us—
"Biggest value I've yet to see. Book is worth at least a dollar." S. Buda, B'klyn, N. Y.
"Your book is as good if not better than others selling at \$1.00."
George Brunet, Montreal, Can.
"CASH IN is the best value I have yet to see in the mail order field."
Lawrence Fox, Brooklyn, N. Y.
"CASH IN" contains only tested ideas covering every type of full- or spare-time enterprise—it's a "masterpiece" in business ventures.
25c a copy postpaid. Send U. S. stamps or coin.
NATIONAL PLANS INSTITUTE, 246 R FIFTH AVE., N. Y. C.

PICK-UP PERFORMANCE

(Continued from previous page)

17.—Design some sort of double-walled massive turntable using mercury pools and baffle plates in order to produce a smooth-action and silent hydraulic-type governor-wow-suppressor.

18.—Design an electronically-stabilized turntable motor using thyratron tubes. Such a system should be high-speed response to a sufficient degree to suppress even the high-frequency type oscillatory wow as well as the usual wow. See diagram.

The circuit is basic and is similar to thyratron controls used in industry and in gunnery fire-control systems. The problem is to develop apparatus which will have high-speed response but at the same time show no sign of hunt or chatter.

It may be seen from the foregoing that much may be done to improve phonograph performance with present apparatus. While

not decrying those who look to sound on film, wire or tape as a means of improved recording, the writer ventures to assert that the phonograph of the future may use disc records, and yet boast a quality of reproduction better than that claimed by their proponents for other systems.

BIBLIOGRAPHY

- "The Quest For Constant Speed"—E. W. Kellogg—page 220—RCA Review—October 1937.
- "A Discussion Of Several Factors Contributing To Good Recordings"—R. A. Lynn—page 363 RCA Review—April 1942.
- "Some Problems Of Disc Recording"—S. J. Be-gun—page 389 IRE Proceedings—Sept. 1940.
- "Recording And Reproducing Standards"—L. C. Smeby—page 355 IRE Proceedings—Aug. 1940.
- "The Measurement Of Transcription T.T. Speed Variation"—H. E. Roys—page 52 IRE Proceedings—Feb. 1943.
- "Some Recent Developments In Record Reproducing Systems"—C. L. Beers & C. M. Sinnott—page 138 IRE Proceedings—April 1943.
- Numerous Past Issues Of The "Journal Of The Society Of Motion-Picture Engineers."

RADIO WAVES AND RADIO ANTENNAS

(Continued from page 25)

tennas at an angle (like OB, OC, OD, etc., in Fig. 1) which would otherwise go on out into space and be lost.

WAVE-ANGLE AND FREQUENCY

Let us now consider Fig. 2. The long, solid, curved line represents the surface of the earth; the region included between the two long, curved, broken lines represents the Ionosphere. At the extreme left we have our overworked vertical transmitting antenna (as in Fig. 1) with half its radiation pattern showing, the other half being, of course, omitted for the sake of clarity. We have shown also the ground wave.

(1) The next two higher-angle waves, those immediately above the ground wave, leave the antenna at an angle and are reflected by the ionosphere. These are called reflected rays or SKY WAVES.

The higher the frequency, the harder it is for the ionosphere to return these waves to Earth. Waves at commercial broadcasting frequencies, being of long wavelength, are easily returned by the ionosphere under conditions obtaining most of the time and would come down well within the ground wave range, go up on another "hop," come down some distance beyond, go up again, etc. In this case, reception would be continuous as we get farther and farther from the transmitter until the waves became too attenuated to actuate a receiver.

(2) When the frequency is high, as in short wave work, it frequently occurs that the sky waves are not returned to earth until considerably beyond the ground wave range. In such cases, there will be a region called a SKIP DISTANCE region between the ground wave reception in which no signals are heard from that particular station. This area was given the designation "skip distance" because the sky wave "skips" over it. "Skipping" will be discussed a bit more fully in a subsequent section.

(3) Fig. 2 further shows how it is possible to have secondary skip distance regions between the first and second zones of (sky wave) reception.

(4) The reader will observe that the three waves shown at highest angles of radiation were not returned to Earth at all. These waves penetrated the Ionosphere and went on out into space. This can be interpreted as a generalization: The higher the angle of radiation, the more likely is the ray to penetrate the Ionosphere.

(5) The angle of the highest wave to be returned to Earth at a given wavelength and with a given condition of the layer is known as the critical angle. This varies with the wavelength, becoming smaller as the wavelength becomes shorter, with the layer thickness, increasing as the layer increases in extent, and with the free electron density, increasing as the density of free electrons.

(6) The radiation included between the critical angle and the ground is known as the cone of useful radiation.

(7) The writer feels that the meanings of the terms "actual height" and "virtual height" are sufficiently evident from the figure.

DAY AND NIGHT PROPAGATION

The more extensive the Ionosphere, the higher is the critical angle at which reflection is obtainable, in other words, the lower the layer extends, the easier it is for the Ionosphere to return angular radiation to us.

The reader should recall that just such low layer-heights occur during the daytime when ultra-violet light from the sun penetrates deep into the atmosphere and ionizes the nocturnally ineffective E-layer.

Figs. 3-A and 3-B illustrate these points.

Fig. 3-A is representative of conditions normally obtaining during daylight hours. Notice that the low E-layer occupies a position about 70 miles above the surface while the F₁ and F₂ layers lie, respectively,

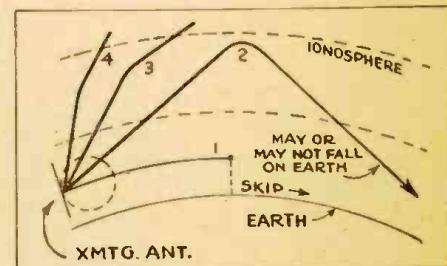

Fig. 4(d).—As the frequency increases, the higher-angle rays penetrate the Heavyside Layer, and those that return may miss the earth.

about 140 and 200 to 250 miles up. We have also shown our vertical half-wave antenna and 4 typical waves emanating from it: a ground wave (1), and typical low (2), medium (3), and high (4) angle waves.

Notice that during the daytime (Fig. 3-A) all the angular radiation is easily and

quickly returned to Earth by the low-lying Ionosphere, at low frequencies, at least. The high-angle wave (4) and medium-angle wave (3) come down well within the ground wave range of broadcast and the longer short wavelengths, while even the low-angle wave (2) does not come down too far from the transmitter. By the time these waves have made several "hops" they will become too attenuated to actuate a receiver.

At night, however, when the powerful ionizing radiations from the Sun are removed, the E and F₁ layer disappear as such, leaving but one F layer at a height of approximately 180 miles—much higher than the 70-mile or so daytime E-Layer height. Under such conditions, our typical waves will not be returned so quickly, as shown in Fig. 3-B, and in the short wave range, skipping phenomena will appear, for even the higher angle waves, like 4, may be returned to Earth beyond the ground wave range.

These considerations should somewhat clarify the well-established generalization that a wave of a given wavelength and power will generally give greater "DX" at night than will the same wave in the daytime.

FREQUENCY AND REFLECTION

Let us now consider Figs. 4-A, -B, -C, and -D. We have shown in each a restricted cross-section of the Earth's surface, as represented by the long, curved lines, and the overlying Ionosphere, as represented between the two long, curved, broken lines. We also have our vertical antenna, as in Fig. 3, emanating 4 typical waves—the ground wave (1), and the low (2), medium (3), and high (4) angle waves.

The figures are identical in all these respects, but are very different in one important respect: In each the antenna is assumed to be radiating a different wavelength.

In Fig. 4-A, the wavelength is very long (low frequency) as in commercial broadcast stations; in 4-B and 4-C the wavelength is shorter and shorter until in Fig. 4-D we have represented conditions obtaining at the ultra-short wavelengths, say, something of the order of 5 meters or so.

The reader should note in these figures the following generalizations which, although far from being rigid, hold pretty well under conditions obtaining most of the time:

(1.) For a given wavelength, the higher the angle of radiation, the deeper it penetrates into the ionosphere, or, otherwise stated—the harder it is to reflect. Thus in Fig. 4-A, for example, the high-angle wave (4) penetrates deep into the Ionosphere before it finally gets sent back to Earth. The medium-angle wave (3) is reflected much sooner, while the low-angle wave (2) barely skims the lower level of the layer. Compare this with the other three figures.

(2.) For a given wavelength, the higher the angle of a reflected wave, the closer to the station it will return to Earth. Low-angle waves give better "DX" than high. In Fig. 4-A, again, we note that the high-angle wave returns to Earth much closer to the station than does the medium (3) wave, while the low-angle wave returns farthest away of all. Compare with the other figures.

(3.) For a given angle of radiation, the shorter the wavelength, the deeper into the ionosphere it penetrates; or the shorter the wavelength of a wave, the harder it is to reflect. Let us consider the medium-angle waves (3), for example. In Fig. 4-A, where the wavelength is long, it is easily returned to Earth; in Fig. 4-B (shorter wavelength), it is also returned, but not until it has penetrated much deeper into the Iono-

EXPERIMENTERS

The war has made a terrific inroad in practically all electrical and mechanical supplies. We are fortunate in being able to offer difficult to obtain merchandise listed below. As supplies are limited, we suggest that you order immediately before certain of the items are sold out. All of the attractive items listed here are brand new, except where indicated. ALL are in PERFECT WORKING ORDER. In many cases, the parts alone total more than the price we are asking. Satisfaction guaranteed or your money back.

ORDER FROM THIS PAGE. Use our convenient coupon. Include sufficient extra remittance for parcel post charges, otherwise order is sent express collect. Any excess will be refunded. All C.O.D. shipments require 20% deposit. NO C.O.D. shipments on orders for less than \$3.00. If full remittance accompanies order, deduct 2% discount. Send money order, certified check, or new U. S. stamps. No C. O. D.'s to foreign countries.

ORDER TODAY LIMITED QUANTITIES PROMPT SHIPMENTS ASSURED

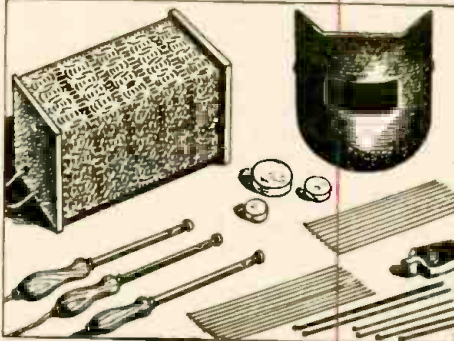

THE MAGIC ELECTRIC WELDER

Here is one of the most compact, practical welders we have ever seen. Anyone can use it for shop, farm and home repairs. WELDS, BRAZES, SOLDERS, CUTS ALL METALS. ANYONE CAN OPERATE IT. Repairs steel, cast iron, aluminum, brass, copper, bronze, etc. Complete with power unit, flame and metallic arc attachments. (Really two welders in one). Carbons, fluxes, rods, mask included. Just plug it in any electric outlet. 110 volts AC or DC. For hobbyist or professional. GET IN ON THE GREAT WELDING BOOM. This fine set quickly teaches you welding. Low cost to operate—about 5c an hour. COMPLETE SAFETY is assured. No fumes with this outfit. SET COMES COMPLETE—nothing else to buy.

Used by the U. S. Navy, American Tel. & Tel. Co.; Eastman Kodak Co.; Bell Laboratories, etc. BRAND NEW OUTFIT. Guaranteed for one year. Complete simple instructions with each set.

ITEM NO. 158
YOUR PRICE \$19.95

WESTERN ELECTRIC BREAST MIKE

This is a fine light-weight aircraft carbon microphone. It weighs only 1 lb. Mike comes with brosat. plate mounting and has 2-way swiveling adjustment so that it can be adjusted to desired position. There are 2 woven straps: one goes around neck, the other around chest. Straps can be snapped on and off quickly by an ingenious arrangement.

This excellent mike can be adapted for home broadcast or private communication systems. By dismantling breastplate, it can be used as desk mike.

Comes complete with 3-foot cord and hard rubber plug. Finished in spherulized plate, non-rustable.

THIS IS A BRAND NEW MIKE. IT HAS NEVER BEEN SOLD AT SUCH A LOW PRICE BEFORE. ORIGINAL LIST PRICE \$15.00. Shipping weight, 2 lbs.

ITEM NO. 152
YOUR PRICE \$2.55

POWERFUL ALL-PURPOSE INDUCTION MOTOR
IDEAL FOR EXPERIMENTERS—101 USES

Sturdily constructed to precision standards, this self-starting reversible shaded pole A.C. induction motor is powerful enough for a number of uses. Some of these are: Automatic Timing Devices, Current Interrupters, Electric Fans, Electric Chimes, Window Displays, Photocell Control Devices, Electric Vibrators, Small Grinders, Buffers and Polishers, Miniature Pumps, Mechanical Models, Sirens, and other applications.

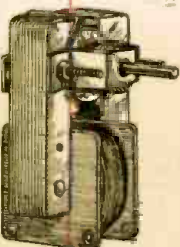

Consumes about 15 watts of power and has a speed of 3,000 r.p.m. When geared down, this sturdy unit will constantly operate an 18-inch turntable loaded with 200 lbs. dead weight—THAT'S POWER!

Dimensions, 8" high by 2" wide by 1 1/2" deep; has 4 convenient mounting studs; shaft is 3/16" diameter, and runs in self-aligning oil-retaining bearings. Designed for 110-20 volts, 50-60 cycles A.C. only.

ITEM NO. 147
YOUR PRICE \$1.95

ULTRA MAGNET

LIFTS MORE THAN 20 TIMES ITS OWN WEIGHT

LITTLE GIANT MAGNET. Lifts 5 lbs. easily. Weighs 4 oz. Made of ALNICO new high-magnetic steel. Complete with keeper. World's most powerful magnet ever made. The experimenter and hobbyist will find hundreds of excellent uses for this high quality permanent magnet. Measures 1 1/4" x 1 1/4". Shp. Wt. 3/4 lbs.

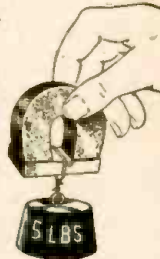

ITEM NO. 159
YOUR PRICE \$1.25

VARIABLE SPEED UNIVERSAL MOTOR

For 110 Volts, A.C. or D.C. All Nickel Plate



Edison Dictaphone motor 1/50 H. P. Used but in excellent condition. For buffing, polishing, drilling, sawing; runs Phonographs, radio models, blowers, lathes, etc. Special control permits variable speeds up to 1500 r.p.m. 3/16" shaft. Variable from both sides of motor. Cast iron base has 3 screw mounting holes.

Height 4 1/2"; length 7 1/2"; width 5 1/4". Shaft is 1 1/4" long on one side. Shp. Wt. 8 lbs.

ITEM NO. 157
YOUR PRICE \$3.45

POWER ADJUSTABLE RHEOSTAT

Here is an excellent rheostat used especially to regulate speeds of small motors, such as our Handy Workshop Outfit. This rheostat can be used in connection with motors up to 1/20 h.p.

This fine rheostat is wire-wound on porcelain insulation. The black enamel steel casing is perforated for ventilation. Adjustable handle regulates speed of motor easily and smoothly. Size 6"x2 1/4" overall. Shp. Wt. 2 lbs.

ITEM NO. 153
YOUR PRICE \$1.45



AMAZING BLACK LIGHT!!

Powerful 250-Watt Ultra-Violet Source



The best and most practical source of ultra-violet light for general experimental and entertainment use. Makes all fluorescent substances brilliantly luminous. No transformers of any kind needed. Fits any standard lamp socket. Made with special filter glass permitting only 2 ultra-violet rays to come through. Brings out beautiful opalescent hues in various types of materials. Swell for amateur parties, plays, etc. to obtain unique lighting effects. Bulb only. Shp. Wt. 1 lb.

ITEM NO. 87
YOUR PRICE \$2.45

WATTHOUR METER

Completely overhauled and ready for immediate service. Designed for regular 110 volt, 60 cycle 2-wire A.C. circuit. Servicemen use it in their shops to check current consumption of sets, soldering irons, etc. Keeps costs down. If dismantled the parts alone would bring the price. The elaborate gear train could be used as a counter on machines of various kinds. Simple to install: 2 wires from the line and 2 wires to the load. Sturdily constructed in heavy metal case. 8 1/2" high, 6 1/2" wide, 5" deep. Westinghouse, G. E. or Ft. Wayne makes. Shp. Wt. 14 lbs.

ITEM NO. 33
YOUR PRICE \$4.95

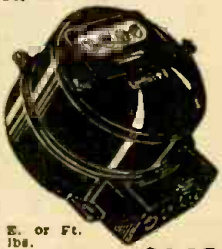

HUDSON SPECIALTIES CO., 40 West Broadway, N. Y. C.

IT'S EASY TO ORDER—CLIP COUPON—MAIL NOW ORDER FROM THIS PAGE.

HUDSON SPECIALTIES CO., 40 West Broadway, Dept. RC-10-43, New York, N. Y.

I have ordered below the number of the items I'm ordering. My full remittance of \$..... (include shipping charges) is enclosed. NO C.O.D. ORDERS UNLESS ACCOMPANIED WITH A DEPOSIT.

OR my deposit of \$..... is enclosed (20% required), ship order C.O.D. for balance. NO C.O.D. ORDER FOR LESS THAN \$3.00. (New U. S. stamps, check or money order accepted.)

Circle Item No. wanted: 33 67 147 152 153 157 158 159

Name Address

Please Print Clearly

City State

Send remittance by check, stamps or money order; register letter if you send cash or stamps.

Learn RADIO COMMUNICATIONS

Be a Gov't Licensed RADIO OPERATOR
 "Learn-by-Doing" **ON ACTUAL RADIO EQUIPMENT** in the **COYNE SHOPS**

Get ready for a great Victory future in Radio. Expert training at COYNE prepares for Gov't License test, quickly, easily. Fascinating, well-paid work in Aircraft Communication, Broadcast stations, Merchant Marine, Police Radio. "Learn-by-Doing" at Coyne!

I'LL FINANCE YOUR TRAINING!
 Start now—pay tuition after graduation. My plan has helped thousands. I assist you in getting part-time work while at COYNE to help pay living expenses. Real Employment Service when trained.

ELECTRONICS AND TELEVISION
 Tremendous expansion in Communication Electronics and Television predicted after the war—a world of new opportunities. Get ready NOW with practical Coyne Radio Training.

FREE BOOK! Mail coupon, get facts now. Big whether you're 16 or up to 50. Send today!

H.C. LEWIS, Pres., RADIO DIV., COYNE ELEC. SCHOOL, 500 S. Paulina St., Dept. 73-8H, Chicago 12, Illinois

Send me **FREE BOOK**, "Your Future in Radio", and details of easy "Pay-After-Graduation" plan.

NAME.....
 ADDRESS.....
 CITY..... STATE.....

RADIO AND ELECTRONIC DEVICES



BURSTEIN-APPLEBEE CO.
 1012-14 McGee St. Kansas City, Mo.

Complete Plans

For Building Useful and Practical Things at Home. Each issue of Popular Homecraft is crammed with plans for making such beautiful and useful things as: Furniture, Bird Houses, Lamps, Outdoor Garden Furniture, Candle Equipment, etc. Covers lathe work, tools, wood-working, leathercraft, copper. You'll find "how" to make almost everything from the pages of Popular Homecraft. Scores of drawings and photographs make every step simple as A B C. A real "How-To-Do-It" magazine.

Six Months' Trial \$1.00
 Send \$1.00 today for trial six months' subscription. Money Back If Not Delighted.

POPULAR HOMECRAFT
 837 Palmolive Building Chicago, Ill.

Trial 6 Months \$1.00

High Efficiency results in Sound National Defense that is why **NATIONAL DEFENSE SOUND SYSTEMS** are equipped with **University Reflex High Power Loudspeakers** UNIVERSITY LABS. 225 VARICK ST. N.Y.C.



sphere; in Fig. 4-C, where the wavelength is shorter still, it penetrates to the uppermost reaches of the Ionosphere before finally getting turned back; while in Fig. 4-D, at an ultra-short wavelength, the medium angle wave penetrates the Ionosphere completely and goes on out into space. Observe the behavior of the high (4) and low (2) angle waves in Figs. 4-A, -B, -C, and -D.

(4) For a given angle of radiation, the shorter the wavelength, the farther away from the station it returns to earth. Note the low-angle waves (2) in the figures where, as the wavelength becomes progressively shorter, the distance from the station at which the wave returns to Earth becomes progressively greater.

REFLECTION AND SKIPPING

(5) Notice that at the relatively longer wavelengths (Figs. 4-A and 4-B) the reception is continuous until the waves become too attenuated to actuate receiving systems any longer. The ground wave takes care of receivers up to 40 miles or more, and the easily-reflected long-wavelength sky waves return to Earth continuously to maintain communication.

However, for the short wavelength used in Fig. 4-C, entirely different circumstances obtain. Here the high-angle waves (4) are lost out in space—the Ionosphere failing completely to return them—and the medium-angle radiation returns to earth well beyond the ground wave region thereby creating a skip distance range. Generally speaking, the skip distance range increases as the wavelength decreases until, when we get up into the ultra-short waves (Fig. 4-D) the Kennelly-Heaviside Layer is unable to return either the high or the medium angle waves, and usually either fails or encounters great difficulty in returning even the low angle waves, which frequently are reflected at such small angles that they come down and miss the earth.

This last mentioned circumstance is better illustrated in Figs. 5-A and 5-B where the entire Earth and Ionosphere are shown together with the transmitting antenna. In Fig. 5-A the lowest-angle radiation was so

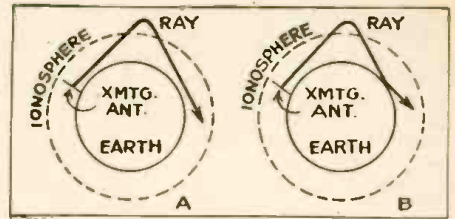

Fig. 5.—The path travelled by very short waves (under about ten meters). In many cases these may miss the earth entirely.

hard to reflect that it came down and missed the Earth. In Fig. 5-B, however, it just barely clipped the other side of the Earth. Under conditions like this the station can be heard only within the ground wave range and at a point way over on the other side of the planet! All the rest of the Earth would be in one great, big skip range!

CAUSES OF FADING

There are, of course, some types of fading which arise out of disorders within the receiver itself, but the real "fading" as radio engineers apply the word is an interesting phenomenon arising out of propagation.

Suppose a receiving station were located in such a position that its antenna intercepted 2 or more waves from the same station at once. Let us imagine it to be receiving a ground wave and a sky wave simultaneously. Now the Ionosphere is a highly changeable entity and slight variations in it occur from minute to minute. These variations would, of course, be imparted to the impinging waves and would shift them slightly from time to time. Thus the receiver would be reproducing 2 waves of the same frequency constantly shifting with respect to one another. This results in alternate reinforcement and nullification or "bucking" with the consequent variation in receiver output known as "fading."

This is a common occurrence in short wave work—especially when the waves have spanned long distances between transmitter and receiver.

CHECKING POWER SUPPLIES

(Continued from page 26)

checked. If the voltage comes up after being very low or zero it is obvious a new condenser was needed. This test is not a positive one unless the voltage across R3 is also checked. If R3 were open, replacement of C4 alone would not result in any change in voltage across the terminals of C4.

A common cause of trouble in sets of this type is a short circuit or excessive leakage in C3 in Fig. 4. This will cause an excessive amount of current through R1 and R2, tending to overload and burn up these units. At the same time that excessive current flows through R1 and R2, the voltages will rise across these resistors and larger than normal bias will be applied to the amplifier

tubes in the radio receiver. While the voltage across the fixed bias resistors has increased the B supply voltage for the plates of the receiver's tubes has gone down, so that the bad condition of low plate voltage and high bias may produce severe distortion in the circuits of the set. A voltmeter may be connected with its positive terminal on ground and its negative terminal on the junction of R1 and R2 to check the voltage across R2. The voltmeter positive terminal may be left on ground and its negative terminal connected to the junction of R1 and R2 to check the voltage across R1 and R2. Or the meter may be connected directly across either R1 or R2 to check the sep-

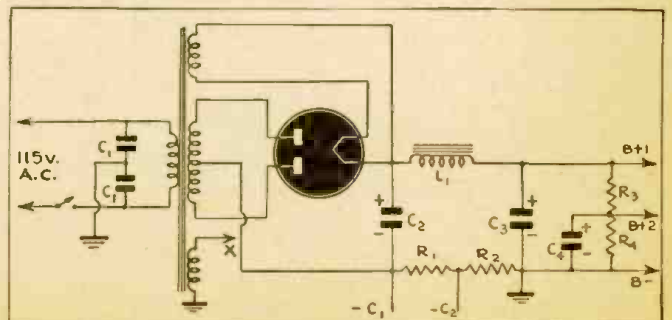

Fig. 4.—A standard power pack, with two leads for returns of grids which are to be maintained at different negative voltages. It is likely that —C1 is brought to the output tube grid, and —C2 to the I.F. and R.F. grid returns.

arate voltages in the grid-base circuits. The resistance of the speaker field L1 can be checked with an ohmmeter when the set power is turned off. Since the maximum current flowing through the field or choke is usually known, the voltage across it is readily calculated using Ohm's Law. Assuming the current maximum is .1 ampere (100 ma.) and the resistance of the choke is 1,000 ohms, a common value, the drop across it is 1,000 x .1 or 100 volts normally. Therefore, if we measure the voltage across L1 and find that it is 150 or 200 volts we know immediately that there is something wrong in the power system. How can a higher than normal voltage be applied to L1? We know that decreasing the resistance from B plus to ground allows the voltage across L1 to rise, but the voltage across B plus and B- in the output drops.

If R3 and R4 open up, or if the bias on the power tubes in the set is too high, the load on the power supply will be equivalent to a high resistance load and the load current will be small. When this happens the current in L1 is small, the IR drop across it is also small and there is more voltage available for the load. The opposite effect is noticed when the bias is too low, R3 and R4 are decreased in value or if any defect which will decrease the load resistance is present, the output voltage of the supply will then drop.

Note particularly that in checking the filament voltage of the rectifier the voltmeter is an A.C. type which is placed across the filament pins of the tube and NOT from filament to ground. This is a mistake students make as long as meters hold out.

THE POWER TRANSFORMER

In checking the filament winding for the other tubes, one lead may be connected to X, the other to ground. To quickly check for shorts, leave the rectifier tube out of its socket and observe whether or not the power transformer continues to overheat. If you wish, measure the primary current of the transformer by connecting an A.C. ammeter in series with the switch. One lead to the switch can usually be disconnected conveniently and the ammeter is attached to that lead, the other side going to the bare contact on the switch.

In replacing a power transformer that is burned out, a 25-watt lamp in series with the A.C. line, as shown in Fig. 5, can be used for testing. The lamp will light brightest on the lowest impedance winding of the group and dimmest on the highest impedance winding. The lamp therefore permits identification of the various windings. The highest impedance winding will be the one connecting to the rectifier plates, next highest is the primary and then the filament winding for the amplifier tubes (generally) followed by the rectifier filament winding.

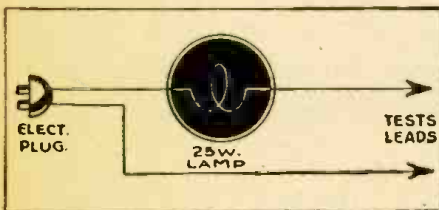

Fig. 5.—The impedance-checking lamp.

In some sets the amplifier tubes filament winding will be the one of lowest impedance, depending upon the tubes that are used and the filament current. This is true of 2.5 volt heater types all connected to the same winding. The voltages can readily be checked exactly, once tentative identification has been made. The primary is always located easily and can be connected to the line while secondary voltages are checked.

Whatever YOU WANT In A HEADSET

You'll find in a Cannon-Ball Guaranteed Headset: Sensitivity. Clarity of tone. Dependable performance. Quality at fair price. Folder C-10 illustrates complete line. Write Headset Headquarters.

C. F. CANNON COMPANY
SPRINGWATER, N. Y.

FADA
FACTORY SERVICE DEPT.

has replacement parts for all FADA models manufactured during the last 10 years. Call, write, phone or send 10c for our latest Replacement Parts Catalog.

FADA OF NEW YORK
928 Broadway, New York, N. Y.
Gramercy 7-0951

SUBSCRIBE NOW

TO-

AND RECEIVE FREE THIS DICTIONARY

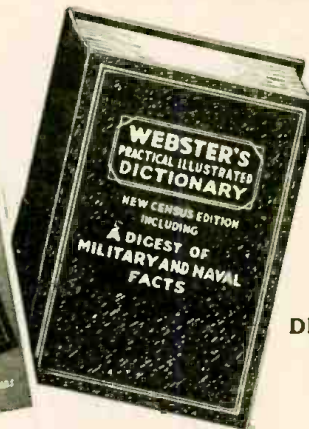

FULL LIBRARY SIZE WEBSTER DICTIONARY 378 PAGES

FIVE MONTHS \$1.00
TWELVE MONTHS \$2.00

SPECIAL NOTICE TO OUR READERS

Due to wartime curtailment of paper, we are unable to meet the increasing newstand demand for RADIO-CRAFT. We are therefore making this special introductory offer to our readers. Assure yourself of getting a copy of RADIO-CRAFT monthly by subscribing now and at the same time co-operate in making this wartime measure effective. Don't delay—Send in your order today. Take advantage of our special long-term offer and protect yourself against any possible increase in price by sending \$2.00 for 12 issues.

If you will take advantage NOW of our special subscription offer of five months for \$1.00 or twelve months for \$2.00, we will send you ABSOLUTELY FREE and POSTPAID this 378-page WEBSTER'S PRACTICAL ILLUSTRATED DICTIONARY—useful and instructive to all. This self-pronouncing authoritative dictionary—a brand new work throughout—contains the most up-to-date words now in common use. Over 20,000 definitions in all. In addition, it has the following: List of Largest Cities in the U. S.; List of Principal Cities of the U. S.; List of Principal Cities of Canada; National Parks of the U. S.; Time and its Variations; Tables of Weights and Measures; Presidents of the U. S.; Synonyms and Antonyms; Dictionary of Commerce and Law; Dictionary of Forms of Address; Military and Naval Information (illustrated); Digest of the Purposes of Current Federal Agencies.

THIS IS A TIME LIMITED OFFER

MAIL COUPON TODAY FOR A SUBSCRIPTION AND DICTIONARY

RADIO-CRAFT
25 WEST BROADWAY
NEW YORK 7, N. Y.

RADIO-CRAFT, DEPT. 1043, 25 WEST BROADWAY, NEW YORK 7, N. Y.

Gentlemen: Enclosed you will find my remittance for which enter my subscription to RADIO-CRAFT Magazine for the period checked below. Send me ABSOLUTELY FREE and POSTPAID the Webster Dictionary.

- 5 months — \$1.00
- 12 months — \$2.00
- This is a new order
- Renewal

NAME

ADDRESS

CITY Postal (if) Dist. No. (any) STATE

Remit by check or money order; register letter if you send cash or unused U. S. Postage Stamps. (Canadian and foreign orders must be accompanied by an International Money Order.) On Canadian orders add 50c for postage; on foreign add 75c for one year.

**None better then
or Now!**

WHEN Victory is ours and better amplifiers are designed and perfected, you can bet your last dollar on the engineering skill of Amplifier Co. of America. Basic Design is all important. No new developments or improvements have come along during the last few years which would make our popular line of direct-coupled amplifiers obsolete.

Amplifier Co. of America, the recognized leader in improvements and modern direct-coupled FM-AM amplifiers, has made an outstanding contribution to the Sound Industry by making available their Amplifier Manual specially prepared by A. C. Shaney, Chief Engineer.

Explains the theory and practical application of:

- Variable Speed Non-Overloading Push-Pull Expansion;
- Non-Frequency Discriminating Scratch Suppression;
- Push-Pull Balanced Direct-Coupled Amplification;
- Push-Pull High-Frequency Equalization; Push-Pull Low-Frequency Equalization; Push-Pull Volume Compression; Automatic Volume Limitation; Automatic Volume Control; Calibrated V.U. Indicator; Audio Spectrum Control; Remote Control.

if you are interested in the latest audio developments, you can't afford to be without this complete compilation of authentic articles on Direct-Coupled Amplifiers. 32 pages 8 1/2" x 11". Over 100 diagrams and illustrations.

Priced to Cover Cost of **25c** Send Stamps
Printing and Mailing or Coin

AMPLIFIER CO. OF AMERICA

396 BROADWAY, NEW YORK, N. Y.

LEARN CODE the way you'll
be using it by
SOUND



The best way to learn to read code is by listening to code. The best way to learn to send code is by hearing your own sending repeated back to you. With the new All-Electric Master Teleplex Code Teaching Machine, you learn code the natural, easy, fascinating way. Only instrument ever produced which records your sending in visible dots and dashes—then SENDS BACK your own key work at any speed you desire. There are NO PERFORATIONS—NO INK. Far superior to anything ever developed—a marvel of simplicity. That's why practically every school teaching code uses TELEPLEX. We furnish complete course, including the All-Electric Master Teleplex. Give you personal instruction with a MONEY BACK GUARANTEE—all at a surprisingly low cost. Write today for FREE catalog \$10. No obligations.

TELEPLEX CO., 107 HUDSON ST.,
JERSEY CITY, N. J.



**"THE
INDUCTANCE
AUTHORITY"**

By EDWARD M. SHIEPE, B.S., M.E.E.

THE ONLY BOOK OF ITS KIND IN THE WORLD. "The Inductance Authority" entirely dispenses with any and all computation for the construction of solenoid coils for tuning with variable or fixed condensers of any capacity, covering from ultra frequencies to the borderline of audio frequencies. All one has to do is to read the charts. Accuracy to 1 per cent may be attained. It is the first time that any system dispensing with calculations and correction factors has been presented.

There are thirty-eight charts, of which thirty-six cover the numbers of turns and inductive results for the various wire sizes used in commercial practice (Nos. 14 to 32), as well as the different types of covering (single silk, cotton-double silk, double cotton and enamel) and diameters of 1/4, 3/8, 1, 1 1/4, 1 1/2, 1 3/4, 2, 2 1/4, 2 1/2, 2 3/4 and 3 inches.

Each turns chart for a given wire has a separate curve for each of the thirteen form diameters.

The book contains all the necessary information to give the final word on coil construction to service men engaged in replacement work, home experimenters, short-wave enthusiasts, amateurs, engineers, teachers, students, etc.

There are ten pages of textual discussion by Mr. Shiepe, graduate of the Massachusetts Institute of Technology and of the Polytechnic Institute of Brooklyn, in which the considerations for accuracy in attaining inductive values are set forth.

The book has a flexible fiber cover, the page size is 9 x 12 inches and the legibility of all curves (black lines on white field) is excellent.

Order from your dealer or direct—\$2.50

GOLD SHIELD PRODUCTS

350 Greenwich St., (Dept. R.C.10), New York City

A MULTI-UTILITY PANEL

Dear Editor:

Herewith is a picture of my test panel. The following explains the different units starting from the left:

Top, square panel; bottom, D.C. supply, 1 1/2, 2, 45, 90 and 135 volts, as well as 6 volts at 10 amperes. There are break-in switches on both meters to allow their use on both A and B circuits. The left-hand meter reads 25 and 50 mills and 2 1/2 and 25 amperes. The right-hand meter reads 3, 12, 120 and 300 volts. A switch on the 6-volt supply, used for checking vibrators in car sets, gives low voltage for sticking points. A variable control is used to check vibrators in low-drain 6-volt house (farm) sets.

The receptacle in the left-hand corner is for a cable to reach across the bench to test consoles and portables with short leads.

The next unit at the top of the panel is a substitute speaker consisting of four chokes brought out to tip jacks, to take the place of speaker fields ranging from 500 to 2750 ohms, also an output transformer with tapped primary and a P.M. speaker. All connections are brought out to tip jacks. On the same panel is mounted a pilot light and switch to control all equipment and outlets. The outlets are all separately fused.

The lower unit is a Hickock signal generator Model 188 with output meter. Next, at the top, is an R.C.A. 2-inch scope; below it a Radio City Model 661 electronic multimeter. There is a small panel just to the right of the multimeter. The top section of this is used for a neon leakage tester with a tapped transformer and rectifier giving 200-800 volts. On the lower part of the panel I have brought out leads from the meter in the multimeter so I can use it as an ordinary meter for 6, 150, 300 and 600 volts and 5,000, 50,000 and 5,000,000 ohms.

I use standard jacks and a phone plug to eliminate all switching when changing from volts to ohms or from one range to another. This is a real time saver.

At the top right end is a Supreme Model 599 tube and set tester. This unit lifts out and is all I carry on outside calls. I have added 2 switches and 16 volts of C batteries and 2 uni-cells with a rheostat to test either 1 1/2 or 2-volt tubes in unwired homes.

The lower unit has an A.C. voltmeter, an A.C. ammeter and a tapped autotransformer supplying 80 to 130 volts.

J. B. LAPHAM,
Courtenay, B. C.

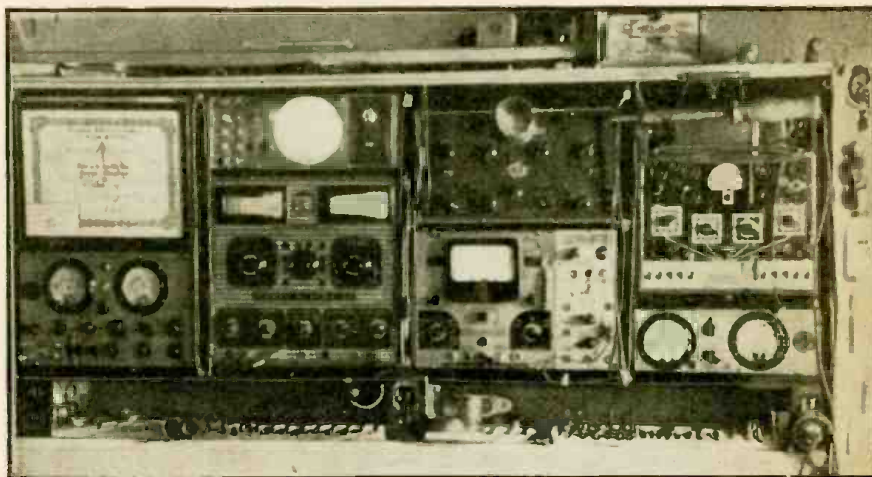

IMPS ARE AN AID TO SERVICEMEN!

Dear Editor:

I have been a reader of your excellent *Radio-Craft* for almost fourteen years, since November, 1929. Before 1929 I cut my teeth on Mr. Gernback's magazines, *Science and Invention* and *Radio News*. My interest in your magazine is from the standpoint of the serviceman and engineer since that was my profession in civilian life.

Since I have also spent several hard weeks' study in a classroom with the temperature between 96 and 98 degrees, I can sympathize with Cpl. F. S. G. (R.-C. 8-43). I have not had the great delight (?) of reading Mr. Rimer's letter. I don't think there was any intention to "run down" the Armed Services, I am convinced that *Radio-Craft* would not print any such material in its pages.

Now to the subject of "Imps," I say a monument should be erected to the memory of the scholar who discovered the pesty things. I look on them as a heaven-sent opportunity, a chance to pass the buck for all of my shortcomings. Ours is a tough life sometimes and the "Imps" must have burning cars, they take a lot of abuse when

there is no one in the offing whom we can outrank. +1/4*?ae+%c looks wonderful on paper, but has the Cpl. tried using them generously on a Sergeant when there was no other convenient outlet? That is what I thought. Yes, the "Imps," may they be blessed.

The term "Rube Goldberg" dates back farther than 1941 and the magazine investigators, Sir. The investigators used it as a convenient designation for any equipment which they did not fully understand, meaning anything any more complicated than a screwdriver. Ahhhh yes, the investigators, may they be blessed to. It has taken thousands of dollars, and months of time in truthful advertising, to cure the terrible black eye that honest Servicemen took from that one article. We all owe R.C.A. an orchid for the wonderful work they did on that job. One thing we should not overlook though, we do have those Gyps in our ranks, they are thicker now than ever before, I think the magazine article gave some of these out here a number of new ideas.

CPL. WILLIAM L. HOY,
Seattle, Wash.

NUMBERS ON TUBE SOCKETS?

Dear Editor:

On Page 516 of your June issue, a reader asks for pictorial diagrams and states that although he and his friends know the symbols, they still cannot make the sets from schematic plans.

I am an old timer, but I have to refer to the tube manual to find proper prong connections for twin triodes, etc.

To save this trouble—and most of us have it—would it not simplify matters for everyone if you would *always* number the leads to the tubes as you do on Page 366 of the March issue?

JAMES R. MILLS,
Toronto, Canada

(There are a number of ways of representing tube sockets in a schematic. These range from the plain circle, through those that number or letter the leads as they come through the circle—with no attempt at sequence—to the double circle with numbers and designations, but no symbols in the tubes, as on Page 544, June. Which do our readers prefer?—Editor)

PERMANENCE VS. SPEED

Dear Editor:

I would like to put my oar into this Buck-Embree discussion about the 20 radios repaired in an 8-hour day.

I have been in Radio Servicing for nearly twenty years and I can't honestly turn out over 10 a day. But those 10 stay repaired and are not in the following week.

The last issue of *Radio-Craft* has a very interesting article, "Keep 'Em Playing," by Mr. M. J. Edwards. I have done a little along this line here in Coeur D'Alene.

I would like Mr. Edwards' view on the question of 20 sets repaired in a day. What does he think?

C. F. CARRICK,
Coeur D'Alene, Idaho

WARTIME ALIBIS

Radio-Craft has received the following letter from N. H. Silverman, author of "A Wartime Ohmmeter" in the August issue, who has just moved to California.

Dear Editor:

Had an interesting experience with a relative's radio receiver, which had been in a local radio shop for nearly 5 months. The old alibi: "Can't get parts. War, y'know," was used—even as you and I . . . well, I have used it—occasionally.

From nearly 25 years' experience—I turned pro June 19, 1919, when I got PAID for building a receiver—I know none of us actually spend 5 months on any radio receiver. Once a man *thinks* he's licked, he lets the set alone, hoping he'll fix it—some day. The day rarely arrives, but the irate owner does.

This was a Philco 38-93, if memory serves. Intermittent. Trouble was due to defective screen grid by-pass condenser—which I suspected when my relative described the trouble.

When he complained that the receiver didn't have any pep, I had a hunch—yep! open antenna lead in primary of antenna coil!—as is so often the case in this model. In 20 minutes the radio played "better as new." As a finish, I was offered \$54.00 for a 54-hour week. So now I am a Radioman again, and may be able to write some more articles on ohmmeters and suchlike.

NATHAN H. SILVERMAN,
Los Angeles, Calif.

Lowest Priced Publications for Experimenters

10 FOR 50c

Here is a large number of radio, short-wave, and mechanical "how-to-make-it" designs. Each is a special publication originated by masters in their respective fields. For the low price of 50 CENTS, you buy pamphlets with photographic reproductions of complete mechanical layout, and full description to make it possible for anyone to build the project in question.

PLEASE ORDER EACH PROJECT BY ITS PUBLICATION NUMBER, and use the special coupon below. We accept money-orders, cash, checks or new U. S. stamps. (No foreign stamps.) If you send cash or stamps, register your letter. Money refunded if you are not satisfied. ANY TWENTY-FOUR PUBLICATIONS FOR ONE DOLLAR.

SHORT-WAVE RECEIVER PUBLICATIONS

- HOW TO MAKE THE "OSCILLODYNE" 1-TUBE WONDER SET. No. 101
- HOW TO MAKE THE "19" TWIN-PLEX (ONE TUBE PERFORMS AS TWO) RECEIVER. No. 102
- HOW TO MAKE THE WIZARD-1-TUBE 50-WATT TRANSMITTER. No. 103
- HOW TO MAKE THE IMPROVED 3-TUBE DOERLE SET FOR BATTERY OPERATION. No. 104
- HOW TO MAKE THE "GO-GET-'EM 2" RECEIVER FOR THE BEGINNER. No. 105
- HOW TO MAKE THE 1-TUBE-ALL-ELECTRIC OSCILLODYNE. No. 106
- HOW TO MAKE THE 2 TO 5 METER TWO-TUBE LOUDSPEAKER SET. No. 107
- HOW TO MAKE THE 3-TUBE BATTERY SHORT-WAVE RECEIVER. No. 108
- THE BRIEF-CASE SHORT-WAVE RECEIVER AND HOW TO BUILD IT. No. 109
- HOW TO BUILD THE POCKET SHORT-WAVE RECEIVER. No. 110
- HOW TO BUILD THE CIGAR-BOX 1-TUBE "CATCH ALL" RECEIVER. No. 111
- HOW TO BUILD THE "DUAL-WAVE" SHORT-WAVE BATTERY RECEIVER. No. 112
- HOW TO BUILD THE 1-TUBE "53" TWINPLEX" RECEIVER. No. 113
- HOW TO BUILD THE PORTABLE MINIDYNE SHORT-WAVE BATTERY SET. No. 114
- HOW TO BUILD THE HAM-BAND "PEE-WEE" 2-TUBER. No. 115
- HOW TO BUILD THE DUO-AMPLIDYNE. No. 116
- HOW TO BUILD THE "MONO-COIL 2". No. 117

RADIO BROADCAST RECEIVER AND SPECIAL RADIO PUBLICATIONS

- HOW TO MAKE THE A.C.-D.C. "CASH BOX" RECEIVER No. 118
- HOW TO MAKE BEGINNER'S 2-TUBE ALL-WAVE SET. No. 119
- HOW TO BUILD THE "RADIO-LAMP" 4-TUBE TABLE RECEIVER. No. 120
- HOW TO BUILD A SUPER-SENSITIVE ALL-WAVE CRYSTAL SET. No. 121
- HOW TO BUILD THE 2-TUBE "PENTODE PORTABLE" BROADCAST SET. No. 122
- HOW TO BUILD THE RADIO "TREASURE" FINDER. No. 123
- HOW TO BUILD THE GERNSBACK ONE-TUBE PENTODE LOUDSPEAKER SET. No. 124
- HOW TO BUILD THE WORLD'S SMALLEST ONE TUBE BATTERY RADIO. No. 125
- HOW TO BUILD A 6-TUBE BATTERY ALL-WAVE "FARM PORTABLE" SET. No. 126
- HOW TO MAKE AN A.C.-D.C. ONE-TUBE "DEAF AID." No. 127
- HOW TO BUILD A PIANOTRON. No. 128
- HOW TO BUILD THE ONE-DOLLAR RADIO. No. 129
- HOW TO MAKE A VARIABLE-TONE CODE PRACTICE SET. No. 130

MECHANICAL PROJECTS PUBLICATIONS

- HOW TO MAKE A SOUTH SEA OUTRIGGER CANOE. No. 131
- HOW TO BUILD A PEE-WEE AUTOMOBILE. No. 132
- HOW TO BUILD A DUAL-CONTROL GLIDER. No. 133
- HOW TO BUILD A HOUSEBOAT ON PONTOONS. No. 134
- HOW TO MAKE A BAND SAW FROM OLD AUTO PARTS. No. 135
- HOW TO BUILD A REAL LATHE FOR \$5.00. No. 136
- HOW TO BUILD A SAIL CATBOAT. No. 137
- HOW TO BUILD A SIMPLE PORTABLE REFRIGERATOR. No. 138
- HOW TO BUILD A XYLOPHONE. No. 139
- HOW TO BUILD THE ROWMOBILE. No. 140
- HOW TO BUILD LARGE TESLA AND OUDIN COILS GIVING 18-INCH SPARKS. No. 141
- HOW TO MAKE AN ARC WELDER. No. 142
- HOW TO USE AN A.C. ARC WELDER. No. 143
- HOW TO MAKE YOUR OWN MICROSCOPE. No. 144
- HOW TO MAKE A WIMSHURST ELECTROSTATIC MACHINE. No. 145
- HOW TO MAKE A POWER DRILL FROM SCRAP PARTS. No. 146
- HOW TO BUILD A GOOD LATHE FOR \$1.00. No. 147
- HOW TO MAKE AND EXPERIMENT WITH AN ELECTROPHORUS. No. 148
- HOW TO MAKE AN ELECTRIC ARC WELDER FROM AN AUTOMOBILE GENERATOR. No. 149

RADIO PUBLICATIONS, 25 West Broadway, NEW YORK 7, N. Y. RC 10

I enclose \$..... for the publications listed by number, at right, at the rate of 50c FOR ANY TEN PUBLICATIONS, NO ORDER FOR LESS THAN 50c ACCEPTED, \$1.00 for 24 publications. These publications are to be sent to me Postpaid. I have placed a circle around each number which I want.

PLEASE PRINT CLEARLY

Name	Address	101	102	103	104	105	106
City	State	107	108	109	110	111	112
		113	114	115	116	117	118
		119	120	121	122	123	124
		125	126	127	128	129	130
		131	132	133	134	135	136
		137	138	139	140	141	142
		143	144	145	146	147	148
							149

10 BEST RADIO BOOKS 10 CENTS EACH

- RADIO FANS EVERYWHERE—these fine ten cent text books give you an excellent foundation for the study of RADIO. They are clearly written, profusely illustrated and contain over 15,000 words in each book. You'll be amazed at the wealth of information contained in these handy books. Excellent for reference—ideal for every technical library. YOUR MONEY BACK if you are not satisfied. PROMPT SHIPMENTS
- No. 1—HOW TO BUILD FOUR DOERLE SHORT WAVE SETS
 - No. 2—HOW TO MAKE THE MOST POPULAR ALL-WAVE 1- AND 2-TUBE RECEIVERS
 - No. 3—ALTERNATING CURRENT FOR BEGINNERS
 - No. 4—ALL ABOUT AERIALS
 - No. 5—BEGINNERS' RADIO DICTIONARY
 - No. 6—HOW TO HAVE FUN WITH RADIO
 - No. 7—HOW TO READ RADIO DIAGRAMS
 - No. 8—RADIO FOR BEGINNERS
 - No. 9—SIMPLE ELECTRICAL EXPERIMENTS
 - No. 10—TELEVISION

BOOKS ARE ALL UNIFORM

Every book in the GERNSBACK EDUCATIONAL LIBRARY has 32 pages—with illustrations varying from 30 to 66 in number. Each title volume contains over 15,000 words. Positively radio's greatest book buy! If you do not think these books worth the price asked, return them in 24 hours and your money will be instantly refunded.

RADIO PUBLICATIONS • 25 WEST BROADWAY • NEW YORK 7, N. Y.

RADIO PUBLICATIONS, Dept. RC-043
25 WEST BROADWAY, NEW YORK 7, N. Y.

Gentlemen: Please send immediately, POSTPAID, the book numbers circled below. I am enclosing cents—each book being 10c.

1 2 3 4 5 6 7 8 9 10
NEW NEW

Send FREE listing of 48 new 10c publications.

PLEASE PRINT CLEARLY

Name

Address

City

State

Remit by check or money order—register letter if you send cash or unused U. S. postage stamps.

MAIL COUPON TODAY!

• ADVERTISING INDEX •

ALL-ROUND BRIDGE ANALYZER

(Continued from page 32)

checked on low voltage, however.

The instrument gives direct readings on the following scales: Capacity, .001 to 8 mfd., in two ranges; resistance, 10 to

90,000 ohms; inductance, 1 millihenry to 9 Henries.

Parts List

- C1—.01 mfd.
- C2—1.0 mfd.
- R1—100 ohms
- R2—10,000 ohms
- R—10,000-ohm volume control
- Ch1—10 millihenry choke
- Ch2—1 henry choke
- Sw1—Toggle switch
- Sw2—S.P. 6-position switch

All other items are self-explanatory or explained in the text.

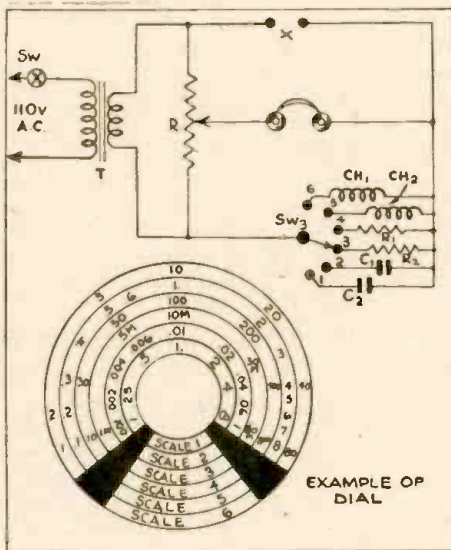

Inventions Wanted

Patented or Unpatented

We have been successfully selling inventions, patented and unpatented, since 1924. Write us, if you have a practical, useful idea for sale.

CHARTERED INSTITUTE OF AMERICAN INVENTORS

Dept. 110, 631 Pa. Ave., N. W., Washington, D. C.

PATENTS—TRADE MARKS

Booklet concerning Inventions & Patents Form "Evidence of Conception" with instructions for use and "Schedule of Government and Attorneys Fees"—Free

LANCASTER, ALLWINE & ROMMEL
Registered Patent Attorneys

436 Bowen Bldg. Washington, D. C.

OPPORTUNITY AD-LETS

Advertisements in this section cost 20 cents a word for each insertion. Name, address and initials must be included at the above rate. Cash should accompany all classified advertisements unless placed by an accredited advertising agency. No advertisement for less than ten words accepted. Ten percent discount six issues, twenty percent for twelve issues. Objectionable or misleading advertisements not accepted. Advertisements for November, 1943, issues must reach us not later than October 8th, 1943.

Radio-Craft • 25 W. B'way • New York 7, N. Y.

RADIO SERVICEMEN AND EXPERIMENTERS SEND for our giant radio catalogue. Save dollars. United Radio Co. (1000P) Newark, N. J.

USED CORRESPONDENCE COURSES AND TECHNICAL Books Bought, Sold, Rented. Catalog Free. Educational Exchange, Henager, Alabama.

ORDER YOUR COPY TODAY

Limited Supply Available

Volume 2 of the OFFICIAL REFRIGERATION MANUAL, which was published in 1935, contains service data and information of value to everyone interested in refrigeration.

There has been a tremendous demand for this manual, especially during the last year. This has been due to the discontinuance of new models for the duration of the present emergency and the necessity of servicing all old refrigerators and keeping them in service as long as possible.

You will find this Manual very helpful in repairing refrigerators and keeping them in good working order until new refrigerators can again be manufactured.

OVER 350 PAGES
OVER 300 DIAGRAMS

To order this Refrigeration Manual—

MAIL COUPON
TODAY FOR YOUR COPY

RADCRAFT PUBLICATIONS, INC.
25 West Broadway, New York 7, N. Y.

RADCRAFT PUBLICATIONS, INC. RC-1043
25 West Broadway, New York 7, N. Y.

Gentlemen:—Enclosed you will find my remittance of \$5.00, for which please send me one copy of the OFFICIAL REFRIGERATION SERVICE MANUAL (Volume II). I understand that this book is to be shipped to me POSTAGE PREPAID.

Name Please Print Clearly

Address

City State

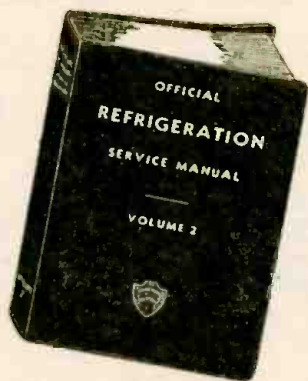

Partial Contents

- Theory and Fundamental Laws
- Methods of Refrigeration
- Refrigerants, Lubricants and Brines
- Handling and Storage of Refrigerants
- Compression System of Refrigeration
- Liquid Throttle Devices Refrigeration Systems
- Electric Control Devices
- Compressors, Types, Seals, Valves, Capacities
- Evaporators and Cooling Units Service Tools
- Commercial Unit Specifications
- Servicing Refrigeration Apparatus
- Servicing Low Side Float Valve Systems
- Servicing High Side Float Valve Systems
- Servicing Expansion Valve Systems
- Servicing Thermostatic Valve Systems
- Servicing Restrictor and Capillary Tube Systems
- Charging Systems with Refrigerant
- Electrical Service: Motors, Fuses, Hookups
- Estimating Refrigeration Loads

Index to advertisers

Allied Radio Corp	46
Amperite Co.	49
Audel & Company	Back Cover
Audiograph	43
Amplifier Company of America	60
Burstein-Applebee	58
Cannon Company, C. F.	59
Chartered Institute of America	62
Cortlandt Distributing Co.	49
Coyne Electrical School	58
Echophone	Inside Back Cover
Fada of New York	59
General Electric Co.	50
Gold Shield Products	60
Hallcrafters, Inc.	3, 4
Harrison Radio	51
Henry Radio	49
Hudson Specialties	57
Lancaster, Allwine & Rommel	62
Maedel Publishing House	63
Meissner Manufacturing Co.	45
National Plans Institute	56
National Radio Institute	1
National Schools	47
National Union Corp.	Inside Front Cover
Ohmite Mfg. Co.	48
Onan & Sons, D. W.	53
Opportunity Adlets	62
Pioneer Gen-E-Motor	41
Popular Homecraft	58

RADIO SCHOOL DIRECTORY

Page 64

American School	
Candler System	
Capitol Radio Engineering Institute	
Commercial Radio Institute	
Lincoln Engineering School	
Mass. Radio School	
New York Y.M.C.A. Schools	
RCA Institutes	
Tri-State College	

Radcraft Publications, Inc.	55, 59, 62
Radio Publications	61
Radio & Technical Publishing Co.	35
Sprayberry Academy of Radio	52
Sprague Products Co.	37
Supreme Instruments	53
Sylvania Electric Co.	42
Technifax	54
Teleplex	60
Triplet Electrical Instrument Co.	51
University Laboratories	58
Western Electric Co.	56

(While every precaution is taken to insure accuracy, we cannot guarantee against the possibility of an occasional change or omission in the preparation of this index.)

BOOK REVIEWS

MARCONI, PIONEER OF RADIO, by Douglas Coe. Illustrated by Kreigh Collins. Published by Julian Messner, Inc. Stiff cloth covers, 6 x 9 inches, 272 pages. Price \$2.50.

Frankly a book for younger readers, this biography of Marconi shows a thoroughness and grasp which would not have been wasted on a far heavier treatment of the subject. The author fortunately resists throughout the temptation to write a "serious book" and sprinkles his work throughout with human-interest features and humorous anecdotes, to the great benefit of his young (and older) readers.

Proportionately more space is spent on the years 1902-1907 than in most works on Marconi. These represented a period of doldrums in the history of Marconi's telegraph company—a period in which great results were continually in sight, but never quite achieved. To the author, (as no doubt to Marconi himself) they were among the most important years in the history of the inventor. Once consistent wireless communication across the Atlantic had been accomplished, the rest of the way was comparatively easy.

As might be expected in these days of UHF and SHF, Marconi's early experiments with directional short-wave, in the order of two meters, (the patents on which, taken out before the turn of the century, ran out before practical use could be made of them), are given marked attention.

A complete index adds to the value and interest of the book, as does a bibliography. There is also a list of the honors and awards presented to Marconi.

The argument as to whether Marconi is or is not entitled to be considered the inventor of wireless communication is answered here in the words of Sir William Preece, attacking (in 1897) those who insisted that the young inventor had contributed nothing to the science of producing and detecting electromagnetic waves.

"He has not discovered any new rays," said Preece; "his recorder is based on Branley's coherer. Columbus did not invent the egg, but he showed how to make it stand on its end, and Marconi has produced . . . a new system of telegraphy that will reach places hitherto inaccessible."

SUCCESSFUL RADIO REPAIRING, with Available Substitute Parts, by M. N. Beitman. Published by Supreme Publications. Heavy paper covers, 5½ x 8 inches, 32 pages. Price 25c.

This useful little booklet discusses the various repairs which may be made with parts not exactly the same type as those removed. There are notes on increasing the value of a resistor, making small condensers, combining new components with those already in a circuit to permit using repair parts of non-standard size, repair and replacement of R.F. and I.F. coils, and even power transformers and field coils.

Critical and non-critical circuits in a receiver are compared, and the serviceman is not only told what he can do in the way of substituting available components—he is also informed as to where he must maintain exactly the constants of the circuit under repair.

COMMUNICATION CIRCUITS, by Lawrence A. Ware and Henry R. Reed. Published by John Wiley and Sons. Stiff cloth covers, 6 x 9 inches, 287 pages. Price \$3.50.

This text is intended as first-course material for those interested in communication engineering. Knowledge of calculus and the elements of alternating current are presupposed. For the student whose mathematics has not been adapted to electromagnetic theory, Maxwell's equations are developed in one of the Appendices in the form in which they are most useful in dealing with wave guides and co-axial transmission lines. Another section of the Appendix seeks to clear up the difficulties caused by the usual student's unfamiliarity with hyperbolic functions and his consequent unwillingness to use them. (A table of natural hyperbolic functions is included.)

A feature of the book is its attention to ultra-high-frequencies. A full chapter is devoted to rectangular wave guides, and another to cylindrical guides. The authors believe that the importance micro-waves are now assuming warrants a more extensive treatment than has usually been given the subject in the past. While the book covers communication circuits from the lowest voice frequencies up, the growing use of UHF has been kept in view in preparing all sections.

PRACTICAL OUTLINE OF MECHANICAL TRADES, for Home Study. Edited by William L. Schaaf, assisted by a staff of technical specialists. Stiff cloth covers, 6 x 8½ inches, 951 pages.

The "Practical Outline" is composed of a series of articles, each written by a specialist in the field, covering Electrical Trades, Physics, Chemistry, Woodworking and Pattern Making, Mathematics, Mechanical Drawing and Machine Shop and Metal Work.

The first section, which covers 294 pages, is a highly practical course in mathematics, in which the work is related directly to the problems of the shop. It is followed by a section on mechanical drawing.

Part Two of the book is subdivided into a number of technical subjects, including Applied Physics, (a chapter is devoted to strength of materials), Chemistry, Materials of Trade and Industry, and Machine Elements. The latter section refers to tapers, threads, bearings, transmission elements, etc.

The large section on Machine Shop work will be especially valuable to the experimenter or hobbyist setting up his own workshop. The standard equipment is described in terms clear enough for the novice and complete enough to permit him to do a wide range of jobs without danger of wrecking his new machinery. It is followed by a 5-chapter section on Woodworking and Patternmaking. The chief emphasis is on patternmaking, as the book is directed more toward shop practice than to the amateur carpenter or joiner.

A section on Metal Trades deals with Press Work, Forging and Welding, and Heat Treatment of Steels. This last chapter is especially interesting for its excellent description of the process of tempering steel.

THE ABC'S OF RADIO, by the Staff of the Electronics Department, General Electric Co. Published by General Electric Co. Stiff paper covers, 8 x 11 inches, 68 pages. Price 25c.

Short paragraphs, bold sub-heads and teaching through numerous line-cuts feature this little book, designed to give a grasp of radio to non-technical persons employed in radio industry, or who may find it advantageous to use radio-electronic devices.

A popular style is used throughout. Mathematics is by-passed, and an appeal is made to the drawings to clear up any difficult point. The only divergence from simplicity is in the language used. Whether this was due to habit or because it was expected that readers would largely be persons of more than average education is not clear, but it is unfortunate, nevertheless. It is true that "The action of a capacitor is explained by the electron structure of matter and is caused by the displacement of electrons in the conductor and dielectric." It is equally true that—in a semi-popular work—the idea could be expressed in simpler terms and with shorter words, to the great advantage of the many who may start with preconceived concepts of the complexity of the subject they are undertaking. Such students are sometimes over-ready to be scared off by a few long and involved technical phrases.

A new and extremely interesting feature is the drawing in the last section, "Trouble Analyzing and Correction." A number of pictorial-schematic circuits are shown, in which the schematic symbols are combined with pictures of the various pieces of apparatus. This should be an excellent method of teaching the radioist who has arrived at the pictorial-diagram stage, how to read ordinary schematics.

MATHEMATICS FOR RADIO

Two volumes, prepared for home study. Book I (314 pp.) covers the algebra, arithmetic, and geometry; Book II (329 pp.) covers the advanced algebra, trigonometry, and complex numbers necessary to read technical books and articles on radio.

MAEDEL PUBLISHING HOUSE Room 102
593 East 38 Street, Brooklyn, New York

Send me MATHEMATICS FOR RADIO AND COMMUNICATION as checked below. I enclose payment therefor with the understanding that I may return the book(s) within 5 days in good condition and my money will be refunded.

Name

Address

- Book I at \$3.75 plus 6c postage
 Book II at \$4.00 plus 6c postage
 Books I and II at \$7.75 postage prepaid

Foreign and Canadian prices 25c per volume higher

• RADIO SCHOOL DIRECTORY •

Radio School Directory

TO OUR READERS—NOW IS THE TIME TO TAKE UP RADIO!

NOW, more than ever before America needs trained radio men. The Army, the Navy and the Air Force are continuously on the lookout for men who have had training in radio. Scores of war industries require radio men in various capacities throughout the country. There now is and there will be a great shortage of radio men for years to come. Reputable schools of Radio advertise to help you.

LEARN RADIO

Pre-Induction Courses for beginners lead to higher ratings in Army and Navy. Catalog free.

MASS. RADIO SCHOOL
88 BOYLSTON ST., BOSTON, MASS., Est. 1899

LES Correspondence Courses in **RADIO and ELECTRICAL ENGINEERING**

ELECTRICAL ENGINEERING Get good grasp of wide electrical field. Prepare yourself, at Low Cost, for secure future. Modern, simplified, you can understand quickly. **RADIO ENGINEERING** Extra fine course in radio, suitable address. Photo-electric work. Trains you to be super-service man, real vacuum tube technician. Servicemen needed badly. Diploma on completion. Tuition \$25, either course. Deferred payment plan. **FREE** Get copies of school catalogs, student magazines, complete details. **SEND NOW!**

LINCOLN ENGINEERING SCHOOL Franklin Stn., Box 61-C56 WASHINGTON, D. C. (Formerly at Lincoln, Nebr.)

RADIO ENGINEERING!

RADIO Engineering offers unusual opportunities for **WOMEN** as well as **MEN**. B. S. Degree. Modern laboratory, latest equipment. Courses also in Civil, Electrical, Mechanical, Chemical, Aeronautical Engineering; Business Administration, Accounting, Secretarial Science. Special Preparatory Dept. Tuition, living costs low. Enter Sept., Jan., March, June. **Catalog.**

TRI-STATE COLLEGE ANGOLA, INDIANA

COMMERCIAL RADIO INSTITUTE

A radio training center for twenty-three years.

RESIDENT COURSES ONLY

Pre-Induction, Broadcast, Service, Aeronautical and Radio telegraphy classes now forming for October 4th. Literature upon request.

Dept. C., 38 West Biddle St., Baltimore 1, Md.

RADIO TECHNOLOGY

RCA Institute offers an intensive two-year course of high standard embracing all phases of Radio and Television. Practical training with modern equipment. Also shorter specialized courses in Commercial Radio Operating, Radio and Television Servicing, and Aviation Communications. For Free Catalog write Dept. RC-43.

RCA INSTITUTES, Inc.
A Radio Corporation of America Service
75 VARICK STREET NEW YORK 13, N. Y.

Pre-Induction RADIO COURSES

for Civilians and those entering Military Service
New classes now starting for men and women.

- Radio Operating
- Code
- Radio Servicing
- Radio—Electronics

NEW YORK Y.M.C.A. SCHOOLS
4 West 63rd Street, New York City

RADIO OPERATORS WANTED

Learn to Send and Receive Radio Code at home or in Camp, or prepare for higher proficiency and rating through same easy, practical System used in training radiotelegraph specialists. Thousands of operators needed. Write for **FREE** book.

CANDLER SYSTEM CO.
Dept. 3-L Box 928, Denver 1, Colo., U.S.A.

SLIDE RULE OR SCREWDRIVER

... which will YOU be using 2 years from now?

Add Technical Training to Your Present Experience—THEN Get That **BETTER** Radio Job You Want!

Thousands of new men have joined the ranks of the radio industry for the duration. But after the war, even more thousands will return from the armed forces. War production will settle down to supplying civilian needs.

Where will you fit into this picture? If you are wise, you will look ahead and prepare for the good-paying jobs in radio-electronics and industrial electronics.

It is up to you to decide if you will be a "screwdriver" mechanic or a real technician in a responsible engineering position.

CREI can help you prepare by providing you with a proven program of home study training that will increase your technical ability and equip you to advance to the better-paying radio jobs that offer security and opportunity. The facts about CREI and what it can do for you are printed in a 32-page booklet. It is well worth your reading. Send for it today.

• WRITE FOR FREE 32-PAGE BOOKLET

If you have had professional or amateur radio experience and want to make more money—let us prove to you we have something you need to qualify for a better radio job. To help us intelligently answer your inquiry—PLEASE STATE BRIEFLY YOUR BACKGROUND OF EXPERIENCE, EDUCATION AND PRESENT POSITION.



CAPITOL RADIO ENGINEERING INSTITUTE

Home Study Courses in Practical Radio-Electronics
Engineering for Professional Self-Improvement
Dept. RC-10, 3224-16th St., N. W.
WASHINGTON 10, D. C.

Contractors to the U. S. Navy, Coast Guard and Signal Corps. Producers of Well-Trained Technical Radiomen for Industry

RADIO OPERATION SERVICING COMPLETE HOME TRAINING

Fit yourself for important work in wartime, and after. Make use of your spare time to master basic principles of radio. Up-to-date course includes electives in operating and servicing. Write for **FREE** BULLETIN. No obligation.
AMERICAN SCHOOL
Dept. R79, Drexel at 58th St., Chicago 37, Ill.

THE LISTENING POST

(Continued from page 47)

Mc.	Call	Location and Schedule
15.230	—	KOMSOMOLSK, SIBERIA, USSR. 7:40 to 8:20 am; 10:15 to 10:30 am; 5:15 to 5:40 pm; 6:45 to 7:25 pm; 9:15 to 9:40 pm; 11:15 to 11:40 pm.
15.250	WLWK	CINCINNATI, OHIO. 8:30 am to 5:15 pm, 5:30 pm to midnight.
15.250	—	VICHY, FRANCE. 11:15 am to 1:30 pm.
15.270	WCBX	NEW YORK CITY; 7 am to 4:45 pm.
15.270	WCDA	NEW YORK CITY; 7:30 to 11:30 pm.
15.290	WKLJ	NEW YORK CITY
15.29	KWID	SAN FRANCISCO, CALIFORNIA; 1 to 2:45 am.
15.300	2RO6	ROME, ITALY. Day and night transmissions.
15.32	BBC	LONDON, ENGLAND. Afternoons.
15.32	VLI3	SYDNEY, AUSTRALIA; Western North American beam, evenings; news in English at 1:10 am.
15.32	BBC	SAN FRANCISCO, CALIFORNIA. 10:30 pm.
15.330	WGEO	SCHENECTADY, NEW YORK; 6 to 8 am; 8:15 am to 3 pm; 3:15 to 5:15 pm.
15.345	FGA	DAKAR, SENEGAL, AFRICA. 3:15 to 5:20 pm.
15.350	WRUL	BOSTON, MASSACHUSETTS; 7:30 to 11:15 pm.
15.430	—	ACCRA, GOLD COAST. Heard testing at 2:20 pm.
15.465	PRE9	FORTALEZA, BRAZIL; 5 to 9:08 pm; variable.
15.750	—	MOSCOW, USSR. North American beam. 7:40 to 8:50 am; Sundays, 8:20 to 9:30 am.
15.980	AFHQ	ALGIERS, NORTH AFRICA. 8 to 9:45 am.
16.025	AFHQ	ALGIERS, NORTH AFRICA. Variable times.
17.48	—	ALASKA. Saturdays, 6:45 pm; irregular.
17.72	LRA5	BUENOS AIRES, ARGENTINA; off at the present time.
17.750	WRUW	BOSTON, MASSACHUSETTS; 7:30 to 10:45 pm.
17.765	—	VICHY, FRANCE.
17.775	OPL	LEOPOLDVILLE, BELGIAN CONGO. 2:15 to 3:45 pm; 4:15 to 4:30 pm.
17.780	WNBI	NEW YORK CITY. 6:15 to 8:15 pm.
17.780	WRCA	NEW YORK CITY. 9 am to 2:45 pm.
17.800	WLWO	CINCINNATI, OHIO. 9:15 am to 3:30 pm, 5:30 to 8:15 pm.
17.800	TGWA	GUATEMALA CITY, GUATEMALA.
17.830	WCBX	NEW YORK CITY; 4:55 to 7:45 pm.
17.830	WCDA	NEW YORK CITY; 7:45 am to 4:45 pm.
17.84	—	ATHLONE, IRELAND; 8:30 to 9:30 am; 1:30 to 2:15 pm.
17.850	PRL8	RIO DE JANEIRO, BRAZIL.
17.870	WNBI	NEW YORK CITY; 8:30 pm to midnight.
17.915	CR7BI	LOURENCO MARQUES, MOZAMBIQUE.
18.135	YDA	BATAVIA, JAVA; India beam, 7 to noon.
18.45	HBF	GENEVA, SWITZERLAND.
18.48	HBH	GENEVA, SWITZERLAND.
20.040	OPL	LEOPOLDVILLE, BELGIAN CONGO.

**"JUST THINK, HOGARTH, IT TOOK
ECHOPHONE EC-1 AND TOTAL
WAR TO BRING US TOGETHER!"**

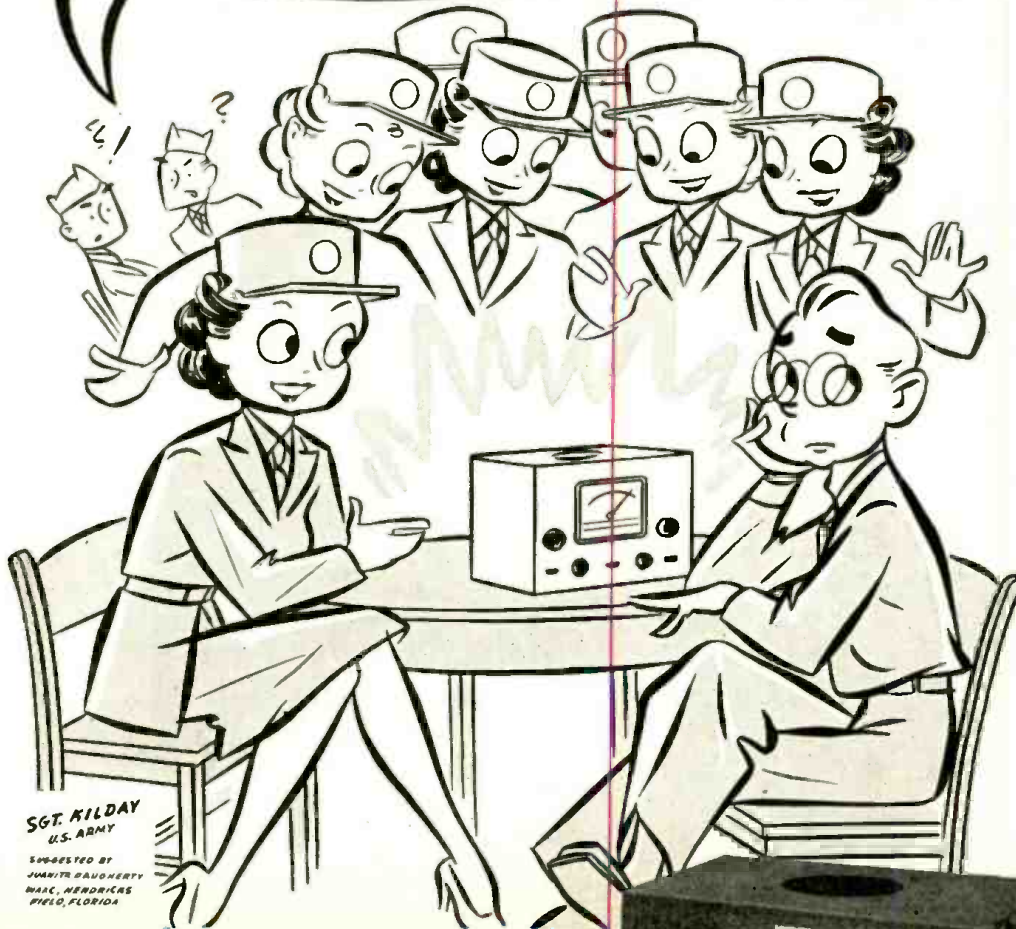

SGT. KILDAY
U.S. ARMY

SUGGESTED BY
JANITHA DAUGHERTY
MASC, HENDRIKAS
PHELLO, FLORIDA

Echophone Model EC-1

(Illustrated) a compact communications receiver with every necessary feature for good reception. Covers from 550 kc. to 30 mc. on three bands. Electrical bandspread on all bands. Six tubes. Self-contained speaker. Operates on 115-125 volts AC or DC.



ECHOPHONE RADIO CO., 201 EAST 26th ST., CHICAGO, ILLINOIS

Audels -MANS RADIO GUIDE

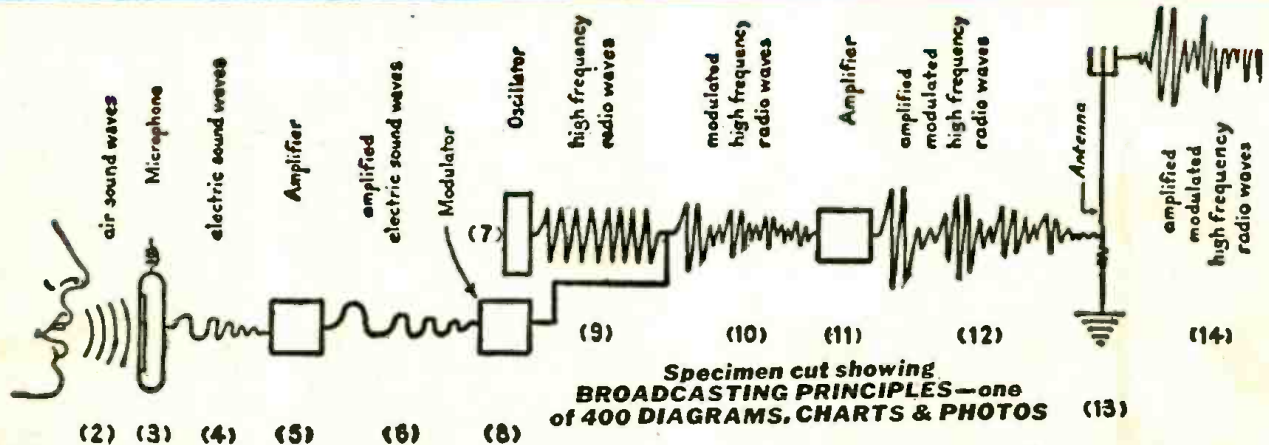

Specimen cut showing BROADCASTING PRINCIPLES—one of 400 DIAGRAMS, CHARTS & PHOTOS

(1) QUESTIONS AND ANSWERS

1001 FACTS

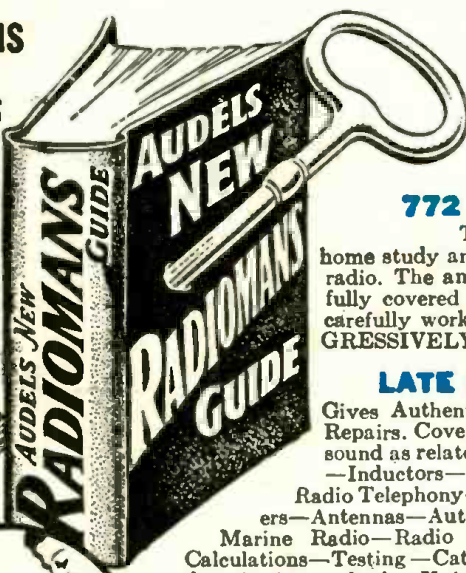

THE KEY TO PRACTICAL RADIO INFORMATION

Including Frequency Modulation—Television, etc.
Inside Information for Aviation, Marine, Commercial Operators and Technicians, Servicemen and Students

772 PAGES, 400 DIAGRAMS, CHARTS & PHOTOS

This well organized reading course in Radio is especially suitable for home study and as a ready reference guide to help you learn the inside facts about radio. The amount of mathematics required for a successful study of this book is fully covered as the various chapters include numerous practical radio problems, carefully worked out, step by step, to their final solution. The contents are PROGRESSIVELY ARRANGED AND CAREFULLY INDEXED.

LATE DATA—EASY TO READ AND UNDERSTAND

Gives Authentic Principles and Practices in Construction, Operation, Service & Repairs. Covers clearly and concisely Radio fundamentals—Ohm's Law—Physics of sound as related to radio science—Measuring instruments—Power supply—Resistors—Inductors—Condensers—Transformers and examples—Broadcasting stations—Radio Telephony—Receivers—Diagrams—Construction—Control systems—Loudspeakers—Antennas—Auto Radio—Phonograph pickups—Public Address Systems—Aircraft & Marine Radio—Radio Compass—Beacons—Automatic Radio Alarms—Short Wave—Coil Calculations—Testing—Cathode ray oscillographs—Static Elimination—Trouble Pointers—Underwriter's standards—Units & tables. REVIEW QUESTIONS—Ready Reference Index.

HIGHLY ENDORSED—ASK TO SEE IT ON 7 DAYS' FREE TRIAL

MAIL COUPON TODAY

THEO. AUDEL & CO., Publishers, 49 West 23rd St., New York
Mail AUDELS NEW RADIOMAN'S GUIDE for free examination. If O.K. I will send you \$1 in 7 days; then remit \$1 monthly until \$4 is paid. Otherwise I will return it.

Name.....
Address.....
Occupation.....
Reference.....

RCF

\$4 COMPLETE
PAY \$1 A
ONLY 1 MO.