

RADIO'S GREATEST MAGAZINE

RADIO-CRAFT

with
**POPULAR
ELECTRONICS**
★

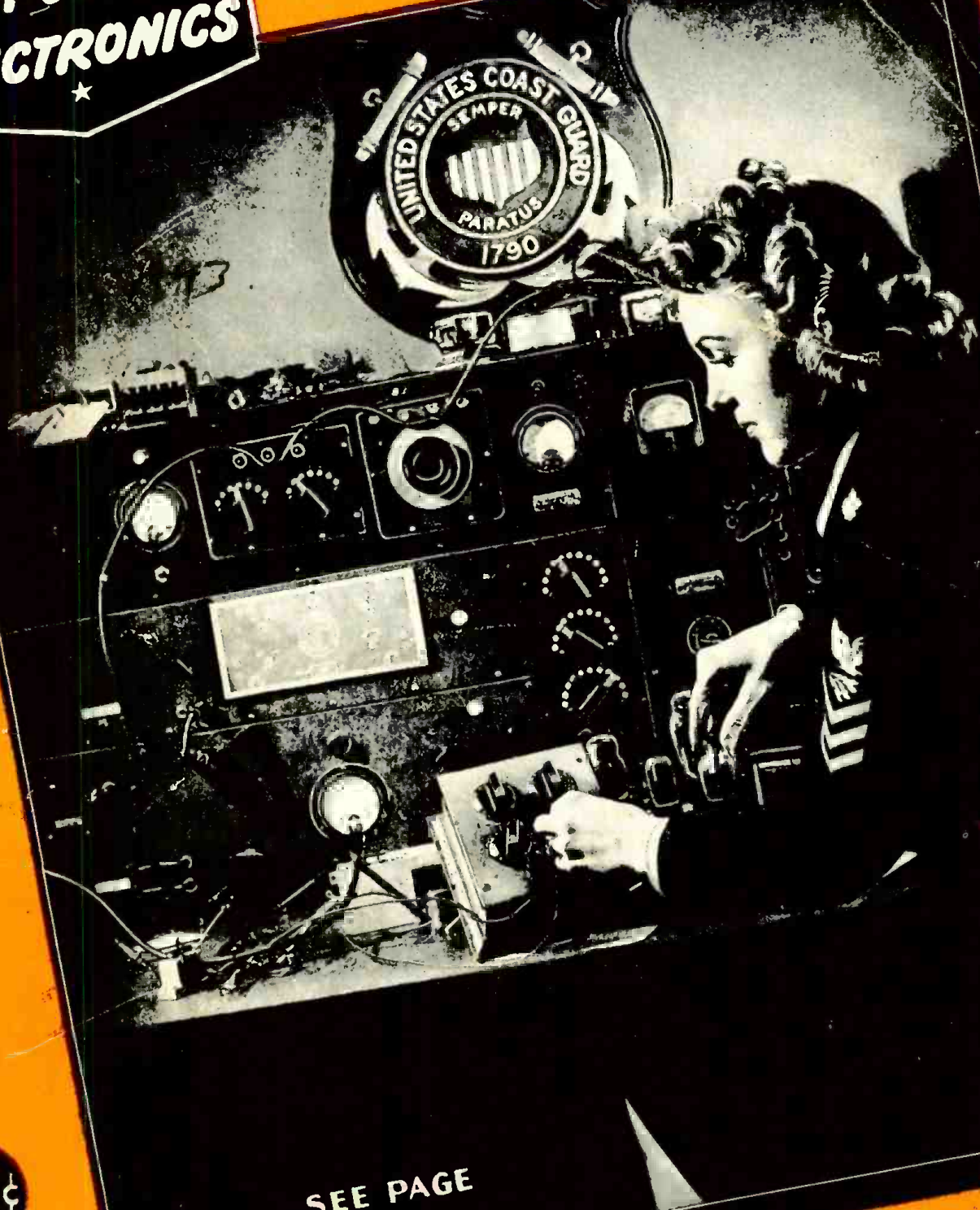

MAY

25¢

CANADA 30¢

1943

SEE PAGE
463

OVER 100 ILLUSTRATIONS

VULTEE AIRCRAFT SELECTS HALLICRAFTERS EQUIPMENT FOR RADIO FLIGHT RECORDER

The ultra-sensitive ground-unit "brain" of Vultee Aircraft's new radio recorder is monitored by a Hallicrafters shortwave radio communications receiver. This test-flight unit, originated by Vultee engineers, gives multiple instrument readings flashed in split-second cycles through a Hallicrafters communications receiver to ground crew tabulators during actual test flights.

Hallicrafters communications receiver (illustrated) Model SX-25—12 tubes, 4 bands. Frequency range of 550 kc. to 42 mc.

Your post-war Hallicrafters communications receiver will be worth waiting for.

World's largest exclusive manufacturer of shortwave radio communications equipment

hallicrafters

CHICAGO, U.S.A.





I WILL TRAIN YOU TO START A SPARE TIME OR FULL TIME RADIO SERVICE BUSINESS WITHOUT CAPITAL

I Trained These Men

I Trained These Men

FREE LESSON

I will send you FREE a Sample lesson, "Getting Acquainted with Receiver Servicing," to show you how practical it is to train for a good-pay Radio job at home in spare time. It's a valuable lesson. Study it—keep it—without any obligation whatsoever. This lesson tells how Superheterodyne Receivers work—why Radio Tubes fail—how to fix Electrodynamic Loud-speakers and Output Transformers—how Gang Tuning Condensers work. Gives hints on I.F. Transformer Repair—how to locate defective soldered joints—Antenna Oscillator Coil facts—Receiver Servicing Technique—dozens of other hints, facts, explanations. Illustrated with 31 photos, sketches, drawings. Get your copy at once—mail the coupon NOW!

These Men Have SPARE TIME BUSINESSES



"I repaired some Radios when I was off my tenth lesson. I don't see how you can give so much for such a small amount of money. I have made an average of \$10 a week—just spare time."—JOHN JERRY, 1337 Kalamath St., Denver, Colorado.

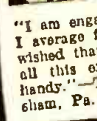

"I am engaged in spare time Radio work. I average from \$5 to \$10 a week. I often wished that I had enrolled sooner because all this extra money sure does come in handy."—THEODORE K. DUBREE, Hordsham, Pa.



"I am doing spare time Radio work. and I am averaging around \$300 a year. The extra dollars mean so much—the difference between just barely getting by and living comfortably."—O H N WASHKO, 97 New Cranberry, Hazleton, Pa.

These Men Have FULL TIME BUSINESSES



"For several years I have been in business for myself making around \$200 a month. Business has steadily increased. I have N.R.I. to thank for my start in this field."—ARLIE J. FROELNER, 300 W. Texas Ave., Goose Creek, Texas.

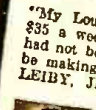

"My Loudspeaker System pays me about \$35 a week besides my Radio work. If it had not been for your Course, I would still be making common wages."—MILTON K. LEIBY, JR., Tipton, Pa.



"I started Radio in the Marines in 1917. Later I started studying Radio with N.R.I. I recommend N.R.I. Training to any man no matter how long he has worked. Radio I now have my own business."—CHARLES P. HELMUTH, 16 Hobart Ave., Absecon, N. J.

Is This What You Want to Know?

Knowing the answers to the 22 questions below and others which arise while doing Radio jobs, has spelled the difference between success and failure for many men. Such knowledge represents the difference between a skilled, well-paid Radio Technician or Operator and the too common "Radio screwdriver mechanic." If you do not know all the answers; if you want to make more money in Radio, I will train you at home to be a Radio Technician or Operator whether you are already in Radio, or are just a beginner without knowledge or experience.

- How to read Radio diagrams and analyze them.
- How to run a Radio service shop successfully.
- How to use and operate electronic controls.
- How to locate parts in a chassis with and without service data.
- How to know the cause of receiver trouble from observed effects.
- How to make tests which isolate the defective stage and parts.
- How to align Radio receivers without reference to specific instructions.
- Short cuts in servicing midgeet universal receivers.
- Learning how Radio circuits work through home demonstrations.
- How to obtain additional basic Radio training for military, naval and war industry Radio jobs.
- How accurately timed pulses are produced and used.
- How the cathode ray tube works and is used.
- How to adjust a Radio transmitter for best operation.
- How to service without specialized servicing equipment.
- How transmitters are modulated and keyed.
- How Radio-electronic devices are used commercially as controls.
- How Radio meters and testers work and how to use them.
- How Radio waves are beamed and intercepted.
- How Radio equipment is automatically and remotely controlled.
- How a frequency modulated system works.
- How timed circuits effect Radio circuit operation.
- How the superheterodyne receiver works.

Now is the time to get ahead—in RADIO! The wartime shortage of Radio Technicians and Operators gives you a great opportunity to open your own Radio Servicing Business, or to go after a good Radio job with a bright peacetime future. Start at once. MAIL THE COUPON for a FREE Lesson from my Radio Course, plus my big, 64-page book, "Win Rich Rewards in Radio." See for yourself how I will train you at home in spare time to be a Radio Technician or Operator!

You'll read how my Course can help you—just as it helped the six men above—to start your own Radio business on money you make while learning. You'll see how N.R.I. also prepares you for a good job in many of Radio's profitable branches—Broadcasting, Radio Manufacturing, Public Address Systems, Aviation, Police, Commercial Radio, etc. MAIL THE COUPON NOW!

More Radio Technicians and Operators Now Make \$50 a Week Than Ever Before

There's a big shortage of capable Radio Technicians and Operators because so many have joined the Army and Navy. Fixing Radios pays better now than for years. With new Radios out of production, fixing old sets, which were formerly traded in, adds greatly to the normal number of servicing jobs. Broadcasting Stations, Aviation and Police Radio, Ship Radio and other communications branches are scrambling for Operators and Technicians. You may never see a time again when it will be so easy to get started in this fascinating field. The Government

TRAINING MEN FOR VITAL RADIO JOBS

GOOD FOR BOTH 64 PAGE BOOK SAMPLE LESSON FREE

J. E. SMITH, President, Dept. 3EX
National Radio Institute, Washington, D. C.

Without obligating me, mail your Sample Lesson and 64-page book FREE. I am particularly interested in the branch of Radio checked below. (No salesman will call. Write plainly.)

<input type="checkbox"/> Radio Service Business of My Own	<input type="checkbox"/> Aviation Radio
<input type="checkbox"/> Servicing Technicians for Radio Stores and Factories	<input type="checkbox"/> Operating Broadcasting Stations
<input type="checkbox"/> Spare Time Radio Servicing	<input type="checkbox"/> Army, Navy Radio Jobs
<input type="checkbox"/> Government Civilian Radio	<input type="checkbox"/> Operating Police Radio Stations
	<input type="checkbox"/> Operating Ship and Harbor Radio

(If you have not decided which branch you prefer—mail coupon for facts to help you decide.)

Name Age.....

Address

City State..... 4FR-2

too needs hundreds of competent civilian and enlisted Radio men and women. Radio factories, with huge war orders to fill, have been advertising for trained personnel. And think of the NEW jobs Television, Frequency Modulation, Electronics and other Radio developments will open after the war! This is the sort of opportunity you shouldn't pass up.

EXTRA PAY IN ARMY, NAVY, TOO

Men likely to go into military service, soldiers, sailors, marines should mail the Coupon Now! Learning Radio helps Service men get extra rank, extra prestige, more interesting duties. MUCH HIGHER PAY. Also prepares for good Radio jobs after service ends. Over 1,700 Service men now enrolled.

Many Beginners Soon Make \$5, \$10 a Week Extra in Spare Time

There's probably an opportunity right in your neighborhood to make money in spare time fixing Radios. I'll give you the training that has started hundreds of N.R.I. students making \$5, \$10 a week extra within a few months after enrolling. The N.R.I. Course isn't something just prepared to take advantage of the present market for technical books and courses. It has been tried, tested, developed, perfected during the 25 years we have been teaching Radio.

Find Out What N.R.I. Can Do for You

MAIL COUPON NOW for a FREE Sample Lesson and our 64-page illustrated book. You'll see the many fascinating jobs Radio offers and how YOU can train at home. If you want to jump your pay—mail Coupon at once in an envelope or paste on a penny postal!—J. E. Smith, President, Dept. 3EX, National Radio Institute, Washington, D. C.



RADIO-CRAFT

Incorporating

RADIO & TELEVISION

HUGO GERNSBACK
Editor-in-Chief

FRED SHUNAMAN
Associate Editor

G. ALIQUO
Circulation Manager

IN THE NEXT ISSUE

The June issue will contain the following:

- More on Repairing Meters
- WERS and the Amateur Reactance and Resonance
- A Floating-Grid Relay
- And a continuation of the series on: **POPULAR ELECTRONICS**

Contents **MAY, 1943** **Issue**

VOLUME XIV -- NUMBER 8

Mailbag	452
Editorial: Radar	by Hugo Gernsback 455
Radio Month in Review	456
A Spar "Radioman" (Cover Feature)	463

POPULAR ELECTRONICS

Popular Electronics, Part IV	by Raymond F. Yates 458
The Age of Electrons	by E. L. Robinson 460
Electrified Outlook for Electronics	462
How to Make An Exponential Horn	by James Langham 464

SERVICING

Radio Meter Repairing	by F. J. Lingel 465
Convert the Auto Radio to Electric Operation	by Fred Shunaman 466
How to Service Volume Controls	by J. Beever 467
RADIO SERVICE DATA SHEET: No. 333 Philco Model 42-345	468

SOUND

Practical Audio Amplifier Theory, Part IV	by Ted Powell 472
Radio's New Voice—The Sonovox	473
Hearing Aid Problems—A Biological Approach	474

EXPERIMENTERS

R. F. Carrier Communications, Part II	by Werner Muller 475
Phase—Don't Let It Phase You	by Fred Shunaman 476
Crystal Receiver Works Loudspeaker	by L. Hewlett 478

CONSTRUCTION

A Compact Bedside Radio	by Bob White 479
High Fidelity Receiver for Local Reception	by Stanley Dowgiala 480
Four-Tube T.R.F. Portable	by John M. Weber 481
Using the Old Parts	by E. E. Youngkin 481

TEST INSTRUMENTS

A Simple V.T. Voltmeter	by E. Antoine 482
-------------------------------	-------------------

BEGINNERS

Electron-Ray Tubes for the Beginner	by Eric Leslie 486
Power Supplies for Class-B Amplifiers	by Karl E. Schubel 488
What You Should Know About Volts & Ohms	489

DEPARTMENTS

Servicing Notes	470
Listening Post	483
Latest Radio Apparatus	484
Question Box	494
Radio Hookups	498
Radio Kinks	500
Book Reviews	511



Published by Radcraft Publications, Inc. Publication office: 29 Worthington Street, Springfield, Mass. Editorial and Advertising Offices: 25 West Broadway, New York City, Chicago Advertising Office: RADIO-CRAFT, 520 North Michigan Avenue, Chicago, Ill.

RADIO-CRAFT is published monthly, on the first of the month preceding that of date; subscription price is \$2.50 per year in U. S. (In foreign countries, 75c additional per year to cover postage; Canada, 50c additional.) Entered at the post office at Springfield as second-class matter under the act of March 3, 1879. All communications about subscriptions should be addressed to: Radio-Craft, 25 West Broadway, New York, N. Y.

Notice of CHANGE OF ADDRESS should reach us at least one month in advance. Be sure to give your OLD ADDRESS as well as the new, as without the old address we cannot find your name in our files.



Foreign Agents:

London—Gorrings American News Agency, 9A Green St., Leicester Square, W. C. 2, England.
Melbourne—McGill's Agency, 179 Elizabeth St., Australia.
Dunedin—James Johnston, Ltd., New Zealand.



Text and illustrations of this magazine are copyright and must not be reproduced without permission of the copyright owners.



Copyright 1943 Radcraft Publications, Inc.

7 Days FREE TRIAL

Costs You Nothing to Examine This Amazing New Three Volume Set of REFERENCE BOOKS OF PRACTICAL



ELECTRICITY

Each Book 8½ x 11 inches. Handsomely Bound in Harvard Red and Gold Leatherette.

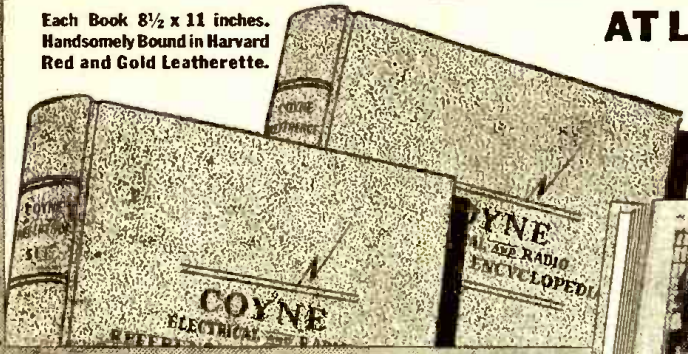

AT LAST! A set of electrical books written in clear, understandable language for the "beginner" or "old timer." Solves your everyday electrical problems easily, quickly and thoroughly.

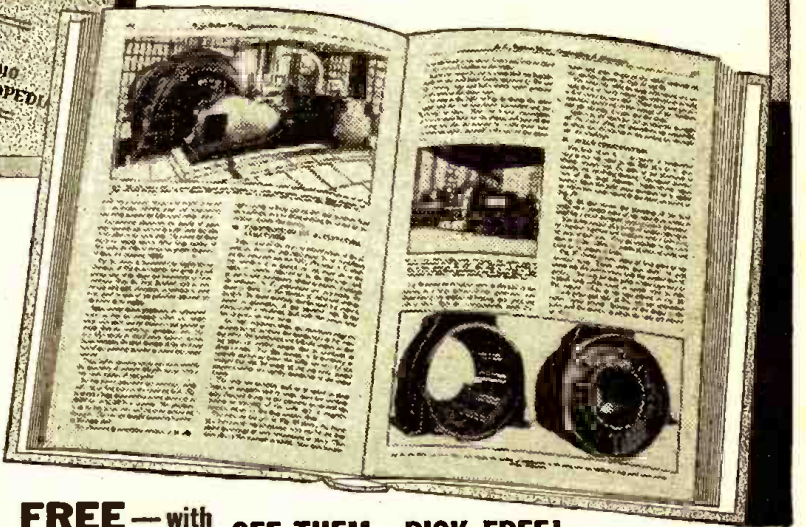

SEND NO MONEY! COUPON BRINGS COMPLETE SET!

Now at last, it's easy, practical to get a knowledge of Electricity at home. Whether you want to learn Electricity or whether you are now doing electrical work, you need these books.

AUTHORITATIVE. PRACTICAL—prepared by experts. Used regularly on the job by hundreds of Electricians, service men, radio men, air cadets, students, maintenance men, etc. **EASY. COMPLETE.** Covers everything Electrical: Armature winding, A.C. and D.C. Motors, generators, electronics, automotive electricity, refrigeration, etc., etc. Answers your electrical questions quickly, clearly, completely. Also includes Radio, Television.

FREE—with Reference Books
Send for these reference books now, and I'll include 1 full year of Technical Service—personal advice by mail on any Electrical or Radio subject.

SEE THEM—RISK FREE!

Don't send a penny. Simply mail coupon below and receive your set. Examine books 7 days, with no obligation. Then, if you decide they are the finest, most practical reference set you ever saw, send \$1.95, and then \$2.00 monthly until total price of \$13.95 is paid. I'll prepay all shipping charges. Offer is limited. Mail coupon NOW.

H. C. LEWIS, Pres., COYNE ELECTRICAL SCHOOL
500 So. Paulina St. Dept. 53-T2 Chicago, Ill.

HUNDREDS OF PICTURES AND DIAGRAMS! HUNDREDS OF ELECTRICAL SUBJECTS AT YOUR FINGER TIPS!

A few of the many branches of Electricity explained and pictured in this amazing set are:

- | | | |
|------------------|-----------------|----------------|
| Air Conditioning | Refrigeration | Power Plants |
| Telephony | House Wiring | Diesel Engines |
| Auto Electricity | Electric Signs | Motors |
| Talking Pictures | Home Appliances | Armatures |
| Generators | Switchboards | A.C. and D.C. |

*Complete Ready Reference Index of over 2000 listings tells you instantly where to look up any electrical fact.

H. C. LEWIS, Pres.
COYNE ELECTRICAL SCHOOL
500 S. Paulina St., Dept. 53-T2
Chicago, Ill.

NO RISK COUPON

Send me the big 3-volume Coyne Electrical and Radio Encyclopedia, postpaid. Within 7 days after receiving the books, I'll either return them or send you \$1.95, and \$2 a month until advertised price of \$13.95 is paid.

NAME.....
ADDRESS.....
CITY..... STATE.....
OCCUPATION..... AGE.....
SAVE 10%—Send cash price, \$12.55, with order if preferred—you save \$1.40. Same 7-day free trial and return privilege.

"KNOW-HOW"
IN A PACKAGE

SYLVANIA SERVICEMAN SERVICE

by
FRANK FAX



JUST 70¢ BUYS:

← No. 1
Technical Manual
35¢

No. 2 →
Tube Complement Book
35¢

No. 3 →
Characteristics
Sheet
FREE

No. 4 →
Correlation of
Tube Types for
Substitution Chart
FREE

No. 5 →
Sylvania Base
Chart
FREE



• If your jobber cannot supply you, mail your order to Frank Fax, Dept. RC-5, Sylvania Electric Products Inc., Emporium, Pa.

SYLVANIA

ELECTRIC PRODUCTS INC.
RADIO DIVISION

OLDTIMER RETURNS TO RADIO

Dear Editor:

I just took up set building, after 15 years of factory made stuff. Armed with a handful of back issues of *Radio-Craft*, with seven R-C Library numbers, Q. & A.'s, etc., I sank pronto into a sea of theory, vague terms, conflicting ideas, and love letters between servicemen, not to mention Mr. W. Moody vs. all comers!!!

I quit set building when air conditioning came in, to make a living or a fortune (?), for the advanced "bug" turned repairman.

Mr. Earl Peterson said a few things in my behalf in the February issue, although Mr. W. Moody said plenty when he asked: "Why the Super-Het?" I do not like A.C.-D.C. power supplies, otherwise Mr. Moody was 100% correct.

Why can't someone explain in simple terms how to figure capacity for bypass condensers as used for self-bias on cathodes? Also how to use an A.C. power supply for an ohmmeter, now that batteries are out of civilian circulation?

Many similar ideas come to mind, but

maybe they would annoy the *Radiotricians*?

RICHARD O'CONNOR,
North Pelham, N. Y.

(We withheld diagrams of small power supplies in the March issue, under the apparently mistaken impression that we had been printing too many of them. There were two in the February issue [and a couple of experimental ones] and two in the January issue, as well as a complete figure—Page 232—of the typical power supply for an A.C.-D.C. set. This would have been perfect as a power supply for an instrument.

As to the calculations for cathode bypass condensers, our Technical Editor reports, "For audio bypass work I generally use condensers varying from 0.5 to 50 microfarads, depending on what happens to be handy and on the frequency response of the rest of the amplifier. If the stage acts unstable, I take the bypass condenser off and discard it." The question will nevertheless be answered more academically in the Question Box.—Editor)

PRO BEGINNER

Dear Editor:

I wish to congratulate you on continuing to get the monthly edition of *Radio-Craft* on the market in these trying times. With so many of the boys in the armed forces now it means a great deal of extra work for those who are left to carry on the regular work. Some of the letters mention errors being made in publishing circuit diagrams, etc. May I say that there always have been errors and think likely there always will be, as it is a very simple matter to make a mistake even in copying a circuit.

I may say that the first superheterodyne I constructed was bought in kit form from a first rate radio distributor. It was a 4-tube battery-operated kit and was supposed to be a good DX'er, and easy on batteries. I constructed the set and when finished I found that on the low-frequency padder of the short-wave band, they had failed to show a parallel mica condenser on the diagram, nor did they include the part in the kit; also the circuit was extremely hard on the B-batteries.

Some of the boys seem to delight in knocking the competitive serviceman and I wonder why. We know that the magazine is widely read by beginners and I do not believe this is a good way to educate the beginner. May I mention Mr. Buck's letter of April, 1942, where he states that he services 15 to 20 sets in an 8-hour day. Now this is a very foolish statement, as it just

cannot be done by one person. To remove the tubes from these sets and test them would require almost this amount of time, and someone would be getting "gyped" very badly.

I feel that the average service shop could take on a lad these times to help out and it would be a good training for the boy. He could remove the chassis from the cabinet, and other such small jobs for a beginner, and if he is willing to really study, he would get along very fast.

This may be a good spot to bring up the licensing of the servicemen, yes, I believe they should all have to have a license, not just write an exam with a whole list of technical work; but do some actual service work and a small amount of technical figuring. I believe that every man should have to serve an apprenticeship and then write and work a stiff exam at the finish. This would improve the radio service to the set owner I am quite sure, but I will admit there would always be the percentage of GYP-PERS.

I feel that it would be best to publish a good deal of information for beginners now, possibly more along the lines of actual servicing, rather than experimental data, although there must be some experimental work, if the beginner is to advance and find out for himself.

B. W. EMBREE,
MacGregor, Manitoba, Can.

MINIMUM EQUIPMENT

Dear Editor:

Since test equipment is so hard to obtain, what can an aspiring radio serviceman just trying his wings, as it were, do for radio test equipment? What is the minimum that a radio service shop can get along with in testing? What are the absolute essential test instruments for good servicing?

Please enlighten me on this matter as testers are so difficult to get.

FRED E. VAUGHN,
Eugene, Oregon.

(Experienced servicemen say there are four pieces of equipment the serviceman cannot get along without. First and most important—the tube checker. Next, the circuit tester, or volt-ohm-milliammeter. The other two pieces are a signal generator [test oscillator] and condenser analyzer.

Should the serviceman who is equipped with this particular "absolute minimum" wish to increase his stock of equipment, a vacuum-tube voltmeter is probably the next step.—Editor)

A CORRECTION

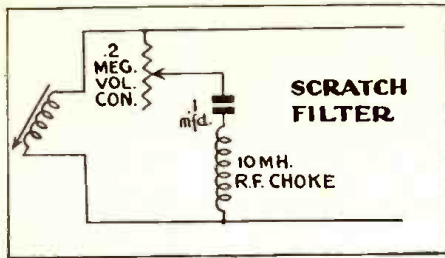

Dear Editor:

Glancing through the February *Radio-Craft*, I happened to notice the circuit for a scratch filter on Page 314.

This circuit is incorrect. I am attaching a hand drawn circuit diagram of the same parts, hooked up correctly.

L. M. DEZETTEL,
Chicago, Ill.

(The correct drawing is shown here.—Editor.)

ELECTRONIC TONE CORRECTORS

Dear Editor:

On Page 367 of the March, 1943, issue I saw listed an Electronic Tone Corrector, by Stanley Dowgiala. Reading further I saw a comment by the Editor, and was surprised. Mr. Editor, that was not an oversight—you were correct the first time and the tube still is a 6L5!

I don't know where Stanley got this circuit, but I have been fooling around with it for a long time. The first time I saw it was in a book called *Tricks of the Trade*. The first two 6L5's are electronic mixers, the third one is for highs and the 6C8 for bass.

We have built, torn down and rebuilt this circuit in dozens of different ways for the last six years. You would hardly recognize it at times, but the old circuit is always in it some place. We do not even use the original type tubes in it. As for the output tubes—they never did make a hit in the radio and amplifier world, but I would rather have them in this particular case than beam power tubes.

This tone corrector was put into a dem-

onstrator for playing records and will handle the low C on a pipe organ and right up to the highs of the wood-wind variety. Only a few commercial amplifiers can compete with this hook-up for tone correction. Neither do you need as much volume control, as the 6C8 and the 6L5 will take care of both volume and tone.

This corrector properly made is absolutely noiseless—the only way I could tell the power was on in one of these designs was through the pickup needle or by a faulty volume control.

Our worst headache was incorporating a mike to one of the 6L5's. When this is not just right you get a hum through the whole thing like nobody's business.

I am only a dumb electronic technician who has taken a few radio courses, but if any amplifier man wants good results he will not go wrong in taking my recommendation for this corrector. Do not use dual volume controls on it.

W. HARRY RASH,
Rose Hill, Delaware

BISMUTH AND UNUSED IDEAS

Dear Editor:

In various engineering departments where I have worked, organized use was made of the sub- and un-conscious intelligence of the engineers. Usually cards were made up, suggesting methods of attaining various results—even if at the time they appeared obviously impossible. Every individual staff member had a certain number of these, which he kept for a time, sorting them over for a few minutes every morning, and making out a suggestion or experiment card—however absurd it might then appear—if and when and as he could.

These suggestion cards were duplicated, and digested by other members of the group. It sounds silly, but various projects were conceived and executed, in spite of their obvious impossibility.

The ease with which some things like electronic tubes were manufactured may have led us to overlook better bets. For example, what wouldn't a lot of people give even now, for amplification without tubes and high voltages. If the human race would look at its problems like a cow trying to find a hole in a fence, perhaps some less expensive solutions for many problems could be found. Your writer, using the cow-hunting-for-a-hole method, is well aware that the electronic tube is a combination of some elements of the crowbar and some elements of relay running. It is one way—out of at least several ways—of using a trigger effect, in combination with a relay running arrangement.

Here is a neglected fact, if ever there was one: Bismuth—in a magnetic field—alters in resistance to the passage of electric currents. Not knowing the degree of resistance change, your writer will never-

theless describe a possible use of this characteristic of bismuth. If it works, a cheap type of receiver might be the result.

One reason bismuth has never been used in radio reception is possibly because no really effective way was known to subject it usefully to a magnetic field. But suppose we coated some iron particles with an insulating varnish, then coated the same particles with bismuth before the varnish was quite dry. We would then have something similar to the granules used in carbon microphones. These bismuth-coated iron particles could be made up into a core with a long path for a locally-applied current, and put inside a coil in which a current was flowing variably. The local current ought to flow with similar variations if everything is done correctly. That is, providing the bismuth changes its resistance sufficiently in a proper magnetic field.

This suggestion is free and all yours—and small pay it is for all the writer learned from reading the early issues of various radio magazines edited by Mr. Gernsback. This suggestion only illustrates possibilities—which might be developed by going back to the coherer and de-coherer as the first electronic trigger.

Make the most of what an old timer—with an irreplaceable perspective—can suggest to modern "engineers" who seek to base all progress on that modern miracle—the electronic vacuum tube. However great their idolatry or technological fixation, the writer thinks that the electronic vacuum tube may yet turn out to be unnecessary in amplification jobs.

W. F. LUHNOW,
Boulder, Colo.

I'LL SHOW YOU HOW TO GO PLACES IN RADIO

MILITARY OR CIVILIAN

TRAIN AT HOME or AT CAMP

Right now . . . more than ever before. Radio calls for trained men. This is your BIG opportunity! My practical Home Training will fit you quickly to move in any of three directions. You can have a splendid business of your own . . . devoted to the busy and profitable field of civilian Radio Repair work . . . Or you can choose an interesting, good paying Radio job in one of the Nation's Radio plants at work on equipment for planes, tanks, ships, etc. . . . Or if you enter the Army, Navy or Marines my training will fit you for more interesting assignments with higher rating, better pay.

NO PREVIOUS EXPERIENCE NEEDED

Sprayberry Training starts right at the beginning of Radio unfolds each subject in a simplified, logical, understandable style. You learn Television, Frequency Modulation, Signal Training, Mobile Radio (Auto-Tank), Aviation Radio, Radio Set Repair and Installation Work. You will be prepared to cash in on the coming great era of Electronics and Electronic Equipment. Your Training will not interfere with your present duties.

READ WHAT THIS GRADUATE SAYS "Salary Has Increased"

"Since I have finished your Radio training I had to enlarge my laboratory with additional equipment, as I have all the Radio repair work that I can handle. My salary has increased to 50 to 75 dollars a week. I install transmitter equipment and public addressing systems. Money can not buy the training that I received through your Academy."—Asa Smith, Post Box 528, Ft. Leavenworth, Kansas.

EARN WHILE YOU LEARN

Along with your Training, you will receive my Business Builders which will show you how to put your knowledge to profitable use in handling money-making Radio Repair jobs shortly after you begin the Course. No matter if you remain a civilian or enter military service, Radio Training will give you a wonderful future.

EASY TO START

Your success is my responsibility. I know how to get Radio across so that you will understand it . . . and remember it.

GET THE FACTS ABOUT MY TRAINING—NOW! ALL FEATURES ARE FULLY EXPLAINED IN MY BIG, ILLUSTRATED FREE BOOK. WRITE FOR IT AT ONCE!!



RUSH THIS COUPON FREE for BIG FREE BOOK

DON'T DELAY! ACT NOW!

SPRAYBERRY ACADEMY OF RADIO
F. L. SPRAYBERRY, Pres.
620-E University Place, N.W., Washington, D. C.

Please send me FREE copy of "HOW TO MAKE MONEY IN RADIO."

Name Age

Address

City State

Tear off this coupon, mail in envelope or paste on penny postcard.

"OH GOODY! NOW I CAN LISTEN
TO YOUR NEW ECHOPHONE EC-1"



Echophone Model EC-1

6 tubes, 3 bands. Tunes from 550 kc. to 30 mc. Beat frequency oscillator. Bandspread logging scale. Self-contained speaker. Electrical bandspread on all bands. AC/DC. 115-125 volts. ECHOPHONE RADIO CO., 201 EAST 26TH ST., CHICAGO, ILLINOIS

RADIO-CRAFT

Incorporating

RADIO & TELEVISION

... One important radio war machine is now disclosed to the public—although it never was a secret ...

"RADIO'S GREATEST MAGAZINE"

RADAR

By the Editor — HUGO GERNSBACK

RADAR, the great hush-hush radio war secret, last month was officially declared less of a secret by a joint release of the War and Navy Departments in Washington, on April 24, 1943. While many thousands of war workers were in on the Radar secret, the public at large—and even many radio men—did not know much about it.

According to the official release, the term RADAR means **R**ADIO **D**etecting **A**nd **R**anging. "Radar is used by static ground defenses to provide data for anti-aircraft guns for use in smashing Axis planes through cloud cover, and by airplanes and warships.

"It is one of the marvels made possible by the electron tube. Ultra-high-frequency waves traveling with the speed of light can be focused to scan the air and sea. When they strike an enemy ship or airplane, they bounce back.

"Radio waves travel at a constant speed of 186,000 miles a second. Thus, a small space of time is required for such signals to travel to a reflecting surface and return to a radio receiver, so that with means provided for measuring this time interval, it is possible to determine the distance to a given target.

"Radar operates through fog, storms and darkness, as well as through cloudless skies."

According to press reports, the Radio Location System known as Radar in the United States was devised by Sir Robert Alexander Watson Watt. It is said that the system was one of the means in the Battle of Britain which enabled the Royal Air Force, greatly outnumbered in planes, to give English pilots a priceless opportunity to obtain much needed rest between repeated German attacks. The reason for this was that the British Location System operates in this manner: The equipment is worked so that when the angle and speed of reflected short wave beams are recorded at several stations, it is possible to compute not only the location or distance, but also the speed, direction and altitude of distant unseen planes. Signals can be sent out at regular intervals, and any interruption in the usual signal reception pattern indicates immediately the presence of a new reflecting object within the range of the beam. That is the chief reason why it is no longer necessary to maintain constant fighter patrol aircraft. It saves valuable fuel and makes more men and planes available to meet raiders when they *actually* do appear. It will be remembered back in 1940 when England first installed the Radio Location System, American volunteers with technical radio experience were called upon, and many young American technicians served abroad during the crucial Battle of Britain.

Great Britain's Radio Location System has been available to the United States long before Pearl Harbor. Indeed, the British Information Services in New York disclosed that Sir Robert visited the United States in 1941 and 1942, giving the United States Army and Air Force chiefs complete information on the principles and operation of Radio Location.

Sir Robert was knighted on King George VI's birthday honors list in June with the cryptic tag, "pioneer in radio location." Two

months ago, however, the British Science News Letter credited him as "the British scientist who had the leading scientific part" in the development of Britain's aerial watchdog.

Beginning in 1919, Sir Robert received a series of patents for mechanical radio direction finders, and in 1935 he started his major research in airplane radio location.

And while English shores now bristle with Sir Robert's Radio Locators, and while the American shores likewise are protected for thousands of miles by extensive Radar installation on a huge scale—it should be noted that despite all the secret atmosphere, there is nothing at all new about it. Indeed, the principle may be called a bit ancient. Strangely enough, all of it was predicted by me as far back as 1935 in an editorial entitled, "*Short Waves and War*," in the November, 1935, issue of **SHORT WAVE CRAFT**. I reprint part of the editorial herewith:

"Recently the so-called mystery ray has been given quite a good deal of publicity in the press. It seems this particular ray, which is nothing but micro short waves, was simultaneously developed by the United States Army, also in Germany, and by several other powers as well. These micro waves appear to pierce fog and even clouds, and work along optical lines. It will be impossible hereafter for an airplane to hide in the fog and even behind clouds, because the mystery wave directed against it is reflected down to earth where it is used for recording or alarm purposes.

"A city, during the next war, will easily be protected against unheralded enemy aircraft by having a barrage of such micro waves surrounding the entire city, the action being automatic in such a manner that automatic recording instruments will immediately sound the alarm when an airplane appears overhead within the confines of the city. It will be impossible, in the future, for an enemy airplane to get through such a short-wave barrage. (Note: This prediction came true in the Battle of England in 1940.)

"This, however, is only one of the more spectacular war uses of short waves. For propaganda purposes, all of the short-wave stations of the various nations will be worked at full blast! One nation will outshout the other, in trying to tell the enemy population certain war facts which the home government may wish to suppress at all costs. We will then have the interesting experience where one government, in order to defeat this purpose, will try to 'jam' the enemy station from sending out such propaganda by broadcasting on approximately the same wave. This would then nullify the enemy's efforts because listeners could no longer make out what the foreign messages were."

I append the last paragraph from my 1935 editorial merely because everything I said there also came true with a vengeance!

A Digest of News Events of Interest to the Radio Craftsman



The facsimile apparatus with which picture news of American victory was rushed to the United States. The picture is formed on the cylinder at the right.

SIGNAL CORPS SPEEDS PICTURES OF WAR

The U. S. Signal Corps, pioneer of more than one of the Army's technical developments, and originator of the famed V-mail, has scored again. Last month photos of actual battle scenes in Africa were being snapped at the front, developed close to the scene of action, flashed across the ocean and printed in American newspapers with such celerity that (due to the difference in time) actions taking place early in the afternoon appeared in some papers at *noon of the same day*.

Part of the success of this recent Signal Corps is due to a civilian engineer, L. A. Thompson of Acme Newspictures, Inc., of Cleveland, Ohio. Mr. Thompson has been concerned with the development of telephoto transmission apparatus for the last several years, and had considerable success in perfecting a two-way transceiver for handling telephoto transmission over land wires.

The Signal Corps, noting his success in land-wire transmission of pictures, assigned Mr. Thompson to convert existing equipment to radio use. Two and a half months of intense laboratory research and practical experiment resulted in the present equipment. It is considered a triumph in mastery of the problem of distortion from atmospherics, which was one of the chief factors hampering radio picture transmission.

Mr. Thompson built the test transmitter, which was immediately flown to Africa by Capt. Lawrence D. Prehn. At the end of three weeks of test the Signal Corps declared the equipment satisfactory and ready

to start regular work as part of the Army Pictorial Service.

The first triumph of the new service was the transmission of pictures of the capture of Gafsa. Photographs rushed to the station were being printed from the transmitted negatives in Washington seven minutes after their arrival from the African station.

SHORT WAVES ARE NAMED

The FCC moved last month to clear up some of the confusion surrounding nomenclature in the short-wave spectra. Advance in these bands has been so rapid that areas referred to by some as being in the ultra-short region are considered by others to be almost long waves!

To standardize the frequency designations and abbreviations, the FCC has adopted the system now used by the United Nations' Combined Chiefs of Staff. Naturally the system is bound to fall short of being entirely satisfactory, the difficulties of pro-

AMERICAN BROADCASTS REACH AXIS WOMEN

Women of Nazi Germany and the occupied countries are reached daily by anti-Axis broadcasts, according to recent reports from OWI sources last month. The American schedules are timed to reach Europe during the afternoon hours, when, experience has shown, women are most likely to be listening to their radios.

Reaction to the broadcasts is difficult to gauge. Some "fan" mail is smuggled out of occupied countries. Reports may also be received from the various underground movements. The chief source of information on the effectiveness of these broadcasts is, however, the official Axis stations themselves. When Berlin and Rome attack the American broadcasts and attempt to play down their effect, it is safe to assume that a sufficiently large number of women are listening to worry the government concerned.

The women of Europe are more interested in politics than in soap opera, and the Office of War Information bases its broadcasts on that fact. News broadcasts and short addresses of a political nature by distinguished Americans are featured. The program may then be rounded off with a discussion of child care or methods of struggle against tuberculosis, or by some special feature such as a dramatization of Nazi labor conscription of Russian women.

Reception is said to be excellent in France and a large and important audience is claimed. Actual signal strength in France and nearby parts of Axis countries can be checked to some extent by noting reception in neutral Switzerland.

While the broadcast talks generally attempt to impress listeners with the advantages of democracy and of the sincerity of the United Nations in their fight for the rights and the future of the common man, some immediate and practical directives are given. Women are advised, for instance, to avoid arms factories, transport centers and other points likely to be bombed. While emphasizing that the United States will make every effort to avoid striking non-military objectives, the point is clearly made that all points essential to Axis military power may soon become acquainted with the American bomber.

viding a satisfactory system being the chief reason why these designations have not already been standardized.

The spectrum is broken up into seven bands, the lowest of which extends from 3 to 30, and the highest from 3 million to 30 million kilocycles. The allocations are shown in the table.

The new system will be welcomed by all workers in these bands as a means of unifying the designations applied and of avoiding confusion during the war period.

Frequency in Kc.	Designations	Abbreviations
10 to 30	Very low	VLF
30 to 300	Low	LF
300 to 3,000	Medium	MF
3,000 to 30,000	High	HF
30,000 to 300,000	Very high	VHF
300,000 to 3,000,000	Ultra high	UHF
3,000,000 to 30,000,000	Super high	SHF

WPB WILL BOOST BATTERY OUTPUT

The serious shortage of radio batteries which threatens to cut more than ten million listeners off the air entirely may be partly overcome soon, according to WPB reports last month. According to the Board, "readjustments and rescheduling of battery production" is in order.

Reports show that in some areas more than one-third of the battery-operated radios are already inoperative, due to lack of power. This must be considered a serious situation, as the farmer depends on his receiver for important news such as crop and price reports and weather forecasts. His production efficiency therefore is cut by the loss of his radio.

No immediate plans have been made, but it is understood that the WPB will attempt to increase the production of radio batteries under an arrangement by which the Dept. of Agriculture will take the responsibility of rationing them. Thus the available supply will be spread out equitably over all areas.

According to WPB figures, radio battery production has dropped from a pre-war figure of 4,500,000 to the present rate of 2,400,000 batteries annually. During the same period the number of sets has increased by nearly a million, and daily listening time per set is said to have risen from three to five hours daily. War, weather and farm news is credited for these increases.

The importance with which this matter is regarded in the rural states is shown by the recent reference in both the Senate and the House of Representatives to a resolution passed by the Nebraska Legislature. The resolution, after pointing out the importance of rural radio service in maintaining and increasing food production, says in part: "We earnestly commend to the War Production Board that it release a sufficient supply of B-batteries and other farm radio receiving set supplies to permit farmers and ranchers to maintain existing radio equipment."

Broadcasters of the State of Mississippi agreed to petition their Congressmen for relief in the battery situation, and resolutions similar to that of Nebraska have been introduced in the Legislatures of Minnesota, Iowa and North and South Dakota.

DON N. DULWEBER ACCIDENTALLY KILLED

Don Noble Dulweber, president of Supreme Instruments Corporation, was accidentally shot and killed at his home by the discharge of a shotgun which was knocked over as he opened a closet door last month. Death was instantaneous.

Mr. Dulweber was thirty-seven years of age. A man of great ability, he was head of Supreme Instruments Corporation, internationally known for testing equipment, and was a director of the Bank of Greenwood, Miss. His death is a loss to American radio.

"OLD RECORD" BROADCAST NOW SCIENTIFIC EXHIBIT

A museum which up to now has existed only on the radio waves became an actual exhibit when WOR's "Wax Museum" moved into the Museum of Science and Industry in Rockefeller Plaza, New York City last month.

"Wax Museum," the well-known program, presents records from the early days of the phonograph, many of which have now become valuable collectors' items. The Wax Museum exhibit presents a visual history of recording from the earliest days to the present.

WOR's exhibit came into being through the cooperation of RCA-Victor, Columbia Records, Decca Records, and the United States Army. The recording companies

RCA-Victor's contribution to the exhibit consists of one of the first recording machines of the spring-wind type built by Victor in 1912, a display showing the steps in making a record, an early Victor phonograph, a photographic exhibit of the record scrap drive, and a picture story contrasting early and present recording.

Columbia Records have loaned the exhibit many interesting early pieces of recording apparatus. Among them are: the original hand-made model of the Bell and Taintor Graphophone (1885), the production model of the Treadle Graphophone (1886), the first disc model Graphophone (1900), an early wax cylinder phonograph (1898), the first record-changer for cylinder



Billy Murray (right) famous early recording artist, demonstrates recording technique on a 1912 model recorder while RCA engineer Fred Maisch looks on at WOR's "Wax Museum" exhibit at the N. Y. Museum of Science and Industry.

have loaned priceless historical equipment to the exhibit, including the hand-made Bell and Taintor Graphophone made in Washington in 1885; the U. S. Army brings the exhibit right up to the moment by lending for display the machine which enables our troops all over the world to listen to the latest recordings, as well as the special records prepared by the Army itself. These records will also be on display.

The photograph shows Billy Murray—possibly the greatest recording artist of all time—demonstrating the recording technique of 1912. Unknown to the younger generation of "platter" fans, Billy's name can be recalled by "Casey Jones," the most famous of all the songs he popularized.

records (1900), one of the first electric motors for phonographs (1896), a cylinder-duplicating machine (1895), a cylinder record matrix (1902) and several early types of recording horns. Columbia is also lending a display showing their lamination process in making records.

Decca Records has sent the exhibit many early records, including some of the first discs made by Emile Berliner, the inventor of the disc method of recording, and a display of record jackets.

The recording companies are also lending many of their famous early records, dating back to the turn of the century, which will be played for the visitors to the exhibit.

OFFICE OF CIVILIAN DEFENSE ENCOURAGES WERS

Radio amateurs and others who wish to serve their country in WERS will welcome a statement by the Office of Civilian Defense, made last month. The Office intends to expand and popularize this useful service. Says OCD Director James M. Landis, "Thousands of Defense Councils, particularly those in target areas, can now substantially increase the effectiveness and flexibility of their defense forces through the War Emergency Radio Service. OCD strongly recommends that every community take steps immediately to give itself this added protec-

tion in case of enemy attack." It is pointed out by the OCD that WERS is practically invulnerable, not being subject to being put out of action by bomb hits. It consists of numerous small transmitters and receivers reporting to central stations. Even if one of these central units were put out of action, traffic could soon be routed through another.

The system has wide coverage, being able to connect to points not reached by line telephone. Many points can be reached by line telephone. Many points can be reached

simultaneously by broadcast from a central station, thus saving the time wasted in calling up one point after another to deliver the same message.

WERS is also the most mobile of all forms of communication. The small units can easily be carried along in fire trucks, ambulances or motor cars, or installed near scenes of emergency.

Good starts in WERS have been made in many cities and districts. It is expected that OCD's efforts and encouragement will accelerate the movement greatly.

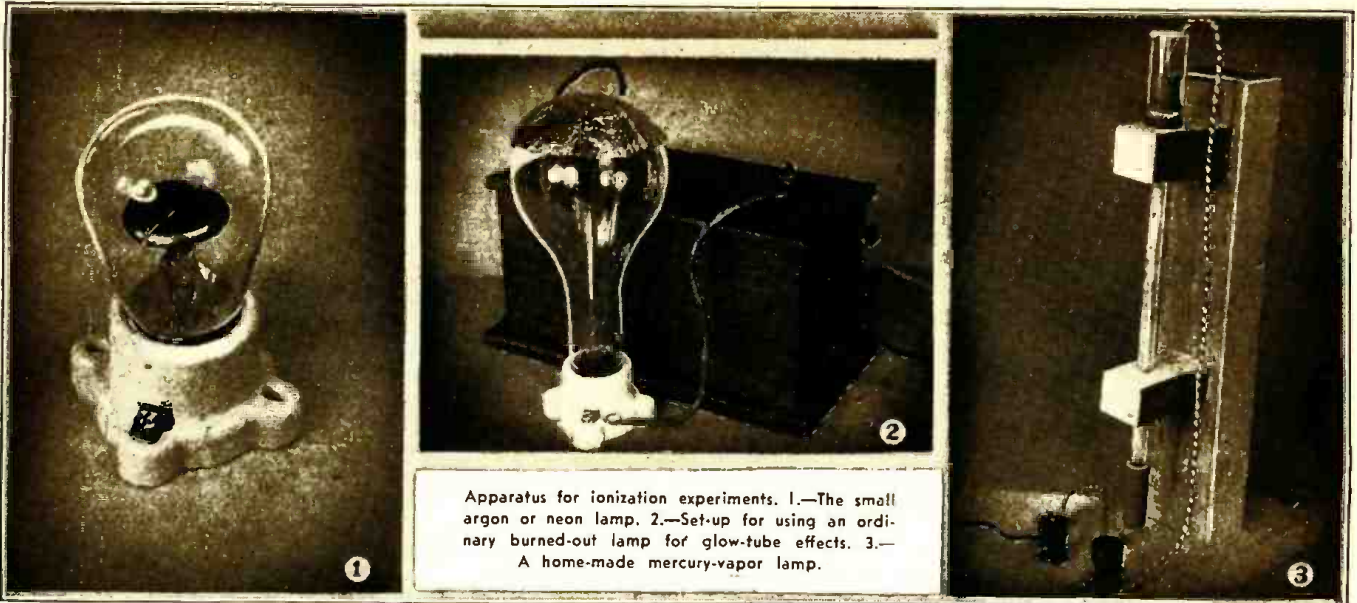

Apparatus for ionization experiments. 1.—The small argon or neon lamp. 2.—Set-up for using an ordinary burned-out lamp for glow-tube effects. 3.—A home-made mercury-vapor lamp.

POPULAR ELECTRONICS*

By RAYMOND F. YATES

PART IV

THE last few paragraphs of the last Chapter were devoted to a very elementary discussion of the phenomenon of ionization. Ionization is so important to the new science of electronics that further discussion of the subject is imperative. Our failure to understand this important matter would leave an embarrassingly large gap in our knowledge of the subject.

We have learned that radium emanations, ultra-violet light, X-rays, etc., may render a gas relatively conductive. However, it must not be supposed that we refer to conductance in the sense that a piece of copper or iron will pass current at very low voltage. Gases require voltages on the whole much higher than any of the metals.

ATOMS, ELECTRONS AND IONS

But first, what is an ion and what is ionization? We have got to come back to our atoms, molecules and electrons for a moment before that can be adequately answered. We already know that atoms are dynamic electric patterns or conformations involving positively charged protons in the central position and spinning negative electrons on the outside. Few indeed are the atoms of matter that exhibit electrical indifference—which is another way of saying chemical stability—like neon, helium and platinum. Such chemical stability or electrical neutrality means a balanced condition between the two opposite electrical forces.

Ions do not enjoy such stability. The ion is an electrically over-balanced particle; heavy either on the positive or the negative side. If it has a preponderance of electrons, it is electro-negative and seeks positive influence. If it is deficient in electrons, it is positively charged. We can say, then, that a negative ion is an atom or a molecule which has added to itself one or more electrons to create a dominant negative charge. On the other hand, a positive ion is a formerly neutral atom which has somehow or other lost one or more of its outer ring or valance electrons.

To prevent confusion at this point, especially on the part of the reader who has done some scattered reading about electronics, it will be well to briefly outline other basic electrical constituents of matter. We already have in mind the proton (+) and the electron (-). There is also a particle called a neutron which, as might easily be surmised from the name, is electrically neither fish nor fowl. We might regard it as a collapsed atom of hydrogen where the single electron has for some reason or other been attracted

to the proton. The result is a blanking out, a neutralization of electric charges.

Then there is the positron which, as its name indicates, is a positively charged particle; indeed what we might call a positive electron.

Returning to the subject of ionization, the ionization of gases is of principal interest as it relates to the broad subject of electronics. Some of the electronic tubes in wide use today depend in a very large measure upon the ionization of gases and metallic vapors.

A gas, any gas, is said to be ionized when it contains free electrons or free positively charged atoms (ions). We have already said that ionization may be brought about by ultra-violet light, heat, etc. It may also be brought about by collisions between ions and neutral molecules. Electrons striking atoms and molecules bring quick ionic effects.

When electrons or free positive atoms are caused to move at high speed through gases, great ionization results. One of the most effective ways of bringing such particles to high speed is by the use of high electric potentials applied to gases in glass containers equipped with the proper electrodes. Indeed it was an early investigation along these lines by Sir William Crookes that resulted in the discovery of the electron itself. We also see the results of heavy ionization when an ordinary high voltage spark passes across a gap. However, in the case of ordinary atmospheric pressure, these sparks are usually thin and stringy.

EFFECTS OF VACUUM

When the pressure of a gas through which an electric discharge may be passing is reduced to about 1/1000th that of the atmosphere rather strange things begin to happen. Glass containers holding gases at such pressures and provided with electrodes are called Geissler tubes after their early 19th-Century inventor. It is very edifying to take an unexhausted tube of the Geissler type and connect it both to a vacuum pump and a high potential spark coil so that the various effects on the discharge may be seen as the gas pressure is lowered.

Our diagram (Fig. 1) shows the natural disposition and color of the discharge when a gas pressure of 1/1000th that of normal is reached.

If this pressure is reduced still further, other changes in the nature of the discharge occur. The dark space grows in length until it fills the entire tube. This is brought about when a pressure of about

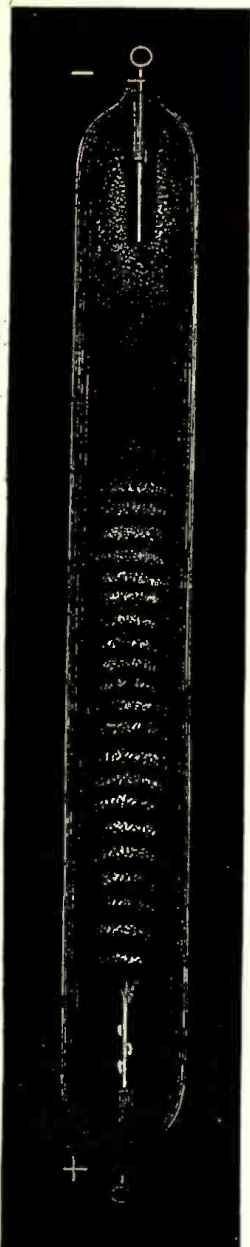
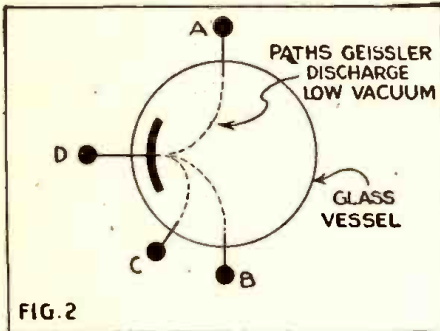

Fig. 1

*Application for Trade Mark Title, pending in U. S. Patent Office.

1/1,000,000th atmosphere is created. The tube still emits light but from the walls only; a kind of fluorescence. The fluorescence is characteristic of the more or less highly exhausted Crookes so that by merely carrying the exhaustion of a Geissler tube to a higher point we eventually arrive at what is actually known as a Crookes tube. Crookes and his contempo-



aries gave a great deal of thought to the nature of this display and Crookes himself finally thought it was due to the bombardment of particles which he believed represented a fourth state of matter which he called "radiant." There were, he theorized, solids, liquids, gases, and *radiant matter*. Some referred to the discharges within in the Crookes tubes as cathode rays.

Later it was shown to the satisfaction of all that the so-called cathode rays were really streams of rapidly moving particles and the speed of these particles was

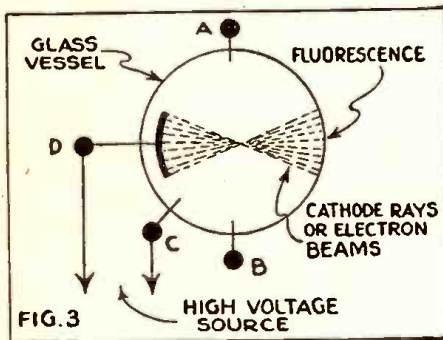

determined in a large measure by the voltage of the electricity applied at the terminals of the tube. Among other things noted, it was found that the particles move at prodigious speeds even with relatively low voltages and that they move in straight lines.

A most interesting experiment conducted with a special tube can be made. This tube, Fig. 2, is provided with three anodes (ABC) and one cathode (D), the latter taking a partially spherical form.

If a Geissler evacuation is had, the luminous effect will be curved from the cathode to whatever electrode is connected to the high voltage source. When the exhaustion of the tube is continued until a Crookes' vacuum is reached, an entirely different effect is had as will be seen by reference to Fig. 3. When such a condition prevails, it matters little where the electrode opposite the concave cathode is located. The discharge in the tube will be concentrated much as a beam of light and it will behave in the manner indicated at Fig. 3.

WHAT ARE CATHODE RAYS

Such a discharge is referred to as cathode rays. These cath-

ode rays are of great interest to students of electronics. It has been discovered that they bear optical properties. Now it will be shown that they have mechanical properties as well. If a delicately balanced light wheel is set in such a way within a cathode tube that the rays will impinge upon the vanes, the wheel, curiously enough, will be set in motion. (See Fig 4.)

The rays have thermic properties also as will be noted in Fig. 5. Taking further advantage of their optical properties, the rays are concentrated through the agency of a reflector which causes them to fall with great concentration upon a piece of platinum foil interposed between the cathode and anode. After a few minutes of operation, the foil becomes highly heated and with sufficient voltage and in time may be caused to melt.

Measurement has shown that the cathode rays move with a velocity 1/10th that of light. Indeed their speed depends upon the voltage with which they are generated or propelled. At very high voltages, they reach speeds well over 100,000 miles per second. It was the observation of these rays by Crookes and others that led eventually to the discovery of the electron, for cathode rays are nothing more or less than *naked electrons* torn loose from surrounding matter and hurled across the evacuated space of the container.

These electron beams (cathode rays) are also capable of producing shadows if bodies are interposed, thus further demonstrating their optical properties. (Fig. 6) The electrons can also be shot through an aluminum window mounted at the end of a cathode tube and in such a position that the particles will strike it directly. Leonard freed electrons by this method years ago and the escaped particles were called "Leonard rays." However, the rays did not progress much further than the distance of a few millimeters once they reached the open atmosphere. Collision with atmospheric molecules and atoms soon robbed the particles of their energy and left only heavy ionization.

THE X-RAY, AN ELECTRON TUBE

An X-ray tube is shown in Fig. 7. Such tubes are really concerned with two types of rays, X-rays and cathode rays. These tubes have highly evacuated spaces and the rays impinging on the target (T) are cathode rays pure and simple. These rays apparently hammer X-rays out of the platinum target; a sort of secondary emission having properties far different than cathode rays. By employing a heated filament, as indicated in Fig. 7b, a more powerful source of X-rays may be obtained, due to the greater emission of electrons from the hot cathode.

The discharge of electricity through evacuated spaces and the conduction of electricity through ionized gases has a great deal to do with electronics. In a sense, the ordinary radio vacuum tube is a cathode ray tube inasmuch as it involves the movement of electrons across a vacuum. Fluorescent lighting, neon signs, gaseous discharge tubes, mercury rectifiers, and glow lamps for recording motion picture sounds

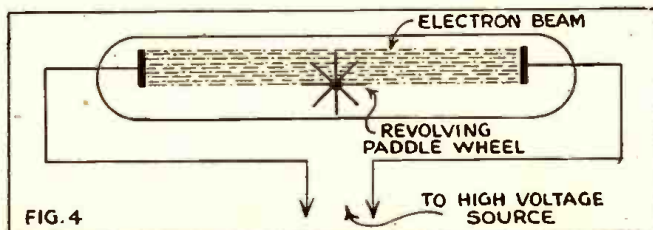

FIG. 4

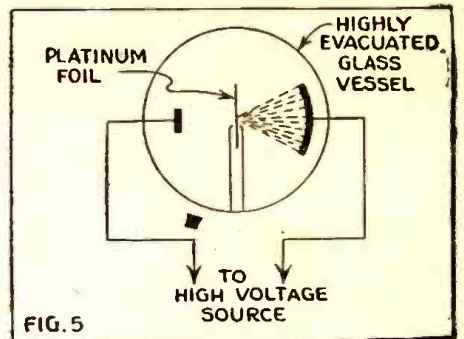

FIG. 5

are all members of the large and useful electronic family.

There are a few experiments in gas conduction that may be made by the student. For instance, a burned out electric lamp connected to the secondary of a spark coil in the manner shown in the drawing (Fig 8) and photograph will offer the means for a number of fascinating experiments. When the coil, which may be the ignition coil from an old Model T Ford (twenty-five cents at any auto junk yard) is operated, a strange

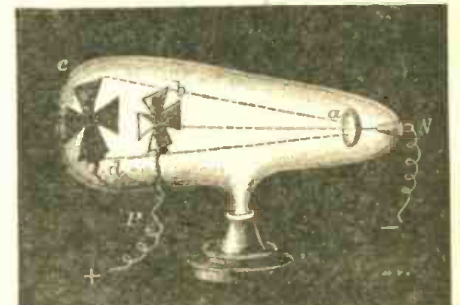

Fig. 6. The external circuits are so connected that (a) is the cathode and (b) the anode. A dark shadow is thrown by the anode on the end of the otherwise brightly glowing tube.

and weird glow will appear inside the tube. There is a certain amount of ionization of residual gas within the bulb, fluorescence, etc. Naturally, the coil should be operated in a perfectly dark room, because that will render visible things that might not otherwise be seen.

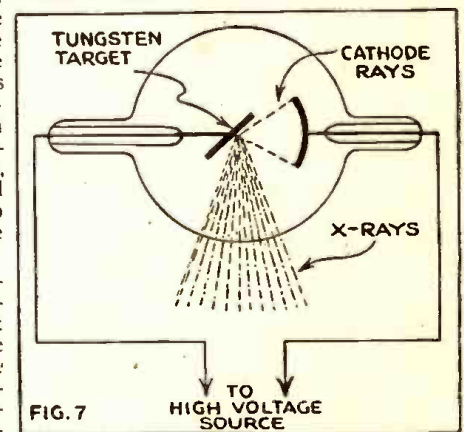

FIG. 7

Another experiment involves a small 3-watt argon or neon lamp which may be purchased for 25 cents. A small coil of wire is placed in series with the spark coil secondary along with a spark gap. A second coil consisting simply of a few turns of bell wire is connected to the terminals of the neon or argon lamp. When this coil is brought near the coil on the spark coil, (Continued on page 502)



1.—The Inductotherm electronic diathermy apparatus. 2.—This group demonstrates that electronic apparatus can function for each of the five senses. 3.—The artist's conception of an atom surrounded by electrons. 4.—Ohio State Police X-ray a suspicious package.

THE AGE OF ELECTRONS

By E. L. ROBINSON*

ALL the world of matter is composed of molecules. Molecules, in turn, are combinations of the 92 established elements, or kinds of atoms—sodium, iron, oxygen, uranium, and the rest. But if the world of substance is built of molecules, and the molecular world is built of atoms, what are atoms built of?

In 1897, the great English physicist, Sir J. J. Thomson, gave his answer. Atoms, Thomson said, are made of tiny, unseen particles of electricity, now called electrons. Science today knows that there are other constituents of the atom—neutrons and protons—clustered together in the nucleus. Around this nucleus, the negatively charged electrons revolve as earth and planets revolve around the sun. This is a simplified idea of the structure of matter, and omits the possibility of other particles, like the mesotron and the neutrino. But the picture is accurate enough, if you remember that whirling electrons can be divorced from the influence of the nucleus and put to useful work.

How is this accomplished? Through the amazing medium of the vacuum tube, the foundation of the Electronic Age! By this magic tube, doors open automatically as you pass, machines match fabric shades, the eyesight of children is guarded, and engineers reclaim sulphur that formerly vanished up factory chimneys.

One day in 1883, Thomas Edison, experimenting with his newly invented electric light bulb, observed a glow inside the horse-shoe-shaped carbon filament, accompanied by a rapid disintegration of the filament. Investigating, Edison sealed a metal plate inside the tube. When plate and positive side of the supply circuit were connected, an

electric current flowed across space from filament to plate! This was the "Edison Effect," the basis of modern electronics. Thereupon occurred one of those curious intervals in the history of science. A great discovery lay idle. Not until years later did any one begin to build upon the foundation that Edison unknowingly had erected.

Professor J. A. Fleming, an English physicist, in 1904 found an application of the Edison Effect—a detector for wireless telegraphy, called the Fleming Valve. Soon after this, Dr. Lee de Forest, also studying the Edison Effect, added a grid to Fleming's Valve. This small wire screen, electrically charged, controlled the amount of current flowing through the valve. De Forest's tube, the "audion," pointed the way to all radio telephony and radio broadcasting, and when E. H. Armstrong discovered how to use the audion to amplify radio frequency waves, the "cat's whisker" earphone era had come to an end.

THE RISE OF MODERN TUBES

Meanwhile, at the General Electric laboratories in Schenectady arrived a young man from the Stevens Institute of Technology. He was Dr. Irving Langmuir, with a gifted mind and an unsatisfied curiosity about the secrets of the universe.

Langmuir's interest in the Edison Effect arose out of systematic study of tungsten, used for lamp filaments. He found that gas in the tubes of that day prevented their operation at high voltage. Removing the gas, Langmuir discovered the "space-charge" law governing the flow of electrons in a high vacuum. The result was a vacuum tube that worked dependably at 250 volts. The old audion tube had been limited to 30 volts! Thus originated the true high-

vacuum power tube, destined to handle many kilowatts of power, and to amplify the impulse of a microphone for long distance radiation, as waves from an antenna.

It was a new goal in the fascinating search for electronic knowledge!

Through the ages electrons had pursued their course without once being segregated and put to work. Into that invisible world, Langmuir now entered, and made the "big little things" do man's bidding. He harnessed the power of the electron for as long as mankind endures.

Following Langmuir's discovery, Dr. A. W. Hull and his colleagues in the General Electric laboratories devised many new types of electronic tubes—including the screen grid tube now used in all modern radio reception, the magnetron, the dynatron, and the thyatron. Today, across the world, hundreds of types of electronic tubes serve man's command. They range in size from tiny globes to long cylinder tubes, twenty-five feet tall. They work for the doctor, the fireman, the artist, the fruit packer, the sea captain, the air pilot, the policeman. They have wrought a revolution—not by force of arms, not by might, but by the will and intelligence of man.

ELECTRONS IN INDUSTRY

In great sprawling factories busy on arms production, in cotton mill, printing plant, fruit-packing house, steel mill, railroad, and knitting mill, the magic electronic tube is working miracles for American industry.

Many types of electronic tubes, from the husky ignitron and thyatron used in welding metals of war; to photo tubes that measure light; to amplifier tubes that amplify sound are now manufactured. They are of all sizes, and ratings range up to a mil-

*Electronics Dept., General Electric Co.

lion volts. They are stepping up production, increasing human efficiency with a speed and accuracy undreamed of only a few short years ago!

COLOR ANALYSIS

A recording spectrophotometer, utilizing a photoelectric cell, now provides the most reliable method of analyzing color ever devised. The human eye can detect some ten thousand tints of reds, blues, greens, browns, yellows. But this amazing tool of the Electronic Age defines two million different shades! It is already used profitably in the chemical, paper, textile, and paint industries. In weaving, an electronic device automatically squares the lengthwise and crosswise threads, the warp and the weft. Electronic eyes inspect sheets of metal gliding swiftly from the rolls, spot pinhole defects, and mark them for later discard. Electronic tubes turn on highway lights as the sky darkens, and turn them off when morning comes. Stir one or two cups of boiling water with a strip of metal. An industrial engineer can tell you which one! The "electric eye," an electronic device, readily detects the infinitesimal amount of metal dissolved during the brief stirring.

Electronic devices control the high-speed wrapping of packages, fill ginger-ale bottles to the proper level. Electronic rectifiers furnish power to produce vital war metals like aluminum. And electronic tubes, through carrier current, enable power station operators to carry on conversations over the same lines that carry the electric power; or to control distant apparatus in the same way. X-rays, too, are electronic in origin. Long indispensable to physician and dentist, they now aid modern industry. Across the country, X-ray units of many types and sizes examine heavy castings for imperfections.

X-RAY TUBES

The new million-volt X-ray unit photographs in 16 minutes the internal structure of heavy metal thicknesses which formerly required exposures of 60 hours. X-rays detect porosities and fissures in welded metal seams; and locate potential blow-outs in tires—on the wheel, before they happen. In the food industries, too, electronics plays a part. X-rays inspect candy to detect intrusive foreign materials, and check packaged goods for deficiencies in fill. X-ray examination of oranges saved California citrus packers \$7,000,000 in one record year, when frost made every good orange count heavily. Similar fluoroscopic X-ray inspection checks golf balls, molded plastics, rubber heels and wire insulation.

One of the most fascinating applications of electronics is the analysis of crystalline substances—metals, fibre, paints, ceramics—by X-ray "diffraction." The physicist places in a "camera" a sample of the material to be studied, and directs at it a stream of X-rays. The sample diffracts the rays, and the diffracted radiation creates a pattern on sensitized film. The physicist simply reads the diffraction pattern, and by calculation can determine what structural changes occur when metal is rolled; can classify cotton, wool, silk and other natural and synthetic fibres according to strength; and even identify the minerals in rhubarb!

The tiny electron, partner of business in a thousand ways, is also mobilized to gigantic tasks set by industry's power machinery. Steel companies must match the power frequency of huge driving motors to the frequency of the utility lines. Once the only way would have been with great rotating converters. Today, the magic electron can do this work.

Only imagination now limits the use of the electronic tube in industry. The magic tube that levels elevators in skyscrapers, counts traffic, and controls the flow of power in electric furnaces, will double and triple its industrial deeds in the future. The money that the electronic tube will save, the burdens it will lift, the inventions it will stimulate, no man can now foresee.

FM, A NEW ADVANCE

FM reception, developed by Major E. H. Armstrong, abolishes the imperfections of present-day radio. One of these is static, caused by Nature's lightning and sunspots, by man's electric razors or dial telephones. FM reception is clear and unmarred. The human ear is sensitive to a range of sound from 16 to 16,000 vibrations or cycles per second. Conventional radio does not reproduce sounds higher than 5000 cycles. But FM radio opens up the full highway—the range of piano, violin, voice—with all the delicate overtones that give music color and life.

FM eliminates interference, the hum and cross-talk on the same channel. Even when two or more stations are near, FM selects only the one you wish. Only the war defers a wholly new conception of radio performance in your home.

TELEVISION

Voices have spanned the miles for years, and signals have journeyed across the Atlantic since the War between the States. Man still dreamed of bridging distance by pictures.

In 1884, the inventor Nipkov first suggested the scanning disk—a device that divided a picture, and strung it into one long line of light which, transmitted, was divided again in many lines by a receiver to form the original picture. But not until the invention of the cathode-ray camera and picture tubes did television become a rich promise for the home.

How does television work?

The electronic camera tube is mounted in the television camera, and the camera trained on singer, or football field, or airplane. The image is focused on a photosensitive plate at the back of the tube, and the tube converts that image into a series of electrical impulses. These impulses are carried over a cable to a skyscraper antenna, and there transmitted. In the receiving set in your home is another electronic marvel—the cathode-ray picture tube. A stream of electrons, controlled at the skyscraper antenna, now plays across a fluorescent screen in the wide end of the tube. Electrical impulses are thereby converted

(Continued on page 463)

130-TON X-RAY MACHINE NEARS COMPLETION

Approaching completion in the General Electric Research Laboratory in Schenectady is this large electron accelerator which, when finished will generate X-rays at voltages up to a hundred million. Its most pressing war function is to make possible the evaluation of such X-rays for the examination of thicker metal sections than can now be studied by means of X-rays.

The picture shows the lower part of the huge alternating-current magnet, made of slabs of steel spaced apart for cooling and

consisting of thin sheets cemented together. Examining one of the circular magnet pole faces, between which the electrons will be whirled around in a six-foot doughnut shaped vacuum tube are (right to left) Dr. Ernest E. Charlton and W. F. Westendorp of the Laboratory's X-ray section, and Rudolph Wroblewski, who is assisting in the erection of the device, which will weigh 130 tons when completed. Part of the upper half of the magnet is visible in the upper right-hand corner.



ELECTRIFIED OUTLOOK FOR ELECTRONICS

AS the word "Radio" was mystical back in 1920, so the word "Electronics" now is a magic symbol. While the term may sound new to the masses, yet the electrical laboratories of the nation have been devoting hours upon hours every day for the past five years to experiments with "electronics." In the halls of science it is not a question now of what electronics can do but of what it cannot do. *In fact, the postwar world will be an electronic one. It is time to get something down in black and white before some are misled.*

What is Electronics?—In some ways this question can be answered as easily as the seemingly simple question, "What is electricity?" Nevertheless, electronics is the name which has been given to the science or art of putting the electron to work. The electron, of course, can be defined. It is the most elementary charge of negative electricity. *The invention of the three-electrode tube, about thirty years ago, gave the science of electronics its real birth.* By this invention the door was opened to a vast storehouse from which much has already been requisitioned. Radio, synchronized sound and motion in the talkies, television, and other marvels have all been developed from this source.

Fostered by Present War—World War II has advanced electronics by at least ten years. As the electron tube was the favorite child of scientists after World War I, so electronics promises to emerge from the present conflict a giant in stature. Many of the most fascinating applications of electronic equipment by the armed forces, of course, are shrouded by closely drawn censorship. This one fact is clearly evident—namely, that thousands are being carefully trained in this field as part of the war effort. *Undoubtedly these thousands will influence greatly the postwar growth of the*

industry, both as employed personnel and as customers for the manufacturers and distributors of electronic equipment.

Pierces Cloud and Fog—Here is just one example of electronic development which has been released by military censorship. It is the radio locator. This alone has saved London from the vengeance of the Luftwaffe. It is able to pierce clouds and fog.

The present article from a financial institution, Babson's Statistical Organization, is timely and important to the radio industry. When financiers become interested in a new industry, it usually means that it has arrived in a big way. Electronics is no exception to the rule.

So delicate is this device that it detects the approach of planes, counts and identifies them, and raises the alarm long before they could be apprehended visually. It scans the horizon constantly and it informs both ground forces and those aloft when the enemy comes within range. An even more recent development has been the electronic control of cannon fire. This enables anti-aircraft batteries, for example, to follow the course of the enemy planes and maintain a close continuity of accurate firing data.

Radar Makes Hawk Eyes—We are now intent upon the construction of escort vessels to combat the submarine menace and increase the ratio of new merchant ship tonnage to losses. The eyes of these escort vessels are found in a new and secret device known as radar. *It sees what ordinary vision cannot and it promises to revolutionize transportation on the sea and in the air*

before the close of the war and thereafter.

Present Industrial Uses—Already the electron tubes have been adapted to industrial use in countless diverse operations with complete success. These have resulted in not only remarkable economies in time and energy, but also added safety and accuracy. Not subject to fatigue or human limitations, it can work relentlessly at incredible speeds. Its power to accelerate production and at the same time to heighten efficiency and certify uniformity is uncanny. *Many of its forms have become daily companions as, for instance, fluorescent and sodium lamps, and electric eyes which open doors and draw the hands of a punch press operator out of harm's way.*

Catalog of Uses Infinite—In a few minutes the X-ray can explore the internal structure of heavy metal and detect any hidden flaws. Huge castings, such as valves, can be tested for sand bubbles which might cause them to fail under pressure. Welded seams can be examined for fissures. In the same manner, potential weaknesses in automobile tires can be revealed while they are on the wheel and possibly accidents avoided. On the loom an electronic device automatically squares the threads of the warp and the weft. *The human eye can differentiate between 10,000 tints but the electronic eye defines 2,000,000 shades.* By means of electronic tubes, power station operators can converse over or govern distant apparatus over the same lines which transmit electric energy. *Even in agriculture, electronics offers unlimited possibilities.* It may breed cold-resistant corn and superior livestock, extirpate the fruit fly and multiply soil fertility to give all peoples more generous supplies of foods. *It is still morning in the field of electronics. Your business, your home life, both will be made easier in coming years by the science of electronics.*

ELECTRON TUBES END TEDIOUS JOBS

AS electricity eased the burden of many "back-breaking" jobs in American industry, so too will the electron tube eliminate many tiresome and routine tasks which now fatigue the worker, predicted W. C. White, director of General Electric's electronics laboratory, in a recent talk.

He also pointed to new developments in the science of electronics which are destined to benefit mankind in many ways. The stimulus of war research has enabled electronic engineers to produce and use electrical frequencies ten times higher than a few years ago, and as a result new things are bound to be produced which will add to the usefulness or pleasure of living. "Whenever something comes along that is ten times faster, slower, larger, higher, stronger, or lighter than its predecessor," Mr. White said, "scientists and engineers soon put it to work doing new and useful things."

The new ultra-high frequency waves have properties similar to light and will function

in cases where light will not. For instance, in the navigation of ships and planes, the use of these electronic waves are invaluable for they penetrate darkness, storm and fog, and enable the pilot to see obstacles heretofore hidden to view on such occasions.

The very high frequency waves can be substituted for the light beam in photoelectric relays (electric eyes) used in industry and elsewhere, and will be free of certain of the limitations of light used in these relays.

"Electron tubes are sure to play an important part in the trend toward routine saving. By this I mean the ability of a piece of equipment to do something that one of the human senses, plus certain muscles of the body do without the aid of the thinking brain. The tube will do these things, and do them more efficiently without errors due to fatigue or human judgement," Mr. White told audience.

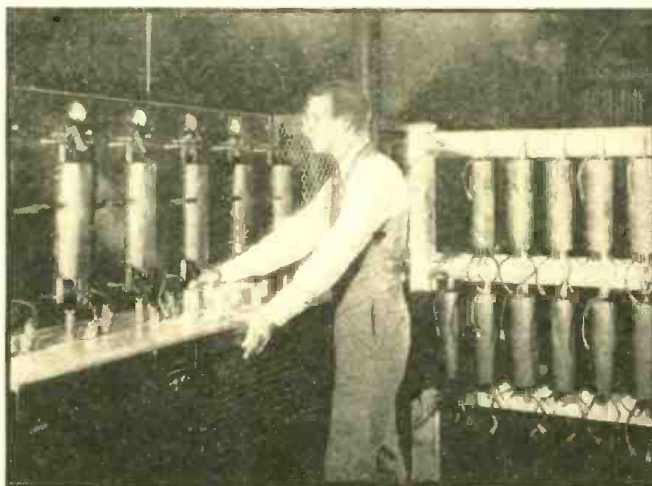

Phanotron tubes being tested in General Electric's Electronics Department before shipment to industrial war plants where they will be used for power rectification, to change A-C electric power to D-C, which is much more convenient for workers using small motors, such as are used on machine tools.

A SPAR "RADIOMAN"

(COVER FEATURE)

REPRESENTED on our front cover is a scene in the daily training life of a member of one of the newest branches of Uncle Sam's armed forces. When the Coast Guard opened its ranks to the girls who know their dits and dahs, it became for the first time possible for a woman to be a radioman.

These SPARS, as the women of the Coast Guard service are called, receive their training at the University of Wisconsin, where they undergo a 16-week course. Classes are conducted in code, typing, procedure, radio theory and Coast Guard matters.

Ratings and wages for the SPARS are the same as for the men of the Coast Guard. When they can pass a code test at 22 words

per minute they are rated Radioman 3rd Class, with a corresponding raise in pay.

They learn considerable theory—enough to make their work both interesting and instructive. Following along lines often advocated by the Editor and Publisher of *Radio-Craft*, they are shown how things go in radio by actually seeing apparatus in operation. Movies and other educational aids are freely used throughout. The student follows pictorial diagrams till she can read a schematic.

The theory is started at the very bottom of the ladder. The elements and principles of electricity are first learned, then applied to the fundamentals of radio communication. Gradually the course passes to more

complicated applications of radio equipment.

Not the least attractive feature offered the SPAR is the knowledge that when she comes out of this war she will be able to hold down a skilled job in a radio factory. She also learns typing, copying radio signals direct from the air onto the typewriter. A novel and painless method enables the SPAR to do this, though she may never have "pecked" a key before.

It is the job of the Coast Guard to land the Army. Everyone now knows how well they did this job at Casablanca. Perhaps in the near future such posts may be manned by feminine radiomen of the SPARS. (Photo courtesy Chicago Public Relations Office, U. S. Coast Guard.)

THE AGE OF ELECTRONS

(Continued from page 461)

into varying degrees of light, forming again in your television set the clear image of singer, or college football field, or airplane!

ELECTRONS ON GUARD

Electrons stand on guard in other ways and places. Fog is an ancient foe. Ships reduce speed, wary of oncoming vessels. Airplanes are grounded, and cars crawl along. But now, through astonishing electronic devices, captain and pilot can "see" through the murky whiteness, and even detect the position of reefs. Tomorrow, airplanes will land blind, as safe in fog as in sunlight.

In the police departments of the nation the electron wars on crime. Police cars, equipped with two-way FM radio, cruise the streets. A brisk command orders the squad car to the scene of accident or violence. There in seconds, police act, and the culprit is taken. Electrons fight fire. Insulation smoulders in an unattended power station. Smoke rises, unseen. A beam of light is interrupted, an electronic "fire-warden" smells the smoke, and a signal sounds . . .

The electron, servant of man, is man's protector also!

ELECTRONS IN AGRICULTURE

Early this year, after a long period of experiment, an enterprising seedsman in Philadelphia offered American gardeners two new calendulas. One flower is golden, double petaled, the other orange and semi-double. Both were created by the genetic effect of X-rays on seeds. Thus does the electron enter the world of growing things!

Scientists for years have experimented in this fascinating realm. Apple and fruit trees, berry bushes, tomato seeds, and string beans have been bombarded with 1,000,000-volt X-rays. Cannot the action that produces different strains of flowers also produce grains and vegetables and cotton and fruits of higher yield and finer quality than before?

Science is looking to friendly Nature to see. The electronic microscope has revealed already to biologists the character of the tobacco mosaic virus—a deadly crop disease, costing growers millions of dollars yearly. Perhaps that knowledge is the beginning of the cure. Tomato growers in the great garden states of the Union ask how soil fertility can be increased. The electron may

reveal it—to the benefit of farmer and consumer.

The electron may some day develop a cold-resistant strain of corn; breed a superior stock of cattle; develop fruit untouched by fly drosophila; create for the poorer peoples of the world, in their own soil, the elements of robust health. Nature

ELECTRONICS vs. RADIONICS

WE have noted an unfortunate attempt from several quarters to befuddle the public with the term RADIONICS. Why this red herring should be dragged across the well established Electronics trail, at this late date, seems a profound mystery.

Electronics treats on the science of the electron. Radionics treats on—what? The science of Radio? The science of the Ion? The coiners of the word remain silent here, but somehow make you believe that Radionics has to do with electronics plus radio.

The attempt to try and hitch Radio to the Electron in a single word at this time is most unfortunate. Radio still is radiant energy. Since the discovery of Radium by the Curies over a generation ago, the word RADON, for instance, was used by them as a synonym for Radium emanation. R.C.A. for several decades successfully used the term RADIOTRON for their vacuum tubes.

In 1924 I coined the humorous word RADIOTICS for a radio joke column. Maybe that is the less befuddling term!

Hugo Gernsback

and earth are willing. All that is lacking is the imagination of man, and already, on the electronic horizon, a light is shining.

ELECTRONS IN MEDICINE

It was November 8, 1895, that Professor

Wilhelm Roentgen, at the University of Würzburg, first observed the effects of a mysterious form of radiation. Aptly he named it for the unknown—the X-ray.

Science was stirred. For the first time, man might now see the structures within his own living body. Dr. William D. Coolidge, today director of General Electric research, was one who foresaw the X-ray's possibilities for human good. Equipped with a new knowledge of electron behavior, he developed the Coolidge hot-cathode X-ray tube—the basis of modern X-ray practice.

Medical men can make stop-motion radiographic "snapshots" of the heart in a fraction of a second. They can see that a leg bone is set properly, and how a rib is knitting. They can find gall stones, kidney stones, bladder stones; detect tuberculosis and silicosis in the early stages; discover ulcers and tumors that might not otherwise be discovered until too late. And the X-ray is the one satisfactory method of locating bullets, metal splinters and other foreign bodies embedded in the flesh.

In therapy, X-rays treat skin disorders, acute infections, inflammations, gas gangrene. Newest weapon in the fight against deep-seated malignancies is the giant 1,000,000-volt X-ray generator. By inductothermy, or artificial fever, medicine again works hand in hand with Nature. Here, electronic tubes produce high-frequency currents that generate therapeutic heat deep in human tissues. The Inductotherm can be used in local treatments also. Coils of insulated cable are placed around the part to be treated, and heat soothes and speeds the healing of sprains and fractures—if heat is indicated.

In the war against heart disease, an electronic instrument—the electrocardiograph—detects and amplifies electric currents generated by heart actions, and records their variations on photographic paper.

With the electron microscope, newest electronic instrument to come to medicine's aid, physicians can look at typhoid and anthrax germs in structural form. It is possible that science will next reveal the life processes of these germs—what they feed on, how they reproduce. The electronic science marches on. New discoveries in preventive medicine are no longer rare. Man's old dream of a world free from sickness and pain is not yet here, but we are nearer to it, by far, than man has yet been.

HOW TO MAKE AN EXPONENTIAL HORN

By JAMES LANGHAM

ANY speaker sounds good if you put it in a big enough box. We were respectful—being young and inexperienced in radio—and so believed him implicitly. So we bought the speaker, built a nice big box and—surprisingly—thought it sounded pretty good until we heard something better. Our car was dull in those days.

Then by and by permanent magnet speakers came in and the idea fascinated us. Imagine not having to have a field supply! So we saved our dough and paid \$36.00 (net price) for a fine PM. We had by that time learned not to believe these "practical radio men" and went to considerable time and trouble to build a tuned baffle box.

We had learned that the waves from the front and the back of the speaker are 180 degrees out of phase, and thought the idea of a slot for the bass notes to escape from the back of the box, to reinforce the front wave, was a fine idea. We conquered an impulse to slap some plywood together into a box and decided to go about it in a more scientific manner. We fed an audio oscillator (borrowed) into the outfit, and placed a mike 10 feet from the speaker. Then we hitched up another amplifier and an output meter (also borrowed) to see what the speaker would do without any baffle. We plotted a fine curve with response down five DB at 8000 and 70 cycles. It was and is about the best single speaker on the market in our opinion: Cinaudagraph with a 2½-inch voice-coil, curvilinear cone and a big chunk of Alnico magnet on the back end. We decided, since our low response fell off about 70 cycles, it would be nice to make our box resonate around 50-cycles, (that gives a nice big bump) and design the outlet to reinforce a 30-cycle tone. Then we got the plywood.

We had trouble until we hit on the simple angle of thumping the box and then listening to a tone from the oscillator. Then we found we'd cut the wood a little too short and narrow, and had to be content with a resonance at 55-cycles, and even that was with the back butted on the box instead of fitted inside. Then we thought we'd design the slot to give a half-wave at 30-cycles for

the sound from the back of the cone to travel. We looked up some figures on the speed of sound in average air and found that a 30-cycle tone has a wavelength of nearly 40 feet. This was out of the question in a box the size of ours, so we decided 55-cycles was low enough for us to hear anyhow.

After the box was painted and we'd listened for some time we thought we'd try a slot anyhow. So we did, and listened. Then we'd cover up part of the slot with a board and listen again. We found that we could extend the bass down to a good 45-cycles without any falling off at all—and what is more important, we could play with the shape of the slot and smooth out two dips in the overall response at 1100 and at 2200-cycles. Our last curve showed a response within 3-DB from 45 to 7500 cycles and within 5-DB from 42 to 8000 cycles.

It was just after that time that we moved to a larger house and experimentation was dropped for awhile, and we turned to pick-ups and equalizers. We didn't get going on speakers and baffles again till about a year or so later.

We had been studying radio and sound, and noted that while a cone speaker has an efficiency of about 10 to 15%, that that of a horn approaches 50%. This idea intrigued us and we dug into the subject a bit. We found curves comparing exponential, conical, and parabolic horns, with the exponential type way ahead of the other two, as to efficiency and response. We corroborated what he had suspected: That a cone speaker can be driven only so far before the amount of second harmonic produced by the cone itself becomes noticeable. Therefore it is desirable to operate the unit at a lower level and use the higher efficiency of a horn to make it louder. So we decided we'd experiment a bit with a horn.

Using our nice cone speaker again to drive the horn we built a monstrosity in the garage. Here's how we went about it.

First we dug up the formula:

$$S_x = S_1 e^{mx}$$

where

S_1 is the area of the horn at the throat
 S_x is the area at any distance x
 x is the distance from the throat
 c is 2.72

m is a flare constant for the horn

Also the book said that for good results the distance across the mouth of the horn should be not less than ¼-wavelength of the lowest frequency to be emitted. That was when the XYL decided it would be built in the garage instead of in the house. We were planning to emit 50-cycles anyhow (our original thought had been 30), and ¼-wavelength at 50-cycles is about 68 inches. We decided to increase this to 80 inches—let's do it right, huh?—that idea.

Proceeding further with the design—with the help of the book—we discovered that a horn whose area doubled every 12 inches would have a cut-off at 64 cycles, and a horn whose area doubled every 6 inches would have a cut-off of 128 cycles. To get a figure for doubling the area of our horn with the 50-cycle cut-off we worked out a simple problem in proportion:

$$\frac{64}{D} = \frac{50}{12}$$

D came out equal to 15.36 inches. In other words our horn had to double its area every 15.36 inches to have a cut-off at 50 cycles.

The throat of our horn had to fit our 13-inch speaker, so the value of S_1 would equal (13 x 13) or 169 square inches, and the area at 15.36 inches would be (2 x 169) or 238 square inches. This meant that we could find the value of "m" in the horn formula, by substituting 15.36 for "x" and 238 for S_x : $238 = 169 \times 2.72^{15.36m}$.

The value of "m" came out equal to 0.045, so we now had a formula for a horn with response down to 50 cycles: $S_x = S_1 e^{0.045x}$, and in our case with S_1 fixed at 169 square inches, $S_x = 169 \times 2.72^{0.045x}$. From that relationship we were able to calculate the exact measurements of the horn.

The building of it took some pains as we were not carpenters, but we did manage to bend some ¼ inch plywood to the dimensions shown, and by judicious bracing, were reasonably sure it would stay that way.

The thing was a whisker over 80 inches long (6 feet 8 inches if you prefer) and the mouth size (80 x 80) still left a little room around the sides of the single car garage so we finished up the plywood by walling up that opening and using the smaller door in the back of the garage to get in and out.

The big day came and we carried out the good amplifier and a turntable unit to the garage. The XYL and a few friends gathered in the driveway along with some curious neighbors to hear the nice concert. I screwed the speaker onto the throat of the horn and hitched everything up—put a record on the turntable and let her go. I don't know what made me pick out that bagpipe record except that that seemed like outdoor music—sort of.

The amplifier in question had a pair of

(Continued on page 501)

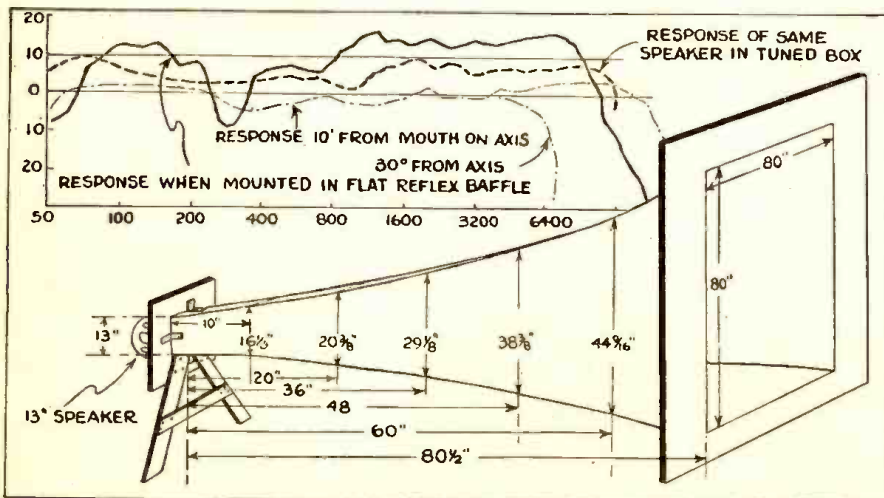

The seven-foot exponential horn. All necessary dimensions are given.

RADIO METER REPAIRING

By F. J. LINGEL*

THE wise serviceman has always considered meter repairs to be outside his field. When his meters ceased to work satisfactorily, he either sent them to the manufacturer or other reliable instrument man for repair, or replaced them outright. It was often cheaper and more efficient to install a new meter than to have an old one repaired.

We are in a different world today. There will be no more new meters for the duration, as far as servicemen are concerned. The repair problem is in many cases well-nigh unsolvable. Meter manufacturers and instrument men are piled high with government work and are not permitted to use

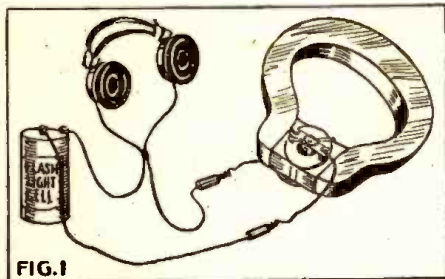

FIG. 1

Having gathered together the necessary tools, the next thing to do is to prepare a place to work. This should be a level bench or table, in a clean place, as free from drafts, dust and corrosive fumes as possible. The space should be well lighted, and the working surface covered with a smooth, white glazed paper, free from lint or fuzz.

A watchmaker's eyepiece or other small magnifying glass will be found useful.

TAKING DOWN THE METER

If the pointer does not move from the zero mark on the scale when normal voltages or currents are applied, check all connections to the instrument proper. That is, before checking the instrument, first check the connections in the tester, or other piece of equipment in which it was used. The defective connection may be elsewhere than in the instrument itself. *More than one perfect meter has been sent back for repair because of an open connection in associated circuits.*

Electrical continuity of the moving coil and the series resistors may be checked with a head-set and a small 1½-volt dry-cell connected in series with the part to be tested. A sharp click will indicate a continuous electrical circuit. (See Fig. 1.)

Now remove the case, first unscrewing the three small screws which hold the case to the base, and take off the front part of the case. Then remove the back connection nuts from the studs projecting through the base, and you have the movement "out in the open."

If inspection shows that the moving coil is in good condition and unburned, and the springs are in position and show no sag or other indications of overload, it is likely that the trouble will be located under one of the following three items, listed with their symptoms in the order of their difficulty.

If there is a broken connection or unsoldered joint in the meter, it should be soldered. This should be very carefully done, using rosin flux, and as little soldering flux as possible.

Blow the pointer lightly, and if it shows signs of sticking at some particular point on the scale, it is possible that a small piece of foreign matter is wedged between the moving coil and magnet. Sight through the opening between the moving coil and magnet and locate the obstruction. Then remove it with one of the special tools provided. The fine steel needle will be especially useful here.

If the pointer shows signs of sticking or dragging over the whole scale arc, the pivots or jewels may be worn or coated with dirt. To note defective operation from this cause, tap the meter lightly while it is registering. If the pointer moves more

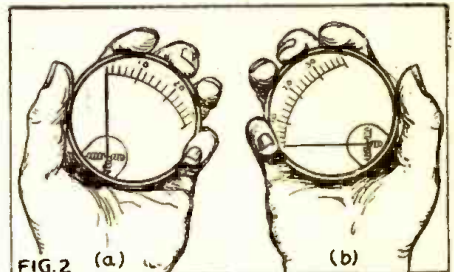

FIG. 2 (a)

(b)

their materials and time in the repair of civilian apparatus.

There are many cases where the skilled serviceman may be able to effect minor repairs and adjustments, putting discarded meters back into service again. This applies particularly to meters in which the moving coil and the springs are in good condition. Repairs and adjustments on these may be made by any person who is skilled in delicate work. If your touch is not particularly fine, the local watchmaker can probably make such adjustments.

THE NECESSARY TOOLS

Besides the usual socket wrenches, pliers, etc., to be found in every good service shop—and which will be needed to take the movement out of the case—a number of special tools will be needed. These are necessary because of the very small parts used in measuring instruments. The most necessary items are:

1 or 2 small jeweler's screwdrivers (such as may sometimes be found in sewing machine kits).

Small embroidery or manicure scissors.

A pair of very small long-nosed pliers.

A pair of fine tweezers (get these from a drug store, a first-aid kit, or borrow the girl friend's finest pair of eyebrow tweezers, when she is not looking).

A fine steel needle with a wood or rubber handle. A fine long sewing needle mounted in a handle made of a pencil eraser will do.

A small soldering iron, such as can be made from heavy copper wire either set in a wooden handle or used as an extension to your smallest radio soldering iron.

*Triplet Electrical Instrument Co.

Some typical meters as they appear out of the case. The removable moving-coil unit is shown in the upper right corner.

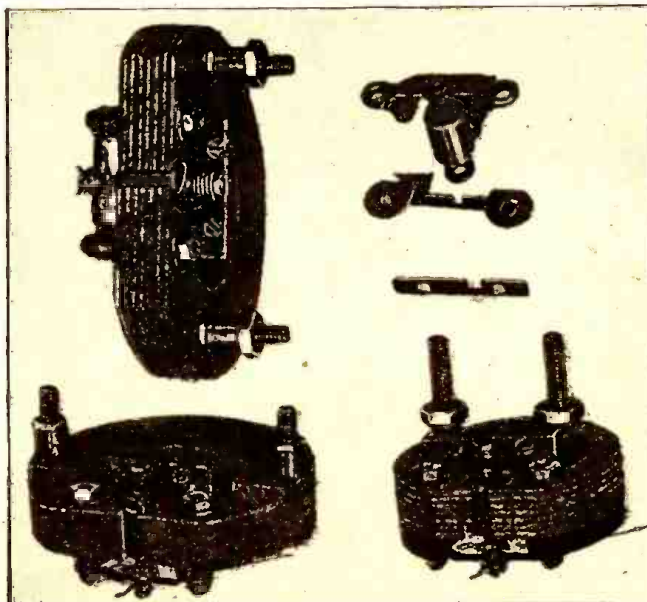

than one scale division, it is probable that the pivots or jewels are in need of cleaning or repolishing.

CLEANING PIVOTS AND JEWELS

To clean or repolish the pivot or jewel, unsolder the outside turn of the spring from the spring support by bringing the hot soldering iron against the support where the spring is soldered. Remove the jewel bearing lock nut and carefully unscrew the jewel screw. *Note the arrangement of the spring support and pointer stop, on the pointer side of the moving coil.* Also the insulating washers and spring support on the opposite jewel bearing assembly. This is necessary in order that they may be replaced properly.

The pivot and jewel screw may then be cleaned with a small, soft wood stick soaked in clean alcohol. The jewel surface can be cleaned and slightly polished by means of a small stick applied to the pivot surface through the jewel screw opening. When cleaning the pivots, a small brass or fibre spacer should be placed between the moving coil and the iron core so that excessive pressure is not exerted on the opposite pivot and bearing.

Replace the jewel screws and associated assemblies, making sure the spring is neatly soldered and that the turns of the spring do not touch each other. Adjust the clearance between the jewel screw and pivot so there is just a noticeable movement in the jewel when the coil is lightly moved from side to side by a slight pressure on the pointer tip. The actual distance between the pivot and the jewel surface with the movement in the horizontal position should be approximately 0.002 to 0.005 inches. (Continued on page 490.)

CONVERT THE AUTO RADIO TO ELECTRIC OPERATION

By FRED SHUNAMAN

MORE than one car owner, with his machine confined to the garage for the duration, feels the loss of his auto radio as keenly as he feels the loss of the car itself. In some cases it is a

sometimes rather large condensers which are connected between the "hot" lead of the battery and the ground. These are often big enough to practically short-circuit the 6-volt A.C. winding. Fig. 1 shows a typical

many of the vibrator transformer. By using a 12-volt winding, the amperage is cut in two.

If a permanent-magnet speaker is used with the receiver, no change is necessary. If the speaker had a six-volt field, it will have to be replaced by either a P.M. or a higher-resistance dynamic speaker. The field of the latter can be used instead of the original filter choke. Many modern auto radios use a resistance-condenser filter, and substituting a speaker field of about the same resistance as the filter resistor will be an actual improvement.

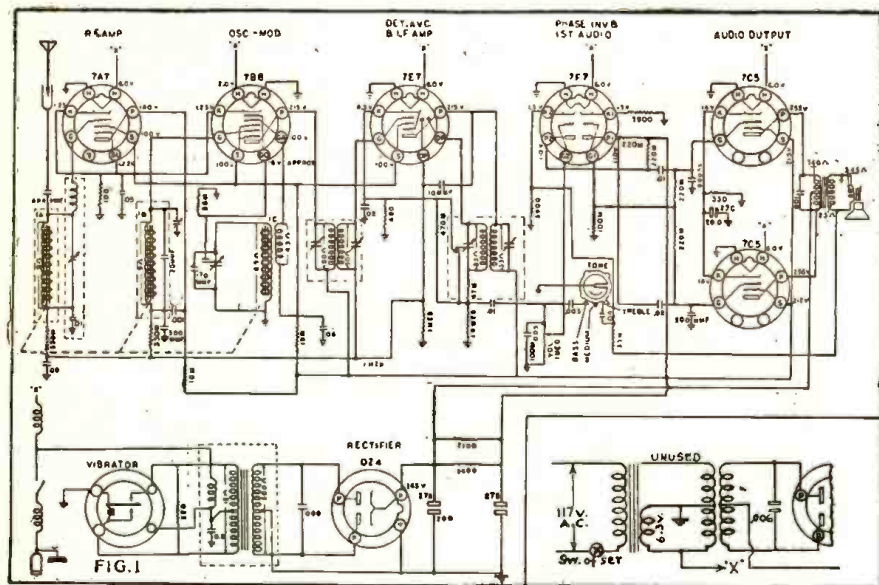

USING A POWER TRANSFORMER

A "true conversion" may be affected by installing a straight radio power transformer. This makes the set an ordinary A.C. radio, and it will be necessary to do considerable work if it is ever desired to use it as an auto radio again. It has the advantage that there are no parts "hung on" as in the former system.

To make this kind of a conversion, the first step is to secure a transformer of the type used in a broadcast receiver. The filament winding must be for 6.3-volt tubes, although if an old transformer with a 2.5-volt center-tapped winding is available, half this winding may be placed in series with the usual 5-volt rectifier winding to supply 6.25 volts—close enough for the job. (See Fig. 2.)

Note that the transformer secondary must be not much higher in voltage than the secondary of the vibrator transformer. This is especially true in sets using gas rectifiers like the OZ4, whose peak inverse voltage is low. If a 6X5, 6Z4 (84) or similar tube is used, the secondary voltage may be (Continued on page 490)

better machine than the small or old-fashioned receiver in his home. In other cases he would like to use it as a second home radio set. Many an experimentally-minded car-radio owner is now wondering: "Isn't there some way I can make my set work on the 117-volt line?"

There are several ways to convert an automobile radio to electric use. Each has its advantages and disadvantages. In selecting any one of them the set owner or serviceman will be guided by: The results he wishes to obtain; the amount of time or money he desires to invest; whether or not he may wish to re-convert the set to an auto radio again; and—chief point of all—by what auxiliary apparatus is at hand or is obtainable.

The greatest difficulty in converting a battery portable to electric operation (the problem of filament supply) does not exist in auto radios. Unlike the 1.4-volt tubes, which must have pure D.C. for their operation, the tubes in an auto set work well in A.C. The auto radio does present its own pet trouble—the speaker. Many of the newer sets use P.M. speakers, which are not affected by any change in the power supply. Practically all the older ones used a 6-volt field, which *must* be supplied with D.C. The only method applicable to most of these is to throw them away and install a P.M. unit, or an electrodynamic unit with a higher field resistance.

THE SIMPLEST SYSTEM

The easiest of all methods of converting an automobile radio is to attach across half the input winding of the vibrator transformer a source of 6 volts A.C. This can be supplied from a good 6.3-volt filament transformer. The only necessary precaution, as a rule, is to remove from the circuit the

circuit of this type "before" and "after."

A husky transformer will be required—one that will supply the rated amperage of the set being converted. This may run from four to eight amperes, or even higher. If you have a transformer with two 6.3-volt windings, or even one with a 6.3 and a 5-volt winding, the two may be hooked up in series and attached across the whole pri-

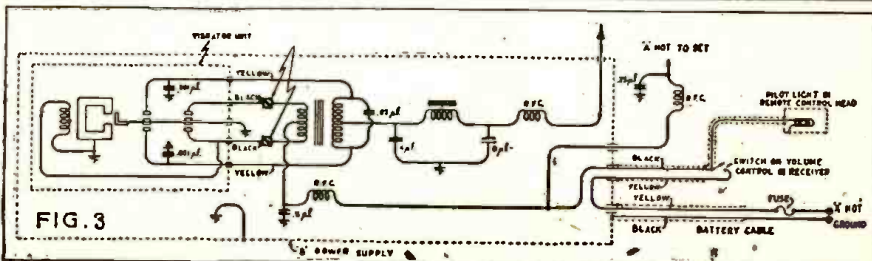
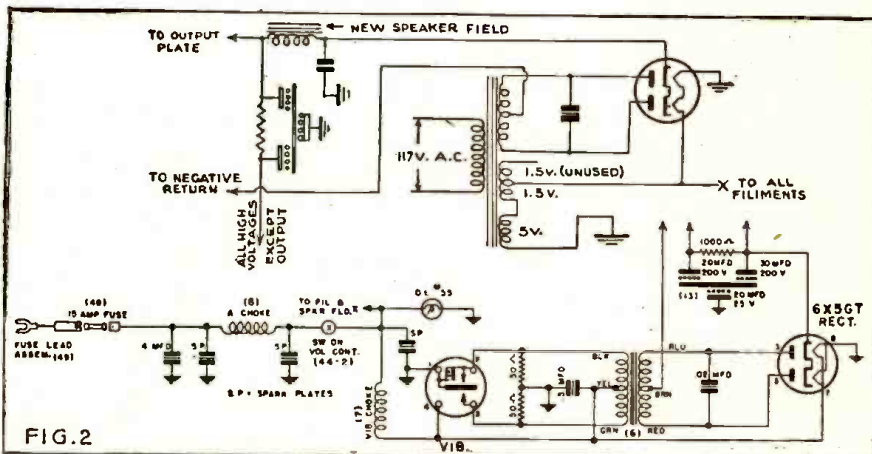

HOW TO SERVICE VOLUME CONTROLS

By J. BEEVER

MUCH has been said on the subject of servicing volume controls, most of it in a negative vein. A large number of attempts are continually being made to improve their performance by means of lead-penciling the elements. I agree with most of those who have expressed their opinions on this subject that these attempts are largely futile.

However I have gone into the matter with a little more thoroughness than is shown by most who have referred to this subject, the tendency being to brush the reader off with a simple remark to the effect that repairs are not possible. I intend to demonstrate that repairs are possible in ninety per cent of the cases encountered. In order to dispel the notion that this is a matter of hypothesis or "pure research," I should like to make it clear that the author is a practicing serviceman, owning and operating an establishment devoted almost entirely to the repair of radios.

TYPES

Volume controls may be roughly divided into two types, wire-wound and carbon element, of which the latter type is by far the most predominant in domestic sets. The wire-wound type found great popularity in the early days of receiver construction when control resistances ran to values between 6 ohms (filament rheostats) and 10,000 ohms (bias control resistors). Since about 1933, however, the practice has been largely to use signal attenuator types in the grid circuits of audio amplifiers or load resistances in diode A.V.C. circuits. These applications require very high resistances, varying from one-tenth megohm to two and one-half megohms. For this value, wire-wound types are impractical. For this reason I shall dispose of the wire wound type quickly and at once.

The wire wound type control consists of a flexible insulating strip wrapped with a resistive metallic conductor, such as nichrome or similar alloys, the entire strip bent into the arc of a circle described by the movement of the rotating contact arm. The arm is terminated by a slider contact, designed to tap off current from the resistive section.

The only service procedure possible with any lasting results is cleaning the contacting parts, namely the slider arm, wire element and arm bushing, which usually is the only means of connection between the slider arm and the center tap lug. Accumulations of greasy dust will cause leakages and bad contacts resulting in noisy operation.

However, the main cause of failure with these units is the wearing through of the wire wrapping. It is possible to repair this breakage by soldering a small strip of copper or brass foil across the open section, but this procedure is not advised except in a case of absolute necessity, since the wearing through of any section indicates that the whole strip must be badly worn and susceptible to subsequent break-through at other adjacent points. Suffice it to say that troubles

caused by anything other than dirt in this type of unit calls for replacement in preference to repair.

CARBON TYPE

To proceed to the more often encountered type of control, the carbon element type, a brief description is not amiss. This type is essentially the same as the wire-wound, except for the resistance element used which is usually composed of a circular strip of paper coated through about 300 degrees of its arc with a compound containing carbon or graphite as its conductive substance. This compound may be coated to various thicknesses in different portions of the arc in order to give the control "taper." Taper is a method of spreading, i.e., making more gradual, the progressive resistance of the control over that section of the arc of rotation which is most sensitive in its action in the circuit. The object is to prevent a critical point at which the volume may suddenly go from a high to a low level. These controls use various methods of mounting the sliding contacts or wipers to minimize friction with a view to extending the usable life of the carbon element. As a rule, the wiper is insulated from the rotating shaft and bushing, since the wiper is often the terminating point of a sensitive circuit which would be affected by body capacity through the knob. This is achieved by various methods depending on the manufacturer's design, usually by means of a slip ring and wiper contact on the contact shoe, which is mounted on a fiber section turned by means of the shaft and knob.

GENERAL PROCEDURE

In measures tending to correction of defective units a system of approach to the problem is used by the author. The first step is to determine the original resistance value of the element as recommended by the set manufacturer. Once this is done, disconnect the control from its associated circuits and measure the total resistance of the element. Compare the two figures thus obtained. If the present value of the resistance is 20% plus or minus that given by the manufacturer or less, service measures are in order. Should the discrepancy be greater, discard the control and replace with a new unit. A value 20% or more minus the specified resistance indicates a leakage of current through the insulating portions of the control. A value 20% plus the specified resistance indicates failure of the element. The author's observations have been that 90% of carbon element volume control failure is not due to failure of the element.

EFFECTS OF GREASE

It may be noticed in checking a set with noisy controls that the knob of the volume control may be pulled outward with considerable reduction in the crackling caused in the output by this type of trouble. This is a significant observation. If the carbon element were cracked or the arc burned, this could have no appreciable effect on its

conducting ability. *The real cause is usually accumulation of oxidized grease or oil on the slip ring of the wiper arm.*

At the time of assembly, the manufacturer usually coats the slip ring with a type of grease which inhibits oxidation of these brass or phosphor bronze contact areas. As a rule, this grease coating will maintain its original condition from one to two years. It eventually becomes hardened, and being a non-conductor finally causes the slip ring to make imperfect contact, giving evidence of itself by noise in the output of the set. The obvious remedy is removal of the offending substance. Controls may be quieted by the mere process of working them repeatedly through their arc of rotation while immersed in a grease solvent such as carbon tetrachloride or gasoline, but I do not recommend this procedure since it does not allow for thorough cleaning or replacement of the lubricant. The only real method of repair entails the disassembling of the control, which is not nearly so difficult as some repairmen seem to believe.

In taking apart, the first step is to remove the switch or dust cover as the case may be. Next it will be noted that the shaft is held in the bushing by a split retainer ring pressed into a groove in the shaft. This may be removed by clamping the control shaft in a bench vise leaving just enough of the shaft exposed to work on the washer. A small piece of sheet metal fairly stiff (the back of a hacksaw blade has been found useful), pressed against the open portion of the washer will push it back far enough for a pointed tool to be inserted in the gap exposed and the washer removed. The wiper arm and shaft will then push out through the mounting bushing.

Inspection of the slip ring, which will be found on the rear of the plate which carries the contact shoes or springs, will usually show a green waxy substance which will pick off easily with the fingernail. This is the original grease, the coloring coming from the metallic sulphides and oxides which the metal has formed with atmospheric acids and gases. The slip ring wiper will usually be found to be a horseshoe-shaped piece of metal which straddles the shaft of the control and usually has two raised portions which bear against the slip ring, the tension being obtained from the arch formed by a bend in the legs of the horseshoe-shaped portion.

Inspection of the element will show that it is polished where the contact shoe has rubbed it in its travels back and forth. This is natural and not harmful. Do not try to remove the shine. Inspect the contact shoe. This will show a polished area surrounded by an accumulation of dust from the carbon surface.

Immerse the disassembled sections in a grease solvent (carbon tetrachloride, gasoline, Energine, etc.), and clean thoroughly by brushing with a small soft paintbrush. A half inch brush will be found most eco-

(Continued on page 491)

PHILCO MODEL 42-345

Tuning Bands:

The tuning bands covered are: Broadcast band, 540 to 1720 kilocycles; Medium Range, (airplane, police) of 2.3 to 7 megacycles; and Short-Wave band, 9 to 15.5 megacycles.

Power Supply:

The standard set is equipped for 115 volts, 60 cycles A.C. By changing the transformer as indicated on the parts list, the set can be operated on 25-cycle current at 115 volts.

Audio Output:

An audio output of two watts is obtained.

Philco Tubes Used:

The tube complement is as follows—One XXL, converter; one XXL, oscillator; one 7B7, 1st I.F.; one 7B7, 2nd I.F.; one 7C6, 2nd detector, 1st audio and automatic volume control; one 7B5 audio output tube; and one 7Y4, rectifier.

Cabinet Dimensions:

Height, 10-11/16 inches; Width, 16 inches; Depth, 9 1/2 inches.

Circuit Description

Model 42-345, Code 121, is a seven (7) tube superheterodyne radio employing electric push-button tuning for automatically selecting standard broadcast stations and three (3) tuning bands covering Standard, Police, and Short-wave stations. In addition, this model employs the built-in Philco low impedance loop aerial, for reception of stations without an external aerial. Connections are also provided for an external aerial to be used in sections where signal strength is weak, such as steel reinforced buildings and other shielded areas.

The set uses Philco Loktal tubes throughout. Other features included are: XXI noise reducing converter tube; two-stage intermediate-frequency amplifier, (intermediate frequency 455 kilocycles); automatic volume control with delay action due to A.V.C. diode return being brought to the junction of the

220- and 68-ohm resistors in the negative end of the circuit, thus being kept at a negative voltage relative to the cathode. A separate A.V.C. lead is brought out to the second I.F. stage. The tone control is in the grid circuit of the audio output tube, and consists of a .003 condenser in series with a 500,000-ohm variable resistor. This circuit is less liable to burn-out than tone-control circuits in the plate. The single 7B5 audio output tube furnishes sufficient volume for ordinary home use, output being conservatively rated at two watts.

Electric Push-Button Tuning

Six (6) electric tuning push-buttons are provided for automatically selecting stations. Five (5) of the push-buttons are used from broadcast stations and one push-button for controlling (ON-OFF) the power supply. The procedure for adjusting the push-buttons will be found in the instructions supplied with the radio.

External Aerial Connections

The built-in low-impedance loop aerial system of these models is designed to operate without an outside aerial or ground, and to give exceptional receiving performance under average conditions.

To operate the radio, however, in steel reinforced buildings and other shielded loca-

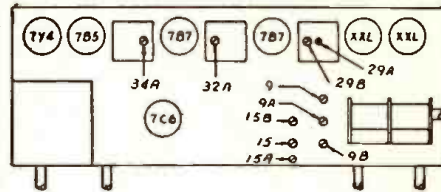

Fig. 2

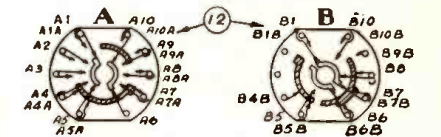

Fig. 3

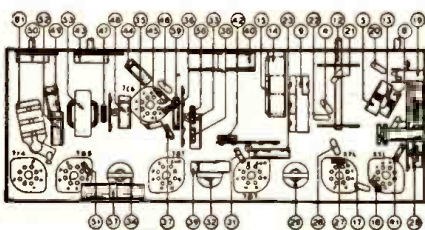

Fig. 1

tions, where signal strength is weak, the Philco outdoor aerial part No. 45-2817 is recommended for maximum receiving performance. The outdoor aerial can be easily connected to the radio by inserting the plug attached to the transformer (supplied with the aerial) into the socket provided at the rear of the radio. This aerial can be obtained from your local Philco distributor.

The Figures

An under-chassis view of the set, with numbers referring to the numbers shown on the schematic, is shown in Fig. 1. Top-chassis view, with tube positions and locations of trimmer condensers, appears in Fig. 2. Fig. 3 shows the switches, as viewed from the rear of the chassis, bottom view, in position No. 1 (pushbutton). The letters indicate the position of switch wafers from front of chassis, bottom view. Letter after lug number indicates lug for shaded rotor. The solid rotor is at the front of switch wafer; shaded rotor is at rear of wafer.

ALIGNING R. F. AND I. F. COMPENSATORS
EQUIPMENT REQUIRED

1. SIGNAL GENERATOR: Covering the frequency range of the receiver, such as Philco Model 070.
2. ALIGNING INDICATOR: Either a vacuum tube voltmeter or an audio output meter may be used as an aligning indicator. Philco Models 027 and 028 circuit testers contain both these meters.
3. TOOLS: Philco Fiber Screw Driver, Part No. 45-2610.

CONNECTING ALIGNING INSTRUMENTS

PROCEDURE—MODEL 42-345; 42-365

Operations in Order	SIGNAL GENERATOR		RECEIVER		Adjust Compensators in Order	Special Instructions
	Output Connections to Radio	Dial Setting	Dial Setting	Control Setting		
1	Aerial Section Tuning Condenser	455 KC	540 KC	Vol. Max. Band Switch "Brdest."	42-345 29A 29B 29A 32A 34A	42-365 29A 29B 32A 41A
2	Loop (See above Instructions)	1720 KC	1720 KC	"	15	6B Note A
3	"	1500 KC	1500 KC	"	9	13
4	"	580 KC	580 KC	"	9B	13A Roll Tuning Condenser Note B
5				Repeat Operation 2		
6	"	6.7 MC	6.7 MC	Band Switch "Police"	15A	6A
7	"	15.5 MC	15.5 MC	Band Switch S. W.	15B Osc. 9A Acr.	6 Osc. 4 Note C

In order to adjust the radio outside of the cabinet the dial scale should be removed from the cabinet and placed on the dial background plate. The dial scale can be held in position by clips or rubber bands. The loop aerial should also be placed in approximately the same position around or near the chassis as when assembled.

NOTE A.—Adjusting Dial Pointer: In order to adjust the receiver correctly, the dial must be aligned to track properly

with the tuning condenser. To do this, proceed as follows: Turn the tuning condenser to the maximum capacity position (plates fully meshed). With the condenser in this position, set the tuning pointer on the first mark below 540 KC.

NOTE B.—When adjusting the low frequency compensator (Broadcast) or the aerial padders of the high frequency tuning range; the receiver tuning condenser must be adjusted (rolled) as follows: First, tune the compensator for

maximum output, then vary the tuning condenser of the receiver for maximum output. Now turn the compensator slightly to the right or left and again vary the receiver tuning condenser for maximum output. This procedure of first setting the compensator and then varying the tuning condenser is continued until maximum output reading is obtained as read on the output meter.

NOTE C.—Turn tuning condenser until pointer is on 15.5 MC mark, then adjust oscillator compensator to maximum on the second signal peak from the tight position (compensator closed). The Short Wave Aerial padder should then be "rolled" to maximum on the 15 MC signal. See Note B.

Audio Output Meter: If this type of aligning meter is used, connect it to the voice coil terminals of the speaker or from the plate of the 35A5 tube to the chassis. Adjust the meter for the 0 to 10 volt scale.

Signal Generator: When adjusting the I. F. padders, the high side of the signal generator is connected through a .1 mfd. condenser to the antenna section of the tuning condenser. Connect the ground or low side of the generator to the chassis.

When aligning the R. F. padders a loop is made from a few turns of wire and connected to the signal generator output terminals; the signal generator is then placed close to the loop of the radio.

Radio Service Data Sheet

333

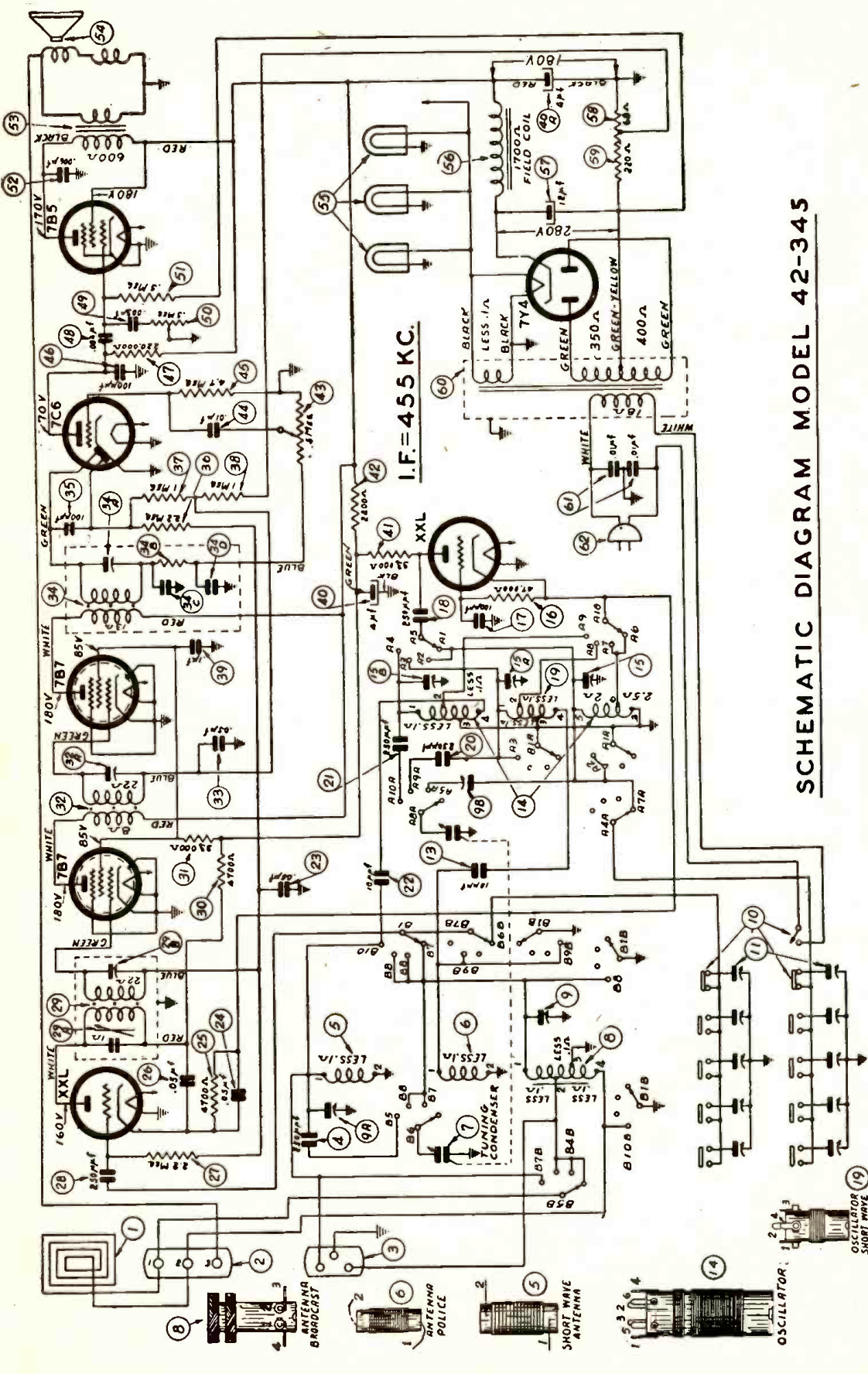

SCHEMATIC DIAGRAM MODEL 42-345

Sch. No.	Description	Sch. No.	Description	Sch. No.	Description
1	Loop Aerial Panel	25	Resistor (4700 ohms)	34D	Condenser (Part of 34A)
2	Antenna Board	26	Condenser (.05 mfd., 400 volts)	35	Mica Condenser (Part of 34A)
3	External Aerial Socket	27	Resistor (2.2 megohms)	36	Resistor (2.2 megohms)
4	Silver Mica Condenser (250 mmfd)	28	Mica Condenser (250 mmfd)	37	Resistor (1 megohm)
5	Aerial Transformer (S. W.)	29	Primary Compensator (Part of 29)	38	Resistor (1 megohm)
6	Antenna Polarity Switch	30	Secondary Compensator (Part of 29)	39	Condenser (.1 mfd., 400 volts)
7	Aerial Transformer (Broadcast)	31	2nd P. Transformer	40	Electrolytic Condenser (4-4 mfd., 400 volts)
8	Compensator (Aerial—Broadcast)	32	Secondary Compensator (Part of 29)	41	Electrolytic Condenser (4 mrd (Part of 40))
9	Compensator (Aerial—S. W.)	33	Resistor (33,000 ohms)	42	Resistor (33,000 ohms)
9A	Compensator (Aerial—S. W.)	34	2nd P. Transformer	43	Volume Control
9B	Oscillator Compensator (580 KC)	35	Resistor (33,000 ohms)	44	Condenser (.01 mfd., 400 volts)
10	Push-Buttons and Power Switch	36	Resistor (33,000 ohms)	45	Resistor (220 ohms)
11	Push-Button Compensating Condenser	37	Resistor (33,000 ohms)	46	Resistor (220 ohms)
12	Band Switch	38	Resistor (33,000 ohms)	47	Resistor (220 ohms)
		39	Resistor (33,000 ohms)	48	Resistor (220 ohms)
		40	Resistor (33,000 ohms)	49	Resistor (220 ohms)
		41	Resistor (33,000 ohms)	50	Resistor (220 ohms)
		42	Resistor (33,000 ohms)	51	Resistor (220 ohms)
		43	Resistor (33,000 ohms)	52	Resistor (220 ohms)
		44	Resistor (33,000 ohms)	53	Resistor (220 ohms)
		45	Resistor (33,000 ohms)	54	Resistor (220 ohms)
		46	Resistor (33,000 ohms)	55	Resistor (220 ohms)
		47	Resistor (33,000 ohms)	56	Resistor (220 ohms)
		48	Resistor (33,000 ohms)	57	Resistor (220 ohms)
		49	Resistor (33,000 ohms)	58	Resistor (220 ohms)
		50	Resistor (33,000 ohms)	59	Resistor (220 ohms)
		51	Resistor (33,000 ohms)	60	Resistor (220 ohms)
		52	Resistor (33,000 ohms)	61	Resistor (220 ohms)
		53	Resistor (33,000 ohms)	62	Resistor (220 ohms)
		54	Resistor (33,000 ohms)		
		55	Resistor (33,000 ohms)		
		56	Resistor (33,000 ohms)		
		57	Resistor (33,000 ohms)		
		58	Resistor (33,000 ohms)		
		59	Resistor (33,000 ohms)		
		60	Resistor (33,000 ohms)		
		61	Resistor (33,000 ohms)		
		62	Resistor (33,000 ohms)		

SERVICING NOTES

Trouble in

. . . . ZENITH AUTO RADIO MODEL 6M192

If you have vibrator hash do the following: Bond the shield cans on the r-f oscillator-detector coils by soldering together and make a good bond to the chassis. Also be sure to solder all ground lugs held by rivets. This applies to other models with coil shield mounted in a like manner.

C. A. VAUGHN,
Los Angeles, Calif.

. . . . PHILCO MODEL 37-38

When this model has a large amount of background noise and oscillation, the trouble can be eliminated by connecting a .05 mfd. condenser from the screen supply of the 1C7G and 1D5G tubes to ground.

FRANK V. VOSEJPKA,
Lonsdale, Minn.

. . . . TRUETONE MODEL D-720

Complaint of no reception can usually be traced to a defective plate resistor of the 75. This unit should be replaced with a 1-watt wirewound resistor. This will insure the part with longer life.

HARRY WILLIAMS,
Sandusky, Ohio.

. . . . STEWART-WARNER MODEL 1925

These sets develop a scratchy noise like static but lower in intensity. Voltages appear normal but by measuring the resistance of the primary of the intermediate transformers with a low-range ohmmeter a high resistance coupling is noted. Replace defective transformer and align it. This is a sure cure for the trouble. This would also apply to other sets.

DELBERT SHAFFNER,
Deepwater, Mo.

. . . . PHILCO MODEL 215 (1942)

This 4-tube battery receiver had poor sensitivity and selectivity, with local stations spreading. Complete alignment failed to correct this.

Placing a 65-350-mmfd. padder condenser across the untuned primary of the second I.F. transformer and adjusting for maximum was found to solve the selectivity problem and also greatly increased the sensitivity.

REGINALD COX,
Hoyt Station, N.B.

. . . . MIDGET SETS

To get added audio signal in most midget sets, try bypassing the power amplifier cathode resistor with a high-capacity, low voltage condenser. A 25-mfd., 25-volt unit will be about right in most instances. In production, this type of receiver seldom has a bypass condenser, due to economic or physical reasons.

W. J. WALNER,
Binghamton, N. Y.

(The idea is good, but more of these midgets have cathode condensers on the audio stage than the writer thinks.—Editor)

. . . . AIRLINE 93WG—1000

Oscillation after set warms up. Tighten coil shields, change 17,000-ohm (R2) decoupling resistor.

HENRY D. MORSE,
Homer, N. Y.

. . . . WESTINGHOUSE 53

Distorted because of opening of 0.1 mfd. condenser to cathode of 2A5. It also became dead when 0.1 mfd. condenser to 57 cathode opened intermittently.

Better to replace both these condensers on any complaint of distortion and intermittent.

WALTER J. SMITH,
Port Colborne, Ont.

. . . . VICTOR 98K

Intermittent. Three condensers attached to volume control intermittently open.

WALTER J. SMITH,
Port Colborne, Ont.

ATTENTION SERVICEMEN!

Do you have any Servicing Notes available which you would like to bring to the attention of the readers of *Radio-Craft*? If so, send them along and if they are published a one year's subscription to *Radio-Craft* will be awarded you.

. . . . VICTOR 86T

Loud rattling becoming worse when volume control turned lower. The 0.25-mfd. condenser between lower end of volume control and 6F5 cathode intermittently open.

WALTER J. SMITH,
Port Colborne, Ont.

. . . . FADA 252 AND OTHERS

It is almost impossible to get 6SS7 tubes as used in the Fada 252 model. This set uses a 50L6 output tube.

Replace the two 6SS7's with 12SK7's and change 50L6 for 35L6. This leaves filament voltages correct and needs no circuit change.

J. BEEVER,
West Brownsville, Pa.

. . . . WESTINGHOUSE W-99

Set dead. Grounded end of volume control open. This leaves negative leads of filter condensers ungrounded, putting cathodes and plates at the same voltage.

Scarcity of parts warrants disassembling volume control and unwinding a couple of turns of resistance wire at open end and resoldering.

WALTER J. SMITH,
Port Colborne, Ont.

. . . . RCA AND GE 1938 AND 1939 RECEIVERS

It has come to my attention that cutouts in RCA and GE receivers of '39 and '40 vintage is usually due to intermittent operation of bypass condensers which are connected by short leads. Almost invariably, the small pancake of wire which is soldered to the ends of the condenser foils is pulled loose—inside the sealing compound. This seems to be caused by contraction and ex-

pansion of the condenser due to chassis heat, the short leads allowing no room for expansion.

In cutouts in the receivers, move all condensers with short, tight leads, and the trouble will usually soon become apparent. It might be wise to mount all pigtail condensers with a little bend in the lead to allow for this expansion and contraction.

J. BEEVER,
West Brownsville, Pa.

. . . . CROSSLEY MODEL 117

Distorts after being in operation about 2 minutes—more pronounced at fairly high volume.

Try a new 6K5-G first audio tube. The tube tester probably will not indicate a defect.

FRANK O. MILLER,
Hillsboro, Ohio.

. . . . PHILCO MODEL PT-25, PT-26

and others having the line dropping resistor riveted to chassis: Hum modulation on all stations. Sounds similar to defective input filter condenser.

Check for leakage between line resistor and chassis.

FRANK O. MILLER,
Hillsboro, Ohio.

. . . . ALL SETS USING 35Z5 RECTIFIER

Static-like noises on strong signals or when chassis is tapped.

Try a new 35Z5 or pilot lamp.

FRANK O. MILLER,
Hillsboro, Ohio.

. . . . PHILCO MYSTERY CONTROL

The complaint was lack of reception at times when using Mystery Control; also, the Mystery Control would select the wrong station.

The complaint sounded complicated but the cure is very simple. Remove the cover from the Mystery Control relays located on top of the chassis. Inside are located 2 relays. One is a holding relay and the other a quick-release relay. (You can identify the holding relay by the copper slug on one end.) This relay has a small adjusting screw and a locking nut located in the top of the armature. Loosen the locking nut and turn the screw in about ¼-turn. Tighten locking nut. Turn set on and check operation.

This holding relay in this case did not release at all at times thus keeping the automatic silencing switch closed. Due to holding too long it also upset operation of the station selector switch.

R. B. OLSON,
Rockford, Ill.

. . . . WILCOX-GAY 6T11

Due to the high surge voltage encountered, the 1st filter condenser usually shorts or the electrolyte decomposes and capacity drops to a low level. Replacing the original with the recommended 8 mf. 450 V. unit does not help as the trouble only appears again.

Probably the best and most economical repair is to connect two 16 mf., 450 V. elec-

(Continued on page 492)

FIX ANY RADIO

Amazing New Invention

**Simplified
Radio
Servicing
by
Comparison
Method**

Learn radio by a simplified method. Repair radios in minutes instead of hours. Revolutionary, different Comparison technique permits you to do expert work almost immediately. Most repairs can be made without test equipment. Simple point-to-point, cross-reference, circuit suggestions locate faults quickly and easily.

COMPLETE
\$1.50
ONLY
SPECIAL OFFER
READ THE DETAILS

FOR BEGINNERS OR EXPERTS

Understand radio principles; find any radio fault with ease. Follow the comparison tests given on 16 large trouble-shooting blueprints. Over 1,000 practical repair hints. Hundreds of simplified tests using a 5¢ resistor and a filter condenser. Covers every radio set—new and old. Introductory material for beginners and to serve as a review for experienced radio men. Also several chapters on test equipment. Presented in manual form, 112 fact pages 8½ x 11 inches. Entire plan is stark new and will help you get ahead in radio quickly.



Developed by
M. N. Beitman,
radio engineer,
teacher, author,
& serviceman.

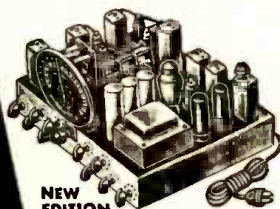

NEW EDITION
**REPAIR ANY
RADIO IN MINUTES**

Learn how to localize the trouble without any equipment. Make tests, measure voltage, trace the signal with a resistor, small condenser, and a crystal detector. Inject signals without any signal generator. Test parts by the new Comparison method. Test tubes without equipment. Repair any radio expertly following illustrated, simplified plans. Improve your radio servicing ability. Examine the plan without obligations—without risk. Send coupon.



PRACTICAL USEFUL FACTS AND HINTS

Hundreds of service hints, trouble-shooting ideas, simplified tests, repair suggestions, and alignment methods are included. Benefit by the experience of others. Use the most practical method for finding the fault and making the repair. Save time on every job.

FIX MOST SETS WITHOUT TESTERS

Follow the COMPARISON technique and repair 4 out of 5 sets without equipment. Speed up your work; locate faults quickly; make repairs efficiently. Be fair with yourself and try this new plan without obligation. Take advantage of our "no-risk" trial. Send coupon today. Use this time-saving, money-making radio servicing training for 10 days without any obligations. See how quickly you will learn helpful methods. Save time every day on every radio job. Learn new short-cuts in radio servicing. Get ahead in Radio. Repair sets for fun and profit. Prepare for higher rank and better pay in the Army. Act today.



MONEY-BACK GUARANTEE

You must be entirely satisfied or your money will be refunded without a question. The training will more than pay for itself on the first radio job or with higher rank in the Army. Examine and use this unique plan for 10 days at our risk. Send coupon right now—use the plan this week.

"NO RISK" TRIAL ORDER COUPON

SUPREME PUBLICATIONS, 328 S. Jefferson St., Chicago, Ill.

Ship my copy of the complete Simplified Radio Servicing by COMPARISON Method manual. I must be entirely satisfied or you will refund my total remittance.

- I am enclosing \$1.50, full price. Send postpaid.
- Send C. O. D. I will pay the mailman \$1.50 and a few Cents Postage.
- Also send other Supreme Publications books as listed in letter.

NAME

ADDRESS

(Use Coupon or Send Order in a Letter)

Other Practical Radio Manuals

How to MODERNIZE RADIOS for Profit



Cash in by improving audio circuits, modernizing cabinets, adding features usually found on late model sets. Practical job-sheets with schematics and photographs make the work easy. You are told how to obtain modernization work, what to charge, and how to complete the job quickly and efficiently. Large size, 8½x11 in. manual is priced at only **\$1.00**

MOST-OFTEN-NEEDED RADIO DIAGRAMS



The most popular radio diagrams available in low priced manuals. Large size: 8½ x 11 inches.
1942 Manual, Volume 5, 204 pages.... **\$2.00**
1941 Manual, Volume 4, 192 pages.... **each NET**
1940 Manual, Volume 3, 208 pages.... **\$2.50**
1939 Manual, Volume 2, 192 pages....
1926-38 Manual, Volume 1, 244 pages, alignment, hints, parts lists.....

PRACTICAL RADIO MATHEMATICS



Introduces and explains the use of arithmetic and elementary algebra in connection with units, color code, meter scales, Ohm's Law, alternating currents, ohmmeter testing, wattage rating, series and parallel connections, capacity, inductance, mixed circuits, vacuum tubes, curves, the decibel, etc., etc., and has numerous examples. Net..... **25c**

SEE YOUR RADIO JOBBER OR SEND COUPON

Supreme Publications

PUBLISHERS OF RADIO BOOKS, MANUALS, AND DIAGRAMS

328 South Jefferson Street

Chicago, Illinois

PRACTICAL AUDIO AMPLIFIER THEORY

By TED POWELL

PART IV

THE simple tone-corrector circuit across the 6L6 plates is a bit antiquated, but was used because it was found that inverse-feedback would be of little value in this amplifier since it is Class A, and has few wave-form effects to correct.

A tone-control of this type can be used not only to correct for frequency response of recordings and amplifier components, but also to flatten out the peaked response characteristics.

Capacitance was varied, rather than resistance, since amplifier tube theory calls for a shunt resistance value of about 1.3 times the plate load impedance in series with a suitable capacitance in order to obtain the optimum response.

The range of capacitances will depend upon the frequency characteristics of the various components, and the selection of any particular capacitance by means of the switch depends upon the characteristics of the recording and the acoustics of the amplifier location. If an inverse feedback loop is employed, this tone-control circuit must be omitted, and one must be set up somewhere further back in the amplifier. This must be done in order that the tone control will not interfere with the proper operation of the feedback loop by feeding back a signal with some high-frequency cut-off.

INVERSE FEEDBACK

Some readers might wonder at the absence of a feedback loop in this amplifier. To use a simple analogy, it is almost like taking a massive dose of sulfathiazol to cure a touch of indigestion and indisposition. In fact, when inverse feedback was tried out and increased considerably, only a lowering of gain and a sort of tone-control effect (with a slightly "phony" quality), was noted.

One explanation for this apparent failure of inverse feedback lies in the fact that great care must be exercised in choosing the type of feedback loop and the constants of the components of the network. Under certain conditions where amplifier circuits develop little distortion (and if a tap-off signal is fed back from a circuit with strong non-linear phase-shift vs. frequency characteristic), more total phase-shift and wave-form distortion can be generated over certain frequency ranges, than without the use of feedback. Furthermore, sum-and-difference frequency distortion (intermodulation or cross-modulation distortion as it is sometimes called, especially the odd-order type), presents some complexities whose results must be rather difficult to predict theoretically. At any rate, after considerable trials and careful listening tests, reverse feedback was discarded as being worthless in this amplifier.

It has always been the writer's opinion that many radio men, like some aircraft men, have gone overboard in their estimation of the value and of the results of this circuiting innovation. It has its place and its value, but also it has its limitations, and

is no magic cure-all for the poor performance of cheap amplifier components.

However, if any reader wishes to experiment with a feedback loop, he might try several types with various resistor-condenser combinations. An advisable choice would be the one employing a loop tying in the voice-coil winding and the input circuits to the driver stage. This will tend to reduce speaker cone transients under sudden changes of signal amplitude as well as some types of audio distortion and power supply hum, if any.

Mr. Powell discusses tone-control and inverse feedback in this installment. Some interesting speculations on ideal output transformers are included. (A schematic of the amplifier discussed was printed in both the February and March issues.)

The coupling condensers may be of any value (about 0.003-mfd. and up) and the resistors will have to be rather low, (perhaps less than 10,000 ohms) since the amplifier gain is very low and should preferably be in the form of a high-grade twin potentiometer so that the amount of feedback can be varied gradually for optimum results.

Generally speaking, the condensers control the range of frequencies fed back and hence the frequency characteristics of the net result. The resistors control the amount of feedback and thus the degree of the frequency characteristics changes due to the feedback.

Of course, the circuit reactions are not as simple as all this. The two circuit components have a time constant which enters into design considerations. To design a feedback loop in order to achieve optimum fidelity for any given set of amplifier conditions, requires an elaborate series of compromises and an array of calculations involving the consideration of the band-width to be passed, the amount of phase shift correction to be made, the frequency characteristics of the original amplifier circuit, the time constant of the grid coupling circuit at the receiving end of the feedback loop, the amplification of the amplifier stages involved before and after feedback has been introduced, stray shunt capacitances and their time constants, plate load resistances of the stages involved, the time constant of the feedback loop itself, etc. This usually must be undergone for both the lower and higher frequency ranges, and by assuming certain conditions and making certain permissible approximations, the calculations can be made reasonably capable of solution. However, trial-and-error methods with subsequent cathode-ray and sine-

wave or square-wave checks (or inter-modulation checks) are more practical, less laborious and much more dependable, than calculation methods.

OUTPUT TRANSFORMER

The choice of the output transformer (as in the case of the mike or pick-up or speaker) will to a large extent determine the quality of an audio system's performance. A cheap unit inserted here will nullify any advantages the circuit may possess. The output transformer is by far the weakest link in an amplifier circuit where frequency response is concerned.

A good lab type unit may have a response curve flat from about 80 to 8,000 cycles, flat within ½ DB from about 30 to 15,000 cycles, and flat within 1 DB from about 15 to 20,000 cycles. Special custom-built units can be obtained at a cost of from \$20 to \$30, with a response flat from 15 to over 20,000 cycles within ½ DB.

Lab standard units are made with special self-shielded, torroidal-type, sectional, inter-leaved windings which have low leakage reactance (which have a choke effect upon the high frequencies) and low shunt and distributed capacitances (which have a by-pass effect upon the higher frequencies). The leakage reactance and stray capacitances are counter-balanced against each other (resonated) by careful design and workmanship of coil and core size and shape, so that an extended and flattened frequency response is obtained. A good audio transformer represents perhaps one of the most difficult and complex design problems encountered in radio work, and is the result of many calculations, compromises, and construction of trial-and-error models.

Oddly enough, even the costliest lab type output transformers have silicon steel cores. The explanation given by manufacturer's pamphlets is that since the output transformer is a power device, it must dissipate appreciable power in its windings and core, and its core must be able to withstand considerable flux densities. (Highly sensitive super-permeable alloys would be ruined under such operating conditions.) Furthermore, the extra costs involved in the use of any such alloys would not be justified by the results that might be obtained.

Such a statement may be open to some question. If a magnetically stable alloy (intermediate in its characteristics between silicon steel and hipernic) could be developed, it would make possible a much smaller-cored transformer. This would mean smaller windings, and therefore smaller leakage reactance and shunt capacitances, and a more extended frequency response. Such transformers would be of considerable value in FM work and would be well worth the extra costs. An audio transformer with a frequency range covering the whole audio range within ½ DB would be brought within the realm of possibility.

(Continued on page 506)

RADIO'S NEW VOICE — THE SONOVOX

THE strange spoken and sung words that have invaded the radio programs in the form of commercial announcements by means of the fog horn, a singing guitar quartet and a number of other devices, previously not known to be able to produce intelligible words, are produced by novel acoustical apparatus, the details of which should be interesting to the radio craftsman.

The sounds are produced by means of the *Sonovox*, a device which is capable of superimposing words on any type of sound. Originally used in motion pictures—principally in Walt Disney films—this new advertising means has invaded the radio to such an extent that the innocent listener wonders what to expect next.

The invention of Gilbert M. Wright, a former physics instructor, and more recently a motion-picture playwright and short story writer, this device is said to be capable of translating a motion-picture film from one language into another.

DISCOVERED WHILE SHAVING

The story told about this invention is that Mr. Wright conceived the idea while he was shaving with his electric razor. When he opened his mouth the sound of the razor's vibrations seemed to come out of it. He rushed out and bought a tuning fork, struck the tines and held the base of the fork to his throat. Voicing a silent "Hello," the sound "Hello" in the "A" of the tuning fork emanated from his mouth—faintly, but it was there. An amplifier, he thought, might do the trick. Realizing that the word-forming movements of the mouth could be superimposed on any external sound, Mr. Wright set about developing his device.

The radio experimenter will recognize the analogy of amplitude modulation broadcasting applied to this principle. The generated sound is the carrier wave and the resonant cavity of the mouth is the modulator which controls the amplitude of the carrier.

The apparatus used is so reminiscent of the dynamic loudspeaker that there is little doubt in the mind of the radioman that the original *Sonovox* was, indeed, an ordinary dynamic speaker revamped a little for the work.

HOW IT WORKS

As will be seen in Fig. 1, the *Sonovox* unit—one of which is used on each side of the throat—looks somewhat like an overgrown headphone unit. It is in fact a small pot magnet, such as is used in many a P.M. speaker. Parts marked 1, 2, 3 and 4 are the center pole, the outside shell and the top and bottom yokes respectively. The paper or fibre voice-coil form—called the armature in this device—is shown at 5, and carries the voice coil at 7, with leads going out through grommets 8 and 9.

Here is where the *Sonovox* unit begins to depart from the standard pattern of a loudspeaker. There is no diaphragm or cone. Instead, a piece of cork or other light material is cemented in the open end of the

words silently with his lips, tongue and palate, the whistle or saw will seem to speak realistically.

Some strange and unusual effects can be produced. The human voice, as generated by the passage of air through the larynx, is restricted in pitch. It ranges from about 80 cycles (deepest bass), to 1,200 cycles in a high soprano. The *Sonovox* makes spoken language possible over a range from about 20 to 6,000 cycles. The effect of the "inhuman voice," speaking good English, often approaches the eerie.

An interesting point is that the natural voice of the Articulator—as the operator of the device is called—has no effect on the emitted sound. A woman can articulate parts at 20 cycles per second, and a man using the *Sonovox* can articulate in English a record in French by Lily Pons, achieving a translation in her own natural soprano voice.

This opens up a field for a special method of translating moving pictures. We may in the future be able to present our Hollywood actors and actresses speaking a multitude of foreign languages in their own natural voices. Much would depend on the skill of the articulators. They must be specially trained, as well as have an innate sense of timing and rhythm. Already a new profession has sprung up, and the American Federation of Radio Artists has classified the Articulator in the same category as a radio actor.



Broadcasting with the *Sonovox*. The attractive young lady at the right is the "Articulator."

voice-coil form, as shown at 6. A piece of sponge rubber, 10, is placed between the cork and the end of the central magnet pole.

The two units are connected to the output of a good amplifier, which can be fed with a steady tone, such as that of a fog-horn, whistle, etc., or may be supplied with ordinary music.

The operator of the instrument places the units against his throat, as shown in the photograph. The vibration of the two cork pistons actually makes the skin of his throat a diaphragm, and the inside of his throat an acoustic chamber. If the operator molds

USES OF THE SONOVOX

The uses of the *Sonovox* in entertainment are many and varied. Every week sees a new program making use of the instrument for advertising purposes or to create unique sound effects. It has been used several times in moving pictures. Disney's *Reluctant Dragon* included not only *Sonovox* effects, but a demonstration of the device by Robert Benchley, who showed how to make a train speak.

Another use, on which Mr. Wright is now working, may be to restore speech to certain types of mutes. Persons who cannot speak due to injuries to or defects in the larynx or vocal cords, may now be supplied with an artificial voice.

Those who have lost their voice will be able to speak immediately with the help of the *Sonovox*. Those who have never spoken will of course require a course of training. With the help of the oscilloscope to show them the proper sound forms, this is a comparatively simple matter.

Already the *Sonovox* has been demonstrated over the air by a mute who spoke and sang with the help of the instrument.

Thus the electron tube—which has made such strides in reducing the handicap of deafness—may extend its aid to another class of handicapped, giving a voice to the dumb tongue as well as language to the deaf ear.

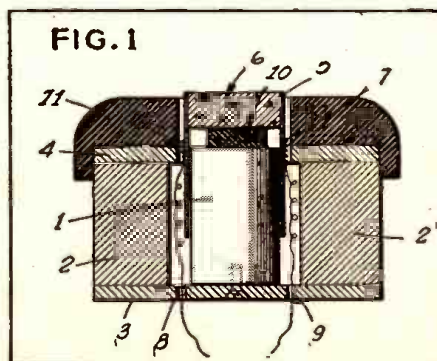

HEARING AID PROBLEMS— A BIOLOGICAL APPROACH

MASS-PRODUCTION of hearing aids—unlike the production of ordinary amplifiers—is not purely a question of apparatus and design. The user must be considered to a much greater extent than in other forms of audio equipment. The delicacy and complexity of his hearing organs—which render them liable to derangements of various kinds—set definite limits on the mass distribution of devices to help the hard of hearing. It is the intention of this article to indicate briefly the main fields of utility for aids to hearing.

THE HUMAN SOUND RECEIVER

The auditory apparatus comprises four main parts, schematically shown in Fig. 1.

(1) The outer ear, collecting and directing the compression waves of sound on to the ear-drum, a membrane sensibly aperiodic over the frequency spectrum of hearing.

(2) The middle ear, comprising an air-filled chamber with a chain of tiny bones or ossicles, which transfer the vibrations of the ear-drum to a further membrane on the inner side. The mechanical layout of the ossicles is such as to be optimal for transforming vibrations in air at the ear-drum to vibrations in fluid at the inner side of the inner membrane. To compensate for changes in air pressure, due to temperature or height, the middle ear cavity is provided with a release passage known as the Eustachian tube.

(3) The inner ear, which is filled with fluid, has suspended in it a relatively long and narrow membrane made up of parallel fibres arranged transversely to the long axis of the membrane. The generally accepted theory of hearing compares this so-called basilar membrane to a miniature harp, or series of piano strings; the transverse fibres are graded from one end to the other both in length and tension, and, although very minute in comparison with harp strings, are immersed in fluid, which greatly lowers their natural frequency of vibration. Each one (or each adjacent few, for they are not quite individually free to move) may be set into mechanical resonance by a note of the appropriate frequency being applied to the outer ear. The selective resonance effect of these tuned fibres is very sharp, and where the sound heard is a complex one we must assume that the fibres

corresponding to the sinusoidal components of the complex sound are in simultaneous resonance, although they may be separated by an intervening inactive portion of the basilar membrane. Microscopic and experimental evidence is in general agreement with the above conception.

(4) So far, the auditory apparatus consists of mechanical devices for translating and analyzing sound waves into physical movement, represented for each component tone by the resonant vibration of the appropriate basilar membrane fibres. This fibre movement stimulates the connection of the auditory nerve which corresponds to the fibre; speaking broadly, each membrane fibre has its own insulated strand in the nerve, which collects the strands into a cable and passes them on into the brain. In the brain the auditory pathway is extremely involved, with several relay stations before the nerve impulses are recorded in the conscious part of the brain. It is important to realize for electro-acoustic work that the impulses in the auditory nerve are not electrical replicas of the sound waves applied; the general belief now is that the mechanism is not to be compared to a microphone (which transforms sound waves into electrical energy of similar form), but rather to a multiple indicator in which movement of one of the components closes an electrical circuit attached to that component only.

CAUSES OF DEAFNESS

The possible sites of damage causing deafness may be considered from the above explanation and diagram. Conduction of sound may be impaired in the outer ear by blockage or perforation of the ear-drum; in the middle ear by stiffening of the joints of the ossicles, by pressure developing through obstruction to the release tube, by inflammation and swelling of the soft lining of the middle ear cavity, or, not uncommonly, by loss of movement at the inner membrane of the inner ear.

In such conditions localized to the outer or middle ear, the analytical powers of the inner ear and their registration in consciousness remain unimpaired; and although the normal path of vibration conduction is not available, the use of bone-conduction, whereby the skull bones transmit the vibrations directly to the inner ear, is still possible, though less efficient. This provides the hearing-aid designer with the problem of producing an output device which will work when tightly applied to the bones of the skull.

Damage to the inner ear may be local or widespread. Portions of the basilar membrane may degenerate if subjected to continual strong stimulation of restrict-

ed frequency, as occurs in some of the noisy occupations such as boiler-making. In many cases of congenital deafness the inner ear is partially or wholly absent. Accidental damage may injure the inner ear, and a number of pathological processes cause its progressive deterioration in whole or in part. In the case of defects in the basilar membrane, the hearing-aid problem is quite different, for in such instances the resonant machinery is destroyed, and no amount of amplification conducted either through air or bone, can produce the sensation of the missing tones in the absence of the mechanical transformer. Damage to the auditory pathway may occur in the course of the auditory nerve, in the relay centres of the brain, or in the conscious part of the brain itself. On account of the inaccessibility of the auditory apparatus as a whole, and its complexity, the tracking down of the cause producing the damage in any of these

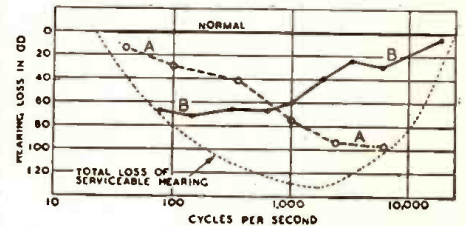

Fig. 2. Curves A and B show frequency characteristics of two forms of deafness.

portions is a matter of the most refined diagnosis and long experience.

FREQUENCY RESPONSE

The range of frequencies to which the human ear responds is—for young and healthy persons—roughly from 20 to 20,000 cycles per second. The sensitivity to weak sounds varies greatly with frequency, being at a maximum in the region of 2,000 cycles per second.

No noticeable loss in intelligibility results if hearing-aid devices are designed to cut off all frequencies above 8,000 and below 250 cycles. Reduction of the upper cut-off below about 4,000 cycles results in serious loss of clarity in the sibilants, whose waveform contains a large proportion of high harmonics.

At the lower end of the scale a different situation exists. If the ear is supplied with harmonics in sufficient volume, it is able to reconstruct the bass fundamental to a remarkable degree, even though that fundamental itself be completely filtered out. This is due to a kind rectification effect in the ear-drum, and is widely taken advantage of in telephone design.

This is a very valuable phenomenon from the hearing-aid point of view, in that the majority of aids can take advantage of reduced size and weight implied by limiting the lower frequency reproduction to 200 c/s.

Investigation of the frequency spectra of various forms of deafness can be done with precision with various types of audiometer. Elaborate precautions have to be taken in

(Continued on page 508)

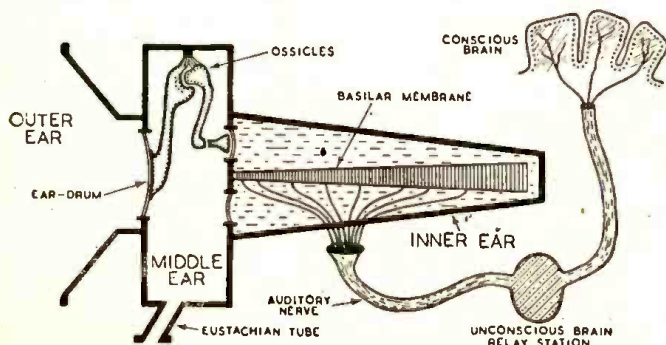

Fig. 1. The mechanism of the outer, middle and inner ear.

R. F. CARRIER COMMUNICATIONS

By WERNER MULLER

PART II

PERHAPS the simplest form of carrier system of fair merit is a circuit that was originated in 1936. Its popularity was well deserved since it performed well in its initial applications. It was a 4-tube circuit where one tube had two functions. It acted as a detector, in one position, while in another position it performed as an oscillator. The circuit is shown in Figure 1.

As can be seen the circuit is simple in design as well as in operation. It is adapted for A.C. or D.C. use. In operation the unit will perform excellently on A.C. lines while in D.C. lines it is somewhat erratic in performance. The reason for this has been explained in Article 1. The R.F. output power is about 1 watt. This limit in power is due to the low plate voltages available from the rectifier. Since the unit is designed to operate on A.C. or D.C. and derives its power therefrom, the maximum D.C. is about 112 volts. The design incorporates several features, that are omitted at times, namely a low frequency cutoff and a hash filter. The low frequency cutoff filter is a desirable feature. Since the D.C. power is supplied from a half wave rectifier circuit and a high efficiency filter is costly for this type of unit, the addition of the low frequency cutoff prevents the usual 120 cycle ripple to be noticed. Another factor when A.C. line operation is used is the fact that the 60 cycle line frequency modulates the transmitted R.F. carrier and thus rides through when speech is reproduced from the loudspeaker.

The hash filter is also essential since in most A.C.-D.C. types of power supply the rectifier tubes generate or tend to generate sporadic or constant noises that are readily transmitted through the supply if no precautions are taken to squelch these disturbances.

Other design features of importance are the isolation of the chassis from the power lines and the tuning and line capacitor.

The tuning capacitor should be of the best grade obtainable. If the capacitor is designed to operate in a circuit rated for 500 V.D.C. it should be changed to 1000 volt D.C. operation. Standard trimmer capacitors can be used, provided the insulation between plates is increased. The following observations have established these facts:

In ordinary operation it was found that moisture and the high R.F. produced in the circuit caused these capacitors to arc or short circuit. The only salvation for this trouble was double spacing of the mica insulation in the capacitor. The spring tension holding the plates together is also important since any shifting of these plates will cause a change in the tuned circuit causing a shift in frequency. The output coil is a series tuned affair that is tuned to maximum R.F. output into a 20-ohm resistive load.

The unit operates around 100 Kc. It will transmit under ideal conditions through as many as 24 stories in one building. On telephone lines it will operate up to 15 miles. Provision to attach the unit to external transmitting media terminals has been pro-

vided to break the feeder to the power line. By doing this the output is available for other types of feeding.

The adjustment of the transmitter can be accomplished by placing a small 150 Milliamp lamp across the output circuit and then adjusting the trimmer condensers for maximum light output, or two units can be placed alongside each other; one in receiving and the other in transmitting position. Keep the volume level of the receiving station below the point of feedback. Then turn the trimmer condenser at the transmitter slowly till an increase or decrease in feedback tells when proper adjustment has been obtained, the best point of course being at the time of maximum feedback.

The unit also incorporates a call signal for calling the remote station if it is desired to do so.

The parts list follows:

Parts List

CONDENSERS

- C1, C2, C3—depend on operating frequency
- C4—0.01 mfd. mica
- C5—0.005 mfd. mica
- C6, C16—0.002 mfd. mica or paper
- C7, C10—0.002 mfd. mica
- C8, C9, C14—0.1 mfd. paper
- C11—20 mfd., 25-volt electrolytic
- C12, C13, C15—0.001 mfd. mica or paper
- C17—10 mfd., 300-volt electrolytic
- C18—30 mfd., 300-volt electrolytic

RESISTORS

- R1—10,000 ohms, 1 watt
- R2—50,000-ohm volume control
- R3—10 megohms, 1/2 watt
- R4—5 megohms, 1/2 watt
- R5—1 megohm, 1/2 watt
- R6—250,000 ohms, 1/2 watt
- R7—500,000 ohms, 1/2 watt
- R8—500 ohms, 1 watt
- R.L.—Line cord, 120 ohms, 20 watts

MISCELLANEOUS

- L1, L2, L3—Depend on operating frequency
- L4—85-millihenry R.F. choke
- SW1—On-off switch
- SW2—3-pole, 3-position switch
- CH—2 400-ohm filter chokes
- Speaker—P.M. speaker with transformer
- Fuse—1/2-ampere fuse

TUBES

- VT1—25L6
- VT2—6SJ7
- VT3—25L6
- VT4—25Z5

The coil L1, L2, L3 is special* and the relationship and spacing is important, especially the phase relationship between L1 and L2. VT1 operates as a slightly regenerative detector when receiving the signal and this regeneration depends chiefly on the phase relationship of L1-L2. Improper phasing will give loss in receiving power. All coils are wound on a 5/8" tube and should be wound with 7/41 litz wire. Smaller wire sizes will give trouble since the coil will heat when in a transmitting position.

The next article will give complete data on a completely operated A.C. type of unit with a power output of 6 watts of R.F. This unit is one of the latest developments in this line. It is versatile and can be used under the most trying conditions. It will operate on A.C. lines, telephone lines, clock lines, direct wires, fences and ground circuits.

*Design of these coils depends on the transmission frequency. The experimenter desiring to operate near 100 Kc may start out with a 175-Kc I. P. transformer, shunting it with a variable condenser of about .001 mfd. Coil L3 may be wound with from 20 to 70 turns (approximately) to match the inductance of the circuit into which the transmitter is to be coupled.

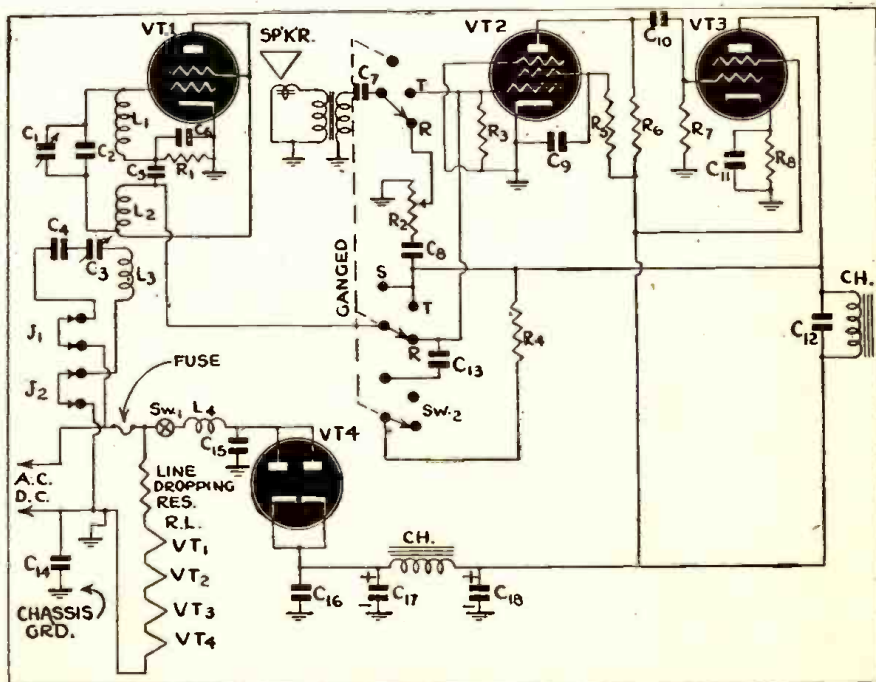



Heinrich F. E. Lenz

PHASE — DON'T LET IT PHASE YOU

By FRED SHUNAMAN

This is the third of a series of articles on Lenz' Law and alternating current circuits. The manner of the periodic rise and fall of alternating currents in our ordinary house lighting circuits is investigated. The next article will discuss reactance and resonance, with some experiments concerned with blowing out 250-volt condensers on a 110-volt electric line.

WHAT is phase? We speak of the phases of the moon without any feeling of mystery. They are the stages of its periodic change—the point which it has reached at any given time in its progress from a silver sliver in the West through its growth to “full moon” and down again to the same slim crescent in the eastern morning sky.

Similarly with alternating current. It also has its phases in its periodic progress from zero to peak and down again to zero; then through the same process in the opposite direction. The “phase” of the current at any given time is the point it has reached in its periodical variation, as zero, one-quarter of maximum value, one-half, three-quarters, maximum or “peak” value, and so down again to three-quarters maximum, one-half, etc.

“But,” says the indignant reader, “this is altogether too simple! We hear about phase mostly when people talk about currents being ‘out of phase.’ Where does this come in on your explanation? Can the moon get out of phase?”

The difficulty here is that we are interested in both the voltage and the current in an electric circuit, and in some alternating current circuits the current and voltage do not pass through the same “phase” of their periodic change at the same instant. The current may reach zero or maximum slightly before the voltage, or vice versa. This is the famous “out of phase” condition. To understand the how and why of this let us first take a brief glance at alternating current.

ALTERNATING CURRENT

We know that alternating current differs from direct in that it runs first one way along a conductor, then reverses and runs the other way. It changes direction 120 times a second in our electric light lines. It can reverse from about 50 to 12,000 times

a second in (high-fidelity) audio equipment, and to almost any limit in radio-frequency apparatus.

Note well that these changes are by no means sudden. In a 120-volt, 1-ampere circuit, for example, current does not flow at exactly 120 volts, 1 ampere for a 120th of a second, then repeat the action in the reverse direction. It rises gradually from zero to about 170 volts and 1.4 amperes, then drops gradually back to zero again at the end of the 120th of a second period. The only reason it is called 120-volt, 1 ampere current is that it does the same amount of work that a direct current of 120 volts and 1 ampere would do.

RATE OF CHANGE

Neither does the current always increase or decrease at the same rate. We do not intend to go into the mathematics of the proposition; it is enough to say that as the values of voltage and current near zero they change very rapidly, and while voltage and current are at a maximum on each alternation there is an instant where they hardly change at all. Then the process speeds up to the zero point and gradually slows down again to the next maximum, with the current flowing in the opposite direction. The action is like that of a stone thrown into the air. It has its maximum speed at the start, slows down to the peak of its flight, remains motionless an instant, then speeds up again on the way down.

The reason for this peculiar rate of change in alternating current is that it is ground out by rotating machinery, so prob-

ably a wheel would give a better example. Consider a point on the rim of a wheel, using the horizontal line through the axle as a reference. (See Fig. 1). As the point is on that line, and moving up, practically all its motion is upward, and therefore the upward motion in relation to the base line is rapid. At the top of the wheel, all the motion is forward. The motion in relation to the base line is zero.

As it turns forward and down, the relative speed of change in position with that of the base line increases, till as it passes

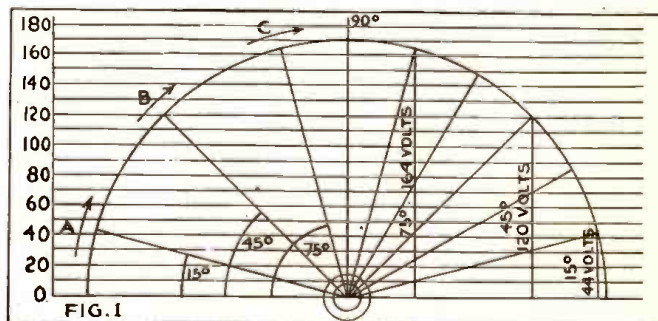

through the line it is again moving at a maximum rate. This is the case with ordinary alternating current, and if you call the base line “zero” and the top of the wheel 170 volts, you can get the voltage at any point of the cycle by dropping a vertical line from the point we are watching (on the rim of the wheel) to the base line.

CURRENT IN A CONDENSER

If we try to put A.C. through a circuit with a condenser in it, such as the one in Fig. 2, some interesting things happen. In a D.C. circuit, as we have seen, the current simply rushes in and the voltage rises till

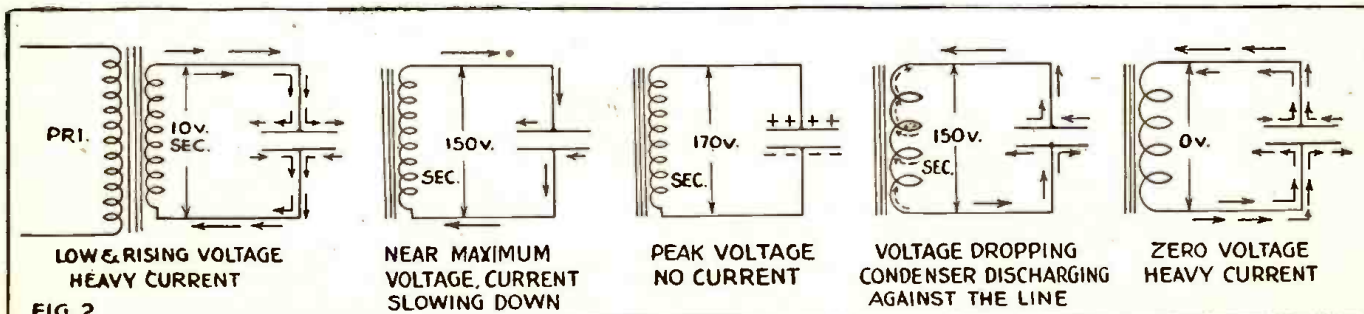

current ceases to flow and the voltage across the condenser is the same as that of the source. Then everything remains in that condition. The process starts the same way in an A.C. circuit. The voltage starts out from zero and there is a big rush of current into the condenser. Voltage continues to rise and current to flow, the rate of increase decreasing till, when the voltage has reached its peak, there is no flow of current, and source and condenser have a voltage of 170 (more or less) across them.

Now the line voltage begins to drop. As it falls to—for example—160 volts, there is a back flow into the line from the condenser, the voltage of which is ten volts higher than that of the line. Line voltage continues to drop rapidly, and the condenser to discharge just as fast. The line voltage drops to zero, with the condenser—no line voltage bucking it—discharging at maximum speed. Then the line current starts to flow the other way, now helping the condenser. It continues to discharge—or, if you like to put it that way—to charge up in the opposite direction, till, when the line voltage again reaches 170, it is fully charged and there is no current flowing into or out of it. Then the whole process starts over again and continues as long as you keep the switch closed.

The interesting—almost the startling thing—about this experiment was: **THE CURRENT WAS FLOWING AT ITS STRONGEST WHEN THERE WAS NO VOLTAGE ON THE LINE, AND HAD STOPPED ENTIRELY WHEN VOLTAGE WAS AT A MAXIMUM.** It got off to a flying start when the voltage was just rising from zero, had stopped dead when the voltage reached its peak, was again at maximum when the voltage reversed, and had again dropped to zero by the time the voltage had reached a maximum in the opposite direction.

We would almost think that something had happened to Ohm's Law, if a little consideration didn't show us that the same thing is happening all the time, and all around us. In filling any capacity—say a jacked-up auto tire—the flow of (air) current is greatest at the start, when the pressure is zero, and decreases during the pumping process, though we seldom pump to the point where no more air can be forced into the tire. In getting a drink from an old-fashioned pump, we expect the greatest flow of water just at the instant the plunger reaches the top of its stroke—at the instant when there is no pressure forcing the water up. In fact, if we had a two cylinder pump, working on each half of the stroke, we would have a perfect analogy of the action of alternating electric current.

A cycle (on our ordinary electric light lines) occupies 1/60th of a second. An alternation therefore takes up 1/120th of a

second. Since the current is one-half an alternation ahead of the voltage, it is said to **LEAD THE VOLTAGE** by 90 degrees. This is talking in terms of 360 degrees to the cycle. (A cycle is a circle—have you noticed that it always gets around to the point it started out from?) When frequency is high, the fractions of a second that amount to a quarter of a cycle are too small to play with, so the habit of dividing the cycle up like a circle—into 360 degrees—and measuring the leads and lags in degrees, has become universal.

So we have a current 90 degrees ahead of the voltage—a leading current 90 degrees out of phase—and there was nothing mysterious about it. We can hardly imagine how it could have been different.

HOW AN INDUCTANCE ACTS

Current in an inductance is a little harder to understand, though it sticks to its rule of doing exactly the reverse of what it would do in a capacitive circuit. Fig 3 shows a circuit like that of Fig 2, with an inductor instead of a condenser. We know that when the voltage starts to rise in the transformer secondary, (SEC.), the voltage across L will rise more rapidly than the current. An ordinary A.C. line is shown here instead of the transformer secondary.

In the direct-current circuit this didn't matter—much. Shortly after the current was turned on it reached its full value and stayed that way till it was switched off.

In this case, the voltage rises, the magnetic field around the coil continues to strengthen, and the bucking voltage set up by that field holds current down to a minimum, as explained by Mr. Lenz. Only as the voltage reaches its maximum and stops increasing does any amount of current start to flow through the coil. Now, having reached the 170-volt mark, the voltage starts to decrease and the magnetic field to weaken. Not only does the coil now permit all the current to flow through it, but even adds some of its own, supplied by the weakening magnetic field. The line current drops faster and faster as it approaches zero, and as the collapse of the magnetic field around L speeds up, so does the current from it increase, till as the voltage and line current reach zero, L is pouring out electricity at its fastest.

Now current and voltage from the line turn, and the coil is magnetized in the opposite direction. The first effect of this is to help the former current, as the current created by the field newly set up is in the same direction as that still flowing from the coil. So current continues to flow, fighting a losing battle with that from the line, and dropping slowly as the voltage rises against it. As the line voltage reaches 170 volts on the second alternation, the coil current has dropped to zero, ready to turn around and start again as soon as its magnetic field has

stopped growing and begun to collapse.

We have exactly the same situation as we had with the condenser—maximum current at zero voltage, and zero current at maximum voltage. The only difference is that in the condenser the current got off to a good start a quarter-cycle (90 degrees) ahead of the voltage, while here it lags behind the same quarter cycle. There's nothing strange about its behavior here either. It couldn't very well have done otherwise.

It's rather hard to check experiments like these without a cathode-ray oscilloscope, which will show you what the currents or voltages are doing at any given instant, but if you try this, use a coil with a large iron core, plenty of turns, and large wire. It should have as much inductance as possible for its resistance. We want it to look to the line current like a "pure inductance," or the results will get all mixed up.

The reason is, that in a circuit with only resistance in it, current and voltage travel together, as we would expect. They hit their minimums and maximums at the same instant, and any other point—or phase—of their cycle at exactly the same time. Yes, you've guessed it; they're always **IN PHASE!**

The current leads the voltage by 90 degrees in a circuit containing all condenser and no resistance, and lags by the same amount in one with nothing but inductance in it. If a circuit contains both capacitance or inductance and also resistance, the current is neither in phase nor 90 degrees out. The exact difference between the time voltage and current hit corresponding parts of their cycle depends on the proportional amounts of resistance and capacitance or inductance in the circuit, and can be anything between zero and 90 degrees.

It is easy to get a condenser with practically no resistance—almost impossible to get a coil with much inductance unless accompanied by a considerable quantity of resistance. Unless you are careful, you may pick on a coil that looks like an inductor to you, but looks more like a resistor to the line.

This is why so many things fail to work out "the way it is in the books." We forget that we are not dealing with the pure and simple qualities of our texts, but with actual apparatus, which "is seldom simple and never pure."

Later we may expect to try some experiments to show that inductance and capacitance are opposite in their action, and that while both retard the flow of current in an A.C. circuit, if put together in the same circuit, they neutralize each other. We will also see that in retarding current flow, they are different but not opposite in their action to the action of resistance. This may help us to gather some information about *resonant circuits*.

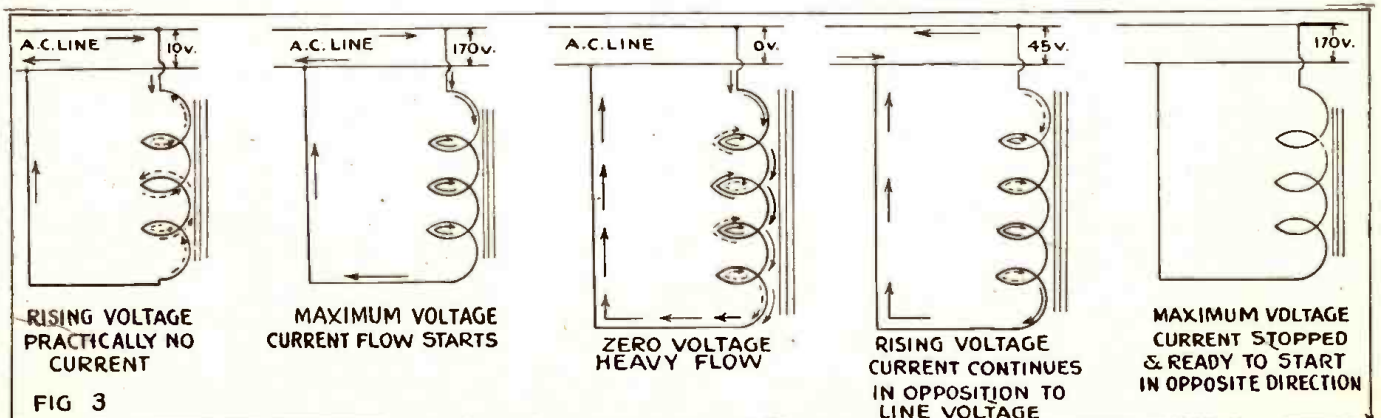

FIG 3

CRYSTAL RECEIVER WORKS LOUDSPEAKER

By L. HEWLETT

The crystal radio receiving set never became obsolete. Surprising as it may seem, there are still actually millions of crystal radio sets in use the world over. Indeed, the radio crystal is a bit on the ascendancy again on account of war restrictions which often make it difficult to obtain tubes and other radio supplies. The lowly crystal set with its most excellent sound reproduction is a good stand-by, particularly for emergency purposes. This is one of the reasons for publishing this article.

“YE OLDE CRYSTAL” still reigns supreme as the most perfect rectifying-detector known, giving crystal-clear, distortionless reception with a bell-like clarity that is really amazing to one who has never listened to a crystal-set.

Regarding DX (distance) reception, there are many indisputable records of 1000 miles, and over; in fact J. M. McDonald, Technical Director of the great WLW, (*The Nation's Station*) says (in a recent letter) “It is quite probable that a well-engineered crystal set would be capable of receiving signals HALF-WAY AROUND THE WORLD.”

As for cost, no radio can be built at such low cost as a crystal set and it costs absolutely nothing to operate, working without tubes, batteries, or electric-current. Now with all these remarkable qualities, it should be universally used, BUT, the crystal does not amplify, and will not ordinarily operate a loudspeaker, and its beautiful tonal quality must be heard via phones. So there was the problem, could a crystal circuit be designed and improved so that it would give loudspeaker reception naturally, on local stations where enough power was available? Most folks listen to their local stations, anyway.

There was just one place where this necessary data could be “dug up,” namely in the original *Radio News*, published and edited by Hugo Gernsback. Anyone fortunate enough to have a file of these magazines dating back to 1919, has the means right at hand of obtaining a liberal radio education. An education that will go far ahead of what is termed “modern radio.”

I make no claim for anything new in this Loudspeaker Crystal Set, it is merely a combination of principles and circuit arrangements that were printed many years ago in various issues of Mr. Gernsback's *Radio News*, and the fact that it works is proof that Mr. Gernsback “knew his onions.”

THE CIRCUIT

A cursory glance will show that it is a combined “Acceptor” and “Rejector” wave-trap hook-up; BUT there is more to it than appears on the surface, namely, we are confronted with a “radio mystery,” viz., the voltage-drop across the secondary S, and the tuning condenser C, under this condition, will be GREATER than the voltage induced in the secondary winding by the electromagnetic induction from the primary, that is: THE TUNED CIRCUIT ITSELF CAUSES A “GAIN” OF VOLTAGE.

Incidentally, this circuit arrangement

was “lifted bodily” from The DETECTORIUM Crystal Set invented by Mr. Hugo Gernsback in 1910, just 33 years ago. However his diagram “D” is even simpler, as he achieves the results with only one coil, whereas I use 2, in the interests of selectivity, which was not necessary in 1910.

No part or component of the set is critical. Any B.C. range variable condenser can be used, and I made a point of listing components that were easily obtainable (See diagram plate).

ANTENNA AND GROUND

Here comes the “rub” where the country residents will have it all over the unfortunate city dwellers, BECAUSE we must use an extra long antenna in order to “soak up” enough energy to give us speaker-volume. However, the length of our antenna depends largely upon the wavelength of the local station that we wish to listen to, pre-

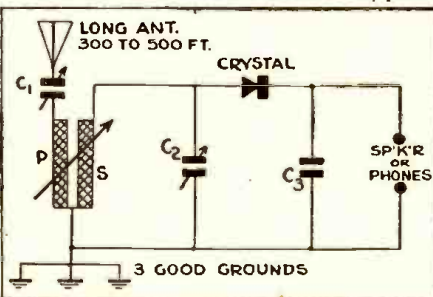

The parts referred to in the diagram are as follows: C1, C2, broadcast variable condensers, any size .0025 to .0025. C3, fixed bypass phone condenser, .001 to .005. Crystal, any good ADJUSTABLE type. P, S, primary and secondary of coil-coupler. Spiderweb coils are recommended, as giving maximum coupling. Number of turns depend on type of coil—experiment for correct number.

erably a station that has a lively “morning program” so that our crystal set speaker can be placed near the bed and wake us up in time for work. (Alarm-clocks are getting scarce).

No switch is necessary, as simply detuning the variable condenser will silence the set. Getting back to the length of the antenna, you simply divide 490,000 by the frequency of the local station. For instance, a frequency of 1460-Kc. would require 334-ft., and 980-Kc. would need 500-ft. It is not necessary that the antenna run in a straight line, but merely that it have that continuous length. If splices are necessary, BE SURE to make good electrical connections, soldering being best.

Bear in mind that every different locality, has a different radio response, that's why an experimenter who knows the peculiarities of

his own locality, can always build a superior receiver, as compared to the standardized commercial sets. In this article it is presumed that the reader knows what a “Cat-whisker” is, and also knows how to “tickle a crystal” and find the “hot spot.” Don't look for a blast from your speaker at the very start, but have the patience to experiment and make many changes until you get things just right for 100% reception in your locality.

AND LAST, but not least, 3 separate and VERY GOOD ground connections are essential. Not 3 wires to one ground, but rather 3 good grounds to one wire, said wire leading to the ground post on your set.

THE CRYSTAL DETECTOR

The heart of your set, is the crystal, which unfortunately is quite a mystery, and apparently unsolvable. The nearest approach to its solution was made by Prof. Pelabon, of the University of Lille, France. His theory of “The Atmosphere of Metals and Metalloids,” was practically demonstrated with metal-ball rectifiers, which gave excellent radio reception. Carborundum-crystals are the sharpest tuning, and have very high resistance. They will tune-in a station on one division of a 100 calibrated dial.

Incidentally Carborundum is the crystal that Hugo Gernsback used in his famous “Megadyne Loudspeaker Radio” which was just as popular in England, and the Continent, as it was in the U.S.A. His “Interflex” receiver was the fore-runner of the “Megadyne,” and will be remembered by all the old-timers in radio.

Next in selectivity and resistance, comes silicon. Following silicon, is pyrites or ferum, which is extremely hard, but rather broad-tuning, and sensitive. Next we have galena and molybdenite, which are soft, and VERY SENSITIVE, being best for Dx. and short-wave reception, as they will bring in the weakest signals. The old-time Dx. records were mostly made with galena-crystals. The softer the crystal, the lighter the contact has to be made, whereas with Carborundum, a steel point with a rather heavy contact (up to 5 lbs.) gives best results.

In closing, will be glad to answer any questions from experimenters, but must refuse to enter into any controversy regarding principles involved in crystal-reception. Unfortunately we still have with-us, a large proportion of “knockers” and a small percentage of “boosters.” Critical controversy over trivial technicalities, is NOT helpful, and this article is intended to help the crystal-experimenter obtain better results in his experiments.

A COMPACT BEDSIDE RADIO

By BOB WHITE

Expensive radio parts are not always necessary—or obtainable—for satisfactory results. Here we have a set built from that heterogenous collection of old and used parts, referred to affectionately by the Experimenter (and sometimes contemptuously by the green newcomer) as the "Junk Box." Lacking in complicated circuits, and straightforward in construction, this is an excellent project for the beginner's first set.



Bob White and his receiver. Cabinet and chassis are built of easy-to-get materials.

HERE is something in a bedside radio. It is an ideal radio, compact and economical, and should interest junior radio technicians who read *Radio-Craft*. This receiver is very inexpensive to build, and has a minimum of current drain.

The power supply is made up of a 3-volt "A" battery with a variable rheostat, and a "B" battery rating 90 volts. By using a 1G6G, a single 1.5-volt dry cell may be used for the "A" battery, and the rheostat dispensed with.

The four-inch speaker is of the permanent type, with an output transformer to match. It is housed in the small cabinet with the other parts, and the volume of such a speaker is ideal for the bedside listener.

The circuit is very simple, and very few parts are needed. The receiver will be found to be excellent for local reception, with good volume and fair selectivity.

THE CABINET

The cabinet is the first part to be constructed. The panel and the base are first fastened together. Then the back, the sides, and the top are nailed together as a unit. A reasonably good fit is required, so that the back unit may be slipped off when inspection or repair work is to be done on the receiver. The cabinet should be planned around the parts to be contained in it. There should be six holes drilled in the cabinet: for the speaker, the toggle switch, the tuning condenser, the antenna lead, the power-supply cable, and for the tube sighting aperture. The exterior of the cabinet may be

finished to match the room in which it will be used.

PLACEMENT OF PARTS

After the cabinet is completed, the parts are fastened in place. The speaker is mounted so the 1J6G, 19 or 1G6G tube will be held below. Notice in the photos that the parts are so placed that the small amount of available space is utilized. Care should be taken in the tube mounting; pins 1-8 or 1-6 are in a down position, and the wires from the socket are stapled down to the base.

WIRING HINTS

The wiring is simple, but care must be exercised in the soldering, and in seeing to it that the wires are well insulated. Special care should be taken with the filament and "B" wires. Solid hook-up wire is recommended, and it is used also for the antenna and power-supply cable.

COIL DATA

The coil is the last part to be constructed. After the wiring is done, up to the variable condenser, the set is ready for testing operation. When it is working correctly, a buzz should be heard coming over the speaker when the grid wire is touched. The coil employed is tuned to the broadcast band. It may be the plug-in type, or 100 or so turns of insulated wire on a cardboard tube, which is then coated with dope. A primary is not necessary, but better results may possibly be obtained if a primary is used.

The coil may then be wound as before, with 20 or 30 turns jumble-wound on top of it at the ground end. A more finished coil can be made—in plug-in form if desired—by using a standard 1½-inch coil form. Wind this with 150 turns of No. 30 enamelled wire. Wind the primary with 30 turns of the same wire, starting the primary winding on the form ⅛ to ¼ inch from the ground end of the secondary.

The two winding coils will be found very good in places where the receiver is not selective enough. A coil with a primary and secondary will also cover a greater portion of the broadcast band with the 140-mmfd. condenser. If a 350-mmfd. condenser is used, this will not be important.

A 140 mmf. variable condenser was used in building this set. A larger condenser may be used, if desired, but a larger cabinet would be necessary.

OPERATING DETAILS

After the coil is constructed and adjusted to the correct frequency range, the set is ready for operation. Flip the toggle switch up, which should be the "on" position, and tune the condenser to a loud station. Try different antenna and ground systems. A ground is not necessary for local stations.

Adjust the filament rheostat for loudest results. The lighting of the filament may be seen by looking through the tube hole, placed in the side of the cabinet for that purpose.

Selectivity is governed by the length of the antenna.

This set is a very good practical receiver. Practical, obtainable parts are used in its construction. The tone is good and clear, and while its volume is ample for its purpose, it is not so loud that it might unintentionally disturb others, who might be enjoying their own program in near-by rooms.

Parts List

CONDENSERS

- C1—140 mmf. or a broadcast tuning condenser
- C2—0.00025-mfd. paper
- C3—0.02-mfd. paper

RESISTORS

- R1—2-megohms
- R2, R3—0.5-megohms

MISCELLANEOUS

- CL1 broadcast coil, with or without a primary
- 1—Tube socket, for 1J6, 1G6 or 19 tube
- 1—Pointer knob
- 1—4-inch P.M. speaker
- 1—T1 Output transformer (mounted on speaker)
- 1—Toggle switch
- 25 Ft. Hook-up wire, solid
- 1—Wooden cabinet; 2 staples; 22 nails or screws

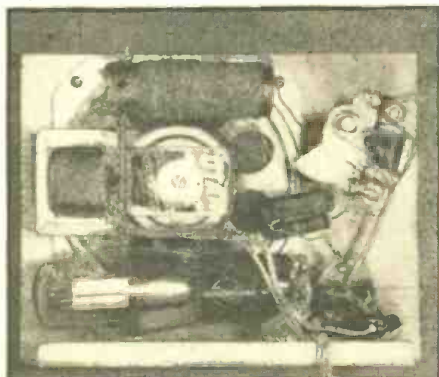

Underside of the receiver. Jumble wound coil is shown near the top.

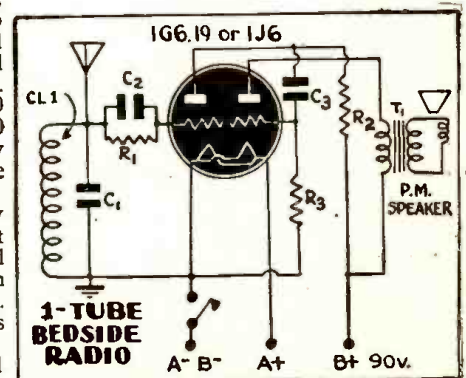

The straightforward, non-regenerative circuit makes this an easy set to build.

HIGH FIDELITY RECEIVER FOR LOCAL RECEPTION

By STANLEY DOWGIALA

AS contrasted to the usual type of receiver which has high-gain R.F. stages, and a single pentode or tetrode output stage, a local high fidelity receiver may be considered as a high-grade amplifier with enough R.F. tuning to bring in the local stations which broadcast good music.

There is no need for several R.F. stages in a receiver of this type, since selectivity and sensitivity are secondary to good quality. Only one stage of R.F. and a detector are required.

THE TUNER

In this receiver the well-known iron-core R.F. transformers are used, for broad tuning of the locals, with low noise level. The 6K7GT pentode in the R.F. is followed by a 6J5 triode in an infinite impedance type detector circuit. This type detector, as is well known, has the ability to handle large signals with low distortion, and in addition does not react on its tuned circuit. All of which contributes to high quality.

From here on the set amounts to a high fidelity audio amplifier. The 6J7GT is used for obtaining special tone-control effects. Its input is from the 1-megohm volume control, which can be switched from radio (R) or to phonograph (P), as desired.

TONE CONTROL FEATURES

It will be noted in the plate circuit of the 6J7GT that there are two resonant circuits in series with a 30,000-ohm resistor.

This grouping constitutes the tone-control circuit. The upper choke-condenser combination, (near the tube on the diagram) is resonant to high frequencies. It is shunted by a 0.025 and 1-megohm-control series combination. When the control is at minimum position, the treble response is at maximum (loudest and strongest "highs").

The lower choke-condenser combination, (near the B+ line), is resonant to low frequencies. It too, is shunted by a series condenser-control combination, consisting of a 0.5-mfd. condenser and a 1-megohm variable resistor. Manipulation of this control gives the desired degree of bass boost. When the control is at maximum, bass response is at maximum.

Thus with two controls—one each for treble and bass, almost an infinite number of tone combinations is possible, to suit the listener's requirements.

2ND A.F. STAGE

The purpose of this stage is to build up the voltage coming in from the tone-controlled 6J7GT. Owing to the attenuation (weakening) of the "highs," when the bass is boosted, the signal must be built up to swing the grids of the output tubes to peak efficiency.

This stage also provides phase-inversion input to the 6L6GT's, in order that they may operate in push-pull. There is no reason why a good push-pull input transformer cannot be used, if one is on hand, instead of phase-inversion.

OUTPUT STAGE

The high-efficiency, high-quality output 6L6GT's are used in the output, feeding a 12-inch or 15-inch speaker, to maintain excellent response. It will be noted there is a 0.003-mfd. condenser in series with a 2.5-mhy. choke coil to absorb any radio-frequencies which may have gotten through to this point.

POWER SUPPLY

Three choke coils are shown (if the fields are considered as chokes), for maximum filtering. Also, if desired, the first 25-mfd. filter condenser may be omitted. This would then provide "choke-input" filtering of the 5Z3 output, and while the voltage would be a little lower, the regulation would be improved. Good regulation is imperative with high-fidelity audio work.

Although the diagram shows a choice of 5Z3 or 80 type rectifiers, it is believed the 5Z3 will prove the better, in this case, in the long run. It is more rugged, will carry a heavier current, and has the ability to absorb power-line surges with minimum chance of breakdown.

To insure minimum pick-up of hum, a 0.1-mfd. (or two of them in series with center connection grounded) is recommended in the 117-volt primary input to the power transformer.

This receiver has given excellent response, and is well worth the effort of building it, to those who want good music, and have the parts needed.

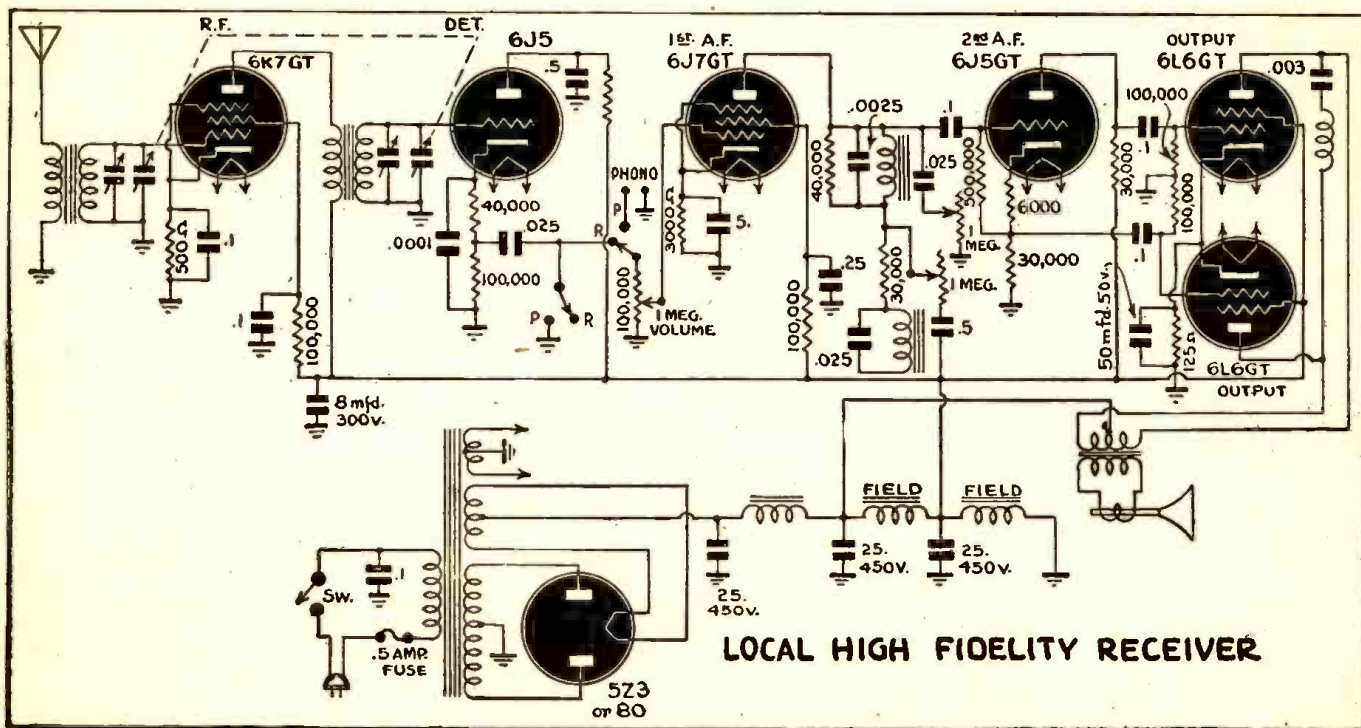

The stress is on audio amplification in this receiver; just one radio-frequency stage being added to improve selectivity. Thorough filtering and careful tone-equalization help to make the set truly Hi-Fi, while abundant power is secured with the 6L6 output. The resistor in the plate circuit of the 6J5 is experimentally determined. This one was 50,000 ohms, but may be much lower.

FOUR-TUBE T. R. F. PORTABLE

By JOHN M. WEBER

HERE is a simple but powerful little radio set which I designed for a portable, and which I believe might be of interest to *Radio-Craft* readers. I believe it is just what many readers have been looking for in the way of an easily-constructed but very efficient portable radio.

Due to the fact that this is a T.R.F. circuit it is very easily constructed, in that it does not have many tuned trimmer and padder condensers as one would find in superheterodyne circuits. Superhets are difficult for the average constructor to adjust, especially if he does not have a signal generator. This set has only three trimmers on the tuning condenser which are easily adjusted by sound without any equipment.

This four-tube T.R.F. has an automatic volume control and a loop aerial. It uses the small 1.5-volt octal base glass type tubes.

Two 1N5GT tubes are used as tuned-radio-frequency amplifiers, and a 1H5GT tube is used as a tuned detector, A.V.C. and first audio amplifier.

The output tube is a 1A5GT, which will give plenty of volume to operate a four-inch dynamic speaker.

The loop is wound to fit the box or case in which the radio is mounted. The larger the diameter of the loop, the better it will operate.

The proper number of turns is determined by using many more than necessary and removing a few at a time until the set tunes properly. However, good loops can be bought already wound for a small sum.

The 1N5GT tubes must be well shielded and the wire running to the control grid of the 1H5GT tube must be a piece of shielded wire.

The sensitivity and selectivity of the set is as good or better than the average superheterodyne due to the high-gain Meissner R.F. coils used. Two small 45-volt "B" batteries are used for the "B" supply and a small 1.5 "A" battery supplies the filament current.

The "A" battery drain is about 0.25 amp., and the "B" drain is less than 10 milliamperes, so it can be seen that a good set of batteries will last a long time.

No "C" battery is necessary because a resistor in the "B" minus lead has the proper voltage drop to supply the right grid bias to the 1A5GT output tube.

This receiver is very economical to construct because of the simple circuit and the few parts used. I am confident that any constructor or experimenter who builds it will be well pleased with its operation.

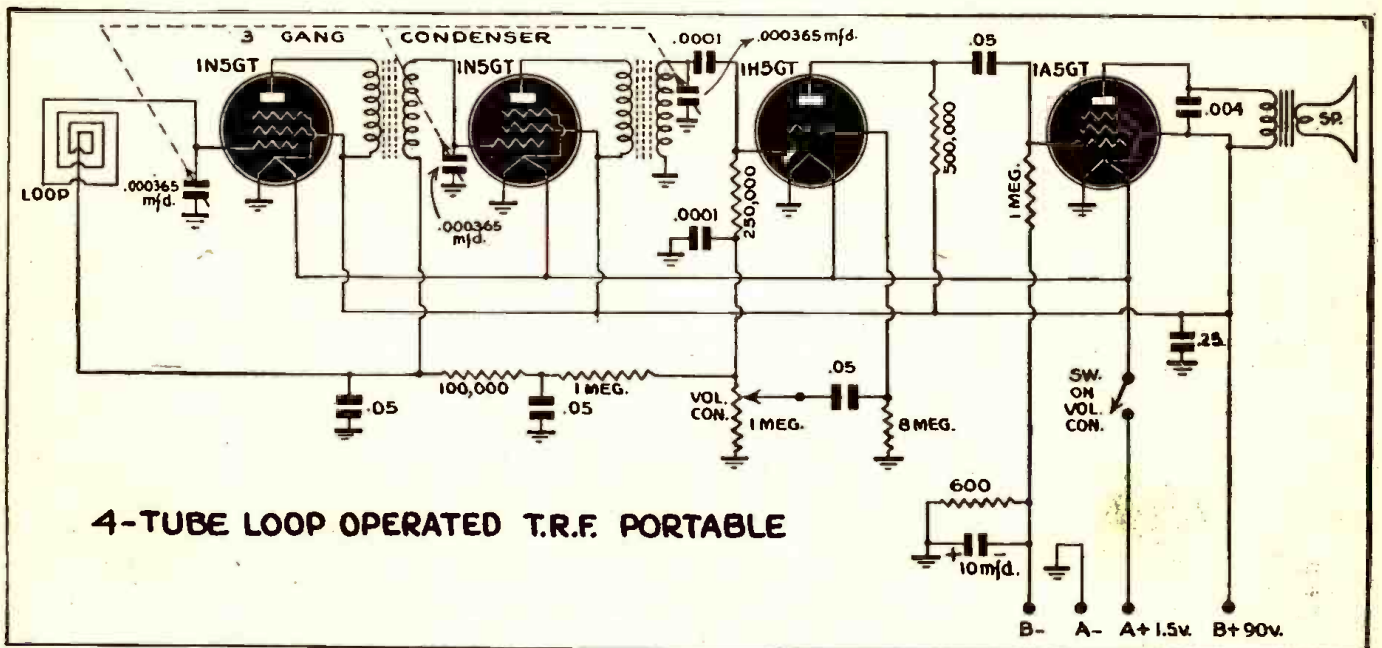

USING THE OLD PARTS

By E. E. YOUNGKIN

WITH radio parts getting scarcer every day the radio serviceman must keep his ingenuity working overtime to keep receivers in his community operating. It is with this concept in mind that I submit the following ideas. They are not intended as regular service practice but as emergency measures to keep receivers operating for the duration.

The type 35Z5 tube burns out quite frequently. Checking with an ohmmeter will show that most of the burnouts occur between tube contacts 2 and 3. When 35Z5 type tubes cannot be obtained, operation can be restored by shunting a 40-ohm resistor across contacts 2 and 3. The resistor should be connected across the tube prongs so that no changes in the receiver will be required when new tubes are again available.

The defective 35Z5's lying around the shop can be put to work too. In experimental circuits using 0.15 amp. tubes they may be used as rectifiers or ballasts. They should be connected so that there is 28 to 30 volts drop across the heaters. The heater connections will now be 3 and 7 instead of 2 and 7.

Now, more than ever, it pays to be familiar with tube-base charts and tube manuals. For instance a receiver needs a 5Y3 or 5Y4 tube, and none are to be had. A look into the tube manual shows they are essentially the same as the type 80 except for the base connections. So a simple adapter can be rigged up using the base of the old tube and an old four-prong socket. The adapter need not be a work of art, but the connections and insulation should be good.

Black bakelite cabinets can be repaired by coating the edges of the break with shellac and allowing it to dry for a couple of days. After drying, the break is filled in by melting a phonograph record with a large soldering iron. Don't expect the iron to turn the record into a liquid—it just melts at about the same consistency as solder and must be worked into the break with the iron. The breaks should be filled a little above the surrounding surface and then sanded down flush. Colored cabinets can be finished the same way and then given a coat of quick drying lacquer.

Another example of using up the scrap—a fellow is tired of hooking up a small record player on top of his radio and would

(Continued on page 510)

A SIMPLE V. T. VOLTMETER

By E. ANTOINE

TOO many radio servicemen and experimenters fail to realize the importance of the vacuum-tube voltmeter. The modern radio, with its complicated high resistance networks, demands a voltmeter that draws little or no current. The ordinary voltmeter is absolutely useless to measure these minute currents. In order to operate the mech-

anically chosen as best suited for our needs and pocketbook.

It will be noted that no amplifier is used, and the circuit represents simplicity and straight-forwardness, with probably the exception of the input circuit, possibly not new, but seldom seen. It was found that the average V.T.V.M. would cut the signal as

much as 50% when measuring A.V.C. and grid bias voltages. Therefore a 2½-megohm resistor was placed as near to the circuit under test as possible. It was embodied directly in the test prod, next to the probing needle itself, inside the bakelite tubing. This completely cut out any tendency towards absorption by the test prods, and left the circuit and signal absolutely undisturbed.

Diagram No. 2 shows the method of wiring these resistors. Note that they are all high values, 5 meg. each. Sw. 3 is a double pole switch.

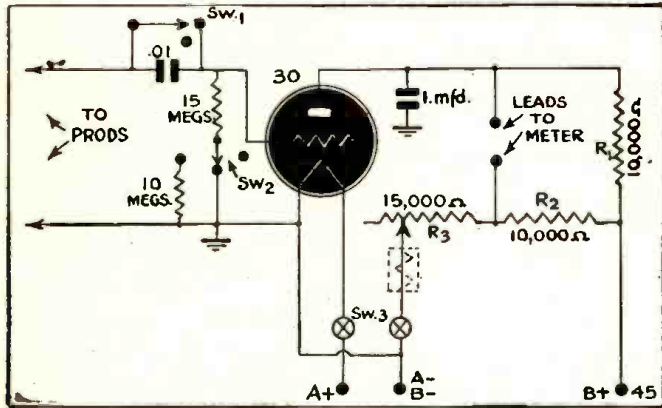

This simple vacuum-tube voltmeter utilizes the meter already at hand in The Serviceman's volt-ohm-milliammeter.

anism of the ordinary meter, the amount of current required is often more than is present in the circuit itself. The circuit under test is upset to such a degree that it is rendered inoperative or practically so. But not only can a V.T.V.M. be used in the measurements of A.V.C., A.F.C., and grid bias voltages, but it is the finest of output meters, and in re-aligning the modern superhet, it is indispensable.

DESIGN CONSIDERATIONS

With a view to constructing a V.T.V.M. that would meet practically all of the requirements of the radio serviceman and experimenter, the circuit shown in diagram No. 1 was evolved. The question of performance at relatively low cost was of major importance. Simplicity came next. Here in Canada we have vast territories unserved by the Power Commission, and it was therefore decided to have the unit entirely self-contained. This made it a versatile piece of equipment that could be picked up and taken wherever the occasion demanded.

Now let's take a look at the circuit

to a length of wire from the grid leak, and left protruding from the case. Where necessary an additional resistance of 5 or 10 megohms can be clipped into the circuit to increase the input resistance. Sw. 1 is to be closed for D.C. and open for A.C. voltage measurements. R1 and R2 are ordinary carbon resistors, as identical in resistance values as possible. In this case 180 volts were applied across the resistor and the exact current passed was noted. A number of other resistors were substituted, until one was found that passed exactly the same current at the same voltage. This proved to be more accurate than a simple ohmmeter test. R3 is to balance the bridge and have the meter needle read zero, at no signal input and with the test prods shorted. Due to slight circuit variations it may be found necessary to add a 5,000 to 10,000 ohm-resistor in series with this control in order to obtain balance at zero. This additional resistor is shown in the diagram in dotted lines. The meter used in this case was a 400 micro-ampere movement, and proved very satisfactory. It is the meter of the multi-tester, and was used externally. A

CALIBRATION

To calibrate the V.T.V.M., a bank of fresh flash-light cells was found best for the purpose. Each cell has a potential of approximately 1½ volts, and when applied in steps of 1½ volt, the meter is easily calibrated.

CONSTRUCTION

No constructional difficulties presented themselves, but the entire unit, including

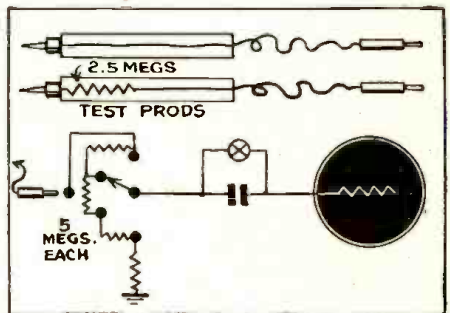

the batteries should be mounted in a metal container. This was found desirable at this point due to the 50-Kw. C.B.C. stations less than one-half mile away. It was noted that when this station was on the air, a reading of ½-volt existed between antenna and ground.

Use good grade components, with low leakage, preferably porcelain or Isolantite.

A 1½-volt filament battery was found sufficient, and 45-volts on the plate. Resistor R3 is to compensate for battery depreciation.

SOLVING RESISTOR PROBLEMS IN PARALLEL

Following is a very short method of solving a certain resistance problem, without the use of algebra, which should be of benefit to many readers of *Radio-Craft* and to all electrical workers in general.

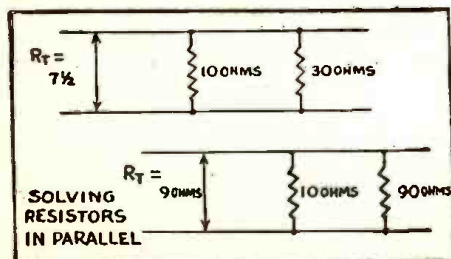

The problem is to calculate the unknown resistance in parallel with a known resistance, when the combined resistance is known.

The problem may be solved by using the following rule:

Multiply the combined resistance by the known resistance, and divide the product by the difference between the combined resistance and the known resistance.

As shown in the upper section of the diagram the known resistance is 10 ohms and the combined resistance is 7½ ohms. What is the unknown resistance? Solution:

$$\frac{10 \times 7\frac{1}{2}}{10 - 7\frac{1}{2}} = 30 \text{ ohms}$$

As shown in the lower section of the diagram, the known resistance is 10 ohms, and the combined resistance is 9 ohms. What is the unknown resistance? Solution:

$$\frac{10 \times 9}{10 - 9} = 90 \text{ ohms}$$

But when the difference between the known resistance and the combined resistance is one, the division is not necessary, as is plainly evident and the solution becomes the simple operation of multiplication as follows:

$$10 \times 9 = 90 \text{ ohms.}$$

R. A. BELL,
Port Clinton, Ohio.

THE LISTENING POST

Edited by ELMER R. FULLER

FIRST, I want to renew my acquaintance with all of the former readers of the days of *Radio & Television*, and I wish to make many new friends in the future. We shall attempt to publish each month a list of the stations and their schedules, and to maintain such accuracy as is possible under present conditions.

Due to war conditions, it is not now possible for us to do the job we would like to do. It is my main desire to maintain a staff of observers for the amateur bands, such as was done before. However, I shall be only too glad to receive reports and suggestions from our readers. Because of the war, we shall have to limit our reports and observations to the commercial broadcast stations.

There are now on the air many stations that are not identified. These may or may not be those operated by our enemy nations

or their agents. We can say this much, **THAT ALL STATIONS OPERATED UNDER THE STARS AND STRIPES HAVE CALL LETTERS ASSIGNED TO THEM, AND ALL OF THEM USE THEM! WE ARE NOT AFRAID TO BE IDENTIFIED WITH THE FREEDOM FOR WHICH WE ARE OFFERING OUR LIVES TODAY.**

Very good reception is being had from PRL8, located in Rio de Janeiro, Brazil. It is heard on 11.15 megacycles and is on the air every day except Sunday. They sign off at 11 pm, EWT. The British Broadcasting Corporation on 9.95 mc., transmitting to the West Indies, is on Sunday, Tuesday, Thursday, and Saturday at 7 to 7:30 pm. At 7:30 they broadcast to Canada. Also the BBC has a program in

its African service on Mondays at 4 pm. This is on 15.26 megacycles. The announcer is usually a woman, although a man is usually in charge of the program.

An old friend, which can be depended upon for good reception is HCJB, in Quito, Ecuador. They broadcast in English at 8 am and 6 and 9 pm. Other broadcasts are in Spanish, although the music is very enjoyable. They are on 12.45 mc. and several other frequencies. This one, however, is beamed to North America, and therefore comes in better.

An unknown station has been heard several times recently on 6.35 mc. about 9 to 12 pm. They speak several languages, but not English.

We would like to hear from all readers, both old and new. Please address: Elmer R. Fuller, c/o Radio-Craft Magazine, 25 West Broadway, New York, N. Y.

Mc.	Call	Location and Schedule	Mc.	Call	Location and Schedule	Mc.	Call	Location and Schedule
17.840	—	ATHLONE, IRELAND. "Radio Eireann." 8:30 to 9:30 am. 1:30 to 2:15 pm.	12.11	TPZ	at 8 am and 6 and 9 pm. At other times in Spanish and other languages.	9.650	WGEO	4 am, 5:15 to 7:30 pm. Central American beam; 7:30 pm to 8 am.
17.830	LRAS	BUENOS AIRES, ARGENTINA. Afternoons.	11.893	WRCA	ALGIERS. BOUND BROOK, NEW JERSEY. European beam. 1 to 4:45 pm. 4 to 8:45 am; Latin American beam, 5 to 11:30 pm.	9.650	WCBX	SCHENECTADY, N. Y. Australian beam, 7:15 to 8 am. BRENTWOOD, NEW YORK. Latin America beam, 8 to 11:30 pm.
17.830	WCRC	BRENTWOOD, NEW YORK. European beam. 6 am to 5 pm. Buenos Aires beam. 5:30 to 7 pm.	11.830	WCRC	BRENTWOOD, NEW YORK. Latin American beam, 7:30 pm to midnight daily.	9.606	ZRL	CAPE TOWN, SOUTH AFRICA. Daylight transmissions. LONDON, 4 to 4:45 pm.
17.8	WLWO	MASON, OHIO. European beam. 10 am to 1 pm.	11.830	WCDA	BRENTWOOD, NEW YORK. European beam, 6 am to 6:30 pm daily.	9.6	GRY	ATHLONE, IRELAND. "Radio Eireann." 7:10 to 8 pm.
17.780	WRCA	NEW YORK CITY. European beam. 9 am to 12:45 pm, daily.	11.720	—	BELGIAN CONGO, opens at 1:30 pm.	9.595	—	MASON, OHIO. East South American beam, 7 to 12 pm. LONDON. American beam, 7 pm. to 12:45 am.
15.850	WCW	European beam. 6:45 to 9 am. 5:15 to 6:15 pm.	11.710	WLWO	MASON, OHIO. European beam, 1:15 to 5:15 pm.	9.590	WLWO	MASON, OHIO. East South American beam, 7 to 12 pm. LONDON. American beam, 7 pm. to 12:45 am.
15.39	GRE	LONDON. 11:30 am to 3 pm.	11.705	SBP	MOTALA, SWEDEN, weekdays, 2:45 to 3:10 am, 7 to 7:55 am, 11 am to 2:15 pm, 9 to 10 pm. Sundays 4 to 10 am, 11 am to 5:15 pm, 9 to 10 pm. The programs are beamed to North America on even dates and to South America on odd dates, thus alternating with SBT.	9.562	OAX4T	LIMA, PERU. "Radio Nacional" 2 to 8 pm, daily.
15.350	WRUL	SCITUATE, MASS. European beam. 7:15 to 9 am.	11.68	GRG	LONDON, 2:30 to 3:45 pm.	9.543	XEFT	MEXICO. Evenings.
15.270	WCBX	BRENTWOOD, NEW YORK. European beam, 6 am to 4:30 pm. Rio beam. 5 to 7:45 pm.	11.150	PRL8	RIO DE JANEIRO, BRAZIL. Afternoons and evenings except Sundays. Off at 11 pm.	9.523	ZRH	JOHANNESBURG, SOUTH AFRICA. Daylight transmissions.
15.260	BBC	MANCHESTER, ENGLAND. African service. Heard Monday at 4 pm.	10.100	WJQA	Australian beam. 7:15 to 8 am.	9.535	SBU	MOTALA, SWEDEN. 2:30 to 5:15 pm, daily.
15.250	WLWO	MASON, OHIO. Latin American beam 5:30 to 7 pm.	9.950	BBC	LONDON. To the West Indies, 7 to 7:30 pm. Sunday, Tuesday, Thursday, Saturday. To Canada, 7:30 pm, same days.	9.480	WCBX	BRENTWOOD, NEW JERSEY. Latin American beam, 8 to 11:30 pm.
15.155	SBT	MOTALA, SWEDEN. Weekdays, 7 to 7:55 am, 11 am to 2:15 pm, 2:30 to 5:15 pm, 9 to 10 pm. Sundays, 4 to 10 am, 11 am to 2:15 pm, 9 to 10 pm. On days with odd dates, beamed to North America, on even dates to South America.	9.905	WRX	West South American beam, 8 pm to midnight.	8.96	TPZ2	ALGIERS.
15.150	WNBI	BOUND BROOK, NEW JERSEY. European beam. 8 am to 5 pm daily.	9.755	—	DURBAN, SOUTH AFRICA. Day and night transmissions.	8.860	—	West South American beam, 8 to 12 pm.
15.129	—	ATHLONE, IRELAND. "Radio Eireann." 2:30 to 5 pm.	9.700	WRUL	SCITUATE, MASS. Central American beam, 7:30 pm to 2 am.	8.60	—	West South American beam, 8 pm to 2 am.
15.100	BBC	LONDON, ENGLAND. Sunday morning. Off at 11:15 am.	9.69	LRAI	BUENOS AIRES, ARGENTINA. Afternoons.	8.810	WJP	European beam, 6 to 6:30 am.
14.925	PSE	RIO DE JANEIRO, BRAZIL. "Hora de Brazil" North American beam. Daily at 7 to 8 pm.	9.670	WNBI	BOUND BROOK, NEW JERSEY. European beam, 2 to	8.035	CNR	MOROCCO, afternoons.
12.455	HCJB	QUITO, ECUADOR, "La Voz de los Andes" (The Voice of the Andes) in English daily				7.565	WDJ	North Africa beam, 11:45 pm to 2 am.

(Continued on page 510)

• LATEST RADIO APPARATUS •

RECORDING SOUND ANALYZER

Western Electric Co.
New York City

THE RA-281 is a sound frequency analyzer with a range of 10 to 9,500 cycles. For special requirements it can be modified to operate up to 25,000 cycles. The ranges 10 to 1000 and 100 to 9,500 are spread over a 180-degree rotation of the tuning condenser.

Analysis is by the sweep method, a synchronous driving motor being coupled to the dial so as to sweep through the frequency in question at a definite rate. The output of the analyzer is connected to the graphic recorder which traces on a chart the level of the frequency through which the analyzer dial is passing. It is claimed that it can analyze and record a pattern of sound levels extending over a band from 10 to 10,000 cycles in a period of two minutes.



The recording unit covers a range of 50 decibels on paper $4\frac{1}{2}$ inches wide and changes in input level of 58 decibels per second can be followed accurately.

The analyzer and recorder are two separate units, each with its own power supply, and may be used independently. The analyzer may also be used as a standard sound level meter, with a range of 30 to 130 decibels, the analyzer equipment being switched out of the circuit for this application.

Eleven tubes are used in the analyzer unit, 8 in the recorder.

The equipment may be used with the non-directional 630A microphone or with a special vibration pickup, which is used if the measuring range is to be extended down into the sub-sonic frequencies.—Radio-Craft

FIVE-INCH OSCILLOSCOPE

Allen B. DuMont Laboratories, Inc.
Passaic, N. J.

LARGER screen size, and the inclusion of a Z-axis amplifier to modulate the beam with any signal applied to its input, or with a return trace blanking impulse produced by the linear-time-base generator, distinguishes this Type 241 oscilloscope from previous models.

The Y-axis response is uniform from 20 cycles per second to 2 megacycles. Square wave and sinusoidal wave response also are comparably faithful.

The X-axis amplifier has a uniform char-

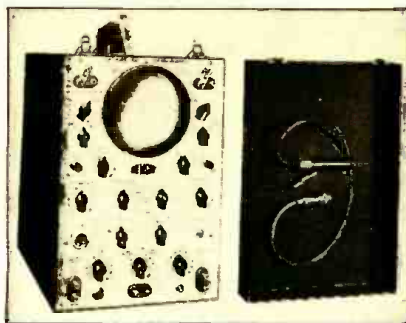

acteristic from 10 cycles per second to 100 kilocycles.

Both amplifiers have distortionless input attenuators and gain controls. Provision is made to connect signals directly with the deflection plates when frequencies to be observed are beyond the useful limits of the amplifiers.

Self-contained, operating directly off the 60-cycle, 117-volt, A.C. line, the instrument weighs 65 pounds, and measures $17\frac{1}{2}$ " high, $10\frac{3}{4}$ " wide by 21" deep.—Radio-Craft

LUXTRON PHOTO-ELECTRIC CELLS

Bradley Laboratories, Inc.
New Haven, Conn.

THESE cells are available in a variety of mountings, including prong type for standard tube sockets, threaded stud type, pig-tail wire connector type, or uncased.

The base of the cell is an iron plate with a thin layer of selenium. A transparent layer of a special alloy (which combines good electrical characteristics with desirable light-transmission qualities) is deposited, in turn, on the selenium layer.

A protective coating of lacquer helps make the cell impervious to ordinary mechanical injury. The iron base plate is also protected by a non-corroding metal sprayed over the rear surface.—Radio-Craft

TANDEM CONTROLS

Clarostat Mfg. Co.
Brooklyn, N. Y.

A PLURALITY of circuits, up to 24 if required, can be controlled by the single shaft of the No. 42 Series Control.

This requirement is often met with in electronic and radio devices, where several circuits must be controlled simultaneously. The new design permits the nesting and locking of all units into a compact stack.

The metal end discs and tie-rods hold the cases together and provide ample rigidity.

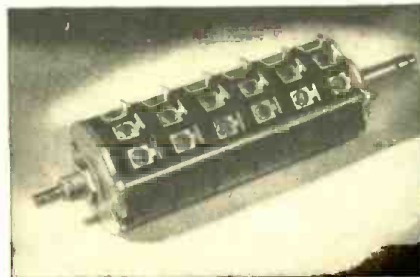

The single shaft passes through, and locks with each rotor in the stack. The finished assembly therefore is to all mechanical intents and purposes, a single-control with a multiplicity of independent sections. All units of the control of course pass through the same degree of rotation as the single shaft is rotated.

Individual units can be of any standard resistance, taper, taps, and hop-offs, to meet

individual circuit requirements.—Radio-Craft

CARBON MICROPHONE

Miles Reproducer Co.
New York City

A MATEURS remember when the carbon microphone was the only one used for general voice transmission, the newer

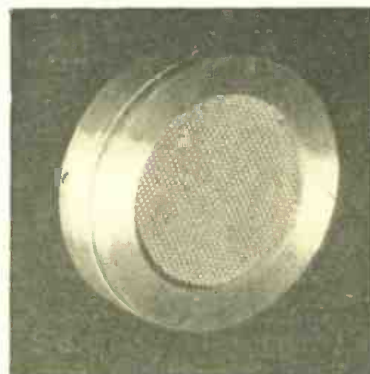

and more expensive types being employed only for music transmission in broadcast studios.

The Type M-300 is a single-button microphone of improved type, free from carbon rush. The frequency response is 70-3500 cycles. It uses up to 6 volts at 8-10 mils. Resistance 200 ohms. Outside diameter $1\frac{1}{2}$ inches, thickness $\frac{3}{8}$ -inch. Weight 6 ounces.—Radio-Craft

TELERAD FREQUENCY METER

Fred E. Garner Co.
Chicago, Ill.

FOUR models of this line are announced. All are crystal controlled, and by means of a "Class-C" harmonic amplifier circuit embodied in the unit, provide accurate fre-



quency carrier signals every 10 kc. and every 100 kc. up to 45 megacycles. A carrier signal is also produced every 1000 kc. from one megacycle to 120 megacycles. A convenient panel-mounted "on-off" switch permits use of a 1000-cycle modulated note.

Provision is made to adjust the meter with the help of some standard such as WWV, so that the accuracy of the meter may be maintained under all conditions, and in spite of temperature variations. Special models equipped with two precision crystals ground to 100 and 1000 kc., respectively, are offered. It is claimed that with these models drift can be kept to a maximum of 2 to 3 cycles per megacycle per degree Centigrade.—Radio-Craft

The SPRAGUE TRADING POST

EXCHANGE — BUY — SELL

WILL BUY — Signal generator; VTVM; late model tube tester. Ervin Johnson, 18 Westfield St., West Haven, Conn.

WILL SWAP OR SELL—Halli-crafter S-19R "Sky Buddy" and Webster 15-watt Amplifier, and other equipment. Need a scope, analyst, bridge, test equipment, or what have you? Askin Radio Service, 1107 South Main St., Paris, Ill.

RIDER CHANALYST WANTED —Also tubes, parts, tools and quality test equipment. Metairie Radio Shop, 341 Metairie Rd., New Orleans, La.

WANTED FOR CASH—ac-dc set tester; also signal generator. Give full details in first letter. Sylvan D. Snelling, 4520 N. Glebe Rd., Arlington, Va.

WANTED — Meissner de luxe signal shifter. Will trade slightly used Clough Brengle OXC signal generator for it, plus cash. Pvt. Harold N. Christianson, 602 CA (AA), 1st Bn., Hq. Btry., Paterson, N. J.

RIDER'S MANUALS WANTED—Full set. Name price and condition in first letter. Arthur Huonder, Larpenaur & East Ave., St. Paul, Minn.

WANTED—Vibrator tester, ohm-meter, G.E. ac-dc radio model L-500, also other G.E. and Westinghouse small radios. Raymond Billingsby, Radio Service, Box 236, Mound Valley, Kansas.

WANT TO BUY RECEIVER—Sky Buddy S19R, Sky Champion S20R, Howard 435A, Howard 436, or Howard 436A. Martin Redlich, Pullman, Wash.

TUBES, INSTRUMENTS FOR SALE—1 channel analyst with V.T.V.M., new condition; tubes, condensers and resistors at attractive discount; also many parts for Majestic, Philco, Eveready, Bosch, Sparton, etc. Will trade sound equipment for test equipment. Write for details, John H. Gray, Jr., Box 46, Bridgewater, Conn.

WANTED AT ONCE—Halli-crafter SX-28, SX-25, RCA 111 or any good communication receiver with crystal. R. C. Payne, 1529 West Main St., Charlottesville, Va.

WANTED — Halli-crafter, Sky Traveler, Model S-29, E. N. Story, 118 Sumter St., Providence, R. I.

WANTED—Solar BQC condenser analyzer—any condition. Irving Weinberg, 532 E. Blancke St., Linden, N. J.

WILL PAY CASH—for RCA junior Voltohmyst, State condition and lowest price in first letter. Also want a Jackson model 640 oscillator, Dick H. Hine-line, 1105 So. Milwaukee St., Jackson, Mich.

WANTED — Sprague Tel-O-Mike or other condenser checker; Radio phone recorder comb.; recorder unit cutter and motor; Halli-crafter S-20R; 6C8—6J7—68J7 tubes, new or used; Thord, tone cont. choke T14C70. Have phone amps, parts, etc. Cash or trade. What do you need? C. J. Seymour, 3110 Division St., Los Angeles, Calif.

FOR SALE — A.T.I. Television and Electronics course; one photo electric relay with 2,000 C.C.-P.E.C.; one 200-watt transformer with taps from 1.25 volts to 1,200 volts -0-15 m.a.; a few tubes, chokes and other equipment. Leon Latham, 1016 N. Everett St., Streator, Ill.

VOLT-OHM — M.A. METER WANTED—Urgently needed at air base. Quick sale for meter in good shape. Joseph A. Warm, A.R.T. c/o U.S.N.R., Sanford Naval Air Station, Sanford, Florida.

FOR SALE—Weston-Jewell model 444 two-meter analyzer, \$35; Weston-Jewell model 562 test oscillator, \$30; Rider's Volumes 1 and 2, \$7. All practically new. Max Strauss, 11118 Clifton Blvd., Cleveland, Ohio.

TUBES OFFERED—Wide assortment of tubes in original cartons; also good used tubes and parts for many make sets — converters, motors, etc. Want 12SA7—12SK750L6—Oscilloscope; Rider's Manuals, Stephenson's Radio Service, 1307 H St., N.W., Washington, D. C.

Your own ad run FREE!

The "Trading Post" is Sprague's way of helping radio servicemen obtain the parts and equipment they need, or dispose of the things they do not need during this period of wartime shortages. Send in your own ad today—to appear free of charge in this or one of the various other leading radio magazines on our list. Keep it short—**WRITE CLEARLY**—and confine it to radio items. "Emergency" ads will receive first attention. Address it to:

SPRAGUE PRODUCTS CO., Dept. RC35
North Adams, Mass.

TUBES WANTED—50L6, 35L6, 3526, 12SA7 and 12SQ7. Will pay full list prices, or send list of tubes needed so we can exchange. Granger Radio Service, 62 Spring St., Rochester, N. Y.

WANTED URGENTLY—4½" fan-shaped O-1 Ma. meter; cash. Will sell or swap 1—HY40, 3—T55 transmitting tubes. Spears Radio Service, 901 So. Fort Harrison Ave., Clearwater, Florida.

RIDER'S MANUALS WANTED—Volumes 1 to 12. State price and condition. John R. Westberg, R. D. No. 1—Box 81, Laveen, Arizona.

METERS TO SELL OR SWAP—Supreme model 90 ac-dc analyzer and model 19 tube checker; Jewel model 85 dc analyzer and 0-3-15-150 ac VM, excellent for panel board. All meters, shunts, multipliers in A-1 condition. Need Precision Apparatus E-200 signal generator. What do you offer? Robert Blackmar, 991 Sacket Ave., New York, N. Y.

WANTED — Rider's manuals, complete set or separate copies; Rider chanalyst or other good make of signal tracer. Bradley D. Haskell, Youngstown, N. Y.

WANTED—New or used table model ac or ac-dc radios; also batteries and 3525 tubes. What have you? Will pay cash or trade some tubes. Lee Amusement Co., L. & H. Radio Co., Shellman, Ga.

WILL EXCHANGE — Earphones and code keys (3 of each) for 0 to 1 mil. or 3525 tubes, or what have you? All letters answered. Weir Cove Radio Service, 508 Garden Way, Weir Cove, W. Va.

FOR SALE — 400-watt E.C.O. XTL, Phone and C.W. Transmitter—\$250; 2 RK20 tubes—\$6 each; Weston 50 m.a. dc 301 meter—\$4.50; 1 used 2-speed Green flyer motor and XTL pick-up—\$12; 6 2MF 2000 W.V. paper condensers—\$1.50 each; 6 1MF 2000 W.V. paper condensers—\$1.00 each; 25 2MF 200 W.V. paper condensers canned—15c each; 1 wood lathe—\$12. All F.O.B., 1 week's trial. Al. R. Daves, 1418 —81st St., Brooklyn, N. Y.

WANTED — No. 739 Triplett V.O.M. to go in pocket tester. Crossno Radio Service, Route 2, Paris, Ark.

WANTED—Condenser tester Solar model CC or CB, for cash; also D.B. meter. Henry Gombyeski, 22 Manuel Ave., Johnston, R. I.

THESE ARE THE LATEST SPRAGUE STYLES

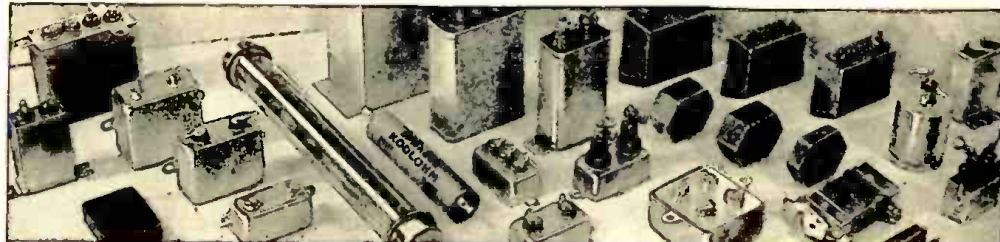

Here are some of the Sprague Condenser and Koolohm Resistor types being supplied in tremendous quantities for war requirements. Many of these represent outstanding engineering achievements which will be reflected in Sprague radio service and industrial components for post war needs.

Meanwhile—as always—you can count on Sprague Condensers for today's radio service needs. Busy as we are with war work, we're also doing our level best to keep you supplied with Atom Midget Drys, TC Tubulars and other types needed to keep radios working on the home front. Ask for them by name!



SPRAGUE
PRODUCTS CO.
North Adams, Mass.

SPRAGUE CONDENSERS AND KOOLOHM RESISTORS

ELECTRON-RAY TUBES FOR THE BEGINNER

By ERIC LESLIE

THE student or experimenter who feels he has mastered the subject of vacuum tubes may feel he is up against a new set of problems when he is confronted with the electron-ray indicator tubes, such as the common 6E5. They do not seem to be related in any way to the tubes he has been handling. Amplification, transconduct-

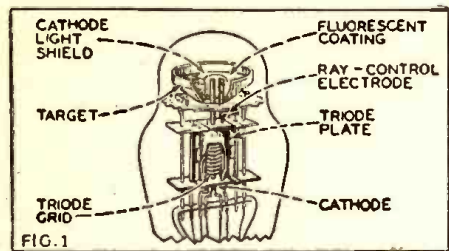

FIG. 1
Cut-away view of a characteristic electron-ray tube. Control electrode can be seen rising from top of plate assembly.

ance and such terms appear to have no meaning when applied to them. As far as he knows, they exist merely—in some mysterious way not related to ordinary tube operation—to wink an eye.

This is not the case. Electron-ray indicators, as this group of tubes are called, are ordinary tubes with a few added features. Later in this article, we will build a one-tube receiver with one of them. If such points as amplification factor and transconductance are not mentioned in the characteristics chart, it is because we are not as much interested in these features as in others. The difference between sharp cut-off and remote cut-off, which distinguishes tubes as much alike as the 6K7 and the 6J7, is very important to electron-ray tubes, and divides them into two main classes, the 6E5 representing the sharp, and the 6U5/6G5, the remote cut-off type.

CONSTRUCTION

If you can get one of these tubes and break it up, you will find that near the base it appears to be an ordinary triode. Cathode, grid and plate are all there. At the top of the tube there is a dish-shaped element called the target, which we recognize immediately as the part which produced the beautiful green glow characteristic of these tubes. We note also that the cathode is long enough to project up into this section, and that there is also a projection from the plate. Fig. 1 is a breakdown of the 6E5, and names all the parts.

HOW IT WORKS

The triode section of the tube works like any other triode. A positive increase of voltage on the grid increases the plate current and a negative increase decreases it. The increase or decrease of plate current is used to widen or narrow the shadow on the green target in the top of the tube.

The top section of the tube is also a triode, in which the target becomes a new plate and the plate of the lower triode is the grid. More correctly, it is the small projection from the top of the plate, which extends up to the top of the cathode, and is

called the control-electrode, which acts as the grid. The cathode is common to both sections of the tube (Fig. 2).

Electrons from the top end of the cathode are attracted to the target, as they are to the plate in the lower section of the tube. The target is coated with a fluorescent material which glows with a green light when struck by electrons. If it were not for the control electrode, all portions of the target would glow equally. If the control electrode is at the same voltage as the target, this is just what happens. If the voltage on the control electrode drops much below the target, electrons will try to avoid it and will spread away from it, following the greater attraction of the highly positive portions of the target which are not shielded by the control electrode. This leaves a V-shaped space behind this electrode which receives no electrons, does not glow, and forms the familiar "shadow" on the tar-

get. As the difference between the voltage of the target and control electrode becomes greater, the wider grows this shadow, reaching a maximum of 90 or 100 degrees in ordinary receivers.

CONTROL

The method of control is simplicity itself, and shows how ordinary a vacuum tube the electron-ray indicator is. The

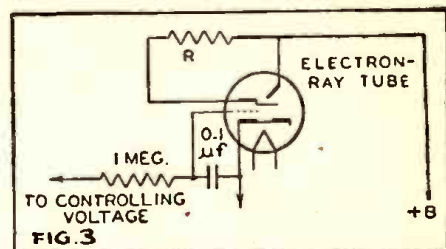

FIG. 3
Circuit of the electron-ray tube. R is usually about one megohm in resistance.

target is connected to the high-voltage source, and its voltage remains constant. The plate (and control-electrode projection) are connected to the target through a 1-megohm resistor. If there is no plate current, the voltage of the target and plate is the same. Any current drawn by the plate must flow through the 1-megohm resistor (R of Fig. 3). A current flowing through this resistor will cause a voltage drop which increases directly as does the current, making the control-electrode increasingly negative as compared with the target.

The plate-current can be increased or decreased by varying the grid voltage, as in any other tube. The 6E5 is so designed that with a grid-to-cathode voltage of -8 (target voltage 250) the shadow will disappear. When the grid voltage rises to equal that of the cathode, the plate current is increased to a point where the resulting shadow angle is 90 degrees. The electron-ray tube is as simple as that!

HOW TO USE IT

The method of varying the grid voltage depends on the use we want to make of the tube. Its most common application is as a tuning indicator on radio receivers. Attaching such a tube to an old receiver is not difficult. If the detector tube is a diode (or a combination tube with a diode) the attachment is a matter of detail. If a triode tube is used as detector, the first step is to substitute a diode, then proceed with the ray-tube.

Fig. 4 shows the connection of an electron-ray tube to an old set. Since the flow of electrons across the two resistors between the bottom of the I.F. winding shown makes the line marked "to A.V.C." more negative as the strength of the signal increases, it is only necessary to attach the electron-ray tube grid to the same point to have a voltage that varies according to the strength of the station tuned in.

In some sets the A.V.C. voltage is taken from one of the diodes through a separate resistor, as in B of Fig. 4. In this case we

6E5 CATHODE-RAY TUNING TUBE

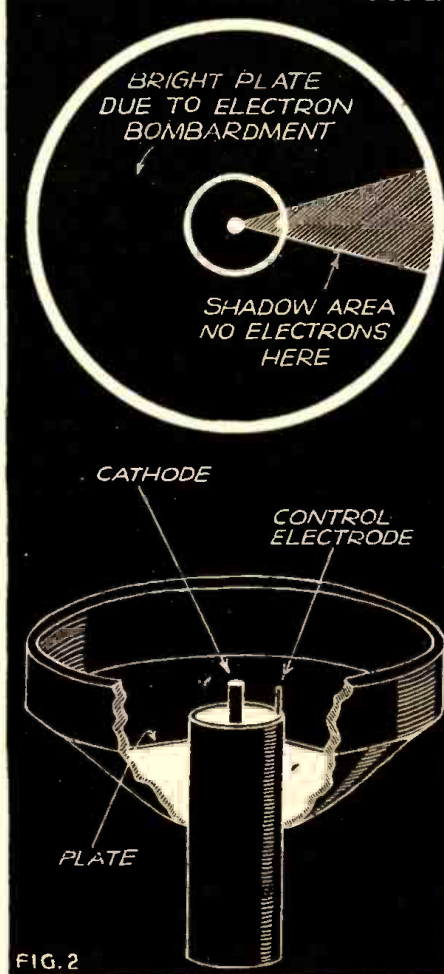
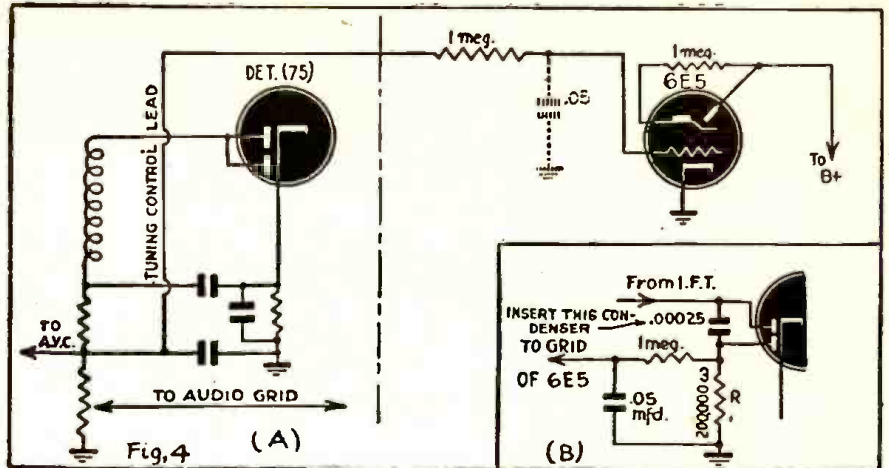

FIG. 2
Top half: Shadow partly closed. Bottom half: Cathode and control electrode.

still try to attach to the line that goes out to the grid returns of the R.F. and I.F. tubes. In some cases it is convenient to separate the two diodes with a small condenser and use one of them for the tuning indicator. This is especially true when some of the parts are located in inaccessible places. The values of resistors and condensers shown at B will be suitable for such a circuit.

If the tuning-indicator follows the signal too closely—widens and narrows with strong and weak signals—it may be advisable to install a condenser as shown in the dotted lines. This condenser will act as a "flywheel" charging up on the strong peaks and discharging when little voltage is applied, and will tend to keep the grid of the 6E5 at a voltage equivalent to the average signal voltage impressed.



How an electron-ray indicator may be attached to an old set. Fig. 8. shows a separate circuit for the tube.

REMOTE CUT-OFF TYPE

If the set is a large one, with very high A.V.C. voltages, it may be advisable to use a 6U5/6G5 instead of the 6E5. With a target voltage of 250, a bias of -8 volts on the 6E5 grid will close the shadow angle. Under the same conditions, a grid voltage of -22 is necessary to close the shadow angle on the 6U5. The 6AB5/6N5 can be used on A.C.-D.C. sets with 0.15 ampere filament tubes. Its characteristics are more like the 6U5 than the 6E5.

OTHER USES

The electron-ray tube has many uses other than that of tuning indicator. Before we go into these however, look at the diagram of a one-tube receiver, using a 6E5. The experienced constructor will note that it is a standard regenerative circuit. SW2 is provided to short the resistor between target and plate, giving more plate voltage for weak signals. With this resistor shorted, there is no voltage drop between target and plate, and consequently no tuning-indicator effect.

Fig. 5 shows all the constructional details very clearly. The original coil (L1, L2) was an iron-core inductance with some of the turns of L2 removed to avoid excessive oscillation, but any standard R.F. coil will work. Remember also that the triode section of many electron-ray tubes is still good after all the fluorescent material has been burned off the target. As far as reception of signals is concerned, a discarded tube will in many cases give as good results as a new one. Have your tube checked for emission.

A new tube will give you tuning-indicator effect as well as reception. Using a long aerial (100 to 200 feet) well up in the

air, local stations should close the eye 1/4 inch or more.

USE IN TEST INSTRUMENTS

The ray-tube has been used in a number of circuits, such as condenser analyzers and vacuum-tube voltmeters. The instrument is

so designed that the electron-ray tube is across a Wheatstone bridge. A sufficient voltage applied causes the bridge to be thrown off balance and a voltage applied to the grid which closes the shadow. Balance is restored with a variable resistor, to the shaft of which a pointer is attached. This pointer moves over a scale which may be calibrated in volts or ohms or microfarads, according to the type of meter.

A simple capacity-measuring device is shown in Fig. 6. R forms two of the arms of the bridge; the standard condensers C1, C2 and C3 is one of the other arms, and the fourth is the unknown capacity itself. Alternating current is supplied to the two junctions A and B, and the tube is connected across the two other junctions, C and D.

Assume that we have a voltage of 50 across AB, the switch on the center arm, and a condenser of exactly 0.1 mfd inserted at the binding posts X. As the voltage

drop across the two 0.1 mfd. condensers will be the same. Point C will remain about 25 volts from either A or B. Now if we move point D (the center arm of potentiometer R) exactly to the center of R, D and C will be at the same voltage, and the shadow on the 6E5 will open to its maximum.

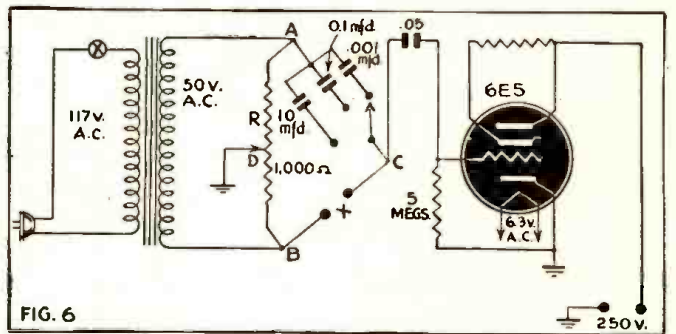

This capacity measuring circuit follows the principle of the Wheatstone bridge. It is practical and easy to construct.

A slight movement of potentiometer arm D will permit enough voltage to reach the 6E5 grid to close the shadow.

This "capacity analyzer" will measure condensers from 100 micro-microfarads to 100 microfarads with fair accuracy, depending largely on how carefully it has been calibrated and upon the accuracy of the condensers chosen as standards. The potentiometer R should be a "linear" type, with no taper, or calibration will be irregular.

(Continued on page 510)

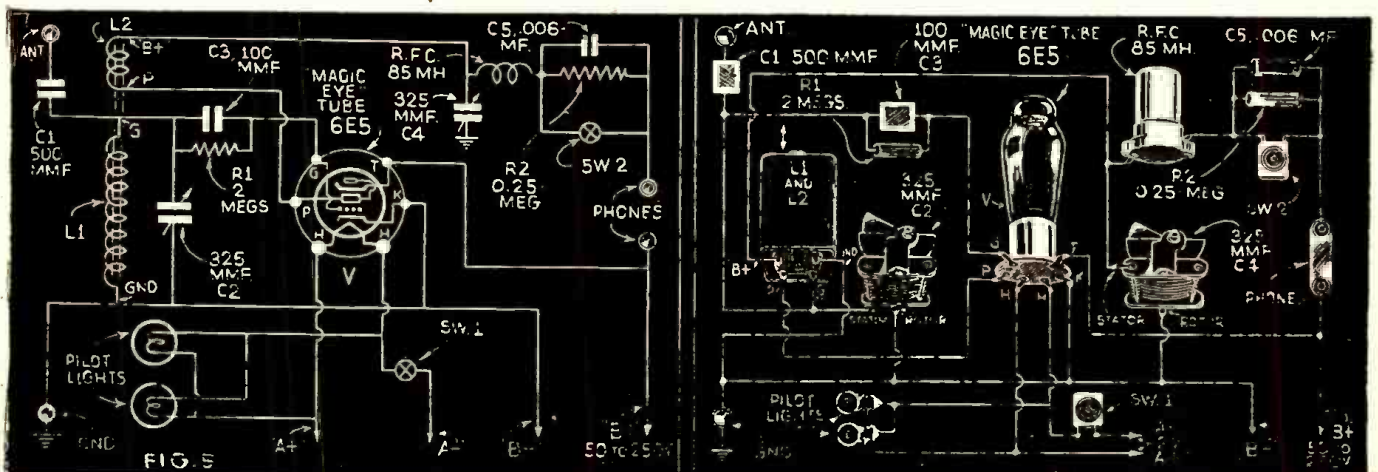

This unusual receiver was named the "Cyclops," because of its one eye, which the constructor mounted in the center of the panel. Its efficiency is not noticeably different from that of any other single-tube triode receiver.

POWER SUPPLIES FOR CLASS-B AMPLIFIERS

By KARL E. SCHUBEL

If the beginner runs into difficulty when building a high-fidelity amplifier or a multi-stage receiver, it may be due to insufficient, or unstable, power supply. Some of the principal points regarding stable power supplies are given here.

BY heavy-duty power supplies we mean those which supply power to high-quality amplifiers using the 2A3 or the 6L6, or to Class B amplifiers.

These high-quality amplifiers require heavy currents (usually 150-mils for the

output stage alone), and they need that current without corresponding fluctuations in plate voltage. The maintenance of this steady flow of power is called *regulation*.

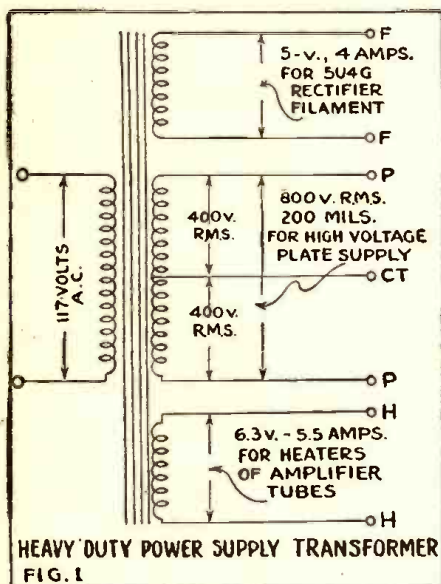

output stage alone), and they need that current without corresponding fluctuations in plate voltage. The maintenance of this steady flow of power is called *regulation*.

REGULATION

If an attempt is made to operate a heavy-duty amplifier from an ordinary power supply the results would be disappointing (especially when the volume control is turned up and only distortion resulted), and might even be disastrous, if the rectifier and filter circuit were overloaded enough to heat up to a high degree. Such operation is due to poor regulation, which in turn means poor judgment in trying to operate something big with something small, and not suited to the task.

SELECTION OF COMPONENTS

As outlined in a previous article on power supplies, the procedure to follow is to add up the currents in all the amplifier tubes at full load. For example, two 6L6's in the output, at 250-volts draw about 156-mils. Two triodes, in preceding stages, would take 5-mils each, maximum.

This totals up to 166-mils. Since the 80 rectifier is good for only 125-mils, it is ruled out. The next nearest size tube would be the 5Z3, or a 5U4-G, which is rated 225-mils at 550-volts RMS, with choke-input type filter-circuit. This tube assures plenty

CHOKE INPUT FILTER

In this type of filter the rectified current passes directly from the rectifier filament (or heater), to the first filter choke. No filter condenser is used. The reason for this is that the surge of voltage is slowed down by the inductance of the choke, and this is where regulation begins. (See Fig 2).

Usually two filter chokes are used. The first one is called a "swinging" choke, because its inductance varies (with the current going through it), from a low value (about 5-henries) to a top value (usually about 20-henries).

This is achieved by winding the coil on a smaller core, and with a smaller air-gap, than with the conventional choke. As a result, when current increases, the core saturates to some extent, and the inductance drops. Such chokes must be very carefully designed to be effective.

The second choke is a standard filter choke, which operates more or less with a middle value of inductance. It does not have to deal with extreme surges, since the swinging choke has smoothed down the ripple considerably. The purpose of the filter choke is simply to approach a direct-current output by reducing the ripple to an unobjectionable amount. It must have the proper current rating of course. (In this case, 250-mils.) The swinging choke likewise. Thus full power will be assured at the output of the filter.

MERCURY VAPOR RECTIFIERS

These tubes (such as the -83) were developed to meet the needs of power supplies for Class B amplifiers. They have a low internal resistance (owing to the ionization of the mercury vapor molecules) and therefore have a low internal voltage drop (about 15-volts, as compared to 75-volts in the 80 type rectifier).

The 83 is susceptible to damage if required to supply full current before the filament is thoroughly heated. For this reason it is not fitted to work with direct-heated cathode tubes like the 2A3, 6A3, etc. This weakness led to the development of another type of heavy-duty rectifier tube.

The newer high-current, low-resistance rectifiers have an indirectly-heated cathode capable of supplying a large flow of electrons. The internal resistance of the tube, and hence its internal voltage drop, is kept low by reducing the space between the cathodes and plates to a minimum. The 83 and 5V4 are typical of this kind of rectifier.

With choke-input filtering they supply ample current with steady voltage, thus meeting the needs of the Class B amplifier, in which large surges of current take place, without corresponding fluctuations in plate voltage.

VOLTAGE REGULATOR TUBES

Where a heavy duty power supply is used with a large receiver, or one with

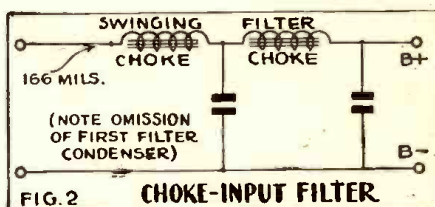

The choke input gives a lower output voltage for a given transformer, but with far better regulation.

a high-fidelity output, special tubes (gas filled) are used to stabilize intermediate voltages to the screens and plates of some of the stages.

There are four sizes of these tubes in common use—the VR75-30, VR90-30, VR104-30, and the VR150-30.

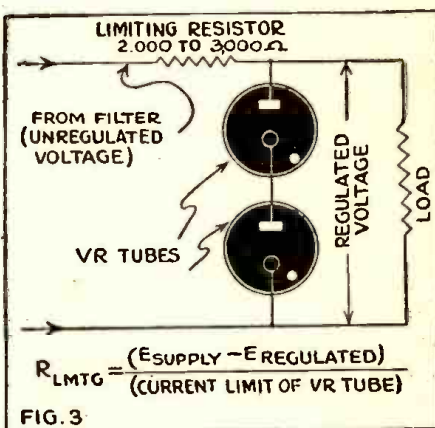

These tubes must be operated within rated current limits.

How stabilizing tubes are hooked up. Limiting resistor prevents damage to tubes by excessive current.

The designation number of the tube tells its function and its voltage and current values. For example, VR150-30 means: "Voltage Regulator Tube; operating voltage, 150; operating current, 30 mils maximum."

These tubes are connected across the intermediate voltage tap and the B- of the power supply voltage divider. Or if used to stabilize an entire power supply output, would probably have two of the VR150-30 type in series across the output. (See Fig. 3.)

These tubes are also finding wide application in electronic devices of all sorts, which are used for measurement, counting, grading, controlling, indicating, and in making and reproducing sound motion pictures.

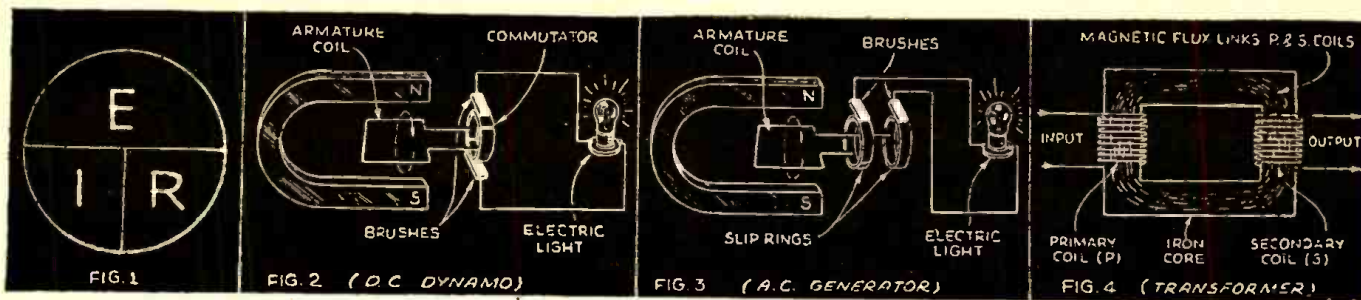

WHAT YOU SHOULD KNOW ABOUT VOLTS AND OHMS

THE beginner has noticed that whenever he hears the word *current*, he is likely to hear very shortly the word *voltage* or *resistance*. It is no haphazard accident that these terms are grouped together, and no accident or coincidence that a discussion of one usually involves the other two. Current, voltage and resistance are directly related—for if we know any two of these terms, we can always find the third through the use of a very simple, but exceedingly important formula known as *Ohm's law*. Briefly stated, Ohm's law (named after the man who first formulated it) is:

$$E = I \times R \quad I = \frac{E}{R} \quad R = \frac{E}{I}$$

Since it would be very cumbersome to write out the words—voltage-current-resistance in the formula, we simply substitute alphabetical letters for them. Thus, for example, we let the capital letter E stand for voltage; I for current (in amperes) and the letter R for resistance (expressed in ohms).

We need not make any effort to memorize this simple formula, since there is a very easy way of remembering it. Simply draw a circle, as shown in Fig. 1. Draw a horizontal line through the center, cutting it into two halves, then cut the lower half into quarters, and put in the letters E, I and R as shown. Using the Ohm's Law Circle is easy. To find the voltage, cover the letter E at the top of the circle, and you have the answer, I times R. If we wanted to find the resistance, we would just cover the letter R with a finger and the answer would be E over I. To find the current, we would cover the letter I and the answer would be E divided by R (or E over R).

At the close of the previous lesson we discussed *alternating* and *direct* current—now let us see how these currents are made.

HOW CURRENT IS PRODUCED

We have already seen (Lenz's Law in

Modern Speech, February) that a permanent magnet has a magnetic field about its poles. It was also shown that if we took this permanent magnet, and plunged it in and out of a coil of wire, a galvanometer connected to the coil would show a reading. If, instead of moving the magnet in and out of the coil, we moved the coil and kept the magnet still, the result would be exactly the same. Here, then, we have the basic idea for generating current . . . simply take a permanent magnet and revolve a coil of wire around it.

In Fig. 2 we see the elementary principle of the D.C. dynamo. We are already familiar with our old friend the permanent magnet. The part labeled "armature coil" is nothing more or less than a coil of wire. This coil of wire is mounted on a shaft. The shaft is not shown in the drawing since it is purely a mechanical feature and need not concern us here. When the armature coil of wire starts to revolve between the poles of the magnet, a current of electricity is generated in the coil. However, the current in the coil would be of no use to us, unless we could in some way draw it off and put it to use. This is done by connecting the armature coil (as shown in the sketch) to a *commutator*. The commutator in its simple form is a copper ring, the two halves of which are separated by a bit of insulating material. Since the commutator is connected to the armature coil, it rotates with it. In order to utilize the current in the rotating commutator, we place brushes of copper mesh in contact with the commutator. We can now light up a lamp by connecting it across the commutator brushes. To sum up—a D.C. dynamo may be simply a coil of wire moving in a magnetic field, plus a provision for leading the current away from the moving coil by means of sliding contacts.

The generation of *alternating* current follows the same principle, except that two *slip rings* are used to draw off the current instead of using a commutator (shown in Fig. 3). Naturally, the generators we have

shown are the simplest types imaginable. Modern generators do not use permanent magnets, but use relatively soft iron over which are wound coils of wire (carrying current) to produce the magnetic effect. The amount of voltage and current that we can get out of our generator depends upon the strength of the magnetic field, the size of the wire, the number of turns that constitute the armature coil, and the speed with which we rotate the armature coil.

TRANSFORMER ACTION

Now that we have produced alternating current by means of an A.C. generator, there are a number of things that we can do with this current. We can put the current through a coil and get a magnetic field; and if we place another coil near to the first one we will get our current back again. But we have already learned that iron is a much better conductor of magnetic lines of force than the surrounding air. If then we would provide the magnetic lines of force with an "iron" path instead of an "air" path, we would get a greater transfer of energy. At this point, let us no longer call the coils of wire "first" coil and "second" coil, but rather "primary" coil and "secondary" coil. (Fig. 4.)

So far the primary and secondary have had the *same* number of turns. But suppose that we made the *secondary* coil with *twice* the number of turns that it had before. We would then find that the voltage across the secondary would be doubled. If we tripled the number of turns in the secondary coil we would get triple the voltage. Fig. 5, using conventional radio symbols, shows a simple transformer connected across an A.C. generator. If our generator were designed to deliver 110 volts, we could get 220 volts in the secondary by simply winding that secondary coil with twice the number of turns that the primary coil has. Thus we can increase our voltage, but we do so at the expense of our current, which becomes reduced.

(Continued on page 503)

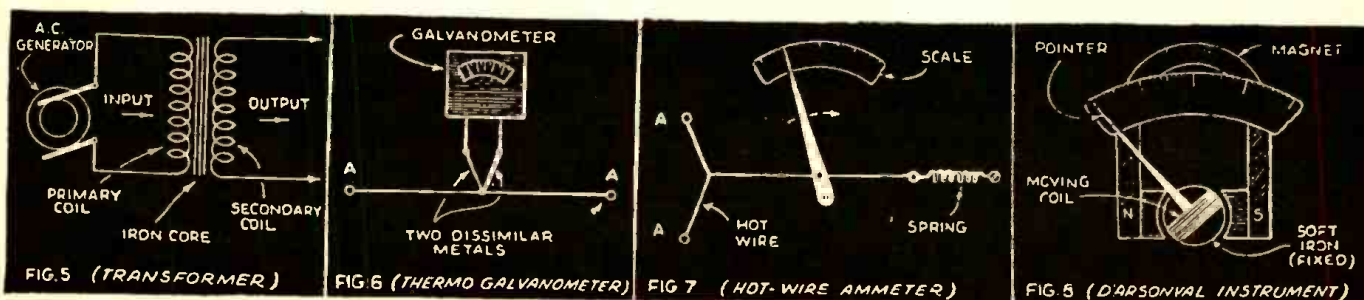

RADIO METER REPAIRING

(Continued from page 465)

No attempt should be made to remove the mechanism from between the openings of the magnet. This generally requires recharging of the magnets and realignment of the whole frame assembly.

RE-BALANCING

If the pointer has been thrown off balance by severe jar or overload, it may be rebalanced by adjusting the small spring adjusting weights on the brass cross arms.

The exact nature of the adjustment depends on the design, in some cases the weights slide along the arms. Others use a

screw type threaded arrangement.

Use the tweezers to hold the small spring weights and adjust them on the balance arms. The two arms at right angles to the pointers are for side balance. After adjusting the pointer to zero position with the meter in a horizontal position, by means of the zero adjustment, turn the meter till the pointer is in a vertical position, and adjust the side weights till the pointer is correctly on zero. Now turn the meter again till the pointer is in a horizontal position and adjust the tail weight to bring it again correctly over zero. (See Fig. 2).

Before placing the mechanism back on the base and in the case, make certain that all the parts are clean and free from dirt and dust particles which may lodge in the movement. When mounting the case, make certain that the small zero adjusting screw in the lower portion of the case front is in such a position as to engage the fork-shaped section attached to the upper spring support.

Milliammeters and ammeters can be compared with "Good" meters by connecting the two *in series*. Voltmeters and kilovoltmeters are compared with "Good" meters by connecting them *in parallel*.

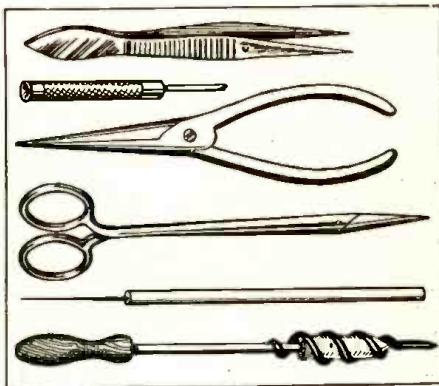

The tools required for meter work are easily improvised or obtained watchmakers' or surgeons' supplies.

These instructions deal with meter troubles in which the springs and moving coils are in good condition—in other words, those in which the movement is not "burnt out." This latter class of meters may also be repaired, if the necessary replacement parts are available. The work requires much more skill and can be done *only if the proper equipment is available*. The serviceman who has attained a considerable amount of skill in meter work may wish to attempt this kind of work. The next article in this series will tell him how to proceed.

(This is the first of a series of two articles. The second will appear in the June issue.)

CONVERT THE AUTO RADIO TO ELECTRIC OPERATION

(Continued from page 466)

higher. The speaker field may then be inserted in place of the filter choke, bringing the voltage down to the level required for satisfactory operation, and solving the speaker field problem at the same time. A typical conversion job of this type is shown in Fig. 2.

THE SYNCHRONOUS VIBRATOR

The older auto radios all used low-voltage vibrators and a tube to rectify the A.C. from the high-voltage secondary. Most modern sets use the same system. There was a time when the "synchronous vibrator," which rectified the high-voltage A.C., was very popular. These sets have no rectifier tube, and it is necessary to install one.

Method 2 of converting will be found

YOUR MONEY BACK!

... if Ghirardi's Big, 972-page RADIO PHYSICS COURSE doesn't teach you Radio faster, easier and at less cost than any other book!

STOP WISHING FOR A BETTER JOB

... Study This Book and Get One!

Are you one of the thousands of men who'd like to learn Radio, but can't seem to make up their minds just what to do, or how to get started for a profitable, interesting career? If so, this is your opportunity! Ghirardi's famous RADIO PHYSICS COURSE book is exactly what you need to teach yourself right from the ground up, at home in spare time. It's the easiest, quickest, and most inexpensive way of getting started. That's why it has given more people their basic training than any other book ever published. That's why it is used in more U. S. Army Signal Corps, Navy, and civilian schools and colleges, and for more home study, than any other radio text book of its kind. Would you want any better proof than this?

EASILY WORTH \$50 IF YOU BOUGHT IT AS A COMPLETE COURSE

WHAT ABOUT ELECTRONICS?

You've probably been reading a lot lately about the tremendous Post-war future in the amazing Electronic industry. But did you know that the so-called "radio" circuit is the basis of practically all Electronic developments—and that a knowledge of Radio fundamentals such as is given in RADIO PHYSICS COURSE is your "Open Sesame!" to this vast new industry, as well as to Radio itself?

LEARN RADIO

at Home in Your Spare Time

and for Only \$5 COMPLETE

Starting right at the beginning, Ghirardi teaches you, step by step. He takes nothing for granted. He explains every last detail so that it is crystal-clear before you go on to the next. Because of this thoroughness, RADIO PHYSICS COURSE is a large volume—far larger than any other book of its type. Actually, it gives you the scope of 36 different courses in one, packed into nearly 1000 pages, made easily understandable by more than 500 special illustrations, and containing 856 self-testing review questions. Get started NOW for a fascinating Radio-Electronics future in industry, in the Signal Corps, Navy, Aviation, commercial broadcasting, television, in a business of your own, or in any one of the many other branches. Mail the coupon today! Our 5-day MONEY-BACK Trial offer enables you to examine this great book without ASSUMING ANY RISK WHATSOEVER!

RADIO & TECHNICAL PUBLISHING CO., Dept. RC-53
45 Astor Place, New York, N. Y.

Rush me a copy of your big 972-page RADIO PHYSICS COURSE book. \$5 enclosed (\$5.50 foreign).

Send C. O. D. for \$5 (\$5.50 foreign) plus postage.

In either case, I may return the book within 5 days for refund.

Name _____

Address _____

City _____ State _____

COMPLETE BASIC RADIO TRAINING in one big volume!

the best for such cases. If there is a spare 5-volt winding on the transformer used, an 80 or 5Y3 can be used. If it is inconvenient to supply 5 volts, a tube like the 6X5 or 84 can be operated off the same filament line as the other tubes. If Method 1 is used, the rectifier filament may be operated with the others in the set, from the 6-volt winding which supplies all the power. A gas rectifier—which requires no filament winding—may

spring. Certain types have a flat nickel-plated bronze spring in the form of a loop with a little less diameter than the outer edge of the element. This is held clear of the element by spring tension and pressed down to make contact at various portions by the action of a pad on the end of the rotor arm. The only thing necessary here is cleaning by the previously described procedure, making sure to follow when dry by a small spot of vaseline on the side of the contact spring which carries the rotor arm. It is hardly necessary to point out that care should be taken not to get too much vaseline into the unit.

It is advisable on these units to inspect

the rivet which fastens the spring to the frame of the control. This customarily mounts the terminal lug on its other end. Should this be loose it will result in noisy or intermittent operation. If inspection shows this to be the case, do not attempt to rivet tighter. The usual result of these efforts is a cracked case. Solder both sides of the rivet, using the least possible amount of solder and carefully cleaning away excess flux.

POLISHING

When the various parts of the volume control are thoroughly dry take an ordinary
(Continued on following page)

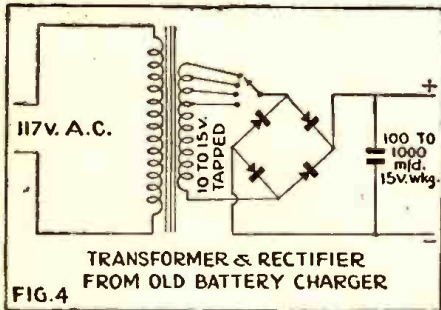

TRANSFORMER & RECTIFIER FROM OLD BATTERY CHARGER

be used, if preferred. (A standard "sync" circuit is shown in Fig. 3.)

OTHER METHODS

Many owners have toyed with the idea of supplying the receiver with 6 volts D.C., obtained by rectification from the A.C. lines. This would be an almost ideal method, as it would call for no changes whatever in the receiver.

A circuit for such a conversion is shown in Fig. 4. This method is feasible only where an old battery charger (tube or dry-plate type) is available. Otherwise it would be much more expensive than either of the previous two methods. A good-sized condenser across the output, together with the primary of the vibrator transformer, will do all the filtering necessary.

One advantage of this system is that the 6-volt speaker can be used without any changes.

Where 110 volts D.C. is the only current available we have a straight A.C.-D.C. conversion job, with the filaments connected in series, etc. There is no difference in procedure in converting any other A.C. set. Servicemen in D.C. areas usually have had considerable experience with such jobs, and any instructions here may be superfluous.

The same applies to advice on installation, mechanical modifications, etc. The electrical change is only half the job. The set will in most cases have to be put in a cabinet, the dial shafts lengthened, and other little jobs done. These are details, but should on no account be neglected. The final appearance and convenience of the set will contribute in no small measure to your enjoyment of the finished job.

HOW TO SERVICE VOLUME CONTROLS

(Continued from page 467)

nomical. Some type controls have a separate tiny washer with a polished surface on one side and a small hole bored through the center as a contact shoe. The rotor arm of this type has a pointed flat spring on the insulating disc which fits into the hole of this washer, thus moving it around on the element. With this type, insert the point of a penknife into the hole of the washer and rotate the blade once or twice, thus insuring a good contact between the washer and

JUST OUT!

3rd Edition of Ghirardi's RADIO TROUBLESHOOTER'S HANDBOOK

STOP GUESSING ON RADIO SERVICE JOBS!

Every Wasted Minute Costs You Money!

Here is the most important book any service shop or individual can own during these critical times—bar none! Enables you to cut corners—save valuable troubleshooting and repair time—train new technicians—repair cheap sets at a real profit—handle tough jobs in half the usual time—and much more. Now in its 3rd Edition, completely revised, bigger than ever, and CONTAINING NINE ADDITIONAL SECTIONS OF VITAL NEW MATERIAL.

It's 404-page Case History Compilation gives common trouble symptoms, their causes and remedies, for over 4800 models of the 202 most popular makes of receivers. Often, these entirely eliminate the need for testing. ALMOST ALWAYS, they save from 25% to 50% of the time you would normally require to repair a set.

NOW COVERS 75 IMPORTANT SUBJECTS

This feature, however, is ONLY ONE OF 75 IMPORTANT SUBJECTS covered in this brand new HANDBOOK. Never before has such a wide variety of useful servicing information been presented so authoritatively within the covers of a single inexpensive volume! There are scores of charts, graphs, etc.—all designed to HELP YOU REPAIR MORE RADIOS EASIER AND IN LESS TIME! There are I-F alignment peaks for over 20,000 super-hets; a big data section on I-F transformer troubles—AND THE MOST UP-TO-THE-MINUTE TUBE CHART you've ever seen containing complete information on EVERY tube type and with dozens of practical tips on how the types may be interchanged or replaced by more readily available types. Dozens of other charts, tips and holds make this RADIO TROUBLESHOOTER'S HANDBOOK absolutely indispensable to busy servicemen at a time when test equipment is scarce, when parts often have to be substituted, and when it is more necessary than ever before to have COMPLETE SERVICE REFERENCE DATA at your fingertips.

EXAMINE IT FOR 5 DAYS!

Sold for only \$5 on an ABSOLUTE 5-DAY MONEY-BACK GUARANTEE BASIS. Order your copy today while the available supply lasts. Your money will be cheerfully refunded if you don't agree within 5 days that this book is the finest service investment you can possibly make!

RADIO & TECHNICAL PUBLISHING CO., Dept. RC-53
45 Astor Place, New York, N. Y.

Rush me a copy of the new 3rd REVISED Edition of your RADIO TROUBLESHOOTER'S HANDBOOK.

\$5 enclosed (\$5.50 foreign)

Send C. O. D. for \$5 (\$5.50 foreign) plus postage.

In either case, if I am not fully satisfied, I may return the book within 5 days of receipt for full refund.

Name

Address

City State

**ALFRED A. GHIRARDI'S
BIG, WARTIME
SERVICE HANDBOOK**

The Data Book That Pays
for Itself in Time Saved on
the Very First Job

Only \$5 Complete

MONEY-BACK GUARANTEE... You Cannot Lose!

HOW TO SERVICE VOLUME CONTROLS

(Continued from previous page)

pencil eraser, or better, a pencil equipped with an eraser, and rub the parts of the slip ring or wipers which bear on one another. This will result in a bright polish without scarring the surface of the metal. *Never use sandpaper.* When sufficiently bright, use the paintbrush again to remove all traces of rubber dust which may remain in the case. It is advisable at this time to increase the tension of the various springs by a little judicious bending, care being taken not to bend too far or hard as to cause excessive pressures which may result in undue wear.

Next apply a small amount of vaseline to the sliding portions of these contacts, *with the exception of those which contact the element.* Never use oil or graphite grease,

since the first cannot be depended on to stay where it belongs and the second contains a conducting substance.

ASSEMBLY

Reassembly is merely a reversal of the process of taking apart with the exception of the split washer which is simply pushed into place and squeezed shut with a pair of pliers.

It must be borne in mind that the instructions given above have been kept general in order to give a wider scope of application. Any differences in structure of the above described controls should only require the application of that well-known American commodity, horse-sense, to solve with results satisfactory to all concerned.

SERVICING NOTES

(Continued from page 470)

trolytics of the small tubular style in series, plus to minus, with the free ends of proper polarity connected to the rectifier filament and ground. This combination gives 8 mf., 900 V. working. Both condensers should be of exactly the same type and manufacture so that the voltage drop across them is divided *equally*. Leave the original can above-chassis for appearance sake, but disconnect it. This system may be used on many other sets that use heater-type receiving tubes and filament-type power rectifier, where high surge is found.

L. W. KRIZAN,
Chicago, Ill.

.... **RCA VICTOR HIGH-FIDELITY MODELS HF2, HF4, and U130**

Inoperative or no A.V.C. action—also distortion—may be due to an open R.F. or a shorted grid coupling condenser in the 1st radio-frequency stage; no A.V.C. may be carried by a shorted or open 0.05-mf. R.F. bypass condenser in the A.V.C. network value. Distortion may be traced to the 6F6 output tubes not being matched closely enough.

.... **MAJESTIC MODEL 90**

A very common trouble with this set is quick fading or snapping off to half volume. This is usually caused by one or more of the 3 bypass condensers bypassing the R.F. and detector cathode circuits. These condensers are all in metal cases, riveted to the inside of the side of the chassis. It is almost impossible to detect these condensers in the act of opening and closing since any kind of connections with test leads will result in normal operation for a short time. The only sure way to correct this trouble is to replace all 3 condensers with 0.5-mf. tubular condensers. Just as sure as you replace one and leave the other two in, you will be called back and have a nasty time explaining to the customer.

BINFORD OWENS.

.... **RCA U-30**

This model utilizes automatic motor tuning. In several models I have discovered that erratic or complete inoperation of the automatic mechanism is caused by a leaky or open motor-starting condenser connected across the tuning motor. It is rated for intermittent use only and is frequently a cause for repair.

This unit, a 60-mf. 40-V. A.C. electrolytic is mounted directly on the tuning motor. Replacement with a manufacturer's part restores complete operation and smooth even travel of pointer over the face of the dial.

A. W. FREYER,
Holyoke, Mass.

.... **SONORA A-11 SETS**

When this small A.C.-D.C. set hums do not always suspect the filter as defective. This round or tubular filter is of the plug-in type and mounted on a regular octal base. The prongs on the socket often lose tension and soldering is the best permanent remedy.

Another type of recurrent fault in the Sonora A-11 is an intermittent noise and cutting-off of signals when tuning this set between 90 and 130 on the dial. The trouble is not in the tuning condenser but is caused by the plates (rotor) of the condenser rubbing against the tube shield of the 6D6 tube. To remedy, slip a small piece of mica under the tube base on the side next to the condenser so that the tube will tilt just enough to clear the metal plates of the condenser.

MARION L. RHODES,
Knightstown, Ind.

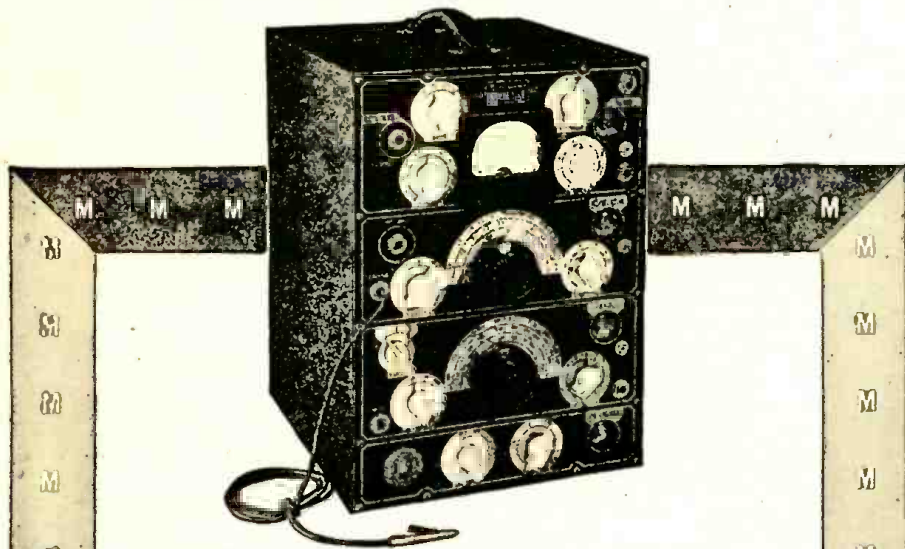

Solves Service Problems Faster!

The New Improved Meissner Analyst

WITH 4 RANGE ELECTRONIC V. M.

Contains All These Outstanding Features!

- Locates faults by "Signal Tracing"
- Every channel on a separate panel
- All controls fully calibrated
- Shielded test cables and prods
- All terminals on front panel
- New 4 range Electronic Voltmeter
- Wide-range Audio Test Channel
- Oscillator trouble-shooter channel
- 95-1700 kc. RF-IF channel
- Line current indicator channel
- Measures gain, stage by stage
- Locates intermittent faults faster
- Checks alignment of receivers
- Voltmeter input, 10,000 ohms
- All channels may be used at once
- Uses 4 electron-ray indicators
- Operates on 110 volts, 60 cycles
- Portable — convenient to use

The Meissner Analyst has been precision engineered for the utmost in efficient service work on receivers of yesterday, today and tomorrow. The Analyst has the unerring ability to locate faults and lay them open for your examination . . . entirely fundamental in testing procedure, it will not become obsolete. Five separate channels provide as many different functions: each is separated in its own panel division and all controls are accurately calibrated with functions clearly indicated. Meissner Analyst is shipped complete with 12 tubes—wired, aligned, laboratory tested, ready for service. Net price \$96.25.

See your Meissner distributor or write for complete catalog.



"PRECISION-BUILT PRODUCTS"

DYNAMITE- 194? STYLE!



The electron tube is the dynamic force of the future. Today, National Union engineers are doing their part in tube research to harness the "dynamite" that will usher in the Age of Electronics. Their laboratories are in the thick of the battle of production. Out of their achievements for war, National Union will bring you, as a serviceman, new knowledge and new opportunity. For in the future, as in the past, you can look to National Union not only for the newest tubes but for the new style test equipment you will need. And for guidance on how to use them.

Transmitting Tubes • Cathode Ray Tubes • Receiving Tubes •
Special Purpose Tubes • Condensers • Volume Controls • Photo
Electric Cells • Exciter Lamps • Panel Lamps • Flashlight Bulbs

NATIONAL UNION RADIO CORPORATION
Newark, N. J. Lansdale, Pa.



SPOT WELDING

Infinite care and precision in delicate assemblies are a tradition of National Union manufacture. It takes rigid and expert training as well as skilled and nimble fingers to perform this Spot Welding operation... and to enable it to pass the "eagle-eye" test that makes it fit for use in National Union Electronic Tubes.

NATIONAL UNION ELECTRONIC TUBES

QUESTION BOX

QUERIES

All queries should be accompanied by a fee of 25c to cover research involved. If a schematic or diagram is wanted please send 50c. to cover circuits up to 5 tubes; for 5 to 8 tube circuits, 75c; over 8 tubes, \$1.00.
 Be sure to send the fullest possible details when asking questions. Give names and MODEL NUMBERS when referring to receivers. Include schematics of your apparatus whenever you have such. Serial numbers of radios are useless as a means of identification.
 No picture diagrams can be supplied.
 Back issues 1942, 25c each; 1941, 30c each; 1940, 35c each.
 Any issue, prior to 1940, if in stock, 50c per copy.

BROADCAST RECEIVER

? Please send me a schematic diagram of a broadcast receiver using a 6D6 tuned R.F., 6C6 detector, 6D6 audio (resistance capacity coupled), and 12A7 output and rectifier, using a line cord resistor.—M. B., Tulsa, Okla.

A. The schematic is shown. CHOKE may be an ordinary A.C.-D.C. choke or the field of a loud-speaker, if the latter is fairly low in resistance. Check to be sure your line-cord resistor is the right size.

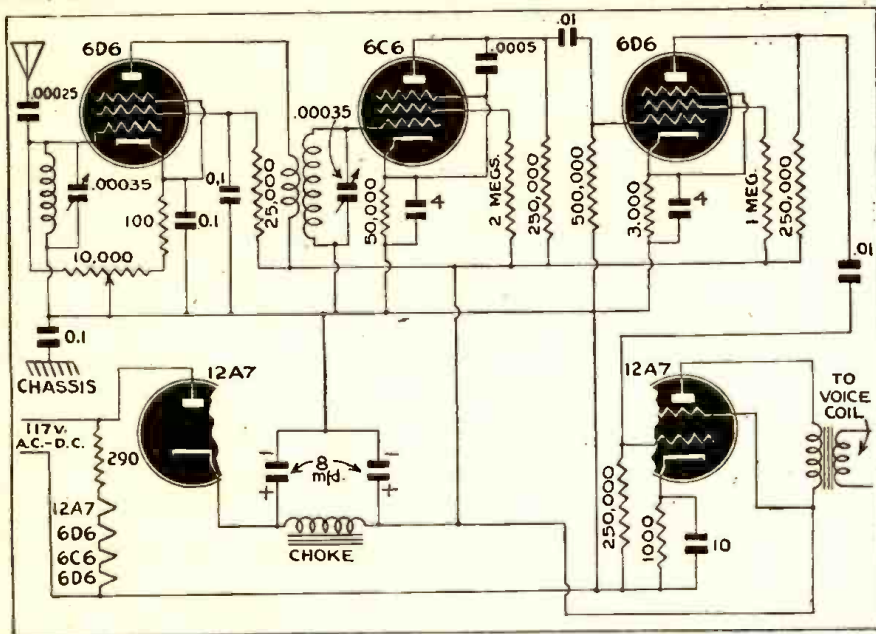

A SMALL AMPLIFIER

? Will you kindly send me a diagram of a small amplifier using a 6C6 pentode, a 6C6, triode-connected, a 25A6 and a 25Z5? —S. T. J., Bronx, N. Y.

A. Herewith the diagram. A 76 can be used as the second tube, with a slight loss of gain. A 43 will work as well as the 25A6 in the last stage.

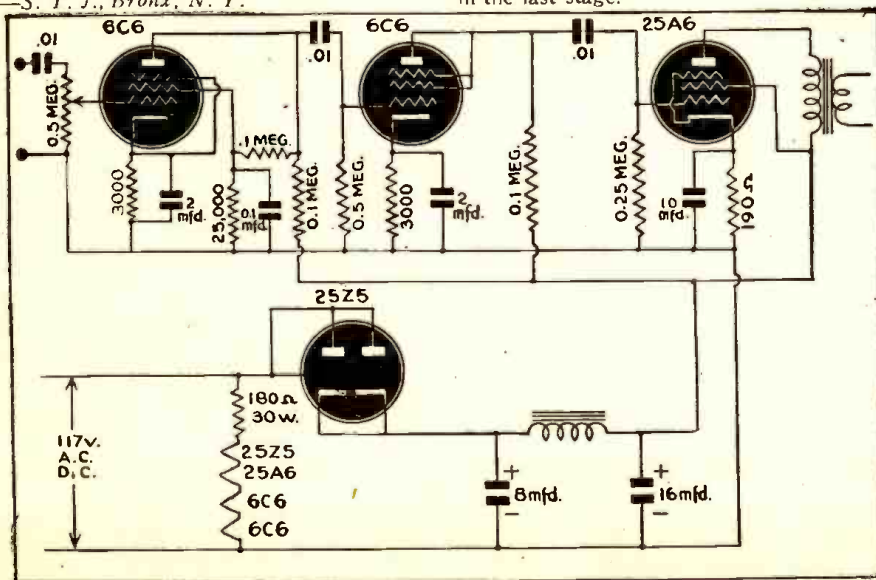

CALCULATIONS FOR CATHODE CONDENSERS

? Why can't someone explain in simple terms how to figure cathode by-pass condensers?—R. O'C., North Pelham, N. Y.

A. Calculation of cathode by-pass condensers is not difficult. The reactance of a condenser depends on the frequency of the current, and may be computed by the formula

$$\frac{1,000,000}{6.28 f C}$$

if f is the frequency of the current in cycles and C is the capacity in microfarads.

We find that a 1-mfd. condenser has a reactance in the order of 3,000 ohms at 50 cycles, 250 ohms at 400 cycles and 30 ohms at 3,000 cycles (in round figures).

If this condenser is used as a by-pass across a 2,500-ohm resistor, as used in the cathode of a tube in a resistance-coupled amplifier circuit, about 90% of the audio-frequency currents at 400 cycles would be bypassed through it. At 50 cycles, however, it would be taking less than half the current, and would be unsatisfactory as a by-pass.

The same condenser, used across a 150-ohm cathode resistor (in an output-tube cathode circuit), would by-pass considerably less than half the current, and would have to be made much bigger.

The exact size of the condenser is a compromise between perfect by-passing and the cost of large condensers. The ideal by-pass is one that passes 90% or more of the alternating component of the cathode current at the lowest frequency it is desired to amplify, and condensers may be calculated to come as close to this as practical.

If the cathode condenser is omitted, a certain amount of degeneration, or negative feed-back, is introduced. This cuts the volume considerably, but in some cases is not undesirable, as both audio fidelity and stability are increased.

WESTON SCALE

? Can you tell me where I can get a scale for a Weston 301 meter? I want a scale as follows: D.C. volts: 0-10, 50, 250, 500, 2500; A.C. volts: 0-15, 150, 1500; D.C. Mils: 0-1, 10, 100, 1000; Ohms: 0-50, 500, 5000, 500,000.—W.D.N.H., Weyburn, Sask.

A. Only standard Weston scales are available. You cannot however get a special scale unless you engage a draftsman to make it for you on special order. These scales are catalogued by Burstein-Applebee in Kansas City, and can be obtained in New York from Blan, and the Radio Man, Dey St.

Watch **MIDWEST** for the *Radio of Tomorrow!*

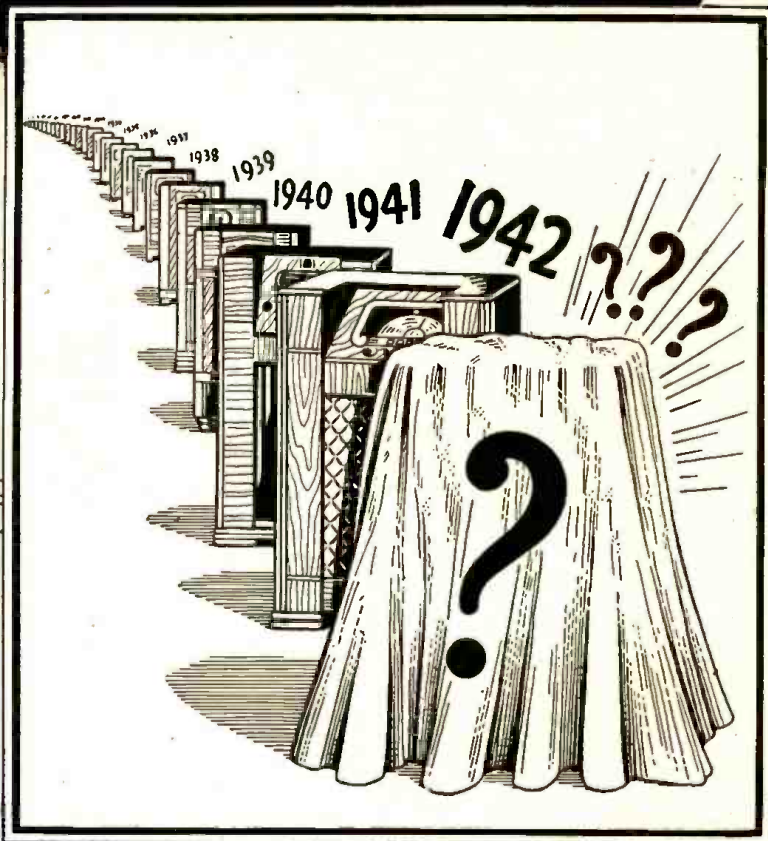
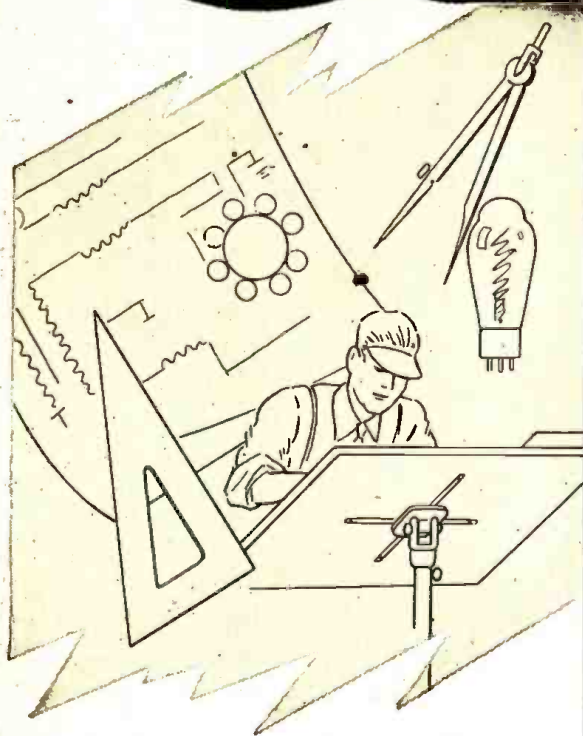

THE spur of production for the war needs of our Armed Forces has resulted in tremendous advances in the science of radio. New features and sensational advancements are even now ready . . . waiting only for the resumption of peacetime radio production.

Midwest, for 22 years recognized as a pioneer

in radio advancements, is keeping abreast of today's rapid developments in radio engineering. Plans are in the making . . . research in the industry goes on unceasingly . . . so that when the time comes that civilian radios may again be produced, Midwest will once more be "first with the finest."

**MIDWEST IS NOW PRODUCING
100% FOR UNCLE SAM -- BUT**

*When Victory Is Won
You'll Be Buying Your Midwest Radio
Direct From The Factory*

SAVING UP TO 50% WILL BE AS POPULAR AS EVER



THIS comprehensive 20-page booklet on our Armed Forces absolutely free if you send 10¢ for a U. S. War Savings Stamp. Just send 10¢ in coin or postage stamps and your booklet and War Savings Stamp will be sent promptly.

**MIDWEST RADIO CORPORATION
DEPT. 12-C CINCINNATI, OHIO**

QUESTION BOX

ALLIED...
ARSENAL of SUPPLY for EVERYTHING in RADIO and ELECTRONICS.

1943
ALLIED RADIO
 322 WEST JACKSON ST. CHICAGO, ILL. U.S.A.

GET all your Radio and Electronic needs quickly from this ONE dependable central source of supply...over 10,000 items for the Armed Forces, for Radio Training, for Research Laboratories, for War Industries, and for Service Replacement. Our large complete stocks speed delivery. Our experienced staff is ready to help you. Send for your new Allied Catalog today... it's FREE!

SEND FOR THESE NEW BOOKS

- | | | | |
|--|---|--|---|
| | Dictionary of Radio Terms. No. 37-751 10c | | Radio Data Handbook. No. 37-754 25c |
| | Radio Circuit Handbook. No. 37-753 10c | | Radio Builders Handbook. No. 37-750 10c |
| | Radio Formulas & Data Book. No. 37-752 10c | | Simplified Radio Servicing. No. 37-755 10c |
- Write for Quantity Prices*

ALLIED RADIO CORP., Dept. 2-E-3
 833 W. Jackson Blvd., Chicago, Ill.
 Please send following books (.....c enclosed)
 FREE 37-750 37-752 37-754
 1943 Catalog 37-751 37-753 37-755

Name.....
 Address.....
 City..... State.....

ALLIED RADIO

ADDING AMPLIFICATION

? I would like to add a stage of amplification to a one-tube radio, using a 1Q5-GT or similar tube. Would you also tell me how to determine the approximate capacity of variable condensers without testing and a good way to clean crystal detectors?—*H. H., Dallas, Ore.*

A. A one-stage audio amplifier circuit, using a tube similar to the 1Q5-GT, is shown in the April Question Box. Unfortunately there is no way of readily determining the capacity of variable condensers without testing.

The days when a .0005 condenser had 23 plates and a .00035 had 17, are gone forever. Even an experienced serviceman, while he would have no difficulty in distinguishing between a 140-mmfd. and a 350-mmfd. condenser, might not know whether a given condenser had a capacity of, say, 140 or 100 mmfd.

The best cleaner for crystals is alcohol or carbon tetrachloride (Carbana). Do not touch the crystal after cleaning, as grease from the fingers is the worst form of dirt you can get on it.

TWO-TUBE MIDGET AMPLIFIER

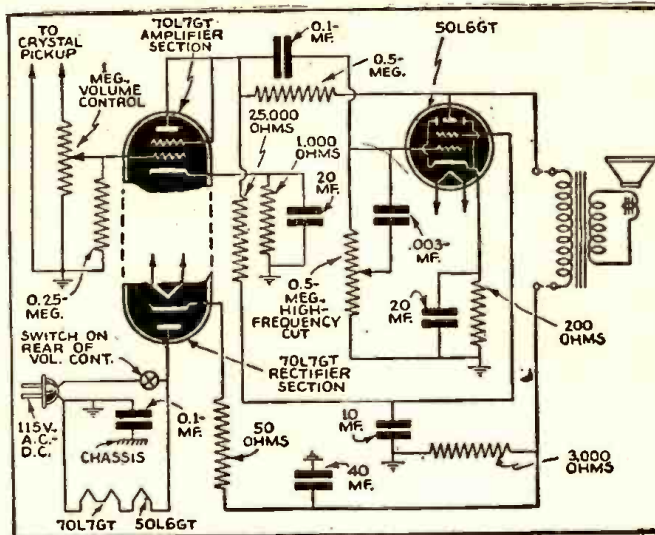

? Will you please print me a diagram of a small amplifier using a 70L7-GT and a 50L6-GT? This amplifier used inverse feedback.—*J. C. M., Camp Davis.*

A. Herewith the required schematic. The pentode section of the 70L7 is used as a triode in this amplifier. The combination of high-voltage filaments makes unnecessary any filament ballast resistor. Used with a small speaker, this is the perfect "midget" amplifier.

S. W. DIATHERMY MACHINE

? I would like a circuit for a short-wave diathermy machine of simple construction, to have an output of about 50 watts.—*P. M., Wood Lake, Neb.*

types of diathermy apparatus is shown. As these sets cause radio interference, they should be operated in a shielded enclosure. R.F. chokes may be placed in the 110-volt line if R.F. feeds back into the house lighting circuits.

A. The circuit for one of the simplest

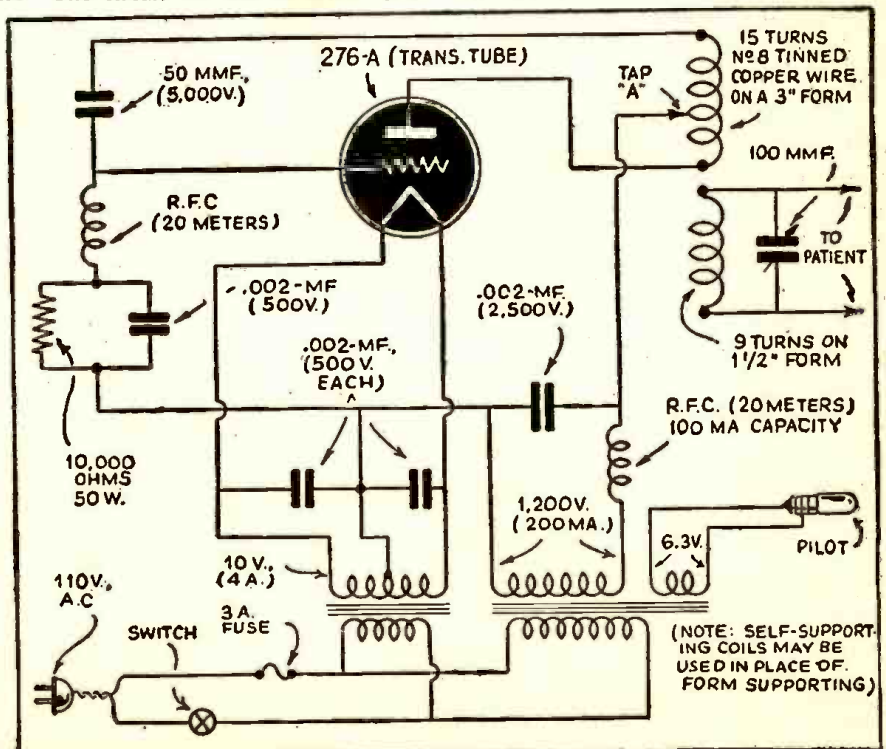

(NOTE: SELF-SUPPORTING COILS MAY BE USED IN PLACE OF FORM SUPPORTING)



GRAB YOURSELF A COPY OF THIS BRAND NEW MANUAL BOYS! ITS JAM PACKED WITH DATA, CIRCUITS AND ALL THE SET INFO YOU NEED UP TO DATE OF GOVERNMENT SHUT DOWN APRIL '42.

**Read These Facts!
LOOK AT A COPY NOW**

See for yourself — COMPARE!

\$10.00

MORE LISTINGS: This 1942 Radio Circuit Manual has nearly 400 more listings than the last edition of a similar manual. Covers receivers manufactured up to time of Government shut down order in April 1942. The set you're looking for here when you need it!

MORE POPULAR SETS: Listings of many popular set models are far more complete than in other manual recent edition. Check for yourself on such makes as Lafayette, Emerson, Pilot, Philco, RCA, Stewart Warner. This completeness will save you many times the cost of the book by saving your time enabling you to handle work more promptly.

PERFECT DIAGRAMS: There's nothing more annoying or costly than finding an incomplete circuit drawing. An artist carefully checked and retouched every diagram in the Radio Circuit Manual to make sure of PERFECT diagrams. The printing is clear, distinct, complete! You'll enjoy using this manual.

MORE ON PAGE: Ever had to fumble around turning pages because complete information didn't appear on one page? The Radio Circuit manual has big roomy pages which permit more complete data on a single page than any other manual. Another time-saver for you.

HANDY SIZE: The Radio Circuit Manual is thin, not fat, dumpy and bulky. This thin size and large page size makes it much easier to handle, easier to store

in a minimum of shelf space. The book lies open too, without pages flopping over so you have to hunt for your place again.

QUICK REFERENCE INDEX: The index in this manual is complete for both 41 and 42 editions. A big feature is the fact it tells you at a glance if a model is the same as another model number. No hunting back and forth, it's right there. Big readable page numbers and model numbers make for quick finding of what you want.

SPECIAL REFERENCE CHARTS: Special late edition charts on tube and battery interchangeability, pilot lights, ohms law, color codes. The information you often search for is here. Also a special article by F. L. Sprayberry to make your wartime service job easier.

COMPLETE DATA: The big pages feature not only Schematics, but quick reference IF spot, Parts Lists, Dial Stringing diagrams, tuning range and data, tube locations, voltage charts, trimmer locations, push button set-ups, alignment notes and procedures, record changer details.

Published By
RADCRAFT PUBLICATIONS, INC.
25 WEST BROADWAY,
NEW YORK, N. Y.

RADCRAFT PUBLICATIONS, INC., 25 WEST BROADWAY, NEW YORK, N. Y. DEPT. RC 5-43
Gentlemen: Enclosed find my remittance of \$10.00 for which send me, POSTPAID, my copy of the RADIO CIRCUIT MANUAL-1942

Name Address City State

(Send remittance in form of check or money order; register your letter if you send cash)

Diagrams for

THE RADIO EXPERIMENTER

If you have a new Hook-Up, send it along; a pencil diagram will do. Be sure to include a brief description.

All diagrams and descriptions accepted and published will be awarded a year's subscription. Diagrams may be for receivers, adapters, amplifiers, etc. Send them to Hook-Up Editor, RADIO-CRAFT, 25 W. Broadway, New York City.

AMPLIFIER FOR MUSICAL INSTRUMENT

This amplifier has excellent output, especially with a P.M. speaker. If an electrodynamic type is used it must have its own field supply, as the 6X5 shown has all it can do to supply the amplifier tubes with plate current.

The 6SC7 acts as the input mixer with combined plate feed to the 6SF5. The various parts should be readily obtainable from junk parts or old sets.

The amplifier can be mounted on any suitable chassis to suit the speaker case, for portability.

Although the tubes shown are of the metal type, their "G" or "GT" counterparts may be used, but must be shielded (especially the 6SC7), if hum is encountered.

The experienced constructor will know how to lay out the job, and space the parts for maximum accessibility.

Cable from the pickup on the instrument to the input should be of the shielded type.

EDWARD CHRISTNER,
Middletown, Ohio.

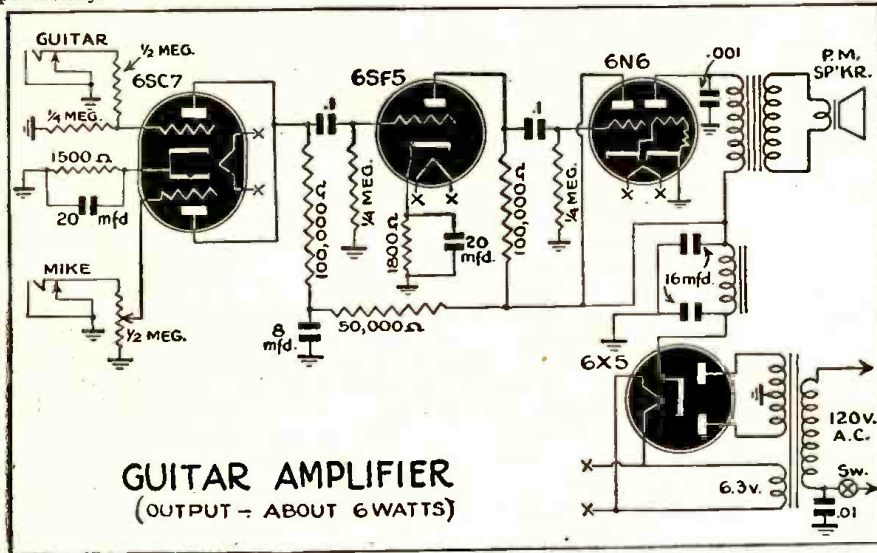

TWO TUBES EQUAL THREE IN THIS PORTABLE RECEIVER

This receiver was designed primarily to be used as an all around portable and short-wave receiver. Its cost is low because many of the parts can be found in the good old junk box.

This receiver can be built into a 6 x 6 x 6 inch cabinet complete with batteries and a two-inch P.M. speaker.

A three and one-half foot detachable

whip antenna mounted on the top of the cabinet proved very successful for portable use. With a regular antenna South American stations can be picked up very easily.

For economy on batteries a socket should be provided for an external power supply. Bud four-prong plug-in coils are used.

BIL CUNNINGHAM,
Spokane, Washington.

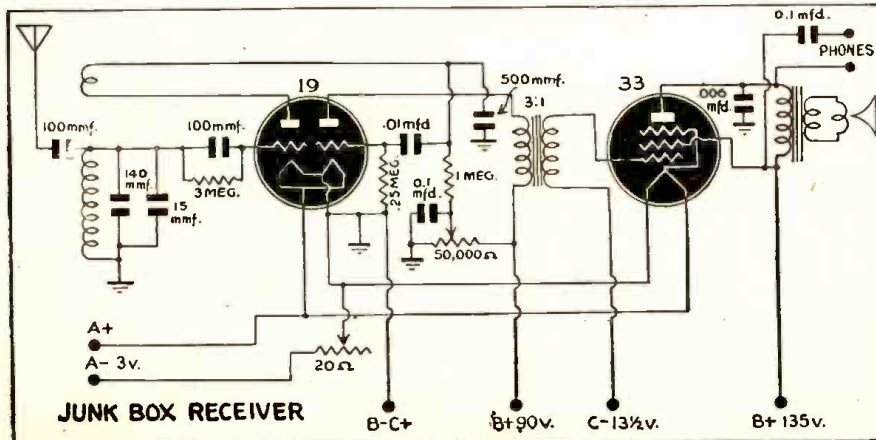

GROUP CODE OSCILLATOR

During the past few months I have found a great need for an inexpensive audio oscillator to instruct groups, such as defense classes and Boy Scouts, in code.

After careful examination of many oscil-

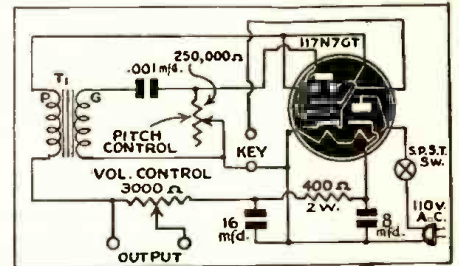

lator plans, I worked this one out. I am using a 117N7GT tube instead of the conventional 117L7GT. I have found from past experience that the 117N7GT lasts a great deal longer under keying surges.

Any old plate-to-grid transformer will do for T1, preferably one having a 3:1 ratio.

This rig will drive a fair-sized P.M. speaker or a dozen or more phones.

Rheostat R3 controls the tone, and R2 controls the volume.

If the set fails to oscillate, reverse either set of leads going to the audio oscillator.

I am sure this plan will far exceed any existing 117-volt oscillator in both economy and performance. I have been using this one for several months, and at school most of the students have put their O.K. on the plan after building one.

DUDLEY BUCK,
Santa Barbara, Calif.

ONE TUBE RECEIVER

This new type of radio receiving brings in stations as clearly as a crystal set, with absolutely no hum and with fine selectivity and sensitivity.

The 25Z5 acts as a diode and has its plates and cathodes tied together.

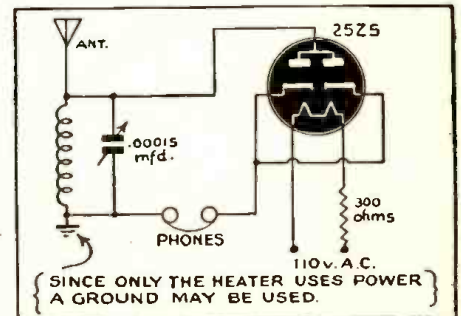

A 2,000 ohm headphone should be used. Since only the heater uses power a ground may be used.

NOLIN QUILLET,
Cochrane, Ontario, Canada

NEW RADIO-CRAFT LIBRARY BOOKS



THE four latest books of our well-known RADIO-CRAFT Red Books—Nos. 25, 26, 27 and 28—recently published.

These four books are all on timely subjects and we recommend every one of them to you strongly.

Now, more than ever, radio education has become a burning question. If you are to be in the National Service, in the Army, Navy or Air Force, practical radio knowledge is of paramount importance. **YOU CAN GET BETTER RATINGS AND ADVANCE QUICKER IF YOU HAVE A GOOD RADIO BACKGROUND.**

Conversely, if you are not with the armed forces, there is a whole of a job to be done at home. With more and more men going into the service, the demand for practical servicemen becomes greater each day. Therefore we say: **PROFIT BY THESE UNIQUE BOOKS, WHICH ARE PRICED SO LOW THAT THEY ARE WITHIN THE REACH OF EVERYONE'S PURSE.**

No. 25—HOME-MADE RADIO TEST INSTRUMENTS

This book includes articles covering a wide range of test apparatus of live interest to every radio man. Servicemen will find many circuits in this book to make their work more profitable. New ideas in test equipment make it possible to service radio receivers more quickly.

Laboratory workers and experimenters will find many articles which describe in detail construction and use of all essential radio test units—multi-meters, oscillators, stage-analysis testers, oscilloscope equipment, V-T. voltmeters, etc. Even advanced technicians will be interested in the circuit arrangements showing the new and improved variations of well-known, basic test equipment. A MUST for every serviceman. This book contains 86 illustrations.

Outline of Contents: A Low-Cost Signal Chaser—Signal Tracer Test Unit—Simplified Practical Signal Tracer—A Home-Made Infinite-Resistance Tube Checker—Build This Direct-Reading V-T. Voltmeter—How to Make a Modern V-T. Voltmeter—Measuring High Values of A.C. Voltage and Current With a Low-Range Meter—How to Make a Meter-Range Extender—How to Build a Practical Tube Tester and Set-Analyzer Adapter—The Beginners' Simple Volt-Williammeter—Switch This Simplified Beat-Type Test Unit—Midget Oscilloscope—How to Make and Use a Frequency Wobbler—Double Tracing Your Oscilloscope—Home-Made Frequency Modulator.

No. 26—MODERN BATTERY RADIO SETS

Whether you are a radio man or a beginner, the articles in this book give you basic circuit arrangements or elementary radio receivers which serve the dual role of teaching the elements of radio reception, as well as making perfectly-operating 1- and 2-tube radio receivers. Picture diagrams and bread-board layouts galore.

Advanced radio set builders are offered more complicated arrangements. Laboratory workers and engineers will find in many of the articles circuit and constructional features which have become commercial practice. Many entirely new ideas are given in this book. One of the most important volumes we recently issued. This book contains 76 illustrations.

Outline of Contents: Beginner's 1-Tube High-Gain All-Wave Receiver—Beginners-Build This 1-Tube Loop Receiver—A 3-in.-1" Battery Portable—An Easily-Built "Fleawing Superregenerative" 2-in.-1" "Card File" Battery Set—A 2-Tube Superhet. With Pentagrid Regenerative 2nd-Detector—The 4-Tube Superhet. Vacation Portable—The "Lunchbox 5" Battery Portable—The Seafarer's Loop-Type Boat Radio Set—4-Tube Permeability Portable—An All-Purpose Portable—A Typical Commercial 3-Way Portable (Pilot Models X-1452 and X-1453)—Switch This Simplified Beat-Type Battery Radio Sets—Making a Simple Portable Aerial—Making a Pilot-Light Fuse—Old Auto Sets for New Cars—Using a Loop Portable in Cars—Quasi-Electric Soldering Iron—Lamp Bulbs as Resistors.

No. 27—MODERN RADIO SERVICING TECHNIQUE

Here is a book of great importance to every radio man, every radio engineer, and particularly all radio servicemen. A list of the contents which follows shows the importance of this book. It is really jam-packed to over-flowing with radio-meet. Whether you are a servicing beginner or whether you are an experienced serviceman—you will find many important helps in this volume.

Book is eminently practical and will solve many problems for you. More important: It will show you many short-cuts, all calculated to save your time and patience. Practical everyday data on standard receivers appears throughout the book. A whole of a book compressed into a minimum of space. Contains 98 important illustrations.

Outline of Contents: Elementary Servicing Technique—Correct Procedure for the Servicing Beginner—Elementary Procedure for Servicing Radio Sets—A.F.C. Alignment Made Easy—Dynamic Servicing—Dynamic Testing Simplifies Servicing—Modern Receiver Test Requirements—Servicing Universal A.C.-D.C. Receivers—Servicing "Orphans" and Private-Brand Sets—Emergency Servicing Without Test Meters—Servicing Coils—Servicing R.F. Coils—Servicing Oscillator Coils—General Information—R.M.A. Transformer Color Code—What Causes Echo, Fading?—Radio Service Puzzlers.

No. 28—ALL ABOUT FREQUENCY MODULATION

Here is a complete compilation of pertinent data on the entire subject of the new coming art of Frequency Modulation.

There is no question but that Frequency Modulation is already revolutionizing radio broadcasting in this country. Were it not for the war, there would now be a tremendous boom in this new art—yet, even with war restrictions imposed upon it, Frequency Modulation is still jumping ahead by leaps and bounds.

With Frequency Modulation no longer a theory—with hundreds of stations already dotting the land and with countless hundreds of others to come when peace is achieved once more—every radio man should read up and know all there is to know on this most important subject.

This particular handbook is chuck-full with a tremendous amount of information which you probably will not find in any similar book in print. Outline of Contents: The ABC of F.M.—Frequency vs. Amplitude Modulation—Basic Facts About F.M. Broadcasting—Construction—Build This Practical F.M. Adapter—Audio Amplification—F.M. Audio Amplifier, Part 1—F.M. Audio Amplifier, Part 2—F.M. Audio Amplifier, Part 3—F.M. Service—Part 1, Antenna Installation and Service—Part 2, Receiver Alignment and Diagnosis—Part 3, Test Equipment for F.M. Servicing, Engineering—Part 1, The How and Why of F.M.—Part 2, The How and Why of F.M.—Theory and Design Considerations of R.F. and I.F. Coils in F.M. Receivers.

SPECIAL SEND-NO-MONEY OFFER

It is not necessary that you send money with order. If you wish to take advantage of our C.O.D. plan, simply cut out the coupon, paste it on a post card and send it to us. Books will be sent to you immediately.

All four books are listed uniformly at 50c each. No discount on less than three books.

If you wish to take advantage of our special offer, ordering three books or more, we make an unusual low price to you as follows:

3 books—\$1.25

4 books—\$1.50

Do not fail to send coupon today!

RADCRAFT PUBLICATIONS, INC.
25 West Broadway, New York, N. Y.

RADCRAFT PUBLICATIONS, INC.		543
25 West Broadway, New York, N. Y.		
Gentlemen:		
Rush to me by return mail, as per your special offer, the following books: (Check books selected.)		
<input type="checkbox"/>	No. 25—HOME-MADE RADIO TEST INSTRUMENTS.	
<input type="checkbox"/>	No. 26—MODERN BATTERY RADIO SETS.	
<input type="checkbox"/>	No. 27—MODERN RADIO SERVICING TECHNIQUE.	
<input type="checkbox"/>	No. 28—ALL ABOUT FREQUENCY MODULATION.	
I will pay postman \$1.00 (if two books are ordered) plus a few cents postage and charges, \$1.25 for three books, plus a few cents postage and charges, \$1.50 for four books, plus a few cents postage and charges. WE CANNOT SEND A SINGLE 50c BOOK C.O.D.		
NAME	PLEASE PRINT CLEARLY	
ADDRESS		
CITY	STATE	
<input type="checkbox"/> Save shipping and C.O.D. charges! Check here if you send cash with order. (Cash, U.S. new postage stamps, money order, check.) Foreign countries no C.O.D. Add 20% to all prices quoted.		

RADIO KINKS

MODEL "T" COILS

Dear Editor:

One of the many uses of Model T or other generator cutouts is that of a wireless buzzer. By using only the primary winding connected to an alternating current of 2.5 to 10 volts, the armature is set into vibration at a high frequency.

The tone may be adjusted by experimenting with armature H and spring E. The contacts G are not used in this application.

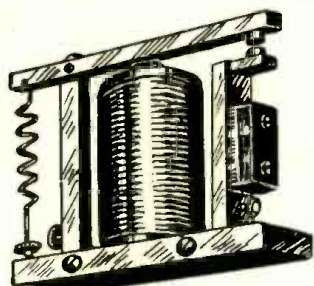

"MODEL T" CODE BUZZER

I have found this to be very useful for practicing code, and use two separate ones connected to the same source to provide different tones.

It uses but a small amount of current (about 10 watts) and may be used with a bell-ringing transformer, in parallel with your radio 2.5 or 6.3 volt filament winding, or with an old audio transformer connected to 110-volts, A.C.

LORNE S. SHARP,
Crossfield, Alta., Canada.

CIRCUIT TESTER

A very handy circuit tester can be constructed at small cost. The tester which I am describing is very good in tracing leads in various circuits and comes in handy when checking transformers, chokes and even condensers.

The circuit consists of a coil of wire wound on a cardboard tube. Approximately 100 turns should be plenty. A cheap compass inside the coil will be the indicator.

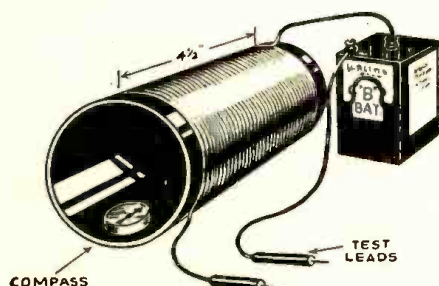

CIRCUIT TESTER

A test lead is connected to one end of the coil and two dry cells of the flashlight type are connected between the other test lead and the coil.

ERRA P. DAWSON
Represa, Calif.

Do you have any interesting and novel kinks which you would like to bring to the attention of RADIO-CRAFT readers? If so, send them in addressed to the Kink Editor. A seven-month subscription to RADIO-CRAFT will be awarded for each kink published.

PREVENT SLIDING OF TELEGRAPH KEYS

This idea is one which I believe will stop the sliding of telegraph keys 100 per cent. It is very simple and efficient. It consists of just gluing (I found shellac to be the best) short lengths of rubber bands under the key.

Some of the advantages are as follows: It does not obstruct any part of the key; it

PIECES OF RUBBER BANDS

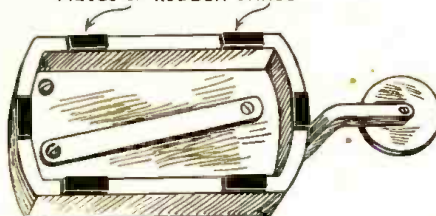

does not raise the key an appreciable amount; and it is practically unnoticeable.

I believe others will appreciate it also.

MYRON I. JAFFE,
Mattapan, Mass.

HOME MADE TEST PRODS

I have been using this kink for some years and find it very helpful.

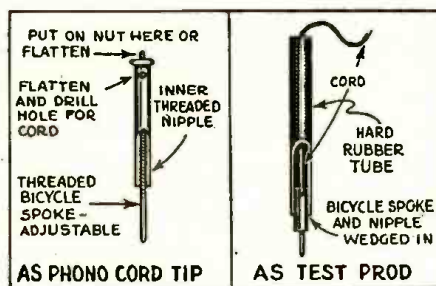

Any old fountain pen barrel will serve as the tube, and a bicycle spoke or other stiff wire can be wedged into the tube, cut to the length desired, usually about 5 to 6 inches.

The short pieces of bicycle spoke can be used for phone cord tips by retaining the spoke coupling, threaded on the spoke, and putting a nut or a flattened and drilled piece on the free end. The projecting tip of the spoke can be $\frac{3}{4}$ to 1 inch long. It can be adjusted slightly by threading in and out of the coupling.

EMIL B. HEBERGER,
Rochester, N. Y.

HOMEMADE BLOWER

The following information can be used by anyone to construct a blower at a very low cost.

I replaced the old suction fan with one of my own design, after the pattern of the "pusher" type fans. Then I drilled $\frac{1}{4}$ -inch holes all around the motor case, so as to have air holes for the fans to draw air through.

Taking a funnel purchased at the 5 & 10c store, I soldered it with aluminum solder to the motor frame. Then I fastened an old percolator handle to the former wheel mountings, for a good handle to hold the blower by.

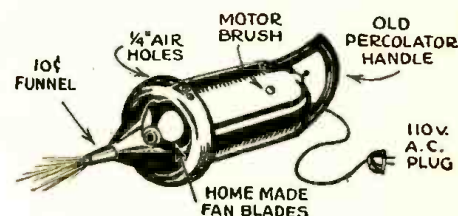

I have used this blower to clean the dust and dirt out of condensers and coils. It does a very good job.

W. H. McCARTNEY,
Canonsburg, Pa.

BAND SPREAD CONDENSER

This band spread condenser was made from an old junk box condenser (from one of the first battery radios made). This was one of the condensers that was put together with screws instead of by other means.

First it was taken apart and the two bars at each end that held the stator plates were cut out about $\frac{1}{2}$ -inch in the center of this bar (see diagram). All but two plates were then removed from the two sections.

Before doing this affix the two bakelite pieces on each end by putting a hole through the bakelite and the center of the bar that is going to be cut out. Then make two holes $\frac{3}{8}$ of an inch from the center of the first hole and tap these. This condenser took me about four hours to construct.

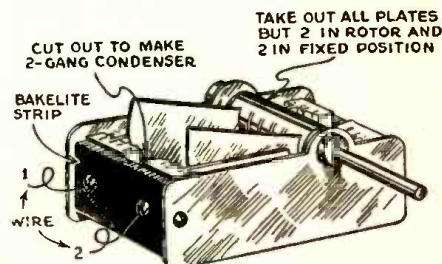

BAND SPREAD CONDENSER

Other types of condensers can be made into band spread condensers with little work and thinking. A two-gang condenser would be still better for a band spread condenser if the plates are broken or taken out.

LAWRENCE HANT,
Flint, Michigan

HOW TO MAKE AN EXPONENTIAL HORN

(Continued from page 464)

2A3's in class AB2, and put out about 30 watts undistorted, and as I recall, I had the gain up pretty high. It didn't sound loud in the garage. . . .

Of course I turned it down as soon as my wife came in the little door holding her cars and wearing an agonized expression but three of the neighbors never did speak to us again. Loud? The police said they could hear it easily in the station house a mile and three-quarters away. A Scotsman called on us and thanked us for the concert but most of the people just don't appreciate bagpipes. Even yet.

I changed records and I turned it way down and then I listened. It was grand—that's all—it was fine. I borrowed some equipment and the curves showed a noticeable improvement in the response except for one thing: The high frequencies seemed to be concentrated in a rather narrow beam, and even as much as 30 degrees off the axis would cause considerable attenuation of the "highs." We hung the mike about 10 feet away, in a direct line, over by the kitchen window, to get the curve shown. The other line is the response in a flat baffle with which I experimented after we were evicted from the house.

One thing seemed notable. The music sounded more natural. There was a *clean-ness* of reproduction throughout the range—even with records. This intrigued us and we looked further (while the landlord filled out papers). We found that it came out to harmonic distortion. A tone of 50-cycles had less apparent loudness with the big horn, than it had in the tuned box, and that puzzled us. We set things up to have the two units side by side, and keyed back and forth, and found a noticeable second and third harmonic in the tuned box, and a fairly pure tone in the horn. It was a true bass and a clean bass. I was about to make an exponential plug to insert in the horn to spread the high frequencies when we had to move again. We left the horn in the garage and the new tenant made a rabbit hutch out of it.

Of course, after that we didn't feel satisfied with a box, but we were tired of moving, and the size of a 50-cycle horn prohibits its use inside anything but a skating rink or a convention hall. We couldn't fold the horn (as they do in theaters) because then we would lose the high notes.

We fiddled around with flat baffles for a while in the new home. Tried various shapes and sizes, and came to the conclusion that there's not an awful lot to be done with a flat baffle. The larger it is the lower the response attained, but it's still not like a horn.

About then we got into some vital work for Uncle Sam and our experiments are strictly on war lines, but we have traded and managed to acquire the makings of a two-way system. At present it consists of a 15-inch Lansing cone speaker in a tuned box, and a Western Electric 555 driver with a 12-cell horn. The high unit has a cut-off of 750 cycles, thus indicating a cross-over frequency of about 800 cycles. The fellow we traded it from considered it a fine unit but we have plans for after the war. We are going to build a *folded* horn for the low frequencies, and then by golly we'll be able to get the results we want in a living room—it'll just take up only one wall. At present we're stuck because we have a housing shortage in this city and are living in a trailer. Our only radio measures less than two cubic feet complete and at times we begrudge it that space. But after the war. . . .

SPECIAL GENERATORS INCREASE RANGE OF JEEP RADIO

JEEP radio apparatus, serving U. S. Marines in scattered jungle fighting throughout the Pacific, has been given a "louder voice and longer ears" to assure the maintenance of the long lines of communication required in this type of warfare, it was announced here today.

Special 12-volt generators permitting mechanized scouting parties to transmit and receive short-wave messages from command posts miles away are being placed in Jeeps on a mass production basis, according to Joseph W. Frazer, president of Willys-Overland Motors.

The extra generator is mounted on a

special standard between the front seats and is driven by the vehicle's four-cylinder engine through a power take-off attached to the rear of the transfer case. An additional compartment is built into the instrument panel for a loud speaker and a remote control selector.

In addition to its extensive use as a reconnaissance vehicle in the Pacific area, the Jeep is being widely employed as a personnel and cargo carrier there because of its ability to traverse the tortuous jungle paths closed to other cars and trucks because of their size.



Our Birthday Gift for War . . . and Peace!

We're young in years—old in experience—here at Scientific Radio Products, Inc. For we've just passed our first "birthday."

During one four months' period we produced more crystals—perfect ones—than the entire United States made a couple of years ago. *And we are constantly "upping our production!"*

Right now, we have one important customer,—Uncle Sam . . . he's taking our output. But our facilities are such that we can supply the same quality crystals for other important needs.

Write us today!



X-ray Orientation



Above—Leo Meyerson W9GFQ



Below—E. M. Shideler W9IFI

Scientific RADIO PRODUCTS CO.
 738 W. Bdwy. LEO MEYERSON W9GFQ Council Bluffs, Iowa
 E. M. SHIDELER W9IFI
 MANUFACTURERS OF PIEZO ELECTRIC CRYSTALS AND ASSOCIATED EQUIPMENT



HIGH EFFICIENCY results in *Sound National Defense* that is why **NATIONAL DEFENSE SOUND SYSTEMS** are equipped with *University Reflex* HIGH POWER LOUSPEAKERS **UNIVERSITY LABS.** 225 VARICK ST. N.Y.C.

PATENTS—TRADE MARKS

Booklet concerning Inventions & Patents Form "Evidence of Conception" with instructions for use and "Schedule of Government and Attorneys Fees"—Free
LANCASTER, ALLWINE & ROMMEL
Registered Patent Attorneys

436 Bowen Bldg. Washington, D. C.

OPPORTUNITY AD-LETS

Advertisements in this section cost 20 cents a word for each insertion. Name, address and initials must be included at the above rate. Cash should accompany all classified advertisements unless placed by an accredited advertising agency. No advertisement for less than ten words accepted. Ten percent discount six issues, twenty percent for twelve issues. Objectionable or misleading advertisements not accepted. Advertisements for June, 1943, issue must reach us not later than May 15, 1943.

Radio-Craft • 25 W. B'way • New York, N. Y.

WANTED FOR CASH AEROVOX MODEL 95 LC checkers. If you have one and wish to sell, notify E. H. Scott Laboratories, 4450 Ravenswood Avenue, Chicago, Illinois.

SERVICEMEN, EXPERIMENTERS — CONSTRUCT condenser tester that will detect shorted condensers without removing from circuit. Simple and easy to build. Diagram for dollar bill. Rolshouse and Kissinger, 2100 St. Paul St., Baltimore, Md.

RADIO SERVICEMEN AND EXPERIMENTERS SEND for our giant radio catalogue. Save dollars. United Radio Co., (100P) Newark, N. J.

SONG POEMS WANTED TO BE SET TO MUSIC. SEND poem for immediate consideration. Five Star Music Masters, 415 Beacon Bldg., Boston, Mass.

POPULAR ELECTRONICS

(Continued from page 459)

the neon lamp will light by induction.

MAKING YOUR OWN VACUUM

If the experimenter wishes to investigate the subject of the passage of electricity through gas, he will find it necessary to purchase or to make a vacuum pump. A Sprengel pump (See Fig. 9) may be very easily devised from modest materials as will be seen from the drawing. About one pound of mercury will be needed to operate it and a very high vacuum can be achieved with patience. As the vacuum progresses, the mercury will mount higher and higher in the tube. When it reaches a level 29 inches above the level in the reservoir, a very high vacuum will be had in the vessel being evacuated. Of course, the experimenter should employ small vessels for more rapid evacuation of air.

It will be noticed that the pump is operated by manipulating the stop cock to permit a large globule of mercury to drop. This acts as a piston in the tube and pushes air before it. This action creates a high vacuum in the connected vessel.

It will be understood that the mercury in both the top and bottom reservoir must be used to keep the tube sealed at both ends. Thus, all of the mercury in the top should not be permitted to run out before the supply is replenished from the overflow dish at the bottom. The rubber joints of the pump should also be smeared with vaseline and wound with string.

A HOME-MADE MERCURY LAMP
A very simple and effective demonstra-

tion of the ionization of the vapor of mercury can be devised as shown in Fig. 10 and the photograph. The experimenter will have to procure a piece of fused quartz

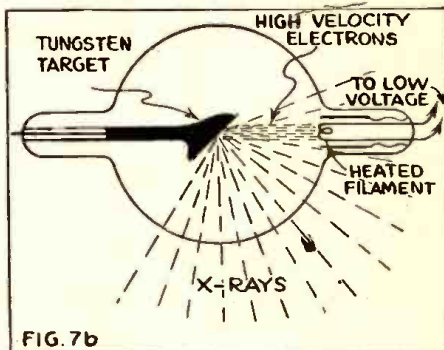

FIG. 7b

tube 8 or 10 inches long and with a bore not much in excess of a millimeter. The tube is mounted in a wooden frame and provided with a reservoir for the mercury which may be a second piece of large glass

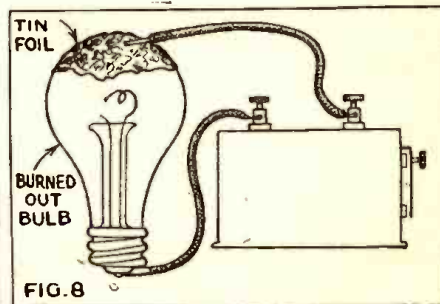

FIG. 8

tubing the connection between it and the quartz tube being established through the agency of a tight-fitting cork.

Electrodes of iron wire are employed, the lower being put in place with sealing wax, the upper one merely dipping in the mercury pool in the reservoir. A relatively small amount of mercury will be needed and this is poured in from the top.

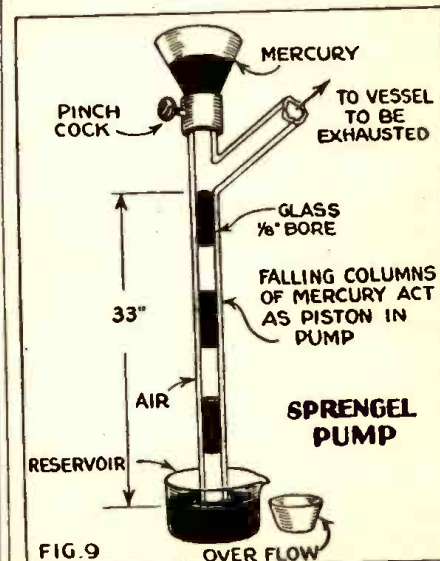

FIG. 9

HARRISON HAS IT!

Echophone

COMMUNICATIONS RECEIVERS



MODEL EC-2

- Model EC-2 \$42.50
- Model EC-3 59.50
- Model EC-1 24.50

HALLICRAFTERS

- Sky Buddy S-19R \$32.50
- Sky Champion S-20R 54.50

Orders for these receivers should carry a priority rating of AA-4, or better. Not available for individual civilian use. Apply at your local War Production Board.

CODE PRACTICE SET

Buzzer and key, heavily nickel plated, of single unit construction, mounted on wood base. Adjustable high frequency pitch. Complete with silk covered cord, in attractive box with code chart on cover. Works on one or two flashlight or dry cells.

Postpaid—\$2.45

6L6G TUBES

First grade, meter tested, fully guaranteed.

Postpaid—\$1.37 each

(Three for \$3.75—postpaid)

P. M. DYNAMIC SPEAKERS

5 inch, with output transformer to match single plate of 8000 ohms \$1.95

Magnavox, 10 inch. 16 ounce magnet! 6 ohm voice coil \$5.25 (Not postpaid)

Immediate delivery of the above items, without priority, while quantities last. SEND REMITTANCE WITH ORDER. TODAY! (Money back if not satisfied.)

HARRISON
RADIO CORPORATION

11 WEST BROADWAY

NEW YORK CITY

The lamp operates on about 50 to 80 volts D.C. The lamp is started by using a small flame brought near the tube near the middle. Owing to the low boiling point of

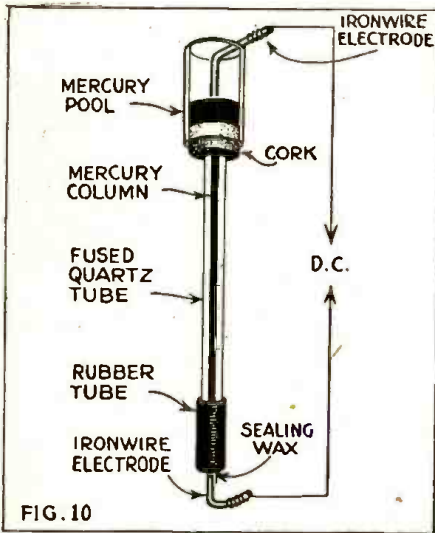

FIG. 10

the metal, boiling will result and the mercury vapor produced will create two columns of mercury. A mercury vapor arc, rich in ultra-violet, will be established between the lower and upper columns of mercury.

Due to the low thermal expansion of glass, this sort of tubing cannot be used with the lamp. It should also be recalled that mercury vapor is highly toxic and should not be inhaled.

WHAT YOU SHOULD KNOW ABOUT VOLTS AND OHMS

(Continued from page 489)

The voltage times the current in amperes equals watts of power. Suppose that we built a step-up transformer that would give us *twice* the voltage of the generator. If we measured the reduced amount of current and multiplied it by the increased voltage, we would get an answer which we would call "watts."

MEASURING THE CURRENT

The *thermo-galvanometer* is shown in Fig. 6. If two dissimilar metals are brought together and heated, a current of electricity is generated. The current generated is in direct proportion to the amount of heat. In this case, if we passed a current through the wire marked A, the two dissimilar metals connected to the wire would increase sufficiently in temperature to develop an electric current which would be indicated on the galvanometer.

Still another method of measuring current is through the use of a *hot-wire* ammeter, as shown in Fig. 7. In this instance, when a current passes through the wire marked A, the wire gets warm and expands, causing the spring to move the indicating needle over a scale. The amount that a given wire will expand depends upon the amount of current.

THE D'ARSONVAL MOVEMENT

However, the most widely employed current or voltage measuring device is the D'Arsonval instrument, shown in Fig. 8. Once again we have our powerful steel magnet. Placed between the poles of this magnet is a tiny coil of wire, delicately

pivoted in place. A needle pointer is connected to the coil and so placed that it can move over a scale. The needle is held in zero position by means of a small, fine spring, quite similar to the hair springs found in watches.

Now let us pass a small current through the coil; this will create a magnetic field about the coil. This magnetic field will tend to align itself with the magnetic field already existing between the poles of the permanent magnet; hence, the coil of wire will move.

The opposition of the springs tend to drive it back toward zero again, so that for any rate of current within the range of the meter, there is a definite point on the scale where the needle will come to rest.

BE A RADIO TECHNICIAN



GET ON TECHNICAL FRONT

RADIO Technicians are in bigger demand than ever before. War-time demands for Radio Experts are tremendous, but after the war the need for trained men will be still greater. Radio is the field that will continue to advance during the war and afterwards. That's important to you, because you want to work in a field that is expanding and will not shrink in years to come.

FREE TRIAL LESSON
proves
you can learn
quickly.

National School's Radio Training's geared to your needs. Every phase of your training is tested.

SHOP METHOD HOME TRAINING

fully qualifies you for bigger pay jobs



QUALIFY FOR THESE JOBS

Radio Expert
Broadcasting
Aircraft—Marine
Indust. Electronics
Studio Technician
Gov't. Service
Remanufacture



NATIONAL GRADUATES WIN GOOD POSITIONS.

AIRLINES EXPERT

"I cannot praise the training I received at National too highly. It has repaid itself many ways. An with Eastern Air Lines."
Pierre Berube,
Jackson Hts., N. Y.

WITH WIBX

"I have been in the broadcasting field since graduating from National. Am with Station WIBX. I recommend your School."
Fred Hoffman,
Utica, N. Y.

For 38 years National Schools has trained ambitious men for Top Pay Trades in Los Angeles. The same technique, the identical shop methods that are so successful in training Radio men at the School, are now available to you by National's Plan of Home training. You are assigned a progressive series of instructive lessons and you learn step-by-step. It's the Shop-Method Training Plan, developed for men who want practical, easy-to-grasp instruction in Radio. You learn how to build, repair and service Radios, learn fundamentals of Broadcasting, basic elements of Electronics; you acquire the ability to professionally handle all types of radio equipment.

EARN WHILE LEARNING

You can keep your present job and learn RADIO in all its fascinating branches without further delay. National Schools of Los Angeles has provided an amazing method of training which brings instruction to you right in your home. Many men in Military service have enrolled and continue their training in service.

Send for Free Lesson and Book

Act Now. You'll be amazed when you receive our Free Trial Lesson, Opportunity Book and full details. No obligation; no cost. Investigate.



Many men in Military Service have enrolled

NATIONAL SCHOOLS

Los Angeles California

ESTABLISHED 1905

MAIL OPPORTUNITY COUPON FOR QUICK ACTION

National Schools, Dept. RC-5 (Mail in envelope or 4000 So. Figueroa, Los Angeles, Calif. paste on penny postals)
Mail me FREE, without obligation, one Lesson and Opportunity Book, with full details about how I CAN become a RADIO Technician.

NAME _____ AGE _____
ADDRESS _____
CITY _____ STATE _____

REQUEST FULL DETAILS

TRIPLETT
Combat Line
INSTRUMENTS

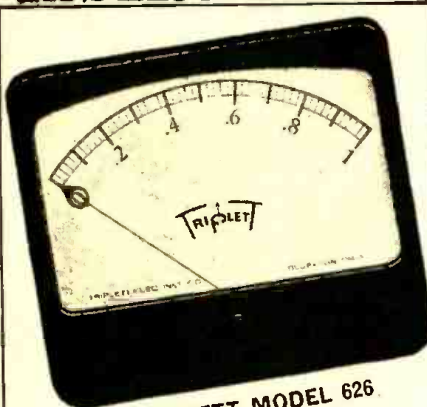

TRIPLETT MODEL 626
with long 5.60" scale
This illustration is 1/3 actual size. Note long scale and minimum panel space required.

TRIPLETT

A WORD ABOUT DELIVERIES
Naturally deliveries are subject to necessary priority regulations. We urge prompt filing of orders for delivery as expeditiously as may be consistent with America's War effort. TRIPLETT ELECTRICAL INSTRUMENT CO., BLUFFTON, O.

LAWRENCE SLIDE RULES

With A, B, C, D, C1 and K Scales

FEATURES: Nickel Silver Framed Indicator with integral friction springs. Scales calibrated directly on well seasoned wood. Will retain accuracy regardless of temperature or humidity changes.

Instructions and illustrations of primary operations clearly printed on back of rule for ready reference or teaching. Each rule in a durable pocket carrying case for convenience and protection.

The extremely low price of these slide rules and their absolute accuracy makes them ideal for the student as well as the working man who has always wanted to learn to use a slide rule.

LAWRENCE 10 inch white-enamelled slide rule with flat magnifier. In black case. Price, including 28-page instruction book..... No. 457... 60c
Secret Code Slide Rule, with 20-page book No. 458... 30c
28-page illustrated book of instructions, postpaid No. 459... 15c

GOLD SHIELD PRODUCTS

359 Greenwich St. (Dept. RC5) New York City

GUARDING COMMUNICATIONS WHERE THE GOING IS TOUGH!

SUPREME TESTING INSTRUMENTS

The famous 504-A and other SUPREME Testing Instruments are on active duty in all parts of the world. Now more ruggedly built, more accurate and dependable than ever, SUPREME Instruments will be your logical choice when victory is won.



SUPREME INSTRUMENTS CORP., GREENWOOD, MISSISSIPPI

ELECTRONICS DOES CALCULATIONS

Blaise Pascal in 1642 invented the first calculating device, a stylus-driven adding mechanism. From this start developed the crank- and motor-driven gear machines and the electrically operated punched-card machines. Now, under the impetus of military needs, electronic (vacuum tube) control is opening a new range of usefulness covering the most complex and difficult mathematical operations. Although war secrecy permits only a glimpse of these new devices, it is apparent that they promise a revolution in scientific technique.

By what is essentially instantaneous computation inside a vacuum tube, without moving parts, it will be possible to attack problems regardless of mathematical difficulty and to obtain, through procedures once hopelessly complex, information previously possible only through experiment or not obtainable at all. These developments are an outgrowth of "theoretical" research in the immediate prewar period, when a great

"Computational Center" was set up in Cambridge, England, and a similar project was begun at the Massachusetts Institute of Technology.

The Wavelength Analyzer at M. I. T. indicates the possibilities. The structure of a copper atom, for instance, is revealed by the light of an electric spark, which is broken up by a spectrograph into several thousand lines recorded on a photographic plate. Complete analysis of these lines by hand is tedious and lengthy almost to the point of impossibility, but the exposed photographic plate can be put into one end of the Wavelength Analyzer and a list of the wavelengths received at the other end. Swiss military journals describe an electronic machine which corrects the aim of an anti-aircraft gun for wind velocity at various altitudes in the millionth of a second. This calculation previously required five minutes and hence was useless.—*Industrial Bulletin*.

A DEMONSTRATION MULTIVIBRATOR

By E. WILKINSON, Ph.D.

THE apparatus shown in the sketch below was developed in Loughborough College to assist students in understanding the working of the multivibrator. It portrays the electrical processes which are taking place in an actual circuit at a speed slow enough to be appreciated.

The circuit is a normal symmetrical multivibrator, except for the two grid condensers, which are enormous compared with ordinary standards. Each is an electrolytic condenser of 16-mfd. capacity, controlling the oscillation frequency down to one cycle in about three seconds. The layout of components on the breadboard brings them into positions corresponding to the circuit diagram which is drawn out on a ground-glass screen. This forms the front face of the instrument, and the rest of the glass is blacked so that individual parts of the diagram may be illuminated from behind.

The operation of the multivibrator depends upon the periodic charge and discharge of the two condensers. This is demonstrated by each condenser circuit automatically lighting up blue when charging and red when discharging.

The lamps illuminating the diagram are switched on and off by a mercury-vapor relay, contained in the main body of the apparatus, and controlled directly by the grid potential of one of the multivibrator tubes. The lamps illuminating the charge path of

condenser 1 and the discharge path of condenser 2 are fed in parallel from a low-voltage winding on a filament or a power transformer.

The lamps in the discharge path of condenser 1 and the charge path of condenser 2, are fed in series with a ballast resistance and the primary of this transformer.

The function of the gas-filled relay is to short a high-voltage secondary winding, thereby cutting out the parallel lamps and throwing the power filament supply almost entirely across the series lamps and the ballast resistance. The increased primary current is then sufficient to light the series lamps.

The working of the triggered multivibrator may also be demonstrated. Free running is stopped by increasing the bias resistance and cutting off tube No. 1. The cover plate, seen in the diagram below, hides the lower part of the diagram when the circuit is running free. This is now removed to show the modification in the circuit.

Condenser No. 1 discharges and remains discharged, while condenser No. 2 becomes charged.

This condition holds until the application of a triggering pulse overcomes the bias and allows a single changcover of the illuminated and darkened parts of the circuit.—*Wireless World, London*.

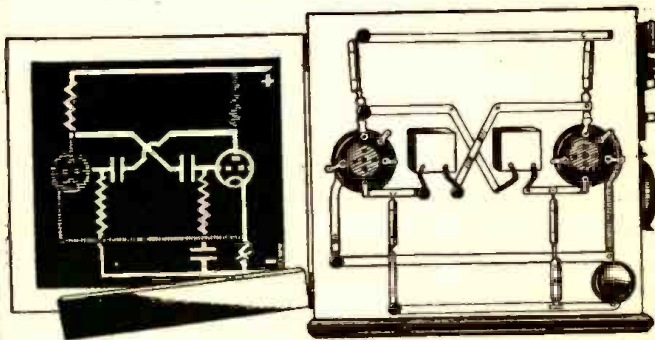

The parts of this demonstration multivibrator are mounted in the positions they occupy in the conventional circuit. Pilot lamps behind the black-painted ground-glass screen indicate charge and discharge conditions. The lines of the schematic are transparent: Circuit values are chosen to give a complete cycle every three seconds.

**PHONOGRAPH NEEDLE POINTS
Blunt or Sharp?**

INTERESTING comment on this subject by John Brierly:

I do not think it is quite correct to say that it has been generally accepted that for optimum results the tip of the reproducing point should be of as small radius as possible. That is not altogether a reasonable conclusion unless the cutting stylus is included in the specification as well.

The downward pressure of a pickup is often determined by calculating the maximum force between the point and the groove wall and assuming, for practical purposes, that the groove wall is inclined at an angle of about 45 degrees from the vertical; this latter assumption is most important and if it is effectively erroneous the result can be rather similar to that obtained by having an insufficient downward pressure. For instance, when the point reaches to the bottom of the groove (or nearly so) it is most unlikely, in the average case, that it will at the same time make good contact with the upper part of the groove wall. A little consideration will show that unless the downward pressure is infinitely large, a certain amount of lost motion must occur, and, owing to various considerations, its effect increases with frequency. It is noteworthy that matters are improved by recording at a higher level—providing, of course, that the downward pressure of the pickup is proportionately increased.

My experiments with various shapes and sizes of points have had to be carried out with points made in comparatively soft steel, which rendered exact observation rather difficult, but two conclusions were clear:—

(1) That for the reproduction of the higher frequencies with a minimum of "fizziness" it is absolutely essential that the point should make good contact with the upper part of the groove wall.

(2) Needle and record wear increases very rapidly as the contact with the bottom of the groove is reduced.

For optimum results, in so far as high-quality reproduction is concerned, at any rate, it would seem that the point should fit the groove at the bottom as well as the sides, but preference should be given to good contact with the upper part of the sides. At the same time, if this is carried too far, the fact should not be ignored that considerably greater wear will result. —*Wireless World (London).*

MINIATURE THYRATRON

Designed for installations where weight and space limitations must be considered, General Electric has brought out the GL-502, a small thyatron with two grids—one for control, the other for shielding. The tube is only 2½ inches high and weighs 2 ounces.

It is intended for application in general control equipment and in industrial welding apparatus.

The control characteristic is practically independent of the ambient temperature, over a wide range, and since the grid current is low enough to permit the use of a high resistance in the grid circuit, the tube has high sensitivity.

The grid-anode capacitance is sufficiently low to permit high inertia to line voltage surges. The peak inverse anode voltage rating is 1300 volts, and the instantaneous current rating 500 milliamperes. The average current rating is 100 milliamperes.

The cathode is of the quick-heating type, and is rated 6.3 volts at 0.6 amperes.

**NOW WESTON MODEL 785
INDUSTRIAL
CIRCUIT TESTER!**

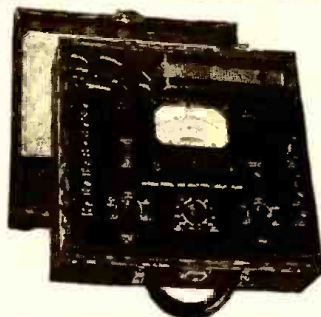

**Tests Insulation
and Cable Cover-
ing Resistance
Values as Well!**

With this new, compact unit which fits into the spare compartment and connects into the ohmmeter circuit with a pair of leads, Model 785 now provides for resistance measurements up to a value of 900 megohms. Thus the broad range coverage of this versatile maintenance tool now is as follows:

DC VOLTAGE . . . 0-1/10/50/200/500/1000 volts—20,000 ohms per volt. (*5000 volt range with external multiplier.)

AC VOLTAGE . . . 0-5/15/30/150/300/750 volts—1000 ohms per volt.

DC CURRENT . . . 0-50 microamperes, 1/10/100 milliamperes, 1 ampere and

10 amperes (*ranges above 10 amperes with external shunts).

AC CURRENT . . . self-contained ranges 0-5/15/10 amperes (*higher ranges with an external current transformer).

RESISTANCE . . . 0-3000, 0-30,000, 0-300,000 ohms, 0-3 megohms, 0 to 30 megohms (self-contained batteries). 0-900 megohms (*with compact Model 792 Resistance Tester shown in illustration).

**Extra equipment on special order.*

For complete facts on Model 785 write Weston Electrical Instrument Corp., 599 Frelinghuysen Ave., Newark, N. J.

WESTON Instruments

Learn

**RADIO quickly
for BIG PAY JOBS**



Pay Only \$1 a Month
Start today to qualify
for a bigger, better
job and real money.
MAIL COUPON TODAY

THOUSANDS of Radio Technicians needed for industry and our armed forces RIGHT NOW! This home study book—the "Radio Man's Standard Reference"—will enable you to qualify for rapid advancement and big pay.

**5 DAY EXAMINATION
Pay as you learn**

This book provides a complete course in Radio and Electronics. Written in simple, non-technical language—easy to understand.

**COMPLETELY REVISED—INCLUDES FREQUENCY
MODULATION**

Covers radio transmission and reception—sound pictures—short wave—public address systems—television—photo cells. More than 500 articles complete in themselves—over 1,100 additional definitions and references. Each section divided with cross-references to all related subjects. 1,000 pages—1,178 illustrations—130 tables—105 graphs.

ORDER YOUR COPY TODAY

DRAKE & CO.,

Dept. RC-5, 600 W. Van Buren St., Chicago, Ill.

DRAKE & CO., Dept. RC-5, 600 W. Van Buren St., Chicago, Ill.

Send me—Drake's Cyclopedic of Radio and Electronics, \$5.00.
—Drake's Electrical and Radio Dictionary, \$2.50. I will pay
postman \$1.00 plus charges (Postage prepaid if cash in advance)
and will remit \$1.00 per month until full purchase price is paid. If
not satisfied, I will return book within 5 days and my \$1.00 will be
refunded.

Name

Address

City State

Position

Company

**DRAKE'S ELECTRICAL
AND RADIO DICTIONARY**

Contains over 3,800 definitions of all technical words and terms used in all branches of radio, aviation, navigation and industrial control, photo-electricity, television, electricity, and magnetism. Fully illustrated. 300 pages. Only **\$2.50**

TECHNICAL BULLETINS

Technical bulletins give reliable information in easy-to-follow form, and save valuable time otherwise spent in laborious reading of numerous books. Every subject is treated briefly and concisely, yet completely. No complicated mathematics, chemistry, electricity, or theory. Each bulletin is written in simple language.

Each Bulletin consists of a set of large sheets, assembled in one packet, size 9 x 14 1/2"; weight 1/4 lb. Numerous illustrations, diagrams, charts to supplement text.

**PRICE \$1.00 EACH POSTPAID
ORDER BY NUMBER**

- D-111—DESIGNING AND BUILDING TRANSFORMERS
- D-112—DESIGNING ELECTRO-MAGNETS
- D-113—HOW TO DESIGN SOLENOIDS AND PLUNGER MAGNETS
- D-101—USING NICHROME RESISTANCE WIRE
- D-106—REWINDING ELECTRIC MOTORS
- D-144—A. C. CURRENT CONTROLLED WITH EASILY MADE CHOKE COILS
- D-148—DESIGNING AND USING ELECTRIC RELAYS
- D-127—SMALL ELECTRIC LIGHT PLANTS
- D-134—ELECTRICAL EXPERIMENTS WITH SIMPLE MATERIALS
- D-131—MODEL MAKERS & INVENTORS GUIDE TO REMOTE-CONTROL SWITCHING
- D-137—ELECTRICAL METERS EASILY BUILT
- D-136—SMALL A.C. ARC WELDER CONSTRUCTION AND USE

—GEOPHYSICAL— PROSPECTING PRINTS TREASURE FINDERS

With any one of the modern geophysical methods described in the Blue-Print patterns, radio outfits and instruments can be constructed to locate metal and ore deposits (prospecting); finding lost or buried treasures; metal war relics; sea and land mines and "duds"; mineral deposits; subterranean water veins; oil deposits (under certain circumstances); buried gas and water pipes; tools or other metallic objects sunken in water, etc., etc.

Folder No. 1
THE "RADIOFLECTOR PILOT"

Folder No. 2
THE "HARMONIC FREQUENCY LOCATOR"

Folder No. 3
THE "BEAT-NOTE INDICATOR"

Folder No. 4
THE "RADIO-BALANCE SURVEYOR"

Folder No. 5
THE "VARIABLE INDUCTANCE MONITOR"

Folder No. 6
THE "HUGHES INDUCTANCE-BALANCE EXPLORER"

Folder No. 7
THE "RADIODYNE PROSPECTOR"

Each set of blueprints and instructions enclosed in heavy envelope (9 1/2" x 12 1/2"). Blueprints 22" x 34"; eight-page illustrated 8 1/2" x 11" folder of instructions and construction data. **\$5.00**

The complete set of seven folders. Shipping weight 2 lbs. (add 25c for shipping anywhere in U.S.A.) **\$3.00**

Send Stamps, Cash or Money Order

TECHNIFAX

1917 S. STATE ST. RC543 CHICAGO, ILL.

506

PRACTICAL AUDIO AMPLIFIER THEORY

(Continued from page 472)

An important point to bear in mind here is the fact that about 10% of the output wattage is dissipated in the transformer windings and core, as heat loss.

Here again we face the misleading amplifier ratings commonly used to rate commercial equipment. The wattage ratings are usually based upon the output of the tubes, and not upon the useful wattage in the speaker.

The important point to remember here however, is the fact that an amplifier will be only as good as the output transformer. The writer has had many an amusing experience with radio men who have developed cases of the "raves" over some pet amplifier which was described as the "finest I've ever heard—nothing like it!" etc., etc. A glance at the wonder-of-wonders would disclose a standard four-dollar P.A. output transformer with a mediocre response curve straddling the amplifier chassis like a roadside bill-board advertising a clearance sale. While few people care to spend a fortune on audio components, "super" performance can neither be expected nor obtained unless "super" components are inserted into the amplifier.

THE LOUDSPEAKER

Taking an audio system as a whole and assuming all components to be first class units, the weakest point in the system as far as fidelity is concerned is the reproducer. The best types of auditorium hi-fidelity units have a response which at best is only flat within 1 DB from about 30 to 10,000 cycles. Thus to satisfactorily handle the output of a hi-fidelity amplifier, such costly speakers are necessary or co-axial assemblies must be resorted to. Where extended hi-frequency response is desired, especially in FM work, multiple-speaker assemblies are necessary since wide-range units are as yet lab. curios.

The speaker design requirements for both high and low frequency response tend to work in direct opposition to each other. To obtain a single-unit speaker with a wide range response appears to be pretty much of an impossibility. Thus to get an extended bass response, a large cone area is required. This means a massive cone and voice-coil structure. A disadvantage is the tendency of the large-area cone to flex at the voice coil at high frequency. To get extended high frequency response, a light-weight cone with considerable rigidity is required, especially at the voice-coil end. In other words, if a speaker is designed with a large cone in order to obtain good low-frequency response, the cone will have too much mass to vibrate efficiently at high frequencies and will tend to flex at the voice-coil end at these frequencies instead of vibrating as a whole. If the unit is designed with a small cone to obtain extended high frequency response, the natural period of vibration of the small cone will be so high as to make it impossible to oscillate at even one hundred cycles, let alone twenty or thirty cycles.

However, the word "impossible" has long since been proven to be more a term than a reality. Modern technicians are now solving this reproducer problem by means of several ingenious methods. One method is to increase cone rigidity at the voice-coil end by installing an aluminum insert about three inches wide. This light-weight metallic insert increases the cone weight only slightly and increases the rigidity enough so that

a response flat within 1 DB from 30 to about 10,000 cycles is obtained with a single unit reproducer. Another method is to use some sort of an exponentially curved cone which has greater rigidity than a simple conical form. Still another method is to use a special cone material which has greater stiffness than the usual cone material, and has a gradually decreasing cross-sectional thickness out to the edge of the cone. Various combinations of these tactics can be employed to produce a single-cone speaker with rather remarkable performance characteristics. One large electrical corporation's technicians have developed a reproducer with a frequency response extending from 30 to 18,000 cycles. This brings to mind a recent letter published in *Radio-Craft* wherein an indignant manufacturer gave vent to his feelings because some other manufacturer dared to claim that one of his speakers had a response range extending out to 10,000 cycles.

Coaxial and multiple-speaker assemblies can be used with good results, especially where greatly extended frequency ranges are desired, provided well-designed input channels with good cross-over characteristics are employed. Such systems tend to have a slightly "phony" effect in the "cross-over" regions because of phase-interference effects which can be detected by an experienced ear.

The new PM speakers are recommended if the price can be met, because the power supply hum nuisance is minimized, power supply and receiver circuiting is simplified, and receiver wattage consumption lowered considerably.

These speakers are equal in every way to the standard dynamic unit and have been made possible by the new "K" type of "hard" magnetic alloys recently developed. They are heat-pressure-moulded alloys of cobalt, nickel, iron, aluminum and other metals. They are made by placing the finely powdered ingredients under terrific pressures and then fusing or "sintering" them into "strain" type, porous, and very hard, metallic alloys, possessing remarkably high-flux density fields when properly magnetized and heat-treated. A high grade PM speaker with such a relatively small-sized magnet develops a magnetic field as intense as that of a larger electro-magnetic type.

BAFFLING

If a standard type of speaker cabinet is used as the speaker baffling system, the quality of the speaker output will be improved somewhat if the inside walls of the cabinet are sound-proofed with a multiple layer of felt, perforated Celotex and cloth padding. This will tend to eliminate speaker response peaks by reducing cabinet resonance, reflection and reverberation effects at certain frequencies.

There are many commercial and home-made types of speaker baffling systems in existence, all based upon absorption, reflection, reverberation, resonance, infinite-baffling or any combinations of these effects which with proper design and co-ordination with speaker, amplifier, cabinet and general acoustic condition characteristics, will improve speaker response to an appreciable degree.

THE POWER SUPPLY

On the face of it, the power supply would seem to have little or no bearing upon an

amplifier's performance as far as fidelity is concerned. Actually it has a definite influence in three ways.

If the power line supply and the rectifier system are not well filtered, so far as R.F. frequencies are concerned, certain types of static and external cross-modulation interference (especially tunable hum) will get into the amplifier circuits and spoil fidelity because of "masking" and inter-modulation effects.

If sufficient plate supply ripple filtering is not resorted to, a similar marring of fidelity will take place when the power frequency ripple and its harmonics get into the amplifier circuits.

If the power supply unit has poor regulation and the plate supply voltages fluctuate with signal amplitude variations (plate current variations), then an additional non-linearity factor is introduced into the amplifier tube circuits and harmonic distortion is generated to a greater degree than tube and circuit design calls for.

Thus the use of R.F. chokes and condensers in the power supply system and generous-sized power transformers, chokes, and filter condensers will tend to keep R.F. and power frequency interference down to a minimum. Also power supply regulation will be kept good, and will prevent the generation of unnecessary harmonic distortion because of over-saturated magnetic cores and inadequate filtering.

SHIELDING BY-PASSING

Generally speaking, the more filtering and by-passing resorted to in the design and construction of an amplifier, the less the probability of trouble with cross-talk, hum and oscillation. Even the amplifier tubes themselves should be shielded, unless they are metal envelope tubes. An old stunt used to demonstrate the need for such shielding consisted of the removal of the speaker leads from the amplifier and the suspension of earphone leads next to the power output tubes. When the gain was turned up, the amplifier signal could be heard in the earphones through the tiny capacity pick-up between the earphone leads and the power tubes.

However, the important fact must be stressed that the over-all constants of an amplifier circuit may be such that an addition of by-passing or shielding may actually *increase* instead of decrease circuit instability, or noise. Circuit constants and their inter-relationship in a completed amplifier are so complex that no fixed formulas or rules can be set up to fully predict any particular circuit's behavior under any set of operating conditions. Trial and error methods are the only dependable ones for the elimination of "bugs" in a newly-designed amplifier. Even the most experienced of design engineers cannot completely predict a circuit's behavior as it stands on paper and trial models must be built and various "bugs" eliminated before the unit can be safely placed upon the market. Circuit components may have to be shifted about; shielding shifted, added or eliminated in various stages; tube electrode voltages lowered; circuit gain lowered by various other means; certain circuit alterations made; tube types changed, etc., etc., in order to obtain satisfactory all-round performance. In other words, degeneration and regeneration effects can be counter-balanced in order to get stable operation by simply juggling circuiting constants around a bit.

Generally speaking, the more shielding resorted to, the more satisfactory and re-

(Continued on following page)

RADIO-CRAFT for MAY, 1943

HALLICRAFTERS ★ HALLICRAFTERS ★

LET'S ALL PITCH IN!

WE CAN all help win this war by selling our government the communications receivers and equipment they need quickly and in sufficient quantities.

That is the reason I pay *highest cash prices* for used communications equipment.

When this war is over you will be in the market for new equipment and by taking advantage of my offer to purchase your present equipment at highest cash prices you will be in a position to buy new and better equipment than you now own.

Write, telephone or telegraph me description of your used communications receivers, transmitters and parts of standard make; you will be paid cash immediately without bother or red tape. I am particularly interested in *Hallcrafters*.

I also have a store at 2335 Westwood Blvd., West Los Angeles, Calif.

Bob Henry, W9ARA
HENRY RADIO SHOP
BUTLER, MISSOURI



COMPLETE STOCKS

I still have large stocks of receivers, 2½ meter equipment, meters, tubes, transformers, resistors, condensers, panels, chassis, and radio parts of all sorts. I sell and rent code teaching equipment. Your orders and inquiries invited.

"WORLD'S LARGEST DISTRIBUTOR OF COMMUNICATIONS RECEIVERS"



FREE!

with \$1.00 subscription to **RADIO-CRAFT**

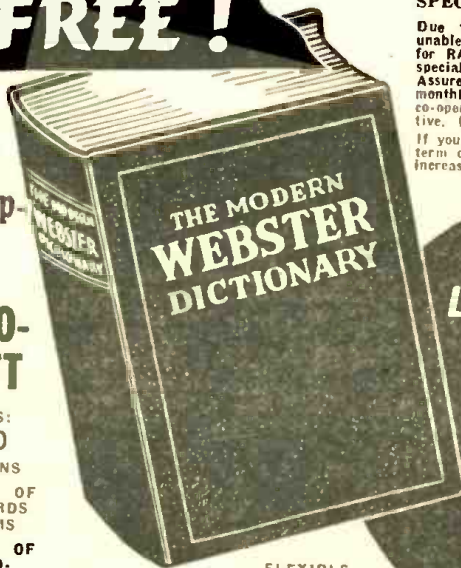

CONTAINS: **22,000** DEFINITIONS
DICTIONARY OF RADIO WORDS AND TERMS
DICTIONARY OF THE AUTO-MOBILE
TABLES, TREATISES, ETC.

FLEXIBLE IMITATION LEATHERETTE COVER. SIZE 5½"x8"

SPECIAL NOTICE TO OUR READERS

Due to wartime curtailment of paper, we are unable to meet the increasing news-stand demand for **RADIO-CRAFT**. We are therefore making this special introductory offer to our readers. Assure yourself of getting a copy of **RADIO-CRAFT** monthly by subscribing now and at the same time co-operate in making this wartime measure effective. Don't delay—Send in your order today. If you wish to take advantage of our special long-term offer and protect yourself against any possible increase in price, send \$1.50 for 12 issues.

FULL LIBRARY SIZE

MODERN WEBSTER DICTIONARY

416 PAGES

FILL OUT—MAIL THIS COUPON TODAY!

RADIO-CRAFT, 25 West Broadway, New York, N. Y.
 This is a New Order Extend my Present subscription
 Gentlemen: Enclosed you will find One Dollar for which enter my subscription to **RADIO-CRAFT** Magazine for Seven Months. Send me **ABSOLUTELY FREE** and **POST PAID**, my copy of the **MODERN WEBSTER DICTIONARY**.
 Name Please print clearly
 Address
 City State
 RC 5-43
 (Remit by check or money order; reletter letter if you send cash or unused U.S. Postage Stamp)

If you will take advantage NOW of our special subscription offer of seven months for \$1.00, we will send you **ABSOLUTELY FREE** and **POST-PAID** this 416 page full library size **MODERN WEBSTER DICTIONARY**—useful and instructive to everyone. This self-pronouncing authoritative dictionary—a new work throughout—contains the most up-to-date words now in common use, 22,000 definitions in all. It also features a Glossary of Radio Words and Terms, Dictionary of the Automobile, Treatises on Practical Syntax, Etymology, Punctuation and Standard English by well known authorities, Metric Tables, Time, State Flowers, National Parks of the U. S., etc.

This is a time limited offer, so don't delay in returning the Coupon.

RADIO-CRAFT

25 WEST BROADWAY NEW YORK CITY

HALLICRAFTERS ★ HALLICRAFTERS

EXPERIMENTERS

The war has made a terrific inroad in practically all electrical and mechanical supplies. We are fortunate in being able to offer difficult to obtain merchandise listed below. As supplies are limited, we suggest that you order immediately before certain of the items are sold out. All of the attractive items listed here are brand new, except where indicated. ALL are in PERFECT WORKING ORDER. In many cases, the parts alone total more than the price we are asking. Satisfaction guaranteed or your money back.

ORDER FROM THIS PAGE. Use our convenient coupon. Include sufficient extra remittance for parcel post charges. Otherwise order is sent express collect. Any excess will be refunded. All C.O.D. shipments require 20% deposit. NO C.O.D. shipments on orders for less than \$3.00. If full remittance accompanies order, deduct 2% discount. Send money order, certified check, or new U. S. stamps. No C. O. D.'s to foreign countries.

ORDER TODAY LIMITED QUANTITIES PROMPT SHIPMENTS ASSURED

THE SODERWAND SUPER SOLDERING IRON

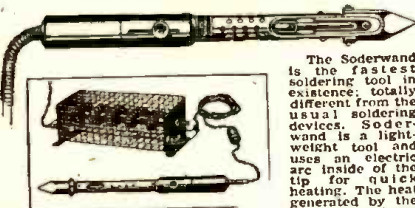

The Soderwand is the fastest soldering tool in existence; totally different from the usual soldering devices. Soderwand is a light-weight tool and uses an electric arc inside of the tip for quick heating. The heat generated by the arc is so intense enough to flow solder. There is a constant surplus of heat which makes quick soldering jobs seem easy. Current consumption is small, as only intermittent current is necessary to keep iron hot. Convenient thumb control cuts current on or off. Simple in design. Burn-out impossible as there is no heating element to burn out.

The Soderwand is an all-purpose tool that takes care of the heaviest or most delicate job with equal ease. IMPORTANT: This is a brand new item and comes in its original packing. We acquired the manufacturer's entire stock, which is the reason why we can sell the tool for so little money. THE ORIGINAL PRICE WAS \$5.00

Supplied with regular No. 5 prismatic tips, 14 feet of cord, attachments, plugs, resistance unit, and two extra sets of carbons. Made for 110 volts A.C. 60 cycles, or D.C. Size: 13" long. Tool weighs 10 oz. Ship. wt. of outfit 4 lbs.

ITEM NO. 154
YOUR PRICE **\$3.00**

WATCH-CASE MICROPHONE

This mike contains a unit like the famous Skinderviken Button, mounted in a cast-aluminum case resembling a large watch case. A push-to-talk switch is mounted in the case. 200-ohm impedance. Works into any transformer designed for single button microphones. Operates on one dry cell. Just the thing for home telephone sets, "home broadcasting," use with phonograph oscillators, etc. Case finished in black enamel. Slightly used. Size 2 3/8" x 1 1/2". Ship. wt. 1 1/2 oz.



ITEM NO. 156
YOUR PRICE **\$1.00**

SENSITIVE RELAY



This relay has back and front contacts, breaking one contact and making another when actuated. 5-ohm coils, sterling silver contacts, 5 binding posts. Relay can be adjusted to trip at 30 milliamperes. Invaluable to experimenters. Can be used for remote control of apparatus, as circuit-breaker, etc. will operate as electronic relay in plate circuit of average power tubes, as in air-raid "alert" units and other automatic devices. Adjustable half-spring tension. Heavy slate and iron base 2 1/4" x 5 1/4". All metal parts (except base) in heavy brass. Slightly used, but a first-class relay in all respects. Ship. Wt. 3 lbs.

ITEM NO. 155
YOUR PRICE **\$1.85**

POWERFUL ALL-PURPOSE INDUCTION MOTOR IDEAL FOR EXPERIMENTERS—101 USES

Sturdily constructed to precision standards, this self-starting shaded pole A.C. induction motor is powerful enough for a large variety of uses. Some of these are: Automatic Timing Devices, Current Interrupters, Electric Fans, Electric Chimes, Window Displays, Photo Cell Control Devices, Electric Vibrators, Small Grinders, Buffers and Polishers, Miniature Pumps, Mechanical Models, Sirens, and other applications.

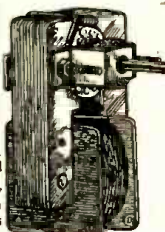

Consumes about 15 watts of power and has a speed of 3,000 r.p.m. When geared down, this sturdy unit will constantly operate an 18-inch turntable loaded with 200 lbs. dead weight—THAT'S POWER!
Dimensions, 3" high by 2" wide by 1 3/4" deep; has 4 convenient mounting studs; shaft is 3/8" long by 3/16" diameter, and runs in self-aligning oil-retaining bearings. Designed for 110-20 volts, 50-60 cycles, A.C. only.

ITEM NO. 147
YOUR PRICE **\$1.45**

WESTERN ELECTRIC BREAST MIKE

This is a fine light-weight aircraft carbon microphone. It weighs only 1 lb.

Mike comes with breast-plate mounting and has 2-way swiveling adjustment so that it can be adjusted to any desired position. There are 2 woven straps; one goes around neck, the other around chest. Straps can be snapped on and off quickly by an ingenious arrangement.

This excellent mike can be adapted for home broadcasting or private communication systems. By dismounting breastplate, it can be used as desk mike. Comes complete with 8-foot cord and hard rubber plug. Finished in spherulized plate, non-rustable.

THIS IS A BRAND NEW MIKE. IT HAS NEVER BEEN SOLD AT SUCH A LOW PRICE BEFORE. ORIGINAL LIST PRICE \$15.00. Shipping weight, 2 lbs.

ITEM NO. 152
YOUR PRICE **\$2.55**



VARIABLE SPEED UNIVERSAL MOTOR

For 110 Volts, A.C. or D.C. All Nickel Plate



Edison Dictaphone motor 1/50 H. P. Used but in excellent condition. For burning, polishing, drilling, sawing; runs phonographs, fans, models, blowers, lathes, etc. Special control permits variable speeds up to 1500 r.p.m. 5/16" shaft extends from both sides of motor. Cast iron base has 3 screw mounting holes.

Height 4 1/2"; length 7 1/2"; width 5 1/2". Shaft is 1 3/4" long on one side. Ship. Wt. 8 lbs.

ITEM NO. 157
YOUR PRICE **\$2.95**

POWER ADJUSTABLE RHEOSTAT

Here is an excellent rheostat used especially to regulate speeds of small motors, such as our Handy Workshop Outfit. This rheostat can be used in connection with motors up to 1/20 h.p.



This one rheostat is wire-wound on porcelain insulation. The black enamel steel case is perforated for ventilation. Adjustable handle regulates speed of motor easily and smoothly. Size 5"x2 3/4" overall. Ship. Wt. 2 lbs.

ITEM NO. 153
YOUR PRICE **\$1.45**

AMAZING BLACK LIGHT!!

Powerful 250-Watt Ultra-Violet Source



The best and most practical source of ultra-violet light for general experimental and entertainment use. Makes all fluorescent substances brilliantly luminescent. No transformers of any kind needed. Fits any standard lamp socket. Made with special filter glass permitting only ultra-violet rays to come through. Brings out beautiful opalescent hues in various types of materials. Small for amateur parties, plays, etc. to obtain unique lighting effects. Bulb only. Ship. Wt. 1 lb.

ITEM NO. 87
YOUR PRICE **\$2.00**

WATTHOUR METER

Completely overhauled and ready for immediate service. Designed for regular 110-volt, 60 cycle 2-wire A.C. circuit. Servicemen use it in their shops to check current consumption of sets, soldering irons, etc. Keeps coats down. If dismantled, the parts alone would bring the price. The elaborate gear train could be used as a counter on machines of various kinds. Simple to install: 2 wires from the line and 2 wires to the load. Sturdily constructed in heavy metal case, 8 1/2" high, 8 1/4" wide, 5" deep. Westinghouse, G. E. or Ft. Wayne makes. Ship. Wt. 14 lbs.



ITEM NO. 33
YOUR PRICE **\$4.95**

PRACTICAL AUDIO AMPLIFIER THEORY

(Continued from previous page)

pendable is the amplifier's operation. This is especially true where low-level (hi-gain) pre-amplifier circuits are concerned.

Thus hi-gain mike circuits often must be individually canned in their own shields and individual resistors, condensers and even certain wiring leads must be individually shielded with metallic braiding or tubing in order to minimize hum pick-up and instability problems. Perforated shields are often necessary across the open bottom of the amplifier chassis and about the whole amplifier chassis itself.

By blindly increasing the values of the by-pass condensers, the circuit constructor will often find that not only will circuit performance fail to improve but it may even deteriorate. If instability is the problem, there will usually be only a change in the oscillation frequency. If there is low-frequency degeneration, it may only grow worse. By properly proportioning the values of the filter or by-pass condensers and resistors with respect to the other circuiting constants of the amplifier stage, it is possible to obtain a low-frequency phase-shift and cut-off correction effect. Circuits and formulas for such low-frequency compensation circuits can be found in technical literature on video amplifiers. Final values are arrived at by means of square-wave generator and cathode-ray oscilloscope checks of the amplifier circuits.

Generally speaking, however, the heavier the cathode and screen-grid by-pass condensers, the better the low-frequency response, since degeneration effects are lessened at these frequencies. As mentioned above, this is not always necessarily true and it is always wiser to refer to the compensation formulas used in television work.

HEARING AID PROBLEMS—A BIOLOGICAL APPROACH

(Continued from page 474)

regard to the exclusion of outside noises, which are liable to distort the true spectrum. Speaking generally, defects in conduction tend to depress the low-frequency end of the scale (Fig. 2, curve B), whereas one of the common types of damage to the basilar membrane results in a loss of the higher notes (Fig. 2, curve A).

Knowing an individual's sensitivity in this way, a good hearing aid ought readily to be adjustable to have a compensatory rising or falling characteristic as the case might demand, and the production of such an aid with a really wide range of tone control would be of the greatest value. It is not absolutely necessary to employ an audiometer; in careful and well-instructed hands a good set of tuning-forks can give much of the necessary information, though precautions about external noise are even more necessary in this case. There are one or two standardized speech tests which if employed intelligently can give vital practical information.

POSSIBLE HARMFUL USE?

Various correspondents have raised the question as to whether a maladjusted aid can do damage without the user being aware of discomfort. There is no doubt that damage can be done to the basilar membrane by continued stimulation at an intensity

HUDSON SPECIALTIES CO., 40 West Broadway, N. Y. C.

IT'S EASY TO ORDER—CLIP COUPON—MAIL NOW ORDER FROM THIS PAGE.

HUDSON SPECIALTIES CO., 40 West Broadway, Dept. RC-5-43, New York, N. Y.

I have circled below the numbers of the items I'm ordering. My full remittance of \$..... (include shipping charges) is enclosed. NO C.O.D. ORDERS UNLESS ACCOMPANIED WITH A DEPOSIT.

OR my deposit of \$..... is enclosed (20% required), ship order C.O.D. for balance. NO C.O.D. order for less than \$3.00. (New U. S. stamps, check or money order accepted.)

Circle Item No. wanted: 33 87 147 152 153 154 155 156 157

Name Address

City State

Send remittance by check, stamps or money order; register letter if you send cash or stamps.

considerably below the level of discomfort, but the possibility of this in practice is not very likely, with a good instrument, as it represents a very decided peak in the spectrum in a region to which the patient must necessarily be sensitive, and the majority of deaf persons are very intolerant of this, as of excessive background noise and cracklings. There are exceptions to this general finding, but the great majority of hearing-aid users could probably safely be left to adjust the tone-controlling device for themselves.

MEDICAL DIAGNOSIS

But that is by no means the whole tale. The basic biological argument against the mass-distribution of deaf aids is not that the aid may do damage, but that the possible resort to the aid without systematic medical examination may allow a pathological process to progress beyond repair, while early detection might have the possibility of arrest or cure. This is not the place to discuss pathology, but one must bear in mind that the most precise audiometer curve tells only the result of the damage and not the underlying cause. A great number of the conditions causing deafness are progressive; some are not obviously connected with the ear, but are reflections of some generalized disorder, and the correct diagnosis is often dependent on a lifetime of specialized experience in otology.

It has been suggested that radio technicians might well be trained to fit deaf persons with hearing aids, and the term "otician" has been used to describe those so trained. This suggestion may have been prompted by the analogy of the optician. It is not altogether a sound analogy. The majority of the refractive errors measured

and corrected by the trained optician are relatively superficial and stable in character, and are more accessible to examination. They correspond rather to the hearing variations in acuity level of from plus to minus 10 db, which are found in average persons, but which in everyday life go uncorrected because we do not use the ear normally for the fine discrimination that we require from the eye under modern conditions. The basic pathology is widely different and the refractive errors tend to be much less progressive than many of the common causes of deafness. Moreover, one must remember that many deaf persons will not be benefited at all by the use of aids. The "otician" may, indeed, if he is doubtful as to the cause of deafness, recommend the client to seek medical advice; the difficulty is that the honest "otician," despite audiometer or fork tests, will nearly always be doubtful as to the cause, without a knowledge of which no form of treatment, hearing-aid or anything else, can wisely be employed.

POTENTIAL DANGERS

The mass-distribution project bears this potential danger, all too common in medical matters—palliative self-treatment until the damage has gone too far. The production in quantity of a standardized device, of knowledgeable design, reasonable price, and flexibility in adjustment of tone and intensity range, is quite another matter. A medical diagnosis made, and the possibility of hearing-aid use established, the radio and sound specialist is the competent authority to supply, maintain and adjust such a device, and service of this nature would be of greatest value both to the otologist and to great numbers of deaf persons.—*Wireless World (London)*

INVENTORS' CLEARING HOUSE

The National Inventors' Council, of the Department of Commerce, fills a long-felt need for a central governmental agency to which inventions and suggestions pertaining to war, can be submitted.

All the inventions are classified, and those of particular interest to radiomen are as follows:

Remotely controlled devices, such as aerial and marine torpedoes, by such means as radiant energy, sound or light. Land vehicles, land, sea, air mines—controlled from a remote point. Apparatus for remote control of any device. Locating devices operating by means of sound, heat, radiant energy, or other known or unknown rays.

Radio transmitters and receivers, circuits, vacuum tubes, static eliminators. Television devices and apparatus, iconoscopes. Telegraphy, telephony, systems of communications by means of light both visible and invisible. Teaching systems for radio or blinker operators. Electricity in general, where not otherwise provided for. Generation of electrical power, alarm systems, batteries, etc. Cryptography and machines or apparatus for use in coding and decoding messages.

If the inventor will submit his inventions or ideas in accordance with the following simple directions, he will expedite the handling thereof, and secure prompt consideration by the Council and by the armed forces concerned. It might be stated also, that all suggestions are held confidential by the Council and will not be disclosed to any unauthorized persons.

1. The Council will restrict its activities to suggestions pertinent to the war effort. Ideas pertaining to general government use cannot be dealt with by the Council.

2. Submit all suggestions in writing, and in such detail that the objectives and the proposed methods or means of carrying them out, are fully and clearly stated. The technical staff of the Council is fully qualified to evaluate the suggestions from written descriptions and drawings.

3. Each suggestion should be submitted as a separate document, clearly typewritten, accompanied by the necessary blueprints. Pages should be fastened together.

4. The Council will retain all documents submitted to it in the interests of simplifying the procedure and preserving the official records. The inventor is advised to retain duplicates of all material submitted. Sign and date the duplicates, in the presence of witnesses. Do not send models unless specifically requested.

5. Use English. No consideration can be given to suggestions written in a foreign language.

6. If suggestions or inventions for improving national defense are not adopted, the reasons for refusal cannot be divulged, as such disclosure might reveal highly confidential information on projects already in process in certain government departments.

7. The Council has no authority to do any development or experimental work needed to bring an invention to a state of usefulness.

8. The Council cannot consider manufactured products which are already in general use or are available on the open market. Such items are purchased directly by the Army and the Navy, and should be submitted in the usual way through the procurement procedures.

LEARN CODE!

Self-Contained Battery Portable



Model 100
\$9.85
COMPLETE Plus Postage

OFFICIAL U. S. SIGNAL CORPS FIELD TELEPHONE—TELEGRAPH SET

Just Released for Civilian Use!

MODEL 100—FOR CODE and PHONE. Practice code with this convenient, portable telegraph set or operate it as an outdoor, field telephone over hundreds of feet on a line without external batteries. Includes constant frequency buzzer, adjustable key, microphone, headphone, 4 batteries, genuine leather carrying case, diagram, operating instructions. Complete **\$9.85**

MODEL 101—FOR CODE PRACTICE ONLY. Similar to Model 100 except it does not include microphone or headphone. Price **\$6.85**

—MAIL ORDERS FILLED—

Please accompany all mail orders by postal money order including 75c to cover cost of special handling, packing, insurance and postage.

Quantity Limited—So Hurry!

New York's Oldest Radio Supply House

★ SUN RADIO CO. ★

212 FULTON ST., NEW YORK CITY

—RUSH COUPON TODAY—

SUN RADIO CO., Box R-5
212 Fulton St., New York City

Gentlemen: Enclosed find \$..... for which please rush at once the following:

() MODEL 100 Signal Corps Buzzer outfit complete at \$9.85 (plus 75c postage)

() MODEL 101 (Less microphone and headphone) at \$6.85 (plus 75c for postage).

NAME

ADDRESS

CITY STATE

Please Print Carefully

ELEMENTARY MATHEMATICS

The Book that takes Drudgery out of Mathematics

Only **50c** postpaid

SOLVES EVERYDAY PROBLEMS—HELPS YOU GET AHEAD IN LIFE

CONTENTS OF BOOK

CHAPTER I. Arithmetic—Addition—Subtraction—Multiplication—Division.

CHAPTER II. Factoring and Cancellation—Fractions—Decimals—Percentage—Ratio and Proportion.

CHAPTER III. The Metric System.

CHAPTER IV. How to Measure Surfaces and Capacity (Geometry).

CHAPTER V. Powers and Involution—Roots and Evolution.

CHAPTER VI. Mathematics for the Manual and Technical Craftsman—Thermometer conversions—Graphs or Curve Plotting—Logarithms—Use of the Slide Rule.

CHAPTER VII. Special Mathematics for the Radio Technician.

CHAPTER VIII. Commercial Calculations—Interest—Discounts—Short Cut Arithmetic.

CHAPTER IX. Weights and Measures—Useful Tables.

ONLY **50c** POSTPAID

Send Stamps, Cash or Money Order.
Send today for your copy of this indispensable book. It can be carried readily in your pocket. (Size 6 x 9 in.)

TECHNIFAX

1917 S. State St., RC-543, Chicago, Ill.

• BEGINNERS •

LISTENING POST

(Continued from page 483)

6.120 —	GERMANY calling, North American beam, variable times. Same lies as heard on 7.29 mc at 11 pm.	6.060 WCDA	BRENTWOOD, NEW YORK. Central American beam, 7:15 pm to 2 am.
6.11 GSL	LONDON. American beam, 5:15 pm to 12:45 am.	6.040 WRUW	SCITUATE, MASS. European beam, 6 to 7 am.
6.098 ZRK	CAPTOWN, SOUTH AFRICA. Day and night transmissions.	6.007 ZRH	JOHANNESBURG, SOUTH AFRICA. Evening transmissions.
6.095 OAX4H	LIMA, PERU. "Radio Mundial."	4.925 HJAP	CARTAGENA, COLOMBIA.
6.082 OAX4T	LIMA, PERU. "Radio Nacional."	4.905 HJAG	BARRANQUILLA, COLOMBIA.
6.080 WLWO	MASON, OHIO. European beam, 12:15 to 6 am.	4.885 HJBP	MEDELLIN, COLOMBIA.
6.07 XGOY	CHUNGKING, CHINA, am around 8:30.	4.865 HJFK	PEREIRA, COLOMBIA.
		4.835 HJAD	CARTAGENA, COLOMBIA.
		4.785 HJAB	BARRANQUILLA, COLOMBIA.
		2.92 GRC	LONDON, 7 pm to 12:45 am.

USING THE OLD PARTS

(Continued from page 481)

like it converted into a phonograph that could be used independent of the radio. Parts are scarce and are to be used for repairs. A search through the scrap brings up a four-tube A.C.-D.C. chassis. The volume control, three tubes and the antenna coil are missing. The 70L7 is still good and a 12SQ7 is in stock. Another search finds a "bum" 35Z5 as above. The 35Z5 is placed in the 12SA7 socket with all leads, ex-

cept heater leads, removed. Contacts 2 and 3 are connected together. The heater connections of the 12SK7 are shorted to complete the heater circuit. The record-player has a volume control, so the leads are connected from the negative to the grid of the 12SQ7. Results—a phonograph at the cost of one new tube.

Undoubtedly a better amplifier could be built, but this one serves the purpose with a minimum of new parts.

ONE MILLION RECEIVERS

One million radio receivers are already out of order, due to lack of essential parts, it is claimed on excellent authority. This represents two per cent of the receivers of the country. Thousands of others are becoming inefficient through lack of timely repair, and the same source estimates that an additional 5,000 are going silent daily.

At least part of the trouble is due to the lack of servicemen, who have gone into the forces or joined more essential industries, but shortage of materials, and especially of tubes, is the central cause.

A short time ago it was officially announced that production of 115 preferred types for civilian use would begin shortly. The set owner was to have 11,000,000 new tubes shortly, and 45,000,000 before the year was out. Radio users breathed sighs of relief, and began asking dealers when the new tubes were expected.

The situation does not justify such optimism. Representatives of a number of the seven large manufacturers who were to share in the "civilian tube program" reveal that "not a single bit of material has been officially allocated" for the manufacture of these tubes, and until that is done the program is meaningless. A very small portion of the present output is being diverted into civilian channels.

The question of material is not the only one engaging the attention of those who are now trying to solve the home set owners' problem. "Even if we got orders tomorrow we could not immediately begin turning out tubes," one of the factory men is quoted. "We all have large current war tube commitments. It might be weeks or months before the additional work could receive attention."

Another representative pointed out that the whole industry was capable of putting out only 2,000,000 tubes a month above the present huge war output. At that rate the plan for 11,000,000 tubes every three months could only be half filled, and even this output might be cut drastically should new military needs arise.

Experts are confident that the actual picture is not as bad as it might appear from the foregoing. "One working receiver in every home" is considered important to national morale, and every effort will be made to maintain that minimum. This might mean that the 50,000,000 radio receivers in the U.S.A. would be reduced to 30,000,000.

The last year has shown that production figures are always susceptible of rapid upward revision. There is no reason for believing that tube manufacturers will fail to face the challenge so successfully met by other branches of America's industry. There may be a few weeks or even months of difficult travel, but it is almost certain that by the end of the year the war-time tube program will be operating on schedule.

"HANDY RADIO TESTER"

A NUMBER of inquiries have been received as to the value of parts in the "Handy Radio Tester," published in the March issue.

The answer is: That this is a junk-box job, planned to use parts already in the possession of the experimenter. The values of the parts are the values of those parts already in your junk-box. A little judgment and common sense will of course have to be used in selecting them.

As to the coil: If you have a condenser of about .00035 or .00025, use No. 28 enamel on a 1-inch coil form, or of No. 26 on a 1½-inch form, reducing the number of turns about one-third in the latter case.

ELECTRON-RAY TUBES FOR THE BEGINNER

(Continued from page 487)

USE IN VTVM'S

Vacuum-tube voltmeters may be constructed on the same principle. A circuit for one of these instruments will appear in the June issue.

Other types of voltmeters have been built, using the closing of the shadow angle as the grid bias is changed to indicate the voltages applied. The tube is mounted so that its top just comes up through a panel. A calibrated scale mounted on the panel around the end of the tube reads the amount of shadow closing, in volts. The edge of the shadow acts as the pointer in this instrument.

USE IN SIGNAL TRACERS

Electron-ray tubes may be found in other test instruments, notably the multi-channel signal tracers, which may use two or three of them. They are used to indicate volume level in audio amplifiers or recording amplifiers. Hooked up as a vacuum-tube voltmeter, the tube may be used in an output meter.

The ingenious experimenter will find many applications where this relatively cheap tube may be made to do the work of an expensive meter, and in many cases, do it better.

CORRECTIONS

In the April issue, on Page 429, a mistake was made in the cathode resistor of the "Ten-Watt Class-B Amplifier." This resistor was listed as 900,000 instead of 900 ohms.

The schematic of the "Handy Tester and Signal Tracer" on Page 411 also contains an error. The grid and plate of the 6C5 are incorrectly shown connected together.

This would, of course, render the whole device inoperative.

NOW—A REALLY HIGH-POWERED—Radio Engineering Library

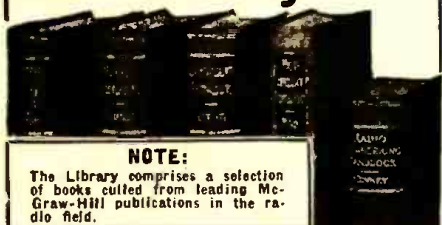

NOTE:

The Library comprises a selection of books culled from leading McGraw-Hill publications in the radio field.

- especially selected by radio specialists of McGraw-Hill publications
- to give most complete, dependable coverage of facts needed by all whose fields are grounded on radio fundamentals
- available at a special price and terms

THESE books cover circuit phenomena, tube theory, networks, measurements, and other subjects—give specialized treatments of all fields of practical design and application. They are books of recognized position in the literature—books you will refer to and be referred to often. If you are a practical designer, researcher or engineer in any field based on radio, you want these books for the help they give in hundreds of problems throughout the whole field of radio engineering.

5 VOLUMES, 3319 PAGES, 2289 ILLUSTRATIONS

1. Eastman's FUNDAMENTALS OF VACUUM TUBES
2. Terman's RADIO ENGINEERING
3. Everitt's COMMUNICATION ENGINEERING
4. Mudd's HIGH FREQUENCY MEASUREMENTS
5. Henney's RADIO ENGINEERING HANDBOOK

10 days' examination. Easy terms. Special price under this offer less than books bought separately. Add these standard works to your library now; pay small monthly installments, while you use the books.

10 DAYS' FREE EXAMINATION—SEND COUPON

McGraw-Hill Book Co., 330 W. 42nd Street, N. Y. C.

Send me Radio Engineering Library, 5 vols., for 10 days' examination on approval. In 10 days I will send \$3.00 plus few cents postage, and \$3.00 monthly till \$24.00 is paid, or return books postpaid. (We pay postage on orders accompanied by remittance of first installment.)

Name

Address

City and State

Position

Company

RC 5-43

BOOK REVIEWS

PRE-SERVICE COURSE IN SHOP PRACTICE, by William J. Kennedy. John Wiley & Sons. Stiff cloth covers, 6 x 9 inches, 337 pages. Price \$2.00.

This book is based on the requirements of the U. S. Army for pre-induction training to be offered to high school seniors. Shopwork is treated as related to military needs, and the mechanical skills needed by a mechanized army are stressed.

The first four chapters, or one hundred and ten pages, deal with tools, including hand tools, machine tools and measuring instruments. The student is told enough about drilling machines, lathes and milling machines to prepare him for direct instruction on the machine itself. The chapter on "Common Essential Tools" is an excellent treatise on the care, proper handling and safe use of such simple and commonly-abused instruments as the screwdriver, pliers and chisel.

Following are three chapters on wood-working, including layout, cutting, jointing, assembly, finishing and preservation. More detailed instructions on the use of tools used in wood-working are included.

Further chapters deal with metal work, with detailed treatment of the use of drills, and other metal-working tools, and soft sold chapter on soldering. Hard and soft soldering processes are described.

The last chapters are devoted to rigging, and include splice and knot work, wiring and wire splicing.

While this book is designed for pre-induction training, it is a good volume for a handy man. It shows how to do in a workmanlike manner the things that he is already able to rough through in crude style.

APPLIED ELECTRONICS, by the Staff of the Department of Electrical Engineering, Massachusetts Institute of Technology. Published by John Wiley & Sons, Inc. M.I.T. 6½ x 9 inches, 772 pages. Price \$6.50.

This work is introduced as "a first course in Electronics, electron tubes, and associated circuits." It forms part of the M.I.T. Electrical Engineering Series, and is the third book in the group. Although a knowledge of mathematics is necessary to the student who wishes to use it as a textbook, the general reader will find it thoroughly interesting.

The book opens with a 55-page chapter on Electron Ballistics, dealing with the motion of the individual electron. From here it takes the reader through chapters on electronic emission from metals, and conduction through vacuum, gases and vapors, to the subject of electron tubes.

Two chapters deal with tubes, one handling high-vacuum and the other, gas types. Ignitrons and Thyratrons are discussed here and are further dealt with in the following two chapters on rectifiers.

From here the book deals with the electron tube as the radioman knows it, with three chapters on amplification. The first of these discusses Class A single-stage amplifiers, including such subjects as ideal output transformers for impedance matching and

single-stage amplifiers using triodes or pentodes in push-pull or parallel.

The second chapter on amplification deals with Cascade Amplifiers, class A1, including a discussion of degenerative feed-back. The third chapter includes all types of amplifiers with operation extending beyond the linear range of the tube characteristic—Class A-B, Class B and Class C. A chapter on oscillators and one on demodulation or detection, complete the book.

Coming at this time, and from such a source, this book will no doubt find a wide and ready welcome from electrical engineers wishing to orient themselves toward electronics, students, advanced radiomen and others.

WHAT YOU SHOULD KNOW ABOUT THE SIGNAL CORPS, by Harry Meyer Davis and F. G. Fassett, Jr. Published by W. W. Norton & Co., Inc. Stiff cloth covers, 5½ x 8½ inches, 214 pages. Price \$2.50.

Beginning with the history of the art of communications in an introductory chapter, the authors start out with the history of the Signal Corps from its founding just before the Civil War to the present. The status of the Corps in our modern army—its organization and methods of cooperation with the other branches of the military arm—are also treated thoroughly.

The lay reader will find some of the most interesting parts of the book those which deal with little-known activities of the Signal Corps. Many persons know that the Corps is the official photographer of the Army. Few realize, however, that our V-mail service is also a Signal Corps activity.

It is also news to most people that the United States Weather Bureau started as a branch of the Signal Corps. Founded by Chief Signal Officer Myer, the founder of the Corps, it remained under the Signal Corps till 1890. Neither is it common knowledge that military aviation was pioneered by the Signal Corps, and that up to May, 1918, all American army planes were operated as part of the Aviation Section, Signal Corps.

Other sections deal with Signal Corps men (and women) and materiel, with the difficulties encountered in warfare, as well as the amusing sides of combat signal engineering, and with the educational work done by the film studios which form part of the photographic branch of the Corps.

RADIO SERVICING COURSE BOOK, compiled by M. N. Beitman. Published by Supreme Publications. Flexible paper covers, size 8½ x 10½ inches.

This is the fifth edition of a work already well-known to many servicemen. Stressing the practical angle, it makes immediate application of even the earlier lessons on conductance, Ohm's Law, D.C. and A.C., etc., to immediate problems connected with modern radio apparatus. The cuts assist toward the same end, the publishers having broken with a commonly-encountered tendency to show simplified circuits,

in which the action can easily be made clear, but which have the overwhelming disadvantage that they resemble nothing in existence at the present day. The pictures here are of the most modern types of equipment.

Actual servicing is brought in early in the course, and the use of servicing instruments is well handled. Methods of using cathode-ray oscilloscopes are described. The humbler instruments are not neglected, as is evidenced by the graphical treatment of the effects produced by introducing a meter in certain radio circuits, a subject little considered by many servicemen.

The entire course runs to 20 lessons, the earlier part being taken up with fundamentals and simple servicing, and the more advanced lessons dealing with Use of Servicing Instruments, Public Address, Recording, Meters, Power Supplies, Transmission, Photo-Electric Cells and Moving-pictures, Frequency Control and similar subjects.

LABORATORY MANUAL IN RADIO, by Francis E. Almstead, Kirke E. Davis and George K. Stone. Published by McGraw-Hill Book Co. 6 x 9 inches, paper covers. 139 pages. Price 80 cents.

This manual is designed for the student working in class under an instructor. Eminent practical in its nature, it starts with an introductory chapter on the use and care of tools employed in a radio laboratory. The first experiment described is to learn to use a soldering iron and make a soldered joint.

From this down-to-earth start, the student is conducted through experiments designed to teach him to hook radio parts together in a set, then to construct an audio-frequency oscillator. Five experiments with vacuum-tube characteristics should teach him more about their operation than as many chapters of a standard text.

Further experiments are designed to give the student practical knowledge of measuring resistance, Ohm's Law, the action of vacuum-tube rectifiers, the behavior of coils and condensers in direct- and alternating-current circuits, resonance, receiving circuits, antennas, use and construction of instruments and continuity tests in receivers to discover defective parts. Altogether thirty-six experiments are described.

Pages are provided for the student's notes, these being ruled into tables or squared for graphs wherever the experiment requires it. A brief appendix contains the commoner formulas and some suggestions on laboratory work and equipment.

WHAT EVERY USER OF ELECTRICITY SHOULD KNOW, by P. Palmer and S. Palmer. Published by the authors. Flexible fiber covers, 5½ x 8½ inches, 21 pages. Price \$1.00.

The authors boast that they have compressed much into little in this booklet. The boast is justified. In its twenty-one pages is supplied practically all the information needed by the careful householder who wishes to get the utmost from the dollars

(Continued on following page)

WE WON'T TALK—BUT

AMPLIFIER COMPANY OF AMERICA wishes to advise its many patrons among readers of RADIO-CRAFT that some time in the near future (the nearer the better) we will again be at your service with "eye openers" that will amaze you.

At present our facilities are devoted entirely to the production of war essentials. Please write us for assistance on Sound Engineering problems helpful to the war effort only.

(ELECTRONIC DIVISION)

AMPLIFIER CO. of AMERICA
17 WEST 20TH STREET NEW YORK N. Y.

ELECTRONICS

Engineers
Laboratory Assistants
Production Men

**Well Paying War Job Plus
Peace Time Career!**

Ideal working conditions with expanding manufacturers now at war work and planning peace time developments. Unlimited opportunity for an important place in a New World of Radio.

Men employed at full skill in war industry should not apply!

All others write Today!

PANORAMIC RADIO CORP.
242 West 53th Street
New York

Headset Headquarters

CANNON-BALL

is unusually sensitive. For clarity of tone, dependable performance, quality at a fair price, choose the Cannon-Ball Guaranteed Headset you like best. Folder C-5 illustrates complete Cannon-Ball line of efficient Headsets.

Write.

Scientifically Built Heavy bar magnets greatly increase their efficiency.

C. F. CANNON COMPANY
SPRINGWATER, N. Y.

LEARN CODE the way you'll be using it by **SOUND**

The best way to learn to read code is by listening to code. The best way to learn to send code is by hearing your own sending repeated back to you. With the new All-Electric Master Teleplex Code Teaching Machine, you learn code the natural, easy, fascinating way. Only instrument ever produced which records your sending in visible dots and dashes—then SENDS BACK your own key work at any speed you desire. There are NO PERFORATIONS—NO INK. Far superior to anything ever devised—a marvel of simplicity. That's why practically every school teaching code uses TELEPLEX. We furnish complete course, including the All-Electric Master Teleplex. Give your personal instruction with a MONEY BACK GUARANTEE—all at a surprisingly low cost. Write today for FREE catalog.

**107 HUDSON ST.
TELEPLEX CO., JERSEY CITY, N. J.**

TUBES FOR SALE

Kellogg — McCullough AC Tubes

All brand new in original factory cartons. Limited supply.

12 or more 59c. Less than 12, 79c.

LUXOR RADIO MFG. CO.
509 West 23rd St., N. Y. City

USED Correspondence Courses

COMPLETE HOME-STUDY COURSES and self-instruction books, slightly used, sold, slightly priced, exchanged. All subjects. Satisfaction guaranteed. Cash paid for used courses. Full details and \$4.00 illustrated bargain catalog FREE. Write today! NELSON COMPANY, 500 Sherman, Dept. E-210, Chicago

Book Reviews

(Continued from previous page)

he spends for electric service. There is even room for a one-page introduction, in which the authors aver that electricity was first put to practical use over 4000 years ago, by the legendary Chinese ruler Hwang-Ti.

Starting out with the question "What is a Kilowatt-Hour?" they describe the electric meter—with a page of figures which show pictorially how to read it. The connection between meter readings and electric light bills is briefly and precisely explained and the customer told how he can check his bill.

Meter problems, such as accuracy and "creep" are discussed, and the user is shown how to find how many watts he is using at a given time.

Different types of electric lights are discussed from the economic point of view, as are electric refrigerators, clocks and other appliances. Even the question of proper wiring in connection with current consumption is taken up. A table showing the consumption of all types of electric household appliances is given, the electricity used being tabulated both in watts and in hours of use required to consume one kilowatt-hour of electricity.

GO EASY ON CLASS B

THE beginner is cautioned not to try to make a Class B amplifier out of a Class A amplifier, simply by grounding the cathodes of the output tubes. The chances are he will burn out the secondary winding of the push-pull input transformer if he does. A special transformer, called a Class B push-pull input transformer, with a ratio of 1:1 or of 1.5:1, must be used.

Also, the preceding stage must be a driver stage, such as a power pentode in triode connection, or two triodes in push-pull. The reason is that the Class B output stage draws current in its grid circuit, and the current must be supplied by the driver. (In Class A the first A.F. must supply voltage only; no current.)

Another requirement is a separate grid bias supply, which must have ample power and good regulation, so that the grid bias may be steady under all conditions of plate current surging in in the Class B output.

The beginner is therefore advised, if he wants to experiment with Class B operation, to use an acceptable design already worked out, with recommended components (which vary somewhat with the types of tubes available), and not depend on guesswork.

Since Class B is used chiefly for public address systems, transmitter modulation, etc., he would do well to stick to Class A operation for awhile, until he is sure of himself on advanced work.

Index to advertisers

Allied Radio Corp.	496
Amplifier Co. of America	512
Audel & Co., Theo.	Back Cover
Burstein Applebee	503
Cannon Co., C. F.	512
Coyne Electrical School	451
Drake & Co., Frederick J.	505
Echophone	454
Gold Shield Products	504
Hallicrafters, Inc.	Inside Front Cover
Harrison Radio	502
Henry Radio Shop	507
Hudson Specialties Company	508
Lancaster, Allwine & Rommel	502
Luxor Radio Mfg. Co.	512
McGraw-Hill Book Co.	510
Meissner Manufacturing Co.	492
Midwest Radio Corp.	495
National Radio Institute	449
National Schools	503
National Union Corp.	493
Nelson Company	512
Opportunity Adlets	502
Panoramic Radio Corp.	512
Popular Homecraft	512

RADIO SCHOOL DIRECTORY

- Acme Trade Schools, Inc.
- Candler System Co.
- Capitol Radio Engineering Institute
- Commercial Radio Institute
- Lincoln Engineering School
- Mass. Radio School
- Metropolitan Technical School
- N.Y. Y.M.C.A. Schools
- RCA Institute
- Radio-Television Institute
- Tri-State College

Radcraft Publications, Inc.	497, 498
Radio & Technical Publish. Co.	490
Scientific Radio	
Sprague Products Co.	4
Sprayberry Academy of Radio	45
Sun Radio	509
Supreme Instruments Corp.	504
Supreme Publications	471
Sylvania Electric Co.	452
Technifax	506, 509
Teleplex Company	512
Triplett Electrical Instrument Co.	504
University Laboratories	502
Weston Electrical Instruments	505

(While every precaution is taken to insure accuracy, we cannot guarantee against the possibility of an occasional change or omission in the preparation of this index.)

Complete Plans

For Building Useful and Practical Things at Home. Each issue of Popular Homecraft is crammed with plans for making such beautiful and useful things as: Furniture, Bird Houses, Lamps, Outdoor Garden Furniture, Candle Equipment, etc. Covers lathe work, tools, wood-working, leathercraft, copper, etc. You'll find "how" to make almost everything from the pages of Popular Homecraft. Scores of drawings and photographs make every step simple as A B C. A real "How-To-Do-It" magazine.

Six Months' Trial \$1.00

Send \$1.00 today for trial six months' subscription. Money Back If Not Delighted.

POPULAR HOMECRAFT

937 Palmolive Building Chicago, Ill.

Trial 6 Months \$1.00

Radio School Directory

TO OUR READERS

NOW, more than ever before America needs trained radio men. The Army, the Navy and the Air Force are continuously on the lookout for men who have had training in radio. Scores of war industries require radio men in various capacities throughout the country. There now is and there

will be a great shortage of radio men for years to come. NOW IS THE TIME TO TAKE UP RADIO.

The leading radio schools listed in these pages are training thousands of men in all branches of radio. We suggest that you read their advertisements carefully.

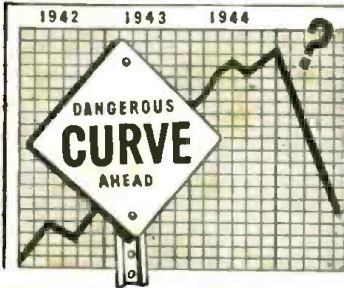

Technical Training Now Will Insure you of A Lasting Career in Radio and Industrial Electronics

Believe in signs? NOW is the time to make sure of the road ahead? Any thinking radioman will realize that the future belongs to those men who are equipped to handle important technical assignments. After the present emergency, thousands of untrained, unprepared radiomen will be left behind, when employers can take their pick of the best men. That's why CREI stresses the need now for a planned program of training . . . to increase your technical ability so that you will be in a position to command an important job when the inevitable readjustment comes after the war. You can make your present radio job pay you dividends in the years to come by investing in a CREI home study course in Practical Engineering. CREI specialized training a second you to advancement, increased pay and radio adventure in the great post-war field of industrial electronics.

WRITE IF YOU WANT A FREE 32-PAGE BOOKLET

Let us and professional men who have radio experience make more money for you. We have the know-how you need to qualify for a radio job. To help you get gently answer your questions. PLEASE STATE FULLY YOUR BACKGROUND OF EXPERIENCE, EDUCATION AND PRESENT POSITION.



CREI Students, Graduates — ATTENTION!

The CREI Placement Bureau is flooded with requests for CREI trained radiomen. Employers in all branches of radio want trained men. Your government wants every man to perform his job or be placed in a job, that will allow him to work at maximum productivity. If you are or will be in need of re-employment write your CREI Placement Bureau at once.

CAPITOL RADIO ENGINEERING INSTITUTE

Home Study Courses in Practical Radio Engineering for Professional Self-Improvement
Dept. RC-5, 3224-16th Street, N.W.
WASHINGTON, D. C.

Contractors to the U. S. Signal Corps—U. S. Coast Guard
Producers of Well-trained Technical Radiomen for Industry

LEARN RADIO

600 LICENSED graduates placed in past 7 years in shipping, broadcasting, aviation, police, etc.; we also teach radio servicing and repairing; new beginners' class now forming; 60-page catalog free; oldest, largest and best equipped.

MASS. RADIO SCHOOL
18 BOYLSTON ST., BOSTON, MASS., Est. 1899

CALLING ALERT MEN
CALLING ALERT MEN
CALLING ALERT MEN

RADIO OPERATORS WANTED

Good pay, adventure, interesting work! Army, Navy and Commerce need thousands of men who can send and receive Radiotelegraph Code. Learn Code at home or improve your proficiency and rating through the famous Candler System . . . the same easy, simple system used in training Radiotelegraph Specialists in Signal Corps, Navy, Marines, Coast Guard, Navy Reserve, Airlines and Amateurs. Qualify quickly. No long-drawn-out studies. Candler System established quarter century. Candler has trained world's champions, experts in telegraph communications. You can give you fast sending and receiving technique. Tremendous new field for operators both in and out of Armed Services. Instruction for beginners and operators. You can learn code or increase your w.p.m. speed and improve proficiency. We help you qualify in half the usual time for amateur or commercial license and a good rating.

Write today for FREE Candler Book of Facts. It costs you nothing.

CANDLER SYSTEM CO.
P. O. Box 928 Dept. 5-E
Denver, Colorado U.S.A.
Craven House, 121, Kingsway, London, W.C. 2

RADIO ENGINEERING!

ENTER June 15, 1943 and finish July 1, 1945 in accord with Selective Service Directive. B.S. Degree. Modern laboratory, latest equipment. Courses also in Civil, Electrical, Mechanical, Chemical, Aeronautical Engineering; Business Administration, Accounting, Secretarial Science. Special Preparatory Dept. Tuition, living costs low. 60th year. Catalog.

TRI-STATE COLLEGE 2453 COLLEGE AVE. ANCOOLA, INDIANA.

PRE-INDUCTION RADIO COURSES

FOR CIVILIANS AND THOSE ENTERING MILITARY SERVICE

NEW CLASSES NOW STARTING

- RADIO OPERATING
- CODE
- RADIO SERVICING

New York Y.M.C.A. Schools
4 W. 64th Street New York City

LES Correspondence Courses in **RADIO and ELECTRICAL ENGINEERING**

ELECTRICAL ENGINEERING Get good grasp of wide electrical field. Prepare yourself, at Low Cost, for secure future. Modern, simplified, you can understand quickly.

RADIO ENGINEERING Extra fine course in radio, public address, photo-electric tube. Trains you to be super-service man, real vacuum tube technician. Servicemen needed badly. Diploma on completion. Tuition \$25, other course deferred payment plan.

FREE Get copies of school catalogs, student magazines, complete details. SEND NOW!

LINCOLN ENGINEERING SCHOOL Box 931-C48, LINCOLN, NEBR.

RADIO COURSES

for Men and Women

PRE-INDUCTION AND CIVILIAN TRAINING

Write, Phone or Call 9 a.m. to 9:30 p.m.

METROPOLITAN TECHNICAL SCHOOLS
Licensed by State of New York
RADIO DIVISION Dept. R
7 CENTRAL PARK WEST, N.Y. Circle 7-2515

WELDERS IN GREAT NEED BY WAR INDUSTRIES—



Your time if invested now (at small expense) in a Welding career will qualify you for immediate earnings as there is a definite shortage of Welders in our war effort.

In the new world of tomorrow Welders will be in great demand as important factors in the rebuilding of essential ships, planes, etc. You learn welding by actually "Doing Welding" under the guidance of experts.

Join our Spring Classes now being formed—Have a trade that pays earnings in the higher income brackets. Write or call us today.

ACME TRADE SCHOOLS, Inc.
236 West 54th St., New York, N. Y.
Off Broadway Circle 6-3453



RADIO - TELEVISION VITAL to War Effort

Enroll now with new groups. Opportunity under war conditions and real future in peacetime.

Radio-Television Institute
Dept. R. C.
480 Lexington Ave., New York, N. Y.

COMMERCIAL RADIO INSTITUTE

A radio training center for over twenty years. Well equipped. Excellent faculty. Practical resident courses in Defense, Radio Telegraphy, Broadcast, Servicing, Industrial, Television, Aeronautical, Drafting, Mathematics and Studio Technique. Placement bureau. Classes now forming for June 14. Catalog upon request.
Dept. D, 38 West Biddle Street, Baltimore, Md.

RADIO TECHNOLOGY

RCA Institute offers an intensive two-year course of high standard embracing all phases of Radio and Television. Practical training with modern equipment. Also shorter specialized courses in Commercial Radio Operating, Radio and Television Servicing, and Aviation Communications. For Free Catalog write Dept. RC-43.

RCA INSTITUTES, Inc.
A Radio Corporation of America Service
75 VARICK STREET NEW YORK

Audels

RADIO -MANS GUIDE

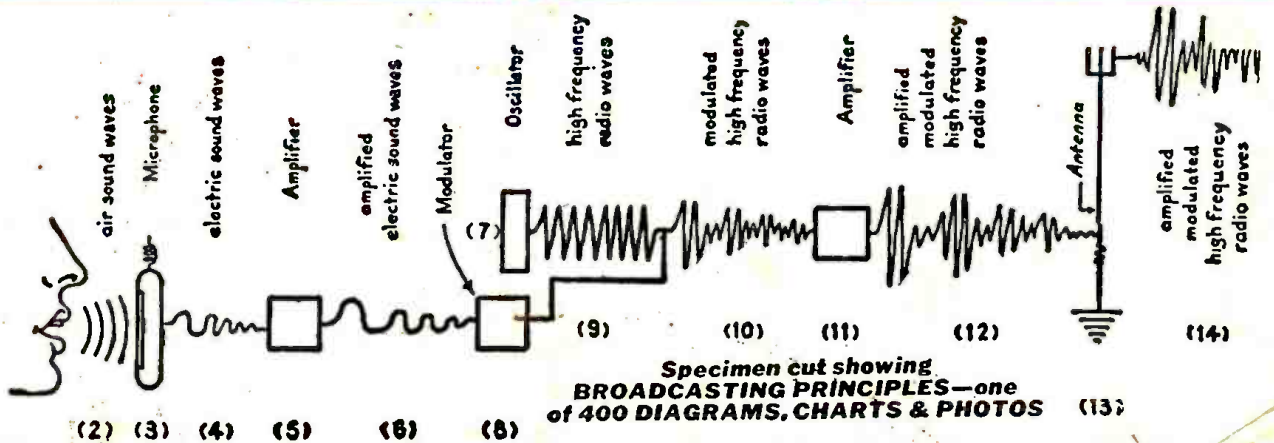

(1) QUESTIONS AND ANSWERS

1001 FACTS



THE KEY TO PRACTICAL RADIO INFORMATION

Including Frequency Modulation—Television,

Inside Information for Aviation, Marine, Commercial Operators and Technicians, Servicemen and Students

772 PAGES, 400 DIAGRAMS, CHARTS & PHOTOS

This well organized reading course in Radio is especially suitable for home study and as a ready reference guide to help you learn the inside facts about radio. The amount of mathematics required for a successful study of this book is fully covered as the various chapters include numerous practical radio problems carefully worked out, step by step, to their final solution. The contents are PROGRESSIVELY ARRANGED AND CAREFULLY INDEXED.

LATE DATA—EASY TO READ AND UNDERSTAND

Gives Authentic Principles and Practices in Construction, Operation, Service & Repairs. Covers clearly and concisely Radio fundamentals—Ohm's Law—Physics of sound as related to radio science—Measuring instruments—Power supply—Resistors—Inductors—Condensers—Transformers and examples—Broadcasting stations—Radio Telephony—Receivers—Diagrams—Construction—Control systems—Loudspeakers—Antennas—Auto Radio—Phonograph pickups—Public Address Systems—Aircraft & Marine Radio—Radio Compass—Beacons—Automatic Radio Alarms—Short Wave—Coil Calculations—Testing—Cathode ray oscillographs—Static Elimination—Trouble Pointers—Underwriter's standards—Units & tables. REVIEW QUESTIONS—Ready Reference Index.

HIGHLY ENDORSED—ASK TO SEE IT ON 7 DAYS' FREE TRIAL

MAIL COUPON TODAY

THEO. AUDEL & CO., Publishers, 49 West 23rd St., New York

Mail AUDELS NEW RADIOMAN'S GUIDE for free examination. If O.K. I will send you \$1 in 7 days; then remit \$1 monthly until \$4 is paid. Otherwise I will return it.

Name.....

Address.....

Occupation.....

Reference..... RCF

\$4 COMPLETE
PAY \$1 A
ONLY 1 MO.