

RADIO'S GREATEST MAGAZINE

RADIO-CRAFT

Incorporating

**RADIO &
TELEVISION**

HUGO GERNSBACK, Editor

**WALKING
PLANE DETECTOR**
See Page 587



20

JUNE

25¢

CANADA 30¢
1942

OVER 125 ILLUSTRATIONS



the hallicrafters co.
CHICAGO, U. S. A.

Keep Communications Open

Their Aim Must Be Good!

... and it is good! ... because they have the World's finest equipment. American manufacturers are also aiming at a goal and that goal is to produce more and more equipment in record-breaking time ... and they are succeeding far beyond expectations!

With our greatly increased facilities the production of HALLICRAFTERS communications equipment goes forward steadily for both our armed forces and civilian requirements ... we are achieving our aim!

IN WHICH OF THESE RADIO FIELDS DO YOU WANT A GOOD JOB --

I Have Trained Men at Home to Make \$30, \$40, \$50 a Week in Radio

MAIL THE COUPON



HAVE YOUR OWN RADIO SERVICE BUSINESS

The Radio service business is booming now due to the shortage of new sets. The country's 57,400,000

home and auto sets are getting older, requiring repairs, new tubes and parts. This means more and more full time and spare time opportunities for Radio Technicians to get good jobs with Radio stores, paying \$30, \$40, \$50 a week, or to start their own spare time or full time Radio service businesses. I give you the training in Radio Theory necessary to repair modern Radio receivers; show you how to establish and operate your own Radio business. I send you Radio equipment to conduct practical experiments and build testing equipment to give you valuable, practical experience. Mail coupon for complete information.



GET A JOB AS A RADIO OPERATOR

N.R.I. - Trained Radio Operators and Technicians have good jobs in many of the country's 882 Broad-

casting Stations which are among the country's best paid industries. Others make as much as \$30, \$40, \$50 a week as Operators and Technicians with Commercial, Aviation, Police Marine, Radio Stations and on ships at sea. The Government is calling for civilian Operators and Technicians for Government Radio Stations and other Government Radio services. I give you the training necessary to pass examinations for U. S. Government Radiotelegraph and Radiotelephone Licenses. I train you to be ready when Television, F.M. and other Radio developments open jobs in the future. Get the facts NOW. Mail the Coupon.



MAKE \$5, \$10 A WEEK EXTRA FIXING RADIOS IN SPARE TIME

Many men I train hold their regular jobs and make as much as \$5, \$10 extra a week, fixing

Radios in spare time. Due to the shortage of new sets, there's more need for repairs, new parts, new tubes on the 57,400,000 Home and Auto Radios in the U.S. creating new spare time opportunities practically everywhere. My Extra Money Job Sheets show you how to begin cashing in on Radio's opportunities a few months after you enroll and increase your earnings as you progress. My 50-50 method of training—half with Radio parts I send you and half with my Lesson texts—gives you knowledge and experience. You build a practical Radio service instrument from parts I send you. Get the facts—Mail the Coupon—NOW.

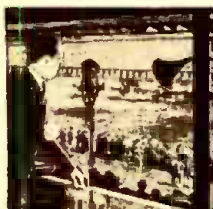

GOOD JOBS IN MANY OTHER RADIO BRANCHES

I teach you the fundamentals of Loud Speaker Systems, Inter Communicating Systems and other

sound amplifying apparatus, which you need to get and hold a good job in these branches of Radio. I train you to get and hold jobs in Radio factories, busy right now filling Government orders for millions of dollars worth of Radio equipment. I teach you the fundamentals of Electronics necessary to understand electronic controls and instruments being used by industry today. I give you a fundamental training in all important branches of Radio, plus practical experience in handling real Radio parts. BOTH are necessary to get and hold good jobs in Radio today.



EXTRA PAY, EXTRA RANK IN ARMY, NAVY

Communication Technicians are in demand in our Army, Navy, Marine Corps and Coast Guard to-

day, and the men with Technical ratings can make several times the base enlistment pay, win extra rank, prestige and interesting Radio duties. Many men who may be called for military service are training with me to help them get better pay and advance rank in the service. I am also training men now in the Army and Navy who enrolled to help get ahead in the service and be ready for a job in Radio when their service ends. The addition of Radio to the many mechanized units and armored divisions of the Army and the many new ships of the Navy is creating a demand for Radio Operators and Technicians. Mail Coupon today for details.



NEW FIELDS TO OPEN MORE JOBS AFTER THE WAR

Due to the War many new branches of Radio are being held back. Television, just starting in practical form, will expand after the War. Frequency Modulation, just licensed before war began to handle limited commercial programs, will be another field of opportunity for the future. Electronic Controls and Instruments for Industry, Medicine, Science and Business will expand when the War ends. Many new fields, too, will be developed during this war which will offer good commercial possibilities and good jobs for the future. Radio is a fast growing industry today. It will be a fast-moving field of opportunity in the future.

Mail Coupon For 64-Page Book And Sample Lesson FREE

You owe it to yourself to find out the many opportunities Radio offers YOU, and to find out how I can train you at home for them. MAIL THE COUPON. I'll send you my big 64-page book "Rich Rewards in Radio" and a Sample Lesson by return mail. Read my Book. See the many opportunities which await you in Radio when you are a trained Radio Technician or Operator. Look over my Sample Lesson. It will give you a good idea of how complete, how easy-to-understand, how thorough my training really is. Read letters from more than 100 men I have trained so you can see what they are doing and earning—so that you can judge for yourself what I can do for you. Pick your field in Radio—and START TRAINING FOR IT NOW. MAIL THE COUPON—in an envelope or pasted on a penny postal. DO IT NOW.

J. E. SMITH, President, Dept. 2FX

NATIONAL RADIO INSTITUTE

Washington, D. C.

RADIO-CRAFT for JUNE, 1942

GOOD FOR BOTH 64 PAGE BOOK SAMPLE LESSON FREE

J. E. SMITH, President, Dept. 2FX
National Radio Institute, Washington, D. C.

Mail me FREE without obligation, Sample Lesson and 64-page book "Rich Rewards in Radio," which tells about Radio's opportunities and explains your 50-50 method of training men at home. (No salesman will call. Write plainly.)

Name Age

Address

City State 2FX



RADIO-CRAFT

Incorporating

RADIO & TELEVISION

HUGO GERNSBACK
Editor-in-Chief

HARRY CONVISER
Managing Editor

G. ALIQUO
Circulation Manager

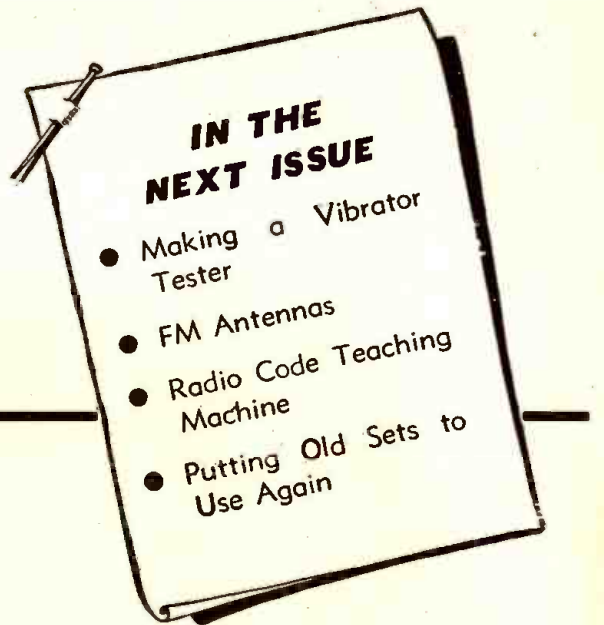

Contents **JUNE, 1942** Issue

VOLUME XIII -- NUMBER 10

Mailbag	580
Editorial: What Is Your Radio War Effort? Hugo Gernsback	583
The Radio Month in Review	584

SERVICING

Signal Tracer You Can Build from Odd Parts	586
Walking Plane Detector (Front Cover Feature)	587
Electron Microscope in New Fields Dr. V. K. Zworykin	587
Air Raid Business to Shoot at Eugene A. Conklin	588
Make Your Own Non-Metal Shields Bernard H. Porter	589
War-time Radio Repairs Homer C. Buck	590
RADIO SERVICE DATA SHEET:	
No. 323 Zenith Model 7G605	592
Modernize Your Shop for Wartime Service . . Eugene A. Conklin	594
A Simple Service Test Panel Edgar Boles	596
Standard Output of Receivers Willard Moody	597
Application of the Ohmmeter Willard Moody	597
Operating Notes	619, 622

SOUND

19-Watt Medium Power Amplifier	598
Build Your Own Experimental Electronic Organ—PART II Conclusion W. K. Allan	600
Construct a Home Recorder Larry Le Kashman	602
Two-Dimensional Sound and Acoustics Willard Moody	606
An Inexpensive Bass and Treble Booster Carl A. Helber	608
A Complete P. A. System—PART II Conclusion	
Ricardo Muniz, E.E., and Robert J. Bergemann, Jr.	609
An Equalizer for Recorders W. W. Blair	610

EXPERIMENTERS

"Magic-Eye" Indicators for Measurements . . . G. A. Hay, B.Sc.	612
Voltage Multiplying Rectifiers and How They Work	614
Stabilized Feedback for Radio Transmitters H. S. Black	616
How to Determine Thyatron Characteristics	
Jonathan S. Lee, W8CQP	618

DEPARTMENTS, ETC.

Mailbag	580
The Radio Month in Review	584
Operating Notes	619, 622
RADIO SERVICE DATA SHEETS (See Servicing)	592
Latest Radio Apparatus	620
Book Reviews	637

RADIO & TELEVISION

Shortwave Reception on a Midget Set A. Binneweg, Jr.	622
2 Tubes=5 in This Receiver W. J. Vette	623
5-Tube Short-Wave Superhet Receiver H. H. Arnold	626
Walkie-Talkie and Alert Airplane Detector . . George F. Baptiste	629
A 2-4 Tube Progressive Receiver for 110 Vts. A.C.-D.C.	
L. M. Dezettel	632
Question Box	635
Radio Patents	638



Published by Radcraft Publications, Inc. Publication office: 29 Worthington Street, Springfield, Mass. Editorial and Advertising Offices: 25 West Broadway, New York City. Chicago Advertising Office: RADIO-CRAFT, 520 North Michigan Avenue, Chicago, Ill.

RADIO-CRAFT is published monthly, on the first of the month preceding that of date; subscription price is \$2.50 per year in U. S. (In foreign countries, 75c additional per year to cover postage; Canada, 50c additional.) Entered at the post office at Springfield as second-class matter under the act of March 3, 1879. All communications about subscriptions should be addressed to: 29 Worthington Street, Springfield, Mass., or Director of Circulation, 25 West Broadway, New York, N. Y.



Foreign Agents:

- London—Gorrings's American News Agency, 9A Green St., Leicester Square, W. C. 2, England.
- Paris—Messageries Dawson, 4 Rue Faubourg, Poissonniere, France.
- Melbourne—McGill's Agency, 179 Elizabeth St., Australia.
- Dunedin—James Johnston, Ltd., New Zealand.



Text and illustrations of this magazine are copyright and must not be reproduced without permission of the copyright owners.



Copyright 1942 Radcraft Publications, Inc.

A WAR MESSAGE FROM THE UNITED STATES TREASURY DEPARTMENT

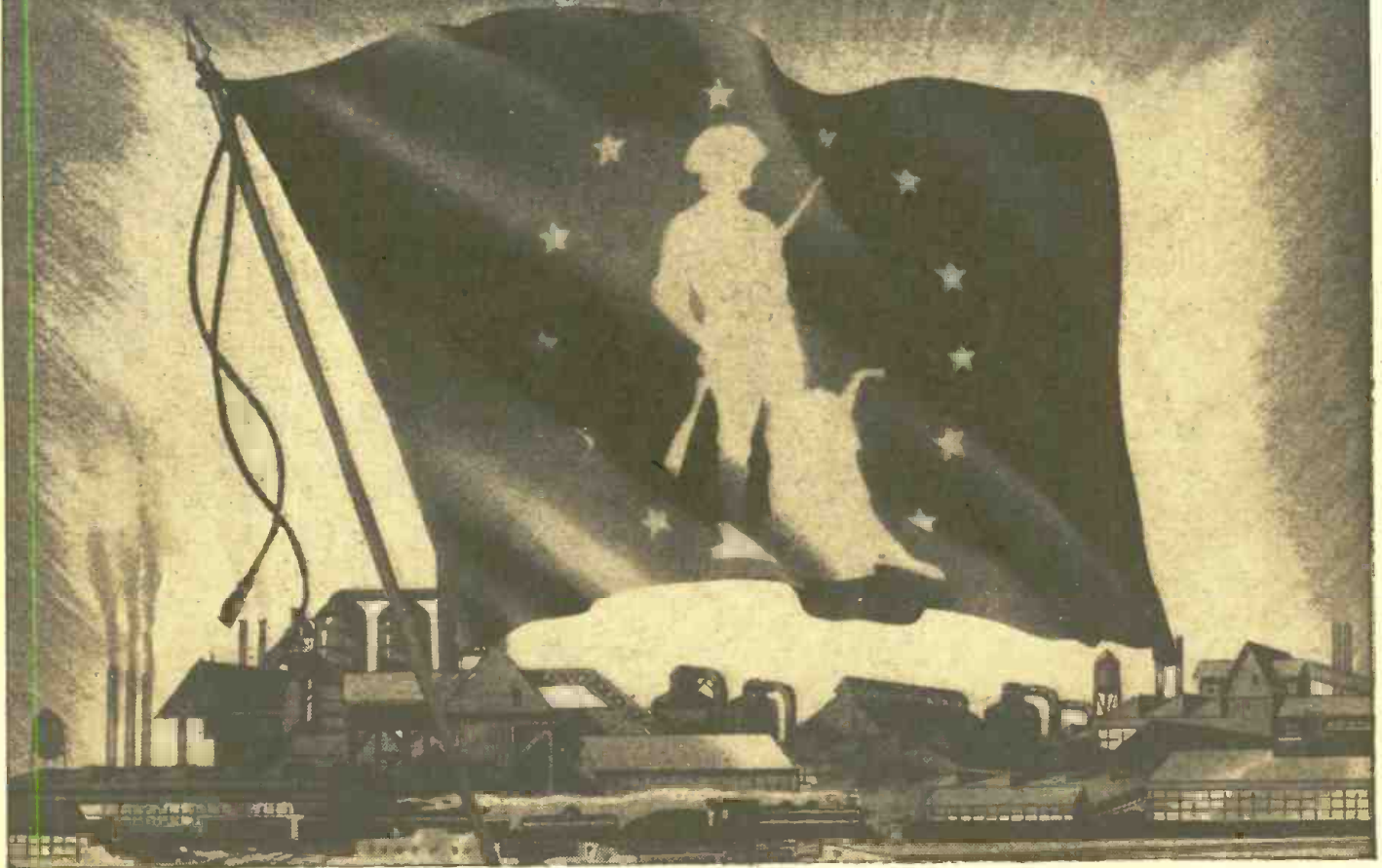

Next to the Stars and Stripes . . .

AS PROUD A FLAG AS INDUSTRY CAN FLY

Signifying 90 Percent or More Employee Participation in the Pay-Roll Savings Plan

IT doesn't go into the smoke of battle, but wherever you see this flag you know that it spells Victory for our boys on the fighting fronts. To everyone, it means that the firm which flies it has attained 90 percent or more employee participation in the Pay-Roll Savings Plan . . . that their employees are turning a part of their earnings into tanks and planes and guns *regularly, every* pay day, through the systematic purchase of U. S. War Bonds.

You don't need to be engaged in war production activity to fly this flag. Any patriotic firm can qualify and make a vital contribution to Victory by making the Pay-Roll Savings Plan available to its employees, and by securing 90 percent or more employee participation. Then notify your State Defense Savings Staff Administrator that

you have reached the goal. He will tell you how you may obtain your flag.

If your firm has already installed the Pay-Roll Savings Plan, now is the time to increase your efforts: (1) To secure wider participation and reach the 90-percent goal; (2) to encourage employees to increase their allotments until 10 percent or more of your gross pay roll is subscribed for Bonds. "Token" allotments will not win this war any more than "token" resistance will keep our enemies from our shores, our homes. If your firm has yet to install the Plan, remember, **TIME IS SHORT:**

Write or wire for full facts and literature on installing your Pay-Roll Savings Plan now. Address Treasury Department, Section D, 709 12th St., NW., Washington, D. C.

Make Every Pay Day "Bond Day"



U. S. **WAR Bonds** ★ **Stamps**

This Space is a Contribution to Victory by Radio-Craft

28 Ways to Cash
in on

SYLVANIA SERVICEMAN SERVICE

by
FRANK FAX



WITH new sets off the market for the duration, you servicemen are going to have plenty of work to do—maybe as much as you can handle.

We'd like to make sure you get your share of the repair jobs, so we're helping all we can in the one way we can help most—providing you with as many sales aids as possible.

Below is a complete list of these business-getters. Many are free—the others are offered at bargain prices. All are useful magnets in attracting new repair trade to your shop.

As you can see, it's a pretty well-rounded assortment and we think we've covered about everything. But there may be some possibilities we've overlooked—or maybe you have good ideas of your own on what constitutes an enticing counter card or window display.

So if you have any suggestions, fire away. Address your notes to Frank Fax, Dept. C6, Hygrade Sylvania Corp., Emporium, Pa.

And don't forget, you can procure any of the 28 items now on our list direct from your local Sylvania jobber, or write me. Act today so that you'll be set for the bulge in business that's coming—sure as victory.

- | | |
|--|--|
| 1. Window displays, dummy tube cartons, timely window streamers, etc. (From your Sylvania jobber only) | 15. Service hints booklets |
| 2. Counter displays | 16. Technical manual |
| 3. Electric clock signs | 17. Tube base charts |
| 4. Electric window signs | 18. Price cards |
| 5. Outdoor metal signs | 19. Sylvania News |
| 6. Window cards | 20. Characteristics sheets |
| 7. Personalized postal cards | 21. Interchangeable tube charts |
| 8. Imprinted match books | 22. Tube complement books |
| 9. Imprinted tube stickers | 23. Floor model cabinet |
| 10. Business cards | 24. Large and small service carrying kits |
| 11. Doorknob hangers | 25. Customer card index files |
| 12. Newspaper mats | 26. Service garments |
| 13. Store stationery | 27. 3-in-1 business forms |
| 14. Billheads | 28. Job record cards (with customer receipt) |

SYLVANIA

RADIO TUBE DIVISION
HYGRADE SYLVANIA CORPORATION

What Our Readers Think

PRACTICAL SET TESTS

Dear Editor:

I hope that you will be kind enough to publish this letter in the "Mailbag." I have enjoyed reading the "friendly feuds" that have appeared here from time to time and I am quite sure many other readers have also.

Therefore I would like to offer the following problem for consideration, since I am quite sure that there will be a difference of opinion on the subject and the "Mailbag" is the place to speak our minds!

It is a good idea to have a test for sets just repaired in the shop. It should be used to break down weak parts that would shortly go bad in the customer's home. You can't realize how important this test would be in these war times, when our radios must not fail. I would like to hear from fellow servicemen who have a "sure-fire" test such as this. It is no doubt one of the most important items of a repair job. Perhaps the "Mailbag" will be willing to publish a few of the better ideas contributed along this line.

In reply to my request for data on the subject of final testing, I received the following data from Lowry E. Easley, Prop. of Evans Radio Laboratory and Pres. of the Chicago Chapter of Radio Servicemen of America.

"A good final test which we have used with success for some time, is to play the radio which we have just repaired for an hour or more at about ten percent higher line voltage than normal, then if you can spare the time, another hour at ten percent lower voltage. The tests you use seem excellent to me and if you have time to do so, the national (Radio Servicemen of America, Freeport, Ill.) office would appreciate your sending all the data you have available on the subject."

So there you are! If you have any ideas I am sure every conscientious radioman will want to hear about it.

Again I say this test is all important in any repair job just now, and I am sure all of us radiomen will appreciate any time spent in aiding the cause.

JAMES R. LIMBECK,
Glendale, Calif.

MR. MOODY DOFFS HIS SOMBRERO

Dear Editor:

I believe that I owe an apology to Homer Buck. He, naturally, feels the necessity of defending his views and as long as I started the "name calling," it is up to me to do what I can to stop it.

It seems to me that all of us can learn by sharing opinions and ideas. Sometimes, by heating up the letters, "quick action" is gained. But, it seems much more can be gained by calm, gentlemanly expression of ideas and so, in the future, I hope we can keep it on that level.

WILLARD MOODY,

P. S. It might also be worthwhile for servicemen generally not to run down the character and antecedents of the serviceman who last repaired the set. A customer gets the idea that all servicemen are vain, opinionated and not very bright when the previous repair job is criticized. Even though the repair job deserves it, perhaps it is better to let it go, except in flagrant cases of ineptitude.

"Tell-Tale" Telephone Wanted

Editor:

Here's my idea—why doesn't someone "invent" and manufacture a "Tell-Tale-Telephone"?

A Tell-Tale-Telephone will be any ordinary telephone to which will be attached a device—say a small disc at the bottom of your present phone. This disc to measure 1 inch by ½ inch—on this disc will be shown (the minute you raise the receiver off the hook) the number of the phone at the other end of the line, that is trying to call you.

Photographs are being sent nowadays into newspaper offices over telegraph-wires (or for all that I know perhaps over telephone wires too), so such a device to be attached to your present telephone, ought to be a very simple matter. In case it can't be done over telephone-wires, how about employing television?—and get Mr. Philo Farnsworth busy on the idea?

The "Tell-Tale-Telephone" will enable you to know in a flash the minute you remove the receiver from the hook, who is at the other end of the line.

FRANK J. DICKERT,
614 East Locust Street,
Scranton, Pa.

LIKES FM FEATURES

Dear Editor:

We enjoyed the March "FM" number very much. Please print everything you can get your hands on covering the subject of FM. We never bought RADIO-CRAFT until you began publishing articles on FM. Your March number is a "knock out"!

Thanks for the three pages on FM in the April issue.

We buy every issue now!

A. L. ALDRICH,
Santa Maria, Calif.

WHAT A SOLDIER WANTS

Dear Editor:

You stated that you wanted to know what kind of article we would like to see in RADIO-CRAFT. Due to the fact that our country is at war, and more fellows find themselves working on army equipment, I believe that articles that would enable them to do their job better would be just the thing. For instance, we have frequency modulation equipment—more data on F.M. would help us immensely. We have all types of high frequency equipment; therefore, high frequency articles would also be of aid to us.

Army servicemen are called upon to do field repairs on all types of transmitters and receivers. Why not print some articles on trouble-shooting and repairing in the field? Very few radiomen have had any experience in this type of work. I have been in the army 21 months and it certainly is surprising what type of repairs I was called upon to do under adverse conditions.

Therefore if there is anything you can publish that would be of assistance, I know all the service radio mechanics would be very appreciative.

PVT. WILLIAM F. BABCOCK,
Fort Bliss, Texas

ANENT "SCREW-DRIVER SERVICEMEN!"

Dear Editor:

I have just finished reading your April issue of *RADIO-CRAFT*. I like it very much except for one thing. There are two letters in it by a fellow named Buck. He may be all right in a shop that is interested in selling radios but not selling service—but he wouldn't be worth a darn to Uncle Sam. At least, I would not want him to be in my Service Dept. Here are the reasons:

First: Every job we do must be done absolutely *properly*, as well as *promptly*. Every job is a *precision* job. Every radio must be depended upon at all times. So, makeshift repairs like he evidently makes, would not be of any help.

Second: He says in his letter "How many Servicemen use schematics and manufacturer's data, especially alignment data?" Well, all "good" servicemen do. We men in the Army pay special attention to every word the manufacturer says, because our jobs *must* be done right!

Third: Uncle Sam doesn't overburden us with test equipment, but he does furnish the essentials and we surely have them with us on each and every job. "Screw-driver" servicemen cannot do much in the Army.

I would suggest to Mr. Buck that he "wise-up." If he would, he would probably increase his earnings and be of much more help to the young servicemen who want to be good servicemen some day. Test equipment is not made to *look at!* Manufacturers' data is not printed to be ignored—and good servicemen *use both!*

Pvt. W. F. BABCOCK,
Fort Bliss, Texas

**RADIO-CRAFT VITAMINS
A TO Z**

Dear Editor:

For several years I have been more or less a silent member of your family of *Radio-Crafters*, content merely to select, analyze and partially digest various articles from your famous magazine. But now your repeated invitations to hear from your silent readers moves me to speak up.

Dozens of articles have appeared in *Radio-Craft* covering unique hook-ups, clever baffles, volume-expanders, tone-correctors, bass-boosters, wide range apparatus, etc. Your articles were just the vitamins I needed to spur me into action.

Serviceman Wins Action

● THE legal charge of "unlawfully withholding a radio" has lost some of its sting.

In fact, the possibility that radio servicemen may be successfully faced with such charges while they're trying to collect their *service-estimating* fees, was considerably weakened last month when the Court of Special Sessions in New York City dismissed the charges against a local radio man.

This was the case of the serviceman who dared to stand his ground, and insisted on his repair estimate fee of \$1, in spite of all the cop-calling and court action that his irate customer undertook. The dealer had his "estimate charge" sign displayed in his store, and also mentioned it to the customer. Yet he was forced into a long series of court appearances because the radio owner denied knowledge of the fee, and refused to pay it. Meanwhile the dealer hung on to the set, with this magazine reporting

The happiest hours of my life were the ones between 10 P.M. and 3 A.M. keeping all the neighbors miserably awake listening to my wonderful concoctions gleaned from the pages of *Radio-Craft*. I could hardly wait to play a friend musician's favorite record on my latest machine and to note the astonishment on his face when he heard his record yield bass that vibrated the floor, highs that tickled his ears, and expansion that took his breath away. All my efforts were more than rewarded and the hours of the night were golden ones.

I like to recall building L. M. Barcus's Add-On-Bass-Booster. After spending a night and a day constructing it I finally tried it out early in the evening. Practically all the stations were operating on chains at the time of evening and the Booster made little if any difference in reception. To say the least I was bitterly disappointed and shut the thing off in disgust. About 11 P.M. I tried again tuning in a local program from Detroit. It should suffice to say my wife tried for two hours in vain to pry me away from my precious apparatus.

Being somewhat of a musician, having scraped upon a fiddle for years, you may well be assured that anything approaching high fidelity is of interest to me. And also being somewhat of a lazy, money-less, audio-oscillator-less, and oscilloscope-less individual you may readily realize that I must carefully weigh my ambition, wealth, and laboratory apparatus (a volt-ohm-milliammeter), when selecting any of your articles for action. I most assuredly consider the prize to have been worth the effort.

ART KNOWLES,
Bay City, Mich.

SOMETHING TO THINK ABOUT

Dear Editor:

While experimenting with a cathode-ray tube it occurred to me that this could be used as a communication system by the Signal Corps.

The transmitter would consist of a film containing two sound tracks. One sound track is to control the voltage of the horizontal deflector plates of the Cathode-Ray tube at the receiver. The other sound track is to control the voltage of the vertical deflector plates. The sound tracks pass over photo-cells modulating the grids of the transmitting tubes. The transmitter radiates two predetermined wave lengths.

RADIO NEWS AND VIEWS

the case and hundreds of servicemen applauding.

The radio man sailed into the battle because he thought it was high time somebody did something to establish service work as a decent professional skill.

There is one step, however, that radio men can take *now*. And that is to be sure that the customer receives formal and unmistakable notification that a service estimate charge will be made. Printed claim-checks or tags, which constitute a contract and leave no doubt about the agreement, are the best, although prominent display signs and verbal mention are usually enough.

These steps should be taken to avoid all court action, civil or criminal, and are of special importance in these times. The serviceman's time is now more valuable, and if his charges are questioned to any degree, it will have a particularly unfortunate effect on his business.—*Radio Retailing & Radio Today*.

The receiver consists of a cathode-ray tube, the deflector plates of which are connected to a radio set tuned to both frequencies being transmitted. The image would be the message in the form of words.

SIDNEY BOWER,
Pacific Palisades, Calif.

"PORTABLE" SERVICE KIT

Dear Editor:

In the April issue of *RADIO-CRAFT* you ask readers to state the kind of articles they desire. Here are a few I would like to see.

Articles on the development of a *really* portable service kit easily carried in a brief-case. This will be necessary when the tire shortage becomes acute and cars are laid up, thereby necessitating repairs in the home. This should develop combination tools, a simple oscillator of limited scope—perhaps made in a flashlight case, use of small meters, etc.

Articles on the care of radio tools due to the scarcity of replacement. These articles should inform the reader on how to use and sharpen drills, screw-drivers, tin-snips, etc. A list of essential tools and most useful gadgets should also be given. Also the development of a head-band with a small light and reflector, such as doctors use, to be worn on the head, throwing light on the work from the same angle as the head is moved.

Articles (or a series of articles) on just how to conceive, lay out and construct a small audio amplifier, explaining how to figure various requirements. Also a step-by-step explanation in tube selection, circuit used, etc. Also something that a *beginner* in the field of radio can build and experiment with, which requires but a small cash outlay or the use of "junk-box" parts only.

Articles on auto radio aerials—kinds, types, and how each works. Also why the use of an insulated bumper aerial is not more widely used. The development of a *portable* aerial to hang on a car for use with portable radios.

Articles on using a crystal detector, with midget hearing-aid tubes, for "pocket" radios.

Some of these articles have probably appeared years ago, but "new slants" will make them valuable and interesting again.

IRL GORDON,
Akron, Ohio

Radio-Tube Production Jumps

● BEHIND the scenes radio engineers have been developing electronic tubes to do new and surprising feats for the Army, Navy and Air Forces. War demands have created an expansion unparalleled in the rise of the radio industry in the last two decades. Many plants throughout the country are participating in the production of required instruments.

In the Westinghouse plants twenty-five kinds of tubes are being produced for the armed forces, making possible unrivaled means of communication. The tubes range from large units which produce enough excess heat to warm a six-room house to a diminutive one for portable one-watt sets.

The one-watt sets, called "walkie-talkie stations," weigh five pounds. They are designed to be carried by individuals, enabling soldiers in the Signal Corps to carry on two-way conversations. The set can be carried by a parachute trooper, giving him a two-mile range of communication.—*N. Y. Herald-Tribune*.

Pledge

**TRIPLETT MEN AND WOMEN
HAVE SIGNED THIS PLEDGE TO
AMERICA'S VICTORY**

The Nation needs us strong—

I WILL KEEP FIT!

Lost hours help our enemies.
My working time is America's time—

I WILL TAKE NO "TIME-OFF"!

Carelessness causes accidents.
Accidents annually cost enough man-hours to build 15,000 bombers—

I WILL BE CAREFUL!

Some American soldier may die if indifference to the
importance of small jobs results in poor work—

I WILL KEEP MY INTEREST!

The future welfare of America will rest upon the increased
knowledge which will emerge from present necessity—

I WILL ADVANCE!

These things I PLEDGE that our future
may be secure for Life, Work and Service.



★ ★ ★
Accuracy—as Ever

Despite the rush of present production there is no relaxation from rigid requirements of accuracy in calibration and inspection of fine Triplet instruments. No compromise is permitted to affect in the slightest those exacting standards which have become the international Hallmark for precision and quality.

THE TRIPLETT ELECTRICAL INSTRUMENT CO.
BLUFFTON, OHIO

RADIO-CRAFT

Incorporating

RADIO & TELEVISION

"RADIO'S GREATEST MAGAZINE"

... Every Radio man CAN help win the War ...

WHAT IS YOUR RADIO WAR EFFORT?

By the Editor — HUGO GERNSBACK

NOT all of us can be at the front, fly a plane, fight the war at sea, or man guns or tanks on land. That should be evident. Nevertheless, in a machine war—in the midst of which we now find ourselves—the actual fighting front has lost its former significance. When bombs rain on cities hundreds of miles away from the front, when submarines sink ships thousands of miles distant from the country at war, the civilians who stay at home not only can do their bit in their war effort but, indeed, they can serve their country as much as, and often better than the fighting forces themselves.

Modern war is a thing of tremendous complexity. It is improbable that the present war will be won by a single instrumentality—rather, an all-out effort of all the fighting forces with all the various war machines, is what wins wars today. It may surprise many people to know that actually few wars have been won by the fighting forces alone. In modern wars particularly, usually the efforts of civilians or a civilian invention frequently clinches the war. In the Civil War, for instance, the invention of the iron-clad battleship was the factor that turned the tide. The invention was not made by a military man but by a private individual—Erickson. In the first World War, the tank—not a military invention—turned the tide and, yet military men poo-pooed the tank and called it preposterous, simply because they were not acquainted with its possibilities. Today the tank no longer needs recommendation to anyone.

Again, the airplane, which is the main weapon of the present war, was not a military invention at all, but hailed from Dayton, Ohio, originated by the Wright Brothers, humble bicycle repair men.

No one will deny that radio communication and everything that goes with it today, also is a major weapon. As great as have been the strides in radio, much remains to be done and it is here where you—THE LAYMAN—can do a mighty service to your country if you can adapt radio to the war effort in a way that it is not being used today.

Whether you are a radio amateur, a radio serviceman, a radio engineer, or a radio-mechanical inventor, the country needs your thoughts and services. An idea that at first may seem to be mediocre often turns out to be a tremendous war weapon. During the World War, Major Armstrong's regenerative circuit helped radio communication as nothing had helped it ever before. It made radio communication certain, where previously it had been haphazard.

Radio engineers already are helping to solve complex war problems. There remain the other classes which up to now have been lost sight of. While the radio amateur is vigilant and listens in during his spare time for messages which may emanate from a potential enemy, not all amateurs are doing this. There is no reason why every amateur who owns a receiving set should not be able to organize himself so that he can listen in at certain hours of certain days. By following a regular routine, using different wave bands messages which do not appear regular may thus be detected; they then can be reported to the nearest Radio Inspector or to the F.C.C. in Washington.

It has been shown time and again that nowadays practically all Fifth Columnists' work is done by spies landing on the United Nations' shores by means of submarines. These spies, always have been well trained by the German or Japanese spy schools. These

men after illegally entering the U. S. easily pass as Americans and can move along the countryside unmolested. All of them have special portable radio transmitting equipment, because that is the only certain means they have for communication. It is often difficult to apprehend such spies because they move fast, never staying in one locality for any length of time.

It would be a simple matter for a number of amateurs to form their own listening network, and by simple triangulation draw a bead on a suspected transmitting station and instantly notify headquarters. In such cases, capture is often brought about successfully. The only requirement is that the amateurs work in conjunction with each other and that they are separated by a number of miles. The rest, from a technical viewpoint, is simple.

And here is an important word of advice to servicemen. A spy or fifth columnist in the pursuit of his work, sooner or later will require such parts as batteries, tubes, etc., and frequently he will have to buy them from servicemen, radio stores, and other supply houses. A safe rule is to *suspect everybody* unless, of course, you have known the man intimately for many years. Remember—we are at war and radio can be a dangerous weapon. This gives you the right to ask questions. If your suspicions are aroused, do not let on that you suspect the person. If you are certain, it is easy enough to get in touch with the nearest authority, or otherwise detain the stranger if you are satisfied what his status is. In large cities radio police cars can be summoned in a matter of minutes, by telephone. It is often better to have someone detained and questioned by a police officer, providing you have a good reason for doing so.

What is not wanted, of course, is an epidemic of citizens being questioned by policemen all over the country, but if you use horse sense, it will not hurt anyone to have a man questioned. If the party is a citizen in good standing, he won't resent it; if he is not, much is to be gained.

Finally, if you are a radio experimenter and are mechanically inclined, you can serve your country by becoming an unofficial airplane listening post. Any radio experimenter worth the name can, with little money and time invested, build a radio plane detector and amplifier. Many of these have been described in this magazine and many more will follow. These radio plane detectors are most vital. Remember, we have long coast lines and these detectors can become of very great importance if you are within 100 miles of any coast line in the United States. Even interior localities can make use of all the airplane detectors that can be built by private individuals. Sooner or later, if you gain sufficient experience in operating such a station, the authorities will take official recognition of you, all depending upon your equipment and how efficiently you can make it work.

It is almost certain that parts of this country will be visited by invading aircraft, and the faster the alarm can be spread, the better it will be for your country.

Remember, always, that the man who first heard the Japanese planes approaching Pearl Harbor was only a "private," listening in on his own time for practice, but he recognized the approaching airplanes and the United States subsequently acknowledged its gratefulness to him. Incidentally, his name is Joseph L. Lochard, now a staff sergeant.

Every radio man can do his share! You can do yours!

•THE RADIO MONTH IN REVIEW•

A Digest of News Events of Interest to the Radio Craftsman



How well science duplicates the five senses of seeing, hearing, tasting, feeling and smelling is demonstrated by Walter Mikelson, General Electric engineer. The girls designate the functions as the engineer adjusts the equipment. **SEEING**—With the electric eye, science exceeds nature in many ways; **HEARING**—The sound detector can make a fly on a microphone sound like a soldier tramping; **TOUCH**—The smoothness gage makes a surface, seemingly smooth to the touch, feel like the Rocky Mountains; **SMELL**—The mercury detector beats the nose when it comes to poisonous mercury vapors, **TASTE**—This apparatus finds the smallest trace of lemon juice in a glass of water, a sourness the human taste cannot detect.

RADIO TUBES DUPLICATE HUMAN SENSES

How radio tubes and electronic equipment can be made to duplicate or even exceed in sensitivity the human senses was demonstrated last month at a dinner inaugurating General Electric's electronic program to show the war and peace-time benefits derived from the use of tubes. The dinner was followed by a broadcast witnessed by 250 employees and guests.

Dr. W. R. G. Baker, vice-president in charge of the Radio and Television Department, predicted that new applications will provide employment for hundreds of thousands of persons after the war.

"Out of the crucible of war new science, new methods, processes and materials always come," Dr. Baker said. "Electron tubes (such as the popular 'electric eye'), so simple in appearance yet so mysterious, will touch our lives in countless ways wherever and however we live and work. Electronics will become the bright new word of the future, and promises new and higher standards of living," he said.

Briefly explaining electronics to the radio audience at the start of the broadcast, Charles E. Wilson, president of the company, said: "Perhaps we should call electronics the fire of the future. Like fire, it can be a savage foe or a powerful servant. Like fire, it is almost universal in its potential applications to our lives. Fire was a gift to the barbarians, which men have shaped to their uses.

"Electronics has been no gift. The men of science learned its secrets and earned its blessings during decades of unremitting toil, patience, trial and error, and brain work. To most people, electronics is radio, with all of its entertainment, communication and service. But the electronic tube, so innocent and so mysterious to a layman's eyes, will touch you, in the years to come, wherever and however you live—your sight, hearing, and taste, the food you eat, the healing of your body, the safety of your home, and the tremendous progress of your

business, whatever it may be."

Dr. Baker, who acted as toastmaster at the dinner, was introduced by Robert S. Peare, Publicity Department manager. Mr. Peare quieted the diners merely by passing his hand back and forth through an invisible beam of light focused on a photoelectric tube which operated a knocker, and thereby served as an "electronic gavel." After introducing the persons at the head table, and speaking briefly about the electronics program, Dr. Baker introduced E. S. Lee, engineer in charge of the General Engineering Laboratory, who addressed the gathering on the subject, "Continuous Threads of Activity."

Mr. Lee traced the growth of the new science of electronics from the original, creative work in high-vacuum tubes by Dr. Irving Langmuir, down to present-day electronic developments. He explained the phenomenal progress of electronics in the communication field, and pointed to the increasing applications in other fields.

"Today," he said, "our products are being used as controls for opening doors, levelling elevators, limiting motions, bringing out exactness in registering in printing presses, straightening cloth in textile machinery, controlling punch presses, timing welding operations to give exact welding performance, counting, calculating, controlling lighting and illumination levels, detecting metals, locating defects and pinholes in metals, as smoke indicators and in a score of measuring instruments for measuring sound and vibration, color, light, frequency, speed, thickness, pressure, temperature, turbidity; as relays and telemeters, as power rectifiers, for examining large metal structures for flaws, and in the field of medicine for diagnosis and healing to alleviate pain and suffering; all of these and many more until the total of the electronic products of the General Electric Company are numbered as near as to a thousand, with no end in sight."

UNION COLLEGE WORKSHOP MERGES WITH RADIO CLUB

Members of the Union College Radio Workshop, which originated the "wired wireless" network last September, has joined with the Radio Club of the college to form the Union College Radio Society. The Radio Workshop was established as a college activity in 1939 at the request of students interested in studying radio program work. Under the guidance of J. R. Sheehan, program manager of G-E stations W2XOY and of WGEO and WGEA, workshop members have obtained practical radio experience by planning, producing, directing and acting on a number of sports, dramatic, and musical programs sent out by these G-E stations in the last three years. The Radio Club was begun by students interested in the technical or engineering branches of broadcasting and they assisted in the development of the college network.

The U.C.R.S. network, which now has acquired a new FM receiver, plans to relay major sporting events, news broadcasts, important concerts, and popular network programs carried by W2XOY. It has twenty-five students on its staff and operates from "studios" in the Union College Electrical Engineering Building over special wires installed, or now being installed, by the students to all fraternity houses and dormitories on the campus. The wires terminate in fuse boxes of the various establishments, permitting listeners to tune in by plugging radios into any ordinary house outlet. The group hopes to reach off-campus houses soon by telephone transmission.

U.C.R.S. men are proud of the fact that their signal, sent out at 640 kilocycles, is not just an "audio" signal but is a true radio signal, transmitted over wires instead of through the air.

The Union College Radio Society is a member of the Intercollegiate Broadcasting System, begun when student at Brown University in Providence, Rhode Island, started sending out programs via the campus radiator pipes, and which is now a nationwide institution. David Borst, technical manager of I.B.S. and one of the designers of the original Brown network, is now employed at the General Electric Schenectady Works, and has done considerable work in helping to establish and develop the Union College network.

[Plans and constructional details were described in *Radio-Craft* for April, 1940.—Editor]

HOW TO BE AT TWO PLACES AT SAME TIME

Paul Manship, celebrated sculptor, made his farewell address, as retiring president of the National Sculpture Society before a meeting of the society last month and at the same time participated in a Metropolitan Museum of Art program televised by the Columbia Broadcasting System.

Eager to keep both engagements, Manship had a television receiver installed for the meeting with his colleagues at the Architectural League. The same evening he appeared on the Metropolitan Museum program and showed televiewers bronze models of many of his famous statues. Manship arranged with CBS officials to continue the broadcast after the Metropolitan Museum program so he could deliver the farewell talk to his fellow sculptors.

FM CONTINUES EXPANSION

The police and fire departments of Milwaukee announced last month that they were planning a total of 109 two-way FM units to provide the most efficient communications system available. Allotment of necessary materials was made recently by the War Production Board.

News From FM Centers

The third FM station to go on the air since last November, W49PH, of Philadelphia, is owned and operated by WIP. Clifford Harris, chief engineer of WIP, has been named manager of the FM outlet. Also on the air regularly are W53PH (WFIL) and W69PH (WCAU).

Arrangements were completed last month permitting WPRU, the intramural broadcasting system of Princeton University, to pick up programs of W53PH for three hours daily and relay them to student radios. Similar permission has been extended to collegians by many FM stations in different parts of the country.

Yankee Network

FM listeners in the six New England states are finding numerous and unusual musical offerings begun last month over the Yankee Network's W43B, of Boston, and W39B, of Mount Washington, N. H. Heard exclusively on FM, the schedule includes musical programs picked up from W43B-W39B by the Intercollegiate Network and relayed over campus intramural radio systems to New England college students.

12-Mile Beam Link

Spanning a 12-mile gap, W47A last month completed installation of a special beamed radio system that carries its programs from the W47A studios in downtown Schenectady up to the transmitting site in the Helderberg Mountains. The installation uses a 25-watt transmitter in the city and a special crystal-controlled receiver at the opposite end of the 12-mile circuit.

Directional antennas for both transmission and reception provide perfect service at all times, thus eliminating the need for telephone wire connection between studios and transmitter, the usual practice in broadcasting. The relay operates in the 330 to 342 megacycle band of the radio frequency spectrum, and is the first such studio-transmitter link authorized at that micro-wavelength. Similar links on lower frequencies (notably the 43-mile circuit employed by W43B) have been operating with success for some time.

MORE FM STATIONS

Despite curtailments on the granting of further FM station construction permits and WPB restrictions on the procurement of basic materials for building stations, several more FM outlets were able to get on the air last month.

These were transmitters which had been almost completed and had much of their essential equipment already installed and therefore did not fall under the official Washington ban. Outstanding is W41MM, the giant mountain-top FM station on Clingman's Peak in North Carolina, which is licensed, when at full power, to cover almost 70,000 square miles in seven states in the South. Another newcomer was W49PH, in Philadelphia. Other stations in Philadelphia and Fort Wayne are also expected on the air soon.

Power increases and improved antenna systems were also possible for a number of



Miss Marjorie E. Allen, first woman transmitting engineer, serves also as control engineer and announcer at FM station W47NY.

the FM stations. Several other FM licensees, unable to complete the full power installations authorized by their original construction permits, were expected to make use of reduced wattage and temporary antennas for the duration of the war.

Although no more FM receivers—or civilian receivers of any kind—are now being manufactured the public will still find a number of FM models on display in stores and, through a process of voluntary rationing to dealers, some brands are likely to be available until late next fall. Public demand, however, is running high and consumers usually face long delays before their new FM sets can be delivered. The national total of FM receivers in use is now reckoned at somewhere between 350,000 and 400,000 units.

There has been no indication of any plan on the part of FM broadcasters to discontinue or curtail their service because of the war. In fact preliminary returns of a survey being conducted among FM station owners by the Zenith Radio Corporation of Chicago point to "a generally optimistic tone." Thus far only one FM outlet in the country has reduced its daily broadcasting schedule—from 18 to 12 hours—because of a shortage of engineers.

Although no further construction permits can now be granted by the Federal Communications Commission for FM transmitters in broadcast service, a total of 63 FM stations have thus far been authorized to operate commercially. Of these, 27 are now on the air. Some 50 applications for construction permits are still pending and must remain so until peace returns.

HOUSTON JOINS FM CHAIN

The latest addition to the growing organization of the American Network, Inc., FM's first chain of stations, is the Houston Printing Corporation, publisher of the "Houston (Texas) Post" and applicant for an FM station in that city.

The American Network now has eleven leading FM groups on its roster.

WOMAN GETS W47NY POST AS TRANSMITTER ENGINEER

Woman's role in radio has been augmented considerably by the news that Marjorie E. Allen has become a transmitting engineer, the first and possibly only woman holding this position in the United States. A sister of Harold Allen (W2MWV), in private life a Wall Street broker, Miss Allen operates the transmitter at W47NY, the Muzak Frequency-Modulation station, 70 Pine Street, New York, N. Y.

Miss Allen, a pupil of John G. Hart, of the American Radio Institute, passed her first Federal examination in less than five weeks. Diligent study enabled her to obtain a 2nd-Class Radiotelegraph license, the highest license issued by the F.C.C. to any applicant not having had six months public station experience. One month later she received her 2nd-Class Radiotelephone license.

When Walter Graham, Chief Engineer of W47NY inquired for a student having the necessary qualifications, Miss Allen's name was offered. Mr. Graham was skeptical. "After all," he said, "the position calls for a transmitting engineer, not a control-room engineer." Yet Miss Allen was accepted and is now serving as Transmitting Engineer, Control-Room Engineer and Announcer at W47NY.

The radio field for women is gradually expanding, not only for technical work but also for radio operators. Thus far, no authorizations have been made for women radio operators on board ship, but the future will probably see many women radio operators in point-to-point stations, the land stations which transmit radiograms from one city to another within the United States and to non-Axis countries.

SIGNAL CORPS NEEDS MEN

There is an urgent need for several hundred electricians and radio mechanics at the Signal Corps Radar Laboratory, Belmar, New Jersey. The salaries range from \$1800 to \$2600 per annum in accordance with the length and quality of the applicant's experience. Electricians should have industrial experience.

SIGNAL TRACER YOU Can Build

from ODD PARTS ~ A WAR Project

HERE is a medium-sized, low-priced instrument with much more scope than the baby ones, and with slightly limited use in comparison with the large type, but all that a general serviceman wishes. As can be seen from the diagram, the instrument is fairly simple and easy to build. Use reliable parts and you cannot fail. The signal can be followed from the aerial, where it is first received,

until it reaches the speaker or until it disappears, gets distorted or weak. When this point is reached the trouble is, of course, localized. A check with a simple voltmeter and another trouble is over.

IN OPERATION

The second diagram shows a superhet circuit, with positions marked where the test probe of the "signal tracer" is to be

placed, and the results that should be obtained, or if no results, what the possible trouble would be.

1. Place the probe at T1—the aerial terminal on the set, and a signal or number of signals should be received, indicating that the aerial is in order.

2. By placing the probe at T2 a signal should again be received, and in this case can be tuned by turning the dial on the receiver. If no signal results, this could possibly be due to gang condenser blades touching, open-circuit grid coil, or open-circuit aerial coil.

3. The signal here should be amplified. No signals would indicate open-circuit primary in No. 1 intermediate or 6J8G tube.

4. No signal would possibly be a break in the secondary of the I.F.T. or the oscillator section may not be working.

(Note.—Although T3 is really after the oscillator stage, even if the oscillator section were not working, the signal would still come through, not tuned to the I.F. but on its original frequency as received on the aerial. This would not be noticed until the probe was applied as T4. To test the oscillator, turn the probe switch to the grid of the magic eye and apply the probe to the grid of the 6J8G, T5. If the eye closes, it indicates that the oscillator section is in order. At the same time the probe may be applied to any part of the A.V.C. line at points 13, 14 and 7, and the 6E5 will act as a normal magic eye, and at the same time check your A.V.C.)

6. Signal should be greatly amplified. No signal—open-circuit primary I.F.T. No. 2 or 6U7G tube.

7. No signal could be "open-circuit" secondary I.F.T. No. 2.

AUDIO CHECKING

To this stage the probe has been used in the R.F. position except when checking the oscillator and A.V.C. sections—now turn the probe to a high audio.

8. No signal could be due to a faulty .01 mf. condenser going to volume control, faulty volume control or .0005 mf. condenser across volume control.

9. Signal should again be greatly amplified and signal tracer volume control should need to be turned back. Trouble developing here could be .25 megohm or 15,000-ohm resistors and 6B6G tube.

Now turn probe switch to low audio.

10. Any signs of a fault could usually be traced to .1 mf. condenser going to plate of 6B6G, or .5 megohm resistor going to the center tap of power transformer.

11. The signal reaches its loudest point here. No signal usually denotes burnt-out speaker transformer or 6V6G tube.

12. No signal—could be "open" or "short-circuited" secondary of speaker transformer or voice coil.

SEARCHING FOR TROUBLES

This diagram is not intended to show every fault that can be located but as a guide as to where the signal may be picked up with the signal tracer.

When looking for the source of hum, motor-boating, oscillation or noise, the probe should also be placed on the suppressor grids, cathodes and screen grids.

Below—Diagram of the Signal Tracer and also circuit of a modern superhet receiver, with the "test" locations indicated thereon.

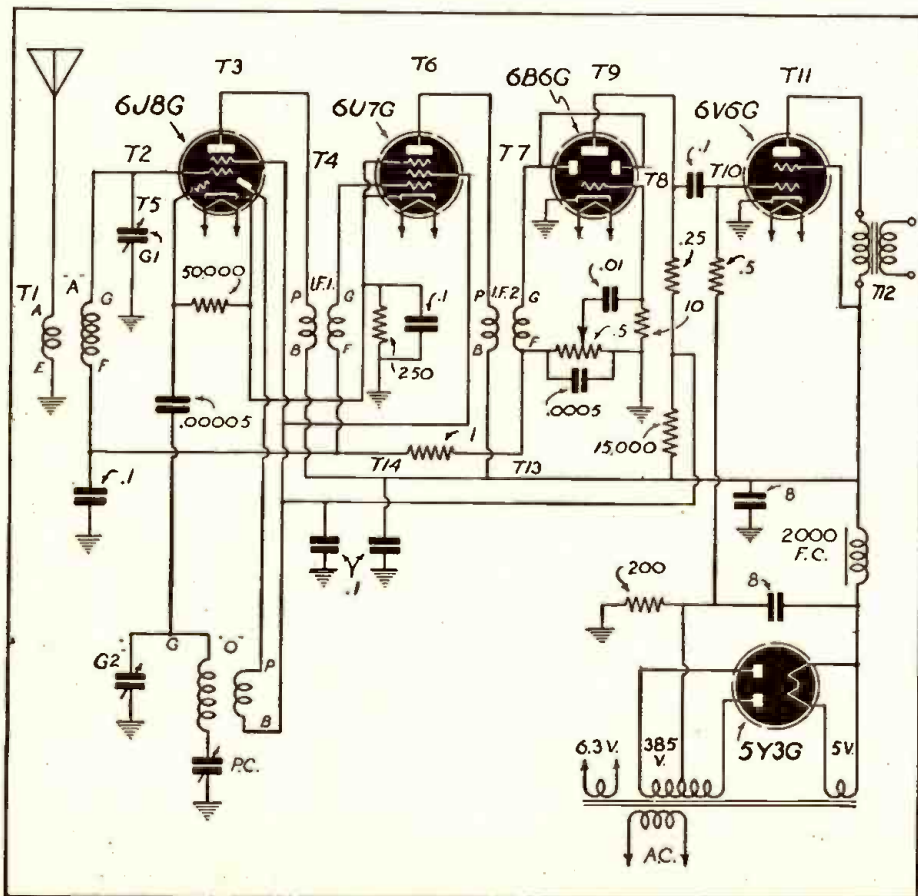
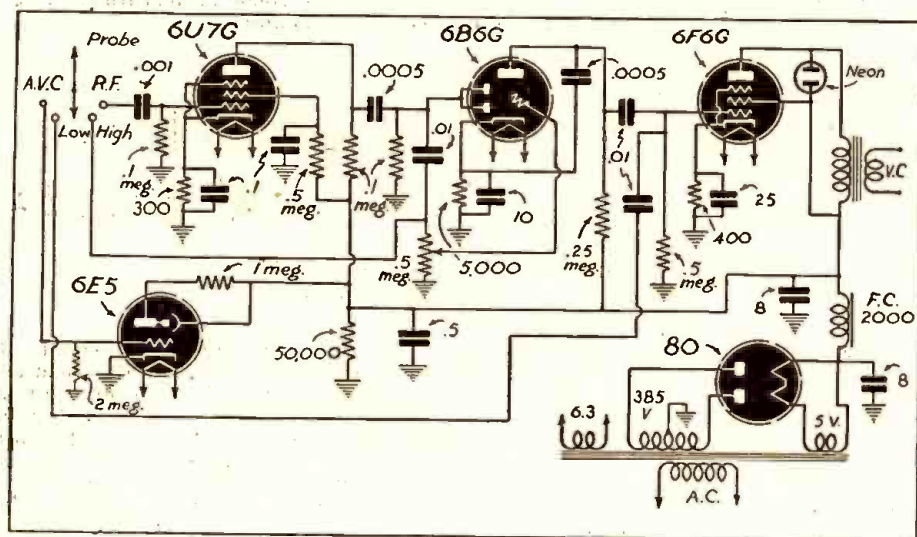

In numbers of cases the trouble can be traced to these elements. A loud signal on any of these usually denotes an "open" resistor or condenser. The only section of this signal tracer that needs any further discussion is the *output indicator*. This gives a rough visible check of gain per stage, etc.

THE NEON INDICATOR

This indicator is made from a 3-watt neon lamp. These are used for pilot lamps on power mains and are obtainable from practically any electrical dealer. To make the indicator, first remove the brass base from the lamp. Inside this base there is a small wire-wound resistor. Remove this resistor and connect the two remaining leads coming through the glass across the speaker transformer. An ordinary "magic eye" escutcheon can be used for the panel. This system can also be used across the speaker of any radio set and makes a fairly successful noise eliminator. Heavy bursts of static will light the lamp very brightly and at the same time create a partial short-circuit across the speaker.

A PRECAUTION

It is necessary, however, to remove any by-pass condenser or tone control connected to the plate of the output tube, as these would be charged and discharged by the ionizing effect of the neon lamp and create a noise worse than the original static.

Note in the Signal Tracer input that the two right-hand switch positions are for high-gain and low-gain input. The left-hand positions are: AVC for the upper terminal and audio input for the lower position.

In conclusion, do not overlook the fact that one of the secrets of signal tracing is the low capacity probe and cable. If ordinary shielded wire is used the results will not be satisfactory. — *Reproduced through the courtesy of "The Australasian Radio World."*

RADIO TRANSMISSION KNOWS NO STATE BOUNDARIES

JUDGE EMMERICH FREED of the United States District Court for the Northern District of Ohio, Eastern Division, in the case of *United States of America v. Betteridge and Wolf*, in an opinion dated February 6, 1942, stated that operation of any radio transmitter within the United States or certain of its territories or possessions must be licensed by the Federal Communications Commission and conducted by a licensed operator. The opinion points out:

"A careful analysis of the prohibited operation of a radio transmitting apparatus without a license discloses that the section is so all-inclusive that it would require great imaginative faculty to find an instance where the operation of a transmitting apparatus would not be embraced within the provisions of the Act. In fact, I am bound to come to the conclusion that all the operations of a radio transmitting apparatus fall into one or the other or several subsections of the statute and that under the Act none can operate without a license."

This case involves the prosecution of two individuals who had operated an unlicensed (5 meter) transmitter at Thistledown Race Track, near Cleveland, Ohio, in August, 1941, in connection with a scheme to best the bookies by signalling "tips" while the races were being run.

In considering the point, the court said: "There is evidence to the effect that such transmissions could not be controlled by the sender except as to volume and would transmit energy, signals, and communications in radiated directions and that such transmissions would interfere with any other radio transmissions using the same frequency at the same time either from outside the State to points within the State of Ohio, or from inside the State of Ohio to points outside the state."

WALKING PLANE DETECTOR

Cover Feature

AN aural plane detector, easily carried and operated by one man, has been developed by The Zadig Patents, for use by individual spotters of the Aircraft Warning Service. The accessories for the device, including the power supply, are housed in a case smaller than the usual gas mask container.

When the device is to be put in use, the spotter puts on a headpiece suggestive of the Buck Rogers fantasies, consisting of earphones topped by a parabolic "concentrator" of sound waves, from which wires are plugged into an amplifying apparatus in the case. When a low-pitched sound in the earphones heralds the approach of a plane, the spotter turns his body until the sound is at its loudest. He is then facing the on-coming plane and is able to turn his binoculars swiftly and accurately on the aircraft to be identified.

It is claimed that the device has been

passed upon by technicians of the U. S. Army Signal Corps and by members of the Aircraft Warning Service, who find that it can be used effectively by spotters without technical training.

The pick-up unit is made of a thermo-plastic material molded into a parabolic curve having a microphone of special characteristics placed at the focal point. The headband which carries the earphones also supports the concentrator.

The amplifier and its batteries are contained in a shielded drawer which slides into a compartment at the bottom of the carrying case. The amplifier uses three tubes of the miniature type connected in a high-gain circuit. Filters eliminate noises other than those emanating from the approaching plane. A volume-control knob regulates the sound in the earphones to the watcher's comfort.

ELECTRON MICROSCOPE IN NEW FIELDS

By **DR. V. K. ZWORYKIN**

Associate Director, RCA Laboratories

Few innovations in the scientific world have made a place for themselves as quickly as the electron microscope; and no wonder. While for centuries previous to this remarkable contribution of radio, research men had been able to enhance the range of the visible world only by small steps, gradually perfecting the light microscope to its present high stage of excellence, the electron microscope almost at once revealed detail of structures up to a hundred times as fine as that visible with the earlier instruments. Within the past year the electron microscope, having been made commercially available has increasingly proved its value in the fields of biology, chemistry, and metallurgy. Its utility has been greatly enhanced by the development of new methods of observation.

OPERATION EXPLAINED

As the name implies, the electron microscope utilizes electrons in place of light to form a magnified image of the object to be examined. As these minute charged particles, even when possessing a velocity comparable with that of light, do not readily traverse matter, the electron microscope must be carefully evacuated, i.e., freed of air. Furthermore, the electron rays cannot be focused in the usual fashion by material lenses or pass through a glass slide supporting the object. Finally, they cannot be observed directly by the human eye.

Under these conditions it is not surprising that the electron microscope presents an appearance differing greatly from that of the light microscope. Nevertheless, the basic arrangements of the two instruments are quite analogous. In the electron microscope electrons emitted by a hot filament are accelerated by a carefully stabilized difference of potential of about 60 kilovolts and concentrated by the "condenser lens"—the magnetic field between suitably shaped pole pieces of an electromagnet—on the object, which is usually supported by a colloidal film about a two-millionth inch in thickness. After passing through the object

and being partly scattered by the latter, the electrons are focused under the influence of a second "magnetic lens"—namely, the objective—into an intermediate electron image of the object. This is then further magnified by the magnetic "projector lens," which throws it on a luminescent screen so that it becomes visible to the eye. When the screen is replaced—by means of a simple turn of a knob—by a photographic plate, the image is recorded on it permanently. To facilitate the exchange of object and photographic plates, airlocks are provided at both points, making it unnecessary to evacuate the microscope anew after each exchange.

To further the application of the instrument in the field of biology, an RCA Fellowship for electron microscope research was established under the auspices of the National Research Council, and Dr. Thomas F. Anderson of the University of Wisconsin was appointed to the post. Collaborating with a large number of prominent scientists, Dr. Anderson has investigated numerous biological problems. In the field of bacteriology many of the disease-producing micro-organisms have revealed a wealth of internal structure which heretofore could only be surmised. In some cases chemical changes within the individual germs—for example, the formation of metallic tellurium crystals in diphtheria bacilli—could be observed.

STUDY CHROMOSOMES

Even more striking has been the success of the electron microscope in the field of the viruses, disease-causing agents beyond the range of the ordinary microscope. A micrograph shows a fan of tobacco mosaic disease virus "molecules" cohering in characteristic fashion. Numerous other plant viruses and the effect on them of immunizing materials have been studied, yielding valuable information for the eventual control of the diseases caused by them.

Simultaneously work has gone on to de-
(Continued on page 604)



C. F. DECKER
Plaza Radio
Englewood, N. J.

"I appreciate the N.U. Equipment Plan very much. It enables servicemen to secure the necessary equipment with a minimum of expense. Their method of doing business plus service helps are a big asset to anyone in the radio business. I have always found N.U. products very reliable."

WHERE YOU FIND
NATIONAL UNION
YOU FIND BETTER
RADIO SERVICE

PREMIUM
Quality
TUBES



BATTERIES



CONDENSERS

also *Transmitting tubes, panel lamps, cathode ray tubes, exciter lamps, sound equipment, photo electric cells, sound accessories, dry batteries, flash light bulbs.*

NATIONAL UNION invites . . .

All radio service dealers to enjoy the benefits of the N. U. Shop Equipment Plan. The latest in tube testers and test equipment are available to you . . .

More than 60,000 completed deals prove the success of this plan. Investigate now.

Ask Your N. U. Distributor or Write



NATIONAL UNION
RADIO Corp.
57 STATE ST., NEWARK, N. J.

AIR-RAID BUSINESS TO SHOOT AT

EUGENE A. CONKLIN

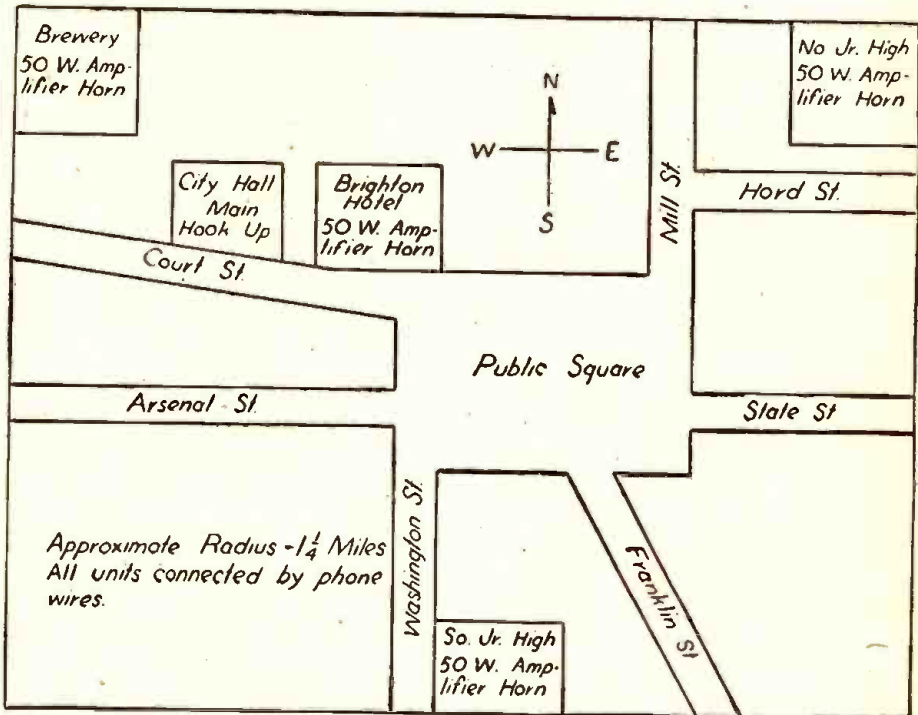

Rough plan showing location of air raid alarm apparatus in Watertown, N. Y.

EVERY community, regardless of its size, is a potential prospect for sale or rental of an air-raid system, similar to that installed by Van Radio of Syracuse and Curtis Shearn of Watertown. And any serviceman can install such a system with ease and profit accordingly.

Watertown, New York, a thriving town of 35,000 located eight miles from Pine Camp, one of the nation's key training camps, has tried out and found practicable a typical air-raid siren unit. The outfit consists of a microphone and oscillator located in Police Headquarters and auxiliary amplifiers and air horns strategically placed in various parts of the city.

Auxiliary units were connected with Police Headquarters via telephone wire. The oscillator was used to give intermittent air-raid warnings. The all-clear signal was produced by steady oscillations.

The equipment utilized was as follows: One 70 watt amplifier and air horn, requiring twenty pounds of air pressure to function, was located atop the Hotel Brighton—the highest spot in the city and in the heart of the downtown area. The schools of the city were selected for the erection of fifty watt amplifiers with two air horns, because of the fact that they were separated from each other by equidistances.

There were several kinks which needed ironing out. The average air-warden is not familiar with broadcasting procedure and invariably hogs or shies away from the mike, causing distortion accordingly. Also tubes in booster amplifiers require a few seconds to warm up—a fact which the layman does not always appreciate. The suggestion has been made by Van and Shearn that all speaker and amplifier connections be checked before air-raid tests and that Servicemen or trained assistants be sta-

tioned near each one to spot trouble or shut-offs.

Van and Curtis Shearn point out that the average serviceman has material available to construct such a system, in miniature at least. Priorities on replacements are not as rigid as those on radio transmitting and receiving equipment proper.

Another scheme worth trying is the equipping of a portable sound truck with a small siren or straight P.A. outfit, going from one small town to another, renting it out to communities under a thousand inhabitants. The serviceman pitches his truck in the center of the town and acts as announcer, giving air warning instructions. Because he is familiar with mike technique, he makes an excellent choice for such a position. Serviceman can cruise about between five and six adjacent towns in one week, realizing excellent nightly rates out of such a procedure.

Also see your local civic defense council about renting your sound truck for cruising about city streets boosting defense bond sales and calling attention of passersby to the benefits of enlistment in the Army, Navy or Marine service. Many local organizations will be willing to pay for the use of your P.A. facilities at Bingo Benefits and socials of one sort or another.

As has been suggested before, servicemen should talk with their local councils about holding a "Radio Registration Census Day." On that day all citizens appear at the City Hall and fill out small cards giving model of set, its condition (operative or not) length of time since last serviced, etc. This information permits the defense council to check on the number of citizens who could receive air-raid warnings or defense instructions when relayed over local or near-by radio station. Servicemen act as a

(Continued on page 625)

Make Your Own NON-METAL SHIELDS

Servicemen searching for substitutes for metal will find useful suggestions in this article dealing with shields made by painting any non-metallic surface with a conductive colloidal graphite solution.

BERNARD H. PORTER*

THERE are several scattered, but standard practices in the electronics field which with slight re-adaptation provide a ready means of forming non-metal shields for a variety of purposes. The more obvious of these are described here with a view to aiding engineers currently searching for metal substitutes.

VACUUM TUBES AND GROUND CONNECTIONS

As the first example of present usage, consider the operation of the type FP-54 plotron. This tube acquires, from simple handling alone, surface charges that tend to leak off via the control grid circuit and increase the grid current in the process. This undesirable condition is eliminated, at the manufacturer's recommendation, by applying a film of aqueous colloidal graphite directly to the pre-cleansed glass and up to within an inch of the control grid connection. The dried, electrically conductive layer, connected to a source of potential equal to that of the grid, provides the necessary dissipative path.

The obvious adoption of this practice applies as metal radio tubes and metal shields for glass tubes become increasingly scarce. The exterior surfaces of glass tubes, rendered grease-free with chromic acid followed by thorough water-rinsing and air-drying, are painted or sprayed with an aqueous colloidal graphite solution of fairly high concentration (1 part Aquadag to 3 parts H₂O).

Such coatings possess a matte-like surface conducive to heat dissipation. Since the electric-furnace graphite composing them is also a better thermal conductor than most metals, little difficulty in radiating filament heat is encountered. Graphiting the tube surface in lattice or cross-hatch fashion, leaving small areas of glass exposed, is also feasible, should the problem of heat dissipation persist.

Permanent grounding connection to the conductive film may be made, in some cases, by extending the film down over the tube base to touch or be sealed to an appropriate lead in the top of the baseboard or chassis. In other instances, contact is made with a loop of wire or a narrow band clamp placed about the tube. If these parts are first hot-dipped in dilute colloidal graphite solution, better electrical connection is assured, particularly if a final application of the more concentrated product is made to seal edges between the connection and the glass. This treatment is also recommended when the connection is made to the tube prior to the coating operation. Successive graphite layers are preferably dried with circulating warm air before fresh solution is applied.

*Research Laboratories, Acheson Colloids Corp., Newark, N. J.

SHIELD FORMS AND THEIR GROUNDING

Practices currently employed in the shielding of electronic musical instruments are equally as adaptable. In this instance (U. S. Patent No. 1,927,030), the interior non-conducting walls and parts of electric pianos, organs, violins and similar devices are coated with films of colloidal graphite in distilled water to insure stable and hum-free performance. Thus, converting this procedure to broader use, fibrous board or sheets, first impregnated in dilute graphite solution, then surface coated with a more concentrated dispersion, make ideal non-metal shield partitions between stages or radio components. Slow or heat drying under pressure may be advisable directly after the impregnation treatment. Soft polishing of the dried film will both increase its electrical conductivity and contribute to improved appearance.

Similarly, glass, plastic and wood in sheet form may be surface coated for the same purpose. Tubular shields pressed or formed from glass, plastic, fibrous material or other non-conductors are likewise rendered conductive. The entire cabinet or case, whether wood or plastic, may be treated by spraying, should the use of metal chassis become restricted or this practice seem, for other reasons, expedient. The grounding of graphite films on comparatively thin supports is accomplished with metal eyelets, inserted through the piece and preferably having one end of the wire lead soldered in place before coating is made. Additional sealing or covering with concentrated colloidal graphite about the points of contact to the film is necessary, whether eyelets are inserted before or after the main application.

A useful method for making electrical connection to graphite film deposits of this class also follows from the current practice of cementing filaments to leads in carbon filament lamps wherein globules of concentrated colloidal graphite, dried at the filament-lead juncture, provide a positive, vibration-resisting contact. In this immediate instance of shield-grounding, the bare lead, preferably small in gauge, is bent spring fashion to the graphited surface in question and cemented in position with the heavy dispersion. A spot of nitro-cellulose varnish applied over the dried globule further aids in strengthening the connection.

Many experimenters currently apply colloidal-graphited water to the porcelain tower constructions and non-conducting high vacuum parts of electrostatic generators as a shield against radial fields. Inflated rubber inner tubes or similar loop constructions of neutron generators are also protected in this way. These and similar practices common to recent physical investigations substantiate the propriety of the foregoing suggestions for shielding and in

addition suggest that both glass and rubber tubing, treated in this way, may conceivably assure an effective substitute for tubular metal shields. The minute graphite particles assist in stopping microscopic glass cavities—a feature of practical value when high vacuums are also involved; and, in the case of rubber, do not impair flexibility or produce a film susceptible to flaking. Should the two types of tubing require splicing, both the exterior of the larger tube and the interior throughout the length of the joint are coated to insure good electrical connection to the coated smaller tube. Grounding is accomplished with metal eyelets inserted in the walls of the rubber tube, and with the lead embedded or sealed by heating into the glass tubing.

Research workers have long employed colloidal graphite films for guard rings whenever, in vacuum techniques, it was inconvenient to prepare metal ring strips that would properly fit the encased parts. Should metals become unavailable for this use, the practice of painting guard ring formations with aqueous colloidal graphite is worthy of more universal acceptance. Such rings can be employed on certain types of photoelectric cells and in all other instances where metal rings are customarily used. In fact, the facility with which graphite films are applied, together with their adhesive properties with respect to glass, porcelain, bakelite and enamel, frequently makes them much preferred to metal.

Permanent electrical contact to film rings is easily effected by coating over, or cementing by means of the concentrated product, the connecting wires previously sealed into the glass for this purpose. The difference in coefficients of expansion involved between the base material and the graphite is preferably kept as small as possible, even though, within limits, the graphite particles tend to slide over one another.

Methods of producing ionization and counting tubes, insulation-measuring contacts, thermopiles, and means of coating complicated form-joints of vacuum apparatus is too fully described elsewhere to warrant treatment here. Methods of coating the interior of vacuum and cathode-ray tubes, making counter electrodes for photocells, and producing focusing anodes from non-conductive base materials is well known. It is sufficient to mention that all of these applications have, at some stage in their development, employed metals and metal foils, which have been, for various reasons, supplanted by graphite films. With an increasing number of non-conductors being presently demanded for new uses, normally served by conducting bodies, the electrical conductivity obtainable from graphite colloidal dispersed in suitable carriers will be more extensively utilized.—*Electronics, New York.*

War-Time Radio Repairs

HOMER C. BUCK

WITH a scarcity of radio parts ahead, it wouldn't be amiss to review the art of repairing components that go hay-wire most often. It is not known at this time to what extent we might have to use our manufacturing ability. With Uncle Sam digging deeper every day into our natural resources, we might, eventually find it profitable, even necessary, to repair the most humble of parts.

The author has had some experience along this line, and for those who have had little or no occasion to take things apart and attempt to repair them, the author—using the pronoun “we”—will relate ideas or experiences concerning the most common parts. Those who might feel differently about some particular repair, we will leave to their own decisions, for better or worse.

Meters—Before opening a discussion of radio parts, repair and replacement, it is felt that a word of warning be expressed concerning our pet tool, the *meter*.

If for some cause a Serviceman ruins his meter, he may as well close shop, if he cannot make the necessary repair.

To purchase meters and movements now, one must have a so-called “priority number.” This permission is granted to essential industries and cannot be obtained by an individual. The instrument manufacturers have turned over their facilities to the U. S. Government, leaving the radioman *on his own*. One glance at a combat plane's instrument panel will clarify the reason.

The meter, generally speaking, can be repaired if the movement has not been burned out, by anyone accustomed to fine tools and mechanisms. To explain: the meter consists of a magnet and movement. This movement is made up of a bobbin of very fine wire on an aluminum frame and is suspended between two jewels or stanchions mounted at opposite ends of this rectangular frame. Soldered to each stanchion is a very fine hair spring, similar to those used in a watch, which govern the pointer in returning to zero adjustment. This pointer is fastened to the moving coil at the point where one of the stanchions is fastened. At this place the pointer resembles a cross in that it has a cross-bar. It will be noticed that this cross-bar has two tiny spiralled bits of wire on either end as well as a bit of spiralled wire or drop of solder on the tip of the cross, or main body of the pointer. The purpose of this is to balance the movement. A perfectly balanced meter will retain its zero adjustment and read full scale when held in any position. In radio service this is not so critical except for two positions, upright and flat. But then for greater accuracy at $\frac{1}{4}$, $\frac{1}{2}$ and $\frac{3}{4}$ scale, deflection weights or spiralled bits of wire on the cross-bar can be shifted slightly.

In the main, in the flat position, the hair springs, magnetic flux and number of turns of wire on the movement govern the full-scale deflection. In the upright position, if the meter reads too high, shift the spiralled wire down a little on the cross-tip or add a bit of solder if the movement is of that type. If the meter reads too low, shift the cross-tip spiralled wire towards the stanchion or remove a little solder on the other type.

A good deal more can be said about balancing a movement, but we feel that this is sufficient to acquaint the reader with the

principle. A sticking movement is usually caused by turns of the spiralled hair-spring sticking together. A fine dust particle is sufficient to cause this. For removal of dust particles, use an 8 power lense and a needle. Do not try to blow the dirt out!

The break in “open” movements is usually found where the wire is soldered to the stanchions. A short connecting wire can be used to renew the continuity. Brush the enamel off the movement wire with the tip of a piece of sandpaper 2 inches by 1/16 inch under a lense. It is very easy to snap this wire. The soldering iron should be clean. To get an idea of the magnitude of the solder on an iron in comparison with the work, look at the soldering iron tip with a lense.

Condensers: the capacity of a used wet electrolytic condenser can be restored by punching a hole in the top of the can and injecting distilled water with an eye-dropper, sealing the hole afterward with a sheet metal screw. A peg would never do because of the pressure created in the can by electrolytic action under load. Distilled water will go into the solution with what remains of the old electrolyte, increasing the electrode surface coverage. Distilled water being non-metallic, the voltage breakdown will remain practically the same. Leave a space of about $\frac{1}{4}$ inch from the top of the can to the solution. Never use tap water as the voltage breakdown point will be lowered and cause increase of leakage current.

Where the electrolyte equals around $\frac{1}{4}$ of the solution, the ill effects that might be observed are that very little dielectric films can be renewed. It would seem at this time, a good idea to save electrolyte from old condensers and store it in glass jars. To overcome the ill effects in a weak solution, shake the can well after “doctoring.”

Dry type electrolytics, to our knowledge, cannot be repaired, although where the capacity is low, an injection of distilled water may help. As a rule, dry type condensers suffer from excessive current drain and the film is destroyed. Where in a wet electrolytic, the solution is in active contact with the can and electrode, the mixture in a dry type is rather inert and cannot “cover up” weakness in the dielectric film; our own idea of course.

Modern tubular electrolytics with mounting strap are usually good, surprising as it may seem, even after the average Serviceman has discarded them as defective. This type of condenser is usually found in cheap receivers. The excessive heat in confined spaces and the warmth of the electrolyte itself is sufficient to cause saturation of the cardboard container.

Tubular, paper type, condensers will be found to be “shorted” in one spot only, usually. This *short* can be found by melting the wax from the ends of the container, allowing the pig-tails to fall out, moving the foil and unrolling. When the spot has been reached, clean the foil away from the burned paper for $\frac{1}{8}$ of an inch and check for further *shorts*. If a charred spot appears on more than one turn of the foil, clean the foil away from these spots also. Upon rerolling foil and inserting in container, insert pig-tails in place and wrap wire of pig-tails once around each end of container to prevent “opening” by straining.

SALE! RADIO PARTS

ALL NEW! GUARANTEED
100% PERFECT!

P.M. Speakers, Brand New! Several thousand in original manufacturers' boxes. 4" and 5" (less transformers) V. C. impedance 8-4 ohms. 4" at 89c each. 5" at \$1.10 each while they last.

NEW! WEBSTER MAGNETIC PICKUPS. 10,000 ohm impedance. Brake head type . . . gray crackle finish . . . in original manufacturers' cases. Guaranteed 100% perfect. Formerly were \$11.95 list. . . Now \$3.95 each.

PUSH BACK WIRE in assorted lengths . . . per lb. 60c FREE. Thousands of Parts bargains. WRITE TODAY for free catalog of hardware and replacement parts. LET US SAVE YOU MONEY—Drop a post card NOW!

RANDOLPH RADIO

609 W. Randolph St., Chicago, Ill.
“Millions of Parts for Millions of Radios”



“THE INDUCTANCE AUTHORITY”

By EDWARD M. SHIEPE, B.S., M.E.E.
[A NEW BOOK]

THE ONLY BOOK OF ITS KIND IN THE WORLD, “The Inductance Authority” entirely dispenses with any and all computation for the construction of solenoid coils for tuning with variable or fixed condensers of any capacity, covering from ultra frequencies to the borderline of audio frequencies. All one has to do is to read the charts. Accuracy to 1 per cent may be attained. It is the first time that any system dispensing with calculations and correction factors has been presented.

There are thirty-eight charts, of which thirty-six cover the numbers of turns and inductive results for the various wire sizes used in commercial practice (Nos. 14 to 32), as well as the different types of covering (single silk, cotton-double silk, double cotton and enamel) and diameters of $\frac{1}{8}$, $\frac{1}{4}$, $1\frac{1}{8}$, $1\frac{1}{4}$, $1\frac{1}{2}$, $1\frac{3}{4}$, 2, $2\frac{1}{4}$, $2\frac{1}{2}$, $2\frac{3}{4}$ and 3 inches.

Each turns chart for a given wire has a separate curve for each of the thirteen form diameters.

The book contains all the necessary information to give the final word on coil construction to service men engaged in replacement work, home experimenters, short-wave enthusiasts, amateurs, engineers, teachers, students, etc.

There are ten pages of textual discussion by Mr. Shiepe, graduate of the Massachusetts Institute of Technology and of the Polytechnic Institute of Brooklyn, in which the considerations for accuracy in attaining inductive values are set forth.

The book has a flexible fiber black cover the page size is 9 x 12 inches and the legibility of all curves (black lines on white field) is excellent.

Price postpaid \$2.50

GOLD SHIELD PRODUCTS

350 Greenwich St. (Dept. RC6)
New York City



Amazing New “WALSCO” STAPLE DRIVER

for radio men, electricians, or anyone doing stapling. Makes wire and cable installations twice as easy—much neater—saves half the time. Wires can be stapled in corners, behind pipes, into moldings—places never accessible with a hammer and ordinary staples. Drives staples even into wall, brick, mortar, etc. Magnet works automatically and holds strips of staples which come in several colors. Ask your jobber for demonstration and catalogue 41-C of all WALSCO PRODUCTS

or write WALTER L. SCHOTT CO.
5264 W. Pico Boulevard, Los Angeles, California

Press pig-tails in firmly with a match stick and melt stick shellac into the ends of the container with a soldering iron. A suitable "jig" for this purpose can be made up of a few blocks of wood to insure positive contact, allowing the stick shellac to cool. It is rather impossible to solder pig tails to aluminum foil.

Mica condensers can be split and studied sufficiently to make suitable air-trimmers in duplicate, or a short twisted pair of wires can be used instead. A further increase of capacity without lengthening the wires can be had by sheathing the pair in a short length of banding braid. The resultant capacity, of course, is determined by trial.

Coils: We have made it our business to remove a good supply of coils from junk receivers. With the available wire we have been able to repair and replace coils of all descriptions. In repairing, or rewinding, there is always the old coil and usually another in the receiver to use as a standard. The wire used in coils varies in size and the number of strands to a cable—5, 7 and 10 strands. Replacing single strand wire is figuratively easy, but 10-strand cable is rather fun! To separate the ends of a 10-strand cable, brush the ends over the forefinger with a small stiff brush, using GC service solvent to cleanse. Removing the enamel from these wires requires patience for a good clean job. Brush the wire with a piece of sandpaper while holding the tips of the wires over the forefinger. Do not rub with the sandpaper or bend the wires, as they will snap off very easily. Study these wires under a lense after rubbing with sandpaper. This will acquaint the reader with the nature of the work and paint a picture in the mind of what is happening to the wire when removing the enamel. Upon repairing a litz wound coil, compare its resistance, when finished, to that of the one remaining in the receiver with a low ohm meter. If one or more of the five wires do not make contact with the others there will be an increase of resistance and inductance as these wires are all in parallel. Celluloid dissolved in acetone or stick shellac can be used for tacking.

Stick shellac is a very useful substance to have around the shop. It can be purchased at any good paint or hardware store. It comes in assorted colors and shades. It can be melted with the tip of a soldering iron to fill dents in cabinets, tacking wires and for moisture-proofing parts.

In replacing a coil of an IF transformer it is difficult to follow a pie-wound formation. But if two fibre washers with inside diameter the same as the form is pushed over the form and cemented in place, a suitable spool will be formed. The fibre washers can be left in place after filling in with wire.

Speakers: now is a good time to start salvaging old speaker parts.

It is questionable, at this time, which speaker will replace which. It is a toss up between the copper in a dynamic and the nickel in a P.M. But with plenty of old speaker pots kicking around, we should worry. Somewhere around the place we still have a sheet of blueprint (tracing) cloth we used to employ when speaker cones were hard to get and the cost of speakers meant a small withdrawal from the bank. More tracing cloth may be obtained at any good stationery supply house.

Carefully remove an old cone from the pot and slit it from voice coil to rim. Using it as a pattern, trace a duplicate on the tracing cloth, allowing a quarter-inch overlap for cementing with GC service cement.

(Continued on page 605)

Now You Can Get All **3** from Wholesale Radio!

Model EC-1

Here is the biggest buy in a communications receiver! The Echophone Model EC-1 has all the necessary features for good reception plus a low cost. Tunes from 550 kc. to 30 mc. on three bands. Six tubes. Electrical bandspread on all bands. Self-contained speaker. Operates on 115-125 volts A.C. or D.C.



Model EC-2

Up to the minute communications performance with the eight-tube Echophone Model EC-2. Three bands cover 550 kc. to 30 mc. Self-contained five-inch dynamic speaker. Preselection on all bands. Calibrated bandspread scale on 80/40/20/10 meter bands. Electrical bandspread at all frequencies in the tuning range. Operates on 115 volts A.C.-D.C.



Model EC-3

You can't beat the Echophone Model EC-3 for performance in its price range. Check all these features! Crystal filter (four position variable selectivity). Calibrated bandspread. Automatic noise limiter. Preselection on all bands. 2 stage I.F. amplifier. Flywheel tuning. Separate 6" PM speaker. CW monitor. 10 tubes. 3 bands. Tunes from 550 kc. to 30 mc. Electrical bandspread. Operates on 115 volts A.C.-D.C.

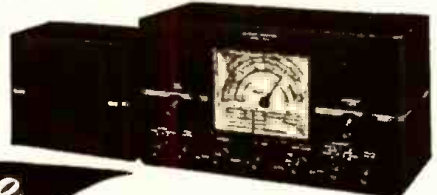

Write for free catalog

WHOLESALE RADIO LABORATORIES

76 West Broadway, Council Bluffs, Iowa

PROTECT that 40%

Now more than ever the jobber and service man must protect the standing which he has built. Condenser replacements account for about 40% of all radio repair jobs. Dependable condensers are therefore essential to the building of the utmost in customer satisfaction and in holding your clientele.

CONTINUOUS, DEPENDABLE SERVICE

For 21 years the manufacturers of POLYMET ELECTROLYTIC and BY-PASS condensers have striven to improve quality and service. Add to this a liberal and reasonable mark-up and the fact that no fly-by-night "bargain catalogs" can undersell you on POLYMET. You're protected, your customer is satisfied, your profits and volume increase. We're conserving vital defense materials by limiting sizes to those most universally used. These will serve practically every need, replacing larger electrolytics when proper capacity and voltage are used. Complete listing of available types and prices will be forwarded upon request.



POLYMET CONDENSER CO.
699 E. 135TH. ST., NEW YORK, N.Y.

A CALL TO SERVICE MEN!

The Editors would like to hear from radio men in the service as to what kind of articles they would like to see in RADIO-CRAFT.

Do you want more articles on "how and why"—including the mathematics, of frequency modulation?

Or do you want more Elementary Electricity articles with electrical hints, circuits and constructional data?

Or do you want more articles on Antennas, Ultra Short Waves, etc.?

Let's hear from you and we will endeavor to publish what you most need. A post-card will do. Write to the Editor, RADIO-CRAFT, 25 W. Broadway, New York City.

Radio Service Data Sheet

ZENITH Model 7G605 110-Volt A.C.-D.C.-Battery Portable Receiver

GENERAL FEATURES

The Zenith Trans-Ocean Clipper Deluxe Portable is designed to receive standard broadcast and short-wave stations in any location, a moving train, a plane, a boat or in the home. It is precision-built, incorporating an advanced design with the latest circuit innovations assuring efficient radio reception at all times.

This receiver is an A.C.-D.C. or BATTERY operated seven tube superheterodyne, including rectifier, covering the standard broadcast and foreign-domestic short-wave bands. A three-section tuning condenser with a tuned R.F. stage insures good sensitivity. Seven tuned circuits give sharp selectivity. It is equipped with a five-inch permanent-magnet speaker and a four-button "RADIORGAN" tone control. The built-in movable duplex WAVEMAGNET assembly (incidentally, an exclusive Zenith patent) consists of the standard WAVEMAGNET along with the recently developed Zenith Short-wave Magnet, each specifically designed for reception in its own band or bands. A WAVEBOOSTER has been built into the Short-wave Magnet so that short-wave stations may be peaked for maximum volume. The WAVE-ROD, which may be "telescoped" in and out of its operating position, is provided for average short-wave reception and also for broadcast reception in rural or isolated areas where signal strength is likely to be extremely low. It is automatically incorporated into the circuit by the Robot-Switch as the WAVE-ROD is unfolded from the cabinet. The Time-Band Selector on the front panel indicates and permits selecting the short-wave band most suitable to the time of day. Each shortwave band is "electrically" spread, which means that short-wave stations are separated from each other to a greater extent and also that elusive short-wave stations are tuned with greater ease and accuracy. The 16, 19, 25, 31 and 49 meter bands each have full bandspread tuning. A calibrated "second scale" has been provided on the dial face along with a separate logging chart so that various SW stations may be quickly identified and easily relocated. All coils are fully compensated against variations in temperature and climatic conditions—the performance of the receiver does not vary with seasonal or geographical changes.

The receiver can be operated from any one of three sources of power, as follows:

1. The Portable Z-985 Zenith dry battery pack and two standard flashlight batteries.
2. Alternating Current (A.C.) 110 to 125 volts, 25 to 60 cycles.
3. Direct Current (D.C.) 110 to 125 volts.

The power consumption of the radio is 25 watts.

BATTERY OPERATION

IMPORTANT: The 110-volt plug must be inserted in the changeover socket to operate the receiver on its self-contained dry batteries; this automatically operates a safety switch. The excess 110-volt line cord must be stored above the tubes at the rear right side of the case. The back-cover is then closed and the receiver is ready for operation.

Note: The batteries should be checked from time to time (three to six months) to determine their condition. If the flashlight batteries are weak or dead, they may be replaced by any standard make although the metal-covered leak-proof type No. 2LP is recommended because of the protection against corrosion and leakage. The large battery pack, Zenith part No. Z-985, is obtainable through Zenith dealers.

SERVICE DATA

All voltages measured with a 20,000 ohm per volt meter from B minus to socket contact indicated.

All voltages are positive D.C. unless marked otherwise.

Volume control full on.

Line voltage 117 A.C. or D.C. 25 to 60 cycle or Battery Pack Z-985 and two flashlight cells.

Stage Gains
Bc. and I.F.

Ant. to R.F. grid 5X at 1000 Kc.

R.F. grid to conv. grid 9X at 1000 Kc.

Conv. grid to I.F. grid 66X at 455 Kc.

Overall audio 900 at .05 watt, 400 cycles.



The Zenith Model 7G605 A.C., D.C. or battery receiver for broadcast and short-wave bands.

OPERATION ON D.C. OR A.C. POWER

(110 to 125 volts)

Remove the line cord plug from the socket in the rear of the receiver and plug it into the 110-volt power outlet.

The battery saver switch is automatically operated when the 110-volt plug is removed from the receptacle on the chassis and prevents any drain from the dry battery pack while the receiver is being operated from an electrical outlet.

Approximately one minute will be required for the tubes to reach operating temperature. If the receiver fails to operate within one minute when connected to direct current, reverse the plug at the electrical outlet. This procedure may also be helpful in suppressing hum or electrical interference (vacuum cleaners, etc.) when the receiver is operated on alternating current.

TUNING

The Time-Band Selector switch, located to the right on the front panel provides a means of selecting one of the following bands:

1. Broadcast.....540 to 1620 Kc.
2. 49 Meters.....6.0 to 6.5 Mc.
3. 31 Meters.....9.4 to 9.8 Mc.
4. 25 Meters.....11.7 to 11.9 Mc.
5. 19 Meters.....15.1 to 15.3 Mc.
6. 16 Meters.....17.6 to 18.0 Mc.

Tuning the Broadcast Band

Press in the BROADCAST button, thereby switching in the broadcast band. Tuning is accomplished by the upper control knob. The pointer should be moved over the station until the exact center of the wave is found; otherwise the tone will be distorted. Under average receiving conditions for broadcast reception, it is not necessary to remove the WAVE-ROD or the duplex WAVEMAGNET from the cabinet.

For broadcast reception in remote or isolated areas, or for out-of-town stations, unfold the WAVE-ROD from the cabinet and extend it to its full length. This automatically connects the WAVE-ROD, thereby increasing the sensitivity of the receiver.

For broadcast reception in steel-enclosed loca-

tions such as airplanes, trains, or automobiles, fold the WAVE-ROD into the cabinet and attach the duplex WAVEMAGNET, provided with suction cups, to a window.

Tuning the Short-Wave Bands

Press in one of the push-buttons, thereby switching in the proper band for tuning. Under average short-wave receiving conditions, unfold the WAVE-ROD from the cabinet and extend it to its full length. Follow the same procedure as set forth in "Tuning the Broadcast Band," being certain to rotate the tuning knob slowly so as not to pass over, unnoticed, the weaker, more distant stations.

Short wave reception in steel-enclosed locations is limited to the 19, 25 and 31 meter bands, for which the Short-Wave Magnet is designed. It will be necessary to attach the duplex Wavemagnet to a window after folding the WAVE-ROD into the cabinet.

BUILT-IN MOVABLE DUPLEX WAVE-MAGNET

This receiver is equipped with a Detachable Duplex WAVEMAGNET, an exclusive Zenith feature, making possible efficient operation in steel-enclosed locations where other portables without this feature operate poorly or not at all. The WAVEMAGNET assembly must be removed from the back of the cabinet and attached to a window if optimum performance is expected in locations such as airplanes, boats, trains, buses, automobiles or steel buildings.

It is likely that best short-wave reception will be obtained with the duplex WAVEMAGNET assembly placed in a vertical position on the glass next to the edge of the window. However, this is not always the rule, as different results will be noted in different locations.

IMPORTANT: Make certain the WAVE-ROD is completely folded into the cabinet when using the duplex WAVEMAGNET.

The duplex WAVEMAGNET is connected to the receiver by a flexible cable and is held within the back cover of the cabinet by means of two clamps. This cable is so designed as to fold evenly when the WAVEMAGNET assembly is placed within the cabinet cover. Unlatch the back cover to remove the WAVEMAGNET assembly for placement on the window. It is advisable to try different positions and angles with respect to the glass in placing the WAVEMAGNET. It is recommended that the receiver be tuned to a weaker broadcast station during the experimental period and the WAVEMAGNET first tried in a position parallel to the glass. Once the best position on the glass and the best angle with respect to the glass have been determined, both for best reception and minimum noise, the duplex WAVEMAGNET should be attached securely to the glass by means of the two rubber suction cups which are first moistened with water or glycerine to make them adhere firmly to the glass.

A three-position switch located in the rear of the chassis offers additional adjustment for best reception.

RADIORGAN TONE CONTROL

The tonal characteristics of the radio may be regulated to the listener's personal preference by means of the four buttons contained in the "RADIORGAN."

To operate the buttons, they are placed in the position toward the arrowhead. The portion of the tonal range affected is shown above each button. There are sixteen different tonal combinations available.

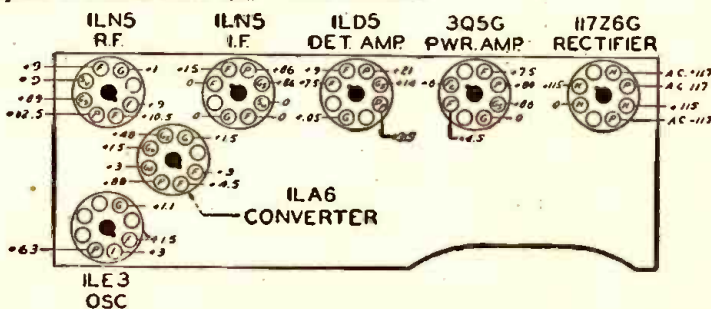

SECRET VOLTAGES—BOTTOM SIDE UP

Radio Service Data Sheet

323

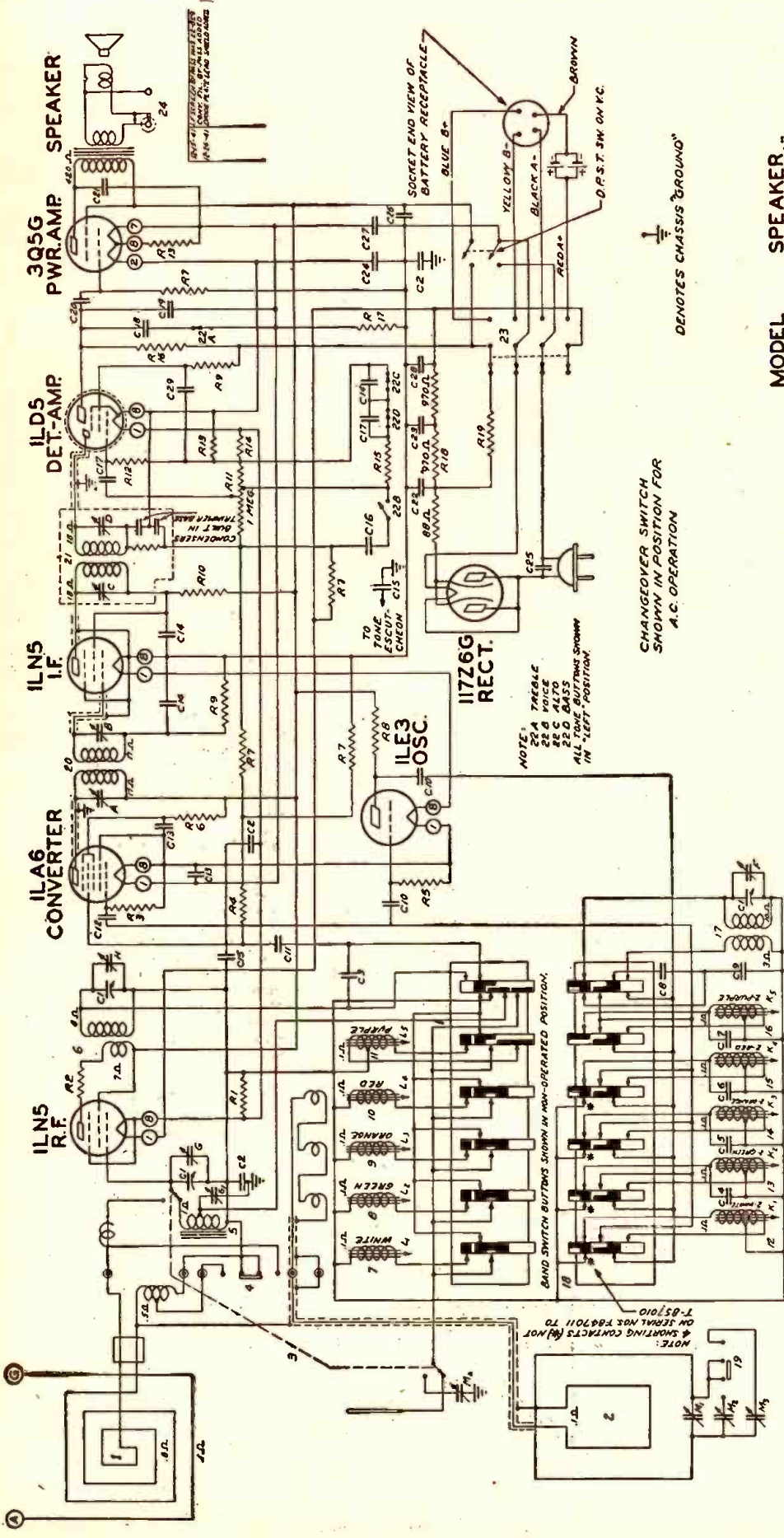

MODEL 7G 605

SPEAKER 49-501 5 1/4"

BATTERY PACK NO Z985

110 V. A.C.-D.C. BATTERY PACK
 UNIVERSAL PORTABLE
 I.F. FREQUENCY 455KC.
 7 TUBE SUPERHETERODYNE
 CHASSIS NO 7B04 6 BAND
 ZENITH RADIO CORPORATION
 CHICAGO, ILL.

QWG PART NO.	DESCRIPTION	QWG PART NO.	DESCRIPTION	QWG PART NO.	DESCRIPTION	QWG PART NO.	DESCRIPTION
C1	22-1001 THREE GANG VARIABLE	1	510680 BROADCAST WAVE MAGNET	24	44-17 MICROPHONE JACK	1	510680 BROADCAST WAVE MAGNET
C2	22-1001 15 MMFD COMP	2	510682 SHORTWAVE WAVE MAGNET	4	1E1 I.F. TRANS. SEC.	2	510682 SHORTWAVE WAVE MAGNET
C3	22-1001 15 MMFD COMP	3	510684 ANTENNA TAPLE SWITCH	6	2E1 I.F. TRANS. SEC.	3	510684 ANTENNA TAPLE SWITCH
C4	22-1001 100 MMFD COMP	4	510686 ANTENNA COIL ASSEM.	7	BROADCAST OSC (ON BANG)	4	510686 ANTENNA COIL ASSEM.
C5	22-1001 100 MMFD COMP	5	510688 6MC. ANTENNA COIL ASSEM.	8	BROADCAST DET. (ON BANG)	5	510688 6MC. ANTENNA COIL ASSEM.
C6	22-1001 100 MMFD COMP	6	510690 9 MC. OSCILLATOR COIL ASSEM.	9	SHORTWAVE OSC. 6 MC.	6	510690 9 MC. OSCILLATOR COIL ASSEM.
C7	22-1001 100 MMFD COMP	7	510692 12 MC. OSCILLATOR COIL ASSEM.	10	SHORTWAVE OSC. 12 MC.	7	510692 12 MC. OSCILLATOR COIL ASSEM.
C8	22-1001 100 MMFD COMP	8	510694 15 MC. OSCILLATOR COIL ASSEM.	11	SHORTWAVE OSC. 15 MC.	8	510694 15 MC. OSCILLATOR COIL ASSEM.
C9	22-1001 100 MMFD COMP	9	510696 18 MC. OSCILLATOR COIL ASSEM.	12	SHORTWAVE OSC. 18 MC.	9	510696 18 MC. OSCILLATOR COIL ASSEM.
C10	22-1001 100 MMFD COMP	10	510698 21 MC. OSCILLATOR COIL ASSEM.	13	SHORTWAVE OSC. 21 MC.	10	510698 21 MC. OSCILLATOR COIL ASSEM.
C11	22-1001 100 MMFD COMP	11	510700 24 MC. OSCILLATOR COIL ASSEM.	14	SHORTWAVE OSC. 24 MC.	11	510700 24 MC. OSCILLATOR COIL ASSEM.
C12	22-1001 100 MMFD COMP	12	510702 27 MC. OSCILLATOR COIL ASSEM.	15	SHORTWAVE OSC. 27 MC.	12	510702 27 MC. OSCILLATOR COIL ASSEM.
C13	22-1001 100 MMFD COMP	13	510704 30 MC. OSCILLATOR COIL ASSEM.	16	SHORTWAVE OSC. 30 MC.	13	510704 30 MC. OSCILLATOR COIL ASSEM.
C14	22-1001 100 MMFD COMP	14	510706 33 MC. OSCILLATOR COIL ASSEM.	17	SHORTWAVE OSC. 33 MC.	14	510706 33 MC. OSCILLATOR COIL ASSEM.
C15	22-1001 100 MMFD COMP	15	510708 36 MC. OSCILLATOR COIL ASSEM.	18	SHORTWAVE OSC. 36 MC.	15	510708 36 MC. OSCILLATOR COIL ASSEM.
C16	22-1001 100 MMFD COMP	16	510710 39 MC. OSCILLATOR COIL ASSEM.	19	SHORTWAVE OSC. 39 MC.	16	510710 39 MC. OSCILLATOR COIL ASSEM.
C17	22-1001 100 MMFD COMP	17	510712 42 MC. OSCILLATOR COIL ASSEM.	20	SHORTWAVE OSC. 42 MC.	17	510712 42 MC. OSCILLATOR COIL ASSEM.
C18	22-1001 100 MMFD COMP	18	510714 45 MC. OSCILLATOR COIL ASSEM.	21	SHORTWAVE OSC. 45 MC.	18	510714 45 MC. OSCILLATOR COIL ASSEM.
C19	22-1001 100 MMFD COMP	19	510716 48 MC. OSCILLATOR COIL ASSEM.	22	SHORTWAVE OSC. 48 MC.	19	510716 48 MC. OSCILLATOR COIL ASSEM.
C20	22-1001 100 MMFD COMP	20	510718 51 MC. OSCILLATOR COIL ASSEM.	23	SHORTWAVE OSC. 51 MC.	20	510718 51 MC. OSCILLATOR COIL ASSEM.
C21	22-1001 100 MMFD COMP	21	510720 54 MC. OSCILLATOR COIL ASSEM.	24	SHORTWAVE OSC. 54 MC.	21	510720 54 MC. OSCILLATOR COIL ASSEM.
C22	22-1001 100 MMFD COMP	22	510722 57 MC. OSCILLATOR COIL ASSEM.	25	SHORTWAVE OSC. 57 MC.	22	510722 57 MC. OSCILLATOR COIL ASSEM.
C23	22-1001 100 MMFD COMP	23	510724 60 MC. OSCILLATOR COIL ASSEM.	26	SHORTWAVE OSC. 60 MC.	23	510724 60 MC. OSCILLATOR COIL ASSEM.
C24	22-1001 100 MMFD COMP	24	510726 63 MC. OSCILLATOR COIL ASSEM.	27	SHORTWAVE OSC. 63 MC.	24	510726 63 MC. OSCILLATOR COIL ASSEM.
C25	22-1001 100 MMFD COMP	25	510728 66 MC. OSCILLATOR COIL ASSEM.	28	SHORTWAVE OSC. 66 MC.	25	510728 66 MC. OSCILLATOR COIL ASSEM.
C26	22-1001 100 MMFD COMP	26	510730 69 MC. OSCILLATOR COIL ASSEM.	29	SHORTWAVE OSC. 69 MC.	26	510730 69 MC. OSCILLATOR COIL ASSEM.
C27	22-1001 100 MMFD COMP	27	510732 72 MC. OSCILLATOR COIL ASSEM.	30	SHORTWAVE OSC. 72 MC.	27	510732 72 MC. OSCILLATOR COIL ASSEM.
C28	22-1001 100 MMFD COMP	28	510734 75 MC. OSCILLATOR COIL ASSEM.	31	SHORTWAVE OSC. 75 MC.	28	510734 75 MC. OSCILLATOR COIL ASSEM.
C29	22-1001 100 MMFD COMP	29	510736 78 MC. OSCILLATOR COIL ASSEM.	32	SHORTWAVE OSC. 78 MC.	29	510736 78 MC. OSCILLATOR COIL ASSEM.
C30	22-1001 100 MMFD COMP	30	510738 81 MC. OSCILLATOR COIL ASSEM.	33	SHORTWAVE OSC. 81 MC.	30	510738 81 MC. OSCILLATOR COIL ASSEM.
C31	22-1001 100 MMFD COMP	31	510740 84 MC. OSCILLATOR COIL ASSEM.	34	SHORTWAVE OSC. 84 MC.	31	510740 84 MC. OSCILLATOR COIL ASSEM.

Modernize Your Shop For WARTIME Service

EUGENE A. CONKLIN

WAR is on! That means that every American family will want and **NEED** a first-class *operative* radio in its home for constant contact with important local and national developments on the war front. Many radios need overhauling and others could stand some repairing. The important thing to remember is that in this emergency the customer may come to you of his own volition, without any high-pressure advertising or costly publicity campaigns. What he sees in your shop will determine whether or not you

will get "repeat" calls after the present emergency ceases.

Your ability to charge a two-dollar hourly inspection rate or \$1.50 minimum, plus full LIST prices for replacements, plus any other charges depends upon whether your clients regard you as a *professional* man, on the same level as the medical practitioner, or whether you are classified as a *second-rate* man who should do the job for a very small sum. Compare your service shop with Mattraw Radio in the city of Watertown, N. Y., which has a population of 35,000. Mattraw gets the most service-call business and charges the highest price in his section for servicing. There is one important difference between Mattraw and other radio shops—this place of business is *professional looking!* It looks alert and ready for business. To begin with, Mattraw warns that one must watch his *curb-signs* and outdoor displays, as many transients pass by places of business and stop at the place which arrests their attention.

Many times when transients are in your community, they discover that their radios or portables need repairing. If your curb-sign attracts their attention, you no doubt will make a service sale! A good suggestion is to install signs which resemble the "No Parking" signs which are seen along the road. These should be yellow in color to be most effective.

As to your shop sign, now that electric power is being rationed, it will not be necessary to have a neon light or an electrical sign. Instead install a metal flange with shop name and identifying emblem (any emblem which can be seen from afar and which symbolizes radio is suitable). Red white and blue patriotic effects are quite striking and effective at present. Your local sign expert can give you an excellent unit of this nature for a slight investment.

Then there is the show window! Many service experts fill the available window-space with broken down radio tubes, outmoded consoles, and a miscellaneous assortment of "junk" which would do credit only to a salvage man's inspirations. Instead Mattraw suggests—borrow photos of radio stars from a near-by radio station, frame and mount them in the window. Cut out and place newspaper radio schedules conspicuously in the window for the coming week. Take *Radio Guide* or *Radio Mirror* and show photos cut from their pages. Or get the local YMCA, Boy Scouts, USO or Red Cross to each decorate your window for a week with a display of their work and accomplishments! Besides attracting attention you are creating organized community "goodwill" and that is a precious commodity these days. In closing, do not neglect to utilize displays furnished by manufacturers and jobbers. Mattraw uses many window displays contributed by school youngsters and church groups, because he feels that future orders for sound service and repairs will result from such cooperation.

The outer-reception office is next on the modernization menu. A flat-top desk, second-hand if necessary, but with a re-varnish job, should be located in the center section of the room. A typewriter should be nearby. Also a business-like file should

be near the desk. A typewriter is a *must* in handling bookkeeping transactions between the jobber, factory, and yourself. It means cementing transactions between customers and yourself when business-like typewritten receipts, forms, etc., are issued.

The file should contain a complete envelope for each customer. At a cost of three cents, which covers file envelope and paper inside for the record, you know exactly what the case history of any receiver in your community has been. Doctors keep files, bursting with records of their patients. A "sick radio" is a mighty important patient to the serviceman. How these file records are kept, their format, etc., are individual problems, depending upon your particular ingenuity.

In the outer reception room there should be a few easy chairs and a table with current publications (not "a-la-dentist's office" where issues are at least a month old before they receive feature billing). Mattraw finds that when he is busy on a set in his work center, a customer may enter. Waiting is much more pleasant if the surroundings are pleasing. Mattraw advises that tiled linoleum cover the floor and that the wall receive attention in the form of framed photos showing anything and everything in the field of radio, from early television receivers to control panels at Radio City. Technical periodicals yield photos along this line.

A plateglass partition separates the workroom from the outer reception room just as in the radio studio, actual performers go through their antics in soundproof surroundings, where the audience can watch but not interfere. A serviceman deserves the same privacy. Mattraw isolated his work-center by fitting up glass partitions and having a system installed so that when his part-time secretary was not on duty in the reception room, he would be advised of the customer's arrival. If he is working on a set, the serviceman pushes a button whereby an illuminated sign comes into action on the secretary's desk, reading "Serviceman working—will be with you shortly. Make yourself comfortable"—or words to that effect.

The workroom, Mattraw believes should be left to the serviceman's own inclinations. However it should present a business-like appearance with every tool in its place, and a place for every tool. Mattraw lines up all finished radio jobs in one corner of the workroom, with an identification tag on each. The bench proper contains wall panel and testing apparatus. One chair with rolling castors is in front of the bench, so that the serviceman can slide from one end of the bench to the other in a matter of seconds, when a particular item of replacement is desired. A file containing back issues of periodicals, textbooks and service manuals should be conspicuously displayed in one portion of the work-center, so that the spectator gets the same reaction as when the doctor's bookcase, crammed full of medical journals, is on view.

Lighting throughout the outer reception room should be of the tubular-indirect effect. *Nothing impresses a potential customer more than a specialized type of illumination.* Consult your electrical contractor or else find yourself a scheme worth having as to color, type of lighting fixtures and composition.

Mattraw reports that this modernization project enables you to raise service prices to the well-known "roof", on the basis of increased expenditure for modernization. Serviceman Mattraw even charges fifty cents to check any set of tubes brought into the shop—no free service—but positively **NONE!**

REMEMBER PEARL HARBOR!
Keep 'Em Flying!
Buy War Bonds

BIG BOY

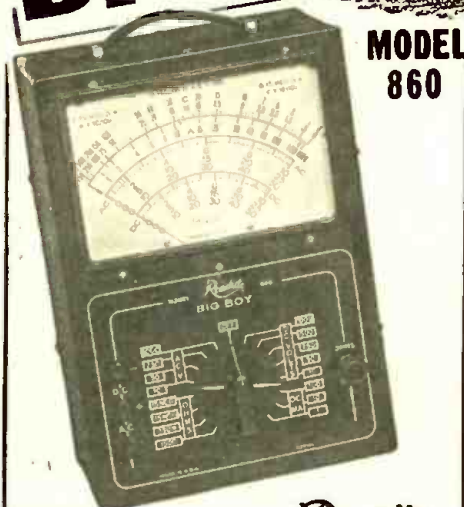

Performance . . . Eye Ap-
peal . . . Value . . . Sen-
sationally Priced at \$19.65,
Dealer Net Price

Readrite
RANSER

Here is an AC-DC Volt-Ohm-Milliammeter with all the ranges you want . . . easily readable on the large 7" instrument with extra-long 6" scale. In a new up-to-the-minute three-tone case. DC Volts 0-10-50-250-500-1000 at 5000 Ohms per volt DC; 1000 ohms per volt AC. AC Volts 0-10-50-250-1000 at 400 ohms per volt; DC Ma. 0-1-10-100; Resistance ranges: 0-1500 Low Ohms; 0-150,000 Ohms and 0-7.5 and 0-15 Megohms. Maroon case with red and silver panel, attached handle.

Dealer Net Price, \$19.65

For Catalog Write—Section 516 College Drive

READRITE METER WORKS, Bluffton, Ohio



HIGH EFFICIENCY
results in
Sound National
Defense
that is why
**NATIONAL DE-
FENSE SOUND**
SYSTEMS
are equipped with
University Reflex
HIGH POWER
LOUDSPEAKERS
UNIVERSITY LABS.
195 CHRYSTIE ST. N.Y.C.

OFF THE PRESS!

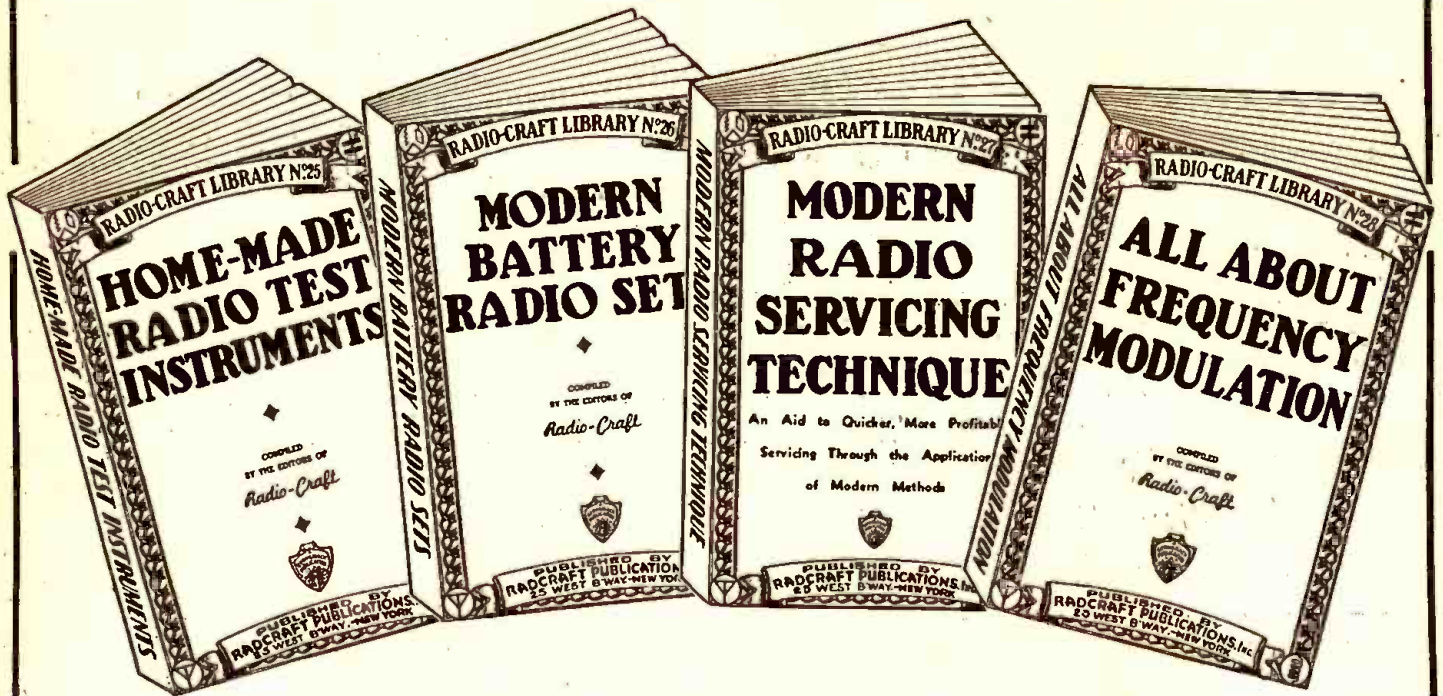

New RADIO-CRAFT Library Books

THE four latest books of our well-known RADIO-CRAFT Red Books—Nos. 25, 26, 27 and 28—have just come off the press. These four books are all on timely subjects and we recommend every one of them to you strongly. Now, more than ever, radio education has become a burning question. If you are to be in the National Service; in the Army, Navy or Air Force—practical radio knowledge is of paramount importance. **YOU CAN GET BETTER RATINGS AND ADVANCE QUICKER IF YOU HAVE A GOOD RADIO BACKGROUND.**

Conversely, if you are not with the armed forces, there is a whole of a job to be done at home. With more and more men going into the service, the demand for practical servicemen becomes greater each day. Therefore we say: **PROFIT BY THESE UNIQUE BOOKS, WHICH ARE PRICED SO LOW THAT THEY ARE WITHIN THE REACH OF EVERYONE'S PURSE.**

No. 25—HOME-MADE RADIO TEST INSTRUMENTS

This book includes articles covering a wide range of test apparatus of live interest to every radio man. Servicemen will find many circuits in this book to make their work more profitable. New ideas in test equipment make it possible to service radio receivers more quickly.

Laboratory workers and experimenters will find many articles which describe in detail construction and use of all essential radio test units—multi-motors, oscillators, stage-analysis testers, oscilloscope equipment, V-T, voltmeters, etc. Even advanced technicians will be interested in the circuit arrangements showing the new and improved variations of well-known, basic test equipment. A MUST for every serviceman. This book contains 86 illustrations.

Outline of Contents: A Low-Cost Signal Chaser—Signal Tracer Test Unit—Simplified Practical Signal Tracer—A Home-Made Infinite-Resistance Tube Checker—Build This Direct-Reading V-T Voltmeter—How to Make a Modern V-T Voltmeter—Measuring High Values of A.C. Voltage and Current with a Low-Range Meter—How to Make a Meter-Range Extender—How to Build a Practical Tube Tester and Set Analyzer Adapter—The Beginner's Simple Volt-Milliammeter—Build This Simplified Neon-Type Test Unit—Midrange Oscilloscope—How to Make and Use a Frequency Wobbler—Double Tracing Your Oscilloscope—Home-Made Frequency Modulator.

No. 26—MODERN BATTERY RADIO SETS

Whether you are a radio man or a beginner, the articles in this book give you basic circuit arrangements or elementary radio receivers which serve the dual role of teaching the elements of radio reception, as well as making perfectly operating 1- and 2-tube radio receivers. Picture diagrams and bread-board layouts galore.

Advanced radio set builders are offered more complicated arrangements. Laboratory workers and engineers will find in many of the articles circuit and constructional features which have become commercial practice. Many entirely new ideas are given in this book. One of the most important volumes we recently issued. This book contains 76 illustrations.

Outline of Contents: Beginner's 1-Tube High-Gain All-Wave Receiver—Beginners-Build This 1-Tube Loop Receiver—A "3-in-1" Battery Portable—An Easily-Built "Fluorescing Superregenerative" 2-in-1 "Card File" Battery Set—A 2-Tube Superhet. With Pentagrid Regenerative 2nd-Detector—The 4-Tube Superhet. Variation Portable—The "Lunchbox 5" Battery Portable—The "Seafarer" Loop-Type Boat Radio Set—4-Tube Portability Portable—An All-Purpose Portable—A Typical Commercial 3-Way Portable (Pilot Models X-1452 and X-1453)—Switch for Varying "C" Bias on Battery Radio Sets—Making a Simple Portable Aerial—Making a Pilot-Light Fuse—Old Auto Sets for New Cars—Using a Loop Portable in Cars—Quasi-Electric Soldering Iron—Lamp Bulbs as Resistors.

No. 27—MODERN RADIO SERVICING TECHNIQUE

Here is a book of great importance to every radio man, every radio engineer, and particularly all radio servicemen. A list of the contents which follows shows the importance of this book, literally jam-packed to overflowing with radio-meat. Whether you are a serviceman beginner or whether you are an experienced serviceman, you will find many important helps in this volume. Book is eminently practical and will solve many problems for you. More important: it will show you many short-cuts, all calculated to save your time and patience. Practical everyday data on standard receivers appears throughout the book. A whole of a book compressed into a minimum of space. Contains 98 important illustrations.

Outline of Contents: Elementary Servicing Technique—Correct Procedure for the Servicing Beginner—Elementary Procedure for Servicing Radio Sets—A.F.C. Alignment Made Easy—Dynamic Servicing—Dynamic Testing Simplifies Servicing—Modern Receiver Test Requirements—Servicing Universal A.C.-D.C. Receivers—Servicing "Orphans" and Private-Brand Sets—Emergency Servicing Without Test Meters—Servicing Coils—Servicing R.F. Coils—Servicing Oscillator Coils—General Information—RMA Transformer Color Code—What Causes Echo, Fading?—Radio Service Puzzlers.

No. 28—ALL ABOUT FREQUENCY MODULATION

Here is a complete compilation of pertinent data on the entire subject of the now coming art of Frequency Modulation.

There is no question but that Frequency Modulation is already revolutionizing radio broadcasting in this country. Were it not for the war, there would now be a tremendous boom in this new art—yet, even with war restrictions imposed upon it, Frequency Modulation is still jumping ahead by leaps and bounds.

With Frequency Modulation no longer a theory—with hundreds of stations already dotting the land and with countless hundreds of others to come when peace is achieved once more—every radio man should read up and know all there is to know on this most important subject.

This particular handbook is chuck-full with a tremendous amount of information which you probably will not find in any similar book in print.

Outline of Contents: The ABC of F.M.—Frequency vs. Amplitude Modulation—Basic Facts About F.M. Broadcasting—Construction—Build This Practical F.M. Adapter—Audio Amplification—F.M. Audio Amplifier, Part 1—F.M. Audio Amplifier, Part 2—F.M. Audio Amplifier, Part 3—F.M. Service—Part 1, Antenna Installation and Service—Part 2, Receiver Alignment and Diagnosis—Part 3, Test Equipment for F.M. Servicing, Engineering—Part 1, The How and Why of F.M.—Part 2, The How and Why of F.M.—Theory and Design Considerations of R.F. and I.F. Coils in F.M. Receivers.

SPECIAL SEND-NO-MONEY OFFER

It is not necessary that you send money with order. If you wish to take advantage of our C.O.D. plan, simply cut out the coupon, paste it on a post card and send it to us. Books will be sent to you immediately.

All four books are listed uniformly at 50c each. No discount on less than three books.

If you wish to take advantage of our special offer, ordering three books or more, we make an unusual low price to you as follows:

3 books—\$1.25
4 books—\$1.50

Do not fail to send coupon today!

RAD-CRAFT PUBLICATIONS, INC.
25 West Broadway, New York, N. Y.

Radcraft Publications, Inc.,		042
25 West Broadway,		
New York, N. Y.		
Gentlemen:		
Rush to me by return mail, as per your special offer, the following books: (Check books selected.)		
<input type="checkbox"/>	No. 25—HOME-MADE RADIO TEST INSTRUMENTS.	
<input type="checkbox"/>	No. 26—MODERN BATTERY RADIO SETS.	
<input type="checkbox"/>	No. 27—MODERN RADIO SERVICING TECHNIQUE.	
<input type="checkbox"/>	No. 28—ALL ABOUT FREQUENCY MODULATION.	
I will pay postage \$1.00 (if two books are ordered) plus a few cents postage and charges, \$1.25 for three books, plus a few cents postage and charges, \$1.50 for four books, plus a few cents postage and charges. WE CANNOT SEND A SINGLE 50c BOOK C.O.D.		
NAME		
ADDRESS		
CITY		STATE
<input type="checkbox"/> Save shipping and C.O.D. charges! Check here if you send cash with order. (Cash, U.S. new postage stamps, money order, check.) Foreign countries no C.O.D. Add 20% to all prices quoted.		

A Simple

SERVICE TEST PANEL

The service test panel here described can be built at low cost from standard parts readily found in the average shop spare-parts box. Many useful tests may be made with this simplest of service test panels.

EDGAR BOLES

DUE to the national emergency, and the Army's calling up radio Servicemen, there exists a shortage of experienced radio men. This service work must be done. Therefore this work is going to fall on the spare-time radio man, the student and the beginner in radio work. It is for these men who, for financial and other reasons, cannot afford to invest in the expensive test equipment used in servicing sets today, that this article is written.

Here is a simple test panel that can be built at a very low cost. Enough parts, except for a few tip-jacks, crystal detector and voltmeter, can be obtained from a second-hand radio set, which can be bought cheaply; or if you wish, you may buy all the parts from any radio supply house. It is a combination Voltmeter Alignment Indicator, and a simple Signal Tracer, with which receiver troubles can be isolated within a few minutes.

As shown in the diagram it is a rack-and-panel job having three compartments—the bottom chassis on which the power-supply is built, the voltmeter is also located here; the middle compartment, which has the alignment indicator; and the third shelf on which the signal tracer is built. The three chassis of shelves measure 8 by 11 ins. and are sup-

ported by 4 angle-irons, one at each corner, to which the panel is fastened. Chassis are also bound together by soldering heavy copper wire from the power-supply chassis to each succeeding chassis; thus each chassis can be used as a grounding point and B-. The panel may be made of masonite, hard rubber, or metal (if metal is used, tip-jacks must be insulated). As the tuning indicator is mounted in a horizontal position, middle chassis may be omitted if desired. As indicated in the diagram there is a switch in each filament so that any stage may be used independent of others. Now for some tests with this apparatus:

First, if the set is dead the first step is to test all voltages, plug test leads in jacks No. 6-7 with black lead in 7, connect other end to chassis of set under test, with red test prod in No. 6. Proceed to test all voltages beginning with power-supply and continue on to plate of output tube, testing all screen and plate voltages. If voltages test O.K., troubles are in signal circuit of set. To test signal circuit, remove test leads and insert in jacks 1 and 3 of signal tracer. (Turn signal tracer power on). Black lead in No. 3 jack, connect other end to ground or chassis of set. With red prod in jack No. 1 touch grid terminal of first R. F. tube. a

signal should be heard in speaker of signal tracer. If coil and associated circuit are O.K. (signal may be rather weak at this point) test each succeeding grid input terminals in same manner, up to and including detector stage. If all signals are O.K. to this point, the trouble lies in audio section.

To test audio stages, remove red prod from jack No. 1 and insert in jack No. 2, leaving black prod as is; place red prod on plate terminal of detector. Move on to grid input of first Audio tube, test each succeeding grid input and plate output of Audio stages, and also speaker voice-coil terminals. If a dead stage is found, trouble is always toward detector from stage being tested (in audio stages and toward Antenna in R.F. stages). After isolating the defective stage it is a simple matter to find faulty part.

The alignment indicator: Its purpose is to be used as an output meter when aligning a set. To align a set, place test prods in jacks 4 and 5, black prod in No. 5 and connected to ground of set. Red prod in No. 4 is connected to A.V.C. bus of set. If oscillator is not available, tune in strong signal on set and adjust trimmers for minimum shadow on eye. Not only does this indicator serve as an output meter, it often leads to a tuning eye "installation" for you.

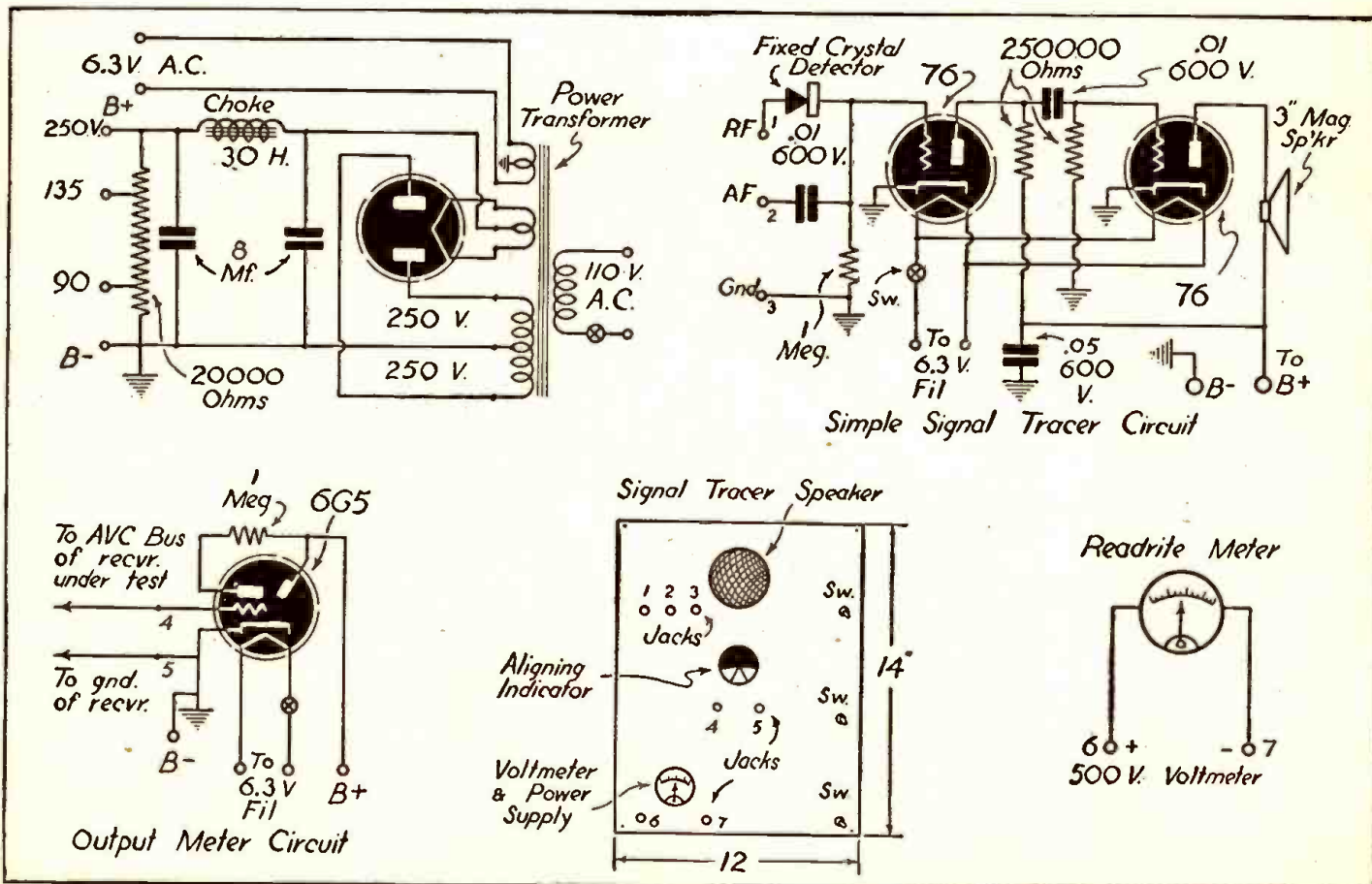

Standard Output of Receivers

WILLARD MOODY

THE I.R.E. standard of output generally used by manufacturers of receivers is 50 milliwatts. For purposes of practical measurement it can be assumed that impedance of the loudspeaker voice coil is practically equivalent to D.C. resistance, and on this basis the table given below has been calculated for various values of voltage and resistance. The input of a standard generator, calibrated in *microvolts*, is used to produce a signal which gives standard output.

That microvolt input which produces standard output is a measure of the receiver sensitivity. Thus, standard output for a 20 microvolt input signal would mean a sensitivity of 20 microvolts for a certain specified frequency on the receiver's dial. Sensitivity will vary, according to the signal frequency, and it is necessary therefore that the frequency be given, as otherwise the sensitivity rating would be meaningless. The *method of connection* between generator and receiver must also be specified, so that measurements can be duplicated. In manufacturing, production standards are derived from figures furnished by the laboratory engineer. Generators are used which are calibrated in microvolts, as are most better grade service generators. By using this system, the serviceman can gain a better idea of receiver sensitivity in fairly absolute terms. By noting that a certain set brought

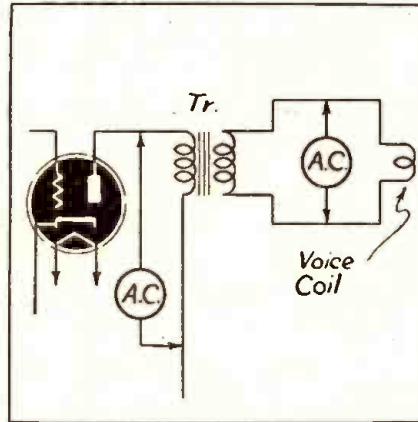

The diagram above shows the relations of the plate and speaker circuits in the output stage.

in for repair has a sensitivity of 60 microvolts at 550 kc. (kilocycles) and that when it is repaired the sensitivity is 25 microvolts, or whatever figure it happens to be, he can show definitely that the receiver's performance is improved.

If your generator has an attenuator of the dual type, and is calibrated in microvolts, all well and good. However, should the output be doubtful, you can still use the system by assuming that the generator is calibrated in uv and setting the readings down in your notebook. Suppose your attenuator on the signal generator reads from 0-5 on the rough control and from 0-100 on the "fine" control. When the attenuator is set to 2 on "rough" and say 34 on "fine," you may assume the output is 2 times 34 or 68 microvolts. This is your standard, your gauge for judging receiver sensitivity. If you wish, you may call it by its "fancy name," quantitative alignment. It will help you to do a better job by making your work more precise.

A.C. Coil Volts-Ohms*	Voice Coil	A.C. RL Volts-Ohms**	
.24	1	7.07	1,000
.31	2	8.66	1,500
.38	3	10	2,000
.44	4	11.9	2,500
.5	5	12.5	3,000
.54	6	13.2	3,500
.59	7	14.1	4,000
.63	8	15.0	4,500
.67	9	15.8	5,000
.70	10	17.3	6,000
.74	11	18.7	7,000
.77	12	20.0	8,000
.80	13	21.2	9,000
.83	14	22.2	10,000
.86	15	23.4	11,000

*Voltages taken with vacuum tube volt-meter, practically infinite resistance.
**Vacuum tube volt-meter used. Ohmic values represent impedance of plate circuit, consisting of voice coil reflection through output transformer.

Application of the Ohmmeter

THE serviceman may find many of the troubles common to receivers by a quick resistance test.

For example, assume that an A.C. set (using a power transformer) is "dead" and the rectifier tube (in most cases an 80 or 5Z3) has its plates heated, due to a heavy current.

What would cause the rectifier to overheat?

Obviously, if too much current is being passed through the tube there must be a *short-circuit* from B+ to ground. This *short* could be in the first filter condenser, the second filter condenser or in the plate circuit of the output tube. In some cases it will be in the plate return or screen return of the I.F., mixer or R.F. tubes.

Assuming that the receiver is switched off or the line plug withdrawn, the *ohm-meter* may be applied between rectifier filament and ground. If the first filter is "gone," the meter may indicate a dead short or a low resistance of 200 or 300 ohms. Since the maximum current through an 80 rectifier is 100 ma. approximately and the voltage from filament to ground will be about 300 volts, the maximum resistance in low value terms cannot or should not be less than $300/.1 = 3000$ ohms. Thus, if a condenser tests as 1000 ohms it is defective, even though it hasn't a "dead" short.

The same principle applies in an A.C.-D.C. set where we may have a 25Z5 rectifier. The maximum current of the rectifier may be 100 ma. and the voltage from cathode to line return 100 volts, so that the lowest value of resistance that can be tolerated in the circuit is $100/.1 = 1000$ ohms. In actual practice it is common to find a 500-ohm series field in A.C. or A.C.-D.C. sets, while it is also common to find in A.C.-D.C. sets

a *shunt* field of 3000 ohms from rectifier cathode to line return.

The fact should be kept in mind when making resistance measurements on sets of the A.C.-D.C. type employing shunt field, that the 3000 ohms field resistance is in parallel with the filter condenser. Therefore, once you have found a low resistance in a set, disconnect condensers in that part of the circuit and check those condensers individually.

Start your analysis from rectifier cathode to line return, or from output tube plate or screen to output tube cathode in A.C.-D.C. sets. In A.C. receivers, check from output tube plate to chassis, from output tube screen to chassis.

A very common cause of trouble in many receivers is *short-circuiting* of output tube plate by-pass to cathode or chassis. This burns out the primary of the output transformer in many cases, or at least "pulls down" the available plate voltage—not only for the output tube, but for the other tubes in the set. With the added load due to plate circuit *short*, the voltage from the rectifier circuit of the set drops.

In order to check on the resistance of the output transformer primary, connect your ohmmeter between output tube plate and screen or plate and B+ at rectifier filament. To check for *short*, connect meter between plate and B-.

The resistance between output tube plate and screen will generally be between 100 and 300 ohms. The resistance from output tube screen to rectifier filament will generally be of the order of 200 to 2000 ohms, depending on circuit design.

Get into the habit of making point-to-point resistance measurements by using the ohmmeter and the manufacturers' data.

Short circuits from oscillator plate return or I.F. screen return to B- can quickly be located by connecting ohmmeter to B- and the screen or plate return.

Continuity in an I.F. transformer primary can be checked by connecting your meter between plate and B+ or I.F. plate and output tube screen or output plate return.

In sets using A.V.C. and common grid return for I.F. and mixer, the grid coils for both stages can quickly be checked for continuity by applying the meter between the two grids. A high-range ohmmeter should be used where the grids are isolated by A.V.C. resistors.

One way of checking quickly whether a condenser in the grid return of an A.V.C.-controlled tube is *shorted*, is to apply the ohmmeter and simply disconnect the A.V.C. resistor in the *high* side of the condenser.

Where an antenna coil is used in the set, the primary is quickly checked for an *open* by connecting the meter between Ant. and Gnd. posts. In A.C.-D.C. sets, a series condenser is used with a primary coil and it is necessary to connect the meter *after* the condenser when making this test.

These are but a few of the ways in which resistance measurements will help you to do a speedier, more efficient job. With a good volt-ohmmeter the serviceman can find 90% of the troubles which are common to all receivers. But he must think in terms of fundamental principles of Ohm's law, tube operation and basic circuits. By working with receivers day after day, the professional serviceman soon familiarizes himself with basic circuits, most common tubes and their pin connections. Then he can quickly "go through" a circuit, tracing the various wires, identifying the tubes and parts.

—Willard Moody



Appearance of the completed power amplifier.

19-WATT MEDIUM POWER AMPLIFIER

This general-purpose, medium-power audio amplifier will operate one or more loud-speakers. The output stage is fitted with impedance-matching transformer, so that various speakers or groups of speakers may be matched to the amplifier.

THE 525 amplifier combines both high-gain and quality performance at low cost. The 25 watts of undistorted power output assures clear reproduction of speech or music from either a *microphone* or *phonograph pickup*.

All tube types and components used have been selected and combined into a tested circuit which will perform excellently as indicated in the specifications. The tube line-up is as follows: Two 6SJ7 high gain pre-amplifier channels, 6N7 electronic mixer 6N7 Class A driver, two 6L6's push-pull Class AB1 output amplifier and 5Z3 rectifier.

Two high-gain inputs for crystal microphones are brought out to standard microphone connectors. Other types of microphones such as Dynamic or Velocity may be used providing they have an average output level and high impedance characteristics. Two volume controls provide separate gain adjustment and mixing for each channel. One of these controls is also used for fading a microphone against the phonograph pickup, which may be connected to the medium level input terminals located on the back of chassis.

The 6SJ7 pre-amplifier and 6N7 mixer are all resistance coupled to provide simple circuit design and good frequency response without excessive inductive pickup in the high-gain stages. Circuits are designed with correct bypass condensers and plate isolating circuits to minimize any possibility of interstage coupling. The 6N7 driver with paralleled grids and plates as well as a balanced driver transformer of correct ratio assures maximum gain with minimum distortion. The plate choke and coupling condenser provide a boost in bass response. The output transformer was selected for its

SPECIFICATIONS

Power Output—
 Rated: +36.2 DB or 25 Watts—5% Distortion
 +35 DB or 19 Watts—No Distortion
 Peak: +38 DB or 38 Watts—Max. Distortion

Frequency Response—
 -3 DB at 60; +1 DB 180 to 15,000 C.P.S.
 Treble Attenuation 22 DB at 10,000 C.P.S.
 Bass Attenuation 20 DB at 200 C.P.S.

Input Circuits—All High Impedance
 Two Mike Low Level Inputs—Gain 114.5 DB
 One Phono Med. Level Input—Gain 80.4 DB
 (Gain based on 100,000 ohm grid impedance)

Output Impedance—4, 8, 15, 250, 500 Ohms
Hum Level—55 DB Below Rated Output
Power Input—190 V. A. @ 115 Volts 60 Cycles
Dimensions, Without Dust Cover—17" x 10" x 8 3/4"
Weight, Without Dust Cover—27 Lbs.

efficiency, impedance match and overall frequency response.

DUAL TONE CONTROL

A useful feature of this amplifier is the dual tone control circuit. Independent control of high and low tones makes it possible to attenuate either or both. In P.A. systems this permits the adjustment of tone to fit the installation while for the amateur, the cutting of the "highs" and "lows" provides

a penetrating radiophone signal. The special Stancor tone control is of hum-bucking construction, well shielded to minimize hum pickup. This unit and two dual potentiometers are clearly shown in the diagram and easily wired. Other equalizing circuits "A," "B," "C" are introduced to provide a uniformly flat frequency response as shown in the data curve.

The power supply is designed to operate efficiently with a heavy-duty transformer supplying all filament voltages and plate voltage for a well regulated, filtered D.C. supply. The primary of this transformer is tapped for 105 and 115 volts in order to correct for line voltage variations.

CONSTRUCTION DETAILS

To facilitate the assembly of the 525 amplifier, the order of operations should be as follows. Sockets must be mounted in their proper positions on the chassis and turned to permit short direct paths between their terminals and the circuit points to which they connect. The bottom view picture is helpful in showing these positions. All of the sockets are octal, with the exception of the four-prong socket for the rectifier. Socket contact numbers are marked around the tube symbols on the diagram.

With the provided hardware, the transformers and chokes are mounted in the positions shown. Power transformer, T3, is placed on top the chassis so that its leads feed through the two large holes. Most of the leads will better reach their respective channels if the primary side feeds through the hole near the rectifier socket. Output transformer, T25, also mounts on top the chassis having its primary leads protruding through the hole near the 6L6 sockets. Driver transformer, T33, is mount-

Two more views of the amplifier, which is constructed from standard parts.

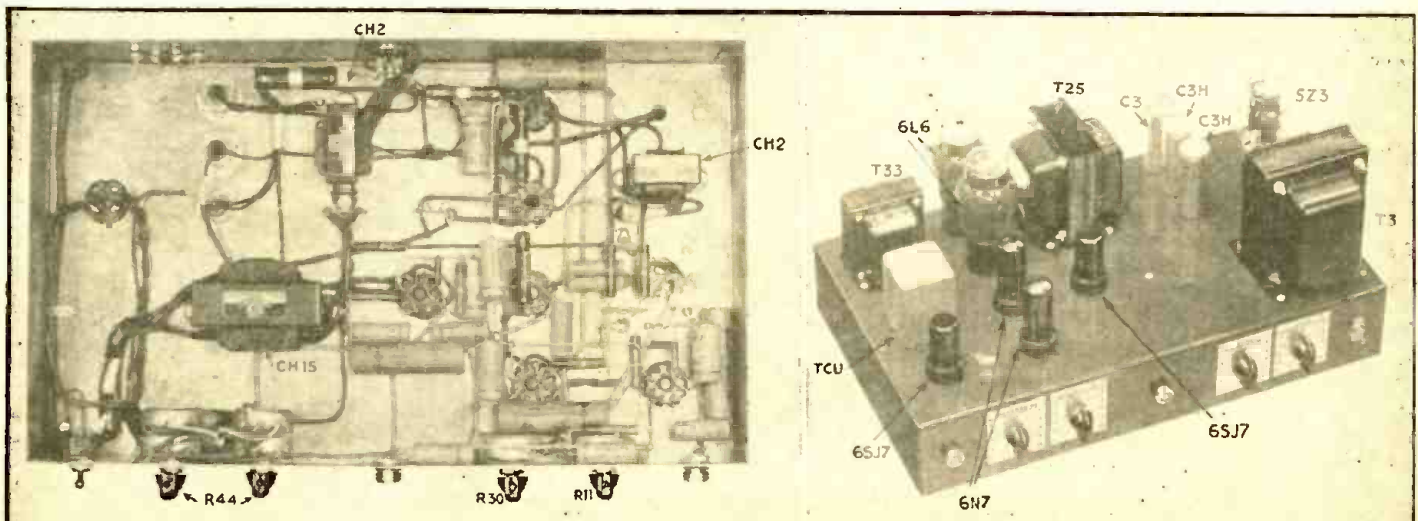

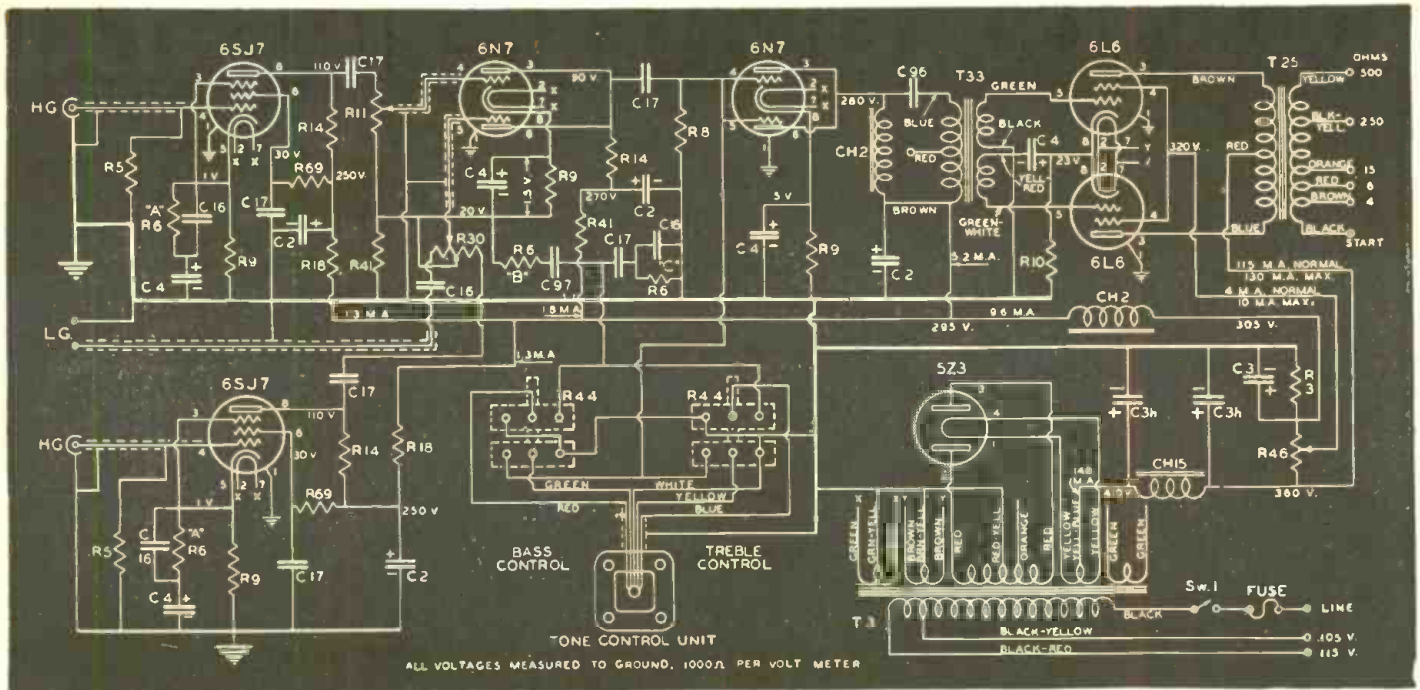

Wiring diagram for the 19-watt power amplifier.

ed on the chassis so that its secondary leads come through the rear hole and its primary leads through the other hole.

The cast case housing the tone control unit is mounted on the chassis in the position indicated by the photograph. The long leads which protrude through the chassis hole are fed through the length of 1/2" diameter shielding braid so that the lead ends will reach the dual potentiometers to which they connect. Below the chassis, we find filter choke, CH2, is secured into place between the filter condensers and rectifier tube socket with its leads facing the former. Audio choke, CH2, is fastened below the chassis as shown with its leads facing the front.

Three metal cased .8 mfd. electrolytic condensers are each fastened by single large nuts into the provided 3/4" diameter chassis holes. Various components along the front of the chassis may be mounted next. According to the pictures, we find that from left to right, a high gain input cable connector, two volume control potentiometers, another high gain input cable connector, two dual tone control potentiometers, and a S.P.S.T. toggle switch are accommodated by the front apron of the chassis. In fastening the potentiometers, the correct dial plates are held into their respective front positions by the single nuts which hold the controls. Knobs are affixed to the protruding shafts so that their indications on the dial plates coincide with the electrical settings of the potentiometers.

Filament leads, which may be wired first, should be twisted and placed close to the chassis, using the pushback wire provided in the kit. To minimize the possibility of hum, a common grounding bus-bar should be used, which connects to the chassis at one predetermined point and to which all grounding components, such as fixed condensers, resistors and shield braiding, are connected. The best point on the chassis for connecting the grounding bus is near the No. 1 pin of the 6N7 electronic mixer stage. Even input cable connectors are grounded to this bus after having been insulated with their fibre washers from direct contact with the chassis. The No. 1 socket contacts, which connect to the metal shells

of the tubes, making convenient points for the nucleus of the grounding bus which may be formed of solid No. 14 bare wire.

Shielding braid used over the leads between the high gain input cable connectors and the control grids of the 6SJ7's as well as on the leads connecting the arms of the potentiometers to the grids of the 6N7 mixer stage and on the lead connecting to the low gain rear input terminals.

The amplifier is protected by a 3 ampere fuse. Provisions are made for one hole mounting of a fuse receptacle inside the rear apron of the chassis below the line cord and terminal strip.

Small parts are self-supported by their leads, which connect directly to the proper tube socket terminals, grounding bus, and lug strips. Spare socket contacts make convenient mounting lugs, such as the number six pins of the 6L6 sockets. Although the photographs are very useful for determining the positions of the various parts, it is advisable to wire strictly by the schematic diagram. Be careful that electrolytic condensers, C2, C3, and C4, are connected into the circuit with the proper polarity as indicated on the schematic diagram. The secondary leads of the output transformer, T25, are soldered to the contacts of the rear five prong socket. This provides convenient means for connecting speakers with five prong plugs.

Voltage measurements should correspond to those shown on the diagram.

Parts of the circuit using R6 and C16 and marked "A," "B," and "C," are com-

pensating circuits to give the amplifier a frequency response curve which is uniformly flat while tone controls are set at full. Reducing the value of resistance R6 in "A" and "B" will increase the bass response. Increasing R6 in "C" will increase the treble response. The overall gain will likewise be increased.

APPLICATION

The regular output transformer as used in the amplifier is tapped at 4, 8, 15 ohms for voice coil matching or 250 and 500 ohms for line matching. One or more speakers, capable of handling more than 30 watts may be connected to the output of the amplifier. A single speaker having a voice coil impedance of 4, 8 or 15 ohms may be applied to the respective tap and common lead providing the correct impedance value. Two 8 ohm speakers may be connected in parallel across the 4 ohm tap and the common lead or two 15 ohm speakers may be applied in parallel across the 8 ohm tap and the common lead. Speakers may be of the permanent magnet dynamic for electro dynamic types, however, the latter requires a field exciter supply.

This amplifier makes an excellent plate modulator for transmitters having Class C amplifier inputs up to 75 watts. For this purpose, it is necessary to substitute a modulation output transformer for the output transformer included with the kit. It should also be pointed out that the 525 amplifier will cathode modulate R.F. ampli-

(Continued on page 615)

The graphic curve shown at the right gives some idea of the excellent performance of the audio amplifier here described.

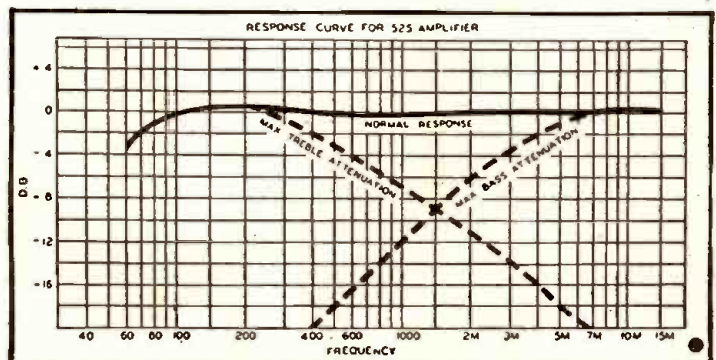

BUILD YOUR OWN EXPERIMENTAL ELECTRONIC ORGAN

W. K. ALLAN

Part II—Conclusion

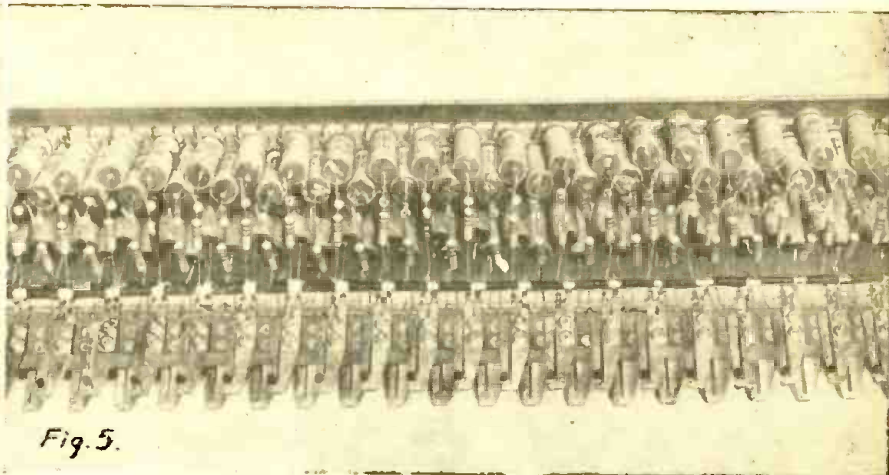
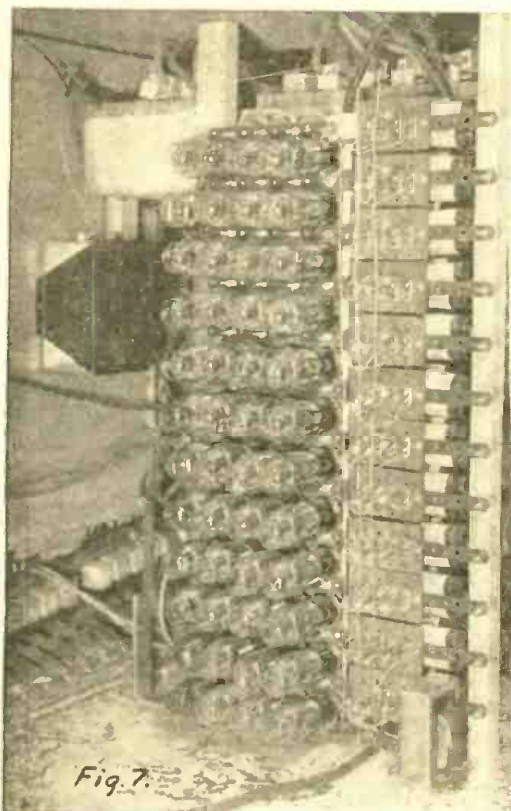

Fig. 5 Photo of "Key Contacts" Showing: 1.—How contacts are bolted to alternate sides of wood strip to permit same spacing as manual keys. 2.—"Lake" voltage bus. 3.—"Click Suppressor" resistors 15,000 ohms. The C's are marked by different color-coded resistors. 4.—"Bucket" condensers .25 mf. 5.—"Leak" resistors, 5 megohms. "Lake" bus is hidden between the upper and lower sets of condensers. 6.—"Tank" condensers .25 mf. 6.—Cable from "tank" condensers to 2 megohm resistors and .1 mf. cathode condensers at '76 tubes. 8.—Angle-iron ground bus.

Fig. 7 showing: 1.—4 octaves of '76 tubes. 2.—Other end of cable from "manuals." 3.—Cathode condensers. 4.—Cut-off bias busses with 5-megohm resistors. 5.—Output transformer. (The 2-megohm resistors from cable to cathodes are behind the terminal strips.) Pedal contacts at bottom rear. Ends of 61 pole coupler switches connected to cables from manuals, are visible at top. Pressed wood bottom of reed wind chest for "vibration pickup" on bottom manual is visible at top.

FIGURE 4 shows the diagram of the writer's harp or vibra-harp (or piano or organ or violin stop), i.e., any of these effects may be obtained separately but not simultaneously. To use Hammond's analogy a bucket with a leak is filled at a lake and then emptied

into a tank. By controlling the amount of water taken at the lake and the size (and direction) of the leak, any rate of flow into the tank is obtainable. For example, if the bucket is filled at the lake (to -100 volts) and the leak is very large (0 volts, i.e., grounded), then as the

key is depressed so that the bucket discharges into the tank, it starts at a high rate (-100) but almost instantly drops to nothing, due to the run-off through the leak. This momentarily neutralizes the cathode cut-off but quickly dies away, simulating a harp if the condenser is across the

Fig. 4 shows simplified version of Hammond system. Fig. 6 shows contacts for key switches.

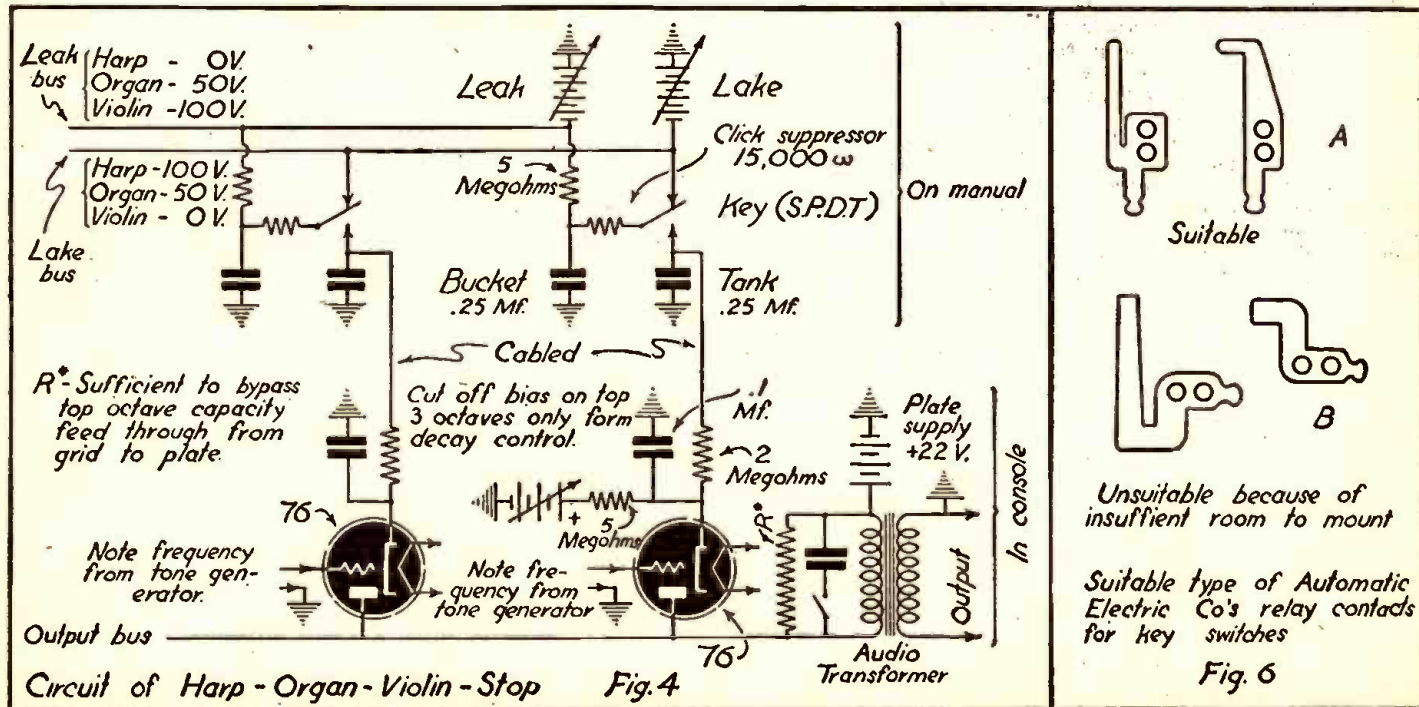

SUPER SPECIALS

output transformer, or a vibraharp if the tremolo shutter is running and the cathode cut-off is reduced for a very slow decay. Do not run harp through volume control but leave at top volume always, as the harp effect is obtained by quickly rising to maximum volume and rapidly dying away. If the condenser is removed and the cathode cut-off is removed, the tone resembles a piano due to the ring after the key is released.

Again, if the bucket is filled partly at the lake (-50 volts) and the leak is set at -50 volts, then like the widow's cruse the bucket always maintains the same charge, so that when the key is depressed the effect is a sustained (undamped) organ tone. The cut-off bias should not be too sudden (+).

Finally, if the bucket condenser is empty (0 volts) but the leak is (-100) reversed, then when the key is pressed, nothing at first enters the tank, but as the charge flows up into the bucket through the leak, the tone gradually builds up and when the key is released it dies away slowly, if there is almost no cut-off voltage. With no condenser across the output and artistic use of the swell pedal or volume control, this makes a really excellent violin effect for slow passages.

If the Novachord patents are studied it is seen that Fig. 4 is a simplified version of the circuit. It would be better to use screen-grid tubes to eliminate the capacity feed-through found on the top octaves with triodes. Better values of resistors and capacitors may be chosen, but these work well with the type '76 tubes and voltages used, and there is nothing critical. The heater voltages are very low and old tubes seem to work fine. For a 6W7G tube the lake varies from -200 volts to 0; the click suppressor is 6000 ohms, the bucket condenser is .3 mf.; its leak resistor is 4 megohms and the leak varies from 0 to -200 volts; the tank is .3 mf. and the resistor to the tube cathode is 4 megohms. The cut-off bias of +6 volts is fed to the tank condenser through a 600,000 ohm resistor and the screen voltage is 25. These values from patent 2,126,464 are for notes near middle C, and would be varied slightly for other notes, e.g., more cut-off bias for higher notes.

Contacts—Fig. 5 shows the telephone relay type contacts. Be sure to get the ones similar to A not B, Fig. 6, as the former require less space. They alternate between top and bottom sides of the strip. No. 6-32 machine screws through the keys (alternately long and short) provide adjustment. The contacts, 15,000 ohm and 5 megohm resistors, together with the bucket and tank condensers, are mounted on the manual from which a cable leads to the 2 megohm resistors, .1 mf. condensers and tube sockets and 5 megohm cut-off resistors, which are mounted in the console (Fig. 7).

To any readers planning an electromagnetic tone generator it cannot be over-emphasized that *copper contacts cannot key the output of any low voltage tone generator* because of their oxide film. However, tubes do an excellent job, producing many effects from a single set of pick-up coils, so forming an ideal *clickless-keying* system, with the envelope of both attack and decay completely under control.

Other electron tubes, e.g., neon tubes or cathode ray tubes may be used to produce electronic music.

ANALYSIS OF ELECTRONIC TUBE ORGAN ADVANTAGES

1. Wide range of beautiful effects obtainable from tube keying control.

(Continued on page 625)

All of the attractive items listed here are brand new. ALL are in PERFECT WORKING ORDER. In many cases, the parts alone total more than the price we are asking. 100% satisfaction guaranteed or your money refunded. ORDER FROM THIS PAGE. Use the convenient coupon below. Include sufficient extra remittance for parcel post charges, else order shipped express, collect. Any excess will be refunded. C.O.D. shipments require 20% deposit. If full remittance accompanies order, deduct 2% discount. Send money order, certified check, new U. S. stamps. No C.O.D. to foreign countries.

ORDER TODAY LIMITED QUANTITIES PROMPT SHIPMENTS ASSURED

HANDY WORKSHOP OUTFIT

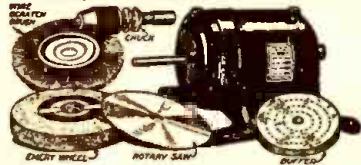

Here is a marvelous article that to the best of our knowledge has never sold at such a low price. This outfit must be seen to be appreciated. It delivers the goods! It comprises a variable speed universal motor for 110 volts A.C. or D.C. Made originally for dictaphone machines by American Gramophone Co. Motor is reconditioned and in excellent condition; all other parts are brand new. Special lever control permits various speeds up to 3000 r.p.m. Measures 7 1/2" x 3 3/4" diam. overall.

Included in the outfit are the following items, as illustrated: 1 excellent chuck which takes drills and other tools—chuck is easily screwed to motor shaft; standard emery wheel, 4" diameter; fine steel rotary saw, 4" diameter; wire scratch brush, 4" diameter; standard cloth buffer, 3" diameter. Total Wt. 9 lbs.

ITEM NO. 149 Complete outfit, including motor. **\$4.95**
YOUR PRICE

WESTON MODEL 562 A.C.-D.C. AMMETER



Designed by Weston for the Eastman Kodak Co. It is a precision-built magnetic-vane type ammeter which, with suitable shunts, can be used as a milliammeter too. It is 2" in diameter and designed for panel mounting. Bakelite base and black-enamelled cover. Shp. Wt. 2 lbs.

ITEM NO. 85 **\$1.25**
YOUR PRICE

POWERFUL ALL-PURPOSE INDUCTION MOTOR IDEAL FOR EXPERIMENTERS—101 USES

Sturdily constructed to precision standards, this self-starting shaded pole A.C. induction motor is powerful enough for a large variety of uses. Some of these are: Automatic Timing Devices, Current Interrupters, Electric Fans, Electric Chimes, Window Displays, Photoeol Control Devices, Electric Vibrators, Small Grinders, Buffers and Polishers, Miniature Pumps, Mechanical Models, Sewing Machines, Phonograph Motors, Coffee Grinders, Motion Picture Projectors, Motorized Valves, Sirens, and other applications.

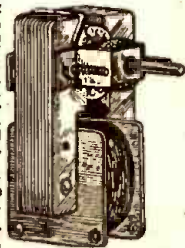

Consumes about 15 watts of power and has a speed of 3,000 r.p.m. When geared down, this sturdy unit will constantly operate an 16-inch turntable loaded with 200 lbs. dead weight—THAT'S POWER!

The motor is of modest dimensions, 8 inches high by 2 inches wide by 1 1/2 inches deep; has 4 convenient mounting studs; shaft is 3/8" long by 3/16" diameter, and runs in self-aligning, oil-retaining bearings; the best materials, perfect precision assembly and rigid inspection certify to its high quality, and assure long life. Designed for 110-20 volts, 50-60 cycles. A.C. only.

ITEM NO. 107 **\$1.29**
YOUR PRICE

100 POWER TELESCOPE LENS KIT

Make your own high powered 6 ft. telescope! Now you can thrill to a close-up view of the worlds out in space. See the rings around Saturn, the mountains of the moon! Kit contains 3" diam., 75" focal length, ground and polished objective lens and 2 astronomical eye-pieces, magnification 50x and 100x. Complete kit with full instructions.

ITEM NO. 123 **\$1.95**
YOUR PRICE

NEW—EXTRA LARGE LENS KIT—contains completely finished 4" diameter 100" focal length ground and polished objective lens, three 1 1/2" diameter eye-pieces giving 66x, 133x, and 200x. An aluminumized diagonal for overhead viewing, and a color filter for insertion in any eyepiece.

ITEM NO. 123L **\$3.95**
YOUR PRICE

WESTERN ELECTRIC BREAST MIKE

This is a fine light-weight aircraft carbon microphone. It weighs only 1 lb. Mike comes with breast-plate mounting and has 2-way swiveling adjustment so that it can be adjusted to any desired position. There are 2 woven straps; one goes around neck, the other around chest. Straps can be snapped on and off quickly by an ingenious arrangement.



This excellent mike can be adapted for home broadcasting or private communication systems. By dismounting breastplate, it can be used as desk mike. Comes complete with 6-foot cord and hard rubber plug. Finished in sherardized plate, non-rustable.

THIS IS A BRAND NEW MIKE. IT HAS NEVER BEEN SOLD AT SUCH A LOW PRICE BEFORE. ORIGINAL LIST PRICE \$15.00. Shipping weight, 2 lbs.

ITEM NO. 152 **\$1.00**
YOUR PRICE ..

METAL CUTTING SAW



Here is an ideal steel special-cutting saw made of fine tool steel specially designed to cut metal. Teeth are set at a special double angle for metal-cutting work. Saw is specially hardened for long and extended use; measures 3 1/2" diameter; center hole is 1/2" square; thickness 42/1000 (42 mils.) 3/64".

ITEM NO. 151 **50c**
YOUR PRICE

POWER ADJUSTABLE RHEOSTAT

Here is an excellent rheostat used especially to regulate speeds of small motors, such as our Handy Workshop Outfit. This rheostat can be used in connection with motors up to 1/20 h.p.



This fine rheostat is wire-wound on porcelain insulation. The black enamel steel casing is perforated for ventilation. Adjustable handle regulates speed of motor easily and smoothly. Size 5"x2 3/4" overall. Shp. Wt. 2 lbs.

ITEM NO. 153 **\$1.20**
YOUR PRICE

AMAZING BLACK LIGHT!!

Powerful 250-Watt Ultra-Violet Source



The best and most practical source of ultra-violet light for general experimental and entertainment use. Makes all fluorescent substances brilliantly luminescent. No transformers of any kind needed. Fits any standard lamp socket. Made with special filter glass permitting only ultra-violet rays to come through. Brings out beautiful opalescent hues in various types of materials. Swell for amateur parties, plays, etc. to obtain unique lighting effects. Bulb only. Shp. Wt. 1 lb.

ITEM NO. 87 **\$2.00**
YOUR PRICE

WATT HOUR METER

Completely overhauled and ready for immediate service. Designed for regular 110-volt, 60 cycle 2-wire A.C. circuit. Servicemen use it in their shops to check current consumption of sets, soldering irons, etc. Keeps costs down. If dismantled, the parts alone would bring the price. The elaborate gear train could be used as a counter on machines of various kinds.

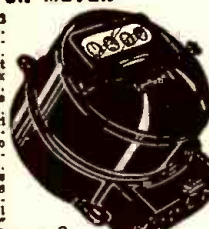

Simple to install; 2 wires from the line and 2 wires to the load. Sturdily constructed in heavy metal case. Size: 8" high, 6 1/2" wide, 5" deep. Westinghouse or General Electric. Shp. Wt. 14 lbs.

ITEM NO. 124 **\$4.50**
YOUR PRICE

HUDSON SPECIALTIES CO., 40 West Broadway, N. Y. C.

IT'S EASY TO ORDER—CLIP COUPON—MAIL NOW ORDER FROM THIS PAGE.

HUDSON SPECIALTIES CO., 40 West Broadway, Dept. RC-6/42, New York, N. Y.

I have circled below the numbers of the items I'm ordering. My full remittance of \$..... (include shipping charges) is enclosed.

OR my deposit of \$..... is enclosed (20% required), ship order C.O.D. for balance. No C.O.D. order for less than \$2.00. (New U. S. stamps, check or money order accepted.)

Circle item No. wanted: 11, 33, 35, 87, 123, 123L, 147, 149, 151, 152, 153

Name

Address

City

State

Send remittance by check, stamps or money order; register letter if you send cash or stamps.

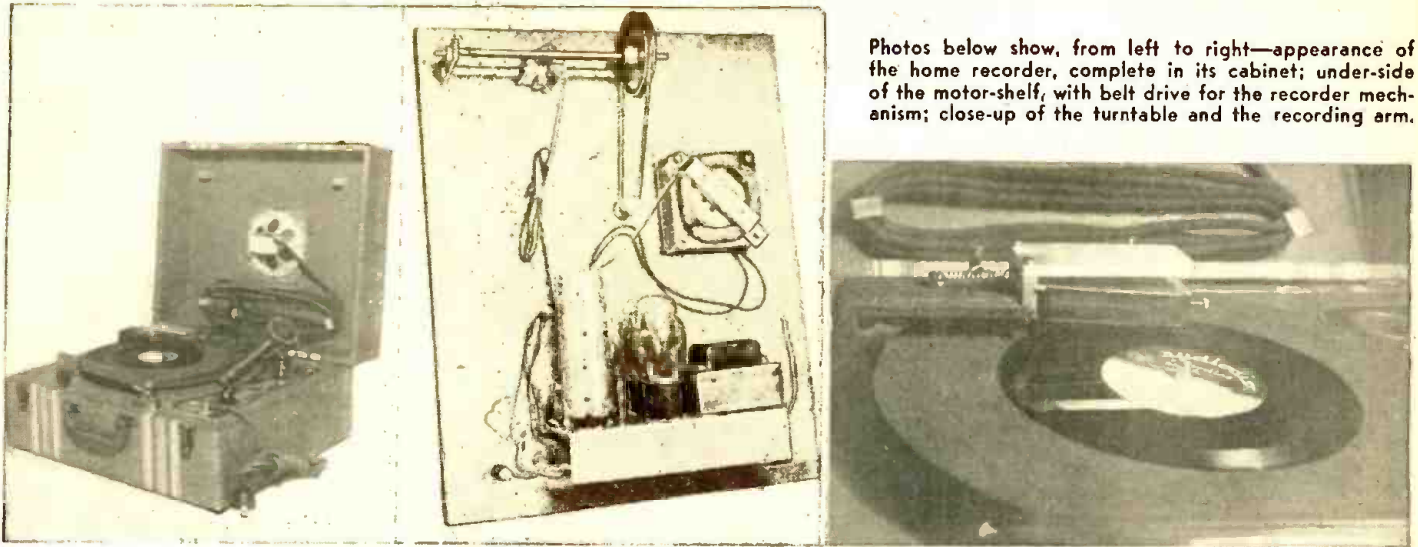

Photos below show, from left to right—appearance of the home recorder, complete in its cabinet; under-side of the motor-shelf, with belt drive for the recorder mechanism; close-up of the turntable and the recording arm.

Construct A HOME RECORDER

A home recorder is probably one of the best pieces of apparatus for the experimenter to attempt to construct in wartime, when it is difficult to obtain apparatus, plus the restrictions on amateur radio station operations, etc. This particular recorder worked out very nicely, as built by the author.

LARRY LE KASHMAN

DESPITE the comparatively low cost of some home recording units there are still experimenters who prefer constructing their own recording mechanism. Contrary to general belief it is possible to duplicate and in many cases surpass even medium price recorders in so far as quality is concerned. There is no comparison between costs in as much as the parts needed are almost all stock items. The home constructor need not worry about overhead or profit, a further inducement to make no sacrifices in quality in order to save a few cents. The total price for parts to construct this unit, including the case, should not exceed \$20.00.

The portable recorder illustrated in this article follows a popular trend in so far as mobility is concerned. A recording machine can be a constant source of amusement at parties and gatherings. It may be an educational instrument and one of profit to the serviceman. Many schools are turning to records as the most satisfactory method for correcting speech defects. The tremendous boom in record players during the past few years has made most parents fertile material for exploitation of such items as records of piano recitals, weddings, graduations, in fact any significant event. Indeed it is not difficult to foresee the day when chronological record albums are as much an integral part of the home as photograph albums. This inexpensive recorder is an invitation to you to join the fun with home-made records.

The design and construction of this recorder can be clearly shown as three separate phases. Construction of the amplifier; construction of the recording and playback mechanism; and mounting and assembling the completed units.

The requirements for the amplifier are primarily ability to deliver several watts of output in a small space. Since the cutter's requirements are only several milliwatts the power is of no consideration there. A tone control is desirable in playback and a method of switching the amplifier from record to playback must be incorporated.

The volume, or level indicator, is better treated as an integral part of the cutter. A D.C. amplifier is not necessary since the phonograph motor will not operate on direct current. Because of their availability, usually in a junk box, the line-up consisted of a 57-57-45 and an 80 rectifier. It should be stressed that the builder may use any small amplifier he may choose, provided the same layout and physical dimensions are adhered to. Since the power transformer is mounted on the small chassis with the tubes, every precaution against hum must be taken. All ground leads should be returned to a common point near the first audio stage. In addition the first 57 must be well shielded. The power output of the 45 is more than sufficient to operate the cutter; however more power output may be desirable if the constructor wishes to provide greater playback volume in a large room or noisy location. More output will necessitate the use of a larger speaker which will complicate the mechanical layout of the recorder.

The switching system is quite simple. It is accomplished by the use of a D.P.D.T. toggle switch. The switch is used to transfer the amplifier output from speaker to cutter and the amplifier input from pickup to microphone. This is clearly illustrated in the circuit diagram. There is a simple attenuating network in the pickup circuit to drop it's level so that it does not overload the first stage. The unit may be used as a PA system by connecting the speaker in place of the cutter. However it has not been done here because the small amplifier does not make a particularly satisfactory PA system. Most recorders are used as PA systems only because it is a sales feature and is convenient to the manufacturer, since it merely requires a slightly different switching arrangement.

The feed mechanism is composed of items, that for the most part may be purchased in any hardware store. The lead screw and slide bar are supported by 3" stock angle irons. The lead screw is a piece of 3/8"-16 threaded rod. The engaging nut is 1/3 of a 3/8"-16 nut, an operation per-

formed with a hack saw. The pulley on the lead screw (P1) is manufactured by the Boston Gear Works (Catalog PVL 3). The pulley on the motor (P2) is a piece of 5/8" round brass with a 3/16" deep "V" cut in it. This V is put in by mounting the stock in an electric drill check and applying pressure with the corner of a file as the machine turns. The pulley is then mounted on the center of the turntable by means of a 6/32 machine screw, after the center of the turntable has been drilled and tapped. The motor is a General Industries model GI-RM4 which is a heavy-duty rim-drive type.

Builders are forewarned that no other low price motor will perform without excess wobble and wows. No substitute should be accepted unless it is a higher price motor which the constructor can have no doubts about. The pulleys are connected with a vacuum cleaner belt, whose size may vary slightly and whose dimensions are best obtained when the unit is assembled.

The arm, while it follows a complicated sounding constructional routine, is simple to obtain and very inexpensive. A wooden pattern is made and left at the local foundry. They will usually make a casting for forty or fifty cents. Any classified telephone book will reveal at least one foundry in even the smallest town. Similarly if no machine shop is available for the small amount of machine work involved most commercial shops, reached in the same manner, will do the work for a very small fee. The main thing in keeping these costs down is to give them a minimum of work. Know exactly what you want, have it marked out accurately and neatly, and don't rush them on the job. The diagram should remove any fears you have about a complicated pattern making job. Incidentally if you are fortunate enough to have a vocational high school available, the entire cutting mechanism would be "duck soup" for any student.

The cutter is a Shure 14-ohm magnetic cutter. A crystal cutter may be used with suitable changes in the coupling system and these are shown in the main diagram. A

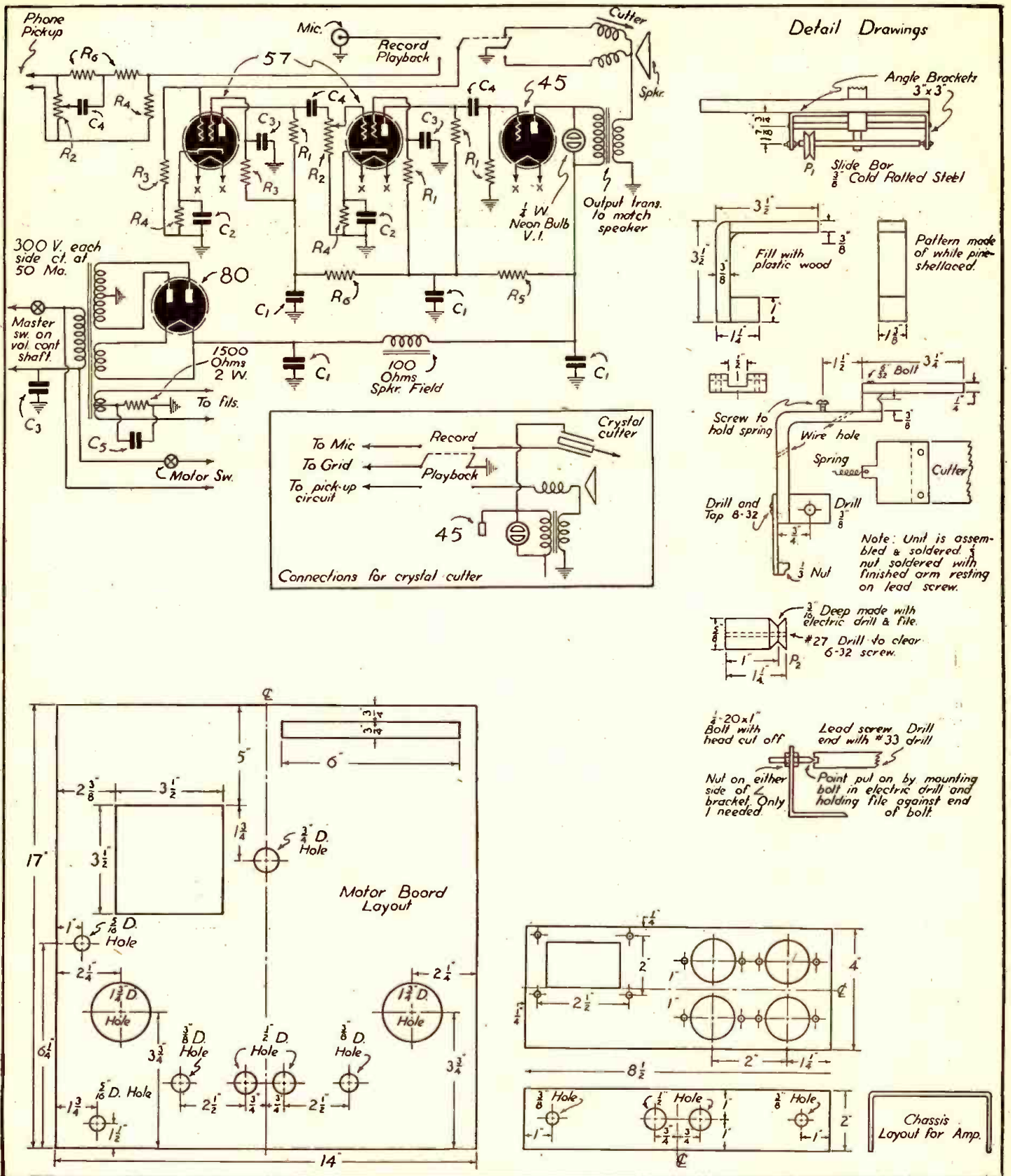

Wiring diagram and other constructional hints for building Mr. LeKashman's "Home Recorder" are given in the above drawing. Anyone with a little ingenuity, by following the description given in the accompanying text, should be able to build this home recorder successfully.

crystal cutter will give somewhat better quality and probably offer ample compensation for its slightly higher cost. Mounting of the cutter is on a knife edge bearing, since that is the type usually supplied with the cutter. We must also refer to a diagram since most readers are probably not familiar with the mounting details of a cutting head.

Mounting the complete units is not a

serious problem. The playback arm, which may be any standard phonograph arm of any variety from inexpensive crystal to permanent point "featherweights," is mounted by using the manufacturer's template supplied with the arm. The most important thing is to supply the motor and cutting apparatus with a solid foundation. The case illustrated was made up by a local manufacturer at a cost of four dollars.

Since feedback between the cutter and playback arm and speaker is all too common with speakers in the same case, it is purposely left out. Feedback of the type mentioned can be eliminated by cutting out the low frequency response of the amplifier. Usually, if that type feedback is encountered in a portable unit, the builder will find himself hopelessly snared in difficulties. It

(Continued on page 640)

•SERVICING•

BOOST Service Profits

LOWEST PRICES...
FASTER DELIVERY at
RADOLEK

LARGEST STOCK OF
EVERYTHING IN RADIO



Thousands of progressive servicemen rely on Radolek for their complete requirements of repair materials. Radolek has in stock for prompt delivery replacement parts to repair any radio—every type of tube, transformer, speaker, condenser, volume control, resistor, auto radio accessory, etc. Everything you need at lowest prices. You get what you want when you want it—Radolek understands service problems—gets your order to you in double-quick time. Buying from Radolek means Greater Values, Better Service and More Profits. The big new Radolek Radio Service Guide is yours FREE for the asking. Send for your copy today!

**RADOLEK P. A. SYSTEMS
FOR EVERY REQUIREMENT**



Thousands of successful Radolek P.A. installations are proof of quality, superior design and top performance. Complete systems for permanent, portable or mobile use—wide choice of microphones, speakers and related equipment. Radolek P.A. Systems give you more for your money in Performance, Styling, Dependability and Reserve Power. Select the P.A. apparatus you need from Radolek's big new FREE catalog.

RADOLEK REPAIR SERVICE

Let Radolek repair your damaged or burned out transformers, coils, speakers, test equipment, etc. Many items cannot now be replaced and therefore repairing is the only alternative. Trained craftsmen, using precision tools and factory methods, assure perfect jobs equal to new. Write for prices or better still, send in any article to be repaired. It will be handled promptly.

FREE!



SEND FOR NEW FREE
RADIO SERVICE GUIDE

RADOLEK CO., Dept. C-67
601 W. Randolph St., Chicago, Ill.

Please send the Big FREE Radio Service Guide.

Name

Address

DEALER SERVICEMAN SOUND ENG

SAVE AT RADOLEK

ELECTRON MICROSCOPE IN NEW FIELDS

(Continued from page 587)

termine the structure of chromosomes, the entities within every living cell which determine the inheritable characteristics of the organism. These studies, which require extraordinary skill in the preparation of the specimens, indicate the great complexity of these basic elements. Other investigations have concerned themselves with revealing the delicate forms of insect life. Micrographs have been made showing a breathing tube of a mosquito larva, magnified 7,500 times. These, like the scales of butterfly wings and the iridescent wing covers of beetles, have shown structures of great beauty and regularity.

APPLIED TO METALS

In the field of industry the electron microscope found almost immediate applications in the study and control of all types of matter in finely divided form—powders, suspensions, dusts and smokes, the characteristic states of pigments, insecticides, ceramic materials, medical preparations, and many other substances where the individual particles are too small to be identified by the light microscope. The electron microscope, with its much greater resolving power, not only makes it possible to count the particles and to classify them with respect to their size, but also shows their characteristic shapes, which are found to differ widely. A good example of this are micrographs which show the characteristic cubic form of magnesium oxide smoke particles and the minute thin plates which make up an arsenate insecticide powder. Size, shape, and size distribution of the particles are all of them characteristics of vital importance for the physical and chemical behavior of the material studied.

The electron microscope cannot be applied directly to the study of bulk matter, such as the polished and etched metal specimens from which metallographers seek to gain information regarding the constitution of the metal in question. However, a method has been worked out for the preparation of collodion replicas of the surface which are only about a millionth of an inch in thickness, and which serve as the object in the electron microscope. In a micrograph of a particular etched steel specimen of "pearlite," obtained from such a replica, the dark portions of the picture represent iron carbide ridges embedded in pure iron in characteristic manner. This replica technique has enabled metallographers to extrapolate the validity of important laws relating to the physical properties of steels and their etch patterns far beyond the limit imposed by the light microscope. The same technique proves useful in the study of non-metallic bulk materials, such as ceramics, quartz, glass, etc.

Other advances in the application of the electron microscope have resulted from a modification of the equipment. An electron microscope has been adapted for use with extremely high voltages up to 300 kilovolts. As the penetration of matter by the electrons increases rapidly with their kinetic energy, it is possible herewith to see details in objects, e.g., the larger bacteria and fine sections of organic tissue, which appear totally opaque at the lower voltages.

Another application for which the electron microscope is especially well suited—due to its remarkable depth of focus—is the preparation of stereoscopic or three-dimensional microscope pictures. For this purpose two pictures of the object are taken in succession, the object being tilted in a special

(Continued on page 640)

Articles on Frequency Modulation In Past Issues of This Magazine

- A Frequency Modulation "Converter"—R. Muniz, E.E., and J. Haddad—June, 1940.
- Frequency Modulation—R. Muniz, E.E., and J. Haddad—July, 1940.
- Hints on Operating the "FM" Receiver—R. Muniz, E.E., W. Oestreicher—Aug., 1940.
- Principles of Frequency Modulation—R. Muniz, E.E.—Aug., 1940.
- Principles of Frequency Modulation—R. Muniz, E.E., Part 2—Sept., 1940.
- Building the Browning "Frequency Modulation"—G. H. Browning—Oct., 1940.
- Frequency Modulation "Tuner"—to Suit Your Pocketbook—Larry LeKashman and Anton Schmidt—Oct., 1940.
- A Frequency Modulation Tuner—Herman Yellin—Dec., 1940.
- A "Pull-Swing" Frequency Modulation System for the Amateur—R. Muniz, E.E., Donald and Warren Oestreicher—Feb., 1941. (Also March, April and May, 1941.)
- Principles of Frequency Modulation—F. L. Sprayberry—Feb., 1941.
- An U.H.F. Receiver for FM and AM—S. Gordon Taylor—Feb., 1941.
- FM Receiver for the Home—L. M. Dezettel—March, 1941.
- Principles of Frequency Modulation—Part 2—F. L. Sprayberry—March, 1941.
- Principles of Frequency Modulation—Part 3—F. L. Sprayberry—April, 1941.

TELEVISION ARTICLES

In Past Issues of Radio & Television

- New Portable Television Pickup—Sept., 1940.
- 10 by 8 Inch Television Images—Television Club, Brooklyn Tech. High School—Oct., 1940.
- Amateur Television Made Practical by New Image Pickup Tube—Aug., 1940.
- A Semi-Portable Television Receiver—R. H. Horn—Jan., 1941.
- Television Travels 190 Miles Over Wires—Mar., 1941.
- Interference Phenomena in Television Reception—Thornton Chew—April, 1941.

ATTENTION! SERVICEMEN!

Tell the Editors what kind of articles you want!

Also send along an article of your own now and then, describing your "pet ideas" for War-Time servicing.

WARTIME RADIO REPAIRS

(Continued from page 591)

Muslin can be used to make a flexible rim. Voice coils can be replaced by forming the tracing cloth around a cylinder of the diameter desired. Before ruining the voice coil to be replaced, study it carefully as to number of turns, size of wire, whether it is bank-wound, single-layer, etc. Either celluloid dissolved in acetone or collodion can be used to tack wire.

Open field coils can sometimes be repaired by using a small arc-welder to create a fusing spark internally. This arc will sometimes weld the open wires or layers of wires near the break. 315 turns of 14 or 16 wire in the primary and around 100 turns of like size wire in the secondary of an old transformer shell will do the trick.

Input transformers can be replaced by resistance-capacity networks. The number of circuits available in radio manuals will enable one to choose a suitable circuit.

If worst comes to worst in IF transformer repairs, one can be eliminated and a resistance-capacity network substituted. If it be the first IF transformer, replace it with the second, and use a resistance-capacity network in the second stage.

Volume controls: noisy volume controls can be repaired by washing off the carbon residue with carbon tetrachloride. Burned out volume controls can be replaced with an old "band" switch. We may have a lot of band switches on hand. Ah! Suitable taps are made from a number of series resistors totaling the value of the original control, the number of taps conforming with the number of points of contact on the switch.

Tubes and Resistors of course, are going to give us trouble as we have no concrete ideas along this line; we will have to leave this subject for someone else. Although, in compensation for a scarcity of tubes and resistors, circuits can be reduced to smaller tube complements. So long as the O.P.M. allows us a rectifier, audio amplifier and an R. F. tube, they shall have *MUSIC*—and *NEWS!*

HOMER C. BUCK,
Detroit, Mich.

VOICE COIL RATTLE

In these days of scarcity of materials and parts it is often necessary to repair the old in order to give prompt service. One of the major service headaches has always been speaker rattle caused by a defective voice coil.

This rattle is often caused by loose turns on the voice coil mounted on the apex of the cone. To remedy this, remove the cone from the speaker and cover the voice coil winding with a thin coat of clear lacquer which can be purchased at any paint store. While this is drying, remove all particles on the speaker pole pieces with a piece of sticky friction tape. After replacing and recentering cone it will be found in most cases that the speaker performs as well as new.—*Ralph Hunter, Catskill, N. Y., C-D Capacitor.*

EMERSON 1941 MODELS

In various makes of Emerson 1941 models all tubes may be found to check O.K. but the pilot light fails to light. In some cases the lamp may be burned out.

The remedy found by the writer was to replace the 35Z5-GT tube which developed an open circuit at the pilot light tap of the filament circuit. A tube tester is not apt to show this on test but in any event it is recommended that the 35Z5-GT tube be replaced with a new one.—*Lewis Kanoy, Winston-Salem, N. C. in C-D Capacitor.*



**WINNERS
OF THE WORLD'S MOST CONVINCING
AWARD OF MERIT**

Long ago, Sprague TC Tubular (by-pass) Condensers first won the World's Most Convincing Award of Merit—and they've continued to win it year after year. It isn't a grand prize or blue ribbon. It's far more convincing than that. It's the continued first choice preference for Sprague TC's by leading servicemen, engineers, manufacturers and amateurs—men who prefer TC's, who specify TC's, and who insist on TC's for a wide variety of jobs—men whose actual field experience helped write the now-famous TC slogan "Not a Failure in a Million!"

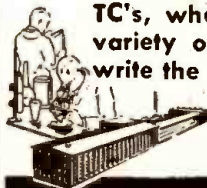

WRITE FOR CATALOG . . . or ask your Sprague jobber for a copy describing all Sprague Condenser types including Atom midgel dry electrolytics and famous Sprague Koolohms—the greatest wire wound resistor development in the history of Radio.

SPRAGUE TC TUBULARS

"NOT A FAILURE IN A MILLION"

SPRAGUE PRODUCTS COMPANY, North Adams, Mass.

FCC RELAXES REGULATIONS FOR STATION OPERATORS

At a meeting of the Federal Communications Commission held last month at its offices in Washington, D. C., the commission acted on the request of the Defense Communications Board for further relaxation of its rules and regulations governing the requirements for operators of broadcast stations—by issuing the following ruling:

"IT APPEARING. That the demand of the military services for radiotelegraph and radiotelephone operators has increased as a result of the war and that such demand has decreased the number of operators qualified for operation of broadcast stations resulting in a shortage of such operators:

"IT IS ORDERED. That until further order of the Commission, notwithstanding the provisions of Section 13.61 of the Commission's Rules and Regulations Governing Commercial Radio Operators, a broadcast station of any class, which by reason of actual inability to secure the services of an operator or operators of a higher class could not otherwise be operated, may be operated by holders of any class commercial operator license;

"PROVIDED, HOWEVER. That all classes of commercial operator licenses shall be valid for the operation of broadcast stations upon the condition that one or more first-class radiotelephone operators are employed who shall be responsible at all times for the technical operation of the station and shall make all adjustments of the transmitter equipment other than minor adjustments which normally are needed in the daily operation of a station;

"PROVIDED, FURTHER. That a broadcast station may be operated by a holder of a restricted radiotelephone operator permit only in the event such permit has been endorsed by the Commission to show the operator's proficiency in radiotelephone theory as ascertained through examination.

"PROVIDED, FURTHER. That nothing contained herein shall be construed to relieve a station licensee of responsibility for the operation of the station in exact accordance with the Rules and Regulations of the Commission; and,

"PROVIDED, FURTHER. That Section 13.61 of the Commission's Rules and Regulations Governing Commercial Radio Operators shall remain in full force and effect except as modified by this order."

Two-Dimensional

SOUND AND ACOUSTICS

WILLARD MOODY

THE true fidelity of reproduction attainable by radio and audio power amplifier circuits used in broadcasting or public address is not yet explored to the limit. There is considerable room for improvement. Investigation and research is continually being carried forward with that ultimate objective of the perfect illusion as the goal, to present perfectly to a listener in one place the voice or music heard in a distant concert hall or theatre.

The Bell Telephone Laboratories have conducted exhaustive scientific investigations designed to bring out the details asso-

ciated with reproduction of music in concert halls, such as Carnegie in New York, so that music lovers, ever critical of quality, could be satisfied to hear a symphony originating in another city and still not lose any of the thrilling realism and power of a great orchestra.* The matter of stereophonic reproduction as applied to the ordinary radio receiver in the home has not been fully considered. Stereophonic sound and

auditory perspective, are terms used to describe a means of reproduction that gives the listener a sense of localization or the illusion of listening to the performance in the presence of the artists—artists who may in reality be hundreds of miles away.

DUO-DIMENSIONAL SOUND

The first attempt at stereophonic, or as we prefer to name it, *duo-dimensional* sound, was in 1881, at the Paris Electrical Exhibition. Telephone headsets were used. Amplifiers available at that time were crude and unworkable. In conjunction with wide range of frequency modulation duo-dimensional sound should form an important integral of a system designed for peak fidelity. In motion picture work, because of the increased volume range possible in electronic recording on film, duo-dimensional sound has found prompt favor as an advancement in the art. *Fantasia* a wonderful motion picture is one example.

Any system of reproduction is based on the requirement that perfectly flat amplification of all frequencies extending from 30 to 15,000 cycles per second is necessary for truly high fidelity.

The attainment of perfect fidelity electrically is today a practical reality and prediction of frequency response of an amplifier or transmitter is a definite science of known laws and principles. But now research should be instituted to determine if any further acoustic contributions are possible. The economic question will determine the amount of work done in the case of the home receiver, but with defense cutting down quantity there is a likelihood that quality will come to the fore. Receivers will be fewer but better, in anticipation of normal times yet to come.

ACOUSTIC CONDITIONS ARE GOVERNED BY SOUND POWER

The maximum peak power delivered by an orchestra is concentrated in the region between 250 and 500 cycles per second. It is here that the loud-speaker and cabinet of a home radio receiver, or any other reproducer, must withstand a sudden volume pressure. In certain receivers, if an audio oscillator be varied from 30 to 500 cycles, the parts of the dial or the chassis tuner may be found to vibrate and rattle at their natural mechanical frequency, causing noise on strong passages. Cabinet resonance may also take place at 15 to 20 cycles, depending on construction, and hinges or loose doors that ordinarily appear solid may vibrate. Ruggedness and good wood in a cabinet are just as essential for really fine reproduction, as good wood is essential to the tone of a fine violin or piano.

In certain instances, where for example a serviceman in his shop has two radio receivers playing at the same time, it will be noticed that there is, in effect, a sensible time lag between the sound issuing from the loudspeaker of one set and the sound from the second set. There is an "echo" effect. That, in short, is *stereophonic* sound reproduction. There are two ways that such echoes may be produced, electrically and acoustically: If sound is projected from the front of a loudspeaker in a fairly large room, with blank walls, the initial sound impulse will come directly to the ears of the listener and the second sound impulse will arrive a split second later, depending on the amount of time that it took the

The drawing shows the relation between peak power and frequency; also baffle dimensions for certain frequencies.

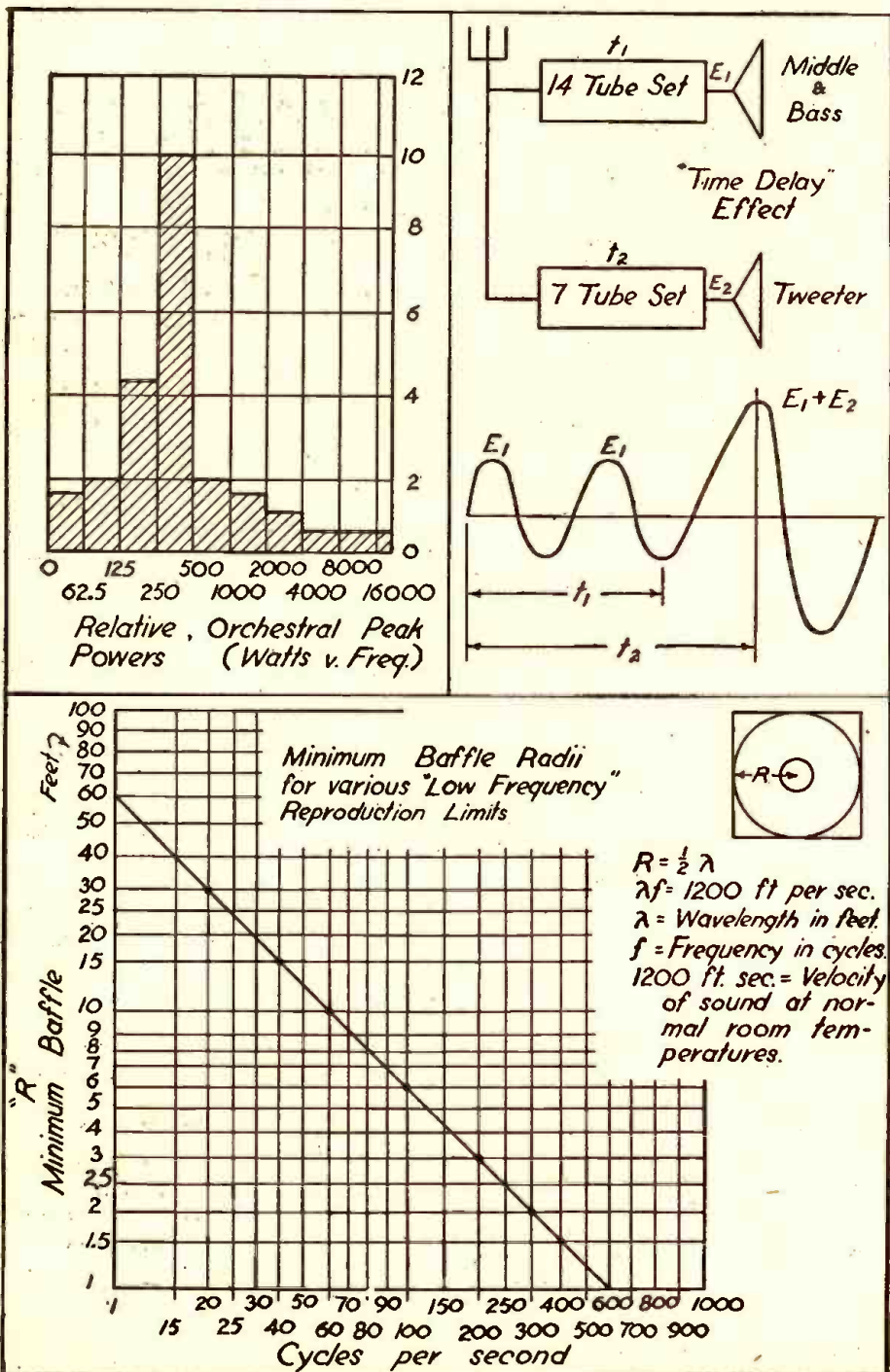

original sound to pass to the blank reflecting wall and be sent back as a reverberation. That is the acoustic form of echo effect or duo-dimensional sound.

An electrical equivalent may be generated by feeding a signal into two amplifiers, one amplifier having an appreciably different transit time than the other. By this means the reproducer of the one amplifier will have an output at a certain instant, that is a split second later in striking the ear than the first amplifier's output. This is, in short, *time delay* introduced electrically. The realistic effect of this may be experienced most simply by placing two radio receivers at a distance in the same hearing range. Tuning both sets to the same program, and being seated at one receiver, there will be a time lag between the hearing of the sound coming from the nearest set, and the reception of the sound coming from the second set.

A brief technical explanation of *time delay* is given by Terman in his valuable book entitled *Radio Engineering*, pages 759 and 760, 2nd edition.

FIDELITY AND TONE CONTROL ARE INSEPARABLE

The use of tone control for bass boost and treble boost is essential in order to correct for the acoustic differences between locations in which the receiver may be placed. Another consideration is background noise of the location. Masking of the higher pitched sounds may occur if the noise is appreciable. A tone control is necessary to bring up the *highs* or the *lows* under certain conditions. Volume control compensation also is indicated. To a certain extent *duo-dimensional sound* overcomes these difficulties, particularly if one loudspeaker is placed away from the radio receiver proper and sound from two sources is provided.

The *reverberation time* of a room is established by the volume and character of the confining walls. A room of great volume, such as a concert hall, or theatre, may have a *time delay* rate for sound decay that will approximate several seconds duration. On the other hand, because of the relatively small dimensions of the rooms of an average home, the time rate will be extremely short, particularly where there is much furniture or other sound absorbing material in the room. Acoustics may be improved generally by using heavy rugs on the floor, for example, so that sound will be readily absorbed and reflections reduced. In some instances, where *duo-dimensional sound* is wanted, a room without furnishings, except for bare necessities, will be instrumental in producing a pronounced reverberation time or acoustic echo. Perhaps that's why so many people like to whistle or sing when taking a bath or shower. The hard, reflecting walls of the bathroom make the sound resonate better than it would in an ordinary room or outdoors.

An automobile radio is another example of reverberation effect; the relatively small dimensions of the car interior, especially with windows closed, makes the radio have a depth and richness that are especially pleasant.

In view of the above facts, *duo-dimensional sound* offers great promise. Experimentation with time delay circuits will probably receive great impetus in the immediate future.

Also see Proc. I.R.E. July, 1941, Acoustic Phenomena, Wolf.
 *Auditory Perspective, Electrical Engineering, January, 1934.
 *Auditory Perspective, Bell System Technical Journal, April, 1934.
 Stereophonic Sound, Electronics, May, 1940 and Fantasound, March, 1941.
 Radio Service Dealer, December, 1940. Stereophonic Sound, Cowan Co., N.Y.C.

TIMELY SUGGESTION TO YOUR CUSTOMERS ON CARE OF SETS

With the end of radio production at hand, the Consumer Division, Office of Price Administration, issued the following suggestions to the public for the proper care of home radios:

Make sure that the radio is not placed with its back flat against the wall. Tubes, transformers, and resistors heat up, and free circulation of air is required to prevent overheating. Leave an inch or so between the cabinet and wall.

Check the set's electric cord and plug. The plug should fit firmly into the wall socket and the wires leading to it should be intact.

Check connections also on nearby electrical appliances and lamps. Loose connections on nearby gadgets cause static. Sometimes moving a nearby appliance or lamp farther away will help reception.

If the radio crackles, check the aerial and ground wires to determine whether they are broken in any place or are rubbing against other wires or trees or metals.

If you have not set up a ground connection and your radio is raucous, fix one up by connecting a wire from your radio's ground post to a water or steam pipe. Do not use your gas pipe as a ground.

If you have an outside aerial, make sure that it is equipped with a lightning arrester. Even small "static discharges"—not lightning—may ruin a set unless they are bypassed by the arrester.

Check the set's tubes, to see that they fit firmly in their sockets. Occasionally what may seem to be a bad tube is merely a good tube that is fitted loosely into its socket.

Clean the dust out of your set often. A hand vacuum cleaner will help.

If your radio's performance is unsatisfactory and none of these home adjustments help, it's time to call in the repairman.

These points should be observed: Call in a repairman from a reputable radio dealer—one with whom you are acquainted, if possible.

Insist that he fix the set at your home. Reliable service shops have portable testing and repair equipment for home calls.

If the serviceman insists on carrying the set to the shop, persuade him to give you an inventory of the adjustments he thinks will be necessary, and request the return of old parts which he finds necessary to replace.—*The C-D Capacitor.*

CHEAP ENDLESS DIAL BELTS

Dial belts, as most any radio repair man knows, are hard to stock because of the fact that most every set using one must have a belt to fit it, and a universal replacement is hardly possible. I've used this kink several times in the past and it worked very well.

At the 5 and 10 pick up a couple of pairs of shoe laces, about 28 inches long, of the small type that is used in men's oxfords. Clip one of the tips off close and since this leaves a hollow tube, the other end can be worked inside like a snake swallowing its tail. Work the tip up into the string till it is almost tight enough to fit the drive pulleys, then work the tip out through the side through the mesh, and pull it up to the proper length, then clip this tip off also. With a needle and good stout thread take a few stitches through the ends of the string which prevents it from slipping out again. Then you have a good stout endless belt, which has no knots and works very smoothly.—*Happy Kingsland.*

WEBSTER RECORDER AND PLAYBACK ASSEMBLY



\$28.95

Plays records up to 12" dia. Cuts records up to 10" dia. outside-in at 110 lines per inch. 78 RPM induction type motor employs an internal rim-drive to the turntable. Assembly includes 10" turntable, motor, cutting mechanism, crystal cutting head, 1 1/2 ounce low-pressure crystal pickup. Complete unit with case and Astatic microphone. Wt. 25 lbs. Size 16"x13"x9". For 110V. 60 cycles. Diagram furnished for Amplifier Connection.
 NOTE: Should you want to purchase the above units separately, your prices will be as follows:
 Webster Recording Unit only \$19.95
 Case 4.95
 Microphone 4.45
 Cutting Transformer75
 Positively no C.O.D. shipments made, unless order is accompanied by a deposit of at least 25%. All prices F.O.B. Chicago.

ARROW RADIO CO.

Div. 542, 900 to 910 Jackson Blvd., Chicago, Illinois

New Direct-Coupled FM - AM AMPLIFIER MANUAL

By A. C. SHANEY
 Chief Engineer, Amplifier Co. of America
**For the Layman, Serviceman
 Recordist and Engineer**

Regardless of whether you are interested in the finest type of phonograph reproduction, high fidelity recording, sound-on-film applications, FM or AM programs, you will find invaluable information in this practical handbook. Written by the leading exponent of direct-coupled amplifiers who has spent more than 10 years improving and perfecting the famous Loftin-White circuit.

Explains the theory and practical application of:
 Variable Speed Non-Overloading Push-Pull Expansion
 Non-Frequency Discriminating Scratch Suppression
 Pull-Push Balanced Direct-Coupled Amplification
 Push-Pull High-Frequency Equalization
 Push-Pull Low-Frequency Equalization
 Push-Pull Volume Compression
 Automatic Volume Limitation
 Automatic Volume Control
 Calibrated V.U. Indicator
 Audio Spectrum Control
 Remote Control

If you are interested in the latest audio developments, you can't afford to be without this complete compilation of authentic articles on Direct-Coupled Amplifiers. 32 pages 8 1/2" x 11". Over 100 diagrams and illustrations.

Priced to Cover Cost of **25c**
 Printing and Mailing

Send Stamps or Coin

AMPLIFIER CO. OF AMERICA

17 WEST 20TH ST. NEW YORK, N. Y.

NEW CATALOG

OF SOUND AMPLIFYING SYSTEMS

AUDIOGRAPH Sound Systems represent the latest in Public Address equipment—a complete line plus pre-tested accessories.

NEW LOWER PRICES

Outstanding quality and performance at prices that help you meet any competition.

WRITE FOR YOUR FREE COPY

AUDIOGRAPH
 THE FIRST NAME IN SOUND

111 W. Randolph Street, Chicago, U.S.A.

An Inexpensive

BASS AND TREBLE BOOSTER

CARL A. HELBER

A GREAT many designs for amplifier bass boosters have been presented in various radio publications. The fact that the auxiliary equipment associated with the amplifier is not perfect makes corrective devices necessary if a higher degree of fidelity is to be attained. Even a perfect amplifier is incapable of giving good results if the speaker which it operates has a poor response characteristic. The general tendency, even in good speakers, is for a dropping off of the response at the lower as well as the higher frequencies. This particular booster is being used with a very inexpensive phonograph pickup, which also is less responsive to the higher and lower frequencies. To correct for these undesirable characteristics, it is necessary

to introduce a circuit which will attenuate the middle band of frequencies more than the lowest and highest frequencies.

One of the simplest methods of attenuating the middle and high frequencies, thus obtaining a greater low frequency response, is to shunt the input terminals of the amplifier with a condenser-resistor arrangement as shown in Fig. 1. As the input frequency increases, the impedance of the condenser decreases and more and more of the input voltage appears across resistor "R" where it cannot be used. The characteristic curve, Fig. 2, shows that hardly any of the frequencies greater than 3000 cycles will be present in the output of the circuit, at least they will be attenuated so greatly that they will not be heard. The ratio of the output

would not be eliminated entirely. The circuit in Fig. 3 shows a very simple method of accomplishing this characteristic. In this circuit, resistor R_2 is deliberately connected in series with condenser C so that even if the impedance of the condenser did approach zero at high frequencies, the response (E_o/E_i) could not fall below the value $R_2/R_2 + R_1$. This fact can be seen more readily if the circuit is considered as a voltage divider with a variable impedance. Resistances R_1 and R_2 present an essentially constant impedance at all frequencies whereas "C" presents a decreasing impedance with an increasing frequency. The output impedance will then be the sum of the impedances of "C" and R_2 and thus cannot fall below a minimum value of R_2 . Since very little current is present in the attenuator circuit, E_o/E_i will be equal to the impedance of the output circuit divided by the total impedance of the whole circuit. Fig. 3 also shows an actual response curve of this circuit. The mathematical solution is more complex than the solution of the simple circuit shown in Fig. 1 and the curve was obtained by actual measurements of the output and input voltages.

This circuit works quite well as a bass booster but causes no high frequency boosting. By shunting a condenser across R_1 in Fig. 3 the response characteristic can be made to rise at both ends because of increasing amounts of voltage which are shunted around R_1 as the impedance of C_2 decreases with increasing frequency. Fig. 4 shows this circuit and the corresponding response curve.

In practice the input terminals are connected to the phonograph pickup and the output terminals to the amplifier input. The circuit constants actually being used at present are $R_1 = 250,000$, $R_2 = 25,000$, $C_1 = .006$ mf., and $C_2 = .001$ mf. These constants give just about the same curve as is shown in Fig. 4 but are better suited to the high input impedance requirements of the crystal pickup. The characteristics of the booster can be varied to suit individual needs by changing either C_1 or C_2 or both. The values given above serve admirably for the outfit on which the booster is being used.

The volume control for the amplifier is in the crystal circuit as shown in Fig. 5 and because of the not too small shunting capacity of the leads, the higher frequencies are greatly attenuated. This fault is corrected by connecting a variable resistance and fixed condenser across points A and B as shown. This arrangement adds as much of the high frequency voltage as is necessary for satisfactory sound production by shunting some of it around the upper part of the volume control. The variable resistance R controls the amount of the higher frequencies which will be added.

Although extremely simple, this circuit has worked wonders on an inexpensive phonograph outfit. Even records which are sadly lacking in both bass and treble passages are made more brilliant and lifelike. Whereas before adding the corrective circuit, organ records lacked the full majestic qualities of which the organ is capable, they are now more realistic and exciting than ever.

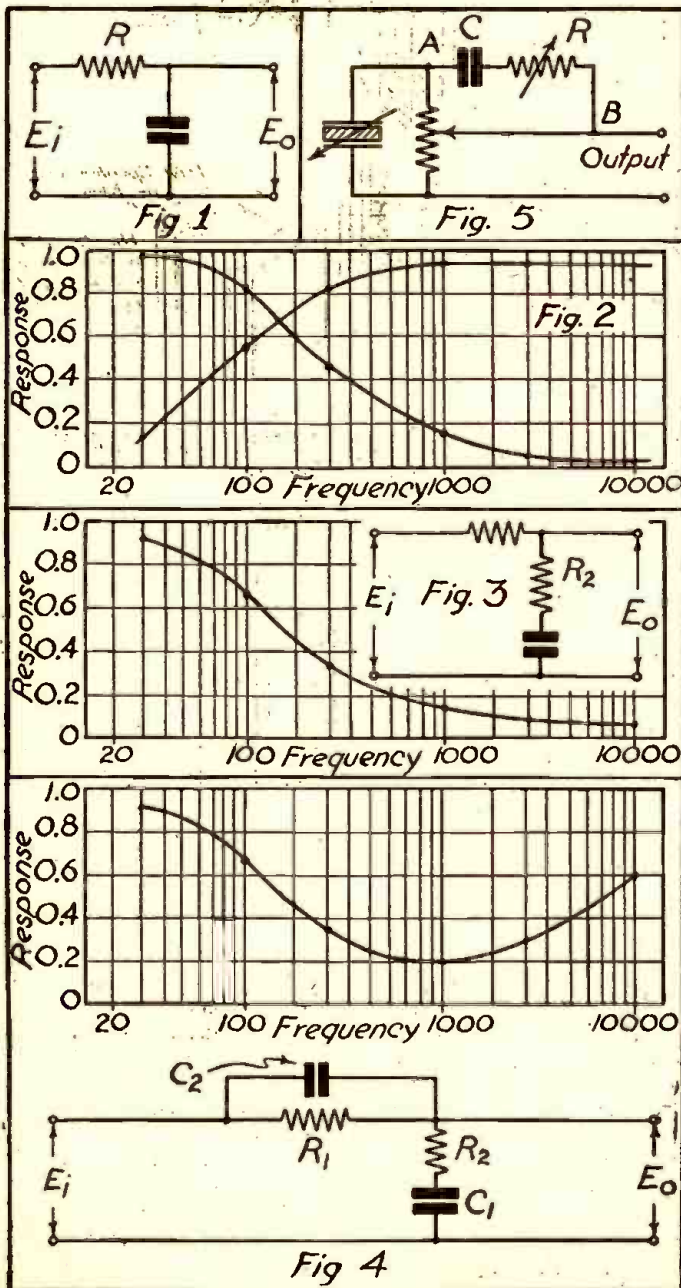

to input voltage (a measure of the response) is given by the relation

$$E_o/E_i = \frac{R_2}{\sqrt{R_2^2 + X_c^2}}$$

where $X_c = \frac{1}{2\pi fC}$ (C in farads). When R is equal to 10,000 ohms and C is equal to 0.1 mf., the response is as shown in Fig. 2. The response at 10,000 cycles is less than one fiftieth of the response at 30 cycles. It is interesting to note that the voltage across the resistor increases as the frequency increases, whereas the voltage across the condenser decreases with an increase in frequency. Fig. 2 also shows a graph of the voltage appearing across the resistor. The value E_o/E_i is in this case equal to

$$\frac{R_2}{\sqrt{R_2^2 + X_c^2}}$$

The disadvantage of this high frequency attenuator circuit is that the higher frequencies are almost entirely cut-out.

A more desirable characteristic would be one that would cause the response to decrease to some minimum value with an increase in frequency so that the high frequencies

The accompanying charts and diagrams show how to improve the performance of an audio amplifier, by making a few simple changes in the circuits.

A COMPLETE P.A. SYSTEM

Part 2—Concluded from Last Issue

RICARDO MUNIZ, E.E., and ROBERT J. BERGEMANN, JR.

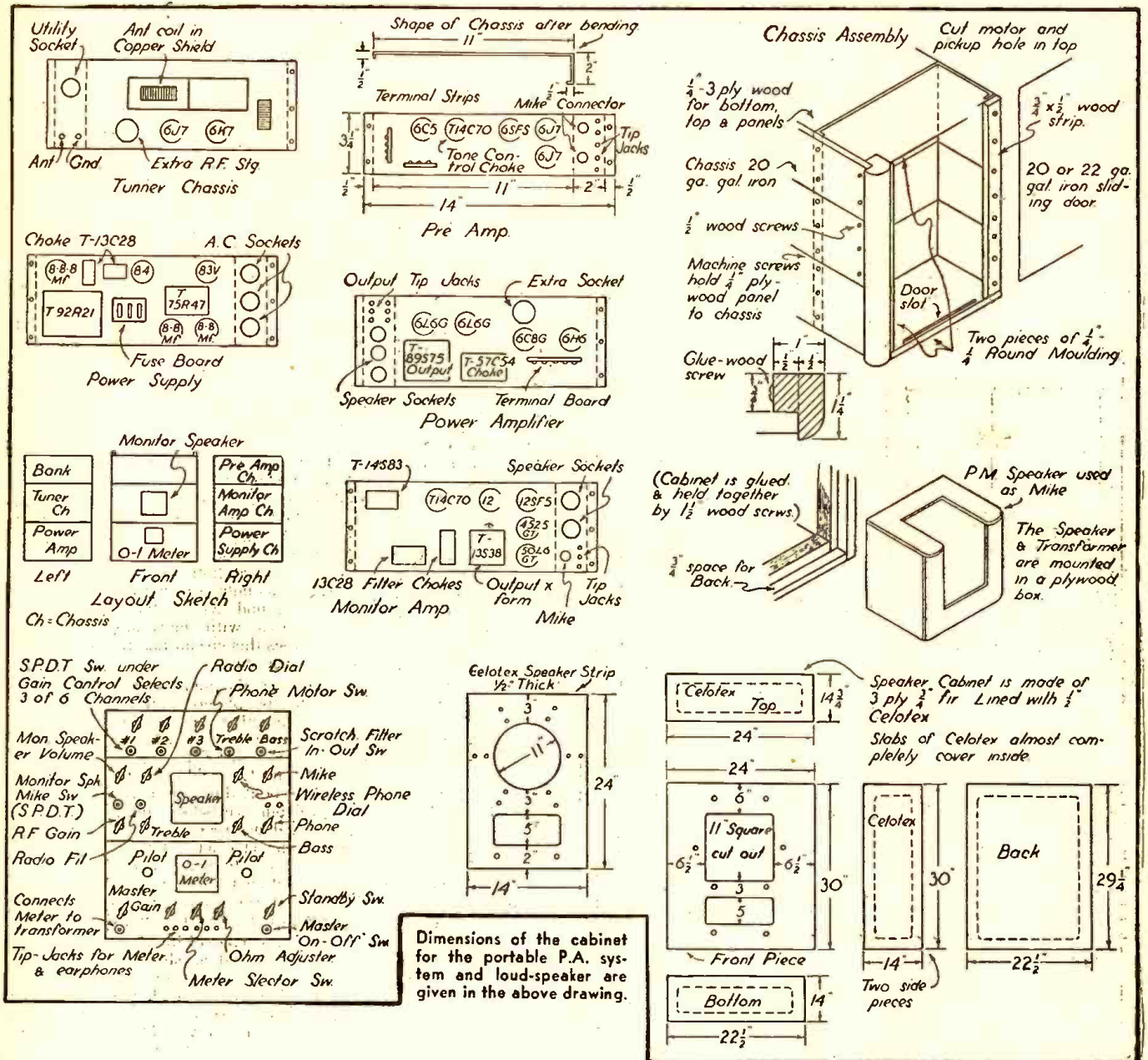

AS explained in Part I of this article which appeared in the May number, page 534, this portable P.A. system will appeal to the average experimenter and set constructor. Servicemen will find this article worth saving also, together with the complete wiring diagram given on Page 535 of the May number. This portable P.A. set will be found to "fill the bill" for many special P.A. requirements. Also the set may be built from spare parts and is so flexible in its design, that odd parts can be fitted in very nicely without losing the benefits of the design.

MAIN "CASE"

The unique chassis mounting is easily duplicated. Use 1/4" plywood for the panels, top and bottom. Drill all panel holes before mounting the panels. Use No. 20 gauge galvanized iron for the various chassis. Unless the constructor has had some experience with sheet metal, it might be advisable to have a tin-smith cut the sheet to size and bend it in "brake." The handy constructor however will find it unnecessary to resort to this unless it suits his convenience. It is not difficult to cut sheet metal with a cheap pair of "tin-snips" and a brake can be made from odd scraps to be

found around the average home workshop. It is more convenient to drill holes in the chassis before bending them up. Of course holes can be drilled even after the chassis are mounted in the CASE, but this is not advisable.

When the panels and chassis have been assembled, use shellac as a filler for the wood and paint on top of this with any desired color. Cream enamel and black (for the trim) were used on the unit illustrated. This gives a very snappy appearance and yet gives a rugged finish. It does not scuff easily.

AMPLIFIERS AND PARTS

GUARANTEED IN ABSOLUTE PERFECT MECHANICAL AND ELECTRICAL CONDITION, ALTHOUGH SLIGHTLY USED.

Photo shows 30 watt ampl. # 104A



All ampl. shipped Ready to operate

#102A—12 WATT PUSH-PULL 2A3 AMPLIFIER
Frequency response plus or minus 21dB. from 30 to 15,000 CPS. bass and treble boost. Inputs for phono pick-up or radio tuner. Output impedance 8 or 16 ohms to P.M. or Electro-Dynamic speakers, supplies field current for one or two 2500 ohm speaker fields. An excellent amplifier for FM or recording.
\$18.45

Set of Matched Tubes for either #102 or #102A, 1-57, 1-56, 2-2A3, 1-5Z3 **\$1.73**

#102—12 WATT PUSH-PULL 2A3 AMPLIFIER
Same as above, but without stages of crystal pick-up. Schematic furnished free to change unit over to these stages.
To be used with one or two 2500 ohm dynamic speakers 16 ohm voice coil. May be changed over to use P.M. speakers. Input for magnetic pickup. Variable tone control.
\$8.75

Shipping Weight 25 lbs. for either of above

#103A—20 WATT PUSH-PULL 6L6 AMPLIFIER
Input for one crystal or dynamic microphone. Input for one crystal or magnetic phono pick-up. Full range tone control. Frequency response 30 to 10,000 CPS. Output impedance 8, or 16 ohms to FM or Electro-Dynamic speakers, supplies field current for one or two 2500 ohm speaker fields.
\$15.95

Set of Matched Tubes: 1-6SF5, 1-76, 1-6A6, 2-6L6, 1-5Z3 **\$2.29**

#103—20 WATT PUSH-PULL 6L6 AMPLIFIER
Same as above, but without stages of crystal pick-up and crystal microphone. Schematic furnished free to change unit over to these stages.

To be used with one or two 2500 ohm dynamic speakers 16 ohm voice coil. May be changed over to use P.M. speakers. Input for magnetic pickup. Variable tone control.
\$9.85

Set of Matched Tubes: 2-6L6, 1-6A6, 1-76, 1-5Z3 **\$1.78**

Shipping Weight 24 lbs. for either of above

#104A—30 WATT PUSH-PULL 6L6 AMPLIFIER
Input for two crystal, dynamic or velocity microphones individually controlled. Input for crystal or high impedance phono pick-up. Full range tone control. Frequency response 30 to 10,000 CPS. Output impedance 2.6, 3.2, 4, 5.3, 8 and 16 ohms to P.M. or Electro-Dynamic speakers, supplies field current for one or two 2500 ohm speaker fields.
\$21.45

Set of Matched Tubes: 2-6SF5, 1-6C6, 1-6A6, 2-6L6, 1-5Z3 **\$2.80**

#104—30 WATT PUSH-PULL 6L6 AMPLIFIER
Same as above, but without stages of crystal pick-up and crystal, dynamic or velocity microphone. Schematic furnished free to change unit over to these stages. Has input for magnetic pickup, volume control, variable tone control. Supplies field current to one or two 2500 ohm dynamic speakers, output impedance 2.6, 3.2, 4, 5.3, 8, and 16 ohms. Full 30 watts output.
\$12.05

Set of Matched Tubes: 1-6C6, 1-6A6, 2-6L6, 1-5Z3 **\$1.78**

Shipping Weight 26 lbs. for either of above
All Amplifiers Less Tubes & Speakers.

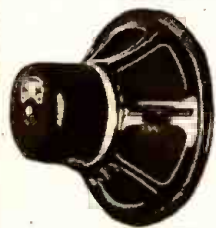

JENSEN 10 INCH ELECTRO-DYNAMIC SPEAKER
2500 OHM FIELD
16 OHM VOICE-COIL

EACH **\$2.95**
Shipping Weight 7 lbs.

ORDERS SHIPPED SAME DAY AS RECEIVED. All goods are sent Express collect if no money for Parcel Post is included in remittance. Customers in Foreign countries are requested to remit in U. S. Currency or International Money Orders and include enough money to ship goods prepaid. Order from this ad.

25% deposit required on all C.O.D. orders.

PEERLESS RADIO AND SOUND CORP.

11 So. Desplains St., Dept. 642 CHICAGO, ILL.

AN EQUALIZER FOR RECORDERS

W. W. BLAIR

In broadcasting and recording it is essential that high fidelity standards are kept, however there are always the "Bugs" to be excluded from any system. I recall the recording apparatus owned by a friend of mine. He was very well educated along R.F. lines but lacked sufficient training in the A.F. field. He had built an amplifier for use with his recording apparatus, when he ran a curve on it and it proved to be flat within 1/2 db from 30 to 12,000 cycles. Being proud of his amplifier, he proceeded to connect it to his recorder. The first record was cut, and being very confident of the results, he played the record back.

The music was fair but on voice there were no highs. There was also a very noticeable turntable rumble which was recorded. My friend started to tear his hair, and I don't blame him a bit. He suddenly realized that he had neglected checking quite a few things. He got hold of the instructions which came with the cutting head, which by the way was one of those super bargain jobs. Upon reading them carefully he discovered that the response of the cutting head was flat within 2 db from 60 to 3500 cycles; then the response tapered off gradually to a minus 8

db level at 7000. This definitely proved where he was losing the "highs." He was ready to give up—at least he had that "Who shot John" expression on his face, so I thought I might take a chance and open my big trap with, "Why don't you incorporate an equalizer in the circuit?"

"Gee whiz, I don't have room on the chassis for one of those weird gadgets," he commented mournfully. He had always been one of those boys who liked to build a 10 tube superhet in a coffee can! I proceeded to look over the amplifier and discovered that he had a 6SC7 dual triode unit tube hooked cascade as a voltage amplifier. This was followed by a 6C5 and a pair of 6F6's which were connected push-pull; this was the extent of the amplifier. The chassis was solidly full, no room for anything. The old bean snapped, and, believe it or not, I got an idea. He could replace the 6C5 with another 6SC7 and with a couple of small chokes he would have a swell equalizer.

We got our skulls together and worked out a circuit and you can see was the outcome; it worked so swell-elegant that we thought there were others who could use it.

This diagram shows how the revamped amplifier was made to provide necessary equalization. The text may help you to improve your recording equipment.

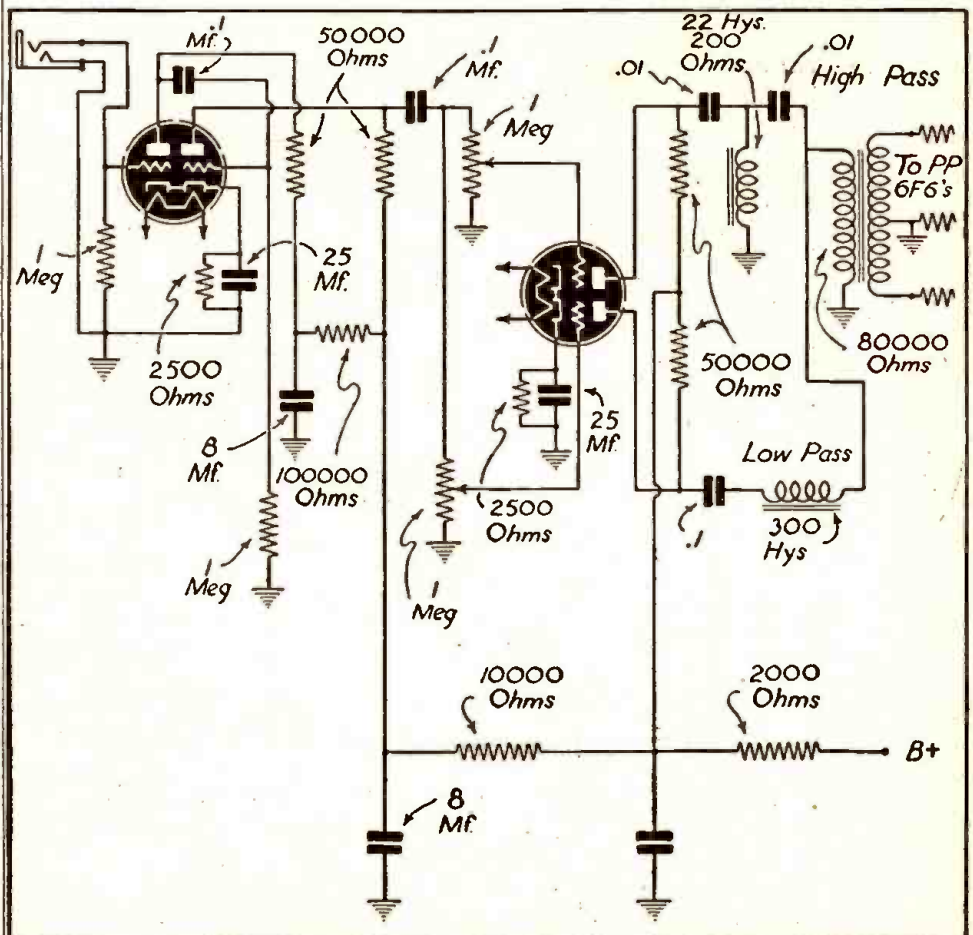

A New Type of Service Manual!

RADIO CIRCUIT MANUAL - 1941

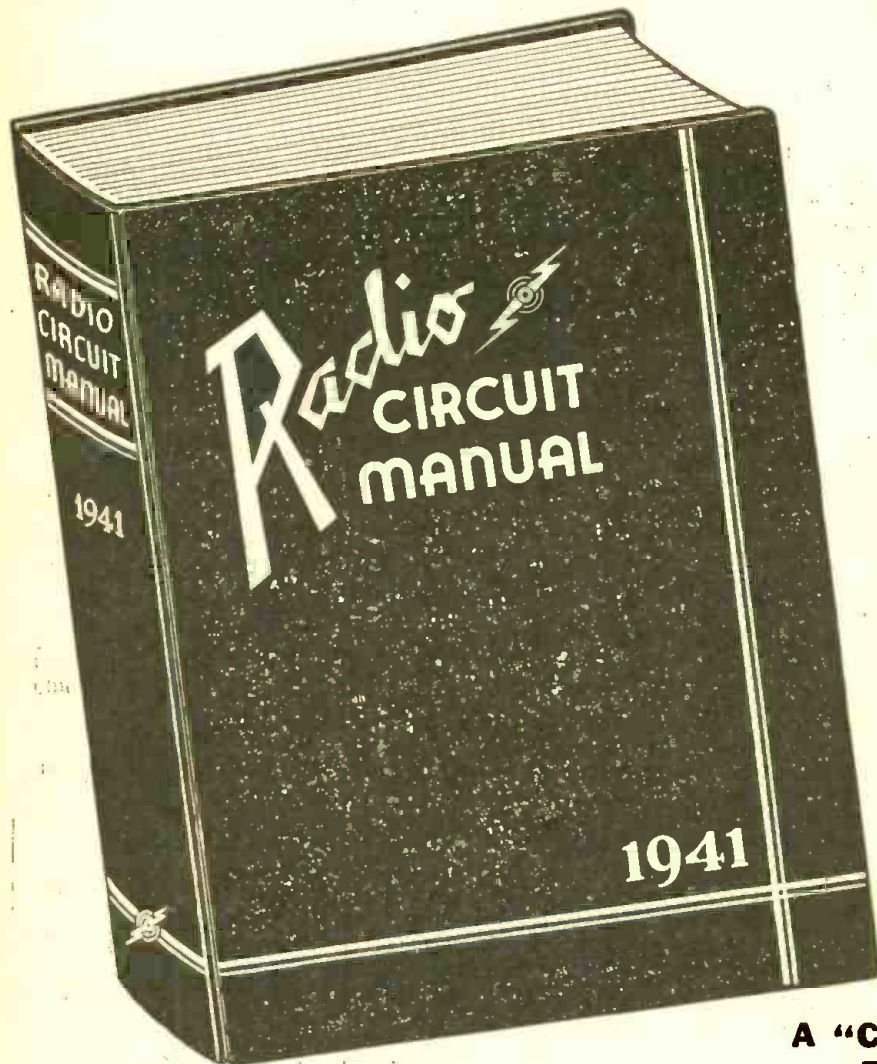

**The Only EDITED Manual
Ever Published!**

DIRECTORY OF RECEIVERS MANUFACTURED IN 1940 AND UP TO JUNE, 1941

MORE INFORMATION IN HALF THE NUMBER OF PAGES

The value of a service manual is measured not by the number of pages but by the amount of useful information. Thus, in only 736 pages this Radio Circuit Manual covers over 200 receiver models MORE than does any other competitive manual in twice the number of pages.

HOW DID WE DO IT? . . .

. . . By increasing the size of our page; by discarding non-essential data and editing the balance; by listing only those receivers which the Service Engineer will definitely have to repair (no communications or export receivers, no shortwave sets or amplifiers, no electronic devices, etc.); by many months of hard work based on a definite plan of procedure and a clear understanding of the actual requirements of the Service Engineer. There is no "dead weight" information to add bulk to this Manual. Every word counts. Every minute of reading time is well spent.

OUTSTANDING FEATURES

- Contains data on more than 1800 receiver models—more than any other radio service manual.
- Only 736 pages—less than half the bulk of any other manual and more than 1/3 lighter.
- All information is EDITED—all non-essential data deleted and the balance checked and correlated with the schematics and sketches.
- 40% larger page permits listing of all information on one page. (A few unavoidable cases excepted.)
- I.F. peaks for all superhet circuits are boldly displayed in black boxes;—none missing, all accurate.
- No space wasted on communications and export receivers, amplifiers, electronic musical instruments, etc.—a 100% Service Engineer's Manual.

A "CUSTOM-TAILORED" MANUAL FOR SERVICE ENGINEERS

Here, at last, is a Service Manual deliberately PLANNED for the Service Engineer. Instead of a mere hodge-podge collection of service data, as manuals have been in the past, this RADIO CIRCUIT MANUAL is an orderly compilation of essential radio diagrams and service information, carefully edited and uniformly presented for the maximum convenience of the busy Service Engineer. All time-consuming, non-essential data have been weeded out, and the remaining information, vitally important to the rapid and efficient servicing of modern radio receivers, has been laid out in a logical, easy-reading style which cuts time from the day's work. Because of this and other features which are self-evident upon first observation, it has been possible to list all information pertaining to a given model on a single page.

In 736 pages this Manual presents essential service data on over 1800 receiver models;—more than any other existing service manual on the market!

ONLY ONE MANUAL PER YEAR!

The new technique used in compiling this RADIO CIRCUIT MANUAL—1941 makes it possible to include in a single book all the new receiver models which the radio industry can produce in a single year. This factor alone represents an important saving to all Service Engineers.

A PERMANENT INSTITUTION

This Radio Circuit Manual—1941 is NOT a one-time proposition. Next Year there will be a Radio Circuit Manual—1942, the following Year, 1943 and so on indefinitely—each Manual better than the other as new methods are worked out for expediting and simplifying the work of the practicing Service Engineer.

← THE OLD TYPE MANUALS—Bulky, heavy, hard to handle, space consuming, less USEFUL data despite greater number of pages.



→ OUR NEW MANUAL—Lighter, compact, easy to handle, takes half as much room on the shelf, more USEFUL information despite fewer number of pages.

MANUALS NOW READY!

RADCRAFT PUBLICATIONS, INC.,
25 West Broadway, New York, N. Y.
Gentlemen: Enclosed find my remittance of \$10.00, for which send me, POSTPAID, my copy of the RADIO CIRCUIT MANUAL—1941.

Name
Address
City State
RC-6-42

(Send remittance in form of check or money order; register your letter if you send cash.)

ORDER YOUR MANUAL IMMEDIATELY—NOW!

Get your copy directly from us by filling out and mailing the convenient coupon shown at left, or get it directly from your favorite distributor.

736 pages; size 13 5/8 x 10 1/4 x 2 in. thick; loose leaf, leatheroid-covered stiff binder; net weight 6 1/2 lbs.

ONLY
1000

RADCRAFT PUBLICATIONS, INC.
25 WEST BROADWAY NEW YORK, N. Y.

"MAGIC-EYE" Indicators

for Measurements

G. A. HAY, B.Sc.

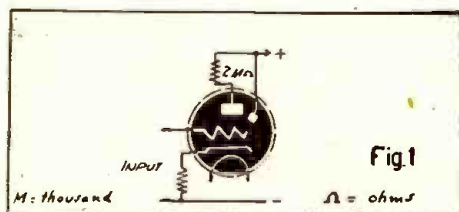

Fig. 1

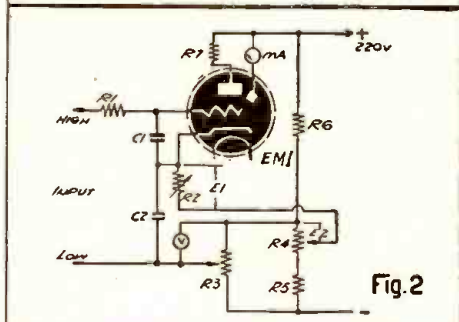

Fig. 2

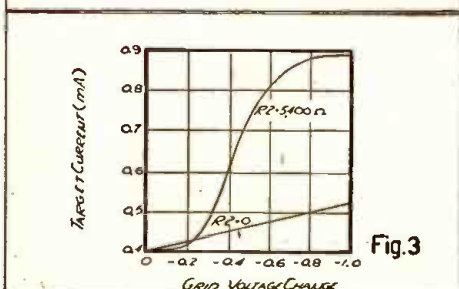

Fig. 3

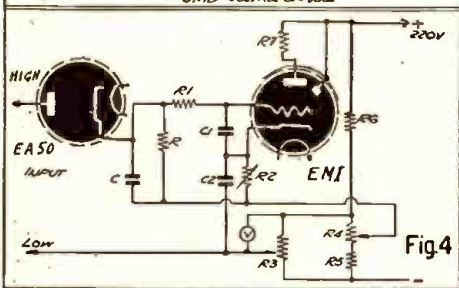

Fig. 4

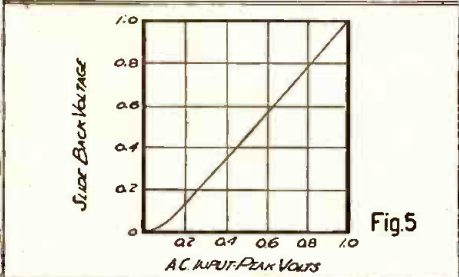

Fig. 5

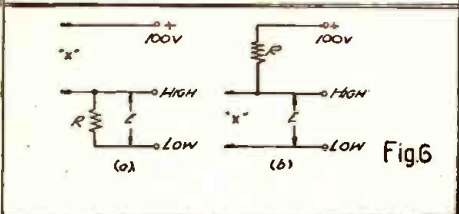

Fig. 6

THE cathode-ray tuning indicator tube has been widely used as a null indicator in bridges and other laboratory gear in which measurements depend on a current balance. It will give a clear visual indication of a change of about 0.1 volt D.C. with a very high input impedance, and has the additional advantages of lack of inertia and—most important to the private experimenter—cheapness and robustness.

It occurred to the author that if this sensitivity could be increased substantially, the use of the "magic eye" would be extended considerably. As a result of some work undertaken with this end in view, the sensitivity has been increased about ten times with little additional apparatus, and more than a hundred times with some extra complication.

The principle underlying the arrangement giving the ten times increase is illustrated in Fig. 1. It is well known that the inclusion of an un-bypassed cathode resistor in a normal stage of amplification results in degeneration or *negative feed-back*, with resultant decrease in gain and increase in stability. This is due to the action of a single tube in introducing a 180 deg. phase shift. The tuning indicator, however, is the equivalent of two triodes in series or cascade, and therefore the plate current of the second stage (i. e. the target current), is 360 deg. out of phase with the grid voltage on the first triode; in other words, the two are in phase. The cathode current is the sum of the triode and target currents, and as the latter predominates, the cathode current is also in phase with the grid voltage, and an increase in the negative grid voltage will therefore result in an increase in the cathode current.

If we now place a cathode resistance in circuit, as in Fig. 1, feed-back will be obtained which is in phase with the input, and *regeneration* will result, giving rise to *increased gain and decreased stability*.

In order to investigate this effect experimentally, the circuit shown in Fig. 2 was set up. R1 and C1 form a *filter* which will prevent the passage of alternating potentials to the grid in subsequent applications. R2 is the cathode feed-back resistance: as this gives an initial negative grid bias E, which is excessive, it is necessary to take the cathode return to a point negative to the grid circuit. This semi-variable potential E2 (controlled by R4) opposes E1 and thus it is possible to work the tube at any initial grid bias required. In addition to the initial value, extra negative potential as indicated by V is available from R3 for measurement purposes, slide-back voltage, etc.

In estimating the sensitivity, the target current was taken as a measure of the shadow angle, maximum and minimum shadow corresponding to currents of 0.42 and 0.9 ma. respectively. In addition, in the particular tube used, a Mullard (English) EM1, there were two marks on the target itself which served as reference marks; thus avoiding the parallax inevitable with markings on the glass envelope, and making possible a very precise setting.

Fig. 3 shows the increased sensitivity obtained with R2 set to 5,400 ohms, the points marked "high" and "low" in Fig. 2 being connected together. As expected, increasing the value of R2 gives continuously in-

creasing sensitivity up to a certain point, when backlash and instability occur. At this point the increase in gain is about fifty times. It is therefore unwise to attempt an increase of more than ten times on account of the difficulty of adjustment and the effect of supply voltage fluctuations, etc. With the 5,400-ohm cathode resistor, a definite movement of the shadow was obtained for a grid voltage change of ± 5 mv, as compared with ± 50 mv for the indicator used in the normal way. This was obtained with complete stability and lack of zero shift, without a regulated high-tension supply.

The indicator used in the manner described has been used in various pieces of laboratory equipment, of which two of the most useful have been a slide-back diode tube voltmeter and a "megohmmeter."

Various designs for diode tube voltmeters operating under slide-back conditions have appeared, but, to the writer's knowledge, all have involved the use of an extra tube to attain the required sensitivity in adjustment. With the above form of indicator, this complication becomes unnecessary, and hence a very simple circuit will suffice.

This, as finally evolved, is shown in Fig. 4. It will be seen that the null indicator is a duplicate of Fig. 2, while a series diode circuit has been added to act as a rectifier, the tube used being a Mullard (English) EA50 television diode. The rectified current through this is detected by causing it to develop a potential difference across a 10,000-ohm resistor R, shunted by a condenser C of 0.01 mf. At first the test leads are short-circuited, and the shadow adjusted to a reference point by using R4. The unknown voltage is then applied, and the slide-back voltage increased by means of R3 until the shadow returns to zero, when V indicates the peak value of the voltage.

In practice, errors occur, due to the curvature of the diode characteristic. Actually, as the calibration curve of the instrument shows (Fig. 5), the slide-back voltage is a true measure of the peak value for voltages above 1 volt peak. Below this the meter needs calibrating, and the minimum readable voltage is about 0.1 volt, which is quite satisfactory for normal use. The upper limit of voltage is restricted by the maximum permissible diode plate voltage—in this case 50.

Calibration was done at 50 cycles per second. There is no reason to suppose that this will not hold up to quite high frequencies; the errors involved in using the peak diode voltmeter at ultra-high frequencies have been previously dealt with (E. C. S. Megaw, *Wireless Engineer*, 1936) [London]. In any case, if the diode is made into the form of a probe with an extra 100 mmf. silvered ceramic or mica bypass condenser, little trouble will be experienced with it on any normal frequency.

The main disadvantage of the diode voltmeter is its extremely low input impedance on part of the positive half-cycle, thus taking power from the circuit under examination. The impedance consists of a resistance in parallel with a capacitive reactance. The latter is of the order of 5-8 mmf., and is, therefore, negligible at audio frequencies, while at radio frequencies it usually forms part of a tuned circuit. The resistance component is given approximately by the

Several improved methods are here diagrammed and explained for the use of "magic-eye" tubes as indicators.

relation: R_z equals R divided by 2, and thus will be about 5,000 ohms. Rough measurement of this at 50 cycles per second gave an average value of 4,000 ohms, which is in reasonable agreement with theory.

When using the indicator as a D.C. voltmeter its input resistance is infinite; it can therefore be used for the measurement of very high resistances.

In Fig. 6 (a) R is a standard high resistance connected between the high and low input terminals of Fig. 2. The unknown resistance X is connected between "high" and a source of positive potential of 100 V, which may be a tapping on the main potential divider.

The two resistances, R and X , therefore form a potential divider across which a voltage of 100 is applied. The voltage E appearing across the standard is then measured. It is apparent that X over R equals 100 minus E , divided by E ; and further, that X equals 100 minus E , divided by E , then multiplied by R .

If we assume R to be 10,000 ohms, and the measurable voltage range 0.1 to 100 volts (actually greater in the case of D.C.), X ranges from zero to ten million ohms.

If now X and R are interchanged, as in Fig. 6 (b), X equals E over 100 minus E , multiplied by R , and X ranges from 10,000 ohms to infinity. This represents a very satisfactory range for rough testing. Insulation of the various leads is important, and for this reason it is perhaps unwise to attempt any switching, but to use some scheme of link connections on terminals supported on mica. No trouble has been experienced from the fact that the EM1 grid terminal is on the base instead of a top cap. The 1,000-ohm resistor in the indicator unit limits the flow of grid current at high positive potentials.

This form of megohmmeter has been used with success in a variety of measurements. Different ranges can be covered, of course, by using different standard resistances.

While the above principles have been treated in rather a general manner, it is hoped that an opportunity will occur in the future to describe a laboratory test instrument embodying these ideas, and capable of doing practically anything in the way of general testing.—Courtesy WIRELESS WORLD, London.

LOCATING PLANES BY RADIO WAVES

A very interesting article entitled "Raiders vs. Radio" recently appeared in the editorial columns of the *New York Times*, which goes on to say "that every new weapon brings forth its own antagonist. . . . Directional radio beams were at first developed to serve the airplane in flying on the beam through darkness and fog. Now, with equal drama and mystery, science gives *electronic eyes* to the defender against night raids."

The article mentions the importance of the German radio listening station for the detection of British bombing planes, which station was recently destroyed.

The U. S. Army Aircraft Warning Service has been experimenting and developing special airplane radio locator apparatus for a long time. At present the results obtained with this type of airplane locator are said to be quite startling. In fact the apparatus has been improved to the point where it can be hooked up with electrical and mechanical gear, so as to continuously point an anti-aircraft gun at a plane in flight.

For Defense

RADIO TRAINING

USE MEISSNER KITS

From a one tube kit to a three tube kit with "Add-One" features. These kits give the fundamentals of radio construction and are ideal for group teaching of assembly.

The Kits utilize the latest type of 1½ volt battery operated tubes, providing good performance with minimum battery drain. Each kit is supplied with a plug-in coil to cover the broadcast band, 200 to 545 meters; additional coils available to make a real "All-Wave" receiver.

Everything required for completion of the set is included (except batteries, tubes and headphones). The Pictorial Wiring diagram included with each kit greatly simplifies the assembly.

One tube battery receiver kits—\$5.50 list.
Two tube battery receiver kits—\$6.75 list.
Three tube battery receiver kits—\$8.50 list.

NEW! Kits are now available for AC-DC operation with the same progressive building operation. See your Meissner jobber.

Write for Complete New Catalog. Address Dept. CT-6

Meissner

MT. CARMEL, ILLINOIS
"PRECISION-BUILT PRODUCTS"

WET ELECTROLYTIC CAPACITOR REPLACEMENT

Since wet electrolytic capacitors are seemingly so difficult to obtain during these times of aluminum conservation for defense purposes, the writer has made replacements of all wet types electrolytic capacitors (except those of the voltage regulator type) with tubular type dry electrolytics in the manner as follows:

The electrolyte and complete anode assembly are first removed from the can which is cleaned well. A short brass machine screw and nut is then inserted through a hole in the can to which is soldered the negative lead of a dry electrolytic tubular type capacitor of the same capacity and voltage rating of the wet unit. The positive lead of the capacitor is brought through the insulated rubber bushing for

the positive terminal connection. The top cover is then replaced on the can and the completed unit is ready for remounting to replace the original wet unit.—E. Gagliano in "C. D. Capacitor."

RESISTOR CORD REPAIR

After careful inspection of open line cords on numerous sets, in most cases the resistance wire will be found broken at the connection to the plug. Making a new connection or resoldering the break in the resistor wire will in most cases remedy the trouble completely and satisfactorily. A new plug may be necessary, but care should be taken not to shorten the resistor wire so much as to affect the efficient operation of the set.—George Vesley in "C D Capacitor."

VOLTAGE-MULTIPLYING RECTIFIERS AND HOW THEY WORK

Very little has been written on Voltage Multipliers and how they work, so that this article will be of more than passing interest to all radio students and servicemen. The action of the rectifier tubes when connected in voltage-multiplier circuits is important and interesting.

THE voltage-doubler circuit is very well known and quite widely used, but it is not always realized that the principle can be extended. Voltage-tripler and voltage-quadrupler circuits are quite possible, and in some cases form a cheap and easy way of obtaining a high-voltage supply.

They are all based on the voltage-doubler, and in order to understand how they work it is necessary to be quite clear about the mode of operation of this simpler circuit. The arrangement is shown in Fig. 1, and it will be seen that two tubes are used with two reservoir condensers. The AC input can be either from a transformer or directly from the A.C. line.

On the positive half-cycles of the input the point A is positive with respect to B, and the plate of V1 is positive with respect to its cathode, for this tube is connected in series with C1 across AB. The tube consequently conducts, and C1 charges through the tube, the upper plate of this condenser becoming positive with respect to the lower.

The tube V2, in series with C2, is also joined across the points AB. Its cathode is connected to A, however, so that its anode is more negative than its cathode. It is, therefore, non-conductive and does nothing.

On the negative half-cycles of the input the position of the two tubes is reversed. V1 is now non-conductive and V2 conductive. The condenser C2 now charges through V2, and its upper plate becomes positive with respect to the lower.

The output voltage is taken across both condensers in series, and is thus twice that on either condenser alone. When no current is taken from the output each condenser charges to a potential of 1.414 times the RMS value of the input alternating voltage. On load the output voltage is lower than this, and depends very largely upon the output current in relation to the capacity of the condensers.

The simplest way of looking at the voltage-doubler is to consider it as two half-wave rectifiers with the outputs in series. The rectifiers, however, conduct alternately and function on opposite half-cycles

of the supply, so that the circuit as a whole is a full-wave rectifier.

The voltage-doubler of Fig. 1 is based upon the series-type half-wave rectifier of Fig. 2 (a) and consists merely of two of these used together. It is, however, equally possible to employ the parallel-type of rectifier shown in Fig. 2 (b); it is so called because the output is taken in shunt with the tube instead of in series with it.

The operation is substantially the same. The tube conducts on the negative half-cycles and the condenser charges, its right-hand plate becoming positive with respect to its left-hand. When two of these rectifiers are put together in the obvious way the voltage-doubler of Fig. 1 results. This normal voltage-doubler, therefore, can be broken down into two series-type half-wave rectifiers, or into two parallel-type.

It is, however, possible to build a voltage-doubler from one half-wave rectifier of each type, instead of from two of either. This is shown in Fig. 3, and it should be noted that this circuit has one terminal of the input and output common. This may

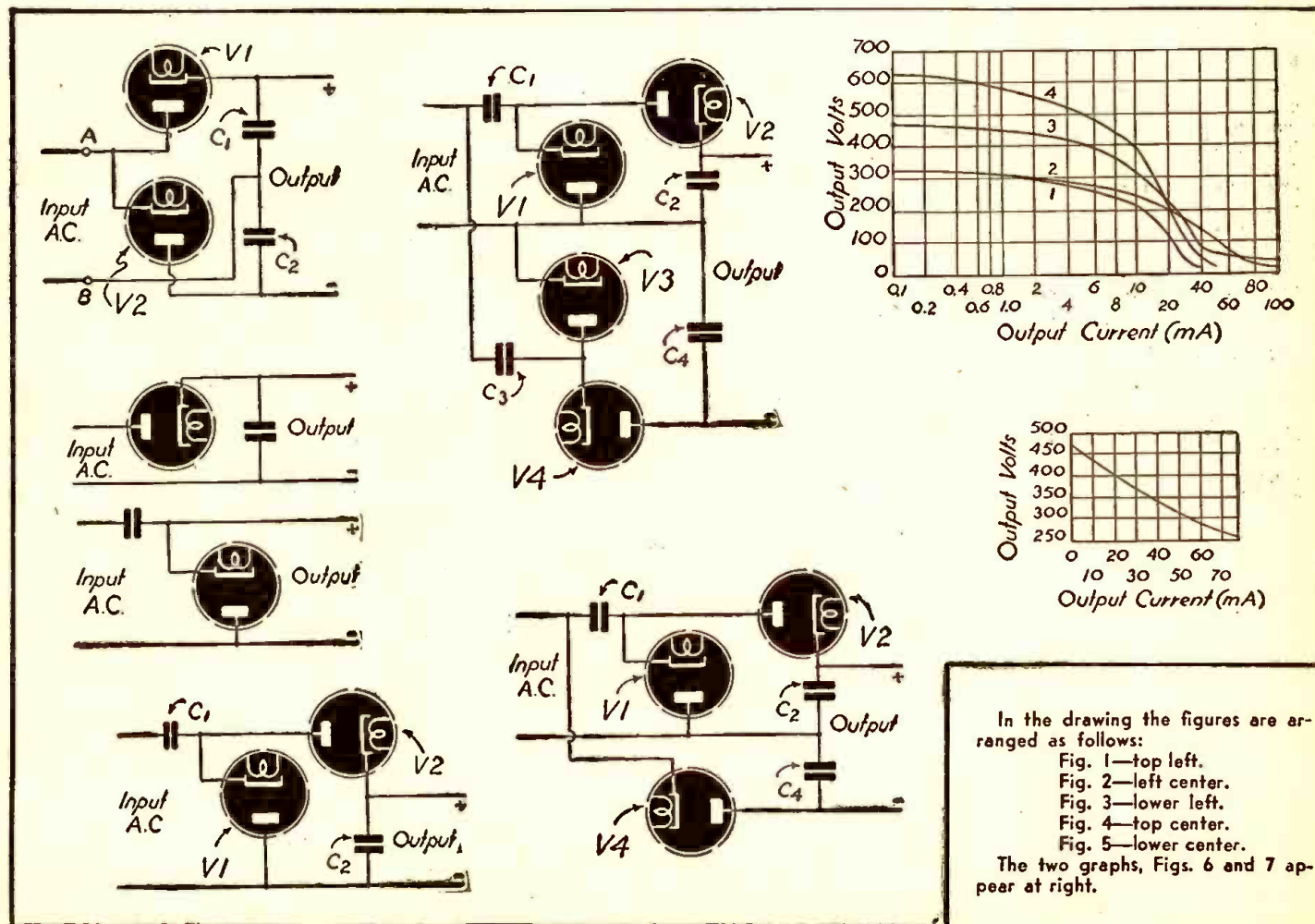

make it preferable, in some circumstances, to the conventional circuit.

Before discussing this circuit, it is necessary to be quite clear about the simpler half-wave rectifiers of Fig. 2. The series circuit (a) works on the positive half-cycles of input, and on no load the condenser becomes charged to the peak value of the input voltage. On load, the condenser discharges to some extent during the time when the tube is not conducting, so that the voltage across it fluctuates. The mean discharge current constitutes the current drawn from the circuit and used in the load, while the fluctuations are the ripple, or hum, on the output.

In the case of the shunt circuit (b) exactly the same thing happens, so far as the condenser is concerned, but the output is now the condenser voltage in series with the AC supply. When no current is drawn, instead of the output voltage being constant at the peak value of the input, it is fluctuating between zero and twice the peak value, with a mean value equal to the peak value of the input.

This is why the circuit as it stands is never used. Even on no load, the ripple voltage on the output is equal to the mean steady voltage.

This effect is turned to advantage in the voltage-doubler of Fig. 3, however, and it will be seen that this circuit consists of a series-type half-wave rectifier following a parallel type. What happens is this. V1 conducts on the negative half-cycles of the input voltage, and C1 charges so that its right-hand plate becomes positive with respect to its left. V2 is non-conductive during these periods.

On the positive half-cycles V1 becomes non-conductive and V2 conductive. The voltage acting on V2, however, is not merely the input voltage but the sum of this voltage and that across C1. This total voltage acts through V2 to charge C2. On no load C1 is charged to the peak value of the input and C2 to twice the peak value. This condenser, therefore, must be rated for working at twice the voltage that will suffice for C1. The rating for the latter is, of course, the peak input voltage, and is adequate for both condensers in the usual circuit of Fig. 1. In this respect the arrangement of Fig. 3 is less economical.

It should be pointed out here that in the foregoing description the term half-cycle has been used as if the valves conducted for precisely this time. In actual fact, of course, the conducting period is usually less than one-half of each cycle, and depends on the load current in relation to the condenser capacity.

The voltage-quadrupler should now be clear. It is nothing more than two voltage-doublers of the type of Fig. 3, and the arrangement is shown in Fig. 4. C2 and C4 should be of twice the voltage rating of C1 and C3, but the capacities can all be the same. The actual values used depend on the current, and can only be small when the current is also small.

The voltage-tripler is a combination of the voltage-doubler of Fig. 3, and the half-wave rectifier of Fig. 2 (a). It is the quadrupler less V3 and C3, and is shown in Fig. 5.

The regulation of these circuits is by no means good unless very large capacities are used. This is not only expensive but bad for the rectifiers on account of the high peak currents which will then flow. In general, therefore, they are most useful when high voltages at low currents are wanted. The quadrupler, for instance, could well be used for operating a C.R. tube, and with a 230 volt mains supply would deliver something like 1,200-1,300 volts without any transformer.

The performance of these circuits is well brought out by the curves of Fig. 6, which are reproduced from the May, 1941, issue of *Electronics*. In each case the condensers have a capacity of 2.1 μF , and the input is 115 volts at 60 c/s. Curve 1 is for a shunt-type voltage-doubler, and curve 2 for the series type; it is clear that the latter is the better when the current exceeds about 2 MA under these conditions. Curves 3 and 4 refer to the voltage-tripler and quadrupler circuits, and it is obvious that the high output voltage is only obtainable with quite low currents.

Above about 17 MA the output of the quadrupler is less than that of the tripler, and above some 22 MA both are inferior to the series-type voltage-doubler. With larger capacity condensers the cross-over points of the curves would be at higher currents; condensers of 2 μF capacity are definitely too small for any output greater than a few milliamperes. They are about right for a C.R. tube supply, but not for anything requiring more current.

Fig. 7 also reproduced from *Electronics*, shows the performance of a tripler using 2525 valves and 8- μF condensers, the input being 117 volts. Although the slope of the curve is fairly steep, it is clear that the circuit is useful for currents up to 50 MA or so. At this current an output of just over 300 volts is obtainable.

In conclusion, it should be pointed out that, although the diagrams all show tubes for the rectifiers, there is no reason why metal rectifiers should not be used. Indeed, they have the advantage of not needing a heater supply, for this is often troublesome to arrange economically in multiplier circuits.—*Courtesy Wireless World.*

19 WATT AMPLIFIER

(Continued from page 599)

fiers up to 250 watts input. For multi-purpose driver use and plate and cathode modulation, a Stancor Poly-Pedance output transformer will satisfy a variety of operating conditions.

A peak-limiting circuit may be added for use in a modulator as a per-cent modulation control or in some P.A. systems as an automatic volume control of speech only. The Stancor 525 amplifier will find many applications in sound system work and its output is so realistic that audiences will be pleased with its sound-re-enforcing quality.

- C2—4 mfd. 450 volt tubular electrolytic condenser
- C3—8 mfd. 450 volt can electrolytic condenser
- C3H—8 mfd. 600 volt can electrolytic condenser
- C4—10 mfd. 25 volt tubular electrolytic condenser
- C16—.01 mfd. 400 volt tubular paper condenser
- C17—.1 mfd. 400 volt tubular paper condenser
- C96—.05 mfd. 400 volt tubular paper condenser
- C97—.5 mfd. 200 volt tubular paper condenser
- R3—25,000 ohm 10 watt wirewound resistor
- R5—5 megohm 1/2 watt carbon resistor
- R6—3,000 ohm 1/2 watt carbon resistor
- R8—250,000 ohm 1 watt carbon resistor
- R9—1,000 ohm 1/2 watt carbon resistor
- R10—200 ohm 10 watt wirewound resistor
- R11—500,000 ohm potentiometer
- R14—100,000 ohm 1 watt carbon resistor
- R18—25,000 ohm 1 watt carbon resistor
- R30—1 megohm potentiometer—center tapped
- R41—10,000 ohm 1 watt carbon resistor
- R44—250,000 ohm dual potentiometer
- R46—3,000 ohm 10 watt wirewound resistor
- R69—1 megohm 1 watt carbon resistor
- SW1—S.P.S.T. toggle switch
- T3—Power transformer—STANCOR P4004
- T33—Driver transformer—STANCOR A4777
- T25—Output transformer—STANCOR A3801
- TCU—Tone control unit—STANCOR C2332-1
- CH2—Filter choke—STANCOR C1515
- CH15—Filter choke—STANCOR C1710

- ACCESSORIES**
 Tubes—2-6SJ7, 2-6N7, 2-6L6, 1-5Z3
 Mic.—Crystal or similar type
 Cover—Dust cover for standard 17" x 10" chassis
 Speakers—Electro or permanent magnet dynamics

This article prepared from data supplied through the courtesy of the Standard Transformer Corp.

SPRAYBERRY RADIO TRAINING FULL EQUIPMENT

Experience Easily Acquired at Home



You Do Practice-Giving Experiments. Many Special Features... ALL Designed to Help You Make Fast Progress

SPRAYBERRY Training starts right at the beginning of Radio... unfolds each subject

In a simplified, logical, understandable style. You easily learn Television, Frequency Modulation, Signal Tracing, Mobile Radio (Auto-Tank), Aviation Radio, Electronics, Facsimile Radio, Radio Set Repair and Installation work.

Training Prepares You for a Business: of Your Own... Or Good Radio Jobs at Excellent Pay

The great fascinating and progressive field of Radio offers many opportunities to the man who wants to get ahead. My Training is designed to give you quick access to these opportunities.

SPRAYBERRY Methods are thorough and practical. Your Training will not interfere with your present work. No previous experience is needed.

You Get Professional Test Equipment Plus Complete Radio Set

With the Radio Parts given (everything needed to build a Complete Receiver) you conduct interesting informative experiments with your own hands. Also you are supplied a modern TESTER-ANALYZER.

Earn While You Learn My BUSINESS BUILDERS show you how to put your equipment to actual use in handling money-making Radio Service Jobs shortly after you begin training.

THE SPRAYBERRY COURSE IS SOLD UNDER MONEY-BACK AGREEMENT



RUSH COUPON for BIG FREE BOOK

SPRAYBERRY ACADEMY OF RADIO
 F. L. Sprayberry, President
 520-F University Place, N. W.
 Washington, D. C.

Please rush my FREE copy of "HOW TO MAKE MONEY IN RADIO."

Name
 Address
 City State
 (Mail in envelope or paste on penny postcard)



YOUR ONE DEPENDABLE SOURCE OF SUPPLY... Your ALLIED Catalog!

Radio plays a big part in our march to Victory. American radio must stay to top efficiency in the home, in factories, in research labs, in instruction centers. You can help serve on ALLIED radio front by depending on ALLIED for everything in Radio. Your ALLIED Catalog has everything—Radio Receivers; Test Equipment; PA and Intercom Systems to speed up production; 15,000 Parts for service replacement work, for industrial and search application; Tubes, Books, Tools—backed by complete stocks and speedy service. Keep your ALLIED Catalog handy!

SEND FOR YOUR FREE COPY NOW!

ALLIED RADIO CORP.

ALLIED RADIO CORP.
 833 W. Jackson Blvd., Dept. 2-F-42
 Chicago, Illinois.

Send me your FREE 1942 Radio Supply Catalog.

Name
 Address
 City State

STABILIZED FEEDBACK

for

Radio Transmitters

H. S. BLACK*

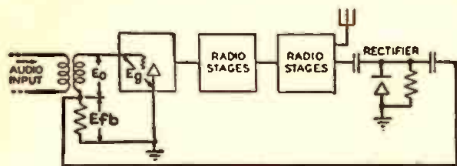

Feedback returns to the input a portion of the output in reverse phase, and in this way cancels part of the output noise and distortion.

FEEDBACK is the action which may take place when a portion of the output of a transmission device, such as an amplifier, is returned to its input. The feedback can be either positive or negative, that is, in a direction either to increase or to decrease the amplification. Stabilized feedback employs the negative feedback principle in a new and revolutionary manner to actually control the properties and characteristics of wave transmission systems.

If to a typical vacuum tube amplifier fed from a source of input waves to be amplified, we add a suitable path for returning some of the output wave to the input, the waves appearing on the grid of the first tube come from these two circuit branches. Thus there are three waves to be considered in relation to the input side of the amplifier: the incoming or signal wave; the feedback wave; and the voltage wave on the first grid, which is the algebraic sum of the first two.

A primary consideration, of course, is whether the feedback wave is positive or negative. Both types of feedback have been utilized heretofore. The principal use of negative feedback has been, until the advent of stabilized feedback, in the "neutralization" of radio frequency amplifiers, to overcome the inherent tendency toward self-oscillation due to positive feedback through inductive or capacitive coupling of elements of the input and output circuits. These effects become more pronounced as the frequencies become higher and are often of such a nature as to place a definite limit on the amount of amplification that can be utilized.

Negative feedback as heretofore commonly applied in radio frequency amplifiers has had as its purpose the reduction or cancellation of inherent positive feedback. If the negative feedback is increased from an infinitesimal amount in any given case, it reaches its optimum value in opposing positive feedback when it just equals the positive feedback. At that point the amplifier is a strictly unilateral circuit having no feedback, positive or negative.

In contrast to the use of negative feedback as discussed above, the stabilized feedback amplifier employs negative feedback in much larger amounts and for a different purpose. For stabilized feedback the negative feedback is increased to a value where it not only equals but greatly exceeds the amplitude of the wave that is effective on the first grid.

Thus a small wave effective on the grid controls a cycle of operations involving waves of much greater magnitude. Far from resulting in liability to self-oscillation, a technique has been discovered whereby the greater the negative feedback ratio the more exact is the correspondence in all respects between the output wave and the incoming wave, so that it may be said that

Here is an authoritative article written by the inventor of the feedback type of amplifier. Mr. Black has participated in the development of many phases of carrier telephone systems, including repeaters and line filters. He is in charge of a Bell Laboratories group devoted primarily to carrier amplifier development.

the more complete is the control of the output wave by the incoming wave.

The following example will be helpful in illustrating how stabilized feedback in an amplifier improves the fidelity characteristics.

It is generally accepted that the amplified signal wave in the output of an amplifier is accompanied by distortion produced in the tube, and as the signal output is increased, the percentage of distortion will increase.

In a simple system to which feedback can be applied but with no feedback wave, there is a given amount of output signal and a given amount of unwanted distortion. If, now, negative feedback is gradually introduced in an increasing amount and at the same time the incoming signal is increased by an exactly corresponding amount, the voltage effective on the grid due to the signal alone remains unchanged, and, therefore, the signal output remains unchanged in amplitude. By virtue of the negative feedback, however, some of the distortion is being fed back to the grid in such sense as to reduce the distortion appearing in the output. The result is less distortion with no diminution in signal output, a new improvement in linearity of the circuit.

The apparatus for increasing the negatively fed-back wave might be visualized as an amplifier of variable gain. Likewise, the apparatus for producing a corresponding increase in the signal input may be thought of as an amplifier of variable gain. Since the coordinated changes assumed to take place in these two amplifiers are a simultaneous increase in their amplifications by exactly equal amounts, the next step is to visualize these two amplifiers as one and the same amplifier through which both the incoming signal and the feedback wave are transmitted. This amplifier can be pictured as introduced just ahead of the existing amplifier, but after the junction of the incoming and the feedback circuits.

Thus the distortion in a given circuit can be reduced relative to the signal by first adding a negative feedback and then adding to the total gain of the amplifier, still keeping the amplitude of the signal effective on the grid of the final tube the same as before and, consequently, the signal output the same. In other words, the gain in the

amplifying path is increased but the increase is nullified by a negative feedback.

The more important transmission features obtained by the use of a stabilized feedback circuit are:

1. Improved stability of gain and amplification.
2. Improved modulation.
3. Improved linearity (gain independent of input).
4. Improved and stabilized impedances.
5. Improved phase shift.
6. Reduced phase distortion.
7. Reduced variation of gain with frequency.
8. Reduction of noise generated within the amplifier or from power supply circuits.
9. The possibility of delivering constant voltage or constant current to a varying load or output impedance.
10. Reduction in the susceptance of the circuit to external fields or interference.
11. Improvement in load carrying capacity.
12. Practicability of using less precise and hence usually cheaper circuit parts without sacrifice of performance or reliability.

BIBLIOGRAPHY

Articles on Stabilized Feedback by
Bell System Engineers

REGENERATION THEORY by H. Nyquist *Bell System Technical Journal*; January, 1932; p. 126.

STABILIZED FEEDBACK AMPLIFIERS by H. S. Black *Electrical Engineering*; January, 1934 p. 114.

FEEDBACK AMPLIFIERS by H. S. Black *Bell Laboratories Record*; June, 1934; p. 290.

STABILIZED FEEDBACK by H. S. Black *Pick-Ups*; July, 1936; p. 12.

STABILIZED FEEDBACK FOR RADIO TRANSMITTERS by L. G. Young *Bell Laboratories Record*; February, 1937; p. 182.

STABILIZED FEEDBACK OSCILLATORS by G. H. Stevenson *Bell System Technical Journal*; July, 1938; p. 458.

THE APPLICATION OF NEGATIVE FEEDBACK TO FREQUENCY MODULATION SYSTEMS by J. G. Chaffee *Proceedings of the Institute of Radio Engineers*; May, 1939; p. 317. *The Bell System Technical Journal*; July, 1939; p. 404.

FREQUENCY MODULATION—THEORY OF THE FEEDBACK RECEIVING CIRCUIT by John R. Carson *Bell System Technical Journal*; July, 1939; p. 395.

—Pickups

*Member, Technical Staff, Bell Telephone Laboratories.

Saturable Reactor Tuning Indicator

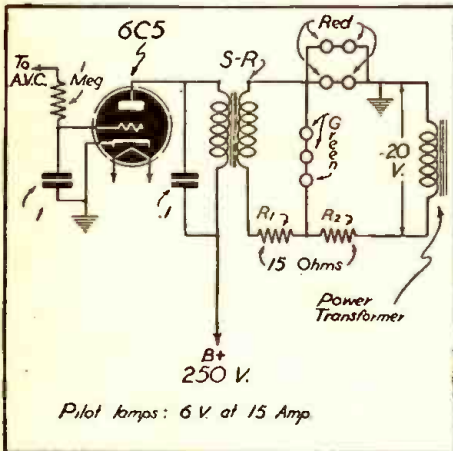

CERTAIN receivers manufactured several years ago by G.E. employed "saturable reactors". A saturable reactor is a device which has the property of changing its series impedance when direct current is applied. A coil having an iron core and A.C. current flowing through it will oppose the flow of A.C. due to its impedance. By sending a direct current through that coil or by varying the intensity of that direct current, the opposition of the coil to A.C. can be controlled. The effect of the D.C. is to "saturate" the core, filling it with magnetic flux lines, so that beyond a certain critical point the core will be incapable of absorbing any more lines of force.

In the G.E. tuning unit, the D.C. flows in a primary coil and the A.C. flows in a secondary. When the D.C. is increased, the primary inductance and impedance are decreased. This lowered value of primary impedance is reflected into the secondary and

the secondary impedance becomes lowered. As a result, it shunts the green pilot lamps. The shunting effect is limited, however, by R1, a 15-ohm resistor. Off resonance, then, with the A.V.C. bias on the 6C5 lowered the 6C5 plate current and the primary current in S-R is high and the impedance of the primary low. The green pilot lights, therefore, are not brightly lit, but the red are. This is true since the green lamps have a low-resistance shunt and the current in the red lamps increases due to the low-voltage drop across the green lamps and the application of a higher voltage to the red lamps.

On resonance, the A.V.C. bias applied to the 6C5 causes an increase in the primary impedance of S-R, since the 6C5 D.C. current is reduced and the core saturation is similarly reduced. As a result the inductance of the secondary increases and its impedance also increases, causing a smaller shunt effect across the green lamps. As the shunt across the lamps is of increased resistance, the current goes through the lamps and they light more brightly. The series current required for the green lamps to light is .15 ampere and is .3 ampere for the red lamps, since the red lamps are in parallel. Therefore, although the green lamps receive sufficient current on resonance, the red lamps do not. The green and red are, effectively, in series at resonance. If .15 ampere flows in each green lamp, .075 ampere flows in each red lamp. The reds may glow dimly but the green will be much brighter at resonance.—Willard Moody.

F.C.C. ORDERS REGISTRATION OF DIATHERMY MACHINES

Washington, May 17—All owners of diathermy apparatus, including dealer stocks, must register each such device with the Federal Communications Commission by June 8, that agency announced today.

A spokesman of the F. C. C. stated that this step was being taken as a wartime security measure, as such apparatus can easily be converted into short-wave radio transmitters. It is suspected that some diathermy apparatus are being so used by Axis agents to signal German submarines lurking off the Atlantic Coast valuable information regarding the movements of United Nations shipping.

Diathermy apparatus resemble floor-model radios in appearance and are used by physicians, osteopaths and physiotherapists for the treatment of various ailments. They are designed to generate radio frequency energy and operate in such manner that patients may be treated for internal disorders by generation of heat within their bodies.

It is estimated that there are 100,000 diathermy apparatus throughout the United States, mostly in the hands of professional persons, while a considerable proportion is owned by individuals for private use. There are some portable models and, of the total, a few are not factory made.—N. Y. Herald-Tribune.

SEVERAL GOOD IDEAS

When you are anxiously waiting for a program and something blows out in your radio, it can sometimes be repaired temporarily with a few odd parts.

The carbon rods from flashlight batteries have a resistance of about 50 ohms and may be converted to resistors by the addition of a grid grip at each end.

If more resistance is needed, clean out a tall pickle jar and fill with distilled water. Attach a small piece of metal to the end of a piece of rubber covered wire and drop it to the bottom of the jar. Hang another piece of wire over the edge of the glass for the second connection. If the jar is clean and the water is distilled, the resistance will be quite high. Adding small amounts of vinegar or lemon juice will lower the resistance. This arrangement may also be used for a volume control.

Almost all capacities can be had by adjusting a variable condenser to the right value. It might be a good idea to calibrate a variable condenser for emergencies.

For R.F. chokes use the base of the old one and scramble wind a few hundred turns of number thirty or twenty-eight wire around it.

Broken tube sockets can be repaired with cellulose cement or even with nail polish.—Franklin Williams.

SERVICE MEN HAVE BOUGHT OVER 100,000 SUPREME TESTERS

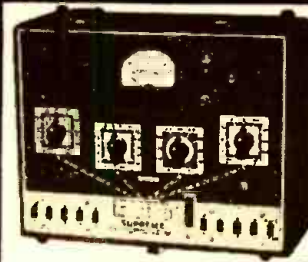

Be sure you see the complete SUPREME line before you purchase new test equipment. See your Jobber or write for new catalog.

WRITE FOR
NEW CATALOG
AND PRICES

SUPREME
TESTING INSTRUMENTS

GREENWOOD,
MISSISSIPPI
U. S. A.

DATAPRINTS



TESLA-LOUDIN COILS

- 20c Ea. in order for 10 (Data and Drawings only.)
- 86" Sp'k Tesla-Oudin Coil 40c (1 K.W. Exc. Trf. Data incl.)
- 8" Sp'k Tesla-Oudin Coil 40c (1/2 K.W. Exc. Trf. Data incl.)
- 3/4" Sp'k Oudin; 110 Vt. "Kick Coil" type.....40c
- 3" Tesla Works on Ford Coil.....40c
- 1" Sp'k Vibrator Hi-Freq. Coil 40c

NEW! 5 ft. Sp'k. Oudin Coil & Exciter
Data75c



Induction PIPE & ORE LOCATOR

Induction Type, Data40c
Radio Type40c

More DATAPRINTS 40c each!

- 5 Meter Superhet.
- 3/4 Meter Tr. & Rec.
- 20 A.C. Probs. & Ans.
- 20 Telephone Hook-ups
- 100 Mech. Movements
- 20 Motor Hook-ups
- Television Hook-up
- 20 Elec. Party Tricks
- Solenoids and Magnets
- get list.
- Fry Eggs on Ice!
- Experimental Photo- phone
- Radio Control for Models
- Diathermy Apparatus
- Inductor Organ
- Electric Refrigerator
- Wheatstone Bridge
- Weld. Transf. 2 K.W.
- Rewinding Armatures
- String Galvanometer
- 20 Simple Bell Circuits
- Steel Wire Recorder!
- Water Wheels
- Water Turbines
- Photo Cell and Relay
- Ring 4 bells; 2 Wires
- 20 Tesla Tricks
- Polarized Relay
- Induction Balance
- Electric Pipe Thawer

Special Prices: 4 prints \$1.00; 10 for \$2.00; Single, 40c each. Get New Catalog 100 A.

The DATAPRINT Co.

Lock Box 322D, Ramsey, N. J.

Complete Plans

For Building Useful and Practical Things at Home. Each issue of Popular Homecraft is crammed with plans for making such beautiful and useful things as: Furniture, Bird Houses, Lamps, Outdoor Garden Furniture, Candles, Equipment, etc. Covers lathe work, tools, wood-working, leathercraft, copper. You'll find "how" to make almost everything from the pages of Popular Homecraft. Scores of drawings and photographs make every step simple as A B C. A real "How-To-Do-It" magazine.



Six Months' Trial \$1.00

Send \$1.00 today for trial six months' subscription. Money Back If Not Delighted.

POPULAR HOMECRAFT

937 Palmolive Building Chicago, Ill.

Trial 6 Months \$1.00

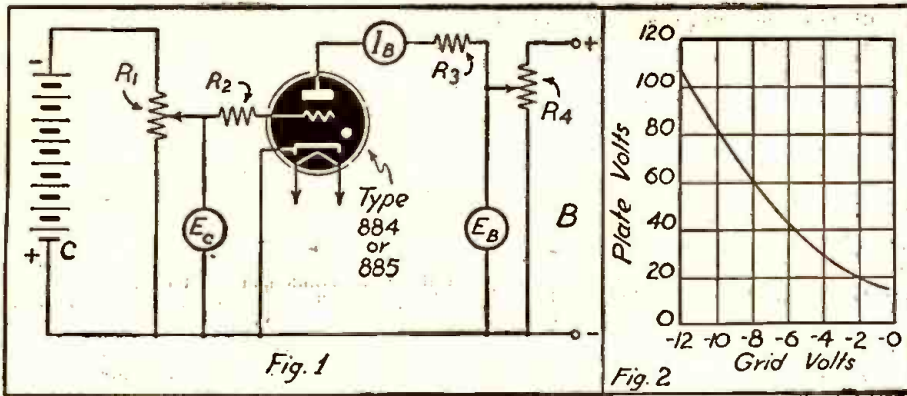

The Student Designer and Experimenter will find valuable information in this lucid explanation of gaseous triodes and their behavior.

The circuit diagram in Fig. 1 shows how to obtain a characteristic curve for grid-controlled gaseous tubes. Unlike high-vacuum tubes, the Thyatron grid serves only as a trigger, causing the tube to conduct, or fire. The curve of Fig. 2 shows the minimum grid and plate voltages necessary for starting conduction, and is obtained by successive tests. Before applying plate voltage to the tube, let the heater warm up for several minutes. R_1 and R_4 are potentiometers across the battery supplies and may be any convenient values. R_2 should be 1000 ohms for each volt of grid potential applied ($1000 \times E_0$). R_3 may be several thousand ohms.

How to Determine THYRATRON Characteristics

JONATHAN S. LEE, W8CQP

MANY vacuum tube experimenters of the home-grown variety and many amateurs, who have experimented for years with many types of vacuum tubes—diodes, triodes, pentodes, cathode-ray tubes, and multi-elements tubes—have never taken advantage of the remarkable features available in *gas-filled triodes* which are called thyratrons.

Thyratrons have many novel and useful applications in the fields of electrical control and industry. These tubes can be used as rectifiers to change alternating current to direct current, inverters to change direct current to alternating current, relays for opening and closing circuits, saw-tooth wave generators for cathode-ray tube sweep circuits, control devices in electric welding circuits, and stroboscopes.

The unusual action which occurs in a three-element, gas-filled tube is due to the presence of a small amount of gas intentionally injected into the tube during the process of manufacture. This gas may be either mercury vapor or one of the inert (chemically inactive) gases. Argon is often used because it is an inert gas and therefore does not react chemically with the electrodes of the tube. It also has a relatively low molecular weight and ionizes, or loses one of its outer electrons, at the relatively low potential of 15.69 volts. All of these three items are advantageous.

IONIZATION BY COLLISION

In operation, the heater of a thyatron is connected to an alternating current supply. Electrons are emitted from the cathode at different speeds and are accelerated towards the positively-charged plate. If the energy of these moving electrons is sufficient, the emitted electrons will knock an outer electron from its position in an argon atom or molecule. This process is called *ionization by collision*. The positively-charged argon ion is a by-product of this action. The argon ion moves towards the negatively-charged cathode while the "knocked-off" electron joins the emitted electrons on their way to the plate. All of this occurs if the grid potential is such as to permit electrons to flow freely from the cathode to the plate.

The tube is then said to be *conducting*. But if the grid is sufficiently negative and the plate voltage not too high, no electrons will flow.

The action of the grid in a thyatron is different from the grid action in a high vacuum tube. In the latter, the grid may start, or stop, or vary the magnitude of the plate current in any manner. In the thyatron, the grid may start the current, but it cannot stop it or change its magnitude. As a result, the thyatron acts similarly to an electro-magnetic relay—it can start or stop the current in an external circuit to which the thyatron is connected, *providing* that the proper external variation occurs.

CURVE NEEDED

In designing a circuit in which the action of a thyatron is to be utilized, it is necessary to know the voltages of the grid and the plate which the tube will conduct or "fire." This depends to a large extent upon the resistance of the plate and grid circuits. For a given tube and circuit there are a number of pairs of grid and plate voltages at which the tube will fire. Experimental information concerning the electrode voltages may be plotted to form a grid-control characteristic curve. From this curve any intermediate values of grid and plate voltage may be read for the same values of grid and plate circuit resistance.

To obtain a grid-control characteristic curve, the designer or experimenter may use the circuit diagram given in figure 1. The thyatron may be either a type 884 or a type 885. These two types are similar except for the heater voltage. The 884 requires 6.3 volts A.C. at .6 amperes and the 885, -2.5 volts A.C. at 1.4 amperes.

The resistor used in the grid circuit should be 1000 ohms for each volt of grid potential. As the maximum grid voltage in the experimental circuit is 12 volts, a grid resistor of 10,000 ohms is a convenient value. The resistor in the plate circuit may have a different value than that indicated, but it should be large enough to keep the plate current within the limits of the tube

and the plate current meter. Several thousand ohms will suffice.

HOW TO PLOT CURVE

In order to obtain the data needed to plot a curve, first apply the heater voltage for several minutes in order that the cathode may be adequately heated. Next set the grid voltage at 12 volts *negative* and *carefully* and *slowly* increase the plate voltage from zero to a voltage at which the tube conducts or "fires." This will be indicated by a *pink glow* between the cathode and the plate, and by a *sudden increase in the reading of the plate current meter*. If the glow is used as a current indicator, the plate current meter may be eliminated from the circuit. However, the sudden "kick" of the pointer of the meter is a more accurate indication. The values of the grid and the plate voltage should be recorded just at the point where the plate current increases. Immediately reduce the plate voltage to zero and repeat the procedure for a grid voltage of 11 volts *negative*. Proceed by one volt steps until the grid voltage equals zero.

The data obtained by the above method is plotted on a sheet of ordinary graph paper with grid volts laid off to scale along the horizontal axis and plate volts laid off to scale along the vertical axis. A typical result is shown in figure 2. An analysis of this curve shows that for the plate and grid resistors used, the thyatron conducts in the region above the curve, and does not conduct in the region below the curve. Any vertical line drawn on the graph parallel to the plate voltage axis will be divided into two parts by the control curve. The upper part of this vertical line represents *conduction* through the tube. The lower part represents *no conduction* through the tube. At the intersection of the curve and the vertical line, the values of the grid and the plate voltages at which the tube will "fire" for the circuit constants used may easily be read from the graph.

An interesting variation of the experiment would be to change the value of the plate resistor slightly and determine how the variation causes the grid-control characteristic curve to shift on the graph.

Operating Notes

Trouble in . . .

PHILCO 1942 RECORD CHANGERS

Slippage at bell drive has been found in cases where the bolts holding trunnion bearing was stripped causing bearing to shift back.

PHILCO 1942 RECORD CHANGERS

Rasping noise as motor is running is caused by bell drive shaft hitting frame at base. Some holes were found off center in respect with bearing. Reversing bearing clears up trouble.

ZENITH 7G605

Ring sound (microphonics) as set is playing is caused in most cases by bad 1LD5 tube. Try several until you find the one least microphonic, as they have a tendency to be so.

PHILCO 42-1008

If you cannot pad high frequency antenna adjustment properly, remove padder and replace with one which has more capacity.

DETROLA RECORD CHANGER

Common complaint is failure to reject either manually or automatically. Under the large drive wheel you'll find the reject lever. It sticks and doesn't drop. Just loosen one turn on supporting screw and it will work OK. Also see that the drive belt doesn't slip.

MOTOROLA WR3 RECORD PLAYER

Continuous tripping is caused by failure of latch to hold. This latch has a small spring attached to it to pull it into place; increase tension of spring.

LEONARD CHIOMA,
Waterbury, Conn.

I would like to submit for *Radio-Craft* "Operating Notes" column some more service hints as follows:

PHILCO 1941 PHONO MODELS

If these models lose volume check the lead from set to phono transformer. Usually you will find the cable twisted shorting internal lead.

ZENITH 11S474

Set dead with about 150 V. negative on grid of tubes. Check candiohm resistor for open 40 ohm section. This is the H.V. center tap to ground.

ZENITH FM MODELS

Set works OK on standard band but dead on FM band. Replace the 1852 tube in FM circuit.

PHILCO 41-250

Automatic tuning will not work well on manual tuning. Change the dual 370 mmf condenser No. 21 on circuit diagram.

LEONARD CHIOMA,
Waterbury, Conn.

ATWATER KENT 84

When a loud hum or no reception occurs. Open electrolytic condenser mounted on top of chassis in a round cardboard container. Replace with 16 mf. 600 w.v. unit and normal reception results.

LADD MACDONALD,
Chester, Conn.

GRUNOW 532M

The cause of low volume and intermittent reception can be corrected by opening electrolytic condenser. Replace with 8 mf. 600 w.v. and check the by-pass condensers. These are quite often open, due to this break.

GRUNOW 532

Noise-crackling and popping and faulty volume control can be corrected by replac-

ing with new unit with cover. Old control open and dirty. Do not try to repair.

GRUNOW 532

Popping and high noise level is usually caused by defective pilot light and volume control.

GRUNOW 11B

When set cuts out after warming up, turn off power for a few minutes and then turn on again. This restores normal reception. The trouble is found in a defective electrolytic condenser mounted on top of chassis. Replace with a 16 mf. 600 w.v. unit.

SPARTON 25

Complaint: Intermittent and noisy reception. Pig-tail unsoldered on variable condenser. Replace with new flexible wire and connect so that it will not rub or catch on sides of condenser frame. Also check grid cap connections on these models, as some have been found to be the cause of such trouble.

STEWART WARNER 91-62

Low volume and hum can be corrected by replacing opening 8 mf. electrolytic condenser. Also opening Magic-Eye tube 6G5 will cause snapping and crackling noises.

PHILCO TRANSITONE A.C.-D.C.

Can't tune. Broken dial cord which should be replaced with a good strong cord.

When noisy and intermittent reception occurs, replace 35A5 tube and 35Z3 tube.

MAJESTIC "CHARLIE McCARTHY"

A loud hum in this set can be corrected by checking 25Z6 GT tube, and also checking the plate condensers. Ballast tube also needs replacing in this model quite often.

CROSLEY 167 "DUAL FIVE"

Low hum and no reception is usually caused by defective wire-wound resistor from 80 tube to ground. Replaced with a 10 watt 10,000 ohm unit, this trouble was cleared up. Also check tubes, as these have been found *shorted*. The type 57 was the one most commonly found defective.

GRUNOW CHASSIS TYPE 4-B

In this set, the 80 tube became red hot. The power transformer smoked and sized. Trouble found to be in defective electrolytic condenser strapped to chassis (bottom rear.) Replace with 16 mfd. 600 w.v. unit. Two of these models also required new tubes as result of this break down.

GENERAL ELECTRIC A-82 and A-87

Receiver smokes and no reception. On several of these models the following cause was found for the trouble. Smoke was seen coming from underneath the 6A8 tube located on the "SENTRY BOX". Examination revealed that the fault was in the coil assembly in the coil compartment directly underneath the 6A8 tube and the tuning condenser.

Complete unit may be dismantled from the chassis by removing side-fastening bolts, unscrewing the dial mechanism anchoring nut and unsoldering the leads to the chassis from the terminal strips. In order to remove the coil shield cans it is necessary to take out the frequency band switch shaft. With "SENTRY BOX" dismantled from chassis the dial gears may be disengaged and the switch shaft removed merely by lifting the reduction drive end of the dial assembly, allowing the switch gear to pass the dial scale cap shaft. If the "SENTRY BOX" is left mounted in place, removal of switch shaft requires removing the dial scale gear and cap shaft. Once the switch shaft is out, any coil assembly may be easily removed for inspection. The faulty coil assembly is the one nearest the front

of the chassis. After removal, for safest results, replace all condensers with .1 mf. 600 w.v. units and with a 1 watt 10,000 ohm resistor. The cause of all this trouble was found to be in this resistor.

PHILCO JR. 80

This set when turned on gave off a terrific amount of hum. Checking the electrolytic condensers revealed that the 8 mf. condenser was defective. Replacement of this was made with a new 8 mf. 600 w.v. unit. This condenser is No. 7558 on the schematic. The receiver then played but with no volume. Resistor No. 22 on schematic was found to be open, so a 1 meg. resistor was used as a replacement. The receiver then played normally except for a few dead-spots on the lower end of the band. Re-alignment of the set brought back full signal strength to the complete band.

FADA 5F50

Weak signal or none at all: This fault was traced to the Antenna coil. A new coil brought back normal reception.

ZENITH 6D315

When this set goes dead the built-in antenna is usually found to be shorted to the chassis through a loose wire. Removal of this wire cures the fault. This receiver may also be re-aligned for better results.

AIRLINE 14WG624

The complaint on this receiver was that it made a loud swishing noise no matter which way the set was turned. An outside antenna was connected and C2 the antenna trimmer was adjusted until this noise was completely balanced out.

This set has also been brought in *dead*. The pilot light should be replaced, and the leads to some of the resistors and condensers have been found shorting on each other. This may be easily fixed by moving the leads or by using spaghetti on the leads involved.

ZENITH 71, 72, 73, 77, 712, 722, 732, 772

Receiver brought in "dead." First check located defective fuse mounted on front of Power Pack. Receiver turned on after fuse was replaced and loud popping, frying and scratching noises resulted. The 80 tube on the power pack flared up inside and got very hot. Next check revealed that the three electrolytic condensers located on top of the power pack were defective. These were replaced as follows: (1) 16 mf. 450 w.v. and the other two by a 8x8 450 w.v. unit. The receiver then played normally except on the lower end of the band where loud howling and feed-back were encountered. New tubes and replacement of leads did not stop the noise, so the set was then balanced and the trouble removed.

To balance the set, the following method was used. In the rear of the var. condenser shield can are four holes. There is a hex nut located inside each of these holes for adjustments. For convenience these holes are numbered from 1 to 4. (From left to right receiver front facing you.) Set dial at 14 hundred kc. and after set is tuned to resonance, starting with No. 4 hole, turn hex nut slowly back and forth until loudest signal is heard. Should not be necessary to turn nut more than one half turn. Then do the same with No. 2 nut. No. 2 and No. 4 being grid circuit adjustments will be most critical. Next adjust No. 3 and last of all No. 1. These are less critical but an adjustment can be made for maximum volume. Finally peak No. 4 and No. 2. Set is then retuned to exact resonance with signal and if necessary, repeat the former adjustments. Any signal between 12 and 15 hundred kc. may be used.

(Continued on page 622)

LATEST RADIO APPARATUS.

BUY YOUR ECHOPHONE FROM HARRISON!

Model EC-1

The Echophone EC-1 offers all you could ever want in a moderate priced communications receiver, has all the features for good reception! Tunes from 550 kc. to 30 mc. on three bands. Six tubes. Electrical bandspread on all bands. Self-contained speaker. Operates on 115-125 volts, A.C. or D.C.



Model EC-2

You can have real communications performance with the Echophone Model EC-2. Three bands cover 550 kc. to 30 mc. Self-contained five-inch dynamic speaker. Preselection on all bands. Calibrated bandspread scale on 80/40/20/10 meter bands. Electrical bandspread at all frequencies in the tuning range. Operates on 115 volts A.C. or D.C.

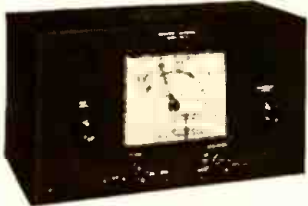

Model EC-3

The Echophone Model EC-3 will give you up-to-the-minute communications performance—read the features! Crystal filter (four position variable selectivity). Calibrated bandspread. Automatic noise limiter. Preselection on all bands. 2 stage I.F. amplifier. Fly-wheel tuning. Separate 6" PM dynamic speaker. CW Monitor. 10 tubes. 3 bands. Tunes from 550 kc. to 30 mc. Electrical bandspread. Operates on 115 volts A.C. or D.C.



HARRISON RADIO CO.

12 WEST BROADWAY, NEW YORK CITY

INDICATOR LIGHT

Littelfuse Incorporated
4757 Ravenswood Ave., Chicago

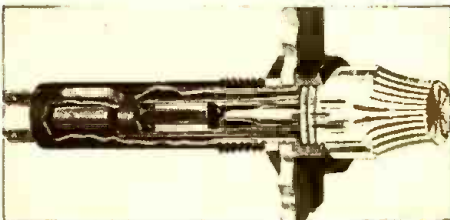

● A NEW indicator that lights only when the circuit is broken is announced by Littelfuse, Inc. It is listed as No. 1414, and is applicable to any circuits, circuit-breakers, line switches, etc.

When installed in connection with remote motor control it gives a visible signal to show "on" or "off." When the circuit-breaker opens the light goes on. It is obtainable for 24- or 48-volt filament lamps, with which no resistor is used. Otherwise, a built-in 200,000-ohm protective resistor is employed in series with a neon lamp. The resistor prevents the lamp from burning out on high-voltage surges. The neon lamp glows on currents as low as 100 micro-amperes.—Radio-Craft

WIDE-RANGE BRIDGE

Shallcross Mfg. Co.,
Collingdale, Pa.

● THE Wheatstone Bridge will do certain jobs of resistance measuring in an adequate manner.

Other measuring requirements are met best by using the Kelvin Bridge.

Since many instances in research and production involve problems that are varied and cover a wide range of resistances, the ideal resistance measuring instrument would be a light weight, sturdy and accurate, portable Bridge, combining in ONE instrument the features of both the Wheatstone and the Kelvin Bridges.

A new addition to the Shallcross testing and measuring instruments is the No. 638-1 Kelvin-Wheatstone Bridge. It has an effective range from 0.0001 ohm to 11,000,000 ohms. By using a source of current of considerable capacity (such as a single cell of a storage battery), resistances as low as 0.00001 ohm may be detected and measured.

The rheostat arm consists of four decades, variable in 1 ohm steps. The ratio arm has two sets of multipliers. The set designated "W" is for use in Wheatstone Bridge measuring and another set, designated "K," is for use when measuring with the Kelvin bridge method. A built-in galvanometer having a deflection of 1 mm/microampere is an integral part of the set. Should greater accuracy be required, a more sensitive external galvanometer may be used.

The instrument is sturdy and light in weight.—Radio-Craft

REPLACEMENT ELECTROLYTICS

Sprague Products Company
North Adams, Mass.



● A SERIES of tubular cardboard dry electrolytic, the new Sprague Type WR Wet Replacement Capacitors are now made for use in place of wet electrolytics which, due to their aluminum

thread-neck cans are unobtainable because of war restrictions. They replace also various aluminum can-type dry electrolytics, now no longer available.

Although standard dry electrolytic condensers can sometimes be used as wet replacements, the safety margin is likely to be insufficient in many applications. Sprague Type WR's have a much higher voltage formation than standard dries to insure their standing up under the high peak voltages which are impressed on wet electrolytics. They are built to handle the A.C. ripples that might cause standard 450-volt dry electrolytics to overheat to a point where they break down. The diameter of WR's is the same as that of standard wets so they will fit the screw-type can mounting holes. Their metal feet can then be soldered to the chassis for firm mounting. These units are now available in three sizes: WR-8, which replaces wet or dry electrolytics in capacities from 4 to 8 mfd.; WR-16, which replaces capacities from 12 to 18 mfd., and WR-25, which replaces capacities from 20 to 40 mfd.—Radio-Craft

SILVER MICAS

Solar Manufacturing Corp.
Bayonne, N. J.

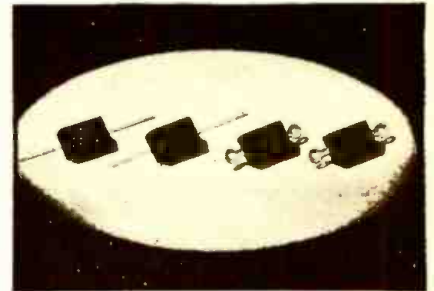

● THESE Solar Types MWS, MOS, MKS and MLS mica capacitors are recommended for use in frequency-modulation circuits and automatic tuning arrangements where an unusually high degree of stability is essential.

They are molded in low-loss Bakelite under controlled conditions. The silvering process assures permanent adherence of silver to mica, which is vital for long-term stability characteristics.

Strong, flexible tinned brass terminal leads are firmly secured to each section. They are made to withstand severe mechanical abuse. Type MLS is supplied with terminal lugs.—Radio-Craft

BLACKOUT SWITCH

Photoswitch Incorporated
21 Chestnut St., Cambridge, Mass.



● PUBLIC utilities, outdoor advertising concerns and retail stores faced with the problem of automatic black-out illumination controls will find this requirement met in the PHOTO-SWITCH Blackout Controls Types A28C and A16B.

These controls are an economical, reliable, and foolproof method for permitting illuminated billboards, store window displays, and other time-switch controlled illumination to remain in operation in districts where blackout regulations are in effect. They have already been formally approved by the blackout committees of many of the large Eastern cities and are being adopted by the leading outdoor advertising concerns.

In operation the units are located on billboards or in the store windows to be controlled. They are aligned with the nearest street lamp. When this centrally controlled street lamp is turned out, PHOTOSWITCH observes this and turns off the illumination which it is controlling. Another type controls lighted signs or other illumination primarily controlled through a time switch. In this case, the time switch contacts may be used to turn on and off the PHOTOSWITCH and the PHOTOSWITCH contacts may be used directly to control the illumination.

PHOTOSWITCH Blackout Controls are readily installed in any location within 100 feet of a street lamp. Alignment of the eye of the control with the street lamp is easily accomplished. The specially designed optical system on this unit makes it relatively insensitive to light from any source other than the street lamp which it is observing. A time delay is designed into the circuit of the control to make it independent of momentary fluctuation and flickering of the street lamp.—Radio-Craft

TRANSMITTING CAPACITORS

Aerovox Corporation
New Bedford, Mass.



DESIGNED for ultra-high-frequency radio transmitters, television and FM transmitters and other related applications in the ultra-high-frequency range, the new Type 1860 transmitting capacitor is readily adaptable for use as a fixed tuning capacitor, for by-passing, blocking, coupling and neutralizing, and as an antenna series capacitor. Losses are extremely low because of the highly refined sulphur compound utilized as the dielectric, the elimination of corona and the unique design and construction. The case is grounded and a single high-tension mica-insulated brass terminal is used. The aluminum case is 2" in diameter by 2" or 2½" high, and is provided with a mounting base with 2 holes for 10-32 screws. These units are available in .00001 and .000025 mfd. in 10,000 volts and .00005 mfd. in 5,000 volts.—Radio-Craft

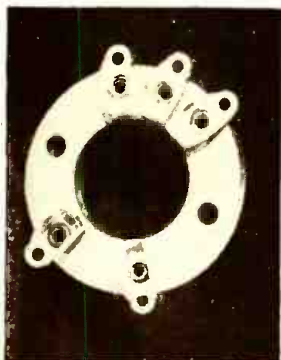

NEW SECTIONAL RESISTOR

Westinghouse Meter Division
Newark, N. J.

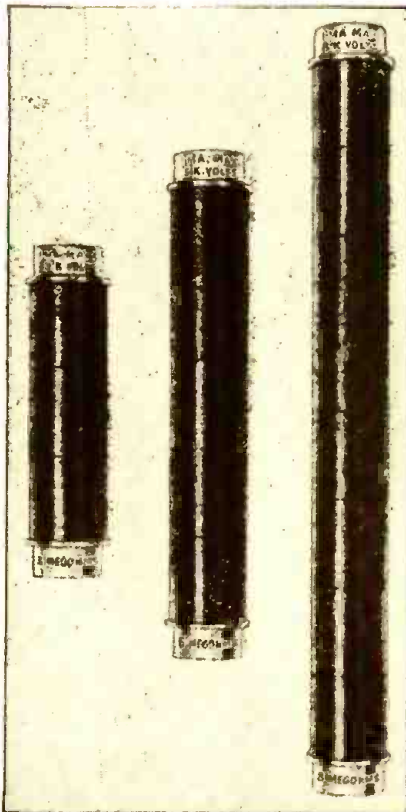

FOR use in radio circuits, power rectifiers and laboratories in measuring any high-voltage A-C or D-C circuit of 250 to 30,000 volts, the Westinghouse sectional resistors were designed to replace some of the older box-type resistors which had a high power consumption and were inconvenient to install or replace.

Made up of individual, hermetically sealed wire-wound units on a ceramic spool, the resistor units have values of from 0.25 to one megohm and a rated current of one milliampere. Dimensions are 1¾ inches by 1¼ inches in diameter per section. The ceramic spool is sectionalized, and adjacent sections are wound in opposite directions to obtain a non-inductive resistance.

Two nickel-plated brass shield cups are slipped over the spool before the outer cover is molded on. The cups, together with a phenolic retainer ring prevent the molded material from coming in contact with the spool during the molding process and also provide electrostatic shielding. Ends of the shield cup are tapped with a 10-32 thread. Units are connected electrically and mechanically by a 10-32 stud and mounting ferrules are held in place with a 10-32 screw.

Resistance is held within close tolerance, permitting interchangeability of units having the same voltage rating. When a number of sections are mounted on one shaft, permanent taps may be taken off between any two sections, permitting a multiplicity of resistance combinations on one complete unit. For switchboard mounting, insulators are available in 7.5, 15 and 30-KV sizes.—Radio-Craft

ACORN TUBE SOCKET

A. W. Franklin Mfg. Corp.
175 Varick St., New York, N. Y.

THIS socket was designed to meet the rigid specifications of Army, Navy, and Signal Corps for special applications. The ceramic is of approved Steatite, glazed on top and sides and is impregnated in a special wax to prevent moisture absorption. It has minimum electrical losses at ultra-high frequencies.

Contacts are of Tempered Phosphor Bronze heavily silver-plated to withstand 100-hour salt spray test, and designed to hold tubes with a minimum of insertion pressure under severe vibration tests. The contact jaws effect a "scissors hold" on the tube pin and assure electrical contact to the tinned portion.—Radio-Craft

FASTEST WAY TO LEARN CODE

Easy, Fascinating, LEARN by EAR
To Be a GOOD OP.

This New All Electric Master Telex Code Teaching Machine is exactly what thousands are looking for. No experience needed. Ideal for beginners—steps up WPM for ALL Ops. There is no guess work with Master Telex, because it records your sending in visible dots and dashes by a brand new method on a specially prepared tape. There are NO PERFORATIONS, NO INK. Far Superior to anything ever developed. A marvel of simplicity. You SEE and HEAR exactly how you are making your signals. You learn the code the way you'll be using it—by SOUND. That's why practically every school teaching code uses TELEPLEX. Complete course included at no extra charge. Used by many schools for teaching code. Low cost; easy terms. MONEY BACK GUARANTEE. Send now for booklet RN6, no obligation. Postcard will do.

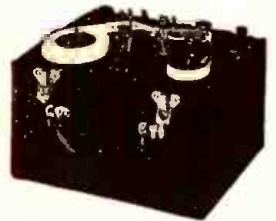

TELEPLEX CO. 107 HUDSON ST.
JERSEY CITY, N. J.

LAWRENCE SLIDE RULES

With A, B, C, D, CI and K Scales

FEATURES: Nickel Silver Framed Indicator with integral friction springs. Scales calibrated directly on well seasoned wood. Will retain accuracy regardless of temperature or humidity changes.

Instructions and illustrations of primary operations clearly printed on back of rule for ready reference or teaching. Each rule in a durable pocket carrying case for convenience and protection.

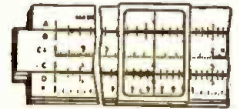

The extremely low price of these slide rules and their absolute accuracy makes them ideal for the student as well as the working man who has always wanted to learn to use a slide rule. No. 456 Price..... 25c each, 5 for \$1.00.

LAWRENCE 10 inch white-enamelled slide-rule with clear glass magnifier, in black case. Price, including 28-page instruction book..... No. 457... 60c

Secret Code Slide Rule, with 20-page book No. 458... 30c (2 for 50c)

28-page illustrated book of instructions, postpaid No. 459... 15c

GOLD SHIELD PRODUCTS

350 Greenwich St. (Dept. RC6) New York City

RADIO

CATALOG NO. 58

164 PAGES
SETS-PARTS
SUPPLIES
FLUORESCENT

Burstein Applebee Co.

BIG FREE CATALOG

EVERYTHING IN RADIO

Sets, parts, supplies, public address systems, amateur equipment, testers, kits and fluorescent lighting at lowest prices. Huge stocks, bought months ago... ready for shipment the same day your order is received. The Defense Program is making big demands on our industry but because of our advance buying we are able to fill your orders promptly and efficiently.

PACKED WITH VALUES!

BURSTEIN-APPLEBEE COMPANY
1012-14 McGEE STREET, KANSAS CITY, MISSOURI

Do you need BINDING POSTS?

The XL PUSH POST with its Spring Action assures Constant Contact and quick connection.

Manufactured in All Aluminum Type M at 12c each.

Aluminum Body, Bakelite Top Type B1 at 15c each.

Types CP or NP. ALL BRASS-STAINLESS STEEL SPRING & PIN. PROVEN by 240 HR. SALT SPRAY TEST as NON-CORROSIVE at 28c each.

Manufacturers and Dealers Liberal Discounts

X. L. RADIO LABORATORIES
420 West Chicago Ave., Chicago, Ill.

MAKE OLD RADIOS NEW

You can learn quickly to modernize all sets. No more new radios. Cash-in by improving audio circuits, modernizing cabinets, adding features usually found on late model sets. Practical job-sheets with schematics and photographs make the work easy. Complete, 8½ x 11 inches, manual, only \$1.00, post-paid. Money back guaranteed.

SUPREME PUBLICATIONS
3727 W. 13th Street, Chicago, Ill.

•SERVICING•

FREE!

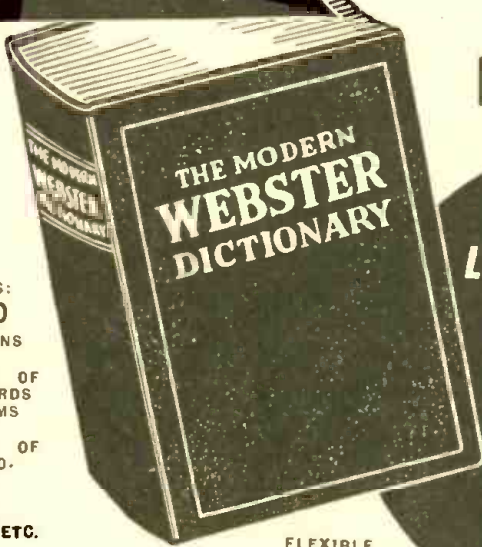

CONTAINS:
22,000
DEFINITIONS
•
DICTIONARY OF
RADIO WORDS
AND TERMS
•
DICTIONARY OF
THE AUTO.
MOBILE
•
TABLES,
TREATISES, ETC.

FLEXIBLE
IMITATION
LEATHERETTE
COVER, SIZE 5 1/2"x8"

with \$1.00 subscription
to

RADIO-CRAFT

FULL
LIBRARY SIZE
MODERN
WEBSTER
DICTIONARY
416
PAGES

FILL OUT—MAIL THIS COUPON TODAY!

If you will take advantage NOW of our special subscription offer of eight months for \$1.00, we will send you ABSOLUTELY FREE and POST-PAID this 416 page full library size MODERN WEBSTER DICTIONARY—useful and instructive to everyone. This self-pronouncing authoritative dictionary—a new work throughout—contains the most up-to-date words now in common use, 22,000 definitions in all. It also features a Glossary of Radio Words and Terms, Dictionary of the Automobile, Treatises on Practical Syntax, Etymology, Punctuation and Standard English by well known authorities, Metric Tables, Time, State Flowers, National Parks of the U. S., etc.

This is a time limited offer, so don't delay in returning the Coupon.

RADIO-CRAFT

25 WEST BROADWAY NEW YORK CITY

RADIO-CRAFT, 25 West Broadway, New York, N. Y.
 This is a New Order Extend my Present subscription
 Gentlemen: Enclosed you will find One Dollar for which enter my subscription to RADIO-CRAFT Magazine for Eight Months. Send me ABSOLUTELY FREE and POST-PAID, my copy of the MODERN WEBSTER DICTIONARY.
 Name
 Address
 City State RC-6-42
 (Remit by check or money order; register letter if you send cash or unused U.S. Postage Stamps)

SPECIAL

ABC OF TELEVISION
 Contains latest material on Television developments. It covers theory of scanning; how the eye sees; the photo-electric cell; neon lamps; hood for broad channel width in transmission signals; cathode ray tube and television receivers; Farnsworth system of television transmission; and other important features.

SHORT WAVE GUIDE
 Covers hundreds of short-wave questions and answers; illustrates popular short-wave links; gives explicit instructions for building simple short-wave receivers; instruction on the best type of antenna installation; diagram and construction details for building transmitters.

S. W. RADIO QUIZ BOOK
 This book covers questions and answers on transmitters, short-wave receivers, practical links, wrinkles and technical winding data; novel hook-ups for experimenters; how to "hook-up" converters, noise silencers, power supplies, modulators, beat oscillators, antennas, proselators, 5-meter receivers.

Popular Book Corp.,
 25 W. Broadway,
 New York, N. Y.
 Gentlemen:
 Enclosed you will find remittance for 75c (cash, now U. S. stamps or money order accepted) for which please send me at once your 3 books
ABC OF TELEVISION **SHORT WAVE GUIDE**
SHORT WAVE RADIO QUIZ BOOK
 Name
 Address
 City State RC-6-42

OPERATING NOTES

(Continued from page 619)

... **SPEAKER ADJUSTMENT** for the above models
 On some of these models the speaker cone gives off a terrific rattle and buzz. Remove ring, then cut cone out carefully with sharp knife or razor blade. This is sometimes necessary so that all of the dried ring can be cleared. The cone may then be replaced and cemented in place with dope.

Speaker may also be re-centered for better results. (Clean speaker carefully before replacing cone.)
 If a loud howl prevails, and nothing else helps, moving the speaker back a couple of inches from the front of the cabinet often eliminates this trouble.
LADD MACDONALD,
 Chester, Conn.

Short-Wave Reception on a Midget Set

SOME time ago, I needed a temporary amateur receiver, and after some experimentation, found the set described here to be quite effective, not only for the amateur 160-meter range but also for the police calls and other stations in this range.
 If you have, or can get a small midget radio that has a stage of R.F. and a detector, it is possible to convert it into a good short-wave receiver. By "good", is meant one able to receive low-power phone stations with a 100-ft. antenna. The ordinary midget radio is almost dead on the 160-meter phone band because it does not regenerate at the higher frequencies. It does receive some but not anywhere near as good as the one to be described, which makes use of a link coupling regeneration control.

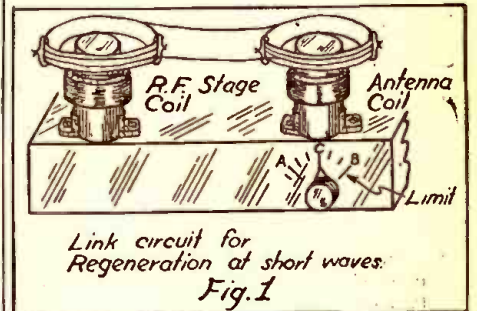

The link circuit of Fig. 1 can be permanently installed on a pair of uprights provided next to each coil. These could be soldered to the chassis or arranged to be held to the chassis with machine screws and nuts. The exact construction is not important and will vary perhaps with the individual case.

My link was simply 12 turns of wire at each end, separated from the windings of the coils by one half inch all around. Ordinary insulated hook-up or other wire could be used, the coils of the link being formed by tying the turns together with cotton string. The coils can be of any desired kind.

The link is simply a continuous length of wire with two coils, one at each end. This can be made of a length of hook-up wire, the two ends being joined together.

An important factor is the direction of the winding of the coil at one end of the link circuit. If the receiver does not squeal or give a click, indicating the start of oscillation, up one of the coils, turn it over and put it back in place. The receiver should then oscillate easily.

In Fig. 1 the volume control knob is shown. Three positions of the knob are indicated. Position B is maximum volume. After you have found the proper coil direction, move one of the link coils up and down for the proper position at which oscillation begins. If oscillation should start at point A on the volume scale, move the coil up until the oscillations close. Then leave the coils there or fix them in place, by arranging small dowel rods on top of the chassis extending upwards to the coils.

- ... **DETROLA 168**
 Dead—Open in the power cord. Replace with 200 ohm unit.
- ... **EMERSON 8N206**
 When set goes dead or has intermittent reception, open lead is indicated in the Antenna Coil. Replace with new coil.

2 Tubes = 5 in This Receiver

WM. J. VETTE

By utilizing dual purpose tubes in a new and cleverly developed circuit, the author causes 2 tubes to do the work of 5, and under some conditions 7.

YES, it is possible, although it may seem a bit far-fetched, to build a little set with only two tubes, in which these two tubes perform the functions of seven single-purpose tubes!

A glance at the diagram will show that the circuit is actually that of a set using four tubes, but by making use of the 3A8GT tube, only two tubes are needed to perform the four functions, as these tubes are in reality two separate tubes in one glass envelope. Then, by careful use of regeneration in two stages, the efficiency is increased to the point where seven different tube functions are carried out.

Let us analyze the circuit and see if we can find where the extra three tubes are hidden:

In the first tube envelope we find that the functions of a super-heterodyne first detector and oscillator are combined. So we have two tubes accounted for here. But wait . . . the first detector is regenerative . . . and we find that the increased gain and selectivity will approximate that obtained with an additional tuned R.F. stage using a high gain tube. So let's take credit for an extra tube in this stage; we have found three of the tubes so far, and only one of the two actual tubes has been considered. Do you think we can make the next stage do the work of four more tubes? Let's see what takes place there.

In the next stage we have a conventional I.F. amplifier circuit . . . this only accounts for one more tube, so let us consider the triode section of the tube. This is hooked up as a regenerative second detector, and brings our total tubes found so far only to five. But wait, we said it was regenerative . . . this might stretch the tube's functions a bit if we consider it more closely. The regeneration would of course make it possible to receive code, or CW, signals, and otherwise we would need a separate beat oscillator tube to make this possible, so we have *six tubes* now. The *seventh* is found the moment we take note of the fact that, as in the case of the first detector, the regeneration introduced so increases the gain and selectivity that the effect of an additional amplifying stage is had. And there we have the *seven** tubes, though only two of them show in the photographs.

In building this little set, very small parts, of the very highest quality, were chosen, to allow of a small, compact layout in keeping with the fact that although most of the parts, except tubes, of a seven tube set are needed, only two actual tubes are used, and the layout could easily become bulky and awkward, with inefficiency as the result.

LAYING OUT THE PARTS

Before starting to build the set, obtain all of the parts, and lay them out approximately as shown in the photos; I used an aluminum sub-chassis base, but due to the present unavailability of that material the constructor may have to find a substitute, such as an old chassis from some other receiver, etc. For this reason, I will not give any hard, fast dimensions or detailed layouts, other than to mention that the chassis shown measures slightly less than 4"x6"x1½" high, to allow mounting in a standard 4x6 steel file cabinet, easily had at any dime store. The photos show the set enclosed in this cabinet.

Before mounting all of the parts, it is necessary to make some alterations of the second I.F. transformer. Remove the coil and trimmer assembly from the case very carefully, and take the grid (white with green tracer) lead down to the bottom, instead of up through the top of the case. Then add the tickler or *regeneration* winding. This consists of between 40 and 50 turns of number 30 wire, insulated, wound between the upper transformer coil and the trimmer assembly. You will have to unsolder all of the

*The editor considers it best to evaluate the line-up as equivalent to five tubes, as the gain may not be apparent under all conditions.

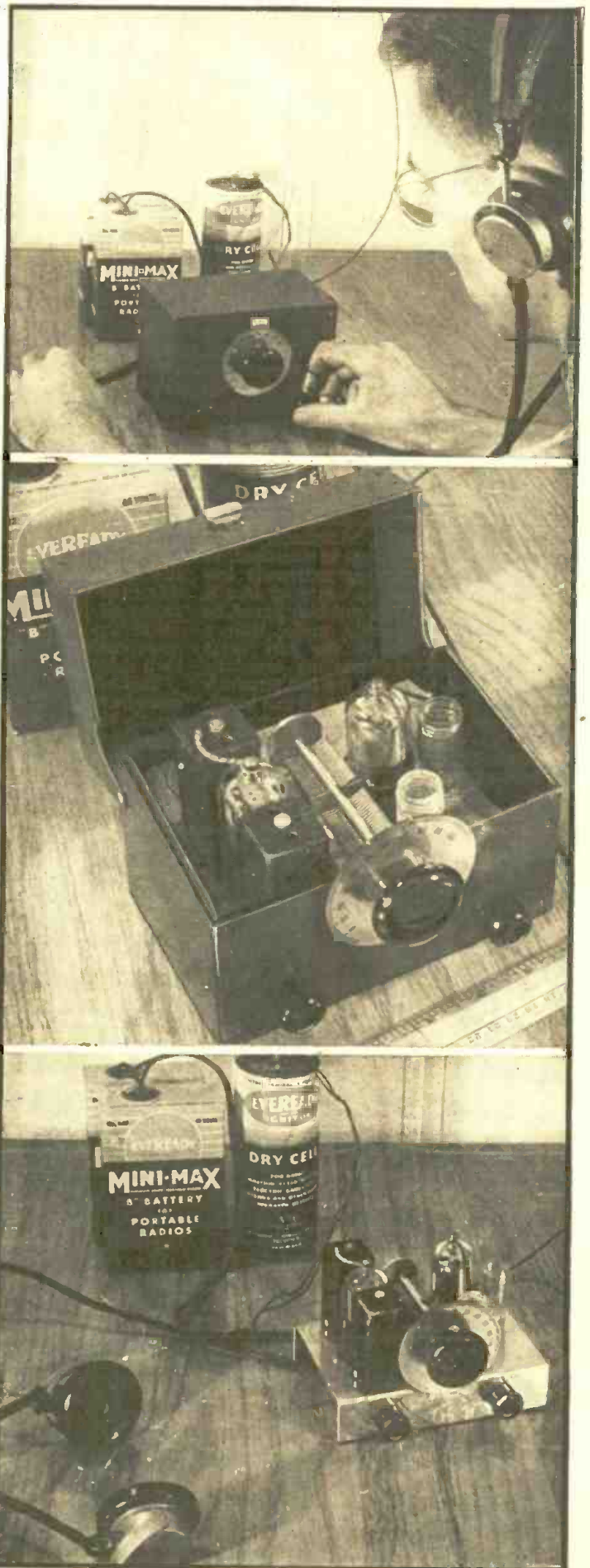

Photos above show the "2 in 5" receiver in operation. Center—the receiver cabinet with lid open. Lower photo—view of chassis and headphones.

wires going to the trimmers from the coils before winding this coil, and this should be done with extreme care. Make sure all of these wires are connected again before replacing the coil in its case. After winding the tickler, cover it with the coil dope (Amphenol 912-A) given in the parts list, and let dry hard before touching. Bring the tickler leads down through the bottom of the case through pieces of small spaghetti tubing, long enough to protect the wires clear to their points of connection to the circuit.

In wiring the set, do not make any ground connections directly to the chassis. Run a length of heavy tinned bus bar from one end of the set to the other, and make all grounds to this bus. When some part is automatically grounded to the chassis by means of its mounting screws, ignore this ground, and run a separate wire to the main bus. Greatly increased stability results from this precaution, as the chassis is not called upon to carry R.F. currents, and strays are much more easily confined through the shielding of the various parts.

In making soldered connections to the coil sockets and tube sockets, made of the new ultra-low-loss material, Amphenol Polystyrene, extreme care must be exercised, as this material possesses an extremely low melting point. Be certain that your iron is quite hot and very clean and well tinned, so the joint can be quickly made, with a minimum of heating of the part being soldered. These precautions are especially important when soldering the coil terminals on the coil forms, also made of this excellent material, as the least bit of heat reaching the base of the coil form will result in the prong affected either pulling through the base of the form, or leaning over at

such an angle that the coil will not fit its socket. This all makes the use of these materials sound rather difficult, but such is not really the case, as a little practice makes the job quite easy. As mentioned above, just make certain that your iron is very clean, brightly tinned and HOT.

COIL CONSIDERATIONS

The coils are wound according to the data given at the end of the parts list. Many constructors will wonder how it happens that there is no auxiliary trimmer condenser incorporated in the first detector circuit, for bringing this circuit into exact alignment with the oscillator. I found that since I was more interested in the higher frequency bands, and since tracking was much easier to bring about in these bands, I was able to juggle the windings of the two coils enough to make them track quite closely. However, on the coils for the lower frequencies, a greater tracking error will be introduced, and some means of alignment will be needed. The conventional method of bringing a small variable condenser, connected in parallel with the first detector tuning condenser, out to a panel control, is not practical in this set, for due to the method of coupling the oscillator into the first detector, the two circuits have a tendency to lock, the changes made in the tuning of the detector cause the oscillator frequency to vary somewhat. Therefore, some means of individual compensation for each detector coil should be sought.

This may take the form of what the radio manufacturers call a "gimmick"; this is merely two pieces of insulated wire twisted together and connected across the grid and ground points of the coil being treated, the capacity so introduced being varied by the

amount of wire twisted together. However, as I mentioned above, I found it easy to juggle the coil windings themselves, varying the distributed capacities enough to obtain the balance needed. Then the coils were given heavy coats of the liquid 912-A, which acts to hold the windings in place, preventing change of characteristics due either to climactic changes or to mechanical shock. It is quite important to use this cement with these forms, as it is very difficult to get the windings tight on this surface, and some means of holding them down where you want them is necessary.

After the set is completely wired, check the wiring very carefully against the diagram before attaching the batteries. Be especially certain that the proper filament terminals on the tube are connected as shown in the diagram, else you might have a section of one of the tubes shorted out.

When connected up, the I.F. stages should preferably be aligned at 456 kc. by means of a good signal generator, although as a makeshift, they may be peaked at some unknown frequency by means of some noise generator, such as a sharp buzzer, etc. This latter method should be used only if the constructor can't beg, borrow or steal the use of a signal generator, as the proper operation of these critical circuits can be greatly affected by misalignment. Lineup of the input (first detector) will be carried out as described before, either juggling the windings of the coils or by use of a gimmick.

TUNING UP!

This all done, we are ready to hunt for signals.

The center dial is, of course, the tuning

Complete wiring diagram for "2 in 5" receiver.

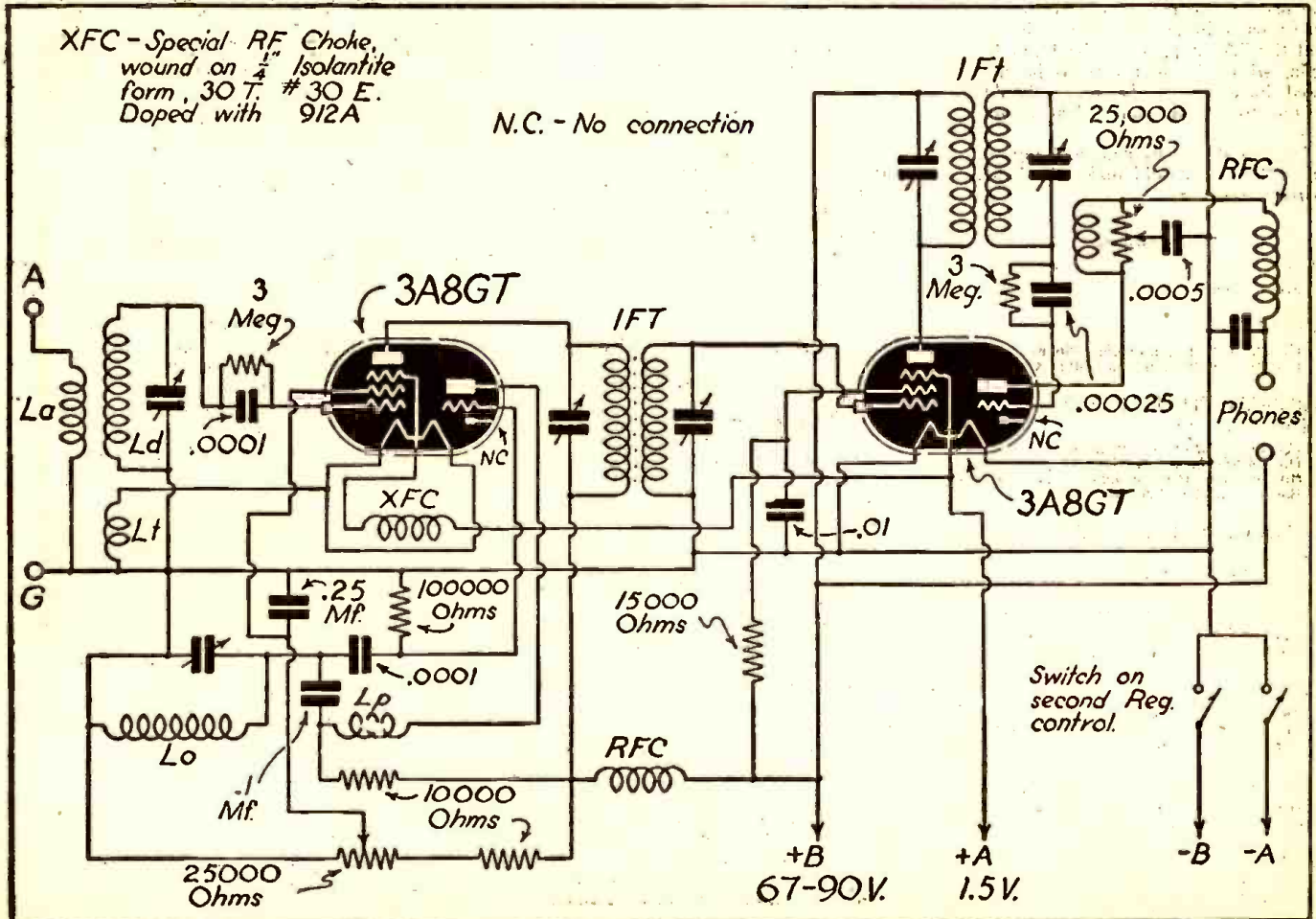

control. The small knob on the left controls the second detector regeneration, and will also have an effect on the volume of the set, while the knob on the right controls the regeneration in the first detector, and will also affect the sensitivity and selectivity.

To operate, turn the right-hand knob about half way on, and turn the left hand, or second detector knob, to the point where a rushing sound is heard in the headphones. Then turning the tuning knob should produce signals, accompanied by a whistle, which may be cleared up by turning the regeneration control back just to the point where the whistle disappears. This knob is handled exactly like the standard regeneration knob on a regenerative set. The other control knob is used to sharpen the selectivity and sensitivity of the first stage.

If it is found that turning the main regeneration control full on does not produce regeneration, try reversing the wires coming from the tickler on the second I.F. transformer.

Using almost any sort of aerial, you should be able to tune in the whole world, but you of course must realize that no set can be better than the aerial it is connected to. You will find the operation of this set unusually stable and smooth, and the careful constructor should be rewarded with a remarkable little set capable of remarkably big performance.

One of the many advantages of this set is the fact that although the performance is that of seven (or five . . . Editor) tubes, the battery drain is that of only three or four tubes . . . this is quite important when one has to buy batteries. The batteries shown with the set were chosen to permit of a certain amount of portability, with enough stamina for fixed use; if one desires even greater portability, the set can be housed in a cabinet of slightly larger size, to allow the use of the ultra small Mini-Max batteries used in personal portable receivers, and the "A" supply can be from flashlight cells, while if the set is to be used at a fixed location, the batteries should be of larger size, and should last a very long time.

Due to its small size and big performance, this set should make the "ideal" emergency receiver.

Parts List

RCA
2—3A8GT Tubes

ALLADIN
1—C100M I.F. Transformer, 456 Kc.
1—C101M I.F. Transformer, 456 Kc.

AMERICAN PHENOLIC CO.
(AMPHENOL)
8—No. 24-5H Midget coil forms
2—No. 54-5H Midget sockets, 5 prong
2—No. 54 Super MIP polystyrene octal tube sockets
1—Bottle Liquid 912-A coil dope

INTERNATIONAL RESISTANCE CORP.
(IRC) RESISTORS
2—D-11-120 Metallized controls, 25,000 ohm
1—No. 42 switch, DPST
2—10,000 ohm 1/2 watt resistors, BT-1/2
1—15,000 ohm 1/2 watt resistor, BT-1/2
1—100,000 ohm 1/2 watt resistor, BT-1/2
2—3 Megohm 1/2 watt resistors, BT-1/2

SPRAGUE
2—SM-31 Silvered Mica capacitors, .0001 mf.
1—SM-35 Silvered Mica capacitor, .0005 mf.
2—1FM-325 Fixed Mica capacitors, .00025 mf.

HAMMARLUND
1—HFD-140 Dual tuning Condenser, .00014 mf.
2—CH-X R.F. Chokes, 2.5 mh.

CROWE
1—No. 6341 vernier tuning dial
2—No. 6129 black plastic knobs

NATIONAL CARBON COMPANY
(EVEREADY)

2—No. 482 Mini-Max "B" batteries, 45 volt
1—No. 6 Dry cell "A" battery, 1.5 volt

AEROVOX

3—.1 mf. 200 volt paper tubular condensers
1—.25 mf. 200 volt paper tubular condenser
1—4 mf. 150 volt "Dandee" tubular condenser

MISCELLANEOUS

Sub-chassis material
Hook-up wire, small grid caps, cabinet, hardware, headphones, etc.

COIL DATA

All coils wound on Amphenol Polystyrene coil forms, 3/4" diameter. Ld and Lo wound to 1 inch length.

Band (Meters)	La	Ld	Lt	Lo	Lp
80	11	62	6	55	11
40	7	28	4 1/2	24	9
20	4	15	3	13 1/2	7
10	2 1/2	3 1/2	1 1/2	3 1/2	4

La, Lt and Lp wound with No. 30 E. for all bands.

Ld and Lo wound with No. 18 E. on 10 and 20. Ld and Lo wound with No. 28 E. on 40 and 80. (E = enameled copper wire)

Special filament R.F. choke is wound on old 1 watt resistor, 1 megohm resistance or more, and has 30 turns No. 30 E.

All coils treated with liquid 912A after winding.

...

AIR-RAID BUSINESS

(Continued from page 588)

checking force to go over cards and put data in convenient form for the councils examination.

Arrangements may be made whereby any citizen filling out a card may arrange to have his or her set checked over within next five days at a special rate of \$1.00, plus replacements—if any—at list prices. Citizen may indicate on card choice of serviceman or leave it up to service group to split up accordingly. In order to secure this rate a definite time and place must be arranged for the set testing; this insures against waste of serviceman's valuable time. The volume of business secured in this way, plus community good-will, will more than compensate for the admittedly low rate charged for the set inspection.

...

ELECTRONIC ORGAN

(Continued from page 601)

2. Easy to build for an electrician who is not a skilled mechanic.
3. True ensemble non-mechanical tone.
4. Large number of true harmonics, but the relative intensity is not under control unless Ranger system is used.
5. True organ attack if oscillator starts up when key is pressed, not true if oscillator runs all the time, unless special keying system is used.
6. One tube can go out of commission without upsetting the whole organ.

DISADVANTAGES

1. Expensive to build.
2. Requires tuning. Only one octave need be tuned if frequency halving or doubling is employed.
3. Limited to one type of tone at a time, i.e., can't make manuals differ in tone except by super or other coupling, unless oscillators operate continuously.
4. Stops from control tubes can be obtained separately, but not in combination.

GET YOUR RATING

★ NOW!

Prepare for increased pay positions in the Army, Navy, Merchant Marine or Commercial Communications fields. There is a serious shortage of trained Radio code operators . . . you can prepare for one of these jobs without leaving your own home with the simplified Candler System. Over a quarter of a century of experience in training radio code operators. Write today and find out how easy it is to learn code now or improve code proficiency, and be prepared for the future. Mail a post card now . . . there's no obligation and no salesman will call!



A Free Book for You!

FREE 52 page BOOK OF FACTS contains inside advice and tips from the champions, and world's fastest amateur and commercial operators. Get your copy of this free book now! Write today.

CANDLER SYSTEM CO.
Box 928, Dept. C-6
Denver, Colorado

RADIO ENGINEERING
DEGREE IN 2 1/2 YEARS

• Complete Radio Engineering Course in 27 months. Bachelor of Science Degree. Radio (television, talking pictures, and the vast electronic field) offers unusual opportunities. Defense needs call for the engineer. Demand exceeds the supply. Courses also in Civil, Electrical, Mechanical, Chemical, Aeronautical Engineering; Business Administration, Accounting, Secretarial Science. Tuition, living costs low. World famous for technical 2 1/2 year courses. Special preparatory department for those who lack required high school work. Enter September, January, March, June, 59th year. Write for catalog. 2462 COLLEGE AVE. ANGOLA, IND.



TRI-STATE COLLEGE

Headset Headquarters



GUARANTEE CANNON-BALL

Phones to give absolute satisfaction. Unusually sensitive. Noted for fidelity and clarity of tone. Folder C-6 illustrates complete Cannon-Ball line. Write

C. F. CANNON COMPANY
SPRINGWATER, N. Y.

Inventions Wanted
Patented or Unpatented

We have been successfully selling inventions, patented and unpatented, since 1924. Write us. If you have a practical, useful idea for sale.

CHARTERED INSTITUTE
OF AMERICAN INVENTORS
Dept. 109 Barrister Building, Washington, D.C.

PATENTS—TRADE MARKS

Booklet concerning Inventions & Patents Form "Evidence of Conception" with instructions for use and "Schedule of Government and Attorneys Fees"—Free
LANCASTER, ALLWINE & ROMMEL
Registered Patent Attorneys
436 Bowen Bldg. Washington, D. C.

5-Tube Short-Wave SUPERHET RECEIVER

This short-wave superhet will appeal to the beginner in set-building, as it is well explained by the author and the parts are fairly simple to assemble and align.

HOWARD H. ARNOLD

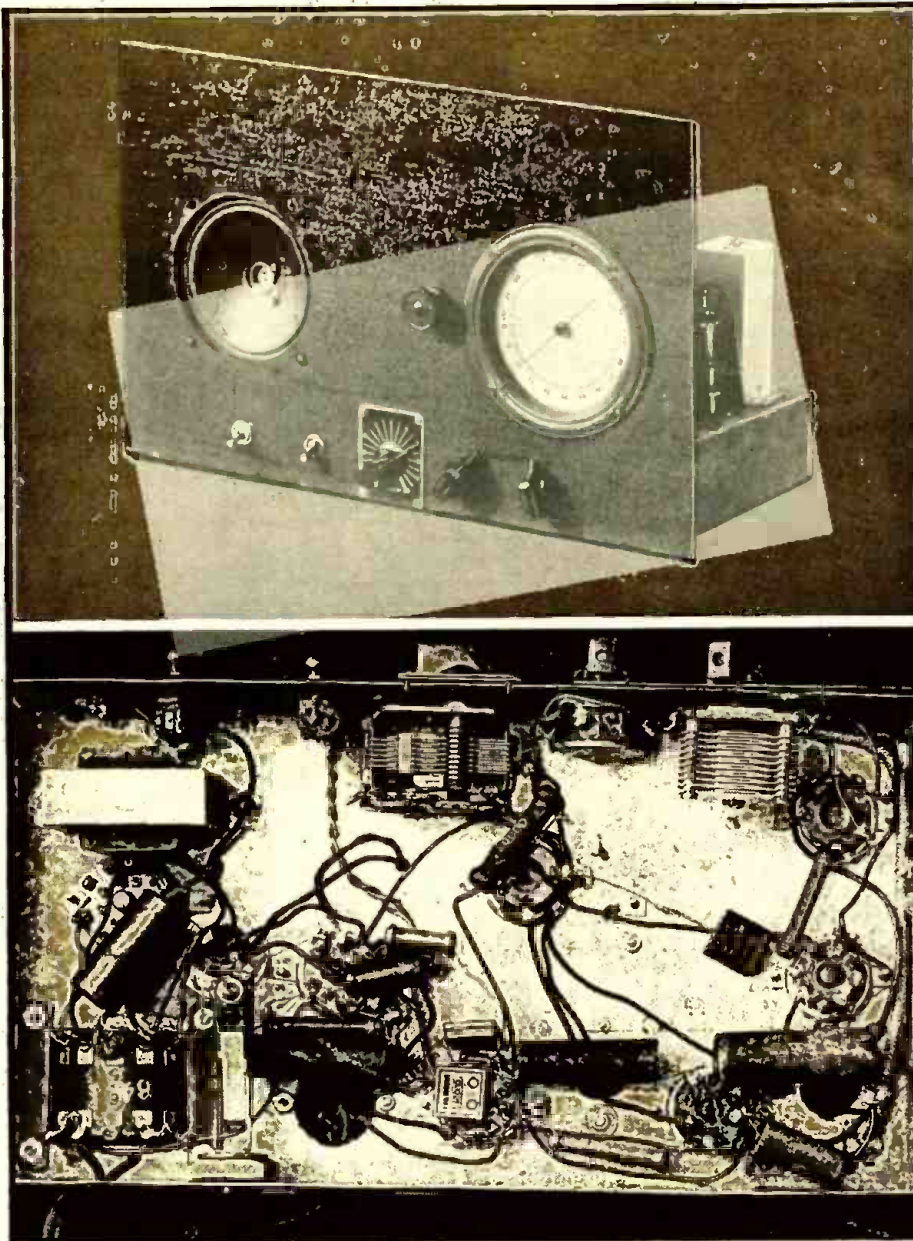

Above—front and bottom views of the short-wave superhet receiver.

HERE it is! All you radio "bugs" who have been wanting to build yourself a good receiver, but just didn't have the nerve to start—all you beginners who have been looking for a set that is easy to construct, but will still work like a communications receiver should—here it is.

The author makes no claims of new circuit innovations or of extremely new applications of existing circuits. Rather the only claim to a place on your operating table that this set has is its very compact and efficient application of well known principles. The parts complement has been kept

low and standard; easily obtainable parts have been adhered to. The cost of the parts should not be found exorbitant, but nowhere has quality been sacrificed for cost. The low cost of the parts is rather due to the use of double-purpose tubes, and to the design of the circuits around tubes which require a minimum of circuit components.

SAVING TUBES

To begin with, the beat frequency oscillator, which usually requires a separate tube, has been combined into the detector

circuit through the use of a double triode, the 6C8G. This idea saved an extra tube.

It also saved the annoying necessity of external coupling into the second detector circuit, as the inter-electrode capacity of the two triode sections serves admirably as the coupling "condenser." Another example of a similar saving is the choice of the 6K8 as oscillator-converter tube. The use of the internally connected "injection" grid in this tube eliminates an external oscillator coupling condenser, and at the same time cuts down on losses by doing away with the external wiring of this circuit. The one extravagance the author allowed himself was the use of 1500 k.c. I.F. transformers of the iron core variety, rather than the cheaper air core type. It was found a wise choice, too, since the gain of this type of transformer is inherently much higher than the air-core type. The choice of 1500 kc. rather than a more conventional lower frequency type was, of course, made necessary by the lack of an R.F. or pre-selector stage. The image rejection ratio was thus kept high enough so as to be unobjectionable.

The second detector is wired in a conventional "power" or grid-bias detector circuit. This was found desirable over a diode circuit as it introduced enough gain into the audio circuit so that a 2-stage audio system was not necessary. Sufficient space has been reserved on the chassis for the addition of another tube, however, thus allowing the constructor to add a diode detector, thus making automatic volume control possible, at some later date. Panel space is also reserved for an "R" meter, if automatic volume control should be added. A point which should appeal to the beginner is the fact that separate oscillator and R.F. variable condensers are used, thus doing away with the difficult and patience-trying problem of tracking the sections of the gang condenser in more conventional circuits. A 140 mmf. condenser tunes the R.F. section, a 150 mmf. "bathtub" type tunes the oscillator and a 30 mmf. nidget is used for spreading the amateur or foreign bands over the whole tuning dial.

A dynamic loudspeaker is used, and its field, together with 3 8 mf. condensers and a 30 hy. choke, provide excellent power supply filtering. The phone plug is connected into the grid circuit of the 6F6G, doing away with D.C. in the phones, and also making it possible to use high-impedance crystal phones if desired, without external blocking condensers.

CONSTRUCTION

So much for the design. Now for the construction. The set is constructed on an electrical alloy or galvanized chassis base, 7" x 12" x 2". The panel is 15" x 9". The bandspread in the original is a 4" airplane type dial, mounted so that the knob extends to the left of the dial, and even with the center. To mount it in this way, the dial must be revamped slightly. The small metal tabs

that hold the glass in place are bent up carefully, and the glass removed, as well as the gasket below it. The hand is next taken off, and the celluloid dial scale will then fall free. Remove the scale, and turn it 90° to the right, so that the scale will be in position for reading properly when the dial is mounted on its side. Then cut a notch in the dial scale in the right position to engage the pin which serves to hold it in position. Then carefully reassemble the entire mechanism. Some means must be devised for supporting the dial in this position, and just what this will be depends on the type of dial you have chosen. In the model being described, a simple right-angle bracket mounted on the base of the oscillator tuning condenser, which, incidentally, extends through a cutout in the chassis top, was sufficient, together with the support given the dial by the connection to the tuning condenser shaft. The 30 mmf. tuning condenser must also be mounted on a right-angle bracket. No particular data is given

for this part of the construction, as all measurements, etc., will depend entirely on the parts used.

CHASSIS DETAILS

The chassis must of course be obtained before you can start construction. A word might be said here in regard to the source of supply for this unit. It probably can be obtained from any of the radio mail-order houses, but when this is done, it is usually necessary to punch and drill your own chassis. Considerable equipment is necessary to do this job, and do it neatly, and the beginner is not always so equipped. The author has found that the proprietor of your local tin shop is usually equipped for such work, and is always quite willing to be helpful in this line. Almost all sheet-metal shops have a grade of galvanized sheet metal that is excellent for a chassis, and can cut, bend, drill and punch both the chassis and panel for only slightly more than you would pay for the same material,

unpunched, from usual sources. It might pay you to make friends with your tin-smith.

After the chassis and panel have been prepared, mount all of the larger parts—that is, the power transformer, tuning condensers, speaker, volume control, switches, b.f.o. transformer, I.F. transformers, choke, "can" type electrolytic condenser, dial, and tube sockets. Also the dial plate which is to serve as a band-set marker on the large oscillator tuning condenser can be mounted now more conveniently than after the wiring is completed. If the holes have been drilled and punched as given in the specifications, very little trouble should be experienced with this phase of the work. The panel is held to the chassis by the mounting bushings for the two switches, volume control, and R.F. tuning condenser. The speaker is fastened to the panel with four 1/8" stove bolts and the dial escutcheon is held in place with the four small machine screws provided.

Below—wiring diagram for the 5-tube superhet receiver.

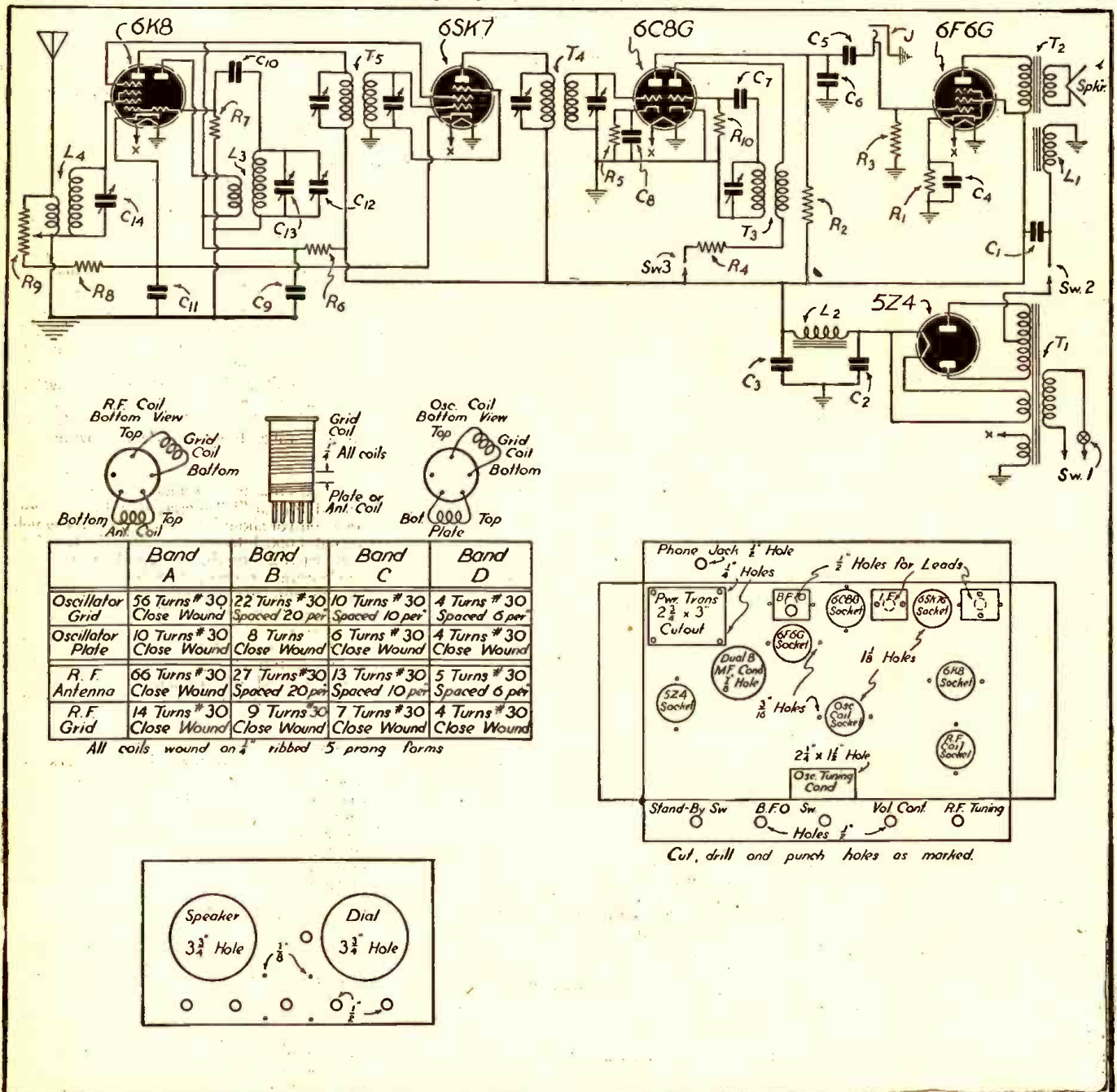

PERFORMANCE and ECONOMY!

with

Echophone COMMERCIAL

Model EC-1

Here is your opportunity to have all the communications features at a moderate price with an Echophone EC-1. Six tubes. Three bands. Tunes from 550 kc. to 30 mc. Electrical bandspread on all bands. Self-contained speaker. Operates on 115-125 volts A.C. or D.C.



Model EC-2

All these communications features are yours at a price that you can afford to pay, with the Echophone EC-2. Three bands tune from 550 kc. to 30 mc. Self-contained 5" dynamic speaker. Preselection on all bands. Calibrated bandspread scale on 80/40/20/10 meter bands. Electrical bandspread at all frequencies in the tuning range. Operates on 115 volts A.C. or D.C.



Model EC-3

Check all these features and then you will know why so many buy an Echophone Model EC-3 for real communications performance! Crystal filter (four position variable selectivity). Calibrated bandspread. Automatic noise limiter. Preselection on all bands. 2 stage I.F. amplifier. Flywheel tuning. Separate 6" PM dynamic speaker. CW monitor. 10 tubes. 3 bands. Tunes from 550 kc. to 30 mc. Electrical bandspread. Operates on 115 volts A.C. or D.C.



The RADIO SHACK

167 WASHINGTON ST., BOSTON, MASS., U.S.A.

WIRING THE SET

Now to proceed with the wiring. The first step is to wire the power supply. The filtering circuit not being exactly conventional, it should be borne in mind that it is a good plan to check with the diagram frequently to avoid mistakes. Also remember that the base connections for the 5Z4 tube are a little out of the ordinary, as are the 6C8G, 6SK7 and 6K8.

After wiring the power supply, bring the "positive B" lead to the screen of the 6F6G socket and to the spare terminal on the 5-prong oscillator coil socket. These will serve as distribution points from which secondary leads may be run to the various points requiring high voltage.

The filament circuit should next be wired. It is not necessary to use a twisted pair of wires to connect the heaters in this set, as is sometimes the case. Simply ground one side of each heater at the socket, and ground one of the 6.3 volt terminals at the power transformer. Then use a single wire to carry the filament current to the other terminal of each tube.

Now start with the antenna coil and, carefully following the diagram, and checking off each connection as made, wire the R.F. circuit. Then proceed to the oscillator coil and the oscillator circuit. The I.F. comes next, the detector, and the b.f.o. Finally the power output stage is connected, and the phone jack is wired as per the diagram. This is so connected that when the plug is inserted the audio voltage goes through the phones to ground, instead of to the grid of the 6F6G. When the plug is removed, the circuit is again completed to the grid.

No special precautions are necessary in wiring this circuit, except to make all leads short and direct. The condensers and resistors are all mounted by their own leads, and ground connections are made to lugs

attached to the chassis with the bolts which hold the sockets in place. The ground returns are, for the most part, made direct to chassis. However, in the R.F. and oscillator circuits, it was found advisable to use a common return. This was done by using a shielded antenna lead to the volume control, grounding it at several points to the chassis, and using the shield as the ground bus bar. The inside shielded wire was used for the antenna lead.

COIL DATA

Coil data is given in a separate table. You may either wind your own coils to these specifications, or obtain them ready wound to your specifications. The more economical of the two choices would be, of course, to purchase the coils forms and wind them yourself. This should not be difficult if you follow the specifications closely, and coat the complete coils with coil dope to keep the windings in place. The beat frequency oscillator circuit is connected as shown in the diagram, the red wire going to B+, blue to plate, green through the condenser to grid, and black to ground. The yellow wire in the transformer specified in the list of parts is not used, the end being cut off and taped, to prevent short circuits.

Adjustment of the tone of the b.f.o. is made by the knob, which extends through the top of the shield can.

Aside from following every connection on the diagram carefully, there are no special precautions which need be repeated. However, there is one "kink" which may prove advantageous to the inexperienced. This is to use several colors of wire for wiring the circuit. Use blue for plate circuits, green for grid circuits, red for high voltage, yellow for filaments, black for cathodes, and bare for ground, or some similar scheme of your own making. Thus, you can check back

through the wiring easily and errors can easily be discerned, as a red wire going to a filament, cathode, plate or ground connection directly is obviously a mistake, and similarly for the other colors.

OPERATING HINTS

Now it may be well to say a few words about operation. The set is designed for an antenna with a transposed lead-in, which terminates in a low impedance line. Such an antenna is the "Zepp", the half-wave doublet, etc. However, almost any good antenna will give satisfactory results. An outside or water-pipe ground is also essential.

First plug a pair of coils and all the tubes into the proper sockets. Then plug the receiver into the power-supply, and turn the volume control (second control from right) toward the right. With the standby switch and b.f.o. switch (first and second from left, respectively) in the off (up) position, allow 30 seconds for the tubes to warm up. Now, with the phone plug removed and antenna and ground connected, volume control full on, turn the "stand-by" switch on. Remove the grid clip from the 6C8G tube and touch the grid cap with your finger. A loud buzz or roar should be heard in the loudspeaker. If the circuit from the detector on is working properly, now proceed to the oscillator section. Merely touch the stator of the band-spread oscillator condenser. A click in the speaker indicates a properly connected oscillator circuit. If these tests prove satisfactory, the final "proof of the pudding" is its operation. Tune the Oscillator Band-set condenser, the center control in the lower row, slowly from one side to the other. Somewhere in its range a station or group of stations will be heard. Now rotate the Antenna condenser, at the far right, until the signals come in at maximum volume. Then rotate the band-spread condenser to receive the desired signal and readjust the antenna condenser slightly for maximum volume with minimum noise level. You will soon get on to operating the three controls in such a manner as to obtain maximum performance.

Your receiver can undoubtedly be made to operate better by aligning the I.F.'s. If you have a test oscillator, this will be easy. If not, it can be done approximately with the aid of the beat frequency oscillator. Simply disconnect the antenna, and ground, start the b.f.o., and tune the trimmers for maximum "hiss" in the speaker. Then peak them again on a weak signal and the "alignment" of this set is complete.

A coat of black crackle enamel on the panel, a set of new knobs, and a few pains to keep things neat, and you'll have a set that you'll be proud to own. Just a couple of words of caution—Don't substitute parts unless you know they are electrically identical to those specified. Don't forget to check your wiring. Don't expect the impossible! With these don'ts in mind, I'm sure you won't be disappointed in this little set. If there is enough demand for an improved model, with a a.v.c., etc., the author will revamp the set for these refinements and publish the new design data. So let's hear how you come out.

BURNT FIELD COILS

Speaker field coils and phonograph motor field coils that have their insulation badly charred and are loose through overheating from shorts, etc., but which have continuity of winding, can be repaired by placing the winding in a can of high melting point insulating pitch or compound. The same compound that transformers are sealed in. Boil the unit for about ten minutes, remove and hang up to drip. This will reinsulate each wire and will make the winding tight and safe again.—Robert Murray in "Sylvania News."

Defense WALKIE-TALKIE and AIRPLANE DETECTOR

GEORGE FRANCIS BAPTISTE

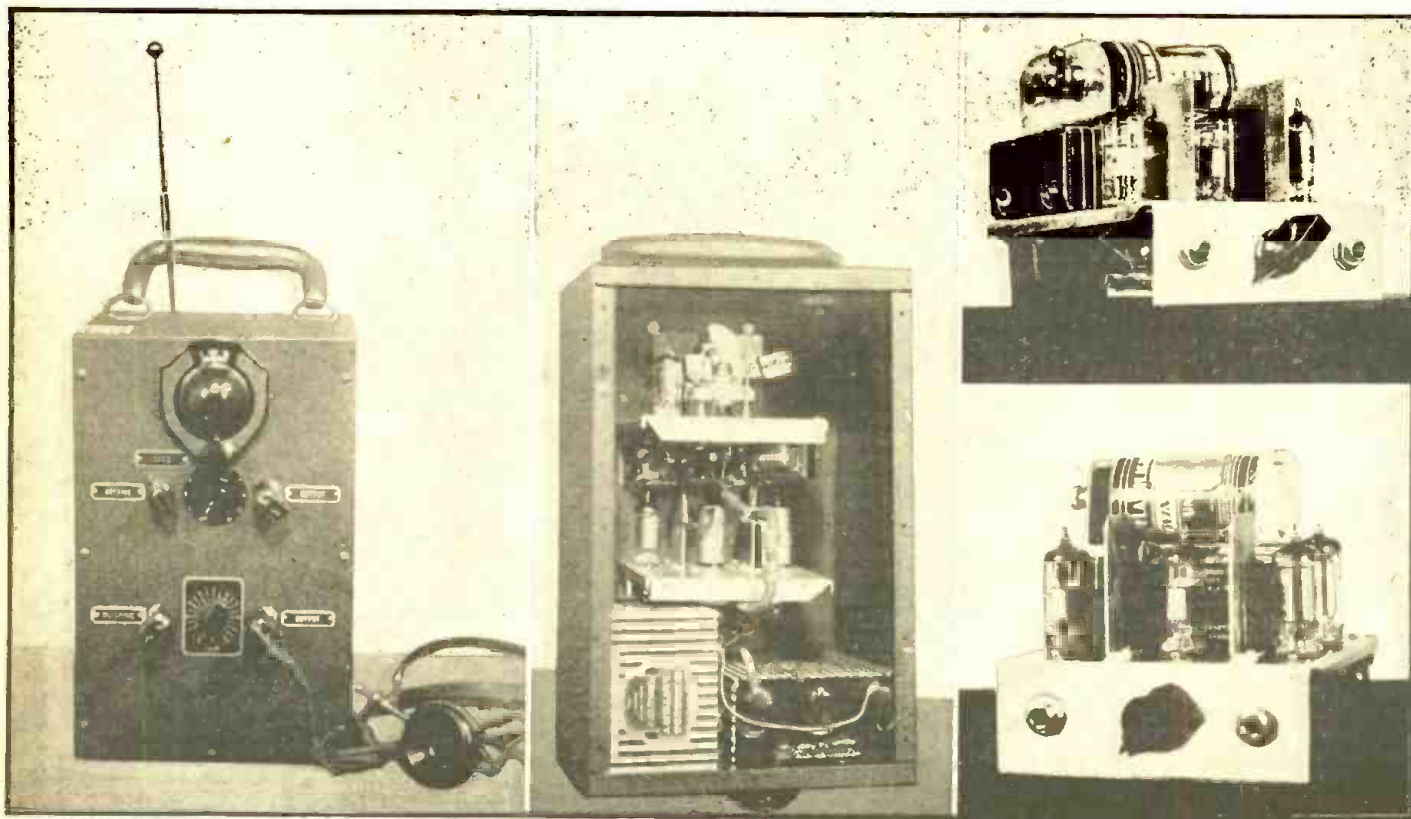

Front and rear views of the Walkie-Talkie transceiver and Airplane Detector, together with photographs showing close-up view of the audio amplifier before it is assembled in the transceiver cabinet.

CIVILIAN Radio Defense, in close cooperation with our Armed Forces and the Civilian Radio Nets, will help protect the men behind the guns as well as those at home. Here is a unit that is indeed valuable—it combines a *Walkie-Talkie* along with a *Sound Detector* that can be used for detecting airplanes as well as assisting to find anyone trapped in building cellars or buried underneath debris resulting from air raids, etc. Some of its features are the use of a high-gain amplifier, using low-drain miniature tubes, with exceptionally low "A" and "B" battery currents and miniature batteries if desired; (see article entitled "*A High-Gain Miniature Battery Powered Amplifier*" which appeared in the October, 1941, issue of *RADIO-CRAFT*). The sound section can be used independently for those who are hard of hearing; the *Walkie-Talkie* can also be used separately. A carbon or a crystal microphone can also be used, whichever one desires.

The complete weight of this unit with all the equipment is less than ten pounds. It gives a person a good opportunity for making numerous experiments. The range of the transmitter is of course limited to local work and will have a coverage of two to fifteen miles, depending upon the terrain or location.

A twenty-two to forty-eight inch telescope car antenna is used, with a plug fitted to the end so that it can be plugged into the top of the outfit and adjusted for best results.

CONSTRUCTION DATA

Diagram No. 1 is the schematic for the complete unit. Diagram No. 2 shows the chassis layout covering both the Sound and Walkie-Talkie units on a separate chassis and wired independently, and also tested separately. They are then mounted on the front panel. Diagram No. 4 is the layout for this panel, with Diagram No. 3 showing a top view of the cabinet and the correct marking for the jack for the antenna plug, which should be mounted on a piece of quartz so as to reduce losses in transmitting power.

Picture No. 1 is the front view of the completed unit and gives a general idea as to the appearance of the completed unit. Picture No. 2 shows the rear view of the complete unit in the cabinet; picture No. 3 is a bottom view of the sound amplifier, with picture No. 4 showing the unit completed. This can be used as a separate unit for such *sound detection* as desired.

Each unit has its own separate volume control and super-regeneration control; for the sound amplifier this is the *gain* control. Its position will depend upon the type of microphone used. There are provisions for two pairs of crystal phones, or if one desires, only one pair of phones. A small three-inch P.M. speaker can be mounted on the top of the cabinet or plugged in separately.

In the construction of the *sound amplifier* the choice of the best parts obtainable should be used, with all plate and grid wires

separated as far apart as possible (see article entitled "*A High-Gain Battery Powered Amplifier*," in the October, 1941, issue of *RADIO-CRAFT*). This will be of great help in assisting one in the construction of such an amplifier. Also it will be noted that a *volume control* is connected across the microphone transformer (carbon microphone) so that the level of same can be adjusted to its proper value, as the gain is quite high.

In regard to the use of the unit as a *sound detector* for the *location of planes*, the microphone should be mounted in a box that can be rotated to various positions; or the microphone can be attached to the end of a trumpet horn and rotated for the best directional effect. This is a matter of one's own choice and engineering ability. The use of this device where traffic noises are present is quite annoying, but in quiet locations the system is very sensitive and surprising results can be obtained. Wind noises are bothersome at times, but these can be greatly reduced by placing a piece of silk cloth over the end of the trumpet horn or speaker box. The microphone unit should be weather-proofed so as to be protected from damage caused by moisture or rain. In general, best results are obtained in locations that are not too noisy. A little practice will enable the user to become very proficient in the operation of it for such work as locating airplanes. The human ear's usefulness in detecting an approaching airplane can only be best compensated for by the selection of low noise levels near

the location of the microphone. It may be well to state that by mounting the microphone with rubber-band supports and springs, the passage of ground wave vibrations from the soil is greatly reduced. Rubber cushions on the legs of the microphone mounting also helps. As a final suggestion such microphones or horns can be mounted on a car and used in various places, as one moves from place to place.

Microphones, and speaker if used, or phones should be well separated so as to prevent any audio "feed-back," with cable shielded well so as to reduce any possible feed-back. Many times it is impossible to see the approach of planes due to poor visibility, but their approach and direction can be determined. One should carry a small pocket compass so as to determine the direction; or, better still, find a way to mount the compass on the trumpet horn or speaker box. It would be advisable to line a speaker box with some acoustic material on the bottom and sides with the suspension of the microphone in the center.

BAND COVERAGE

This transceiver is for the two and one-half meter (112 mc.) band, but with other coils of more turns it can be used on the five meter band, and with less turns on the one and one-quarter meter (224 mc.) band.

For operation in the five meter band (56 megacycles) eight turns are about right, using the same size wire (No. 16 tinned copper wire on a 1/2 inch dia. form). Four turns cover the two and one-half meter band (112 megacycles) and for the 224 megacycles band, two turns and one condenser plate. The coil may be spread out or squeezed together to suit the desired band-spread effect, depending on the amount one wishes.

A Bud three-plate tuning condenser is used with one of the plates removed. The

transceiver should be adjusted in the 2 1/2 meter band, with a coil of four turns spread out to one inch evenly and wound on a one-half inch form. In order to bring the 2 1/2 meter band in the center of the tuning dial, place a soldering iron on the stator plate. This will heat the solder holding the plate, bring in the plate spacing closer to about 1/32 of an inch. This will do the trick very well. The stator plate can be left in that position for all bands. Do not use any kind of soldering flux, use only resin core, as an acid flux will cause leakage at ultra high frequencies, causing the transceiver not to operate properly.

After the transceiver has been checked carefully and is ready for operation, connect the "A" battery first, and then the "B" batteries. Place the "Send-Receive" switch in the proper position, turn on the battery switch, this is also the super-regeneration control; at the same time have the crystal earphones plugged in and also the antenna (the antenna is a telescopic model as used on auto radios and has a microphone plug connected to it). Plug it into the antenna jack at the top of the cabinet and adjust it to about forty-two inches, then advance the volume control slowly until a rushing sound is heard in the earphones. This should be quite loud and smooth over the entire range of the tuning dial. If such is not the case, adjust the antenna trimmer until this effect is obtained, and also adjust the telescopic antenna. This will also improve the super-regeneration and make it smoother. There is no further adjustment required as this also takes care of the transmitter section. However, if one desires he may connect a milliammeter in the R.F. choke lead, and adjust the antenna for maximum current and then mark the antenna. This will give you the maximum power output also, and all that is required is to adjust the antenna trimmer for the receiver end.

Sometimes it is difficult to obtain perfect super-regeneration; to cure this change the value of the grid-leak to one of lower or higher value, as tubes vary. Upon tuning in a strong carrier, this rushing sound or super-regeneration sound completely clears off. On weak signals this sound is slightly noticeable. This is common with all super-regeneration receivers. In adjusting the antenna trimmer use an insulated screw-driver, or a quarter-inch polystyrene rod filed down to fit the antenna trimmer.

The tube line-up is as follows: the 958 acorn tube is the detector and oscillator; the 1S4 is the audio amplifier tube and used only in receiving. This tube is also one of the modulators, the final modulator; the other tubes in the sound detector are used as a resistance-coupled high-gain amplifier; these are also used as modulators. They are as follows: two type 1S5 pentodes and one type 1S4. These in turn feed the final type 1S4 on the receiver chassis and in turn mix with the 958 detector-oscillator, which is used as an oscillator for transmitting.

There is nothing tricky about the circuit, as it is a straight super-regenerative circuit, and the high-gain amplifier is also a straight audio amplifier. Both circuits have been tried independently, but the idea was to be able to use a crystal microphone, and do away with the carbon microphone and battery, and also to have a sound detector. This can also be used as a pre-amplifier; battery consumption is very low. A complete list of parts is appended.

XTAL PHONES USED AS A MICROPHONE

In using the transceiver as a transmitter, all that is necessary is to place the "send-receive" switch in the "send" position, and turn on the main high-gain amplifier volume control. Plug in your crystal ear-phones or else you can have a separate crystal

Wiring diagram of the transceiver

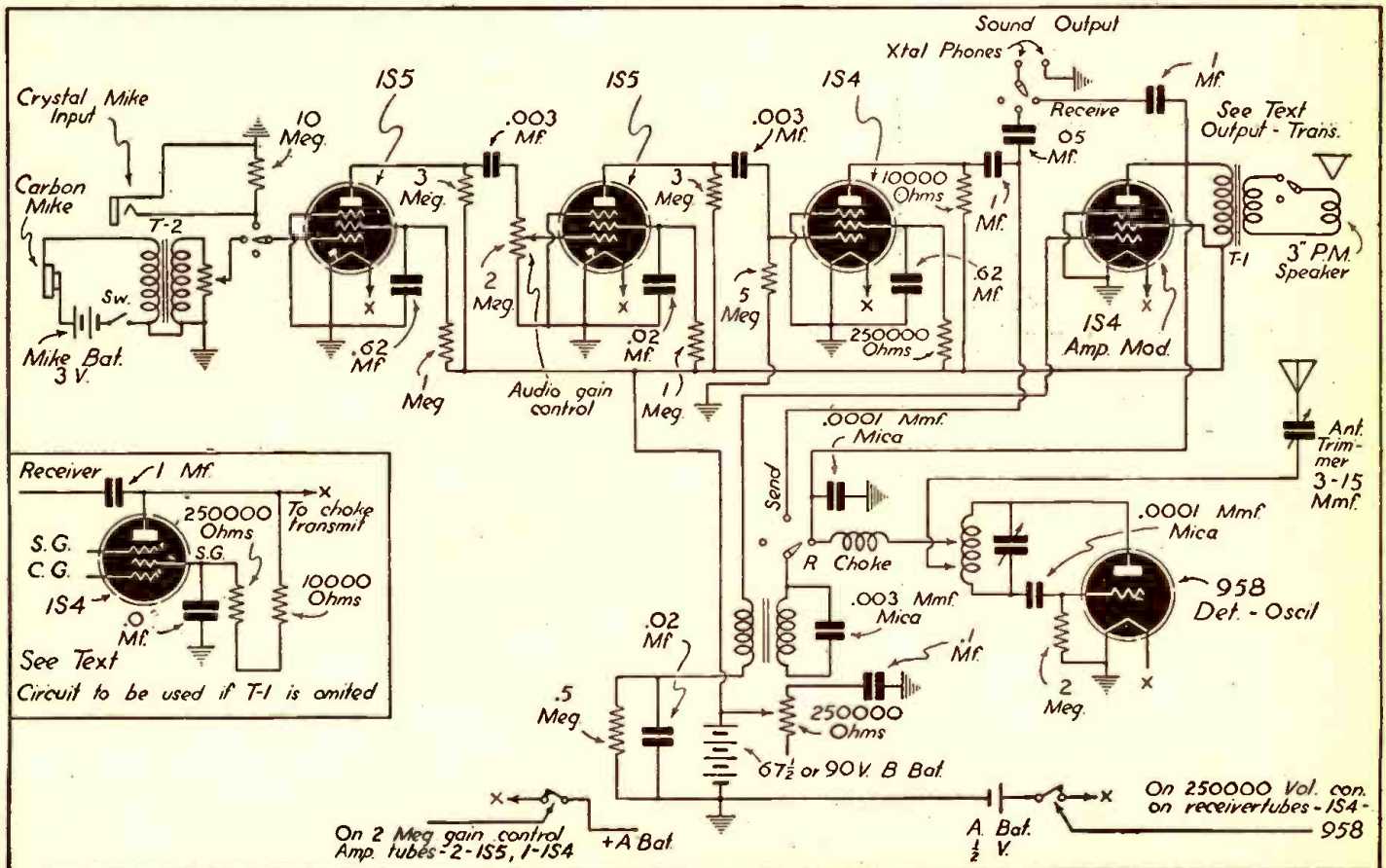

microphone. The gain control if turned too high may cause over-modulation and distortion. This position of the amplifier gain control will be around three or four on the gain control dial; this can best be found by experience. To use earphones as a microphone connect the left hand open switch terminal to the crystal microphone volume control. It is surprising how good crystal phones work as a microphone; I have used them with this outfit and found it unnecessary to use a special crystal microphone. In the schematic diagram there is provision for a carbon microphone input if one wishes; this may be omitted. There is also provision for a small PM speaker. I personally prefer the crystal microphone and crystal earphones; it is just a matter of choice. With a crystal microphone one can get away from the carbon mike hiss, which is very annoying. All transceivers I have seen use carbon microphones, but here is one that does not.

To receive again, just throw the send-receive switch back to the receive position. One crystal phone can be used for receiving all the time, and the other for the microphone. Two people can talk at the same time—another novel feature.

Parts List

RESISTORS

- Two I.R.C., 1/2 watt, 3 megohm
- One I.R.C., 1/2 watt, 10 megohm
- Two I.R.C., 1/2 watt, 1 megohm
- Two I.R.C., 1/2 watt, .5 megohm
- Two I.R.C., 1/2 watt, 10,000 ohms
- Two I.R.C., 1/2 watt, 250,000 ohms
- One I.R.C., 1/2 watt, 200,000 ohms
- One I.R.C., 1/2 watt, 150,000 ohms

CONDENSERS

- Two Aerovox .0001 mf. silver mica
- One Aerovox .003 mf. mica postage-stamp style
- Two Aerovox .05 mf. tubulars, 400 V. rating
- Two Aerovox .1 mf. tubulars, 400 V. rating
- Four Aerovox .01 mf. tubulars, 400 V. rating
- Two Aerovox .003 mf. tubulars, 400 V. rating
- One Bud midget condenser, single spaced (see text)

TUBES

- Two RCA Type 1S4 miniature tubes
- Two RCA Type 1S5 miniature tubes
- One RCA Type 958 Acorn tube

BATTERIES

- One or Two Burgess type XX45 67 1/2 V. "B" or
- One Burgess 5308, 45 V. "B" battery
- One Burgess 5156, 22 1/2 V. "B" battery
- One Burgess 1 1/2 V. "A," Type 4F4
- (See text for carbon mike battery)

MISCELLANEOUS

- One Bud cabinet 12 x 7 3/4 x 6 1/2 ins., portable with carrying handle, black finish
- Four Amphenol miniature tube sockets
- One Amphenol, type PCIM male and female connector
- One Amphenol Polystyrene rod, 1/4 inch diameter
- One Millen Quartz sheet, 3 x 8 1/4 ins., 1/10 in. thick
- One Yaxley 3100 series switch, 4 circuit, 3 positions, 1 1/4 inch diameter
- Three Yaxley, type A-1, midget jacks
- Two Yaxley, type A-2, midget jacks
- Two Yaxley plugs shielded shell type, nickel plated
- One Hammarlund acorn tube socket, Code USH 900
- One Hammarlund Mex 3-30 mf. trimmer
- One Stancor transformer, Audio type A-53
- One UTC transformer, microphone-to-grid, type A-35
- One Oxford speaker. 2 1/2 inch PM speaker and transformer to match same for 5000 ohm load
- One Banner telescope antenna, 22 inch to 60 inch opened or similar
- One Brush pair of XTAL phones, communication type B.J.
- One Brush crystal microphone (see text)
- One Kurz-Karsh 3 1/2 inch dial
- One Universal carbon microphone—single button (see text)
- Two 1/2 inch brass spacers, 7/8 inch long
- One 7 x 10 inch panel electrolyly or similar
- Nuts, bolts, washers, soldering lugs, wire, etc., Etched metal name plates
- One S.P.S.T. snap switch, with "off"-"on" name plate

*Note that a special permit from the F.C.C. and D.C.B. must be obtained for operating any radio transmitters, no matter how small, under present war-time conditions.

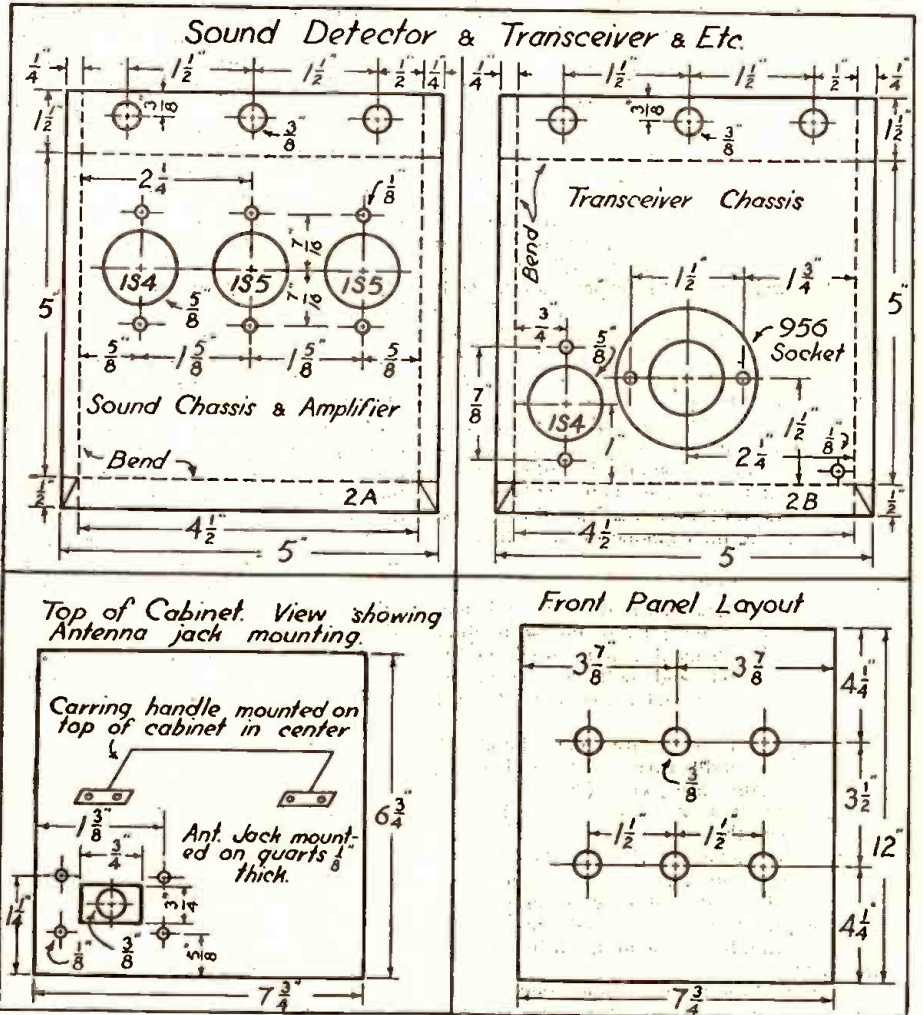

Layout data for the chassis and panel are given above.

RADIO AMATEUR COURSE
By G.W. Shuart "W2AMN"
PRICE 50c

Your Money Back—
If the RADIO AMATEUR COURSE does not represent the greatest book value ever offered to the radio "fans" for **50c**

To convince you that there isn't a better book huy today, the publishers of the RADIO AMATEUR COURSE make the sensational offer of a money-back guarantee on such a low-priced book. Stop in at any of the many dealers handling this book and examine it. See for yourself if the RADIO AMATEUR COURSE isn't just the book you've always wanted.

Printed on the finest coated paper—well illustrated attractive 4-color cover—complete with radio information you must have. It contains a step-by-step program for obtaining a short-wave radio education.

Written by George W. Shuart, W2AMN
foremost short-wave authority

RADIO AND TELEVISION
25 West Broadway, New York, N. Y.

Gentlemen: I enclose herewith my remittance of Fifty Cents (50c) for which please send me POSTPAID my copy of the RADIO AMATEUR COURSE. (Remit by check or money order; register letter if you send cash or unused U. S. Postage stamps.)

Name

Address

City State RC-6-42

148 PAGES
6 x 9 INCHES
OVER 150 RADIO DIAGRAMS
and TECHNICAL PHOTOGRAPHS

RADIO AND TELEVISION
25 West Broadway New York, N. Y.

A 2-4 TUBE PROGRESSIVE RECEIVER

for 110 Vts. A.C.-D.C.

Part I—HEADPHONE UNIT

This receiver will appeal to the beginner in radio set construction, as it is designed so that it can be built in two "progressive" sections. The first section, described in the present article, provides headphone reception of radio signals, while the second section, to appear in a later issue, describes how to incorporate an amplifier to operate a loud-speaker. The parts required are fairly easy to obtain and the assembly is straightforward and simple.

Several views of the headphone unit of the "progressive" receiver are shown in the accompanying photos.

L. M. DEZETTEL, W9SFW*

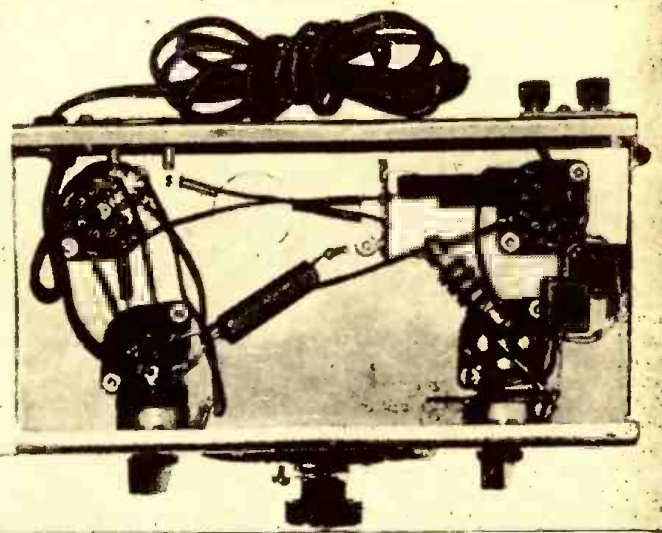

● THE receiver we are about to describe fills a two-fold purpose. It answers the many requests for a simple 2 tube A.C.-D.C. receiver. It anticipates later requests for adding additional amplification to it for operating a loud speaker.

As a simple 2 tube A.C.-D.C. receiver, it is all that one desires for headphone operation. A 12J5GT triode is used as a regenerative detector. All-wave operation is obtained through the use of standard 4 prong plug-in coils. These coils are inexpensive and eliminate the tedious job of winding your own. A 45Z5GT tube rectifies the A.C. and has, in addition, a tap on the filament for a pilot lamp.

It is advisable to follow the template instructions in the making of the chassis. Two additional socket holes are provided for extra amplifier stages which you certainly will want to add at a later date. It is much easier to put those extra holes on to the chassis now, before the set is assembled and wired, rather than after.

The identification of the various holes in the drilling template is apparent from the back-view photograph of this set. On the rear lip of the chassis, the first hole is for a rubber grommet for the line cord. The next four holes mount the dual tip jack strip for the headphones. The three holes on the right are for mounting the antenna-ground strip. The socket hole at the extreme left is for the 45Z5GT tube. Between

it and the panel we mount the electrolytic condenser. This is a three section electrolytic condenser, with two 150 volt sections at 40 and 20 mfd. and one 25 volt section at 20 mfd. The latter will be used for the amplifier to be added later. In the center you can see the 140 mmfd. variable condenser used for tuning. It will be necessary to make a small "L" bracket out of metal for mounting this condenser to the panel. The little gadget above the variable condenser is the pilot light mount.

Front panel controls are (from left to right on the front panel view) the regeneration control, main tuning control and rotary switch. In regard to the latter, we suggest that if you plan on adding the amplifier that you purchase a 100,000 ohm potentiometer with S.P.S.T. switch on it. For the present you will use just the switch for turning this set on and off.

"BREADBOARD" CONSTRUCTION OPTIONAL

If you prefer, you may use the breadboard style of constructing this set, and a masonite or thin plywood panel. Electrically, however, metal is preferred as it reduces body capacity effect and hum pickup. If a wood baseboard is used it will be preferable to purchase baseboard type sockets instead of the wafer sockets indicated in the parts list.

No drilling details are given here for the panel as you may wish to use some other vernier dial than that shown in the photo-

graph. The one shown here is a National type B and was chosen for its smooth action and variable vernier ratio feature. A drilling template is furnished with it.

Assemble all of the large parts to the chassis and panel in the order mentioned above and as shown in the photograph. The electrolytic condenser is furnished with a wafer socket which mounts to the chassis in the same way as tube sockets. The condenser is then inserted, and three metal tabs on the bottom are twisted to hold it firmly in the socket. A three point wiring terminal was mounted in approximately the center of the chassis as a wiring convenience. All fixed condensers, resistors and the R.F. chokes are supported by their own pigtail leads when wired.

WIRING SIMPLE BUT IMPORTANT

Wiring should be done slowly and carefully. Use a hot, well-tinned soldering iron and resin core solder. Do not use acid flux. The soldering iron should be held against the connections until the connections themselves are hot enough to flow the solder. Wiring leads should be as short and direct as possible. This is especially important if ultra shortwave operation is desired.

Notice that there is no direct connection between the wiring and the chassis itself. This is important if you wish to prevent sparks between the chassis and any external ground that it may happen to come in contact with. The schematic diagram shows a variable condenser mounted directly to the

*Engineer Allied Radio Corporation, Chicago, Illinois.

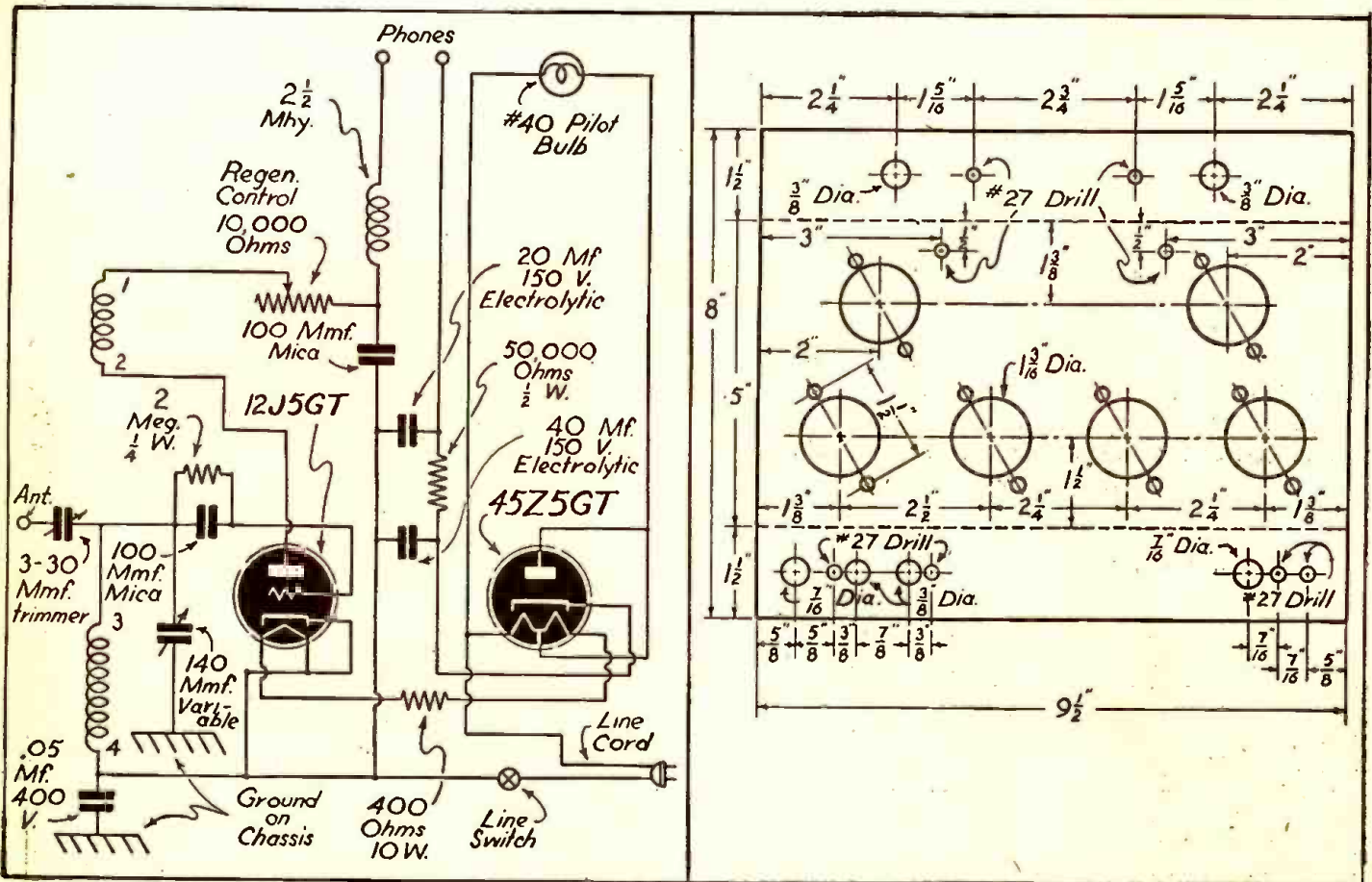

Wiring diagram for the headphone section of the "progressive" receiver.

panel. The R.F. voltage in this condenser gets its electrical return path in the circuit through the .05 mf. tubular condenser, also shown connected to the chassis.

Although a combination antenna-ground binding post is used, actually it is not necessary to use an external ground with this set. The set receives its ground through the line cord.

Before you say "done," check over the wiring once more. Use a colored pencil to draw over the connections in the diagram as you check them against your set. This is a great help in preventing oversights. If you have followed the diagram carefully and done the job neatly, using short connections, you should get immediate results. "ON THE AIR"!

We shall begin our operation by using one of the broadcast coils. On the broadcast band you will hear stations immediately and have a chance to become acquainted with the manipulation of the controls—not that it is the least bit difficult. Plug in the two tubes and the coil and insert the line cord in any A.C. or D.C. outlet, having an output anywhere from 105 to 125 volts. Turn on the switch at the right and allow a minute for the tubes to warm up. Turn the regeneration control to the right, but not so far that a continuous squeal is heard. Revolve the tuning condenser until a station whistle

is heard. Keep the condenser tuned to the center of this whistle and at the same time turn the regeneration control slowly to the left until the whistle stops. At the point where the whistle just stops as you turn the control to the left, or just begins as you turn the control to the right, is the *critical point of oscillation*. It is at this point that you will obtain the greatest selectivity and sensitivity. Broadcast (200 to 550 meters) stations are best heard just below this critical point of oscillation.

You can now try one of the *short-wave* coils. There is only one thing to keep in mind when tuning for shortwave stations. The condenser must be turned *very slowly*, otherwise it is easy to pass over these S-W stations. This is the reason that a good vernier dial is necessary. CM (code) signals can be copied when the regeneration control is set a *little past the critical point*.

It goes without saying, that a good pair of headphones should be used for best results. They should be of the magnetic type and have between two and three thousand ohms impedance. The antenna should be from 75 to 100 feet long, installed as high and as clear from any other obstacles as possible. As mentioned before, no ground is necessary.

Next month, we will describe the method of adding two stages of amplification. The

additional stages will permit loud-speaker operation of the more powerful stations, as well as increased sensitivity when using headphones. The transition is easy and all of the parts used in the present set except the 400 ohm resistor will be used in the four-tube set of next month.

Parts List for "Progressive" A.C.-D.C.

- All-Wave Set
- 1—9 1/2"x5"x1 1/2" metal chassis
 - 1—7"x10" black crackle finished panel
 - 1—NATIONAL type B vernier dial
 - 1—10,000 ohm potentiometer
 - 1—Rotary on-off switch
 - 2—Bar knobs
 - 1—140 mmf. tuning condenser Knight N1127
 - 4—Octal wafer sockets
 - 1—4 prong wafer socket
 - 1—Dial illuminator (NATIONAL)
 - 1—3 section filter condenser, MALLORY FPT306
 - 1—Twin antenna-ground terminal, EBY
 - 1—Twin pin jack
 - 1—2 1/2 mh. R.F. choke
 - 1—400 ohm 10 watt resistor
 - 1—50,000 ohm 1/2 watt resistor
 - 1—2 megohm 1/4 watt resistor
 - 1—3-30 mmf. mica trimmer condenser
 - 1—.05 mf. 400 volt tubular condenser
 - 2—100 mmf. mica condensers
 - 1—Line cord and plug
 - 1—Rubber grommet to fit 7/16" dia. hole
 - 1—Set of 4 prong "broadcast" coils (200 to 550 meters)
 - 1—Set of 4 prong S-W coils
 - 1—12J5GT tube
 - 1—45Z5GT tube
 - 1—Pair 2000 ohm magnetic headphones
- (To be concluded)

SERVICE NOTES

... CONTINENTAL RADIO AND TELEVISION (Admiral, Mantola, and others) MODELS 4F, 4D

On these models using wood cabinets, weak reception on distant stations is often caused by absorption of moisture by the wood. This is easily remedied by drying out the cabinets in an oven or by using an electric bulb inside the cabinet. The set must be realigned after drying for best results. When the set refused to align, this

may be caused by open secondary of the oscillator coil.

... MODELS 4A, 4F, 4D

Weak reception in this model may be caused by an open 2nd I.F. coil. If exact replacement is not available, Meissner I.F. winding No. 16-6601 mounted directly on old trimmer and dipped in hot paraffin to keep out moisture makes a very satisfactory replacement.

Impaired reception or whistle in this set is often caused by open 4 mf. 150 volt electrolytic condenser which goes from B-plus to ground.

... RCA AUTOMATIC RECORD CHANGERS

When the exact replacement starting condensers are not available on models using condenser starters, a 1 mf. 600 volt paper condenser makes a satisfactory replacement.

TECHNICAL BULLETINS

Technical bulletins give reliable information in easy-to-follow form, and save valuable time otherwise spent in laborious reading of numerous books. Every subject is treated briefly and concisely, yet completely. No complicated mathematics, chemistry, electricity, or theory. Each bulletin is written in simple language.

PRICE \$1.00 EACH POSTPAID
ORDER BY NUMBER

ELECTRICAL DESIGN & CONSTRUCTION

D-111—DESIGNING AND BUILDING TRANSFORMERS.—Simple, non-mathematical methods for designing transformers of all kinds. Also special transformers such as are used for ultra-violet lamps, Neon tubes, etc.

D-112—DESIGNING ELECTRO-MAGNETS.—The subject of electro-magnet design is so clearly explained that anyone can design and build magnets for practically every purpose. Complete, practical data covering both A.C. and D.C. magnets.

D-113—HOW TO DESIGN SOLENOIDS AND PLUNGER MAGNETS.—Anyone who is interested in solenoids or plunger magnets cannot afford to be without this non-mathematical, simple and practical information.

D-101—USING NICHROME RESISTANCE WIRE.—Explains how to repair electric flat irons, toasters, rheostats, resistors and other electric heating devices. Simplified methods of figuring lengths and sizes of wire for any job.

D-106—REWINDING ELECTRIC MOTORS.—Complete information, diagrams, sketches, tables, etc., to enable any shop man, mechanic, electrician, experimenter, etc., to rewind A.C. and D.C. motors and generators of all types.

D-144—A. C. CURRENT CONTROLLED WITH EASILY MADE CHOKE COILS.—How to design and construct choke coils. How to determine size and amount of wire required, how to find the core size. Full details on assembly and coil winding.

D-148—DESIGNING AND USING ELECTRIC RELAYS.—Simple practical instructions for designing, building, and using A.C. and D.C. relays; also thermo-electric relays. Includes practical relay control systems for motors and machinery.

D-127—SMALL ELECTRIC LIGHT PLANTS, DESIGN AND CONSTRUCTION.—Tells how to design and build small electric light plants for cottages, camps or country homes at small cost. Covers construction of a 110-volt system to light six 30-watt lamps, how to build a 6-volt system using an auto-generator, with or without a battery, and how to convert a Ford model "T" generator to a 110-volt, A.C. generator.

D-134—ELECTRICAL EXPERIMENTS WITH SIMPLE MATERIALS.—How anyone without previous knowledge of electricity can perform harmless, interesting, and educational experiments with simple, inexpensive materials.

D-131—MODEL MAKERS & INVENTORS GUIDE TO REMOTE-CONTROL SWITCHING.—Controlling electrical devices, train models, equipment of all types at a distance by means of a telephone dial.

D-137—ELECTRICAL METERS EASILY BUILT.—Information that will enable students to build experimental electrical meters to measure alternating or direct currents. Including ammeters, voltmeters and wattmeters sufficiently accurate for experimental purposes.

Each Bulletin consists of a set of large sheets, assembled in one packet, size 9 x 14 1/2"; weight 1/4 lb. Numerous illustrations, diagrams, charts to supplement text.

TECHNIFAX

1917 S. STATE ST. (DEPT. 642) CHICAGO, ILL.

DEPT. 642

TECHNIFAX 1917 So. State, Chicago, Ill.

Enclosed find \$..... for which please send me postpaid the following Technical Bulletins:

Nos.

Name

Street and Number

City and State

RENOVATING AND POLISHING CABINETS

● THERE is no reason why a scratched or dull cabinet should be tolerated, for after all, a radio set is an article of furniture as well as a musical instrument. The majority of marks that make a cabinet look shabby are scratches, chips and finger marks, and such cabinets can easily be rejuvenated by the following method, which should be followed for both French polished and sprayed cabinets.

The materials required are: A small bottle of French polish, a "water" stain in powder to match the color of the cabinet and a fine paint brush.

FOR SCRATCHED SURFACES

To touch up scratches or chips, proceed as follows: Place a little polish in a saucer and add just enough of the powder stain to color the mixture, mix well and gradually add more powder until the approximate color required is obtained. It is as well to be a little on the light side, as the color can always be darkened when adding a second coat.

Thoroughly clean the scratch with a cloth dipped in methylated spirits and carefully "paint" the scratch with the mixture of stain and polish, taking very great care not to get any on the polished surface of the cabinet, or the surface will be spoiled. Should the mixture get on the cabinet, wipe it away as quickly as possible.

When the first coat has dried thoroughly, a second may be applied, and if the scratch has been colored to match the rest of the cabinet by the first application of the mixture, the second "dose" should be of polish only. Otherwise, continue the treatment as outlined above with another coating of the mixture. When tackled in this way, the scratch will soon be filled and will scarcely be discernible.

USING PLASTIC WOOD

Some scratches, or chips, are too deep to be removed by this method, and plastic wood should be used. This is obtainable from most hardware stores and, since it will not take a stain, the colored variety should be used and a little pressed firmly into the scratch with the blade of a pen-knife. Here, again, take care not to allow any of the plastic wood to creep on to the rest of the cabinet, as it contains a powerful solvent which will quickly attack the polish and give it a mat surface. Smooth off the surface of the wood as soon as it is applied, and leave to dry for at least an hour. Plastic wood contracts as it dries, so the surface when applied should be just slightly above the level of the cabinet. When hard, it should be carefully levelled down with a very fine sandpaper. The mixture of stain and polish may then be applied as before, and any irregularities in the surface of the plastic wood will be levelled up by this application. This method is so effective that the position of a scratch may be practically hidden.

When a cabinet is merely dull, the application of a little "oil" or "liquid glass" coupled with plenty of "elbow grease" should be tried. It is surprising what a few minutes of such treatment will do. In fact, any of the many commercial car polishes (cellulose type) are extremely good, not only for removing finger marks and generally cleaning up the cabinet, but also in

giving an extremely high polish and removing fine scratches from most of the finishes used in cabinet manufacture. Such treatment is of no avail when the cabinet has been hand French polished.

Perhaps the worst kind of cabinet to tackle is one on which the actual polish surface has worn off due to continual use and polishing. Too many people make a habit of regularly polishing their cabinet with polish, with the result that they do more harm than good, and gradually remove the surface. Rub it over occasionally by all means, but use only a soft, clean duster with no polish.

In such a case, the only way to make a good job of the cabinet is to "strip" it, that is, to remove all that remains of the existing polished surface by well rubbing the cabinet with fine sandpaper. Always sandpaper the way of the grain, never across the grain, and make a perfectly smooth and uniform surface before attempting any re-polishing. After sandpapering, clean the cabinet with a duster and then with a rag moistened with methylated spirits to remove all grease.

This time, however, the polish cannot be applied with a brush, or a very uneven surface, showing all brush marks, would result. The following method should be followed, and although it may seem a little tedious, it will render results equal to a new cabinet, and is well worth the time and patience.

POLISHING HINTS

Place a small amount of cotton wool in the center of a square of linen or fine rag, and pour sufficient of the staining polish (which should be made up as described above), on to the wool so as to damp it right through. Wind the rag round the wool so as to make it into a tight pad with a smooth polishing surface. Slight pressure of the fingers on the sides of the pad should cause some of the polish to ooze through the linen.

Apply the polish in circular motions, with a gentle but firm pressure, taking care to cover every portion of the surface with a layer of polish. If more polish is required, never pour it on to the rag, but on to the pad and add polish to the cotton wool. If the pad sticks to the surface being polished, apply a little linseed oil to the actual polishing surface of the pad. On no account add more than one large drop unless the surface is extremely large. This will prevent the pad sticking as the polish hardens.

When the first application has dried thoroughly, rub it over very lightly with extra-fine sandpaper, working the way of the grain as before, and then apply another layer of polish, but using this time a slightly drier pad, and working in very small circles. Work up and down the surface in these small circles and, at the end of each line, draw the pad very lightly across the newly-polished surface in the direction of the grain.

If it is found that the surface is patchy when dry, i.e., polished in some places, but with dull patches here and there, the surface must be lightly sandpapered once more and the above procedure repeated again, until, finally, a highly polished surface is obtained. Practice, of course, makes

(Continued on page 636)

Question Box

160-METER AMPLIFIER

? Can you print a diagram of a 100-watt single-tube R.F. amplifier to be driven by my E.C.O. driver unit for 160-meter operation.—C. Kramer, Atchinson, Kans.

A. A single-ended output stage using a Hytron HY-40Z tube and capable of slightly over 100 watts input when plate is modulated is shown herewith. The 30-ohm center-tapped filament resistor may be omitted if the filament supply is center tapped. If a 200 mmf per section split stator tuning condenser is not available a 100 mmf per section unit can be used with a 50 mmf fixed air condenser connected in parallel. Standard 100-watt coils can be used.

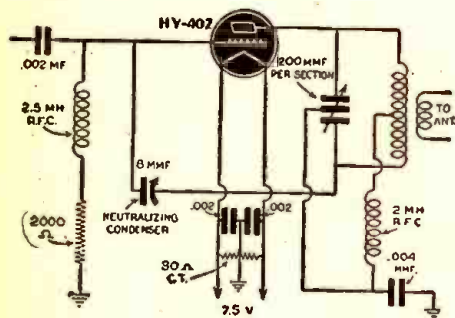

TRANSFORMER AS CHOKE

? Can an audio transformer be used as a filter choke?—B. Williams, Baton Rouge, La.

A. The ordinary interstage audio transformers have quite a high resistance and are wound with very fine wire so that not more than 5 or 10 milliamperes of current should be passed through them. For such low currents they may be used where their high resistance is no detriment. The primary winding should be used, as it generally has a lower resistance and is wound with larger wire than the secondary. Output transformers are wound with a larger size of wire and they can often be used in power supplies delivering currents of 50 to 100 m.a. Generally, the transformer will be rated for use with a certain tube and since the plate current of that tube is known, that current will be the current rating of the transformer used as a choke. The primary winding is the one referred to.

INCREASING BANDSPREAD

? How can I obtain more bandspread on my T.R.F. receiver?—Dan Brennan, Toronto, Ont., Can.

A. Additional bandspread would depend on the type of bandspread you already have in your receiver. We assume you have separate bandspread and band-setting condensers. If the band-spreading condensers are tapped across part of the coil, shifting the tap lower down on the coil (toward the ground side) will increase the bandspread. If the bandspread condenser is connected across the entire coil, connect it to a tap a few turns down from the grid end, but if this is not practical you will have to use a smaller size of bandspread condenser. By experimenting with the tap on the coil, the amount of bandspread can be made to fit your requirements.

RC FILTERS

? Can you tell me what frequencies are bypassed by the various sizes of bypass condensers?—T. Brown, Santa Barbara, Calif.

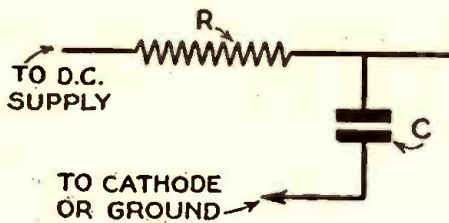

A. The frequencies bypassed are a function not only of the condenser impedance but of the impedance of the circuit in which it is placed. The sketch shows the position of the bypass condenser in relation to the decoupling resistor generally used in the plate supply leads of tubes. These filter networks are used to provide a low impedance path for the signal current direct to the tube cathode or ground rather than by the route through the power supply circuit.

The impedance of a condenser can be calculated from the formula of $X_c = \frac{1}{2\pi f C}$

where f is the frequency, C the capacity in farads and π is 3.14. Actually, this is the equation for capacitive reactance, but is sufficiently close to the impedance for our purpose.

Good engineering practice calls for the impedance of the condenser to be about one tenth the value of the resistance at the lowest frequency it is desired to bypass. Generally the resistor value is first determined and is made as large as possible consistent with the allowable voltage drop through it. The condenser value is then calculated from

a variation of the above formula $C = \frac{1}{2\pi f X_c}$

Where the voltage drop must be kept as small as possible, a choke coil can be used instead of the resistor. The impedance of an air-wound choke can be calculated as follows:

$$Z = \sqrt{R^2 + (2\pi f L)^2}$$

where R is the D.C. resistance, " f " the lowest frequency and L the inductance in henries.

POWER SUPPLY

? Could you furnish a diagram of a power-supply to furnish 6.3 volts at 0.3 amperes for use in starting my car in winter when the car battery will not start it?—J. Weeks, Chicago, Ill.

A. The starting motor of a car draws between 100 and 300 amperes and a power-supply capable of delivering this huge current would be prohibitive. I would suggest getting a new battery or perhaps your old one can be overhauled.

COIL DATA

? In the 4-tube short-wave receiver shown on page 175 of the July issue, what size wire is used for the coils?—J. Bunyan, N. Y.

A. Number sixteen enameled copper wire can be used for the grid coils, while #28 or #30 enameled can be used for L-2.

We have a large stock of

**HALLICRAFTERS
NATIONAL
HAMMARLUND
RME
HOWARD**

RECEIVERS, transmitters and all radio supplies of all sorts at lowest wholesale prices. Order from us for immediate delivery. We will help you get the best equipment for your use and cooperate with you to see that you are 100% satisfied.

- YOU get 10-day trial
- YOU get best trade-in

We also have a store at 2335 Westwood Blvd., West Los Angeles, Calif. Write, phone, telegraph us anytime about any radio supplies. It will pay you to deal with us. Your inquiries invited.

HENRY RADIO SHOP

Butler, Missouri

"World's Largest Distributors of Communications Receivers"

**Significant
Isn't It**

... THAT WHERE
REQUIREMENTS
ARE CRITICAL

**KENYON
TRANSFORMERS**

ARE SPECIFIED

KENYON TRANSFORMER CO., Inc.

840 BARRY ST. NEW YORK, N. Y.

New Handy **UNIVERSAL REPLACEMENT** Coils

Write for Catalog

SOLAR MFG. CORP., Bayonne, N. J.

RADIO COMMUNICATION COURSES

QUALIFYING FOR ALL FEDERAL LICENSES

RESIDENT and HOME STUDY

WRITE FOR FULL PARTICULARS

AMERICAN RADIO INSTITUTE

1123 BROADWAY
NEW YORK

RENOVATING AND POLISHING CABINETS

(Continued from page 634)

a great deal of difference to the ease with which a cabinet may be completely repolished.

Finally, there are one or two hints that may save time and patience, viz., *never attempt polishing except in a dry atmosphere*; always see that the pad is clean and smooth, and, above all, *never go over a polished surface until it has become quite hard*. It is

not the amount of polish, nor the pressure, that produces a good surface, simply the continued rubbing. Speed does not matter, but rather an even, steady circular movement with even pressure.

If the pad is stopped on the work, a mark will be made which can only be removed by sandpapering off the entire surface.—"Radiogram" (New Zealand).

LEAKY RESISTANCE TESTER

● DESIGNED specifically for use in detecting minute leaks in the rubberized canvas so widely used in air raid precautions work is an interesting piece of apparatus described by A. W. Russell in *Electronic Engineering* of Great Britain. The diagram herewith shows the circuit.

In use, the rubberized canvas is fitted between two rollers saturated in brine or other suitable conducting liquid and the resistance (which is normally about 10 megohms with perfect material) drops to a few thousand ohms if there is a pinhole in the rubber layer.

"V1" has a cathode bias as shown, while the grid receives a further negative bias, the actual value being determined by the ratio of the resistance between the rollers and the value of R1.

When there are no pinholes, the resistance is very high and the bias on V1 equals the voltage drop across R4. When, however, the resistance of the material under test falls, indicating the presence of a defect, the negative bias is increased, causing a positive impulse to be fed to the grid and the gas triode V2, which then discharges, operating the relay in its plate circuit. This may be used to ring a bell or to make a mark on the edge of the material, indicating the approximate position of the defect.

The values of all parts are given in the following table. These are devised to oper-

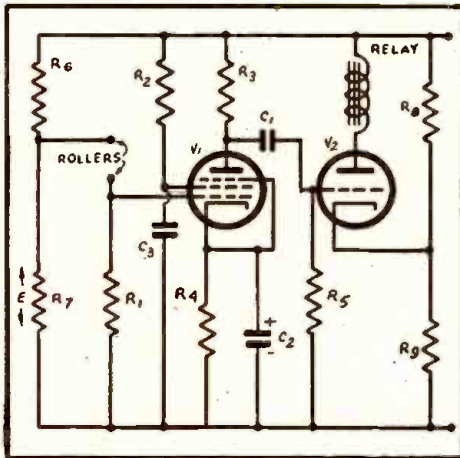

ate the circuit when the resistance between the rollers drops to 25,000 ohms or less. In order to change these values, it is necessary only to change the value of the voltage fed in through the terminal shown at the right and the value of resistor R1.

R1	5,000 ohms	C1	0.5 mf.
R2	0.125 meg.	C2	50 mf.
R3	5,000 ohms	C3	8 mf.
R4	500 ohms	Relay:	10 mA.
R5	1.0 meg.		17,500 ohms
R6	32,000 ohms		
R7	1,000 ohms		
R8	24,000 ohms		
R9	1,000 ohms		

OPA PRICE CEILING AFFECTS SERVICEMEN

● BEGINNING July 1, 1942, no one may charge more for services sold at retail in connection with a commodity than he charged in March 1942. Beginning May 18, 1942, prices for goods sold at retail (with certain specified exceptions) may not be higher than those of March 1932. If the service or merchandise was not sold during March, 1932, the ceiling price is set by the highest March 1942 sale price of a similar service or article.

Radio servicemen are specifically included in the explanation issued by the Office of Price Administration following the announcement of the program to stabilize living costs. In their case the Government ruling works out as follows:

Beginning May 18, prices for radio tubes, parts, etc., used in repair work or sold over the counter, and prices of radio sets, phonographs, amplifiers and other goods sold at retail may not be higher than the March 1942 price.

Beginning July 1, 1942, charges for radio or other equipment repairs, inspection charges, and other charges connected with radio servicing may not be higher than the highest price charged in March 1942.

It should be noted that such charges and retail prices are not set at a standard level for the entire service profession, or for all radio dealers. If your competitor charged during March higher prices than yours for either merchandise or services, he is still at liberty to charge on that basis, while your March prices fix your rate.

If you were not in the service business or selling at retail during March 1942, your service charges and prices may be the highest prices charged by a competitor whose business is similar to yours, and who was in business during that period. The effective date of the Maximum Price Decree in retail servicing is delayed until July 1 to give OPA time to set up machinery for the administration of maximum prices in this field. It is to be understood that in the meantime all retail servicing operators will patriotically govern themselves by not charging any price higher than the highest price charged in March, 1942.

The radio jobber's maximum price to you is also established by the highest prices he charged in March 1942. The price ceiling for jobbers went into effect on May 11. Customary allowances, discounts or other price differentials cannot be changed, except to lower the price.

Every retail and wholesale establishment automatically is licensed to sell under the general maximum price regulation at the date the ceiling applies to it, and every new store established after that date is automatically licensed. This license gives the Office of Price Administration a basis for action against stores that refuse to conform to regulations.

OPA may ask a court to suspend, for as long as twelve months, the license of a store which, after receiving a warning notice, violates OPA regulations. Without a license the store cannot operate. Convictions for certain violations may also bring a fine up to \$5,000 and imprisonment up to one year, or both.

If OPA regulations, as they apply to your business, are not entirely clear, we suggest that you get in touch with the nearest OPA office. Such offices are located in all large cities.—*Sylvania News*.

SLOGAN

A good slogan for Servicemen to put into a window is:
WE KEEP 'EM PLAYING
It ties in with similar war slogans. A humorous drawing showing an ante-diluvian radio set playing perfectly can be added.

MENLO PARK REMINISCENCES, Volume III, by Francis Jehl. Published by The Edison Institute, Dearborn, Mich. Stiff cloth covers, size 4 3/4 x 7 1/2 ins., pages from 923 to 1156, illustrated. Price Cloth covers \$1.00, paper covers 50c.

One of the most interesting and delightful descriptions of the early struggles of Edison and his associates to establish the first electric lighting plants, is set forth in this newest volume by Mr. Jehl. Not only is the book of interest historically, for the sketches and photographs given, but many amusing anecdotes are included; some of these stories revolving around early electrical inventors who were destined to become leaders in this great industry. The book contains most interesting illustrations of the early Edison factories and power stations. A fine description of the events occurring when the old Pearl Street Central Station was put into operation is given by Mr. Jehl.

Another chapter describes the first Three-Wire Station at Sunbury, Pa.

The final chapter of the book describes the restoration of the Edison Laboratory by Henry Ford at Dearborn, Michigan.

You can read this book with interest, be amused, and learn a lot besides.

RADIO NAVIGATION by W. J. D. Allan. Published by Chemical Publishing Co., Inc., Brooklyn, N. Y. Size 5 1/2 x 8 3/4 ins., cloth covers, 106 pages.

The opening chapters deal with electricity, alternating current, oscillating circuits, radiation, wave transmission, sine wave analysis, etc.

Chapter II takes up the directional loop antennas, with polar diagrams showing how it works. The author then discusses the method of determining location by means of the rotatable loop antenna, and discusses direction-finding loop errors, coastal refraction, methods of calibration, also night and "skip" effects, etc.

The closing section explains how to obtain a "fix" by simultaneous bearings, great circle bearings, mercator bearings, long range loop bearing—with calculations of different types of radio-direction finders, route markers and approach beacons, etc.

INTERIOR ELECTRIC WIRING AND ESTIMATING (Third Edition, 1942), by Albert Uhl, Arthur L. Nelson, and Carl H. Dunlap. Published by the American Technical Society, Chicago, Ill. Cloth covers, size 5 1/2 x 8 1/2 inches, 354 pages. Price \$2.50.

This book is valuable to all interested in electricity, not only to engineers and architects, but also to contractors and students. The methods of wiring used today differ greatly from those used a few years ago because electricity has been brought into rural districts and also has been extended to a more wider use of exterior lighting. Therefore, this book goes into detail explaining the different kinds of wiring used, which is inexpensive and yet safe. Due to the fact that the subject of wiring is so vast, this book deals only with interior electric wiring.

This book is easily understood by the beginner as the authors have endeavored to use special technical terms used by the everyday workmen, and have shown in detail how to perform many operations in the easiest manner.

The latter section of the book shows the wireman how to start in business for himself, with the assurance that he will be successful in bidding on jobs.

Among many fine features this work contains is the fact that 8 blueprints for instructional purposes accompany the book, and also that it is profusely illustrated with specially drawn diagrams, charts and sketches.

THE MYSTERIES OF TELEVISION. by Arthur Van Dyck. Stiff paper covers, size 8 1/2 x 11, 56 pages, illustrated with diagrams and photos, published by The House of Little Books, New York, N. Y.

This book, printed in large readable type, with clear illustrations specially made in picture form, makes this book a very good one for the lay reader who knows practically nothing about television. The picture-diagrams show in a clear manner how the waves are restricted to a distance limited by the horizon; how mobile television transmitters pick up "spot news" scenes and relay them to the headquarters station, etc. Other picturized diagrams show how the image and voice is picked up, amplified, transmitted and received. A number of popular questions and answers on television are given at the close of the book, and a dictionary of television terms concludes this popular treatise.

AUDEL'S NEW RADIOMANS GUIDEBOOK, by E. P. Anderson; Theo. Audel & Co., Publishers; New York, N. Y. Flexible covers, size 5 x 6 3/4 inches. Illustrated, 756 pages. Price \$4.

This is a new and revised edition of a most ambitious undertaking—an attempt to place between two covers all the sciences contributing to the art of radio.

It is the author's belief that servicing of radio equipment requires more than a set of rules or formulas, that an analytical approach is needed in tackling new problems, and he draws liberally on such information as he deems necessary for an understanding of fundamentals. But he includes the rules and formulas as well.

Although arranged as a progressive treatise, it is very useful as a handbook. The reader may refer either from the tabled List of Chapters or from the Ready Reference Index to a myriad items, theoretical and practical, and if his specific problem isn't answered some simple solution of an analogous case may be used as a guide. Numerous illustrations supplement the text.

Einstein and Steinmetz will be found in its first pages (regarding the ether theory), the Underwriters' Standards in its last (regarding radio installation requirements), and between them is a world of material ranging from ethereal to earthly.

This Guidebook is to be recommended as a text book for the beginner and as a reference book for the Serviceman and Experimenter.

BASIC RADIO by J. Barton Hoag. Published by D. Van Nostrand Company, Inc. Cloth covers, size 5 1/2 x 8 1/2 ins., 358 pages. Price \$3.25.

Basic Radio, The Essentials of Electron Tubes and Their Circuits is as timely and authoritative a textbook as anyone could ask for. It is timely because of its excellence as preparatory material for persons desiring to enter some radio branch of war work. It is authoritative because its author, Dr. Hoag, Professor, with the rank of Lieutenant Commander, United States Coast Guard, heads the Coast Guard Academy and formerly was Assistant Professor of Physics at Chicago University. He is a Fellow of the American Physical Society and a member of the Institute of Radio Engineers.

But don't let this array of titles frighten you. If Professor Hoag (author also of *Electron and Nuclear Physics*) is theoretical, certainly Commander Hoag is practical. His experience as instructor in the Army Radio School at Colorado College in 1918, if not his present post, must have guided him in writing for beginners having a limited scholastic background. Therefore, through the use of visual aids, such as curves and graphs, he has been able to keep at a minimum the need for mathematical equations usually formidable to the beginner.

The student will find this textbook very much alive, since the author has omitted most of the material and equipment which, in the rapid rise of radio, have already outlived their usefulness. Circuit diagrams are numerous—chiefly basic diagrams, but many of them give complete details. Subjects are presented in progressive form, generally beginning with an introduction followed by a simple application, related variations and final development.

A specially prepared section of Problems and Questions is given in the back of the book. No answers are given because the student is expected to refer to the book or to other radio literature.

Contained also in this book are chapters dealing with equipment related to the field of radio. There are two chapters of gas-filled tubes and their application, explaining their use in stroboscopes, grid-controlled rectifiers and D.C. to A.C. inverters.

WIRELESS COILS, CHOKES & TRANSFORMERS, Edited by F. J. Camm; Chemical Publishing Company, Inc. Size 5 1/2 x 8 3/4 inches. Illustrated, 180 pages. Price \$2.50.

The radio craftsman will find this compilation of articles useful for a better understanding of the construction of coils, principally R.F., I.F. and short wave. There are no bothersome formulas, but rather practical working values, hook-ups and picture diagrams. Useful formulas and other radio data are contained in the appendix. A number of coil winding machines that can be built by the home constructor are described in detail.

The text has a delightful British flavor, but its terminology may cause an American reader to be slightly puzzled. The English "valve" actually is a better name for a radio tube, since the grid controls the flow of the electron stream in much the same way as the mechanical valve controls the flow of a gas or liquid. "High Tension" and "Low Tension" are, respectively, high and low voltage. "Mains Transformers" are power transformers, "mains" being power lines. The English use "earth" for ground, "screened coils" for shielded coils and several other different but easily recognizable terms.

LEARN RADIO TELEVISION

600 LICENSED graduates placed in past 7 years in shipping, broadcasting, aviation, police, etc.; we also teach radio servicing and repairing; new beginners' class forming Sept. 8th; 60-page catalog free; oldest, largest and best equipped.

MASS. RADIO SCHOOL
18 BOYLSTON ST., BOSTON, MASS., Est. 1899

RADIO ENGINEERING

broadcasting, aviation and police radio, servicing, marine radio telegraphy and telephony, Morse telegraphy and railway accounting taught thoroughly, 48 weeks' Engineering course equivalent to 3 years of college radio work. All expenses low. Catalog free. School established 1874.

The Dodge Institute, Monroe St., Valparaiso, Ind.

LESLIE'S Correspondence Courses in **RADIO and ELECTRICAL ENGINEERING**
ELECTRICAL ENGINEERING Get good grasp of wide electrical field. Prepare yourself at Low Cost. For secure future. Modern, simplified, you can understand quickly.
RADIO ENGINEERING Extra fine course in radio, publishes address, photo-electric work. Trains you to be super-service man, repair vacuum tube technician. Exper. kits furnished. Diploma on completion. Tuition, \$25. either course. Deferred payment plan. Get copies of school catalogs, student magazines, complete details. SEND NOW!
FREE
LINCOLN ENGINEERING SCHOOL Box 931-C42, LINCOLN, NEBR.

COMMERCIAL RADIO INSTITUTE

A radio training center for over twenty years. Well equipped. Excellent faculty. Practical resident courses in Defense, Radio Telegraphy, Broadcast. Servicing, Industrial, Television, Aeronautical, Drafting, Mathematics and Studio Technique. Placement bureau. Classes now forming for June 8th. Catalog upon request.
Dept. D, 38 West Biddle Street, Baltimore, Md.

RADIO TECHNOLOGY

RCA Institutes offer an intensive course of high standard embracing all phases of Radio and Television. Practical training with modern equipment at New York and Chicago schools. Also specialized courses in Aviation Communications, Radio Servicing and Commercial Operating. For Free Catalog write Dept. RC-42.
RCA INSTITUTES, Inc.
A Radio Corporation of America Service
75 Varick St., New York, 1154 Merchandise Mart, Chicago

CHECK HERE!
—If you want a BETTER radio job! Your radio experience backed by CREI modern technical training will equip you to share in the better, good-paying jobs that await trained men. Technical ability is the only thing that stands between you and a better job NOW and a secure radio career in the future. Write for FREE BOOKLET and details.
CAPITOL RADIO ENGINEERING INSTITUTE, Dept. RC-5, 3224 16th St., N.W., Washington, D. C.

USED Correspondence Courses
COMPLETE HOME-STUDY COURSES and educational books, slightly used. Sold, rented, exchanged. All subjects. Money-back guarantee. Cash paid for used courses. Full details and illustrated 76-page bargain catalog FREE. Write today!
NELSON COMPANY, 500 Sherman, Dept. E-210, Chicago

OPPORTUNITY AD-LETS

Advertisements in this section cost 15 cents a word for each insertion. Name, address and initials must be included at the above rate. Cash should accompany all classified advertisements unless placed by an accredited advertising agency. No advertisement for less than ten words accepted. Ten percent discount six issues, twenty percent for twelve issues. Objectionable or misleading advertisements not accepted. Advertisements for July, 1942, issue must reach us not later than June 10, 1942.

Radio-Craft • 25 W. B'way • New York, N. Y.

ONE, TWO AND THREE-TUBE SET PLANS: "TELIO", "Tellotron", "Tello-Builder", "Radio-Builder", "Radio-Tello"—All 25c. Telloradio, 524 Fairbanks Avenue, Oakland, California.

SPOT CASH UP TO \$5.00 FOR NEW RADIO INVENTIONS. Tellotron, 524 Fairbanks Avenue, Oakland, California.

WANTED: SET RIDER'S MANUALS. P.O. BOX 963, San Bernardino, Calif.

RADIO PATENT REVIEW

SCANNING APPARATUS

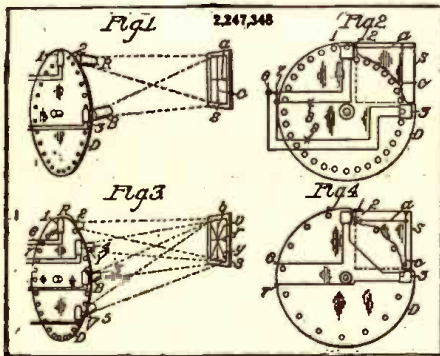

2,247,348 issued to Aloysius J. Cawle, Pittston, Pa.

● THE idea here is to produce brighter, clearer and more detailed images. This is accomplished in general by scanning several component images in different directions and superimposing those images to form a composite image of great detail and definition. Each of those images may be composed of light of a certain complementary or elementary color and their combination into a composite image produces an image in natural colors.

MEANS FOR ANGULARLY MOUNTING VEHICLE ANTENNAS

No. 2,274,884, L. S. Brach, East Orange, New Jersey.

This invention relates to means for adjusting the angular position of an antenna on an automotive vehicle. Different makes of such vehicles have different body shapes or angularities, and therefore present a problem to providing a somewhat standardized mounting which will position the antenna in a manner conforming to the angularity of the body where it is desired to mount the radio antenna.

The principal object of the invention is to provide a mounting which is adaptable to many car or vehicle bodies, whereby the antenna may be positioned in such a manner that it will extend in a direction conforming to the slope or angularity of the adjacent parts of the body.

A further object is to provide means for adjusting the angularity of the antenna which is relatively simple and which can be manipulated very quickly from the exterior of the vehicle, and then locked in position by means within the vehicle.

The inventor claims:

Means for mounting a radio antenna on an automotive vehicle comprising, a hollow mounting insulator with means for fastening it to a part of the exterior of the vehicle, an antenna section extending into the interior of said insulator, an angle selector plate positioned within the insulator and extending transversely across the lower part of the hollow portion of the insulator and adapted to have a radio set antenna wire connected thereto, said plate having a plurality of positioning means along its length while the end of said antenna section has a cooperative positioning device to

Still another object is the employment of an ordinary Nipkow disk or its equivalent, for the production of those composite images, which are in turn made up of several component images scanned in different directions.

Another feature of this patent is the use of one-half or one portion of the disk for the production of several component images, while the other half of the disk may be used for the scanning of an object and the production of several image varied currents corresponding to several component images scanned in different directions. Thus one-half of the circumference or periphery of the disk may be provided with photoelectric cells for the transmission of images and the other half may be provided with glow lamps for the reproduction of a received image, thus producing a two-way television apparatus of great simplicity and usefulness. Thus the field of usefulness of the simple Nipkow disk is greatly widened.

Instead of superimposing the various differently scanned images, they may be projected in juxtaposition. Both transmitter and receiver would in the event be adjusted for juxtaposed projection. The apparatus is instantly convertible into either type, juxtaposed or superimposing scanning.

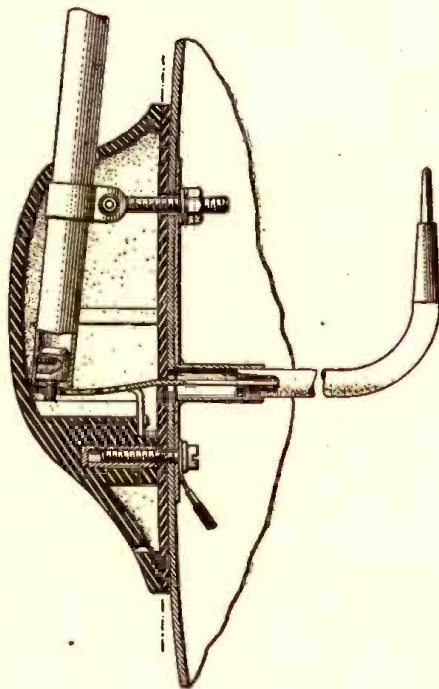

engage said positioning means, and an adjusting stud insulatively fastened to the antenna section within the hollow insulator and extending within the vehicle and having locking means therewith, whereby the angle of inclination of the antenna may be locked from within the vehicle.

POLARIZATION MODULATION

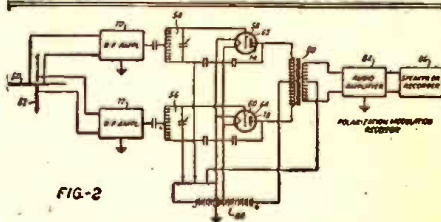
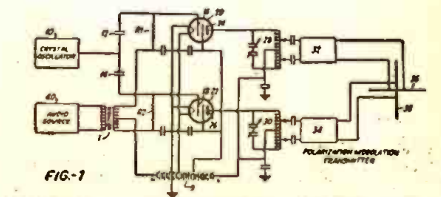

No. 2,273,911, issued to G. L. Usselman, Port Jefferson, N. Y.

This invention concerns a new and improved method and means for radio communication, and, more particularly, a system of radio communication by means of polarization modulation.

The principle of operation is as follows:

Radio-frequency excitation voltage is supplied in parallel or cophasally to the control grids 16 and 18 of tubes 20 and 24 from the oscillator 10 Fig. 1. This carrier frequency is amplified or amplified and multiplied in tank circuits 28 and 30 and units 32 and 34 respectively, and then it is delivered to antennas 36 and 38 respectively. When there is no modulation present both antennas will radiate energy of equal intensity but this radiated energy will be polarized in different planes having a fixed polarization angle difference depending upon the position of antennas 36 and 38 and manner of excitation.

Now if audio-frequency signals are applied from source 40, they will be delivered in phase opposition through transformer T and resistors R1 and R2 to the control grids 16 and 18 of tubes 20 and 22. This signal then modulates the radio-frequency power to the antennas at an audio rate and since the audio modulation is in phase opposition, the radiation of one antenna will be a maximum when that of the other antenna is a minimum. The resultant radiated wave energy polarization will consequently swing back and forth through the radiation polarization angle of the antennas 36 and 38. Of course, this new system of radio communication may also be considered as operating over two paths of the same frequency. These two paths are oriented in space to have different polarization. The intelligence or signal is transmitted by differentially modulating the carrier energy of these two paths which have the unlike polarization.

The energy radiated from these transmitting antennas travels through space and some of it reaches the receiving antennas shown in Fig. 2. The polarization position or direction of the signal energy may change during its transmission through space but it will still retain its polarization oscillation or modulation. The energy picked up by receiving antennas 50 and 52, which are predominantly responsive to energy of a polarization corresponding to the polarization of the energy radiated by antennas 36 and 38 respectively, is transmitted through amplifiers 70 and 72 and tank circuits 54 and 56 to the grids of detector tubes 62 and



Do Your Part—Invest in Defense Bonds and Stamps



64 respectively. Tank circuits 54 and 56 are tuned to the signals received on antennas 50 and 52. The grid biases of tubes 62 and 64 should be set for maximum efficiency as detectors. Now as the polarization of the incoming wave energy varies, it will be detected by tubes 62 and 64 and translated into low frequency or signal frequency push-pull current and voltages by transformer 80. The audio-frequency signals from transformer 80 may be amplified by amplifier 84 and then transmitted to the loudspeaker or recorder 86.

Antennas 50 and 52 should be of a type which is sensitive to changes in polarization of the received wave energy so that when the polarization is such that a maximum amount of energy is intercepted by one antenna, a minimum amount of wave energy is intercepted by the other antenna. Then, as the polarization of the received wave energy oscillates back and forth through an angle corresponding to the rate and intensity of the audio-frequency modulating signals in the transmitter, the changes in polarization will be detected in the receiver by the push-pull detector and amplified into audible signals in the loudspeaker.

TELEVISION RECEIVER

No. 2,275,028, K. A. Chittick and R. C. Ballard.

This invention relates to the high voltage supply unit for the cathode ray tube in television receivers.

A high-voltage unit of this character includes a step-up transformer for transforming the line voltage, such as 110 volts, to a voltage of several thousand volts. This transformer must be safe from voltage breakdown at several times the normal operating voltage, the present underwriter's requirement being that the transformer be able to operate with three times normal voltage across the primary without any voltage breakdown between the primary and

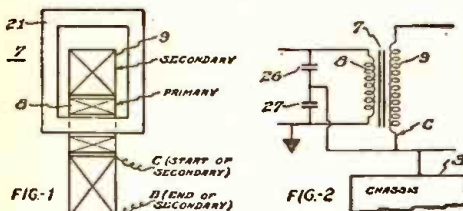

secondary windings. If a transformer is designed with enough insulation to withstand the above-mentioned test, it substantially increases the size and the cost of the transformer.

An object of the invention is to provide an improved means for and method of preventing voltage breakdown of the transformer.

The transformer is of the type in which one end of the secondary winding is adjacent to the primary winding, while the other end of the secondary winding is spaced a substantial distance therefrom. In accordance with the invention, a condenser of large capacity as compared with transformer distributed capacity is connected between one end of the secondary winding and the primary winding whereby substantially the entire voltage difference between the primary and secondary windings appears at the other end of the secondary. Thus, the high voltage difference appears at a point where there is no danger of voltage breakdown.

In practice it is found that many re-

ceivers are operated with the chassis ungrounded. Since the chassis is commonly used as a bus connection in wiring up the receiver, the chassis may acquire a high voltage above ground if there is a voltage breakdown of the transformer. The importance of avoiding a transformer breakdown under these circumstances will be appreciated.

The construction of the transformer 7 is shown in Fig. 1 where the primary coil 8 is wound on one leg of a closed iron core 21. The secondary winding 9 is wound over the primary coil 8 with the secondary winding starting at the point C adjacent to the primary winding and ending at the point B spaced a maximum distance from the primary coil. It will be apparent that it will require a much higher voltage to cause breakdown between the point B and the primary than between the point C and the primary.

In Fig. 2 the normal A.-C. voltage of the chassis 3 with respect to ground is one-half the line voltage. This result is obtained by connecting the end C of the secondary 9

to both sides of the 110-volt line through the condensers 26 and 27, each of which has large capacity as compared with the distributed capacity of the transformer 7. In this way, voltage breakdown of the transformer 7 is prevented and, at the same time, the chassis is at a lower A.-C. voltage with respect to ground.

AERIALS

In order to vary the effective height or length of an aerial, particularly for microwave working, the conducting part consists of a column of mercury in an open tube of insulating material. The lower end of the tube is immersed in a stump of mercury, and the height of the column is adjusted for varying wave-lengths by hydraulic or pneumatic pressure supplied through a calibrated gauge. The invention is applicable to a number of dipoles forming a directional array.

A. C. Ducati. Convention dates (Italy), October 15th, 1938, and August 30, 1939. No. 535425.

Lowest Priced Publications for Experimenters

10 FOR 50c

Here is a large number of radio, short-wave, and mechanical "how-to-make-it" designs.

Each is a special publication originated by masters in their respective fields.

For the low price of 50 CENTS, you buy TEN complete pamphlets with photographic reproductions, complete mechanical layout, and full description to make it possible for anyone to build the project in question.

PLEASE ORDER EACH PROJECT BY ITS PUBLICATION NUMBER, and use the special coupon below.

We accept money-orders, cash, checks or new U. S. stamps. (No foreign stamps.) If you send cash or stamps, register your letter.

Money refunded if you are not satisfied. ANY TWENTY-FOUR PUBLICATIONS FOR ONE DOLLAR.

SHORT-WAVE RECEIVER PUBLICATIONS

- HOW TO MAKE THE "OSCILLODYNE" 1 TUBE WONDER SET.....No. 101
- HOW TO MAKE THE "19" TWIN-PLEX (ONE TUBE PERFORMS AS TWO) RECEIVER.....No. 102
- HOW TO MAKE THE WIZARD. 1-TUBE 50-WATT TRANSMITTER.....No. 103
- HOW TO MAKE THE IMPROVED 3-TUBE DOERLE SET FOR BATTERY OPERATION.....No. 104
- HOW TO MAKE THE "GO-GET-EM 2" RECEIVER FOR THE BEGINNER.....No. 105
- HOW TO MAKE THE 1-TUBE-ALL-ELECTRIC OSCILLODYNE.....No. 106
- HOW TO MAKE THE 2 TO 5 METER TWO-TUBE LOUDSPEAKER SET.....No. 107
- HOW TO MAKE THE 3-TUBE BATTERY SHORT-WAVE RECEIVER.....No. 108
- THE BRIEF-CASE SHORT-WAVE RECEIVER AND HOW TO BUILD IT.....No. 109
- HOW TO BUILD THE POCKET SHORT-WAVE RECEIVER.....No. 110
- HOW TO BUILD THE CIGAR-BOX 1-TUBE "CATCH ALL" RECEIVER.....No. 111
- HOW TO BUILD THE "DUAL-WAVE" SHORT-WAVE BATTERY RECEIVER.....No. 112
- HOW TO BUILD THE 1-TUBE "53" TWINPLEX" RECEIVER.....No. 113
- HOW TO BUILD THE PORTABLE MINIDYNE SHORT-WAVE BATTERY SET.....No. 114
- HOW TO BUILD THE HAM-BAND "PEE-WEE" 2-TUBER.....No. 115
- HOW TO BUILD THE DUO-AMPLIDYNE.....No. 116
- HOW TO BUILD THE "MONO-COIL 2".....No. 117

RADIO BROADCAST RECEIVER AND SPECIAL RADIO PUBLICATIONS

- HOW TO MAKE THE A.C.-D.C. "CASH BOX" RECEIVER.....No. 118
- HOW TO MAKE BEGINNER'S 2-TUBE ALL-WAVE SET.....No. 119
- HOW TO BUILD THE "RADIO-LAMP" 4-TUBE TABLE RECEIVER.....No. 120
- HOW TO BUILD A SUPER-SENSITIVE ALL-WAVE CRYSTAL SET.....No. 121
- HOW TO BUILD THE 2-TUBE "PENTODE PORTABLE" BROADCAST SET.....No. 122
- HOW TO BUILD THE RADIO "TREASURE" FINOER.....No. 123
- HOW TO BUILD THE GERNSBACK ONE-TUBE PENTODE LOUDSPEAKER SET.....No. 124
- HOW TO BUILD THE WORLD'S SMALLEST ONE TUBE BATTERY RADIO.....No. 125
- HOW TO BUILD A 6-TUBE BATTERY ALL-WAVE "FARM PORTABLE" SET.....No. 126
- HOW TO MAKE AN A.C.-D.C. ONE-TUBE "DEAF AID".....No. 127
- HOW TO BUILD A PIANOTRON.....No. 128
- HOW TO BUILD THE ONE-DOLLAR RADIO.....No. 129
- HOW TO MAKE A VARIABLE-TONE CODE PRACTICE SET.....No. 130

MECHANICAL PROJECTS PUBLICATIONS

- HOW TO MAKE A SOUTH SEA OUTRIGGER CANOE.....No. 131
- HOW TO BUILD A PEE-WEE AUTOMOBILE.....No. 132
- HOW TO BUILD A DUAL-CONTROL GLIDER.....No. 133
- HOW TO BUILD A HOUSEBOAT ON PONTOONS.....No. 134
- HOW TO MAKE A BAND SAW FROM OLD AUTO PARTS.....No. 135
- HOW TO BUILD A REAL LATHE FOR \$5.00.....No. 136
- HOW TO BUILD A SAIL CAT-BOAT.....No. 137
- HOW TO BUILD A SIMPLE PORTABLE REFRIGERATOR.....No. 138
- HOW TO BUILD A XYLOPHONE.....No. 139
- HOW TO BUILD THE ROWMO-BILE.....No. 140
- HOW TO BUILD LARGE TESLA AND OUDIN COILS GIVING 18-INCH SPARKS.....No. 141
- HOW TO MAKE AN ARC WELDER.....No. 142
- HOW TO USE AN A.C. ARC WELDER.....No. 143
- HOW TO MAKE YOUR OWN MICROSCOPE.....No. 144
- HOW TO MAKE A WIMSHURST ELECTROSTATIC MACHINE.....No. 145
- HOW TO MAKE A POWER DRILL PRESS FROM SCRAP PARTS.....No. 146
- HOW TO BUILD A GOOD LATHE FOR \$1.00.....No. 147
- HOW TO MAKE AND EXPERIMENT WITH AN ELECTROPHOROUS.....No. 148
- HOW TO MAKE AN ELECTRIC ARC WELDER FROM AN AUTOMOBILE GENERATOR.....No. 149

RADIO PUBLICATIONS, 25 West Broadway, NEW YORK, N. Y.

RADIO PUBLICATIONS, 25 West Broadway, NEW YORK, N. Y. RC 6

I enclose \$.....for the publications listed by number, at	101	102	103	104	105	106
right, at the rate of 50c FOR ANY TEN PUBLICATIONS. NO	107	108	109	110	111	112
ORDER FOR LESS THAN 50c ACCEPTED. \$1.00 for 24 publica-	113	114	115	116	117	118
tions. These publications are to be sent to me postpaid. I have	119	120	121	122	123	124
placed a circle around each number which I want.	125	126	127	128	129	130
Name	131	132	133	134	135	136
Address	137	138	139	140	141	142
City	143	144	145	146	147	148
State						149

SERVICING

The Book that takes Drudgery out of Mathematics

Only **50¢** postpaid

SOLVES EVERYDAY PROBLEMS — HELPS YOU GET AHEAD IN LIFE

How many times have you lost money because of a mistake in figuring? Do you know how to figure quickly and correctly? Can you figure discounts, interest rates, taxes and all the other calculations you meet up with in your daily life?

Are you having trouble qualifying for Army or Navy promotion because you're not up on mathematics?

Here is the book that gives you a good background in mathematics; that takes all the irritation and drudgery out of it. You don't need to be scared of mathematics, because here's the subject explained without frills, without useless computations.

Here's the book for men in the armed forces; for business men; technicians and craftsmen, explaining and answering everyday mathematical problems in easy-to-understand words and illustrations.

Yes, it's the key to a simple understanding of mathematics. It's a real study course in mathematics for the man who's alert to the importance of mathematics in the world today.

ELEMENTARY MATHEMATICS

● EASY — SIMPLIFIED — PRACTICAL ●

CONTENTS OF BOOK

- CHAPTER I. Arithmetic—Addition—Subtraction—Multiplication—Division.
- CHAPTER II. Factoring and Cancellation—Fractions—Decimals—Percentage—Ratio and Proportion.
- CHAPTER III. The Metric System.
- CHAPTER IV. How to Measure Surfaces and Capacity (Geometry).
- CHAPTER V. Powers and Involutions—Roots and Evolution.
- CHAPTER VI. Mathematics for the Manual and Technical Craftsman—Thermometer conversions—Graphs or Curve Plotting—Logarithms—Use of the Slide Rule.
- CHAPTER VII. Special Mathematics for the Radio Technician.
- CHAPTER VIII. Commercial Calculations—Interest—Discounts—Short Cut Arithmetic.
- CHAPTER IX. Weights and Measures—Useful Tables.

ONLY
50¢
POSTPAID

Send Stamps, Cash or Money Order.

Send today for your copy of this indispensable book. It can be carried readily in your pocket. (Size 6 x 9 in.)

TECHNIFAX

1917 S. State St., RC-642, Chicago, Ill.

THE EDITORS WANT

good **constructional** articles (with clear photos and diagrams), Radio Receivers and other sets, especially "FM" Tuners and Adapters. We also are anxious to see constructional articles on Short Wave Receivers; also general articles on Antennas, etc.

WHO WILL BE FIRST?

Now is the time for all good men to come to the aid of their country . . . by constructing simple radio sets using from one to four tubes and made entirely from old radio parts or substitute materials.

RADIO-CRAFT wishes to publish photographs and descriptions of such sets. Regular space rates will be paid. LET'S GET BUSY.

EDITOR.

ELECTRON MICROSCOPE IN NEW FIELDS

(Continued from page 604)

object holder at a fixed small angle with respect to the instrument axis, first in one direction and then in the opposite. When the two pictures so obtained, after developing and printing, are placed in an ordinary stereoscope, the object appears, greatly magnified, in its proper space relationship. The result is very striking. A stereoscopic pair of pictures of zinc oxide smoke, when viewed with a stereoscope, reveals beautifully how the individual particles are supported by one another, pairs of opposite spikes of each "star" being bent in opposing directions out of the plane of the center of the star.

This glimpse of a year's progress with the electron microscope may serve better as an indication of future possibilities than as a record of past accomplishments. Considerable as these may be, they are bound to be outdistanced in a very brief time by the concerted effort of the many workers who, even at the present moment, are applying the electron microscope to the solution of their problems.—R.C.A. Radio Age, N. Y.

R. C. A. MODEL 45X1

If a set of this type comes in for repair on account of intermittent operation, a careful check of the output transformer may reveal partial short circuit in the primary winding.

The writer had occasion to trace trouble in a set for several hours only to find this to be the cause of the trouble. In some cases repair of the transformer winding may be made in the shop, but it is advisable to replace the transformer with a new one for best results.—Floyd E. Smith, Prairie du Rocher, Ill. in C-D Capacitor.

CONSTRUCT A HOME RECORDER

(Continued from page 603)

is a wise man who does not invite trouble. The *volume indicator* is a neon bulb put across the output transformer primary. By several test cuts it is possible to determine at what bulb brilliancy the cut is normal. This will vary with cutters, needles, and blanks and testing is the only method to set *maximum* and *minimum* levels.

Miscellaneous information that will assist the builder: Be sure and *ground* the motor frame. Use a good quality disc and a guaranteed steel cutting needle. The percentage of bad steel cutting needles sold occasionally runs over 50% in the average package. A low price crystal microphone is satisfactory. Read the book "How to Make Good Recordings" by Audio Devices, Inc. A screw on the cutting arm is provided for adjusting depth of cut. The spring may be obtained at any hardware store and it pays to try a few different springs, since they are very cheap. Adjustments must be made until the cut is at a point where the scratch is not noticeable and the shaving is clean and silken. Audio Devices' book covers the mechanics of recording quite thoroughly, and a great deal more satisfaction may be obtained from this or any recorder by knowing what one is doing and why. If the instructions and diagrams are carefully followed this recorder is guaranteed to perform. Amateurs may vary the mounting and have a recorder in their station. Speech amplifiers make excellent phono amplifiers and it is easily arranged to record directly from the air. The multitude of uses that this recorder can be put to make it a "must" in every "live-wire" radio fan's shack.

Index to advertisers

Allied Radio Corp.	615
American Radio Institute	636
Amperite Corp.	Inside Back Cover
Amplifier Co. of America	607
Arrow Radio	607
Audel & Co., Theo.	Back Cover
Burstein-Applebee Co.	621
Candler System Co.	625
Cannon Co., C. H.	625
Capitol Radio Engineering, Inc.	637
Chartered Institute of America	625
Commercial Radio Institute	637
Data Print Co.	617
Dodge's Institute	637
Gold Shield Products	621, 590
Hallicrafters, Inc.	Inside Front Cover
Harrison Radio	620
Henry Radio	635
Hudson Specialties Company	601
Hygrade Sylvania Corp.	580
Kenyon Transformer, Inc.	635
Lancaster, Allwine & Rommel	625
Lincoln Engineering School	637
Mass. Radio School	637
Meck Industries, John	607
Meissner Manufacturing Co.	613
National Radio Institute	577
National Union Corp.	588
Nelson Company	637
Opportunity Adlets	637
Peerless Sound & Radio Co.	610
Polymet Condenser Co.	591
Popular Book Corp.	622
Popular Homecraft	617
Radcraft Publications, Inc.	595, 611
RCA Institutes	637
Radio Publications	639
Radio Shack	628
Radolek Co.	604
Radio & Television	631
Randolph Radio	590
Readrite Meter Works	594
Schott Co., Walter L.	590
Solar Manufacturing Co.	635
Sprague Products Co.	605
Sprayberry Academy of Radio	615
Supreme Instruments Corp.	617
Supreme Publications	621
Technifax	634, 640
Teleplex Company	621
Treasury Department	579
Triplett Electric Instruments Co.	582
Tri-State College	625
University Laboratories	594
Wholesale Radio Laboratories	591
X. L. Laboratories	621

(While every precaution is taken to insure accuracy, we cannot guarantee against the possibility of an occasional change or omission in the preparation of this index.)

"Finest Dynamic I ever used"
 SAYS EVAN R. RUSHING, SOUND ENGINEER, HOTEL NEW YORKER

**AMPERITE
 P.G. DYNAMIC**
 BRINGS STUDIO QUALITY
 TO ORDINARY P.A. JOBS

- **UNI-DIRECTIONAL.** NEW SUPERIOR ELIPSOID PICKUP PATTERN
- **ELIMINATES FEEDBACK** TROUBLE BECAUSE IT HAS LOWEST FEEDBACK POINT OF ALL DIAPHRAGM TYPE MICROPHONES
- **FLAT RESPONSE.** FREE FROM ANNOYING PEAKS, GIVING STUDIO-QUALITY REPRODUCTION.

The P.G. diaphragm follows air particle velocity where amplitude is a GRADIENT of the PRESSURE. In ordinary dynamics amplitude is restricted from following air particle velocity.

The P.G. DYNAMIC is a radical improvement in this type of microphone. You can actually hear the difference. Case is designed according to modern acoustic principles. Rugged, not affected by temperature, altitude or humidity. HAS UNUSUALLY HIGH OUTPUT. —55 DB.

MODEL PGH (PGL, 200 ohms). Excellent for high fidelity P.A. installations, broadcast studio, and professional recording. With switch, cable connector, 25' cable. Chrome finish. LIST \$32.00 (40-10000 C.P.S.)

MODEL PGAH (PGAL, 200 ohms). For speech and music. 70-8000 C.P.S. Switch, cable connector, 12' cable. Chrome. LIST \$25.00

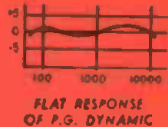

**COMBINATION VELOCITY-DYNAMIC
 ACHIEVED WITH
 ACOUSTIC COMPENSATOR**



An exclusive Amperite feature: By moving up the Acoustic Compensator you change the AMPERITE VELOCITY to a DYNAMIC microphone without peaks. At the same time you reduce the back pick-up, making the microphone practically UNI-DIRECTIONAL.

WITH ACOUSTIC COMPENSATOR:
 MODEL RBHk: RBMk (200 ohms) with switch, cable connector.

Chrome. LIST \$42.00

RSHk: RBSk (200 ohms). Switch, cable connector, Acoustic Compensator.

Chrome or Gunmetal. LIST \$32.00

WRITE FOR FREE SALES AIDS

AMPERITE ©

AMPERITE KONTAK MIKE
 Puts Musical Instruments Across



So beautiful is the tone produced with the Kontak Mike, that it was used in the Philadelphia Symphony to amplify a mandolin solo. Gives excellent results with any amplifier, radio sets, and record players.

MODEL SKH (hi-imp) LIST \$12.00

MODEL KKH, with hand volume control. LIST 18.00

Plug extra List 1.50

FOOT PEDAL, for making beautiful crescendos LIST 12.00

561 BROADWAY, N. Y. U.S.A.

Specify **AMPERITE**



PRACTICAL RADIO INFORMATION

Including Frequency Modulation—Television, etc.

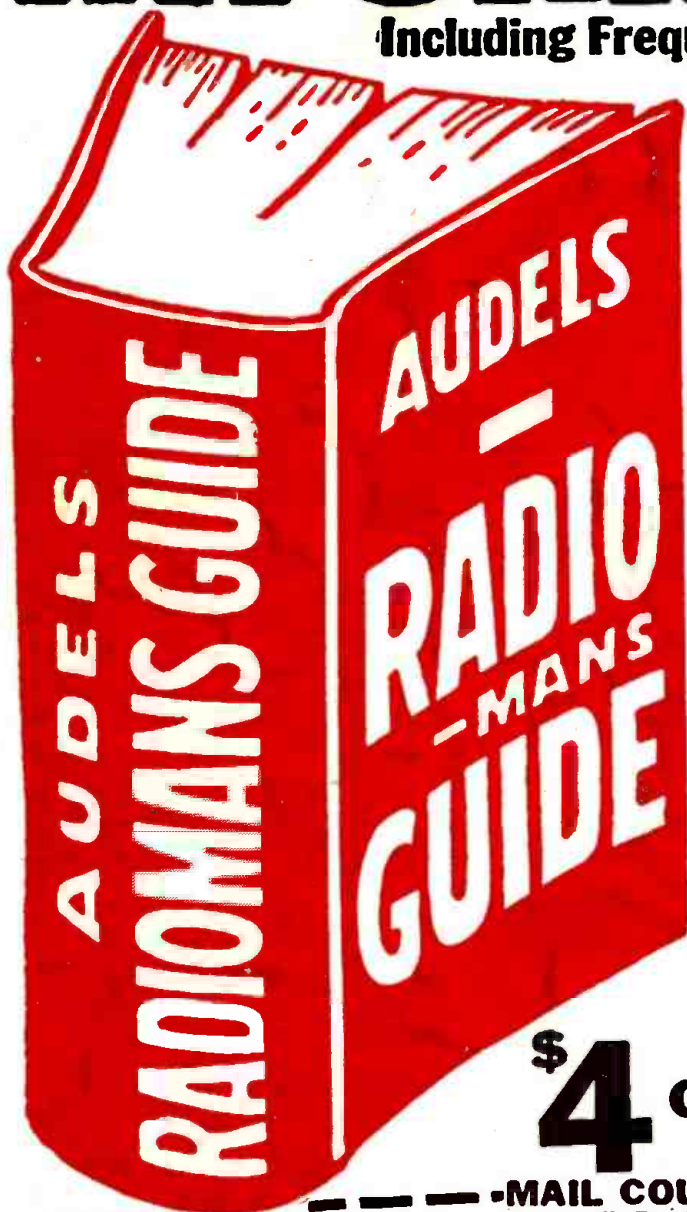

Inside Information for all Servicemen—Aircraft Pilots, Students.

772 PAGES, 400 DIAGRAMS is complete—gives Authentic Principles & Practices in Construction, Operation, Service & Repairs. Covers clearly and concisely Radio fundamentals—Ohm's Law—Physics of sound as related to radio science—Measuring instruments—Power supply—Resistors—Inductors—Condensers—Transformers and examples—Broadcasting stations—Radio Telephony—Receivers—Diagrams—Construction—Control systems—Loud speakers—Antennas—Auto Radio—Phonograph pickups—Public Address Systems—Aircraft & Marine Radio—Radio Compass—Beacons—Automatic Radio Alarms—Short Wave—Coil Calculations—Testing—Cathode ray oscillographs—Static Elimination—Trouble Pointers—Underwriter's standards—Units & tables. REVIEW QUESTIONS—Ready Reference Index.

\$4

COMPLETE • PAY \$1 A MO.

To get this practical information in handy form—Fill in and

— — — — — MAIL COUPON TODAY. — — — — —

AUDEL, Publishers; 49 West 23rd St., New York
Mail AUDELS NEW RADIOMAN'S GUIDE for free examination. If O. K. I will send you \$1 in 7 days; then remit \$1 monthly until \$4 is paid. Otherwise I will return it.

Name -----

Address -----

Occupation -----

Reference -----

RCF