

RADIO'S GREATEST MAGAZINE

K

RADIO-CRAFT

Incorporating

RADIO & TELEVISION

HUGO GERNSBACK, Editor

**"WALKIE TALKIE"
DIRECTS TROOPS**

See Page 331



New Plane-Radio Trainer

"Wien" Bridge

Refinishing Cabinet

Dual Purpose P.A. System

Amplifier Actor Explained

Building Expanded Compressor

"Walkie Talkie" Set

JAN.-FEB.

25¢

CANADA 30¢

1942

W16W BRIDGE
OSC

OVER 125 ILLUSTRATIONS

FREE TRAINING COURSE

IN AIRLINE RADIO * COMMUNICATIONS * TELEVISION

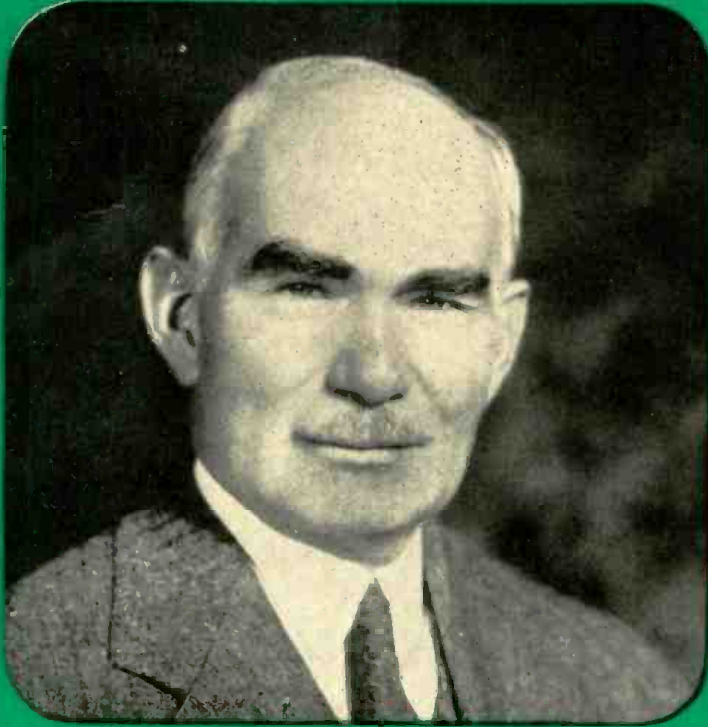

Dr. LEE deFOREST
"FATHER OF RADIO"



U. A. SANABRIA
TELEVISION PIONEER

START NOW . . TRAIN WITHOUT COST UNDER THESE WORLD FAMOUS AUTHORITIES

A GIANT NEW INDUSTRY is now ready to go full speed ahead! For, the United States Government has approved commercial TELEVISION. Properly trained men are needed NOW. And as this fascinating industry rapidly expands, the demand for trained television engineers should be far greater than the supply, for years to come. YOUR GREATEST OPPORTUNITY COMES NOW!

Dr. Lee deForest and U. A. Sanabria, heads of the American Television Laboratories, have assured the government and the industry that they would make available large numbers of well trained men for key positions in television, airline radio, and communications. To make good on

this promise, they will accept suitable young men NOW for their valuable **FREE TRAINING COURSE**. . . 99 lessons with over a million words of text . . . a really amazing offer to progressive, serious-minded men with enough foresight to prepare for a substantial future. *It's an offer you simply can't afford to miss!*

Television with the aid of these famous engineers, has been developed to a high degree of perfection. Everyone, with reasonable qualifications can take advantage of this **FREE TRAINING**. Your future in this wonderful new industry is **SQUARELY UP TO YOU!** Remember, there are no "strings" attached to this offer. This technical training costs you nothing!

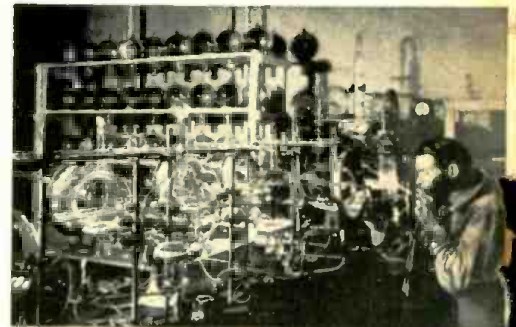

View of the Electronic's Laboratory in the training division of the American Television Laboratories in Chicago. These facilities are used exclusively for providing students with practical instruction necessary for a successful future in television.

Don't wait. Be first. Mail the coupon to us NOW!

A NATIONAL INSTITUTION WITH RESIDENT SCHOOLS IN CHICAGO, DETROIT, HOLLYWOOD.

AMERICAN TELEVISION LABORATORIES
DEPT. 6T, 433 EAST ERIE ST., CHICAGO, ILL.

Gentlemen: I am interested in your **FREE Training Course** in Television Radio Electronics. Without obligation send me all facts at once.

Name _____ Age _____

Street _____

City _____ State _____

**U. S. GOVERNMENT APPROVED
COMMERCIAL TELEVISION
TRAINED MEN ARE NEEDED!**

BE FIRST..ACT NOW..MAIL COUPON FOR APPLICATION AND ALL THE FACTS

I WILL TRAIN YOU TO START A SPARE TIME OR FULL TIME RADIO SERVICE BUSINESS WITHOUT CAPITAL



I Trained These Men

I Trained These Men

YOU Build These and Other Radio Circuits with Standard Radio Parts I Send You With My Course

I send you SIX BIG KITS of Standard Radio Parts as part of my Course. With them you conduct SIXTY sets of experiments, build, test and align Radio circuits, and secure the experience needed to make extra money while learning.



Super-heterodyne Receiver

with preselector, oscillator-mixer-first detector, intermediate frequency stage, diode detector-a.v.c. stage and audio stage, which you build from parts I send you in my SIX Big Kits.

Measuring Instrument

you build early in the Course. This instrument, known as the N.R.I. Tester, is a vacuum tube Voltmeter and multimeter with a sensitivity better than 20,000 ohms-per-volt. You will be able to make the following measurements: a.c. volts up to 550 in 4 ranges; d.c. volts up to 450 in 4 ranges; d.c. currents up to 45 ma. in 2 ranges; resistance values up to 100 meg. in 4 ranges; output measurements of receivers in 4 ranges.



F.M. Signal Generator

really a miniature frequency-modulated transmitter. With it you study frequency modulation, the newest method of Radio communication.



A.M. Signal Generator

The circuit is exactly like the signal generator the serviceman uses. It provides an amplitude-modulated Radio signal for experimental purposes.



You Get This Professional Radio Servicing Instrument

as part of my Course—without extra charge—to help you make more money do better Radio work. For full details mail the Coupon.



FREE LESSON

Get my Sample Lesson, "Radio Receiver Troubles—Their Cause and Remedy," now. See how completely this ONE TEXT covers a long list of troubles in all types of receivers. A special section is devoted to receiver check-up, alignment, balancing, neutralizing, testing. See for yourself how complete, how practical, my Lesson Texts are. MAIL THE COUPON.

These Men Have SPARE TIME BUSINESSES



"I repaired many Radio sets when I was on my tenth lesson. I really don't see how you can give so much for such a small amount of money. I made \$600 in a year and a half—just spare time." **JOHN PERRY**, 1720 Penn St., Denver, Colo.



"I do Radio Service work in my spare time only, operating their own successful spare time servicing Radios 3 months after enrolling with N.R.I." **WM. J. CHERMAK**, R. No. 1, Box 287, Hopkins, Minn.



"I am doing spare time Radio work, and I am averaging around \$500 each—the extra dollars mean so much—the difference between just barely getting by and living comfortably." **JOHN WASHIKO**, 107 New Cranberry, Hazleton, Penna.

These Men Have FULL TIME BUSINESSES



"For several years I have been in business for myself making around \$200 a month. Business has steadily increased. I have N.R.I. to thank for my start in this field." **ARLIE FROEHNER**, 300 W. Texas Ave., Goose Creek, Texas



"I went into business for myself 6 months after enrolling in my Radio repair shop. I do about \$300 worth of business a month. I can't tell you how valuable your Course has been to me." **A. J. RATEN**, Box 1168, Gladewater, Texas



"I am making around \$50 a week after all expenses are paid, and I am getting about the Radio work I can take care of, thanks to N.R.I." **H. W. SPANGLER**, 1261 Gay St., Knoxville, Tenn.

The men above are just a few of many I have trained at home in spare time to be Radio Technicians. Today they are operating their own successful spare time or full time Radio businesses. Hundreds more of my men are holding good jobs in practically every branch of Radio, as Radio Technicians or Operators. Aren't these men PROOF that my 50-50 method of training gives you, in your spare time at home, BOTH a thorough knowledge of Radio principles and the practical experience you need to help you make more money in the fast-growing Radio industry?

Train the Practical N.R.I. Way "Learn It, Do It, Prove It"

My Course is NOT just "book-work" training! No indeed! You get practical experience with Radio parts and test equipment almost from the start. First you LEARN the fundamental facts about Radio parts and circuits by reading my Lesson Texts, prepared especially for home study training. Next, you DO what you have learned, by working with these parts and circuits. Doing with your own hands and seeing with your own eyes make you remember what you learn. Finally, you PROVE what you learn by making measurements with your test equipment before and after you change your Radio circuits or adjust your Radio parts.

You Get SIX Large Kits of Standard Radio Parts

In all, I send you Six Large Practical Kits which contain more than 100 standard Radio parts, including tubes, condensers, resistors, punched chassis bases, a meter, a soldering iron, solder, hook-up wire, hardware and a host of other Radio parts. With all these, you perform 60 different sets of experiments—you make hundreds of tests and measurements and secure a wealth of practical experience. You build the N.R.I. Tester (see column at left), and learn how to use it to measure voltage, current, and resistance. You build dozens of different Radio receiver and transmitter circuits one after another, and secure practical experience with each. You learn how to recognize, locate and repair troubles in Radio circuits. You also get my specially designed Professional Set Servicing Instrument (see bottom of column at left).

Beginners Quickly Learn to Earn, \$5, \$10 a Week Extra In Spare Time

I show you, too, how to get practical servicing experience at home with your Professional Set Servicing Instrument. Many begin doing real Radio work in

their neighborhood only a few months after enrolling. Furthermore, right from the start, I begin sending you Practical Job Sheets—over three dozen in all—which give plans and directions for doing increasingly more profitable Radio servicing jobs. This is why so many of my students start building their own spare time Radio businesses while still learning, and make \$5 to \$10 a week extra.

It's Smart to Train for Radio Now— for Good Jobs Like These

Radio is one of the country's busiest industries. On top of increasing civilian interest in Radio, the Radio industry is rushing to fill hundreds of millions of dollars worth of Government Orders. The 882 broadcast stations in this country employ thousands of Radio Operators and Technicians. Operators are badly needed for the U. S. Merchant Marine, and salaries are higher than ever before for these adventurous jobs. It takes thousands of Radio servicemen to keep this country's 50,000,000 home and auto Radios working. Aviation, Police and Commercial Radio systems are booming. Public Address work means real money for trained Radio men. Television is now on a commercial basis, and promises good jobs soon. My Course can lead you to a good job in any of these profitable fields.



Extra Pay in Army, Navy, Too

Every man likely to go into military service—every soldier, sailor, marine—should mail the Coupon Now! Learning Radio helps men get extra rank, extra prestige, more interesting duty at pay up to 6 times a private's base pay! Also prepares for good Radio jobs after service ends. IT'S SMART TO TRAIN FOR RADIO NOW!



MAIL THE COUPON NOW—for a Sample Lesson and 64-page book FREE. Get the details of how I can give you Practical Training to be a Radio Technician at home in your spare time. Find out about my Course, my Six Kits of Radio Parts, my Professional Radio Servicing Instrument. Read letters from more than 100 men I trained, so you can see what they are doing and earning. MAIL THE COUPON in an envelope, or paste it on a penny postcard.

J. E. SMITH, President
Dept. 2AX
National Radio Institute
Washington, D.C.

GOOD FOR BOTH 64 PAGE BOOK SAMPLE LESSON FREE

J. E. SMITH, President, Dept. 2AX, National Radio Institute, Washington, D. C.

Without obligating me, mail your Sample Lesson and 64-page book FREE. I am particularly interested in the branch of Radio checked below. (No salesman will call. Write plainly.)

- Radio Service Business of My Own
- Service Technician for Radio Stores and Factories
- Spare Time Radio Servicing
- Auto Radio Technician
- Aviation Radio
- Operating Broadcasting Stations
- Army, Navy Radio Jobs
- Operating Police Radio Stations
- Operating Ship and Harbor Radio

(If you have not decided which branch you prefer—mail coupon for facts to help you decide.)

Name Age

Address

City State 14X-1



RADIO-CRAFT

Incorporating

RADIO & TELEVISION

HUGO GERNSBACK
Editor-in-Chief

H. W. SECOR
Managing Editor

CARLOS FROWEIN
Art Director

**NEXT ISSUE
SPECIAL "FM"
NUMBER**

- Why FM Is Growing Rapidly
- Non-Radio Uses for FM
- W7INY's New 10,000 Watt FM Transmitter
- Service Hints and Diagrams of FM Receivers
- A "Tobacco Tin" Hearing Aid
- Trouble for You in '42!

Contents JAN. - FEB., 1942 Issue

VOLUME XIII -- NUMBER 6

Mailbag	324
Editorial: U. S. Radio at War	Hugo Gernsback 329
The Radio Month in Review	330

RADIO DEFENSE

New Plane-Radio Trainer	A. D. Baker 332
P. A. System in Engine Plant	333

SERVICING

Servicing School Sound Systems	B. E. Philippsen 334
How YOU Can Refinish Radio Cabinets	338
RADIO SERVICE DATA SHEETS: No. 319 Crosley Models 22CA, and 22CB, Chassis No. 59	340
Beat Frequencies, the Product of Amplitude Modulation P. Wilson Redcay	342

SOUND

Dual Purpose P. A. System	Andrew Tait 344
Simple Tone Equalizer	Bob Stang 347
What You Should Know About Amplifiers	Wesley Schmitt 348
Build This New Volume "Expander-Compressor" L. M. Dezettel, W9SFW	354
Sound Engineering—No. 23	Conducted by A. C. Shaney 356

ENGINEERING

Airplane Indicator for Flying Fields	358
Coil Coupling Problems, Part II, Conclusion	L. V. Sorensen 360

TEST INSTRUMENTS

Constructing a "Wien Bridge" Audio Oscillator	Bob Stang 362
---	---------------

DEPARTMENTS, ETC.

Mailbag	324
The Radio Month in Review	330
Operating Notes	356
RADIO SERVICE DATA SHEETS (See Servicing)	340
Sound Engineering—No. 23	Conducted by A. C. Shaney 356
Latest Radio Apparatus	364
Book Reviews	345

RADIO & TELEVISION

2 1/2 Meter "Walkie-Talkie" Transceiver	George F. baptiste 368
130,000,000 Tubes Next Year!	371
"Spare Parts" 160 or 75 Meter Phone Transmitter L. B. Robbins	372
Transposed Aerials	A. Binneweg, Jr. 374
Ultra Shortwave "Low Power" Oscillator	376
Radio in Aviation	378
Radio Hook-Ups	381
Ultra High Frequency Tuner	George F. Baptiste 382
Simple Antenna Measurements	Howard H. Arnold 383
"Honor Plaque" Award	384



Published by Radcraft Publications, Inc. Publication office: 29 Worthington Street, Springfield, Mass. Editorial and Advertising Offices: 25 West Broadway, New York City. Chicago Advertising Office: RADIO-CRAFT, 520 North Michigan Avenue, Chicago, Ill.

RADIO-CRAFT is published monthly, on the first of the month preceding that of date; subscription price is \$2.50 per year in U. S. (In foreign countries, 75c additional per year to cover postage; Canada, 50c additional.) Entered at the post office at Springfield as second-class matter under the act of March 3, 1879. All communications about subscriptions should be addressed to: 29 Worthington Street, Springfield, Mass., or Director of Circulation, 25 West Broadway, New York, N. Y.



Foreign Agents:

London—Gorrings's American News Agency, 9A Green St., Leicester Square, W. C. 2, England.

Paris—Messageries Dawson, 4 Rue Faubourg, Poissonniere, France.

Melbourne—McGill's Agency, 179 Elizabeth St., Australia.

Dunedin—James Johnston, Ltd., New Zealand.



Text and illustrations of this magazine are copyright and must not be reproduced without permission of the copyright owners.



Copyright 1942 Radcraft Publications, Inc.



Radio...all out for Victory

Research and invention have placed radio in the first line of battle

COMMUNICATION—rapid communication—is a vital necessity, on land, at sea and in the air. RCA research and engineering developments in both radio and electronics are strengthening—and will further fortify—the bulwarks of our communications system. At Princeton, New Jersey, the new RCA Laboratories—the foremost center of radio research in the world—are under construction.

★ ★ ★

International circuits, operating on short and long waves, have made the United States the communication center of the world. Today, R.C.A. Communications, Inc., conducts direct radiotelegraph service with 49 countries.

★ ★ ★

Production of radio equipment is essential for news and timely information, for military and naval communications, for dissemination of news among foreign countries. The "arsenal of democracy" has a radio voice unsurpassed in range and efficiency. In the RCA Manufacturing Company's plants, workers have pledged themselves to "beat the promise," in production and delivery dates of radio equipment needed for war and civilian defense.

★ ★ ★

American life and property at sea are being safeguarded by ship-and-shore stations.

The Radiomarine Corporation of America has equipped more than 1500 American vessels with radio apparatus and is completely engaged in an all-out war effort.

★ ★ ★

Radio broadcasting is keeping the American people informed accurately and up-to-the-minute. It is a life-line of communication reaching 55,000,000 radio sets in homes and automobiles. It stands as the very symbol of democracy and is one of the essential freedoms for which America fights. The National Broadcasting Company—a service of RCA—and its associated stations, are fully organized for the coordination of wartime broadcasting.

★ ★ ★

New radio operators and technicians must be trained for wartime posts. RCA Institutes, the pioneer radio school of its kind in the United States, has more than 1,200 students enrolled and studying in its New York and Chicago classrooms.

★ ★ ★

When war came and America took its place on the widespread fighting front, radio was At the Ready . . . with radio men and radio facilities prepared to answer the call to duty "in the most tremendous undertaking of our national history."

David Sarnoff

PRESIDENT



Radio Corporation of America

RADIO CITY, NEW YORK

The Services of RCA: RCA Manufacturing Co., Inc. • RCA Laboratories • R.C.A. Communications, Inc. National Broadcasting Company, Inc. • Radiomarine Corporation of America • RCA Institutes, Inc.

Mystery OF THE MULTIPLYING PENNIES

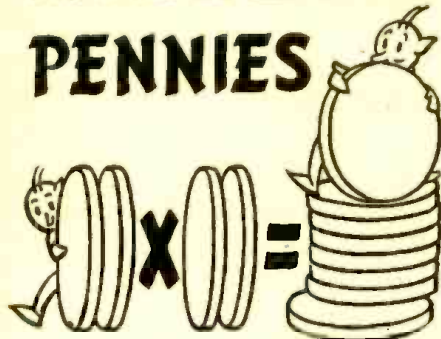

Benjamin Franklin said, "Take care of the pennies and the dollars will take care of themselves." But in a case like this he would no doubt have said something like this—use your pennies wisely and watch them multiply into dollars.

The entire story is told in the new folder, entitled "Mystery of the Multiplying Pennies," published by Sylvania and distributed by Sylvania Jobbers. Your jobber has this folder. Ask him for it.

For here is a complete showing of all the many, many sales helps which Sylvania has produced at considerable expense for your benefit. Some are FREE and some cost only a modest price.

Order from the illustrated folder or from the list below. Get full information and samples either from your jobber or by writing Hygrade Sylvania Corporation, Dept. RC-1, Emporium, Pennsylvania. Order now so that these helps will start working for you at once.

Sylvania Helps You Sell—See Below

- | | |
|---|--|
| 1. Miss America Football Window Display | 15. Service hints booklets |
| 2. Counter displays | 16. Technical manual |
| 3. Electric Clock signs | 17. Tube base charts |
| 4. Electric Window signs | 18. Price cards |
| 5. Outdoor metal signs | 19. Sylvania News Sheets |
| 6. Window cards | 20. Characteristics Sheets |
| 7. Personalized postal cards | 21. Interchangeable tube charts |
| 8. Imprinted match books | 22. Tube complement books |
| 9. Imprinted tube stickers | 23. Floor model cabinet |
| 10. Business cards | 24. Large and small service carrying kits |
| 11. Doorknob hangers | 25. Customer card index files |
| 12. Newspaper mats | 26. Service Garments |
| 13. Store stationery | 27. 3-in-1 business forms |
| 14. Billheads | 28. Job record cards (with customer receipt) |

SYLVANIA

SET-TESTED RADIO TUBES
EMPORIUM, PENNA.

Also makers of Hygrade Lamp Bulbs,
Hygrade Fluorescent Lamps, and
Miralume Fluorescent Light Fixtures

The Ideal Service Shop

Editor:

I have been a reader of *Radio-Craft* for the past five or six years and I think it is "tops" for the Serviceman and Sound Equipment man. I like your present layout and for my part do not want any "ham" gear included.

Let's keep it a Serviceman's magazine. I am an interested reader of the Mailbag and get quite a "kick" as well as some good ideas from the letters printed. I am not too old at the servicing game, about ten or twelve years, I would say, and I get more interested every day.

In the August 1941 issue, Page 70, one

(as you termed him) aggressive Mr. Beauchamp declared that in eight years he had failed to see a picture of a shop as complete and modern as his. From what I could make of the picture of said shop I wonder where Mr. Beauchamp was, say March 1940, Page 521 and back in August, 1939, Page 91. Here are two shops that I think are pretty neat. I have visited the Fox Shop in Richmond, Indiana. I don't think my outfit is the best, but I am pretty proud of it and I am enclosing a photo which I hope you can find space for.

PAUL E. MELTON,
New Castle, Ind.

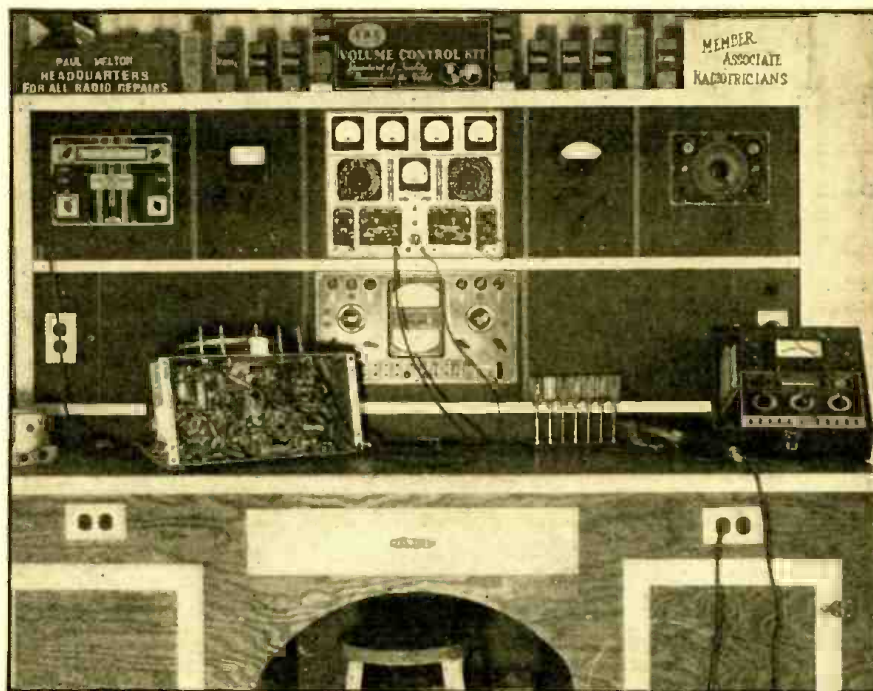

Service Shop of Paul E. Melton

Higher Pay for "Sound" Men!

Editor:

Certainly are a lot of brickbats flying around in your Mailbag, but in many respects Willard Moody has the right dope. Radio is not in its infancy any more, and it is time the "by guess and by God" methods of repairing radios, and installing sound systems, were declared obsolete.

Also, I believe the articles appearing in RC should receive a thorough scrutiny for mistakes, or mistaken ideas, before being published. Happy to see that Mr. Williams of Brush Development Co. jumped on that Microphone article. Two types of mikes indeed; and all the illustrations of a type not mentioned—single diaphragm. I was going to write a blast at that myself, but didn't get around to it.

Too many of the articles on Sound are ridiculous to the experienced Union sound men of N. Y. (What—the Radio Men's Union?—I'll get around to that.) Shaney's articles are fine, but why an article by some kid out in the sticks who has suddenly discovered he can get \$10 a nite by rigging up some junk he calls a P.A. system? We have Union sound firms in New York City that get \$500 for a 3 hour rental, but never think of writing an article about it!!

Now for the Radio Men's Union. (If the Editors wish, we'd be glad to write a complete article about it.) Local 1085, International Brotherhood of Electrical Workers, A.F. of L., has jurisdiction over the Installation, Operation, and Maintenance of Radio Receiving, Television Receiving, and Public Address equipment (including Recording), and Refrigeration, in Greater New York, Westchester and Long Island. Meetings are the first Wednesday in each month at the Hotel Abbey, 149 W. 51 St., N.Y.C., at 8:30 P.M. Dues are \$3 per month, which includes a \$1000.00 Life Insurance policy and Pension Benefits of \$42 a month.

The Union will need about 200 additional sound men to take care of the work this season. Though the Local has been in existence for about 4 years, it is only during the past year that we have really started to organize the field.

All officers and members are employed in the Radio industry. We have contracts with all the large P.A. firms, and the Radio departments of several of the large and small stores.

The boys in the Union have had their pay raised several times, and are learning how to

GET READY FOR A REAL RADIO CAREER!

Make 1942 Your Year!

I. C. S. Radio Courses, Studied at Home, Prepare You for Part-time or Full-time Radio Jobs!

During 1942, many thousands of men will achieve success and prosperity in the growing field of radio. *Will you be among them?* You may be—if you get the *sound, practical training* that is essential to success in radio work.

A few hours of your leisure time each day—in the comfort of your own home—may qualify you for big earnings in this rapidly expanding field. And studying an I. C. S. Radio Course is a thrilling adventure in practical science.

Every one of the five I. C. S. Radio Courses includes Frequency Modulation and Television—and is designed to enable you to capitalize on the profit-opportunities which these new developments are opening to *trained men*.

Your Choice of 5 Courses

For those who wish to secure broad, comprehensive training, I. C. S. offers a *General Radio Course* and a *Radio Operating Course*. The I. C. S. *Practical Radio Servicing Course* enables you to begin practice soon after you start studying—many students pay for the course out of *earnings* before it is completed! (Note to Selectees: Radio training is a big advantage in the Army.)

The *Sound Technician's Course* is an advanced course for the service technician. The *Sound-Picture Projectionist's Course* deals with operation, maintenance and repair of sound equipment, such as is used in talking-picture installations.

One of these I. C. S. Radio Courses, or a combination, may fit you for bigger earnings than you ever dreamed possible—and *at a cost of only a few dollars monthly!* Mail this coupon immediately for full details.

All I. C. S. Courses include FM and TELEVISION



INTERNATIONAL CORRESPONDENCE SCHOOLS

Box 2877-G, Scranton, Penna.

Explain fully about your course in the subject marked X:

- GENERAL RADIO
- RADIO OPERATING
- PRACTICAL RADIO SERVICING
- SOUND TECHNICIAN
- SOUND-PICTURE PROJECTIONIST

Name _____ Age _____

Address _____

City _____ State _____



A CREI COURSE IS THE DIRECT COURSE TO A SECURE FUTURE IN RADIO!

CREI Spare-Time Training Can Prepare You Now for a Responsible, Well-Paid Radio Engineering Position

Your opportunity is here today! Your own radio experience backed by CREI modern technical training can equip you with the ability and knowledge to acquire and hold a responsible, radio engineering position. The only difference between an \$1800 "short term" job today and a \$4000 "career" job tomorrow is your technical qualification as an engineer. Don't waste another day in making your present job pay for your investment in your future.

WRITE TODAY! If you are a professional radioman and want to make more money—let us prove to you we have something you need to qualify for the better job opportunities that can be yours. To help us intelligently answer your inquiry—please state briefly your education, radio experience and present position.



CAPITOL RADIO ENGINEERING INSTITUTE

Dept. RC-1, 3224 16th St., N. W., Wash., D. C.

RADIO TECHNICIANS NOW IN DEMAND

WHETHER YOU ARE 18 OR 35

you owe it to yourself to investigate DODGE training. For the past 58 years the Dodge Institute has trained thousands of successful graduates for the communications industry.

Pioneers in the field of Morse telegraphic instruction, our present radio courses are thorough and modern. Complete instruction in Practical Radio Engineering, Broadcasting, Aviation Radio, Police Radio, Servicing, Morse (wire) Telegraphy and Railway Accounting given in a minimum time.

Our courses have the approval of State Vocational Departments, Major Airlines, State Police Systems, hundreds of Broadcast Stations, the War Department and Radio Manufacturers.

We have been "swamped" with requests for trained radio technicians. A choice of radio employment is open to those who avail themselves of our training NOW! Ask our graduates about DODGE training. Let us send you our catalog without obligation.

THE DODGE TELEGRAPH & RADIO INSTITUTE

504 Monroe St., Valparaiso, Ind.

PREPARE YOURSELF

for a commercial radio position through a home study course written for the man who has forgotten higher mathematics and who has had a non-technical education.

This course qualifies you to pass the Federal Radio Telegraph and Telephone examinations.

An easily read, and easily understood course. Moderate tuition fee. Write for particulars.

AMERICAN RADIO INSTITUTE

1123 Broadway New York City

LEARN RADIO TELEVISION

500 LICENSED graduates placed in past 7 years in shipping, broadcasting, aviation, police, etc.; we also teach radio servicing and repairing; new beginners' class now forming; 60-page catalog free; oldest, largest and best equipped.

MASS. RADIO SCHOOL

18 BOYLSTON ST., BOSTON, Mass., Est. 1899

make a good living out of Radio and P.A., instead of having to scrape and chisel.

Over 85% of the Sound work during last year's Election campaign was handled by Local 1085 men, and this year it will be 99%!

Congrats to Edwin Wolf of W. Roxbury, Mass. Hams certainly know nothing about servicing radios. Your exposé of the Radio Defense Program is also correct, unfortunately.

JERRY NEWMAN,
Bus. Mgr. Local 1085, I.B.E.W.,
Long Island City, N. Y.

KEEP "R-C" FOR THE SERVICEMAN!

Editor:

For many months, the Hams have been clamoring for articles on set construction, transmission, etc. They are hollering for space in good old RADIO-CRAFT, I, for one, am against the least bit of space in "R-C" devoted to rigs and what-nots. The Hams build a rig, stick up an antenna, and then "go to town" bellowing "Hello C Q," "Hello C Q" (or something like that).

RADIO-CRAFT is a very good magazine. It should be devoted entirely to a good cause—THE RADIO SERVICEMAN. It is the Radio SERVICEMAN who is the people's best friend today. All the Hams in the whole U.S.A. could give up their "rig" and nobody but themselves would give a hoot! But what would happen if the SERVICEMAN closed his shop? The serviceman is devoting his time and energy in the interest of the PEOPLE, and not in building a rig and keeping it in first class condition for HIMSELF. Regardless of the adverse criticism some of you fellows may express, my idea of RADIO-CRAFT being solely for the SERVICEMAN will remain unchanged.

Also, Mr. Editor, I believe that the department headed "Latest Radio Apparatus" should be abolished, and in its place, let's have more articles on "F.M." All the apparatus noted in this valuable space is included in the catalogues of the various concerns involved.

In conclusion, Mr. Editor, "R-C" is still tops—whether these changes are made or not.

HARRY C. REED,
Steelton, Penna.

THOSE "GYP" SERVICEMEN

Dear Editor:

In case you have not already done so, may I suggest that you take some appropriate steps by way of commenting upon—and answering—the article contained in the current (August) number of *Reader's Digest*, entitled "The Radio Repair Man Will Gyp You, If You Don't Watch Out."

The article referred to—although written with the best of intent, I am sure—certainly is misleading in more than one way. For instance, a Madison, Wisconsin, service-shop proprietor is quoted as having said that "All you need is a voltmeter and a few other little things"—and while I suspect that HE was referring to set analyzing—the specific reference is to a tube "seller."

Further—"temperamental" tubes are referred to as *mythical*—perhaps truly—however, the writer does not forget some "dead spots" in superheterodyne circuits in connection with which one tube would not serve as an oscillator—while another would. And—further—memory brings to mind the fact that an oscillator that would not function—perhaps—in one circuit—might be entirely satisfactory as an oscillator in some other circuit!

Yours very truly,

C. M. DELANO,
Lincoln, Nebraska.

SPRAYBERRY RADIO TRAINING

includes
FULL EQUIPMENT

Experience Easily Acquired
at Home



You Do Practice-Giving Experiments. Many Special Features. . . ALL Designed to Help You Make Fast Progress

SPRAYBERRY Training starts right at the beginning of Radio. . . unfolds each subject in a simplified, logical, understandable way. You easily learn Television, Frequency Modulation, Signal Tracing, Mobile Radio (Auto-Tank), Aviation Radio, Electronics, Facsimile Radio, Radio Set Repair and Installation work.

Training Prepares You for a Business of Your Own . . . Or Good Radio Jobs at Excellent Pay

The great fascinating and progressive field of Radio offers many opportunities to the man who works ahead. My Training is designed to give you quick access to these opportunities. SPRAYBERRY Methods are thorough and practical. Your Training will not interfere with your present work. No previous experience is needed.

You Get Professional Test Equipment Plus Complete Radio Set

With the Radio Parts given (everything needed to build a Complete Receiver) . . . you conduct interesting informative experiments with your own hands. Also you are supplied a modern **TESTER-ANALYZER**

Earn While You Learn

My **BUSINESS BUILDERS** show you how to put your equipment to actual use in handling money-making Radio Service Jobs shortly after you begin Training.

THE SPRAYBERRY COURSE IS SOLD UNDER MONEY-BACK AGREEMENT

RUSH COUPON for BIG FREE BOOK

SPRAYBERRY ACADEMY OF RADIO
F. L. Sprayberry, President
520-B University Place, N. W.
Washington, D. C.

Please send me a **FREE** copy of "HOW TO MAKE MONEY IN RADIO."

Name

Address

City State

(Mail in envelope or paste on penny postcard)

RADIO TECHNOLOGY



RCA Institutes offer an intensive course of high standard embracing all phases of Radio and Television. Practical training with modern equipment at New York and Chicago schools. Also specialized courses in Aviation Communications, Radio Servicing and Commercial Operating. For Free Catalog Write Dept. RC-42.

RCA INSTITUTES, Inc.
A Radio Corporation of America Service
75 Vartek St., New York, 1154 Merchandise Mart, Chicago



Be a RADIO SERVICE EXPERT
LEARN AT HOME IN SPARE TIME

The demand for radio experts grows every day. Learn this paying profession under personal guidance of qualified engineer and educator. Clear, fascinating instruction and experimental kits make learning easy. Leaders in the radio industry endorse R.T.A. methods. Spare time profits soon pay for training.

FREE book telling what R.T.A. training can do for you.

RADIO TRAINING ASS'N. OF AMERICA
1559 Devon Ave. Dept. RC-12 Chicago, Ill.

RADIO COURSES

Start February

- RADIO OPERATING—BROADCASTING
- RADIO SERVICING—a practical course
- RADIO AMATEUR CODE ● TELEVISION
- ELECTRONICS—1 yr. day course 2 yrs. eve. Day and Evening Classes. Booklet Upon Request.

New York Y.M.C.A. Schools
4 W. 64th Street New York City



Correspondence Courses in RADIO and ELECTRICAL ENGINEERING

ELECTRICAL ENGINEERING Get good grasp of wide electrical field. Prepare yourself at Low Cost, for secure future. Modern simplified, you can understand quickly.

RADIO ENGINEERING Extra fine course in radio, publication. Give address, photo-electric work, technician. Exper. kits furnished. Diploma on completion. Tuition, \$25. either course. Deferred payment plan. Get copies of school catalogs, students magazines, complete details. **SEND NOW!**

FREE

LINCOLN ENGINEERING SCHOOL Box 831-837, LINCOLN, NEBR

USED Correspondence Courses

COMPLETE HOME-STUDY COURSES and educational books, slightly used. Sold for less. All subjects. Money-back guarantee. Cash paid for used courses. Full details and illustrated 72-page bargain catalog **FREE**. Write today!

NELSON COMPANY, 500 Sherman, Dept. A-210, Chicago.

DIXIE NEEDS SERVICEMEN!

THE establishment of army posts throughout the south, the attendant influx of civilians to adjacent towns and cities, the magnet of huge defense industries and the sharp rise in cotton prices have created a boom in the service business in Dixie. All conditions point to a continuance of this boom for several years at least!

This is a genuine appeal to all connected with the radio industry in the east, the north, the west—if you are a good serviceman, if you are acquainted with or know of good servicemen seeking work at top pay commensurate with reasonable living costs, nice country and climate, and congenial surroundings, willing to move to a good job, have them get in touch with Herb Erickson Co., Hendersonville, North Carolina, setting forth their qualifications, salary wanted and preference of location.

Positions are available in North and South Carolina, Tennessee, Alabama, Florida and Georgia. There is need, too, for a number of jobber salesman and countermen who know their business.

ODD CAUSE OF HUM

Dear Editor:

In the October issue of *Radio-Craft* a Mr. Robert Steele inquired as to the cause of a hum in his receiver where a certain mail-order house electric lamp bulb was turned on in his table lamp.

This effect is due, no doubt, to the old bugaboo known as power-line "turn-table" or "modulation" hum which is caused by various non-linearity effects in the power transmission system—usually copper-oxide joint rectification effects. In this case, since the incandescent lamp was quite obviously the cause of the turn-table hum, either a corroded (soldered or spot-welded) joint somewhere in the lamp filament circuit supplied the oxide-rectifying action which caused a cross-modulation effect between the 60 cycle power current and radio signal currents circulating in the power line system. These cross-modulated signals got into Mr. Steele's receiver through the receiver power-pack and by various re-radiation paths into the receiver antenna system. If Mr. Steele possesses a cathode ray and audio oscillator outfits, he can easily check for wave-distortion effects caused by the "cluck" junction within the bulb—if he still has the offending bulb on hand. (See the RCA Review for April, 1937.)

Here the writer will break a long standing policy and enter into a controversy involving personalities in the profession. It's a bit amusing to witness the near-riots Mr. Willard Moody has precipitated in the *Mailbag* columns. It looks like the old story of a bustling, live-wire with new and ambitious ideas being resented by perhaps lesser-trained, more conservative "old-timers" and "stand-patters." Suppose the guy has got an egotistical streak in his make-up? The radio game can use more men like him.

Again, in the case of Mr. Hugo Gernsback, we also have some rather energetic panning. Suppose we take a look "at the record." How many policies, ideas and suggestions made by the man have been eventually adopted, wholly or in part, in subsequent months or years? The batting average is fairly good, considering the playing conditions. After all, this thing called civilization and progress is pretty much the result of the vision, foresight and creative thinking of a mere handful of humans who drag along the rest of mankind behind them.

The spectacle of a politics-gangster machine that has stamped over a bewildered and befuddled continent and made a laughing stock of the ruling classes of the major

nations of this earth, serves us as an object lesson for the penalties reaped by developing a fossilized mentality—for living physically in 1941 and mentally in 1914. If all men thought along the lines of the inveterate "panners," we would still be amoebae floundering about in muck and slime or else hairy creatures running loose in the trees and caves.

If we must criticize, then why not offer something constructive or creative—instead of petty mud-slinging or infantile name-calling?

TED POWELL,
Maspeth, L. I.

MAKES MONEY WITH "P.A." OUTFIT

Dear Editor:

P.A. systems represent a good field and at the same time a profitable one. I say this because I specialize in that field and run it as a "hobby."

Last year a club was running a bus ride to Oakland, N. J., and the fellows held a meeting. One fellow happened to remember me and held up the meeting a while; I was invited to the meeting and the fellows couldn't make up their minds whether to have music or not, because the orchestras cost so much. I suggested to them the use of my P.A. system for entertainment, but the fellows told me that it wouldn't go over well. I proved to them that they can have a lot of fun and good dance music, so I was hired. Sunday came and I went with them with my equipment on the bus ride, and boy, oh boy, did I make a hit! I was being paid for playing requests and the pavilion was overcrowded; I used only one speaker built in a large case. The volume was tremendous and I got good tone quality. My P.A. is only 18 watts. I charged them \$10.00 and collected over \$15.00 for requests and all, and was offered drinks and food and also got myself three other P.A. jobs for following Sundays. I also get jobs on elections. I go to see the politicians in every district, and get 2 to 3 jobs sometimes, on the same day at different hours, and charge only \$8.00 for 2 hours each. I also run some dances with the "P.A." and rent a hall for about \$10 for 3 hours and charge 25c for admission and collect sometimes from \$25 to \$30. Now I am servicing a theatre with the P.A. system every Wednesday night for one hour at a price of \$7. Each Wednesday they have Auction night on the stage. Here is how I got this job.

One auction night I went to the theatre and couldn't understand what the fellow was saying, so I complained to the manager about it. I asked him why he didn't use a P.A. system, and he told me that it costs so much and that there would be a lot of feed-back. I told him it was not true. He asked me for a price and I told him. He was amazed, so I was hired for the following Sunday for a special occasion and for Wednesday.

When I set up my P.A. system, he was again amazed and the entire theatre was covered with good volume, and I got plenty of applause from the patrons at the theatre. I still hold that job under a 3-year contract and get into the show whenever I want to at no extra charge, and get plenty of passes for the kids. I had George Hall speak over my mike and many celebrities on a big "rally" run by the politicians, and expect to have them again this year at my P.A. around November. So, if you have courage and know how to sell P.A. servicing, you can get to the top.

STANLEY DOWGIALA,
Jersey City, N. J.

"COMMON-SENSE" SERVICING

Dear Editor:

I am addressing this, "Dear Editor," but in reality I am writing to A. Bertram, Jr. and his colleagues who have commented from time to time (issue to issue) in the *Mailbag*, upon the seemingly interesting method of mine. I have mailed a few letters, addressed to the *Mailbag*, but apparently they were lost.

Mr. Bertram asked (in the September issue of "R.-C.")—"What happens when you get a set so badly out of line, to get any signal through to make an image?" The answer is—"Bertram: use an oscillator." That was rather a foolish question to make or ask of anyone who reads "R.-C." I don't believe the magazine is being passed around in "sewing circles."

NOTICE

This is the January-February issue of RADIO-CRAFT. The next issue will be our March issue; it will be published a month from the time this reaches you.

All subscribers of record will have their subscriptions automatically lengthened one month.

The Publishers

Test instruments have their place. The place for an instrument not to be is in a place where they are continually in need of repair and/or where they are replaced often, not from obsolescence, but from wear and tear, worn out by Servicemen lacking in analytical ability, men who rely too much upon them.

I know a Serviceman who can locate any trouble in a receiver by using only an oscillator and oscilloscope. The reason is that he uses his knowledge of fundamental radio. That is where an instrument is supposed to be.

Coupling the two above statements the answer is: Take the instruments away from some fellows, regardless of their school-room education and high marks in radio courses, and they would be lost; while others could go on servicing just about as fast with a greasy table knife! I've known fellows to close shop just because their *tube-checker* blew up!

I work for a firm as outside man and although I service one brand of radio, they are manufactured by a half dozen firms. I service 10 to 22 a day and average 250 miles a week. I have an offer to go to work for another concern at a higher wage. This other outfit handles and services all brands. I've worked for them before.

When I worked for this other outfit, I worked as an "analyzer" (if I may use the term) and quick set-up man. I never went wrong on any analysis in any set-up. Due to lack of instruments (and for that matter, I didn't have room for much), I had to develop tricks to speed up the work. I dug down deep for the alignment dope, ha! Servicing several receivers a day in homes necessitates the development. Mastery of the "art" wasn't easy. Although having a complete understanding of the

superheterodyne principle, one is bound to sweat over quite a few sets before he can tune them *without an oscillator*. Having lost a few hairs over it myself, I thought perhaps if I let other Servicemen in on it, together we might make further improvement. But, apparently, I got waylaid. The majority of answers I got through the *Mailbag* were from kids that stick to the old golden rule and what teacher taught them! On the other hand, I found I wasn't so original. I have since met a number of outside men who have been using the same method for years. One of them, by the way, is an engineer for a large manufacturer of radios, and he taught me a few tricks along the same line.

But, to get back to the grind, H. Davis said in the July issue of "R.-C." that he detuned the last I.F. by placing his tracer probe on the plate of the output tube. That seems rather unusual, but should I argue the point? Not me! There are many oddities in tubes and tuned circuits.

What causes push-buttons to be so far out of adjustment, when the set is moved 20 miles in any direction from where it was first set up? Why does one's hand have so much effect on a station tuned in, when it is waved over the chassis? Why is the reception sometimes improved when the set is moved across the room? Watch a V.T.V.M. hand slam when you wave your hand over it. Why do I have to align sets on customers' complaints when these are almost direct from the factory? Did you ever attempt to touch up the short-wave alignment on a set in a home, by hand? Try it sometime. You can never equal it by using an oscillator! Here in Detroit, in certain localities, I can pull out all the R.F. tubes and even some of the audio tubes, and still enjoy a good program from one of our local stations, WXYZ. I could go on but I believe the above is enough to back this statement. When anyone tells me he can hook a foreign body to a tuned circuit, align that circuit and upon removal of the foreign body leave the circuit tuned absolute, as with the foreign body attached. . . . This isn't quite the proper place to express my opinion in the way I would like to give it. When making that statement, I usually get an answer—"Oh! well! For all practical purposes." If that is so, then that answer applies equally as well to my system, if the argument gets too hot.

One last job and I'm off to bed. In reference to Moody's proposed Service Association: I know a hair-dresser who during the hard times, just past, was having a difficult time. One day he met an old friend who is a high government official. He said to him, "You are in a position where passing of laws must have your approval. Could you draft a law compelling all beauty operators to seek a license and in obtaining said license have them face a very stiff exam?" "Why?" asked the official. "To eliminate all the incompetent operators who are cutting prices, using their homes for shops and in general, ruining my business," said my friend. "In other words," said the official, "you are afraid of competition, you would like the world all to yourself. You haven't got enough intestinal fortitude to buck them, to go out and make a name for yourself. Your inferiority complex causes you to rebel against placing your work and talent in a competitive field. Perhaps you are just a little lazy also. If they were just incompetent, mister, you wouldn't be worrying. What you are belly-aching about is honest competition. Certain powers compel me to make such laws, but personally, I wouldn't draft one on my initiative."

HOMER C. BUCK, Detroit, Mich.



MR. A. C. BURNS
Tenth North Radio & Elec.
2355 - 10th Ave. North
Seattle, Washington

I have been selling N. U. tubes for over 10 years and find them most satisfactory. N. U. has been more than helpful in cooperating with the dealer with their equipment, sales promotion and advertising programs. I heartily recommend N. U. to any dealer or serviceman.

WHERE YOU FIND NATIONAL UNION YOU FIND BETTER RADIO SERVICE

PREMIUM Quality TUBES



BATTERIES



CONDENSERS

also Sound X/tra tubes, panel lamps, cathode ray tubes, exciter lamps, sound equipment, photo electric cells, sound accessories, dry batteries, flash light bulbs.

NATIONAL UNION invites . . .

All radio service dealers to enjoy the benefits of the N. U. Shop Equipment Plan. The latest in tube testers and test equipment are available to you . . . prompt delivery. More than 60,000 completed deals prove the success of this plan. Investigate now.

Ask Your N. U. Distributor or Write



NATIONAL UNION RADIO Corp. 57 STATE ST., NEWARK, N. J.

A New Type of Service Manual!

RADIO CIRCUIT MANUAL—1941



**The Only EDITED Manual
Ever Published!**

DIRECTORY OF RECEIVERS MANUFACTURED IN 1940 AND UP TO JUNE, 1941

MORE INFORMATION IN HALF THE NUMBER OF PAGES

The value of a service manual is measured not by the number of pages but by the amount of useful information. Thus, in only 736 pages this Radio Circuit Manual covers over 200 receiver models MORE than does any other competitive manual in twice the number of pages.

HOW DID WE DO IT? . . .

. . . By increasing the size of our page; by discarding non-essential data and editing the balance; by listing only those receivers which the Service Engineer will definitely have to repair (no communications or export receivers, no shortwave sets or amplifiers, no electronic devices, etc.); by many months of hard work based on a definite plan of procedure and a clear understanding of the actual requirements of the Service Engineer. There is no "dead weight" information to add bulk to this Manual. Every word counts. Every minute of reading time is well spent.

OUTSTANDING FEATURES

- Contains data on more than 1800 receiver models!—more than any other radio service manual.
- Only 736 pages!—less than half the bulk of any other manual and more than 1/3 lighter.
- All information is EDITED!—all non-essential data deleted and the balance checked and correlated with the schematics and sketches.
- 40% larger page permits listing of all information on one page. (A few unavoidable cases excepted.)
- I.F. peaks for all superhet circuits are boldly displayed in black boxes!—none missing, all accurate.
- No space wasted on communications and export receivers, amplifiers, electronic musical instruments, etc.—a 100% Service Engineer's Manual.

A "CUSTOM-TAILORED" MANUAL FOR SERVICE ENGINEERS

Here, at last, is a Service Manual deliberately PLANNED for the Service Engineer. Instead of a mere hodge-podge collection of service data, as manuals have been in the past, this RADIO CIRCUIT MANUAL is an orderly compilation of essential radio diagrams and service information, carefully edited and uniformly presented for the maximum convenience of the busy Service Engineer. All time-consuming, non-essential data have been weeded out, and the remaining information, vitally important to the rapid and efficient servicing of modern radio receivers, has been laid out in a logical, easy-reading style which cuts time from the day's work. Because of this and other features which are self-evident upon first observation, it has been possible to list all information pertaining to a given model on a single page.

In 736 pages this Manual presents essential service data on over 1800 receiver models;—more than any other existing service manual on the market!

ONLY ONE MANUAL PER YEAR!

The new technique used in compiling this RADIO CIRCUIT MANUAL—1941 makes it possible to include in a single book all the new receiver models which the radio industry can produce in a single year. This factor alone represents an important saving to all Service Engineers.

A PERMANENT INSTITUTION

This Radio Circuit Manual—1941 is NOT a one-time proposition. Next year there will be a Radio Circuit Manual—1942, the following year, 1943 and so on indefinitely—each Manual better than the other as new methods are worked out for expediting and simplifying the work of the practicing Service Engineer.



← THE OLD TYPE MANUALS—Bulky, heavy, hard to handle, space consuming, less USEFUL data despite greater number of pages.



→ OUR NEW MANUAL—Lighter, compact, easy to handle, takes half as much room on the shelf, more USEFUL information despite fewer number of pages.

MANUALS NOW READY!

RADCRAFT PUBLICATIONS, INC.,
25 West Broadway, New York, N. Y.

Gentlemen: Enclosed find my remittance of \$10.00, for which send me, POSTPAID, my copy of the RADIO CIRCUIT MANUAL—1941.

Name

Address

City State

RC-2-42

(Send remittance in form of check or money order; register your letter if you send cash.)

ORDER YOUR MANUAL IMMEDIATELY—NOW!

Get your copy directly from us by filling out and mailing the convenient coupon shown at left, or get it directly from your favorite distributor.

736 pages; size 13 1/2 x 10 1/4 x 2 in. thick; loose leaf, leatheroid-covered stiff binder; net weight 6 1/2 lbs.

ONLY
1000

RADCRAFT PUBLICATIONS, INC.
25 WEST BROADWAY NEW YORK, N. Y.

RADIO-CRAFT

Incorporating

RADIO & TELEVISION

"RADIO'S GREATEST MAGAZINE"

. . . Radio IS an important weapon.

U.S. RADIO AT WAR

By the Editor — HUGO GERNSBACK

HAVE often mentioned in these pages that to the other great war weapons there has been added one just as important as tanks and airplanes, and that is radio.

It now becomes all too clear, that if anything, this weapon proves to be much more formidable than even the military suspected.

When the Japanese outrage on Pearl Harbor occurred on the morning of December 7, many analysts suspected fifth columnists' work over the Japanese-language broadcast stations of Hawaii. In the latter part of December the *New York Times*' analyst, Mr. Baldwin, commented upon the fact that the location of the United States battleships at Pearl Harbor was accurately known to the Japanese attackers. How was the information conveyed? Apparently by Hawaii's own broadcast stations, he concludes.

I sounded a strong warning on this point as far back as the May, 1941, issue of RADIO-CRAFT, in an editorial entitled "Radiobotage." In that editorial I said as follows, and I quote:

"Eternal vigilance to keep information from going out, either by radio, cable or telegraph, must be the watchword from now on. Since the advent of radio broadcasting, conditions have changed and the "radioboteur"—the Fifth Columnist—who is active, will use the utmost ingenuity to get important information through. It should not take an Edgar Allan Poe to devise effective schemes as to how our radio broadcast stations can be misused to transmit such information, which on the surface looks innocent enough. . . . There are other means whereby Fifth Columnists, and foreign agents, can disguise information in more subtle ways which are not immediately apparent. There are a number of foreign-language stations in this country, which to the writer's mind, should at the present time, not be allowed to broadcast in such languages. (Paragraph originally printed in bold-face type, it is so reprinted here) . . . You do not have to be a master of ingenuity to invent a number of simple and easily arranged codes which can be sent out over these—and for that matter any other broadcast station—by foreign agents who pose as entertainers. Popular songs, even ordinary music, can be arranged in such a way as to convey certain meanings."

Space limitation does not permit to quote other warnings, voiced at that time of the same order. It becomes apparently clear, however, that Japanese Fifth Columnists evidently used exactly these means, and it would not surprise me at all if the same sort of thing goes on even now. I make the strong plea that all radio broadcast stations of every sort must be watched much more closely than ever. I again most strongly urge that no broadcast station for the duration of the war should be allowed to broadcast in any foreign language. I urge the F.C.C. to take immediate steps to change this situation before more harm is done. The foreign language broadcast stations are a nuisance anyway and offend many people today while the country is at war. There should be no excuse for keeping such stations on the air now for a small foreign minority.

Immediately following our declaration of war against the Axis powers, the Federal Communications Commission withdrew the private use of all amateur frequencies for the duration of the war.

The order of the Federal Communications Commission dated December 8 states as follows:

"Whereas a state of war exists between the United States and the Imperial Japanese Government, and the withdrawal from private use of all amateur frequencies is required for the purpose of the National Defense, it is ordered that except as may hereafter be specifically authorized by the Commission, no person shall engage in any amateur radio operation in the Continental United States, its territories and possessions, and that all frequencies heretofore allocated to amateur radio stations under Part 12 of the Rules and Regulations be, and they are hereby, withdrawn from use by any person except as may hereafter be authorized

by the Commission." By order of the Federal Communications Commission, by T. J. Slowie, Secretary.

Immediately thereafter, however, hundreds of amateur radio stations were being returned to the air by the Defense Communications Board to furnish communications vital to the National Defense, according to the American Radio Relay League. As time goes on the Federal Communications Commission will no doubt authorize certain amateurs to operate Defense nets. As an example such networks are being authorized or planned and include the civilian defense net of Westchester County, New York; the amateur communications section of the Florida State Defense Council; a communications chain of the State Guard organization of California, sponsored by Governor Olson; and Connecticut's comprehensive state police network. It is also known that amateurs capable of performing important Defense functions are being given special Defense Communications Board (DCB) authorization upon application by Federal, State and Municipal officials.

The American Radio Relay League also reports that over 10,000 licensed radio amateur operators are already engaged in our war effort in many branches, as for instance amateurs operating aboard battleships, or in the Signal Corps, designing radiolocator equipment and particularly as radio monitoring officers for the F.C.C., instructing army pilots in radio communications and other tasks.

While RADIO-CRAFT will do its utmost to report all of the latest radio developments, it should be understood that there are many radio activities on which we can no longer report, due to self-imposed censorship. Much of this information comes under the heading of military information and as such cannot be printed by us until such time as it has become common property and is known to be in use by the enemy as well.

Readers of RADIO-CRAFT who have ideas on radio subjects which can be used for Defense or military operation may submit such ideas to the Editors of RADIO-CRAFT who will be glad to forward them to the proper authorities in charge. Only new radio ideas can of course be used, and while we have already received many such communications, the majority of them were not new, others were impractical. But, there is always the chance that someone may hit upon an idea that is worthwhile. Always remember that in all wars, the important inventions did not originate with the military authorities at all, but were devised by civilian experts. If any examples are needed you may refer to the first iron-clad battleship, the *Monitor*, the submarine signalling system of Reginald A. Fessenden and many others.

One of the most urgent requirements by the Navy and Air forces is the following:

At present submarines cannot be distinguished as friendly or enemy and it is practically impossible for an airplane when he sees a submarine beneath the waves, to know if it is friend or foe. In military tactics it is often necessary for airplanes to convey important information to submarines, particularly those that are submerged. So far no system that is fool-proof exists. Often at the present time the air force bombs its own submarines. It is well known that a submarine, even when submerged can send radio messages. It can also receive them if not submerged too deeply. Yet with all this no reliable method of communication has been found. The chief reason is that both submarines and airplanes are afraid to use radio for fear of having the information received by the enemy, who also listens. It should, however, be possible to devise a radio communications system between submarines and airplanes, using ultra-high radio frequencies, because such frequencies do not carry far enough to be received by the enemy. It is believed that in time a special directional ultra-shortwave means of communication will be evolved. It would be worthwhile if our radio enthusiasts would tackle this problem. Its solution is urgent.

•THE RADIO MONTH IN REVIEW•

The "radio news" paper for busy radio men. An illustrated digest of the important happenings of the month in every branch of the radio field.

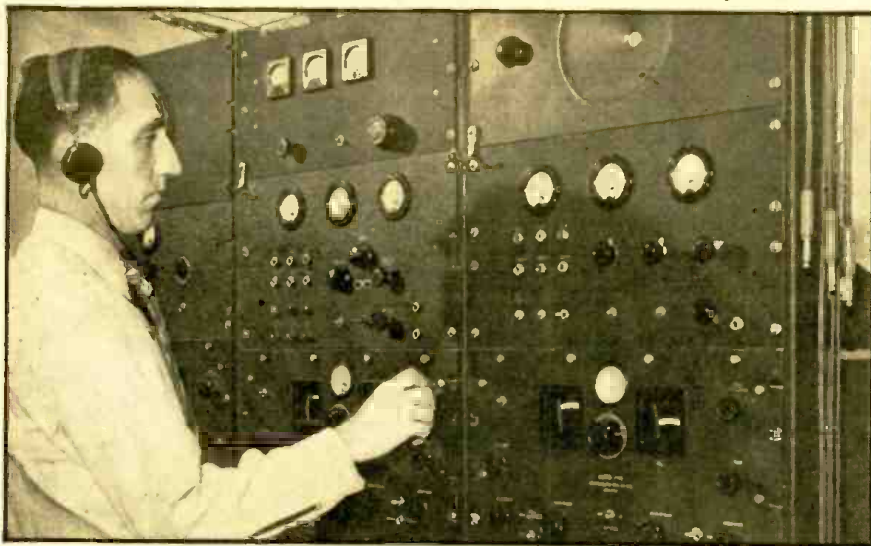

UNITED STATES "LISTENING POST" AT VALHALLA, N. Y.

The accompanying photo shows what is believed to be the biggest non-commercial, radio receiving station in the United States. It is operated by United Press at Valhalla, Westchester County, New York, for the reception of "foreign" short-wave news despatches. This listening post receives scores of special news broadcast daily from European capitals. The operators also monitor dozens of short-wave voice and code "propaganda broadcasts" from the various foreign countries. A high-speed printer circuit connects the listening post with the New York office of the United Press.—U.P. photo.

Rice Weevils to Television:—A high frequency radio tube which now helps to make television broadcasts practical was originally used to kill rice weevils spoiling millions of bushels of grain each year. Built by Westinghouse, the tube transmits 60 million cycles a minute. Insects which came within its range died instantly of a high fever.

Tiniest Light Source:—The tiniest of practical light sources is a midget Westinghouse lamp slightly larger than a grain of rice. It measures about 3/32 inches in diameter and 3/8 inches long. Surgeons use it to light throat and nasal passages during delicate operations.



BRITISH COLOR TELEVISION

Photo shows Color Television receiver, with Mr. John L. Baird, its inventor, beside it. Even though England is at war, a great deal of television and other radio research is being carried on in the laboratory. On this receiver the image measures 2.5 feet wide by 2 feet high. The standard of scanning used with Baird's color television is 600 lines per picture.—Photo from D. W. Aldous.

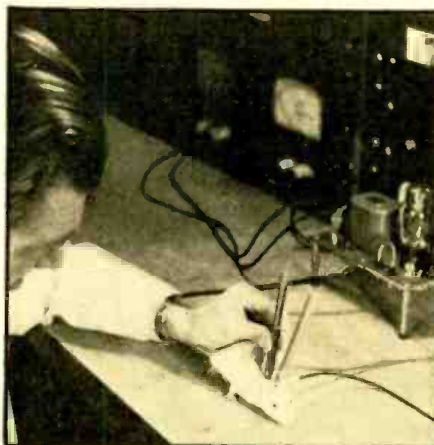

ELECTRO-SHOCK THERAPY

The photo shows the use of two special electrodes for applying high frequency energy to the brain of an albino rat. The apparatus in front of the rack is a converter. The rack contains a wide-range amplifier running from 0 to 200,000 cycles per second, and a supersonic signal generator with a maximum power of 50 watts.—Photo courtesy of General Electromedical Corp.

New Acoustical Treatment for Studios:—WOR's studios are having their faces lifted. It's for sound's sake, not beauty's—all the studios are being given a complete new acoustical treatment.

The revolutionary new method of acoustical treatment gives WOR studios "concert hall" quality. Music transmitted from any WOR studio will carry with it all the richness, the overtones, sharpness and instrumental perspective that were heretofore possible only in a broadcast from an acoustically perfect concert hall.

This new technique makes every studio a composite of uneven surfaces, giving it a slightly surrealist appearance. Various shapes and sizes of sound-absorbing baffles (some square, some rectangular, others

triangular) are applied irregularly to the four walls of each studio, so that no two surfaces are directly parallel. Floors, of course, must remain flat; however, wedge-like baffles are added to the ceilings to make them irregular in surface.

Red Network Stations Gain Power Increases

Since April five power increases in the daytime and ten at night have been granted NBC Red Network outlets, with the FCC authorizing 24 additional power increases, one frequency change and 20 equipment improvements for Red Network stations. Many of the authorized changes are under construction and should be in operation in the near future.

The power increases granted Red Network stations are as follows: KDYL, Salt Lake City, 1000 to 5000 night; KFYZ, Bismarck, 1000 to 5000 night; KGNC, Amarillo, 2500 to 5000 day; KRIS, Corpus Christi, 500 to 1000 day and night; WAPO, Chattanooga, 250 to 5000 day, and 250 to 1000 night; WBEN, Buffalo, 1000 to 5000 night; WFOR, Hattiesburg, Miss., 100 to 250 day and night; WRAC, Washington, 1000 to 5000 night; WSAI, Cincinnati, 1000 to 5000 night; WSOC, Charlotte, 100 to 250 night; WTMJ, Milwaukee, 1000 to 5000 night; KTSM, El Paso, 500 to 1000 day; KGHL, Billings, 1000 to 5000 night.

In addition five stations have been added to the Red Network since April. They are: KDKA, Pittsburgh, operating on 1020 kc., with 50,000 watts power; WBAL, Baltimore, operating on 1090 kc., with 50,000 watts power; WCRS, Greenwood, S. C., operating on 1450 kc., with 250 watts power, and WHIS, Bluefield, W. Va., operating on 1440 kc., with 500 watts night and 1000 watts power days.

Now available to the Red Network are WEAU, Eau Claire, now operating on full power; WFEA, Manchester, available to Red only, and WSFA, Montgomery, now in the Red South Central Group.

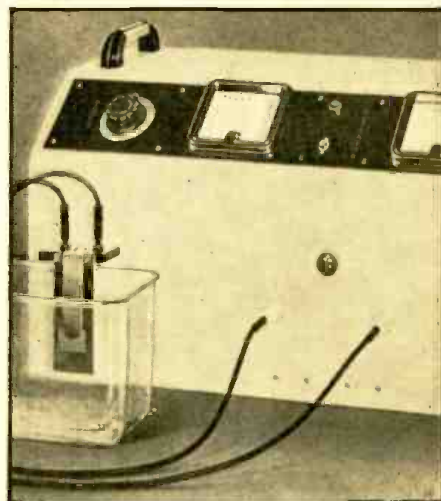

ULTRA-AUDIBLE SOUND GENERATOR

A whole new world of scientific experiment has been opened up to physicists and physiologists by the introduction of the ultra-sonic or super audible sound generator, one type of which is here illustrated. These super audible sounds do many queer things, such as crystallizing liquids, killing small fish and frogs, destroying red corpuscles, etc. The apparatus shown gives 80 watts of ultra-sonic energy at 400 kc.

ON THE COVER!

A U.S. Signal Corps soldier using the Army's "Walkie-Talkie", the light portable transmitting and receiving radio set which may be strapped to a man's back and carried about with him. It will keep him in constant two-way communication with other radio equipped personnel. The set may be placed upon the ground and its metal antenna extended to secure better operation. It weighs considerably less than the regulation Infantry pack.—Photo United States Army Signal Corps.

West Coast Television

First film transmission from the new \$250,000 W6XAO Television transmitter from the top of Mt. Lee were flashed across the airplanes in Hollywood recently, opening what is expected to be a very extensive movie telecasting season, according to Thomas S. Lee, station owner.

A large quantity of films has been obtained for the 500 home televiewer set owners in Southern California. Prior to moving to its new home atop the 1,700 foot mountain, station W6XAO televised more than 11,000,000 feet of picture film from its Seventh and Bixel Streets location. A highlight of the season this year will be television transmission of the winners in the "home movies" annual amateur contest.

In addition to the heavy film schedule W6XAO plans to offer its "lookers" a number of outdoor events, said the Director of Television Harry R. Lubecke, who next month will celebrate the station's Tenth Anniversary on the air. W6XAO transmitted its first video-sound signal December 23, 1931.

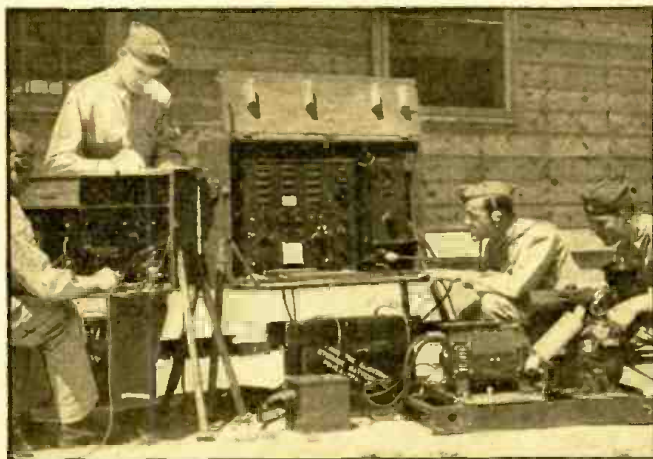

New Magnet Steel:—New alloys for permanent magnets are about thirty times better than the best carbon steels used a decade or more ago, William E. Ruder, head of the metallurgical and magnetic section of the General Electric Research Laboratory, stated recently.

Part of this advance, he explained, has been achieved by heating the magnet material and then slowly cooling it in the field of a powerful magnet.

The latest alnico, an alloy generally consisting of iron, aluminum, nickel and cobalt, he stated, was first proposed by a laboratory in Holland and developed by the General Electric Research Laboratory. This may contain a small amount of copper as well. With magnetic cooling, its maximum energy is about five times greater than that of the best alnico alloys of a few years ago.

The new alnico contains a higher percentage of cobalt than the old, making the cost per pound relatively high. However the high energy content with the resultant saving in size, brings the cost per unit of available energy to a figure quite comparable with the other alnico compositions. He also

WINDSORS SEE TELEVISION!

The large photo at the right shows the Duke and Duchess of Windsor on their recent visit to New York, where they saw a demonstration of N.B.C. television. Clay Morgan of N.B.C. explained the mysteries of television to the Duke and Duchess. The inset photo shows the television image of the Duke and Duchess as they appeared on the television screen in the N.B.C. Studio, where they posed before the iconoscope camera and permitted photos to be taken of their images.—N.B.C. photo.



told of the achievements reached with another kind of magnetic alloy, used to make the thin steel strips for cores of transformers.

W47NV—First Commercial FM Station

Under the direction of Tom Stewart, Director of W47NV (Nashville, Tenn.)—America's first "commercial" frequency modulation station—more than 50,000 people in the W47NV coverage area have been told about frequency modulation and had it demonstrated to them.

W47NV's caravan of two trucks, frequency modulation sets, a tent, a display showing the steps taken during sixteen years of radio progress, and other features has shown at fourteen fairs this season, including the Tennessee State Fair.

With rural areas depending solely upon the radio for the majority of their entertainment, information, and news, the people in the smaller towns are very interested in anything that will give them better reception. The interest shown by them in Frequency Modulation was very evident in the W47NV contacts.

Present plans call for further exploitation of Frequency Modulation through dealers. Plans are also being formulated for city promotion of Frequency Modulation.

W47NV, of Nashville, is owned and operated by the National Life and Accident Insurance Company, Nashville, Tennessee.

U.S. SIGNAL CORPS SCHOOL

The photo at the left shows one of the larger portable U.S. Signal Corps' radio sets, power for which is supplied by a generator driven by a gasoline motor, seen at the right of the picture. The U.S. Signal Corps is using radio more than ever before, both for transmitting code and phone messages. The set shown requires four men to operate it and a truck to transport it.—Photo by Rudy Arnold.

TELEVISION IN NATIONAL DEFENSE

Photo at the right shows CBS cameras televising an Air Raid protection group, part of the civilian and volunteer organization in New York City who will chart the course of approaching enemy bombers in war time. Telephone reports from 40,000 civilian spotters will be checked by this group.—C.B.S. photo.



NEW PLANE-RADIO TRAINER

By A. D. BAKER

Chief Maintenance Instructor, Midland Radio and Television Schools, Inc., Kansas City, Mo.



The "mock-up" is constructed according to plans of the fore part of a Douglas DC-3. The student in the cockpit is wiring a control panel, while the student at the right is removing an aircraft receiver for inspection and testing.

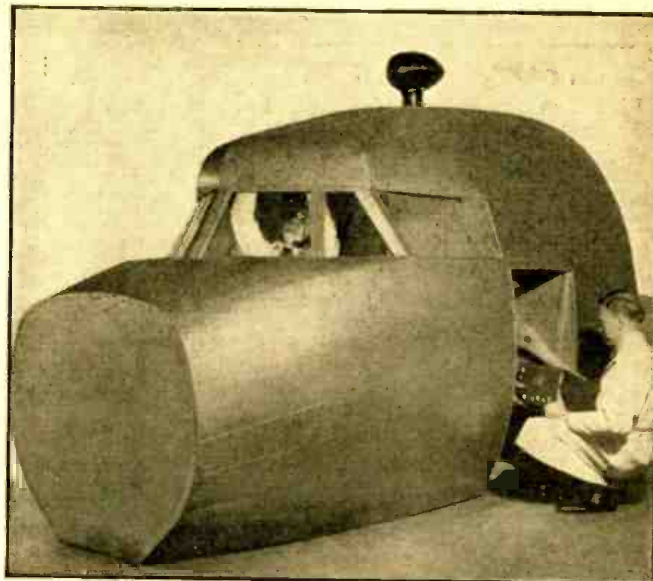

Looking forward through the radio compartment to the cockpit. At left are located transmitting and receiving equipment and power supplies. The master radio control panel appears at center left and is mounted on the pedestal.

BECAUSE of the rapid growth of the Airlines and the highly specialized nature of the work involved in maintaining the radio equipment, a midwest radio school has constructed in its laboratory a "mock-up" of the fore part of a Douglas DC-3 Airliner. This "mock-up" represents a full-sized cockpit and radio compartment. Radio equipment in the "mock-up" consists of a Western Electric communication transmitter and receiver, RCA radio compass receiver, W.E. auxiliary range receiver, W.E. marker receiver, interphone amplifiers, and power supplies.

Quite often the question arises as to why we have this "mock-up" and how it is used to train the radio maintenance students. First of all, the wiring and equipment contained in the "mock-up" is comparable to that which would be found in the same portion of a regular Airliner. Students find approximately the same conditions with which they would be faced, were they working upon the radio equipment in an Airliner in actual flying service.

A student at this school, after satisfactorily completing his radio training and having obtained his First-Class Radiotelephone License, is permitted to enter the "advanced maintenance" portion of his

training. Up to this time, each maintenance student has spent approximately half of his school day in the laboratory, the balance of the day being spent in radio theory and code study. Upon entering the advanced portion of his training, approximately three-quarters of his school day is spent in the maintenance laboratory. Here the class is divided into several groups. Duplicate equipment makes it possible for one group of students to service receivers and transmitters on the test bench, while another group is working in the "mock-up," installing and operating equipment. At the same time other groups of students are working on Airline ground station equipment, which includes a complete W.E. 400-watt ground station installation.

Each student learns the proper procedure to be followed in making such line tests as incoming, outgoing, and through checks. He learns the proper procedure to be followed in locating trouble, how to fill out reports in a manner beneficial to the servicemen in the Radio Maintenance shop.

Each student working in the "mock-up" must spend a certain amount of time on equipment installation. This includes interwiring on the main terminal strip, and

learning how to trace cables with the aid of an ohmmeter and with reference to the numbering system used by Airlines in their blueprints.

The students working on the test benches learn how to use specialized aircraft test equipment to the best advantage when locating trouble in receivers and transmitters. They learn the proper procedure to be followed in cleaning relays and switches, the proper method of aligning receivers by output meter indication, A.V.C. indication, and with an oscilloscope, employing either single or double trace method of alignment.

They must learn to check accurately the frequency of receivers and transmitters to determine the sensitivity of receivers, and to read and understand Lissajous figures. All completed alignment jobs, installations, and construction work must have the strictest investigation of the instructor before the student is permitted to advance to further experiments. Construction work must pass the proposed requirements set forth in Part 16 of the Civil Air Regulations pertaining to airworthiness of aircraft radio equipment. —This article prepared from data supplied by courtesy of Midland Radio & Television Schools, Inc.

NAVY SEEKS RADIO RECRUITS

AN opportunity for radio "hams" and technicians to serve their country in Class V-6 of the United States Naval Reserve and, at the same time, receive valuable training is being offered by the U. S. Navy Department, which is seeking several thousand recruits for one of its newest operations branches.

Qualified applicants will be enlisted immediately as Radiomen, Second Class, which is equal to four full promotions over original enlistments as apprentice seamen. Radiomen Second Class receive a base pay

of \$72 per month and allowances while on duty as technicians and "Radar"* maintenance men. Applicants must be high school graduates and must hold, or have held, Amateur Class "A" or "B" licenses. If applicants lack the license qualifications, they must be actively engaged in radio repair or service work, or have had experience with high frequency design, transmission or reception. They do not necessarily have to be familiar with Morse or other codes.

After training, students will have a chance for advancement in rating up to that of Chief Radioman, which carries a base pay of \$99 per month.

Until further notice, the Commission has canceled all monitoring schedules by broad-

cast stations heretofore maintained after midnight hours for the purpose of checking frequency stability of such stations. This was done in order that full use may be made of broadcast stations for defense purposes.

The Federal Communications Commission announces that at the request of the Army, it has assigned field inspectors to perform liaison duties between the Interceptor Command and the commercial radio stations in each area where radio silence may be required. When the inspector directs a station to maintain radio silence, it should be understood that the order originated with the Interceptor Command of the Army and carries with it the authority of the Federal Communications Commission.

* "Radar" men will operate the newly perfected radio device which locates planes in flight, the delicate and complicated instrument developed in England and used with such meritorious success by the Royal Air Force.



Above—Two of the Atlas Sound DR-42 Dynamic Reflex Projectors installed in the Pratt & Whitney Aircraft engine assembly building. There are 3 speakers in the cluster, one being hidden by the column.
Left—Three 75-watt power stages mounted in rack, together with two-position mixer. Switching permits progressive paging by groups of seven speakers to each power stage. The whole system is controlled from one point, where a "grip-to-talk" microphone is used.

P. A. System in Engine Plant

A LOUDSPEAKER system installed in the engine assembly building of the Pratt & Whitney plant at Hartford, Conn., to page persons in the building, to make announcements and to perform other functions for which the present auto-call system has not proven so adequate. The auto-call system will continue in operation, however, and the loudspeaker system will supplement it.

Messages to go out over the loudspeaker system originate in the Assembly Dept. office. The system is always ready for instantaneous use 24 hours a day.

Approximately 3,000 feet of wire lead from the office to the 21 speaker units in the building. The units are arranged in clusters of three, a cluster being mounted on every other of seven columns down throughout the length of the building. The cluster on each column stands about 25 feet in the air and affords coverage in three directions—forward, right and left. Backward coverage is provided in each case by the forward-pointing speaker of the preceding cluster.

The speakers are operated through three 75 watt amplifiers, in parallel.

Briefly, the initial problem was based on the large area to be covered—925 ft. x 260 ft.—a single floor, topped with the customary angled roofing (framed glass) with alternate high and low bays of approximately 50 to 70 ft. This is Pratt & Whitney's assembly floor, and except for the relatively small composite offices of the production manager and his staff, is unbroken by any partition. There are, however, parallel lines of machines and assembly tables from which come all sorts of noises varying from the sharp rasp of ignition testing, to the loud staccato beat of air and kerosene vapor compressors.

Fortunately, the steel uprights of the building were so positioned that by using every other one, it was possible to mount

the re-entrant speakers in groups of three on five of these pillars. Due to the design of the building, however, it was necessary to mount four speakers at the north end of this row, add two at the south end. This arrangement so positions the speaker groups that the same distance prevails between the center speaker of each group that exists from each side speaker to the opposing wall, thereby eliminating the overlapping of sound or splashing, which invariably results from sound started at several places, but having varying distances to travel.

Three 75 watt power stages were mounted in a gray crackle rack cabinet, together with a two-position mixer. Switching has been provided to permit progressive paging by groups of seven speakers to each power stage. Relay control of the amplifiers has been employed, these being supplied six volts of D.C. from a separate power pack; the whole being controlled from a "grip-to-talk" microphone.

It was found unnecessary to incorporate any frequency cut-off of either high or low range, within the amplifiers beyond the usual manual tone controls. The design of the DR-42 Dynamic Reflex Projectors and PM-23 Driver Units did this work admirably as they passed nothing noticeable, either above, or below, speech range. The ability of the speakers to punch through the previously mentioned noise is uncanny.

POWDER PLANT USES SOUND SYSTEM

Construction of the huge \$69,000,000 powder plant for the Government at Charles-town, Ind., is being facilitated by a recent installation of public address equipment which was described as "a routine job" by Jesse Tillet, Universal Radio Supply Co., Louisville, Ky., who sold and made the installation.

Nucleus of the installation is a combination phonograph and mobile public address

system capable of being operated either from a regular automobile storage battery or from a 110 volt A.C., 60 cycle power supply. The output of the amplifier is rated at 75 watts.

The amplifier feeds five 20 watt PM-23 P.M. dynamic driver units which are coupled to a similar number of DR-42 "Dynamic Reflex" Projectors. The double re-entrant air column speaker, which measures close to 18 inches in length, is said to be equivalent to an air column length of 3½ feet. The low frequency projector cut-off operates at 140 cycles. Sound projection angle is 80 degrees.

This type of weatherproof, outside speaker was chosen because of adverse cross-wind conditions, which normally disperse low intensity sound projection.

Both microphone and amplifier are located in the guard captain's headquarters. The five loudspeakers are placed on the outside of the building and directed to cover a considerable area adjacent to the guard captain's headquarters.

Over this public address system, orders and instructions are given out to the 7,000 employees on this \$69,000,000 project, as they check in and out of the turnstiles in the morning and evening. In addition, special orders are broadcast over this system at various intervals throughout the day. It is expected that further additions to this setup in sound and radio equipment will become necessary as construction of the plant progresses.

With time such an important factor in present national defense needs, it is obvious how modern public address or paging equipment play such an important part in the issuance of regular or special orders and in locating people on a construction job that covers many acres.

This article prepared from data supplied through the courtesy of Atlas Sound Corporation.

SERVICING SCHOOL

B. E. PHILIPPSEN

SOUND SYSTEMS

The author discusses such practical everyday problems as what type of loud-speaker to select for "inside" and "outside" use; what kind of cable to use for outside speakers; long-distance microphone cables; reasons for system going "dead"; low volume on one speaker, etc.

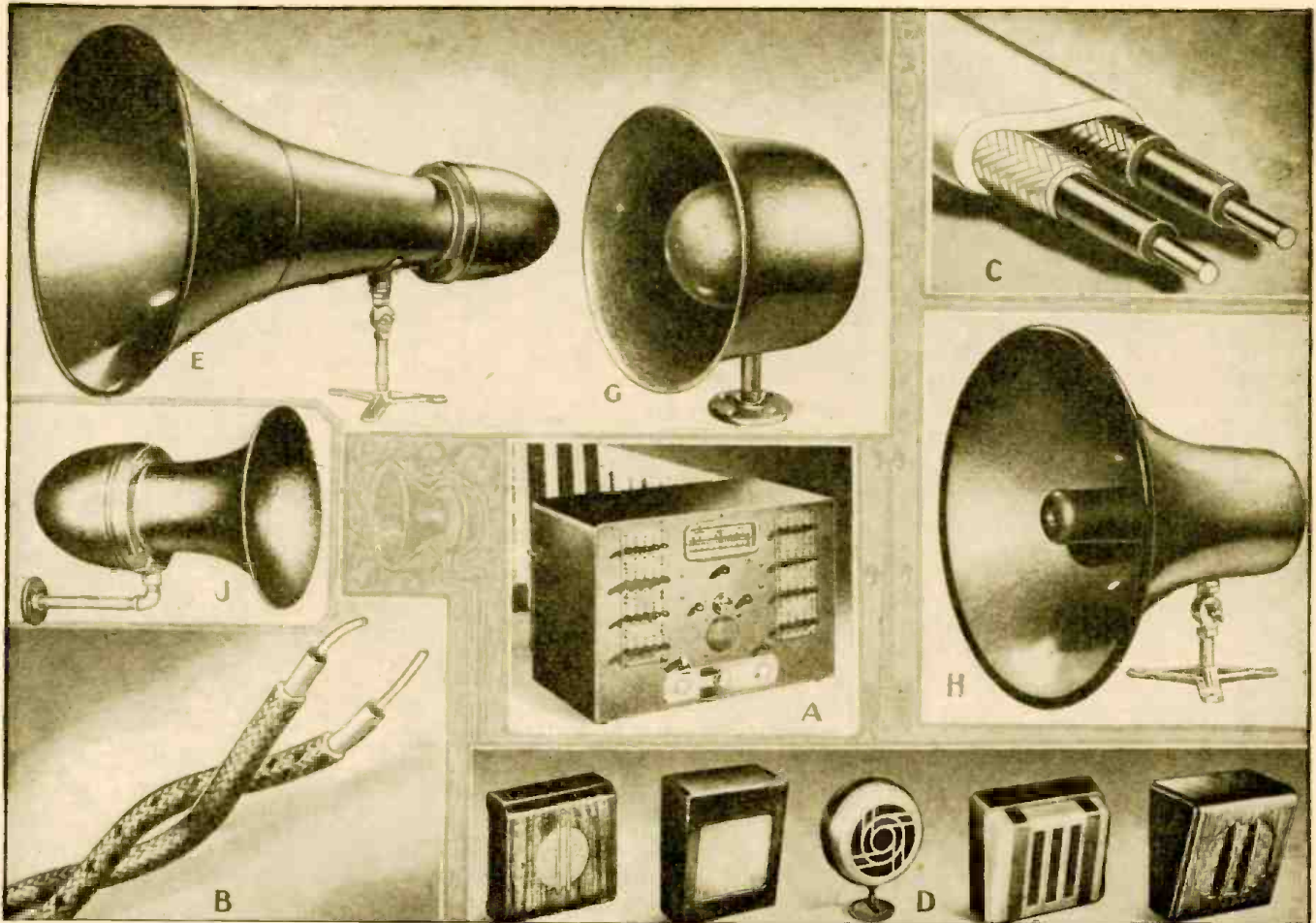

Photo A above shows "radio tuner" built into the front panel of a public address amplifier. B—cloth-covered "twisted pair" wire for connecting indoor speakers. C—lead covered two-wire cable for use underground. D—different types of speakers. E—one type of outdoor trumpet loud-speaker. G and H—water-proof type out-door loudspeakers. J—projector type speaker.

HOW often, since you've been in business, have you driven by the local school, the State Teachers' College or that university campus? Have you ever stopped to at least inquire whether or not a sound system had been installed recently, is it used regularly—no? "Because it hums, we use it only occasionally." There is your cue! Is a new installation being discussed by the school board? When will their next meeting take place and where? If it is a parochial or religious school, quite probably a single superior in charge makes the decisions.

Yes, you interrupt, this sounds good; but I've never done it before, and it looks complicated to me—not only the idea of selling it but the very equipment itself seems pretty thick to comprehend. Why does the average serviceman shy off and look tustly on a simple line of sound equipment which basically contains all the fundamentals of the A.F. section of the everyday broadcast

receiver. Truly enough, one glance at the back of even the smallest school sound system reveals an awe-inspiring maze of miles of wire and a multitude of switches, enough to make even an A.T.&T. engineer step back with respect.

But let's break it down; isn't it true that if the number of switches were reduced to one or two, the complicity of the unit would immediately disappear? Certainly! So for the same reasons only two room switches are shown in the diagram (Fig. 1).

SOUND SYSTEM REQUIREMENTS

Let's ask yourselves what is needed in a modern school sound system; what functions must it perform in the hands of a non-technical though otherwise highly educated school principal or his secretary?

First: He insists on being able to make announcements of importance from his desk to any one individual room, group of rooms, or ALL rooms! The same holds true for

phonograph music or radio programs from the built-in T.R.F. tuner.

Second: When a program or announcement is in progress, and an additional room or rooms are switched in, then the volume level on the first classroom speaker should not drop as it compensates for the other one or two speakers.

Third: The same amplifier should be so arranged that it can also be used as a regular "public address" system in the gymnasium, auditorium, or stadium.

Fourth: There should be provisions for either a built-in or plug-in radio tuner and record player.

To qualify these requirements, we must take a typical installation into consideration. Our School Sound System must handle forty rooms. For the best results we allot 1.5 watts of audio to each room speaker. Some may decide that as little as 0.6 watt is sufficient; but in this case we are compensating for any possibility of noise such

as on a warm summer day when classroom windows are open. There may be traffic roar or another class at recess right outside the classroom window. We know that 1.5 watts is ample. So, if forty classrooms want 1.5 watts each, we then require 40 times 1.5 or 60 watts of audio power. Then 60 watts will be sufficient to take care of all classrooms at one time for an emergency or general announcement. Also, if we like, by throwing the P.A. CLASSROOM switch, the same 60 watts will easily handle either the gymnasium, school auditorium and in most cases the field house or stadium. However, if the stadium is of the very largest double stand or bowl-shaped type, a higher powered amplifier may be used for better coverage. In this case, the gain control on the amplifier panel would merely be retarded for individual classroom use.

"DUMMY" SPEAKER LOADS

Looking at Fig. 1, notice the amplifier output transformer. The primary connects to the plates of the output tubes as is usual in any amplifier. The secondary winding, however, has in addition to the 500 ohm winding a 12.5 ohm and 0.5 ohm tap for monitor speaker output. The 500 ohm terminal is available for operating the unit as a regular P.A. system and follows through the P.A.-CLASSROOM SWITCH and through the ADDITIONAL FACILITY SWITCH to banks of 500 ohm speakers in the Gymnasium, etc. Now you wonder, "What is the purpose of the 12.5 ohm tap on the secondary winding?" To fulfill the first requirement, a bank of switches or keys on the front panel (see Picture A) allow the school principal to cut in any number of rooms up to and including forty rooms. If this were as simple as all that, no further explanation would be necessary. But complications do arise. Suppose that while one room is receiving a program over its loudspeaker, another room is suddenly switched in. Without any electrical compensation it is easy to understand that the volume would drop immediately, since then the available power for one speaker would necessarily need to be divided among two speakers—each receiving one-half the original power. To overcome any such occurrences, the following arrangement is employed.

Each one of the forty speakers is equipped with a 500 ohm output transformer. All speakers are effectively in parallel across the 12.5 ohm speaker line. Since, in a parallel circuit the total impedance is reduced by the value of the individual circuit members, the net impedance becomes 12.5 ohms to match that tap on the output transformer. Or—viewing it mathematically, 500 ohms (at each speaker) divided by forty speakers (in parallel) develops a net impedance of 12.5 ohms. Hence the reason for the 12.5 ohm secondary tap.

As long as the entire group of forty speakers remains in use on the 12.5 ohm output tap, the volume in each speaker will remain constant. But switch off one speaker and the volume in the remaining group will rise, since the power formerly going to the disconnected speaker is now equally divided among the remainder. While disconnecting only one speaker as explained here will not produce an objectionable volume increase in the others, the elimination of 3 to 5 speakers will result in an abstraction to the listeners. To overcome this annoyance, a means must be provided for substituting a load equal to that of the speaker just disconnected. The "dummy load" becomes the answer. Looking again at Fig. 1, inspect the ROOM NO. 1 THREE GANG SWITCH. This consists of three ganged, single-pole, double-throw, switches; A, B,

and C. All three arms are in the "ON" position. Following the 12.5 ohm tap out of the output transformer, through the P.A.-CLASSROOM SWITCH the audio output goes to the "ON" position of switch section "C" to the output terminal on the amplifier to the No. 1 Room speaker with 500 ohm output transformer and back to ground on the chassis. Also points "A" and "B" on the ROOM NO. 1 SWITCH have now disconnected the 500 ohm dummy load resistor from the circuit.

Looking at ROOM NO. 2 THREE GANG SWITCH, X, Y, and Z, it is obvious that it is entirely similar to switch A, B, C, in its function and construction. The schematic shows it in the off position. The arms "X" and "Y" have now closed the circuit including the dummy load, 500 ohm resistor; while switch arm "Z" has opened the speaker circuit. Logically then the audio power is being dissipated by the 500 ohm resistor, and no signal is heard at the speaker. Yet, throughout the entire speaker system, the full power of the amplifier is being used—operating any one individual switch from "off" to "on" position causes no noticeable volume variation in the other speakers.

NEED FOR EMERGENCY SWITCH

Suppose, for example, that an important announcement becomes necessary and must

be "aired" to all classrooms simultaneously. Quite obviously it is a tiresome task to manipulate forty individual, front panel switches. This brings on the need of an Emergency or ALL ROOM switch. Referring again to Fig. 1, observe the action of the "ALL ROOM" ganged switch. In the NORMAL position contact "E" is grounded, thereby providing a return circuit for the 500 ohm dummy load resistors. At the same time point "F" is on open contact. Assume that the need arises for using the "ALL ROOM" or "EMERGENCY" switch. Throwing the switch first of all removes ground from dummy load resistors on all forty THREE GANG ROOM SWITCHES. This prevents any circuits, which happen to be in the "off" position, from having audio power dissipated in the alternate dummy load. Second, the contact "F" connects the 12.5 ohm speaker line from the "on" positions to the "off" positions. This makes it immaterial in whatever position each individual speaker switch may be placed at the moment the "ALL ROOM" switch becomes effective, which completes the second requirement.

The third requirement states that the system be available for use as a regular public address system when the need arises. Fig. 1 shows the P.A.-CLASSROOM switch in the CLASSROOM position. Desiring regular P.A. operation, the switch is thrown so

Typical layout of School Sound System.

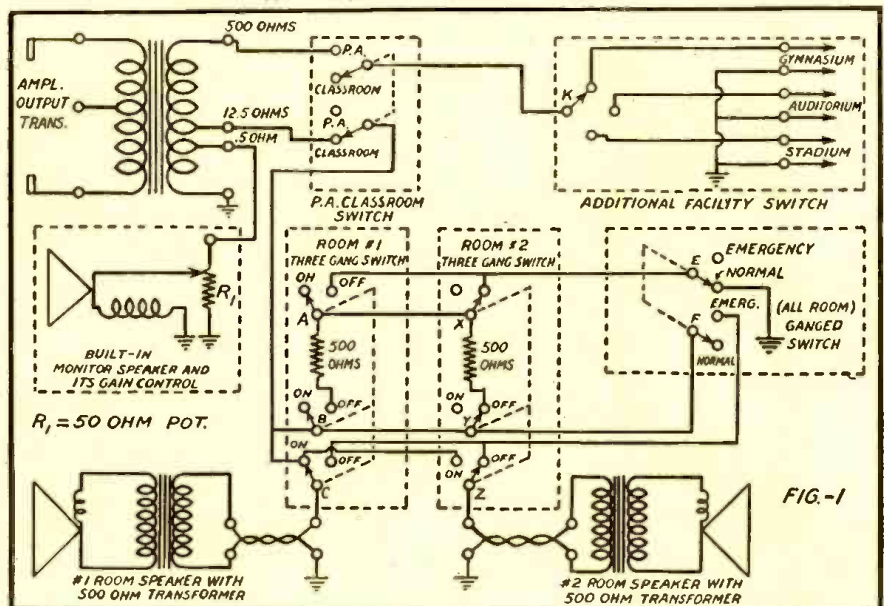

FIG-1

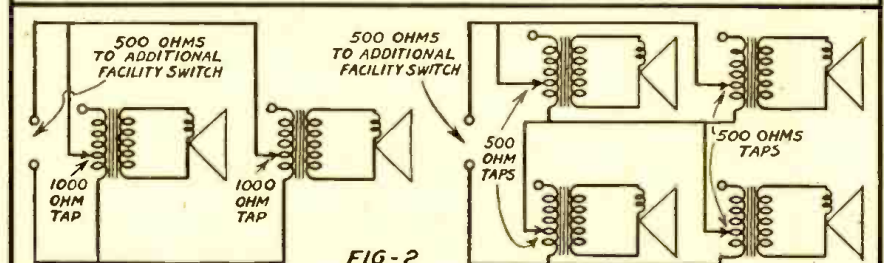

FIG-2

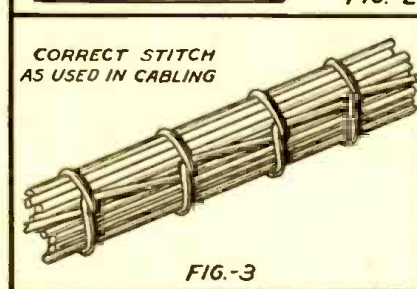

FIG-3

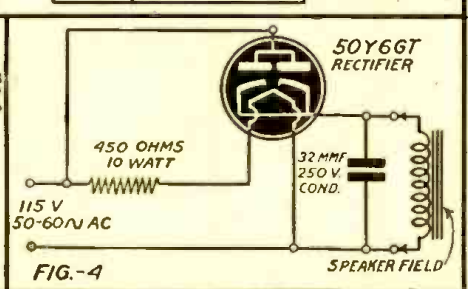
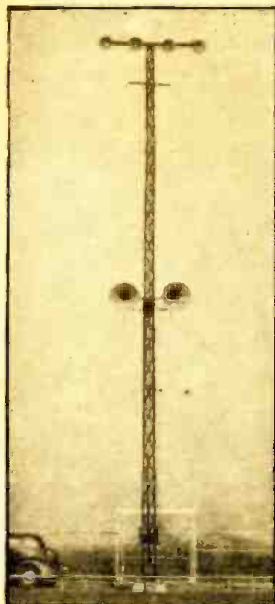

FIG-4



Picture at left shows a typical school athletic field, with two trumpet type speakers mounted on a floodlight tower. In this case they are pulley-controlled and can be brought down after each event.

that contact "J" closes the circuit between the 500 ohm tap on the output transformer and the contact "K" on the ADDITION FACILITY SWITCH. Contact "H" is thrown to the open position. This disconnects entirely the school room system and provides public address service on the 500 ohm line to the ADDITIONAL FACILITY SWITCH. From this point, contact "K" carries the amplifier output to either Gymnasium, Auditorium or Stadium.

It must be understood that these terminate in 500 ohm pairs; from this it follows that the speaker groups in, let us say, the Gymnasium must also be connected so as to reflect an impedance of 500 ohms (see Fig. 2). Many more possible speaker connections have been shown in previous editions of RADIO-CRAFT, so there is no need for greater detail on this subject.

The fourth requirement demands provisions for either a built-in or plug-in radio tuner and phono to provide appropriate educational programs. In the outfit shown in Picture A, the tuner is built into the front panel. The tuner is a standard two-stage tuned-radio-frequency receiver with A.V.C. covering the standard broadcast band. Its output feeds directly into the second stage of the amplifier. Since both cost and space are limiting factors, the record player has been considered as an external item which can be plugged in at will. For the convenience of monitoring either phono records or incoming radio programs, a front panel monitor speaker is provided. A 0.5 ohm tap on the output transformer (see Fig. 1) supplies sufficient output which can be set to any desired level with the potentiometer R1.

INSTALLATION AND PLACEMENT

As can be seen from Picture A, the unit itself is suitable for desk or table mounting. You will find, in most instances, that the school principal prefers placing the outfit on a second table located behind or to the side of his working desk. In this position it is merely a matter of turning in his swivel chair from his usual duties to using the sound system. The mike can be left plugged in, permanently mounted on a desk type stand. As may be anticipated, at this point a problem arises because of the multitude of speaker cables entering the sound system cabinet. It is here that neatness in cabling means so much for appearance's sake.

In running the individual pairs of speaker wires, it is good practise to allow sufficient

surplus length; in other words, cut each lead longer than what appears to be needed. If in doubt, add 10% to the length and be sure. Later, when the entire group of speaker leads has been cabled—AND—put into position, it is a very easy task to clip off a few remaining inches rather than to attempt an ugly looking splice.

After all speaker cables have been run, connected to their respective terminals on the back of the system, and the entire unit tested, it is time to cable the leads. Starting from the point through which they emerge from the floor to the cabinet, every single speaker wire should be included in the cable. With a little foresight, it should be possible to have very little cabled wiring in open view. Endeavor to bring all leads into the principal's office, as near to the sound system cabinet as is practical. Remember, *even neatly cabled wiring is not attractive to the average person.* Rather than have exposed wiring cover the entire cable with wood strips—these to be painted the same color as the adjoining wall surface. This bit of additional labor achieves an atmosphere of the finished product and helps not a little to impress others with your workmanship.

SPEAKER CABLE STITCHING

For a permanent stitching job that lasts seemingly forever, there is no better method than that in use by the Western Electric and A.T.&T. Co. This is shown in Fig. 3. Pay strict attention to the manner in which the cord passes under its loop before going on to the next stitch. This is the secret of keeping the cord tight at all times. Any other method of tying the knot results in a loose, unsatisfactory job. The cord itself may be any good linen shoemaker's line, available at most hardware stores. At first, use lengths of cord five to six feet long; longer lengths may be unwieldy since the entire length of cord must be passed through the loop. Where the short lengths are used, they may be neatly spliced and cabling continued.

WIRE AND SPEAKER PLACEMENT

For all indoor speaker work, the No. 18 cloth covered, "twisted-pair" wire (see Picture B) is suitable. It may be run through air ducts or ventilating shafts and almost anywhere in the interior of the building. Where speaker lines must be run out-of-doors, it is imperative to employ some kind of waterproof cable such as the underground, two-wire, lead covered cable shown in Picture C. Of course there are other satisfactory methods in use, such as steel conduit wiring, etc. The above is given merely as a practical suggestion. A hint—always leave enough surplus wire at the point where the speaker is to be mounted.

As to the placement of the speakers: much has been written on the proper positioning of speakers in auditoriums, gymnasiums, etc., so this topic will concern itself mainly with classroom speakers. Generally, the speaker may be mounted anywhere in the classroom and heard equally well. A better way is to mount the speaker in its baffle directly in front of the class and out of reach. Usually this spot is somewhere above the blackboard level and in the center of the room. Keeping the speaker in front of a class of pupils produces less distraction when an announcement suddenly comes on. Also, it prevents a massed turning of heads to hear the program thereby preserving classroom order. Various types of baffles are shown in Picture D. The circular type, while it may be used in the classroom, is more adaptable to corridors because of its two way (front and back) feature.

Where P.M. speakers are still available, two wire lines suffice, but it is well to

remember that as the National Defense Program continues to grow, more of the electrodynamic types must be pressed into service. This immediately indicates the need for field voltage supply. At present no economically centralized field supply has yet been devised to handle a great number of speakers such as is used in the School Sound System.

There is a solution to this problem which undoubtedly will come into universal use, at least for the duration of the national emergency. Figure 4 shows a simple field supply of the A.C.-D.C. type. Since only three parts are required, the entire assembly may be easily mounted on the speaker frame using a small chassis to hold securely the component apparatus. A 50Y6GT high vacuum rectifier is used with half-wave connections as shown. With the value of filter capacity indicated, the hum level is barely audible. The power pack will deliver approximately 80 to 90 mils at 100 volts. Such units completely built up ready for use will undoubtedly be available very shortly. The question arises, "How can the individual field supplies on each speaker be turned on and off?" One method is to run two additional wires to each speaker to carry the 115 volt A.C. Individual leads from each speaker may be connected in parallel with a switch at the sound system for *master control.* In fact, some of the school systems will presently be available with provisions for turning on the speaker field supplies at the instant the amplifier switch is operated. Remember, too, that in running A.C. lines, they must meet *local electrical inspection!* Therefore, be sure you are familiar with these requirements before stringing unapproved wires which later must be changed.

REGARDING OUTSIDE SPEAKER HORNS

Much depends on whether the school authorities prefer to take down the speaker trumpets or projectors after every athletic event. Some are highly meticulous in this respect, others allow the horns to remain outdoors throughout the season. Where the trumpets are taken down after each period of use, or are not exposed to rain and snow, the trumpets shown in Picture E will provide excellent service. It is especially useful in "spotlighting" sound over a distant crowd or wherever a heavy duty unit is desired. It uses an eight inch, eight ohm P.M. speaker for power. Picture F shows a typical school athletic field with two of these trumpets suspended from the floodlight towers. In this installation they are pulley controlled and can be brought down after being used. From the position shown they direct the sound across the football field in the foreground to the stadium from which the picture was taken.

Where the speakers are to be permanently mounted outdoors, the best types from a standpoint of waterproof construction are those shown in Pictures G and H. Picture G shows a compact trumpet in which an 8-inch P.M. speaker is used as the driver unit. The speaker is mounted in the interior of the horn in such a manner that rain or snow coming into the open bell cannot reach it because of the labyrinth through which it would have to pass. The reflex trumpet shown in Picture H is of similar design, but uses a diaphragm type dynamic unit as the speaker driver.

A school installation is not complete without a direct contact between the principal's office and the boiler room or shop; here the custodian can be reached most of the time. Since this is the one place in a school where the noise level is higher than usual, it is of course essential to override any existing racket. For this purpose the small projector in Picture J is ideal. It produces a clear,

crisp tone on speech and easily penetrates steam and coal noises with a minimum of power. In fact, it has been found practical to connect and consider it in the same manner as any classroom speaker where the noise level is comparably low.

LONG DISTANCE MICROPHONES

When the school sound system amplifier is also used for sound reinforcement in the auditorium or gymnasium, etc., the question of microphone and gain control suggests itself. It is quite probable that the actual distance between the sound system in the principal's office and the school auditorium will be several hundred feet or more. This condition immediately eliminates the use of an ordinary microphone and indicates the need of a "Long Distance" or low impedance mike. These are usually of the 50 ohm type, although other values are in use, such as 250 and 500 ohms. Where the amplifier is permanently located at a central point, these may be used with success, since the length of the line does not appreciably affect the operation of the mike.

Gain Control under these circumstances is ordinarily accomplished by remote control. This is of the type which can be operated at distances as great as 1000 feet from the amplifier. Actually, it constitutes a variable resistance and controls cathode current in one of the voltage amplifier stages of the amplifier; by this process it varies the gain characteristics of the tube and consequently the overall volume in the loudspeakers.

SERVICING SCHOOL SOUND SYSTEMS

When installing a school sound system, it can usually be assumed that everything is in working order at that time. In servicing, or testing, *assumptions* are out of the question. The serviceman must be *sure*, leave nothing untouched in his quest for trouble. As with any task where complexity at first is startling, the systematic method of breakdown brings to light faults in the order of their circuit sequence.

SOUND SYSTEM INOPERATIVE

Suppose a school sound system is completely inoperative. Tubes, of course, have been checked. For the purpose of brevity, the tuner, microphone and phono have been previously found in working order. For quick checking of the amplifier and the entire system, a small P.M. speaker with 500 ohm transformer attached is suitable. For amplifier input, the tuner or phono if any, can be used as a source of signal. Connect the test speaker directly to the 500 ohm terminals of the amplifier output transformer in Fig. 1. If the tuner produces no audible signal with all amplifier controls at normal settings, the amplifier proper is at fault. It then can be removed and treated as an ordinary service job.

Suppose, though, that the amplifier is entirely normal, and one or more of the room speakers is inoperative. On the marked terminal board at the back of the sound system, find the two terminals corresponding to the defective room speaker. Place that room switch on the front panel in the "ON" position. Remove from the terminal board the two wires from the room speaker. Connect the test speaker across the terminals for that speaker. If the output of the tuner is heard at this point, it then follows that the actual room speaker voice coil or speaker transformer is defective. Possible, but not probable, is the chance that the *speaker line is open*.

On the other hand, if no output is had in the test speaker, it is natural to suppose that the trouble lies ahead of this point or in its respective room switch. In some cases

it may be far easier to locate this switch by manipulating the control key and watching at the same time at the back of the cabinet for signs of motion, than to electrically trace the wiring. This holds true for the open type switch. Once located, it is usually simple to tell whether the trouble is due to improper pressure of the moving contact arm, broken arm, or loose switch wiring. This can be done by probing or prodding with the eraser-end of an ordinary pencil, at the same time listening to the test speaker.

As to the *dummy load* resistors, they are most quickly tested for *opens* or *shorts* with an ohmmeter. While a shorted dummy load resistor may be found occasionally, it is far more probable that an open one will be the trouble. Generally speaking, the load resistors do not prove much of a problem. However, it is well to remember that one shorted resistor can cause a short-circuit of more than one speaker. For that reason it is best to see that the resistor is not actually leaning against an adjoining terminal before unsoldering one end for continuity testing.

LOW VOLUME ON 1 SPEAKER

A complaint that may arise is a low volume condition on one room speaker. Improper contact at the switch or dirt between contacts can cause a drop in volume level. Long before the days of "priority" some school sound installations were equipped with electro-dynamics. Here again, it is wise to check with the room speaker at the terminal board before removing the connections at the classroom speaker and substituting the test speaker at that point. It goes without saying that if an *open* field is discovered, it should be replaced with one of identical electrical values. If the speaker field resistance is not indicated on the wiring diagram usually found on the interior of the sound system cabinet, then it is best to measure the field resistance of one of the other classroom speakers.

Whenever switch trouble indicates the need of cleaning, it is of paramount importance to use the best cleaning fluid available. One which has been found to give satisfaction is carbon tetrachloride. This may be obtained commercially at a comparatively low price. It is also sold at most drug stores under the trade name "Carbona" in smaller quantities at higher prices. The prime advantage of this fluid is its lack of residue after cleaning and the fact that, as against gasoline, it is non-inflammable. Using a discarded tooth brush is the easiest and most effective means of applying it to switch contacts. In cases where space is limited, an ordinary pipe cleaner dipped into the fluid is more flexible since it can be bent into a variety of forms.

If at some time or another the serviceman is asked to make a major change or addition to the system, it is wise to indicate that *change* on the *circuit diagram* fastened to the cabinet. Remember, you may not be working on it the next time; so in the spirit of fair play, make it as simple for the next fellow as you would appreciate having it yourself.

This article has been prepared from information supplied through courtesy of Montgomery Ward & Co., Chicago.



For Triplett Customers Only

Long before the state of emergency was proclaimed, the Triplett Company was getting ready to do its part in building our national security. We knew that we must meet important new responsibilities. At the same time, we felt keenly our continuing obligations to our customers—old friends with whom we have had happy business relations through many years.

We doubled—then tripled—our output to fill the needs of our old accounts. We added to our production facilities . . . hired many more men . . . are working extra shifts at time-and-a-half.

All this has not been enough. We have been called on to produce more and more for national defense. We are proud of the job we are doing to help meet the emergency, but it is difficult not to be able to serve our old friends equally as well. In the face of these conditions, the Triplett Company has adopted these policies "for the duration."

FIRST: We will continue to serve you by our service to our mutual responsibility—the national emergency.

SECOND: We will continue to do everything we can to fill orders from our regular customers, even though some deliveries may be temporarily delayed. No business from new accounts has been nor will be accepted until after our old friends have been served, except where priorities make it impossible to do so.

THIRD: Our engineering and research departments will continue to work on the development of superior equipment and improved methods to serve you still better when we can resume normal operations.

The present emergency is incidental and as we work towards the future, we will do our best to continue to merit your confidence and loyalty.

A. H. Triplett

President
The Triplett Electrical
Instrument Company

MANUFACTURERS OF PRECISION
ELECTRICAL INSTRUMENTS

**Next Issue
F-M FEATURES for
SERVICEMEN!**

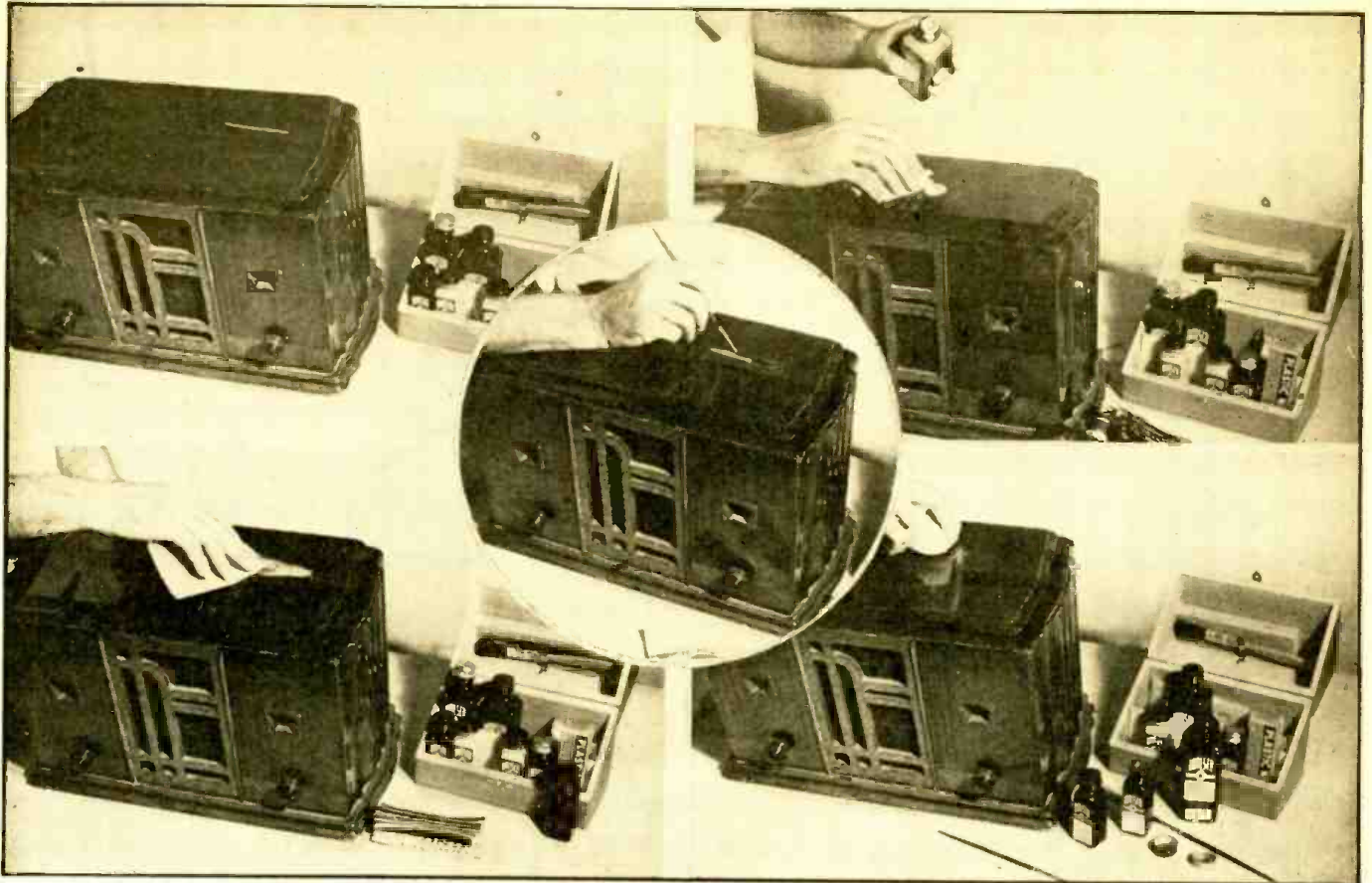

Top left—note the deep scratch on top of cabinet. Lower left—scratch should be sanded with a very fine finishing paper. Center—after thorough cleaning, the scratch is stained with a fine brush. Top right—finishing coat is applied with a French polishing pad. Lower right—finally the whole cabinet is polished.

How YOU Can Refinish Radio Cabinets

LET us first forget all the discouraging experiences that most servicemen had with attempted cabinet patching, and let us see in how many ways cabinet patching can be of great service to the radio man. In the first place, there are those accidental and sometimes unavoidable damages to customers' sets. Ordinarily, a refinisher should be called in (which is seldom done on account of the high cost), or there will be an argument with the customer, who blames the serviceman for not being careful enough. More important than that, however, is the fact that if a repair job is done and the cabinet is also brought into a good-looking condition, a great deal more can be had for the repair work than if the cabinet is left as it was. One might tell the customer that he not only gets a set repaired, but also the cabinet refinished, or what has also proven helpful is to refinish the cabinet without mentioning it at all. In this case, the customer gets something that he hasn't expected. There is hardly any way of creating more good will than by doing such things, and it is proven that this is one of the most effective and cheapest ways of advertising. When the customer gets a set back, he expects it to play right; if he gets something in addition, he will be especially pleased and will remember such *extra service* more than one might think.

For those servicemen who also handle set sales (or work in radio stores) there

are two more profitable angles to cabinet refinishing. There is no store without "trade-ins." The resale price of those sets is determined more by the appearance of the cabinet, than by its working condition. Cabinets left in such a state that anyone can see that the set has been used for years, often have to be sold at a loss, or *are not salable at all*. Sometimes, a very little refinishing can *double the value* of many a set. New sets standing on the floor are sometimes accidentally damaged and have to be sold at a reduced price. Most of those losses can be avoided if someone is around who knows how to refinish a little and has suitable materials for doing so.

Refinishing and patching of cabinets should really be a part of the radio service business. Other professions such as the refrigeration or automotive trades consider refinishing a part of their business. Most every refrigeration serviceman can convert "trade-ins" into an attractive looking condition. So also, most every garage can not only fix your car, but also restore its fine "eye-appeal."

"REFINISHING" CAN BE LEARNED

There are two reasons why the radio man in this respect has not "caught up" with other trades. One is the fact that the art of wood refinishing has an old tradition and is more or less kept a secret among the professional refinishers. The second point

is that the materials used by such refinishers were not obtainable on the open market, and until recently, scarcely any radio man could buy suitable refinishing outfits or accessories even if he wanted to. Those are the reasons why most servicemen regard patching as something they just can't do successfully. Most of them have tried it and have failed. They used unsuitable material (ordinary varnish, lacquer, or stain cannot be used for successful patching) and the damage was often worse afterwards than it was at the start. A refinisher had to be called in and the whole profit on the job was gone. We cannot blame them for giving up after several such experiences.

With the introduction of outfits using the latest chemicals for patching, a wide field has been opened for the serviceman to extend his field of activity—thereby giving him the possibility of increasing his profit. The materials now obtainable through regular radio parts outlets are utilizing new chemicals, which take much of the difficulty out of cabinet refinishing. We do not want to say that now **NO** experience or skill is required in repairing cabinets, but the application of those new products is so easy that every serviceman can learn it in a short time. There are also, however, a class of damages which will necessitate that a refinisher be called in. For instance, a deep scratch across the grain on an expensive set that has to be sold as *new* cannot be

successfully repaired by anyone except a refinisher with years of experience. Fortunately, such cases are rare and even if such damage is not completely eliminated, any improvement is better than none. There is another point which should be brought up. By using suitable materials, no further damage can be made, because real refinishing materials are alcohol soluble and do not cut or affect the original finish of the cabinet. This is of extreme importance, because it cannot be avoided especially on the first experiments that something is done wrong. If the serviceman uses regular material, such as lacquer or stain, he can hardly correct his mistake. If, however, he uses alcohol soluble material, he can wash his patch off with alcohol and just start over again, profiting from his experience.

This article is not intended to give full instructions on patching every damage. Detailed instructions ordinarily come with the refinishing kits and should be followed. We will, however, give a short summary of the common damages to radio cabinets and show how they should be repaired. This should also give the serviceman a good idea of what he needs if he makes refinishing and patching a part of his business.

FRENCH POLISHING

Most cabinet repairs can be classified into three groups—restoring the finish, staining, and filling of holes or nicks. In many cases, the three groups are combined and three different operations have to be performed. The most common repair calls for restoring of the finish. This is necessary when the cabinet is scratched slightly (the stain and wood not penetrated) or if the finish is peeled off or broken loose (as is the case with most "trade-ins"). Commercially, this restoration is done with spraying materials and a gun (air-brush). The average serviceman, not possessing such equipment, must use the "French Polishing Method." This "French Polishing", the backbone of most refinishing operations, used to require a great deal of skill, as the old French Polish was hard to apply and required the addition of a critical amount of oil or oily emulsion to the rubbing pad. The materials obtainable now for this purpose, incorporating the latest synthetics, require hardly any skill. French Polishing (also called "Frenching") is done with a pad made of lint-free cloth and a soft center. The Frenching material is applied to this pad and the cabinet polished evenly in circles. The finish appears in about one minute. Proper Frenching produces a finish even better than the ordinary spray job. A cabinet French Polished can be handled almost immediately and has a high gloss, which can be dulled to any desired shade by using very fine steel wool immediately after the polishing.

STAINING

The second class of damages requires staining. Deep scratches which have penetrated both the finish and the stain, also shipping marks and rubbed through places fall under this classification. This staining requires a little experience, as one has to watch the right shade and the right amount of the stain applied. Commonly used now-a-days are aniline spirit dyes which come ready-mixed. A fine camel's hair brush should be used and some experience should be obtained by practicing on old cabinets. The damage first is sanded smooth and the edges blended in the surrounding finish. The brush is then dipped in the stain and rubbed over some paper or wood to remove excess material. When staining the spot, one has to be careful to brush evenly and not to overlap the strokes. The surrounding

finish must also not be brushed over, as this will result in a ring appearing around the patch. Usually the damage has to be French Polished after the staining operation.

FILLING UP SCRATCHES

If the cabinet has very deep scratches, holes, or broken pieces those cavities must first be filled. The easiest method is filling with plastic wood, wood dough, etc. This method does not always produce a perfect job, but in many cases is entirely satisfactory. Natural color material is being used, which is afterwards stained and French Polished. A better method is the use of Stick Shellac. However, we recommend that the serviceman should first be familiar with French Polishing, staining, and filling by means of plastic wood or similar material before he tries to make repairs with Stick Shellac. The use of Stick Shellac is somewhat difficult, because the shellac has to be melted with a hot knife, and if one is not careful, the surrounding finish might be burned. Not quite easy is the selection of the right shade and the smoothing of the patch afterwards. With a little practice and patience, this however can be learned.—Photos courtesy Walter L. Schott Co.

Grid Damping Antenna Improves S.W. Reception

● ANYONE using a regenerative short wave receiver can save much antenna room and be sure of maximum sharp and loud signals by utilizing this grid damping antenna.

It consists simply of a sliding brass curtain rod that can be extended at least 10 ft. Fasten the base permanently so it will extend its full height.

Then wind the input coil as shown, connecting the rod to the top of the grid coil. The turns shown will suffice for 3500 kc. with about a 35 mmf. tuning condenser. Wind on tube bases.

For other frequencies it will be necessary to cut and try the coil windings. About 7 ft. of rod will give the best signal strength; comparable with the usual long antenna in general use for 3500 kc. For higher frequencies use less rod until the maximum signal strength is reached. Finally, mark these points on the rod for reference.—L. B. Robbins.

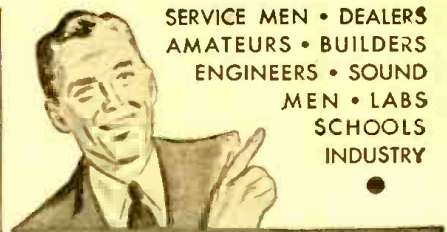
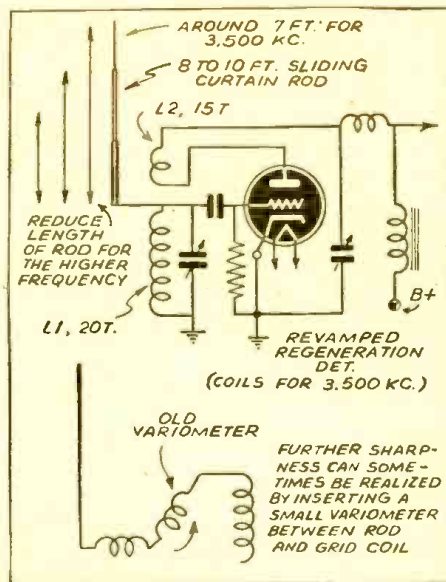

SERVICE MEN • DEALERS
AMATEURS • BUILDERS
ENGINEERS • SOUND
MEN • LABS
SCHOOLS
INDUSTRY

**FOR EVERYTHING
IN RADIO NOW—**
Depend on
ALLIED!

Free!
**RADIO'S
GREATEST
CATALOG**

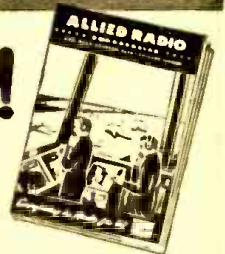

These are unusual times, but you'll find ALLIED now—as always—the same dependable source of supply for Everything in Radio. Stocks are the most complete in the field. Quality is more carefully guarded than ever. Service is speedy. Depend on your ALLIED Catalog to bring you everything you need in a hurry at the lowest prices. Send for your FREE 1942 copy today!



1942 Radio Receivers—better models than ever—a complete line of plastic and wood table models, consoles, phono-radios, FM combinations, phonograph players, recorders, portables, auto sets, farm radios, etc. More than 50 new models that set the pace for value in today's market. They're ready for prompt delivery.



Service Equipment—now, more than ever, radio-service plays a vital role in the maintenance of many millions of American radios. Count on ALLIED for Test Equipment, tools, manuals—and for more than 15,000 quality parts for servicing every type of radio equipment. You can always obtain the part you want when you want it, from ALLIED.



Sound Systems—built to give you more for your PA dollar. Full selection of systems from 7 to 600 watts, designed to meet every sound application need. You'll get the best of the 1942 features, better tone quality, greater usable output. And you can buy on our liberal 15-Day Trial terms and our Easy Time Payment Plan, too!

Specialized Equipment—Amateur Communication Receivers, special radio and electronic parts, accessories, and equipment for industrial applications, for defense instruction, for research labs. Consult our Industrial Division for your requirements. Today, when speed and service count most, it will pay you to keep your ALLIED Radio Catalog handy!



ALLIED RADIO

933 W. Jackson Blvd. Dept. 2-A-2
Chicago, Illinois

Send me Your FREE 212 Page 1942 Catalog.

Name

Address

City State

CROSLY MODELS 22CA AND 22CB—CHASSIS NO. 59

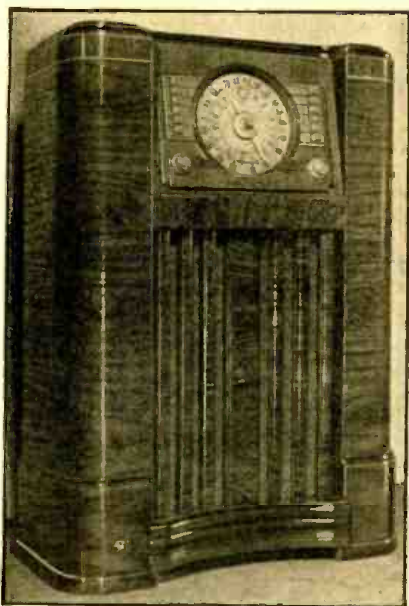

Crosley Model 22CA AM/FM Receiver

Models 22CA and 22CB are twelve-tube superheterodyne receivers designed for Standard Broadcast, Police, International Short-Wave and Frequency Modulation reception.

TUNING RANGES

- American Broadcast 540 to 1630 kc. (555 to 184 meters).
- Police Amateur, etc., 1600 to 5200 kc. (187 to 57.5 meters).
- Shortwave (Foreign) 5.2 to 18.0 mc. (57.5 to 16.6 meters).
- Frequency Modulation 42 to 50 mc. (7.1 to 6.0 meters).

TUBES AND FUNCTIONS

- 6SK7—I.F. amplifier (AM, 1st FM).
- 6SK7—I.F. amplifier, 2nd FM.
- 6SA7—Oscillator.
- 18S2 (6AC7)—Detector—1st FM.
- 6SA7—Converter—AM.
- 6SJ7—Limiter—FM.
- 6H6—Discriminator.
- 6AH7GT—2nd AF Driver.
- 6SQ7 Det. AM, A.S.C. and 1st AF.
- 6V6 (2)—Output.
- 5U4G—Rectifier.

ANTENNA

This receiver incorporates a built-in antenna system. For most effective short wave reception and for FM reception, it is necessary to install a good di-pole or special FM antenna. This antenna should be as high as possible, located away from metal roofs, downspouts, etc., and clear of obstructions. FM reception efficiency will be found to increase in almost direct proportion to the height of the antenna.

POWER SUPPLY

Be sure that power rating (voltage and cycles) as noted on model label pasted to cabinet, corresponds to characteristics of power circuit on which receiver is to be used.

BAND CHANGE SWITCH

The right-hand-inner knob controls the band change switch and automatic tuning. This knob has four positions. Reading from left to right they are as follows: "Automatic"—knob must be in this position when station-tuning push buttons are used. "American"—knob must be in this position for manual tuning on the standard broadcast band. "Police"—knob must be in this position for amateur reception and special services. "Foreign"—all international stations usually received in the United States will be tuned with knob in this position.

FUNCTIONAL SWITCH

The left-hand-inner knob controls the functional switch. It also has four positions. From

left to right, they are: "AM", "FM-1", "FM-2" and "PHONO." Switch is set to "AM" position for all service except FM reception and use of the set with phonograph pickup.

For FM reception, knob is set at either "FM-1" or "FM-2." These two positions constitute a selectivity switch on the FM portion of the receiver. Use "FM-1" for sharp clear reception of stations operating on channels where adjacent channel stations might interfere. "FM-2" provides high fidelity reception over a broader range where other stations cannot interfere. The "PHONO" position is used only when a separate phonograph pickup is installed on the set. It eliminates the necessity of an exterior switch with the pickup.

THE DIAL

The lower-outer numbers on the dial locate stations in the American Broadcast Band. Add one zero (0) to these numbers to read directly in kilocycles.

The lower-inner numbers on the dial are for use when tuning in stations on the Police Band. The upper-outer numbers indicate the position of Foreign or International Short Wave stations and the upper-inner numbers locate FM stations. These numbers are read directly in megacycles.

TUNING THE RECEIVER

For tuning all stations manually except FM set Functional Switch Knob (left-hand-inner) to "AM". Turn Band Change Switch Knob (right-hand-inner) to desired frequency band. Turn the volume control (left-hand-outer knob) approximately half way in a clockwise direction. Rotate the station selector knob (right-hand-outer) slowly until a station is heard.

Increase or decrease volume as desired by readjusting volume control knob. For best quality of reproduction always adjust the station selector to middle of range in which station is being received.

TUNING THE RECEIVER

Two things should be especially remembered when tuning FM broadcasts. First, a station will be found over a wider range of the dial. Second, station will be received with reasonable clarity at three adjacent points on the dial.

To tune FM stations first set Functional Switch at "FM-1" position. Adjust volume control as described in previous section. Move dial pointer slowly over range until station is heard. Continue to turn dial through this point until station is heard again. This second receiving point should be the one where maximum volume and clarity are obtained. If dial is moved still further in the same direction signal will again almost disappear and then again be received with approximately the same characteristics as were noted when signal was first received. The three receiving points will always be found within a very few degrees of each other on the dial. *Always tune to the center point.*

After best dial setting is determined with functional switch set in "FM-1" position switch to "FM-2." If stations are not located too near to each other at that point on the dial higher fidelity and more satisfactory reception generally will be received with switch set at the No. 2 position.

MASTER TONE CONTROL

The Master Tone Control system is operated by the six push buttons located to the left of the dial. More than sixty different tonal variations may be obtained by using different combinations of these buttons.

The upper three buttons are marked "Treble" and the lower three "Bass." With all push buttons out maximum high and bass note reproduction over the complete range of the receiver is obtained. To cut out the highest notes reproduced, press the No. 1 "Treble" button. Additional "highs" are eliminated by depressing buttons Nos. 2 and 3.

Bass note reproduction is reduced in the same way by use of the three lower buttons marked "Bass." Lowest notes reproduced are eliminated by depressing "Bass" button No. 1 and additional bass notes are removed by depressing "Bass" buttons Nos. 2 and 3.

Pushing a button once depresses it and it is released by pushing it again.

By depressing or releasing "Bass" and "Treble" buttons in various combinations, re-

production of the program may be varied to suit the most discriminating listener.

No adjustment of master control push buttons is required.

SETTING THE PUSH BUTTONS (Station Selector)

The six station selector push buttons are set up by means of two adjusting screws per button. These adjusting screws are made accessible by removing the station selector push button escutcheon. Pry off carefully, being careful not to scratch the main escutcheon.

Select the call letter tabs of your six favorite broadcasting stations from the station call letter sheet provided. Break off celluloid protector from strip, fold over call letter identification tab and insert in slot in the top of push button to be set for that particular station. Remove buttons to place call letters in position.

NOTE: When placing call tabs in the buttons be sure to arrange them according to their frequency (kilocycles), that is: the station whose frequency is well within the range covered by the No. 1 button, should be placed in that button and so on with the rest of the buttons to be set.

SET-UP PROCEDURE

Remove station selector push button escutcheon. Turn the receiver on and let it operate for a sufficient length of time to permit the tubes to reach their normal operating conditions.

NOTE: To simplify the set up and insure accurate adjustments the following pre-adjustments should be made.

Tighten all Antenna Trimmer screws moderately tight. See Fig. 1. Turn the Oscillator adjusting screws to the left (counter clockwise) until the threaded portion extends approximately 1/2 inch.

NOTE: Care should be taken when adjusting the oscillator screws so that the selected station is not passed over. Turn the screws slowly. It is essential that the frequency (kilocycles) of the station selected is within the range of the push button to be set for that station. See Fig. 1.

1. Turn the band change switch to the "American" position. Using the station selector knob, carefully tune in the station to which the No. 1 push button is to be set. Note program.

2. Turn the band change switch to the "Automatic" position, depress No. 1 push button, and using a small screw driver, carefully turn in a clockwise direction the Oscillator adjusting screw until the station previously tuned in manually is heard again. Adjust for maximum output in the speaker.

3. Adjust the Antenna adjusting screw for maximum volume in the speaker.

4. Turn band change switch from "Automatic" to "American" and back again to check if adjustment has been correctly made. There should be no change in tone quality when switched from one to the other.

5. Repeat above procedure for the remaining push buttons.

To tune the receiver with the push buttons, set the band change switch on "Automatic" and depress completely the button corresponding to the station you wish to hear.

PHONO-CONNECTION

This receiver is so constructed as to be adaptable to a phonograph pickup (high impedance type) for the reproduction of recordings.

The connecting terminals provided on rear of chassis may also be used for the reproduction of "television" sound if proper converter unit is obtained.

INSTALLATION

Loosen but do not remove the four screws which hold the chassis on its shelf in the cabinet. The screws should only be loosened sufficiently to allow removal of the cardboard strips on which chassis rests during shipment. In its proper position the bottom of the chassis should clear the cabinet shelf by approximately 3/16 of an inch. It is intended that chassis "float" freely on the mounting springs provided, and care should be taken that no part of the chassis or dial touch the cabinet at any point.

Best results will not be obtained from receiver if it is located near large metal objects, such as metal partitions, radiators, etc.

BEAT FREQUENCIES

the Product of

AMPLITUDE MODULATION

P. WILSON REDCAY

The author explains the phenomena of "Beats"—how and why they are generated, and their effect on the operation of radio sets. Some of the angles discussed by the author are "adjacent station interference"—"high fidelity" receivers and "television."

AFTER a careful study of beat frequencies we find this to be a product of amplitude modulation. Upon examining the beat frequency audio oscillator Fig. 1A we find a fixed and a variable oscillator (for example 500 kc. and 490 kc.). Either one can be called a modulator and the other an oscillator. (See Fig. 1B.) The difference or side-band frequencies lie at a great distance apart, i.e., one side-band falls

within the audio frequencies (10 kc.) the other theoretically lies between the multiple of the signal and oscillator frequencies, or 990 kc. and carries a 20 kc. beat, as explained later.

During the first alternation of a complete cycle of the 10 kc. wave, known as the beat or lower side-band, the 500 kc. and the 490 kc. frequencies are "in phase" (0° to 180°) and increase in amplitude. During the sec-

ond or last alternation the 500 kc. and the 490 kc. frequency are "out of phase" (180° to 360°) reducing the amplitude to a minimum. The second or high frequency side-band is produced from a multiple of the oscillator and the modulator frequency as shown in Fig. 1C, which rises and falls in amplitude similar to the lower side-band, thus producing a 20 kc. modulation on the 990 kc. side-band frequency. This only occurs at 0° and 180°, i.e., when the 500 kc. and the 490 kc. voltages are "out of step" 90°, resulting in a rise in amplitude. (See Fig. 1C No. II.)

The accompanying diagrams show the circuit set-up and also the resultant effects when beat frequencies are produced. The beat frequency is that due to the difference in frequency between two waves or carriers.

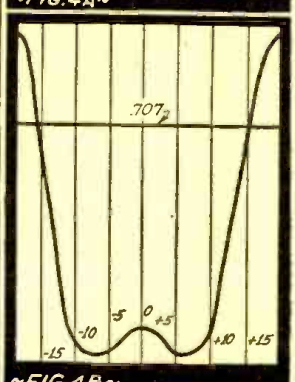
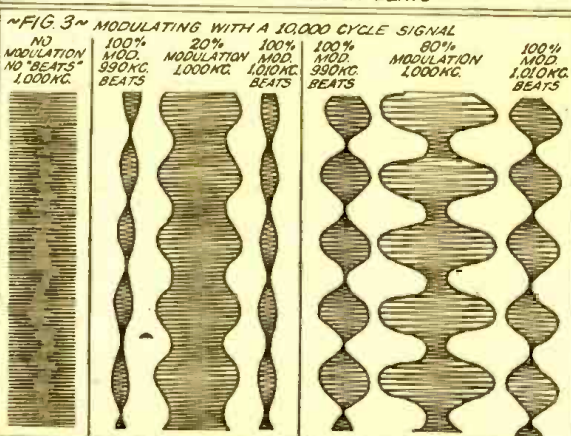
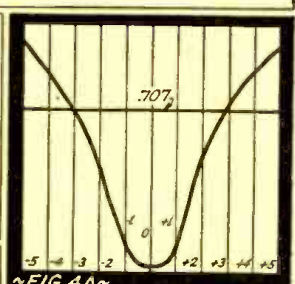
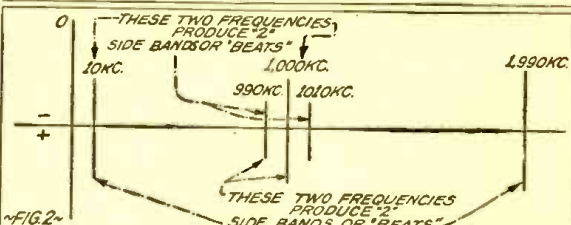
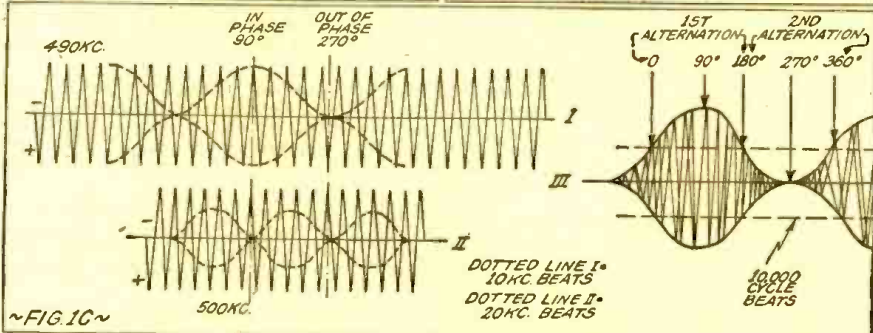
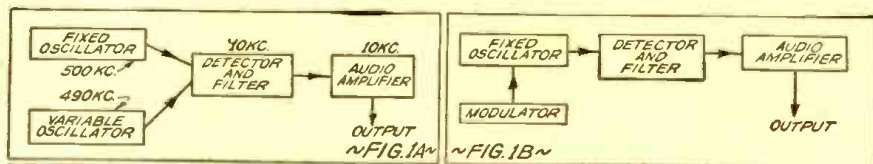

REVERSING THIS PROCESS

Let us reverse the process and use an audio signal of 10 kc. to modulate an oscillator of 1,000 kc. (Fig. 2). This will therefore produce a difference or "beat" at 990 kc. and 1010 kc. Theoretically these "beats" are side-bands as mentioned before, and only appear during the process of modulation, i.e., a form of carrier suppression or "ghost carrier" (see Fig. 3), and is caused by phase changes during modulation.

Suppose the 1,000 kc. carrier was modulated at a signal frequency of 5 kc. (5,000 cycles) and used a selective receiver of approximately 3 kc. to resonate the 1,000 kc. carrier (Fig. 4A). We find the 5 kc. signal greatly attenuated due to the high selectivity of the receiver. By adjusting the tuning of the receiver to approx. 1,005 kc. the carrier is side-banded and the receiver is in resonance with the 5 kc. "beat" or "ghost carrier" frequency and will amplify all frequencies in the vicinity of the 5 kc. "beat" frequency depending on the selectivity of the receiver. This, of course, will cause undesirable distortion at the receiver's output.

It might be well to mention here that these "beats" take the form of 100% modulation envelopes (See Fig. 3.), the amplitude depending directly on the percentage of modulation of the carrier.

ADJACENT STATION INTERFERENCE

If, while listening to a station at 1,010 kc. the adjacent station of 1,000 kc. modulates with a signal in excess of 5,000 cycles, such as bells, canaries, etc., the receiver listening to 1,010 kc. will receive these "ghost carriers" at a signal level depending directly on the modulation percentage of this signal on the 1,000 kc. carrier. These "ghost beats" after detection in the receiver, again modulate the 10 kc. heterodyne whistle which is the product of the two carriers causing intermodulation. $F_p - F_s = F_i$

- F_p Product of two carriers or 10 kc.
- F_s Signal "beats"
- F_i "Intermodulation" frequency

HIGH FIDELITY RECEIVERS

So as not to attenuate these higher signal frequencies or "beats," the receiver must be made less selective. Staggering the inter-

mediate frequency stages of a superheterodyne will broadly resonate these signal beats. If the receiver uses variable coupling, there will be two distinct resonant peaks (Fig. 4-b). These peaks rest 5 to 10 kc. off carrier frequency and broadly resonate the beat frequencies, and signal attenuation will take place over the .707 point. The center dip being slightly off resonance with the lower beat frequencies, will cause a slight attenuation of the "lows." With the receiver properly aligned in the "high fidelity" position, the peaks will resonate equally on each side-band, creating a proper phase balance.

TELEVISION

In television the video frequencies must be of equal intensity to effect a very clear picture. This can only be accomplished by using an intermediate frequency amplifier free of resonance peaks. These peaks in the I.F. amplifier will resonate the "beats," causing a higher amplification of certain signal frequencies and phase delaying others, causing phase distortion and resulting in poor contrast of image.

CONCLUSION

Whenever the modulation frequency is higher than the audible range, it enters the radio frequency spectrum and a different method of modulation is employed. Regardless of the type of amplitude modulation employed, "beats" are generated and these depend mainly on the strength and the frequency of the modulation signal.

SERVICE NOTES

STATION RIDING

The writer received a complaint of very bad station riding. In fact, it was impossible to receive one station without half a dozen other stations riding in. After trying every trick in the bag, a portable receiver was used to track down the interference. It was found on the next block from the customer's home where a new home was being constructed. At this point the station riding in the portable receiver was at its worst. The trouble was located accidentally. As the writer leaned against a fuse box on the tool shack, the trouble was cleared. On investigation, it was found that the conduit pipes leading to and from the box were fastened insecurely. One piece of the conduit was grounded, and the other was not. Not wishing to tamper with this temporary wiring, a ground clamp was fastened to each piece of conduit, and then wired together. Thus, a customer and a serviceman were made happy.—Leo G. Sands.

RCA U-45

Inoperative. All voltages very low. Candohm voltage divider shorting to chassis at high voltage end. The two sections on this end (2500 and 3000 ohms) may be replaced by separate resistors as the other two sections of the unit will not be affected and can still be used. This trouble seems almost inevitable on this model judging from my experience with them.

PHILCO 38-2

Inoperative. Plate and screen voltages low, positive voltage on grid of one of the 6F6G output tubes. Shorted or leaking .01 condenser from screen of one output tube to grid of the other. Replace with 600 volt unit instead of the 400 volt originally used. This condenser is sometimes the cause of intermittent reception.

RCA 45X1

Intermittent reception or inoperative. Defective 220 mmf. mica condenser from center terminal of volume control to ground.

SYLVAN SIGMUND

Radio Phone Links Islands with Mainland

Smith and Tangier Islands in Chesapeake Bay have had small fishing populations since Revolutionary days. Their point of contact with the mainland is Crisfield, a small Maryland town on the eastern shore of the Chesapeake some ten miles east of the islands. Crisfield is a railroad terminal, and here the island fishermen bring their catches for shipment to the large centers of population. Except for the fishing boats, the only means of communication with the islands has been a mail boat, which makes one trip a day. During the winter of 1938 and 1939 a severe freeze stopped all water traffic for several weeks, and unfortunate results of the lack of communication at this time led to the installation of emergency radio telephone service late in 1939. The demands placed on this service indicated that permanent and more adequate facilities were needed. As a result, the Bell Telephone Laboratories developed a special radio transmitting and receiving equipment, which was installed for the Chesapeake Bay service some months ago.

This new radio telephone equipment is designed for operation at the ultra-high frequencies—either between 30 and 40 or 156 and 162 megacycles. At these latter frequencies, which were chosen for the Chesapeake installation, the waves are short, about two meters long, and they travel in approximately straightline paths. There is little noise, and volume regulation is not required. The distances involved are short. From Crisfield to Smith and Tangier Islands, it is ten and thirteen miles respectively, and fifteen-watt transmitters are used. Since the volume of traffic expected is small, only a single channel to each island has been provided, and a single transmitter and receiver at Crisfield operates with either one of them. The present installation makes provision for a maximum of six telephones on each island. At Crisfield, the radio equipment connects with the local telephone switchboard, and connections to and from it may be established as desired.

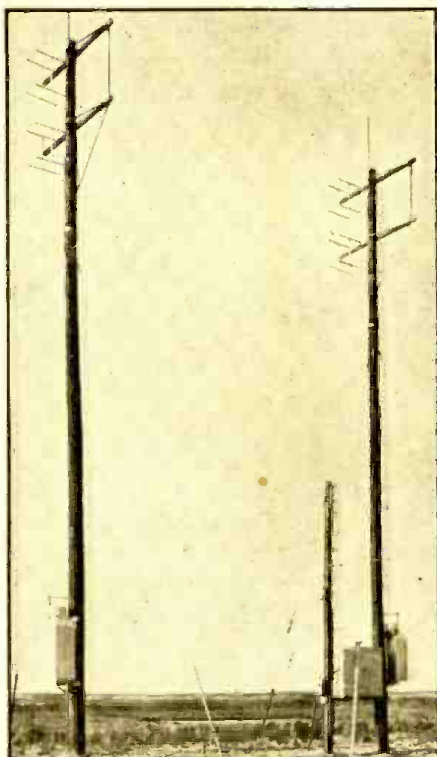

Note the ultra short wave aeriols on pole-tops.

TECHNICAL BULLETINS

Technical bulletins give reliable information in easy-to-follow form, and save valuable time otherwise spent in laborious reading of numerous books. Every subject is treated briefly and concisely, yet completely. No complicated mathematics, chemistry, electricity, or theory. Each bulletin is written in simple language.

PRICE \$1.00 EACH POSTPAID ORDER BY NUMBER

D-106—REWINDING ELECTRIC MOTORS.—Complete information, diagrams, sketches, tables, etc., to enable any shop man, mechanic, electrician, experimenter, etc., to rewind A.C. and D.C. motors and generators of all types.

D-118—ELECTRICAL PIPE THAWING EQUIPMENT.—Frozen water pipes quickly and safely thawed with this rugged high capacity outfit. Gives all details of construction for use on 25, 50 or 60 cycle alternating current, 110 or 220 volts.

D-110—ELECTROPLATING NON-METALLIC OBJECTS AND ELECTRO-FORMING.—How to prepare non-conducting material so that it can be electroplated with copper, nickel, chromium, gold, silver, zinc, cadmium, lead, etc. Complete instructions, simplified procedure, and formulas.

D-128—DIESEL ENGINES, OPERATION AND SERVICE.—Complete, easy-to-understand information about the Diesel engine. Explains operation and maintenance problems.

D-133—SPOT WELDER FOR THE SMALL SHOP.—Complete, easy-to-understand directions to build a 110-volt, 50- or 60-cycle A.C. spot welder for fastening light sheet metal. Shows how to make the welder adaptable for operation on 110- or 220-volt, 25-cycle current, or 220-volt, 50- or 60-cycle current.

D-144—CHOKO COILS EASILY MADE FOR A.C. CONTROL PURPOSES.—How to construct choke coils. How to determine size and amount of wire required, how to find the core size. Full details on assembly and coil winding.

D-102—CLEANING PRODUCTS FOR ALL PURPOSES.—Contains formulas for the manufacture of General Household Cleaners, Toilet-Bowl Cleaner, Paint-Brush Cleaner, Wallpaper Cleaner, Paint Cleaner, White Shoe Cleaner, Waterless Hand Cleaner, Window Glass-Cleaning and Rug Cleaner.

D-115—FLEXIBLE GLUE MOLDS FOR CASTING OBJECTS.—Contains practical working instructions for making flexible molds used in casting novelties, statuary, clock cases, etc., with plastic materials such as magnesite, dental plaster and cement.

D-127—SMALL ELECTRIC LIGHT PLANTS, DESIGN AND CONSTRUCTION.—Tells how to build small electric light plants for cottages, camps or country homes at small cost. Covers construction of a 110-volt system to light six 30-watt lamps, how to build a 6-volt system using an auto-generator, with or without a battery, and how to convert a Ford model "T" generator to a 110-volt, A.C. generator.

D-134—ELECTRICAL EXPERIMENTS WITH SIMPLE MATERIALS.—How anyone without previous knowledge can perform interesting experiments with simple, inexpensive materials.

D-148—DESIGNING AND USING ELECTRIC RELAYS.—Simple practical instructions for building, and using A.C. and D.C. relays; also thermo-electric relays. Includes relay control systems for motors and machinery.

TECHNIFAX

1917 S. STATE ST. (DEPT. 142) CHICAGO, ILL.

DEPT. 142

TECHNIFAX 1917 So. State, Chicago, Ill.

Enclosed find \$..... for which please send me postpaid the following Technical Bulletins:

Nos.

.....

Name

Street and Number

City and State



The photos herewith show the phonograph unit as designed and built by Mr. Tait, together with the crystal pickup and volume indicator. An interesting new wireless oscillator is described by the author, which permits records to be played through the receiver without direct connection. It is also possible to feed radio or microphone "pickup" into any receiver.



Dual-Purpose P. A. System

Part II

Andrew Tait

● THIS complete P.A. System has been described in part in the Sept. issue of this magazine. The finishing part describing the *Phonograph Unit* is herewith described.

On this unit is located the phonograph motor (see photograph), crystal pickup and chassis containing a broadcast tuner, auxiliary microphone channel, and a mystery wireless oscillator.

It is designed so that the tuner, mike and phono can be fed into the amplifier via the patch cord; or the entire phonograph unit can be used without the amplifier. This is accomplished by means of the mystery wireless oscillator, which feeds the mike, phono or tuner into any make radio. The patch cord is a shielded crystal microphone cable.

The *tuner* consists of one stage of tuned radio frequency with R.F. volume control feeding into a detector. The output of the detector in turn is fed, with the changeover switch in *Radio* position, to the audio volume control and hence to the patch cord and wireless oscillator. The patch cord feeds directly to the grid of the 6SF5 tube in the amplifier. This comprises the 3rd channel mixing in this tube. In effect, the line-up of the *tuner*, including the tubes in the amplifier is: 6SJ7GT R.F.; 6SK7GT Det.; 6SF5 A.F.; and 6L6G power stage. Signals of 2 to 3 volts can be fed to the amplifier by this tuner.

When the changeover switch is in *Microphone* position, the crystal micro-

The first part of this article, published in the Sept. number, described the amplifier for the P.A. System. This month the complete phonograph unit is discussed in detail; the "wireless oscillator" is also described.

phone is switched into the grid circuit of the 6SJ7GT detector in place of the tuned circuit, thereby converting it to a microphone preamplifier. The output of this is fed the same as before, to the patch cord and wireless oscillator through the volume control.

When the changeover switch is in *Phonograph* position *only* the crystal pickup is in the circuit, and the output of that goes in similar fashion to patch cord and wireless oscillator—via the *volume control*. From this it can be seen that the same volume control is used to control the volume of all three separate circuits.

This explains how the wireless oscillator can be used instead of the amplifier into any radio. It is actually on all the time—however a switch may be inserted in the B+ to the oscillator if it is desired not to have it on all the time. The wireless oscillator is very convenient in case you want to use it at a house party or dance, where the complete amplifier would be inconvenient and somewhat of a problem to set up.

The changeover switch is a 2-circuit, 3-position non-shorting snap switch.

"Wireless" Oscillator

The *mystery wireless oscillator* is not much of a mystery when you stop to analyze it. Actually it is a low-powered broadcast transmitter or a radio frequency oscillator, tunable to any place on the *broadcast* band on your radio. A multi-purpose tube is used for it, as it is designed for mixing two frequencies such as appear in super-heterodyne circuits. This tube is a 6A8GT. One section is made to oscillate at the broadcast frequency and into the other section the audio signal is injected. This audio signal, coming from the above described units, modulates the transmitter in similar fashion to a larger broadcast transmitter, and makes it possible to receive the speech or music over your radio.

The power-supply for phono unit is a low voltage supply, using a 25Z5 as a rectifier. All the tubes are in series with two 6 volt, 0.3 amp. pilot lamps and a 220 ohm line cord resistor. The line cord from the phono unit plugs into a convenient A.C. outlet located on the amplifier chassis, thus eliminating two A.C. lines to a wall plug.

The chassis for the above described unit was bent from a piece of scrap panel and measures 4" wide x 2" deep x 10" long. These dimensions are of course arbitrary with the builder. If he sees a few short-cuts or a better position to mount the unit, then by all means do it that way.

Phono Unit Cabinet

The entire phonograph unit is mounted in a 1/2" plywood portable case. The dimensions of the case are given in the sketch. Like the speaker cabinets described in the preceding installment, it was nailed and glued together and then stained and finished all over. Ordinary suitcase clasps were used as fasteners for the cover and a chrome handle was added, to help make it look nice and incidentally, to be able to carry it. A piano hinge was used on the back as the hinge. Rubber feet on the bottom and back help to keep the cabinet from becoming marred.

It was found that the output of the tuner was much greater when an antenna was used. A loop antenna can be used very satisfactorily in this case. This can be done by putting thumb-tacks a spaced distance from the corners of the inner side of the cover. Then wind cotton covered wire around them, securing the layers as you wind outwards, with more thumb-tacks. Another way of doing it is to mount a portable loop antenna in the cover. Space can be left in the cover in which to store records. This may be done by adding a few inches to the height of the cover. They may be secured by affixing a post to the center of the cover, so that the records may slip on and be secured with a thumbscrew.

The mounting board which holds all the units is 3/8" plywood and is screwed to corner pieces so that the board is flush with the sides. This means that 12" records and larger can be played with the cover open and 10" records with the cover closed.

Choice of Pickups

The FP-18 Crystal Pickup was chosen because of the exceptionally fine qualities it possesses. Tests showed the frequency response curve to be down a few db. at 8,000 cps. without the pickup being equalized. With equalization the curve is essentially flat to 8,000 cps. and down at 10,000 cps. The drop in output due to the equalizer makes it more desirable not to use it.

The low needle pressure, one ounce, and permanent sapphire point, makes this pickup desirable for those who worry about high needle pressure wearing out records.

The D9 crystal pickup was also used in this article. This is very popular because of its low cost and very good frequency characteristics. The output voltage for the D9 is higher than the FP-18; 1.4 volts against .85 volts. The choice of pickups is important to anyone who is anxious to get accurate reproduction of recordings.

The Shure Rocket Crystal Microphone was used with exceptional results. There is nothing better than a good crystal microphone to bring out the crispness of speech. This microphone has accurate reproduction of all frequencies between 30 and 10,000 cps.

A meter similar to the 411-P is an invaluable aid in building this outfit. Voltages, currents and resistance values can be readily checked with this 5,000 ohms-per-volt meter, causing but minute circuit disturbances. The output of the amplifier can be measured directly in db. or in A.C. volts by connecting across the 500 ohm line. To measure power output of the amplifier a 500-ohm, 25 watt resistor is con-

New SELF-BALANCING
DRIFT-CORRECTING

DIRECT-COUPLED AMPLIFIERS

FOR DISCRIMINATING MUSIC LOVERS

Designed by A. C. Shaney



These new amplifiers bridge the gap between the laboratory and the home, and make available for the first time, extraordinary equipment at less than ordinary prices. Built in a new way, without interstage coupling condensers or transformers. Although specifically designed to meet the strictest requirements of professional sound engineers, these direct-coupled amplifiers embody all desirable features sought by the most discriminating music lovers. Send for Literature.

AMPLIFIER CO. of AMERICA
17 W. 20TH STREET, NEW YORK, N. Y.

BOOK REVIEW

GASEOUS CONDUCTORS. by James Dillon Cobine (1941). Published by McGraw-Hill Book Company, New York, N. Y. Stiff cloth covers, size 6 1/2 x 9 1/4 ins., 606 pages, illustrated. Price \$5.50.

The subject matter presented may be divided into three parts. The first part discusses the physical concepts of the kinetic theory of gases, atomic structure, ionization, and emission phenomena, which are fundamental to an understanding of gaseous conduction. These fundamentals are treated in the first five chapters. The second part includes a study of space charge, breakdown of gases, and the characteristics of the spark, glow, and arc discharges.

Some of the chapter titles are: Motion of Ions and Electrons; Ionization and Deionization; Emis-

sion of Electrons and Ions by Solids; Electric Arc; Circuit Interruption; Gas-Discharge Rectifiers.

THE NEW ARMY OF THE UNITED STATES. Published by the War Department, Washington, D. C. Soft paper covers, size 8 x 10 1/2 ins., 141 pages.

All those interested in the general line-up and organization of the new United States Army will find this book very interesting and valuable. Copies of this book can be obtained by writing to the War Department, Washington, D. C.

Some of the chapter headings are: The Congress and the Army; The Command and General Staff School; the U. S. Army Air Force; the Corps of Engineers; The Signal Corps and its Work.

(Continued on page 351)

FREE!



with \$1.00 subscription
to
RADIO-CRAFT

**FULL
LIBRARY SIZE
MODERN
WEBSTER
DICTIONARY**

**416
PAGES**

CONTAINS:
22,000
DEFINITIONS

•
DICTIONARY OF
RADIO WORDS
AND TERMS

•
DICTIONARY OF
THE AUTO-
MOBILE

•
TABLES,
TREATISES, ETC.

FLEXIBLE
IMITATION
LEATHERETTE
COVER, SIZE 3 1/2" x 8"

If you will take advantage NOW of our special subscription offer of eight months for \$1.00, we will send you **ABSOLUTELY FREE** and **POST-PAID** this 416 page full library size **MODERN WEBSTER DICTIONARY**—useful and instructive to everyone. This self-pronouncing authoritative dictionary—a new work throughout—contains the most up-to-date words now in common use, 22,000 definitions in all. It also features a Glossary of Radio Words and Terms, Dictionary of the Automobile, Treatises on Practical Syntax, Etymology, Punctuation and Standard English by well known authorities, Metric Tables, Time, State Flowers, National Parks of the U. S., etc.

This is a time limited offer,
so don't delay in returning the Coupon.

RADIO-CRAFT
25 W. BROADWAY NEW YORK CITY

FILL OUT—MAIL THIS COUPON TODAY!

RADIO-CRAFT, 25 West Broadway, New York, N. Y.

This is a New Order Extend my present subscription

Gentlemen: Enclosed you will find One Dollar for which enter my subscription to **RADIO & TELEVISION Magazine** for Eight Months. Send me **ABSOLUTELY FREE** and **POST-PAID**, my copy of the **MODERN WEBSTER DICTIONARY**.

Name

Address

City State

RC 2-42

(Remit by check or money order; register letter if you send cash or unused U.S. Postage Stamps)

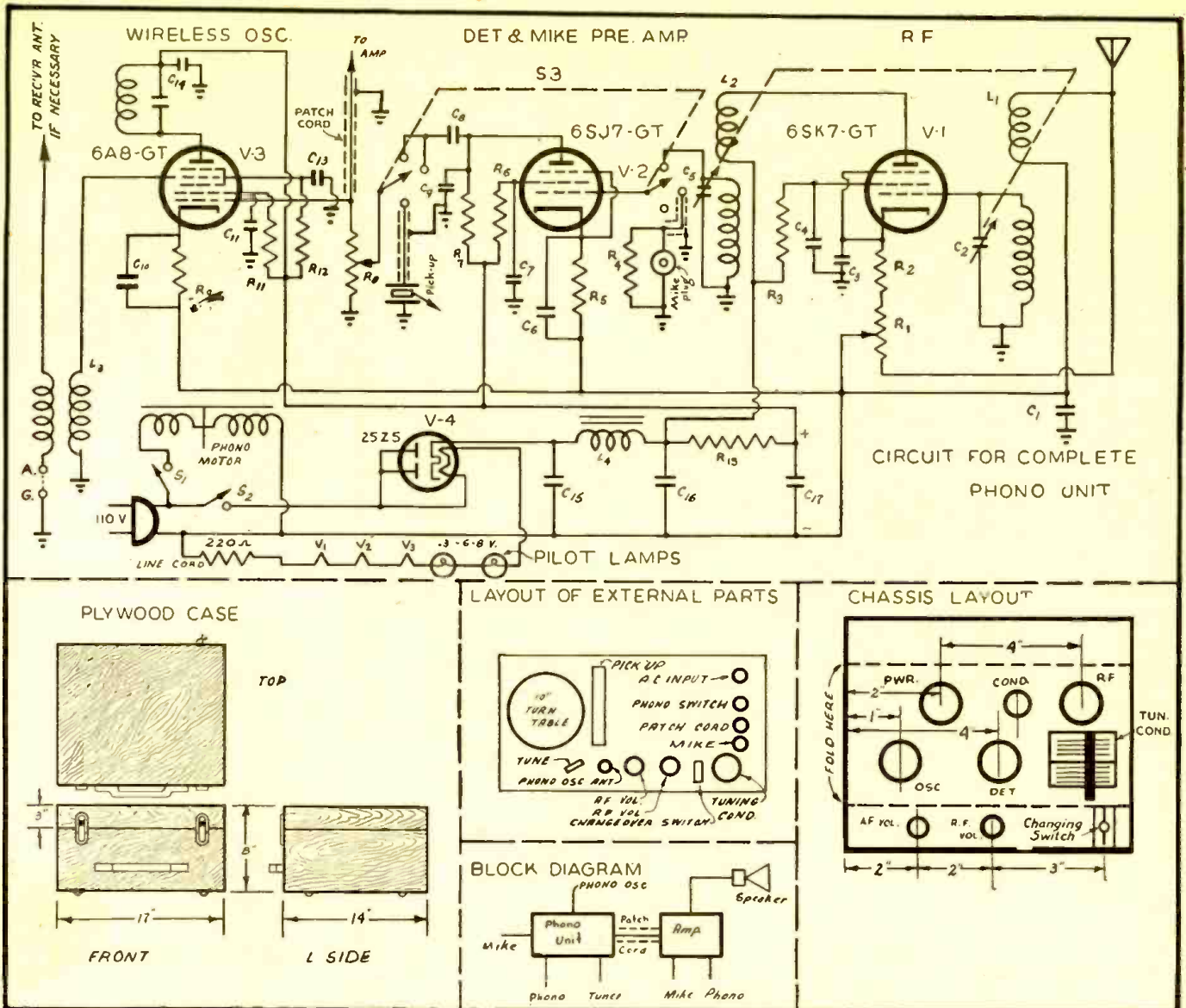

Above—diagram shows phonograph and wireless oscillator hook-up.

nected across the 500 ohm line and measurements are made with volume turned on and speakers disconnected.

To get the *frequency response* curve of the amplifier, a known input must be applied to the input of the amplifier. This input signal may come from a "standard frequency" record played by a pickup such as the FP-18, whose flat characteristics are known, or by another amplifier maintaining constant level for the different frequencies applied. The speakers are disconnected and the output of the amplifier measured with the meter across the 500 ohm line.

If the characteristics of the whole system are desired, the speakers should be connected and measurements made under the same conditions as before. The meter this time is connected across the voice coil tap that carries the speakers.

The idea of building everything including cabinets and chassis appealed to the author from several points of view; first, it is cheaper to build them yourself than to buy them ready made, and second, you can incorporate exactly the design you want without the trouble of tearing down and rebuilding other parts.

The fun and experience to be gained in building an outfit similar to this is entirely enough compensation for the work involved.

Parts List

RCA (Tubes)
V1—6SK7GT, V2—6SJ7GT, V3—6A8GT, V4—25Z5

THORDARSON ELEC. MFG. CO.
L4—T47C07 12 henry choke

BUD RADIO
1—#585-MS de luxe microphone stand
1—SW-1004 SPST toggle switch with plate

INTERNATIONAL RESISTANCE CO. (Resistors)
R1—50,000 ohms Type D Potentiometer (with switch)
R2—200 ohms Type BT½
R3—10,000 ohms Type BT½
R4—3 meg. Type BT½
R5—3000 ohms Type BT½
R6—1 meg. Type BT½
R7—100,000 ohms Type BT½
R8—500,000 ohms Type D Potentiometer
R9—200 ohms Type BT½
R10—3 meg. Type BT½
R11—25,000 ohms Type BT½
R12—10,000 ohms Type BT½
R13—20,000 ohms Type BT-1
S2—#41 switch (on back of R.F. Vol. Control)

CORNELL-DUBILIER CO. (Condensers)
C1—.1 mf. 200 v.
C3—.1 mf. 200 v.
C4—.1 mf. 200 v.
C6—25 mf. 25 v.
C7—.05 mf. 200 v.

C8—.01 mf. 200 v.
C9—.1 mf. 200 v.
C10—20 mf. 25 v.
C11—.05 mf. 200 v.
C12—100 mmf. mica
C13—.1 mf. 200 v.
C14—50 mmf. mica
C15—8 mf. 200 Wv.
C16—8 mf. 200 Wv.
C17—4 mf. 200 Wv.

MEISSNER MFG. CO. (Coils)
L1—14-1022 Ant. Coil
L2—14-1023 R.F. Coil
L3—17-9373 Phono Oscillator Coil
C2—C5. 21-5214 Compact tuning condenser. 2-gang. 365 mmf.
3—25-8223 bakelite bar knobs
1—23-8257 4" round dial

AMPHENOL
2—PC1M mike connectors
2—MC1F mike connectors
3—RS8 tube sockets
1—RS6 tube sockets

CENTRALAB
1—#1454 2-pole, 3-position, positive snap switch

RADIO CITY PRODUCTS
1—411P supertester

ASTATIC MICROPHONE
1—FP-18 crystal pickup (permanent sapphire)
1—D9 crystal pickup

SHURE BROS.
1—"Rocket" 705A "Ultra" crystal microphone

GENERAL INDUSTRIES
1—78RPM "Green Flyer" Model KX

A Simple Tone Equalizer

BOB STANG

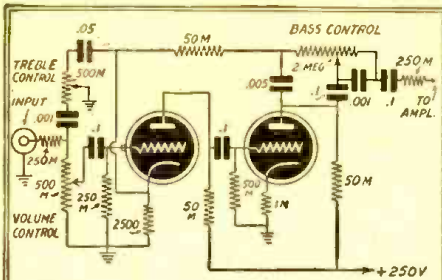

FIG. 1 M = THOUSAND

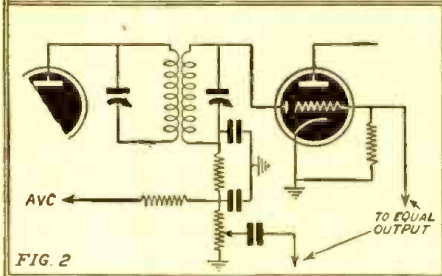

FIG. 2

Two circuits for a simple tone equalizer here described by Bob Stang.

EVERYONE knows that the frequency range of the human ear varies from one individual to the next. It is not as readily recognized that within its frequency limits the audibility curve of any particular ear will be a complex curve, dipping and peaking at any number of points, due to the acoustics of the ear chamber. It follows therefore that given a number of persons, all of whose frequency hearing limits are coincidentally the same, they still will not find equally pleasant any musical reproduction you may provide, even though the frequency range of your receiver is in excess of that of the listeners, and its amplitude response is measurably flat throughout its range.

It is very discouraging to the radio enthusiast to eventually achieve what he fondly believes is a state of perfection, in

the fidelity response of his receiver or phono amplifier, only to find that some critical listeners will claim there is *too much bass*, while others—equally critical—will insist that there is *exaggerated treble!*

Fortunately the problem is not as complicated as it may sound. If it were not for the latitude of the human ear, it might have been necessary to provide a multitude of variables, so that the very response curve of the audio amplifier could be varied to suit individual taste. As things are, if a means of individually varying the relative amplitude of bass and treble is provided, a satisfactory relationship can be attained to meet anyone's taste.

The *tone-control* method is not entirely satisfactory because it merely provides attenuation of the treble. The so-called bass setting is just what would be had if the tone control weren't in the circuit at all. The *tone equalizer*, on the other hand, provides independent amplification of highs and lows—variable at will. A frequency network generally separates highs and lows which are then amplified separately, re-mixed and fed into the amplifier proper. By varying the bass and treble controls, any relationship of bass and treble can be had, even to the complete exclusion of either frequency extreme.

A simple equalizer is diagrammed here. This device can be built on a small chassis and used in conjunction with any set or amplifier. Its power can easily be supplied by the set, since it only requires 6.3 volts at .3 amps. and about 250 volts at 6.5 mils of plate current.

Where it is desired to use it with a complete set, which incorporates its own amplifier, the output of the second detector can be fed directly into the equalizer and its output in turn fed back into the first amplifier of the audio portion of the set. For a typical arrangement of this type, see Fig. 2. There are no special precautions to be taken in wiring the equalizer, except to use shielded wire for both the input and output leads, and to use a tube shield around the 6C8G.

Flashlight Shell Makes a Good Microphone Case

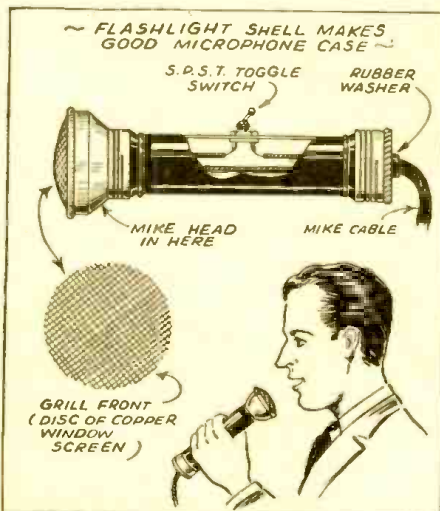

A simple microphone case made from a flashlight shell.

• A LOCAL radio amateur had a microphone unit but no suitable mount for it. He looked around and found an old flashlight shell and proceeded to put the two together, as shown.

The batteries, reflector, bulb and lens were removed so the shell was entirely stripped. Then the diaphragm of the mike was cut to fit where the lens formerly went and was fastened securely in place of the lens by two cardboard rings, one each side, and the flashlight head screwed on.

A hole was drilled in the center of the rear flashlight cover for the mike cable. Then one side of the cable was cut and attached to the contacts of a SPST toggle switch fitted in the light barrel as shown. A grille of copper screen wire was then cut out and soldered inside the light head and the latter then threaded back in place.

It made a fine mike for portable use and is worth copying.—L. B. Robbins.

Save money at PUBLIC ADDRESS HEADQUARTERS



RADOLEK Sound Systems for Every Requirement

Come to Radolek — Public Address Headquarters—where you get more for your money in Performance, Styling, Dependability and Reserve Power. Radolek Deluxe PA Sound Systems, in 15, 30, 50 and 100 watt sizes, incorporate every desirable feature—multiple input channels, built-in input and mixer controls, AVC, "feedback" tone control circuit, output impedance selection, electronic mixing system—all engineered for plus performance. Models for permanent, portable or mobile use. Wide choice of microphones, speakers and related apparatus.

Get the Best at Lowest Cost

Radolek's modern direct policy and volume sales on every amplifier design make it possible for you to get the finest, most modern equipment at rock bottom prices. Thousands of successful Radolek PA installations are proof of quality, dependability and top performance. Send the coupon today for complete information!

EVERYTHING NEW IN RADIO

Radolek stocks every replacement part to repair any radio—every type of tube—everything for auto radio installations, transfer and repair.



FREE!

RADOLEK'S RADIO SERVICE GUIDE



Contains hundreds of up-to-the-minute service items, test equipment, sound apparatus, etc. at lowest prices. Indispensable to every serviceman, dealer and sound engineer. Radolek gives you what you want when you need it. Send for your copy of this great new Radolek catalog today!

Large Stocks - Fast Service

SEND TODAY! PASTE ON A POST CARD

RADOLEK CO., Dept. G-62
601 W. Randolph St., Chicago, Ill.

Please send information on Radolek Public Address Equipment—also the Big Radio Service Guide.

Name _____

Address _____

Dealer Serviceman Sound Eng.

What You Should Know About

AMPLIFIERS

WESLEY SCHMITT

A discussion of the fundamental information necessary in determining the capabilities of an Audio Amplifier, and how its qualities may be analyzed from the material presented in technical data given by the manufacturer.

EVERYONE who sells, builds, or experiments with audio-equipment should have an understanding of the information given in technical descriptions, and a knowledge of the way in which manufacturers arrive at their conclusions. This will aid greatly in determining the merits of a particular amplifier and its desirability for the job it must do. It is well to remember that to arrive at accurate decisions there should be at hand complete and honest statements of power rating, distortion content, frequency response, hum-level, gain, and types of input and output. Two samples of technical material are shown in Fig. 1 and while both are composite and represent no particular brand they do give an idea of the variation in information that is supplied by manufacturers. One gives only part of the necessary material while the other gives a good idea of the performance to be expected from the amplifier.

AMPLIFIER RATINGS

Manufacturers arrive at the advertised power output of their amplifiers in various ways, and allow varying amounts of distortion at the total power output. It would,

Fig. 2, these curves show the latitude in amplifier ratings, where distortion is not considered. The useful power in some cases is considerably below the rated power.

Fig. 3, test equipment considered adequate for accurate measurements.

Fig. 4, heavy vertical lines indicate the variation in frequency response that can occur under a rating of plus or minus two decibels.

Fig. 5, Oscilloscope patterns of various wave forms that indicate a poor output transformer.

Fig. 6, The wave form at A, is an indication of parasitics when it occurs at the higher frequencies. B and C are sine waves, but in C the tips are cut off to show the form taken when an amplifier is driven to the limit of its possible power output.

therefore, be much easier for the purchaser to make an accurate comparison between amplifiers if he had on hand equipment to make measurements on all amplifiers in the same manner. Curves of several commercial amplifiers are given in Fig. 2. All curves were accurately taken with standard test equipment capable of measuring the harmonic distortion, of which seven percent was allowed at all frequencies. These amplifiers would all deliver at some frequency their rated output if the amount of distortion were disregarded.

The common practice is to make all amplifier test measurements with the load a resistance, instead of a speaker or inductive load. This method is both fast and practical, and if all measurements are made in an accurate manner the results will give a good indication of the results to be expected. However, all measurements should be made in every case with the volume controls full on and the amplifier driven to full rated

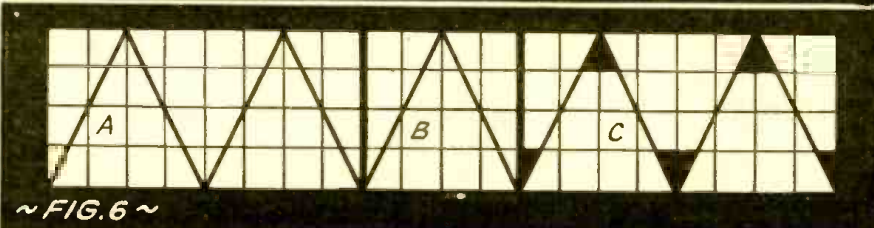
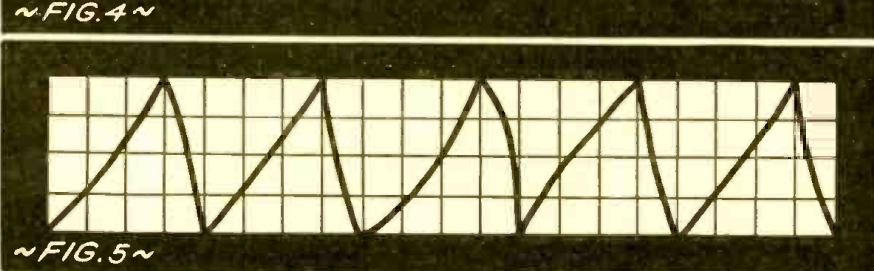
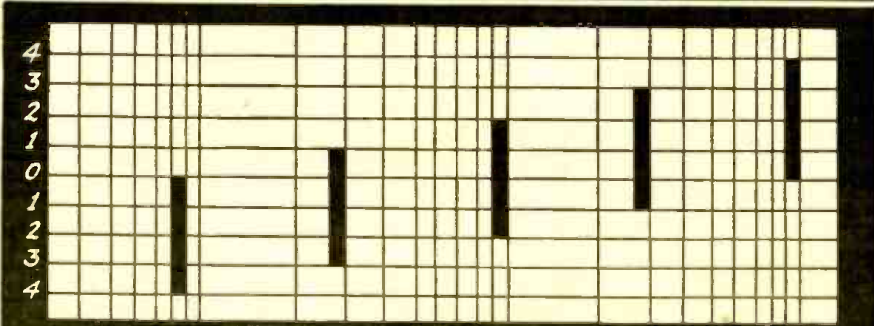
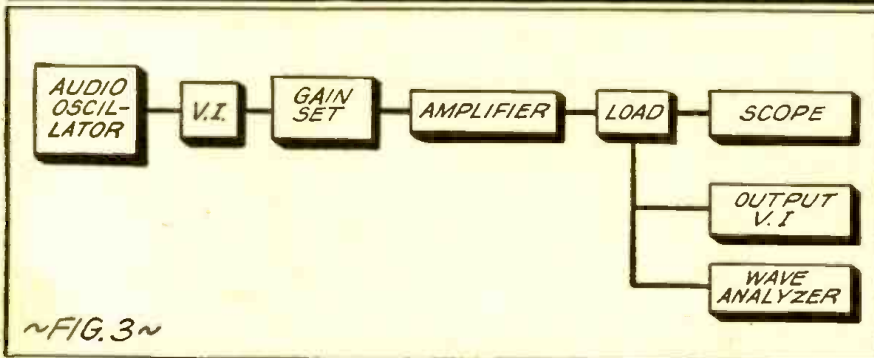
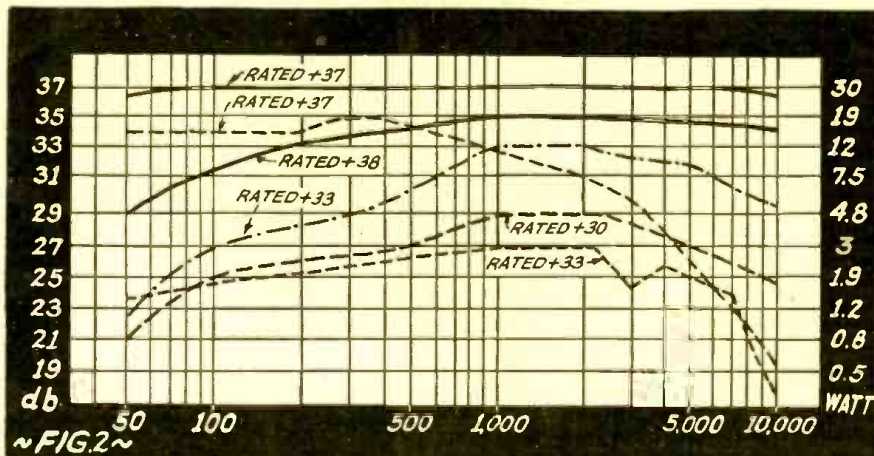

Fig. 1

TECHNICAL DATA 1

Power output—10 Watts with 3.7% distortion
 Inputs—Two high impedance. One for microphone and one for crystal pick-up.
 Output impedances—4.8-15-125-250-500 Ohms.
 Frequency response—Within 1 db. from 50 to 10,000 cycles.
 Gain—Microphone, 108 db. Pick-up, 70 db.
 Hum level—64 db. below full rated output.
 Tubes—Type 6F5G, 6C8G, 6A3, 5Z3.
 Power consumption—235 Watts, 50 or 60 cycle, 115 volts.
 Four stage, Class A, with push-pull output.

TECHNICAL DATA 2

Power output—15 to 18 watts with a minimum of distortion.
 Inputs—Two high impedance. One for microphone and one for phonograph.
 Output impedances—Line and voice-coil.
 Gain—Microphone 114 db. Phono 62 db.
 Hum level—Negligible at full output.
 Tubes—Type 6J7, 6N7, 6L6, 5Z3.
 Power required—50 or 60 cycle, 115 volts.
 Coverage—2000 to 3000 people.

output. If the full rated power cannot be attained without an excess of distortion then the amplifier is overrated and should have been rated where the distortion is nominal. Fig. 3 shows a block diagram of test equipment in a very acceptable set-up for making measurements.

Since there has not been established any standard of measurement for audio-amplifiers and since it is impossible for everyone who uses this type of equipment to possess measuring devices, it is necessary in many instances to depend on the honesty of the manufacturer, and to gather as much information as possible from the material presented.

LIMITING FACTORS

Every amplifier is designed and built for the purpose of increasing the volume of frequencies in the audio range so that they may be heard as desired from one or more reproducing devices. The final result should always be the true reproduction of the original sound with no frequencies added and none of the original frequencies missing. While the ideal as yet cannot be reached the result can be made to satisfy even the most critical listener. All of the factors that are discussed in the following paragraphs contribute to the naturalness of reproduction and to the pleasure of the listener.

GAIN

The gain through an amplifier is partially dependent upon the type of input device being used on the grid of the input tube. A transformer with a high turns ratio will develop a greater voltage on the input grid than a transformer of a lower turns ratio. By the same token, when a resistance is used on the input grid, the gain will increase as the resistance is made larger. When an amplifier is put to actual use the gain may not be as great as supposed if the microphone or pick-up used has a lower impedance than the resistance connected to the input grid. The two are loads on the ends of a line and any mismatch will cause a loss of gain; and in some cases will affect the frequency response. The gain in some instances may be increased by the use of a very high resistance but in combination with a high gain in the input tube the amplifier will tend to be unstable, and liable to regenerative oscillation when the volume control is turned full on. Division of gain as equally as possible throughout all stages results in a more stable condition than the concentration of gain in a single stage.

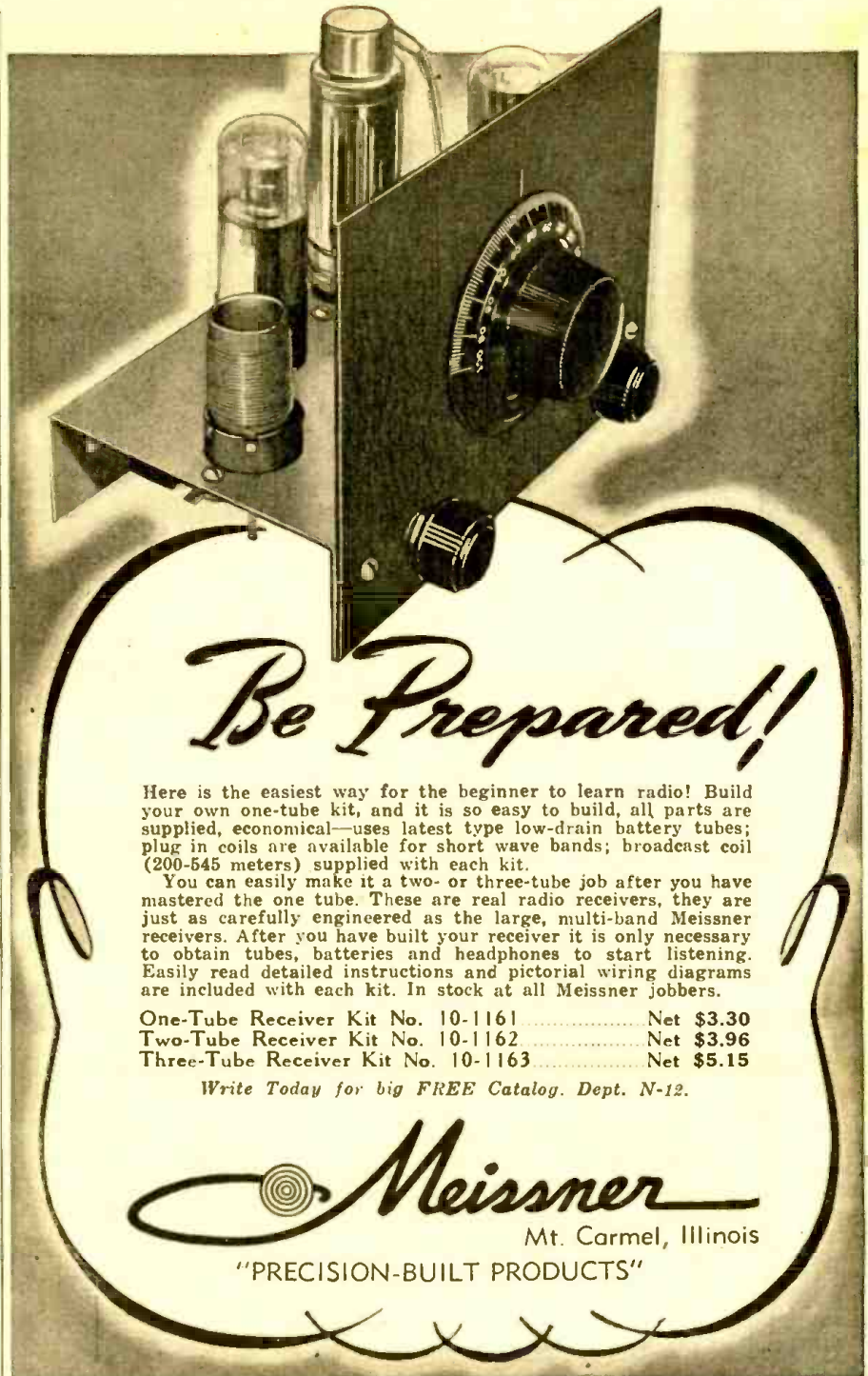

Be Prepared!

Here is the easiest way for the beginner to learn radio! Build your own one-tube kit, and it is so easy to build, all parts are supplied, economical—uses latest type low-drain battery tubes; plug in coils are available for short wave bands; broadcast coil (200-545 meters) supplied with each kit.

You can easily make it a two- or three-tube job after you have mastered the one tube. These are real radio receivers, they are just as carefully engineered as the large, multi-band Meissner receivers. After you have built your receiver it is only necessary to obtain tubes, batteries and headphones to start listening. Easily read detailed instructions and pictorial wiring diagrams are included with each kit. In stock at all Meissner jobbers.

One-Tube Receiver Kit No. 10-1161	Net \$3.30
Two-Tube Receiver Kit No. 10-1162	Net \$3.96
Three-Tube Receiver Kit No. 10-1163	Net \$5.15

Write Today for big FREE Catalog. Dept. N-12.

Meissner
 Mt. Carmel, Illinois
 "PRECISION-BUILT PRODUCTS"

Order your copy NOW—the only

P. A. HANDBOOK



THAT no book has yet been published which covers amplifiers and sound systems (also kindred systems), in one complete, authentic volume is almost unbelievable. Yet, it is a fact, there is no book in print which covers Public Address from A to Z.

Only 25 Cents a Copy

A MATCHLESS VOLUME
 As complete as you would expect to find any engineering handbook—this is how the radio or P. A. man finds the **AMPLIFIER HANDBOOK AND PUBLIC ADDRESS GUIDE**. With essential technical data compiled from an exceptionally large number of sources, the volume covers nearly a hundred different subjects coordinating every conceivable branch or sub-division of Public Address.

Send me others, for friends, also POSTPAID @ 25c each.

Name

City State

Remit by check or money order; register letter if you send cash or unused U.S. Postage Stamps.

**DISPOSAL SALE
AMPLIFIERS & PARTS**

THIS sale comprises parts used in the construction of Juke-Boxes; made by well known amplifier manufacturers such as: Rauland and Operadio. All equipment is reconditioned and in perfect mechanical and electrical condition.

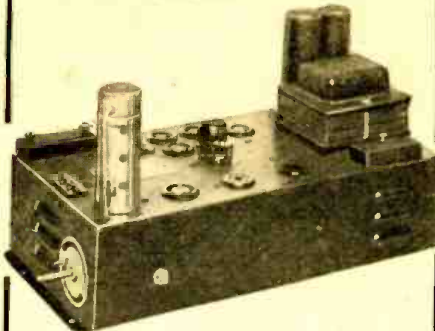

12 WATT PUSH-PULL 2A3 AMPLIFIER
Tube complement 2-2A3, 1-5B, 1-57 and 1-5Z3. To be used with one or two 2500 ohm dynamic speakers 16 ohm voice coil. May be changed over to use P.M. speakers. Input for magnetic pickup. Variable tone control. Schematic furnished to change unit over to use crystal pickup, crystal microphone and P.M. speakers.
Shipping Weight 25 lbs. \$7.95

15 WATT PUSH-PULL 6B5 AMPLIFIER
Tube complement 2-6B5, 1-6A6, 1-76 and 1-5Z3. To be used with one or two 2500 ohm dynamic speakers 16 ohm voice coil. May be changed over to use P.M. speakers. Input for magnetic pickup. Variable tone control. Schematic furnished to change unit over to use crystal pickup, crystal microphone and P.M. speakers.
Shipping Weight 22 lbs. \$8.95

30 WATT PUSH-PULL 6L6 AMPLIFIER
Tube complement 2-6L6, 1-6A6, 1-6C6, 1-5Z3. amplifier as is, has input for magnetic pickup, volume control, variable tone control. Supplies field current to one or two 2500 ohm dynamic speakers, output impedance 2.6, 3.2, 4, 5.3, 8, and 16 ohms. Full 30 watts output. Schematic furnished to change unit over to use crystal pickup and crystal, dynamic or velocity microphone and change over to use P.M. speakers.
Shipping Weight 25 lbs. \$10.95

All Amplifiers Less Tubes & Speakers.



**JENSEN 10 INCH
ELECTRO-DYNAMIC
SPEAKER**
2500 OHM
FIELD
16 OHM
VOICE-COIL
EACH \$2.69
Shipping Weight 7 lbs.

**R.C.A. MAGNETIC
PICK-UP HEAD**
IMPEDANCE 3000 OHMS
Ship. weight 1 lb. **EACH \$1.89**



**NATIONALLY ADVERTISED TUBES
(in sleeves)**

6L6G	6N7	56
6B5	53	57
2A3	6A6	6C6
		76
		5Z3
Each .49	Each .30	Each .25

Ship. weight ea. 8 oz. Additional tubes 4 oz. ea.

ORDERS SHIPPED SAME DAY AS RECEIVED. All goods are sent Express collect if no money for Parcel Post is included in remittance. Customers in Foreign countries are requested to remit in U. S. currency or International Money Orders and include enough money to ship goods prepaid. Order from this ad.

**PEERLESS RADIO
AND SOUND CORP.**

25 S. JEFFERSON ST., Dept. 142 CHICAGO, ILL.

FREQUENCY RESPONSE

The frequency response of an amplifier gives many clues as to performance under actual working conditions. Manufacturers are more and more making a definite statement of the frequency response instead of just mentioning that it is from 50 to 10,000 cycles, or neglecting to refer to it in any way. To be of any value there must be a limit set on the peaks or dips that may occur at any frequency, and to show the variation from a straight line at full rated power if they desire to give essential and complete information.

The frequency response may be shown plus or minus two decibels from 50 to 10,000 cycles, and when this is translated into power in watts lost, its meaning becomes all the more easily understood. Plus or minus two decibels actually means that any frequency can be two decibels below the rated output while any other frequency can be two decibels above the rated output; or, when there is no variation above the rated output that any group of frequencies can be four decibels below, because plus or minus two permits a total variation of four. Fig. 4 shows the latitude given in this type of rating which allows the frequency response to take any form as long as the variation is no greater than that indicated.

**POWER LOSS FROM FREQUENCY
DISCRIMINATION**

As an example of the meaning in watts that a variation of plus or minus two decibels allows, an amplifier may be used that is designed and built to deliver thirty watts of power with an allowable percentage of distortion. It cannot have a peak of even one decibel without introducing a prohibitive amount of distortion at that peak, and so the two decibels would be of no use. Two decibels above thirty watts is plus thirty-nine decibels, or forty-seven and six-tenths watts. This leads to the conclusion, that since the power rating has been established, all the power above that must be distortion and of no value. When the amplifier is driven to full output there will be seventeen and six-tenths watts of distortion at whatever frequencies the peak occurs. Now, if the peak is moved down to thirty watts it is necessary that all other frequencies be moved two decibels lower since the original design established a fixed relation between any two or more frequencies. Two decibels below thirty watts is plus thirty-five decibels, or nineteen watts; and there is a loss of eleven watts at every point except at the peak. Therefore, reducing the power output does not help, due to the peak always being reproduced with approximately one-third more power than any other frequencies. Sound reproduction within that range will be unnatural.

Another situation is the one where any group of frequencies may fall four decibels below the rated output. Four decibels below thirty watts is plus thirty-three, or twelve watts; and at one or more frequencies the amplifier will deliver to a reproducing device only forty percent of its rated output. It will be evident that the more nearly equal the power output for all frequencies the more natural the reproduced sound will be.

ACOUSTICAL FEEDBACK AND PEAKS

The effect of response peaks upon acoustical feedback is a reaction that is seldom considered. Many installations would be much more successful if the gain through the amplifier could be raised to a point where the performer did not have to work with his face buried in the microphone. Care in the placing of speakers and microphones will alleviate this to some extent; but if the resonance point of the room and the ampli-

fier peak are in the same range the result will be very troublesome.

Acoustical feedback is produced by a circulation of energy between the speakers and microphones, and audio-howl will develop at whatever frequency first builds up enough energy to cause sustained oscillations. Peaks will be above all other frequencies and feedback will start as soon as the peak frequencies develop enough energy to sustain themselves. The gain may be turned higher on an amplifier with a flat response before feedback starts, and this added gain many times will make it possible for the performer to work at a comfortable distance from the microphone.

Tone controls of the high frequency cut-off type are quite common, and thought by many to be helpful in the control of amplifier peaks and acoustical problems. If the action of a tone control is studied it can be seen that lowering the high tone response in this manner only covers one difficulty to cause another just as detrimental. Amplifier and acoustical peaks are within a narrow band and quite sharp, while the tone control because of its circuit acts over a wide band with the drop usually starting around one-thousand cycles; the amount of loss continually increasing as the frequencies rise. The result is speech that is boomy and hard to understand.

HARMONIC DISTORTION

Some manufacturers specify the amount of distortion that is tolerated at full power output of their amplifiers and others do not make any note of it. This information is very important if an intelligent analysis of an amplifier's expected performance is to be made. An amplifier could be rated at the limit of the tube capacity which would be a true rating as far as power is concerned, but the distortion at that rating would be well over any tolerable limit.

Since audio-amplifiers are tested on a resistive load it must be remembered that the distortion content shown will be less than the amount encountered when the amplifier is working into an inductive load, which changes its impedance rapidly with frequency. The output tubes are working into a constantly changing load that may vary far above and below the optimum value; due, of course, to the fact that a transformer reflects on the primary side proportionately whatever is on the secondary side, in this case the secondary load being the speaker.

At low frequencies, so necessary in the reproduction of music, this reflected load may be far below the specified impedance and the distortion content at loud volume will be high. This is particularly true of output transformers that are built with too little, or else a poor grade of iron. Wave forms are shown in Fig. 5.

HUM LEVEL

A high hum level is too often accepted as a necessary evil in audio-amplifiers and tolerated, whereas one of the design factors should be the elimination of this annoyance. Hum, in the main, is due to one of the following causes; poor filtering, inductive pick-up, or chassis and ground loops. Poor filtering is the result of a deficiency of capacity, inductance, or resistance where resistance is used for decoupling and filter. A lack of filter and decoupling will also cause motor-boating and instability due to interaction between circuits.

Inductive hum is caused by insufficient shielding, poor layout and crowding of parts within the amplifier. High inductance in chokes frequently is the cause of hum and the only cure is to move the offending part completely off the chassis and connect it by remote leads. This is especially true of

chokes used for equalization and the correction of frequency response.

Ground and chassis loops result from a potential difference between points where the ground connections are made, and can usually be identified by the hum sound that comes from the speaker, which is that of sixty cycle A.C. Usually it is necessary to hunt and try until a neutral grounding point can be found.

When hum is due to causes in the stages ahead of the volume control, the hum will decrease as the volume is turned down, but if it is caused by defects following the volume control it will be much more evident at low volume. This is, of course, evident since in the second case the hum content is constant while the sound output is decreased at the lower volume settings.

Hum is very annoying in the reproduction of music where a resonant type equalizer is used to compensate for bass lost in recording. The reason for this being that the equalizer cannot differentiate between sixty cycle hum and sixty cycle bass; and they are both increased equally.

COVERAGE

Statements are often made that an amplifier with a definite rated output will provide sufficient acoustical output for the coverage of a certain number of people. This is dependent upon a number of things, among which are: indoors; noise level, area to be covered, amount of sound absorption, and the type of coverage wanted. These all affect the power needed out of doors and in addition there is the effect of wind direction noise from outside sources. There is another factor that is frequently overlooked; that is the *speaker efficiency*, which determines the amount of electrical energy that will be converted into usable acoustical energy.

ADDITIONAL SPECIFICATIONS

There are other technical specifications that would be very helpful if they were at hand. Oscilloscope patterns of the wave form at various frequencies would help to give an insight into the amplifier's performance. Fig. 6 shows that wave forms can be of great value when they are interpreted correctly.

Volume controls should be of such value, that they can be turned full on, with no input devices connected, without the amplifier breaking into oscillation.

Manufacturers are always willing to supply information relative to their products if it is desired, and are always happy to help the purchaser in every way possible to make the best possible installation.

TECHNICAL REVIEW OF CATALOGS, ETC.

Amateur Radio—A Beginner's Guide.—Price 50c. Written especially for the amateur radio beginner, this guide-book contains all the information necessary to become a full-fledged amateur and includes plans, photos, diagrams, etc., for the actual construction of a complete rig to go on the air.

The reader is first introduced to amateur radio. Fundamental theory is then presented, and actual construction is begun on the first necessary piece of apparatus, the code oscillator. This leads to and includes the building of a receiver, crystal oscillator transmitter, two-stage transmitter and other amateur equipment. The book is clearly written and the reader without any previous radio experience should have no difficulty in passing his examination and building his own equipment.

This is an excellent reference book for both the beginner and experienced operator, for it contains information on the various parts and purposes of amateur equipment, symbols, list of Q signals, helpful hints, etc. Advanced amateurs will welcome the book for its wealth of information on amateur radio theory.—(Thordarson Electric Mfg. Co.)

BOOK REVIEW

(Continued from page 345)

FUNDAMENTALS OF VACUUM TUBES. by Austin V. Eastman, M.S. Cloth covers, size 6 1/2 x 9 1/4 inches, 584 pages, illustrated. Published by McGraw-Hill Book Co., New York, N. Y.

This book will prove valuable to all those interested in the basic application of vacuum tubes to radio circuits, the practical aspects of the tube at work, rather than an exhaustive investigation of the molecular action occurring in the tube is given. Such interesting topics as rectifier action, characteristic curves of typical tubes, amplification of alternating currents, phase relations in an amplifier, pentagrid converters, hot cathode mercury vapor tubes, tungar tubes, etc., are dealt with in a complete and practical manner.

Other subjects which make the book extremely valuable are—selenium cell, copper oxide cells, cathode-ray tubes, cold-cathode tubes, special tubes for television, the half-wave rectifier, full-wave rectifiers, minimum inductance for rectifier filters, complete rectifier design, circuits for mercury arc rectifiers, operation of mechanical relays, inverters, resistance and transformer-coupled amplifiers, volume control, effect and reasons for distortion, push-pull, and regeneration action analysis, feed-back amplifiers, neutralization, class A, B, and C amplifiers, frequency stability, modulators and demodulators.

THEORY OF GASEOUS CONDUCTION AND ELECTRONICS. by Frederick A. Maxfield, Ph.D., and R. Ralph Benedict, M.S. Cloth covers, size 6 1/2 x 9 1/4 inches, 484 pages, illustrated. Published by McGraw-Hill Book Co., New York, N. Y.

The vacuum tube is so important today in the fields of radio that too much cannot be written on the physics of these electronic devices. These two experts here delve deep into the theory of what makes an electronics tube behave as it does. Not only do they discuss thoroughly the basic action in high vacuum conduction devices, but also the theory and application of corona, sparking, glows and arcs. Stress is placed upon the scientific principles involved in the conduction of electricity through gases, rather than upon specific applications of certain types of apparatus. The involved mathematics of the action taking place in the movements of molecules in gases are discussed, as well as conduction processes, electron emission, deionizing, production of ions in the gas, the physics of the glow discharge and the arc discharge.

The text is illustrated with plenty of diagrams, but it is assumed that the reader has a knowledge of mathematics, including the calculus. The pure science and the mathematical reason why the electron ray in such devices as the cathode ray tube, acts as it does is fully explained. Television students will find important the section on focussing of electron beams, anode beams and a section on television tubes—including the iconoscope. Practical electron emitters are explained, also applications of the diode, the high vacuum triode, photo tubes and their application, diffusion, corona on wires in air, the glow discharge, the negative glow, the vacuum switch, the arc discharge, arc oscillators, extinction of arcs, circuit interrupters, mercury arc rectifiers, the phanotron, the thyatron, the ignitron, inverters and gaseous discharge tubes.

Allied's Radio Builders Handbook.—Among the interesting general topics covered in this book are—What Kind of Set Shall I Build First? How to Read Schematic Diagrams; Some Theoretical Background, Including the Electron Theory, Resistance, Magnetism, Inductance, and Reactance, etc. Other important chapters cover—How to Punch and Drill Chassis Bases; The Antenna and Ground; Some Information Concerning Radio Tubes; Coils and Coil-Winders; The Amateur Radio Code; Resistor Color Code Guide. Some of the sets described include a Knight 2-Tube "DX-ER," an AC-DC Receiver, a 5-Tube Communications Receiver, a 20-Watt Bread-board Transmitter, a 4-Watt Amplifier, a Crystal Set, Code Practice Oscillator, Photo-Cell Relay, 3 Tube Phono Oscillator.—(Allied Radio Corporation, Chicago, Ill.)

Meissner "How-to-Build" Instruction Manual, New Edition.—Price 50c. This very useful Manual should be on the library shelf of every set-builder and experimenter. Every conceivable type of receiver and converter is described and illustrated with large clear diagrams, including physical drawings which can be understood by anyone. Instructions are given with each diagram, so that even a young experimenter who has not built many sets can construct one of the attractive receivers, phonograph oscillators, etc., described. The Meissner "Analyst" is described, with a lengthy chapter on how to make tests with it. Other attractive construction articles which appear in this Manual are—High-Fidelity P.A. Tuner, 3-Tube Midset Receiver, 4-Tube AC/DC T.R.F. Receiver, 7-Tube Broadcast, Long-Wave and Short-Wave Receiver, 8-Tube Combination Receiver, etc. Information and diagrams are given on Frequency Modulation reception and a description of the Meissner combination FM/AM Receiver.—(Meissner Mfg. Co., Mt. Carmel, Illinois.)



The Outstanding Tube Tester Value Checks all type tubes including Locals, Bantam Jr., 1.4 volt Miniatures, Gaseous Rectifier, Ballast, High Voltage Series, etc. Filament Voltages from 1.1 to 110 volts. Direct Reading GOOD-BAD Meter Scale. Professional-appearing case with accessory compartment large enough for carrying Model 739 AC-DC Pocket Volt-Ohm-Milliammeter, thereby giving the serviceman complete testing facilities for calls in the field. . . . Model 432-A with compartment. Dealer Net Price . . . \$20.73. Model 432-A in case less compartment . . . \$19.65. Model 739, Dealer Net Price . . . \$10.89.

WRITE FOR CATALOG—Section 116, College Drive

READRITE METER WORKS, Bluffton, Ohio

Make Your Own "TALKIES" with FILMGRAPH



Anyone can make an instantaneous recording-reproducing of sound on film with FILMGRAPH. Ideal for all types of recording and unusually adaptable for making sound tracks for home movies. Model AL, requiring an amplifier, speaker and microphone, will accommodate 500' reels of FILMGRAPH film for sound tracks to match up with pictures of like length—no stops, no gaps. Cost of recording extremely low, in fact, but a fraction of cost by any other method. Price \$25.00; limited Ask for bulletin 54 or, better yet, rush order to avoid disappointment.

MILES REPRODUCER CO., INC.

Dept. RC, 412 Broadway, New York, N. Y.

RADIO CATALOG
164 PAGES SETS-PARTS SUPPLIES FLUORESCENT
Burstein-Applebee Co.

BIG FREE CATALOG
EVERYTHING IN RADIO
Sets, parts, supplies, public address systems, amateur equipment, testers, kits and fluorescent lighting at lowest prices. Huge stocks, bought months ago . . . ready for shipment the same day your order is received. The Defense Program is making big demands on our industry but because of our advance buying we are able to fill your orders promptly and efficiently.

BURSTEIN-APPLEBEE COMPANY
1012-14 McGEE STREET, KANSAS CITY, MISSOURI

DEFENSE SOUND
Requires High EFFICIENCY
UNIVERSITY
Reflex speakers solve all Defense Sound Problems
UNIVERSITY LABS
195 Chrystie St. New York City

The Washington Monument in Council Bluffs?



**Well not exactly fellows,
But**

If the Hallicrafters receivers I sold in 1941 could be stacked atop each other, they would be even higher than the Washington Monument.

And not only that—I had orders from every state in the union.

These Hallicrafters are swell craftsmen—they know their stuff. Everything they put into a receiver is there for a purpose—to give you the best reception for your money.

Speaking about reception—you'll get a most cordial welcome when you place an order for one of these Hallicrafters with me. I'll see to it that you get your receiver promptly. If you have something you want to trade-in, I'll make it worth your while and remember, I offer you my lowest 6% plan available on any receiver, xmtr, parts and supplies shown in any catalog or advertisement.

Come on fellows, get on the Hallicrafters band wagon. Write me today!

Leo (W9GFQ)

Send for my new, bigger, better 1942 catalogue

124 pages, everything illustrated. A book you will refer to often.

Check this catalog to see how easy it is for you to get on the air—how economical. Send for information on my WRL xmtr kits.

IT'S FREE →

Big 3½ ft. x 4½ ft. U. S. map. Shows time zones, radio zones, monitoring stations, principal cities. 15c to cover postage and packing brings one to you.



**Get
your
halli-
crafter
NOW
and
be set
for 1942**

SKY TRAVELER S-29

This portable brings joy to all who have it. Operates on self-contained batteries—110V AC/DC; tunes 542 kc to 30.5 mc. Complete with battery and antenna \$69.50



SKY BUDDY S-19R

Here is a fine business receiver. Has 6 tubes, tunes 545 kc. to 44 mc. Fits the fellow with a small pocket book. A most dependable receiver. \$32.50



SKY RIDER SX 24

This receiver brings you performance equal to most receivers at twice the price. RF stage, good 10M operation, 9 tubes, crystal. Complete with tubes and crystal, less speaker \$74.50



SKY RIDER SX 28

One of the finest receivers built. Designed for government specifications. Used by 33 countries. Tunes 540 kc. to 40 mc. Has 15 tubes, 2 stages of preselection, noise limiter, 6 step crystal selecting, high fidelity audio, less speaker \$179.50



SKY RIDER SX 32

Every bit of the skill of Hallicrafters craftsmen is in this receiver. 13 tubes; tunes 500 kc. to 40 mc. in 6 bands. 2 RF stages, 6 step crystal selecting, automatic noise limiter. Less speaker \$149.50

P. M. 23 speaker \$15.00



Wholesale RADIO LABORATORIES

744 WEST BROADWAY—COUNCIL BLUFFS, IOWA

*The End
of the
Year*

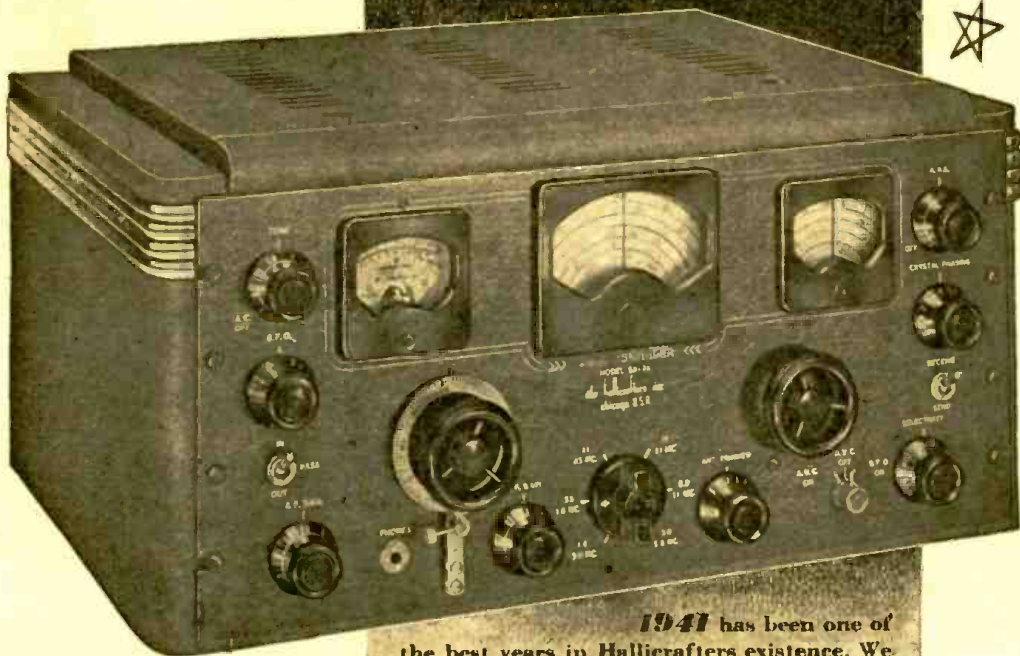

1941 has been one of the best years in Hallicrafters existence. We are grateful for the host of new friends such receivers as the SX-28 has made for us.

As the year comes to a close, we are a little proud that we have been able to fulfill the demand such equipment has enjoyed.

Nineteen forty-two will see us keeping up with our ever-increasing National Defense commitments and still supply radio communications equipment to our old friends.

*Used by 33 Governments
Sold in 89 Countries*

the hallicrafters co.
CHICAGO, U. S. A.

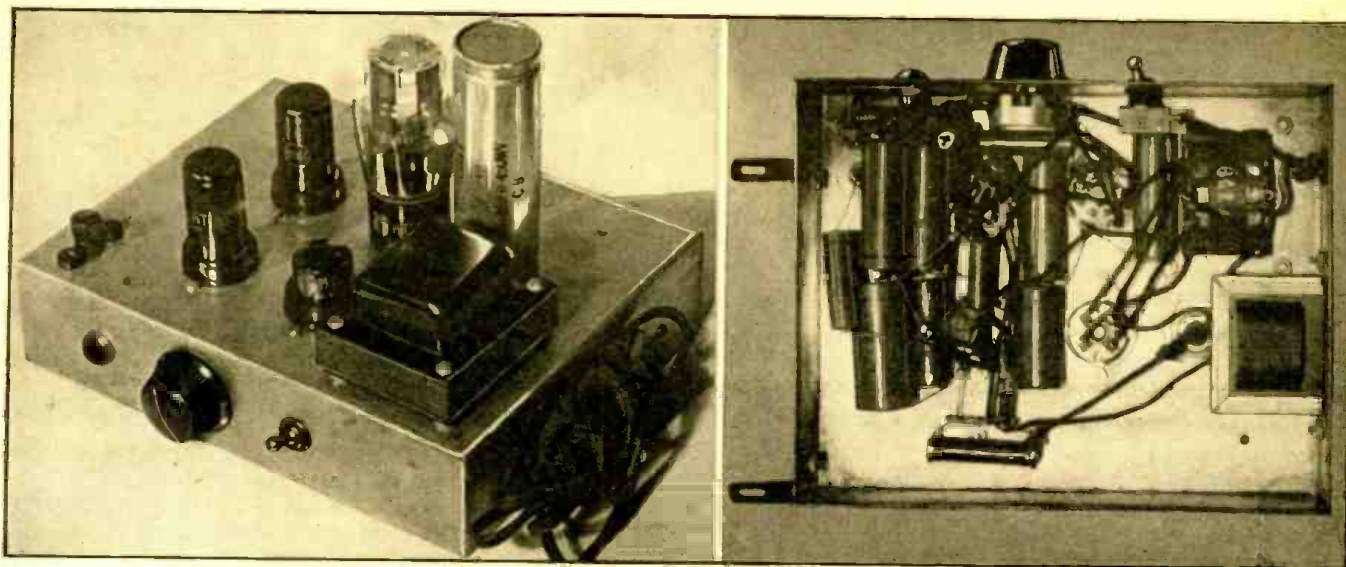

Build This New Volume

EXPANDER-COMPRESSOR

L. M. DEZETTEL, W9SFW

The home-made units here described provide both "expansion" and "compression," either one or the other in varying degrees, with but a single control. There are no critical bias adjustments to make—all tubes are standard receiving type tubes.

BY this time the terms "volume expansion" and "volume compression" are pretty well known to everyone. Volume expansion restores the original dynamic range in recorded music. It also increases the dynamic range, or difference between light and soft passages in radio broadcast music, adding a fullness and brilliance to the music that is thrilling to listen to. *Volume compression* does to a public address amplifier what automatic volume control does to a radio. It levels out the difference between high and low passages, resulting in a constant speaker output. It is especially helpful where the speaker standing before the microphone has a tendency to turn from side to side as he talks. With volume compression the output would be held fairly constant.

The units described here provide both expansion and compression, either one or the other in varying degrees, with but a single control.

Here is a circuit that is entirely new—it eliminates the use of the tricky 6L7 tube. There are no critical bias adjustments to make—all tubes are standard inexpensive receiving-type tubes.

The principle of operation makes use of the remote control grid of a super-control R.F. tube. This is the 6SK7. As you know, this type of tube has been used in the R.F. and I.F. stages of receivers. In that application a D.C. voltage is developed in the diode load circuit of the second detector in superhets. This D.C. voltage from the second detector is added to the fixed bias voltage of the R.F. and I.F. tubes, decreasing the amplification of the tube. There is no reason why the same thing cannot be done with audio voltages, and that is exactly what we do in this "expander-compressor."

Referring to the schematic diagram, an audio voltage is fed to the grid of both the

6SK7 and 6SJ7 tubes. The 6SK7 tube amplifies this voltage and carries it on to the 6H6, where it is rectified. A rectified D.C. voltage in the one-megohm center-tapped potentiometer will vary according to the audio voltage reaching the grid of the 6SK7. The center tap of the one-megohm potentiometer is grounded. The circuit is so arranged that the two ends of the potentiometer are of opposite polarity. Looking at the diagram, the left end of the control will have a positive potential, and the right end will have a negative potential. With the control arm to the left of the potentiometer resistance, positive voltage will be added to the 6SK7 bias, which varies according to the amount of audio voltage at the input. This positive voltage at the 6SK7 grid is added to the fixed bias on it, increasing its amplification. The result is *volume-expansion*. With the control arm to the right of the one-megohm potentiometer, a negative voltage is added to the fixed bias of the 6SK7 tube, causing a decrease in amplification which decreases the audio input. This results in *volume-compression*.

Assembly is simple. Since high-level audio voltages are used, exact placement of parts is not critical. It is best, of course, to use a little logic in the layout so that the leads will not be excessively long.

Wiring should be done carefully with a hot, well-tinned soldering iron. As there are quite a few fixed resistors and condensers in this circuit, you must be careful to do your work slowly, checking against the diagram frequently as you go along. Use as many wiring tie-points as you think is necessary.

One point to keep in mind during the operation of this unit is that the input voltage must be of high level. By "high level" we mean approximately the equivalent of an average crystal pickup output—about two or three volts of audio. A micro-

phone cannot be connected directly to the expander-compressor.

For *phonograph* reproduction the crystal pickup should be connected directly to the input of the unit, and the output of the unit to the amplifier where the phonograph pickup was previously connected.

The large binding post shown at the extreme left in the photograph is a common ground for both input and output. In place of an amplifier the phonograph input of any radio may also be used.

Where it is desired to expand or compress radio music, it is necessary to break the coupling condenser lead between the first and second audio stages. For this, run two shielded leads from the expander-compressor in through the radio set chassis. Connect the input lead to the coupling condenser which has been disconnected from the grid of the second tube. Connect the output lead to the grid of the second tube where the coupling condenser was formerly connected.

The connection, as described above, applies to public address amplifiers also. In high-gain amplifiers break into the coupling between the grid of the driver stage and the plate of the previous stage.

Try the unit first with the expander-compressor control in the center. In this position there is no expansion or compression. Adjust the volume setting so that it is approximately what it was before the unit was connected to the circuit. Now, as you play a record, or have someone speak into the microphone, turn the expander-compressor control either to the left or to the right (depending upon whether you want compression or expansion) slowly until the desired amount of expansion or compression is obtained. At the extreme limits of the control you will find that expansion or compression is quite great. As

a matter of fact, it is possible to over-compress; take care to prevent distortion.

PARTS LIST

KNIGHT PARTS:

- 1—Power transformer, sec. 650 V. A.C. at 40 ma. C.T., 5 V. at 2 A, 6.3 V. at 16 A.
- 1—Filter choke; 25 hy. at 25 ma., 850 ohms
- 1—8 mf., 450 V., upright electrolytic
- 1—8 mf., 450 V., tubular electrolytic
- 1—25 mf., 25 V., tubular electrolytic
- 1—1 mf., 200 V., tubular paper condenser
- 4—5 mf., 200 V., tubular paper condensers
- 2—1 mf., 400 V., tubular paper condensers
- 1—.05 mf., 400 V., tubular paper condenser
- 1—.01 mf., 400 V., tubular paper condenser
- 1—30,000 ohm, 3 watt, carbon resistor
- 1—25,000 ohm, 1/2 watt, carbon resistor
- 1—20,000 ohm, 1/2 watt, carbon resistor
- 1—40,000 ohm, 1/2 watt, carbon resistor
- 1—100,000 ohm, 1/2 watt, carbon resistor
- 1—3,000 ohm, 1/2 watt, carbon resistor

- 1—500 ohm, 1/2 watt, carbon resistor
- 1—500,000 ohm, 1/2 watt, carbon resistor
- 1—250,000 ohm, 1/2 watt, carbon resistor
- 2—1 megohm, 1/2 watt, carbon resistor
- 3—Octal wafer sockets
- 1—4-prong wafer socket

- I.R.C. POTENTIOMETER:
- 1—1 megohm, C.T.-VC-539X

- H. & H. TOGGLE SWITCH:
- 1—S.P.S.T. line switch

MISCELLANEOUS:

- 1—Knob for potentiometer
 - 1—Jewelled pilot lite socket and 6.3 V. bulb
 - 1—Line cord and plug
 - 2—Insulated pin jacks
 - 1—Plain binding post
- Hardware, wire, etc.

This article has been prepared from data supplied by courtesy of Allied Radio Corp.



Individually TESTED!

- Yes, even these inexpensive Aerovox paper tubulars are individually tested. That's true of every Aerovox condenser whether it be a ten-cent paper tubular or a ten-dollar oil-filled capacitor. Each and every Aerovox condenser is factory-tested for your convenience, peace of mind, ultimate pocketbook.
- Ask Your Jobber . . . Ask for these new Aerovox paper tubulars in the colorful yellow, black and red label jackets. Ask for latest catalog—or write direct.

AEROVOX CORPORATION
 NEW BEDFORD, MASS., U. S. A.
 In Canada: AEROVOX CANADA LTD., Hamilton, Ont.
 EXPORT: 100 Varick St., N. Y., Cable 'ARLAB'

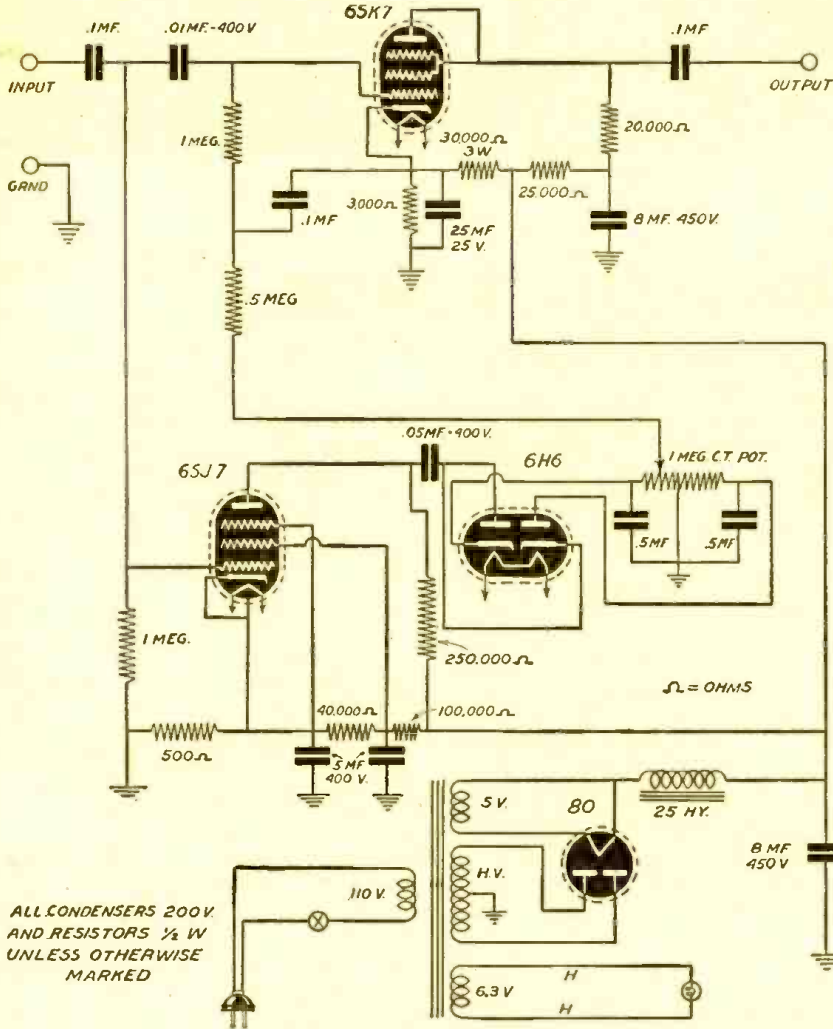

NEW CATALOG
 OF SOUND AMPLIFYING SYSTEMS
 AUDIOGRAPH Sound Systems represent the latest in Public Address equipment—a complete line plus pre-tested accessories.
NEW LOWER PRICES
 Outstanding quality and performance at prices that help you meet any competition.
 WRITE FOR YOUR FREE COPY
AUDIOGRAPH
 THE FIRST NAME IN SOUND
 John Meck Industries—1213 W. Randolph Street, Chicago, U. S. A.

Music Lovers Opportunity
100,000 Phono-Records
 are going to be sold by us at the biggest money-saving opportunity ever offered on records.
 We ship anywhere in the world where mail and freight is still rendering us service.
HERE'S A FEW OF THE BARGAINS!
 Set of 25 Popular Dance Records such as Glen Miller, B. Goodman, T. Dorsey, J. Dorsey, etc. Special \$4.00
 Set of 25 Hillbilly, Cowboy, or Blues Special \$4.00
 Special Set of 20 assorted Red Seal 12 inch Classical double faced records. \$7.00
 Special (We pay shipping charges on above, east of the Rockies)
 Terms: Send 20% with order. Bal. C.O.D.
 Music Lovers and dealers can now obtain outstanding values from one of the few outlets dealing exclusively in Phono-Records. We can supply all your record needs. Write us for Special Bargain Kits of Records consisting of classical or popular, etc.

IF YOU HAVE ANY OLD PHONOGRAPH RECORDS WE BUY THEM
 Dig them up and ship to us. Classical or popular. Victor records. Liberal purchase payment sent the day records are received.
GENEROUS TRADE-IN ALLOWANCE!
 We will also add an extra 10% appraisal allowance on records sent us against any purchase made by you.
 We have unusual records in stock but need more and more for our customers. Don't hesitate in becoming a member of the preferred Coyne record family—It pays and SAVES!
MAIL and PHONE ORDERS Promptly Filled.
COYNE MUSIC SHOP (nothing but records)
 58 Cortlandt St., New York City

Sensational New!
"WALSCO UNIBELT"
 ADJUSTABLE DIAL BELT
 THE GREATEST TIME SAVER FOR RADIO MEN IN YEARS!
 Belts are adjustable and come apart. They can be installed without taking the dial mechanism apart. Patented zipper-like fastener gives instant connection. The WALSCO UNIBELT cannot slip or stretch and one can do a replacement job in two minutes that before took an hour or more.
 Ask your jobber for FREE WALSCO CATALOG No. 42A Or write to WALTER J. SCHOTT CO. 5266 Pico Blvd., Los Angeles, Calif.

SOLAR RED-CAPS
 Smaller Diameter Dry Electrolytics
SPEED Servicing
 Write for Catalog
SOLAR MFG. CORP. Bayonne, New Jersey

SOUND ENGINEERING

Free Design and Advisory Service
For Radio-Craft Subscribers

Conducted by A. C. SHANEY

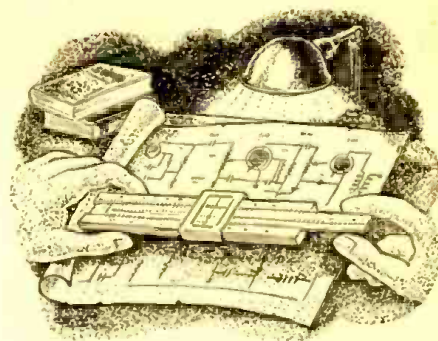

This department is being conducted for the benefit of RADIO-CRAFT subscribers. All design, engineering, or theoretical questions relative to P.A. installations, sound equipment, audio amplifier design, etc., will be answered in this section. (Note: when questions refer to circuit diagrams published in past issues of technical literature, the original, or a copy of the circuit should be supplied in order to facilitate reply.)

No. 23

PUSH-PULL 6L6 TRIODE AMPLIFIER

The Question . . .

Would like to build an amplifier with 6L6's push-pull with screen and plate tied together. Since I can not get characteristics on this type of operation would you mind running curves on the tube. I know that many are interested in seeing curves on this type of operation since the plate resistance would be very low and distortion lower than any tube at present on the market capable of high-power output. Thanking you in advance, I remain

G. PAIGE,
22 Adelaide Street,
London, Ontario, Canada.

The Answer . . .

Although you might be led to believe that the plate resistance and distortion characteristics of a 6L6 triode connected (screen-grid tied to plate) circuit would be lower than a standard triode (as a 2A3), such is not the case. The following tabulations are the rated characteristics of a single 6L6 tube, class A, triode-connected.

	Fixed Bias	Cathode Bias
Plate	250	250 volts
Grid	-20	— volts
Cathode Resistor	—	490 ohms
Peak A-F Grid Voltage	20	20 volts
Zero-Sig. Plate Cur.	40	40 ma.
Max.-Sig. Plate Cur.	44	42 ma.
Plate Resistance	1700	— ohms
Amp. Factor	8	—
Transconductance	4700	— unhos
Load Resistance	5000	6000 ohms
Total Harmonic		
Distortion	5	6 %
Max.-Sig. Power		
Output	1.4	1.3 watts

You will note that the maximum single power output is 1.4 watts for fixed bias operation. A single type 45 tube provides a power output of 1.6 watts with 250 volts at the plate, and its plate resistance is 1610 ohms.

A casual comparison of the characteristics between the 6L6 beam power amplifier (when used as triode) and the old 45 triode amplifier, clearly shows that all of the desirable and advantageous characteristics of the 6L6 are lost when the tube is triode operated.

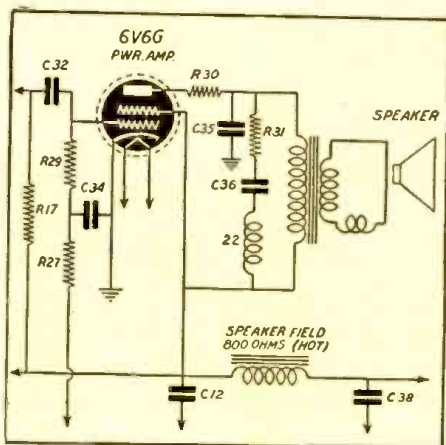

Diagram above shows output circuit of a Zenith receiver, described above at right, together with a suggestion by Mr. Shaney as to how a dual speaker unit may be connected.

There are rare occasions when such operation is desirable, but they are definitely not indicated for use in an amplifier having a low plate resistance, low distortion, and high power output requirements.

DUAL SPEAKER SUBSTITUTION

The Question . . .

I have a Zenith-Model 10H571-chassis 10A3-AM-FM. The greatest demand I make of it is high fidelity, and I believe that the present speaker—a 12" dynamic—is incapable of producing the tonal quality necessary to high fidelity.

Can I substitute the present speaker with a dual unit and bring the audio output to high fidelity range?

As you now know, I'm a beginner, so, in "first grade" language, can you tell me how such a substitution can be made? I am enclosing a schematic of the radio.

Assuring you of my deepest appreciation of your earnest consideration of this letter, I remain,

J. M. ARCIER,
44 Bridge St.
Waterbury, Conn.

The Answer . . .

You can easily replace your present speaker with any dual unit, by removing the old speaker, its coupling transformer, and the equalizing network across the primary, as well as the series resistor (R30) and by-pass condenser (C35).

The only requirement necessary in obtaining the desired results is to match the input transformer of the dual speaker unit, to the output circuit of the amplifier. In your case, a 5000 ohm input transformer should be ordered with the speaker. No other circuit changes are necessary. In other words, simply disconnect everything going to the plate terminal of the output tube and connect the 5000 ohm transformer (of the dual speaker unit) across the screen grid terminal and plate terminal of the 6V6G power amplifier tube. An 800 ohm filter choke should be substituted in place of the present speaker field. If a choke of adequate inductance but low D.C. resistance is employed, a series resistor should be added, so as to make up the difference.

Operating Notes

... MOTOROLA 301 E 401

Trouble in auto radio sets which stop playing and then start up again after cooling, is caused by defective 6SA7 tube.

LEONARD CHIOMA,
Waterbury, Conn.

... MOTOROLA AUTO RADIOS

Complaint usually is that sound becomes distorted only while car is in motion. The trouble is usually cured by retightening the housing on station-selector cable. When the cable turns too freely the car vibrations slightly detunes the set.

LEONARD CHIOMA,
Waterbury, Conn.

... ALL 1941 RCA TABLE MODELS

Due to the restricted length of the speaker connecting leads, time is lost taking the speaker out of the cabinet and exposing the cone to damage and further collecting of (most of them are permanent magnet) iron particles from the bench.

Two useful extension cables at a cost of a few cents may be made by getting from an RCA dealer one 3 male plug part No. 5118, and one female part No. 5119 for one set. For the 4 prongs connector, use part No. 5039 and No. 5040.

ANTONIO FRAU,
Ponce, Puerto Rico.

... RCA VICTOR 10T-10K

If sensitivity of these models drops very low, check the bias switch which is of the slide type, and is operated automatically by the range-selector control (S7) in service diagram. The purpose of this switch is to increase sensitivity on the short and intermediate wave bands, by reducing the residual bias on the AVC and detector tubes.

When this switch is turned clock-wise it may stop and stick in that position and cause decrease in sensitivity. To correct this trouble, clean the contact points of the switch and lubricate the movable parts.

FRED KARFEN,
Johnstown, Pa.

New Radio Books for You

SEE THESE HELPFUL MANUALS AT YOUR RADIO JOBBER OR ORDER FOR EXAMINATION

Most - Often - Needed RADIO DIAGRAMS and Servicing Information

4 OUT OF 5 CIRCUITS YOU NEED

In these easy-to-use complete manuals you have all the diagrams you really need. Over 80% of the sets you service every day are included. Use these important, hint-giving, trouble-shooting circuits to make your service work easier.

1941 VOLUME 4

LATEST MANUAL

Let this newest manual give you most of the 1941 circuits you need, introduce you to new radio developments, help you to do better servicing. Includes schematics, alignment data, service hints, I.F. peaks, and parts lists. 192 pages. 8 1/2 x 11 inches. Volume 4. **\$2.00**
Net only



1940 VOLUME 3

This manual covers all popular models of 43 manufacturers for this important radio year. Data on F.M., 3-way portables, intercoms, recording. Service hints, alignment suggestions. Compiled by M. N. Beitman, radio engineer, author, teacher. **\$2.00**
417 models. 208 pages.....

1939 VOLUME 2

Another condensed manual of most-popular diagrams you need. Circuit data, hints, and information are time-savers and money-makers for you. Begin using these "on-the-job" handbooks this week. Diagrams of 39 manufacturers. 192 pages and index. All manuals, 8 1/2 x 11 inches. **\$2.00**

1926-1938

VOLUME I, MOST POPULAR

The most popular manual of the series. Will pay for itself with time saved in a day. 427 diagrams of most-serviced radios needing service every day. See this book at your jobber or order by coupon. Manual includes parts lists and alignment information. 244 pages. **\$2.50**
Large size 8 1/2 x 11 inches.....

GENERAL ELECTRIC MANUAL

This 64-page complete manual of the most-popular GE sets is something you must have. The entire manual of these "often-needed" important circuits is yours for less than the cost of a single diagram. Size 5 1/2 x 8 1/2 inches. Net Only. **50c**

Simplified Radio Servicing by COMPARISON Method



NEW DEVELOPMENT

You will be able to repair radios in minutes instead of hours. Revolutionary different **Comparison** technique permits you to do expert work on all radio sets. Most repairs can be made without test equipment or with only a volt-ohm-meter. Many simple point-to-point, cross-reference circuit suggestions locate the faults instantly. Plan protected by copyright.

FOR BEGINNERS AND EXPERTS

This new, simplified servicing technique is presented in handy manual form 8 1/2 x 11 inches, 112 pages. Covers every radio set type—new and old models. Over 1,000 practical service hints. 16 large, trouble-shooting blueprints. Charts for circuit tests analysis. 114 simplified tests using only a 5c resistor. Developed by **\$1.50**
M. N. Beitman. Net Price, only..

PRACTICAL RADIO MATHEMATICS

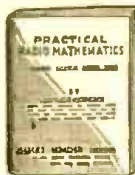

Introduces and explains the use of arithmetic and elementary algebra in connection with units, color code, meter scales, Ohm's Law, alternating currents, ohmmeter testing, wattage rating, series and parallel connections, capacity, inductance, mixed circuits, vacuum tubes, curves, the decibel, etc., etc., and has numerous examples. Plainly written and easy to understand. Only useful data included. 32 pages. Size: 5 1/2 x 8 1/2 inches.... **25c**

SERVICE NOTES

on

RECORD PLAYERS AUTOMATIC CHANGERS WIRELESS UNITS AND HOME RECORDERS

Just what you need to repair quickly and correctly thousands of automatic record changers, manual units, pickups, wireless oscillators, recorders, and combinations. Hundreds of mechanical and electrical diagrams. Instructions for adjustments and repairs. The most popular units of all makes included. 132 large pages, 8 1/2 x 11 inches. Net Price.. **\$1.50**

STEWART-WARNER MANUAL

This handy diagram manual contains diagrams, service notes, alignment data, for popular Stewart-Warner radios of all periods. Get this inexpensive book and be ready to service your next set of this important make. Size: 5 1/2 x 11 inches. **50c**

ARVIN MANUAL

The most-often-needed diagrams of Noblitt-Sparks (Arvin) radios are included in this manual. Service these popular sets with confidence and skill, using this low priced radio publication. Size: 5 1/2 x 11 inches. **50c**

RADIO COURSE BOOK



AMAZING OFFER

Here is your chance to obtain a complete course-manual of 22 large lessons, with all supplementary material for only \$2.50. Full price. Here is a home-study training you can easily afford. Here is the technical radio education you really need. Study radio as experts have at almost no cost.

EVERY PHASE OF RADIO

The lessons are practical, clear, interesting, easy to master and use. No special education or previous experience required. You will enjoy learning important radio facts and doing real radio service work after the 14th lesson. The 317 pictures, diagrams, and illustrations will help you understand every important phase of radio. Learn quickly how to test radio parts, trace circuits, adjust all sets, operate transmitters, and make all needed repairs.

FOR BRUSH-UP AND REVIEW

Learn new speed-tricks of radio fault finding, case histories of common troubles, servicing short-cuts, extra profit ideas. Many large lessons on the use of regular test equipment, explanation of signal tracing, television to the minute, recording dope. With this information you will save enough time on a single radio job to pay the special \$2.50 price for the complete course of 22 money-making lessons. Many active servicemen used this reduced price radio training for brush-up and study of new servicing methods.

NEW EDITION REPRINTED 1941

Reprinted in 1941 with information on signal-tracing, television, visual alignment, P.A., photo-cells, etc. All about AVC, how to use an oscilloscope, what is feedback, resonance action, and every other fact you must know to be **\$2.50** more expert in your work. Net.

MOTOROLA SERVICE MANUAL

This up-to-the-minute manual will tell you how to repair every MOTOROLA auto radio. Includes detail schematics, service notes, alignment data, and parts lists for all of the 72 models made to 1941. Prepared with the help of Galvin Mfg. Co. engineers. This large 8 1/2 x 11 inch, 96 page manual is priced at **\$1.50** only

Cyclopedia of TELEVISION FACTS

This new television book defines and explains every term and part used in television transmitting and receiving equipment. The more important terms are described in greater detail. You will find the TELEVISION CYCLOPEDIA an excellent introduction to television and a great aid in understanding more technical articles and books. Included are many photographs and charts to assist you. Every radio serviceman, amateur, and technician must have this book to understand television. 64 fact-packed pages; 5 1/2 x 8 1/2 inches..... **40c**

HOW TO ORDER BOOKS

Mark in the coupon the manuals you want. Then, either take the coupon to your radio jobber or send the coupon to the publisher and receive the manuals selected by prepaid parcel post. You must be satisfied or your money is promptly refunded.

SEE YOUR JOBBER OR SEND COUPON

SUPREME PUBLICATIONS

328 S. Jefferson St., Chicago, Ill.

I want the manuals listed below. I must be satisfied or you will refund my money.

I am enclosing \$..... send postpaid. Send C.O.D.

NAME

ADDRESS

R. C. 2-42

Supreme Publications

PUBLISHERS OF RADIO BOOKS, MANUALS, AND DIAGRAMS

328 South Jefferson Street

Chicago, Illinois

Airplane Indicator for Flying Fields



Photo above shows operator at airport checking direction of plane transmitting regular communication signal. The receiver employs an Azimuth-indicating device, operating in the 2 to 7 megacycle band. Right—Note size of man and the dipole antennas. Below—Diagram of receiver and arrangement of dipole antennas.



This apparatus gives a visual indication of the direction of regular communication signals sent from a plane, and permits the flying field and the pilot to ascertain the position of the plane at any given moment.

tion-finding determination. It was felt, therefore, that equipment which would operate instantly and automatically on the regular communication transmission from the plane would greatly contribute to the safety of air navigation. With this objective in view, the Bell Telephone Laboratories has recently developed an azimuth-indicating radio receiver, operating in the 2- to 7-megacycle band. The equipment gives a visual indication of the direction of the source of any radio waves to which the set is tuned. The collector system may be located at a site free from electrical noise, while the indicator panel may be located at a regular operating point where personnel is available for observing the directional indications. Only an ordinary telephone circuit is required for connecting the collector system with the indicating and control equipment.

The complete equipment consists of an antenna system, a ten-frequency radio receiver, and an indicator panel, shown in photo. The bright circle is the end of a cathode-ray tube, and a spot of light, normally at the center, moves radially outward along the line of the bearing of the airplane as its radio signal is picked up. Any of the ten frequencies for which the receiver is equipped may be selected by the dial at the bottom of the panel, and a light in the lamp bank at the left indicates the frequency selected. Behind the six vertical bands above

UNDER bad visibility conditions, an airplane pilot's determination of his position is greatly facilitated if the ground station with which he is in communication has equipment for determining the bearing of the plane. Direction-finding equipment has been used for this

purpose for a number of years both in this country and abroad. The existing ground station equipment, however, requires the services of a skilled operator, and because of the time required to take a bearing, it is necessary for the plane to make special transmissions for the direc-

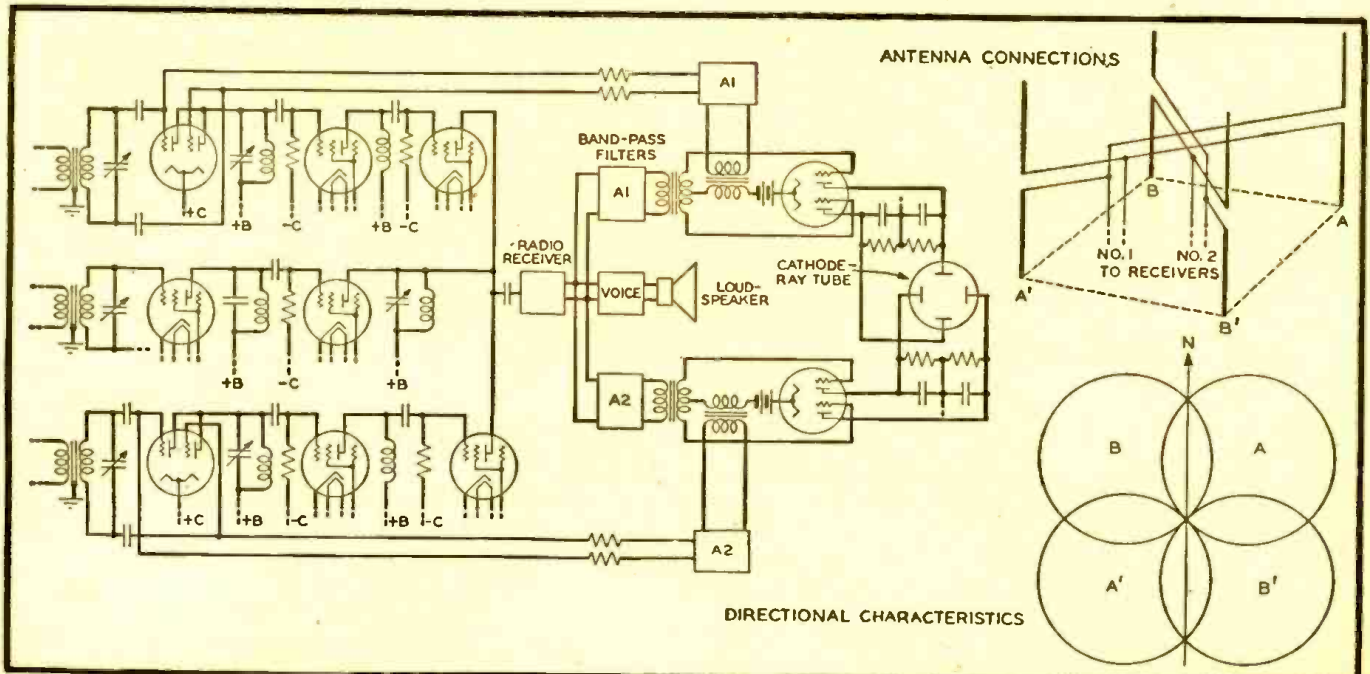

**New Direct-Coupled FM - AM
AMPLIFIER MANUAL**

By A. C. SHANEY

Chief Engineer, Amplifier Co. of America



**For the Layman, Serviceman
Recordist and Engineer**

Regardless of whether you are interested in the finest type of phonograph reproduction, high fidelity recording, sound-on-film applications, FM or AM programs, you will find invaluable information in this practical handbook. Written by the leading exponent of direct-coupled amplifiers who has spent more than 10 years improving and perfecting the famous Loftin-White circuit.

Explains the theory and practical application of:

- Variable Speed Non-Overloading Push-Pull Expansion
- Non-Frequency Discriminating Scratch Suppression
- Push-Pull Balanced Direct-Coupled Amplification
- Push-Pull High-Frequency Equalization
- Push-Pull Low-Frequency Equalization
- Push-Pull Volume Compression
- Automatic Volume Limitation
- Automatic Volume Control
- Calibrated V.U. Indicator
- Audio Spectrum Control
- Remote Control

If you are interested in the latest audio developments, you can't afford to be without this complete compilation of authentic articles on Direct-Coupled Amplifiers. 32 pages 8 1/2" x 11". Over 100 diagrams and illustrations.

Priced to Cover Cost of 20c
Printing and Mailing

Send Stamps or Coins

AMPLIFIER CO. of AMERICA

17 WEST 20TH STREET, NEW YORK, N. Y.

the dial is a loud speaker that reproduces the signal from the plane at the same time the spot of light indicates its direction. Besides dialing the frequency desired, the operator may also dial one of seven sensitivity values. The sensitivity selected is indicated by the bank of lamps located at the right of the panel.

The antenna system consists of four vertical dipoles located at the corners of a square, with a fifth dipole at the center. The four corner antennas are used for determining direction. The central antenna serves as a reference of radio-frequency phase to permit differentiation between directions 180 degrees apart; and in addition, it receives the normal communication signals. The connection of the four directional antennas is as indicated, which also shows the directional characteristics of the antenna array.

This form of antenna structure responds only to the vertical component of the electric field, since the horizontal component is eliminated by a cancellation effect. The horizontal component may arise from the form of the transmitting antenna, as a result of ionospheric reflections, or both, and frequently results in an error in azimuth. By employing only the vertical component, this new azimuth indicator is free from these polarization errors, sometimes called "night effect" or "airplane effect."

A simplified schematic of the circuit when the indicator is at the same location as the antennas, thus eliminating the two-wire transmission link, is shown in Fig. 2. Each pair of directional dipoles is connected to the input of a pair of modulators which are also supplied with an audio-modulating frequency, A1 for one pair and A2 for the other. The carrier and the audio-modulating frequency are both suppressed, and only the sidebands of the audio modulation remain. The outputs of the directional modulators, together with the output of the center antenna, are then combined and passed to the radio receiver. The output of the receiver thus includes the received signal plus the two directional components of frequencies A1 and A2. Filters at the output of the receiver separate these three components; the signal is passed to the loud speaker, and the two directional components to the plates of the cathode-ray tube via conjugate input demodulators. The cathode-ray tube has two pairs of deflecting plates placed at right angles to each other, and the rectified output of one pair of dipoles tends to deflect the spot along the line of one pair of plates, and that of the other pair of dipoles along the line of the other pair of plates.

The spot on the target of the C-R tube

will move to indicate an azimuth of 90 degrees. If there were only the two directional sidebands at the detector input in the radio receiver, there would be an uncertainty between directions 180 degrees apart. The output of the central antenna, however, which is present with the two directional sidebands, provides the means of recovering the original tone frequencies and also serves as a reference of sign, with the result that the bearing is correctly indicated at all times. There is no 180-degree uncertainty as there is with a loop antenna.

To visualize the operation of this equipment, the reader may imagine himself seated before the new indicator at LaGuardia Field.* With the aid of the dial he has selected for observation 4122.5 kilocycles, the two-way plane-to-ground communication frequency for Eastern Airlines. When no carrier is being received, the oscilloscope spot stays near the center of the oscilloscope screen, save for minor excursions due to static or other noise sources. At three or ten minutes before almost any hour in the day, however, the observer is apt to note a deflection of the spot to about azimuth 6 degrees, accompanied by the announcement "flight 1 (say) testing on the ramp." This would be the Eastern Airlines ship scheduled to depart for Washington (and possibly for points south) on the even hour. A few minutes after the hour he would see a deflection of the spot between azimuth 355 and 360 degrees (or 0 degrees) coupled with the announcement from the plane that it is clear of the tower. In both these cases there will have been acknowledgment from the Newark ground station of Eastern Airlines, for which the spot would deflect to about azimuth 290 degrees. Possibly eight or ten minutes after the hour the plane may be heard reporting over Newark, at about the same azimuth as the Newark ground station. At about 18 minutes after the hour the plane should report over the "check point" at Metuchen, New Jersey, the azimuth by this time being about 250 degrees. Sometimes no further reports from this plane will be heard until it reports "over Philadelphia" about a half hour out of LaGuardia.

Each of these observations has taken only about five seconds, the average length of time required for the pilot to report his position. With the exception of dialing the desired frequency, no manipulations or calculations need be made by the operator, since the observed location of the spot with respect to the azimuth scale gives the true bearing directly.—*Courtesy Bell Laboratories Record.*

*The associated collector system is located just north of Floyd Bennett field.

10 BEST RADIO BOOKS 10 CENTS EACH

RADIO FANS EVERYWHERE—these fine ten cent text books give you an excellent foundation for the study of RADIO. They are clearly written, profusely illustrated and contain over 15,000 words in each book. You'll be

amazed at the wealth of information contained in these handy books. Excellent for reference—ideal for every technical library. **YOUR MONEY BACK** if you are not satisfied. **PROMPT SHIPMENTS**

- No. 1—HOW TO BUILD FOUR DOERLE SHORT WAVE SETS
- No. 2—HOW TO MAKE THE MOST POPULAR ALL-WAVE 1- AND 2-TUBE RECEIVERS
- No. 3—ALTERNATING CURRENT FOR BEGINNERS
- No. 4—ALL ABOUT AERIALS

- No. 5—BEGINNERS' RADIO DICTIONARY
- No. 6—HOW TO HAVE FUN WITH RADIO
- No. 7—HOW TO READ RADIO DIAGRAMS
- No. 8—RADIO FOR BEGINNERS
- No. 9—SIMPLE ELECTRICAL EXPERIMENTS
- No. 10—TELEVISION

BOOKS ARE ALL UNIFORM

Every book in the GERNSBACH EDUCATIONAL LIBRARY has 32 pages—with illustrations varying from 30 to 66 in number. Each title volume contains over 15,000 words. Positively radio's greatest book buy! If you do not think these books worth the price asked, return them in 24 hours and your money will be instantly refunded.

RADIO PUBLICATIONS • 25 WEST BROADWAY • NEW YORK, N. Y.

RADIO PUBLICATIONS, Dept. RC-2-42,
25 WEST BROADWAY, NEW YORK, N. Y.

Gentlemen: Please send immediately, POSTPAID, the book numbers circled below. I am enclosing cents —each book being 10c.

1 2 3 4 5 6 7 8 9 10
NEW

Send FREE listing of 48 new 10c publications.

Name Address

City State

Remit by check or money order—register letter if you send cash or unused U. S. postage stamps.

MAIL COUPON TODAY!

**QUICK, EASY WAY
TO TRAIN FOR
RADIO
in 8 WEEKS**

H. C. Lewis
I'LL FINANCE YOUR TRAINING
Mail the Coupon TODAY and I'll not only tell you about my quick, easy way to train for a good pay job in Radio, Television and Sound, BUT, I'll also tell you how you can get it and pay for it, in Easy monthly payments starting 60 days after 8 weeks' training period.

LEARN BY DOING
On Real Equipment in Coyne Shops
Simple, easy method of Practical Training. You don't need previous experience or a lot of book learning. You work on real equipment in the Coyne Shops at Chicago. This 8 weeks training prepares you for a job in service and repair work—we also offer radio operating training. Full details of this training will also be sent you when you send coupon.

**EARN WHILE LEARNING,
Job Help After Graduation**
We help you get part time work to help with living expenses and then give you employment service after graduation.

**H. C. LEWIS, President,
Radio Division, Coyne Electrical School,
500 S. Paulina St., Dept. 12-8M, Chicago, Ill.**

Dear Mr. Lewis:
Please send me your Big FREE Book, and details of your **PAY-AFTER-GRADUATION-PLAN.**

NAME

ADDRESS

CITY STATE

SEND COUPON TODAY

COIL COUPLING

Part 2

L. V. SORENSEN

PROBLEMS

Every student of radio theory and design should study carefully this, and the previous article by Mr. Sorensen, on the action of coupling coils in radio receivers. Poorly designed coils can ruin the selectivity and other characteristics of any receiver; the importance of careful and accurate design of the coils cannot be over-estimated.

effect on the 5.5- to 18-mc. range. This is because the padding condensers become so large that there is virtually no R.F. voltage developed across them and consequently no reinforcement of feedback.

Cathode Tap: The coupling employed in the 6SA7 oscillator circuit is a variation of the tickler type oscillator circuit. The most widely used circuit for this tube is shown in Figure 7-A, where the cathode is connected to a tap on the tuned circuit and the tuning condenser employs specially shaped plates to accomplish tracking with the antenna coil (on a single-band set). On multi-band sets it is necessary to use padding condensers sometimes in the low side of the tuned circuit. Since to put a padding condenser at the low end of the coil would open the cathode circuit for DC, it is necessary to wind a separate cathode winding for feed-back as shown in Figure 7-B.

The similarity between this circuit and the conventional tickler oscillator circuit is made further manifest, when it is called to mind that the screen of this tube is the plate of the oscillator section of the tube, and that the tickler could have been placed in series with the screen grid, if it weren't for the fact that it was desired to keep the screen at ground potential, as far as R.F. is concerned. Sliding the tickler around from the screen grid to the cathode circuit, where it is shown in Figure 7-B, is the method of obtaining the desired ground R.F. potential on the screen grid and still having a feed-back winding.

Suppressing "Wild" Oscillators: As mentioned above, virtually all oscillator circuits in radio sets oscillate stronger at the high-frequency end of the tuning range than at the low end. Where the ratio of highest to lowest frequency is not great, such as 2 to 1, or even less, the difference in oscillator strength is of little consequence, but when the tuning range is stretched to cover a ratio of 3 or $3\frac{1}{2}$ to 1, especially at high frequencies, the difference in oscillator strength at the two ends of the tuning range is troublesome. What frequently happens is that, when coupling is adjusted to obtain satisfactory strength of oscillation at the low-frequency end of the band, the oscillator "goes wild" at the high-frequency end. The usual remedy is to use a suppressor resistor, commonly inserted in the grid circuit, but sometimes in the plate circuit. Adjusting coupling on such circuits involves not only changes in the coupling

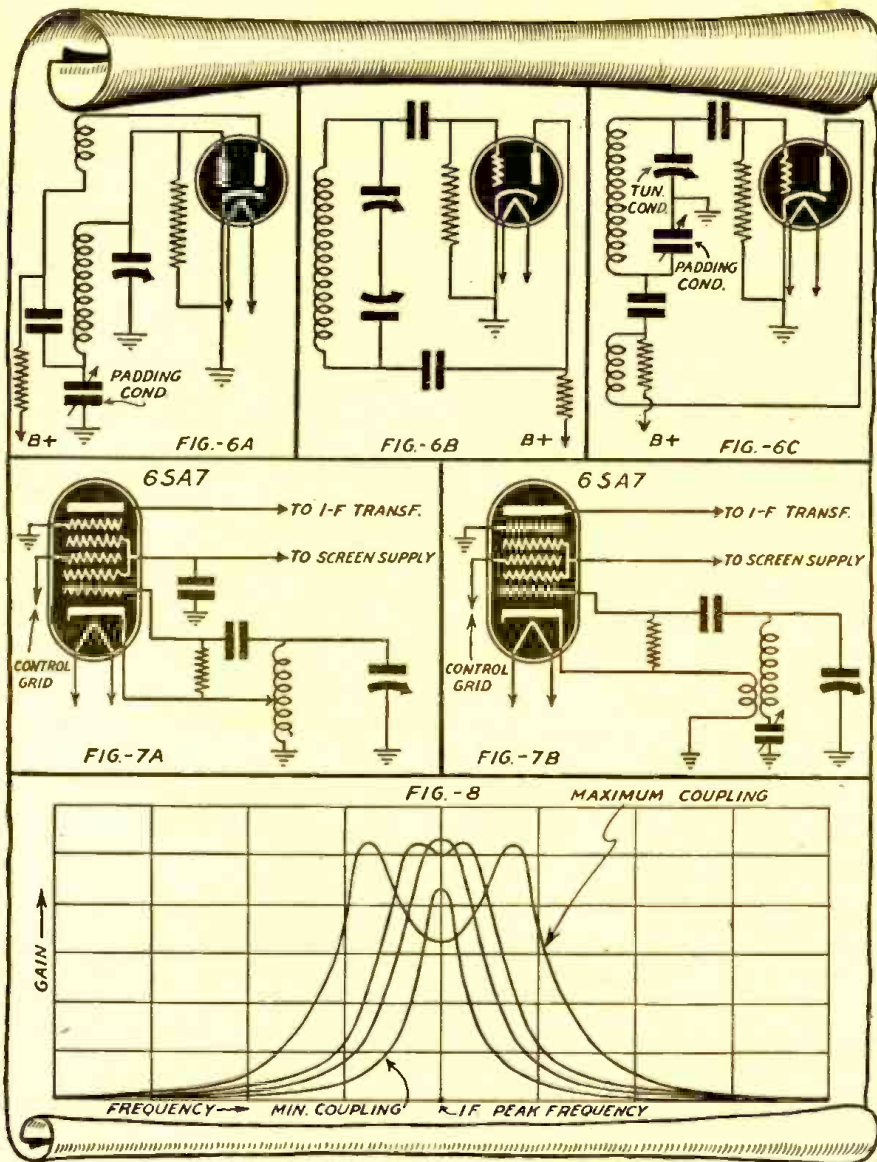

In connection with diagrams above, the author gives a clear explanation of the action occurring in radio coupling coils.

THE coupling employed on oscillator coils is the most uniform type of coupling to be found in a radio set. It may be considered low-impedance coupling wherein the plate is coupled back to its own grid circuit by means of a tightly coupled winding, commonly called the "tickler", usually consisting of considerably fewer turns than the tuned circuit. The natural characteristic of such a circuit is parallel to the gain characteristic of a low-impedance R.F. stage, i.e., highest gain at the high-frequency end of the tuning range. In the case of the oscillator, this characteristic produces the highest strength of oscillation and grid current at the high-frequency end of the band. At the low-frequency end of the band, trouble is sometimes experienced in maintaining un-failing oscillation.

In some instances, in the broadcast band or in the long-wave band, a circuit trick is employed to increase the coupling at the low-frequency end of the band, where the inductive coupling is doing the least good. The trick consists of returning the R.F. current of the plate circuit through the padding condenser, as in Figure 6-A. This circuit is popularly known as a "Modified Colpitts Circuit", because of its close similarity in appearance and performance to the standard Colpitt circuit shown in Figure 6-B. When the circuit is drawn as in Figure 6-C, the similarity between the standard Colpitt and the modified Colpitt circuit is easily seen.

This scheme for reinforcing the coupling at the low-frequency end of the tuning range accomplishes but little on the 1.7- to 5.5-mc. range and may be said to have no

on the coil itself, but changes in the value of the suppressor resistor as well, until satisfactory results are obtained.

I-F Transformers: The coupling employed on I-F transformers is almost always essentially *magnetic*, with whatever stray-capacity coupling there is that cannot be eliminated without the expenditure of money. There are a few exceptions to this general rule, where the coupling is essentially or entirely *capacitive*, but the number of such cases is so few that they are mentioned merely as a matter of interest for the sake of a more complete discussion.

The problem of coupling the two windings of an I-F transformer is considerably simpler than the coupling problems in R-F transformers, because the I-F transformers work at only *one* frequency. Coupling can therefore be adjusted to the optimum (best) value for that one frequency, without making the compromise necessary in R-F transformers, that must work over a whole band of frequencies. Another important difference between I-F transformers and R-F transformers of the usual type is that the I-F transformer usually consists of two circuits resonant to the same frequency, whereas the R-F transformer usually consists of one resonant circuit adjustable over a range of frequencies, while the other circuit is resonant at a frequency far removed from the tuning range of the adjustable circuit.

The I-F transformer, with two circuits tuned to the same frequency, exhibits a rapid change in its characteristics as the degree of coupling is changed. When the circuits are very *loosely coupled*, the selectivity is virtually *unchanged* for a considerable variation in coupling, but the gain is proportional to the mutual inductance or coupling. Representative gain curves for these conditions are shown in Figure 8. As coupling is still further increased, the gain does not continue to increase as fast as the coupling is increased, but another change is noticeable—the selectivity curve becomes somewhat broader at the “nose” of the curve. If coupling is still further increased it will be found that the “nose” of the curve first becomes flat on top and, for further increases in coupling, the selectivity curve becomes “double-humped”. The normal design of I-F transformer has its coupling adjusted to a value that either produces a flat nose or, more commonly, is

just below the value that produces a flat nose. Such a value of coupling produces “comfortable” manufacturing conditions because, if the coupling increases a little, the gain cannot increase appreciably; if the coupling decreases a little, the gain goes down a lesser percentage than the reduction in coupling. There are, of course, accompanying changes in selectivity, but since the overall selectivity of the receiver is a function of all of the tuned circuits working simultaneously, small production variations in the selectivity characteristics of one coil have little effect on the overall results. Only if the selectivity of all of the coils is changed in the *same direction at the same time* (a very unlikely condition) does the over-all selectivity change appreciably.

Critical Coupling: The coupling that makes the selectivity curve just begin to flatten out on the nose is called “critical coupling”. It is not a constant, but depends upon the effective circuit “Q” of the circuits being coupled together. When the circuit “Q” is high, critical coupling results with lower coupling (greater spacing between coils) than when lower-“Q” circuits are employed. For example, if three transformers with identical coils are used as input, interstage, and output transformers, in a set employing two I-F tubes, and the coupling in each transformer is adjusted to produce a flat nose or “critical coupling”, it will be found that the interstage transformer will have the greatest spacing between coils, because it has the highest impedance connected across its winding, with consequently the least effect on the “Q” of the coils alone. The input transformer will have the next closer spacing for critical coupling (if used with a conventional pentagrid converter) because the plate impedance of the converter connected across the transformer primary is, in general, lower than that of the I-F tube connected across the primary of the interstage transformer. The output transformer, working into a conventional diode load will have, effectively, a heavy load connected across its secondary, compared to input and interstage transformers working into virtually infinite-impedance grid circuits, and will consequently have the “Q” of its coils reduced most, and its coupling must therefore be closest to produce the flat-nosed effect.

This article prepared from data supplied by courtesy of Meissner Mfg. Co.



Buy Your SX-28 from Bob Henry..

Why keep your old receiver when you can get the best trade-in value from me on a Hallcrafters New SX-28. Here is a communications receiver that has everything — 15 tubes, 6 bands cover from 550 kc. to 42 mc. with all the latest 1941 features for better communications reception. Drop me a line here at Butler for a free estimate on your trade-in. Easy 6% terms are financed by me to save you money! You can have your choice from the world's largest stock.



Write to me today!

Bob Henry

W9ARA

HENRY RADIO SHOP

BUTLER, MISSOURI

WORLD'S LARGEST DISTRIBUTOR OF AMATEUR RECEIVERS

RADIAL CONE SPEAKER PROJECTORS

University Laboratories
195 Chrystie St., New York, N. Y.

MODEL RBP radial cone speaker projector is replacing University RLP radial cone speaker projector line because in addition to utilizing the “Infinite Baffle” principle of obtaining an added response on the low frequencies, it is very compact in size. Its flat top design is suitable for ceiling or single suspension mounting. This model is made entirely of steel with a “Floating Rubber” speaker mounting and “Non-Resonant” rubber rims. Another important feature is that it is waterproof for outdoor use. This instrument is especially useful for music reproduction in defense factories. It is available for 12 inch and 8 inch cone speakers.—Radio-Craft

OIL-FILLED PLUG-IN CAPACITORS

• **IN STEP** with the growing popularity of the plug-in capacitor technique, already widely used in the electrolytic and wax-filled paper types, the Aerovox Corporation announces a new Series-72 oil-impregnated oil-filled capacitor with four-pin base that fits into a standard UX socket, as distinguished from the octal base of other plug-ins.

The aluminum-sprayed tin-plate pound can comes in 2, 2½ and 3” diameter sizes, and from 2½ to 4¾” high. It is provided with a mounting ring with lugs, so as to be held securely in place and in accordance with Underwriters requirements. These oil-filled plug-ins are available in single-section units up to 16 mfd., and up to 4-4-4 mfd. in multiple-section units, in both the 400 and 600 v. D.C.W. ratings.

These plug-in oil-filled capacitors are particularly desirable for equipment used by the Army, Navy, police, broadcast stations, public address and sound movie systems.

SPECIAL

The books listed below have never been sold by us before. The value of each book is 50c. They are exactly the same as RADIO & TELEVISION'S 50c blue books which have been on the market for years. For a short time only we are selling these at a special reduced price of only 75c for the 3 books. All of the books contain numerous photographic illustrations and diagrams and have stiff flexible cover.

ABC OF TELEVISION

Contains latest material on Television developments. It covers theory of scanning; simple television receiver; how the eye sees; the photo-electric cell; neon lamps; need for broad channel width in transmission of high-fidelity television signals; cathode ray tube and television receivers; Farnsworth system of television transmission, and other important features.

SHORT WAVE GUIDE

Covers hundreds of short-wave questions and answers; illustrates popular short-wave kinks; gives explicit instructions for building simple short-wave type antenna installation; diagram and construction details for building transmitters.

S. W. RADIO QUIZ BOOK

This book covers questions and answers on transmitters, short-wave receivers; practical windings; data; novel hook-ups for experimenters; noise silencers, power supplies, modulators, beat oscillators, antennas, prospectors, 5-meter receivers.

Popular Book Corp.,
25 W. Broadway,
New York, N. Y.

Gentlemen:
Enclosed you will find remittance for 75c (cash, new U. S. stamps or money order accepted) for which please send me at once your 3 books
ABC OF TELEVISION SHORT WAVE GUIDE SHORT WAVE RADIO QUIZ BOOK

Name

Address

City State R&T-2-42

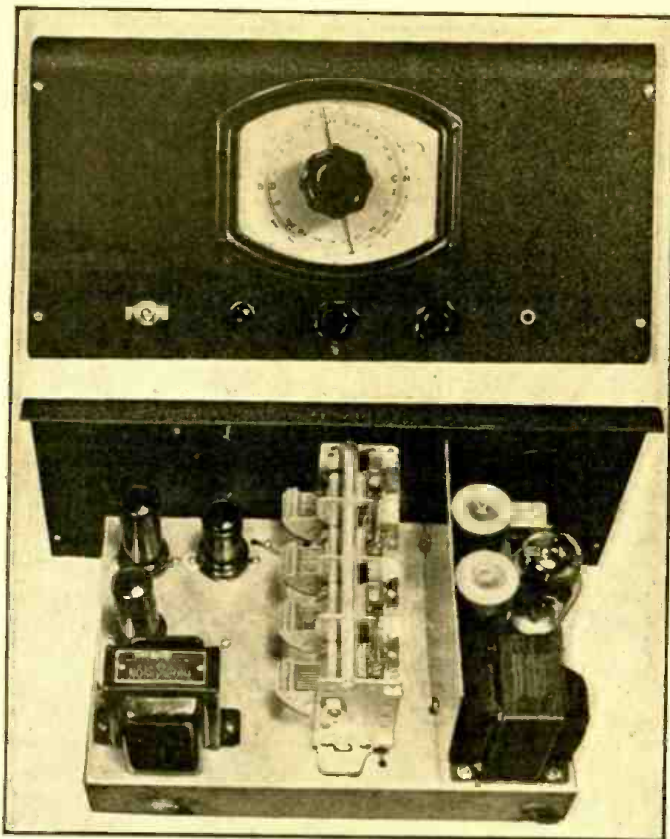

Front and rear views of the Bridge.

Constructing

A

"Wien Bridge" AUDIO OSCILLATOR

BOB STANG

One of the features of the Audio Oscillator here described, is that it is unnecessary to re-calibrate the instrument each time it is put into use. Basically, the circuit is the conventional Wien Bridge, the arms of which are made up of resistance and capacity.

THE recent advent of Frequency Modulation receivers and their supplementary use of high fidelity amplifiers has made the Audio Oscillator a very useful piece of equipment to have around the service shop. In measuring audio amplifier gain and fidelity response, and in the testing of speakers and the acoustic response of cabinets as well as in over-all receiver fidelity tests, the *audio oscillator* has become an essential adjunct to the Signal Generator.

Very good audio oscillators are available commercially but partially for reasons of

economy and in addition—because the author is an incorrigible experimenter—it was decided to see what could be done with a home-built job. A quick survey of the types of oscillator in common use developed a great deal of interest in the recently innovated Wien Bridge type of so-called RC oscillator, primarily because it is unnecessary to re-calibrate this instrument each time it is put into use, and for other reasons that will make themselves obvious. The Audio Beat oscillator was rejected for the reason mentioned and because the audio signal is not a fundamental one.

THE CIRCUIT

The resonant frequency of the circuit is determined by the choice of the paired resistors. With the circuit constants listed, the frequency bands covered were 15 to 150, 125 to 1500, 1300 to 13,500, and 11,000 to 80,000 cycles. It was found possible to make oscillations go readily to 1.5 mc. by using resistors of 10,000 ohms, but due to a degree of attenuation at the higher frequencies and the lack of need in audio circuits for anything higher than about 20,000 cycles, this band was not added. A four-gang condenser of 365 mmf. per section was used with

Wiring diagram of the modified Wien Bridge described by Mr. Stang.

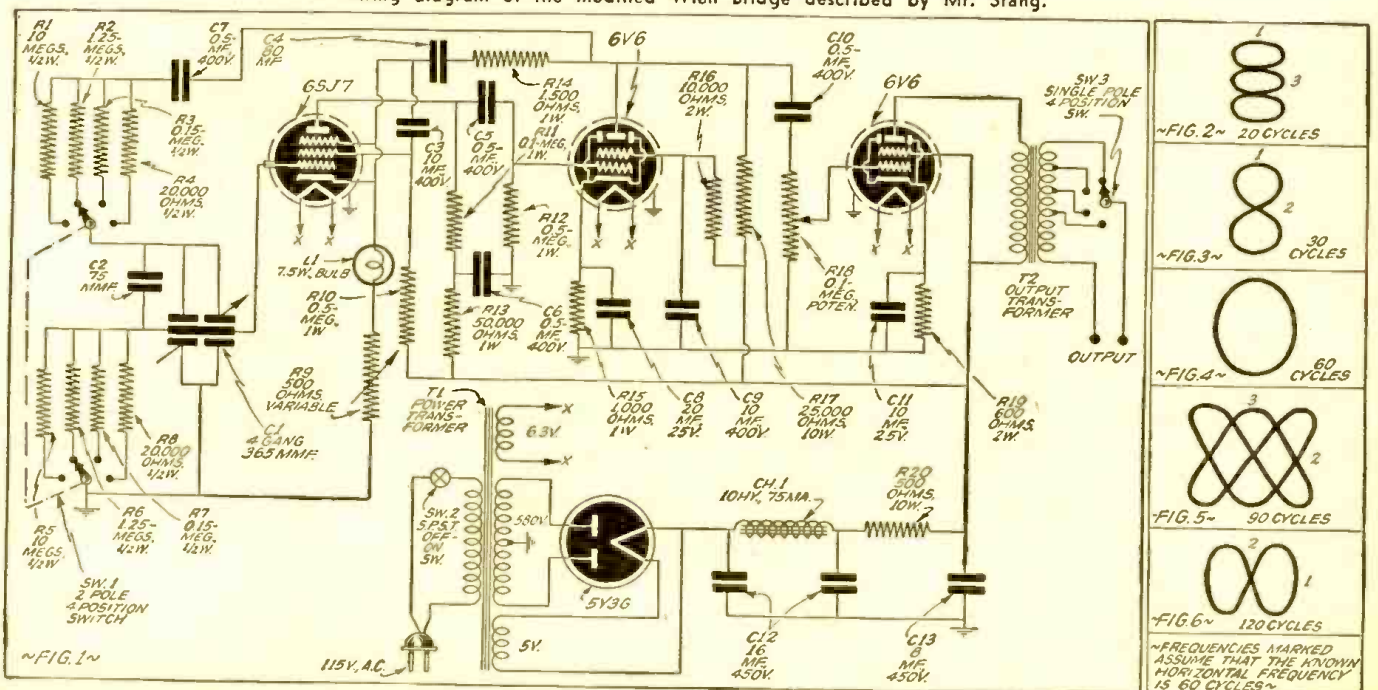

each two sections in parallel to obtain the high capacity required. This condenser must be completely insulated from the chassis, as the rotor is at the grid potential of the 6SJ7 tube. To compensate for the capacity of the gang condenser frame to chassis, a 75 mmf. padder is connected across the section above ground. Although it was hoped that the bands would coincide harmonically, this was not the case with the components used, and so resistors were chosen to give a degree of overlap and separate calibrations made for each band.

If the various components are placed as illustrated not much shielding will be required. The shield shown between the oscillator gang condenser and the power supply was a precaution against hum pickup, but is not necessary except at 30 and 60 cycles where a certain amount of interlocking with line frequency occurred. This same interlocking will also occur if the oscillator is used out of its metal case. No shield is required below the chassis if all leads are kept away from the power supply proper.

The variable degeneration control is not brought out to the panel as this control need only be set once for best wave form, and then should be sealed in this position. Within the useful limits of from about 20 to 20,000 cycles the wave-form is essentially sinusoidal, with less than 5% of distortion. The instrument should not require re-calibration for long periods of time if properly handled. It will be noted that if the dial is rapidly rotated the amplitude of the signal momentarily drops. This action is normal and amplitude will be resumed quickly as the automatic amplitude control action takes place.

The dial depicted was made up from odds and ends that happened to be on hand. It consists of a cardboard dial face which was fastened to the panel and on which the calibration marks were made in pencil. Later these marks were permanently made in ink and the dial carefully replaced. The pointer is a strip of phosphor bronze slipped onto the condenser shaft. A hole large enough to freely pass the condenser shaft was then drilled through the celluloid face of a regular radio escutcheon plate, which was then used to cover the dial. If these articles are not on hand any similar dial arrangement can be used, or a conventional numerically calibrated dial can be used and separate graphs drawn up as a calibration reference. The only important consideration where the dial is concerned, is that it be firmly fixed and that it does not slip so that calibration will be affected.

The tapped output transformer makes it possible to feed an audio signal into loads of various impedances. A good quality transformer should be used, if constant output throughout the audio range is desired. The impedance taps chosen were 10, 250, 500 and 5,000 ohms. These were found most convenient for ordinary applications. It is necessary to at least approximate the impedance of the load with the tap chosen, if good wave form is to be had. If it is desirable to feed the output into high impedance circuits such as directly into the grid of a tube, the 5000 ohm tap should be used and a fixed resistor of about 5000 ohms should be connected directly across the output terminals. About 1/2 watt is available at the output terminals, the output voltage varying from about 2 volts to approximately 50 volts, depending upon the impedance tap used. This output power is sufficient for testing speakers without the necessity for any additional amplification and can also be used to directly (externally) modulate a Signal Generator for overall receiver fidelity tests. These tests can be easily made by connecting the audio

oscillator to the signal generator posts marked "external modulation" and then connecting the signal generator to the antenna and ground posts of the set.

An output meter is connected across the speaker voice coil of the set to be tested and the signal generator varied over the audio range. The limits to which the output voltage remains comparatively constant are the fidelity limits of the receiver. It is important to make sure that the receiver is accurately tuned to the frequency of the signal generator while this test is being made.

CALIBRATION OF THE OSCILLATOR

Before attempting to calibrate the oscillator make sure that the dial pointer is set to that point on the dial that represents the lowest frequency to be calibrated, and that the gang condenser at this point is at maximum capacity. The oscillator and any auxiliary equipment used in calibrating it should be allowed to warm up for at least half an hour before beginning.

The easiest way to calibrate an audio oscillator is by beating its output against that of an already calibrated oscillator. If one is not available but there is on hand, or access can be had to an oscilloscope, with a built-in saw-tooth sweep, the same purpose can be accomplished by the use of Lissajou's figures. These oscilloscopic patterns, five simple examples of which are illustrated in Figs. 2 to 6, indicate a relationship between the frequencies of the voltages applied to the vertical and horizontal deflection plates. In this case the frequency on the horizontal plates will be the known frequency of the A.C. line or the internal sweep of the instrument, the first is also used as an adjustment level for the latter. The ratio of the number of nodal points in the vertical plane to the number in the horizontal plane of the oscilloscope pattern, indicates by what number we have to multiply the known horizontal frequency to get the unknown vertical frequency, in this case the audio oscillator.

For example, if we connect the 60 cycle line as the horizontal frequency and connect our oscillator to the vertical plates, and vary the oscillator until a pattern like Figure 2 appears, since the ratio here is 1 to 3 or 1/3 our frequency is 20 cycles. In like manner Fig. 3 would mean 30 cycles, and Fig. 4, a circle, means the two frequencies are the same. If on the other hand, the known frequency were 600 instead of 60 cycles, the frequencies discussed would be 200, 300 and 600 cycles respectively.

To begin with, follow the procedure described above, marking your determined points in pencil on the dial. When the complexity of the patterns makes it difficult to be sure about the frequency, carefully set the oscillator to some round figure frequency such as 300 cycles. Replace the 60 cycle line sweep with the built-in saw-tooth oscillator of the scope, and carefully adjust its frequency until just one sine wave shows as the pattern. The frequency of the sweep is now 300 cycles and the same computations as above may be continued with this new figure as the denominator of the ratio.

YESTERDAY
TODAY
TOMORROW

← SUPREME



Every instrument scientifically engineered and soundly built for dependable, accurate, profitable radio servicing. See your Jobber or write for new catalog.

SUPREME INSTRUMENTS CORP. GREENWOOD, MISSISSIPPI

GETS DOWN TO BUSINESS RCP Test Equipment ..priced down, too!

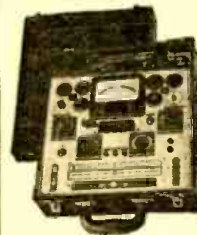

You are just as determined as the next American to put an end to non-essentials for the duration of the emergency. Are you still paying, then, for "non-essentials" in the test equipment you buy . . . paying more for test instruments than you need? Not if you are one of the thousands changing over in these critical times to RCP Test Equipment. In designing this low-cost line, RCP engineers got right down to business, saving materials for defense . . . saving important money for you. Every essential is in every model in the complete RCP line, engineered ahead to increase your efficiency, enable you to handle more jobs in less time. Only the "frills" have been eliminated! That's why today, more than ever, it pays to specify RCP test equipment—and get what you pay for. Ask for CATALOG NO. 125 Just Off Press

RADIO CITY RCP
dependable
test
instruments

PRODUCTS COMPANY, INC.

88 PARK PLACE • NEW YORK, N. Y.

BUILD

the RADIO CITY PRODUCTS CO.

MULTI-RANGE
TESTER

Complete Kit of parts. Outstanding value	\$19.53
Special sale on Radio City Products #446. Complete Kit of Parts	\$9.70
Regular factory wired unit	\$11.70

Both Kits now ready for immediate delivery.
ASK FOR FREE CATALOG

ADSON RADIO

221 Fulton St., New York City

ARMY COLLECTING JALOPY SETS; DEALERS STAND TO GAIN

These days, radio dealers may be singing the Priority Blues, but they will have to thank Defense for one thing—cleaning out the obsolete jalopies of the radio world—if a movement now under way in Boston, Mass., becomes nation-wide.

The Army has asked the citizens of Greater Boston (population about 1,000,000) to contribute 1500 old and disused sets for the men in the service; and a house-to-house collection campaign is under way to ferret them out and speed the donations.

It is stressed that these sets need not be in working condition, for the local NYA radio workshop stands ready to recondition all radios, from console to midget, so as to make them real assets to civilian morale.—Gardner Barker

•LATEST RADIO APPARATUS•

BUY DIRECT FROM THE MANUFACTURER AND SAVE



THE NEW MODEL 1230 SIGNAL GENERATOR WITH 5 STEPS OF SINE WAVE AUDIO SPECIFICATIONS:

1. Combination R.F. and A.F. Signal Generator, R.F.—100 K.C. to 90 Megacycles. A.F.—200 to 7500 cycles; Sine-Wave.—WITH OUTPUT OF OVER 1 VOLT. All direct reading, all by front panel switch manipulation.
2. R.F. and A.F. output independently obtainable, alone or with A.F. (any frequency) modulating R.F.
3. Latest design full-range attenuator used for controlling either the pure or modulated R.F.
4. Accuracy is within 1% on I.F. and broadcast bands; 2% on higher frequencies.
5. Giant dial etched directly on front panel, using a new mechanically perfected drive for perfect vernier control.
6. Operates on 90 to 130 V. A.C. or D.C. (any frequency).

By every criterion this Signal Generator is the one to buy! The price is so low that it is impossible to get such extensive performance even at considerably higher price; and the care taken in calibration, manufacture and testing is such that even the makers of high-priced laboratory instruments can offer no more. For example, no trimmer or padding condensers are used in this model. Instead, all the coils are overwound and turns are removed from each individual coil until the dial tracks. This enables us to compensate for the difference in the distributed capacity in the wiring of each individual instrument thus insuring permanent accuracy. The Model 1230 comes complete with tubes, shielded cables, carrying handle, and instructions. Size 12" x 6" x 9". Shipping weight 15 pounds. **\$14.85**

SUPERIOR INSTRUMENTS CO. 227 Fulton St. Dept. 80
New York, N. Y.

Latest IN RADIO

NEW 15-WATT AMPLIFIER

- A NEWLY developed 15-watt amplifier which achieves an increase in operating efficiency when compared with an earlier model it replaces, has been announced by the RCA Manufacturing Company.

While rated at 15 watts, the new MI-12222 unit is capable of 21 watts of output as a maximum. At its rated output, distortion is less than 3½%. Provision is made for microphone and phonograph inputs, the former at 560,000 ohms, and latter at 500,000 ohms. A terminal board is provided for



making output connections. Separate volume controls are supplied for the microphone and phonograph inputs. A continuously variable tone control and voice-music switch are also incorporated in this amplifier.

Gain of 125 db. is provided for the microphone input, 85 db. for phonograph. Frequency response is from 30 to 10,000 cycles. Dual control intro-tube mixing is another feature of the new unit. The fuse is easily accessible. A microphone plug is furnished with the unit. It is housed in an attractive grey cabinet. Its dimensions are 14½" long, 8¼" deep, and 8¼" high.

HARTFORD BOOSTS FM RADIO SALES

- THE largest department store in Hartford, Conn., took a flyer at interesting its radio customers in frequency-modulation, with all stops pulled, during one week in October. The results were highly gratifying to all concerned. Actual receiver sales developed as a result of the show

were not made available, but the store placed a large order with G. E. Supply Corporation for radio merchandise as a result, and signified its intention of ordering further if the merchandise would be available.

During the show week of October 11-18 all major radio manufacturers contributed various features, but customer interest centered largely in the General Electric motion picture in color, "Listen—It's FM" and the miniature FM demonstrator, which was publicized as the "smallest FM transmitter in the world".

The show was located in Sentinel Hill Hall on the 11th floor of the G. Fox store. Publicity and advertising in all elevator cars, in the Hartford "Courant" and "Times", and through radio stations WTIC and WDRC, was supplemented by promotional material, including several thousand postal card invitations to the movie and demonstration. Postal card invitations were sent to many more thousands of customers asking them to listen to the radio program broadcast three times a week for 13 weeks on WDRC.

A NEW HIGH-FREQUENCY RADIO TRANSMITTING TUBE

- A NEW radio transmitting tube especially designed for high-frequency applications has been announced by the Vacuum Tube Department of the General Electric Company. Designated GL-8009, this water-cooled tube is similar to the GL-880, but has a six-pole terminal mount, and can be used as a Class B modulator, a radio frequency amplifier, and an oscillator.

The design of the terminal mount connections and the inverted anode minimize lead inductance. While designed primarily for television service the tube is suitable for any high-frequency broadcast application. It can be used up to 25 megacycles at maximum ratings, and up to 100 megacycles with reduced ratings. The tube has a plate voltage rating of 10,500 volts maximum at a plate current of six amperes, Class C telegraph service.

GLASS AS AN INSULATOR

- ELECTRICAL and radio engineers interested in the use and potentialities of glass as an insulating material will find useful coordinated information and data in "THE DIELECTRIC STRENGTH OF GLASS—AN ENGINEERING VIEWPOINT." This recent study, by E. B. Shand, is now available in reprint form. The study is organized under three main head-

ings: I. Dielectric Failure of Glass. H. Factors Governing Failure. III. Curve Data. Tables and Data Curves include—Disruptive Strength; Graphic Representation of Breakdown Characteristics; Selected Dielectric Breakdown Data for Glass; Selected Breakdown Data for Porcelain; Oil Puncture Tests on Power Insulators; Dielectric Breakdown Characteristics of "Pyrex" Glass and Porcelain.

Mr. Shand's study was recommended by the AIEE committee on basic sciences.

Copies of "THE DIELECTRIC STRENGTH OF GLASS—AN ENGINEERING VIEWPOINT" may be obtained, without obligation, from the Insulation Division, Corning Glass Works, Corning, New York.

LONG-PLAYING NEEDLE

- LONG-PLAYING NEEDLE: A new long-playing needle, capable of playing 4,000 phonograph records without changing, has been developed in the Philco Research laboratories. It is said to be the only long-playing needle that can be used on the old, heavy electric phonograph arms without increasing record wear. The outstanding characteristic of the new needle is its hard point made of a highly polished precious metal.

Sound System for Line or Battery Operation

Montgomery-Ward & Co.

618 W. Chicago Ave., Chicago, Ill.

- THE accompanying picture shows a 35-watt Airline Mobile Sound Amplifier, which obtains the power from either 105- to 125-volt, 60 cycle A.C. line, or from an ordinary 6-volt storage (or car) battery.

The outfit consists of the amplifier with a built-in record-changer and cover. The mike and adjustable floor stand are included. Also two heavy-duty 12-inch P.M. speakers, with 35 feet of cord and plugs, besides two all steel projectors and auto-top platform for the horns. This 35-watt mobile amplifier is available in 15 different equip-



ment styles. The purchaser may have the choice of selection between the built-in record-player and record-changer. Both are fitted at the factory with a new long-playing needle.

The record-changer plays as many as 12 ten-inch or 10 twelve-inch records.

The amplifier proper is designed with an "eye-level" control panel, which includes individual bass and treble controls. The volume of each mike may be controlled individually, although a fader control varies the gain between mike and phono. This permits making instant announcements during the musical program, either with or without interruption in the music. The amplifier includes 10 tubes; the battery consumption at 6 volts is 22 amperes. Fuses are provided in both A.C. and 6-volt battery lines.—Radio-Craft

MULTI-RANGE TESTER

Precision Apparatus Co.

647 Kent Ave., Brooklyn, N. Y.

THE new Precision Series 832-A is a 31-range, compact A.C.-D.C. multi-range tester. It is built to withstand abuse and rough handling in services to which compact instruments are routinely applied, as in radio service, amateur radio, troubleshooting, etc.

Though small in size, 7x4½x3 inches, it incorporates ranges to 1200 volts D.C., 2400 A.C., 5 megohms, 600 milliamperes and 62 db. The 3-inch square bakelite cased, 800 microampere meter features a scale plate design that has been carried through in black, red and white with large-sized numerals, for maximum visibility. This instrument has an accuracy of 2% D.C. and 3% A.C. The wire-wound shunts and matched metallized multipliers are 1% accurate.—Radio-Craft

NEW DYNAMIC MICROPHONE

• THE TURNER CO., Cedar Rapids, Iowa, is offering a new Dynamic Microphone, Model No. 211, for radio stations, loud-speaker systems, P.A. men, bands, and others requiring a microphone with extended high frequency range. This mike utilizes a new type magnet structure and acoustic network, offering outstanding performance characteristics.



Modern engineering has extended the high frequency range, and the extreme lows have been raised 2 to 4 decibels, to compensate for over-all deficiencies in loud-speaker systems. The unique diaphragm structure results in extremely low harmonic and phase distortion, without sacrificing high output level. The model 211 is equipped with tilting head, balanced line output connection and 25 feet of heavy duty cable. It is finished in rich satin chrome.

HIGH-FREQUENCY IRON CORES

• IN ADDITION to automatic high-speed molding machinery for turning out the usual pressed pieces, Henry L. Crowley & Co. is using a new and exclusive fabricating process for a still wider variety of lengths and shapes. Pieces are also being machined with extreme mechanical accuracy, to meet precise requirements. The versatile fabrication of this plant which has long specialized not only in high-frequency iron but also in custom-built ceramics, makes possible the economical production of either a handful of special pieces, or tens of thousands of standard pieces, thereby meeting the needs of instrument makers and special equipment builders, as well as those of the mass-production set manufacturer.



These iron cores are available in exceptionally large pieces. Large cores are produced for radio transmitting and carrier-frequency purposes, for fine instruments, for induction furnace and X-ray applications, and many other out-of-the-ordinary usages. L-shaped cores, discs, spools, rings, tubes and other shapes are being made, in addition to cores, cuts and plungers for the coils and permeability tuners of radio sets.

HOWARD TO FEATURE F.M.

• THE Howard Radio Company announce their new 1942 F.M. receivers, as well as other new models. This company is very enthusiastic about the new F.M. sets, and particularly about the possibilities for F.M. during the coming year. For the first time, Howard sets will be housed in cabinets constructed in their own new cabinet plant.

Besides F.M. receivers, the Howard company have a complete line of the latest model recorders, radio-phono combinations and standard broadcast and communications receivers.

NEW RADIO INVENTION AMAZES AMERICA!
9 BANDS STARTLE RADIO ENTHUSIASTS

MIDWEST'S NEW METHOD
PLENTY OF ROOM FOR TUNING STATIONS

ORDINARY METHOD
STATIONS TOO CROWDED

9 BANDS

(ON SIX DIAL SCALES)

Super Band Spread Circuit
Makes Foreign Tuning 20 Times Easier!

SAVE UP TO 50%
FACTORY-TO-YOU

PUT THIS CHASSIS IN YOUR PRESENT CABINET

30 DAYS TRIAL

EASY TERMS

UP TO \$50 TRADE-IN

\$19⁷⁵

COMPLETE CHASSIS
With Speaker, Tubes, Push Button Tuning... Magna Tenna Loop Aerial... Ready to Plug In and Play

UP TO 16 TUBES

HERE'S the newest and most exciting of radio inventions—9 bands in a low-priced radio! A "headline" development, this new Midwest feature gives you not just 3 bands, not just 4 bands, not just 5 or 6 bands—but 9 BANDS (on 6 dial scales). Remember! You get the wholesale factory-to-you price when you buy direct from the Midwest factory—you save up to 50%.

Try any new 1942 Midwest model... from 5 to 16 tubes, from \$13.60 to \$169.95. But, regardless of which one you choose... whether 5, 6, 8, 11 or 16 tubes... whether radio-phonograph or radio, you get 30 days trial—in the privacy of your own home—before you make up your mind. Absolutely no obligation.

MIDWEST RADIO CORPORATION
DEPT. 12-F CINCINNATI, OHIO

USER AGENTS WANTED

RADIO-TELEVISION

Oldest, largest Radio-Television school in West trains you for good pay job. Complete instruction including Radio Construction and Service, Broadcast Operating, Sound, Talking Pictures, Television, Public Address, etc. Flexible plan to meet specific needs of those with or without jobs. Transportation allowed to L.A. Earn room and board while learning. Request Free Catalog.

NATIONAL SCHOOLS, Dept. RC-1 Los Angeles

93 SOUND SYSTEMS INSTALLED

• A RECORD-BREAKING total of 93 major sound amplifying and reproducing systems were installed by the RCA Manufacturing Company during a recent 30-day period.

Twelve 100-watt RCA loudspeakers are doing yeoman duty in the Roanoke classifying yards of the Norfolk and Western railroad, constituting one of the most powerful systems of its type in the world. Since the installation, operations in the yard have been carried on with a notable increase in efficiency.

Another unique sound installation has been completed at the Des Moines Ordnance Plant. This system includes a master control station in the Administration Building where microphone, radio and phonograph facilities have been provided. Remote microphones are provided as well as the telephone switchboard (for paging) and at several other points in the plant.

During the 30-day period RCA sound systems were installed in 21 schools and colleges, 12 industrial plants, eight churches, seven U. S. Government projects, 11 hotels, hospitals and institutions, and in many miscellaneous locations.

NEW FARM RADIO SETS

• A NEW line of 1942 "Farm Radio" receivers, incorporating many innovations, has just been announced by Philco.

Of the six new receivers which comprise the new Philco line, four are housed in table model cabinets and two are consoles.

The Philco 125K, with a striking walnut console cabinet, features the new 1 1/2 volt farm radio circuit with two I.P. stages, and makes possible 4 times the selectivity and 3 times the sensitivity of previous farm radio sets.

The Philco 123F is also contained in a newly-

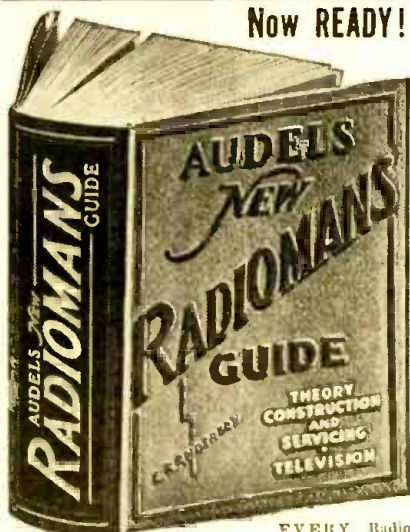

RADIO

EVERY Radio Mechanic—Service Man & Student Needs "Aude's Radiomans Guide"—Now Ready!

The whole subject of Modern Radio—covering the Basic Principles—Construction & Operation—Service—Repairs—Troubles—All Easily Understood. Over 750 Pages, 400 Illustrations, Parts & Diagrams—LATE TELEVISION DATA—Valuable for REFERENCE AND HOME STUDY.

4 To get this practical information in handy form for yourself fill in and mail coupon today.
COMPLETE • PAY ONLY \$1 A MO.

AUDEL, Publishers, 49 W. 23rd St., N. Y. Mail AUDEL'S NEW RADIOMANS GUIDE for free examination. If O. K. I will send you \$1 in 7 days; then remit \$1 monthly until price of \$4 is paid. Otherwise, I will return it.

Name: _____
Address: _____
Occupation: _____
Reference: _____ RCF

designed console cabinet and features such innovations as the 1 1/2 volt farm radio circuit with 5 super-efficient tubes, new large chassis, phase-inverted push-pull pentode audio system, etc.

• LATEST RADIO APPARATUS •



Typical Par-Metal quality: Model DL-3513 streamlined cabinet rack.

Also custom-made jobs, precision engineered to specifications.

ENGINEERS WORKING ON DEFENSE ORDERS:—Write on your company letterhead for our Catalog No. 41.

PAR-METAL PRODUCTS CORP.
32-62 49th St., LONG ISLAND CITY, N. Y.
Export Dept. 100 Varick St., New York, N. Y.

LEARN TO SEND AND RECEIVE CODE

Learn to send and receive code signals, like operators on ships at sea, commercial and amateur land stations. Intercept distress signals, news flashes, bulletins, and many other kinds of interesting radio communications. MASTER TELEPLEX teaches you to receive code exactly the way the world's best operators do—by sound. A specially prepared paper tape, running through a machine, operates an automatic key which sends messages to you, at any speed you desire. There are **NO PERFORATIONS**—NO INK. Far superior to anything ever developed... a marvel of simplicity. As you improve, the machine sends faster, gradually preparing you for top-speed. With the new all Electric MASTER TELEPLEX you learn to send by sending and the signals you send are repeated back to you, exactly as you sent them, thus enabling you to correct your own errors. We furnish a complete course, lend you the Improved All Electric MASTER TELEPLEX and give you personal instruction with a **MONEY BACK GUARANTEE**. Send for our new TELEPLEX FOLDER R N 1 today. **IT'S FREE.**

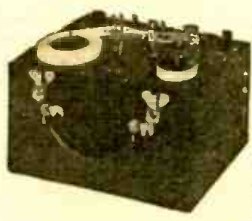

TELEPLEX CO., 107 HUDSON ST., JERSEY CITY, N. J.

PATENTS—TRADE MARKS

Booklet concerning Inventions & Patents Form "Evidence of Conception" with instructions for use and "Schedule of Government and Attorneys Fees"—Free

LANCASTER, ALLWINE & ROMMEL
Registered Patent Attorneys
436 Bowen Bldg. Washington, D. C.

TAKE THIS PROVEN SHORTCUT TO SUCCESSFUL PHOTOGRAPHY

Enroll now at country's largest, best equipped school. Profit by our 32 years of experience in training men and women for photographic success. Individual coaching by experts, for Commercial, News, Portrait, Motion Picture, Color Photography. Resident or home study. Free booklet. **N. Y. INSTITUTE OF PHOTOGRAPHY, Dept. 11, 10 West 33 St., New York, N. Y.**

for **DEPENDABLE**
Crystal Control
BLILEY CRYSTAL UNITS

Ask Your Distributor for Circular A-8

ULTRA-HIGH-FREQUENCY CAPACITORS

• **ENGINEERED** and especially recommended for use in ultra-high-frequency radio transmitters, television and FM transmitters, as well as in miscellaneous applications in the ultra-high-frequency range, the new Type 1860 transmitting capacitor is now made available by Aerovox Corporation. In such applications this capacitor is readily adaptable for use as a fixed tuning capacitor, for by-passing, blocking, coupling and neutralizing, and as an antenna series capacitor. Losses are extremely low because of the highly refined sulphur compound utilized as the dielectric, the elimination of corona as well as the unique design and construction. The case is grounded and a single high-tension mica-insulated brass terminal is used. The aluminum case is 2" in diameter by 2" or 2½" high, and is provided with a mounting base with 2 holes for 10-32 screws. These units are available in .00001 and .000025 mfd. in 10,000 volts and .00005 mfd. in 5,000 volts.

HOME PHONOGRAPH LINE

• A **NEW** line of "Mirror-Tone" home phonographs has just been announced by John Meck Industries. Covered with brown tweed acro-cord, the "Bar Harbor" model has a built-in automatic record changer which will play a half-hour program



of 10 or 12 inch records. The case of this table model is acoustically resonated to provide improved tone quality. One-ounce low-pressure crystal pick-up and high-fidelity amplifier with specially matched speaker are included.

BLACKOUT-PANEL OSCILLOGRAPH

• **IN KEEPING** with the growing blackout consciousness of the times, the Allen B. Du Mont Laboratories, Inc., of Passaic, N. J., announce their new Blackout-Panel Type 208 Oscillograph which can be used under adverse lighting conditions or in total blackness when necessary. This feature may be particularly desirable in certain military applications.

The specially processed steel panel is treated with a non-radio active luminous paint that retains its maximum luminosity for several minutes after exposure to ordinary light, and can be comfortably observed for an hour or more after that. The glow is of the same color and intensity as the standard medium persistence screen of the cathode-ray tube used, thereby minimizing eye-strain. The Blackout Panel is now an optional feature with the Type

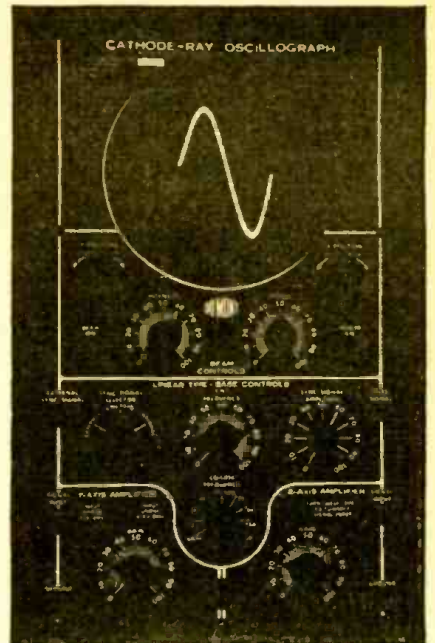

208 Oscillograph, providing still another refinement in this outstanding general-purpose instrument.

1942 HALLICRAFTERS "SKYRIDER 32"

• **THIS** newest receiver in the Hallicrafters line will offer unusual appeal to the more exacting amateur as well as to government, commercial and home defense services, not only for the variety of modern refinements and operating effectiveness which it offers but for its relatively modest cost.

In addition to the usual communications receiver features, this Model SX-32 offers such important ones as two tuned R.F. stages, six degrees of selectivity (three with crystal filter), wide-angle illuminated "S" meter, six tuning ranges for most satisfactory L/C ratios and uniformly high sensitivity, temperature-compensated oscillator, bandspread dial directly calibrated for 80-, 40-, 20- and 10-meter ham bands, antenna trimmer control on front panel for precise resonance at all frequencies, phono jack, A.C. line operation with optional choice of battery or external vibrapack operation through instantaneous change-over plug, etc.

The tuning range is from 500 kc. to 40 mc. in six overlapping bands. All bands are fully calibrated on main dial and the electrical bandspread system permits spread of any portion of the receiver's tuning range. Thirteen tubes are employed including separate H.F. oscillator and mixer tubes, two tuned R.F. stages, two dual tuned I.F. stages, A.V.C. amplifier, automatic noise limiting, B.F.O., audio voltage amplifier and push-pull 6V6 output.

Normally supplied with attractive steel cabinet, the chassis is equally well suited to standard rack mounting. For either method of mounting complete sturdiness is assured by the 14-gauge flame-welded chassis, ½-inch steel panel and box-girder type of construction for R.F. housing assembly.

Complete in cabinet the receiver is 20½" long, 14½" deep and 9½" high. The thoroughly ventilated cabinet is finished in machine-tool gray wrinkle with stainless satin trim.



The new 1942 Model of Hallicrafters Communications Receiver, known as the "Skyrider 32" is here illustrated. All of the necessary controls for extremely selective tuning are provided.

SUPER SPECIALS

New Radio Catalogs

Westinghouse Transmitting Tubes

● THIS looseleaf catalog contains pictures, tabulated data, as well as performance curves on the various radio transmitting tubes designed and built by the Westinghouse Co. Small as well as large tubes are included, and tubes suitable for broadcast stations as well are described. Rectifiers of various types are illustrated and described, together with diagrams for various types of rectifier circuits. High frequency tubes as well as standard types are described.

"Electrical Household Appliances"

● A VERY complete line of household electrical appliances, including radio sets of all styles and sizes, are included in this Westinghouse catalog. Air conditioners as well as refrigerators, sewing machines, electric heaters and stoves are described and elaborately illustrated, as well as toasters and electric hot plates, electric irons, mangles and washing machines.

Allied 1942 Radio Catalog

● ALLIED RADIO CORPORATION has brought out their new 1942 catalog. A large publication comprising 212 pages, it represents months of preparation. The catalog is printed with attractive covers in color.

Fifty new 1942 Knight radio models embodying the latest styling and new features are presented in a 32-page rotogravure section. Introduced are latest PM models, Phono-Radio and Radio-Recorder models in period styling, table models, portables, auto sets, farm radios, record-players, and an unusually complete selection of phonograph and recording accessories.

Thirty new sound systems are listed in the large public address section. These systems make use of the most recent developments in P.A. design and are available in ranges from 7 to 60 watts for all types of application.

For the Serviceman there are over 100 pages devoted to the latest test equipment and over 15,000 parts. Of considerable interest is the bargain merchandise sections and the pages of tools and supplies, also books and manuals on radio and electronic subjects.

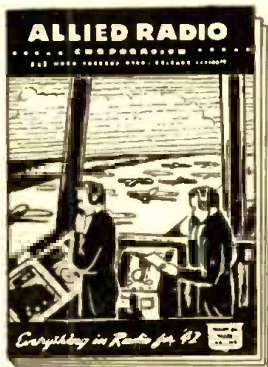

Fluorescent lighting is covered with a large special rotogravure section of its own. A wide variety of fixtures and lamps for the home, store, and industrial application is presented.

A large amateur section covers a wide selection of communication receivers and transmitters, tubes, keys, transformers, and complete parts and accessories for every amateur purpose.

A wide variety of radio set kits using from one to five tubes, accessories, diagrams, and all necessary builders' tools and supplies are listed. A number of kits and projects are listed, suitable for use in the radio training classes organized in connection with the National Defense program.

Precision Test Equipment—Standard of Accuracy—1942 Edition.—This bulletin describes a very interesting and attractive line of test equipment including multi-range testers, etc. Other instruments described and listed are AC/DC Volt-Ohm-Decibel-Milliammeter and testing apparatus suitable for television tests, FM and AM tests, etc. Small, portable multi-range meters suitable for making resistance and continuity tests are described; also signal-generators and industrial AC/DC circuit testers.—(Precision Apparatus Company, Brooklyn, N. Y.)

BL Electrical Rectifiers—Bulletin No. R-38.—This beautifully printed booklet in two colors answers the question "What is a Rectifier and How Does It Work?" Several interesting diagrams and descriptions are given on different types of dry-plate rectifiers manufactured by this company. A table is included, giving the maximum DC output in volts and amperes for different sizes of rectifiers, and the size of the plates for the different loads.—(The Benwood Linze Co., St. Louis, Mo.)

All of the attractive items listed here are brand new. ALL are in PERFECT WORKING ORDER. In many cases, the parts alone total more than the price we are asking. 100% satisfaction guaranteed or your money refunded. ORDER FROM THIS PAGE. Use the convenient coupon below. Include sufficient extra remittance for parcel post charges, else order shipped express, collect. Any excess will be refunded. C.O.D. shipments require 20% deposit. If full remittance accompanies order, deduct 2% discount. Send money order, certified check, new U. S. stamps. No C.O.D. to foreign countries.

ORDER TODAY LIMITED QUANTITIES PROMPT SHIPMENTS ASSURED

HANDY WORKSHOP OUTFIT

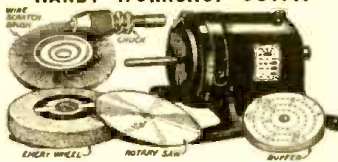

Here is a marvelous article that to the best of our knowledge has never sold at such a low price. This outfit must be seen to be appreciated. It delivers the goods! It comprises a variable speed universal motor for 110 volts A.C. or D.C. Made originally for dictaphone machines by American Gramophone Co. Motor is reconditioned and in excellent condition; all other parts are brand new. Special lever control permits various speeds up to 3000 r.p.m. Measures 7 1/2" x 3 1/4" diam. overall.

Included in the outfit are the following items, as illustrated: 1. excellent chuck which takes drills and other tools—chuck is easily screwed to motor shaft; standard emery wheel, 4" diameter; fine steel rotary saw, 8" diameter; wire scratch brush, 4" diameter; standard cloth buffer, 3" diameter. Total Wt. 9 lbs.

ITEM NO. 149 Complete outfit, including motor. **\$4.95**
Your Price

WESTON MODEL 562 A.C.-D.C. AMMETER

Designed by Weston for the Eastman Kodak Co. It is a precision-built magnetic-vane type ammeter which, with suitable shunts, can be used as a milliammeter too. It is 2" in diameter and designed for panel mounting. Bakelite base and black-enamelled cover. Shp. Wt. 2 lbs.



ITEM NO. 35 Your Price **\$1.25**

POWERFUL ALL-PURPOSE INDUCTION MOTOR IDEAL FOR EXPERIMENTERS—101 USES

Sturdily constructed to precision standards, this self-starting shaded pole A.C. induction motor is powerful enough for a large variety of uses. Some of these are: Automatic Timing Devices, Current Interrupters, Electric Fans, Electric Chimes, Window Displays, Photo-cell Control Devices, Electric Vibrators, Small Grinders, Buffers, and Polishers, Miniature Pumps, Mechanical Models, Sewing Machines, Phonograph Motors, Coffee Grinders, Motion Picture Projectors, Motorized Valves, Sirens, and other applications. Consumes about 15 watts of power and has a speed of 3,000 r.p.m. When geared down, this sturdy unit will constantly operate an 18-inch turntable loaded with 200 lbs. dead weight—THAT'S POWER!

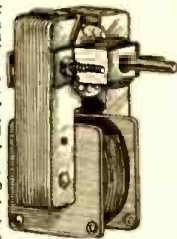

The motor is of midsize dimensions, 3 inches high by 2 inches wide by 1 1/2 inches deep; has 4 convenient mounting studs; shaft is 3/8" long by 3/16" diameter, and runs in self-aligning, oil-retaining bearings; the best materials, perfect precision assembly and rigid inspection certify to its high quality, and assure long life. Designed for 110-20 volts, 50-60 cycles, A.C. only.
ITEM NO. 147
YOUR PRICE **\$1.29**

100 POWER TELESCOPE LENS KIT



Make your own high powered 6 ft. telescope! Now you can thrill to a closeup view of the worlds out in space. See the rings around Saturn, the mountains of the moon! Kit contains 3" diam., 75" focal length, ground and polished objective lens and 2 astronomical eye-pieces, magnification 50x and 100x. Complete kit with full instructions.
ITEM NO. 123
YOUR PRICE **\$1.95**

NEW—EXTRA LARGE LENS KIT—contains completely finished 4" diameter 100" focal length ground and polished objective lens, three 1 1/4" diameter eye-pieces giving 65x, 135x, and 200x, an aluminumized diagonal for overhead viewing, and a color filter for insertion in any eyepiece.
ITEM NO. 123L
YOUR PRICE **\$3.95**

HUDSON SPECIALTIES CO., 40 West Broadway, N. Y. C.

IT'S EASY TO ORDER—CLIP COUPON—MAIL NOW ORDER FROM THIS PAGE.

HUDSON SPECIALTIES CO., 40 West Broadway, Dept. RC-1/42, New York, N. Y.

I have circled below the numbers of the items I'm ordering. My full remittance of \$..... (include shipping charges) is enclosed.

OR my deposit of \$..... is enclosed (20% required), ship order C.O.D. for balance. No C.O.D. order for less than \$2.00. (New U. S. stamps, check or money order accepted.)

Circle Item No. wanted: 11, 33, 35, 50, 87, 123, 123L, 147, 149

Name Address

City State

Send remittance by check, stamps or money order; register letter if you send cash or stamps.

WELDING! BRAZING! SOLDERING! 3-IN-1 PORTABLE ELECTRIC TORCH

WORKS FROM 110 VOLTS A.C. OR D.C. LINE

This electric torch is not a gadget or a toy but a sturdily built outfit using the finest materials. With it you are able to do professional type of welding, brazing and soldering work, regardless of whether or not you've had previous experience. It will do a thousand and one jobs: fender welding, auto body repairs, bumpers, cylinders, tanks and industrial repairs—ideal for steel fitters, plumbers, sheet metal jobs, engineers, maintenance men, radio and bicycle repair men, etc. Works on aluminum, brass, copper, iron, steel and other metals.

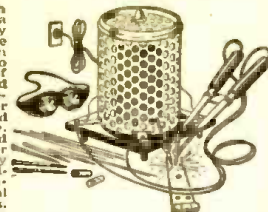

The 3-in-1 electric torch is so simply constructed that even a boy can operate it after reading the simple and concise instructions furnished with the unit. Not necessary to know how to strike an arc! All you do is plug the torch into the light socket, adjust the carbons per instructions, and presto—you have an intense, blazing flame, ready for work. The outfit comes complete with power unit, electric cord, electrode holder, carbons, brazing rods, blazing rods, solder flux, goggles and instructions.

Save money! Do your own repairs. Earn money by doing repairing for others. Simple, practical, durable and safe to handle—that's why the price is amazingly low. Don't delay—order one today. Shp. Wt. 8 lbs.

ITEM NO. 50 Your Price **\$6.95**

VARIABLE SPEED UNIVERSAL MOTOR

FOR 110 VOLTS, A.C. OR D.C.

Made for Dictaphone machines by American Gramophone Co. Used, but in excellent condition. Special lever control permits variable speeds up to 3000 r.p.m. 1/2" shaft extends from both sides of motor. Measures 7 1/2" x 3 1/4" diam. overall. Shp. Wt. 6 3/4 lbs.

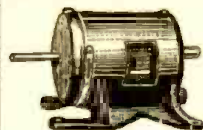

ITEM NO. 11 Your Price **\$1.55**

AMAZING BLACK LIGHT!!

Powerful 250-Watt Ultra-Violet Bulb



The best and most practical source of ultra-violet light for general experimental and entertainment use. Makes all fluorescent substances brilliantly luminescent. No transformers of any kind needed. Fits any standard lamp socket. Made with special filter glass permitting only ultra-violet rays to come through. Brings out beautiful opalescent hues in various types of materials. Great for amateur parties, plays, etc. to obtain unique lighting effects. Bulb only. Size of bulb.

Shp. Wt. 1 lb.
ITEM NO. 87
YOUR PRICE **\$2.00**

WESTINGHOUSE WATTHOUR METER

Completely overhauled and ready for immediate service. Designed for regular 110-volt, 60 cycle 2-wire A.C. circuits. Servicemen use it in their shops to check current consumption of sets, soldering irons, etc. Saves costs down. If dismantled, the parts alone would bring the price. The elaborate gear train could be used as a counter on machines. Various kinds simple to install: 2 wires from the line and 2 wires to the load. Sturdily constructed in heavy metal case. Size: 8 1/2" high, 6 3/4" wide, 2 1/2" deep overall. Shp. Wt. 14 lbs.

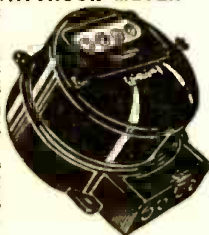

ITEM NO. 33 Your Price **\$4.50**

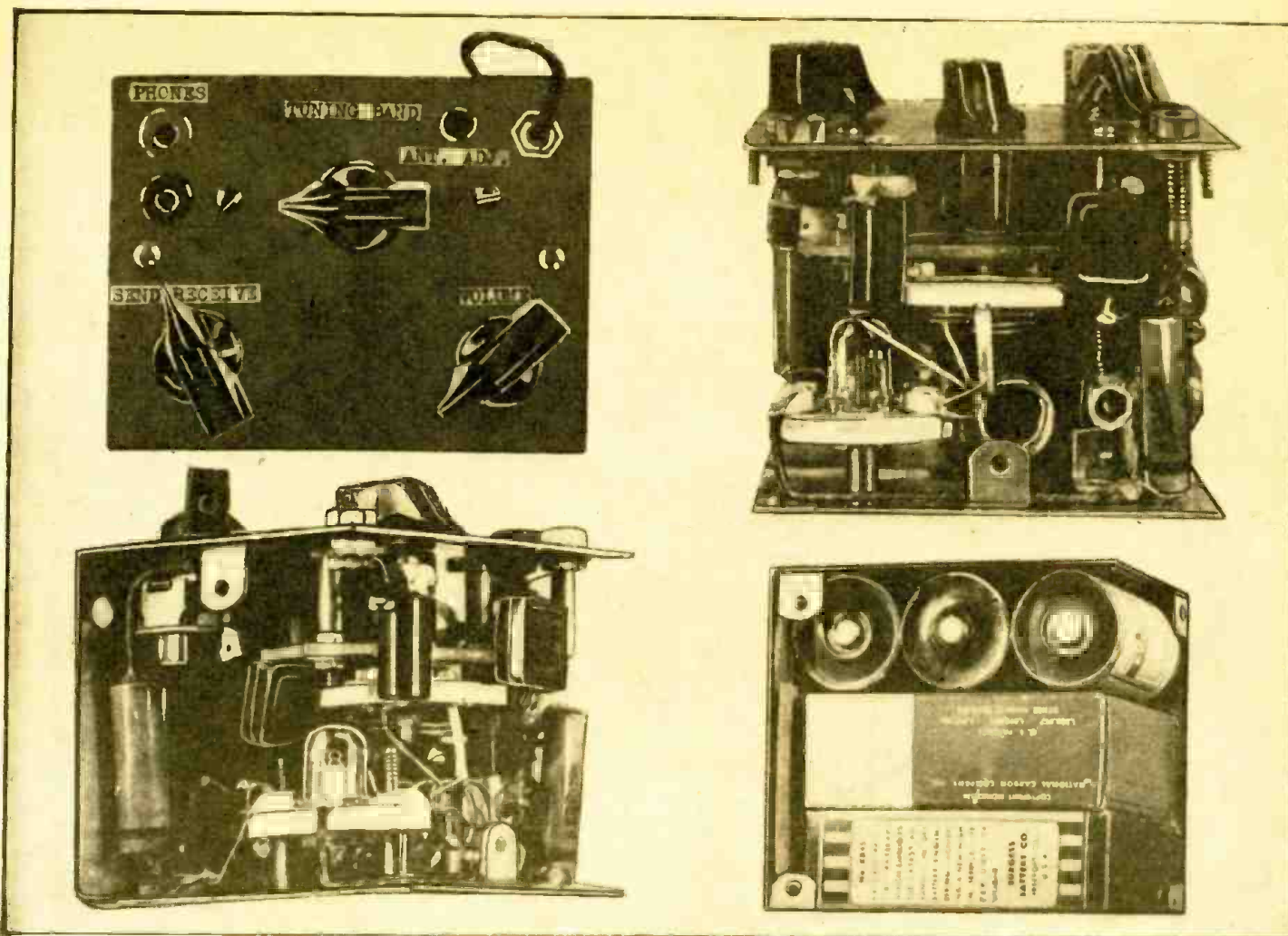

Several views of the Transceiver are shown above.

2½ Meter "Walkie-Talkie"

Transceiver

George F. Baptiste

**This article is published for study purposes only and must not be used for transmitting purposes, as all amateur stations have been ordered off the air since the declaration of war.*

● WITH the F.C.C. regulations* leaving only the 2½ meter band open for portable amateur transmitters equipment, here is a two-way "transceiver" that can be built at reasonable cost and gives excellent results. It is a three-tube outfit and weighs only four pounds, complete with all necessary equipment; its range will vary anywhere from two to fifteen miles, depending of course upon the location. This transceiver covers a frequency range from 90 to 150 megacycles and uses the miniature type tubes, along with one Acorn tube of the 1½ volt battery type. For batteries use is made of the 67½ volt miniature type; two of these are used, with three flashlight cells for the "A" battery. The tube line-up is as follows—1-958 detector and oscillator, 1-1S4 audio amplifier and modulator; an extra 1S5 is used as a speech amplifier; the reason for using the extra 1S5 is because crystal phones are employed for receiving and as a microphone when transmitting. A regular crystal microphone may be used by the addition of an extra jack—this will give

This pocket-sized 2½ meter transceiver uses flashlight cells for the "A" battery, and one of the new compact type "B" batteries. A 4-ft. antenna gave very good results in tests conducted by the author.

a higher audio output and more audio gain. There are many other possible combinations that can be used, simply by changing the speech input resistance to suit the microphone combination one desires to use. Another point is the low "B" battery consumption; the combination used will give well over 150 hours life. As for the flashlight cells their life will vary from twenty-five to thirty-five hours. The average Ham will find this Walkie-Talkie quite the thing for various trips.

Construction Data

Schematic diagram number one shows the circuit of the complete receiver. It is housed

in a small chassis that measures about three by three by four inches (see drawing number two); this is the chassis and battery cover layout. Drawing number three shows the correct dimensions for the drilling and laying out of the various parts in their proper position. Diagram number four is the receiver and batteries container; this can be made of aluminum or electralloy. After the chassis is cut to the correct size and the holes drilled, it can be bent and the various parts mounted. Before doing this it is best to mount the angle-brackets to hold the cabinet together. The angle-brackets are one-half inch with self-tapped holes, so that the receiver and battery case can be removed at will. Seven are needed, three for the receiver end and four for the battery and receiver part of the cabinet (see diagram). These brackets are marked so you cannot go wrong; of course this can be changed or altered to suit one's own need if desired.

The tuning condenser should be mounted on a piece of Quartz Q and insulated from the chassis; this will require two bolts (size

★ ★ ★ **THERE IS NO TOMORROW!** ★ ★ ★

Tomorrow never comes—is certainly a true saying, and waiting for tomorrow to better yourself will never pay dividends. Radio Code Operators are in constant demand by the Army, Navy and in civilian industry. You can prepare yourself now without leaving your own home. Find out today how the famous Candler System can put you in these higher paying positions.

**DELAYS DON'T PAY!
WRITE TODAY**

Start training at home—learn code the easy, practical way—the way thousands have been helped to better jobs.

FREE—52 page BOOK of FACTS!
there's no obligation
Mail the Coupon Today!

CANDLER SYSTEM COMPANY
Dept. S-1, Box 928, Denver, Colorado
Please Rush my FREE Book of FACTS

Name

St. and No.

City State

Choose the CANNON-BALL HEADSET You Like Best



Scientifically Built
Heavy bar magnets greatly increase their efficiency.

Rugged construction. Inside or outside terminals. Sensitive. Clear tone. Dependable quality. Headset Headquarters guarantees satisfaction. Write for folder C-2.

**C. F. CANNON COMPANY
SPRINGWATER, N. Y.**

GOLDENTONE... 50% OFF



DEAL DIRECT FACTORY PRICES.
Over 75 models to choose from—4 to 12 tubes. Portables \$8.98 up. Farm sets \$8.98 up. Car sets \$8.98 up. Foreign hand sets \$8.98 up. Samples 50% off. Quantity discounts. Free 1942 Bargain catalog gives details of 10-day FREE trial, agent's proposition and discounts. No obligation. Mail postcard to:
GOLDENTONE RADIO CO., DEPT. RC, DEARBORN, MICH.

COMMERCIAL RADIO INSTITUTE

A radio training center for over twenty years. Well equipped. Excellent faculty. Practical resident courses in Radio Telegraphy, Broadcast, Servicing, Industrial, Television, Aeronautical, Drafting, Mathematics and Studio Technique. Placement bureau. Classes now forming for mid-year term Feb. 9th. Catalog upon request.
Dept. D, 38 West Biddle Street, Baltimore, Md.

Nilson's MASTER COURSE IN RADIO COMMUNICATION



Fits you for a job, advancement or license examination. Course by A. R. Nilson for home study covers same scope as resident school course. Every Nilson graduate to date has commercial license.

FREE circular 3-C gives full information. Write today.

NILSON RADIO SCHOOL, 51 East 42nd St., New York

dial from minimum to maximum. Another method is to insert a millimeter in the plate circuit of the detector tube on the "B" battery side of the choke coil and adjust this for maximum plate current, at the same time adjusting the antenna trimmer. If a telescope antenna is used, vary its length for the desired results; while this is being done it may be necessary to rearrange the antenna tap terminal. The choke should be soldered as near as possible to the center of the tuning coil, with the antenna tap one turn away toward the plate side of the circuit. A slight rearrangement of this has a considerable effect upon the transmitted power and reception also.

Band Coverage: This can be changed to suit one's special requirements so that higher or lower frequencies can be covered. (See August issue of RADIO & TELEVISION.)

Results Obtained: During the "magnetic storm" that occurred during the month of July, this *transceiver* was in the construction stage and only the receiving end was working; stations on the 112 megacycle band were received at a distance up to 175 miles, and many more stations within that range. The band sure was wide open due to that magnetic storm. It may also be well to state that the *Ultra High Frequency Pocket Receiver* performed with the same results at that time. Almost unbelievable: of course an outside antenna was used and it was located in between a hill and down one hundred feet below the level of the hill. The antenna used was a *doublet* cut to 43 megacycles and tuned.

Transceiver Parts List

- HAMMARLUND (Condensers)**
1—HF-15 mmf. (with one plate removed)
1—3-15 mmf. antenna trimmer (or Meissner)
1—"Acorn" socket Type UHS-900—Isolantite
- JAMES MILLEN MFG. CO.**
1—Sheet of Quartz Q, 1/2 x 2 x 10 inches, standard length
- IRC (Resistors)**
2—20,000 1/2 watt
1—1 megohm 1/2 watt
1—2 megohm 1/2 watt
1—3 megohm 1/2 watt
1—10 megohm 1/2 watt
1—250,000 ohms 1/2 watt
1—150,000 ohms 1/2 watt

- RCA (Tubes)**
1—Type 958 1—Type 1S4 1—Type 1S5
- STANCOR (Transformers)**
1—Type A-53 Audio, 3-1 ratio "midget"
- YAXLEY MFG. CO.**
1—Switch 3100 Series—1 1/4 inch dia., 4 cir. 3-contacts

- AMPHENOL**
2—Miniature tube sockets (Polystyrene)
1—1/4 inch rod—standard length 12 inches

- SPRAGUE (Condensers)**
3—.1 mf. tubulars 400 volts
3—.02 mf. tubulars 400 volts
2—.0001 mf. mica (silvered mica)
1—.002 mf. mica

- BURGESS (Batteries)**
2—Type XX 45—67 1/2 volt miniature B battery (or Eveready No. 467)
3—Type No. 2 Uni-Cells (or Eveready Type No. 950)

- MISCELLANEOUS**
1—CRL volume control Part N-102 with switch plate, midget type
1—Victorine 1/4" bushing for antenna insulation
3—Bar pointer knobs, nuts, bolts, washers, wire, solder, etc.
2—Combination jacks for phone tips or banana plug
6—1/2 x 1/2 inch angle-brackets
2—United-Carr snaps (part No. 52280) for "B" batteries
2—United-Carr snaps (part No. 52281) for "B" batteries
2—Panels 7 x 10 inches—aluminum or electralloy (for cabinet and chassis)

DATAPRINTS

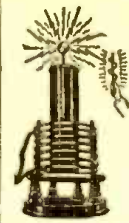

- TESLA-LOUDIN COILS**
20c Ea. in order for 10 (Data and Drawings only.)
36" Sp'k Tesla-Oudin Coil 40c
(1 K.W. Exc. Trf. Data incl.)
8" Sp'k Tesla-Oudin Coil 40c
(1/2 K.W. Exc. Trf. Data incl.)
3" Sp'k Oudin; 110 Vt. "Kick Coil" type..... 40c
3" Tesla Works on Ford Coil 40c
1" Sp'k Vibrator Hi-Freq. Coil 40c
NEW! 5 ft. Sp'k. Oudin Coil & Exciter Data 75c



- Induction PIPE & ORE LOCATOR**
Induction Type, Data 40c
Radio Type 40c

More DATAPRINTS 40c each!

- | | |
|--------------------------|-------------------------|
| 5 Meter Superhet. | Electric Refrigerator |
| 1/2 Meter Tr. & Rec. | Wheatstone Bridge |
| 20 A.C. Probs. & Ans. | Weld. Transf. 2 K.W. |
| 20 Telephone Hook-ups | Rewinding Armatures |
| 100 Mech. Movements | String Galvanometer |
| 20 Motor Hook-ups | 20 Simple Bell Circuits |
| Television Hook-up | Steel Wire Recorder I |
| 20 Elec. Party Tricks | Water Wheels |
| Solenoids and Magnets | Water Turbines |
| —get list. | Photo Cell and Relay |
| Fry Eggs on Ice! | Ring 4 bells: 2 Wires |
| Experimental Photo-phone | 20 Tesla Tricks |
| Radio Control for Models | Polarized Relay |
| Diathermy Apparatus | Induction Balance |
| Inductor Organ | Electric Pipe Thawer |

Special Prices: 4 prints \$1.00; 10 for \$2.00; Single, 40c each. Get New Catalog 100 A.

The DATAPRINT Co.
Lock Box 322D, Ramsey, N. J.

OPPORTUNITY AD-LETS

Advertisements in this section cost 15 cents a word for each insertion. Name, address and initials must be included at the above rate. Cash should accompany all classified advertisements unless placed by an accredited advertising agency. No advertisement for less than ten words accepted. Ten percent discount six issues, twenty percent for twelve issues. Objectionable or misleading advertisements not accepted. Advertisements for March, 1942, issue must reach us not later than January 20th, 1942.
Radio-Craft • 25 W. B'way • New York, N. Y.

EDUCATIONAL COURSES

CORRESPONDENCE COURSES AND EDUCATIONAL books, slightly used, Sold, Rented, Exchanged. All subjects. Satisfaction guaranteed. Cash paid for used courses. Complete details and bargain catalog FREE. Write Nelson Company, 500 Sherman, Dept. B-242, Chicago.

USED CORRESPONDENCE COURSES AND BOOKS. Code, Electricity, Radio, Spanish. (Courses Bought) Sold, rented, Catalog Free. V. W. Vernon, Summer-ville, Ga.

FLUORESCENT LIGHTING

24" FLUORESCENT BENCH LIGHT \$1.49. LESS TUBE. Harold Davis, Jackson, Mississippi.

FOR SALE

FOR SALE: 1 SPRING-OPERATED DYNAMO WATCH- men's flashlight, runs 6 mins. on one winding—\$4.00. 25 cal. "Powder-less" rifle (Crosley) \$5.00. Old "Indian Wars" Book (1850)—\$10.00. Fleming's (1908) Principles of Electric Wave Telegraphy—\$5.00. Harry Secor, % Radio-Craft, 25 W. Broadway, New York.

WANTED—EQUIPMENT

WANTED—USED HIFIDELITY DUAL SPEAKER AND possibly cabinet. State type. Glen Ouden, Terminal Island, Calif.

**REMEMBER PEARL HARBOR!
Keep 'Em Flying!
BUY DEFENSE BONDS**

• TO ALL YOUNG MEN OF AMERICA •

Today, as never before, trained radio men are in great demand not only for service in the armed forces of Uncle Sam, but in many branches of industry such as the Air Transport and Broadcast Industries. Midland training, supervised by instructors released to us by major Airlines and directed by a nine Airline Advisory Board, offers sound employment opportunities to the foresighted, ambitious man. The demand for our qualified students far exceeds the supply.

FREE CATALOG AND MAGAZINE

Investigate the benefits of Midland Airline Radio training without delay. Send for your free copy of our profusely illustrated and colorful fifty-eight page catalog and training outline. A copy of Midland News containing many articles that will be of interest to you will be included. Find out for yourself what other men have accomplished through Midland career training.

MIDLAND RADIO and Television SCHOOLS, INC.

Dept. MR-42

Power and Light Building

Kansas City, Missouri



WRITE TODAY!

DON'T DELAY!

130,000,000 TUBES NEXT YEAR!

A DISCUSSION of the important part which the radio tube industry will be called upon to play in the National Defense program, and of problems facing all radio tube manufacturers with growing shortages of vital materials, was the subject of an informal meeting at the RCA Manufacturing Company's tube plant in Harrison, N. J., recently.

RCA was already supplying a large volume of receiving, transmitting and special purpose tubes to the U. S. armed forces, to Lease-Lend, and to defense equipment manufacturers, while striving to meet requirements for commercial uses.

RCA's tube activities are expanding in all departments to conform with enormous government requirements. It was pointed out that demand for many tubes has increased many-fold and that backlogs of orders are running at record-breaking levels despite tremendously increased production. For example, RCA has increased its output of glass receiving tubes by 17.7% over 1940, and its output of metal receiving tubes by 18.1%. In addition, inventory reserves of completed tubes have been depleted by 24.4%, as compared with last year.

Industry Faced with New Problems: The tube industry's problems will be more serious not only because of limitations imposed by materials shortages, but even more so by the industry's lack of adequate production facilities and trained personnel. To date all of the government's defense requirements for receiving tubes have been met promptly by RCA. These requirements have represented only 6% of the company's total production. At the current production rate,

12% to 15% of total receiving tube production is devoted to defense requirements, and in the company's opinion, this percentage will inevitably increase.

Power and special purpose tubes, however, present a totally different picture. Tremendous demands for these tubes, on which the industry has had little or no experience, are being imposed on the industry by the defense program. RCA has responded by greatly increasing production during the past year. The company is building 357% more power tubes, 147% more cathode-ray tubes and 256% more special purpose tubes than a year ago. In these categories shipments during October were 71% for defense purposes, with every indication that the percentage required for this purpose will increase substantially in the near future. Based on present available estimates, demand in 1942 will be five to six times the value of RCA's 1941 shipments, which are already 2½ times the 1940 total.

(In the next twelve months RCA expects to produce 130 million receiving tubes: the ratio of metal to glass types being approximately 60% metal and 40% glass. This figure means over 300,000 tubes per day and is in addition to all the special purpose tubes, including those for transmitting purposes, cathode-ray tubes, etc.—Editor)

Shortages May Come: As far as power, cathode-ray and special purpose tubes are concerned, many vital civilian services now have difficulty in obtaining the tubes they require to remain in service. The entire industry will have to expand greatly if they are to fill indicated requirements for national defense.

RCA Invites Sub-Contracting

To this end, the RCA Manufacturing Company has indicated its willingness to extend to other (independent) manufacturers of tubes technical assistance in making special tube types developed by RCA. These special types of tubes have been developed at a cost of many thousands of dollars, and such information is normally regarded as a commercial secret. The offer was made in a special letter, dated November 3, 1941, and addressed to the other 18 radio tube manufacturing organizations.

3,000 VESSELS NOW HAVE SHIP-TO-SHORE VOICWAYS

RANGING in size from ocean-going ships to motor boats that could be hoisted aboard a truck, the number of vessels having radio-telephone connection with Bell System telephones now totals about 3,000. They include barges, tugs, tankers and Coast Guard cutters; hospital, quarantine, survey and cable ships; police and fire boats, dredges, water taxis, fishing craft of every description, and yachts.

Marine radio-telephone stations providing the connections between land telephones and those on water craft now dot Uncle Sam's shore lines on the Atlantic and Pacific oceans and the Gulf of Mexico. The first marine radio-telephone service on the upper Mississippi will be established through stations to be built at Memphis, Tenn., and Cape Girardeau, Mo. A station is already in operation at New Orleans.—*Courtesy N. Y. Telephone News Bulletin.*

A "Spare Parts" 160 or 75 Meter Phone Transmitter

L. B. Robbins

This handy transmitter gives about 25 watts output, sufficient for good DX on 160 meters. The whole transmitter can be built at low cost and many of the parts will likely be found among your "spare parts."

● A SURVEY of the radio shack showed the writer a large surplus of unused material. So it was deemed wise to build up a spare transmitter of many such spare parts and get the good out of them. The result is shown in the diagram. M and MG tubes were used which called only for new octal sockets. Otherwise the transmitter cost practically nothing and has proven worth the effort.

The diagram should be self-explanatory as it is a straight R.F. amplifier using a 6F6 in the crystal stage and a 6F6 as a buffer. The final amplifier is a 6L6G. Both buffer and final are self-neutralizing, so that worry is out of the way. The glass tube is used in the "final", because of the heat generated in that stage. Keying, for CW, can be done in the cathode of the "final".

The *speech-amplifier* used a single-button mike swinging the grid of a 6F5 which feeds a 6C5 for the second stage. The modulator is a second 6L6G and plate modulation is used with the Heising system. This latter was chosen only because the proper chokes were available but can always be depended upon for good quality.

The *power-supply* was built up from a 500 volt transformer and is of standard "brute force" design. A 250 volt tap and a 400 volt tap were taken off the bleeder and these voltages fed to R.F. and A.F. sections as specified.

Plenty of meters were available so one was used for each R.F. stage, one for grid current reading to the final, one for mike battery reading and one for reading the total mils of plate and screen current to the entire set. As filament voltages sometimes vary a heavy duty rheostat and an A.C. meter were used in the heater supply to keep that voltage regulated.

In the absence of meters, one good one can be used for checking, by means of jacks in the plate circuits of each stage, or

Complete circuit diagram of the "Spare Parts" transmitter.

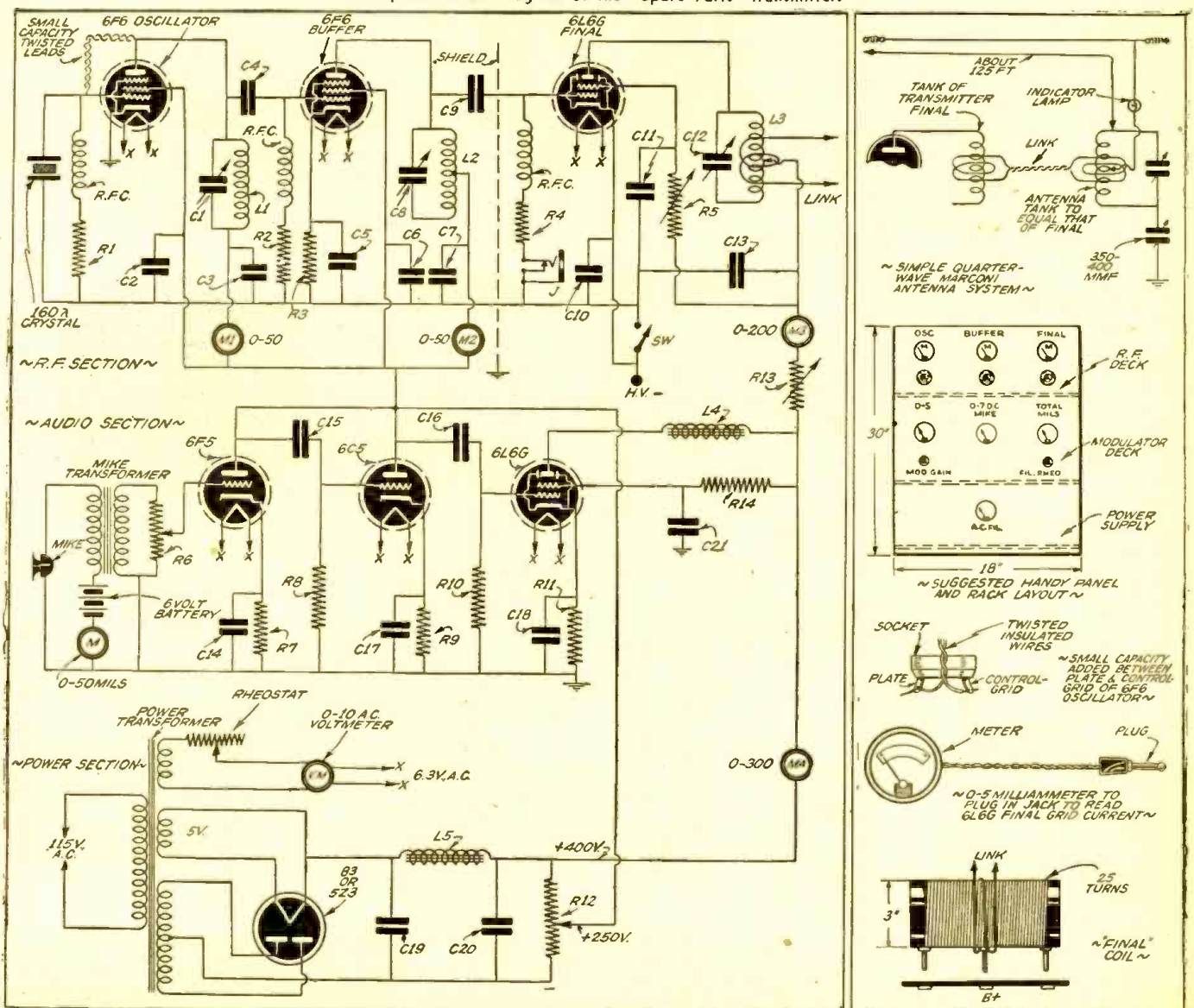

even flashlight bulbs will indicate resonance. However, one meter to read proper current readings is practically necessary. Final adjustments can be carried on from there.

The parts were arranged on three decks and all wiring carried above-board to give easy access. The R.F. was on the top deck, modulator on the middle and the power-supply set up on the lower deck. Each was removable for making repairs, etc., by slipping off dials and knobs, unhooking meters and power wiring.

The panel measures 30 by 18 inches and is of thin plywood and mounted vertically on a suitable rack which takes the decks.

Coils are plug-in on tube bases—the final being however wound on a three inch bakelite tube and fitted with banana plugs to plug in a suitably arranged base strip. The crystal stage reads about 35 mils, buffer 12 or slightly more and the final about 100 mils, when in resonance.

A link-coupled antenna coil is used from the "final," with a quarter-wave Marconi grounded antenna system. About 25 watts output is realized—sufficient for good DX on 160. For 75 meters double in the buffer and use a smaller coil in the final. A suitable crystal will hit both phone bands.

Parts List for "Spare Parts" Transmitter

- C1—250 mmf. variable receiving condenser
- C2-C3—.01 mf. 600 v. fixed condensers
- C4—.00005 mf. midget mica condenser
- C5—.01 mf. 600 v. (C2 and C3)
- C6-C7—.01 mf. 600 v. (C2 and C3)
- C8—250 mmf. variable receiving condenser
- C9—.00005 mf. midget mica condenser
- C10-C11—.01 mf. 600 v. (C2 and C3)
- C12—250 mmf. variable receiving condenser
- C13—.02 mf. 600 v. fixed condenser
- C14—.01 mf. 400 v. fixed condenser
- C15-C16—.01 mf. 600 v. fixed condenser
- C17—25 mf. 25 v. electrolytic condenser
- C18—1 mf. 200 v. electrolytic condenser
- C19-C20—8 mf. 600 v. working voltage condenser
- C21—1 mf. condenser

RESISTORS

- R1—50,000 ohms 1 watt resistor
- R2—10,000 ohms 2 watt resistor
- R3—400 ohms 1 watt resistor
- R4—30,000 ohms 1 watt resistor
- R5—10,000 ohms 10 watt (variable or with slider)
- R6—500,000 ohms variable gain control
- R7—5000 ohms 1 watt
- R8—500,000 ohms 1 watt
- R9—2000 ohms 1 watt
- R10—500,000 ohms 1 watt
- R11—250 ohms 1 watt
- R12—10,000 ohms 100 watt—slider
- R13—100 watt dropping resistor
- R14—10,000 ohms

COILS

- L1—48 turns, No. 20 DCC, wound on tube base
- L2—48 turns, No. 20 DCC, wound on tube base (center-tapped)
- L3—25 turns, No. 14 wire, center-tapped, 3" diam., 4" long
- L4—Heising choke, any good iron core choke of 150 mils, 15.20 henries
- L5—Filter choke, 250 mils, 20 henries
- RFC—2½ mh. R.F. chokes—or 40 turns No. 32 DCC wire, wound on ¼" diam. dowel

MISCELLANEOUS

- SW—S.P.S.T. toggle switch
- Mike—Single-button carbon type
- Bat.—4½-6 volts, dry or storage battery
- M1—0.50 milliammeter
- M2—0.50 milliammeter
- M3—0.150 milliammeter
- M4—0.300 milliammeter
- J.—closed circuit jack
- Sockets—6 octal type for tubes
- 1—5-prong socket for crystal
- 2—4-prong sockets for plug-in coils 1 and 2
- Banana type plugs for L3
- MT—Single-button mike transformer
- PT—Power transformer—1000 volt center-tapped, with 5 v. and 6.3 v. fl. sections

"Hams"—Please tell the Editors what type of articles you would like to see in the Amateur Section of this magazine, now that War has been declared and a general ban placed on Amateur Station operation. Let us hear from you, Pronto!—Editors

METAL CABINETS

for all applications

Make it a habit to rely on BUD for your metal cabinet requirements. BUD cabinets are "tops" in appearance, durability and protection. They give your equipment that handsome, finished appearance that will withstand the most strenuous service.

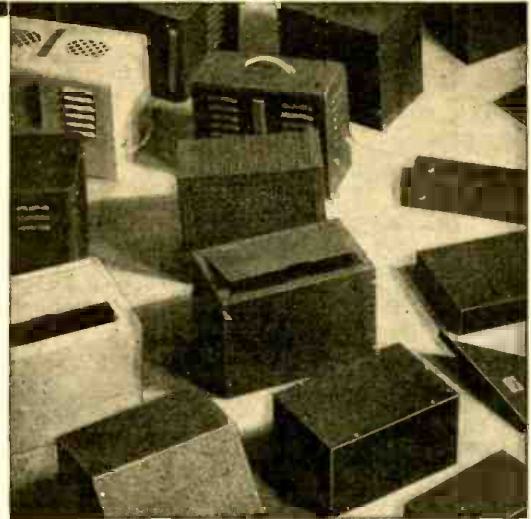

STREAMLINE AMPLIFIER FOUNDATIONS



These foundations add a real "commercial" appearance to any amplifier. The sloping front on the chassis provides adequate space and easy visibility for controls and indicators. Made in four popular sizes. All types have louvres and grilled cut-outs for proper ventilation. The finish is two-tone gray and black crackle enamel.

INSTRUMENT CABINETS

These instrument and receiver cabinets are widely used in many amateur and commercial applications. They are sturdily constructed and economically priced. All types have hinged covers and removable front panels. Made in the following sizes:



- No. C-973 7" x 8" x 7½"
- No. C-993 7" x 10" x 6"
- No. C-994 7" x 12" x 7½"
- No. C-995 7" x 14" x 7½"

- No. C-999 7" x 10" x 8"
- No. C-1190 8" x 16" x 8"
- No. C-975 9" x 15" x 11"

In addition to the items shown above, BUD also has a variety of cabinet racks, chassis, panels, etc. You'll like the way these products fit together. You'll like their easy workability and the many "extras" that reflect their careful design and accurate construction. Your jobber will be glad to assist you in making selections to fit your requirements.



BUD RADIO, INC.

CLEVELAND, OHIO

Transposed Aerials

A. Binneweg, Jr.

● BELIEVE it or not, a short-wave aerial has to be more efficient than an ordinary broadcast station aerial. The reason for this is that broadcast receivers have very high gain because of the low frequencies employed, while short-wave receivers haven't a very high gain. If you wish good results from distant stations, you will have to use a good aerial on your short-wave receiver. This is easy to see if you will consider these facts: An ordinary midget type broadcast receiver will receive very well at broadcast frequencies, but it is practically dead at short waves, unless a good antenna is used with it. The same applies to practically any average short-wave receiver.

It is of course true that a short-wave receiver even with an ordinary aerial will receive from a very great distance. But it is also true that the same receiver will give very much better results when a good aerial is used.

Transposition Aerials

The so-called transposition aerial has a great advantage in that it is resonant to the received waves at certain frequencies and so the pickup is much better. This aerial also has a directional effect because it is normally mounted horizontally, although it could be mounted vertically.

The design of this type of antenna differs. There are, however, so many factors that determine the value of an aerial, that there is little use in splitting hairs over

This article describes how to build a Transposed Aerial that will resonate to the desired frequencies. Many pointers of interest to the short-wave listener and to the experimenter in general are given.

matches and mismatches. I personally don't care whether my aerial is exactly matched or not because, since it is fixed in space, and as no one knows where the desired waves are to come from next, there is little use in trying for such great perfection.

The aerial of Fig. 1 is about as good as the high-priced variety for general use. If you really wished to make use of the directional effect, and had to use a horizontal aerial because you could not use a high pole, use the idea at A in Fig. 1. This is simply two transposition aerials. One of these proceeds north and south, and the other is arranged for east and west reception. Each of these is the same as the large aerial shown in Fig. 1. The centerpiece can be two dowel rods crossing each other or a square piece of three-ply veneer with four holes in it. Dip the wood in melted paraffin. The insulators in the Fig. 1 aerial are short lengths of dowel rod dipped into melted paraffin and each about six or so inches long. Drill the ends of the rods with a small drill.

Theory

A transposition aerial is nothing more than an attempt to raise a necessarily short aerial high into the air, realize the advantages of position, but without detracting from its efficiency by the use of a then necessarily long lead-in. The lead-in in the usual aerial adds to the wavelength of the aerial, but not so in the case of a transposition aerial. The explanation of this is shown in Fig. 2. A is a simple horizontal aerial. B is the same aerial divided at its center while C is the same aerial as A but with a coil at the center. Such a coil is necessary in practical aerials for coupling purposes. This coil "loads" the aerial and so the two halves of the aerial are then somewhat shorter.

If there is some way of coupling this aerial to a receiver, without shortening it (it is short enough already because of the short wavelength), the advantages of position can be realized. At E, there is an aerial as at A, but the entire aerial has to be used as a lead-in to the receiver! At D, two insulated wires have been attached and crossed over, or "transposed," so that the inductance of the lead-in cancels out and, in effect, the lead-in is non-existent so far as changing the aerial electrical constants is concerned. The transposition aerial receives its name from the transposed lead that connects it to the receiver or transmitter. In diagram D of Fig. 2, the coil L is now at the foot of the aerial where it can

Below, the author indicates a number of effective arrangements of Transposed Aerial Lead-Ins.

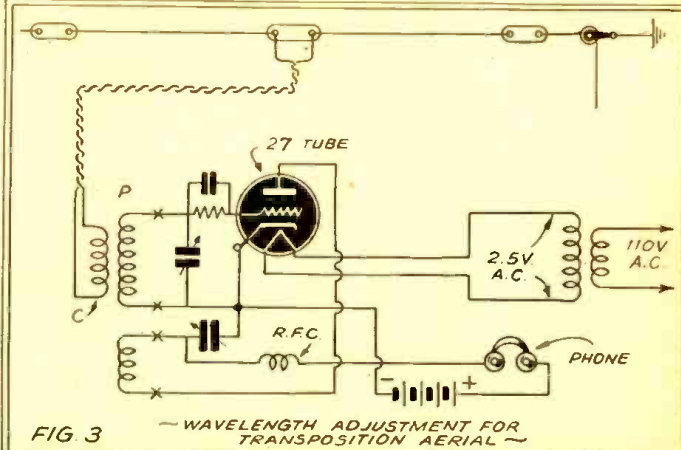
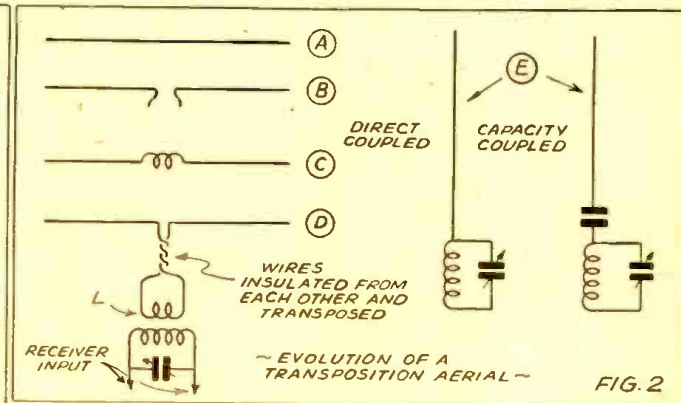
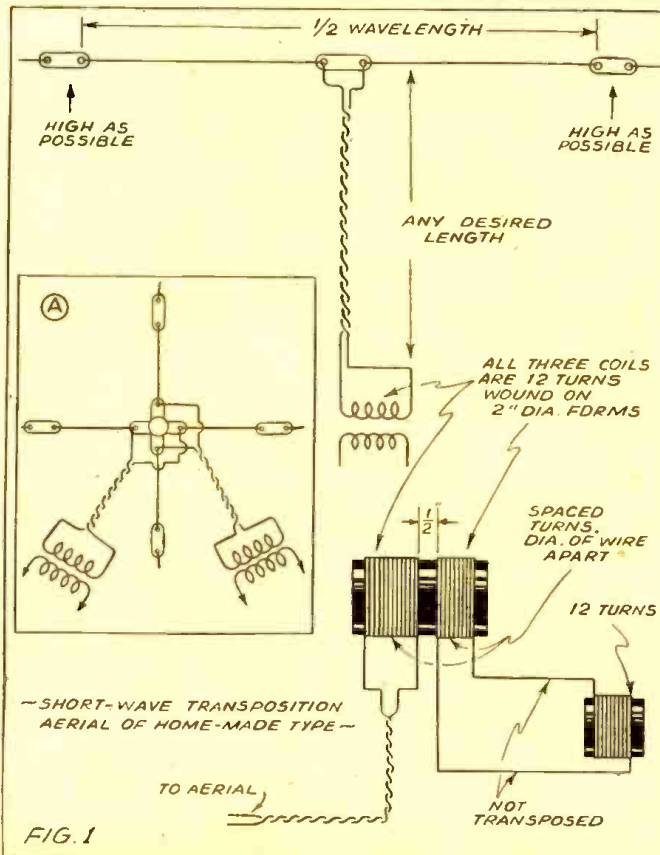

be coupled to the receiver or to the transmitter.

If this aerial was designed for ordinary broadcast reception, you could adjust it to the center of the broadcast band and realize an advantage over a rather wide range of frequencies because any aerial is rather broad tuning. At short waves, the range to be covered is very extensive so that any such fixed tuned aerial would not be a full solution to our problem.

The Short-Wave Problem

To show you what a problem confronts you, it can be stated that a resonant aerial covering the full short-wave spectrum is almost a practical impossibility. This problem is worse than the tuned circuit problem in the short-wave receiver. In short-wave receivers, different coils have to be used at different frequencies, and the problem can be solved because you have small units, coils and condenser, to work with. But try and tune an aerial over that tremendous short-wave range when you can't get at it!

There would be an advantage in doing it; in fact, I believe ordinary short-wave reception would go ahead with a "bang," if everyone could see what a tremendous advantage a tuned aerial that could tune to any desired short-wave would be. When you buy a transposition aerial you usually are getting perhaps the best the technical experts can give you, at quite an expense.

But even these aerials are far short of what we would like to have on our all-wave sets. Did you ever try the transposition aerial designed for short waves on your broadcast receiver? Don't seem to work so good; not made for broadcast.

Some people forgot all about aerials, and started to let short lengths of wire dangle to the floor and carpet, when the high-gain receivers came in. But, to reduce that noise in the back ground, it would be a lot better to increase the size of the aerial, and set the volume control back! A good aerial is an asset on any set for all-around results. Ever want a station 1000 miles away, and couldn't get it because the aerial just wasn't right (at broadcast frequencies)? A good aerial might bring it in consistently. Even if you have a midget receiver, the selectivity of which is not so good with a long aerial, you can use a longer aerial if you use a small single pole double throw switch to cut it out for local reception.

Transposition Aerial Improvements

Some modifications have been made in transposition aerials to improve results or to make them applicable to all-wave conditions, but these have been omitted. This article considers only simple practical aerials for general use at short waves.

The transposition aerial is quite a perfect form of aerial in many respects. It is a very good all-around type. It has only one disadvantage; it is way up in the air and will only resonate over a comparatively limited range of frequencies. The thing to do, then, is to design the aerial for the frequency band you desire to use. Then the aerial will operate at the highest efficiency at the frequencies you wish to receive.

Design of Practical Aerial

A transposition aerial is, theoretically, as shown in Fig. 1, of a definite length across

the top. The length should be one-half of the wavelength at which the aerial is to be resonant. There are chances of making some error so the resonant frequency will not fall where it is desired, hence a measuring scheme has been developed to resonate the aerial to the desired frequency. Make a coil as shown in Fig. 1 and couple the receiver to the coupling coil. Then, raise the horizontal aerial into place and adjust the transposed lead-in to the desired length. Everything is then ready, but the top length may not be correct. Be sure you have the same length of wire (No. 12 enamel is good) in each half of the top section. The poles or whatever holds the two ends of the horizontal wire should be of a sufficient distance apart, when the antenna is resonant. But this is exactly what we want the aerial to do no matter what receiver we are going to use with the aerial.

Adjustment of Transposition Aerial

Suppose that you wanted an aerial that would resonate to a band of frequencies centering around a wavelength of 20 meters. The total top length (the total length of the two halves) will be 10 meters (.5 wave). There are 3.28 feet in a meter, hence the total top length will be 10 times 3.28 or 32.8 feet because it should be 10 meters long; this is 16.4 feet each side of the center insulator. The two halves should be of the same length. Make the two halves each 16.4 feet and raise the aerial into place. Make the coupling coil and have everything in place before you make any measurements.

The total length of the aerial will probably be too long. In Fig. 3, bring the aerial coil, C, next to the coil, P, and tune the regenerative receiver past 20 meters. You will probably notice that part of the dial is "dead," or the receiver will not oscillate at 24 meters and for quite a distance on each side if the coils are close together. The aerial is too long on each side. Drop the aerial by means of the two pulleys and clip off about 6 inches from each outer end next to the insulator. Raise the aerial into place again; and again test it for resonant frequency. Lower the aerial, and cut off another small length at each end. Repeat this process until the aerial resonates at 20 meters.

By reducing the coupling between C and P in Fig. 3, the exact point of resonance can be located. This transposition aerial can then be used with the circuit of Fig. 3 or with any other set having an input coil. But remember that the resonant frequency of the aerial may change if you change the coil C or the transposed leads at the high frequencies. Always have everything that is to be connected to the aerial in place before measurements are made. It is perhaps true that many experimenters build aerials to specification but find, after they try them, that they do not work any better. If you expect to get good results, and to be sure of what you are doing, you will have to learn to make some measurements. Working in the dark is exactly what you are doing if you are comparing aerials or the results from aerials which you have taken no time to actually measure. The transposition aerial is a very valuable addition to any short-wave set and it should be carefully adjusted while in place, and some measurements made to see if the aerial has

been properly designed. If the aerial resonates to some other frequency than the one you intended it to resonate to, you might as well use just a short wire aerial. But if you take a few measurements and know exactly what frequencies the aerial operates best on, I believe you will be surprised at the fine results that can be obtained at short waves from just a few tubes.

Transposed Leads

Some transposition aerials used transposition blocks which can be made from three-ply veneer which is afterwards dipped in melted paraffin. This prevents rains from damaging the wooden block or warping it. In any event, the wires are crossed over each other. A simple type of transposed lead consists of lengths of hookup wire, taped at the joints, or in one long piece, or two long pieces, simply twisted around each other. Transpose the lead all the way up to the center insulator. The center insulator holds the two halves of the aerial and also supports the transposed lead. Whatever you do, carry out a few simple measurements to see whether your aerial is resonant at the proper wavelengths. You will be pleased at the better results that can be obtained when a good, measured antenna is used on whatever short-wave receiver you have, or construct. Build a transposition aerial for the foreign broadcast band and you will be surprised how they will roll in, on any kind of short-wave receiver.

VACUUM TUBE POWER-PACK BLEEDER

● FOR good regulation any power pack needs a bleeder across its output terminals. If you find yourself without one because of burnouts or lack of funds, a reasonably good substitute can be made as follows:

Arrange a 27 type tube and socket between the terminals and connect the heaters to the filament supply of the power transformer. Connect the plate to the plus line and the cathode and grid to the minus with from 2000 to 4000 ohms in series with the grid. A single tube will pass approximately 50 mils. For higher drain use two or more tubes with correspondingly lowered grid bias.—L. B. Robbins.

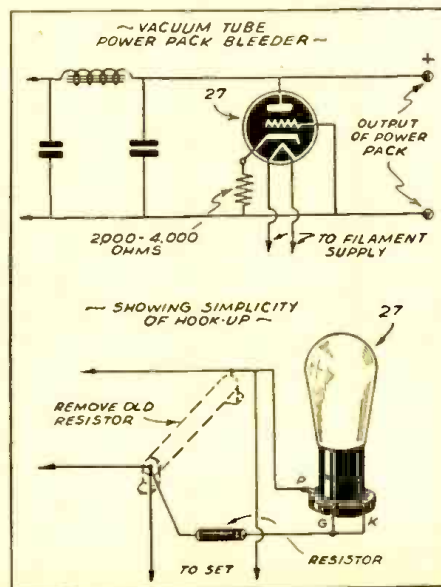

Ultra-Short-Wave

"Low-Power" Oscillator

A. Binneweg, Jr.

● WHEN I tried *ultra short waves* for the first time, I had a hard time making any kind of ordinary circuit work. All published circuits were not satisfactory below about 10 or 15 meters, and some of these circuits would not work at all. This present low-power transmitting circuit is believed to be about as "foolproof" as any circuit possibly could be, and I know that readers who are interested in becoming amateurs or readers who are interested in studying radio operation characteristics and transmitters, will be very much interested in this *simplified ultra-high frequency oscillator* which can be used for transmitting if desired. It is almost impossible for this little set to fail to operate and the cost is so low that I know that many readers will build this set to see how it works.

It is best when becoming an amateur or learning more about radio to study the *simple* circuits first. Transmitters are in general simpler than receivers. This is particularly true of the present transmitter. Another advantage in first trying out a transmitter is that you can study its operation characteristics. Regenerative receivers are very often hard to get operating at ultra-high frequencies so that a transmitter should be constructed first.

Ordinarily the more expensive tubes are employed, but, due to the very high effi-

ciency of this circuit, it will operate well even at 5 meters with just an ordinary type '26 tube. Of course, any similar tube could be used, being careful to apply the correct filament voltage. There are many circuits for ultra-short-wave oscillators that will operate with special ultra-short-wave tubes, but very few of these circuits are "foolproof" and very few of them will operate with a tube such as the type '26. That is the reason why this circuit has been developed and tested.

In the circuit of Fig. 1, two pigtail resistors each of 15 ohms can be used in series. For the filament, use a 1½-volt dry-cell, and use a plate voltage of at least 90 volts. The higher the plate voltage up to about 300 volts, the easier the set will oscillate. I have used this circuit with a type '45 tube with exactly the same constants and with satisfactory results. You can use, in the case of the type '45 tube, a filament transformer providing 2.5 volts A.C. and use the centertap connection as in Fig. 1. The rest of the circuit is exactly the same.

The chokes can be purchased or you can make them yourself. Wind about 100 turns of No. 30 double-cotton-covered wire on a ½-in. diameter form spacing each turn the diameter of the wire. Each choke should be made the same size. Drive a couple of

small wood screws or tacks into the choke form to hold the wire ends. A simple plan of construction is shown in Fig. 2.

Some of the operation characteristics and theory will be interesting and instructive. The actual theory of the circuit operation, and the operation characteristics will become clear if an actual set is built and tested with measuring instruments.

Performance

After you have constructed the little transmitter of Fig. 1 and Fig. 2, and want to know how it performs, raise the plate voltage if you can. If the plate voltage is high enough the transmitter can be tested for oscillations by holding a small ¼-watt neon tube by the bulb and touching the base to the plate terminal of the tube when the set is turned on. If the tube is oscillating, the bulb will light up. With this very high-efficient circuit, using small diameter coils, it is almost certain to operate the first time. If desired you can use two clips on the fixed condenser in the oscillating circuit and so vary the wavelength of the oscillator over a wide range. Always use the same number of plate turns as grid turns. The circuit gives an output into a tuned circuit or antenna of about two watts. A transmitting license is necessary if interference is caused, so it is best to

Circuit diagram for the "fool-proof" ultra short wave oscillator here discussed by Mr. Binneweg.

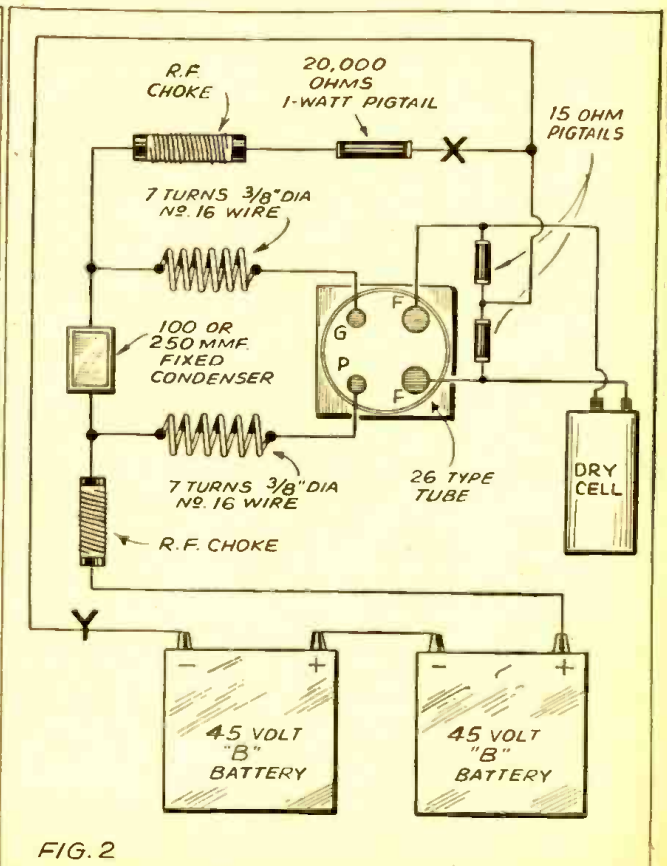
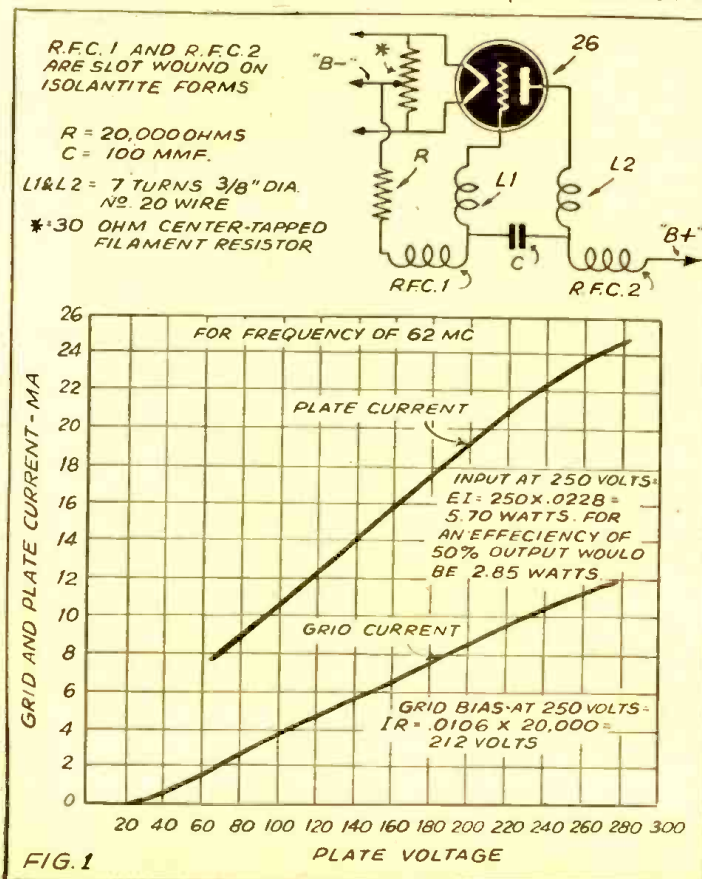

use D.C. on the plate and not to use an aerial on the set. By opening or closing the spring windings of the coils, the wavelength can be adjusted to any desired value.

The transmitter is the real starting point in building up a complete station. After you have built a transmitter, you can calibrate a wavemeter, and with a calibrated wavemeter you can build a receiver.

Instead of using a neon lamp, which is just an indication of whether the set operates or not, you could purchase some measuring instruments which are always useful and really required in transmitting stations, as well as for other test work. For the plate current, use a 100 milliamperemeter. These cost a few dollars but they are always useful in a radio laboratory. In the curves of Fig. 1, it will be seen that the plate current increases up to about 25 milliamperes, when the plate voltage has been increased to 300 volts. If you do not care to use a battery-operated plate supply, use a small power-pack or B-eliminator.

To study the variation in grid current through the grid-leak resistor when the plate voltage is increased, connect the milliammeter in series in the grid circuit, or buy a milliammeter reading up to 25 milliamperes for the purpose. The best test set-up would be to use both a plate current and a grid current milliammeter. The grid meter would be connected at the point "X" in the circuit. Open the circuit and connect the milliammeter terminals in series. If the meter reads backwards connect it the other way. The plate meter could be connected at the point "Y" in the circuit. One or both meters could be used.

Resonance

If a plate meter is used in the circuit, tuning an external wavemeter circuit to the frequency of the transmitter will cause a sudden change in plate current. This change shows that the external circuit is at "resonance," is "tuned to" or is absorbing power from the transmitter. That's what an aerial does. Use a small coil connected across a small 25 or 30 mmf. midget condenser for the tuned circuit. This tuned circuit can be used as a so-called "dummy antenna," which absorbs power like an antenna but has confined circuits so that radiation is at a minimum.

It is best to use a grid meter for resonance purposes.

Performance Calculations

You will notice some calculations in Fig. 1. To find the power input to this simple transmitter, multiply the plate current in amperes flowing by the battery voltage that causes this current to flow. If the plate current is 20 milliamperes it is .020 ampere. If the grid current is 10 milliamperes, it is .010 ampere. If this .01 ampere flows through 20,000 ohms, the grid D.C. voltage will be IR or .010 times 20,000 or 200 volts. Notice that this voltage is not obtained from batteries or power-packs but is caused by the operation of the oscillator. The D.C. meter reads the average D.C. current, no matter what kind of a wave shape the current through the grid resistor is. The fact that a D.C. current flows through the grid resistor shows that the grid must go positive, and so the electrons in the plate current are drawn from the stream to the grid.

Radio Loses Air Bombs

Army officials expressed keen interest recently in a strange-looking, radio-controlled aerial torpedo.

John Hodgdon, former Professor of Engineering with the United States Insular Service, developed the torpedo at his home after experiments which he said began thirty years ago.

His working model, with a six-foot body, has a wingspread of eight feet and an unusually large tail assembly, about six feet across. The ship is powered with three gasoline motors.

They watched his experiments with a six-foot working model in a field near Vallejo, Calif., according to the *New York Times*, and recommended that he continue tests and make a complete report.

The winged torpedo, which operates on a gyroscopic principle, is designed to fly at an altitude of 30,000 feet.

Plane-to-Station Record

The range of uninterrupted plane-to-station radio telephone communication was more than doubled recently when a TWA engineer at the Kansas City base talked directly from a plane to the airline's New York personnel, 1,200 miles away.

The test, conducted at noon, was made possible by the recent licensing of Transcontinental & Western Air, Inc., to use frequencies of 6510 and 10,125 kilocycles. With present frequencies, the radio message of a pilot flying over New York must be relayed through TWA ground stations and wire lines before it reaches Kansas City. These present channels require contacts with ground stations up to about 500 miles.

The airline is completing the installation of the newest type two-way transmitter and receiver units on its transports, which will permit use of the new frequencies merely by the addition of crystals.

NEW Quick-Reference Catalog 18 on Rheostats • Resistors • Tap Switches

FREE

Especially useful today! Gives complete up-to-date information on the wide range of Ohmite stock resistors, rheostats, chokes and switches used in all types of applications—Lists over a thousand stock items, including new developments—Gives descriptions, ratings and prices—Helps you select the right units for each job, easily, quickly. Get your copy of this handy new Catalog 18 now! It's FREE.

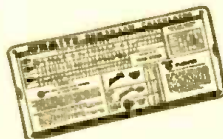

Handy, Useful Ohm's Law Calculator

Figures, ohms, watts, volts, amperes—quickly, easily. Solves any Ohm's Law Problem with one setting of the slide. All values are direct reading. Does not require any slide rule knowledge. Size 4 1/8" x 9". Yours for only 10c to cover handling cost.

OHMITE
RHEOSTATS • RESISTORS • TAP SWITCHES • CHOKES • ATTENUATORS

For Radio, Television, Sound, Electronic and Industrial Uses
CATALOG NUMBER 18

RHEOSTATS, Models B and J, Various Enclosures	1	PLANT DROPPING RESISTORS	11
RESISTORS, Models A, B, R, R, and C, P. L. L.	1	GLYTER-TAPPED RESISTORS	11
WETWIND "CORRUGATED" RESISTORS	1	TAP SWITCHES, Open Type, All-Ceramic	12
WETWIND "CORRUGATED" RESISTORS	1	TAP SWITCHES, Power Type, All-Ceramic	12
"WETWIND" LAMP STYLE RESISTORS	1	TAP SWITCHES, Power Type, All-Ceramic	12
WETWIND "CORRUGATED" RESISTORS	1	Models 111, 112 and 113	12
WETWIND "CORRUGATED" RESISTORS	1	BAND CHANGE SWITCHES (P.C.)	12
WETWIND "CORRUGATED" RESISTORS	1	CHOKES, Audio Frequency Phase	13
WETWIND "CORRUGATED" RESISTORS	1	CHOKES, Power Line	14
WETWIND "CORRUGATED" RESISTORS	1	ATTENUATORS, High Voltage T and L-Types	14
WETWIND "CORRUGATED" RESISTORS	1	SOUNDING SUPPRESSOR	14
WETWIND "CORRUGATED" RESISTORS	1	SLIDING IRON CONTROL RHEOSTATS	14
WETWIND "CORRUGATED" RESISTORS	1	"DETUNING" RESISTANCE BULBS	15
WETWIND "CORRUGATED" RESISTORS	1	DEALS AND KNIVES	15
WETWIND "CORRUGATED" RESISTORS	1	LENS CONTROL	15
WETWIND "CORRUGATED" RESISTORS	1	MODEL TRAIN CONTROL RHEOSTATS	15
WETWIND "CORRUGATED" RESISTORS	1	OHMITE OHM'S LAW CALCULATOR	16

OHMITE MANUFACTURING COMPANY
4895 Floumroy St., Chicago, U. S. A.

Send Free Catalog 18.
 10c enclosed—Send Ohm's Law Calculator.

Name _____
Address _____
City _____ State _____

Rad-Craft Feb., 1942

Be Right with OHMITE RHEOSTATS • RESISTORS • TAP SWITCHES

Radio in Aviation

The many ingenious ways in which radio waves are put to work for the purpose of guiding planes on their journeys are described in this article by Assen Jordanoff.

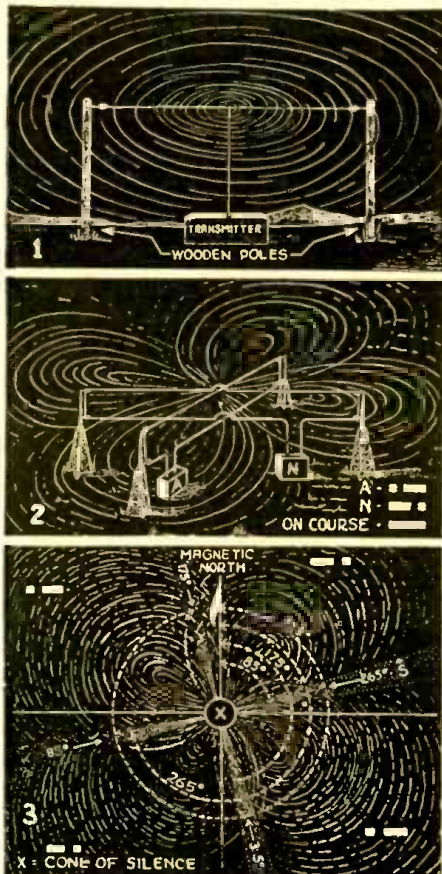

Figs. 1, 2, & 3.—Diagrams above show how radio waves spread out from a transmitter; also how A and N code signals are radiated.

• USE of radio as a navigational aid has contributed increased safety for the flight of the modern airplane, playing a part in aviation perhaps even more important than that performed for ships at sea through the coastal radio communication stations, radio beacons, and radio light vessels. For example, the constant and proper use of radio has established for our airlines a reputation of having completed an average of 95 per cent of scheduled flights under weather conditions that would have made such flights impossible had it been necessary to maintain visual contact with the ground.

These aids may be classified under three categories: (1) communications between ground and plane, between plane and plane, and between plane and ground; (2) predetermined fixed courses or paths known as radio beams upon which the airplane may travel without visual contact with the ground between predetermined points; (3) non-directional radio transmitters on the ground—that is, any source of radio energy toward which the airplane may be definitely flown by the use of proper homing or radio-compass equipment aboard the craft.

The present established airways system in the United States provides several hundred directional radio transmitters available to the transport operator and the private flier, says Assen Jordanoff in *Canadian Aviation*.

The non-directional transmitter (Fig. 1) is any source of radio-wave energy and it fills the space around the transmitter in all directions. Thus it becomes usable as a navigational aid when the airplane is equipped with a radio compass (homing device).

The directional transmitter (Fig. 2) supplies radio energy alternately to loops of electrical conductors placed at right angles to each other. The electrical pattern produced by each of these loops simulates a figure "8" with the crossroads at the center of each loop. These loops are alternately energized by radio-wave energy which produced signals in the earphones attached to the receiver in the aircraft.

This modulated tone is transmitted as the international Morse telegraphic letters A and N. It follows that if an airplane were to maintain flight within the field of the A loop only, the signal heard in the headphone would be only the international Morse telegraphic signal A. Likewise the rule would hold if the aircraft maintained flight only within the field produced by the N loop.

Consequently it is possible to control the pattern of the radio field produced by this type of transmitter so that a definite path of radio waves will be available to you if your plane is equipped with a receiver which can be tuned to these wave lengths (frequencies).

By reference to Fig. 3 it will be noted that the actual invisible flight paths shown by the dots assume a position equidistant from the A and N signal zones. Consequently, as the aircraft is flown on this predetermined course you receive in your headphones a long dash broken approximately every 35 seconds with an identifying signal for that particular station which is given in the international Morse telegraphic code.

If, however, you get off to one or the other side of the established path (beam), you receive more energy from the loop producing the letter A or the letter N, as the case may be, depending upon which direction you are flying. This will immediately advise you that you are getting off course. The "on course" path is actually the zone of weakest signal produced from the opposite A and N zones, but mechanically synchronized, that is, tied together at the transmitter, so that the resultant signal heard in your headphones is a long dash, due to overlapping of the signals A and N.

Notice that the figure-8 patterns cross at the center of the loops. At this point very little or no radio-wave energy is produced. This results in a "cone of silence" as shown

by X, the "crossroads" in Fig. 3. While passing through this "cone of silence" momentarily you do not hear the signal. This indicates that you are passing over the station or the source of radio-wave energy, and since the geographical location of this station is known to you by reference to your maps, and since the identifying signal of this station definitely ties in with the particular transmitter which is producing this beam, you may immediately determine your exact location.

It may be well to mention that there is such a thing as a "fake" cone of silence. Beware of it, particularly if flying near a mountain range. It is supposed to be due to the near proximity of a terrain containing certain metals in their natural state, or possibly to the presence of high-tension electrical conductors.

Let us assume that your magnetic compass is completely out of commission. You may locate yourself by checking to which side of your course the A or N zone falls and then flying straight ahead "on course" (long dash) until you get an increase or decrease of signal intensity indicating whether or not you are flying away from or toward the transmitter. This information may then be tied in with the definite standard of orientation of the courses (refer to Figs. 11 and 12) to the end that you may tell exactly what leg of the beam you are flying. Thereafter the identifying signal transmitted by that beam will give you your geographical position.

The antenna and installation of your aircraft receiver must meet certain definite standards in order to obtain the desired results. Unless you employ a vertical mast antenna with the receiver located directly at its base, or an electrically equal "T" antenna having a perfectly vertical lead-in dropping or rising directly to the receiver—so that no horizontal portion of the antenna is electrically active in the receiver system—you will not get the cone of silence properly or obtain minimum width of "on-course" signal zones. The results of variance from standard aircraft receiver installation practice will give widely varying operation results. Moral: Be sure your receiver installation is correct before you try to fly by instruments and radio.

In tuning your receiving set, the best results are obtained when the volume is set for minimum intensity, yet is loud enough for you to hear the signals clearly. Regardless of how much detailed description is given for the proper use of the radio facilities, actual practice is the best guarantee for mastering with precision the direction of flight by the combined use of a magnetic compass, directional gyro, and the radio aids.

Further to facilitate and ensure safety when the direction of the flight is maintained with the help of the radio beam, "marker Beacons" (radio transmitting stations). These "markers" transmit their characteristic signal in the International Morse Code at intervals of 10 seconds on

the same frequencies as the closest radio-beam transmitting station. These identifying stations have a range of action up to 10 miles, but in most cases less.

Twilight Zone

Fig. 4—It will be remembered from the foregoing that when flying directly "on course," either to or from the transmitter, a long dash is received, as shown by the airplane in position c. On either side of the "on course" zone there is a "twilight zone" where the long dash (on course) is not heard but the A or N signal predominates, depending on whether the plane is more toward the A sector (position b) or the N sector (position d). If we proceed to get further off course, as shown in positions a and e, the opposite course-identifying signal is then lost entirely, and only an A if we are in the A sector or an N if we are in the N sector is heard.

The "cone of silence" assumes the shape of an inverted cone projecting from the earth skyward with its point or apex on the earth. Consequently the width of this cone increases at different altitude levels. Thus the "cone of silence" is more pronounced at higher altitudes.

A cross-section of the "cone of silence" is shown in Fig. 6. It will be noted that at 1,000 feet the width of the cone may be 500 feet, whereas at 5,000 feet it may be one-quarter mile wide or more. It follows that when a definite navigational problem is being worked out much more accuracy may be expected by flying at altitudes above 2,000 feet.

Fig. 7—At certain times of the day, especially at dawn or the dusk of evening, and over certain mountainous territories, the radio path or beam produced by a transmitter will bend. This effect is particularly noted at sunrise and sunset.

In certain territories, generally hilly or mountainous, multiple beams are produced (Fig. 8). These may prove to be very dangerous unless you are conscious of their existence and carefully checking your position with respect to known landmarks. Multiple courses are generally indicated by the lack of a twilight zone.

Thus if you believe that you might be flying a "multiple" you may determine this by flying to the right or left across the course in search of a definite twilight or "on course" indication. If you do not find this, you are quite probably on a "multiple" course and should immediately make every effort to locate the true course.

Reason for Multiple Beams

One reason given for the existence of multiple beams is the presence of metal ore deposits or the effect of a large city. Apparently we shall have to accept that explanation until a better one is discovered. Multiple beams do not represent any great difficulty in maintaining the direction of flight, but it should be borne in mind that when an approach to the radio-range station is made and the flight takes place in the overcast, the nature of the underlying terrain must be taken into consideration, particularly if descent for the purpose of landing must be made through the overcast.

At certain times beams have been known to swing or oscillate over a relatively large territory (Fig. 9), sometimes as far as 25 degrees to either side of the initially pro-

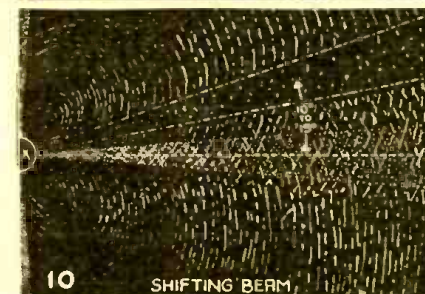
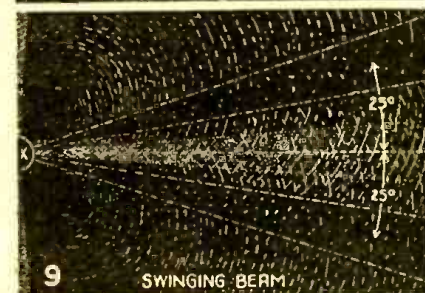
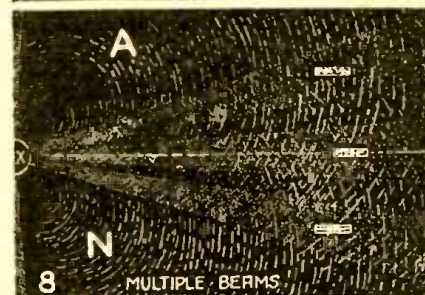
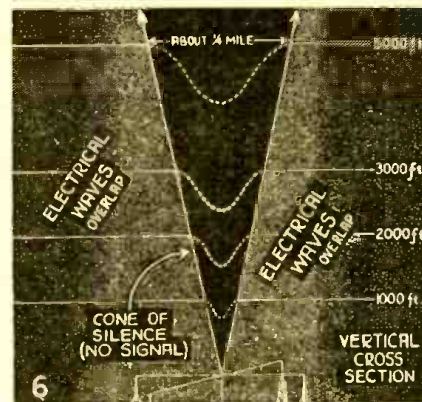
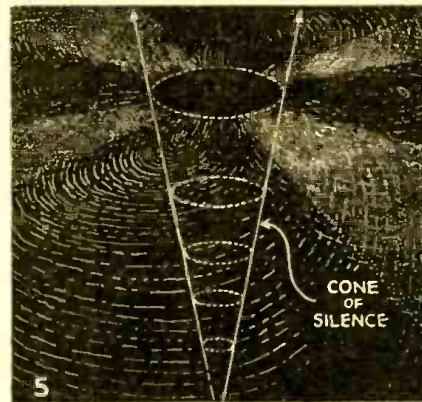
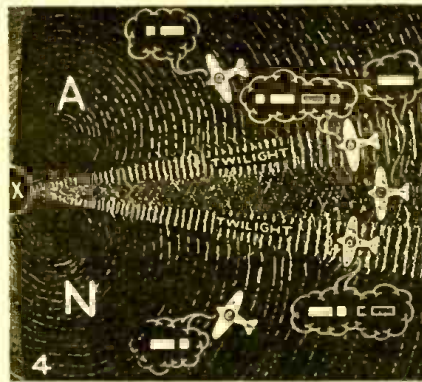

Figs. 4 to 10.—Showing various actions of radio directive beams, cone of silence, etc. The swinging and shifting beams are explained in the text.

jected course. It has been observed that on certain beams the swinging occurs at about 40-second intervals. Since the beam is very narrow close to the transmitter—roughly about 250 feet wide—while at 100 miles from the transmitter it may be seven to 10 miles wide, it would follow that if you were flying a swinging beam some distance from the transmitter you might be considerably off course.

When such a condition exists it will be indicated by the loss of "on course" and the reception of A or N is rapidly changing sequence, such as dash, dot dash, dash, dash dot, dash, dot dash, etc.

At certain times, and under certain conditions, beams will actually shift in their position (Fig. 10). When this occurs they seldom return to their initial alignment. Consequently the authorities are constantly checking the beams for shifting. In any event, if you fly the beam in accordance with the indications which you receive in the headphones, particularly when flying toward the transmitter, you will have no difficulty in arriving at your destination. Before flying over unknown territory, it will be well to be thoroughly informed about the beams. Especially should one avoid flying unfamiliar beams in adverse weather.

When flying toward the beam-transmitting station, keep to the right of the "on course" signal, that is, closer to the twilight zone. And when flying away from the station, keep also to the right side of the "on course" signal but within the twilight zone closer to the off-course signal.

NOTICE

RADIO & TELEVISION

Subscribers:

Inasmuch as RADIO & TELEVISION magazine has been merged with RADIO-CRAFT, all RADIO & TELEVISION subscribers will receive copies of the merged magazine to the conclusion of their subscriptions.

Where readers are subscribers to both magazines, the subscription will be lengthened in the same manner.

THE PUBLISHERS

★ **PERSONAL SERVICE**
By *Bill Harrison*

★
RECEIVERS
AMATEUR EQUIPMENT

Fastest service — lowest prices—most liberal trade-in allowances — easiest time payment terms—in the country!

It will pay you to write to me about any Radio Apparatus you need. I guarantee you complete satisfaction and my personal attention.

73,

Bill Harrison, W2AVA

★
HARRISON RADIO CO.
12 WEST BROADWAY - NEW YORK CITY

MODERN PARTS for MODERN CIRCUITS

THAT HAVE BEEN

"Designed for Application"

CATALOG UPON REQUEST

JAMES MILLEN MFG. CO. INC.
150 EXCHANGE ST. MALDEN, MASS.

EASY TO LEARN CODE

It is easy to learn or increase speed with an Instructograph Code Teacher. Affords the quickest and most practical method yet developed. Available in tapes from beginner's alphabet to typical messages on all subjects. Speed range 5 to 40 WPM. Always ready—no QRM.

MACHINES FOR RENT OR SALE

The Instructograph Code Teacher literally takes the place of an operator-instructor and enables anyone to learn and master code without further assistance. Thousands have used and endorse the Instructograph System. Write today for full particulars and convenient payment and rental plans.



INSTRUCTOGRAPH COMPANY

4713 Sheridan Rd., Chicago, Illinois
Representatives for Canada
Radio College of Canada, 54 Bloor St. West, Toronto.

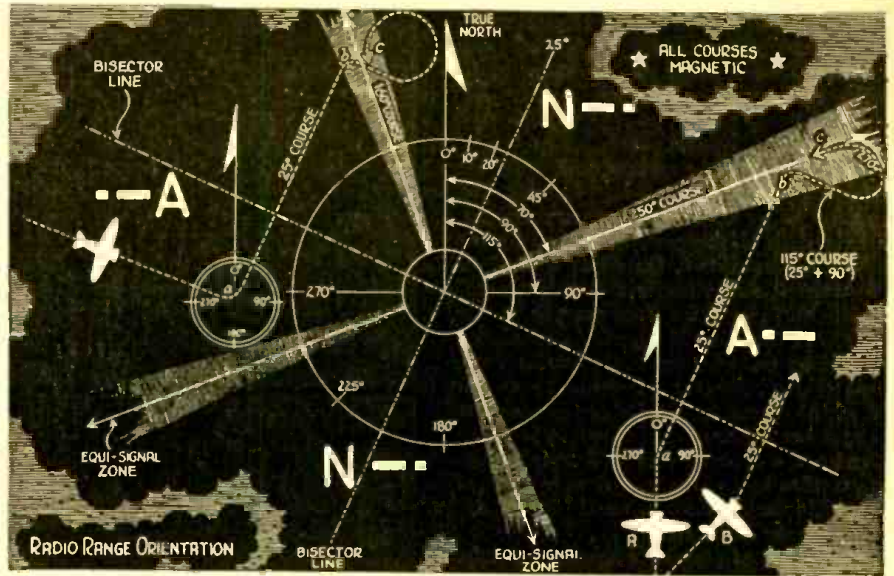

Fig. 11.—Method of orientation required to establish a definite flight path, after one has become lost and must depend solely upon radio and beams.

Fig. 11—This illustration depicts the method of orientation required to establish a definite flight path after one has become lost and must depend solely upon radio and beams. It is assumed that you have an aeronautical chart which shows the geographical alignment of radio-beacon courses. It is assumed also that you are in or on top of an overcast and that your approach must be made on a certain single leg of the radio beacon to ensure that no obstructions will be met as you come down through the overcast on your approach to the airport.

The first step is to determine—by tuning your radio receiver across its entire frequency band—which radio beacon you are closest to. You do this by noting, without changing the volume control, which station is loudest in your headphones. You will thus get this station's identifying signal, and by reference to your chart you may then establish the magnetic compass course of that particular radio beacon's "on-course" signal zones as well as its location with respect to the terminal airport which it serves.

Let us assume that, having so located the nearest station, this station has its beams laid out as shown in Fig. 11. Let us assume, further, that in determining this nearest station you noted that you were receiving an A signal. This would indicate definitely that you were in one or the other of the two A sectors of a particular radio-beacon station which you have already identified.

Referring to Fig. 11 and the magnetic-compass course of the beams, you will note that it is necessary to fly a magnetic-compass course of 25 degrees in order to bisect an "on course" signal zone from any location within the A signal zones in a minimum of time. Proceed to fly this course until the A signal reaching you through your headphones blends first into the twilight zone and then into a full "on course" signal. Then by instruments make a timed turn of 90 degrees to the right. Always to the right.

Note from the diagram what happens. If you were in the easterly A zone your 90 degree turn to the right brings you out of the "on course" zone back into the A signal zone. If you were in the westerly A zone your 90 degree right turn brings you into

the N signal zone. This 90 degree timed right turn immediately gives you definite knowledge of which of the two A zones you have been in. Knowing this, and from your charts knowing the magnetic-compass course of all the "on course" zones, it is a simple matter to proceed on the "on signal" zone into the radio beacon and proceed from its silent zone with the approach to the airport which this beacon serves.

Several methods of orientation are in use, but the above-described method is the basic and generally accepted system, which may be modified with slightly different technique.

Fig. 12—For uniformity and for purposes of orientation, the quadrant through which

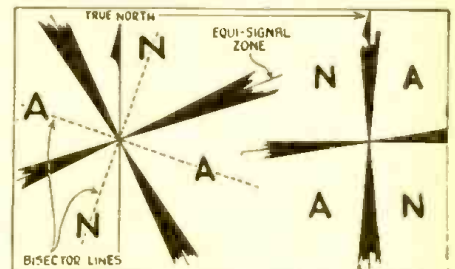

Fig. 12.—For uniformity and for purposes of orientation, the quadrant through which a true-north line from the station passes is always the "N" quadrant.

a true-north line from the station passes is always the N quadrant. If true north coincides with an "on course," the quadrant immediately west is the N quadrant. All radio-range beacons transmit this combination of signals.

The use of directional transmitters such as we have just described requires only a radio receiver in the plane capable of running from 200 to 400 kilocycles, within which frequencies all radio beams in the United States are received.—Courtesy *Canadian Aviation*.

Are you interested? Do you want more articles on Aviation Radio, such as this one, explaining the action of Radio Beams?

Diagrams for

The Radio Experimenter

This is a new department. If you have a new Hook-Up, send it along; a pencil diagram will do. Be sure to include a brief description.

All diagrams and descriptions accepted and published will be awarded a year's subscription. Diagrams may be for receivers, adapters, amplifiers, etc. Send them to Hook-Up Editor, RADIO-CRAFT, 25 W. Broadway, New York City.

SOURCE OF HIGH VOLTAGE

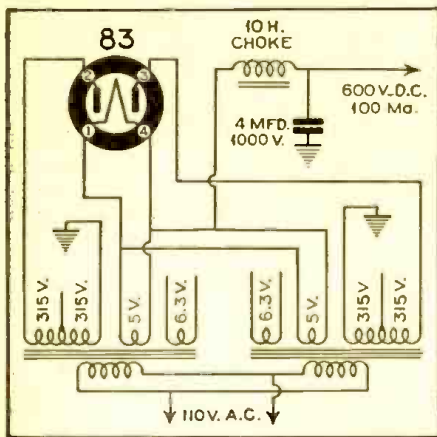

The diagram above, suggested by Harold Held, 57 Clark Street, Paterson, New Jersey, shows a simple way to obtain high voltage for transmitters, etc. Two receiver type power transformers are connected in parallel.

CODE PRACTICE OSCILLATOR

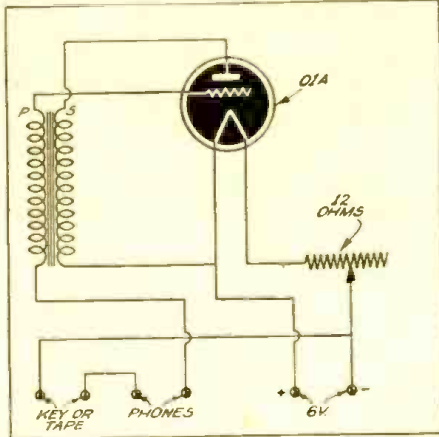

Here's a simple circuit for a code practice oscillator, sent by Mac Craighill, Box 308, Leesburg, Va. This oscillator can be built at slight cost; the transformer may be a 3 to 1 audio type. Rheostat regulates the tone.

8-WATT AUDIO AMPLIFIER

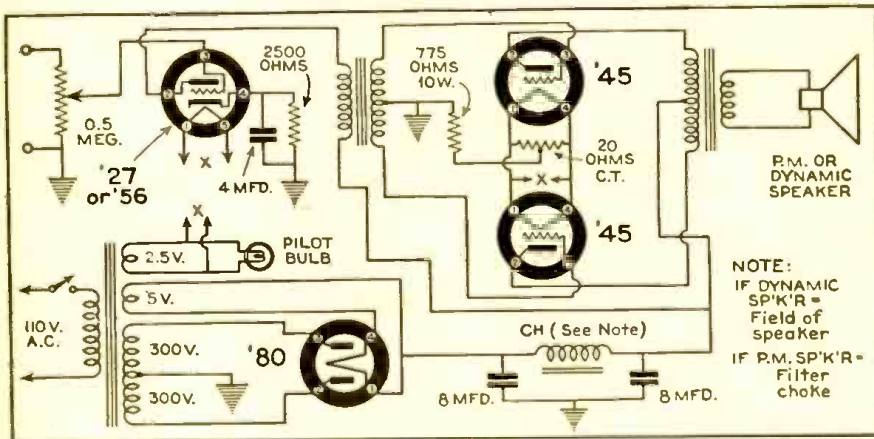

This 8-watt audio amplifier circuit was sent by D. McBride, Box 338, New Market, Ont., Can. This amplifier can be used to provide greater volume for a code practice oscillator, etc. Using midget transformers a very compact unit can be built; with a suitable pre-amplifier a good P. A. system can be assembled.

WHAT IS WRONG WITH THIS DIAGRAM?

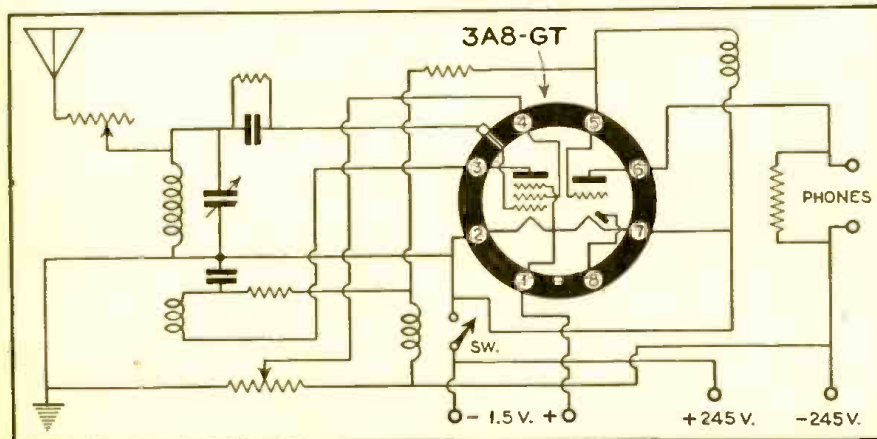

Study this diagram for at least three minutes before turning to the answers on page 383.

SHORT WAVE CONVERTERS for CAR RADIOS

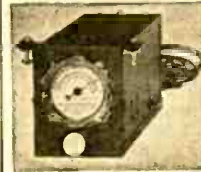

Can be attached to any car radio.

MODEL 600-A covers 40-31.25-20-19 and 16 meter bands. Designed for American and Foreign short wave broadcast. Distance range 5,000 to 10,000 miles. List Price \$24.95

MODEL 700 long wave covers 135 to 410 KC. Receives gov. weather reports, etc. List Price \$24.95

POLICE UNITS MODEL 100-A with fixed condenser, covers 1600 to 2000 kilocycles. \$12.90

List Price \$12.90

MODEL 800 Super Sensitive police converter with fixed condenser. Covers 1500 to 2000 kc. Two metal tubes, exceptional distance range. List Price \$15.95

MODEL 200 with variable condenser, covers 1550 to 6000 kilocycles. List Price \$17.95

MODEL 500-A with variable condenser and illuminated dial covers 1600 to 6000 kc. Very sensitive, has two metal tubes. Exceptional distance range. List Price \$21.95

Jobbers and Dealers Wanted
ABC RADIO LABORATORIES 3334 N. New Jersey St., Dept. RT-12, Indianapolis, Ind., U.S.A.



NEW! 1942 MODEL POCKET RADIO!

NO BATTERIES

BEAUTIFUL PLASTIC CABINET. Fits your pocket or purse.

5 OZ. ABOUT CIGARETTE PACKAGE SIZE—FIXED POWER CRYSTAL. Simple to Operate. OWNERS REPORT 2-3 YEARS SERVICE. THOUSANDS SOLD! M.L. of Ill. says:

"RADIO WORKS FINE!" GUARANTEED TO WORK—ONE YEAR SERVICE GUARANTEE.

Sent complete ready to listen with instructions for use in homes, offices, hotels, in bed, etc. NO ELECTRIC "PLUG IN" REQUIRED—EASY PAYMENT PLAN, as follows:

SEND ONLY \$1.00 (cash, M.O., check) and pay postman \$1.99 plus postage on arrival or send \$2.99 for postpaid delivery! LIMITED NUMBER LEFT—GET YOUR MIDGET NOW! for real enjoyment ideal gift for anyone—ORDER NOW!

MIDGET RADIO CO., Dept. RT-1, KEARNEY, NEBR.

Do you need BINDING POSTS?



The XL PUSH POST with its Spring Action assures Constant Contact and quick connection.

Manufactured in All Aluminum Type M at 22c each.

Aluminum Body, Bakelite Top Type M at 15c each.

Types CP or NP. ALL BRASS—STAIN-LESS STEEL SPRING AND PIN. PROVEN BY 240 RT. SALT SPRAY TEST as NON-CORROSIVE at 22c each.

Manufacturers and Dealers Liberal Discounts

X. L. RADIO LABORATORIES
420 West Chicago Ave., Chicago, Ill.

Laughlin

High Grade Fountain Pen
Fitted with Solid 14 kt Gold pen
\$1.00

Laughlin Ink Writing Pencil
with hardened solid 14 kt gold point, for Manifold and all writing purposes, writes a smooth dry line, no blotters necessary.

Price \$1.00

Try either or both for ten days at our risk. If not found satisfactory return them and we will promptly refund purchase price.

Address

LAUGHLIN MFG. CO.

962 Majestic Bldg.,
DETROIT, MICH.

TIME-SAVING OPERATOR COURSE

This New Course shows how to get a License to Operate Television, Facsimile, Radiotelephone and Broadcasting Stations. Latest, inexpensive, Short-Cut Course by A. Binneves, Jr., B. Sc. Includes 150-page Book with Diagrams! Answers 700 Actual Questions! We answer any other Questions by Mail. NO CODE NECESSARY! Send \$4.00 Now for Self-Study Book and Complete Study Course. No More to Pay!

RADIO-TELIO INSTITUTE
524 Fairbanks Ave., Oakland, California

Inventions Wanted Patented or Unpatented

We have been successfully selling inventions, patented and unpatented, since 1924. Write us, if you have a practical, useful idea for sale.

CHARTERED INSTITUTE
OF AMERICAN INVENTORS

Dept. 109 Barrister Building, Washington, D.C.

Ultra-High Frequency Tuner

George F. Baptiste

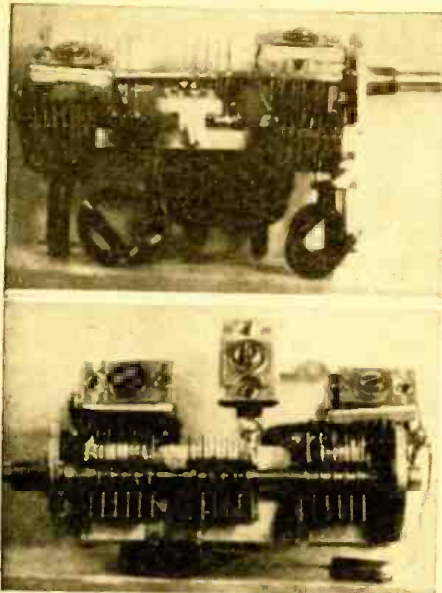

Two views of the condenser unit for the U.H.F. tuner

● A PRACTICAL High Frequency Tuner that can be built for a cost of not more than \$3.00 is something rare, as most high frequency tuners are quite expensive. This tuner was designed with the frequency modulation band in mind, but it can also be used for the reception of amplitude modulations signals as well, and also for other bands, by using different size coils. The tuner comprises an R.F. stage, with a tuned antenna circuit, using an 1852 tube as R.F. and a 6SA7 as converter-oscillator, using a three-gang condenser. Partition shieldings were not used—something rare for at high frequencies it is nearly always necessary. No serious interaction or lock-in effect was experienced with the tubes mentioned, although any others are not recommended. This high frequency tuner covers a range of 38 to 52 megacycles, which includes the frequency modulation band, feeding into a 3 or 5 megacycles I.F. amplifier. This one was used on a Browning Frequency Modulator Receiver and produced excellent results from a frequency modulated station fifty miles away. The gain from the antenna to the 1st I.F. is about 432.

The hardest part is the reconstruction of the two-gang condenser to a three-gang condenser. This is a Hammarlund HFD-30-X dual-spaced unit; first this is taken apart, see Fig. 1 which gives a general idea of just how it is remade. Fig. 2 shows the complete circuit diagram; in the reconstruction of the condenser use a small soldering iron and do not apply too much heat when unsoldering the rotor plates for the new position, the only ones that are removed are the center one; count off five plates from the end and remove the balance of the rotor plates to that section, doing the same with the second section of the rotor, counting from the rear. Be careful not to bend the plates, as these are used for the reconstruction of the center rotor plates and spaced and soldered in place with the proper centering of the plates. You will have two sections of the stator plates left, take a small pair of clipper pliers and count off six plates, then cut the balance off, at the same time being careful not to bend them. Do the same with the other section, this

gives you two stator sections; the balance of the plates are used to make the third section of the stator section off the condenser, it will be necessary to unsolder the stator mount-lug and resolder to the new position; this can be determined best by fitting same in place, space equally—dividing the distance between all the stator sections as nearly equal as possible, the space being about $\frac{3}{4}$ inch. In the construction of the extra stator section it will be necessary to make a small mounting lug; this is done by taking a small piece of copper $\frac{1}{2}$ inch wide by $1\frac{1}{2}$ inches long, cutting and fitting the same to match the other mounting lugs. A small hole is drilled in the center of the copper mounting lug, so that it can be mounted on the isolantite base. There is a hole in the center of the isolantite stator mounting piece, intended for a partition shield; this is where the middle section of the stator plate is mounted; see diagram number one.

The coil construction is not difficult; the antenna coil has two turns, the R.F. eight turns; this is mounted on the rear section of the complete gang condenser. The next is eight turns, tapped at one and one half turns for the oscillator section; this is mounted on the front section of the condenser, as close to the condenser as possible. This coil is mounted directly in line with the R.F. coil in the rear section. The last one to mount is the converter-detector input coil; this also is eight turns and mounted at right-angles directly under the center section of the gang condenser stator plates, which is important. All coils are wound on half-inch forms; there is only one more coil—connecting the R.F. plate to the con-

vertor-detector input circuit. It may be two turns, or eight turns if your R.F. layout is well arranged and does not introduce too much feed-back. It is best to first use two turns and then try the other coil; these are mounted last to suit one's own choice.

As a final note it may be stated that a 6K8 tube was tried; due to wide variations in input resistance at high frequency (40 mc.), the 6SA7 was found superior, eliminating an oscillator plate coil. Good image response was experienced when same was used on a Browning Frequency Modulation receiver, as the tuner. The tuner is as follows from the rear—antenna, middle section, detector input, front section, oscillator section. No body capacity whatever was experienced. The coils are close-wound and then cut to the right number of turns and spaced to three-quarters of an inch in length and one-half inch in diameter. No. 14 plain enamel wire was used throughout.

Parts Required for High Frequency Tuner

Parts for tuner only

HAMMARLUND

- 2—Octal Wafer Sockets
- 1—High Frequency Condenser. Type HFD-30-X. Dual Spaced
- 3—Trimmers Condensers Type MEX-30, 3-30 mmf.

IRC

- 1— $\frac{1}{2}$ watt resistor 200-ohms
- 2— $\frac{1}{2}$ watt resistor 2,000-ohms
- 1— $\frac{1}{2}$ watt resistor 50,000-ohms
- 2— $\frac{1}{2}$ watt resistor 20,000-ohms
- 1— $\frac{1}{2}$ watt resistor 15,000-ohms

MISCELLANEOUS

- 6 feet # 14 Plain Enamel Copper wire

Parts for complete tuner and R.F. System

AEROVOX

- 6—.01 mf. tubular condensers, 600 volt rating
- 1—Mica condenser, 50 mmf.

Circuit for the U.H.F. tuner.

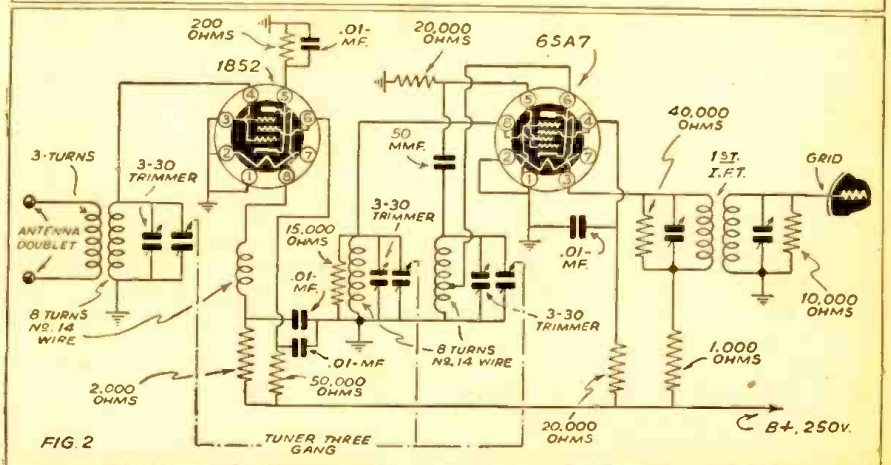
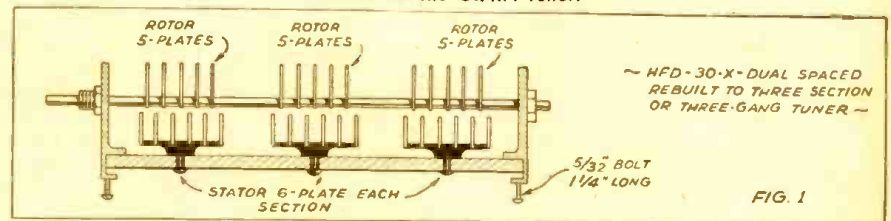

Simple Antenna Measurements

Howard H. Arnold

● HOW many times has the average Ham wished that he knew just exactly what power he was "putting out"!

The first thought was to build up apparatus expressly for the purpose of making such R.F. measurements. It was only a short time till this thought was rapidly discarded, however. We soon discovered that Mr. Average Ham not only could not afford to build up a complicated unit for only one purpose, but didn't even have the inclination to do so. The next thought was to use the regular transmitter for this purpose. However, the wide range of powers, and the high instability of a number of rigs under varying load conditions soon discouraged this system. The problem, then, resolved itself into discovering a stable, moderate cost, source of R.F. energy, to which all advanced Hams had access. And, with the resolution of the problem into these terms, the solution became obvious. Almost every advanced amateur to whom we talked had available either a Meissner Signal-Shifter, or some similar form of ECO or crystal exciter unit. These units are not only designed to remain stable under varying load conditions, but are easily adjusted over the entire operating range of the amateur bands. This, then, will serve admirably as the R.F. oscillator of the antenna measuring equipment.

The next headache encountered was the decade resistor which was necessary. The main requisite of this unit was that it be entirely non-inductive. Now, as almost every amateur knows, non-inductive resistors aren't given away in boxes of crackerjacks, so the monetary angle of this problem was anything but simple. However, a very simple and practical solution was finally reached.

We simply took ten high-quality porcelain electric light sockets and mounted them, connected in series, on a piece of dry hard maple, which in turn was mounted on glass insulators, consisting of four pint milk bottles.

The next step in construction is to secure ten pyrex 30 amp. fuses. These are used to plug the porcelain cleat receptacles just mentioned, and to change the resistance of the circuit, lamp bulbs of different wattage are substituted, one by one, for the fuses. Although this is far from an ideal decade box, it has been found sufficiently free from stray inductance and capacitance changes to give surprisingly accurate results when compared with commercial equipment.

Now, mount on the same board as the decade resistors, at one end, as shown in the diagram, two porcelain stand-off insulators with banana jack tops. This is for the purpose of mounting the tuning inductance, whose construction will be described later. At the opposite end of the mounting board is mounted a .001 mf. shielded condenser, which can be salvaged from almost any Ham's junk-box. Now with the addition of an R.F. milliammeter, the equipment is practically complete. with the construction of the standard inductance. The data for these coils as plotted against the frequency bands to be measured in, is shown in table No. 1.

Now, to use the equipment assembled, connect it as shown in Fig. 2, inserting the proper coil for the frequency band in which measurement is desired.

Have all the porcelain sockets plugged

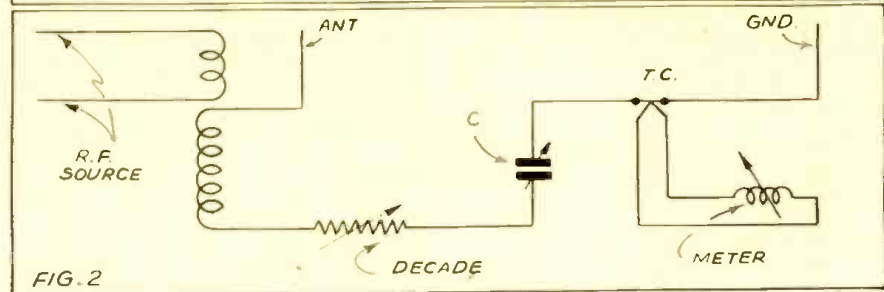
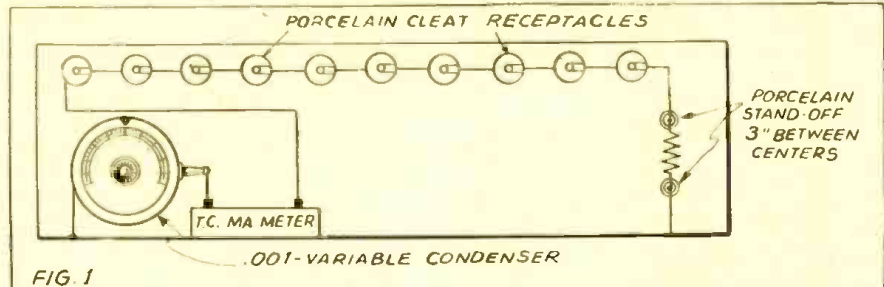

With the simple device illustrated accurate antenna measurements may be made by the Ham.

with ordinary 30 amp. glass fuses. Bring the link from the ECO excitation unit into close coupling with the inductance coil, and then connect the antenna terminals to the proper positions. Be sure, if a ground is used, that this is connected to the condenser terminal, and to the shielded, or rotor terminal of that condenser. Now start the exciter, and watch for a reading on the milliammeter unit. Then tune C to resonance, indicated by maximum reading on the R.F. ma. meter. If the meter rises too high in value, decrease the coupling. After resonance is obtained, decrease the coupling until the meter reads approximately 50 milliamperes. Then start removing fuses and screwing in light bulbs. Use all bulbs of one wattage. Table No. 2 gives the wattage of bulbs of various resistance. You will note that the watts law, I²R, as applied at 110 volts differs considerably from the values given in the table. This is caused by difference in temperature coefficient, not by frequency difference. The bulbs are, for all practical purposes, non-inductive to a large extent. Start with the largest size bulbs available, and screw in ten of them, or enough of them to reduce the R.F. current by half. If the ten bulbs do not reduce the current sufficiently, use the next smaller size. By using a number of bulbs, rather than single ones, the slight variation in individual bulbs tends to balance out, as some of them will run slightly more and some slightly less than the values given. When, with the coupling, condenser setting, etc., remaining the same, the R.F. current is reduced to half of the original value, simply add the resistance of the light bulbs, and you will have a nice approximation of your antenna resistance. Then, when you wonder what efficiency you actually are running, all you have to do is take a meter reading at the point of resistance measurement, and

find your output power by taking the square of the current reading and multiplying it times your antenna resistance, as found in the initial tests.

Of course, the resistance varies with frequency, but the radiation resistance in any one band can be assumed for practical purposes, to be the same, although all different bands on which you intend operation should have a separate series of measurements taken.

TABLE I

Band	No. Turns	Dia.	Spacing Turns per"	Size Wire	In-sulation
160 M.	7	6"	2 1/3	No. 4	Bare
80 M.	7	3"	2 1/3	No. 4	Bare
40 M.	6	1 1/2"	2	No. 10	Bare
20 M.	4	1"	1 1/3	No. 12	Bare

All coils air-wound. Banana plugs on ends.
160 M. and 80 M. coils can be 3/4" O.D. copper tubing.

TABLE II

WATTAGE	300	150	100	75	60	40
RESISTANCE (Cold Ohms)	18	40	62	85	110	165

Answers to Puzzle Diagram on page 381

1. Variable resistance shown in series with the aerial should be a variable capacity.
2. The resistor shown in series with the tickler coil and plate should be an R.F. choke.
3. The coil or choke shown to the right of the potentiometer should be a resistor.
4. The resistor shown just under the tube number should be a condenser.
5. The R.F. choke shown in series with grid terminal 5 and filament terminal 7 should be a resistor.
6. The plus and minus high-voltage terminals should have been marked 45 volts instead of 245 volts; also they are shown reversed.

Index to advertisers

ENGINEERING

Radio Corp. of America 323

PUBLISHERS

Theo. Audel & Company 365
 Data Print Company 370
 Nelson Company 326
 Supreme Publications 357
 Technifax 343

RADIO PARTS

Aerovox Corporation 355
 Bliley Electric Company 366
 Bud Radio, Inc. 373
 C. F. Cannon Company 370
 Meissner Mfg. Co. 349
 James Millen Mfg. Co., Inc. 380
 Ohmite Mfg. Co. 377
 Par Metal Products Corp. 366
 Solar Mfg. Corp. 355
 X. L. Radio Laboratories 381

RADIO SETS

ABC Radio Laboratories 381
 Goldentone Radio Company 370
 Hallicrafters, Inc. 353
 Midget Radio Company 381
 Midwest Radio Corp. 365

RADIO SUPPLY HOUSES

Allied Radio Corp. 339
 Burstein-Applebee Company 351
 Harrison Radio Company 380
 Henry Radio Shop 361
 Hudson Specialties Company 367
 Peerless Sound & Radio Corp. 350
 Radolek Company 347
 Wholesale Radio Laboratories 352

SOUND AND RECORDING EQUIPMENT

Amperite Corporation Inside Back Cover
 Amplifier Company of America 345, 359
 John Meek Industries 355
 Miles Reproducer Co. 351
 University Laboratories 351

SCHOOLS AND CODE INSTRUCTION

American Radio Institute 325
 American Television Labs. Inside Front Cover
 Candler System Company 370
 Capitol Radio Institute 325
 Commercial Radio Institute 370
 Coyne Electrical School 359
 Dodge's Institute 325
 Instructograph Company 380
 International Correspondence Schools 325
 Lincoln Engineering School 325
 Mass. Radio School 325
 Midland Radio & Television School 371
 National Radio Institute 321
 National Schools 365
 New York Y.M.C.A. Schools 325
 Nilson Radio School 370
 Radio-Telio Institute 381
 Radio Training Association 326
 RCA Institutes, Inc. 326
 Sprayberry Academy of Radio 326
 Teleplex Company 366

TEST EQUIPMENT

Adson Radio 363
 Radio City Products Co. 363
 Readrite Meter Works 351
 Superior Instruments Co. 364
 Supreme Instruments Corp. 363
 Triplett Elec. Instruments Company 337

TUBES

Hygrade Sylvania Corp. 324
 National Union Radio Corp. 327
 RCA Manufacturing Co. Back Cover

MISCELLANEOUS

Chartered Institute of American Inventors 381
 Classified Section 370
 Coyne Music Shop 355
 Lancaster, Allwine & Rommel 366
 Laughlin Mfg. Co. 381
 New York Institute of Photography 366
 Remington Rand, Inc. 328

(While every precaution is taken to insure accuracy, we cannot guarantee against the possibility of an occasional change or omission in the preparation of this index.)



"Honor" Plaque Awarded
 To R. Reginald Tibbetts, W6LIH

For Best Station Photo

• THE photo shows the remarkable transmitting and receiving station designed, constructed and operated by R. Reginald Tibbetts of Redwood Valley, Moraga, Calif. His call letters are W6LIH. A Hammarlund Super-Pro Receiver is observed to the left of the rear line of instruments on the desk. Most of the other apparatus is specially built and it is interesting to observe that Mr. Tibbetts, who is the engineer as well as the radio operator, has had windows placed in the front of the transmitter panels so that the tubes can be observed at all times. All of the transmitter circuits are well metered. Note the elaborate array

of jacks and plugs at the right-hand side of the operator's desk. By means of patch-cords various circuits may be tied in for outside pickups, etc. The frequency of the transmitted wave can be adjusted from the desk position, where the key as well as the microphone are also placed. Different frequencies can be selected by means of a dial switch shown on the rear desk panel.

Another patch-cord jack panel is observed at the extreme right of the rear switchboard array, these panels extending clear to the floor. This is just about the finest "Ham" station we have yet feasted our eyes upon. The address of the operator is Redwood Valley, Moraga, California.

Here is the "Award of Honor" Plaque which measures 5" x 7" in size. It is handsomely executed in colors on metal, and is framed, ready to hang on the wall. The name of the winner will be suitably inscribed.

FOR THE DURATION OF THE WAR—Plaque will be awarded for best "Listening Post" photo.

Attach a brief description not longer than 300 words, describing the general line-up of the apparatus employed, the size, type and number of tubes, the type of circuit used, name of commercial receiver — if not home-made.

State briefly the number of continents heard, the total number of stations logged or contacted, and other features of general interest. Mention the type of aerial system.

Important — Enclose a good photograph of yourself, if your likeness does not appear in the picture!

You do not have to be a reader of RADIO-CRAFT in order to enter the contest.

Address all photos and station description to Editor, "Listening Post" Photo Contest, c/o RADIO-CRAFT, 25 West Broadway, New York, N. Y.



"Finest Dynamic I ever used"
 SAYS EVAN R. RUSHING, SOUND ENGINEER, HOTEL NEW YORKER

AMPERITE
P.G. DYNAMIC
 BRINGS STUDIO QUALITY
 TO ORDINARY P.A. JOBS

- **UNI-DIRECTIONAL.** NEW SUPERIOR ELIPSOID PICKUP PATTERN
- **ELIMINATES FEEDBACK** TROUBLE BECAUSE IT HAS LOWEST FEEDBACK POINT OF ALL DIAPHRAGM TYPE MICROPHONES
- **FLAT RESPONSE.** FREE FROM ANNOYING PEAKS, GIVING STUDIO-QUALITY REPRODUCTION.

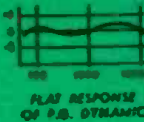

The P.G. diaphragm follows air particle velocity where amplitude is a GRADIENT of the PRESSURE. In ordinary dynamics amplitude is restricted from following air particle velocity.

The P.G. DYNAMIC is a radical improvement in this type of microphone. You can actually hear the difference. Case is designed according to modern acoustic principles. Rugged, not affected by temperature, altitude or humidity. HAS UNUSUALLY HIGH OUTPUT — \$5. DB.

MODEL PGH (PGL 200 ohms). Excellent for high fidelity P.A. installations, broadcast studio, and professional recording. With switch, cable connector, 25' cable. Chrome finish. LIST \$32.00 (40-10000 C.P.S.)
 MODEL PGAL (PGAL 200 ohms). For speech and music 20-8000 C.P.S. Switch, cable connector, 12' cable. Chrome. LIST \$25.00

**COMBINATION VELOCITY-DYNAMIC
 ACHIEVED WITH
 ACOUSTIC COMPENSATOR**

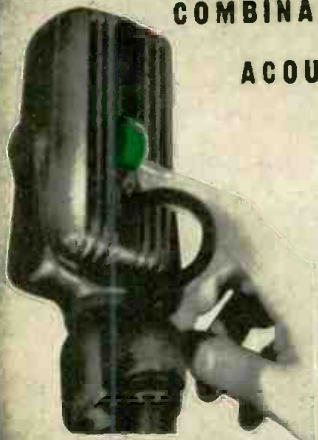

An exclusive Amperite feature: By moving up the Acoustic Compensator you change the AMPERITE VELOCITY to a DYNAMIC microphone without peaks. At the same time you reduce the back pick-up, making the microphone practically UNI-DIRECTIONAL.

WITH ACOUSTIC COMPENSATOR:
 MODEL RBHk: RBMk (200 ohms) with switch, cable connector.
 Chrome. LIST \$42.00

RSHk: RBSk (200 ohms). Switch, cable connector, Acoustic Compensator.
 Chrome or Gunmetal. LIST \$32.00

AMPERITE KONTAK MIKE
 Puts Musical Instruments Across



So beautiful is the tone produced with the Kontak Mike, that it was used in the Philadelphia Symphony to amplify a mandolin solo. Gives excellent results with any amplifier, radio sets, and record players.

- MODEL SKH (hi-imp) LIST \$12.00
- MODEL KKH, with hand volume control. LIST 18.00
- Plug extra List 1.50
- FOOT PEDAL, for making beautiful crescendos LIST 12.00

WRITE FOR FREE SALES AIDS

AMPERITE © 561 BROADWAY, N. Y. U. S. A.

Specify **AMPERITE**



