

RADIO-CRAFT

HUGO GERNSBACK, Editor

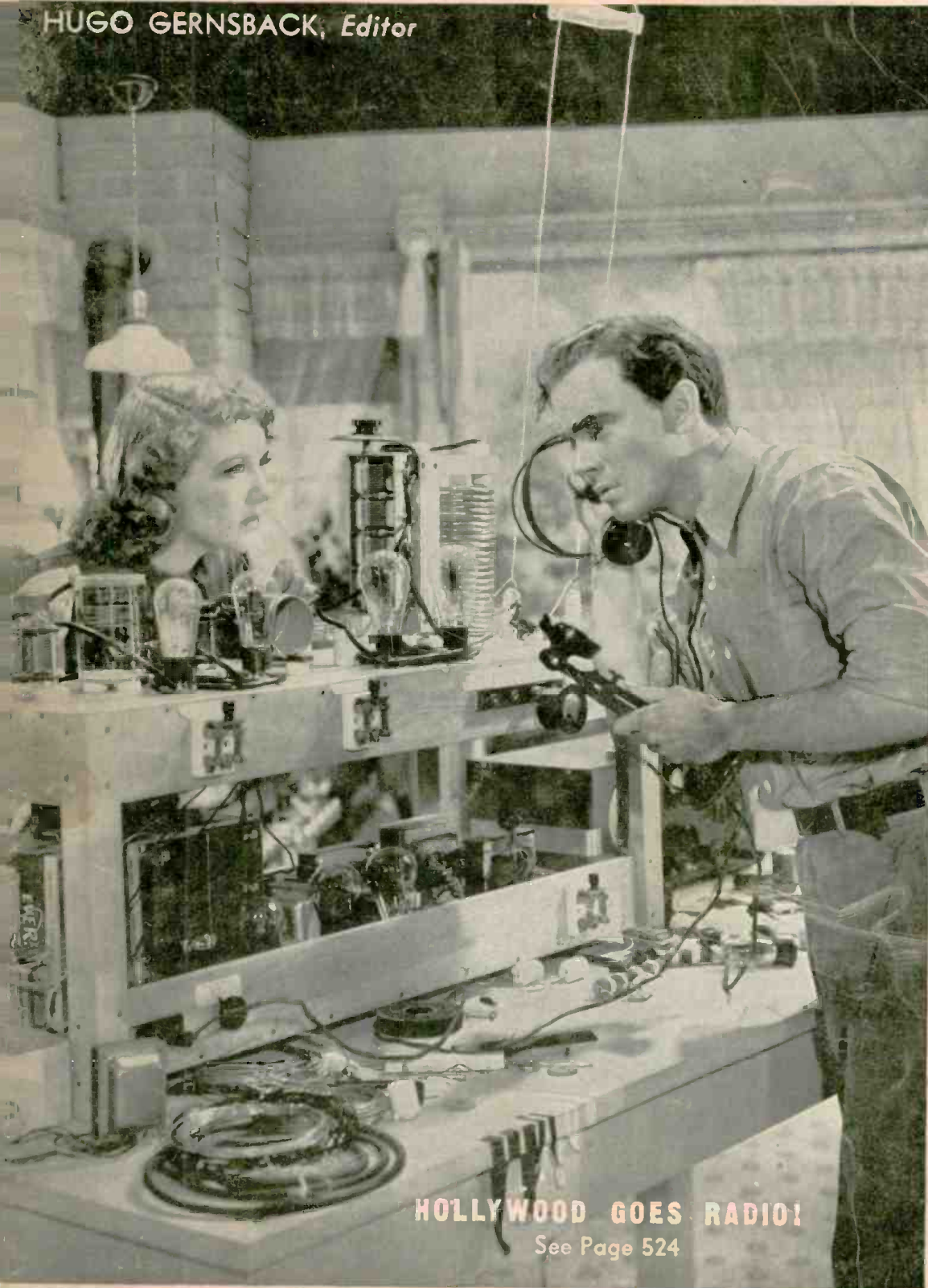

HOLLYWOOD GOES RADIO!
See Page 524

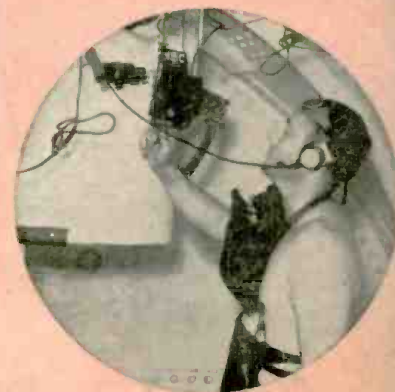

SUBMARINE BROADCAST

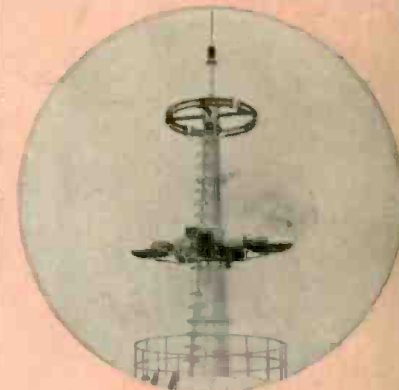

TELEVISION ANTENNA



RAILROAD RADIO



DIRECTIONAL MICROPHONE

MARCH 25c OVER 175 ILLUSTRATIONS
THE PIPELESS ORGAN · WORLD-WIDE TELEVISION
SIMPLE TECHNIQUE FOR MAKING HOME TALKIES

The **AMPERITE**

ACOUSTIC COMPENSATOR

(pat. pend.)

gives you

HIGH OR LOW PITCH

WITH THE SAME MICROPHONE

BIGGER PROFITS To be ahead of competition, and realize a larger profit on each job, you must offer added value in new features. Realizing this **Amperite** gives you *The Acoustic Compensator . . . at no extra cost to you!*

This is an exclusive feature which enables you to (1) lower or raise the response of the microphone; (2) adjust for close talking or distant pickup; (3) adapt microphone to varied conditions.

THESE 4 MODELS HAVE THE ACOUSTIC COMPENSATOR

MODEL RBHk (hi-imp); **RBMk** (200 ohms) Frequency range 40 to 11000 CPS. Output -65 db. . . . Chrome or Gunmetal . . \$42.00 LIST

NEW! MODEL RSHk (hi-imp); **RBSk** (200 ohms) Frequency range 60 to 8000 CPS. Output -68 db. . . Chrome or Gunmetal . . \$32.00 LIST

All of the above are complete with Acoustic Compensator, Switch, Cable Connector, and cable.

NOTE: Roth Sound Service writes. . . "Your mikes are certainly rugged. I've used them in rain, wind, and on the hottest days, but they've always stood up perfectly".



PUSH UP TO INCREASE HIGHS; PUSH DOWN TO INCREASE LOWS



MAKE EXTRA SALES WITH CONTACT MIKES...\$12.00 LIST

Professional and amateur musicians are delighted with the Amperite Contact Microphone. It "makes an ordinary violin sound like a Strad" . . . gives a small piano the tone of a grand. And yet, there is no distortion. No unnatural effects. No "fingering noises" . . . Frequency response 40 to 9000 CPS. Output -40 db. 20' of cable.

Models listed below can be used on most radio sets since 1935 and on all P.A. Systems. They operate with either high or low gain amplifiers. Installation is simple . . . no changes in strings or instruments . . . attached without tools.

MODEL SKH (Hi-imp); **SKL** (200 ohms) \$12.00 LIST
SKH or **SKL** with foot-operated volume control \$20.00 LIST
 Professional Model **KTH** (or **KTL**) \$22.00 LIST

A COMPACT VELOCITY for hand or stand

Though only a little larger than a match box, this Amperite Velocity has the features of the larger microphones. Good for speech and music. Designed for use on stand, but also makes an excellent hand microphone with comfortable pistol grip.

Frequency response 60 to 7500 CPS. Output -70 db. Complete with switch, cable connector, and 25' of cable.

MODEL ACH (hi-imp); or **ACL** (200 ohms) \$25.00 LIST



IMPROVES ANY "LOW-COST" INSTALLATION ON 4 COUNTS!

P.A. Men, you can improve those "price" jobs by using the popular Amperite Model

RAH (or **RAL**). You will get better results because: (1) it is excellent for both speech and music; (2) has flat response without undesirable peaks; (3) reduces feedback; (4) stands up under rain, wind, heat, and rough handling . . . Frequency range 60 to 7500 CPS. Output -68 db. **MODEL RAH** (hi-imp); with 12' of cable; **MODEL RAL** (200 ohms) with 8' of cable. \$22.00 LIST



Sales Aids for the P. A. Man Amperite offers the following co-operation to P.A. Men.

- (1.) FREE Window Decal advertising your Sound Service. Size 5 1/4 x 9 1/4, finished in 4 striking colors.
- (2.) FREE Window Display, 11 x 17.
- (3.) Special Sound Equipment Letterheads. Samples and prices on request.
- (4.) FREE use of cut for printing business cards, etc.

Write for these valuable sales helps, and new Illustrated Bulletins, today!



AMPERITE CO. 561 BROADWAY, N. Y. U. S. A. CABLE ADDRESS ALKEM, NEW YORK



VELOCITY AMPERITE MICROPHONES



J. E. SMITH, President, National Radio Institute
Established 1914

The man who has directed the home study training of more men for the Radio Industry than any other man in America.

Be a Radio Expert

Many make **\$30 \$50 \$75** a week

I will train you at home for many Good Spare Time and Full Time Radio Jobs



Set Servicing

Fixing Radio sets in spare time pays many \$5, \$10, \$15 a week extra while learning. Full time repair pays as much as \$30, \$50, \$75 a week.



Broadcasting Stations

Employ managers, engineers, operators, installation and maintenance men for fascinating jobs and pay up to \$5,000 a year.



Loud Speaker Systems

Building, installing, servicing, operating public address systems is another growing field for men well trained in Radio.



Radio offers you many opportunities for well-paying spare-time and full time jobs. And you don't have to give up your job, leave home or spend a lot of money to train to get those jobs—to become a Radio Expert.

Get Ready Now for Jobs Like These

Radio broadcasting stations employ engineers, operators, station managers and pay well for trained men. Fixing Radio sets in spare time pays many \$200 to \$500 a year—full time jobs with Radio jobs, manufacturers and dealers, as much as \$30, \$50, \$75 a week. Many Radio Experts open full or part time radio sales and repair businesses. Radio manufacturers and jobbers employ test-men, inspectors, foremen, engineers, servicemen, in good-pay jobs with opportunities for advancement. Automobile, police, aviation, commercial Radio and loud speaker systems are newer fields offering good opportunities now and for the future. Television promises to open many good jobs soon. Men I trained have good jobs in these branches of Radio. Read how they got their jobs. Mail coupon.

Why Many Radio Experts Make \$30, \$50, \$75 a Week

Radio is young—yet it's one of our large industries. More than 28,000,000 homes have one or more Radios. There are more Radios than telephones. Every year millions of Radios get out of date and are replaced. Millions more need new tubes, repairs. Over \$50,000,000 are spent every year for Radio repairs alone. Over 5,000,000 auto Radios are in use; more are being sold every day, offering more profit-making opportunities for Radio experts. And RADIO IS STILL YOUNG, GROWING, expanding into new fields. The few hundred \$30, \$50, \$75 a week jobs of 20 years ago have grown to thousands. Yes, Radio offers opportunities—now and for the future!

Many Make \$5, \$10, \$15 a Week Extra in Spare Time While Learning

The day you enroll I start sending Extra Money Job Sheets; show you how to do Radio repair jobs. Throughout your training I send plans and directions that made good spare time money—\$200 to \$500—for hundreds, while learning. I send you special Radio

equipment to conduct experiments and build circuits. This 50-50 method of training makes learning at home interesting, fascinating, practical.

I Also Give You This Professional Servicing Instrument



Here is the instrument every Radio expert needs and wants—an All-Wave, All-Purpose Set-Servicing Instrument. It contains everything necessary to measure A.C. and D.C. voltages and current; to test tubes, resistance; adjust and align any set, old or new. It satisfies your needs for professional servicing after you graduate—can help you make extra money fixing sets while training.

You Are Trained for Television Also

With N. R. I. you take up Television principles right along with Radio principles—the correct method—since Television receivers combine both sight and sound. You also get more than ten text books devoted entirely to Television.

Find Out What Radio Offers You

Act Today. Mail the coupon now for "Rich Rewards in Radio." It's free to any fellow over 16 years old. It points out Radio's spare time and full time opportunities and those coming in Television; tells about my training in Radio and Television; shows you letters from men I trained, telling what they are doing and earning; tells how my Money Back Agreement protects you. Find out what Radio offers YOU! MAIL COUPON in an envelope, or paste on a postcard—NOW!

J. E. SMITH, Pres., National Radio Institute
Dept. 9CX
Washington, D. C.

HERE'S PROOF THAT MY TRAINING PAYS



\$50 Monthly in Spare Time

"I work on Radio part time, still holding my regular job. Since enrolling seven years ago, I have averaged around \$50 every month." JOHN B. MORISSETTE, 809 Valley St., Manchester, N. H.



Makes \$50 to \$60 a Week

"I am making between \$50 and \$60 a week after all expenses are paid, and I am getting all the Radio work I can take care of, thanks to N. R. I." H. W. SPANGLER, 126 1/2 S. Gay St., Knoxville, Tenn.



Operates Public Address System

"I have a position with the Los Angeles Civil Service, operating the Public Address System in the City Hall Council. My salary is \$170 a month." R. H. ROOD, R. 136, City Hall, Los Angeles, Calif.

Lesson on Radio Servicing Tips—FREE

I want to prove that my Training Gives Practical, money-making information, is easy to understand—is what you need to master Radio. My sample lesson text, "Radio Receiver Troubles—Their Cause and Remedy" covers a long list of Radio receiver troubles in A.C., D.C., battery, universal, auto, T. R. F., superheterodyne, all-wave, and other types of sets. And a cross reference system gives you the probable cause and a quick way to locate and remedy these set troubles. A special section is devoted to receiver checkup, alignment, balancing, neutralizing and testings. Get this lesson FREE. No obligation. Just mail coupon.



THIS FREE BOOK HAS HELPED HUNDREDS OF MEN MAKE MORE MONEY



This Coupon is Good for One FREE Copy of My Book

J. E. SMITH, President, Dept. 9CX
National Radio Institute, Washington, D. C.

Dear Mr. Smith: Without obligation, send me free the Sample Lesson and your 64-page Book, "Rich Rewards in Radio," telling about spare time and full time Radio opportunities, and how I can train for them at home in spare time. (Please write plainly.)

NAME AGE

ADDRESS

CITY STATE 14-X1

Please Say That You Saw It in RADIO-CRAFT

RADIO-CRAFT

HUGO GERNSBACK, *Editor-in-Chief*

N. H. LESSEM
Associate Editor

THOS. D. PENTZ
Art Director

ROBERT EICHBERG
Trade Digest Editor

R. D. WASHBURNE, *Managing Editor*

Contents MARCH, 1939 Issue

VOLUME X -- NUMBER 9

Editorial: Radio at the Crossroads.....	Hugo Gernsback	517
The Radio Month in Review.....		518
How Radio Helped Uncle Sam Celebrate "Navy Day".....		520
The Pipeless Organ!—Part I.....	Victor I. Zuck	521
Radio's Latest Mike is "Cardioid Directional".....		522
Television Antenna—1939 Model.....		523
Hollywood Goes Radiol.....		524
First Daily Newspaper by Radio Facsimile.....		526
"Triple-Cone" Offers Better Tone!.....		527
World-Wide Television Progress—a Review.....		528
Operating Notes		530
Effect of A.C. on Dry Electrolytics.....	Paul McKnight Deeley	531
Simple Technique for Making Home Talkies—Part I.....	C. A. Tuthill	532
New Circuits in Modern Radio Receivers—No. 18....	F. L. Sprayberry	534
Practical Servicing Pointers.....	Willard Moody	535
Making a Serviceman's Test Unit—The "Super-Geno-Scope"—Part IV	Canio Maggio	536
25 Years of Training Men for Radiol.....		538
How to Make a Meter-Range Extender.....	M. N. Beitman	538
Servicing Questions & Answers.....		539
Complete Step-by-Step Dynamic Servicing—Part III..	Kendall Clough	540
Wiring Pointers for the Radio Beginner.....	William Boydston Miller	542
The Latest Radio Equipment.....		544
Radio Trade Digest.....		545
RADIO SERVICE DATA SHEETS:		
No. 248—Stewart-Warner High-Fidelity Models 91-821 to 91-829, 98-821 to 98-829, 910-821 to 910-829 (Chassis Models 91-82, 98-82, 910-82).....		549
No. 249—Ditto		552
Book Reviews		574

In the NEXT ISSUE

International Radio Review
A Mile-High Radio Weather Station

How to Make a String-Music Contact Mike

Making a Shop-Type A.C. to D.C. Power Supply

★

BULLETIN

Part 3 of the series of articles titled "This Home—WIRED FOR RADIO" will not appear in this issue. Due to unfavorable weather, construction on the Radio Home has fallen considerably behind schedule. We hope to have the following instalment in the next issue. Part 3 will discuss the steps necessary to adapt the master receiver to the built-in radio system.

★

Published by Radcraft Publications, Inc. Publication office: 29 Worthington Street, Springfield, Mass. Editorial and Advertising Offices: 99 Hudson Street, New York City. Chicago Advertising Office: RADIO-CRAFT, 520 North Michigan Avenue, Chicago, Ill.

RADIO-CRAFT is published monthly, on the first of the month preceding that of date; subscription price is \$2.50 per year in U. S. and Canada. (In foreign countries, \$3.00 a year to cover additional postage.) Entered at the post office at Springfield as second-class matter under the act of March 3, 1879.

Foreign Agents:

London—Gorrings' American News Agency, 9A Green St., Leicester Square, W. C. 2, England.

Paris—Messageries Dawson, 4 Rue Faubourg, Poissonniere, France.

Melbourne—McGill's Agency, 179 Elizabeth St., Australia.

Dunedin—James Johnston, Ltd., New Zealand.

★

Text and illustrations of this magazine are copyright and must not be reproduced without permission of the copyright owners.

★

Copyright 1939 Radcraft Publications, Inc.



STUDENTS BUSY AT WORK IN LARGE COYNE SHOPS

TRAIN MY QUICK, EASY WAY FOR RADIO

**PAY FOR YOUR TRAINING
IN EASY MONTHLY PAYMENTS
AFTER YOU GRADUATE**

Find out all about this wonderful offer. My Big Free Book tells you how you can train for your start to a big pay job in Radio . . . And through my "Pay-Tuition-After-Graduation" Plan, you can start paying your tuition in Easy Monthly Payments two months after your regular 12 weeks training period ends.

"Learn By Doing" in 90 Days In Big Coyne Shops

**ON REAL RADIO, TELEVISION
AND SOUND EQUIPMENT**

In the Big Coyne Shops you have individual help by expert instructors so that you quickly and easily learn Radio by actual work. No advanced education or previous Radio experience is needed. You are taught . . . not by correspondence, not by books or embarrassing reciting . . . but by the Famous Coyne "Learn-By-Doing" training method which has helped hundreds of successful graduates to get

and hold the job they like, or go into business for themselves.

At Coyne you do **Practical Work** on real Radio, Sound and Television equipment.

You wire up, service and repair real radios and sound amplifiers; operate actual television equipment and radio transmitters. When you finish each step you **know how** because you have done the work yourself. At Coyne you get the **practical training** you need for your start in the Radio field.



PART TIME WORK WHILE TRAINING— EMPLOYMENT HELP AFTER GRADUATION

If you are short of money and need part-time work to help pay for your room and board while training, my Employment Department will help you get a part time job. When you have graduated, they will give you Lifetime Employment Service.



Prepare For Jobs Like These

Here are a few jobs in the Radio, Television and Sound Fields. Our Free Employment Bureau gives you Lifetime Employment Service.

- RADIO SERVICE MAN
- PUBLIC ADDRESS & SOUND MAN
- AUTO RADIO INSTALLATION & SERVICE
- RADIO FACTORY INSPECTOR & TESTER
- STUDIO TECHNICIAN
- RADIO OPERATOR
- REFRIGERATION SERVICE MAN

READ WHAT THESE GRADUATES SAY

"Due to Coyne's practical work, it was easy to learn in 12 weeks . . . I got a job with _____ Co. as Radio and Refrigeration Service man. I have had steady work ever since and can truly say that due to Coyne, I have been able to increase my earnings. I would recommend Coyne to anyone who wants good training."—Al Schmidt, Minn.

"I am now Chief Radio Operator for three Radio transmitting stations . . . Did Coyne training pay? Judge for yourself. I am always sure of a job. I have built a nice home, own a good automobile and have a comfortable bank balance to care for emergencies. Since leaving Coyne, I have never been out of work a single day."—L. L. Prejean, La.

GET THE FACTS

Don't let lack of money keep you from sending in the Coupon now. My Big FREE Book is full of facts and photographs which tell you about Coyne training. It also gives you the details of my Pay After Graduation Plan, Spare Time Employment Offer, Graduate Employment Service, Lifetime Scholarship and other advantages.

MAIL
COUPON



**Send Today for
this FREE Book!**

H. C. LEWIS, President,
COYNE ELECTRICAL SCHOOL,
Radio Division,
500 S. Paulina Street,
Dept. 39-8H, Chicago, Ill.

Dear Mr. Lewis:—Without obligation send me your big free illustrated catalog, with all facts about Coyne Training and details of your "Pay-Tuition-After-Graduation" Plan.

Name.....

Address.....

City..... State.....

Mail in envelope or paste on a postcard



COYNE occupies this entire Modern, fireproof Building.

ELECTRIC REFRIGERATION

At this time I am including additional valuable instruction in this important new field because many Radio men are called upon to handle work in this field.

COYNE H. C. LEWIS, President Founded 1899 ELECTRICAL SCHOOL

RADIO DIVISION

500 South Paulina Street Dept. 39-8H Chicago, Ill.

Please Say That You Saw It in RADIO-CRAFT

For Better Servicing - - For Greater Profits - - Use Gernsback Manuals and Books!



SINCE 1931 Servicemen have been buying more **GERNSBACK OFFICIAL RADIO SERVICE MANUALS** year after year. The authentic material, easily accessible diagrams and *complete* service data make them invaluable to dealers and radio Servicemen. *Without a Gernsback Service Manual at the repair job, there's time and profit lost.* Your service kit or laboratory is incomplete without *all* the **GERNSBACK OFFICIAL RADIO SERVICE MANUALS**. There are **GERNSBACK MANUALS** for servicing auto-radios, also refrigeration and air conditioning equipment.

VOLUME 7 OFFICIAL RADIO SERVICE MANUAL
 Over 1,800 Pages • Over 3,000 Illustrations • Stiff, Leatherette, Looseleaf Covers • Size 9 x 12 Inches • Net Weight 10½ lbs. **\$10.00**

1936 OFFICIAL RADIO SERVICE MANUAL
 Over 1,200 Pages • Over 2,500 Illustrations • Stiff, Leatherette, Looseleaf Covers • Size 9 x 12 Inches • Net Weight 8 lbs. **\$7.00**

1935 OFFICIAL RADIO SERVICE MANUAL
 Over 1,000 Pages • Over 3,000 Illustrations • Flexible, Leatherette, Looseleaf Covers • Size 9 x 12 Inches • Net Weight 3¾ lbs. **\$7.00**

1935 OFFICIAL AUTO-RADIO SERVICE MANUAL
 Over 240 Pages • Over 500 Illustrations • Flexible, Leatherette, Looseleaf Covers • Size 9 x 12 Inches • Net Weight 1¾ lbs. **\$2.50**

1934 OFFICIAL RADIO SERVICE MANUAL
 Over 400 Pages • Over 2,000 Illustrations • Flexible, Leatherette, Looseleaf Covers • Size 9 x 12 Inches • Net Weight 2½ lbs. **\$3.50**

1932 OFFICIAL RADIO SERVICE MANUAL
 Over 1,000 Pages • Over 2,000 Illustrations • Flexible, Leatherette, Looseleaf Covers • Size 9 x 12 Inches • Net Weight 4½ lbs. **\$5.00**

OFFICIAL REFRIGERATION SERVICE MANUAL (Volume 1)
 Over 450 Pages • Over 1,200 Illustrations • Flexible, Leatherette, Looseleaf Covers • Size 9 x 12 Inches • Net Weight 2¾ lbs. **\$5.00**

OFFICIAL REFRIGERATION SERVICE MANUAL (Volume 11)
 Over 352 Pages • Over 300 Illustrations • Flexible, Leatherette, Looseleaf Covers • Size 9 x 12 Inches • Net Weight 1¾ lbs. **\$5.00**

OFFICIAL AIR CONDITIONING SERVICE MANUAL
 Over 352 Pages • Over 600 Illustrations • Flexible, Leatherette, Looseleaf Covers • Size 9 x 12 Inches • Net Weight 2½ lbs. **\$5.00**

To order these famous Manuals, see or write to your jobber or favorite mail order house. If more convenient, mail coupon directly to publishers.

Get into the swing of reading instructive, authoritative books on technical subjects—radio, air conditioning and refrigeration. It's the easiest, quickest and most inexpensive way to improve your knowledge on these topics. In this series, popularly known as the **RADIO-CRAFT LIBRARY SERIES**, are all the titles necessary to your personal advancement. Only by careful study of these enlightening books, can you gain adequate experience in fields of radio, air conditioning and refrigeration. Each book is uniform. The volumes measure 6 x 9 inches—contain 64 pages, and have stiff, flexible covers. **PRICE 50c PER BOOK.** All books are sent to you postpaid.

Here Are The Titles:

- | | |
|--|---|
| Book No. 2
MODERN VACUUM TUBES | Book No. 14
POCKET RADIO GUIDE |
| Book No. 3
THE SUPERHETERODYNE BOOK | Book No. 15
ABC OF REFRIGERATION |
| Book No. 6
BRINGING ELECTRIC SETS UP-TO-DATE | Book No. 16
PRACTICAL RADIO CIRCUITS |
| Book No. 9
AUTOMOBILE RADIO AND SERVICING | Book No. 17
SERVICING WITH SET ANALYZERS |
| Book No. 10
HOME RECORDING AND ALL ABOUT IT | Book No. 18
POINT-TO-POINT RESISTANCE ANALYSIS |
| Book No. 12
PUBLIC ADDRESS INSTALLATION AND SERVICE | Book No. 20
THE CATHODE-RAY OSCILLOSCOPE |
| Book No. 13
ABC OF AIR CONDITIONING | Book No. 21
BREAKING INTO RADIO SERVICING |
| | Book No. 22
NEW RADIO QUESTIONS AND ANSWERS |

EACH BOOK IN THIS SERIES—50c

RADCRAFT PUBLICATIONS, Inc., 99 HUDSON ST., NEW YORK, N. Y.
 Gentlemen: Enclosed find my remittance of \$..... for which send me, **POSTPAID**, the Manuals or Books indicated below by a cross (x) in the panel.

- () Volume 7 @ \$10.00 () 1936 Manual @ \$7.00 () 1935 Manual @ \$7.00
 () 1935 Auto-Manual @ \$2.50 () 1934 Manual @ \$3.50 () 1932 Manual @ \$5.00
 () Refrigeration Manual (Vol. 1) @ \$5.00 () Refrigeration Manual (Vol. 2) @ \$5.00
 () Air Conditioning Manual @ \$5.00

RADIO-CRAFT LIBRARY SERIES @ 50c EACH
 Circle book numbers wanted: 2 3 6 9 10 12 13 14 15 16 17 18 20 21 22

Name Address

City State

(Send remittance in form of check or money order; register your letter if you send cash or unused U. S. Postage Stamps.) **RC-339**

RADCRAFT PUBLICATIONS, Inc.
99 HUDSON STREET NEW YORK, N. Y.

Please Say That You Saw It in **RADIO-CRAFT**

IT'S HERE AT LAST A PRACTICAL TELEVISION KIT!!

Two models—one with 3-inch and one with 5-inch tube!

The last word in modern TELEVISION!

SOUND as well as VIDEO —both in one unit!

The New Shock-proof design!

Meissner is FIRST with practical TELEVISION because Meissner has put years of time in research to be READY when REAL TELEVISION arrived. It is HERE NOW!

Get your name in NOW for the first information!

Meissner quality at a price anyone can afford to pay!

WRITE TODAY FOR FULL DETAILS!



Dept. RC-3, MT. CARMEL, ILL.

"A FAMOUS NAME FOR TWO DECADES"

MAIL COUPON!

MEISSNER MFG. CO.,
Mt. Carmel, Illinois Dept. RC 3
Please RUSH me information on
TELEVISION KITS!!

Name

Address

CityState

Please Say That You Saw It in RADIO-CRAFT

For the First Time-



The publishers of RADIO-CRAFT are pleased to announce its first

ANNUAL CATALOG NUMBER

The MAY, 1939 Issue

The radio manufacturers, in cooperation with the publishers, will spend a young fortune to bring this big issue of RADIO-CRAFT to you—at no additional cost—the price remains 25c.

SINCE its first appearance ten years ago, RADIO-CRAFT has faithfully recorded radio progress in all its important phases, month after month, year after year.

For a long time the publishers have felt the need of an important radio service, which is not being rendered by any radio publication today. Therefore, as it has done many times in the past, RADIO-CRAFT again takes the lead with an important radio publishing innovation.

Radio Service Men, Radio Dealers, Radio Experimenters and others actively engaged in radio—indeed the entire radio trade—have long felt the acute need for a comprehensive compendium of the major catalogs of the radio industry, **ALL BOUND BETWEEN TWO COVERS.**

Up to the present time it has been necessary to write to each manufacturer and others in the radio industry for catalogs and circular matter of their equipment. **NONE OF THESE CATALOGS IS STANDARD IN SIZE.** They are, therefore, difficult to file, difficult to keep. They are easily mislaid and lost and, just at the time you need an important catalog, you cannot find it.

For this reason RADIO-CRAFT is now inducing the radio industry to print their key, or master, catalogs which contain the fundamentals of their products, annually in the May issue—**IN A SPECIAL SECTION OF RADIO-CRAFT.**

You will, therefore, get a great many manufacturers' complete catalogs, **FREE WITH EACH MAY ISSUE OF RADIO-CRAFT.** You will no longer have to spend time and postage in writing for

individual catalogs; *they will all appear in your May issue—PLUS THE USUAL FEATURES WHICH YOU GET IN YOUR FAVORITE MAGAZINE.*

AND THAT ISN'T ALL!—A priceless, time-saving "who makes what" Equipment Directory of Radio, Electronics and Public Address apparatus will be included, in addition to the Catalog Section, that would ordinarily go to make up the May issue!!

Needless to say, this epoch-making May number will be kept by everyone for a long time. It will be a regular radio-encyclopedia for reference during months and years to come. *You and every radio man* will consult it again and again during the year; and you won't find it necessary to hunt for catalogs all over your home, office, shop, laboratory, etc. Everything will be at your finger-tips.

In return for this great undertaking we naturally want your support—but most of all **YOUR EXPRESSIONS, YOUR THOUGHTS ON THIS UNPARALLELED CATALOG NUMBER.** While we are busy building this issue, we cannot get too many suggestions, too many expressions from you, our readers.

Tell us, therefore, *now*, **TODAY**, what you think of the idea in general; whether it has your approval, and what else we can do to make this *special* number the success it deserves.

Write to us at once! **THE MOST MERITORIOUS AND WORTHWHILE LETTERS WILL BE PUBLISHED IN THE MAY ISSUE.**

RADIO-CRAFT MAGAZINE

HUGO GERNSBACK, Editor

RADIO-CRAFT

“RADIO'S GREATEST MAGAZINE”

RADIO AT THE CROSSROADS

By the Editor — HUGO GERNSBACK

EVERY so often the Radio Industry finds itself in a dilemma whether to go ahead or to retrograde.

There is nothing new about this because it dates back to the old days of “Wireless” (as Radio used to be called). No sooner is a new and major advance in Radio announced than the rest of the trade finds fault with the latest progressive ideas and for selfish reasons begins to knife the proponents of progress.

When Broadcasting first started we had only crystal receivers. These were excellent and gave good service at the time. When the vacuum tube made its appearance there was immediate dissension and it was pooh-poohed as being expensive, impractical, and no better than a good crystal set. This did not stop the triumphant march of the radio tube and soon the crystal sets fell by the wayside. When the first loudspeakers came along and one audacious manufacturer started to put a loudspeaker into a complete vacuum tube set, again a loud cry went up. This time it hit the headphone-receiver manufacturers, because they knew that the “loud-speaker receiver” would sooner or later kill the “headphone receiver” business—which indeed was what happened.

At that time our radio sets were of course, operated by batteries—ordinarily, storage batteries. Soon the “battery eliminators” made their début and this business grew to tremendous proportions. The public no longer was inclined to fool around with “messy batteries”. The eliminators had their day, but when the first “alternating current” sets appeared on the market the battery eliminator manufacturers were bitter in their denunciation of the new-fangled sets and predicted that they would never be perfected. Instead, they plugged their eliminators more than ever. This, of course, did not stop the A.C. sets which in a short time threw all the eliminators on the junk heap.

At the present time Radio again finds itself at one of its major crossroads. Television is in the offing—this time in real earnest. After having cried “wolf” for over a decade, television is now really on the map and will soon emerge

from its swaddling clothes and become a new radio giant.

The radio industry behaves as it always has done in a crisis of this type—it does not take kindly to the newcomer.

The recent announcement by Radio Corporation of America's President, Mr. David Sarnoff, that television will be ready late in April, has called forth the usual cat-calls and pooh-poohs of a number of manufacturers who can see nothing in television and now do their best to knife it.

These things, are of course, done only for purely selfish reasons because the Radio-set manufacturers are not sure which way the radio cat will jump, and because they feel that the public, who now has been informed of the coming of television, will refrain from buying the regulation radio sets and will sit back and wait the coming of the television set.

While it is true that a few individuals might hold up buying a radio set for such a reason, experience has taught that the majority of individuals will still go on buying as they did before, for a variety of reasons. To begin with, television sets for some time will be rather expensive. Secondly, home television will not be available in all parts of the country for quite a time to come. Indeed, it may be years before you may receive complete television programs at remote sections in this country.

On top of this, it is even doubtful at this time of writing that television will replace sound-radio completely at any time. There probably will always be a market for the present type of radio set and I can envision a home equipped with television sets and with ordinary radio sets as well.

At any rate, the best policy for the radio trade to pursue at the present time is not to confuse the public by squabbling within the trade.

Let the industry read its own radio history and take heed of the lesson that it should have learned, and that is:

“Those who have opposed radio progress most strenuously in the past, were the first ones to be wiped out by the march of radio progress.”



GIRL MEETS VODER

Miss Mary Muldoon is here shown "talking with her fingers" by pressing the keys of the "VODER". This electrical speech-synthesizer, was developed for the Bell Telephone System's exhibits at the San Francisco and New York Fairs to make speech sounds out of electric currents controlled by keys like an organ. It was previewed last month at Franklin Institute, Philadelphia. It is built, except for its keys, entirely of apparatus used in everyday telephone service!

After practising for a year on the VODER, Miss Muldoon—and 24 other girls selected from a group of 300 and each having her own unit to practice on, 4 to 5 hours per day—is able to make this Robot talk, sing, laugh, scream, and in fact imitate almost any earthly, or "unearthly", imaginable noise or sound. A pedal-operated control gives rising and falling inflections. The synthesized speech is heard from the loudspeaker.

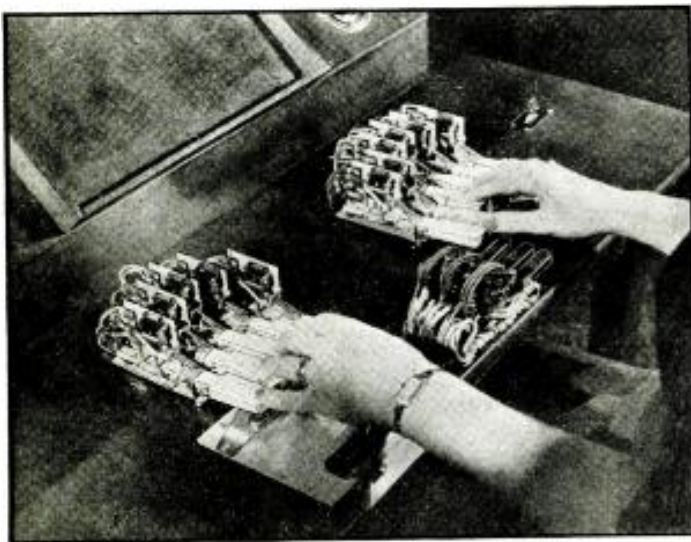

IT'S DONE WITH KEYS

Here's a close-up of the VODER'S keyboard. Ten of the white keys each control a speech sound; the 11th is a volume control. The 3 black keys make the "stop" consonants. Under the operator's left wrist is a switch which changes over certain of VODER'S circuits from producing consonants to producing vowels. "Mr. Voder" still has what Bell engineers call an "electrical accent"; nevertheless, a skilled operator can make "him" say what she wants!

THE RADIO

BROADCASTING

THE greatest diplomats of North and South America put their "beans" together at Lima, Peru, last month for a conference which resulted in the formulation of an anti-aggression accord in the Western Hemisphere.

Shortwave was prominent, bringing daily reports of the confabulations, and voices of national leaders, to the Folks Back Home in their several homelands. In U.S., N.B.C. staged more than 44 such broadcasts; C.B.S. about the same number.

Educational programs will be further expanded in 1939, says Dr. James R. Angell, Educational Counsellor of N.B.C. Child-participation shows, he said last month, would be augmented.

Perhaps under the category of education may be the broadcasts of the Olympic Games from Finland, in July, 1940; perhaps not. Anyway, N. B. C. last month, installed a broadcasting booth in the Olympic Stadium there, has facilities reserved, has lines ordered. Which is just about as foresighted as ordering a set of false teeth and a wheel-chair for a 2-year-old child. The programs will go by wire from the Helsinki Stadium to Berlin; thence to Riverhead, L. I., by radio; thence to the net and the civilized world.

Statistics show that N.B.C.'s international broadcasts increased 11% in '38; that it covered 31 football games, 27 horse races, 20 each of boat races and boxing bouts, out of a total of 143 events; also all continents with spot news from points of origin; gave 333 talks by federal executives and legislators, including 32 by F.D.R. Figures were released last month.

WOR's report showed the station was on with 7,280 hours of programs; 33.62% was popular music, 3.13% serious music, 7.49% "light"; 20.43% was educational and talks; 12.08% was drama; 9.44% was news. The other percentages for the month were pretty scattered.

WMCA, a local station in N.Y., claims a great increase of signal strength through the use of a "ground loss deflector" consisting of about 16 miles of radial wires buried under the antenna. This report last month, means more listeners at no greater cost to the cash customer—Mr. Sponsor.

WTAM, of Cleveland, Ohio, is installing what is claimed to be America's first aluminum concentric transmission cable. It is 460 feet long, and is intended to cut transmission-line radiation. The use of aluminum will save 2/3 of the weight of copper; it will weigh about half a ton, stated reports last month.

Visitors to a recording studio on West 46th St., N.Y.C., may hear serious folk making transcriptions which will be shipped to South America to combat Black & Brown Shirt propaganda there.

Anti-Nazi broadcasts, which have been bothering loyal Partel Members for nearly 2 years, terminated, according to Black Shirt leaders, when Ernst Niekisch was arrested, last month. The station was said to be in a motor truck.

But Radio Libertad continued with its anti-Fascist programs in German and Italian, skipping from frequency to frequency in order to dodge powerful broadcasts of inter-

MONTH IN REVIEW

ference. It's a jail offense to tune-in on it in Germany. Americans can usually catch it between 10 and 11 mc., about 4:00 P.M., E.S.T., we were informed last month.

America has stepped into the lead in broadcasts to South America. Naziland is still second. However, improvements in N.B.C. and C.B.S. stations will greatly augment America's foreign coverage.

In Germany an annual prize of 10,000 reichsmarks is being offered to the person achieving the most interesting result in radio research, states a news item of last month. What if static should be conquered by an Isidore Finkelstein?

RADIO & RELIGION

FATHER CHARLES E. COUGHLIN, Canadian-born priest who years ago vowed to quit "the radio" if his candidate for the presidency, one Lemke (remember?—we thought not) got licked, has aroused a storm by a series of broadcasts, last month, considered controversial.

Father Coughlin broadcast a speech explaining Naziism as the outgrowth of Communism; stated that Jews had founded Communism. Believing his words might result in race prejudice, Station WMCA invoked the age-old rule that ms. of talk must be submitted for station approval prior to broadcast.

When Father Coughlin said this would not be possible, WMCA refused to air his words, with the result that the station has been picketed during subsequent Coughlin talks.

There is also much debate as to whether the good Father's facts are correct, with the "nays" seeming to have the best of it thus far, though the radio priest quotes various authorities he deems accurate.

In the meantime, the Federal Council of Churches of Christ in America have been doing much to cement the friendship between Protestant and Catholic, Jew and Gentile. Other leading religious groups have been performing similar service to the nation and its people during the past month and many months.

Summing up the situation of controversial religious broadcasts, Neville Miller, president of the National Assn. of Broadcasters, said, "Broadcasts inciting racial and religious hatred are an evil not to be tolerated." He added that they are "an abuse of the privilege of free speech and unworthy of American Radio."

CENSORSHIP!

THE board of directors of the NAB last month unanimously accepted a resolution that "American broadcasting stations should not carry advertising for . . . hard liquor." The board represents about 4/7 of the nation's stations.



MUTED TYPING IN A STUDIO

Here is illustrated an actual experiment in the studios of the Columbia Broadcasting System, last month. Placed only 5 ft. away, the studio microphone failed to pick up the sound of the new Remington Noiseless in action, 'tis said.

In fact, it was not until the microphone was 1 ft. away that the typewriter could be heard operating! The same test repeated with a "brand new noisy typewriter" required moving the mike 22 ft. distant before the pick-up equaled the Noiseless 1 ft. from the mike.

Some time ago, the FCC got excited about an N.B.C. broadcast of a Eugene O'Neill play in which the words "damn" and "hell" were used. The news censured such censorship in an editorial headed "Damn It To Hell, It's Dangerous." The N.B.C. plods a step farther. President Lohr of the net announced that no more contracts for advertising beer or light wines would be accepted! The company will still carry those wicked, sinful cigarette shows, though, and it is rumored that there is not even a ban on breakfast food advertising—yet.

(Continued on page 568)



THE CABOOSE CREW RADIOS TO THE LOCOMOTIVE CREW A 1/2-MILE AWAY!

Last month the Pennsylvania Railroad Co. demonstrated, on a train carrying merchandise from Philadelphia to Western and Southern destinations, how short-wave radio may be used to maintain contact between locomotive and caboose with almost any number of cars intervening.

Here's a new application of radio that will may give railroads a helping hand; and radio men a new installation and service field.

Tests were made on the train known to railroaders as "P.9". Conductor Sultzberger, in charge of the train, is shown, above, reading a message held by assistant yardmaster Fallon, giving instructions to the locomotive crew at the other end of the train a 1/2-mile away!

Exchanges of conversation between locomotive and cabin car were reported as "clear and distinct as ordinary telephoning," and as simple in operation.

Thousands of freight trains that daily roll across the wide stretches of the U.S. may soon carry the same sort of radio equipment as the "Penny" last month demonstrated.

Above, Special-duty Engineman John C. Hicks is seen receiving the message Conductor Sultzberger is telephoning from the other end of the train. At the locomotive's throttle is Engineman George W. Wenerick.

The railroad's engineers are still experimenting, however, not only with the radio contact system but also with two other systems.

The radio system employs RCA equipment. A telephone system employing both rails as a circuit uses Union Switch and Signal Co. equipment; and a third using the rails and a paralleling wire on poles as a circuit employs General Electric Co. apparatus.

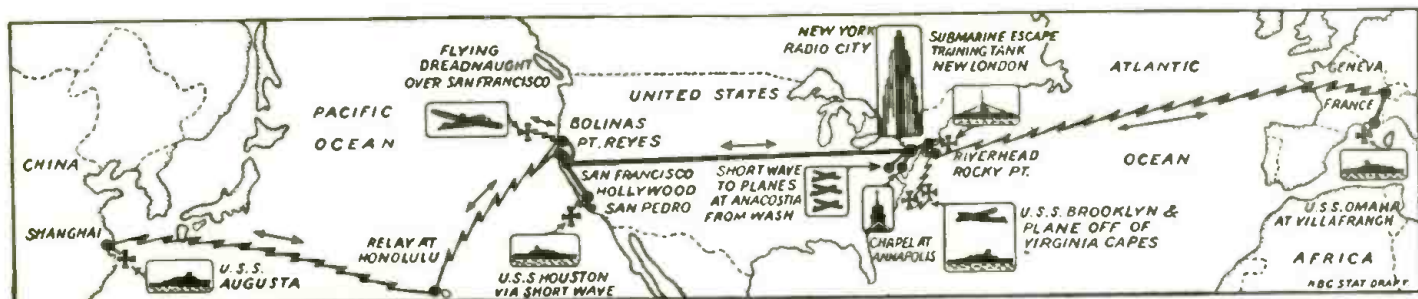

Millions of listeners to an amazing Blue networks broadcast last month, heard the "voice of the Navy" from the air, under the sea, and from China to France. Jagged lines in above diagram indicate radio relays from pick-up points aboard U.S. fighting ships off Shanghai, China, and Villefranche, France. Airplane symbols indicate pick-up points from the air. The "submarine escape" pick-up was made at New London, Conn.

How RADIO Helped Uncle Sam Celebrate "NAVY DAY"

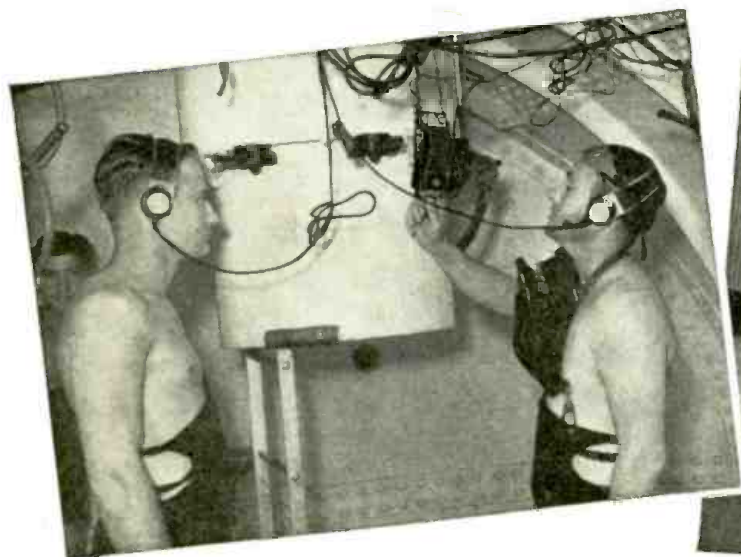

▲ Lieutenant J. K. Morrison, officer in charge of the training tank at the U. S. Naval Submarine Base in New London, Conn., says a few words to the Magic Key "Navy Day" program audience prior to his ascending from the submarine escape chamber 100 ft. below the surface of the water in the training tank. The U. S. Navy's "submarine escape procedure" was dramatized in a dual escape demonstration by Lieuts. J. K. Morrison and (left) William Eddy.



▲ High ranking Navy officials led by Admiral William H. Leahy (circle), Chief of Naval Operations, directed the "Navy Day" salute from Radio City studio 8-H. Land, air and sea forces—the latter represented in miniature on the table map above—of the nation's "first line of defense" responded instantly from remote points of the earth.

NAVAL orders were expedited in transmission by the potent agency of Radio, last month, from headquarters to naval bases in all parts of the world and to naval units operating in the sky, under the sea and afloat when the National Broadcasting Company spectacularly demonstrated the United States Navy's multifarious operations in a broadcast from the far corners of the globe.

As amazing as the demonstration of the might of America's first line of defense was the technical perfection of the broadcast, which, although requiring scores of involved switch-overs to such separated points as Manila and the harbor of Villefranche, in the Mediterranean, and pick-ups from a bomber in flight, a scouting plane far out over the sea and a submarine chamber 100 feet beneath the water, went off without a single hitch.

Almost unbelievable technical difficulties were surmounted in arranging the broadcast, considered by veteran engineers of the network to be one of
(Continued on page 558)



Ben Grauer, N. B. C. announcer, a Navy Medical Officer, and an N. B. C. engineer watch Lieut. Morrison "break water" after the submarine escape demonstration. The actual escape was followed by a microphone from the submarine chamber 100 ft. below the surface.

THE PIPELESS ORGAN!

Here's an electronic musical instrument, conforming with standards of the American Guild of Organists, said to look, play and sound just like a pipe organ.

PART I

VICTOR I. ZUCK

SELECTIVE evolution works in music no less heartlessly than in biology. Back of the present pianos, organs or instruments of the orchestra are ghosts of thousands which have had their day and lost; the lutes, the harpsichords, the strange-shaped serpents, the hundreds of kinds of pipes as far back as Hero's water organ or the ancient pipes of Pan. A similar evolution is choosing and perfecting the newest types of organs by a conscious adaptation of Electronic Science.

One of the more recent of electronic organs is pictured in Fig. A. This instrument is comprised of 2 manuals and pedal clavier built in strict conformity to the standards adopted by the American Guild of Organists and the Royal College of Organists.

ORGAN TONES

Brass vibrators (organ reeds) are utilized in the organ to supply the fundamental and harmonic frequencies. These harmonics are obviously natural ones, inextricably bound up with their corresponding fundamentals. The tones produced in this organ are governed by precisely the same immutable laws of nature that control the making of tone in any wind-blown instrument—the combination of tempered fundamentals with natural harmonics.

The natural frequencies of these vibrators will depend on the ratio of the stiffness to the massiveness (in technical terms, the ratio of the restoring couple to the moment of inertia). Filing the free end of the vibrator tongue will diminish the massiveness, without appreciably affecting the stiffness, and so will increase the frequency. Filing or scraping the fixed end will greatly diminish the frequency and flatten the tone.

Vibrators follow the same law as organ pipes. The *pitch*, *power* and *timbre* of the note depend upon (1) the length, thickness and scale of tongue, and (2) the "voicing," so that whereas the deepest bass note of a stop may be $3\frac{1}{4}$ inches long, the top note in the treble may be less than $\frac{1}{2}$ -inch, and from $\frac{1}{4}$ -inch or more in width down to less than $\frac{1}{16}$ of an inch. The length of the vibrator tongues remain practically constant for a given pitch. The *scale* (width in proportion to length) may be varied considerably for different tonalities (voicing), according to the quality of tone desired. Vibrators of wide scale (other factors being consistent), therefore, give a bold, full and round tone, and vibrators of narrow scale give a keen, brilliant and more strident tone. For the Diapasons and other founda-

tional tonalities, the vibrators, without exception, are furnished with tongues of wide scale—say, about one-quarter their vibrating length in width. The rule that pitch is dependent on length is to be understood to apply to tongues of uniform thickness, and to the radius of gyration or vibrating length.

(Continued on page 550)

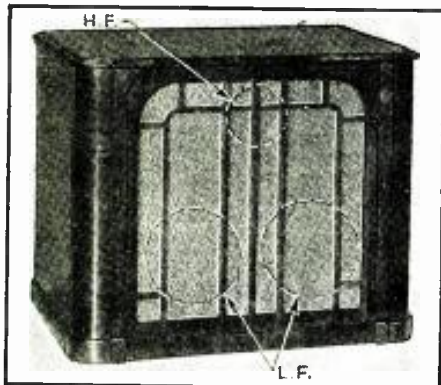

Fig. B

Additional 3-speaker Tone Chambers may be used, when necessary, to double, triple or quadruple the sound volume to suit the needs of any edifice. Unit shown above measures 37 x 23 x 31 ins. high.

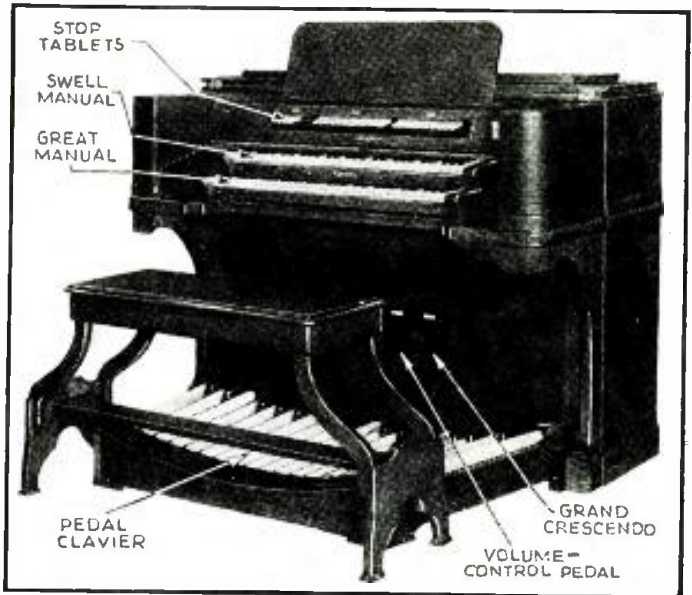

Fig. A

The Cloister-model Organtron, above, measures 57 x 47 x 44 ins. high.

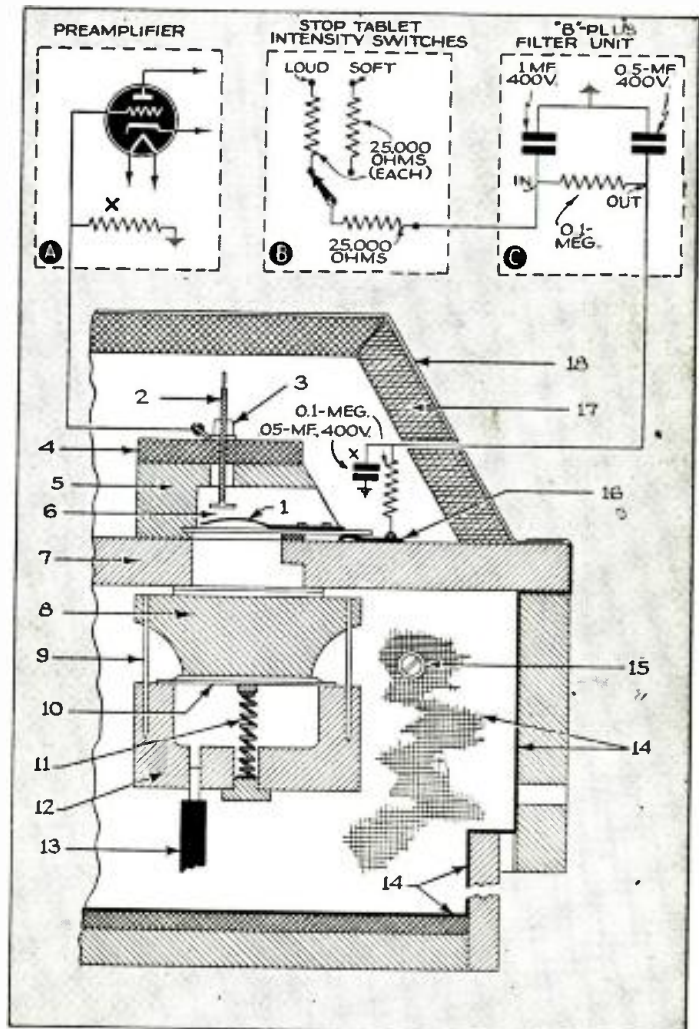

Fig. 1

The electrical principle of the Everett Organtron model STM-1 is illustrated above. The organist releases blasts of air that vibrate regular brass organ reeds which generate voltages in condenser-type pickups.

- | | | |
|--------------------------------|---------------------|-----------------------|
| 1) Reed | 7) Pallet Board | 13) Key Action Tube |
| 2) Adjustable Tone-Screw | 8) Pallet | 14) Screen Shielding |
| 3) Tone-Screw Locknut | 9) Pallet Guide Pin | 15) Ext'l Ground Post |
| 4) Tone-Screw Insulating Strip | 10) Pallet Pouch | 16) "B"-Plus Strip |
| 5) Cell Board | 11) Pallet Spring | 17) Muffling Felt |
| 6) Reed Cell | 12) Pallet Rail | 18) Shield Cover |



Anthony Eden, former British Foreign Secretary, in speaking before the National Association of Manufacturers during the organization's annual dinner at the Hotel Waldorf-Astoria in New York, last month, inaugurated the first public use of the new W. E. Cardioid Microphone.

RADIO'S LATEST MIKE is "Cardioid Directional"

Directional microphones of the "cardioid" type help reduce background and noise reverberation tendencies to a minimum. Newest of the "heart-pattern" microphones introduced develops these advantages to a high degree.

A NEW microphone that picks up equally all sounds reaching it from the front but which loses its sensitivity as the source of sound moves to a position behind it has been announced by the Western Electric Company. If a person talking comes closer to the microphone to compensate for this loss in sensitivity, as he walks around from front to back his path will be a heart-shaped curve or *cardioid*. Because of this unique pick-up characteristic, the device is known as a "cardioid directional" microphone.

The cardioid directional performance of the new mike covers the wide angle of pick-up which experience has shown to be desirable in the majority of applications.

[If you want to get technical, "Cardioid" has been the term used by mathematicians for centuries to express the plot of $1 + \cos \theta$, because of its heart-like shape. Technically, a curve in polar coordinates that represents the sensitivity of the microphone versus the angle of sound approach is similar to the plot of $1 + \cos \theta$, that is, a "cardioid."]

achieves true cardioid directional performance lies in the units selected and the method of equalizing and combining the outputs. For the pressure element the dynamic unit of the well-known Western Electric "Eight Ball" mike was selected because of its demonstrated reliability, efficiency and small size. For the pressure-gradient or velocity element it was necessary, in order to obtain performance comparable to that of the dynamic unit, to design a special, ribbon-type structure using a uniquely shaped ribbon which operates under conditions heretofore considered impossible for this type of microphone.

DIRECTIVITY OVER WIDE FREQUENCY RANGE

Because of its unique construction, the new Western Electric microphone actually approaches ideal cardioid directivity for bass and treble tones as well as for intermediate ones. The minimum discrimination between front and back is 15 db. in the range from 70 to 6000 cycles, 10 db. from 40 to 70 cycles and from 6000 to 8000 cycles. (Continued on page 564)

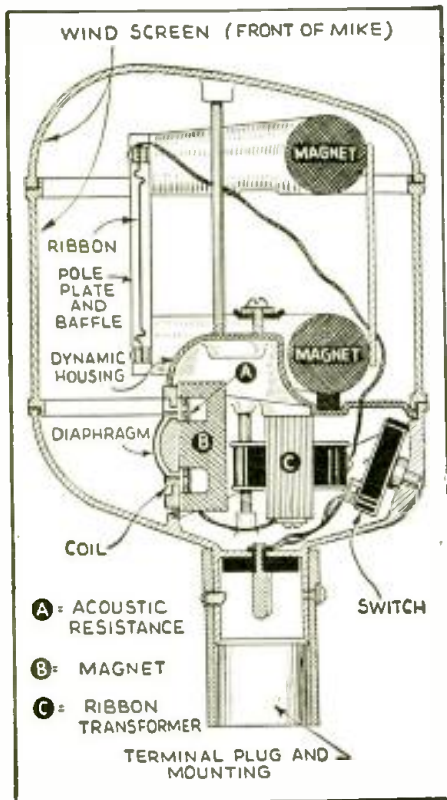

Compare this cross-section illustration of the new Cardioid Microphone of W. E. Co. with the photo at right.

THEORY OF THE CARDIOID

Theoretically in microphones, the cardioid directional response can be obtained by combining the outputs of an ideal, completely non-directional pressure unit, with an ideal bi-directional pressure-gradient unit, commonly known as the "velocity" type. The output of the pressure unit is independent of direction, and may be represented by a pure number, say unity. The pressure-gradient unit has an output which reverses in phase when the sound direction is reversed, and is actually proportional to the cosine of the angle. Adding the two together, the result is $1 + \cos \theta$, the "cardioid."

APPLICATION

Practically speaking, there are no pressure or pressure-gradient (velocity) microphones available which are ideal for the purpose at a workable efficiency and ruggedness except over a limited middle frequency range. Therefore, their simple combination in a so-called uni-directional microphone produces good directional characteristics only over a limited frequency range, and does not give a true cardioid directional performance for bass or treble tones. This results in a distorted balance in the quality of pick-up. The reason that this new mike



Here's a glimpse inside the Western Electric model 639A Cardioid Microphone. Compare with cross-section at left. Ribbon and dynamic microphones are combined in one compact unit.

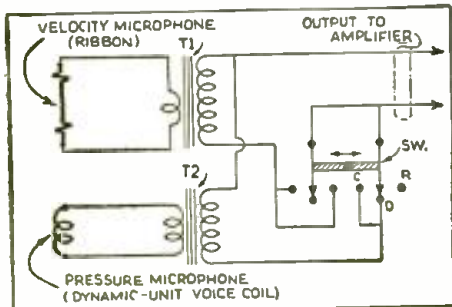
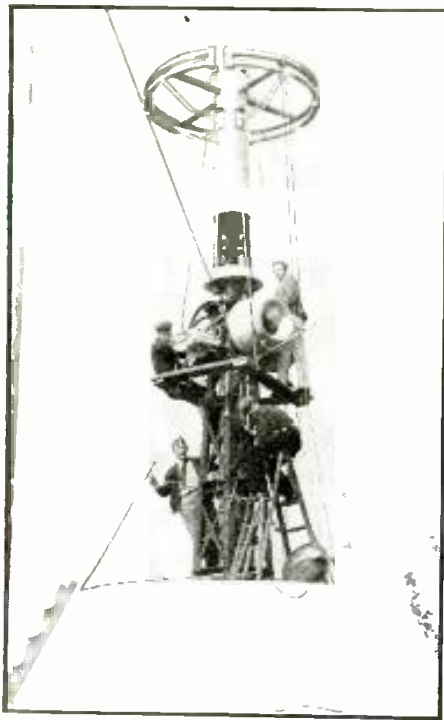
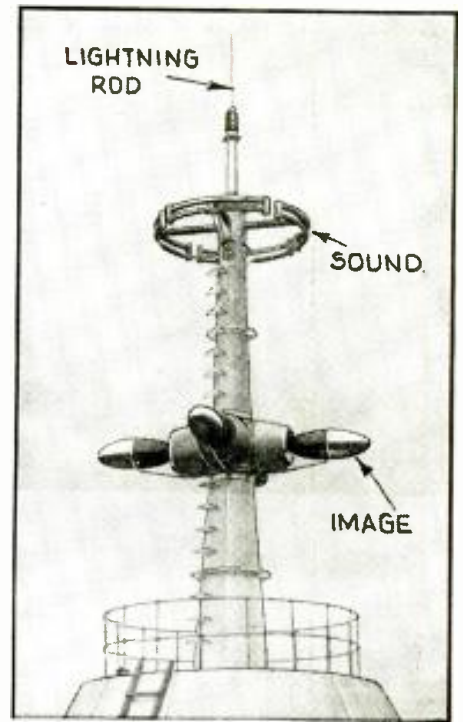

Diagram of how velocity and pressure microphones may be selected individually for bi- or non-directional pick-up (respectively), or connected together for cardioid-directional operation.



At left is shown the new television antenna in the course of pre-fabrication on an experimental structure, at RCA/N.B.C.'s Riverhead, L. I., laboratories, designed to simulate installation conditions to be encountered later in New York City.

At right is shown the new omni-directional television sight-and-sound antenna, with built-in de-icers, erected last month atop the Empire State Building in New York City. This quarter-mile-high antenna will help make home television an actuality by April.



A new, nameless type of "duoquad", composite sight-and-sound television antenna erected last month atop the Empire State Building makes omni-directional coverage of the Metropolitan area possible when programs start next month.

TELEVISION ANTENNA

---- 1939 Model ----

A NEW ERA in radio antennas was ushered in last month with the disclosing of the details of the new television antenna just installed on top of the Empire State Building. The structure enables waves to be launched into space from torpedo-shaped radiators whose "streamlined" shapes mark a major engineering advance.

"BOTTLE-NECK"

The device overcomes a technical bottle-neck in the transmission of television signals by departing from the use of wires; or their equivalent in pipes or masts in various arrays. The new device is unique in its capacity to communicate television waves to the ether over a band width of 30,000,000 cycles a second without accentuating or "peaking" the energy contained in any segment of the band. In engineering terms, the transmission characteristic of the antenna is "flat" over a 30-megacycle band.

The necessity for a new antenna capable of perfectly transmitting a wide band of frequencies has arisen through the development of television and other new radio communication arts. As the radio "intelligence" to be communicated became more detailed and elaborate, the band width necessary to carry it had to be correspondingly enlarged.

In *radiotelegraphy*, a simple word may be transmitted in a second's time or less on a band width of a few hundred cycles. In *radiotelephony*, the additional intelligence conveyed in the

voice intonation demands a band width of several thousand cycles. In *television*, the demand is for almost simultaneous transmission of the vast amount of information contained in a "moving picture" (that is, transient images), which makes necessary band widths of many millions of cycles. Thus, as the radio communication arts become more elaborate and detailed in the intelligence which they convey, wide-band transmission becomes an increasingly important factor.

"DUOQUAD" CONSTRUCTION

The desirability of creating such an antenna, which is still so new that it has not yet been named, was realized in the first field tests conducted on the present experimental standard of 441 lines to the picture. Antenna designs existing at that time were found insufficient to handle the desired band width. The new device, in contrast, will accommodate 6 times the band width then wanted.

In appearance the structure, which will be placed in service in the National Broadcasting Company's experimental field tests, is simple and decorative. Its radiation components will consist of 2 "doublets" for the image signal and 4 "doublets" for accompanying sound. Both antennas are energized through concentric feeders in a common vertical shaft. Interference between sight and sound signals is eliminated by calculated arrangement of the 2 antennas and by using the equivalent of a closed loop for the sound channel and open radiators for "picture" (image) signals.

BUILT-IN DE-ICERS!

The electrical measurements involved in the new structure are as precise as the specifications for a watch, yet in service it must withstand the rigors of the elements at its precarious perch. The antenna includes electrical heating units to prevent the formation of ice, which would enlarge its effective physical dimensions and detract from the perfection of its performance. The entire structure is topped by a lightning rod.

The radiating units nearest the top are for sound signals, and consist of a unique type of doublet, which doubles back on itself. The 4 together form a complete loop. The 4 torpedo-like shapes comprise the 2 doublets for the transmission of the picture signals. Both their elliptical shape, and the contour of the metal "collars" into which they nest, are the result of radical experimental approach.

When presented some months ago, this antenna problem was attacked by a research group under N. E. Lindblad of the RCA laboratories at Rocky Point, L. I. With them worked R. K. Gallup, E. D. Thorne and L. A. Batterman, to reduce the fruits of research to precise, mechanical drawings and physical units, as well as G. L. Usselman, whose specially-designed test transmitter made possible vital observations. Final installation was in charge of H. T. Ryden, whose job it was to see that what might easily be construed as a matter of pipe fitting was treated with a watchmaker's respect for constructional tolerances.



Key to Illustrations

- 1 Johnnie Daniels (John Beal), young Benny Allen (Dickie Moore) and "The Arkansas Traveler" (Bob Burns), in Hollywood's picture of the same name, examine the plans and a miniature model of a newspaper's radio station.
- 2 The principals shown at 1 discuss with Mrs. Martha Allen, widowed publisher of the *Record*, the status of the mayoralty election which the jerry-built radio station, above, influenced.
- 3 Hundreds of hoboes summoned by grapevine and supposedly railroad telegraph work throughout the night to help "The Arkansas Traveler" erect an antenna for the *Record's* broadcast station.
- 4 The newspaper's radio station, set up "in time to meet the deadline set by the Federal Radio Commission," helps make Johnnie Daniels mayor, and fiancée (Judy Allen) oh so happy.
- 5 A Welsh accent verbally analyzed by "Professor Higgins" is picked up by a microphone, concealed in a statue of Buddha, and recorded.
- 6 Jean Cadell as Mrs. Pierce and Leslie Howard as Professor Higgins during the recording of examples of pronunciation by unsuspecting human guinea pigs.
- 7 During playback the gems of phoneticism are analyzed. A wax model of the human ear adds decoration to the corner of the desk.
- 8 Scotts Sunderland as Colonel Pickering hears Leslie Howard as Professor Higgins discourse on the technique of recording accents.

Hollywood

Mystery plays, comedies, color-movies, these and many other round out the script or the staging. Radio finally came into "Arkansas Traveler," and Metro-Goldwyn-Mayer sponsored depend, in the first instance, on radio broadcasting, and

CRITICS of broadcasting have, at times, accused radio of "going Hollywood".

This time the reverse is true. "Hollywood" has "gone radio"—and in a big way. Not only has the film city become the site of important N.B.C. and C.B.S. key studios, but recent rave-rating American pictures—even those of film centers in other countries—have had a marked radio slant.

Two of these pictures, "Pygmalion", a British dramatization of George Bernard Shaw's famous comedy-satire of manners, and "The Arkansas Traveler", a starring vehicle for Bob Burns, the Will Rogers of today, use a great deal of radio and sound apparatus as important adjuncts to their story structure. In fact, the whole plot of the latter picture hinges upon a home-made radio transmitter.

In this picture, Burns, a tramp printer, comes to the rescue of Mrs. Martha Allen, newspaper publisher and owner of a valuable franchise to construct a radio station in a small mid-western

town. The mayor (*hisses!*) is trying to hornswoggle Martha out of the franchise by threatening to run out of town any man who works on the station.

However, the Arkansas Traveler (Burns) sends out word (by railroad telegraph, and supposedly ensuing "courtesies of the road") to his hobo pals, and soon several hundred of them arrive, and start working under the direction of the Mayor's son, who is in love with Mrs. Allen's daughter. Without stopping to eat or sleep for 2 nights and 2 days, the tramps stick to the job, living on coffee and sandwiches supplied by the Ladies' Aid Auxiliary. Of course they finished the rig in time for Mrs. Allen to hold her franchise, or it wouldn't have been a movie!

As you can see by the illustrations on the tops of these 2 pages, the station was planned through models made of Meccano parts; its towers were made of angle iron. The actual transmitter was of the old, familiar breadboard type that looks terrible but always works. Had it been more commercial in





Goes Radio!

types of motion pictures have utilized radio in some form to its own, though, last month, when Paramount Pictures released "Pygmalion." These two top-flight sound motion pictures in the second, on sound recording, as the main theme.

its appearance it would have been less picturesque in its dramatic deshabille.

In "Pygmalion," the story deals with a cockney flower girl, who, taught to speak correctly, rises high in society. The leading masculine role, that of Professor Higgins, was played by Leslie Howard.

To win a bet, Higgins takes an uneducated girl, who speaks atrocious English with a terrible accent, and gives her what amounts to a series of expert lessons in elocution. Departing from the script of the play as it was originally written, the movie professor uses highly elaborate sound recording equipment in making his study of the girl's voice. His apparatus includes Kymographs, microphones, amplifiers, loudspeakers, and a flickering flame or manometer type of oscilloscope.

The oscilloscope used in the picture is extremely interesting. It is far more picturesque than the familiar cathode-ray tube type, though not nearly as convenient nor efficient. In the pictured device, the old principle of a "talking

flame" is employed. This is a gas flame caused to flicker by impressing the voice frequencies on a diaphragm which controls the flow of gas to the burner. The flame, in this form of crude oscilloscope, is viewed in a multi-surfaced mirror revolved at constant speed.

Also seen in the illustrations which accompany this article are the phonograph recorder, with which the Professor is tinkering, several microphones and a loudspeaker.

In order to secure recordings without the subject of the experiments becoming aware of any possible shenanigans the microphone is concealed in an ornamental statue of Buddha, on a table, placed conveniently near the unwitting guinea pig in human form.

There have been numerous films before which dealt with the entertainment side of radio—the "Big Broadcast" series, for example—but this is thought to be the first time that two smash hits have appeared in the same season, each featuring the *technical* side of radio or electronics.

In "Trade Winds," a Walter Wanger Production, recently shown at Radio City Music Hall in New York City, and starring Fredric March and Joan Bennett, a detective-phone and sound system were used to smoke out the villain. The real murderer was induced to confess his crime as the result of a simulated news broadcast from a midget radio set, in the belief that there were no legal witnesses; actually, a microphone was concealed in the midget receiver and the confession, reproduced from a second radio set in an adjacent reception room, was heard by a large assemblage!

"Thanks for Everything" stars Adolphe Menjou in a 20th Century-Fox production based on a radio network program contest to find "Mr. Average American Citizen." In a simulated program that reminds us of *Radio-Craft's* recent article "How to Stage Your Own Broadcast," Jack Haley, the contest winner, has his manhood stirred by a fake war-declaration broadcast that includes realistic sound effects of a flotilla of enemy planes flying over and "bombing" the city.

In "Topper Takes a Trip," a United Artists Picture, Constance Bennett and Roland Young are initiated into the mysteries of remote tuning. They are indeed surprised when what they take to be a dial telephone actually turns out to be a means of tuning-in various broadcast stations, on a receiver across the room, by remote control.



First Daily Newspaper by RADIO FACSIMILE



1 Pages 1, 4 and 7 of "Vol. I, No. 2," of the 9-page "radio newspaper" inaugurated as a regular, daily facsimile program over the St. Louis *Post-Dispatch* station W9XZY, last month, are shown above. The pages are 8½ ins. long, 4 cols. wide.

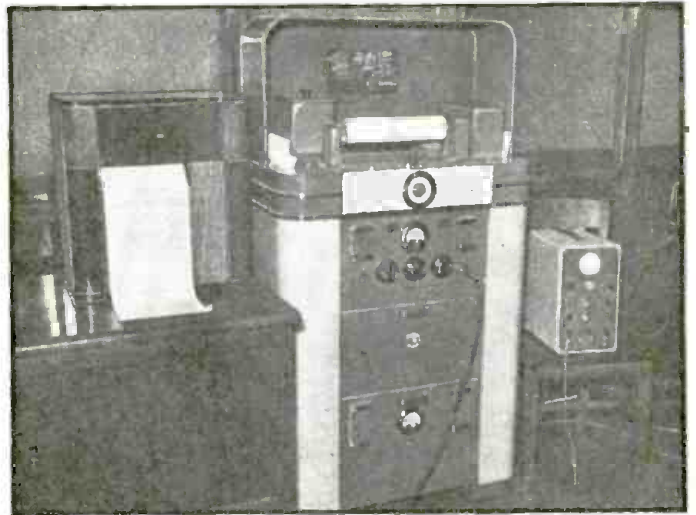

2 The transmitting equipment or Scanner, of the RCA-system facsimile set-up, is shown in center, above; left is a monitor facsimile receiver with a completed page issuing from the instrument. The 100-watt transmitter operates on 31,600 kc.



3 Here you see the master copy being placed on the scanner drum for transmission. The drum turns at the rate of 75 turns per minute. The present experimental transmissions have a fidelity of 125 lines per inch. A photocell is the light-variation pick-up unit.

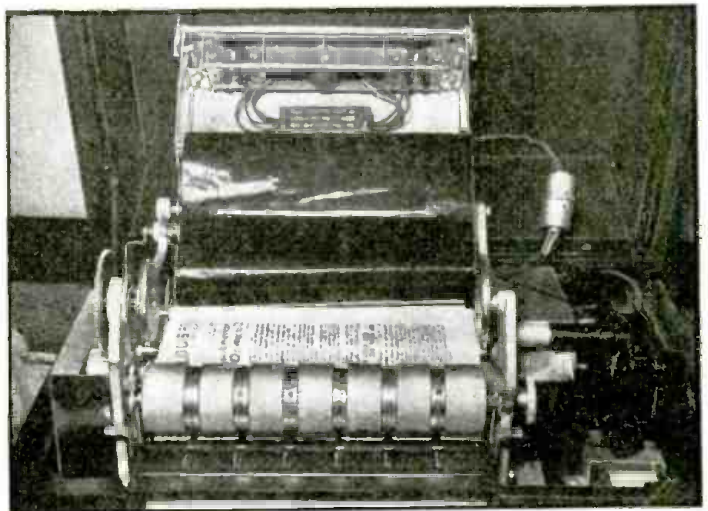

4 The home facsimile receiver or Recorder is here shown open so that the mechanism may be viewed. A stylus (stubby needle) presses carbon paper against unreeling white paper to reproduce the original picture's light variations.

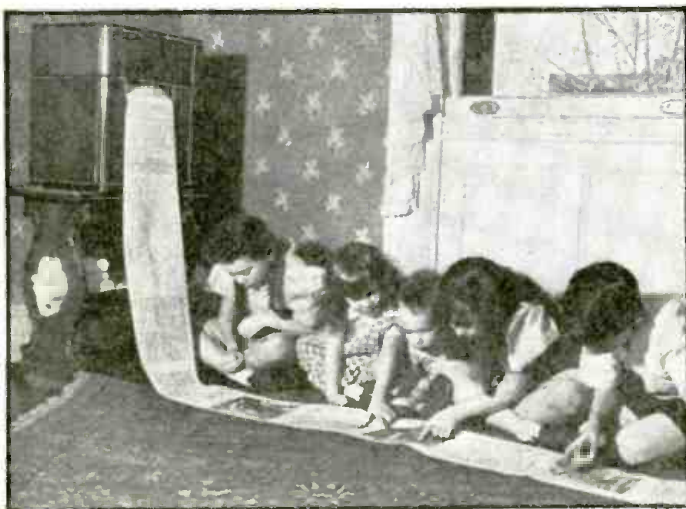

5 Arrival of the afternoon "radio newspaper," on schedule at 2 P. M., rain or shine, is the signal for the folks at home to gather around the facsimile receiver to see the cartoons, news photos, etc., that regular radio programs leave to the imagination.

STATION W9XZY, the experimental radio facsimile broadcasting station operated by the St. Louis *Post-Dispatch*, last month inaugurated the world's first regular broadcast on ultra-high frequencies of specially-prepared facsimile newspapers. The broadcasts will be continued daily and Sunday at 2 p. m.

VOL. I, NO. 1

Number 1 of Vol. I of the *Post-Dispatch's* first radio edition consists of 9 pages 8½ ins. long and 4 columns wide, using the newspaper's regular 7-point type.

In answer to inquiries by *Radio-Craft*, Robert L. Coe, Chief Engineer of radio station KSD, wrote as follows:

So far as the transmitting equipment is concerned, it is the standard scanner manufactured by RCA, the output of which is fed into a 100-watt transmitter operating on 31,600 kc. We selected the ultra-high-frequency band for our experimental operation because it offered the opportunity of broadcasting facsimile during the day time—in fact any time we desire—and it seemed to us these hours would offer us a much better opportunity for ascertaining public reaction to this new

(Continued on page 555)

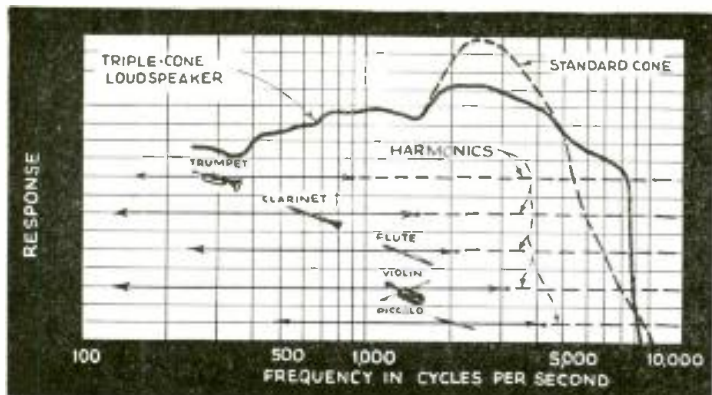

Fig. 1. This response curve compares the new RCA Victor tri-diaphragm loudspeaker (solid line) with a standard 12-in. cone reproducer (dotted).

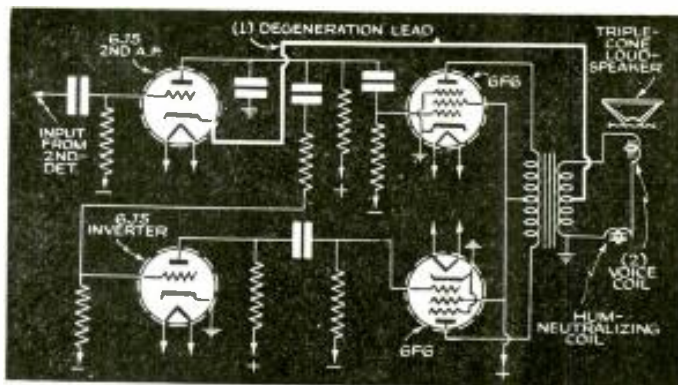

Fig. 2. Inverse feedback (1) from the secondary of the output transformer makes possible an undistorted output of 10 W. The voice coil (2) has an impedance of 2.2 ohms at 400 cycles.

"Triple Cone" Offers Better Tone!

The truth of the aphorism that a chain is no stronger than its weakest link is aptly illustrated in high-fidelity reception. The former need of a high-fidelity loudspeaker to satisfactorily handle the output of a hi-fi receiver has been met in the design of a new wide-range reproducer.

INVERSE audio feedback and a triple-cone loudspeaker are 2 new technical developments which operate together to provide tonal reproduction of a new high standard in several RCA Victor radio and Victrola instruments for 1939.

INVERSE FEEDBACK

The inverse audio feedback circuit provides an improved reproduction over a much wider range of frequencies than that of an ordinary radio set and, together with the new triple-cone high-fidelity speaker (Fig. A), gives an essentially uniform frequency response from 50 to 8,000 cycles (see Fig. 1) by the use of 3 different-size cones in place of the usual 1—for the first time!

In all the models employing inverse feedback in the audio channel, the I.F. amplifier has been designed to pass a frequency band sufficient to provide reception up to 7,500 cycles.

The receivers employ inverse feedback (or "degeneration") in the audio amplifier, feeding back the audio signal from a tap on the output transformer secondary to the cathode of the 2nd A.F. tube. The circuit is shown in Fig. 2. This reduces the gain in the audio circuit from 10 to 15 db. in the various receivers employing this circuit. The loss of gain is made up by means of an additional audio amplifier stage preceding the amplifier within the feedback loop.

The inverse feedback circuit has a beneficial effect upon such undesirable characteristics as hum, amplitude and harmonic distortion, and on so-called "hang-over" effects caused by the mechanical resonances in the loudspeaker cone. Actual measurements show that hum and harmonic distortion is reduced to the same extent as the gain is lowered by the feedback circuit.

While it is desirable by means of feedback to minimize the amplitude dis-

ortion within the audio frequency band that is to be reproduced, it is equally undesirable to leave too large a response region outside this band where no signals will be received. The region of no signal response would reproduce line surges at the low-frequency end of the band; and "monkey chatter" and noise at the high-frequency end. It is not possible to control the response within the feedback loop, so an audio stage is added before the feedback amplifier in which suitable filters are added to control the undesirable responses.

It has been found that the feedback circuit may be made to cause a very much larger reduction in the effective output impedance. This low impedance loads the loudspeaker cone circuit and thereby damps the mechanical oscillation within the cone, resulting in a marked improvement in the "hang-over."

In previous models the problem of tone quality improvement was handled by acoustic treatment of the radio cabinet. A wooden shell was constructed behind the speaker to minimize the back wave from the loudspeaker and to remove resonances within the cabinet. RCA Victor engineers report that the inverse feedback system (referred to in the trade as the "Electrical Magic Voice") has definite advantages over the acoustic treatment both as to efficiency and for ease of servicing.

TRI-CONE SPEAKER

The new-type electrodynamic speaker (see Fig. 3) is actually 3 loudspeakers in one. The 1st, or large outside cone diaphragm, the same size and shape as in an ordinary 12-inch speaker, reproduces tones in the range between 50 and 4,500 cycles. The 2nd cone diaphragm, which is superimposed on part of the larger cone, handles frequencies be-

(Continued on page 556)

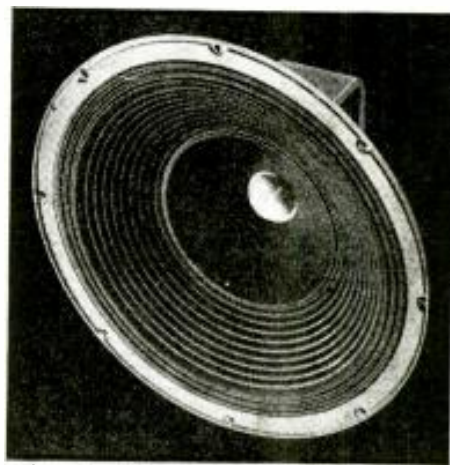

Fig. A. The high-fidelity 3-cone reproducer.

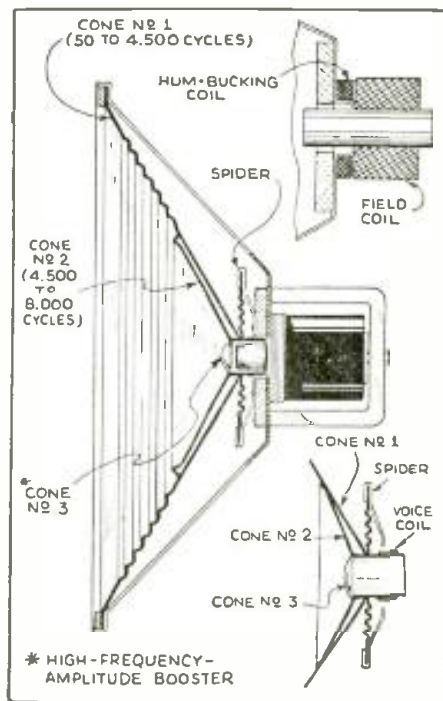
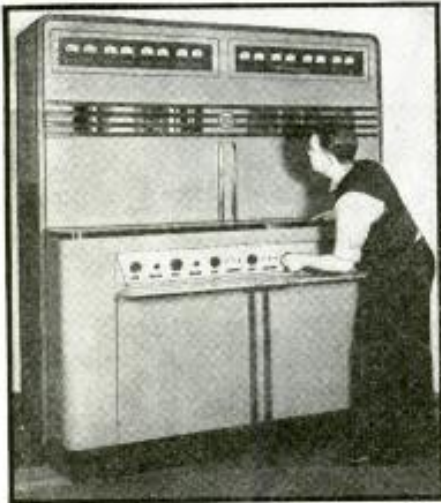

Fig. 3. Cross-section view (made by Radio-Craft from an actual unit supplied by RCA).

WORLD-WIDE TELEVISION



← Frank Roberts and Miss Pierson as they appeared last month on the television screen at the National Broadcasting Company's first experimental television broadcast of an automobile show. As the new Chevrolet drove up Rockefeller Plaza to the RCA Building, its arrival was picked-up through the N. B. C.-RCA television system. All of the leading automobile manufacturers cooperated with N. B. C. in arranging the television broadcast.



Above is illustrated a comparatively low cost, easily demountable 1 kilowatt television transmitter, first medium-power unit in a series of new television items, made available last month by RCA Mfg. Co. The transmitter conforms fully with the recently established R.M.A. standards for 441-line images. An invar rod instead of the usual crystal is used to maintain the carrier frequency stable.



The new mobile unit of the British Broadcasting Co.'s television service utilizes an 80-ft. extension ladder to support its transmitter antenna.

THE present review brings the subject of television up to date, at a time when the period of preliminary experimentation in the United States appears to be on the verge of transition to commercial application. The scientific committee which prepared the following review consisted of these technicians: Carl Dreher, (Chairman; Gordon Chambers, L. E. Clark, J. G. Frayne, Barton Kreuzer, Wesley C. Miller, Hollis Moyses, William Mueller.

DEVELOPMENTS ABROAD

England The lead in putting television on a public service basis, was taken by England, with the inauguration of regular transmission from Alexandra Palace in London on November 2, 1936. Two years have now passed and the results may be assessed.

Notable progress has been made on the technical side and in the quantity and quality of entertainment, but these advances have not been reflected commercially. The situation was summed up not long ago in a British headline, "England Leads the World in Television—But Public Won't Buy." It should be added, however, that subsequently the annual radio show at Radiolympia (August 24-September 3, 1938), at which television was the main attraction, appears to have boosted television receiver sales considerably, and according to a current report one visual set (some of which include sound) is now being sold in the London area for every two sound-only receivers. If this is true, and if such a trend continues, then British television is justified in hoping for better days ahead.

Considerable mystery surrounds the question of how many television receivers are actually in use. Estimates in British publications vary all the way from 2,000 to 9,000, depending apparently more on what the writer is trying to prove than on any reliable count. The most probable total appears to lie between 3,000 and 4,000, which, in a population of 10 million within the service area of Alexandra Palace, is a melancholy showing. And yet no one conversant with the situation as a whole can or does regard it as an evidence of failure.

The reason is, that while sales have lagged, public interest has been sustained,

"The real test of public response" . . . when regular service is initiated and remittance of 8 technicians, all experts in their Academy of Motion Picture Arts and activities here and abroad, in a manner which

and where there is interest there is a potential market. That interest is unmistakable, and it has impressed even critical visitors from abroad. Among other manifestations it has expressed itself in a persistent demand for the extension of television service to the Midlands and the North, even while London has failed to justify the expense of what is already offered.

The experience of the British Broadcasting Corporation in this respect gives point to the caution with which American interests have ventured into the *terra incognita* of television. In the United States the cost of nationwide urban coverage is staggering; even in England it is serious. Once the service has been undertaken it is almost impossible to discontinue it, and if it is to be continued, sooner or later it must be expanded. Even if eventually it gets over the top and produces profits and employment, it may for a time dislocate existing industries. Thus in England, together with the agitation for television transmission in the provinces, there are outcries in the trade that television ballyhoo is ruining the sale of sound receivers without creating a compensating market for television receivers. A parallel complaint points to the unfairness of taxing 8,000,000 licensees of sound receivers for the maintenance of service to a few thousand owners of television apparatus.

Nevertheless, with all these difficulties, the outlook for British television has its bright spots. The technical progress we shall discuss later. Studio programs have improved, although it is generally agreed that they are still far below the average entertainment level of motion pictures and aural broadcasting. The real achievements—and these account in large part for the unflagging interest in the new art—are visual broadcasts of sporting and ceremonial events, including the important Coronation procession. It has been followed by other events of scarcely less interest to the British public.

On June 1 of 1938 the Derby was televised, and prize fights, boat races, soccer games, tennis matches, etc., as well as the more solemn spectacles featuring the royal family, have been received via radio with general approbation. Whatever the technical limitations may have been, the unique sense of psychological immediacy, the vantage points at which the television cameras may be set up for thousands of eyes instead of the few that can be physically accommodated in such favored locations, and the skillful showmanship with which the events have been scanned, have captured the popular imagination and drowned out the voices of pessimism.

Progress in both transmission and reception, while without revolutionary innovations, has been steady and many-sided.

In the field of Theatre Television, during February of '38 Baird demonstrated a mechanical 2-color system affording an image 12x9 feet, but with only 8.33 images per second and 120-line definition.

High-Definition Television in mono-

PROGRESS—A Review

to television reception in the United States . . . "will come in 1939, receivers become available in a number of types and sizes," states a comprehensive fields, in their 1938 report to the Research Council of the Sciences. The report is co-ordinated, with regard to television ac- makes it an outstanding contribution to current television literature.

chrome was shown by Baird in a Gaumont-British West End theatre, notably on June 1 on the occasion of the Derby broadcast. The picture was relayed by short wave from Epsom Downs to Alexandra Palace, thence broadcast and picked up at the theatre on a screen 8x6 feet. The intensity of illumination was low (about 0.75-foot-candle), necessitating the turning off of house lights; otherwise the results were good.

A competing company, Scophony, televised the Derby at another theatre. This organization employs an optico-mechanical system of considerable scientific as well as practical interest, utilizing a light-control cell which works on the principle of diffraction through compressional waves generated in a liquid. The method affords higher screen brightness, but appears to be subject to synchronizing difficulties at the present stage of development.

The consensus of opinion among large audiences at these and other demonstrations was that theatre television, while nowhere near the quality standard of 35 mm. film projection, had reached a stage where it could add the entertainment value of topical broadcasts to film programs, especially in short-subject houses. British Gaumont Equipments announced last June 3 that television apparatus would shortly be available for theatres at a cost of about £1,000 (\$4,800 at the present rate of exchange), but no installations have been reported. Apparently the principal obstacle is the refusal of the B.B.C. to permit reproduction of its broadcasts for paying audiences because of copyright complications, while at the same time the Television Act of 1937 makes transmission by radio a government monopoly, and unless amended will not permit a private corporation to broadcast its own pictures to a chain of theatres.

In the field of English home receivers

there has been development in opposite directions, viz., larger pictures at higher cost and less expensive receivers at the sacrifice of picture size. The latter are the equivalent of midget sound radios, with two important differences. The midget sound radio, while it has acoustic defects, can be heard all over a room, like a large set. A table television receiver, with a screen from 5x4 ins. to 7-½x6 ins. is suitable only for close-viewing by a few persons. A midget sound radio is really cheap. A television midget is still priced at £30 to £40 (\$144 to \$192 at the present rate of exchange).

Large "pictures" (images) are available—but at a price. A few examples: a Baird model incorporating a cathode-ray projector, image size 24x18 ins. at £157-½ (\$756 at the present rate of exchange); an Ecko-Scophony mechanical receiver with an image 2 feet square at £231 (\$1,108.80 at the present rate of exchange); a Philips Radio projector-type receiver, image size 18x14-½ ins. at £126 (\$604.80 at the present rate of exchange). It is true that pictures of this size may be viewed by 30 or more people, but they are also most convenient for smaller gatherings. Under the circumstances, however, the intermediate size of picture afforded by a 12 in. cathode-ray tube—10x7-½ ins.—is still the rule; these instruments cost in the neighborhood of \$300. For those who build their own receivers a cathode-ray tube giving a 12x10 in. "picture" is available at about \$75. Some 16 British manufacturers are offering television receivers, but it is evident that even at the peep-show level their product will not assuage the poor man's lot. Nor even those in middle circumstances, with taxes at the rate of 5 shillings to the pound.

TRANSMITTERS

On the transmitting end, an 8-studio layout is projected for Alexandra Palace, thus

obviating the almost insuperable difficulty of turning out shows from a single studio which must be used for both rehearsal and production. (A second studio is being currently added.) Four Marconi-E.M.I. cameras with greatly increased sensitivity are now used in the studio.

The program hours are 2 a day, 3 hours on Saturday, and 1-½ on Sunday. The transmission standard remains 405 lines, 50 frames per second, and the Postmaster General announced on January 1 (1938) that there will be no change at least until the end of 1940, thus dispelling apprehensions of receiver obsolescence for 3 years from the date of the announcement.

For outside pick-up a second mobile radio unit has been provided. In addition, an equalized cable network is being installed in those sections of London, such as the theatrical district, where televisable events occur most frequently. This will provide an alternative to the radio link and require only a scanning truck at the point of pick-up. A coaxial cable laid between London and Birmingham, and shortly to be extended to Manchester, although designed primarily for telephone purposes, may eventually be used for chain television.

It has been found that under favorable conditions the Alexandra Palace "pictures" may be viewed at distances of the order of 10 times the calculated service range of the station. The normal or optical range is only 25 miles, but authenticated reception has been reported from Ormesby, near Middlesbrough in York, 220 miles from London and almost spanning England from South to North. The pictures have been viewed repeatedly at distances of the order of 100 miles. Such feats require special receiving aerials on hills, and the reliability and quality of reception is necessarily doubtful. However, they indicate the possibility that as additional data accumulates

(Continued on page 572)

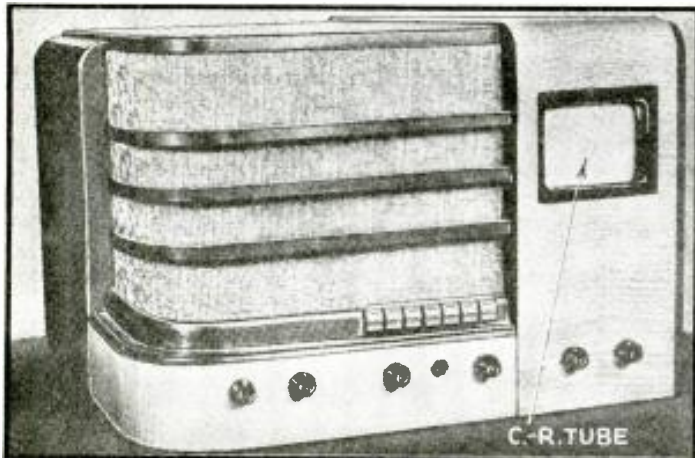

Last month, the General Electric Co. announced the availability of a console-type and, illustrated above, table-type television receiver with sound accompaniment and pushbutton control. These receivers complement the transmitter system, recently described in *Radio-Craft*, designed for "public demonstration of . . . television on a . . . large scale." The table-model set, for direct-viewing, uses a 5-in. cathode-ray tube. The 7 pushbuttons permit selecting any one of 7 possible television channels, only.



In England, The Gramophone Co. (Middlesex) last month announced the Television Monocle, says *Radio-Press-Service*. Held like an ordinary French-phone, it affords "personalized" television image and sound reception. This H.M.V.—His Master's Voice—Television Monocle presents an image about 1½ x 1 in. (which is about all the eye can accommodate at such short range), as viewed on the second of 2 mirrors at 45-deg. angles; the cathode-ray tube is actuated by a nearby receiver. The earpiece at the end of the Monocle completes this televiewer for the "rugged individualist."

OPERATING NOTES

ANALYSES of RADIO RECEIVER SYMPTOMS

SERVICEMEN—What faults have you encountered in late-model radio sets? Note that RADIO-CRAFT will consider your Operating Notes provided they relate to characteristic (repeatedly encountered) faults of a given set model. Payment is made after publication of the Operating Note.

Trouble with . . .

. . . GRUNOW 5B CHASSIS—MODELS 501, 520, 530 and 550

Very weak and distorted reception. Voltage check shows less than 50% of normal. Filter condensers test OK. Trouble is caused by high-resistance short between terminals of 25Z5 wafer socket due to some of the sealing compound in the filter condenser can, located on underside of chassis, seeping in between the layers of the 25Z5 socket. Replace 25Z5 wafer socket with a bakelite socket.

F. J. PROSSER

. . . BRUNSWICK MODEL 11

When this radio set is turned on it makes a crackling noise and continues to do so as long as the receiver is on. This is due to a defective 10 mmf. condenser (coupling condenser) from plate of R.F. 51 to grid of 1st-detector 24. This condenser is built on the end of the stator of the R.F. variable condenser. In repairing this condenser turn out the screw at the end of the stator and replace the mica and insulation.

BILL EDELMAN

. . . RCA VICTOR 948T

Several calls have been made on this model where the purchaser did the installation himself, and used a 2V. storage "A" cell. Calls can be avoided on these models by clipping the series resistor in the positive "A" lead from the cord, *only if the set is to be used on a 2-volt storage cell—not an Aircell.* Also on this model, to avoid distortion and microphonic tube noises, be sure to remove the cloth tape which is looped over the 1G5G output tube, in shipment.

. . . RCA VICTOR 97KG

Speaker rattle which is not caused by out-of-center voice coil, or worn speaker parts, can be easily corrected by placing a rather thick washer under each bolt which holds the voice-coil centering spider retainer in place. The "spider" in this speaker consists of a paper "cone", instead of the usual type.

. . . RCA VICTOR 95T5

The tone of this model can be greatly improved if the back of the cabinet is covered with heavy parchment paper. This can be fixed in a wooden or metal frame, and the frame fastened to the corners of the cabinet in such a way that it is mechanically secure, but is, at the same time, easily removable. This absorbs some of the "highs" from the back-wave, which is the part of the sound wave which makes the tone so "tinny", and objectionable.

. . . MAJESTIC 490

Intermittent operation in this model is almost invariably in the coupling condenser

to the output stage. In replacing this condenser, it is best to cut both leads to the condenser, and thus install a new tone condenser as well. The tone condenser and the coupling condenser have a common lead, and are, therefore, both removed from the circuit if one or the other is.

. . . FADA MODEL 48

Raspy speaker in this model, which, no matter how carefully the voice coil is centered, recurs after a few days' use, is remedied by turning over the washers which hold the spider in place. Indentations in these fibre washers cause the spider to automatically seek the same position after a little vibration slightly loosens the machine screws holding the spider firm. If new fibre washers are available, it is, of course, better to make the indicated substitution.

HOWARD H. ARNOLD,
Arnold's Radio Service

. . . WEBSTER CHICAGO 4P15 AMPLIFIER

Amplifier hum, or dead amplifier. There are two causes for this trouble. This amplifier is a 15-watt job with a 4-position mixer. Hum is caused by a defective 8 mfd. condenser in the 2A3 push-pull circuit. This condenser is connected from the center-tap of the hum resistor across the 2A3 filament to ground. It shunts the 700-ohm resistor which supplies a bias to the 2A3. This low-voltage electrolytic becomes leaky, and the insulating material used in the condenser drips onto the 700-ohm resistor and causes excessive leakage to ground. This is due to the condenser and the resistor being placed too close to the 2A3's which develop much heat.

A similar condition exists in the 76 driver tube circuit, except that the condenser there is the tone control. It is placed directly over the amplifier pilot light, the heat from which causes the insulation compound to melt out and the condenser subsequently becomes dry and short-circuits. This condenser is in the plate circuit of the 76 driver tube.

Another common trouble experienced is the continued breaking down of the 16,000-ohm resistor (10 watt) placed between the 2 chokes in the power pack circuit. Replacing this resistor with a 15-watt resistor overcomes this trouble. Outside of these troubles this amplifier performs excellently. There are 4 type 6C6 tubes used in the mixer; these are fed into 2—6A6's which, in turn, feed 1 type 76 tube which is the driver for a pair of 2A3's in push-pull; the terminating resistance on each input has a value of 2-megs.; and the output impedance provides values of 2, 4, 6, 8, 16, and 500 ohms.

. . . AMPERITE VELOCITY MICROPHONES, MODELS RSH-RAL-RAH

This item deals with low response, or insufficient output of amplifier, traceable to microphone internal connections. Remove microphone housing and shell, check the

microphone ribbon for clearance, and if clear and not striking the sides, examine the connections from the top of ribbon and bottom of the ribbon for good soldered joints. Some of the connections from the ribbon to the microphone transformer were not soldered, in instances that came to the writer's attention, and from this experience it is advisable to check all microphones of this type before installing same on any P.A. installation. Out of 6 cases this condition existed in 4, in that the wire going to the transformer input was just wrapped around the soldering lug. Soldering cured same and we were able to use this type of microphone at a distance of 200 feet from the amplifier without any difficulty; something that could not be done before.

. . . KOLSTER MODEL K-80

Inoperative or completely dead due to the following: open choke to 227 2nd-detector plate; 227 oscillator cathode resistor open (value 0.1-meg.); no A.V.C.; open 500 mmf. grid-coupling condenser of the 224 A.V.C. tube or low A.F. output caused by one of the type 247 output tubes being defective.

. . . SPARTON MODEL 594

Receiver dead: caused by the 75 2nd-detector A.V.C. tube cathode resistor open or a defective volume control. Value of cathode resistor 100 ohms, volume control 0.5-meg. Also replace 78 1st-detector and oscillator. Check the 25Z5 rectifier in that it may have flashed, and if so replace filter condenser as they sometimes have a habit of opening and healing again, causing the 25Z5 to flash; replace with a new condenser and tube.

. . . WELLS-GARDNER AUTO-RADIO SERIES 65

Receiver inoperative due to an open filter choke. Check electrolytic filter condensers (C26, C27) for shorts or opens, replacing with higher value in voltage rating. This is a dual (6-8 mf.) unit with a rating of 350 volts; change to 400 volts. Also check the 84 rectifier tube for an internal short, as this condition is not uncommon.

. . . MOTOROLA MODEL 44

Receiver inoperative, also audio oscillation; frequently caused by an open resistor in the 75 diode and 1st audio frequency tube circuit, as well as an open plate resistor to same; this latter resistance value is 0.5-meg. Replace the resistors and also the 12A5 power tube, and if this does not remedy the trouble, insert a small R.F. choke in the "B+" output, and at the same time place a small buffer condenser across the switch contact points.

GEORGE F. BAPTISTE

. . . SILVERTONE—A.C.-D.C.

There is a Silvertone A.C.-D.C. midget on the market (no marking!) that has the following complement of tubes (1 each): 43, (Continued on page 570)

THE past year, for reasons of increased economy and a desire for reduced physical sizes, has seen a large increase in the use of condensers of the "dry electrolytic" type and employing anode members of the *etched* (or otherwise roughened) *surface* types.

The increased use of dry electrolytic condensers of these types brings up for consideration a point of interest to both design engineer and the Serviceman. This point of interest concerns the behavior of the etched or otherwise roughened surface anode type of dry electrolytic condenser under various operating conditions in so far as stability of initial capacity values is concerned.

OPERATING CONDITIONS

While the standard, polarized type of dry electrolytic condenser is essentially a direct current device, most circuit applications involve not only the application of a direct current potential to the condenser but also an alternating current potential which is generally superimposed on the direct current potential. This is particularly the case where electrolytic condensers are employed in "capacity-fed" filter networks of rectifier-type power supplies. It is the effect on capacity stability of this applied alternating current potential with which this article is primarily concerned.

The essential parts of a dry electrolytic condenser are:

The anode plate

The dielectric or anodic film

The electrolyte or cathode

The electrolyte contacting plate or so-called cathode plate.

A diagrammatic illustration of a dry electrolytic condenser, with applied direct current potential and superimposed alternating current potential, is shown in Fig. 1.

THE "ANODIC FILM"

It is a basic fact that the electrolyte, in a dry electrolytic condenser, must have appreciable electrical resistance and that the higher the operating voltage of the condenser, the higher must be the resistivity of the electrolyte employed. This being the case, it becomes immediately apparent that when an alternating current flows through a dry electrolytic condenser structure there will be an alternating current potential difference set up in the resistance path of the electrolyte, between points (a) and (b) of Fig. 1.

The magnitude of this potential difference is proportional to the product of the resistance of the electrolyte path, times the value of alternating current flowing through the condenser structure. The polarity of this potential difference on one half-cycle is such that the cathode plate is negative with respect to the electrolyte contacting it but on the other half of the cycle the polarity is reversed and the cathode plate becomes positive with respect to the electrolyte contacting the surface of the plate.

Under this latter condition, and if the cathode plate is of a film-forming material, the surface of the cathode plate

(Continued on page 567)



Dry electrolytic condensers. These are representative in appearance to certain of the etched-foil types.

Effect of A.C. on Dry ELECTROLYTICS

Servicemen and laboratory workers frequently encounter loss of capacity in electrolytic condensers. Engineer Deeley shows how the A.C. component affects the capacity of etched-foil dry electrolytics.

PAUL McKNIGHT DEELEY

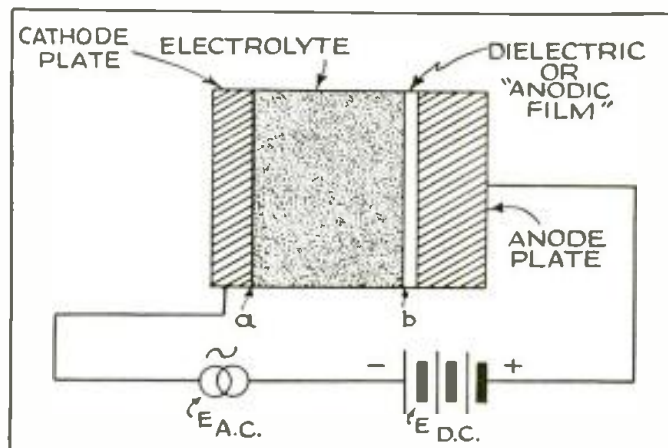

Fig. 1. A magnified cross-section of a dry electrolytic condenser; and, schematic diagram showing A.C. component superimposed on applied D.C. potential.

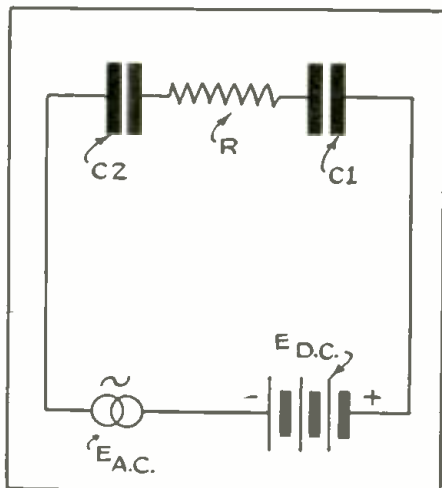

Fig. 2. This diagram shows in schematic form the 2 condensers, effectively in series, resulting from an anodic film having been formed on the cathode plate.

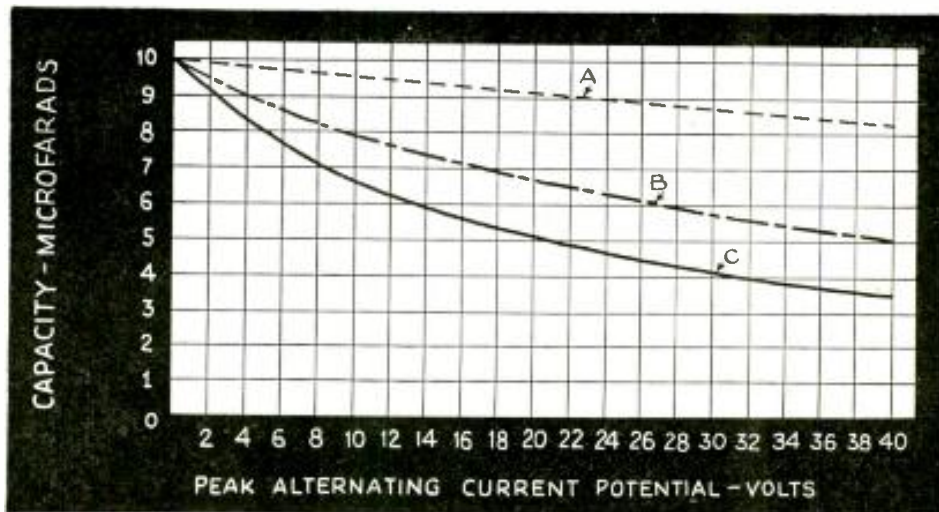

Fig. 3. These curves illustrate the effect of the A.C. component on the effective capacity of dry electrolytic condensers of several types. At A is shown the effect of using a standard plain-foil, 150 W.V. unit; at B, an etched-anode unit of same rating but 5-gain anode surface; and at C, a 10-gain anode.



SIMPLE TECHNIQUE FOR

It's easy to put life into those old motion pictures you took last year or the mean not only the voices of loved ones but sound-effects as well. The probability but its basic principles as Mr. Tuthill shows may be inexpensively

C. A. TUTHILL

A NEW domineering hobby has grabbed the public by their bootstraps. People have gone Camera-Crazy. The whole panorama of the magazine stands has bloomed with a new trend overnight. The flood of Picture Magazines trails the demand of the candid and movie camera addicts. During summer vacations thousands of feet of 8- and 16-millimeter trophies have been bagged. Why should they remain dull and silent? Why not bring them to life; make them talk; preserve their treasured memories by scoring them with your own voice and music?

Here lies a dormant opportunity for wide-awake Servicemen. Here is a chance for many to elaborate upon a very gratifying and profitable photographic hobby. Every movie-camera enthusiast owns a projector and a radio set which harbours an amplifier with db.'s to spare. All he needs to make Talkies of his silent footage is a mike and a recording gadget. As simple as our "A B C's". The block diagram, Fig. 1, shows how it's done.

WHY HOME-TALKIES?

We no longer need look to Hollywood for miracles. Now in our own home, at little expense, we may make genuine Talkies of the entire family. Through the use of equipment at home, budding

talent may be developed until confident to face the auditions of the studios. Baby's reaction to his first Christmas Tree may be stored away for the profound delight of himself and others in later years. We may indelibly preserve such priceless treasures as the final years of Grandmother's silvery radiance for the generations to follow. Can you not realize how sacredly you would guard any records you held of your own ancestors?

People having either 8-, 16-, or 35-millimeter cameras can rather inexpensively include Sound in their projections. It can be recorded either during or after the shooting of their pictures. Since it is far simpler to do the latter we will first discuss Scoring of silent pictures. The combine of sound and picture simultaneously is a bit more involved but will be simplified later in this series.

In either indulgence we have basically two plausible means of recording. Either Film or Disc records may be made. The film track system described on page 746 of *Radio-Craft* for May, 1938, is one most inexpensive means of recording on film that this writer has discovered. The somewhat higher fidelity of variable light density or area records are obtained at a greater monetary outlay.

The second basic method—Disc Recording—also may easily be synchronized. The common run of temporary flow waxes of acetate or similar base are highly satisfactory and easily cut in the manner of phonograph records. Proper levels fed the cutter-head will reduce surface noise in the finished product to less than that in commercial phonograph records. Fixing baths applied by cloth or soft brush will allow surprising wear and permanence if they be played back only with special soft needles.

Should permanent records be desired that will serve in years following, pressings can be obtained for a small fee by submitting your original to a recognized maker of disc records such as RCA-Victor in Camden, N. J. Both film and disc recording will be detailed and simplified in later pages. But—one step at a time. Let us study first the simpler recordings which we shall call *scoring*. Here we merely add sound to silent film already at hand.

SCORING

(1) Great value may be added to your present silent pictures through the *scoring* (or addition) of a descriptive commentary or music. For Example:—If one shoots considerable silent footage while traveling during his summer

vacation, he may, after he returns home, thread up a recorder unit synchronized with a projector. Then, while the details are fresh in his mind, if he describes into a microphone each scene as it unfolds before him, he synchronizes his own voice in comment. Later, his presence is unnecessary for others less acquainted to reap thorough benefit from projection.

(2) Music from any disc record may be fed from an electrical pickup, such as many of you now own, through an audio amplifier to a recorder and thereby a synchronized musical score can be obtained. Care in selection of music befitting the mood of the subject, will net a most gratifying result.

(3) Delightful combinations of music and voice may be had with no effort. Full, rich, main title music may precede the initial scored remarks, as it does in every Movie Theatre. We'll tell you, soon, how to go about making these interpolations.

Once the title is concluded the music may then be dropped to a lower or underlying level to serve as a background

swan would be ruined, were we to hear a train roar by during the scene, yet, very extensive value may be gleaned from the appropriate and not too frequent scoring of sound effects. The inclusion of doorbells, telephones, or any pointed sound effects with definite reason or purpose to the scene, may be mixed-in just as can be music. Several libraries of such sound effects may be drawn upon. They have been on the market for years. Ofttimes local props (properties—stage devices) rigged in proximity to the mike will do.

Astounding realism may be had from the skillful use (not over-use—perpetual noise is *never* entertaining) of sound effects. Sadly amiss of something would be a silent scene one had grabbed of a firetruck tearing down the street. But, if scored later, by a record providing a roar of motor and clanging of bell, the same scene would whip into realism with gripping terror. Still again the proper selection of record to fit the scene and, the zooming in, and fading out of it, on the mixer knob (for Sound Perspective) would mold the

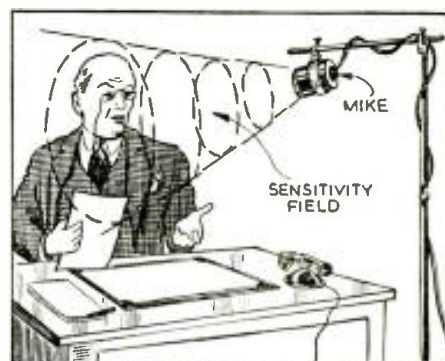

Fig. 3. How to keep the mike out of the camera field and yet within easy earshot of the subject's voice.

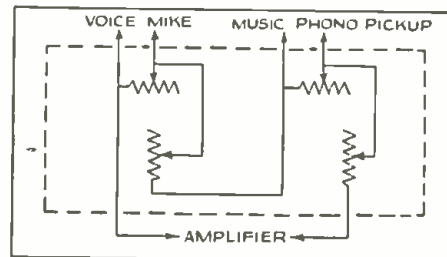

Fig. 2. Diagram of a typical 2-position mixer circuit.

MAKING HOME TALKIES

ones you plan to take this year by adding Sound. And by Sound we mean the production of professional talkies entails considerable expense and technical skill and easily modified for use by the radio man and amateur movie maker.

PART I

fabric augmenting the commentator. For effectiveness this music may be lifted during vocal intervals, then dropped again before the speaker resumes. And finally, after his conclusion, the same music may be boosted to serve as a brilliant end-title.

That specifically is the manner by which Travelogues are released with Sound after having been photographed silently.

To accomplish this electrically it is merely necessary to build a 2-position mixer. (See Fig. 2.) In extent that is merely 2 volume controls tandemed through a balancing network to maintain impedance values. One position or knob controls the amount of music passed through it while the other regulates the level of the voice. Blended in this MIXER the combination is passed on to be amplified and recorded.

A little practice is required to maintain the proper balance between voice and music. If the latter be held just low enough to not interfere with the vocalization, a very colorful finished record is obtained. Again, of course, the selection of the music employed, makes or ruins the blend. Naturally we must not score thunderous chaotic music to a scene of a swan gliding through a still pond.

(4) Again, the scene of the graceful

success of the effort.

Effectiveness rather than realism in sound effects is to be sought for.

In a later section, operation of the recorders and more technical treatments will follow, but for the present let us only concern ourselves with the physical set up.

SETTING THE HOME-TALKIE STAGE

To procure high-grade results is not merely to train a camera and mike at your subject, then grind the machinery. Much time and painstaking will more than pay for itself. Considerable attention should be paid to balance in picture composition and lighting.

If much movement of your actors about the set is to be covered, it may be necessary to arrange some means of following them with the microphone as well as with the camera. Since that would become mighty involved, it is best at first, to have your subjects remain seated or to stand in one place during conversation, or while they sing or play some musical instrument.

ACOUSTIC CONSIDERATIONS

The acoustics of the set, or stage you are setting, must be reckoned with. The farther the mike is from your actors, the more serious becomes the acoustic problem. Small rooms should, for the

most part, be avoided, unless they are generously carpeted, and draped, or tapestried. Any part of a room or hallway having a large content of acoustic "liveness," conducive to excessive reverberation, should be avoided. Large glass areas near windows and panels are quick to reflect sound and cause distortion.

Low ceilings can be draped, if out of the picture, to reduce flare-back. They should be avoided whenever possible. High ceilings are to be desired. Rooms
(Continued on page 556)

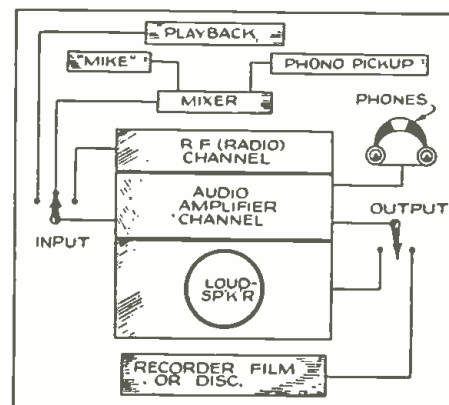

Fig. 1. Block diagram of a home-talkie "set-up" using the family radio receiver as the amplifying equipment.

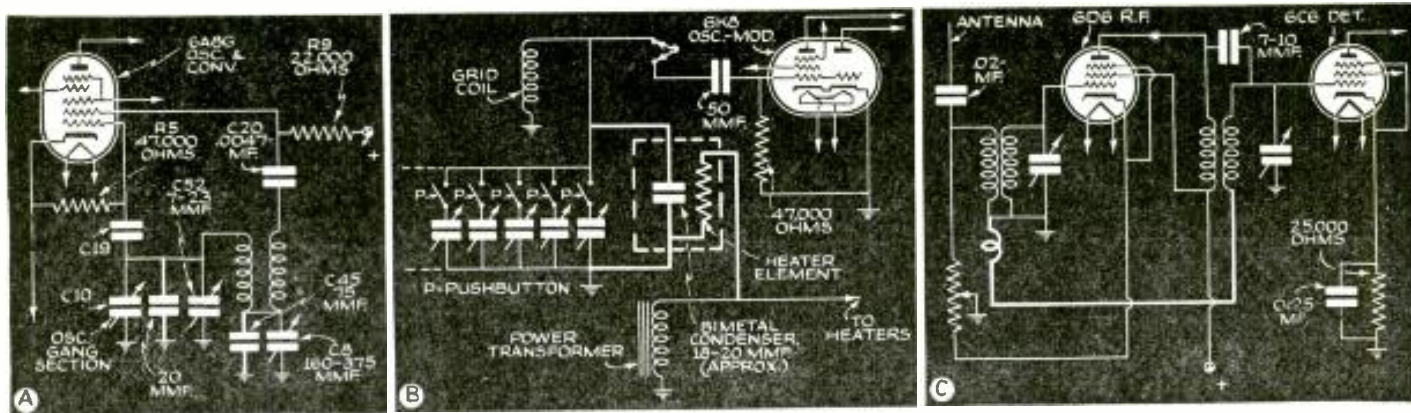

Fig. 1. New circuit details of (A) G.E. models G-95, G-105, (B) Stromberg-Carlson model 345 and (C) Crosley models 418, 428 and 448. The heavy lines accentuate the features.

NEW CIRCUITS IN MODERN RADIO RECEIVERS

The details of the modern radio receiver circuits that make them "different" from previous designs are illustrated and described each month by a well-known technician.

F. L. SPRAYBERRY

NUMBER 18

(1) MINIMIZED OSCILLATOR DRIFT

General Electric Models G-95, G-105. Through the use of special materials and circuit alterations, the oscillator frequency drift caused by temperature and humidity changes is practically eliminated.

Two additional condensers will be found in shunt with the trimmer and padder of the broadcast band oscillator grid coil in Fig. 1A. Each part of the oscillator circuit which was found to contribute to the oscillator drift, due to temperature change, was replaced by an experiment with a part having less change.

This included the use of ceramic insulation in place of bakelite for the oscillator section of the gang condenser, use of an air padder and trimmer in place of the mica type, different method of winding the oscillator coil eliminating cambric insulation, and other part alterations. To off-set the remaining minimum frequency drift, temperature-compensating condensers C52 and C45 are used in shunt with the trimmer and padder, which have sizes calculated to change capacity just the correct amount to keep the frequency constant when other factors tend to change it. They

can maintain the oscillator frequency within 100 cycles in any part of the band.

(2) OSCILLATOR FREQUENCY STABILIZATION

Stromberg-Carlson Model 345. Oscillator frequency drift in this receiver is minimized by a temperature-controlled bimetal condenser in the oscillator tuned circuit.

Across the common heater winding as in Fig. 1B, in constant connection with it is a resistor-heater unit enclosed in a compartment with a bimetal condenser. Circuit construction is of high quality; and oscillator drift bears a definite relation to temperature. The capacity variations per degree change in temperature is then computed and a condenser is used which at a known temperature will have a known capacity. One of its plate sections is controlled by a strip of material made with 2 metals having different coefficients of temperature expansion. Any change in temperature will make the unit bend or turn and this action will operate one set of condenser plates.

When the set is at first turned on, it will be exactly in-tune. Then as the set

rises in temperature, the oscillator frequency will tend to drift, but the bimetal capacity will change to prevent drift, as the compensating heater temperature is proportional to the set's temperature for any unit of time. Thus, the set will remain practically in perfect tune at all times.

(3) IMPROVED SENSITIVITY AND SELECTIVITY IN SMALL SETS

Crosley Models 418, 428, 448. In these circuits reflexing makes its reappearance for greatly improving the selectivity of a tuned-radio-frequency circuit having only 2 tuned stages.

A small section of the detector grid coil (see Fig. 1C) is mounted in inductive coupling relation with the antenna coil so that its amplified signal current will reinforce the signal voltage to the R.F. grid. To prevent self-oscillation the R.F. transformers and associated circuits are designed so that the ratio of voltage fed to the detector grid to that fed back to the R.F. grid is always slightly greater than the actual gain of the R.F. stage. Consistent with the principle of oscillation, in this way the feedback voltage is always smaller
(Continued on page 554)

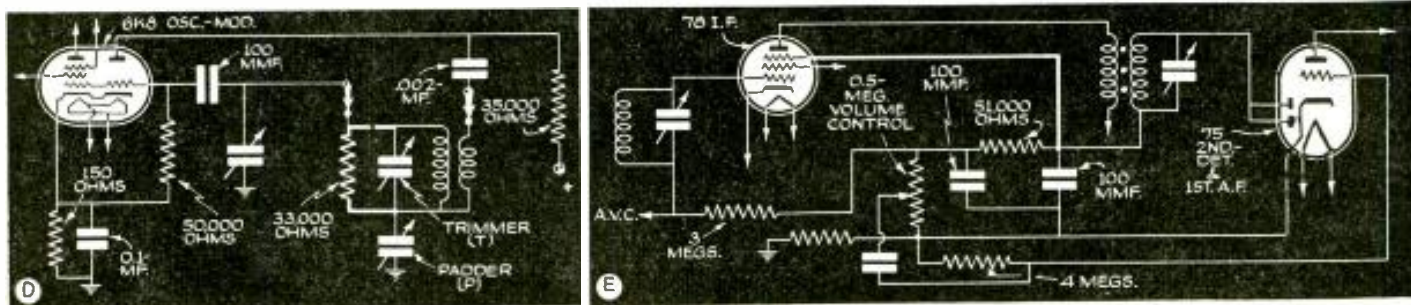

Fig. 2. New circuit features of (A) Philco models H-555 and H-475 and (B) Philco models 39-6 and 39-7 receivers. The heavy lines accentuate the features.

THIS article is presented with the idea in mind of acquainting the inexperienced Serviceman or student with practical knowledge gained by actual work in the servicing of radio receivers and in dealings with the owners of radio sets.

To the experienced Serviceman or engineer, the ground covered will probably be familiar and in some instances will almost duplicate similar experiences. The engineer profits by receiving reports from the field on the ability of his brain-child to stand up in service; to remain trouble-free and to give the highest possible performance for the money spent in building a radio receiver.

A radio Serviceman, because of the nature of his job, goes into the homes of his customers, talks to them and is accepted in most cases as an equal however pretentious the surroundings in which he finds himself may happen to be. After he has had the benefit of some painful experience, he learns, despite what contemporary books on servicing might have led him to believe, that it does not pay to put too much credence in what the customer may tell him. Of course, this doesn't mean that a few preliminary questions should not be asked regarding the nature of the difficulty which the Serviceman has been called to correct. But any long discussion is unwise and apt to lead to trouble. Above all, a professional and dignified, but not stiff, manner is to be cultivated. Be friendly, tactful, and act like a gentleman. It isn't necessary, either, to go out on a job looking like a tramp, even if it is to put up an aerial. But let's not forget the important question of the set itself.

THE customer has complained of noise, let us say. The set is turned on, and to the Serviceman, a loose antenna connection, if responsible, is easily recognized and remedied.

If the locality is a business district or a suburban community still cluttered up with the overhead power-lines of the utility or trolley companies, it is an easy matter to install a modern antenna for reducing such interference. Very often, it will be something of a job to sell the customer the idea that such an antenna is going to do any good, particularly when it's going to cost several dollars. In such cases, knowing that a noticeable improvement is practically certain, it is not a waste of time to make a sale on condition that the antenna shall effect a definite improvement in the set's performance.

IF the customer simply says that the set is "dead," then, with all the confidence in the world you stride over to it and turn it on. If it is an A.C.-D.C. set and it doesn't light up you feel the tubes in the chassis, if they are metals, to see if they are warm; if they are, it's probably the pilot light at fault.

If the complaint is that the set lights up for a moment and then the light dies down, it is probably due to an output or rectifier tube having its cathode shorting to its heater.

If it's distortion, or a hum, more than likely the output or rectifier tube will be defective and the symptoms will be identical in the case of defective filter condensers.

IF the radio receiver is an A.C. set, the troubles outlined above may be somewhat dissimilar. That is, a tunable hum may be caused by an open condenser connected from the power transformer primary to chassis. Or, it may be an open condenser in the grid filter of a fixed bias output stage.

Let us assume that the receiver is dead. The output tube is wiggled or partly removed from its socket. A click should have been heard in the loudspeaker when it was withdrawn

and the plate current to it interrupted providing a signal to the output transformer primary of 1 cycle.

If the click is not heard, a screwdriver can be placed near the field of the speaker if it is an electrodynamic type to see whether the field is being energized. If the screwdriver is not attracted, a resistance measurement from the heater of the rectifier tube to chassis will usually show either a low-resistance dead or short.

If the field is energized and no click when the output tube is removed is heard, the probability is that the primary of the output transformer is gone. If a weak click is heard, the fault will probably be either a high-resistance short from plate to cathode of the output tube or low plate voltage because of a defect in the plate supply.

WHEN the receiver is working all right from output tube to speaker, go down the line, until the weak link in the electrical chain is found, remembering that every tube receives its excitation from either another tube or an antenna. If the I.F. stages are working and the set is dead, it will probably be some fault in the mixer or oscillator circuits of the set.

The idea is to get a clear conception of the fundamental principle which recognizes the passage of a minute amount of energy from the antenna to the speaker which converts it into audible vibrations. Each tube is but a succeeding link in the electrical network and functions only because its predecessor has supplied the necessary impulse or series of impulses.

Practical **SERVICING POINTERS**

Experienced Servicemen are prone to let the beginner in servicing shift for himself. But the author, a practicing radio man in New York City, extends a helping hand.

WILLARD MOODY

checked, removing the grid contact momentarily and listening for the click in the speaker.

The preceding data are well known and although the system is original, born of experience with the writer, many more men must undoubtedly have discovered its principles.

IN conclusion, as regards the customer and your attitude towards him or her, remember that it is always the course of wisdom to invoke the teachings of the psychologist which advise the importance of making the other person never appear inferior to yourself. Get them to talk. Let them tell you of their successes or brag about how smart they were to get the set at a good price. Compliment them on any and everything, tactfully of course, to make up for your superiority over them in one regard, the ability to repair one of their most personal possessions, their "radio."

It may be worthwhile to point out to the tyro that the suggestions given above as possible solutions to problems in servicing radio sets are not to be taken as *conclusive*. However, they do indicate the *probable* sources of trouble and hence it may save considerable time and trouble to first check for these *probable* causes of trouble as the ones that would be likely to exist in the majority of cases.

It is this sort of procedure which a large number of radio Servicemen follow, perhaps in most cases without really realizing it; and that enables the professional radio repair man to "flabbergast" the beginner in radio with the speed with which he services radio sets.

SOMETIMES, in the shop, with the chassis turned up, this idea of listening for a click in the speaker can be conveniently realized by simply placing a voltmeter probe on the plate prong of each tube in the link. An audio system may be quickly checked, in certain of the newer sets, merely by touching the grid cap of the 6F5 or 6Q7 and similar tubes used as audio drivers. Similarly, the 6K7 and the 6A8 tubes and stages can be quickly

MAKING A SERVICEMAN'S TEST UNIT THE "SUPER-GENO-SCOPE"

Here in compact, portable form is a combined oscilloscope, and R.F., I.F., A.F., and modulated (and wobbled) -R.F. and -I.F. oscillator, complete with power supplies. This unit permits visual analysis of any radio set's R.F., I.F., and A.F. circuits.

PART IV (Conclusion)

CANIO MAGGIO



Fig. E. The accessories Mr. Maggio uses include Amplifier and Demodulator units shown by diagram in Fig. 1 (upper-right), pg. 343, December 1938 Radio-Craft, at B and A, respectively.

PRIOR to the output radio frequency calibration of the Super-Geno portion of this versatile servicing instrument, the constructor has to stabilize the frequency modulator and fixed-frequency oscillator. The method of calibrating the latter will be discussed fully in chapters to follow. The accessories required for calibrating the instrument are: a tuned radio frequency receiver having, if possible, diode detection; and, an all-wave receiver.

Figure 5 A-B-C shows various types of detection and indicates connections to the oscilloscope.

PRELIMINARIES

In balancing the frequency control tube the procedure is as follows:

Place all tubes in their respective sockets.

Modulation selector—set at frequency modulation.

Channel width control—at "on" position.

Fixed R.F. oscillator trimmers—set at halfway rotation.

T.R.F.—tuned to resonate to fixed oscillator frequency.

The variable radio frequency oscillator during this process can either be shorted or set at the highest frequency so as to produce only the desired indications.

Having established a signal through the receiver, the output is connected to the oscilloscope input according to Fig. 5.

Oscilloscope settings.

Synchronizing selector—set at Ext. Pos.

Sweep—Int. Pos.

Coarse Frequency—2-3.

Syn. control—advanced until the image is locked.

Assuming the operator has any one of the patterns shown in Fig. 6 A-B-C we find that in A the channel width



Fig. 6. Possible initial 'scope patterns.

control was not advanced to the proper setting; in B, the proper setting was made; and in C, the control was advanced too far. But, before considering the band width it is important to establish the proper phase relation or action of the control tube. That is, coinciding patterns should have an equal amplitude after they are separated from resonance as the patterns "drift" from left to right and from right to left across the screen. (See Fig. 7.) Also the peaks should travel an equal distance and within an equal time from either ends of the horizontal axis. This can be checked against a frequency-calibrated dial scale of the receiver as follows:

The receiver is tuned to resonance until the 2 peaks coincide. Mark the dial indication, then rotate the dial to the left until the peaks lose altitude and again mark the dial indication.

Then, rotate the dial to the right, past resonance until peaks lose amplitude, and again mark the dial indication. The frequency band width, or the calibrated space on the dial should have an equal kilocycle space at either side off-resonance (as for instance F+10 and F-10); if the indications are other than those cited, correct this condition by varying phase adjustments C12, C10, C11 and R13.

A brief explanation of the double-image response follows.

DOUBLE-IMAGE RESPONSE

Assuming that the oscilloscope timing axis is locked at 120 cycles, exactly

TABLE IV

A fairly reliable method for calibrating a signal generator is to use the carrier frequency of broadcast stations. This table gives a list of standard broadcast frequencies "F" and their harmonics.

1/10	1/9	1/8	1/7	1/6	1/5	1/4	1/3	1/2	F	2 F	3 F	4 F	5 F	6 F	7 F	8 F	9 F	10 F
55.	61.1	68.75	78.57	91.66	110.	137.5	183.3	275.	550.	1100	1650	2200	2750	3300	3850	4400	4950	5500
57.	63.33	71.25	81.42	95.	114.	142.5	190.	285.	570	1140	1710	2280	2850	3420	3990	4560	5130	5700
60.	66.66	75.	85.71	100.	120.	150.	200.	300.	600	1200	1800	2400	3000	3600	4200	4800	5400	6000
66.	73.33	82.5	94.28	110.	132.	165.	220.	330.	660	1320	1980	2640	3300	3960	4620	5280	5940	6600
70.	77.77	87.5	100.	116.66	140.	175.	233.33	350.	700	1400	2100	2800	3500	4200	4900	5600	6300	7000
75.	83.33	93.75	107.14	125.	150.	187.5	250.	375.	750	1500	2250	3000	3750	4500	5250	6000	6750	7500
76.	84.4	95.	108.57	126.6	152.	190.	253.33	380.	760	1520	2280	3040	3800	4560	5320	6080	6840	7600
80.	88.88	100.	114.28	133.33	160.	200.	266.66	400.	800	1600	2400	3200	4000	4800	5600	6400	7200	8000
81.	90.	101.25	115.7	135.	162.	202.5	270.	405.	810	1620	2430	3240	4050	4860	5670	6480	7290	8100
86.	95.55	107.5	122.85	143.3	172.	215.	286.6	430.	860	1720	2580	3440	4300	5160	6020	6880	7740	8600
90.	100.	112.5	128.57	150.	180.	225.	300.	450.	900	1800	2700	3600	4500	5400	6300	7200	8100	9000
96.	106.66	120.	137.14	160.	192.	240.	320.	480.	960	1920	2880	3840	4800	5760	6720	7680	8640	9600
100.	111.11	125.	142.85	166.66	200.	250.	333.33	500.	1000	2000	3000	4000	5000	6000	7000	8000	9000	10000
104.	115.55	130.	148.57	173.33	208.	260.	346.66	520.	1040	2080	3120	4160	5200	6240	7280	8320	9360	10400
110.	122.2	137.5	157.1	183.3	220.	275.	366.6	550.	1100	2200	3300	4400	5500	6600	7700	8800	9900	11000
115.	127.77	143.75	164.28	191.66	230.	287.5	383.33	575.	1150	2300	3450	4600	5750	6900	8050	9200	10350	11500
120.	133.33	150.	171.42	200.	240.	300.	400.	600.	1200	2400	3600	4800	6000	7200	8400	9600	10800	12000
125.	138.8	156.2	178.5	208.3	250.	312.5	416.6	625.	1250	2500	3750	5000	6250	7500	8750	10000	11250	12500
130.	144.44	162.5	185.71	216.66	260.	325.	433.33	650.	1300	2600	3900	5200	6500	7800	9100	10400	11700	13000
140.	155.55	175.	200.	233.33	280.	350.	466.66	700.	1400	2800	4200	5600	7000	8400	9800	11200	12600	14000
145.	161.1	181.2	207.1	241.6	290.	362.5	483.3	725.	1450	2900	4350	5800	7250	8700	10150	11600	13050	14500
150.	166.6	187.5	214.2	250.	300.	375.	500.	750.	1500	3000	4500	6000	7500	9000	10500	12000	13500	15000

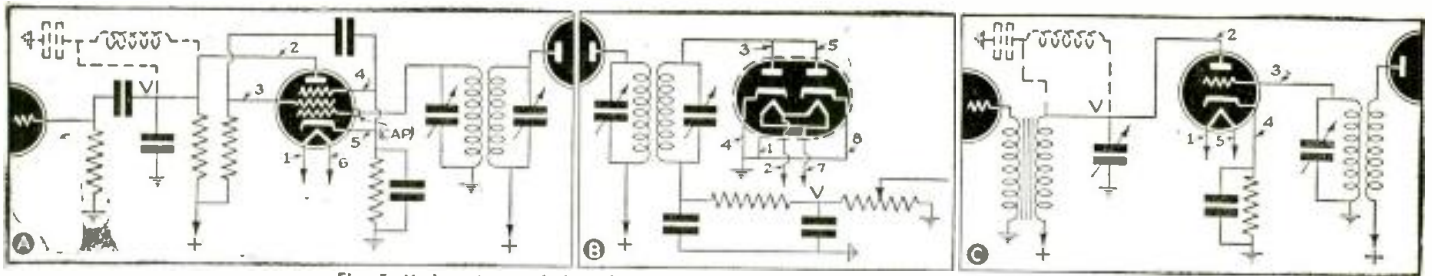

Fig. 5. Various types of detection, and methods of connecting to the oscilloscope.

twice the frequency of the exciting voltage of the frequency control tube and the horizontal deflection progresses from left to right on the screen. Thus in 1/120-second the fixed R.F. oscillator frequency progresses from 885 to 915 kc.; horizontally controlled by the timing axis oscillator, it results in an apparent left-to-right motion. At the end of 1/120-second, the R.F. oscillator frequency starts to decrease and during the successive 1/120-second changes from 915 to 885 kc.

At the peaks of the 60-cycle exciting voltage, the oscilloscope timing oscillator will cause the horizontal deflection to arrive at its maximum on the tube screen, its voltage drops to zero, and the beam returns on the left side of the screen. The voltage then builds up again tracing the reverse resonance curve of the second-half of the exciting voltage cycle (sweep), consequently resulting in the two superimposed curves which are opposed to each other with respect to frequency except at the point corresponding to the resonance of the alignment frequency. See Figs. 8, 9A and 9B.

The synchronizing voltage is provided from the rectifier output which like all full-wave rectifiers, has a 120-cycle output before filtration. This frequency being a product of the 60-cycle supply is the proper synchronizing voltage as to frequency and time constant. This synchronizing voltage is available through Sw.3 (Oscilloscope) and Sw.2 (Super-Geno) when Sw.3 is on Ext. position and Sw.2 on On position; we then have a 120-cycle sync. voltage with switch Sw.2 on Off position for external synchronization.

The Band Width Control (R3) has a range of 0-30 kc. or 15 kc. on either side of the mean frequency and thus will establish a channel width equal to the characteristics of the circuit under alignment.

Thus far we have established the balance of the frequency modulator, and have interpreted its circuit and action in conjunction with the oscilloscope and the channel width control.

CALIBRATION METHOD

The calibration of the two generators can be carried out by employing the following methods.

(1) The two oscillators can be calibrated separately. That is, the fixed R.F. Oscillator is calibrated at 900 kc. and the variable R.F. Oscillator bands are calibrated at their original fundamental frequencies, then the two R.F. currents are added or subtracted to form the heterodyne frequency.

(2) The output heterodyne R.F. current of the two oscillators may be calibrated.

Whichever method is chosen does not alter the calibration results once the constructor has mastered the general principle.

Couple the signal generator (Super-Geno) to the T.R.F. receiver and set the tuning condenser at maximum capacity. Set the R.F. Band Selector at Band 1, Modulation Selector at Frequency Mod., Channel Width Control advanced to match the channel width of the receiver.

Special oscilloscope settings are now made. The Synchronization Control is set at Ext. The synchronizing pulse for the double image is available from the signal generator when switch Sw.2, mechanically-coupled to the Channel Width Control (R3), is set at Int.

The calibration of either the fixed-frequency oscillator or the heterodyne-frequency oscillator is conducted at frequency modulation as this results in a better indication of resonance. When changing from frequency modulation to amplitude modulation there is a frequency discrepancy which is corrected with an air trimmer, condenser C19; this correction should be done when establishing the lowest frequency and before calibration is begun. The heterodyne frequency can be beat against or compared with a known frequency. A reliable source is the frequency of broadcast stations of the broadcast band or a frequency standard oscillator.

Table IV constitutes a comprehensive tabulation of fundamental and harmonic frequencies. While the chart has been computed for a fundamental-frequency range of 550-1,500 kc., any one frequency can be the fundamental or harmonic. For example, with 100 kc. as the fundamental the 6th harmonic will be 600 kc., and if 600 kc. is the fundamental, the 6th harmonic will be 3,600 kc., etc.

CALIBRATION PROCEDURE

The procedure in calibrating the signal generator is simple. Set the tuning condenser at its maximum capacity to

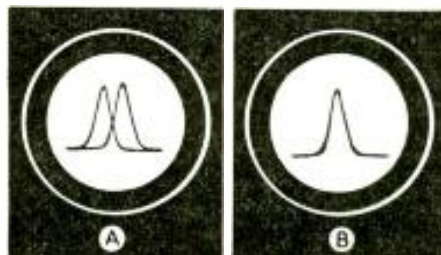

Fig. 9. A—the 2 traces indicate a detuned circuit; B—resonance peak when the curves or peaks are brought together.

generate the lowest frequency of Band 1. This should have a frequency of 85 kc., of which the 8th harmonic is 680 kc. The next step is to establish the higher-frequency-end of the band; at 325 kc. the 2nd-harmonic is 650 kc. To establish the two ends of each band a compensating air trimmer is provided for each band.

To calibrate the band after correction, set the variable oscillator condenser at maximum; zero-beat the heterodyne output frequency with a broadcast station carrier of 680 kc.; vary the receiver dial until it indicates 765 kc., zero-beat or beat with WJZ. The output frequency will then be 85 kc. (rather, the output frequency is equal to the amount of frequency between two points of resonance). A simplified calibration

(Continued on page 554)



Fig. 7. Time indication of 2 tracers.

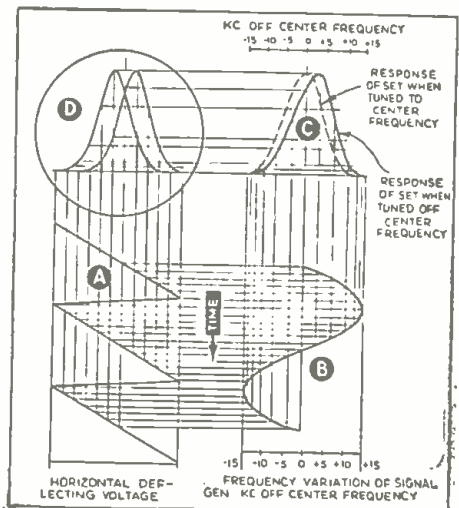

Fig. 8. Two resonance curves appear on the screen of the oscilloscope and these curves are displaced from each other by an amount depending upon the amount that the set is detuned. At A—time sweep H input; B—control sweep voltage.



EMANUEL R. HAAS
Vice-President, N.R.I.

25 Years of Training Men for Radio!

The 912 million dollar Radio Industry that today employs about 345,000 people is generously sprinkled with the graduates, during the last 25 years, of the world's largest Home-Study Radio School.



JAMES E. SMITH
President, N.R.I.

A NATIONALLY- KNOWN school at Washington, D. C., now celebrating its 25th Anniversary Year, is in itself a striking answer to the question of whether radio can be taught by mail.

No business can continually grow and prosper over a period of 25 years unless it does a good job and renders a needed and effective service. No school can long survive which does not teach what it claims it will.

National Radio Institute, the teaching organization referred to above, has grown from a "one man" school, back in 1914, to what is now considered the largest home study



"N.R.I."
A view of the instruction department, with J. A. Dowie, Chief Instructor, and Jos. Kaufman, Director of Education, in foreground. Inset—exterior view of the Washington, D. C., home of National Radio Institute.

Radio school in the world. It has progressed from one small class room, to a modern 3-story building in which a staff of over 100 trained people serve its students.

The school has many letters on file which prove that literally hundreds of successful, satisfied graduates are located all over the U. S. and in most foreign countries over the world.

How does this school teach by mail? Why

does it believe it can do a good job by the home study method of training?

(Continued on page 553)

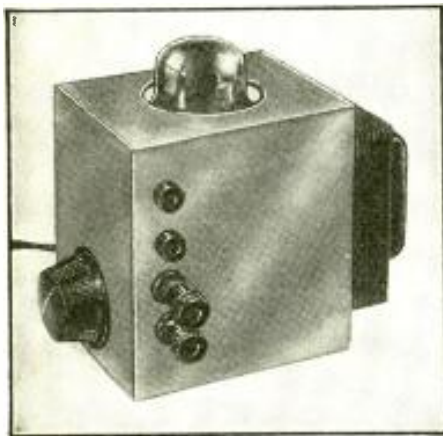

The Meter-Range Extender.

How to Make a METER-RANGE EXTENDER

Radio men! Here's a simple device, costing less than \$3 to build, that enables you to measure up to 10 megohms with a low-priced ohmmeter.

A SINGLE inexpensive tube, a half-dozen parts, and you are ready to accurately measure resistors up to 10 megohms with your present 0 to 0.1-meg. ohmmeter. This unit may be used with any meter having a fundamental movement of 1 ma., a reversed resistance scale, and ordinarily used with a 4.5 volt battery.

If your analyzer uses this type of meter or if you have a similar meter, this 110 volt A.C. power-operated Range-Extender will permit you to measure resistors up to 10 megohms. You will no longer be forced to guess the value of high-resistance resistors, or be inconvenienced by the logarithmic crowding of values at the upper end of the scale.

A 4-tube midget transformer supplies the needed plate voltage and 5 volt filament power to a type '01 tube. Of the number of triode tubes tried, this old stand-by of battery-set days proved best. About 450 volts must be obtained and in this connection the input con-

M. N. BEITMAN

denser size and position grid potential have a direct control. If a 0.1-mf. 600-volt condenser is used, about 450 volts will be obtained with the potentiometer setting at center. The output voltage may be varied 30 volts plus and minus with the setting of the 10,000 ohm potentiometer. In this manner zero adjustment can be obtained.

Since the center scale resistance reading is equal to the series resistor value, a 0.45-meg., 5% precision resistor is used. A 0-1 ma. meter and test prods are connected as indicated. Short the prods and adjust for zero. Then you are ready to measure high values of resistance. If your scale reads 0.1-meg. full-scale, multiply the readings by 100 when using the extender.

Every Serviceman, experimenter, and amateur will find this Range Extender a valuable aid in obtaining accurate results when working with modern circuits. A complete kit of parts including a punched chassis is available from a

(Continued on page 565)

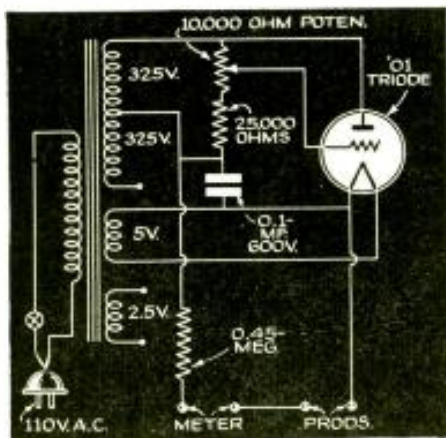

Circuit of Meter-Range Extender.

OSCILLATOR DOESN'T PERK

(114) Milton Lau, Winamac, Indiana.

(Q.) My radio problem involves a Zenith 4V31. Checking this set I find the oscillator section does not work over the broadcast band. At times it will work only from 900 kc. down to 1,500 kc.

I have changed complete oscillator coil assembly, checked condensers, changed tubes and retuned set. Parts list shows the cathode resistor value as 8,000 ohms. The new coil assembly is 9,000 ohms. The only way I can make it work is by shunting 10,000 ohms across this 8,000 ohms. This also increases volume on original set.

Can you please tell me what is the cause; and any suggestions you may have concerning this set.

(A.) The usual procedure when a receiver employing a composite detector oscillator tube does not perform at the low-frequency end of the broadcast band, is to increase the plate current of this tube. The easiest method of accomplishing this is to lower the value of the cathode resistor. By shunting this cathode resistor in your Zenith 4V31, you have done just this. We suggest that the 9,000-ohm resistor be replaced with a 5,000-ohm unit.

VOLUME DROPS TO ONE-HALF

(115) Walter Kath, Hankinson, N. Dak.

(Q.) I have a Philco 37-61 for repair in which the volume drops to about half when the hand is placed near the 6K7 I.F. tube or when the oscillator grid of the 6A8 or associated wires is touched with a metal screwdriver. It can be brought up to full volume for about 5 minutes after it is turned on by touching the 6A8 grid cap but after that it cannot be brought back unless the set is turned off for a while and then turned on. The oscillator grid voltage is about -15 volts when first turned on but gradually goes down to -10 volts and then the set can be made to drop in volume. All coils, I.F.'s, etc., test OK either cold or warmed up. Have had several Philcos do this. Please send information.

(A.) To clear the difficulty experienced with your Philco 37-61 receiver, we suggest replacement of the 0.05-mf. grid filter condenser for the 6A8G tube. This condenser is located directly behind the waveband switch. In some cases, a like condition has been eliminated by replacement of the 0.1-mf. screen-grid bypass condenser, and the addition of a 0.1-mf. unit from the screen-grid terminal of the output tube to chassis.

LACKS VOLUME

(116) Henry Lew, Alameda, Calif.

(Q.) Am servicing an old Majestic Model 90 radio set and wish to get all data about it.

Could you tell me why this set dropped its volume to a mere whisper after I replaced the burned-out filter condensers with new ones? It played very loud (without an antenna, too) and clear for about 15 minutes, then suddenly went "dead." I tested the input and output transformers and they seem to be OK. The tubes are OK, too.

It seems the one who serviced this set before, rearranged the connections for the speaker field supply.

(A.) In the Majestic model 90 receiver, either a choke or 25,000-ohm resistance is enclosed within the condenser block to secure voltage for the detector plate.

Since you state that you replaced defec-

tive filter condensers with new ones, it would seem that original leads were removed from the condenser block and new filters installed externally. This would render the choke or resistor within the block valueless and no plate voltage upon the detector would result. We suggest you check detector plate voltage.

BLOWS POWER TUBE REGULARLY

(117) E. J. Ackerman, Millvale, Pa.

(Q.) I have a Sparton 610 receiver which has developed an odd condition and would appreciate your comments on the trouble.

This receiver blows one of the type 183 power tubes after a month of operation; other than this the set is apparently OK with the exception of a slight hum.

After checking everything seems to be OK with the exception of the electrolytic condenser which I have replaced. Would a breakdown of this condenser cause this con-

SERVICING QUESTIONS & ANSWERS

Servicemen may write, requesting answers to specific service questions. Address inquiries to Service Editor. For questions answered by mail, a service fee of 25c per question is made. Only questions of wide interest can be published.

dition? I figured the 80 would let go first if the condenser was shorted rather than the 183.

I checked for shorts to filament but didn't find any.

Apparently there is some intermittent condition causing the filament to blow; can you advise where the trouble might be?

Voltage and currents are OK; of course, they may not be when the tube blows but it takes so long for this to happen that I can not get it in that state. The funny thing about the whole thing is after the tube blows, when if you immediately replace it with another, the set will operate for 3 or 4 weeks again before it will again blow the tube.

I have replaced the condenser but am afraid to put in another tube and let it go for awhile for fear that this is not causing the trouble and the same thing will occur again.

P.S. The filter condenser that was removed was not shorted when taken out.

(A.) In your inquiry concerning frequent "blow-out" of type 183 tubes, you do not state whether those placed in a particular socket are the "victims". However, trouble on this score is not an uncommon complaint. The usual cause for the condition is excessive plate current. This may be due to excessive filament voltage or an open-circuited 15,000-ohm bleeder resistor in the power unit.

We suggest that you check the above-mentioned resistor and the filament voltage on the type 183 tubes. Should this voltage be greatly in excess of 5 V., small resistors of like value may be installed in each filament leg so that the "center-tap" of the filament winding is not disturbed. Resistors of $\frac{1}{4}$ - or $\frac{1}{2}$ -ohm should do the trick. Some technicians accomplish the result by using the 130-V. tap on the power transformer, although this lowers gain to some extent.

SET "DEAD"

(118) G. A. Younghein, Mitchell, Nebr.

(Q.) The set is a Crosley model 435, 4-tube, 6-volt type. The 6A7 is the first tube in the set and is undoubtedly the oscillator and 1st-detector. I believe the trouble lies in this stage; no click or sound can be heard when the grid cap is touched with an antenna. I have tried a new 6A7 with no success.

There is no voltage across the oscillator section of the gang condenser. The voltages are normal throughout the set and the 6-volt battery is kept fully charged at all times. The next tubes are: type 15 I.F. amplifier; 15 2nd-detector; and, 38 audio amplifier. The I.F. signal goes through (450 kc.) when the signal is applied to the grid of the I.F. amplifier (15) but not with normal volume since the 1st-detector is not operating and the 1st I.F. transformer is not used.

I have tested all resistors and the condensers for open or shorts but yet there is something wrong some place which I have not found or have overlooked.

(A.) Since you state that all voltages at tube elements are normal, but that an I.F. signal cannot be fed through from the control grid of the 6A7, it would seem that the trouble would lie with the primary of the 1st I.F. transformer. Check the D.C. resistance of this primary against that of the 2nd I.F. transformer primary. Possibly, the trimmer across the 1st I.F. primary is shorted, or the D.C. resistance of the primary has increased greatly.

WANTS TO ADD A.V.C.

(119) A. H. Froelich, Evansville, Indiana.

(Q.) Having been called to repair a Stewart-Warner Model 102A, and after satisfactorily completing the job, the customer brought up the subject of an Automatic Volume Control.

The question is: Is it possible to incorporate automatic volume control in the above circuit? If so, kindly give me full particulars.

(A.) It is possible to add A.V.C. to the Stewart-Warner model 102B receiver, but this involves a number of changes. In the first place, a type 2A6 tube would replace the 24A 2nd-detector, and serve as a diode detector and 1st audio stage. The volume control would have to be replaced and connected into the diode-return circuit. At least 4 carbon resistors, 2 mica condensers and 4 0.05- to 0.1-mf. condensers would be required, as well as circuit changes. With this, a certain amount of "juggling" would be necessary to obtain proper performance. We advise against the change.

SET "DEAD"—HUM

(120) Edwin Raulerson, Jr., Avon Park, Fla.

(Q.) The radio is a 5-tube Crosley, Model 167. Set seems to be dead. The grid wires of the output tube (type 42) become greenish-white when the set is turned on. The set has a strong hum and this disappears when the output tube is removed. Tubes, speaker, coils seem to test all right. A new filter condenser has been installed. A few days ago the grid in the output tube turned "cherry" red when the set was turned on but since I tightened the connections to the tube base this has stopped and now the greenish-white color is present. I have looked for shorts but seem unable to find any.

(Continued on page 570)

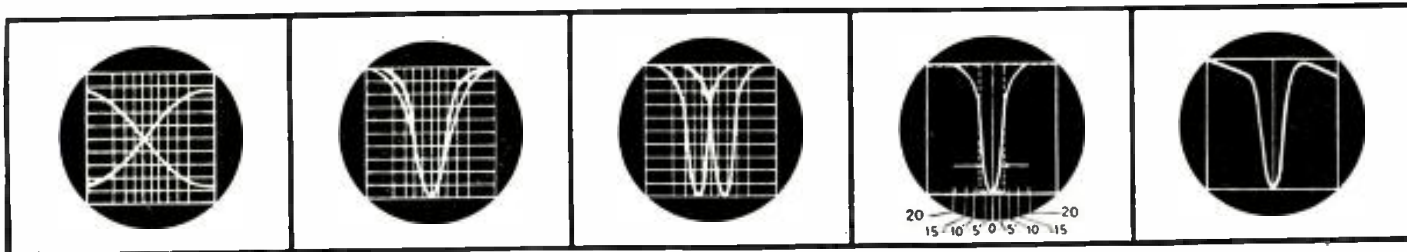

Fig. 4A. Setting the sweep rate for selectivity patterns. Fig. 4J. I.F. aligned to frequency, but selectivity curve not symmetrical. Fig. 4K. I.F. aligned to wrong frequency. Fig. 4L. The actual I.F. curve as compared with a perfect (dotted) curve. Fig. 4M. Tilted feet on curve due to overloading. Reduce input to receiver.

COMPLETE STEP-BY-STEP

What is Dynamic Servicing?—See how many of your associates in the service field increase your earning power by speeding your radio service work. This, Part III, con-

PART III

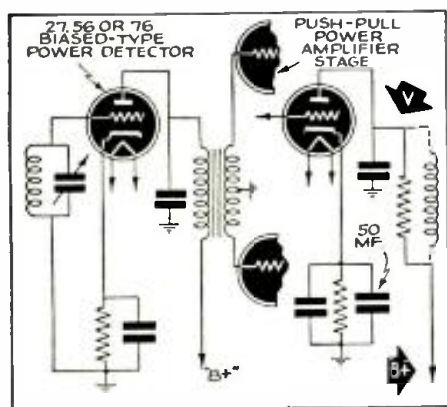

Fig. 4E. Disconnect A.F. transformer as shown at right. Connect 50,000 ohm resistor from "V" to "B+"; connect 50 mf. low-voltage electrolytic condenser across bias resistor. Connect vertical amp. terminals from "V" to ground.

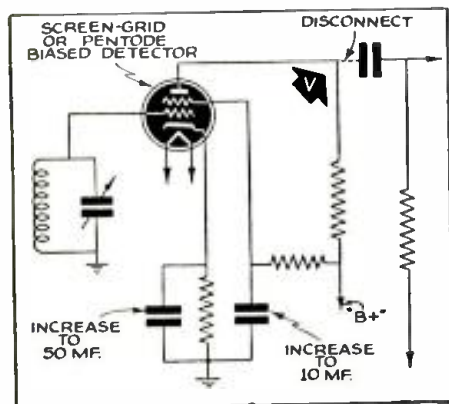

Fig. 4F. Connect vertical amp. terminals from "V" to ground.

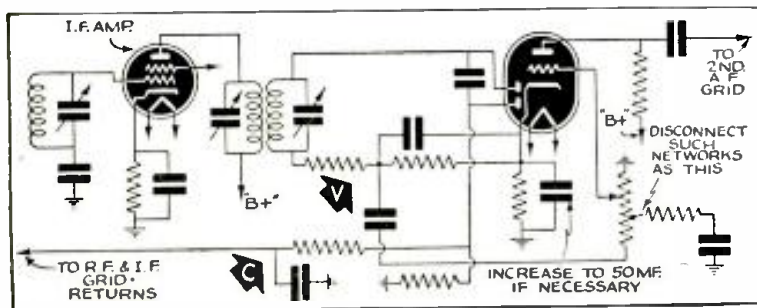

Fig. 4B. Connect vertical amp. from "V" to ground. To interrupt A.V.C., connect temporary shorting wire from "C" to ground (chassis).

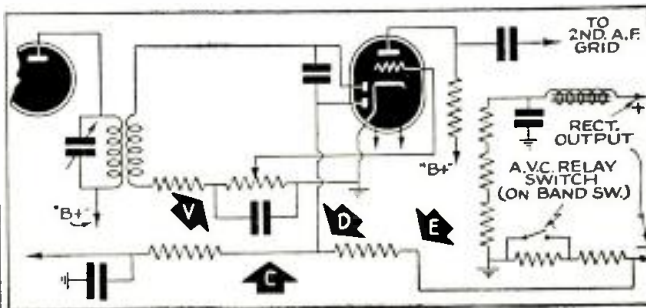

Fig. 4C. Connect vertical amp. terminals from "V" to ground. To interrupt A.V.C., unsolder "C" from "D" and reconnect at "E."

AS we promised last month in Part II, the following portion, Part III, of this article discusses Receiver Alignment Procedure. Part I (Jan. issue) outlined the entire series, as illustrated in a large block diagram—available in wall size—of a typical modern radio receiver showing, step-by-step, the broad, "14-point" plan of dynamic testing with a modern cathode-ray oscilloscope.

Section IV RECEIVER ALIGNMENT PROCEDURE

This is one of the most important applications of the Cathode-Ray Oscilloscope, and is a must operation in the servicing of high-fidelity and other broad-band receivers.

CONNECTING THE INSTRUMENTS

Connect any high-grade Test Oscillator, Signal Generator or Microvolter capable of turning out 1/10-volt or more to the posts of the oscilloscope marked "R.F. IN." Use the regular output lead of the generator and connect the shield of the lead to the lower post. Any modulation in the generator should be turned off. Have on hand shielded leads for connecting the output of the receiver to the VERT. posts of the oscilloscope per instructions to follow.

SETTING THE OSCILLOSCOPE CONTROLS

Place the scale with the non-uniform graduations over the screen of the tube. Turn the SWEEP control to LINEAR.

Turn the CONTROL knob to FREQ. Set the FREQUENCY knob to 55-190 and the SYNC. knob to zero.

The sweep frequency should be adjusted to 120 sweeps per second, using the VERNIER knob. This sweep rate can easily be

identified by connecting the VERT. binding post to a source of 60 cycle voltage and adjusting the VERNIER until the pattern of Fig. 4A is obtained. The sweep circuit should then be locked by advancing the SYNC. control just enough to hold the pattern stationary.

Now, remove the 60-cycle connection to the VERT. binding post and adjust the HORIZONTAL and LEFT-RIGHT controls until the Horizontal trace just fills the screen from 25 to 25 on the scale.

CONNECTING THE VERTICAL CIRCUIT TO THE RADIO RECEIVER

Connection must be made in such a manner that the phase of the rectified voltage will not be disturbed and thereby distort the selectivity picture.

In general, this calls for the increase of certain bypass condensers in some types of circuits, and the elimination of some parts from other types of circuits. The diagrams of Figs. 4B, C, D, E, F and G together with the captions accompanying show the necessary precaution for practically all types of output circuits in common use.

In each case the "high" side of the VERTICAL amplifier (binding post marked VERT.) is connected to the point marked "V" in the circuit diagrams, while the GND. side is connected to the receiver chassis.

Exception. When testing universal A.C.-D.C. receivers, connect the GND. side to the chassis through a 2 mf. paper condenser. This will safeguard both the equipment and the chassis in the event that the latter is above ground potential.

A.F.C. AND A.V.C. CIRCUITS

The A.F.C. circuit should always be shorted out as indicated in Fig. 4C. Most



Fig. 4N. Flat-topping due to overloading. Reduce input to receiver. Fig. 4P. Phase distortion in the output circuit. Fig. 4Q. Showing width of the I.F. channel. Fig. 4R. Pattern showing interference being received. Fig. 4S. Uneven curves caused by regeneration.

DYNAMIC SERVICING

can answer this question! Then read this article and see how this test procedure continues the description of how to set up cathode-ray test equipment for Dynamic analysis.

KENDALL CLOUGH

receivers are equipped with a switch for doing this. (A later section gives instructions for lining up the discriminator circuits after the I.F. circuits have been properly aligned.)

Most receivers have circuit constants which will require the shorting of the A.V.C. for best alignment conditions. Indications for doing this on various types of A.V.C. arrangements are also shown in Figs. 4B, C, D, E, F and G. The point is this—short the A.V.C. in such manner that the normal bias on the I.F. tubes is not lost.

If the receiver has a high-fidelity or broad-tuning switch, always throw this to the sharp-tuning position.

SETTING THE GENERATOR TO THE DESIRED TEST FREQUENCY

For any desired test frequency up to 1,000 kc., subtract the desired frequency from 1,650 kc. and set the Test Generator to the difference. Example: Desired frequency 225 kc.; $1,650 - 225 = 1,425$, which is the correct setting of the Test Generator.

For any desired frequency above 1,000 kc. add the desired frequency to 1,650 kc. and set the Test Generator to the sum.

For your convenience a list of the commonly used frequencies and the correct settings of the Signal Generator are listed in Table I.

ALIGNING

Turn the SWEEP WIDTH control to 50, the R.F. MULTIPLIER to 100, and advance the VERTICAL amplifier control to about 50.

If the receiver is badly out of line, connect the output lead to the control-grid of the I.F. tube just preceding the 2nd-detector, and bring the last I.F. trans-

former into line first. Repeat with the second preceding transformer, etc.

In all cases, the final alignment should be made with the output lead connected to the control-grid of the 1st-detector, using a $\frac{1}{4}$ -meg. resistor and 0.001-mf. condenser, as shown in Fig. 4H.

All the trimmers of the I.F. circuit should be adjusted to bring the height of the selectivity pattern to maximum and at the same time make the peaks of the 2 curves coincide.

If the peaks are in line but the "skirts" are not coincidental, it means that the I.F. system is aligned to the correct frequency, but the selectivity curve is not symmetrical. See Fig. 4J.

(Continued on page 566)

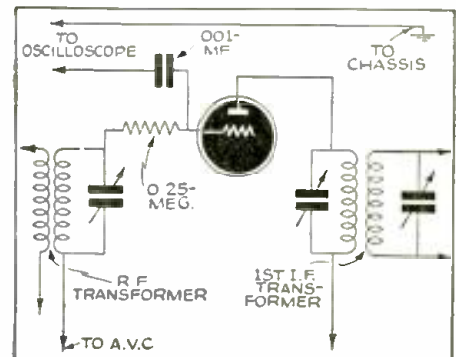

Fig. 4H. Connections for making final adjustments with oscilloscope.

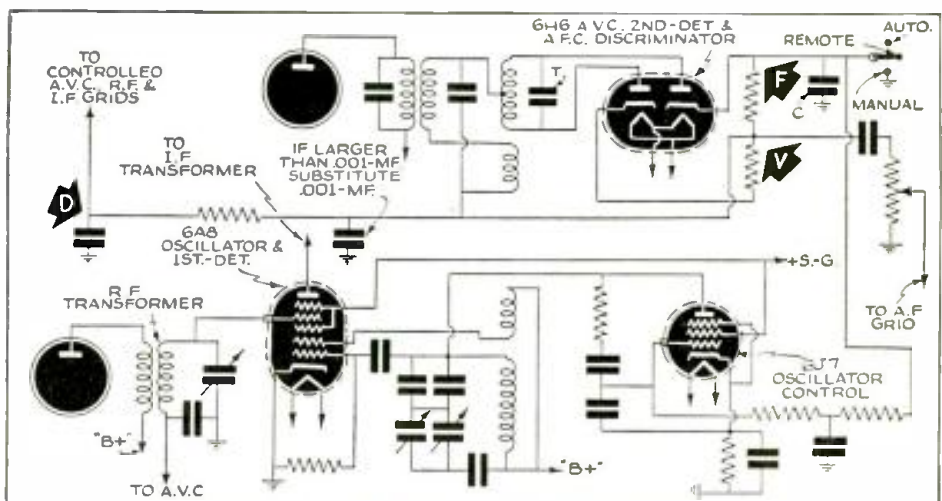

Fig. 4G. To interrupt A.V.C.—connect temporary shorting wire from "D" to ground. To interrupt A.F.C.—connect temporary shorting wire from "F" to ground where no switch is provided, or place A.F.C. switch in manual position. Connect vertical amp. terminals from "V" to ground.

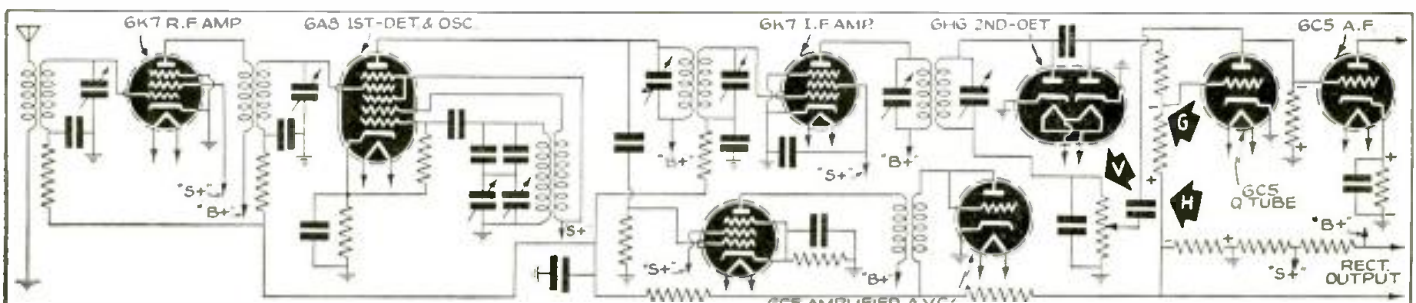

Fig. 4D. Connect vertical amp. terminals from "V" to ground. To interrupt A.V.C.—remove 6C5 A.V.C. tube. To interrupt Q action—open Q switch; or, if there is no Q switch, connect shorting wire from "G" to "H."

WIRING POINTERS FOR

It's no trick at all to wire-up radio sets, says this Californian put tracing paper over the main diagram you want to wire

BEGINNERS in radio sometimes are at a loss as to just where to start when building a receiver. The following is the outline of an orderly procedure that will hasten the completion of the job and lower the chances of mistakes.

The first consideration is the placement of parts. Generally the R.F. section occupies one side of the chassis, the tuning condenser the front center and the A.F. and power supply take the other side and rear of the chassis, but this is no fast rule. The things to strive for are short leads especially in the R.F. section, and the prevention of the magnetic fields of coils and transformers from coupling together. Shielding of coils allows them to be placed up-right next to each other but otherwise

**WILLIAM
BOYDSTON
MILLER**

they should be at right-angles to each other. Tube shields (not used on the metal tubes), can be close-fitting, provided ventilation is allowed for, but shields for coils must have a diameter twice that of the coil; a coil shield that is too close-fitting will absorb too much energy. When the main parts (tuning condenser, coils, tube sockets, transformers, and large filter condensers) have been positioned and fastened the wiring is the next thing.

CIRCUIT BREAKDOWNS

It is a great help to quick accurate

wiring if the circuit diagram is broken down into its main divisions such as plate, grid and power supply circuits. An easy way to do this is to place a piece of tracing paper over the diagram and trace off the plate circuits, shift the paper and trace the grid leads, et cetera, the drawings will make the procedure clear. With this method even the most complicated diagrams can be simplified so that the actual wiring is rapidly done by completing all the plate circuits, then all the grid circuits, etc. A representative circuit—a 7-tube super-het. with push-pull output—is shown in Fig. 1.

COLOR CODING

Using colored wire is a great help when it comes to checking the finished job and also allows the builder to keep the grid leads isolated, as a glance at the color identifies the circuit. Red is a good color for the high-voltage leads including the plates, blue for screen-grids, green for control-grids, black for returns or ground connections and yellow may be used for any special circuits such as A.V.C. Filament or heater wires are twisted so no special color is needed for identification.

A word about ground (chassis) connections (shown as heavy lines in Fig. 1): always take the shortest route, do not use long wires connecting various grounds together. It is good practice, if a low-range ohmmeter is available, to test all soldered joints to make sure that they have no appreciable resistance.

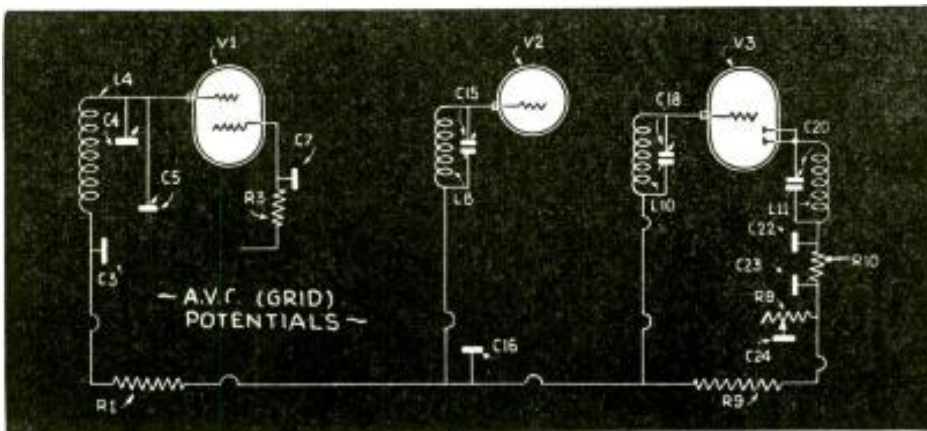

Fig. 2

See how the control-grid wiring is located. Copy onto tracing paper and place over Fig. 1.

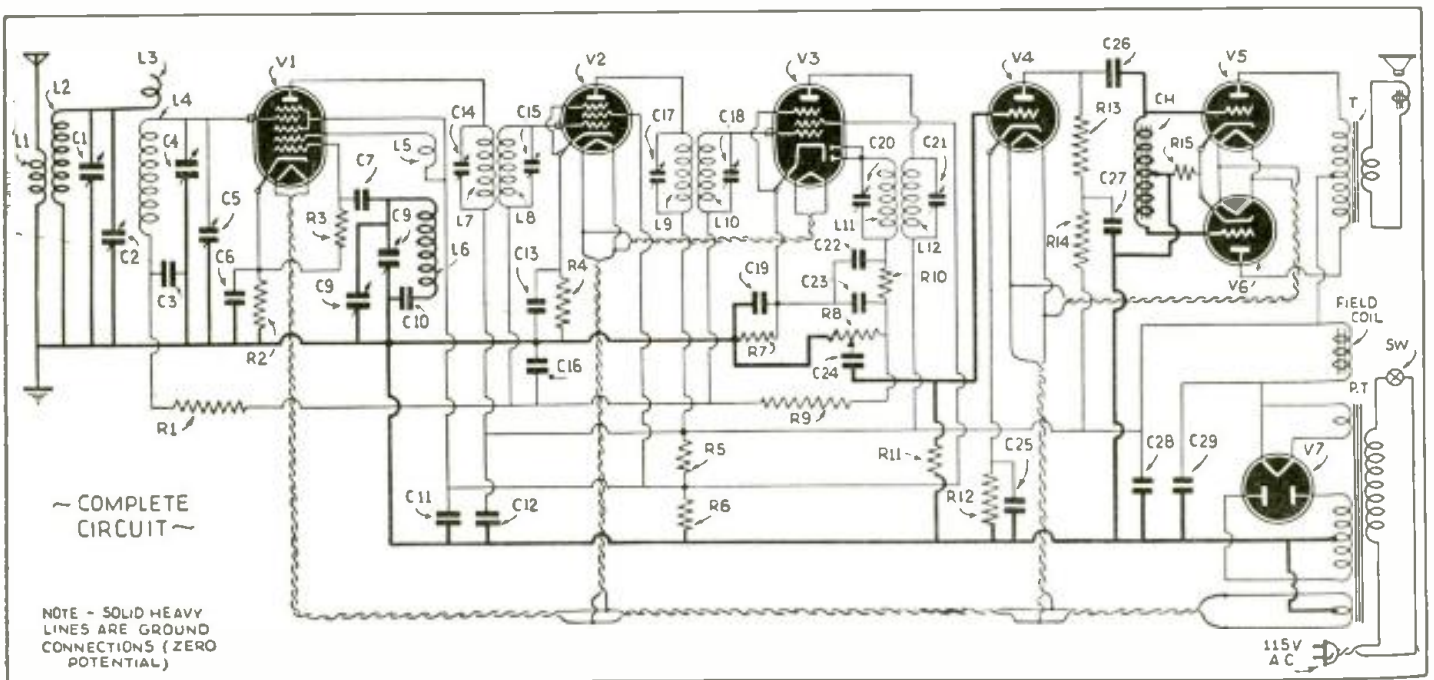

Fig. 1

This is an example of the main diagram which a radio beginner may want to follow in wiring-up a set, circuit-by-circuit.

THE RADIO BEGINNER

radio technician, if you know how. And here's "how":—just into your unit, and trace-out and wire-up the circuit piecemeal.

WIRING SEQUENCE

Heaters—It is often an advantage to wire-in the heaters (twisted leads, in Fig. 1) first as this will establish a reference point for the locating of the other tube socket connections.

Control-grids—The control-grid circuits (Fig. 2) should be the next to be completed making all leads as short as possible.

Plates and Screen-grids — The plates (Fig. 3) and screen-grids (Fig. 4) can now be wired-in, avoiding the control-grid wires; under no conditions should the plate or screen-grid wires run parallel to the control-grid wires. Where there is little room or it is impossible because of the placement of parts to avoid running these wires together, by all means shield the control-grid wire and ground the shield.

Bypass Condensers—With the control-grid circuits (including coils), the plate, screen-grid and heater wiring in, the next step is to install the various bypass condensers, in the cases where these have not been an actual part of one of the other circuits.

Power Supply — The power supply comes next. In wiring the power circuits (all high-voltage leads—plate, screen-grid, rectifier) use a larger wire than for control-grid wiring and one with heavier insulation. Anchor the wires and keep them away from any rough edges or points as the vibration of the speaker may cause them to rub and in time destroy the insulation. Where a wire comes up from below the

chassis through a hole there should be a rubber grommet installed first.

By following this method of dividing up the wiring into its logical parts of plate, screen-grid, control-grid and power supply, a rapid job may be done. It is much easier to check as you go along, too, especially if colored wires are used.

CONCLUSION

The main diagram, Fig. 1, does not include the electrical values of the components inasmuch as this diagram was selected merely as the basis for a discussion of circuit wiring.

See for yourself how really easy it is to duplicate even the most intricate portions of this diagram. Instead of tracing on tissue a portion of the diagram, Fig. 1, as suggested by Mr. Miller, try reversing the procedure. As suggested in the caption under Fig. 2, take such portions of the diagram as have been reproduced in Figs. 2, 3 and 4, and see how these "breakdowns," after being copied onto tracing paper, fit right in place on the main diagram!

This general procedure often makes it possible for the Serviceman to reconstruct and analyze an otherwise unavailable diagram of a faulty receiver.

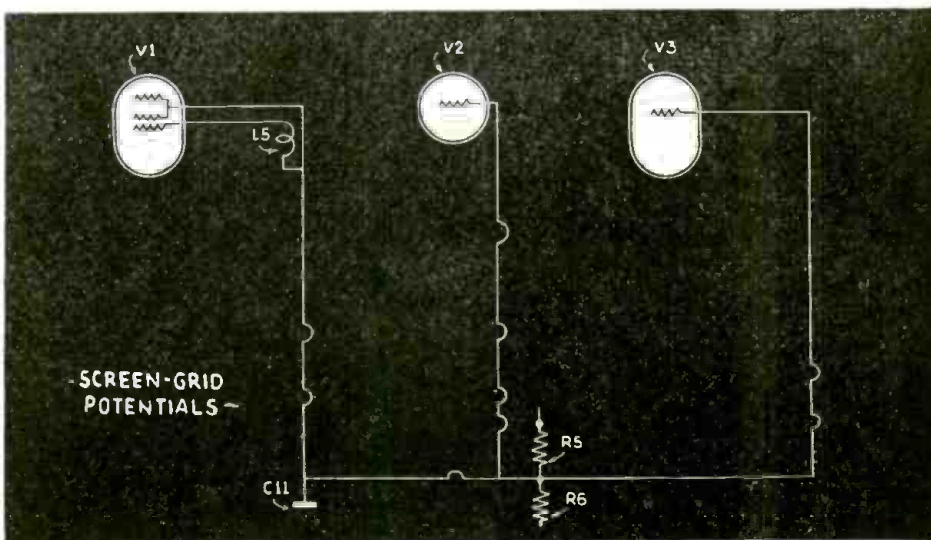

Fig. 4

The screen-grids are wired in accordance with this simple diagram. Easy, isn't it?

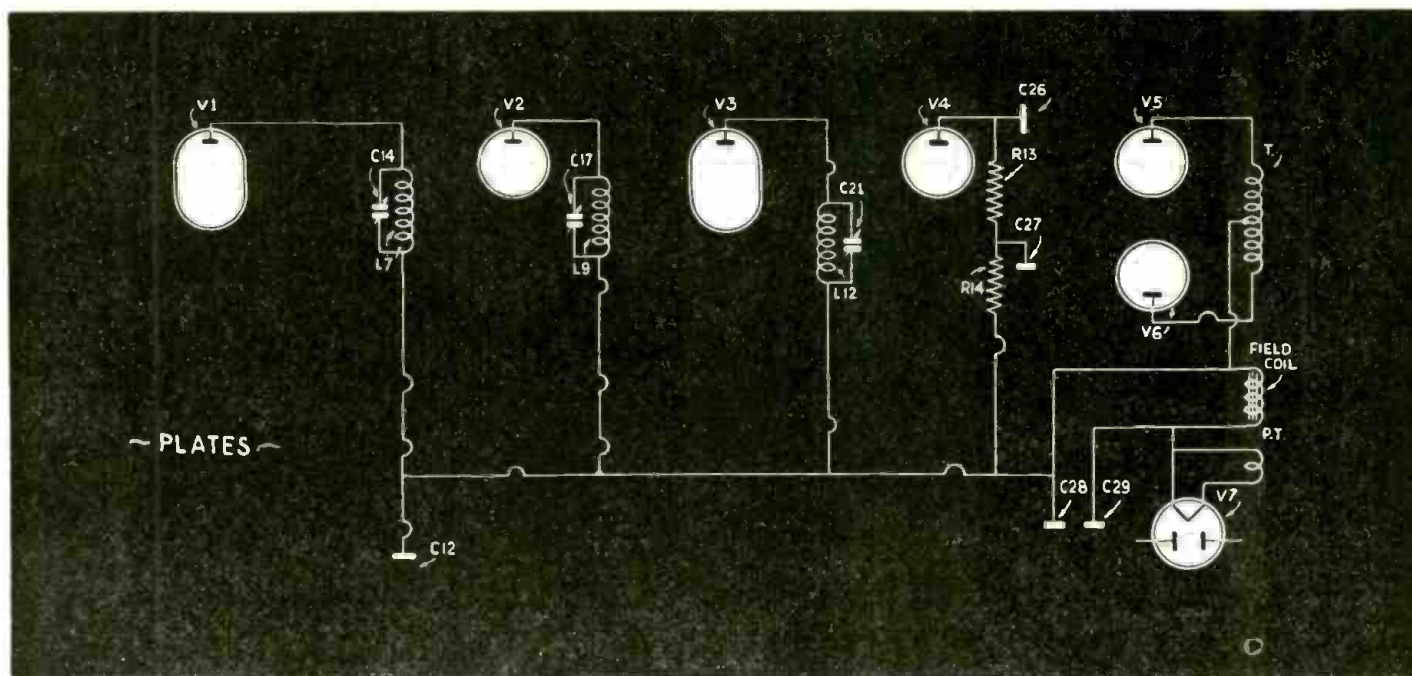

Fig. 3

The plate circuits fail to scare the radio beginner when they are lifted clear of the main diagram in this simple fashion.

THE LATEST RADIO EQUIPMENT

The address of any mentioned manufacturer will be sent on receipt of a self-addressed, stamped envelope. Mention of item number hastens reply.



Top, "5-in." cathode-ray television kit; Below, rear view, new television kit. (1724)

TELEVISION KIT (1724) (Andrea Radio Corp.)

A NEW kit for the set builder who wants to have his own television receiver at minimum cost is now available. Less tubes, the entire kit for building up a table-model television receiver without cabinet may be obtained for under \$80! The cost of the complete set of tubes is a little over \$50 (at present list prices). The kit has been made available by the manufacturer, he states, "first because we feel that many among the initial television audience will be those who made up the old group of set builders and experimenters in the early days of broadcasting."

TRANSCRIPTION RECORD PLAYER (1725) (The Radolek Company)

HERE is a complete, self-contained and portable phonograph music reproducer for playing 10- or 12-in., 78 r.p.m. phonograph records.

Classrooms, advertising agencies, social clubs, fraternities, summer camps, churches, homes, dining rooms, small taverns, and demonstrators are just a few of the many prospects for an outfit of this type.

Incorporates high fidelity, high-quality equipment: crystal pickup with catch holder; self-starting constant-speed phono motor; full 3-W. power amplifier using types 6C5, 6F6 and 80 tubes; 6-in. electrodynamic speaker at front for proper sound distribution; volume control; tone control and on-off switch with indicating plates; needle cup and a complete set of tubes. All housed in a sturdy brown leatherette covered case with corner guards, carrying handle and hinged cover. Size, 14x13x10 ins.

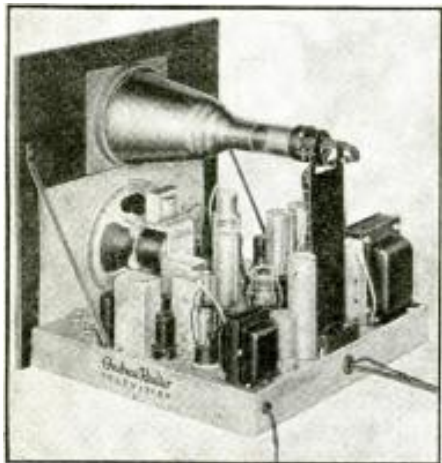

Transcription record player. (1725)

NEW SOUND EQUIPMENT LINE (1726)

(Allied Radio Corp.)

COMPLETELY new in basic design, operating features, and styling, the new 1939 Knight line of public address equipment offers an exceptionally versatile range of Sound Units from 8 to 65 watts, including all types of accessories (blank discs, record players, loudspeakers, microphones, etc.).

Typical of this new line is the *Knight* Deluxe 18-watt (undistorted output) system illustrated. Features include: 4 microphone channels, A.V.C., automatic volume expansion, 2 phono inputs, inverse feedback, tone compensation, speaker selector, master control, and volume level meter.



An 18-W. P.A. system. (1726)

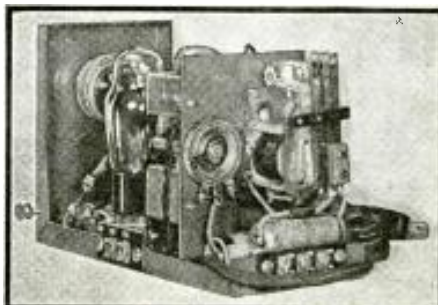

Diversity coupler kit. (1727)

This system is especially suitable for auditorium, recording studio, and orchestral purposes—wherever high quality reproduction is required

DIVERSITY COUPLER KIT (1727) (Edwin I. Guthman & Co., Inc.)

THE diversity coupler can now be bought not only completely assembled, wired and tested, but also as a complete kit of specified parts for easy assembly using only a soldering iron, screwdriver and pliers, or its parts may be bought separately to enable use of any that may now be on hand. (See diagram at end of department.)

The diversity coupler is fundamentally a very sensitive single-pole, double-throw switch. Connected to the A.V.C. load resistor of any good communications or broadcast receiver, it causes the A.V.C. voltage which varies in sympathy with received signal strength to, when the signal fades downward, automatically disconnect the antenna and instantaneously connect in its place a second antenna in which the same signal is fading upward. Operation is just as simple as this explanation, and because the signal which is fading down in a horizontal antenna is at the same instant fading up in a vertical antenna, it is the means of eliminating fading and its accompanying noise interference.

POWER SUPPLY UNIT (1728) (Electro Products Laboratories)

DESIGNATED by the manufacturer as an "A"- "B" battery eliminator the device illustrated here is the first of the sort. This battery eliminator operates on any 6-V. storage battery, windcharger, or other power source. It provides 1½- or 2-V. "A" power; and "B" voltages of 45, 67, 90, 135, and 180 V. at 40 milliamperes. Once installed, the only additional cost is for charging the storage battery and, of course, there is no cost if the unit is used with a windcharger. The model J, as it is called, is specifically built for use with farm radio and low power transmitters.

NEW OHMMETER IS ISOLATED FROM LINE! (1729)

(Weston Electrical Instrument Corp.)

AMONG a series of instruments recently introduced by Weston is an A.C.-operated multi-range ohmmeter having ranges from

(Continued on page 571)



Six-volt power supply unit. (1728)

All the worthwhile
Radio Trade News
of the past Month—
Digested for busy
radio men.

RADIO Grade Digest

A PLEDGE: — To
print the important
news of the radio
industry; to review
major news events;
to help point a path
to radio profits.

IMPORTANT HAPPENINGS OF THE MONTH IN THE RADIO INDUSTRY

No. 7

MARCH, 1939

No. 7

EXPORT BIZ MAY BOOM AS BRITISH POOL DIES

*But Individual Patent Holders
Will Prosecute Infringement
On Own Authority*

The British patent pool has disintegrated, at least temporarily, but the rights to stop American importation still exist through the holders of the original patents who were in the British pool and whose patents have now reverted to the individual companies. The Attaché at London reports in part:

"Where there is at present no pool, a risk continues in this market for the import of American radio receivers and radio-phonographs. Individual manufacturers might press infringement cases even more vigorously than has been the case with the pool. Heretofore, the pool has directed its patent violation activities against important firms or companies with substantial capital and trade position. The major proportion of imports is confined to midget sets. Imports of automobile sets are increasing."

Mailed It Yet?

If you haven't filled out the tax questionnaire sent you by Dun & Bradstreet, do so at once. Something's wrong with business. Maybe it's taxes; maybe not. Anyway, this report will help U.S. find out. Cooperate!

Fix Date for Parts Show

*Annual Exhibit of Components
To Be Held in Chicago
From June 14 to 17*

The Board of Directors of Radio Parts Mfrs. Natl. Trade Show, Inc., voted that the 1939 Natl. Radio Parts Trade Show should be held at the Stevens Hotel in Chi. from June 14 to 17 inclusive.

The first two days of the Show, June 14 and 15, will be "Jobber Days", during which time only jobbers, manufacturers, manufacturers' agents, and manufacturers' engineers are admitted to the Exhibition Hall.

On June 16 and 17 the Show is to be opened to all groups in the radio trade with especial emphasis on manning booths with technically-trained attendants.

ANDREA IN TELEVISION WITH KITS AND SETS

*Radio Pioneer Announces
Sales Plans for
Vision Field*

Within a few weeks after this hits the stands, FADAndrea will be a pioneer in telly, as he was in radio. Old Timers will remember his "160" kit—the components for a beaut of a neut (-rodyne), some 10-15 yrs. ago.

The neut kit was a winner. Basis of Andrea's new line will also be a kit—a 16 tube sight & sound job, selling for a little over \$100 with tubes; about \$75 without.

Dealers who order 6 kits will get one factory-assembled, for use as demonstrator. They will be expected to handle own consumer-instruction & service bugs, & build 1 job from ground up!

Andrea will also produce console & table models, completely assembled, for those who don't want to build their own.

Radio Polices Itself

The National Association of Broadcasters has appointed a committee to "recommend procedures leading to self-imposed regulation of American radio and the development of program standards for the broadcasting industry under NAB jurisdiction."

The following broadcasting leaders comprise the committee:

(Continued on page 560)

A PAIR OF HONEYS



Honey Ida Vollmar's picture in ad of Honey RCA 97KG attracted so much attention that she won a radio spot. Specifications:—Blonde, 23 years, 5' 7", 106 lbs.

HOSPITAL HIS SALESROOM



Illness held 21-yr.-old Edward J. Winterding, Jr., of Cleveland, flat on his back in a hospital cot for 18 mos. But it didn't lick him. Ed sold 9 G-E radios to staff & patients; also sold a washer & a refrigerator to a single fellow-sufferer. Did the work hurt him? NO! Ed gained 30 lbs.—& he gained the RTD ANNUAL CITATION for guts, too.

TELLY SETS FOR SPRING



Dr. W. R. G. Baker, chief of G-E's radio & television division management committee, looks pleased with the performance of his dept.'s new model which the co. will offer in limited quantities this Spring. Controls are placed under lid which has inclined mirror for televiewing. (Yes, it's an imitation image we dubbed in for art's sake.—Editor)

PENNIES COUNT UP



Every sale of a phono-radio—every sale of a record—can bring in a few additional pennies, especially if the customer has an automatic record player. New RCA coin phonograph needle decreases noise and wear; increases fidelity & customer satisfaction.

Sales Helps and Deals

A series of 13 talkies, each of 60 feet, has been prepared to plug Philco Mystery Control. The co. has made tie-ups with various producers, so that dealers can arrange for demonstrations in theaters in practically all parts of U.S. Lobby demonstrations & contests are being planned to aid the theater campaign.

Magic Demonstrator kit (\$8) boosts sales of RCA U-125 sets. It is an electrostatically operated relay and auxiliary relays which switch set on when prospect approaches display. Special record on set gives plug. Can also be used to make 40-in. (\$15) dog, Nipper, bark and give sales talk through speaker concealed in throat. Kit can also be used to light show window when shopper approaches, etc. *Picture on page 517. (Continued on page 563)*

Changes & New Addresses

Save stamps & time! Address your mail right the first time!

HUGH H. EBY, INC., has moved factory & offices to 4700 Stenton Ave., Phila., Penna. (See Picture, below.)

TERMINAL RADIO CORP. has opened a new store at 68 W. 45th St., N.Y.C. Stock includes ham communications receivers & complete sound systems.

AEROVOX CORP. has moved plant & offices to New Bedford, Mass. (See Picture, below.)

TWO NATIONAL TELEVISION NETS RUMORED FOR SPRING

Nationwide Coverage Predictions Now Take Local Limitation Off New Art

With some of the most reliable prognosticators going out on the limb with predictions of national networks, the "Big Cities Only" onus is being removed from television.

Danton Walker, a syndicated Broadway columnist, has stated in print that a \$60,000,000 national network is being formed for the broadcast of radio and television programs. Those in the know were inclined to give Mr. W. the horse laugh when his first paragraph on the proposed net mentioned radio only; they wondered that enough big indies were left to form a net of appreciable power or prestige. But when the second item mentioned television, Public Opinion sighed with relief—it looked more probable.

Ed Sullivan, syndicated Hollywood columnist, went still further, stating definitely that NBC would announce that "transcontinental television is an assured engineering accomplishment" before the end of Feb. (Bell Labs., by *Continued on page 560*)

\$'s & N^o.s Dept.

"Figures can't lie—aren't they unfortunate?"—Lao Teng Pui

BIG BIZ is radio. According to an RCA ad, 345,000 workers & their families—a total of 1,380,000 men, women, children—get their living from radio. Break-down shows over 700 stations; over 500 factories. 25,000 work for wholesalers; 56,000 for retailers; 150,000 are in sales & service. 19,000 work for RCA.

JOBS STILL DOWN, according to U. S. Bureau of Labor's latest (Aug.) *(Continued on page 560)*

HIGH TARIFF REDUCES SALES TO NEW ZEALAND

American radio exports to New Zealand have been seriously affected by tariff restrictions, especially the import duty rates, under the New Zealand tariff which became effective October 1, 1938, according to a recent report to the U. S. Bureau of Foreign and Domestic Commerce from the American Consulate-General at Wellington. For the 6 months ending June 30 last, New Zealand exports of American radio receiving sets totaled 1,173 and 1,630 chassis, compared with exports of 1,949 American sets and 5,353 chassis in the similar 6 months' period of '37. British imports are free of duty and the tariff differential between American and English radios is reported to be "by far the greatest" made against American or other foreign goods in the entire New Zealand customs tariff.

Personal

These men are worth knowing; meet them here.

S. N. (Shure Bros.) SHURE, Pres., ARTHUR (Solar Mfg. Corp.) MOSS, Secy.-Treas., A. A. (Ward Leonard) BERNARD, V-P., & H. E. (Centralab) OSMUN, director, all now officers of the Radio Parts Mfrs. Natl. Trade Show, Inc., were elected to succeed themselves in office for the coming year. (See Page 545 for news on the 1939 Parts Show.)

(Continued on page 560)

CONDENSERS & BINDING POSTS GET NEW HOMES

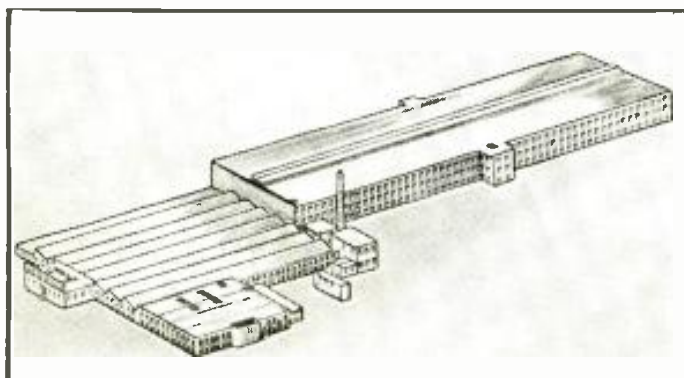

About 6 blocks long by 2 blocks wide, the new Aerovox factory and office building at New Bedford, Mass., has some 433,000 sq. ft. of floor space—or about 3 times as much as the old Brooklyn plant. It was bought for cash! The co. plans to resume full production schedule.

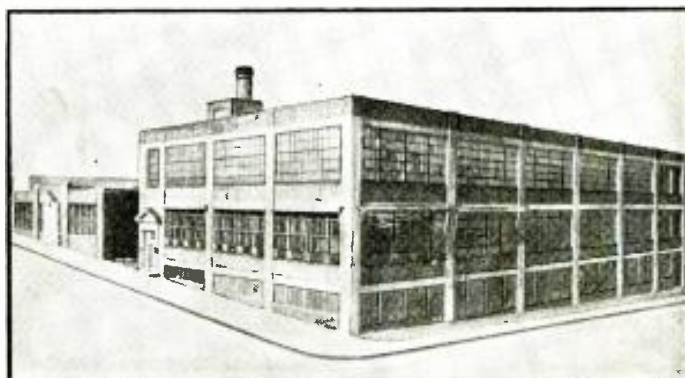

A 3-story corner, with adjoining 1-story building to provide 13,000 additional sq. ft. for further expansion, now houses Eby's plant in Phila. More automatic molding machines, more punch presses, more facilities for assembling, will help the co. meet increased demands.

AN EDITORIAL

by George K. Throckmorton,
President, RCA Manufacturing Company

The two most significant developments in the Radio Industry during 1938 were, in my opinion, the continuing downward price trend of radio sets and the acceleration of public interest in recorded music.

The increased value and performance now being put into the smaller radio units is one of the most important reasons for the downward price trend. Improved manufacturing efficiency and engineering design have contributed largely toward making the better values possible.

It is obvious, therefore, that manufacturer, distributor and dealer must adjust themselves to this condition and

make their 1939 plans accordingly. To keep his dollar volume up, the dealer will have to learn how to sell the smaller radio units in greater volume. This should not be hard, because the lower selling prices now make it practicable for nearly every family to have a separate receiver for almost every room in the house. That is where the dealer will have to look for a large part of his radio market.

Many sales were lost during 1938 because of over-cautious stocking of merchandise. The dealer was unwilling to stock on a more than hand-to-mouth basis, and relied on the wholesale distributor to carry an inventory of merchandise for him. The wholesale distributor in turn was unwilling to take the responsibility of carrying an adequate inventory of merchandise to meet the needs of the dealer. As a result there was an acute shortage of certain attractive merchandise during radio's busiest buying season, and many profit-making opportunities were forfeited.

For the sixth successive year, there has been a marked increase in the popularity of recorded music over the year
(Continued on page 562)

SIX CELEBS WHO MERIT MENTION



ALFRED H. MORTON, new v-p of NBC. He was a capt. in the World War; then to G-E, RCA & NBC, where he managed the Operated Stations Dept.



L. W. TEGGARDEN, mgr. of RCA Renewal Tube Sales, testing plan in Hartford, to allow 25c trade-in on old tubes, give refund guarantee with full set.



WILFRED E. JOHNSON, 33-yr.-old design engineer of G-E, who won honorary engineering society Pi Tau Sigma's gold medal for outstanding achievement.



G. J. CORRIGAN, Jensen Radio Export Mgr., with Mrs. Corrigan, sailed for a 6 mo. sales trip throughout South America, to announce new products.



T. F. BARTON, recently appointed asst. mgr. of the N. Y. district for G-E. He twice won the Charles A. Coffin Foundation awards for great achievements.



NILES TRAMMELL, exec. v-p of NBC, was formerly asst. sales mgr. for RCA, on Pacific Coast. Moved to Chi offices of NBC as mgr., in '28. Now at Radio City.

OFF THE PRESS

Latest information published for you by leading radio companies.

CATALOG. Sears, Roebuck & Co., Chicago, Ill. 44 pp. Specially prepared for "hams", Servicemen, & sound equip't men.

FACTS ABOUT TELEVISION. Amer. Television Corp., N.Y.C. 18 pp. Build-up for telly in general—& co.'s sets.

(Continued on page 561)

TUBE TAX EXEMPTIONS OFF

In a letter to the RMA, Guy T. Helvering, Commissioner of Internal Revenue, told of a new ruling relating to the exemption of tubes from the
(Continued on page 561)

STATION MAKES SETS



So great has been public enthusiasm for WQXR's below-the-bcst-band hi-fi programs that the station has gone into the set biz. New 11-tube A.C.-D.C. job tunes from 1,800 to 540 kc., costs \$135 to \$165 installed. John V. L. Hogan, rear, and R. M. Wilmotte.

"NIPPER" TELLS THE WORLD ABOUT RCA

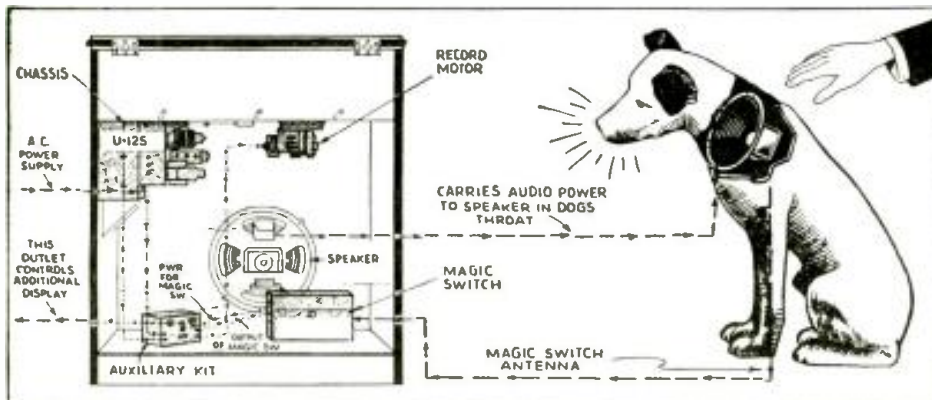

A loudspeaker in his throat, a "magic antenna" in his head, a lot of other gadgets in a U-125 phono-radio, enable 40-in.-high "Nipper" to invite customers into store for demonstration when they pat his head. Apparatus includes \$15 dog (not essential) and \$8 kit, which comprises special record, "magic" (capacity actuated) switch, thermal relay, auxiliary relay which gives thermal relay a chance to cool off between customers. Kit can also be used to light up windows, signs, etc., when folks approach.

CENSUS SURVEY OF BUSINESS: 1937-38 RADIO DEALERS RETAIL DISTRIBUTION

TABLE 1.—SALES FOR 1938 (FIRST-HALF) AND 1937; AND FOR THE YEAR 1935 FOR IDENTICAL STORES, BY GEOGRAPHIC DIVISIONS, STATES AND PRINCIPAL CITIES.

DIVISION AND STATE	SIZE AND PROPORTION OF SAMPLE				YEAR 1937		FIRST HALF 1938	
	NUMBER OF STORES INCLUDED IN 1937-38 SURVEY	PERCENT OF SUCH STORES TO ALL STORES IN 1935 CENSUS	1935 SALES OF SUCH STORES INCLUDED IN 1937-38 SURVEY (100000)	PERCENT OF SUCH SALES TO ALL SALES IN 1935 CENSUS	SALES (100000)	PERCENT CHANGE FROM 1935	SALES (100000)	PERCENT CHANGE FROM FIRST HALF 1937
UNITED STATES	243	6	81,672	10	\$1,000	+44.2	83,024	+22.4
Geographic Divisions								
New England	30	10	470	12	645	+37.4	924	+32.1
Middle Atlantic	69	6	1,217	7	2,971	+27.9	1,140	-18.9
East North Central	54	6	1,211	13	1,642	+4.7	523	-56.7
West North Central	15	3	335	11	447	+33.4	104	-12.4
South Atlantic	16	5	304	9	519	+55.2	201	-16.0
East South Central	4	2	54	3	80	+48.1	41	-10.8
and Mountain	8	4	132	8	171	+29.5	90	-5.9
West South Central	4	7	1,113	10	1,604	+32.2	603	-18.2
Pacific								

This chart shows the rise & fall of retail radio sales. Biz in '37 increased 44.2% since '35, but sales in 1st half of '38 were 22.4% under those for same period of '37. All sales cited are in thousands.

CENSUS SURVEY OF BUSINESS: 1937-38 RADIO DEALERS RETAIL DISTRIBUTION

TABLE 2.—PAY ROLL FOR 1938 (FIRST-HALF) AND 1937 FOR IDENTICAL STORES, BY GEOGRAPHIC DIVISIONS, STATES AND PRINCIPAL CITIES.

DIVISION AND STATE	NUMBER OF STORES INCLUDED IN 1937-38 SURVEY			YEAR 1937		FIRST HALF 1938	
	TOTAL	REPORT INC. PAY ROLL	REPORT. INC. PAY ROLL	PAY ROLL (100000)	PERCENT CHANGE FROM 1935	PAY ROLL (100000)	PERCENT CHANGE FROM FIRST HALF 1937
UNITED STATES	243	209	34	\$1,034,659	+36.6	849,105	-6.1
Geographic Divisions							
New England	30	27	3	91,549	+19.2	35,393	-23.3
Middle Atlantic	69	60	9	289,044	+29.4	132,329	-21.0
East North Central	54	46	10	253,481	+30.1	102,580	-11.6
West North Central	15	12	3	61,905	+37.4	29,179	+2.3
South Atlantic	16	14	2	64,931	+30.1	29,340	-1.7
East South Central and Mountain	4	4	0	6,379	+41.4	2,988	+5.8
West South Central	8	6	2	17,579	+58.8	13,927	+14.5
Pacific	43	36	7	773,460	+40.7	103,111	-2.1

NOTE: PAYROLLS DO NOT INCLUDE COMPENSATION SERVICES TO OWNERS OF UNINCORPORATED BUSINESSES AND SO CANNOT BE COMPARED WITH SALES

This chart shows the rise & fall of retail radio payrolls. Pay rose & fell more slowly than sales. Increase for '37 over '35 was only 34.6%; decrease in 1st 1/2 of '38 from 1st 1/2 of '37 was a mere 6.1%.



The FCC has okayed a license change on WLW & WSAI—from Crosley Radio Corp. to Crosley Corp.—which makes it look as though the co. is planning extensive extra-radio activities . . . Radio will supplement the cables under the English Channel, French & British govts. having ordered a set-up from European subsidiaries of I.T.&T. It'll work from 2.6 to 4.9 meters, with 9 conversations on each of 4 carriers . . .

Pres. Gerard Swope of G-E predicts better biz in '39, & how we hope he's a good predictor! . . . Radio City Products has knocked \$4 off the price of its Model 701 Signal Generator . . . Bruno Labs., of N.Y.C., have taken out a license to make Finch facsimile receiver kits. . . The RMA is definitely against any Parts Shows besides those in Rochester (for engineers) & Chi (Continued on page 562)

BIZ OPPS

There's business for those who will take the trouble to go after it. Can you cash in on this lead?

W. G. Irwin, of 2 Sotheby Road, Highbury, London, N.5, England, writes:

"Will be glad to have details of communications-type receivers in the \$50-\$100 class. (Comparable receiver Hallcraft Sky rider.) Also please quote for delivery CIF London or FOB New York and conditions of payments; i.e., COD, against documents, or cash with order. For operation on 200-250 volt AC, 50 cycle, preferably tapped 110/200/-220/240 or 210/230/250. Alternatively your standard 100-110 volts, 60 cycles would be okay, although it means I'd have to use an autotransformer."

The RSA Monthly Bugle

(News of the Radio Servicemen's Assn.)

The Greater Bridgeport Radio Service Men's Association of Bridgeport, Conn., has joined the RSA. This group is under the direction of L. F. Gravin, Chairman; A. H. Stendahl, Secretary; and Herbert C. Eisenman, Treasurer. Other groups that have signified their intention of joining the RSA in the future are: Fort Wayne, Indiana; Springfield, Illinois; Jacksonville, Illinois; and DeKalb, Illinois.

Danville, Ill., Chapter held a weenie roast and picnic. Russ Lund of Clough-Brengle gave a talk on "Dynamic Testing". Members voted on and accepted 9 new applications for membership.

Peoria, Ill., Chapter is using a cooperative newspaper ad, to run for 17 weeks. The local newspaper is cooperating in giving editorial space in the form of news stories and pictures concerning the work and stability of RSA members in and around Peoria. Servicemen generally in this area report better business conditions.

Pontiac, Mich., Chapter held its first meeting at the new meeting place in the Board of Commerce Building. Members reported great success in their local campaign for fixing up charity sets. The local newspaper is running advertising under the name of RSA, Salvation Army stores and distributes sets, the Press photographs sets and members while fixing sets. Each member gives his suggestions for improvement and these suggestions are discussed at length.

Green Bay, Wis., Chapter held its first annual banquet at White Lave, Wisconsin.

Lansing, Mich., Chapter devoted its last meeting to a discussion of its local bylaws. These bylaws will form the ground work upon which the organization hopes to build its success. Members are enthusiastic about the work accomplished so far and have pledged themselves to continued activity in the future.

(Continued on page 563)



New police, fire & forestry equip't by Radio Engineering Labs. is mounted on 3 separate chassis which lock into shock-mounted weather-proof case, & can be removed without tools for fast servicing. Xtal controlled xmtr has 15-watt output. Receiver is noise suppressed, xtal controlled superhet. Other unit is power supply. 1939 line includes 15, 50, 100, 250 & 500 watt main stations, too.

New Trade Treaty Leaves Radio Cold

No substantial effect on the American radio industry is expected from the British and Canadian reciprocal trade agreements between the U. S. and Great Britain. While the United Kingdom treaty generally favors the British rather than American interests, British competition in this country is expected to continue negligible on account of the superiority and public acceptance of American radio products. There is official and other general opinion that substantial imports of British radio apparatus will not result from the new treaty. The British treaty became effective (Continued on page 563)

STEWART-WARNER HIGH-FIDELITY MODELS 91-821 TO 91-829, 98-821 TO 98-829, 910-821 TO 910-829
(Chassis Models 91-82, 98-82, 910-82)

8-Tube High-Fidelity Superhet.; Pushbutton-Tuning Only (No variable tuning condenser used); Tuning Range 540 to 1750 kc.;
Peri-Dynamic Speaker System.

(See Data Sheet 249 for other information.)

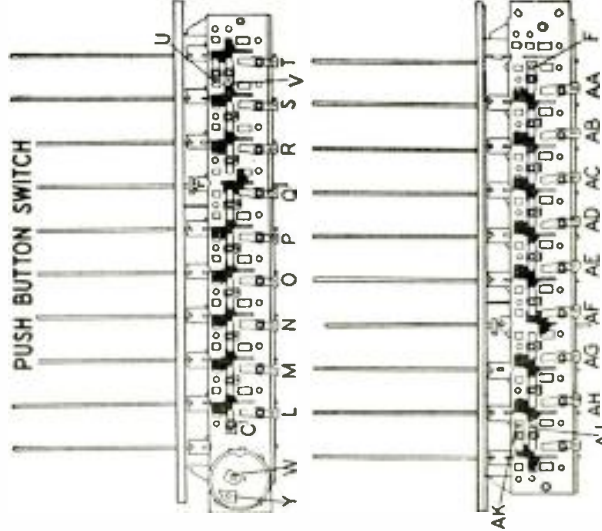
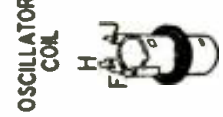
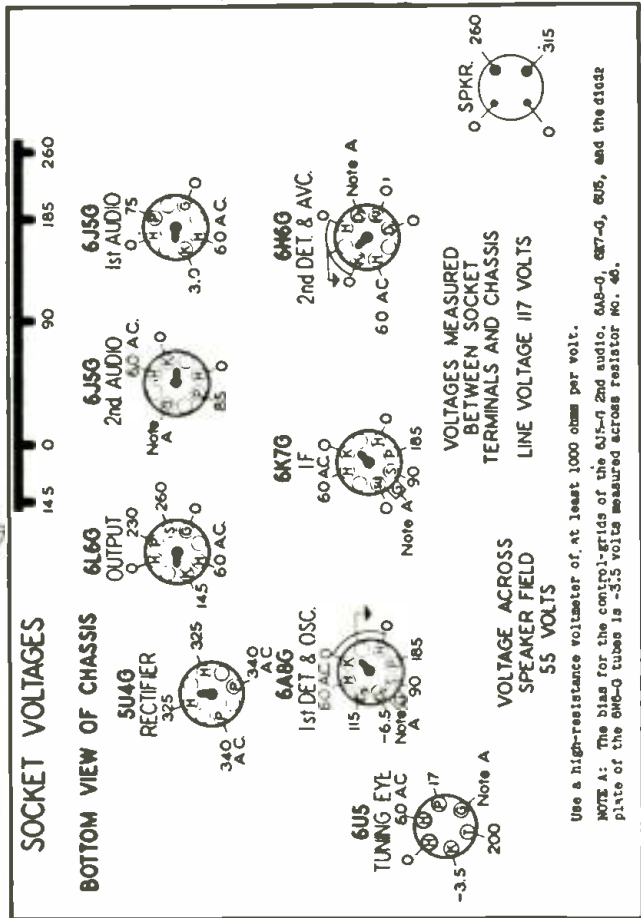
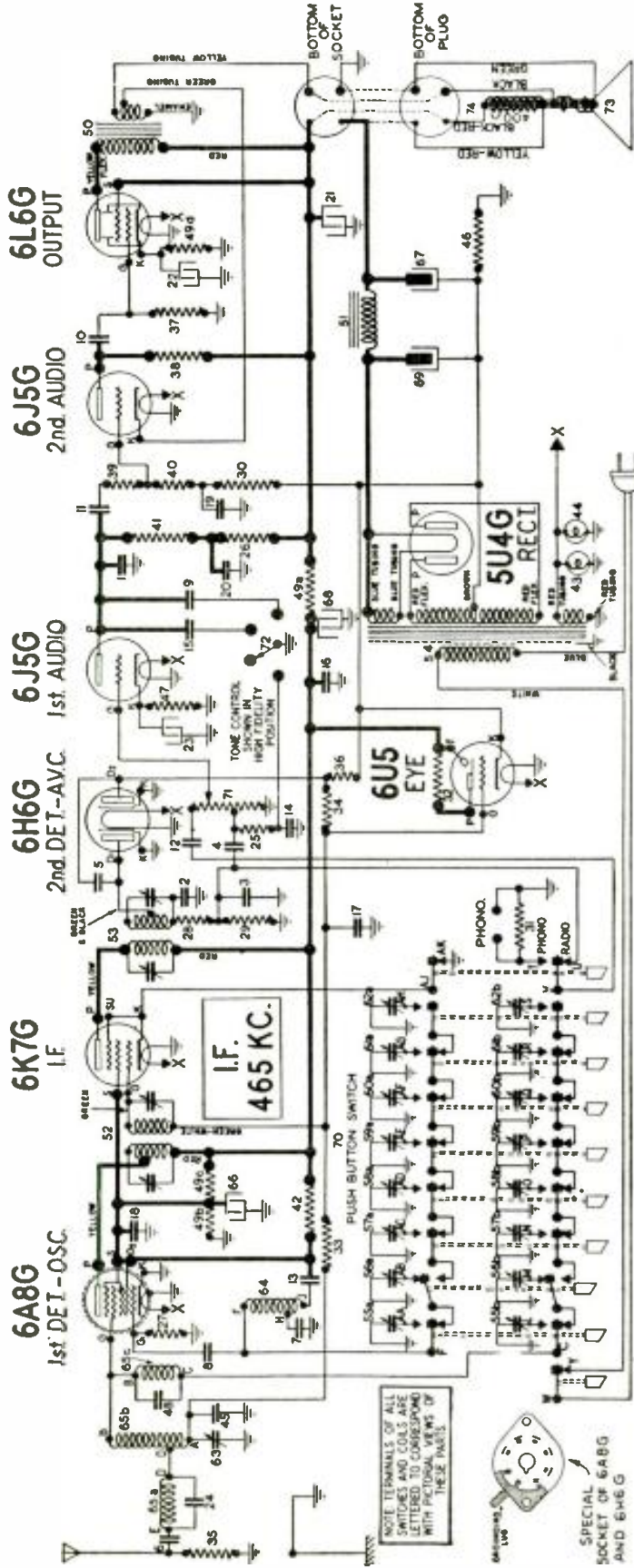

Use a high-resistance voltmeter of at least 1000 ohms per volt.
NOTE A: The bias for the control-grid of the 6U5-5 2nd audio, 6A8-G, 6K7-G, 6U5, and the diode plate of the 6H6-G tube is -3.5 volts measured across resistor No. 46.

Fig. 1. Schematic circuit; and, socket voltages.

NOW I KNOW WHAT I'M DOING!



Of course you do! You've got Ghirardi working for you - the man who has simplified radio service work for thousands!

Here's what he gives you:

- 1 **TEST EQUIPMENT**
- 2 **TROUBLE-SHOOTING**
- 3 **REPAIRING**
- 4 **SPECIAL PROBLEMS**

A 420-page section, giving you the whole theory and construction of every type of test and servicing equipment. Diagrams, construction data, etc., etc.

254 pages of inset short-cuts in tracking down all kinds of set troubles.

184 pages of time-saving repair methods; superhet alignment; interference elimination, etc.

442 pages on Auto-Radio installation and servicing; All-Wave and High-Fidelity sets, AVC and QAVC, Bellini, Advertising, etc.

Let Ghirardi teach you about Servicing

Get a copy of his Modern Radio Servicing. Here is where you'll learn how modern radio service work should be done—and why! Even if you're doing good work every day, you can positively do BETTER work—in a SHORTER time—for BIGGER money—if you let Ghirardi bring your service methods up to the minute. This big book explains everything about servicing—test instruments, trouble-shooting, repair methods, etc.—all that essential background knowledge you have to use in your shop every minute.

EASY AND CLEAR

It's the most thorough and comprehensive text on radio service work ever written. Best of all, it's written so anyone can understand it, for Ghirardi makes everything as plain as A.B.C. Man, what a book this is! And it's yours—yours for better service work. ORDER IT TODAY!

\$4

1300 pages
706 illus.

MODERN Radio Servicing

RADIO & TECHNICAL PUBLISHING CO., 45 Astor Place, New York, Dept. RC-39

- Here is \$4. (84.50 foreign) for my copy of MODERN RADIO SERVICING. Ship prepaid at once with 10-day Money-Back Guarantee.
- Here is \$6.50 (87 foreign), the "Special Limited-Time Combination Price" for the above book, together with the new RADIO TROUBLE-SHOOTERS' HANDBOOK (see ad opposite).

NAME _____
 ADDRESS _____
 CITY _____ STATE _____
 Please send free literature describing detailed contents of MODERN RADIO SERVICING MONEY-BACK GUARANTEE

YOUR FUTURE IN RADIO TELEVISION

These growing industries need trained men for sales, service, operation. Your chance for employment and advancement depends on thorough training. National Schools offer you time tested training. Complete, modern facilities and equipment in the largest trade school in the West. Established 1905.

Send for free booklet that shows how you can prepare for these opportunities.



NATIONAL SCHOOLS

4000 S. Figueroa Street, Los Angeles

NATIONAL SCHOOLS, Dept. S-R.G. Los Angeles
 Please send free Radio and Television Booklet.

NAME _____ AGE _____
 ADDRESS _____
 CITY _____ STATE _____

HOLES IN GLASS

MADE EASY CLEAN SAFE
 Kit of materials and instructions—\$1.00 postpaid
DECO
 2937 Avenue R Brooklyn, New York

THE PIPELESS ORGAN!

(Continued from page 521)

OPERATION OF VIBRATOR

Figure 1 illustrates the basic tone-producing principle of this organ, and the relationship of vibrator to the electrostatic tone screw. Other assemblages are shown to illustrate the various components that operate in conjunction with the vibrator and tone screw. Above each vibrator is a small cell or air chamber. While this chamber has a definite influence on the "speech" of the vibrator, it also has a tendency to magnify the tone of the vibrator.

This system of tone-production is not concerned about the tone of the vibrator itself, so a method of muffling is applied to render the tone inaudible, so as not to disturb the soft tones emanating from the tone chamber shown in Fig. B (this chamber requires 1 high-frequency and 2 low-frequency loudspeakers in order to adequately reproduce the fundamentals, and their harmonics, of a 5-octave range). When the stop tablet on the console shown in Fig. A is pressed downward, the pallet beneath the vibrator, shown in Fig. 1, is made operative. Immediately a key is depressed on the console, the pallet opens. A current of air produced by a suction unit is then driven against the free end of the vibrator tongue, which is at once set into periodic motion. As long as a sufficient current of air is driven against the tongue of the vibrator, the cycle of oscillation continues (the velocity of vibrations increases as the pitch ascends), permitting the air current to take its free course on its way to fill the vacuum created by a motor-driven vacuum exhauster encased within the console. When the stop tablet is cancelled, pallets are made inoperative and no air can pass through the vibrator, which is thus prevented from sounding.

ELECTRICAL PRINCIPLE

The vibrators of the different tonalities are connected in parallel to adjustable polarizing voltages, and when set into periodic motion by key depression, they constitute one side of a condenser microphone (or pickup, as recently described in Radio-Craft—Editor). The electrostatic tone screws of the various tonalities are also connected in parallel, and lead to different input channels in the preamplifier. The tone screws constitute the other side of the condenser microphone (pickup). Between the tone screws and reeds that always escape touching each other exists what is known as an electrostatic charge. The movement of the vibrator tongue varies this charge, thus setting up an alternating current that is impinged upon the grid of the first amplifier tube.

The tone screws are placed over a predetermined part of the vibrator according to the extent of dissonant harmonic elimination desired. Amplitude, or tone regulation, is obtained by raising or lowering the tone screws. Differently shaped and voiced vibrators and variously designed air chambers, mountings intermediately used, materials used, etc., have their effect upon the nature of the electrostatic impulses that are conveyed to the amplifiers and to the tone chambers where they are converted into sound.

Part II will contain a complete working schematic diagram of the pipeless organ. Further, it will describe and diagram all the accessories which are available for this organ. These include special tone chambers, an echo chamber and chimes. The electronic-music field is moving ahead very rapidly. Keep abreast of its progress by reading the articles in Radio-Craft.

NOW-MY SERVICE WORK IS A CINCH!

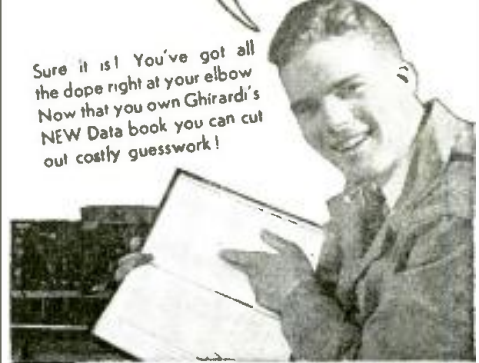

Sure it is! You've got all the dope right at your elbow. Now that you own Ghirardi's NEW Data book you can cut out costly guesswork!

Here's the Dope:

- 1
- 2
- 3
- 4

3,313 CASE HISTORIES
 Trouble symptoms and remedies for over 3,000 sets, compiled from actual service records.

I.-F. PEAKS
 Over 15,000 listings for alignment of all superhets, old and new, incl. '39 models and "orphans."

AUTO-RADIO
 Gear Ratios and Dial Directions of all sets; Installation and Car Ignition System Data for all cars, Special Interference Elimination, Electrical Wiring Diagrams.

OTHER DATA
 Trouble-Shooting Charts, Servicing Records, and Sound Equipment, Trade Directories, and over 30 other charts and tables.

No more room for "Crystal-Gazers" in the Service Game!

Guesswork artists are on their way out of the radio servicing picture. Now you have to KNOW—know WHAT to do and HOW to do it QUICKLY! That's why hundreds of smart, up-to-date service men today are depending on Ghirardi's new practical servicing HANDBOOK. It gives them instantly in compact, tabular or chart form, exactly the factual, factory-checked data they need to speed up their jobs. It makes their work easier, better, faster—and more profitable. For example, just one of Ghirardi's 3,313 Case Histories might save the job itself, to say nothing of hours of labor!

10-DAY TRIAL!
 Try the Handbook in your shop for 10 days. If it doesn't pay out, return it and we'll refund the money. Grab this offer NOW! Mail the coupon TODAY!

Standard Manual Size (8 1/2 x 11)

\$3 OVER 500 pps.

RADIO Troubleshooters' HANDBOOK

RADIO & TECHNICAL PUBLISHING CO., 45 Astor Place, New York, Dept. RC-39

- Here is \$3. (\$3.50 foreign) for my copy of RADIO TROUBLE-SHOOTERS' HANDBOOK. Ship prepaid at once with 10-day Money-Back Guarantee.
- Here is \$6.50 (87 foreign), the "Special Combination Price" for the above book, together with MODERN RADIO SERVICING (see ad opposite).

NAME _____
 ADDRESS _____
 CITY _____ STATE _____
 Please send free literature describing detailed contents of RADIO TROUBLE-SHOOTERS' HANDBOOK MONEY-BACK GUARANTEE

BRUSH'S VIBROMIKE

A contact mike—sensitive—small for stringed musical instruments. Useable with smallest type amplifiers.

Write for your Brush Catalog today.

THE BRUSH DEVELOPMENT COMPANY
 3312 PERKINS AVENUE CLEVELAND, OHIO

PATENTS—TRADE MARKS

All cases submitted given personal attention by members of the firm.
 Form "Evidence of Conception" with instructions for use and "Schedule of Government and Attorneys Fees"—Free
LANCASTER, ALLWINE & ROMMEL
 PATENT LAW OFFICES
 436 Bowen Bldg. Washington, D. C.

TECO TEST EQUIPMENT Sold with a **GUARANTEE & 10 DAYS FREE TRIAL!!!**

Buy direct from the factory. Save 50%. If the Instrument you buy does not meet your needs, return it for full credit on any other TECO equipment. Buy TECO and SAVE the difference!



NEW TECO TUBE TESTER

Model T-10 A genuine achievement! For accurate and rapid work. Has d'Arsonval moving coil meter. Tests all types of tubes. For use on 110 V., 60 cycle AC.

Features • Tests all 4, 5, 6, 7s, 7L and octal base tubes. • Tests by the well established emission method for tube quality. Directly read on the Good ? Bad scale of the meter. • Affords separate neon test for leakage and shorts between elements. • All services performed with 5 controls at maximum—many tests not requiring all controls. • Modern attractive etched panel housed in rugged leatherette carrying case with removable hinged cover and handle. • 60 cycle AC operation. • Supplied with instructions and reference table covering all tubes which you will commonly encounter in servicing. Size 11½x9½x5½". Net Price

\$11⁷⁵

TECO POCK-O-METER AC and DC

A new pocket size volt-ohm-milliammeter that includes AC measurements and is the lowest priced, full-service instrument ever offered! Has 3" d'Arsonval movement 0-1 milliammeter. Comes with etched panel.

SPECIFICATIONS

5 DC ranges: 0/1.5/15/25/75/500 volts.
5 AC ranges: 0/15/40/75/200/1200 volts.
4 DC current ranges: 0/1/10/100/500 ma.
2 resistance ranges: 0/500/500,000 ohms (low ohms read to 1 ohm) Pock-O-Meter supplied complete with batteries, test leads, and instructions. Size 6½x3½x2½"; shipping weight 5 lbs. Our net price

\$8⁴⁵

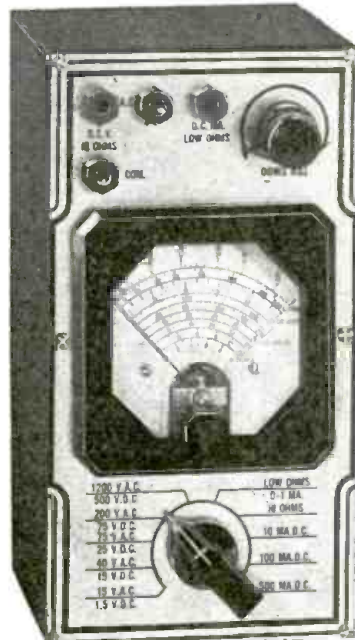

NEW TECO MULTIMETER

MODEL T-15 Here's the unit you need for rapid, accurate measurements. A 1000 ohms per volt type instrument featuring d'Arsonval type movement 0-1 Millimeter. Accuracy 2%. Attractive etched metal panel. For use on 110 V., 60 cycle AC. 2 RESISTANCE RANGES, 0-500 ohms, 500-5 megohms. HIGH AND LOW CAPACITY SCALES, .0005-1 mf. and 0-200 mf. COMPLETE AC and DC VOLTAGE and CURRENT RANGES. DC Voltage: 0-15, 0-150, 0-750 volts; AC Voltage: 0-15, 0-150, 0-750 volts; DC Current: 0-1, 0-15, 0-150, 0-750 ma.; AC Current: 0-15, 0-150, 0-750 ma. THREE DECIBEL RANGES. TECO Multimeter comes complete in carrying case with test leads and instructions. Size 11½x9½x5½". Shipping weight 8 lbs. Our net price...

\$13⁶⁰

TECO T-20 COMBINATION SET TESTER

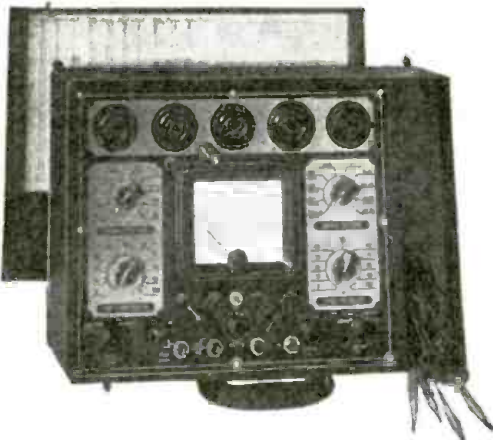

Complete Set Analysis at Your Finger Tips

Combines the functions of the Teco T-10 Tube Tester and T-15 Multimeter. A complete testing laboratory for shop use. A portable trouble shooting laboratory which you can take with you on the job. Fast, accurate trouble shooting with a single service instrument. An invaluable asset to modern field servicing. Specifications of the T-20 are the same as those given for the T-10 Tube Tester and T-15 Multimeter.

The Teco T-20 Set Tester comes complete with an unusually large 4½" d'Arsonval type meter and attractive etched panel; test leads, black leatherette carrying case and instructions for use on 110 volts, 60 cycles, AC. Size 15x10½x6". Shipping weight 17 lbs. Our net price

\$21⁴⁵

THE MODEL T-70, a combination audio and radio frequency Signal Generator with all push button control plus the nine following fixed frequency push buttons: 175 KC—262.5 KC—456 KC—460 KC—465 KC—600 KC—1000 KC—1400 KC—1600 KC.



SPECIFICATIONS:

Radio Frequency Section. Generates radio and intermediate frequencies, 100 K.C. to 60 M.C. in five bands selected by push button switching. Accurately calibrated on 10-inch oblong Crowe vernier dial. The following nine spot frequencies available by push button control: 175 KC, 262.5 KC, 456 KC, 460 KC, 465 KC, 600 KC, 1000 KC, 1400 KC and 1600 KC. Accuracy ½ of 1% on I.F. bands, 1% on broadcast and short wave bands.

Audio Section. Generates audio frequencies, continuously variable from 5 cycles to 10,000 cycles. Divided into five bands with band switching by the push button method, and 5 scales accurately calibrated on etched panel. The audio output is serviceable as modulation on all I.F. and R.F. bands and may also be taken out independently.

Model T-70 works on 90 to 130 Volts A.C. or D.C. (any frequency) and is housed in beautiful, new army grey, crystalline finished cabinet. Front panel is of brushed grey aluminum. Size 13½"x11¼". Shipping weight 18 pounds. Complete with tubes, test leads and instructions. Our net price

\$19⁴⁰



TEST EQUIPMENT COMPANY of America

139 CEDAR STREET

RC-3

NEW YORK, N. Y.

Please Say That You Saw It in RADIO-CRAFT

STEWART-WARNER HIGH-FIDELITY MODELS 91-821 TO 91-829, 98-821 TO 98-829, 910-821 TO 910-829
(Chassis Models 91-82, 98-82, 910-82)

8-Tube High-Fidelity Superhet.; Pushbutton-Tuning Only (No variable tuning condenser used); Tuning Range 540 to 1750 kc.;
Peri-Dynamic Speaker System.

(See Data Sheet 248 for other information.)

ALIGNMENT PROCEDURE

FOR ALIGNMENT: An output meter and an accurately calibrated signal generator with a tuning range from 465 kc. to 1.5 mc. are required.

(1) Connect the output meter across the voice coil or, in series with 0.1-mf. condenser, from the plate of the 6L6G output tube to ground, depending on the type of meter. (The more sensitive type should be connected across the voice coil.)

(2) Connect the ground lead of the signal generator to the "G" post on the antenna terminal strip at the rear of the chassis, or to the metal chassis. The ground and antenna terminals on the antenna terminal strip must be connected together throughout the alignment procedure.

(3) Turn the volume control to the maximum volume position and keep it in this position throughout the entire alignment procedure.

(4) Re-tune pushbutton trimmers to stations as realigning the I.F. stages may have caused detuning of the stations to which the buttons were set.

Dummy Ant.	Connect Signal Generator to:	Signal Generator Frequency
0.1-mf. Condenser	Control-grid of 6A8G Tube	465 kc.
200 mmf. Condenser	Antenna Terminal	465 kc.
Push in Pushbutton	Trimmer Number	Type of Adjustment
Push in any Button Except No. 1 or 10	1-2 3-4	For Maximum Output
No. 9 (Trimmer No. 9a & 9b Tuned to Approximately 600 kc.)	5	For Minimum Output Using a Strong Signal

USE OF THE TUNING EYE

The tuning eye is located at the rear of the chassis (as shown in Fig. 2) and should be used when setting up the pushbuttons to the various stations. Its purpose is to indicate visually the exact point at which the receiver is correctly tuned to a station. Any station is correctly tuned-in when the two open ends of the "V" shadow in the tuning eye are closest together. On strong signals the ends will come together—on weaker stations, they will be more separated. REGARDLESS OF WHETHER YOU ARE TUNING-IN A STRONG OR A WEAK STATION, THE TRIMMER SCREWS SHOULD ALWAYS BE ADJUSTED TO THE POINT WHERE THE ENDS OF THE "V" IN THE EYE ARE CLOSEST TOGETHER.

NOTE: This tuning eye should be removed from its socket in the chassis after the push-buttons have all been set-up. Failure to remove this tube may result in buzzing or rattling sounds such as described below under "Rattles and Buzzes."

HOW TO SET UP THE PUSHBUTTONS

1. Be sure that the set is connected to a good antenna system.
2. Turn on the set at least ¼-hour before setting up the pushbuttons.
3. Make a list of the frequencies of 8 nearby stations to which you wish to set up the buttons. Be sure to select the most powerful nearby stations, since weak signals will not give as satisfactory results.
4. Each of the buttons has a definite tuning range. It is imperative that, in setting up the buttons, you select stations whose frequency is in the indicated tuning range of that button. Failure to select the proper button will result in the incorrect setting of the trimmer adjusting screw and will also cause "drifting."
5. Place the receiver in such a position that the back of the cabinet is readily accessible. Refer to Fig. 2 (showing the back of the cabinet). In the figure, the 8 pairs of trimmer adjusting screws are numbered to correspond to the pushbuttons. These screws are used to tune the receiver to the station selected for each button.

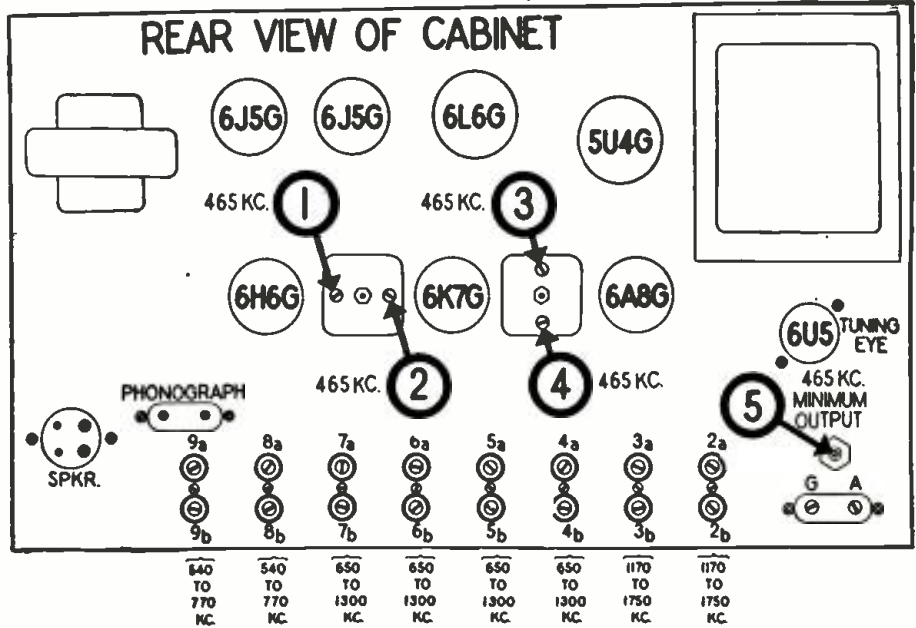

Fig. 2. Locations of tubes and alignment trimmers.

6. Push in Button No. 2. Then insert a screwdriver in Trimmer Screw No. 2a and turn this screw to the left or right until the desired station is heard. The point at which the screw will be correctly set will be indicated when the open ends of the "V" shadow in the tuning eye are closest together. If the station cannot be heard, advance the volume control.
7. Now insert the screwdriver in Trimmer Screw No. 2b and turn it to the right or left until the open ends of the "V" shaped shadow in the tuning eye are closest together. Now re-check the setting of Trimmer Screw No. 2a using the tuning eye shadow to indicate the correct setting.
8. The set-up for Button No. 2 is now complete.

9. Push in Button No. 3 and set up trimmers Nos. 3a and 3b to the desired station in a similar manner.
10. Set up the remaining 6 buttons using their corresponding trimmer screws.
11. In some instances it may be necessary, after the set is operated for a month or more, to re-set the trimmer adjusting screws as they may change their setting due to heat and humidity. Changes in the setting of the trimmer screws will cause poor tone quality.

RATTLES & BUZZES

If during normal operation, buzzing or rattling sounds are heard in the receiver, they will in all probability originate in one or more of the sources listed in this paragraph. These rattles or buzzes generally occur with the tone control in the bass position and with the volume control advanced to a fairly loud level. Check the following for probable sources of noise.

- (1) Loose tube shields. See that shields are properly located, and making good mechanical contact with tube shield base.
- (2) Loose elements in any of the tubes. This applies especially to the 6U5 tuning eye tube. This tube should be removed from the chassis after the buttons have been set-up.
- (3) Loose escutcheon or cabinet parts. Check for mechanical vibration of any parts not securely fastened.

CONNECTING A PHONOGRAPH PICKUP UNIT

The connections to the receiver from a high-impedance pickup unit are made to the terminal strip on the back of the chassis (see Fig. 2, for this terminal strip labelled "PHONOGRAPH"). The 2 leads from the phonograph pickup unit are connected to the

2 terminals on this strip. In case hum is encountered when using this unit, reverse the connections to this terminal strip. If the hum persists, make sure that the receiver has a ground wire connected to it.

HOW TO CHANGE THE OPERATING RANGE OF A BUTTON

The operating range of a button may be changed by merely changing the dual trimmer used with that button. Dual trimmers with the ranges indicated below can be obtained from your Stewart-Warner distributor, or directly from the Stewart-Warner Corp., under the following part numbers:

Part Number	Tuning Range
113953	1,170 to 1,750 kc.
113954	650 to 1,300 kc.
113955	540 to 770 kc.

By referring to Fig. 1, determine the dual trimmer associated with the button whose range you wish to change.

Unsolder the leads from the four terminals on the back of this dual trimmer.

Remove the 6-32 machine screw holding the dual trimmer to the front of the chassis.



Stewart-Warner High-Fidelity Receiver Model 91-827, for local reception. Pushbuttons and controls are on slanting shelf over grille.

25 YEARS OF TRAINING MEN FOR RADIO!

(Continued from page 538)

Specialization seems to be the answer. The entire staff works on the one job of teaching Radio by mail—serving its home-study students—improving its methods of instruction—and constantly revising and rewriting text material to keep its training strictly up-to-date.

Resident schools can and do train men effectively—but here is the N.R.I. version of why correspondence schools also do a good job:

MAIL-RADIO TECHNIQUE

The correspondence-school instructor who prepares his "lecture," or textbook, on a certain subject, approaches the job in this way: He must first go to the school Library, study the subject in detail—get the viewpoint of leading authorities—and make extensive notes. He then roughly outlines the high spots of how he believes the subject should be treated.

This outline is then studied by the Supervisor of Education who makes changes he considers necessary. Then the actual writing is started, and when it is finished, the first draft usually contains at least double the number of words which should be used. So the slow process of cutting and clarifying then takes place—work which can only be done by experienced writer-instructors.

Finally, this lecture seems reasonably acceptable to several instructors, and it goes to the Chief Instructor for criticism as to the manner of presentation, clarity and simplicity. And then, it goes to a Technical Editor who eliminates the final "bugs" and prepares it for the printer.

The first rough proof from the printer is carefully checked for errors, and then the entire text goes back to the Supervisor of Education for his final revisions and OK.

And besides all this, many specialized subjects are assigned to outside authorities—recognized experts in particular fields. These manuscripts must also go through the regular procedure of exhaustive editing, checking and proofreading.

When the student receives this lecture, he studies it until he is thoroughly familiar with the subject—and then places the entire lecture aside for future reference.

This is only one of the features which this Radio-by-mail school claims makes its training effective. It also points to its system of building subject upon subject so that learning is made easier—a system developed by experience with thousands of students. It cites its home experimental outfits which give students practical experience, and demonstrate the actual working of theories studied about in textbooks. A high-grade servicing instrument developed by the school engineers, in collaboration with a nationally-recognized instrument manufacturer, is a part of the course which helps students get valuable practical experience. An unlimited consultation service is another feature of its training which helps to turn out successful graduates.

The National Radio Institute claims, without reservations, that Radio can be successfully taught by mail. N.R.I. has done it for 25 YEARS.

CORRECTION

The "Lunchbox 5" Battery Portable, described on page 464 of the February, 1939, issue, was said to have a "B" drain of only 3½ ma. That's an error; it consumes 8½ ma.

Get This 80-Page Book Tells Everything About True Dynamic Testing

Ordinarily when you buy a piece of test equipment you use it for months before you know what it will do for you. This means you must first make the investment BEFORE you find out if it is profitable. But not so with the Rider Chanalyst! We want you to know exactly what this instrument can do for you and how you operate it. We want you to be sure it's a good investment—BEFORE you buy it. So, we have prepared an 80-page (8½" x 11") book, loaded it with illustrations and written it so you can understand ALL about the Rider Chanalyst

and true dynamic and functional testing the first time you read it. This book with hard covers would ordinarily sell for \$2.50. We will mail it to you for 25 cents in stamps or coin—a fraction of its preparation cost. We do this for we believe a serviceman should have the real facts on what he can expect of an instrument BEFORE he buys it. We know you will want a Chanalyst after you read this book. Send for it today!

You Don't Need An Expert

to demonstrate this easy-to-operate, trouble-shooting instrument. Read this book—go to your Jobbers and

Demonstrate It to Yourself

The RIDER Chanalyst

SERVICE INSTRUMENTS, Inc. 404 Fourth Ave., New York City

MAIL NOW!
ONLY 25¢ in stamps or coin

Service Instruments, Inc.
406 Fourth Ave., New York City
Enclosed find 25 cents (in stamps or coin) for the 80-page book completely explaining the Rider Chanalyst and True Dynamic Testing.

Name.....
Address.....

Please Say That You Saw It in RADIO-CRAFT

**THERE'S A
REAL FUTURE
IN RADIO!**



In the future of radio, there's a future for you — if you're prepared for it! That means SOUND, ESSENTIAL TRAINING — the kind of thorough training that the I. C. S. Radio Courses offer. Be a trained man — an I. C. S. man — a man with a REAL FUTURE! Mail the coupon.

INTERNATIONAL CORRESPONDENCE SCHOOLS

Box 6678-E. Scranton, Penna.
 Explain fully about your course in the subject marked X:
 Radio Sound Technicians
 Experimental Television
 Aviation Section of Radio Operating
 Name _____ Age _____
 Address _____



IT'S "PIE" FOR CENTRALAB

If we were to show the replacement business of the serviceman as a pie, the failure of the average Fixed Resistor would account for a slice that is more than a quarter of the whole pie. That means, of course, that Old Man Centralab plays an important part in the replacement business.

And with a resistor, hard as stone, impervious to moisture, shocks, excessive temperatures, and vibration, the wise serviceman finds it "easy as eatin' pie" to completely satisfy that resistor need with CENTRALAB. Always specify, nay, insist on Centralab at your jobber.



Division of Globe Union, Inc.

Centralab
MILWAUKEE WISCONSIN

**MAKING A SERVICEMAN'S TEST UNIT
THE "SUPER-GENO-SCOPE"**

(Continued from page 537)

example is illustrated in choosing 100 kc. as the fundamental frequency.

Zero-beat this frequency with a broadcast station having a carrier frequency of 600 kc., then retune the receiver dial to (and zero-beat with) a station having a carrier of 700 kc. Then the supposed frequency is 100 kc., which is to be marked on a sheet of graph paper. Retune the receiver to 600 kc. and vary the variable oscillator dial until another note is heard or the indication of a tracer on the oscilloscope screen. The next logical response that can be heard or seen at 600 kc. after the 100 kc., is 120 kc. The 5th-harmonic of 120 kc. is 600 kc. Mark this point on the graph paper. Don't retune set.

The next note is 150 kc., the 4th-harmonic of which is 600 kc.; the next is 200 kc.; the 3rd-harmonic of which is 600 kc.; next 300 kc., the 2nd-harmonic of which is 600 kc.

Various stations are used so as to obtain as many marks as possible on the graph paper before the curve is drawn.

Thus when calibrating the other bands especially those higher than the broadcast band, the calibrated band can be used as a frequency standard to calibrate the next higher band by the use of the 2nd-harmonic method.

A. F. OSCILLATOR

Calibration of the audio oscillator can be carried out by using a standard beat audio frequency oscillator as a frequency

standard. The calibration can be carried out through the comparison method with the oscilloscope as the indicating device.

Connect the beat audio frequency oscillator at the Horizontal Input of the 'scope and the audio oscillator output to the Vertical Input. Under this condition the 'scope is operated with Sweep Selector at Ext. position. The object of connecting the beat audio oscillator to the horizontal-axis input is to establish a frequency ratio of 1-1. Thus with the frequency selector Sw. 4 set at pos. 1 with an assumed frequency of 50 cycles, the beat audio oscillator is varied until a ratio of 1-1 is established, and thus the assumed frequency is equal to the frequency of the beat audio oscillator. The same procedure is followed for each frequency.

Another method, also by comparison, differs only in that the audio note is compared with a musical note (piano). When the proper note is compared references are made to the frequency characteristic of the musical note on the frequency chart. The course of calibration should be carried out by an expert piano tuner or any musician capable of doing so.

Tables V and VI are the abbreviated operating tables. Upon these tables are shown the manipulation of the necessary control for the various types of modulation and the A.F. oscillator for external use. Also are shown the essential controls of the 'scope to be operated in accordance with the type of service rendered by the Super-Geno-Scope.

TABLE VI
Operating Characteristics—SUPER-GENO

Mod.	% Mod.	KC.	Band	Audio Select.	Coarse R.F. Att.	Fine R.F. Att.	R.F. Selector
1 Freq.	—	0-30	1-6	—	1-3	0-100	0-100
2 A.F.	0-50	—	"	1-11	"	"	"
3 60 cy.	0-50	—	"	—	"	"	"
4 C.W.	—	—	"	—	"	"	"
5 Ext. Mod.	0-50	—	"	—	"	"	"
6 A.F. Ext.	—	0-100	—	1-11	—	—	—

TABLE V
Operating Characteristics—SCOPE

V Gain	H Gain	Sweep	Sync.	Coarse Freq.	Fine Freq.	Sync. Control	Notations
1 0-100	0-100	60v.	—	—	—	—	single image
2 "	"	Int.	Ext.	2-3	0-100	0-100	double image
3 "	"	"	Int.	1-6	0-100	0-100	"
4 "	"	"	Int.-60v	1-2	"	"	"
5 "	"	"	Int.	7-8	"	"	C.W. low freq.
6 Depends upon nature of Modulation							
0-100	0-100	Int.	Int.	1-6	0-100	0-100	

NEW CIRCUITS IN MODERN RADIO RECEIVERS

(Continued from page 534)

than that required for self-oscillation. Having this fixed degree of regeneration, the circuit has high selectivity and high gain with reasonable stability.

(4) OSCILLATOR VOLTAGE STABILIZER

Pilot Model H-555, H-475. In the oscillator for the longwave band of these receivers (175 to 300 kc.) the grid tuned circuit is shunted by a fairly low resistance (33,000 ohms).

The oscillator circuit for this band is shown in Fig. 2A, and is conventional, except for this resistance. Its use tends to keep the oscillator grid excitation voltage low and more important, fairly constant over its entire low-frequency band. Because of this resistance the Q of the oscillator grid circuit is kept reasonably constant and the power output of the oscillator is kept fairly constant. Being more important than frequency stability at these

low frequencies, the higher Q of the circuit is sacrificed to advantage.

(5) IMPROVED A.V.C. FOR SMALL SETS

Philco Models 39-6 and 39-7. To make the A.V.C. more effective for a small set having relatively little gain, the suppressor-grid of the I.F. tube is connected to the A.V.C. line.

Note in Fig. 2B that the I.F. suppressor has approximately 10% more A.V.C. voltage impressed upon it due to its connection at the immediate diode-return of the 2nd-detector tuned circuit, rather than at the usual A.V.C. feeder point, at the top of the volume control.

This gives the A.V.C. a different characteristic, that is, its effect at low signal level is negligible while it is very great at high signal levels, tending to still further equalize the output for all inputs.

Please Say That You Saw It in RADIO-CRAFT

**FIRST DAILY NEWSPAPER
BY RADIO FACSIMILE**

(Continued from page 526)

venture.

Of course, our range is limited on the 31,600 kc. channel, but our investigations to date indicate we are obtaining satisfactory coverage of this metropolitan area which certainly offers ample opportunity to develop our present experimental program. Later, if public reaction seems to justify, there is nothing to prevent our putting facsimile over our standard broadcast station KSD during the early morning hours to reach the rural areas surrounding St. Louis (Mo.).

The receiving recorders were also manufactured by RCA and are, of course, equipped with ultra-high-frequency receivers. *Incidentally, we have not experienced nearly as much trouble with interference on the ultra-high-frequency band as was expected. The characteristics of the recorders are such that far more interference can be tolerated than is the case in the reception of sound broadcasting on these frequencies.*

For more than a month experimental laboratory broadcasts of printed matter, photographs and cartoons have been in progress and results have been studied by engineers of KSD, commercial broadcasting station of the *Post-Dispatch*. During the last few weeks (or about the time this story was written) they have been recorded on 15 receiving sets placed in the homes of members of the station's staff.

These sets, manufactured by the Radio Corporation of America, are the first capable of receiving high-frequency facsimile broadcasts, permitting station operation at any hour of the day. Experimental equipment recently in use by a few other stations employed standard broadcast wavelengths, restricting the period of their use to the early morning hours when regular commercial broadcasting stations were quiet.

Within the next month the manufacturer expects to be able to supply receivers at a cost of about \$260. Several will be placed in public places for demonstration. The range of Station W9XZY, broadcasting on 31,600 kilocycles, is from 20 to 30 miles.

On the first page of this "radio newspaper," now being received in every home in the St. Louis service area of W9XZY equipped with a facsimile receiver, are the leading news articles of the day. Then following sports news, several pages of pictures, Fitzpatrick's editorial cartoon, a summary of radio programs and radio gossip, and a page of financial news and stock market quotations.

The original copy of the facsimile newspaper on being printed by regular processes, was placed one page at a time on the cylinder of the sending apparatus. As the cylinder revolves at the rate of 75 times a minute a tiny beam of light (no larger than a pin point), and a photoelectric cell (commonly known as an "electric eye"), move across the page. The amount of reflected light reaching the "electric eye" varies with the black and white of pages of type and with the depth of shading in the photographs.

These light variations control the amount of electric current flowing through the "electric eye."

The varying electrical current is amplified by the transmitter and the outgoing radio waves change in intensity in propor-

(Continued on page 573)

PERFECT?

THEY'VE GOT TO BE!

HERE YOU SEE a corner of a typical Sylvania testing laboratory. In this room, highly skilled experts check Sylvania tubes for quality . . . record life tests . . . check engineering standards.

And Sylvania quality is *not* based on "averages." Each individual tube must prove itself perfect—or be completely destroyed by the "crusher."

Don't take chances with quality—*it means too much to your business!* Sell Sylvania's and you can be *sure* of uniformly fine radio tubes . . . and satisfied customers.

SYLVANIA SET-TESTED RADIO TUBES

*Hygrade Sylvania Corp., Emporium, Pa.
Also makers of Hygrade Lamp Bulbs*



Please Say That You Saw It in RADIO-CRAFT

RCP Presents TEST INSTRUMENTS with a future!

ALL RCP INSTRUMENTS ARE COMPLETELY EQUIPPED FOR TESTING LOGCAL TUBES.

COMBINATION TUBE AND SET TESTER

MODEL 800



Two great RCP instruments—the Tube Tester and Universal Multi-tester—are combined in Model 800. Tests all type tubes; makes all tests at RMA specified voltages and loads. 4 1/2" square meter; individual hot inter-connection short and leakage tests; meter line voltage indicator; 8 A.C. & D.C. voltage ranges 0.5/50/500/1000; D.C. milliamperes 0.10/100/1000; D.C. ammeter 0-10; Ohmmeter 4 ranges from 0 to 10 megohms; low ohm measurements below 0.1 ohm; D.B. meter—8 to 35 db in 4 stages; condenser leakage check and many other features that make this instrument the outstanding "buy" of the season.

Model 800 combination tube and set tester \$27.95

AC-DC MULTITESTER MODEL 444

A MONEY-SAVING CHAMPION



D'Arsonval meter accurate within 2%. Four range AC voltmeter 0.5/50/500/1000 volts. Three range ohmmeter 0/500/50,000/500,000 ohms. Four range DC voltmeter 0.5/50/500/1000 at sensitivity of 1000 ohms per volt. Four decibel ranges -12 to -8/8-28/28-48/34-54 db. Four output ranges. Three current ranges 0.1/10/100 milliamperes. A real value at \$9.95.

Ask your jobber today for full details on the complete RCP line, or write direct.

"TRIPLE CONE" OFFERS BETTER TONE!

(Continued from page 527)

tween 4,500 and 8,000 cycles. The 3rd diaphragm, a dome-shaped cap in the center, tunes the mechanical circuit of the 2nd cone to operate at a higher amplitude, thus increasing the volume of the higher frequencies without distortion. The largest diaphragm is attached directly to the voice coil. The 2 others fasten to the 1st at its apex. It is claimed that the uniform response of the triple-cone speaker over the entire range has never been equalled before in a single-coil speaker. The 2 ranges blend together perfectly in a fidelity of tone that marks a long step forward in that field of radio engineering.

NEW'S ITEMS

RADIO, the great lifesaver of aviation, cost 5 lives when a pilot received signals so well that he grew confused and crashed his plane into the sea off the coast of California. Two passengers were saved, stated press reports last month.

Get out the earmuffs. According to I. M. Leavitt, Philadelphia astronomer, 3 billion square miles of sunspots are due to cause magnetic storms, and hence much static, soon.

RADIO CITY Products Co.
88 PARK PLACE NEW YORK CITY

Model 411 UNIVERSAL SUPER TESTER
The most comprehensive tester ever produced—will be ready next month. It's a sensational buy at \$16.25. Write for complete details.

Size of box: 12 1/2" x 8 1/2"



\$2.75

Shipping Wt. 3 lbs.

Pyro Pantagraph

With this PYRO PANTAGRAPH turn leisure time into profitable hours. Make money a novel, easy way—"Burn Your Way to Extra Dollars with Pyro Pantagraph." This electrical outfit is especially designed for burning designs permanently on Leather, Wood, Cork, Gourds, Bakelite, etc. Simply plug the Pyro-electric pencil in any 110-volt AC or DC outlet and it is ready to be used. Plug and cord furnished as part of equipment.

By the use of a special Pantagraph included in the outfit, any design may be reproduced either in original, reduced or enlarged form. Outfit consists of: one Pyro-electric Pencil; one Pantagraph; three hardwood plaques; one bottle of Varnish; one Brush; one tracing tip and four-page instruction sheet.

Outfit will be forwarded by Express Collect if not sufficient postage included with your order.

WELLWORTH TRADING COMPANY
558 W. WASHINGTON BLVD., Dept. RC-339, Chicago, Ill.

RADIO ENGINEERING



RCA Institutes offer an intensive course of high standard embracing all phases of Radio and Television. Practical training with modern equipment at New York and Chicago schools. Also specialized courses and Home Study Courses under "No obligation" plan. Catalog Dept. RT-39.

RCA INSTITUTES, Inc.

A Radio Corporation of America Service
78 Varick St., New York 1154 Merchandise Mart, Chicago

SIMPLE TECHNIQUE FOR MAKING HOME TALKIES

(Continued from page 533)

with less than 4 walls, having one side opening into another room, lend themselves very nicely.

It is extremely important to select a room highly remote from street noises or any foreign sounds such as constant traffic and radio receivers. The mike, having no brain to divert its attention from these, hears and records them together with the dialogue. Interspersed with the dialogue, such distracting sounds as the above or the ticking of a clock, or the barking of a dog, or the rumble of a ventilating system, become most obnoxious.

PLACEMENT OF MICROPHONES

Lack of space prevents us from discussing the relative merits of non-directional, semi-, or highly-directional mikes. Instead we will confine our treatment to the semi-directional dynamic type obtainable anywhere. To achieve gratifying results it is only necessary to have a working knowledge of the fundamentals of "mike pickup". To have one show in the picture is crude and vulgar. It just isn't done.

The simplest and fastest way to understand the application of a mike (and how to keep it out of the picture) is to think of its beam or coverage as being similar to that of the beam or spread of an automobile headlight. If that headlight be turned or tilted, its light beam would naturally coincide with its movement. So too the sensitivity of a microphone. Its pick-up beam is determined by the position of its face or diaphragm, which corresponds in this comparison to the lens of the lamp.

For Example:— Visualize the old-fashioned shaded lamp centrally hung over the circular dining room table. Its rays (if it were hung high enough) covered the table and those seated around it but scarcely more than that. Now, were we to replace that overhead lamp with a standard dynamic mike, hung face down (its diaphragm about 4 ft. above the parallel with the table top) centrally over the table, its diners could be nicely recorded.

Sound perspective may upset such a procedure which is only cited as an example of sensitivity coverage. A central mike placement would not do at all if one of the diners, while talking, leaned away from it and toward the camera. While he did so he would be the most prominent character in the picture while at the same time he would be the farthest from the mike. There must be maintained at all times, coordinated perspective between sound and picture. Foreground action must be the most prominent in the record.

In commercial practice a complex mike mobility technique is worked out. A skilled operator anticipates an actor's movements (seen in rehearsal) and follows action by means of an elaborate mike boom. That being a lengthy subject in itself, we suggest that in the home our actors be allowed only such movement as is necessary for them to appear natural. Basic simplicity in scenes permits finer lighting, sharper picture and better recording.

A profile or full-faced figure seated across a desk from the camera would likely be framed for the base of the picture to fall somewhere in the desk while its top line would be determined by reasonable head clearance. In this example an ordinary mike placement would be about half-way between the camera and the subject. It should be about 4 1/2 to 5 ft. above the floor, tilted down slightly as though it were a spot-lamp trained upon the subject. See Fig. 3.

Microphones should always be set or suspended in free space. Give them room to "breathe." Particularly they should be kept away from any hard backing such as panels, walls, or lamp reflectors.

CAMERA PROBLEMS AND TECHNIQUE

Why quickly grab a lot of haphazard footage with any old lens after one quick look through the finder? Why retrieve from the developing bath hundreds of frames of aimless picture and only a few of real import?

Please Say That You Saw It in RADIO-CRAFT

Plan your photography thoughtfully and your reward will be generous. Each frame of the hundreds exposed should stand the test were it blown up to become a 5 x 7 still.

Plan in advance what you are going to do and how you are going to go about it. A surprising lack of wasted footage at the end of the month will be the significant return. Don't confine yourself to one lens. Have at least two—one for sharp close-ups and one whose wide angle optics give you a tingle of pride.

General long shots made with a wide-angle camera lens should embody little if any dialogue. Their best purpose is for establishing settings or moods. Or they may be nicely used for entrances and exits, to and from a scene. Only such spread or width of picture should be included as is necessary to accommodate a comfortable distribution of your actors. That is especially true if their conversation is to be recorded. The picture composition should be so set up as to allow little more than a reasonable head clearance for the top frame line of the picture.

Camera noise is one serious bugaboo which must be reduced while recording. Quilted or padded coverings are fairly good but an operating nuisance.

For a negligible cost 3 1/2 ft. panels of celotex about 3 ft. wide may be hinged together as is a 3-piece bedroom screen. Stood on end around the camera it serves very well to eliminate camera noise. In its front or middle sector a sliding panel may be fashioned to provide an adjustable lens port.

If not sufficiently quiet for closer setups, it may have another slab of celotex laid across its top to serve as a roof. Then too, the camera tripod, if set into an old rug, or into a square of celotex, will be much quieter than if spiked into a hard floor surface. Light in weight, this arrangement can be easily moved to another set-up or knocked down.

EXTERIORS

There is little or no agreeable accord between any recording apparatus and penetrating dampness or dust. All parts employed from the microphone itself through to the disc or film should therefore be constantly stowed in dry dust-proof compartments except during actual use. Observance of such common sense as any proud owner of precision equipment would display, is surely deserved by both recording devices and cameras set up on exterior locations.

Fundamentals governing indoor shooting, sketched in previous paragraphs, of course apply likewise to exteriors. Hence there is little to add. However, entirely new elements present themselves, some good—some evil. Akin to the former is the rapid dissipation of camera noise out in the open. Less effort to eliminate it need be spent. Related to the evil is wind, which, when blowing freshly, will create such a rumble across the mike as to require netted screening across its face or even electrical equalization to filter it out. 'Tis better for the novice not to gamble with much footage on a windy day. Approaching airplanes, trains and motorcars may ruin a recording. 'Tis best to wait till they have passed before starting up your equipment.

Part II will discuss the technique of making and adding sound accompaniment to your home movie entertainment. Don't miss it!

ATLAST!—STATIC-FREERADIO!

See the April issue of Radio-Craft for all the details of a startling new system that threatens to obsolete present methods of broadcast transmission and reception!



Get this book
SAVE
on everything in
RADIO!

SEND COUPON FOR
ALLIED'S FREE CATALOG



NOW!

SAVE MONEY! MAKE MONEY!
WITH KNIGHT SOUND SYSTEMS

ALLIED'S great 1939 Catalog shows everything in Radio, including Radio's greatest line of P.A. Systems. More features, more watts for your money; systems from 8 to 65 watts—in standard and de luxe models—permanent, portable, and mobile. Investigate these revolutionary new Sound Systems now—send for ALLIED'S 1939 Catalog. Also, Electric Guitar Amplifier, Booster Power Stage, and the most complete line of recording equipment in the industry!

**30 WATT
DE LUXE MOBILE SYSTEM**
Ideal for sound trucks, orchestras, lecturers, etc. Operates from either 6 volt battery or 110 volts AC. Delivers full 30 watts output with excellent tonal fidelity. 2 mike input channels, dual phono input, separate volume controls, power stage tap, etc. Priced amazingly low—write for details!

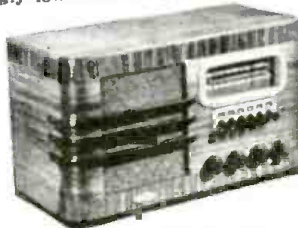

62 NEW SETS

Sensational new KNIGHT values! 62 new models, some as low as \$6.95. New "Tiny Knights," 1.4 volt battery sets, 6 volt radios, sets for AC and AC-DC. Models from 4 to 16 tubes—all backed by Radio's strongest guarantee! Also, complete lines of phono-radios, phonographs, record players, etc.

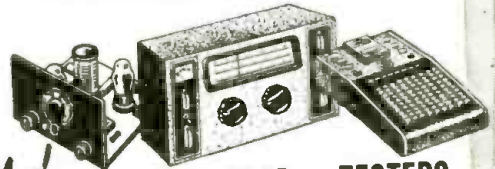

New! KITS... HAM GEAR... TESTERS

Radio's largest selection—Beginners' Kits, Photo Cell Kit, Electric Fence—100 diagrams and projects. Free Parts Lists.

Giant Ham section—newest Hallcrafters, National, Hammarlund, Howard, Thordarson, Utah, G.T.C., Sargent equipment.

All leading lines of tube checkers, set testers, analyzers, oscillographs, Rider, Supreme, Triplet, Readrite, etc.



IT'S A FACT!—ALLIED maintains separate Amateur, P.A., Educational and Sales Promotional Staffs to help make your work easier and more profitable. Write!



RADIO BUILDERS HANDBOOK! Beginner! Send for this new book, written especially for you. Tells how to select circuits, read diagrams, build sets, etc. Only 10c.

**ALLIED
Radio
CORPORATION**

Send for
**FREE
Catalog!**

ALLIED Radio Corp.,
Dept. 2-C-9
835 W. Jackson Blvd., Chicago, Ill.
() Send me your 1939 Radio Catalog.
() Enclosed find 10c (plus 3c postage) for Radio Builders Book.

Name
Address

Be a RADIO EXPERT—Learn AT HOME

RADIO SPECIALISTS NEEDED

Modern receivers with their complicated circuit systems have knocked out the old time cut-and-try radio fixer. Trained men with up-to-the-minute knowledge are needed to service these new sets.

HERE IS YOUR OPPORTUNITY

Your possibilities of making money and getting ahead are limited only by your ability and skill—but you must know more than the other fellow. You must be a radio service specialist, as R.T.A. can train you.



**FREE
OF EXTRA COST**

To start you making money without delay we equip you with this Circuit Analyzer and Point to Point Resistance Tester.

**PRACTICAL TRAINING
AT HOME**

Our home study course is practical "shop and bench" training combined with a thorough set of practical lessons prepared by an experienced Radio service engineer. Four working outfits are also furnished.

**MAKE SPARE TIME
MONEY**

Our training is complete and practical. We show you how to make money almost from the start. The course can easily be made to pay its own way. Investigate now, write for free book of details.

WHAT R.T.A. STUDENTS SAY

Norwood, Ohio
I have connected with a large firm as Radio Service Manager and wish to extend my thanks for your help.
Joseph Rapien, Jr.

Yorkville, Ohio
From Aug. 1 to Dec. 7, 1936, I repaired 163 radios and put up 43 aerials which is very good for part time work while studying your course.
Chas. Koerber.

RADIO TRAINING ASS'N OF AMERICA
Dept RC-39, 4525 RAVENSWOOD AVE., CHICAGO

Please Say That You Saw It in RADIO-CRAFT

HOW RADIO HELPED UNCLE SAM CELEBRATE "NAVY DAY"

(Continued from page 520)

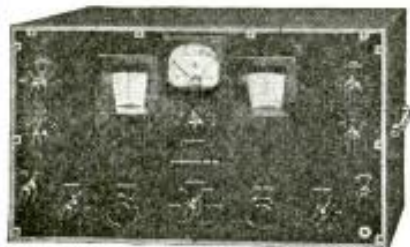

High Performance on ALL Bands

THE new "HQ-120" is designed for both the amateur and short wave listener. It strikes a new high in performance on all bands, from 9.7 to 555 meters. The high sensitivity of the "HQ-120" can be used in even the most crowded bands because of the variable selectivity feature. The new variable crystal filter permits the operator to choose the proper band-width and thus tune out undesirable interference. In addition, the "HQ-120" has a noise limiter, antenna compensator, beat oscillator, accurate "S" meter and many other features described in a 16-page booklet available free of charge... Mail coupon!

HAMMARLUND MFG.-CO., INC.
424-438 W. 33 St., N.Y. City RC-3

Please send 16-page booklet.

Name

Address

City State



HAMMARLUND

Canadian Office: 41 West Ave. No., Hamilton, Ontario

the most difficult jobs of radio engineering ever completed with such satisfactory results.

Approximately 75 engineers were required to handle the numerous pick-ups from planes, ships and naval bases. Another 150 engineers, working at transmitters both here and abroad, and at other points along the line were necessary to make the program function smoothly.

More than 8,500 miles of direct lines were employed to bring the voices of the Navy men participating in the Navy Day salute to the radio audience, and an approximate radio circuit distance of 17,000 miles was covered in bringing in such places as Manila and Villefranche Harbor in the Mediterranean.

SEA-DEFENSE AID

The tribute to Navy Day, which was observed last year (1938) on Thursday, October 27, was broadcast during the "Magic Key of RCA" program, heard from 2:00 to 3:00 p.m., E.S.T., over the N.B.C.-Blue Network. The program drew the enthusiastic acclaim of Secretary of the Navy Claude A. Swanson and Admiral William D. Leahy, Chief of Naval Operations and the Navy's highest ranking officer, who co-ordinated the entire demonstration of the diverse activities of the Navy from the Radio City (New York) studios.

"I was very pleased to hear the excellent Navy Day program put on today by N.B.C.," Secretary Swanson said in a statement released after the broadcast, "and am gratified that so many of our citizens could hear the voices of the senior admirals charged with the direction of our country's first line of defense."

As he left Studio 8-H, the world's largest broadcasting studio, from which point he directed the naval demonstration, Admiral Leahy called the program an "outstanding engineering achievement" and a "direct and valuable contribution to the sea defenses of America."

As calmly as if he were addressing a group of friends gathered in a room, Admiral Leahy opened the broadcast, following a brief talk in which he outlined the aims and purpose of the navy, by calling in the Commander-in-Chief of the Asiatic Fleet, Admiral Harry Y. Yarnell.

Technical arrangements had been made by N.B.C. engineers to permit the entire personnel participating in the broadcast to hear each other at any time. Rear-Admiral George J. Meyers, speaking from Manila, answered Admiral Leahy's call to Admiral Yarnell, saying that although Admiral Yarnell was ready to go on the air conditions did not permit.

Admiral Leahy then called on Rear-Admiral H. E. Lackey, commander of the temporary European Squadron, in his flagship, *Omaha*, off the coast of France. After reporting the disposition of his squadron to Admiral Leahy in New York, Admiral Lackey exchanged greetings with Admiral Meyers in Manila, every word of which was heard perfectly by radio listeners. Admiral Lackey said that "in order to bring my command closer to home," he had arranged for the entire Navy Day salute to be heard by the ship's company over a loudspeaker system.

Admiral Claude Bloch, Commander-in-Chief of the United States Fleet, under whose command is concentrated the principal might of the Navy under the water, on the surface and in the air, then reported

from the heavy cruiser *Houston* at San Pedro, California.

Admiral Bloch introduced Vice-Admiral E. J. King, Commander, Aircraft Battle Force, who conducted the first actual demonstration of a branch of the Navy in operation. Through split-second precision, King's orders to the various departments of the "Flying Dreadnought" to prepare for a bombing attack and his conversation with Admiral Bloch was heard plainly by listeners. In flight over San Diego Harbor, the "Flying Dreadnought" or, *XPB2Y* as it is known officially, simulated an attack on the leading ship of an enemy column.

From the Pacific to the Atlantic it was a short step for radio. With the speed of light, the program turned to the Atlantic Squadron, off the Virginia Capes, for a demonstration of anti-aircraft defense at sea. Rear-Admiral Alfred W. Johnson, on board the light cruiser *Brooklyn*, directed Captain Brereton to "proceed with your exercise at battle stations."

With amazing clarity, the voice of the pilot of Scouting Plane 6 from the *Brooklyn*, flying over the mother ship, reported: "Enemy aircraft sighted approaching on westerly course. Elevation, 10,000. Distant 10 miles. Speed, 200 knots."

"Officer of the Deck," commanded Brereton. "Sound general quarters."

As the men on the cruiser sprang to their stations, radio listeners heard the sound of the men's feet on the iron stairways. Affording a boxseat to listeners, the program continued as the battle lookout reported that 3 enemy planes were "sighted broad-on on starboard bow," as Captain Brereton ordered, "Repel enemy aircraft attack," and as the various gun stations on the ship fired at their imaginary target. The sound of the giant guns on the light cruiser being loaded and the detonations as they were fired was heard as a background to the conversation between the various ship stations as the target range was changed.

Turning from the sea to the United



Lieutenant William Eddy is examined by Navy Medical Officer Schilling following his escape from the bottom (100 feet deep) of the Naval Submarine Escape Training Tank at New London, Conn. Lieutenant Eddy, retired, is now an N.B.C. television engineer.

Cash In!

MAIL ORDER PLANS
TESTED MONEY MAKERS
BUSINESS SECRETS
SUCCESS SCHEMES

360 PAGES **25 CENTS**

360 WAYS TO MAKE MONEY

A MARVEL BOOK
40,000 WORDS
in TEXT!

In "CASH IN" you get ALL the real money-makers — dozens of profitable tested mail order plans, confidential business secrets, dozens of practical tested formulas, successful tested schemes—actual experiences of men who have started on a shoestring—with less than \$10 capital. Money-Back Guarantee.

Buyers of This Book Tell Us—
... "Biggest value I've yet to see. Book is worth at least a dollar." S. BUDA, B'klyn, N. Y.
... "Your book is as good if not better than others selling at \$1.00."
GEORGE BRUNET, Montreal, Can.
... "CASH IN is the best value I have yet to see in the mail order field."
LAWRENCE FOX, Brooklyn, N. Y.

"CASH IN" contains only tested ideas covering every type of full- or spare-time enterprise—it's a "masterpiece" in business ventures.

25 CENTS per copy. Sent POSTPAID anywhere upon receipt of 25 cents U.S. stamps or coin.

NATIONAL PLANS INSTITUTE
246-R FIFTH AVENUE NEW YORK, N. Y.

GET A REAL ELECTRO PLATING KIT ABSOLUTELY FREE!

Complete details as to how it is possible to get a Real Electro Plating Kit FREE, appears on Page 571 of this issue. **TURN TO IT NOW!**

Please Say That You Saw It in RADIO-CRAFT

States Marine Fighting Squadron 1, flying over the Potomac River just south of Washington, and simulating an attack on the Naval Air Station at Anacostia, the program continued with its exposition of naval activities.

Lieutenant-Commander Miles R. Browning, speaking from the command plane, controlled the entire maneuver by radio and his orders, "form right echelon of section vees," "simulate attack on Naval Air Station," were heard not only by the 17 planes under his command but by radio listeners as well. As the planes dived at dizzy speed towards the air station, a radio announcer stationed on the ground, gave a brief description of the attack and kept his microphone open so that the roaring sound of the planes was heard.

The submarine escape procedure developed at the Submarine Base in New London, in which the Navy's famous Momsen Lung is employed, provided the exciting background for the actual demonstration of another of the Navy's diverse phases of duty. Captain R. S. Edwards, commander of the base, directed this portion of the broadcast.

Announcer Ben Grauer, speaking from an observation post at the top of the Escape Training Tower, carried on a conversation with Lieutenant J. K. Morrison, officer in charge of the training tank, and Lieutenant William Eddy, former submarine officer now employed as an N.B.C. Television Engineer. The naval officers, at one time, were 100 feet below water, with Morrison in the bottom of the giant tank, and Eddy in a diving bell.

As Morrison flooded the escape chamber, he carried on a conversation with Eddy who was waiting outside the hatch. Then, when Morrison opened the hatch, Eddy dramatically described the "escape."

Lieutenants Morrison and Eddy employed small type 44A ribbon microphones in broadcasting from beneath the water. It was impossible to use any other type as the tremendous pressure of the water would crush any microphone on which the pressure could not be distributed evenly.

At the conclusion of the demonstration, the program turned again to Admiral Leahy in the Radio City studios. He called the roll of all of the stations and units that had participated in the event and they answered. The program concluded from the U. S. Naval Academy at Annapolis, Md., with the singing of the traditional Naval hymn, "Eternal Father, Strong to Save," by the full Midshipman Choir.

At the N.B.C. studios, a day after the broadcast, Lieutenant Eddy had large bruise marks over his eyes. He said that after he left the diving bell to ascend with the Momsen Lung, he forgot to adjust his goggles as he reached different pressure areas and that the tremendous pressure created a suction which drew blood to the surface of the skin, leaving marks.

Pressure did other things to Big Bill, who used to be a submarine officer himself. A toothache, for example. The pressure got under the fillings of his teeth and pushed them this way and that. His vocal chords contracted, raising the pitch of his voice, and the rhythm of his heartbeat galloped into swing tempo.

As remarkable as the underwater broadcast seemed to listeners, it was just as remarkable to Mr. Eddy, sitting in his diving bell 100 feet under. Without earphones, he could clearly hear the contacts being made with Navy officers on fighting ships in all corners of the world. Water, it may be explained, is a perfect transmitter at the depth he was listening.



PATRONS in Paramount's Balaban & Katz Theaters do not suffer the exasperating interruptions from sound outage. Every show is a perfect show—especially from the standpoint of sound. That's because B & K sound engineers avoid sound track emergencies by practicing a "preventive maintenance" plan—which consists of frequent periodic sound system check-ups with Supreme instruments.

THE stability of the Signal obtained from the new Supreme Model 571 Signal Generator (shown at left) enables them to make the most accurate check on the amplifier. And with the Supreme Model 546 3" Oscilloscope (shown at right) on the output, the slightest variation from normal in the amplifier is faithfully recorded.

SUPREME Instruments are fast winning favor in the theater sound field—just as they have in the radio service field. Which accounts for the fact that more radios are tested each day with Supreme Instruments than with any other kind!

See your Parts Jobber now. He sells Supreme Instruments on the lowest terms in radio history! Or mail the coupon for full information.

SUPREME

SUPREME INSTRUMENTS CORP.
GREENWOOD, MISSISSIPPI, U. S. A.
EXPORT DEPT., Associated Exporters Co., 115 W. 45th Street, New York
Cable Address: LOFRCH, N. Y.

MAIL COUPON TODAY!

SUPREME INSTRUMENTS CORP., Dept. C.2.
Greenwood, Miss.
Please RUSH me your newest information on SUPREME Instruments:
Name _____
Address _____
City _____ State _____

YOUR LAST OPPORTUNITY TO GET THIS FREE BOOK! Only a few copies of the 1938 RADIO REFERENCE ANNUAL are still available! It's the BIG, FREE BOOK of 64 pages you receive when you subscribe to RADIO-CRAFT. The ANNUAL covers set building, servicing, public address, test equipment, plus a number of other interesting topics. Send your remittance of One Dollar to RADIO-CRAFT, 99-R HUDSON STREET, New York, N. Y., and you will receive a subscription to RADIO-CRAFT for Seven Months, and your copy of the 1938 RADIO REFERENCE ANNUAL will be mailed postpaid immediately.

ELECTRICALLY RECORDED

RECORDS

SAVE MONEY
ON ALL BRANDS OF
PHONOGRAPH RECORDS

We have an exceptionally large variety of standard records (play both sides) played by popular artists. Records of hot dance numbers, vocal, waltzes, instrumental, old-timers, hill-billy, etc., are available. WRITE TODAY FOR RECORD CATALOG.

FREE GIANT RADIO CATALOG (or Dealers, Service Men and Experimenters is NOW READY! Send postcard today for yours.)

UNITED RADIO COMPANY
Dept. R-1000, Newark, N. J.

NOW!
FREE to Canadians

WHOLESALE RADIO COMPANY LIMITED, TORONTO, CANADA

—offers YOU their brand new 1939 catalogue FREE! Ninety-two pages chockful of everything NEW in radio for 1939. If you service, build, sell radios, or operate an amateur station in Canada—you'll save MONEY EVERY WAY when you buy from WHOLESALE RADIO. All-inclusive listings of short wave sets, parts, ham gear, kits, test equipment, sound systems, books, tools, accessories at AMAZING LOW PRICES! Nationally known merchandise—lightning fast delivery. Write TODAY to WHOLESALE RADIO COMPANY LIMITED—Dept. R.C.—1133-1137 BAY STREET, TORONTO, CANADA.

Please Say That You Saw It in RADIO-CRAFT

YOU NEED THIS FREE BOOK



It's a money saver.

Sound specialist, serviceman, experimenter, ham — whatever you are, this book is your "baby"! A radio catalog so packed with values, it takes 188 newsy pages to describe 'em! Here, for quick easy reference, arranged so you can compare brands, is every possible radio part and tool. Plus a P.A. section presenting LAFAYETTE'S big complete line for '39. Everything priced low in this great guide to thrifty buying. Send for your FREE copy of Catalog 73 today. Just mail the coupon.

WHOLESALE RADIO SERVICE CO. INC.
 NEW YORK, N. Y. • CHICAGO, ILL. • ATLANTA, GA.
 150 113 ST. N. BY 1N 112 202 W. JACKSON BLDG. 281 FREDERICK STREET
 BOSTON, MASS. • BRONX, N. Y. • NEWARK, N. J. • JAMAICA, L. I.

WHOLESALE RADIO SERVICE CO., Inc.
 Dept. 3C9—100 Sixth Ave., New York, N. Y.
 Rush FREE RADIO Catalog No. 73

Name _____ PLEASE PRINT
 Address _____
 City _____ State _____

PASTE COUPON ON PENNY POST CARD

Readrite RANGER

Always UP-TO-DATE

COMPACT

NEW MODEL 432

ATTRACTIVE

TUBE TESTER

Checks All Types Radio Receiving Tubes
 Including the New 1.5 and 50 Volt Series; Loctal Base Types and the OZ4 and Other Gaseous Rectifiers.

- Separate Plate Tests on Diodes and Rectifiers
- Neon Short and Leakage Tests
- Ballast Tube Continuity Test
- Uses Attractive Triplett Direct Reading Instrument 3" Size. (GOOD-BAD) Scale.
- Line Voltage Adjustment
- New Improved Low Loss Switch

Suitable for counter or portable use. Slipping etched panel of silver and black.

Model 431 \$19.90
 Checks all receiving tubes. (No ballast test.) Tester uses dependable Readrite Meter. Quartered-Oak case same as for Model 432. Write for Catalog—Section 316 College Dr.

READRITE METER WORKS, Bluffton, Ohio

only \$21.60
 COMPLETE IN QUARTERED-OAK CASE

RADIO TRADE DIGEST

RADIO POLICES ITSELF

(Continued from page 545)

Edward Klauber, Executive V-P of CBS; Lenox R. Lohr, President of NBC; Theodore Streibert, V-P of MBS; Paul Morency, WTIC, Hartford, Conn.; Edgar Bill, WMBD, Peoria, Ill.; Ed Craney, KGIR, Butte, Mont.; Neville Miller, Chairman, President, NAB.

TWO NATIONAL TELEVISION NETS RUMORED FOR SPRING

(Continued from page 546)

the way, as reported in the Radio Month in Review department last month, has sent the equivalent of telly programs 2,500 miles by coaxial cable—in the laboratory.—*Editor*)

Radio Daily reports that Solomon Sagall, head of Britain's Scophony, has secured assurances of adequate financing for his American television co.; will return by Mar. 1; will install at the N.Y. World's Fair the largest television screen ever attempted. Story also states that 1 or more major film cos. will probably have Scophony tie-up.

Telly in White House

According to the American Television Corp., their new sight-&-sound receiver has been placed in a reception room on the 2nd floor of the White House in Washington. Similar sets have been installed in the homes of Harold L. Ickes, Secy. of the Interior, Ebert K. Bulew, Acting Secy. of the Interior, & Marvin H. McIntyre, Secy. to the President, Amer. Television states.

G-E Active in Telly Field

Dr. W. R. G. Baker, chairman of the management committee of General Electric's radio & television division, revealed that G-E has been working with telly since 1927; that the art was still in the lab in '36; that it has been developed to the point where the public may help its growth during the past 2 yrs.

Primary problem is to convince public that present telly will not present an instantaneous news-of-the-world service on a 3 x 4 ft. screen, he says. And adds that formation of nets, coverage of country by limited-range stations, production of & payment for programs are also major headaches.

He says that 10,000 sets have been sold in Britain in 2 yrs. This seems optimistic to RTD whose figures indicate actual sales to be 1/5 to 1/3 that great. (See picture, page 545.)

Du Mont Sells 100 Sets

That interest in telly is booming in U.S. is proven in many ways—one of which is that Allen B. Du Mont Labs. claim to have sold over 100 receivers in N.Y. area alone. These are 21-tube sets using the 14-in. C.-R. tube which produces an 8 x 10 in. black & white image, with accompanying sound.

Table model lists at \$395; console using same chassis, at \$445.

Facsimile Facts

Facsimile, too, seems to be going places, though it does not appear to have capti-

vated the public fancy as has television.

Exhibit A. The Finch Telecommunications Labs. announce that 10 fancy stations are now on the air, with 6 more licensed & soon to start transmissions.

Exhibit B. The Crosley Corp. is strongly rumored to be readying a fancy reception kit and/or set for Spring release.

Exhibit C. Bruno Labs. of N.Y.C. have taken a Finch license, & will market a low-price fancy receiver kit this spring.

Exhibit D. RCA is active in the field. For example, WTMJ (Milwaukee Journal) & KSD (St. Louis Post-Dispatch) are on the air with RCA fancy transmitters.

PERSONAL

(Continued from page 546)

J. I. CORNELL has been appointed chief engineer of Solar Mfg. Co., of N.Y.C. & Bayonne, N. J. He was formerly their consulting & field engineer; before that was with Magnavox, RCA, & G-E.

HAL PAULEY, sales mgr. of Pauley-James Corp., of Chicago, back from a trip to Phila. & N.Y.C., reports big advance orders on push-pull vibrators.

ROBERT A. JONES is now Asst. Engineer of G-E's N.Y. district. W. C. PLUMER, of the co.'s Newark, N.J., office replaces Jones at Buffalo, while L. F. STONE becomes engineer at Newark. T. F. BARTON, district engineer of the N.Y. district, has been promoted to asst. managership of the same division.

WILFRID E. JOHNSON, G-E's 33-yr.-old design engineer, won the American Society for Mechanical Engineers' gold medal for outstanding achievement.

FREDERICK R. LACK, director of vacuum tube development at Bell Labs., has been made General Commercial Engineer of Western Electric Co.

DONALD MACGREGOR gave up being V-P & Gen. Mgr. of that Penna. cabinet plant to become Treas. & Gen. Mgr. of Webster Co., Chi.

\$'s & No.'s Dept.

(Continued from page 546)

report, which showed 50.6% under same mo. in '37. Pay-rolls were 55% down. Average weekly earnings were down 8.8% to \$21.20, average hourly wage being 59½c.

207,993 STOCKHOLDERS got a dividend of 20c a share from G-E for the 4th ¼ of '38.

FOOTBALL WON 35% of all set owners as listeners in all cities where games were broadcast in '38. When season opened, only 24.3% listened; when it closed, 44% were going collegiate every Sat.

EXPORTS OFF 36% in Sept. '38, as compared with '37. Breakdown shows:—

Item	'38	'37
Sets (No.)	37,385	56,735
Sets (Value)	\$876,691	\$1,502,753
Tubes (No.)	474,716	765,200
Tubes (Value)	\$198,402	\$328,143
Speakers (No.)	31,529	31,596
Speakers (Value)	\$47,437	\$67,258
Parts, etc.	\$484,203	\$740,237
Xmnt equip.	\$207,211	\$195,504

TOTAL \$1,813,944 \$2,833,895

TAXES BEAR OUT above story, collections on radio & phono units for Oct. '38 being \$465,932—or 47% below '37. For first 10 mo. of '38 collections were 38% below '37—or \$3,270,929. Taxes are 5% of biz, so there must have been a few sales.

RADIO TRADE DIGEST

CANADIAN BIZ also off; first 9 mo. of '38 showed 138,322 sets sold for \$10,233,857, as against 148,026 sets for \$12,552,881 in same mos. of '37.

NETWORK BILLINGS were better than ever in Nov. NBC billed \$3,899,915—15.3% more than same mo. of '37. First 11 mo. of '38 brought in \$37,576,603—7.3% above same period of '37. CBS took in \$2,453,210—7.6% under Nov. '37. Total for 11 mo. was \$24,816,337—4.3% below '37. MBS earned \$360,929 in Nov.—up 39.7% over '37. And in the 11 mo. took \$2,582,955—29.6% better than '37.

ZENITH EARNED 4 times as much in 3 mo. ending Oct. 31 as in 3 preceding mo., the take being \$523,477. But the 1st 6 mo. of '38 were not so good, showing \$648,382—about 17% under same period of '37.

1939 BETTER, according to 22 13-wk. contracts signed by NBC indicating that revenue will be far ahead of 1st 4 mo. of '38. Renewals, as announced in Dec., show nearly 2 1/2 million in renewals.

RED BEATS BLUE, in NBC nets, former taking \$2,872,588; latter, \$901,376, in Oct. Combined total was 13% over same mo. in '37.

TUBE TAX EXEMPTIONS OFF

(Continued from page 547)

radio excise tax, when sold to mfrs. for use in their sets intended for resale.

Mr. Helvering's letter said, in part:

The Bureau of Internal Revenue now holds that tubes and speakers may no longer be sold by the manufacturers thereof tax-free under certificate for use as material or as component parts in the manufacture or production of radio chassis, and manufacturers of tubes may not sell such articles tax-free under certificate for use as material or as component parts in the manufacture or production of power packs or amplifiers.

Manufacturers of tubes and speakers must pay the tax on their sales of such articles, and manufacturers of the other radio components specifically enumerated in the statute with which tubes and speakers are used, will not be permitted to take credit against their tax liability for tax reimbursed to manufacturers of tubes and speakers.

If a radio manufacturer produces a set by assembling radio components purchased tax paid with those of his own manufacture and sells the complete set for a lump sum, tax attaches to such lump sum unless the sale price of the radio components of his own manufacture is stated as a separate item on the invoice to his customer or unless such sale price can be established by adequate records to the satisfaction of the Commissioner.

The only exception to the ruling stated above is in the case of automobile radio receiving sets.

Further details may be had from Mr. Helvering, at the Bureau of Internal Revenue, Washington, D. C.

OFF THE PRESS

(Continued from page 547)

1939 CONDENSER CATALOG. Sprague Prods. Co., North Adams, Mass. 16 pp. Complete line of mfr.'s condensers; exact-duplicate replacement charts.

CONDENSER CATALOG NO. 161. Cornell-Dubilier Electric Corp., South Plainfield, N. J. Describes new line of TQ transmitting condensers.

CONDENSER CATALOG 165A. Same. 12 pp. Consolidates info in Cat. No. 161. Data on entire C-D line.

(Continued on following page)

**Bakelite
V. C.
Form
1 1/2
Inches

Power
Handling
15 Watts**

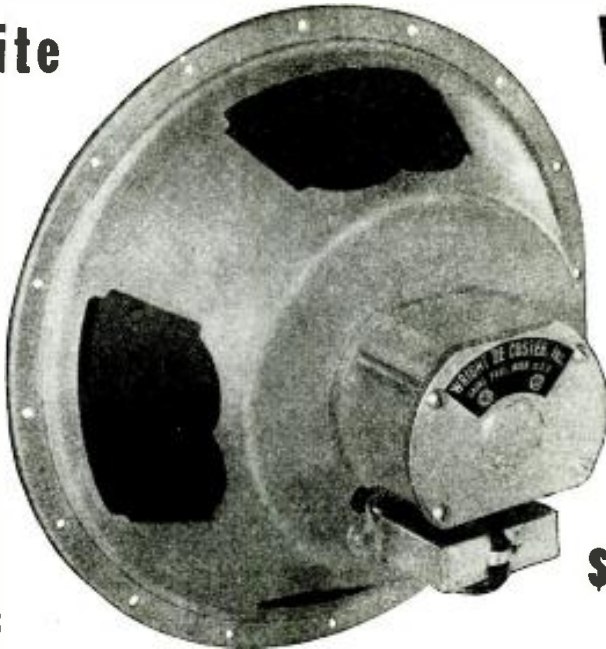

**Weight
of
Magnet
40
OZ.

List
Price
\$12.00**

**N12XL Special 12" Nokoil
Line Trans. 500, 1000, 1500 Ohms
Also N10XL-10" \$11.00 — N8XL-8" \$10.00**

Is your distributor keeping you in touch with these fast selling items?

Those Who Know Quality Demand Wright-DeCoster
Write for New RED Catalog

WRIGHT - DE COSTER, Inc.

2251 University Ave.
ST. PAUL, MINN.

**Own a PRECISION 900A
TUBE and SET TESTER!**



**Your National Union Jobber Will
Give You One If You Buy 34 N.U.
Tubes and/or Condensers per Month**

**TESTS NEW LOKTAL and
SINGLE ENDED TUBES**

In the model 900A, Precision has made for you a most complete modern push button operated dynamic mutual conductance tube tester combined with a 25 multi-range AC and DC volt-ohm-decibel-milliammeter plus a ten ampere range for complete point to point set analysis. This grand instrument also tests ballast units, gas rectifier tubes and magic eye tubes. It's the kind of a scientific device you need to handle more work—make more profits. Go to your National Union jobber, ask him to let you read the complete specification of this set-tube tester.

HERE'S HOW YOU GET ONE!

Your National Union jobber will give you one of these fine new Precision model 900A Tube Testers if you will contract with him to purchase 25 National Union tubes and/or electrolytic condensers now, 31 each month for twenty-two months and 27 in the twenty-fourth month which concludes your two year contract. You place a small deposit when you sign the contract and get it back as a merchandise credit as soon as the total number of tube and/or condenser points have been earned. Why not get one right away, see your jobber, sign up and the instrument is shipped to you immediately—you have full use of it all during the time you are fulfilling your purchasing agreement. If you don't know who your nearest N.U. jobber is, send a coupon today!

**Come on!
Build Customer
Confidence
with
NATIONAL UNION
TUBES and CONDENSERS**

NATIONAL UNION RADIO CORP.
Newark, New Jersey

Who is my nearest N.U. jobber?

Name

Street

City State

RC-339

RADIO COURSES

New Classes Now Starting
RADIO OPERATING—BROADCASTING
● RADIO SERVICING — a practical course
● RADIO AMATEUR CODE ● TELEVISION
● ELECTRONICS—1 yr. day course 2 yrs. eve.
Day and Evening Classes. Booklet Upon Request.
New York Y. M. C. A. Schools
4 W. 64th Street New York City

**PHILCO PARTS
FOR DEALERS AND SERVICEMEN**

FAST SHIPMENTS made anywhere. Genuine Philco Parts and Tubes.
Send 10c postage for Philco **REPLACEMENT PARTS BOOK.**

Catalogue sent **FREE**

WILLIAMS PHILCO Inc.

604 S. ADAMS ST. PEORIA, ILL.

Please Say That You Saw It in RADIO-CRAFT

You Can be a RADIO NOISE DOCTOR



Tackle today's major radio servicing problem — background noises. Due to more appliances in use, and growing sensitivity of all-wave sets, it's a "natural."

AEROVOX provides solution. Six perfected types of noise eliminators. Handy analyzer (above) tells which type to use, and how to apply.

Ask local AEROVOX jobber about these money-making aids. Try one. You'll be amazed. And don't pass up those extra dollars!



Radio Men Find This Book Handy

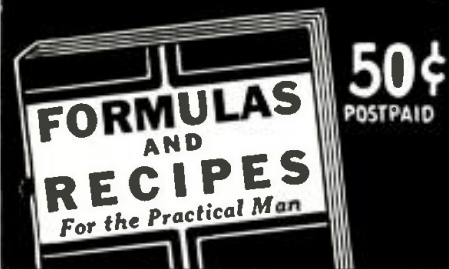

Here Is the Contents of the Book

1. Adhesives: Glues, Cements, Gums, Mucilages. Lubricants 2. Cleansing: Stain Removers, Paint Removers, Bleaches, Cleaning Fluids. 3. Metal Craft: Coloring, Oxidizing, Plating, Repairing, Welding, Polishes, Alloys, Solders, Amalgams. 4. Paints: Colors, Stains, Varnishes, Enamels, Luminous Paint, Washable Paint; Paint Removing, Waterproofing, Fireproofing. 5. Glass Working: Cutting, Drilling, Boring, Bending, Blowing, Etching, Engraving, Frosting, Silvering, etc. 6. Wood-craft: Fillers, Fireproofing, Acid-proofing, Waterproofing, Furniture Polishes, Finishes, etc. 7. Inks: Recipes, Eradicators, Ink Stain Removers, Special Inks, Colored, Indelible, Sympathetic, Invisible, Hectograph. 8. Photography: Developers, Emulsions, Fixers, Sensitizing, Toning, Printing, Photographic Paper, Blueprint Paper, 9. Antidotes for Poisons, Remedies for Burns and Scalds, Disinfectants, First-Aid in Accidents, Emergency Remedies, Home Remedies. 10. Preparation, Manipulation, Handling, Mixing, Measuring, Weighing, Filtering, Straining Solutions; List of Technical Substances; Emulsifying; Use of Hydrometer, Use of Thermometer; Tables of Weights and Measures, Decimal Systems, Useful Tables

TECHNIFAX, Division RC-339
560 W. Washington Blvd., Chicago, Illinois

TECHNIFAX, Division RC-339
560 W. Washington Blvd., Chicago, Illinois
Gentlemen: Enclosed please find 50c (check, money order, coin or unused U.S. stamps accepted) for which send me POSTAGE PREPAID, One Copy of FORMULAS AND RECIPES For the Practical Man.

Name

Address

City State

RADIO TRADE DIGEST

OFF THE PRESS

(Continued from preceding page)

RADIO BATTERIES. B. F. Goodrich Co., Akron, O. 2 pp. Specifications on 2- & 6-volt storage "A" batteries.

MASTER CATALOG. Wholesale Radio Service Co., N.Y.C. 188 pp. Includes 50 coordinated sound systems, 40 amplifiers, about 60 receivers, 88 pp. of parts & service equip't, 40 pp. of cameras & supplies; 8 pp. of special bargains.

CATALOG NO. 200. Insulite Corp. of Amer., N.Y.C. 40 pp. Lists parts, accessories, tools, etc.

MEISSNER CATALOG. Meissner Mfg. Co., Mt. Carmel, Ill. 44 pp. Confidential net prices on kits & parts.

REPLACEMENT TRANSFORMER CATALOG R-3. Kenyon Transformer Co., N.Y.C. 4 pp. Tabular listing of transformers for all purposes.

BOOKLET (in preparation). Television Training Corp., N.Y.C. Describes \$275 Evening (twice weekly for 1 yr.) Course, & \$300 Day (5 times weekly for 9 mo.) Course.

RADIO BUILDER'S HANDBOOK. Allied Radio Corp., Chicago, Ill. 38 pp. Basic radio & constructional info; parts lists, diagrams, & detailed instructions for building several sets.

1939 CATALOG. Allen B. Du Mont Labs., Passaic, N. J. Lists C-R. tubes, oscillographs, oscilloscopes, electronic switch, telly demonstration equip't, rectifiers, etc.

1939 PROFIT GUIDE. Radolek Co., Chicago, Ill. Catalogs 12,000 radio items & electric appliances.

PERIODICALS

SYLVANIA NEWS. Vol. 7, No. 12. Hygrade Sylvania Corp., Emporium, Penna.

TERMINAL RADIOGRAM. Terminal Radio Corp., N.Y.C.

RADIO ENGINEER. Vol. 1, No. 5. Commercial Radio Equipment Co., Kansas City, Mo. Much data on W9XA.

OHMITE NEWS. Nov. issue. Ohmite Mfg. Co., Chicago, Ill. Includes biog. of Steinmetz.

OHMITE NEWS. Dec. issue. Same. Includes biog. of Joule.

WESTON POINTER. Vol. 1, No. 2. Weston Electrical Inst. Co., Newark, N. J. Includes sheet on new V.-T. voltmeter, & 2 oscillators.

BULLETIN. Vol. 4, No. 2. Assoc. Radio Technicians of B.C., Vancouver, B.C. Includes incomplete reviews of several service pubs.; omits *Radio-Craft* (including several good money-making stories).

WORLD NEWS. Vol. 6, No. 1. World Bestg. System, N.Y.C.

PHILCO RADIO STAR ALBUM. Philco, Phila., Penna. 16 pp. Pictures 144 bestrs; logs best & principal foreign S.-W. stations.

PHILCO RADIO LOG. Same. 10 pp. Alphabetical index of Amer., Mex., Canadian & Cuban stations; foreign S.-W. stations, & bestg hrs.

RETAIL SALESMAN'S HANDBOOK. Same. 44 pp. Outlines features of all sets in mfr.'s '39 line.

AN EDITORIAL

(Continued from page 547)

before. This trend has been substantiated by the tremendous number of new turntables that have found their way into homes. Combination radio-Victrolas, of both table and console type, record-playing attachments and portables have been purchased by the public in the greatest volume of many years. Tens of thousands of turntables were distributed through the Victor Record Society Plan alone. These latter instruments will naturally become a replacement market for the larger and more efficient record reproducers found in the higher priced combinations.

While public demand for recorded music has been increasing steadily, distribution has lagged far behind. There are still too many sections in the country where it is yet too difficult for the public to purchase records. That is one of the big jobs ahead in 1939—to make it easier for the public to get the recorded music it craves, whether of the "popular" or the "classical" types. Therein, too, lies a big profit-making opportunity for retail dealers.

The year just brought to a close has demonstrated that the public is in the market for a combination phono-radio costing over a hundred dollars, if the value is there. In fact, there are strong indications that during the coming year it will be difficult to sell any radio set for over a hundred dollars, unless it

also has a good record reproducing system. The smart retail merchandiser will concentrate his efforts on this potential market for higher unit sales to compensate for reduction in higher priced console radio sales.

During the year, the sound amplification (so-called "Public Address"—*Ed.*) market underwent further expansion. New applications for sound reinforcement and distribution are constantly being discovered, as industry and educational institutions are awakened to the value of sound. The business potentialities in this field are, in my opinion, still largely unrealized. The field of sound amplification offers exceptional opportunity for those who are willing to put forth the required effort.

SNOOPS & SCOOPS

(Continued from page 548)

(for jobbers, dealers, Servicemen) . . .

Ho-hum, now it's 166 stations in the NBC web . . . What the Aussies can't understand is how America makes sets so good & so cheap . . . (It's mass production, cully!) . . .

RCA's new internal-loop (antennaless), battery-operated set achieves complete portability. Such sets are a novelty today, but were common enough 10-15 yrs. ago . . .

New auto item is special car-to-trailer interphone—a good sideline for Servicemen . . . When you go to see Connie Bennett in "Topper Takes a Trip," watch for the scene featuring *Philco* Mystery Control—clever publicity, that . . .

Jan. 13 was the day winning RCA distribs & their wives met at the Camden plant, toured it, were fed an Oscar-

Please Say That You Saw It in RADIO-CRAFT

RADIO TRADE DIGEST

of-the-Waldorf dinner, saw "Hellzapoppin'," attended a Toscanini & a Magic Key best, saw a special telly demonstration. . . . Radio-Craft expects to scoop the field next month, with a story on Hammond Organ's new 175-tube "Novachorde" electronic musical instrument. Long-life tube operation and other developments practically eliminate tubes as a service problem. Installation though will be a profitable new field for Servicemen. . . .

Lafayette Mystery Record Player, announced by Wholesale Radio Service, plays records through your radio—without wire connections. . . . Will there be more transcriptions on CBS since the net took over an 80% ownership of Amer. Record Corp.? . . . RCA sound systems have been installed by Franklin K. Lane H.S. in N.Y.C., U. of Ill. stadium, Urbana, Ill., Marine Gardens, Fla.; radio system at the Baranoff Hotel, Juneau, Alaska.

Consolidated Edison is pushing sun lamps & electric blankets to fill-in the after-Xmas low spot on the sales curve. . . . Sprague is out with a full line of Dual Atoms with common neg leads. . . . If you want more dope on the Finch facsy electro-optical system, you can get it out of U. S. Patent 2,136,789. . . . J.F.D. Mfg. Co., Brooklyn, N. Y., offers a coded dial belt chart—a line of 3 ballasts which will replace 800 older types. . . .

Amer. Transformer Corp. denies all knowledge of rumored contract to handle engineering for rumored \$60,000,000 nat'l radio & telly net. . . . RTD's guess is that the net will turn out to be a chain of relay stations to spread telly-with-sound all over the U.S.—& that it will be an offshoot of an existing co. . . . The Turner Co. has quit making amplifiers & inter-office equip't, to concentrate on their mike line.

NEW TRADE TREATY LEAVES RADIO COLD

(Continued from page 548)

tive Jan. 1 for 3 years, while the Canadian treaty revises the previous agreement of 1935 and equalizes U.S. and Canadian radio tariffs.

American concessions in the new treaty with the United Kingdom include a reduction of the American radio tariff from 35 to 25% *ad valorem*. The British tariff is reduced from 33-1/3 to 25% on American amplifiers, loudspeakers, and radio-combination sets. The Canadian agreement makes no changes in existing radio rates applicable to American radio. The British treaty does not apply to Australia, New Zealand, Africa, Ireland, and other minor British possessions.

NEW IMPORT SERVICE

Radelma Co., of 126 Liberty St., N.Y.C., has inaugurated a special buyers' service for foreign importers who lack American reps. The co. will handle on commission basis.

Radelma will handle Radio City Products Co. test equip't sales in Britain, Australia, Bulgaria, & several Latin-American countries and island possessions. The co. will also handle all foreign sales for the Hot Wire Co., electric fence controllers.

THE RSA MONTHLY BUGLE

(Continued from page 548)

Buffalo, N. Y., Chapter nominated officers for 1939. Present at the meeting was Clarence Redstone, Instructor at Buffalo Technical Institute, who gave another talk in his series on "Radio Service and Theory", Norman Schmeltz walked home with the membership prize money.

Boston, Mass., Chapter had Glenn Browning give a complete discourse on servicing with the 'scope and the vacuum-tube voltmeter. He explained alignment, A.V.C., A.F.C., checking all circuits and finding distortion, and alignment of remote control circuits. Many of the instruments used in the lecture were loaned by the H. Jappe Company. A gadget meeting was held in which all members of the chapter exchanged ideas on service instruments and service tricks. Two weeks later George Connors of Sylvania spoke.

So. New Hampshire Chapter's first meeting last month was devoted entirely to business. Many suggestions regarding advertising, handling of complaints, and the Treasurer's report were heard. Later Mr. Sawtelle gave a short talk on "Tubes", Mr. Sanborn instructed on the Radio Course. Other business was transacted concerning an advertising project.

Classification of Chicago Chapter membership is now going ahead at a rapid pace, according to reports by Harold Cunningham, Chairman of the Membership & Qualifications Committee. Members of this Committee visit all members to rather and compile info statistically into a well-prepared "Form-Questionnaire". Some of the minimum requirements for "qualified" membership are: business telephone, place accessible to the public, sales tax registration, and a minimum amount of equipment.

Metropolitan New York Chapter nominated officers for the ensuing year. At a lecture meeting George Conner, Commercial Engineer of Hygrade Sylvania Corp., illustrated methods of improving tone quality of ordinary radios by making minor changes in output circuits. The Dale Radio Company, tube distributors, supplied the Liquid and Solid.

Flint, Mich., Chapter, has almost a 100% membership among local Servicemen. It is in the midst of an advertising program using cooperative advertising and other means to let the public know that good service work can be had from RSA members. In laying out the program for 1939 all officers and members have pledged themselves to continued activity in behalf of the organization.

Steubenville, Ohio, Chapter, has compiled a complete list of meetings through the next 6 months and is working very closely with the National Office of RSA in order that a program of speakers may be had.

Alton, Ill., Chapter, heard Russ Lund explain "Dynamic Testing of Radio Receivers".

Washington, D. C., Chapter, voted 9 new members in. A Board of Directors was organized under the direction of President Joseph B. Austin, Jr. The Membership Committee, under the direction of Chairman Fred Bayhi, started its duties that evening.

Newark, N. J., Chapter, has scheduled 2 consecutive Service meetings to the discussion of "Complete Dynamic Testing" and the "14 point Dynamic check of receiver components and performance" as outlined by Kendall Clough of Clough-Brenkle. Sam M. Harper will deliver the lectures and demonstrations, as he did to the Westchester County, N. Y., group. (See multi-part tech. story on this topic in "R.-C."; Part III appears elsewhere in this issue.—Ed.)

SALES HELPS & DEALS

(Continued from page 546)

500 pieces of promotion material are in the special kits being supplied to RCA dealers to aid in a tube replacement campaign. Deal to public includes week's free trial of new tubes; money back if no improvement in reception. Indications are that \$500,000 in new biz will result.

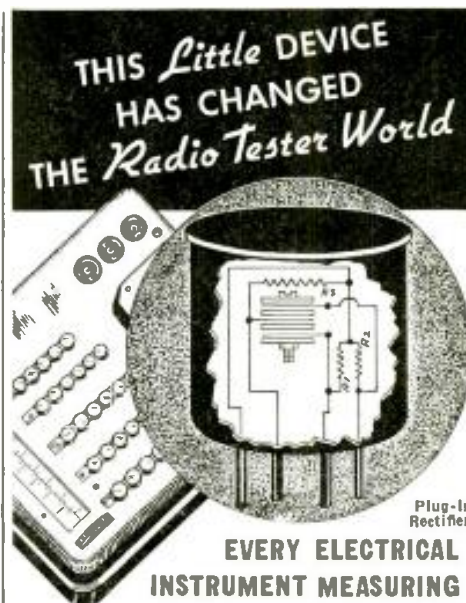

EVERY ELECTRICAL INSTRUMENT MEASURING A.C. VOLTAGES AT HIGH RESISTANCE SHOULD HAVE IT

• Previous Problem:

Deactivation of copper oxide rectifiers caused by overloads or by caustic gases or humid atmospheric conditions prevalent in every locality at some period of time has heretofore necessitated the complete recalibration of the tester on insertion of a new copper oxide rectifier. In most cases this meant return of the complete tester to the factory, with its attendant delay and expense.

• Triplet's Answer:

A plug-in unit incorporating a new copper oxide element precalibrated to a factory standard and thus when plugged into the tester gives you factory calibration. As simple as plugging in a tube. Obtainable through jobber or direct. Rectifier elements are the best units obtainable—completely sealed and for maximum protection against humidity and caustic gases. The great practicability of this little device has in truth changed the Radio Tester World.

THESE and OTHER **TRIPLET** MODELS have Plug-In RECTIFIERS



MODEL 1601 VOLT-OHM-MILLIAMMETER

Complete in Leatherette Case . . . DEALER NET PRICE \$49.33. In Metal Case, DEALER NET PRICE \$45.33.



MODEL 1611 PUSH-BUTTON TUBE TESTER AND VOLT-OHM-MILLIAMMETER

Complete . . . DEALER NET PRICE \$49.50.

SEE YOUR JOBBER—WRITE FOR CATALOG

THE TRIPLET ELECTRICAL INSTRUMENT CO.
163 HARMON AVE., BLUFFTON, OHIO



RADIO'S LATEST MIKE IS "CARDIOID DIRECTIONAL"

(Continued from page 522)

The average discrimination is 20 db. over the range from 40 to 10,000 cycles.

WIDE PICK-UP ZONE

Cardioid directional performance over the entire useful frequency range insures a practical, wide pick-up angle of 120° within which there is no change in quality and with barely a perceptible change in sensitivity; the 60° "wide pick-up zone" is represented in the polar diagram (right) as the angle 60°-0°-60°. The 220° "fading zone," 60°-180°-60°, is still useful for there is no quality change but it may become necessary to make a slight adjustment for the change in sensitivity. The two 30° zones, 60°-90°, have been designated "announcer's" because at this angle the ribbon element contributes very little to the total output and an "announcer" may talk close to the microphone without employing the "voice strap", for equalizing low-frequency boom on close-talking, generally provided in ribbon mikes. The 60° "dead zone", 150°-180°-150°, is broad, and the discrimination is just as good as that for 180° anywhere in this region.

HIGH OUTPUT LEVEL

The open-circuit output level is 84 db. below 1 volt/bar or 64 db. below 1 volt/10 bars. Terminated in its own impedance the power output level is 84 db. below .006-watt. In other words, the output level of the Cardioid Microphone (839A) is 4 to 5 db. higher than the well-known Eight Ball (630A) or Salt-Shaker (633A) Western Electric dynamic microphones and only 2 db. lower than the efficient 618A dynamic.

RUGGED, WINDPROOF

The components of the microphone are compactly assembled in a cast housing which is a combination wind screen for the ribbon unit, case for the dynamic unit, and terminal mounting, resulting in a compact and efficient instrument smaller than an ordinary "velocity" microphone alone of comparable output level. The overall height of the microphone including the plug terminal is 7½" and the weight is approximately 4½ lbs. The casing follows an aerodynamic motive, with bulbous front end.

Experience leaves no doubt that the dynamic unit can be subjected to all sorts of conditions of temperature, wind and shock. However, the delicate ribbon-type microphone has long been considered too frail to withstand even slight breezes without becoming noisy and in some cases failing altogether. The uniquely-shaped ribbon employed in the Cardioid mike introduces a new concept of the possibilities of ribbon structures. Wind noise is much lower than that normally encountered in previous designs, and therefore it may be used successfully in outdoor locations.

3 MICROPHONES IN 1

Since the pressure and pressure-gradient elements are separated mechanically, the choice of either unit individually instead of the combination is made possible by means of a simple switch. The slotted control shaft of the switch is set flush in the surface of the housing. The 3 positions are designated by the letters C (cardioid), D (dynamic), R (ribbon).

Experience and tests have shown that true cardioid directional performance is by far the most desirable of the 3 and will prove entirely satisfactory for the majority of pick-up conditions. Yet this new microphone may be immediately converted into either of the basic types should special occasion demand.

STUDIO USE

In the studio, the microphone placed with the "dead" zone backed against the wall will leave the center of the studio free for use. Echoes from this back wall will be suppressed. For example, in the case of a symphony orchestra, prominence will be given to the direct sound, so that the individuality of the instruments will not be lost. In other words, the quality of the reproduced sounds will be characterized by unusual definition of every instrument; the brasses, the woodwinds and the strings standing out in full naturalness, with the bass very rich and clear without being "boomy." It will be noted that the wide

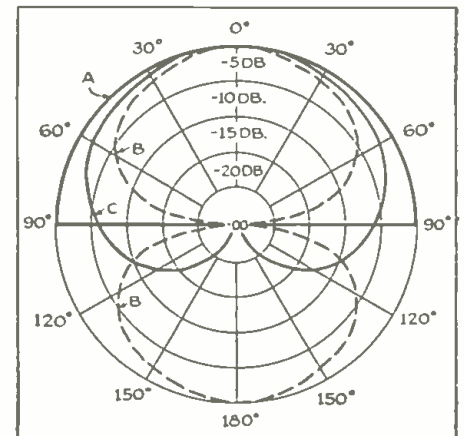

(a) Above, assumed ideal polar diagram of general-purpose directional microphone; (b) Bi-directional characteristic of the pressure-gradient microphone; (c) Cardioid-directional characteristic resulting from annulling one "loop" of a pressure-gradient unit with that of a pressure type.

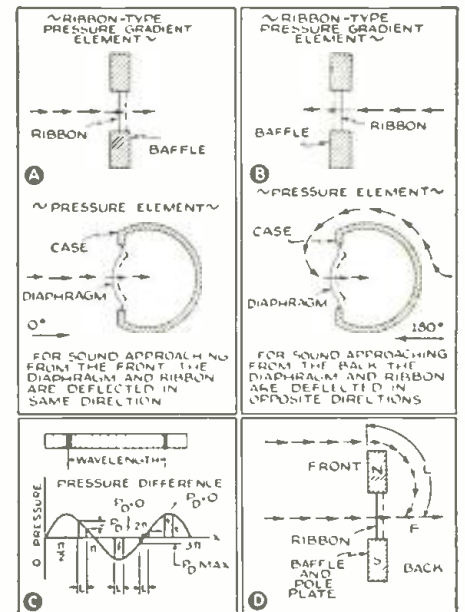

At A and B, above, principle of operation of the Cardioid directional microphone; at C and D, principles of operation of the ribbon-type mike. As shown at A and B, the diaphragm of the pressure element, because sound flows around corners always moves in the same direction regardless of direction of the sound; while, the ribbon of the pressure-gradient element reverses its direction of motion with reversal of sound direction. As shown at C, a pressure difference exists between 2 points in a sound wave. (NOTE that this difference will be zero at maximum and minimum pressure, and largest half-way in between, i.e., Pd is 90° OUT OF PHASE WITH THE PRESSURE); at D, a baffle is seen to introduce an acoustic-path difference, L, between front and back of ribbon (Pressure gradient = rate of change of pressure with distance = $\frac{Pd}{L}$ approx., if L is small compared with wavelength.).

WARDS offer TIME PAYMENTS on Everything!

Free!
WARDS NEW 1939 RADIO CATALOG

- ▼ Nationally Advertised Standard Merchandise
- ▼ Amateur Transmitters, Receivers and Parts
- ▼ Sound Systems of All Types
- ▼ Inter-Office Communication Systems
- ▼ Servicemen's Test Instruments and Equipment

WARDS offer not only the highest quality equipment—not only the lowest prices—but also the privilege of paying for this equipment "AS YOU USE IT" with Wards liberal Time Payment Plan! Every single article in Wards catalog can be purchased in this way, with terms as low as \$2 down and \$2 a month. Why deprive yourself the pleasure of owning the equipment you need, when it is so simple, so convenient, so economical to get it NOW. Remember Wards guarantee "Satisfaction or Your Money Back." Mail the coupon for Wards 1939 Radio Catalog today.

MONTGOMERY WARD
"9 GREAT MAIL ORDER HOUSES • 500 RETAIL STORES"

Free!
MAIL THIS COUPON NOW!

Please rush me Wards 1939 Radio Catalog

Name.....

Address.....

City..... State.....

DO NOT FAIL
to read the important announcement which appears on Page 516 of this issue. It is important news to everyone who is in the radio business.

SOLAR gives you **MORE** for your money

MINICAP

MINICAP +
RAY ELECTROLYTIC CONDENSER

Catalog upon request
SOLAR MFG. CORP., 599 Broadway, New York

Please Say That You Saw It in RADIO-CRAFT

pick-up zone, which applies vertically as well as horizontally, makes tilting of the microphone unnecessary. Because of the true cardioid directional performance, true balance of both lows and highs is assured under reverberant conditions.

THEATRE, AUDITORIUM AND P.A. USE

For theatre, auditorium and public address use, the cardioid mike is a "natural", for its directional characteristic automatically divides the audience from the stage. The announcer in most instances of music pick-up stands *alongside* a cardioid mike.

From a feedback angle, the Cardioid Directional Microphone will solve many troublesome problems in theatres, banquet halls and auditoriums. Since the microphone is directional at low frequencies down to the loudspeaker cut-off, by proper positioning of the microphone and loudspeakers feedback can be reduced to the tertiary form, that is, sound only may be fed back by reflection into the face of the microphone after successive reflection from the rear of the house *and* the back of the stage. With this condition, considerably

more sound reinforcement may be obtained.

The above applications of studio, theatre, auditorium and public address pick-up are of predominant importance. The sound engineer will find many further uses by taking advantage of any or all of them. In addition to its ability to handle varying situations and to provide control at the microphone, the new mike simplifies the existing microphone technique because of its truly cardioid characteristics over the frequency range of from 40 to 10,000 cycles.

To get good cardioid operation required making the ribbon and dynamic mikes small enough to permit placing them close together to minimize sound-wave phase differences. Using heavy ribbon metal and shaping it trough-like for nearly its full length reduced sensitivity to winds and increased the ruggedness; reduced D.C. resistance of the ribbon permitted higher transformer ratio, thus increasing the voltage step-up. In order to maintain directivity over approximately the full frequency range of 50 to 10,000 cycles an equalization network, tiny enough to be tucked into the housing, is introduced in the output circuits of the two elements before combination.

A Vote of Thanks:

We want to take this opportunity to thank the following manufacturers for the exceptional cooperation which made possible the many special constructional articles published in Radio-Craft during the past year.

We found that the many parts and test instruments which they made available to us stood up exceedingly well, even under the trying conditions of experimental construction work.

- | | |
|----------------------------------|------------------------------------|
| Aerovox Corp. | National Union Radio Corp. |
| Amperite Corp. | Philco Radio & Television Corp. |
| Amplifier Company of America | Radio City Products Company |
| Arcturus Radio Tube Company | Radio Corp. of America |
| Centralab | Readrite Meter Works |
| Cinaudagraph Corp. | Service Instruments, Inc. |
| ClaroStat Mfg. Company, Inc. | Solar Mfg. Corp. |
| Cornell-Dubilier Corp. | Sprague Products Company |
| Cornish Wire Company | Superior Instruments Company |
| General Electric Company | Supreme Instruments Corp. |
| Hammarlund Mfg. Company, Inc. | Test Equipment Company of America |
| Hygrade Sylvania Corp. | Triplett Electrical Instrument Co. |
| International Resistance Company | Weston Electrical Instrument Co. |
| P. R. Mallory and Company, Inc. | Wright-DeCoster, Inc. |
| Meissner Mfg. Company | |

HOW TO MAKE A METER-RANGE EXTENDER

(Continued from page 538)



This interior view of the Meter-Range Extender illustrates its simplicity. Note the chassis-mounting power transformer.

mail order radio jobber. (An idea of the total cost of the unit may be obtained by looking up the "mail order catalog" prices of the items in the following List of Parts. —Editor)

LIST OF PARTS

- One power transformer;
- One volume control, 10,000 ohms;
- One resistor, 25,000 ohms, 2 watts;
- One small knob;
- One wafer socket, 4-prong;
- One fixed condenser, 0.1-mf., 600 volts;
- One resistor, 5% type, 0.45-meg.;
- One chassis, drilled and punched;
- One triode tube, type '01;
- Two small brass bushings;
- Two tip-jacks
- Two combination binding posts;
- A.C. cord and plug.

This article has been prepared from data supplied by courtesy of Allied Radio Corp.

Please Say That You Saw It in RADIO-CRAFT

"It Sells tubes for me"
says a service man about

NEW RCA TUBE TESTER!

COSTS ONLY \$37.95
 Stock No. 156-A

Counter type RCA Tube Tester, Stock No. 156-A, net price, \$37.95. Also available in carrying case for portable use as Stock No. 156 — net price, \$39.95

This great new RCA Tube Tester helps you sell tubes! Proof of this is seen in the statements made by a service man in a recent letter to us:

"As one of the first to receive a new RCA Tube Tester I have noticed a very substantial increase in my tube sales...without the usual sales talk. Every customer is personally interested in the true condition of his radio tubes and since the average radio owner can easily understand the action of the RCA Tube Tester, he is entirely convinced that his tube is either bad or good, as the case may be. Actually he sells himself new tubes."

Amazingly simple to work, the new RCA Tube Tester offers a score of outstanding features at low cost. Full details from your RCA parts distributor.

Listen to the Magic Key every Sunday, 2 to 3 P. M., E. S. T., on the NBC Blue Network. For finer radio performance — RCA Radio Tubes.



COMPLETE STEP-BY-STEP DYNAMIC SERVICING

(Continued from page 541)

If the curves appear to be just alike but are not coincidental at any point, it means that while good curve shape has been attained, the I.F. system is aligned slightly off frequency. See Fig. 4K.

Always work toward getting the peaks into line first and then go back over the trimmers to make any possible improvement in lining up the skirts without disturbing the peaks. Some receivers, due to peculiarities of design, will not come into line perfectly throughout the length of the curve.

While touching up the adjustment, also see what can be done to *broaden the curve at the nose* without loss of height of the pattern. This will result in better fidelity and easier tuning for the customer. See Fig. 4L. Here the dotted line is ideal band-pass selectivity curve. The solid line is finally aligned I.F. amplifier. Note that curve is a single line, indicating that it is correctly tuned to the frequency, and symmetrical. Make it as broad as possible between arrows.

Go over the trimmers several times, noting the effect of each trimmer on the curve characteristics, but never reset an adjustment in such manner that vertical amplitude is lost or the *peaks* of the curve thrown out of alignment with each other.

MAINTAINING CORRECT INPUT

As the correct adjustment is approached, the input to the receiver should be reduced to compensate for the increased sensitivity of the I.F. system. This is done by lowering the settings of both the Signal Generator attenuator and the R.F. MULTIPLIER dial on the oscilloscope.

If this is not done, one or more of the I.F. stages is apt to be overloaded, so that the pattern will be distorted through flat-topping as in Fig. 4N, or it will show tilted feet as in Fig. 4M.

If a "high-fidelity" switch controls I.F. coil coupling, throw it to Broad-Band position. The pattern should broaden and be essentially symmetrical. If not, the trimmers may be touched up a little, while flipping the switch back to the Sharp position each time to see that the original selectivity curve has not been adversely affected.

In receivers having A.F.C. circuits of the type of Fig. 4G, where the A.F. and A.V.C. are taken off the same diode as the A.F.C., it will be found that the trimmer on the center-tapped discriminator circuit must be tuned for a minimum amplitude pattern in order to get the correct curve shape.

In receivers using a separate diode for A.F.C., the foregoing will not be true. In fact, the alignment of the discriminator should be passed over entirely at this point and taken care of later according to Sect. 5.

DEFECTIVE PATTERNS AND THEIR CORRECTION

Figure 4P indicates *Phase-Distortion* in the output circuit. Review the principles under the subhead "Connecting the Vertical Circuit to the Radio Receivers" and correct the circuit defect.

In Fig. 4Q *fuzzy or solid pattern* shows intermediate frequency getting through to the VERTICAL plates of the oscilloscope. Remedy: increase the capacity from "V" to chassis, or connect an R.F. choke in series with the VERT. lead.

In Fig. 4R *superimposed traces on the pattern* may be pick-up from a local broadcast station, or noise being picked up by the receiver. The remedy in the first case is to tune the receiver dial to another frequency. If due to noise pick-up, increase the input to the receiver and turn down the vertical amplifier control.

CORRECTION in Part II

The captions of these patterns, published on page 468, Feb., 1939, were transposed. They are reprinted below—correctly.

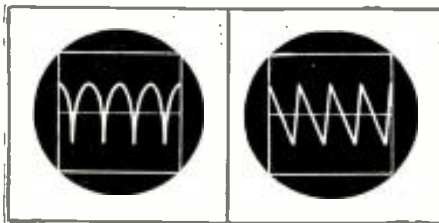

Fig. 2C. Correct pattern, full-wave, choke input.

Fig. 2B. Correct pattern, full-wave rectifier, condenser input.

Figure 4S shows *two unsymmetrical curves* which cannot be brought to coincidence with any adjustment. Cause: regeneration. Look for an open plate or screen-grid bypass condenser.

USING AN ANTI-CAPACITY DEMODULATOR

In cathode-ray alignment, the best and fastest procedure is to connect to the output of the 2nd-detector and to work from the last I.F. grid in the receiver toward the antenna.

Sometimes, however, because of a fault in one of the R.F. or I.F. stages, it may be desirable to apply the Oscilloscope at some point preceding the 2nd-detector.

An *anti-capacity demodulator* permits this without upsetting the alignment of the stage to which it is connected. Through correctly bringing the demodulator into the receiver circuit instead of extending the receiver circuit to the demodulator, the high-capacity effect of long test leads at radio and intermediate frequencies is avoided.

In effect, applying the demodulator is equivalent to moving forward the 2nd-detector of the receiver, without appreciable disturbance of the circuit constants.

The shielded 6H6 Duplex Diode of the demodulator (C-B model 147) is energized by a small shielded filament transformer.

Clip the blue lead to the grid circuit following the stage selected for test, and clip the braided lead to the receiver chassis.

Connect the long shielded leads to the VERT. input of the oscilloscope, with the black lead to GND.

NOTE: Remove the grid cap of the tube following the stage to be checked.

PROCEDURE

With the above connections made, proceed in the usual fashion to align the stages ahead of the point of application of the demodulator until the fault on misalignment has been located. After the fault has been corrected, and the demodulator disconnected, connect the 2nd-detector to the VERT. input of the oscilloscope and make final alignment in the usual manner.

TABLE I

Commonly used frequencies and the correct settings of the signal generator (see text)

Want	Set	Want	Set	Want	Set
55	1595	345	1305	1500	3150
92	1568	350	1300	1525	3175
100	1550	370	1280	1550	3200
107	1543	410	1240	1710	3360
110	1540	427	1223	1720	3370
115	1535	445	1205	1730	3380
120	1530	450	1200	1800	3450
125	1525	455	1195		Me.
130	1520	456	1194	2.0	3.65
132	1518	460	1190	2.4	3.99
140	1510	465	1185	2.44	4.09
145	1505	470	1180	2.5	4.15
150	1500	472.5	1177.5	3.6	5.25
160	1490	477.5	1172.5	3.7	5.35
165	1485	480	1170	3.9	5.55
172.5	1477.5	482.5	1167.5	4.0	5.65
175	1475	485	1165	4.2	5.85
177.5	1472.5	490	1160	4.5	6.15
180	1470	500	1150	5.16	6.81
181.5	1468.5	517.5	1132.5	5.2	6.85
182.5	1467.5	525	1125	6.0	7.65
200	1450	535	1115	8.0	9.65
206	1444	550	1100	9.0	10.65
230	1420	570	1080	10.0	11.65
235	1415	600	1050	10.8	12.45
240	1410	650	1000	11.0	12.65
250	1400	700	950	12.0	13.65
252.5	1397.5	800	850	15.0	16.65
260	1390	950	700	18.0	19.65
262	1388	1000	650	20.0	21.65
262.5	1387.5	1200	2850	21.6	23.25
264	1386	1400	3050	22.0	23.65
265	1385	1425	3075	24.0	25.65

Don't miss Part 4, the next installment.

This article has been prepared from data supplied by courtesy of Clough-Brengle Co.

THANKS FOR THE ORCHID

To the Editor:

I want to congratulate you on your "Marconi—Father of Radio?" story by Commander Loftin in January Radio-Craft.

This story of the real unbiased facts concerning the creative origins of radio by a man eminently fitted to give them, and who has no axe of any kind to grind, has been long, long overdue the public.

The "Marconi—Father of Radio" myth has been long and so thoroughly promulgated and propagandized by large interests (with very large axes to grind) that the layman and even many radio men take it for gospel truth.

All credit to you for publishing it and a debt of thanks to Commander Loftin for his courage!

It's a pity this story can't be dramatized and presented to every radio listener throughout the country, who for all these years, has been thanking false gods for his broadcast blessings. You or your readers may have interest in the fact that Chapter V of my book "Radio Dynamics" (published in 1916 and long out of print), is devoted to a precisely similar account of the early creative history of radio.

Very truly yours,

B. F. MIESSNER

Miessner Inventions, Inc.,
18 Main Street,
Millburn, N. J.

MARCH "RADIO & TELEVISION" FEATURES

- The Voder Creates Human Speech
- Television Prepares For Its Debut
- The Switched-Coil 4 Receiver—Raymond P. Adams
- One-Meter Reception With Ordinary Tubes—Nelson Haas and Carl Erbacher
- A Universal Frequency Meter for the "Ham"—Herman A. Yellin, W2AJL
- New Electronic Television Course—J. Francis Dusek
- Roster of New Licensed "Hams"
- Accurate List of "World Short-Wave Stations"

EFFECT OF A.C. ON DRY ELECTROLYTICS

(Continued from page 531)

will acquire an "anodic film." The thickness of this film will be proportional to the magnitude of the positive polarizing potential. Due to the fact that, in modern practice, the cathode plate is always of aluminum and therefore film-forming, the cathode plate acquires an anodic or dielectric film.

As soon as the surface of the cathode plate acquires this anodic film the entire condenser changes from the original polarized structure to a semi- or non-polarized structure and the result, electrically, is that we now have 2 capacities in series. This condition may be represented by the circuit diagram in Fig. 2.

INTERNAL CAPACITIES

In this diagram C_1 represents the initial capacity of the condenser and the capacity of the anode plate and electrolyte while C_2 represents the capacity of the cathode plate and the electrolyte. The resistance of the electrolyte path from (a) to (b), in Fig. 1, is represented as R.

As 2 capacities in series now exist, the total capacity of the entire structure becomes less than the original capacity as represented by C_1 . The new capacity value

$$\text{is then equal to } \frac{C_1 C_2}{C_1 + C_2}$$

As the capacity of an electrolytic condenser is proportional to the area of the surface of the anode and the thickness of the dielectric or anodic film, and the thickness of the dielectric film is proportional to the magnitude of the anodic polarizing potential, then the value of C_2 must be proportional to the value of the anodic polarizing potential applied to the cathode plate. From this it can be seen that, the higher the value of such a potential applied to the cathode plate, the less will be the value of C_2 and therefore the greater the reduction in over-all capacity of the entire structure.

Where the anode and cathode plates of a dry electrolytic condenser structure are both of plain-surface aluminum foil, alternating current of considerable magnitude may be passed through the condenser without causing a materially detrimental reduction in initial capacity values. To illustrate the actual effect, reference is made to curve A in Fig. 3.

Curve A.—In this curve, the values of resultant capacity are plotted against peak values of superimposed alternating current potential. The condenser used for illustrative purposes is a 10 mf., 150 working volt type.

If, in a 10 mf. 150 working-volt structure, an etched-surface anode is employed, the actual surface area of the anode remains the same but its physical size is re-

duced. Such a reduction in physical size results in a corresponding reduction in the physical size of the cathode plate. Due, however, to the fact that the cathode plate is of plain surface a reduction in surface area is also obtained. If, for example, the etched anode plate has a surface area increase or gain of 5 times that of plain foil, the actual surface area of the cathode plate will be reduced 5 times. In the etched plate structure therefore, for a given applied alternating current potential the value of C_2 (in Fig. 2) will be reduced to 1/5th the value of capacity obtained with the plain foil condenser structure. To illustrate the over-all effect of this condition, reference is made to curve B in Fig. 3.

Curve B.—In curve B, the resultant values of over-all capacity are again plotted against peak values of superimposed alternating current potential.

It should be obvious by this time that should a 10 mf., 150 working-volt structure be fabricated with an anode having a surface area gain of, say 10 times, the effective reduction in original capacity value will be proportionately greater for any given value of superimposed alternating current potential. See Fig. 3, curve C.

Curve C.—It can be seen that, with the higher anode surface area gain structures, a material reduction in original capacity values will result from superimposed alternating current potentials of appreciable magnitude.

Such a condition may frequently be serious in radio receiver circuits in the form of (1) increased hum due to reduced capacity in filter circuit applications and (2) instability due to increased impedance values in bypass applications of dry electrolytic condensers.

There is a remedy, however, in the form of two procedures which insure more stability of initial capacity values.

HOW TO STABILIZE CAPACITIES

(1) The first and most practical is to employ a cathode plate which is etched or otherwise treated so that its surface area is equal to that of the anode plate. When this condition is obtained the effective reduction in initial capacity value becomes the same as is graphically shown in curve A. If the cathode surface area is greater than the anode surface area the capacity stability of the condenser structure will be proportionately even greater than the relationship shown in curve A. This procedure causes but a slight increase in physical size and cost of a given condenser structure.

(2) The other method of insuring capacity stability is to initially form the cathode plate with an anodic film to a potential equal or greater than the maximum peak potential of the superimposed alternating current component which will actually be encountered in the intended condenser application. This procedure naturally necessitates the use of an increased area of both anode and cathode surfaces to the extent

that the relationship $\frac{C_1 C_2}{C_1 + C_2}$ equals the

desired capacity value. Such a resulting semi- or non-polarized condenser structure will give absolute stability of initial capacity values but requires a material increase in physical size and cost.

It is hoped that this article will help shed some light on a subject that may not have been clearly understood by some Servicemen, design engineers and others equally interested.

This article has been prepared from data supplied by courtesy of Cornell-Dubilier Electric Corp.

More Business for you
WITH THE C-D LINE OF
Quietone
RADIO
INTERFERENCE FILTERS

REG. U.S. PAT. OFF.



HERE'S a new profit opportunity for you! Every modern home can use C-D QUIETONE RADIO INTERFERENCE FILTERS. Every service call will hold additional business for you when you demonstrate Quietone Filters.

C-D offers this line of practical, efficient devices, scientifically designed to eliminate radio and electrical disturbances. Wherever there's a washing machine, refrigerator, oil burner, electric shaver or appliance in the home—or outside power lines to interfere with radio reception, there's a need for Quietone. And there's a Quietone unit designed to meet every need. Talk Quietone to your customers.

Show it—sell it!

Investigate the money-making possibilities of these fine items—bearing the twenty-nine year old C-D seal of quality. Ask your local C-D jobber about Quietones or write for complete information. Designed in attractive colors to match room interiors.

Act now! Start cashing in on this money-maker. Use coupon below for free descriptive literature.

CORNELL-DUBILIER
ELECTRIC CORPORATION
1014 Hamilton Blvd., So. Plainfield, N. J.
Cable Address: "CORDU"

CORNELL-DUBILIER ELECTRIC CORP.
1014 Hamilton Blvd., So. Plainfield, N. J.

Please rush descriptive Quietone literature immediately.

Name

Address

City State

Amazing New Radio Attachment BRINGS EXTRA PROFITS to Alert Radio Men

EZYTONE, amazing new invention, quickly attached to any radio by service man, permits hard-of-hearing persons to enjoy same programs as others. True reproduction—no batteries powered solely by radio—sturdily constructed—low priced—GUARANTEED... are the features of this instrument. Also fine for playing radio late at night without disturbing others. Ideal for hospitals, sanitariums, institutions, etc. Here's a service man's big opportunity to make extra easy profits selling and installing **EZYTONE**. Big market. Write today for full details and money making facts.



THE EZYTONE INSTRUMENT CO.
Dept. 43, 409 McGregor, Cincinnati, Ohio

Please Say That You Saw It in RADIO-CRAFT

FOUR NEW 10¢ RADIO BOOKS!



RADIO FANS EVERYWHERE—these little ten cent text books give you an excellent foundation for the study of radio. They are clearly written, profusely illustrated and contain over 15,000 words in each book. You'll be amazed at the wealth of information these volumes have. They are handy for review or reference books.

NO. 5—BEGINNERS' RADIO DICTIONARY

Are you puzzled by radio language? Can you define frequency? Kilocycle? Tetrode? Screen grid? Baffle? If you cannot define these very common radio words and dozens of other, more technical, terms used in all radio magazines and instruction books, you need this book in your library. It's as modern as tomorrow—right up to the minute. It tells you in simple language just what the words that puzzle you really mean. You cannot fully understand the articles you read unless you know what radio terms mean. This is the book that explains the meanings to you. Can you afford to be without it, even one day longer?

NO. 6—HOW TO HAVE FUN WITH RADIO

Stunts for parties. Practical jokes. Scientific experiments and other amusements which can be done with your radio set are explained in this fascinating volume. It tells how to make a newspaper talk—how to produce silent music for dances—how to make visible music—how to make a "silent radio" unit, usable by the deafened—how to make toys which dance to radio music—sixteen clever and amusing stunts in all. Any of these can be done by the novice, and most of them require no more equipment than can be found in the average home. Endless hours of added entertainment will be yours if you follow the instructions given in this lavishly illustrated book.

NO. 7—HOW TO READ RADIO DIAGRAMS

All of the symbols commonly used in radio diagrams are presented in this book, together with pictures of the apparatus they represent and explanations giving an easy method to memorize them. This book, by Robert Eichberg, the well-known radio writer and member of the editorial staff of RADIO-CRAFT magazine, also contains two dozen picture wiring diagrams and two dozen schematic diagrams of simple radio sets that you can build. Every diagram is completely explained in language which is easily understood by the radio beginner. More advanced radio men will be interested in learning the derivation of diagrams, and the many other interesting facts which this book contains.

NO. 8—RADIO FOR BEGINNERS

Hugo Gernsback, the internationally famous radio pioneer, author and editor, whose famous magazines, RADIO AND TELEVISION and RADIO-CRAFT are read by millions, scores another triumph with this new book. Any beginner who reads it will get a thorough ground work in radio theory, clearly explained in simple language, and through the use of many illustrations. Analogies are used to make the mysteries of radio as clear as "2+2 is 4". It also contains diagrams and instructions for building simple radio sets, suitable for the novice. If you want to know how transmitters and receivers work, how radio waves traverse space, and other interesting facts about this modern means of communication, this is the book for you!

Other Titles in This 10c Book Series!

- No. 1—HOW TO BUILD 4 DOERLE SHORT-WAVE SETS
- No. 2—HOW TO MAKE THE MOST POPULAR ALL-WAVE 1- AND 2-TUBE RECEIVERS.
- No. 3—ALTERNATING CURRENT FOR BEGINNERS
- No. 4—ALL ABOUT AERIALS

Four other volumes in this ten-cent radio book series—each on a popular subject—are available. The titles are:

- No. 3—ALTERNATING CURRENT FOR BEGINNERS
- No. 4—ALL ABOUT AERIALS

BOOKS ARE ALL UNIFORM

Every book in the GERNSBACK EDUCATIONAL LIBRARY has 32 pages—with illustrations varying from 30 to 68 in number. Each title volume contains over 15,000 words. Positively radio's greatest book buy! If you do not think these books worth the price asked, return them in 24 hours and your money will be instantly refunded.

RADIO PUBLICATIONS

101 Hudson Street New York, N. Y.

RADIO PUBLICATIONS, Dept. RC-339
101 HUDSON STREET, NEW YORK, N. Y.
Gentlemen: Please send immediately, POSTPAID, the book numbers circled below. I am enclosing cents—each book being 10c.

Send FREE listing of 48 new 10c publications.

Name

Address

City State

Remit by check or money order—register letter if you send cash or unused U. S. postage stamps.

MAIL COUPON TODAY!

Print Your Own
Cards, Stationery, Advertising, labels, paper, circulars, tags, etc. Save money and time. Sold direct from factory only. Junior outfit \$8.25. Senior outfits \$17 and up. Do popular raised printing like engraving with any of our presses. Print for Others, Big Profits. Pays for itself in a short time. Easy rules sent. Write for free catalog of outfits and all details. Kelsey Presses N-97, Meriden, Conn.

WE HAVE THE RADIO YOU WANT
Our 1939 catalog is chock full of the Standard Brand Radios for Home-Farm-Auto. Over 400 models. Also hundreds of Electric Appliances for the home. Celebrating our 50th Anniversary with Big Bargains. Write for your copy today. It's FREE.
MODELL'S Dept. 57 Cortlandt St., N.Y.C.

It's Your Job Today
to prepare for a better radio job tomorrow!

You can make more money if you have the ability to step into the important jobs. Today's opportunities go to the men with **TECHNICAL TRAINING**. Our "Tested Plan for a Future in Radio" tells how YOU can improve your position. Our free book gives details. Write now to—
CAPITOL RADIO ENGINEERING INSTITUTE
Dept. RC-3 3224-16th St., N.W. Washington, D. C.

FREE NEW CATALOG 1939 AMPLIFIERS
Featuring amazingly low prices; Free Trial Offer; 5-Year Guarantee. Write for Catalog No. 3911.
AMPLIFIER CO. of AMERICA
17 WEST 204 STREET NEW YORK, N. Y.

THE RADIO MONTH IN REVIEW

(Continued from page 519)

RADIO & THE COPPERS

BRAVE Denver, Colorado, police were driven into a panic last month when the city installed 2-way radio in its patrol cars. So badly were the cops affected by mike fright, which resulted in their becoming voiceless or stentorian, that a school of elocution had to be established. Now they can say, "There's a drunk in the gutter on 28th Street" without turning pale.

worth 10,000 words"; broadcast words can describe product's use and package, but can not actually show them; television can and will.

Last month the soft-spoken, courteous London Bobbies took a page from the American police book and raised their voices in thunderous peals. Cruisers were equipped with hi-gain amplifiers; mammoth speakers were mounted on their roofs. Now the noted Courtesy Cops can make their plaintive cry of "Pull over to the left, there, youse," easily heard over Pall Mall (pronounced Pell Mell for some reason—maybe it's the speeders) traffic.

Carlton L. Dyer, managing director of Philco's British branch, visiting U.S., said that television would progress more rapidly here than in England. He also mentioned "static," transmitter cost and short range of "U-H.F." But the erudite N. Y. Times headlined his story, "Dyer Sees Barriers in Television's Way."

THE TELEVISION PICTURE

NEWSPAPERS, terrified at the shadow of television looming on the horizon, gave considerable publicity to sceptical statements originating within the trade; little space to the advances which continued to be made during the past month.

Also headlined with an anti-television slant in papers last month was a statement to stockholders by E. F. McDonald, Jr., pres. of Zenith Radio Corp. It is true that Commander McDonald said that offering television receivers for sale to the public at the present time "is, in my opinion, unfair"—but the fact that Zenith was planning immediate experimental broadcasts of high-definition television, and the production of test television receivers was played down.

Reason for press's marked lack of enthusiasm is that television impresses papers as far more serious competitor for advertising revenue than even radio has been. Advertisers' axiom is that "1 picture is

A story under the by-line of Guy Bartlett, of General Electric, appeared in the N. Y. World-Telegram. In this were announced plans for a television transmitter near Schenectady, for the production of console and table model receivers, and for a demonstration of these at the N. Y. World's Fair.

Please Say That You Saw It in RADIO-CRAFT

OPPORTUNITY AD-LETS

Advertisements in this section cost five cents a word for each insertion. Name, address and initials must be included at the above rate. Cash should accompany all classified advertisements unless placed by an accredited advertising agency. No advertisement for less than ten words accepted. Ten percent discount for six issues, twenty percent for twelve issues. Objectionable or misleading advertisements not accepted. Advertisements for April, 1939, issue must reach us not later than February 6th.

Radio-Craft • 99 Hudson St. • New York, N. Y.

BOOKS AND MAGAZINES

WE HAVE A FEW HUNDRED RADIO ENCYCLOPEDIAS, by S. Gornshack, second edition, originally sold at \$3.98. Book has 352 pages, weight 3 lbs., size 9 x 12 inches. Red morocco—keratol flexible binding. Send \$2.49 in stamps, cash or money order and book will be forwarded express collect. Technifax, 558 W. Washington Blvd., Chicago, Illinois.

CAMERAS & SUPPLIES

AMBERTINT 16MM. CAMERA FILM, \$1.85 FOR 100 feet. Inedink machine processing. Daylight loading. Weston Eih. Nonhalat on. Two rolls \$3.50. Order now. Hollywood Studios, Southgate, Calif.

JOIN THE THOUSANDS OF CANDID CAMERA FANS—a genuine minicam equipped with Wollensak 50 mm. lens, speed shutter and accurate "spy glass" view finder. Fixed focus assures sharp pictures 1 1/2 x 1 1/2 inches. Enlarges with clarity up to 8 x 10 inches. Has special compartment to carry extra film roll and tripod socket for mounting. Uses economical Kodak 127 or Agfa A8 film in color or black and white—takes 16 pictures. Housing built of unbreakable bakelite composition. Camera weighs only 9 ounces; measures 3" long by 3" high by 2" wide. Easy to operate and inexpensive to use. Shipped postpaid anywhere in U.S.A. with guarantee of safe delivery—\$3.98. Hudson Specialties Company, 48RC West Broadway, New York, N. Y.

COINS AND STAMPS

IN GREAT DEMAND! KING EDWARD VIII. SET complete 25c. Box 194, Gloucester, Massachusetts.

STAMP COLLECTORS—INTRODUCTORY OFFERING—103 stamps including scarce BI-colored Diamond and Triangular shaped Commemoratives—10c. Approvals. Friendly Philatelists, Box No. 4428R, Philadelphia, Penna.

INSTRUCTION

RADIO ENGINEERING, BROADCASTING, AVIATION and police radio, servicing, marine and Morse telegraphy taught thoroughly. All expenses low. Catalog free. Dodge's Institute, Pine St., Valparaiso, Ind.

MISCELLANEOUS

MEXICAN DIVORCES; NO PUBLICITY. AMERICAN attorney. Box 1736, El Paso, Texas.

MONUMENTS & TOMBSTONES

GENUINE MARBLE, GRANITE, FREIGHT PAID. Catalog free. \$11 up. United States Marble & Granite Co. A-27, Oneco, Fla.

OFFICE SUPPLIES

ENVELOPES—1000—6 1/2's—\$1.75; 1000—10's—\$2.85; 100 sheets carbon paper \$1.50; prepaid. "Everything for the office." Labahn, 803 Main, Evanston, Illinois.

RADIO MEN, ETC.—125—8 1/2 x 11 BOND LETTER—heads and 125 envelopes—\$1.00; statements, billheads. 308—\$1.00. Bennecille, 907 West Roosevelt, Philadelphia, Penna.

PHOTOGRAPHY

ROLLS DEVELOPED—8 LARJAPRINTS (ENLARGE-ments) 35c or 8 regular prints 25c. Star Photo, New Britain, Connecticut.

RADIO

SPEAKER FIELD, MAGNETIC, RELAY AND SOLENO-id rolls made to specifications. Single or large lot orders. Also rewinding. Nothing's Winding Laboratories, P. O. Box 155, Trenton, New Jersey.

SOMETHING BRAND NEW—UNIVERSAL PLUG-IN-376 thermocouple. Unit ready to mount. One Dollar. B. D. Heller, 2374 Webster Avenue, New York, N. Y.

FAN BELT DRIVE A.C. GENERATOR FOR AUTO P.A. \$5.00, J. Orysen, Kenman, Wisconsin.

SALARIED POSITIONS

OUR SYSTEM OF SEARCHING FOR SALARIED POSI-tions, hiding your identity, increases your salary commensurate with training and experience, and with definite results. Write, Executive's Promotion Service, 300 B Street, S.E., Washington, D. C.

SONG POEM WRITERS

WANTED ORIGINAL POEMS, SONGS, FOR IMMEDIATE consideration. Send poems to Columbian Music Publishers, Ltd., Dept. 159, Toronto, Can.

SONGWRITERS! MELODY FOR WORDS \$1.00. Little, 215 Mason Theatre, Los Angeles, California.

EVERYTHING IN RADIO!
A COMPLETE SOURCE FOR YOUR RADIO NEEDS
Our immense stock of radio sets, parts and supplies enables you to purchase your entire needs on one order. You will find all your Nationally Known Favorites in this big book which is FREE for the asking. Practically every order is shipped the same day it is received. WRITE FOR BIG NEW CATALOG

BURSTEIN-APPLEBEE CO.
1012-14 McGee St. • Kansas City, Mo.

Dr. W. R. G. Baker, chairman of the same company's radio and television management committee, further analyzed the new art's problems, raising again the old questions of how to pipe programs, how to determine programs' relative entertainment value—and how to finance broadcasts.

Farnsworth television was demonstrated—and successfully—in San Francisco.

N.B.C. televised the automobile show in New York, and also televised a fire, near which a mobile unit happened to be when the flames broke out, last month.

But perhaps the greatest strides were made by the comparatively unpublicized Don Lee Broadcasting System. Harry R. Lubcke, director of television for the Western net, secured patents on methods and apparatus for synchronization. Rights under these patents were recently sold to RCA. Also in the past months, the net shifted the sound channel of its station, W6XAO, from 54 to 49.75 mc., bringing it closer to the 45 mc. video channel, for easier "ganging" in the receivers. The net also broadcast on Christmas a 25-minute drama which, it claims, was "the first television Christmas vehicle."

Allen B. Du Mont Labs. report a rushing business in television receivers "despite the absence of programs." Explanation was that dealers are using the apparatus in displays, as crowd-catchers.

Across the Pond, London reported that television sound programs, originating there, were picked up and relayed in India!

Italy decreed last month that users of apparatus which creates interference disturbing to radio or video reception are liable to fines.

German police televised an overcoat found beside the body of a murdered man, to whom it did not belong. However, the murderer still eluded the police, at last reports.

Direct pick-up of a play on the stage of a London theater was made successfully.

British R.M.A. members planned a co-operative drive to publicize television in January.

They also planned to make last Xmas a television one, and hoped for the sale of 3,000-4,000 receivers, to supplement the 6,000-7,000 now in use.

The British Assn. Meeting Educational Section discussed television as an aid to schooling. They decided it would be entertaining, instructive, inexpensive.

Facsimile is still advancing, with more newspapers and broadcasting stations taking out transmitting licenses almost weekly. Last month W. G. H. Finch, pioneer in the facsimile field, received 3 new U.S. patents covering the use of a continuously operated 3-gang scanning pen, which increases the speed of transmission and reproduction threefold.

SUDDEN DEATH

RADIO Technician John Hersh, disappointed in love, built an electric chair. Pinning a note on his breast to warn others not to touch him before turning off the current, he seated himself in it and threw the switch. The chair worked perfectly, according to the Chicago coroner, last month.

In Kamatipura, India, 8-year-old Vasudhairabi Sambha went onto the corrugated iron roof of her home. Someone's shorted antenna, touching the metal, apparently

(Continued on following page)

Only the TUBEMASTER



COMBINES
Mutual Conductance
Power Output
Emission
... in one simple test!

None have dared to build a tube tester to equal this performance. *John Meck*

ALL THREE TESTS—Tube engineers tell you that all three tube characteristics must be tested—mutual conductance, power output, and emission. No one alone is enough! The TUBEMASTERS do this and more.

10CT AND 35 V TUBES—You need to test these new tubes every day. The exclusive full roaming infinite combination selector system provides accurate loading of each element on every new tube. Two Year Guarantee against obsolescence.

ILLUMINATED PANEL AND METER—Both indirectly lighted from below for impressive appearance and ease of reading.

SIMPLE TO USE—Only four in-line controls. Read the giant roll chart and set controls in same order. No lost time or embarrassments.

TESTS BALLAST TUBES AND PILOT LIGHTS—No need to buy separate testers for ballast tubes. TUBEMASTER data sheets cover every type of ballast tube.

COUNTER AND PORTABLE TYPES—Complete as illustrated and described. Write for descriptive bulletin net \$34.50

FREE "How to design a tube tester"

John Meck Instruments
162-D N. May St., Chicago, U.S.A.

Send me at once the new engineering bulletin on "How to design a tube tester," and catalogs on your complete line of instruments.

Name

Address

Please Say That You Saw It in RADIO-CRAFT

QUALITY—VALUE—GUARANTEE!

WESTINGHOUSE POWER GENERATOR

Manufactured for U. S. Signal Corps

A. C. ELECTRICAL POWER
 from a Windmill, from available Waterpower, from your Bicycle, Automobile, from your Motorcycle, from your Bicycle, Footpedals or Handcrank, Advertising Signs; operate mitters, Strong Floodlights, Advertising Signs; obtain two phase and three phase AC, etc., etc.

There Are Over 25 Applications
 Some of which are:
 A.C. Dynamo lighting from eight to ten 20 Watt 110 Volt lamps. Short Wave Transmitter supplying 110 Volts AC for operating "Ham" transmitter. Motor Generator. Public Address Systems. Electric Sirens on motor boats, yachts, etc. Camp Lighting. Short Wave artificial lighting apparatus. Television. Pelton Waterwheel for lighting lights or electric signs. Laboratory work, etc., etc.
 1/4 to 1/2 H.P. needed to run generator.
 Generator, as described, including BLUE PRINT 2 1/2 x 2 1/2 in. and Four-Page 8 1/2 x 12 in. INSTRUCTION SHEETS \$7.90
 Send \$2.00 deposit balance C.O.D. Shipping weight 18 lbs.

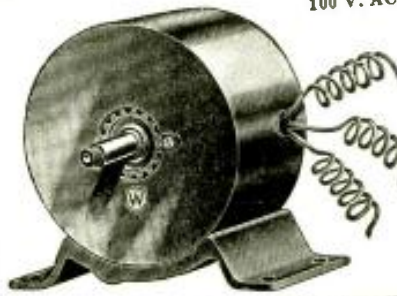

200Watt.
100 V. AC

WESTINGHOUSE UNIVERSAL MOTOR



\$2.55
 110 Volts AC and DC
 Shipping Weight 3 lbs.
 Specifications: 1/30 H.P. operates on either A.C. or D.C. 110 volts, 5000 R.P.M. Rheostat can be used to vary speed. Height 3 3/4" Length 3 3/4" Width 1 3/4" Shaft 1/4" one inch long. Can be used to drive Sewing Machines, Models, Buffing Lathes, Polishing Head, Drills, Grindstones, etc., etc.
\$2.55
 MOTOR only
\$3.55
 MOTOR with Arbor and 1/2" Chuck.
 Add 25c for special packing and mailing anywhere in U. S. A.

G. E. PHONOGRAPH MOTOR



Formerly Sold for \$15.00
\$4.95
 Variable speed induction type self-starting, 110 volt, 25 to 60 cycle, A.C., with speed control, plug and cord. Speed range from 5 to 200 R.P.M. Can be installed in place of old-fashioned, hand-wind and a hundred other uses. These General Electric Motors have never been used and come four packed in original carton. G. E. Electric Phonograph motor as described (with-out turntable) **\$4.95**
 Shipping Weight—12 lbs.

ALL OUR MERCHANDISE IS UNUSED AND SOLD ON A MONEY-BACK GUARANTEE

MICROPHONE AND RECEIVER

This Microphone and telephone headset were built especially for the U. S. Navy Aviation Corps. The Holtzer-Cabot Electric Company constructed the outfit to Government specifications.
 The outfit consists of a low-impedance carbon metal breastplate, securely fastened to a switch on the back of the breast-plate controls the microphone circuit. The carbon-plate controls Utah type, attached to adjustable headband. Twenty-eight feet of very heavy weather and of not more than 10 volts should be used. A storage battery is the most satisfactory current supply.
 U. S. Navy Airplane-type Microphone and Receiver as described **\$4.96**
 Shipping Weight—9 lbs.

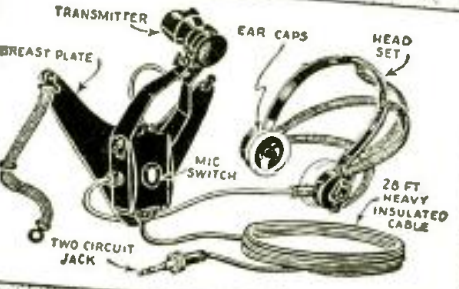

WELLWORTH TRADING CO.

Dept. RC-339
 560 W. WASHINGTON BLVD., CHICAGO, ILL.

★ ORDER DIRECTLY FROM THIS ADVERTISEMENT ★
 WE SHIP 24 HOURS AFTER RECEIPT OF YOUR ORDER, BY EXPRESS COLLECT OR PARCEL POST IF YOU INCLUDE SUFFICIENT POSTAGE.

THE RADIO MONTH IN REVIEW

(Continued from preceding page)

supplied enough current to cause a shock which knocked her from the roof. Her body was found 4 floors below.

Walking in her garden, Mrs. Ethel Ingham, of Middlesborough, England, touched the antenna lead-in beneath a window. The meter of an expert called in by the coroner is said to have indicated 185 volts between "the aerial terminal screw and the lead-in through the window." Heart disease was cited as a contributing cause to Mrs. Ingham's death.

Not death but destruction broke loose near Piedras Negras, Mexico, where station XEPN was destroyed by explosion and fire.

One of the station's owners and its American manager had a controversy, as a result of which the latter hired 5 guards. That night, after the manager had gone home, the explosion occurred. One of the guards turned up missing.

Neither death nor destruction, but catastrophe for one. He was a young resident of Atlantic City, who so over-publicized his plan to eliminate automobile accidents through radio propaganda that the police removed him to a hospital, after he had been given a mental examination. His promotion included placarded taxicabs, an airplane with an advertising trailer, and an imaginary request for an imaginary interview from President Roosevelt, last month.

SERVICING QUESTIONS & ANSWERS

(Continued from page 539)

(A.) Your description of operating symptoms with a Crosley model 167 receiver points to improper grid bias voltage on the type 42 output tube. This is probably the result of leakage in the coupling condenser which would buck the negative grid voltage, or excessive leakage of the output tube cathode bypass condenser. We advise that these 2 condensers be checked at once, by substitution, if other means are not available.

"PLUNK"—"PLINK"

(121) W. J. Thomson, Ottawa, Ontario, Canada.

(Q.) What are the probable causes of a sound in the loudspeaker when the A.C. line switch is turned off?

The sound is like "plunk" with the volume control off and "plink" (smile if you must) when on full. With the control off, the sound is not further affected by removing the diode detector or 1st audio tube, but removing the 2nd audio tube it is completely stopped. The 3rd stage is push-pull 45's to a 12-in. P.M. speaker.

The radio set is a home-made super.
 (A.) The sounds, which you describe, that are heard when your receiver is switched off are entirely normal and expected. Since the rectifier and output tube filaments or heaters require a moment or two to heat or cool, the receiver is in a "live" condition for this brief period. The arc created by the breaking of the line switch is thus reproduced. In receivers employing indirect-heater type tubes, it is not unusual to experience gradual fading reception, after the receiver has been switched off, until the tubes have cooled.

OPERATING NOTES

(Continued from page 530)

6D6, 6C6, 25Z5, and a ballast tube. The pilot light burns out repeatedly, and no wonder!

Checking the ballast tube, a Clarostat type BM36C, I find that it calls for two 200-ma. pilot lights in series, and this set has only one!

To correct this at low cost, insert a 30-ohm resistor in series with the pilot light. A burn-out greatly affects the output of these small sets.

H. Buck

FAIRBANKS MORSE CHASSIS MODEL 56

The filter condensers in this model often become leaky (in both the mechanical and electrical senses). After replacing the condenser, trouble is often experienced with a non-oscillating 6A7 tube (circuit). Close examination will show the electrolyte from the wet filter condenser has corroded the socket of the 6A7 enough to cause non-oscillation, either by poor contact or by shorting. A new socket is the only remedy, as the electrolyte leaks between the 2 laminations, thus causing a low-resistance leakage path.

RCA VICTOR R7

The screen-grid resistor and screen-bleeder on the type 35 tube are frequent offenders. They should be replaced by 1-watt wire-wound units whenever this set comes into the shop, to avoid repeat service calls.

HOWARD H. ARNOLD
 Arnold's Radio Service

Please Say That You Saw It in RADIO-CRAFT

FREE- REAL ELECTROPLATING OUTFIT



Now
You Can **ELECTROPLATE**
Easily with a **BRUSH**

SOMETHING new for radio men—something which gives you the opportunity to make additional profits—or to improve your type of service. Here's an **ELECTROPLATING KIT** amazingly simple to operate—you just Electroplate with a Brush!

NOT A TOY!

You can electroplate for profit, hundreds of things in the household—ashttrays, fixtures, water faucets, worn brackets, door knobs, musical instruments, jewelry and silverware and other articles. It's an indispensable piece of equipment to you for plating articles in hotels, apartments, office buildings, medical and dental offices, factories, schools, laboratories, etc. Exactly the same outfit (but larger) is used professionally by electricians, radio service men, automobile repair shops, etc. Requires one single dry cell 1½-volt battery to operate.

And for radio work, you can electroplate tarnished receiver parts, escutcheons, contacts, worn radio parts and accessories, and display chassis. Put this **REAL ELECTROPLATING KIT** to use immediately—make it the most useful article in your shop or laboratory. And, you can get it absolutely **FREE** (except for slight mailing cost).

Send your subscription today to **RADIO-CRAFT** for One Year (12 issues) and receive absolutely **FREE** this **REAL ELECTROPLATING KIT**. New subscribers are accepted or you may extend your present subscription another twelve months under this offer. Mail your remittance of \$2.50 (plus 10c for shipping charge on kit) to the publishers of **RADIO-CRAFT** (Canada and foreign \$2.85). You will promptly receive your **FREE, REAL ELECTROPLATING OUTFIT** by return mail. Use the coupon below to order your subscription.

RADIO-CRAFT

99 Hudson Street New York, N. Y.

RADIO-CRAFT RC-339
99 Hudson Street, New York, N. Y.

Gentlemen: Enclosed you will find my remittance of \$2.50 for which enter my subscription to **RADIO-CRAFT** for One Year (12 Issues). Send me promptly my **FREE, REAL ELECTROPLATING OUTFIT** (Canada and foreign \$2.85). In U. S. add only 10c additional to cover shipping charges on kit.

New Subscriber Extend Present Subscription

Name

Address

City State

(Send remittance by check, money order or unused U. S. Postage stamps. Register letter if you send cash or stamps.)

THE LATEST RADIO EQUIPMENT

(Continued from page 544)

0.2-meg. up to 300 megohms. Designed for use where resistance measurement requirements call for extremely broad coverage plus constancy in operation, this model 763 ohmmeter (shown below) can be used with good results on the top range as a modified "megger" wherein 125 V. (maximum current 50 microamperes) is available for insulation tests. A line-voltage control is provided.

The indicating instrument requires only 50 microamperes for full-scale deflection. This high sensitivity permits accurate resistance measurements in circuits where the measuring current must be kept at a minimum. Condenser leakage up to 300 megohms is easily measured.

The test circuit has been entirely isolated from the A.C. line in order to prevent shocks to the user when external leads are employed. A filament-type vacuum tube, having characteristics that permit instantaneous readings, acts as a rectifier to supply 125 V. for the 300-meg. range.



High-sensitivity ohmmeter. (1729)

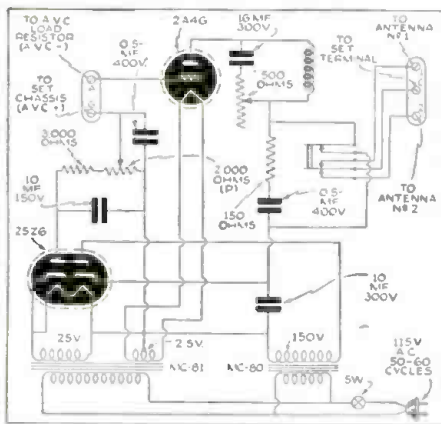

Schematic diagram of the diversity coupler kit illustrated on page 544. (Item 1727)

The Lower House, in Washington, has been wired for sound. Architect David Lynn describes the apparatus as "the most up-to-date in existence."

And a Toledo school, wired for sound, has run some teachers into a peck of trouble when it was learned that one of them had used the equipment to eavesdrop on pupils. Bet that teacher learned plenty!

Please Say That You Saw It in **RADIO-CRAFT**

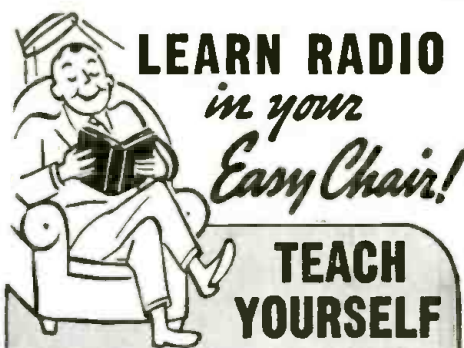

this Quick, Easy Way

In your spare time at home you can give yourself a thorough education in Radio, Electricity, Sound, Television, Cathode-Ray Tubes, etc. Sounds like a lot, and it is a lot, but it's all given to you—36 different subjects in all—in Ghirardi's big self-study radio book. You can spend more time and money elsewhere, but you'll never be able to find a quicker, easier, more economical way to fit yourself for a good radio job. It comes easy to you because of the plain, simple language, freedom from mathematics, clear and thorough explanations, scads of illustrations—these are what speed up your training!

HERE'S WHAT YOU GET:

- Sound—Electrical Theory and Principles — Electrical Currents — Electro-magnetism — Transformers — Inductance — Condensers — Measuring Instruments — Radioactivity — Broadcasting — Heterodyne — Vacuum Tubes — Amplification — Superhets — Coils — Speakers — Receivers of all types — Short-Wave — Auto-Radio — Public Address — Photoelectric Cells — Cathode-Ray Tubes — Television — Testing and Servicing — Sound Motion Pictures — Reference Tables—Etc.
- Follow the example of smart radio students and schools the world over, who use "Ghirardi" more than any other radio book ever written. Get started TODAY!

RADIO PHYSICS COURSE

MAIL NOW

RADIO & TECHNICAL PUBLISHING CO.
45 Astor St., New York, N. Y. Dept. RC-39
PHYSICS COURSE \$4.50 (foreign) for my copy of RADIO
day MONEY-BACK GUARANTEE. ship prepaid at once with 10-

NAME STATE

ADDRESS

CITY 972 Pages 856 Review Questions

Please send free descriptive literature.

TURNER Sound Equipment Catalogue How TURNER Microphones Add Broadcast Quality Modernize your Rig ... at Low Cost

TURNER offers 24 different microphones, streamlined for professional appearance and engineered to assure broadcast quality reports, to enable you to improve your equipment at amazingly low cost. Used by thousands of hams and PA men the world over.

There's a TURNER mike for every purpose—indoors or out. With the TURNER Dynamics and Crystals, you reduce feedback, breakage and blasting troubles. Own a microphone that wins you praise and doubles your enjoyment. See the TURNER mikes and equipment. Write today for TURNER'S Free Microphone bulletin No. 40-C.

---Tear Out and Mail Today---

TURNER CO. Cedar Rapids, Iowa
Please send me your Free Microphone Bulletin No. 40-C.

Name

Address

City State

WORLD-WIDE TELEVISION PROGRESS—A REVIEW

(Continued from page 529)

SPRAGUE ATOMS
"Mightiest Midgets of All"

YOU SAVE 2 WAYS!

Sprague ATOMS (Midget Etched Foil Dry Electrolytic Condensers), save you a whale of a lot of money—and they save space, too! You'll find them far better than most of the big old-style electrolytics for which they are used as universal replacements. Not a "blow-out" in a carload. Unquestionably the highest quality midgets,—the smallest midgets—and the only midgets made in a full line of dual capacity combinations with common negative leads. Write for catalog. See your jobber today!

HOW'S THIS FOR VALUE?

This dual 8-8 mfd. 450 V. ATOM is only 1" x 2 1/2" and lists at only \$1.00. A single 8 mfd. ATOM lists at 60c.



SPRAGUE 450 VOLTS
SPRAGUE PRODUCTS CO.
 North Adams, Mass.

FREE TRIAL OFFER
NEW REMINGTON NOISELESS PORTABLE!
 AS LITTLE AS



10¢ A DAY

Famous Remington Noiseless Portable that speaks in a whisper. Pay as little as 10c a day. Guaranteed by the factory. Standard keyboard. Automatic ribbon reverse. Variable line spacer and all the conveniences of the finest portable ever built. PLUS the NOISELESS feature. Act now. Send coupon TODAY for details.

You don't RISK a Penny

We send you Remington Noiseless Portable for 10 days' free trial. If not satisfied, send it back. We pay all shipping charges.

Typing Course and Carrying Case

You will receive FREE a complete simplified home course in Touch Typing, a handsome sturdy carrying case is included. No obligation. Mail coupon for full details—NOW.

Remington Rand, Inc., Dept. 189-3,
 465 Washington St., Buffalo, N. Y.

Tell me, without obligation, how to get a Free Trial of a New Remington Noiseless Portable, including Carrying Case and Free Typing Course for as little as 10c a day. Send Catalogue.

Name

Address

City State

LET'S LEARN
Correspondence Courses in RADIO and ELECTRICAL ENGINEERING

ELECTRICAL ENGINEERING Get good grasp of wide electrical field. Prepare yourself, at Low Cost, for secure future. Modern, simplified, you can understand quickly.

RADIO ENGINEERING Extra fine course in radio, publication address. Photo-electric work. Trains you to be super-service man, real vacuum tube technician. Exper. kits furnished. Diploma on completion. Tuition, \$25, either course. Deferred payment plan. Get copies of school catalogs, student magazines, complete details. SEND NOW!

FREE

LINCOLN ENGINEERING SCHOOL, Box 931-C3, LINCOLN, NEBR.

on the propagation of the quasi-optical waves used in television, it may be found that the stations have a somewhat greater service range than has been expected. Thus Alexandra Palace is now regarded as having a useful range nearer 50 miles than 25. Should this prove generally true it would be a matter of no small importance, since doubling the radius quadruples the area covered, and by increasing the population within range of television transmitters would materially reduce economic difficulties of distribution.

Germany At this writing experimental transmissions have begun from a transmitter on the Amerika-Haus in Berlin. The power is between 15 and 20 kw., or approximately the same as London, which is rated at 17 kw. The definition is the same as in the United States, 441 lines, but the frame frequency is 50 per second. Two other transmitters are planned, one on the Brocken in central Germany, and one in the Taunus mountains in the West, all to be connected with coaxial cables. Studios are designed for 6-camera operation.

An image 12x10 feet has been shown in a theatre by Fernseh A.G., which has a cross-licensing agreement with Farnsworth in the United States. There are also reports of a 700-line image. Cathode-ray tubes up to 26 ins. diameter have been built. The cost of receivers is said to range between \$175 and \$1,000, with \$320 as an average.

The Germans have had a television-telephone service in operation between Berlin, Leipzig, and Nuremberg for some time, and this summer the coaxial cable was extended to Munich. Mechanical scanning at 180 lines, 25 frames per second is used, and the reproduction is reported to be considerably distorted and not free from flicker. The principal attraction is novelty. The cost of a 3-minute conversation is only RM 4.80 (\$1.92), plus a small charge for notifying the person called; both parties must of course be present at the televising points in their respective cities.

France The Eiffel Tower transmitter is rated at 25 kw., which is more powerful than Berlin or London. Its signals have been viewed at Brighton, 180 miles distant. The station transmits daily for 2-1/2 hours. There are reports of a 12x9 ft. theatre demonstration, with quality approaching 16 mm. projection. (We have not come across any information on home receivers or the extent of distribution of programs.)

DEVELOPMENTS IN THE UNITED STATES

The RCA-N.B.C. experimental transmissions from the Empire State Tower in New York City were initiated in July, 1936, and, with interruptions to permit changes in the equipment, have continued since that date. The system operates with 441 lines and 60 frames per second (the general arrangements, studio-transmitter linkage, etc., remain as described in our 1937 report). A great deal of operating and program data has been gathered and it has just been announced that on the basis of this experience television in the home is regarded as "technically feasible." Accordingly, RCA promises a limited program service and the marketing of receivers before the opening of the New York World's

Fair on April 30, 1939. Television transmitters will also be available, and those RCA licensees who desire to manufacture visual receivers will receive the usual technical cooperation.

The N.B.C. television studio in Radio City is a room 50x30x18 ft., no larger than a single, medium-size Hollywood set. A surprising variety of scenery is accommodated in this small space. Since television, at the present stage, is dramatically a close-up art, the sets are small and can be disposed about the room in such a way that while the cameras are shooting one set, another is being moved into place, with a minimum of disturbance, for the next shot. As an example of this economy, in one play a certain door was used, with a nameplate, as the exterior entrance of a residence; subsequently the nameplate was removed and the same door became part of an interior scene—an office in Scotland Yard; finally the whole wall was taken out and the same area became a cellar. Most of the sets consist merely of a back wall with appropriate props in front of it.

The receivers are equipped with screens 10x7-1/2 ins. Although too small for convenient viewing, the images are bright and sharp, and carry sufficient detail to depict emotions, when rather broadly played, in close-up or semi-close-up. Medium and long shots merely show the figures and are used mainly for entrances, exits, establishing settings, etc. (However, when the action is sufficiently dynamic—fights, acrobatics, etc., the long shots do have entertainment value.) In the main, the story must be carried with 2-shots; a 3-shot is on the borderline of effectiveness. Film takes of exteriors are sometimes intercut to good advantage.

The principal weaknesses of the run of N.B.C. studio productions have been mediocre dialogue, stereotyped situations, and similar remediable faults of material. These have been excused on the ground that as the performances have not been public, the content has been regarded as purely incidental, the essential effort being to determine the visual possibilities of the medium and to solve technical problems. When the material has been up to the mark the results have been definitely entertaining, even with the small screen. One of our members who witnessed some of the demonstrations found it difficult to concentrate on the engineering features—his attention was constantly diverted to the action. *This is as good a test of entertainment quality as any.*

In June of 1938 a number of New York department stores demonstrated television reception, using the Empire State transmissions. The pictures were mostly in the 5x4 in. range and the receivers were priced at \$195 to \$225. Public interest was aroused, but only a few sales were reported. The flurry ended when the transmitter shut down for adjustments. The real test of public response will come in 1939, when regular service is initiated and receivers become available in a number of types and sizes.

Engineering developments in the United States have been mainly in the directions outlined in our 1937 report, and parallel those reported abroad. Progress is slow and laborious, but steady. In general, the advances listed above for the foreign field are either the results of American invention, or they can be duplicated here whenever it becomes expedient.

Demonstrations other than those described above have been offered, but as we

Please Say That You Saw It in RADIO-CRAFT

have not witnessed any of them we shall not attempt to deal with their results. During 1939 a moderate extension of local television coverage is in prospect in various parts of the country. The Columbia Broadcasting System's Chrysler Tower transmitter (in New York City) is expected to be installed early in the year and to begin regular operation in the Spring (or shortly after this issue of *Radio-Craft* appears on the newsstands—*Editor*).

A considerable number of applications for experimental television licenses are on file with the Federal Communications Commission, and one of them, which indirectly involves a motion picture company, has just been granted to the Allen B. Du Mont Laboratories of Passaic, New Jersey, for a station in that neighborhood. Paramount has purchased an interest in Du Mont and advanced an amount, reported to be \$50,000, toward the expenses of research for one year.

In Los Angeles (which, as we pointed out in our 1937 report, may reasonably be expected to carry over into the field of television its importance as a broadcasting and motion picture production center) a station of the Don Lee Broadcasting System has been televising for some years. The present standard is 300 lines at 24 frames per second, visual frequency, and the schedule calls for about 8 hours a week, both film and live subjects being scanned. The visual broadcasts of the 1 kw. transmitter are received by experimenters not only in Los Angeles, but in surrounding towns as much as 30 miles away.

The Farnsworth Television System was demonstrated in Hollywood last summer. The picture was in black and white and about 9x12 ins. in size, the image composed of 441 lines and 60 frames per second. The picture was bright and had considerable entertainment value on close-ups. The longer shots were not as effective.

CONCLUSIONS

We pointed out at the beginning of this report that the long experimental phase of television development is about to culminate. This does not mean, of course, that experimentation is at an end. On the contrary, the experiment now takes on a larger scope, with the emphasis shifting from technical research (although technical development will simultaneously be intensified) to economic and social aspects. The public, from the role of spectators, will become participants in the project, and on the extent and manner of that participation

the effects on the motion picture industry will depend.

That such effects will be evident in the next 2 years is altogether to be expected. That the repercussions will result in revolutionary changes in motion picture production and exhibition within that period is unlikely. The complexity of the television field and the magnitude of its artistic and financial problems, we have pointed out before, are an automatic brake in this respect, and it might be added that this is true of competitive and cooperative potentialities alike. As regards the latter, when television comes into its own it may well open up a vast market for films especially designed for television distribution. Should competitive factors predominate, it is quite obvious that the strongest interests in the television field cannot afford to ignore their own very substantial stake in the business of aural broadcasting. Although radio is nowhere near the end of its growth, financially it has become a mature industry, mindful of its investment in the present while looking into the future, and this tendency constitutes a protection, if one is needed, for the other entertainment industries as well.

And yet, modern technology has its own dynamic imperatives. It will not and should not stand still. New industries are needed, and if their coming is troublesome, it will be far more troublesome if they do not come. Television is one of them and it is a year nearer. We therefore repeat what we said in our last report: that the situation is one which calls for continual observation and analysis by the Motion Picture Industry, and to an increasing degree as events take their course. Accordingly the Committee is of the opinion that the Academy Research Council should immediately proceed to a more thorough consideration than has been undertaken in the past of the prospective relationships between television and motion picture production and exhibition.

In the opinion of the Committee this investigation should cover the artistic, technical, legal, and economic phases of the subject. Therefore, in order that future activities may encompass all phases of the subject, the Committee recommends that it be enlarged to include representation from those other branches of the industry in a position to contribute a wider background to its considerations.

FIRST DAILY NEWSPAPER BY RADIO FACSIMILE

(Continued from page 555)

tion to the amount of light reflected from the copy into the "electric eye."

RECEIVER OPERATION

The antenna of the receiver set in the home picks up these waves. The receiver, a closed cabinet with no dials to be operated or adjustments to be made by the owner, contains continuously-feeding rolls of paper and carbon paper which pass over a revolving metal cylinder from which a small stylus projects.

Pressure, varying with the intensity of the radio waves, is exerted on a metal bar, parallel to the axis of the cylinder, beneath which the paper and carbon is fed. Thus the black and white of the original copy scanned by the "electric eye" is duplicated on the paper passing over the cylinder of the receiving set which is synchronized with that of the sending mechanism.

Printed on only one side, the copy may

be cut or folded to make pages of the facsimile newspaper. It is unnecessary for the reader to be on hand when a broadcast begins since a clock, set for the scheduled time, will automatically start the receiving set and stop it at conclusion of broadcasting. It requires 15 minutes to transmit one page.

One of the receivers has been set up in the engineering department at Washington University, which is co-operating with station W9XZY in a study of problems incident to actual broadcasting outside a manufacturer's laboratory.

Station KSD's engineers have closely followed developments of radio facsimile broadcasting since 1934. Last April, RCA agreed to supply equipment necessary for an experimental program.

(Last month Paramount newsreel made sound films of this "radio newspaper" being received in Mr. Coe's home, *Variety* reported.—*Editor*)



EVERYTHING IN RADIO IN THIS BIG NEW 1939 Radolek Profit Guide.

Radolek has everything under one roof. When you order, you get just what you want promptly and economically. Over 25,000 Radio Servicemen and Dealers now depend upon Radolek Service. Send for your copy of this big book.

OVER 12,000 REPAIR PARTS. Parts to repair any radio receiver made. All leading brands. Every item guaranteed! And all at prices that **SAVE YOU MONEY!**

ALL TUBES. RCA, Sylvania, Raytheon, Philco, etc. Includes Kellogg, special Majestic types and transmitting tubes.

TEST INSTRUMENTS. The most complete line ever displayed in any catalog. Latest improved models that provide every conceivable test necessary for thorough radio receiver analysis.

COMPLETE PUBLIC ADDRESS DISPLAY. New 1939 model public address amplifiers with outputs from 10 to 100 watts. Complete P.A. Systems for permanent, Mobile and Portable Installations. Attractively designed and priced for greater profits.

LATEST RADIO MODELS. The super values of 1939. New Phono-Radio combinations. Automatic tuning sets. Strikingly beautiful cabinets. Also new "Ham" receivers and transmitters!

COMPLETE AUTO RADIO SECTION. Includes vibrator replacement guide, new auto aerials custom panel control plates for all automobiles and new Delco Auto Sets.

3000 NEW ITEMS OVER PREVIOUS EDITION. New items to give you new ideas in conducting your business on a more profitable basis.

The RADOLEK Co.
601 W. Randolph, Chicago, Dept. C-27

Send the 1939 Radolek Radio Profit Guide FREE.

Name

Address

Serviceman? Dealer? Experimenter?

Please Say That You Saw It in RADIO-CRAFT

BOOK REVIEWS

RADIO TROUBLE-SHOOTER'S HANDBOOK, by Alfred A. Ghirardi (1939). Published by Radio Technical Publishing Company. Size 8½ x 11 ins., 518 pgs., 134 illustrations, bound in black gold-lettered Fabrikoid. Price, \$3.00.

Mr. Serviceman:—How many times have you wished that you could immediately put your fingers on certain tables, color codes, tube charts and other items indispensable in radio service work which you knew were "around some place" but which you couldn't spot at the instant? It happens innumerable times every day in the week with every Serviceman, no matter how well organized his shop may be kept. The amount of time wasted in the aggregate must represent a tremendous loss in dollars and cents.

For this reason we feel that "Radio Trouble-Shooter's Handbook" is an exceptionally worthwhile contribution to radio servicing literature in view of the fact that it contains between two covers practically all the important reference material that the average Serviceman has scattered around for handy (?) reference or at least wishes he had available.

Space does not permit a detailed description of the contents but the following breakdown will convey the importance of this book. Its contents is clarified in sections as follows: Case Histories—a service which *Radio-Craft* originated as Operating Notes—of over 3,000 different set models; Intermediate Frequencies of over 15,000 Superhets.; Cross-Index of Corresponding Model Numbers of Different Makes; Trouble-Shooting Charts for Home and Car Radio Sets; Car Ignition System Diagrams; Servicing Sound Recorders and Inter-Office Communicators; Grid Bias Resistor Chart; R.M.A. Color Codes for Resistors, Condensers, Transformers, Loudspeakers and Wiring; Wire Tables; Radio Formulas; Power Supply Design Data; Directories of Set, Tube and Parts Makers, and Test and Sound Equipment Manufacturers; and Answers to Numerical Problems in "Modern Radio Servicing," by the same author (1st edition, 3rd printing).

MIKROPHONE, by Otto Kappelmayer (1938). Published by Deutsch-Literarisches Institut J. Schneider. Size 5¼ x 8 ins., paper covers, 103 illustrations, 143 pages. Price 4.20 rm. (approx. \$2.00).

Radio at last has a book devoted exclusively to the microphone. Let us warn you right at the start, however, that the book is written in German.

This does not change the fact that the circuits and illustrations are quite understandable in any language, and are highly informative except for the fact that the condenser values and diagrams are indicated in centimeters; and, hence, must be converted into micromicrofarads by considering these two terms equal (for example, 500 cm. equals approximately 500 mmf.). Diagrams of the various amplifiers should be fairly easy to apply to American practices.

Microphones of the condenser, ribbon, crystal, magnetic, and carbon types are described at considerable length. Photographs and detailed drawings help illustrate the various descriptions.

PRACTICAL ELECTRICITY, RADIO, REFRIGERATION, AIR CONDITIONING AND DIESEL ENGINES. Complete Reference Set or Library, prepared by Coyne Electrical School teaching and technical staff. Size 9 x 11½ ins., 1,190 pages, 2,012 illustrations. 1938 Revised Edition, leatherette covers, price in 3 bound volumes, \$12.00; price in one large single volume, \$9.85.

The set covers fundamentals of Electricity and Radio; Alarms, Signals and Telephones; Electrical Wiring; Armature Winding and Motor Repairs; D.C. and A.C. Motors, Generators, Controls, Switchboards, Dynamic Braking and General Operation and Care of D.C. and A.C. Power Equipment; Power Factor Correction and Modern Electrical Maintenance Methods; Automotive Ignition; Storage Batteries; Refrigeration and Air-Conditioning; Diesel Engines, Care and Adjustment; Radio and Sound Equipment Principles, Applications, Servicing and Repair; Television Principles and Equipment.

The set has been prepared in simple language and is very well illustrated. It is highly interesting and easily understandable by students, laymen or practical workmen in the field.

Index to advertisers

A	
Aerovox Corporation.....	562
Allied Radio Corporation.....	557
Amperite Corporation.....	Inside Front Cover
Amplifier Co. of America.....	568
B	
The Brush Development Co.....	550
Burstein-Applebee Company.....	569
C	
Capitol Radio Engineering Inst.....	568
Central Radio Laboratories.....	551
Classified Section.....	569
Cornell-Dubilier Electric Corporation.....	567
Coyne Electrical School.....	515
D	
Deco.....	550
E	
Ezytone Instrument Company.....	567
H	
Hammarlund Mfg. Company.....	558
Hygrade Sylvania Corporation.....	555
I	
International Correspondence Schools.....	554
International Resistance Company.....	574
K	
Kelsey Company.....	568
L	
Lancaster, Allwine & Rommel.....	550
Lincoln Engineering School.....	572
M	
John Meek Instruments.....	569
Meissner Mfg. Company.....	515B
Modell's.....	568
N	
National Plans Institute.....	558
National Radio Institute.....	513
National Schools.....	550
National Union Radio Corp.....	561
New York YMCA Schools.....	561
R	
Radio & Technical Pub. Co.....	550, 571
Radio City Products Company.....	556
Radio Publications.....	568
Radio Training Association.....	557
Radolek Company.....	573
RCA Institutes, Inc.....	556
RCA Manufacturing Co., Inc.....	565
Readrite Meter Works.....	560
Remington Rand, Inc.....	572
S	
Service Instruments, Inc.....	553
Solar Manufacturing Company.....	564
Sprague Products Company.....	572
Sprayberry Academy of Radio.....	Back Cover
Superior Instruments Co.....	Inside Back Cover
Supreme Instruments Corporation.....	559
T	
Technifax.....	562
Test Equipment Co. of America.....	551
Triplett Electrical Instr. Co.....	563
The Turner Company.....	571
U	
United Radio Company.....	559
W	
Montgomery Ward & Company.....	564
Wellworth Training Company.....	570, 556
Wholesale Radio Company, Ltd.....	559
Wholesale Radio Service Co., Inc.....	560
Williams Philco, Inc.....	561
Wright-DeCoster, Inc.....	561

(While every precaution is taken to insure accuracy, we cannot guarantee against the possibility of an occasional change or omission in the preparation of this index.)

3 Great Engineering Features



Make CONTROLS Permanently QUIET

All pioneered and perfected by IRC . . . All three available only in IRC Type CS Volume Controls . . . and at ordinary control prices.



NO SLIDE . . . NO FRICTION

Metal-to-metal, sliding contact between rotor arm and end terminal is "out." Noise hasn't a chance. The IRC Silent Spiral (positive contact) Connector sees to that.



THE GLIDING ELEMENT RIDER

Instead of a single "rough-riding" contact to element, five separate spring-like contacts give a cushioned "knee-action" effect. Contact acts independently; each tracks smoothly in perfect unison; each is plated, rounded, smoothed to avoid abrasion and wear.



SMOOTH AS GLASS . . .

The ideal surface for noise-free contact is supplied by the famous IRC Metallized type resistance element permanently bonded to a moisture-proof bakelite base. You can actually feel the difference as the 5-Finger Knee Action Contactor is rotated across this element.

INTERNATIONAL RESISTANCE COMPANY
401 N. BROAD ST., PHILADELPHIA

Please Say That You Saw It in RADIO-CRAFT

SUPERIOR PRESENTS 5 INSTRUMENTS

from its NEW 1100 series!!!! Never before has Superior offered so much for so little! Always the Best Buy in the Instrument Field, Superior in this new 1100 series gives you even more value! We have incorporated many refinements, many new features . . . all proven to be sound and practical. We urge you to read the descriptions below carefully; see how these instruments fit your needs. Buy direct from manufacturer and save 50%.

SUPERIOR INSTRUMENTS ARE GUARANTEED FOR ONE YEAR

THE NEW MODEL 1110-S A.C. - D.C. VOLT OHM MILLIAMMETER

A Midget in Size A Giant in Performance

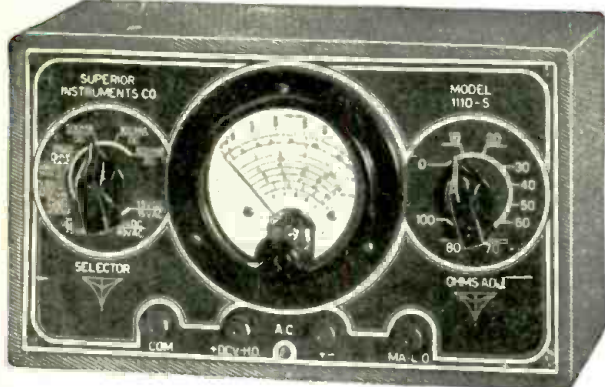

Features modern 0-1 d'Arsonval type meter, precision resistors, neat etched panel housed in new striped fabricoid case.

SPECIFICATIONS:

0-1.5 volts D.C.	0-500 ohms 500-500,000 ohms.	0-15 volts A.C.
0-15 volts D.C.	0-1 ma. D.C.	0-40 volts A.C.
0-25 volts D.C.	0-10 ma. D.C.	0-75 volts A.C.
0-75 volts D.C.	0-100 ma. D.C.	0-200 volts A.C.
0-500 volts D.C.	0-500 ma. D.C.	0-1200 volts A.C.

Model 1110-S supplied complete with batteries, test leads and instructions. Size: 8½" x 5" x 3¼". Shipping weight, 5½ pounds. Our net price

\$7⁸⁵

THE NEW MODEL 1130-S

Signal Generator with Audio Frequencies

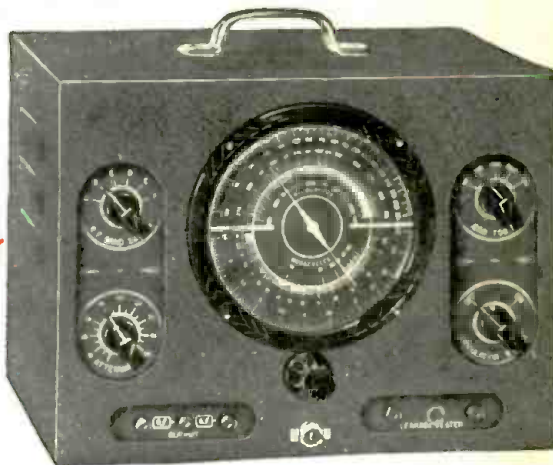

SPECIFICATIONS:

1. Combination R.F. and Audio Signal Generator. R.F. 100 kc. to 100 Mc. A.F.—100-7,500 cycles. All Direct reading, all by front panel switching.
2. R.F. and A.F. output independently obtainable alone or with A.F. (any frequency) modulating R.F.
3. Accuracy is within 1% on I.F. and Broadcast bands; 2% on higher frequencies.
4. Audio frequencies in 5 bands; 100, 400, 1000, 5000, and 7500 cycles.
5. Giant airplane full vision, direct-reading dial.
6. Condenser and other leakages tested to 100 megohms.
7. All services on 90-130 volts A.C. or D.C. (any frequency).

Model 1130-S comes complete with tubes, test leads, carrying handle, instructions. Size 12" x 9" x 6½". Shipping weight 15 pounds. Our net price

\$11⁸⁵

THE NEW MODEL 1150-S SUPER-ALLMETER

Featuring the New Sloping Panel



A genuine achievement! For accurate and rapid measurements. Note the following features: A.C. and D.C. Volts, A.C. and D.C. currents, Resistance, Capacity, Inductance, Decibels, Watts.

SPECIFICATIONS:

- D.C. Voltage: 0-15, 0-150, 0-750 volts D.C.
- A.C. Voltage: 0-15, 0-150, 0-750 volts A.C.
- D.C. Current: 0-1, 0-15, 0-150, 0-750 ma. D.C.
- A.C. Current: 0-15, 0-150, 0-750 ma. A.C.
- 2 Resistance Ranges: 0-500 ohms, 500-5 megohms
- High and Low Capacity Scales: .0005 to 1 mfd. and .05 to 280 mfd.
- 3 Decibel Ranges: -10 to +19, -10 to +38, -10 to +53. Inductance: 1 to 700 Henries
- Watts

Based on 6 mw. at 0 D.B. In 500 ohms. .000000 to 600 Utilizes new 4½" square 0-1 d'Arsonval type meter with precision resistors housed in our newly devised sloping case for rapid and accurate servicing.

Model 1150-S supplied complete with test leads, tabular charts and instructions. Size 10" x 7¼" x 4¼", shipping weight 9 pounds. Our net price

\$11⁸⁵

Model 1150-A Portable carrying cover 75c additional.

THE NEW MODEL 1180-S SET TESTER

A Complete Laboratory All in One Unit!

Featuring Our New Type Sloping Panel for Precise and Rapid Servicing



A complete testing laboratory all in one unit! Combines Superior models 1140-S and 1150-S. For specifications read the description of both these models herewith. Comes housed in sturdy, black case with sloping panel for rapid and simple measurements. Complete with test leads, tabular charts, instructions and tabular data for every known receiving type tube, including many transmitting types. Size 11¼" x 9¼" x 3¾", shipping weight 18 pounds Our net price

\$17⁸⁵

Model 1180-A for Portable Cover, add 95c.

THE NEW MODEL 1140-S TUBE TESTER



A really modern tube tester conforming to all standards of good engineering practice. Utilizes a 3" d'Arsonval type meter with calibrated scale. Furnished in a sturdy black case with sloping panel for easy operation. Removable cover and carrying handle for either portable or counter use.

SPECIFICATIONS:

1. Tests all 4, 5, 6, 7, 7L, and octal base tubes, including diodes.
2. Tests by the well-established emission method for tube quality, directly read on the GOOD? BAD scale of the meter.
3. Affords separate neon test for leakage and shorts between elements.
4. All services performed by the use of only five controls at maximum, and many tests do not require working all the controls.
5. Supplied with instructions and reference table so that the filament voltage and emission measuring controls may be properly set for the enumerated long list of tubes, which includes all tubes commonly encountered in servicing.
6. Works on 90-130 volts A.C. 60 cycle.

Model 1140-S comes complete with instructions and tabular data for every known receiving type of tube as well as many transmitting types. Shipping weight 10 pounds, size 10" x 7¼" x 4¾". Our net price

\$10⁸⁵

Model 1140-A with Portable Cover 75c additional

SUPERIOR INSTRUMENTS CO.

136 Liberty St., RC-339
NEW YORK, N. Y.

A Sword Fit for an Emperor!

RADIO TRAINING FITTED FOR YOU

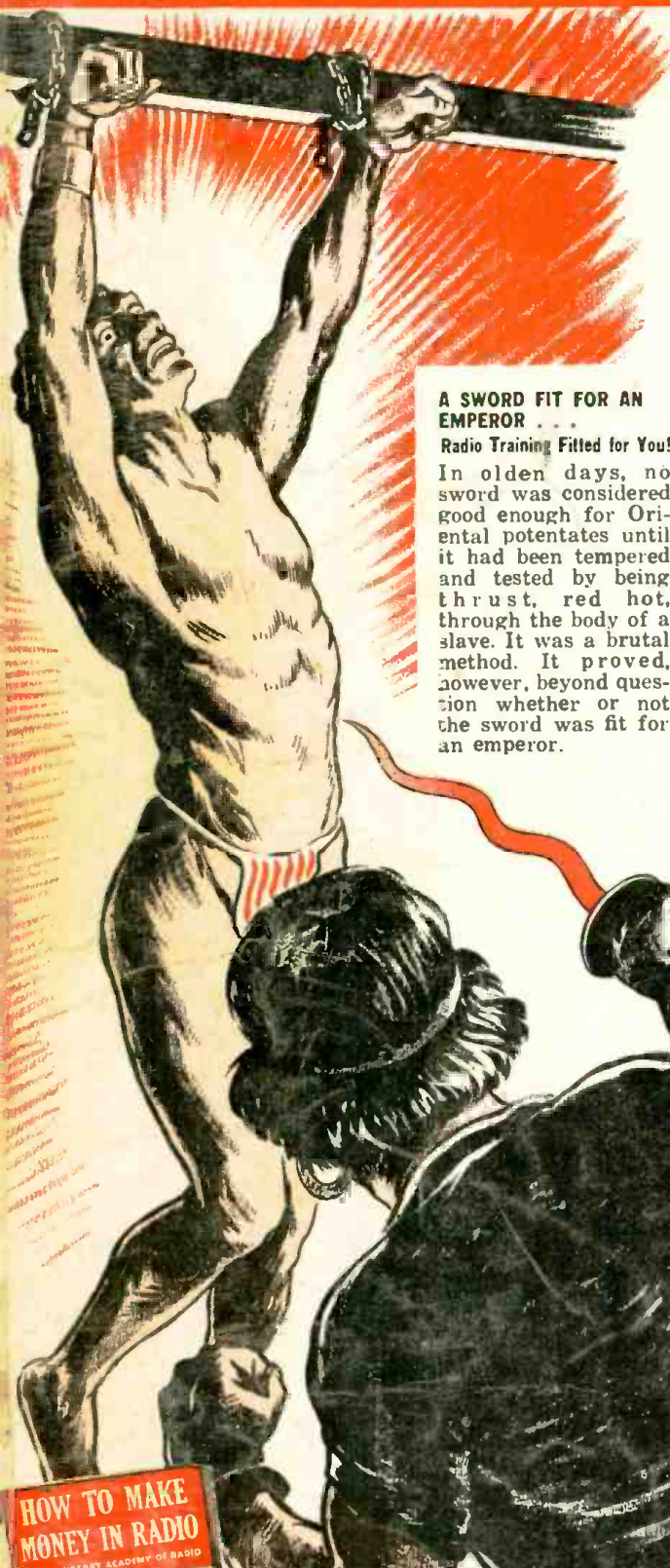

A SWORD FIT FOR AN EMPEROR . . .

Radio Training Fitted for You!

In olden days, no sword was considered good enough for Oriental potentates until it had been tempered and tested by being thrust, red hot, through the body of a slave. It was a brutal method. It proved, however, beyond question whether or not the sword was fit for an emperor.



A STRAIGHT-FROM-THE-SHOULDER TALK TO EVERY READER OF THIS MAGAZINE WHO PLANS TO MAKE MORE MONEY IN RADIO IN 1939

These days we live, *not by the sword*, but by our type of work and our ability to do it well. We're each an emperor in this respect! Success demands that YOU make ABSOLUTELY SURE that your Radio and Television training is of the best—that it will take you straight and sure to your goal—that of MAKING MONEY and achieving all the things which money brings.

As your own personal emperor, you do indeed want the best Radio and Television training you can get. *Sprayberry can give it to you.* This training is proven, tried and time tested. You get practical experience by working with 146 Radio parts—right in your own home. In addition you get a kit of 22 tools, an ALL-WAVE, ALL-PURPOSE ANALYZER, which includes a Signal

Generator, Multimeter and modern 5-socket Analyzer with cable and plug. The Sprayberry Course includes training not only in Radio but also Television, Facsimile, Electronics, Public Address, Broadcast Operating, Amateur Radio, Service and Repair, Short Wave, etc. There are other exclusive training features, such as four and six color circuit diagrams, etc.

MAIL COUPON FOR BIG FREE 52-PAGE BOOK

In this space it is impossible to give even a condensed outline of the New 1939 Sprayberry Radio and Television training. The complete story is told in a new and free 52-page book. Write for it. Mail the coupon NOW. It's a story about Radio you don't want to miss. It is a book you will enjoy reading, and what is more, it will show you how to MAKE REAL MONEY IN RADIO.

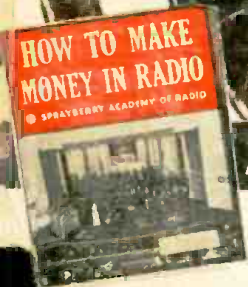

RUSH COUPON FOR MY BIG **FREE** BOOK

SPRAYBERRY ACADEMY OF RADIO
F. L. Sprayberry, Pres.
220-C University Place, N. W.
Washington, D. C.

Please send me FREE copy of "HOW TO MAKE MONEY IN RADIO."

Name Age
Address
City State

Tear off this coupon, mail in envelope or paste on penny postcard.