

Oct 38
RADIO'S GREATEST MAGAZINE

OVER 175 ILLUSTRATIONS

Radio-Craft

SPECIAL
TEST
EQUIPMENT
NUMBER

October

25 Cents

In United States
and Canada

HUGO GERNSBACK Editor

RADIO
HELPS TEST
HEARING-AIDS

See Page 207



New 11-Tube Receiver Introduces "Synchrotronic" Reproduction • New Tubes
World-Flight Radio Set-Up • Details of a 5-inch Television Receiver!

OVER 50,000 RADIO MEN READ RADIO-CRAFT MONTHLY

AMPERITE

offers
"ADJUSTABLE RESPONSE"
 (HIGHER OR LOWER PITCH WITH THE SAME MICROPHONE)

... made possible by
THE ACOUSTIC COMPENSATOR

(pat. pend.)

Here is an improvement of great value at no extra cost! Exclusive with Amperite, the Acoustic Compensator gives you these advantages:

- (1) With the flip of a finger, you can now lower or raise the response of the microphone—without introducing any peaks or other undesirable effects. (Not a volume control. Gradually changes operation of the microphone from constant velocity to constant pressure.)
- (2) Permits adjustment of the microphone for most desirable response for close talking or distant pickup.
- (3) Makes the system immediately adjustable to any "taste," room condition, or equipment.

MODELS RBHK, RBMk, with Acoustic Compensator. Frequency range 40 to 11000 CPS. Output, -65 db. Complete with switch, cable connector and 25' of cable, . . . \$42.00 LIST, Chrome, \$43.00 LIST. MODELS RBHn, RBMn, without acoustic compensator, \$42.00 LIST

Now! Models, RSHK and RBSK with Acoustic Compensator and cable connector . . .

\$32.00 List
 Chrome or Gunmetal

PUSH UP TO INCREASE HIGHS, PUSH DOWN TO INCREASE LOWS



IMPROVES ANY "LOW-COST" INSTALLATION ON 4 COUNTS!

P. A. Men, you can improve those "price" jobs by using the popular Amperite Model RAH (or RAL). You will get better results because (1) it is excellent for both speech and music; (2) has flat response without undesirable peaks; (3) reduces feedback; (4) stands up under rough handling, changes in temperature, pressure or humidity. . . . Frequency range 60 to 7500 cps. Output, -68 db.

MODEL RAH (Hi-imp.) with 12' of cable; MODEL RAL (200 ohms) with 8' of cable. . . . ONLY \$22.00 LIST

NEW LOW-PRICED CONTACT MICROPHONE . . \$12.00 LIST

The success of our Model KTH (\$22.00 List) has created a demand for a popular-priced Amperite Contact Microphone. The new model listed below can be used on most radio sets made since 1935 and on all P.A. systems. It "makes an ordinary violin sound like a Strad" . . . gives a small piano the tone of a Grand. And yet, there is no distortion. No unnatural effects. No "lingering noises." Installation is simple . . . no changes in strings or instruments . . . attached without tools.

Operates with either high or low gain amplifiers. Has frequency response of 40 to 9000 cps. Output, -40 db. 20' of cable.

MODEL SKH (Hi-imp.); SKL (200 ohms) \$12.00 LIST
 SKH or SKL with foot-operated volume control \$20.00 LIST
 Professional Model KTH (or KTL) \$22.00 LIST

"TOPS IN MIKES"

Station KVOL, of Lafayette, La., writes us, unsolicited: ". . . the Amperite mikes have been in service here for almost three years, and have proven themselves to be "tops" in mikes. They have broadcasted in the rain and in the hot sun. They have even been dropped, but they always came through in fine shape . . ." The Amperite Studio Velocity Model SR80n now has -56 db output. Frequency range 40 to 15000 cps. Triple shielded, fitted with switch, (optional), cable connector, and 25' of cable. MODEL SR80n (200 ohms); \$80.00 LIST MODEL SR80Hn (Hi-imp.), \$80.00 LIST



Sales Aids for the P. A. Man Amperite offers the following co-operation to P.A. Men.

- (1) FREE Window Decal advertising your Sound Service. Size 5 1/4 x 9 1/4, finished in 4 striking colors.
- (2) FREE Window Display, 11 x 17.
- (3) Special Sound Equipment Letterheads. Samples and prices on request.
- (4) FREE use of cut for printing business cards, etc.

Write for these valuable sales helps, and new Illustrated Bulletins, today!

AMPERITE CO.

561 BROADWAY, N. Y. U. S. A.

CABLE ADDRESS
 ALKEM, NEW YORK

Better Systems
 Specify Amperite



VELOCITY

AMPERITE

MICROPHONES



Be a Radio Expert

Many make \$30 \$50 \$75 a week

I will train you at home for many Good Spare Time and Full Time Radio Jobs

J. E. SMITH, President, National Radio Institute
Established 1914
The man who has directed the home study training of more men for the Radio Industry than any other man in America.



Set Servicing
Fixing Radio sets in spare time pays many \$5, \$10, \$15 a week extra while learning. Full time repair pays as much as \$30, \$50, \$75 a week.

Broadcasting Stations
Employ managers, engineers, operators, installation and maintenance men for fascinating jobs and pay up to \$5,000 a year.



Loud Speaker Systems
Building, installing, servicing, operating public address systems is another growing field for men well trained in Radio.

HERE'S PROOF THAT MY TRAINING PAYS



\$50 Monthly in Spare Time
"I work on Radio part time, still holding my regular job. Since enrolling seven years ago, I have averaged around \$50 every month."
JOHN B. MORRISSETTE, 809 Valley St., Manchester, N. H.



Makes \$50 to \$60 a Week
"I am making between \$50 and \$60 a week after all expenses are paid, and I am getting all the Radio work I can take care of, thanks to N. R. I." H. W. SPANGLER, 126 1/2 S. Gay St., Knoxville, Tenn.



Operates Public Address System
"I have a position with the Los Angeles Civil Service, operating the Public Address System in the City Hall Council. My salary is \$170 a month." R. H. HOOD, R. 136, City Hall, Los Angeles, Calif.

Lesson on Radio Servicing Tips—FREE

I want to prove that my Training gives practical, money-making information, is easy to understand—in what you need to master Radio. My sample lesson text, "Radio Receiver Troubles—Their Cause and Remedy" covers a long list of Radio receiver troubles in A.C., D.C., battery, transformer, auto, T. R. F. superheterodyne, all-wave, and other types of sets. And a cross-reference system gives you the probable cause and a quick way to locate and remedy these set troubles. A special section is devoted to receiver check-up, alignment, balancing, neutralizing and testing. Get this lesson FREE. No obligation. Just mail coupon.



Do you want to make more money? Radio offers you many opportunities for well-paying spare time and full time jobs. You don't have to know anything about Radio or electricity, give up your present job, leave home or spend a lot of money to become a Radio Expert and also be trained to "cash in" on coming Television opportunities.

Many Radio Experts Make \$30, \$50, \$75 a Week

Radio broadcasting stations employ engineers, operators, station managers and pay up to \$5,000 a year. Fixing Radio sets in spare time pays many \$20 to \$500 a year—full time repair jobs with Radio jobbers, manufacturers, dealers, as much as \$30, \$50, \$75 a week. Many Radio Experts open their own full time or part time radio sales and repair businesses. Radio manufacturers and jobbers employ testers, inspectors, foremen, engineers, servicemen, paying up to \$6,000 a year. Automobile, police, aviation, commercial Radio and loud speaker systems are newer fields, offering good opportunities now and for the future. Television promises to open many good jobs soon. Men I trained have good jobs in these branches of Radio. Read their letters in "Rich Rewards in Radio." Mail the coupon.

There's a Real Future in Radio for Well-Trained Men

Radio today is young—yet it's one of our large industries. More than 28,000,000 homes have one or more Radios. There are more Radios than telephones. Each year millions of Radios get out of date, need replacing or new tubes, repairs. Millions are spent each year for Radio repairs. More than 5,000,000 auto Radios are in use; more are being sold every day, offering more profit-making opportunities for Radio experts. And RADIO IS STILL YOUNG—GROWING. Radio is expanding into other fields. The few hundred \$30, \$50, \$75 a week jobs of 20 years ago have grown to thousands. Yes, Radio offers opportunities—now and in the future!

Many Make \$5, \$10, \$15, a Week Extra in Spare Time While Learning

The day you enroll I start sending you Extra Money Job Sheets. They show you how to do Radio repair jobs, how to cash in quickly. Throughout your training I send you plans and ideas that have made good spare time money—from \$200 to \$500 a

year—for hundreds of fellows. I send you special Radio equipment and show you how to conduct experiments and build circuits illustrating important Radio principles. My Training gives you PRACTICAL EXPERIENCE while learning.

I Also Give You a Professional Servicing Instrument

Here is the instrument every Radio expert needs and wants—an All-Wave, All-Purpose Set-Servicing Instrument. It contains everything necessary to measure A.C. and D.C. voltages and current; to test tubes, resistance; adjust and align any set, old or new. It satisfies your needs for professional servicing after you graduate—can help you make extra money fixing sets while training.



Television, Public Address, Photo Electric Cell Training Included

N.R.I. trains you thoroughly for Radio and also for many opportunities in connection with P.A. systems, Photo-electric cells, Auto and Aviation Radio and to be ready for jobs coming with Television. Get into Radio now. The best jobs in Television will go to Radio trained men who also know Television.

Get My Book About Radio and Television Also Sample Lesson Free

Act Today. Mail the coupon now for "Rich Rewards in Radio." It's free to any fellow over 16 years old. It points out Radio's spare time and full time opportunities and those coming in Television; tells about my training in Radio and Television; shows you letters from men I trained, telling what they are doing and earning; shows my Money Back Agreement. Find out what Radio offers YOU! MAIL THE COUPON in an envelope, or paste on a postcard—NOW!

J. E. SMITH, Pres., National Radio Institute
Dept. 8KX,
Washington, D. C.

THIS FREE BOOK HAS HELPED HUNDREDS OF MEN MAKE MORE MONEY



This Coupon is Good for One FREE Copy of My Book

J. E. SMITH, President, Dept. 8KX
National Radio Institute, Washington, D. C.

Dear Mr. Smith: Without obligation, send me free the Sample Lesson and your 64-page Book, "Rich Rewards in Radio," telling about spare time and full time Radio opportunities, and how I can train for them at home in spare time. (Please write plainly.)

NAME AGE
ADDRESS
CITY STATE 14-X1

Please Say That You Saw It in RADIO-CRAFT



HUGO GERNSBACK, Editor-in-Chief

R. D. WASHBURNE
Managing Editor

N. H. LESSEM
Associate Editor

ROBERT EICHBERG
Trade Digest Editor

THOS. D. PENTZ, Art Director

CONTENTS — Oct. 1938, Issue

Volume X

Number 4

Editorial: Nobody Knows Radio.....Hugo Gernsback	196
The Radio Month in Review.....	198
Radio on a Globe-Circling Dash.....R. D. Bernard	200
Construction Details of a 441-Line Teleceiver.....	202
New High-Fidelity Hearing-Aids.....	206
Radio Helps Test Hearing-Aids.....E. J. Myers	207
"Signal-Test" System of Trouble-ShootingJohn F. Rider	208
Build This 38-Range "Pushbutton" Bench Tester— Part II.....Charles Sicuranza	210
New I—Anti-Noise Counterpoise Antenna System.....	212
New Circuits in Modern Radio Receivers—No.13F. L. Sprayberry	213-214
Home-Built 11-Tube Set Introduces "Syncrotronic" Reproduction.....L. M. Barcus	215-216, 217-218
How to Make a Modern V.-T. VoltmeterHoward G. McEntee	229

RADIO SERVICE DATA SHEETS:

No. 237—Belmont 4-Tube Model 408 (Series A) Bat- tery "Farm" Superhet.....	219-220
No. 238—Stewart-Warner Models 97-561 to 97- 569 (Superhet. Chassis No. 97-56).....	221
New Test Instruments.....	222
Radio Wittiquiz	222
Radio Trade Digest.....	223
The Latest Radio Equipment.....	227
Servicing Questions & Answers.....	230B
Operating Notes	230B

RADIO VOCATION NUMBER

Radio continues to grow by leaps and bounds. Today there is hardly an industry which, in one form or another, does not benefit from Radio and its allied fields. Broadcasting, electronics, public address, television, facsimile, communications—all these branches offer wide-spread opportunities to the man who chooses Radio as a career. Beginners will find in the next issue of RADIO-CRAFT—the RADIO VOCATION NUMBER—not only discussions of money-making opportunities, but simplified construction articles covering several of these fields.

Of course, set builders, sound specialists and other radio groups will find, as usual, articles of special interest in this same issue—

—on the newsstands October 1st.

Published by Redcraft Publications, Inc. Publication office: 29 Worthington Street, Springfield, Mass. Editorial and Advertising Offices: 99 Hudson Street, New York City. Chicago Advertising Office: RADIO-CRAFT, 520 North Michigan Avenue, Chicago, Ill.

Foreign Agents:

London—Gorrings's American News Agency, 9A Green St., Leicester Square, W. C. 2, England.
Paris—Messageries Dawson, 4 Rue Faubourg, Poissonniere, France.
Melbourne—McGill's Agency, 179 Elizabeth St., Australia.
Dunedin—James Johnston, Ltd., New Zealand.

RADIO-CRAFT is published monthly, on the first of the month preceding that of date; subscription price is \$2.50 per year in U. S. and Canada. (In foreign countries, \$3.00 a year to cover additional postage.) Entered at the post office at Springfield as second-class matter under the act of March 3, 1879.

Text and illustrations of this magazine are copyright and must not be reproduced without permission of the copyright owners.

Copyright 1938 Redcraft Publications, Inc.

MANY OPPORTUNITIES FOR THE COYNE TRAINED RADIO MAN

Are You Ready for a Better Job - More Pay?

Don't be an untrained man. Let me show you how to get your start in Radio — a fast growing, live money-making industry.

Prepare for jobs as Assembler, Inspector and Tester—Radio Sales or Service and Installation Work—Broadcasting Station Operator—Wireless Operator on a Ship or Airplane or Sound Work—HUNDREDS OF OPPORTUNITIES for a real future in radio!



12 Weeks of Shop Training

We don't teach by book study. We train you on a great outlay of Radio, Television and Sound equipment—on scores of modern Radio Receivers, actual Broadcasting equipment, Television apparatus and Sound Reproduction equipment, Code and Telegraph equipment, etc. You don't need advanced education or previous experience. We give you — RIGHT HERE IN THE COYNE SHOPS — the actual practice and experience you'll need for your start in this great field. And because we cut out all useless theory and only give that which is necessary you get a practical training in 12 weeks. Mail coupon for all facts about my school and training methods.

TELEVISION and PUBLIC ADDRESS

Television is sure to come as a commercial industry. Rapid progress is now being made in developing this new field. It will offer opportunities to the man who is trained in Radio. Here at Coyne you learn Television principles, and work on actual Television equipment. Public Address Systems offer opportunities to the Trained Radio Man. Here is a great new Radio field which is rapidly expanding. Prepare NOW for these wonderful opportunities! Learn Radio Sound Work at COYNE on actual Sound Reproduction equipment. Not a home study course.

SEND FOR DETAILS OF MY "PAY AFTER GRADUATION" PLAN

Mail the Coupon below and I'll tell you about my "Pay After Graduation" Plan which has enabled hundreds of others to get Coyne training with very little money. On this plan you can get your training first, then take 18 months to complete your small monthly tuition payments starting 5 months after you begin training. Not a home study course.

Mail the coupon for all details of this "Tuition Payment Plan."

PRACTICAL WORK at COYNE in Chicago

ACTUAL, PRACTICAL WORK. You build and service radio sets. You get training on real Broadcasting equipment. You construct Television Receiving Sets and actually transmit your own Television images over our Television equipment. You work on real Sound equipment. You learn Wireless Operating on Actual Code Practice apparatus. We don't waste time on useless theory. We give you the practical training you'll need for your start in Radio—in 12 short weeks. If you desire code, this requires additional time for which there is no extra charge.

Mail Coupon Today for All the Facts

H. C. LEWIS, Pres. RADIO DIVISION Founded 1899

Coyne Electrical School
500 S. Paulina St., Dept. E8-8H, Chicago, Ill.

ELECTRIC REFRIGERATION AIR CONDITIONING AUTOMOBILE ELECTRICAL WORK

Instruction now included at no extra cost. Here is your opportunity to learn these valuable allied lines without extra tuition charge.

PART TIME EMPLOYMENT TO HELP YOU "EARN WHILE LEARNING"

If you are short of money and need part time employment to help pay for your room and board while training, my Employment Department will help you get a part time job.



GET THE FACTS

Don't let lack of money prevent your sending in the Coupon. Mail the Coupon today and I Will send you the Big FREE Coyne Book full of FACTS.

H. C. LEWIS, Pres.

Radio Division, Coyne Electrical School
500 S. Paulina St., Dept. E8-8H, Chicago, Ill.

Dear Mr. Lewis:—Send me your Big Free Radio Book, and all details of your "Pay After Graduation" Plan including valuable instruction in Electric Refrigeration, Air Conditioning and Automobile Electrical Work.

Name

Address

City State

Please Say That You Saw It in RADIO-CRAFT

NEW *Speed* SUPREME INSTRUMENTS



MODEL 594 TUBE TESTER

Uses only one octal socket, but is designed so you can test all non-octal tubes by means of your own analyzer plug and cable unit or the special 593 Push-Button Analyzer (described below).

The Model 594 offers a real chance for servicemen to MODERNIZE their obsolete tube checkers. ANY separate 1 mil. movement meter WHICH YOU NOW HAVE can be used with the 594. (Or use it in conjunction with the meter in the 592 illustrated on the opposite page.)

"Tomorrow's Tube Tester" checks all new or old type receiving tubes including "M", "MG" and "G" types, octals, non-octals, gas rectifiers, magic eye tubes, single section or multi-section types, amplifiers, detectors, converters, rectifiers, etc.

Tubes are checked 4 WAYS. Complete, sectional quality check. "Hot" short, open element and leakage tests are made between ANY TWO ELEMENTS by merely punching a row of push-buttons, one after the other.

Cash price only \$26.00 in case. \$22.50 without case.

MODEL 593 PUSH-BUTTON ANALYZER

Due to a tremendous demand for a separate analyzer unit which can be used with any multimeter or set-tester, as well as an additional necessary unit for the SPEED-SERVICE LAB Rack and Panel, we offer the first all-push-button analyzer. No more connectors and twin-jacks. Just connect your multimeter to the 593's two pin jacks, put the analyzer plug in the set's socket, the set's tube in the 593 and you can make voltage or resistance measurements between any two tube elements or current measurements in any tube element circuit. All you do is press two push-buttons for any reading. No fuss or bother. No special instructions! It's as easy as ringing a door bell.

Cash price, with case, only \$14.65. \$12.50 without case.

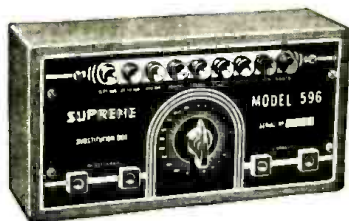
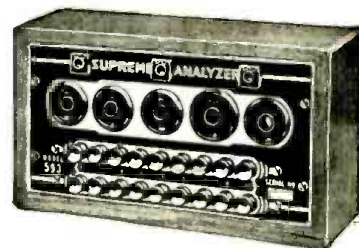

MODEL 596 SUBSTITUTION BOX

A handy service instrument used to determine the proper value of resistance and capacity for replacement work. Contains a variable resistor values to 50,000 ohms and fixed values of 100,000, 250,000, 500,000 ohms and 1 meg. All available through push-buttons. Also three push-buttons give condenser values of .1, .5, and 8.0 microfarads. All ranges terminate at tip jacks and both resistance and capacity can be used at the same time. Saves time and money and helps you do better work in a hurry.

Cash price, with case, only \$10.90. \$8.75 without case.

MODEL 506-P PUSH-BUTTON TUBE TESTER

The fastest operating tube tester ever designed! Simply spin the numerical chart roll until the type number of the tube comes up — then punch the buttons according to the numbers shown (just like a cash register) — and the big illuminated meter reads "Good," "?" or "Bad." THAT IS ALL THERE IS TO IT.

Tests all receiving tube types including "M", "MG" and "G" types for shorts and leaks between elements on neon bulb, and for "Quality" on a large English reading scale. Also checks for open circuited and loose elements. Makes separate tests on diodes, full wave rectifiers and multi-purpose tubes. Line voltage control. No tube will pass the 506-P that won't perform in a radio set.

Cash price, in oak carrying case, only \$59.50.

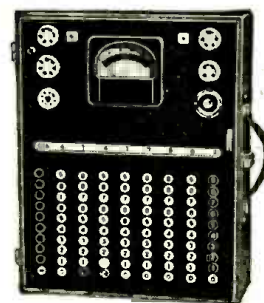

**ALL SUPREME INSTRUMENTS SOLD BY
YOUR PARTS JOBBER ON S.I.C. EASY TERMS**

Please Say That You Saw It in RADIO-CRAFT

THE BIGGEST *in your shop!* LITTLE INSTRUMENT

HERE IS THE BIGGEST VALUE IN THE SMALLEST COMPLETE MULTI-METER ON THE MARKET!



EVERYTHING YOU'D EXPECT IN A \$30 INSTRUMENT!

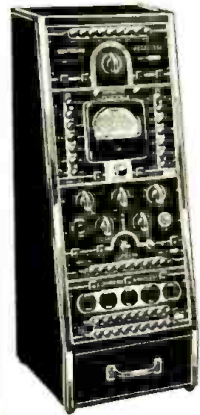

★ SUPREME SERVICE LABRACK

This service laboratory occupies less than one square foot of space on your bench! It contains *all four* of the new SUPREME Speed INSTRUMENTS listed below.

MODEL 596 SUBSTITUTION BOX by means of nine push-buttons allows rapid, accurate, temporary replacement from 1 ohm to 50M, 100M, 250M, 500M, 1 meg.; also capacitors 0.1, 0.5, and 8 mfd. Speeds up your replacement work 100%.

MODEL 594 TUBE TESTER with a new, modern tube testing circuit which utilizes the Model 592 set-tester's meter, and its GOOD-?-BAD scale. TOMORROW'S TUBE TESTER!

MODEL 593 ANALYZER designed to be used with any multimeter or set tester. Just connect your multimeter to the 593's two pin jacks, put the analyzer plug in the set's socket, the set's tube in the 593 and make voltage or resistance measurements!

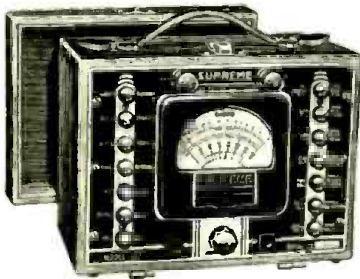

MODEL 592 SET TESTER gives you a total of 47 ranges and functions with two D.C. volts sensitivity—both 1000 ohms per volt and 25,000 ohms per volt—in the same instrument! Completely self-contained. Push-button operated.

Here is a complete pocket lab for only **\$16³⁰**
or it may be purchased on the easy installment terms of \$4.73 cash and 3 payments @ \$4.73.

A REGULAR little pocket laboratory with a case only 3" x 5 3/4" x 2" in size, weighing but 23 ounces—24 ranges—just as accurate and even more convenient than you would expect to find in an instrument twice its price.

At your finger tips are 4 D.C. mil ranges (with first scale division 5 microamperes) of 0/0.3/6/30/150; 4 D.C. volt ranges (with first scale division 0.1 volt) of 0/6/150/300/1500; 4 ohms ranges (with 1 ohm first scale division and 25 ohms center scale) of 0/2,000/20,000/200,000/2 meg.; 4 A.C. volt ranges (with first scale division 0.1 volt) of 0/6/30/150/600; 4 output ranges of 0/6/30/150/600; 4 decibel ranges of -6/+10, +8/+24, +22/+38, +34/+50.

The Model 542 is not a toy—it uses a full size 3" square meter with a rugged, accurate 200 micro-ampere movement and a knife edged pointer. This movement has a sensitivity of 5000 ohms per volt! All ohmmeter ranges, including the megohm range, are operated by batteries furnished with the instrument and contained within its durable black moulded bakelite case. A uni-control takes care of all voltage, current, and D.B. ranges in addition to zero ohms adjustment. The attractive metal panel is finished in silver and black to match the case, meter and other parts.

Because of its convenience and ease of operation it will soon become one of your favorite instruments—just slip it in your coat pocket and you are equipped to make all A.C. and D.C. voltage, Direct Current, Resistance, Output voltage and D.B. measurements!

Your own parts jobber now has the 542 Multi-Meter in stock—order yours TODAY

MAIL COUPON TODAY!

SUPREME INSTRUMENTS CORP.,
Dept. RC-10, Greenwood, Mississippi

Please send me literature on your new Speed instruments

NAME

ADDRESS

CITY STATE

SUPREME INSTRUMENTS CORP., GREENWOOD, MISS., U. S. A.
Export Dept., Associated Exporters Co., 145 W. 45th St., New York City
Cable Address: LOPREH, New York

Please Say That You Saw It in RADIO-CRAFT



' TAKES THE RESISTANCE OUT OF RADIO '

NOBODY KNOWS RADIO

By the Editor — HUGO GERNSBACH

SURPRISING as it may sound, when it comes to the more technical aspects of Radio we know practically nothing about many of its functions. All we have are unproven theories. Incidentally, these theories are being revised from year to year and often from month to month; and very often at the end of a decade we are seemingly as far from the actual truth as we were when we started.

Man occupies a rather unique position in Nature in that he tries to interpret many of her functions by means of his logic, which often turns out to be in error. In many ways Man is blind; and, even when he sees, he is not too sure of what takes place. Our eyes, for instance, are easily fooled and our ears are easily deceived. Thus, when we watch a motion picture that unfolds, the entire process is, of course, purely illusion because nothing moves on the screen except single pictures which jerk along, one after the other, giving us "motion."

But when it comes to other phenomena which we can neither hear, see, nor feel and to which all our senses are blind, we must try to guess what is taking place.

Thus, for instance, when the radio waves which emanate from a transmission aerial are driven into space, none of our senses can tell us what has happened. Indeed, we are not even sure that there *are* any waves. The scientist pictures in his own mind that the aerial waves are propagated into open space somewhat as if there were an infinite number of bubbles, each expanding—at the speed of light—within the preceding one, and each forming a complete shell. That is the classical explanation, but it is purely a guess. No one knows what shape these waves take and if some day we should become equipped with some super eyes we might see radio waves and perhaps they will be a most gorgeous view, impossible to comprehend today.

But what *ARE* the radio waves themselves? Physicists explain they are electromagnetic impulses or stress produced in the "ether" which brings us up right away to another enigma that nobody knows and that is, the "ether" itself. Before we can have electromagnetic waves propagated through space, scientists insist that there must be a medium in which the waves can travel. Just like sound cannot exist where there is no atmosphere, so scientists claim that waves, whether radio or light—both being the same—cannot exist unless there is "ether" for them to move in. Other scientists get along very well without the medium "ether" because they think that the radio waves are not just impulses but are actually composed of matter. Indeed this school maintains that all electricity, light and similar manifestations are matter, whereas the other school thinks just the opposite.

As for the elusive "ether" there has never been any scien-

tific proof of it until very recently and, while some scientists are convinced that the proofs have proven that "ether" exists, the proof leaves much to be desired.

Meanwhile we play with radio waves and all their functions as children might play with mechanical toys. The child does know how to wind up the toy and how to make it go, but what makes it work and all that goes with it, the child has not the slightest notion.

We are in a similar position whereby we can create and transmit radio waves and know how to receive them, but what happens to them in open space we know next to nothing. We do not even know what takes place in our radio sets, which we build, except that the radio waves after they reach the receiving aerial do certain things within the radio receivers. But we are changing our opinion as to this also, and very frequently, for the simple reason that much of our so-called knowledge is pure guess work. For instance, it took many years to get even a little insight into the nature of the received radio or high-frequency currents. Yet there are many things that we still know absolutely nothing about. For instance, at one time it was the thought that a good insulator was necessary to prevent radio frequency from straying away. Today, in certain cases, we actually use the finest type of insulators as actual conductors for the high-frequency currents. In other words the thing that once was Gospel Truth turns out to be something entirely different.

Then take our vacuum tubes, the heart of our radio receivers today. We have a hazy idea that there is such a thing as electronic bombardment going on, in between the heater and plate within the tube; we can even plot curves and measure it with instruments, and have thus acquired a fairly good idea of what goes on from a physical standpoint within the tube. But, try and find out what an electron is and immediately all of our scientists are up a tree. The electronic theory has changed, and with almost monotonous regularity, every year. There are dozens of theories as to the molecule, electron, the proton and the neutron. Each physicist has a pet theory of his own, only to clash with that of the next scientist, who immediately tears down the theory the first one built.

And we seem to get no nearer the real truth now than we were 10 years ago. Indeed, if you read the long-winded scientific papers it would seem that no one yet knows anything at all worth-while about the electron.

We could go on and write a large-size volume on what Man does NOT know about radio, but the few examples cited here give a vivid picture why we still are groping in the dark and why it will take centuries before we will make much headway in the ultimate knowledge of things.



\$10⁹⁵
Model 230-A 5 to 8 Watts



\$15⁹⁵
Model 246-A 15 to 18 Watts



\$28⁷⁵
Model 271-272 Remote & Standard 30 to 40 Watts



\$20⁷⁰
Model 261-A 25 to 35 Watts



\$33⁹⁵
Model 253-A AC-DC 20 to 30 Watts



\$39⁹⁵
Model 283-A 40 to 50 Watts with Equalizer



\$43⁵⁰
Model 269-A 6V-DC—110V-AC 20 to 30 Watts



\$44⁷⁵
Model 277-A 6 Channel 30 to 40 Watts



\$53⁷⁰
Model 291-A 70 to 100 W.



\$87⁹⁵
Model 334-T 6V-DC—110V-AC 30 to 40 Watts



\$33²⁵
Model 311-P 15 to 18 Watts Portable



\$41⁵⁰
Model 320-P 25 to 35 Watts Portable



\$21⁵⁰
Inter-Office Systems



\$19⁹⁵
Model 336-P Studio Portable



\$108⁷⁵

**MORE POWER PER DOLLAR
GREATER DEPENDABILITY
FINER PERFORMANCE**

that's Lafayette

Lafayette presents for 1939 the most complete line of quality-built Public Address Equipment in the world. Lafayette is, in fact, the only line with a sound system for every P. A. requirement. Any way you look at it, Lafayette means more for the money! More watts per dollar, more quality, more constant dependability. Yes, and this year Lafayette brings you even more amazing performance! Select your sound equipment from the line that is complete—and be assured of prompt delivery.

YOUR P. A. DOLLAR GOES FARTHER WHEN YOU GO LAFAYETTE

Model 340-P 40 to 55 Watts Deluxe Portable

Professional Deluxe Amplifying Equipment



Each Channel In Stock Prices On Request



\$74⁵⁰

NEW P.A. CATALOG

You asked for it and we are glad to give it to you. Our new big book showing the complete Lafayette line at list prices. Use it to show to your customers. It will help you sell them. Complete listings of all parts needed to complete any installation no matter how small or large. Write for your FREE copy today. It is waiting here for you. Don't miss a single sale. Write right now!

WHOLESALE RADIO SERVICE CO., INC.
100 SIXTH AVENUE, NEW YORK, N. Y.

Send for list price P.A. catalog 3KL.

Name _____
Address _____
City _____
State _____

PASTE COUPON ON PENNY POSTCARD

RUSH COUPON

WHOLESALE RADIO SERVICE CO. INC.
NEW YORK, N. Y. • CHICAGO, ILL. • ATLANTA, GA.
100 SIXTH AVENUE 901 W. JACKSON BLVD. 263 PEACHTREE STREET
BOSTON, MASS. • BRONX, N. Y. • NEWARK, N. J. • JAMAICA, L. I.

Please Say That You Saw It in RADIO-CRAFT

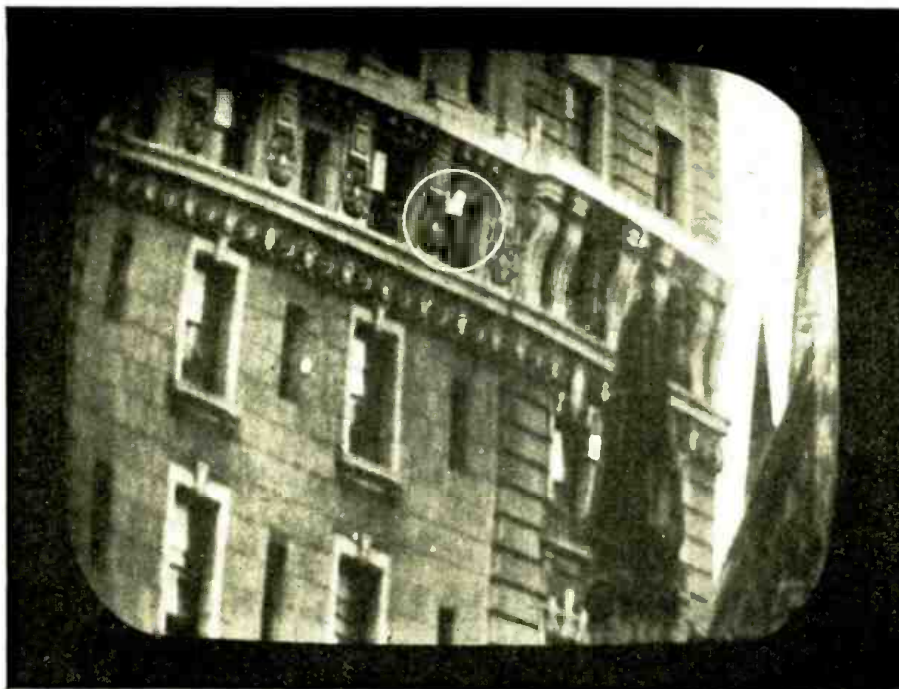

SUICIDE NO. 2 TELEVISED!

TELEVISION hit the feature position in "The Radio Month in Review," this month, with the amazing, *untouched*—except for circle—spot-news photograph (by Haussler), at left, made available to *Radio-Craft* by National Broadcasting Company.

It shows the 441-line image which engineers viewed on a television receiver in RCA License Laboratories, as mentally-deranged, 28-year-old John Warde threatened a leap to certain death from the 17th-floor parapet of a fashionable 5th Avenue hotel across the street. For the 2nd consecutive month N.B.C./RCA engineers had been Johnny-on-the-spot in televising "news in the making"; coincidentally, the 1st instance, also, was that of a suicide (of Marion Perloff; see *Radio-Craft*, Sept. 1938, pg. 134). The television pick-up camera trained on the scene was located in the
(Continued on following page)

A GOVERNOR— VIA RADIO & P.A.?

GOVERNATORIAL returns will give the final answer this fall, but the primary election, last month, gave the Democratic nomination to W. Lee O'Daniel, Texas wah-hoer. With nothing more formidable as campaign material than a group of fast-traveling musicians, a sound truck, and time on the air, flour-salesman O'Daniel seems to have sewed the job up tight, in the weirdest political campaign ever waged in these here now United States. Platform: the 10 Commandments!

THE RADIO MONTH

IT'S dollars to doughnuts that money is now coming out of hiding—and radio, we shall see, is getting a very nice helping of the wampum, gelt, lucre, jack, do-ra-me, etc., etc.

\$347,717 is what it cost Crosley's WLW in Cincinnati to go superpower, witnesses told the Federal Communications Commission, last month. It was a load off WLW's management's chest

to learn that the F.C.C. had granted a stay of execution, uh, we mean, an extension of permission to operate.

\$56,000 bail was set for 4 women and 3 men arrested in 4 lottery raids as a result of information obtained by wire-tapping.

\$200,000 and upwards is expected to be kicked in by RCA for its television display at the New York World's Fair.

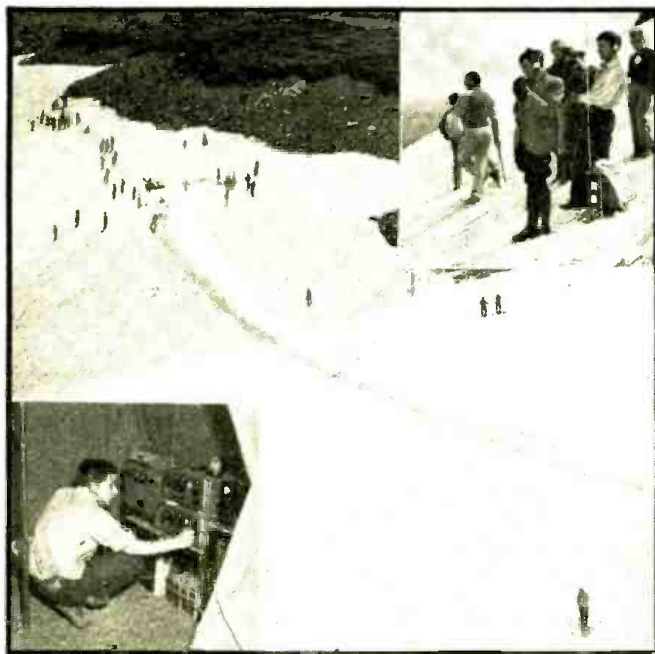

GLACIER SKI

On July 4th, while most of the U.S. sweltered, devotees of skiing participated in a ski meet at St. Mary's Glacier on the Continental Divide near Denver, Colorado. This "remote" over N.B.C.'s Red network used 2 pack transmitters and 2 que receivers on the glacier; ultra-H.F. equipment in a tent 1 1/2 miles away; and a transfer point, 7 miles down-canyon, to a line to station KOA.

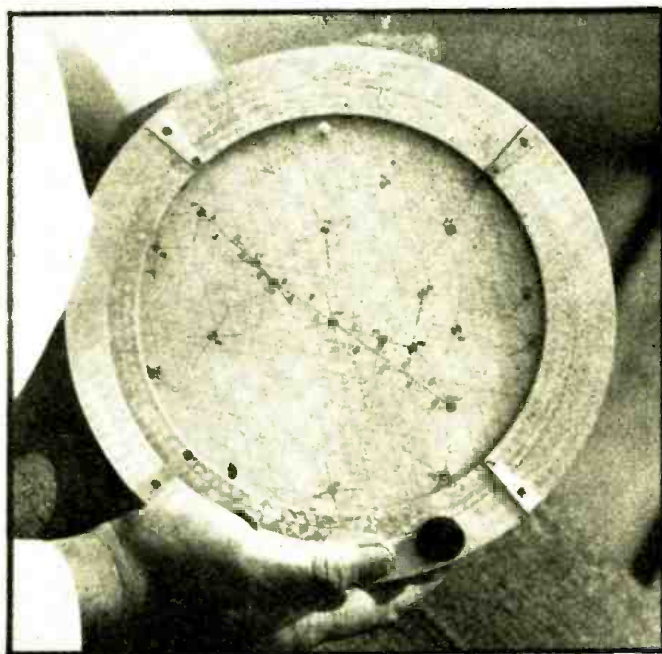

AIRPLANE POSITIONER

Flying safety has upped. Air-Track (*Radio-Craft*, Oct. '37) last month announced the Stark Position Finder—in use, above, on an aviator's lap; it spots a plane's position to within 2 to 5 miles. Compass bearings of 2 radio stations located by radio direction finder are set up on ruled discs; intersection shows position on a 3rd disc's map (16 cover all U.S. airways).

(Continued from preceding page)
 same room with the receiver. Approaching darkness, however, terminated the video pick-up (which did not go on the air) before Warde's fatal plunge.

For 11 drama-filled hours, while horror-stricken, helpless New Yorkers watched one man match wits against the wiles of brilliant, rescue-bent individuals—and while cameramen photographed insouciant Warde, taut-nerved rescue groups, and jammed traffic (a harrowing scene which searchlights illuminated after nightfall)—special-features engineers and announcers with "piggyback" portable transmitters, put on the air for millions of listeners in the tragic event:—a macabre program in which the star performer was also the one person in the audience within the range of nearby loudspeakers doomed to a fatal role.

Television demonstrations, of 441-line type, were scheduled by RCA last month for the New York World's Fair. Mobile video units will be used.

IN REVIEW

\$90,000 for an educational project over WSUI was expected last month to be put on the line by Iowa State University for a project to expand educational radio facilities at the University.

\$225 is all it will cost photo enthusiasts to annex one of Kodak's new six-20 cameras with shutter speeds of 1/25 to 1/200 second photoelectrically-controlled. The electronic system of stopping down the aperture was described in a past issue of *Radio-Craft*. Thus radio entered the camera field, last month.



"S"

This signal ("S" or "S", in the Morse telegraph code), which Marconi selected to bridge the Atlantic Ocean in 1901, was sent from Italy, last month, by Marconi's son Giulio, to conclude dedication of WGY's new 5-studio headquarters in Schenectady, N. Y. Dr. E. F. W. Alexanderson, G.E. consultant, is shown listening-in on a replica of the original receiver.

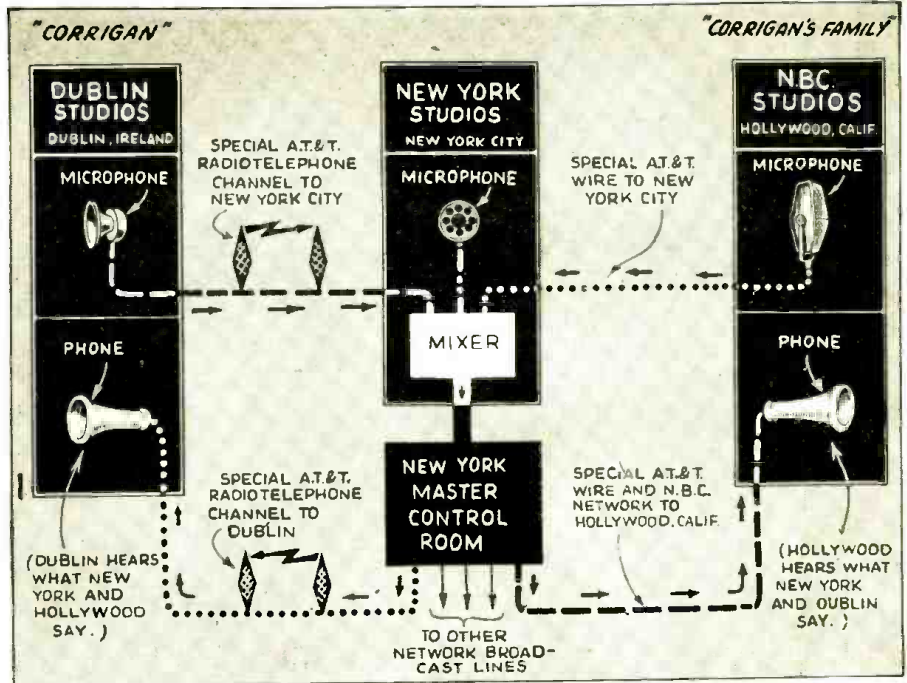

AIRADIO

AVIATION radio absorbed the spotlight of news interest, last month. As a result, airplane—and plane-radio—business has hit a new high "ceiling."

1—Douglas Corrigan, who pulled World's Boner No. 1 when he missed his Californian objective by 6,000 miles in a trans-Atlantic flight, in a radioless \$900 plane, that "accidentally" landed him intact at Baldonnel, Ireland, had recourse to radio upon his arrival in Ireland. He held a reassuring trans-oceanic radiophone conversation from Dublin with his mother in Hollywood—while millions of Americans listened-in via the N.B.C. network! Set-up, above, was sketched for *Radio-Craft* by N.B.C.

2—Howard Hughes and a 4-man crew made a record-breaking journey around the world, with the aid of several radio sets (See article in this issue on pgs. 200 and 201.), in Hughes' *New York World's Fair 1939*.

3—*Mercury*, 10-ton upper or long-range unit of Britain's pick-a-back (piggyback) composite aircraft, carried aloft and launched in the air, at Foynes, England, from its lower or carriership *Maia* (in order to carry more fuel), completed a 2-way, elliptical trans-Atlantic flight to the United States. Talkies, of England's King and Queen landing in France, were brought over by the *Mercury* and were shown to New York audiences 2 days after the regal event!

(Continued on page 232)

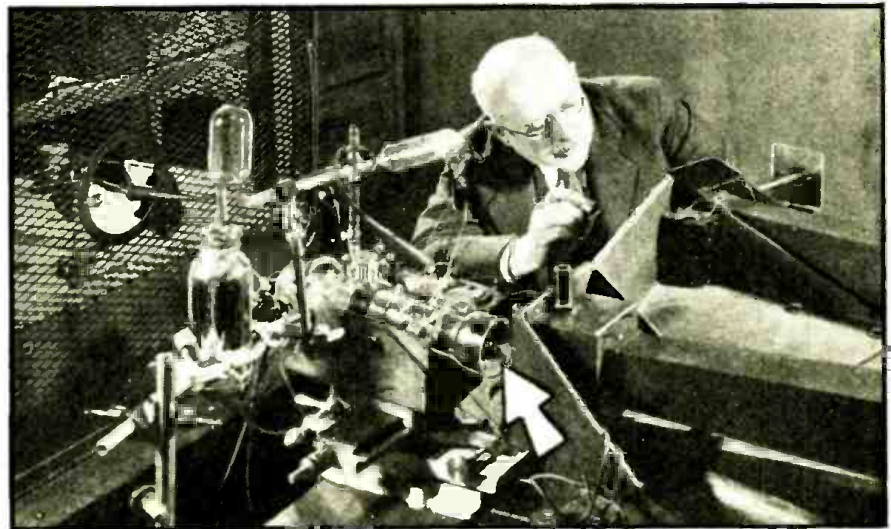

CANAL RAYS

According to information published last month, the "hypothesis" of 40 years ago, by Fitzgerald, Larmor and Lorentz, that atomic "clocks" oscillate more slowly as they move through the "ether," has received experimental proof in Bell Tel. Labs. A Dempster "canal-ray" tube (arrow) is shown in use, as Dr. Herbert E. Ives of the Laboratory compares direct-vision approaching ions and reflected-image receding ions; the differential tending to prove that light waves—and hence radio waves—can appear to have the same velocity across and with a stationary ether. In the canal-ray tube, a high-voltage field speeds an electric arc's hydrogen molecules; at 1,000 miles-per-second they can then be seen, approaching, on the end of the tube.

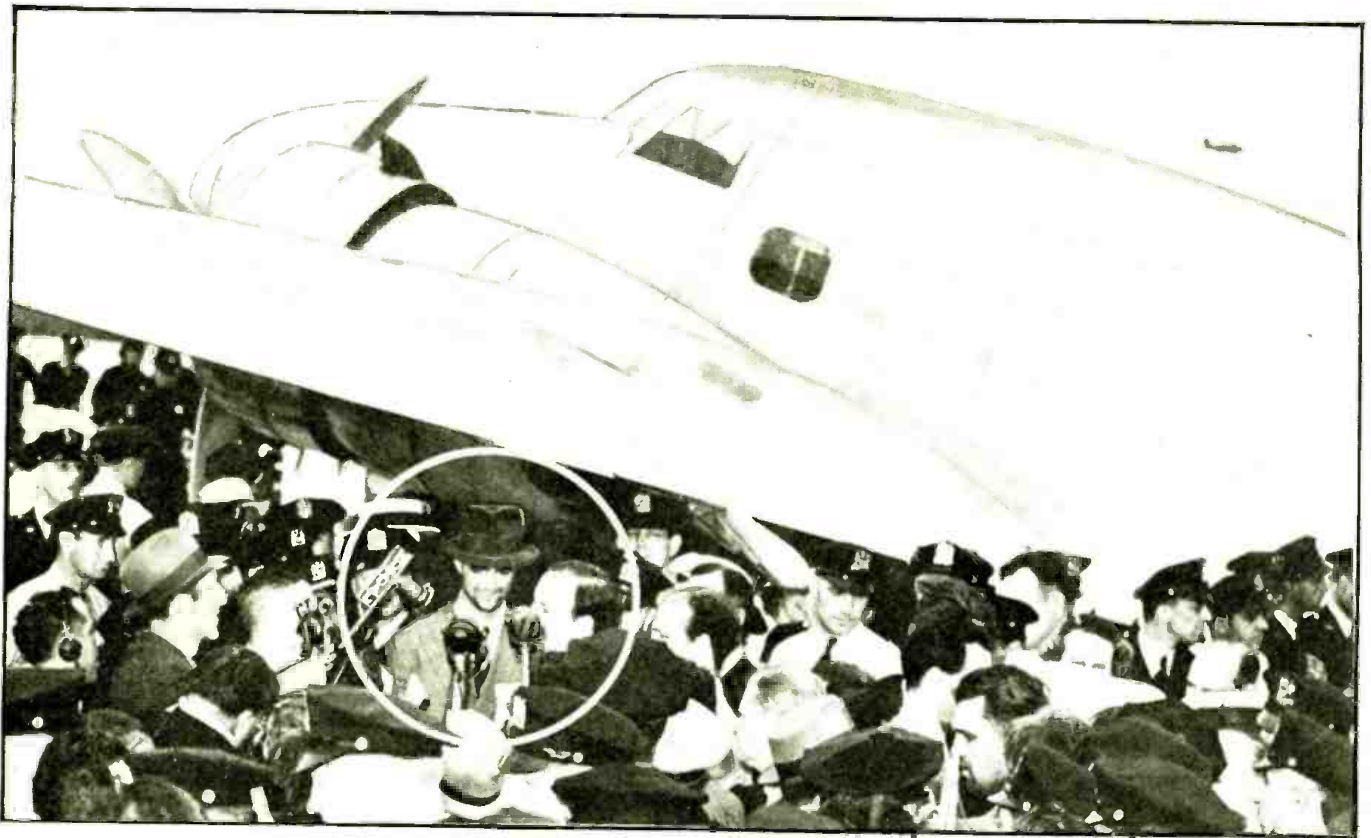

JOURNEY'S END . . .

. . . And safely! A throng of 30,000 admirers greet the returning heroes of the epochal flight of the New York World's Fair 1939. Unshaven, Hughes gracefully carried off the ordeal of an overwhelming welcome, after he and his crew had completed an around-the-world flight of approximately 15,000 miles in less than 4 days.

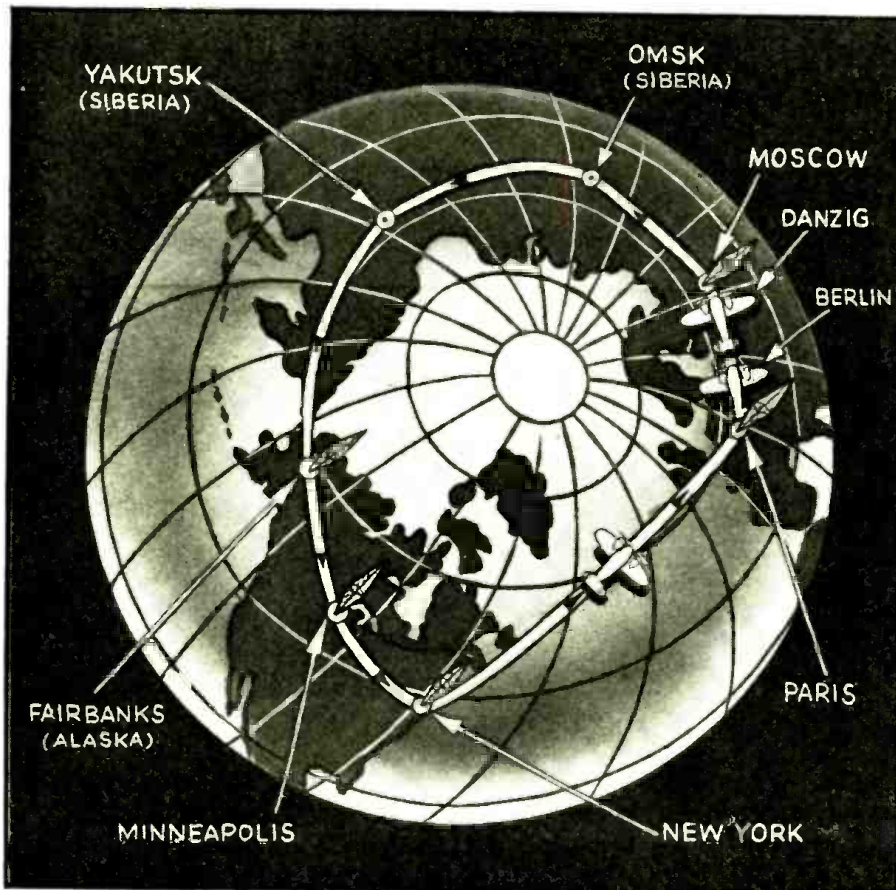

RADIO MAP . . .

. . . Of the Hughes world-girdling flight. Antennas indicate points from which transmissions were made via land stations. Intermediate silhouettes of the plane indicate non-scheduled transmissions from it.



"HE'S LANDING!" . . .

. . . Is the report by announcer Chas. Stark. C.B.S. engineers assist at the pack equipment.

RADIO ON A GLOBE-CIRCLING DASH

R. D. BERNARD

A "flying laboratory," hurtling around the world at 200 miles-per-hour, counts an extensive radio installation a necessity, and means of world-wide contact.

LAST MONTH, bloodless wars were fought on 2 major fronts. First was the battle successfully waged, by Howard Hughes and his crew of 4 experts, against Time, and Nature; second, and less heralded, was the perhaps tie contest between the several networks for 1st Place in the radio sun.

New York World's Fair 1939, silver Lockheed 14 monoplane of aviator Hughes (a millionaire many times over), zipped around the Northern portion of the Northern Hemisphere, as mapped on the facing page, at the record-breaking pace of 205 miles-per-hour. The ship completed the approximately 15,000-mile flight in 91 hours, 8 minutes, 10 seconds—figures which include the slightly zig-zag course over Germany, at a comparatively slow speed (185 m.p.h.) and "over 10,000 ft." altitude, prescribed by Nazi officials. (Magellan took 1,083 days to circumnavigate the globe in 1519-'22.) Flight expenses were said by official sources to total over \$300,000; the plane, with its elaborate radio installation as illustrated below, cost \$200,000.

Starting quietly enough, the flight ended in a blaze of glory—tumultuous greeting by 30,000 persons at Floyd Bennett Airport, from whence they had started only a few days previously—and a triumphal parade by motorcade up Broadway the next day, for more en-

thusiastic reception by 500,000 New Yorkers, who "baptised" the fliers with tickertape and other forms of paper, tons of it!

Included in the 500 lbs. of radio equipment carried on the flight was a 15-watt, 10-inch-square, portable emergency radio outfit. This waterproof radio set was powered for 4 hours of continuous operation, and was supplied with a balloon, to be filled from an available nitrogen tank, for carrying an antenna into the air in the event of an emergency landing on land or water.

A "casualty" of the flight was the loss, twice, of trailing antennas, which, in the second instance, temporarily put Hughes' plane out of radio contact with the listening world.

Important benefits of the flight included a 40-page report of flight minutiae, and information that Siberian mountains mapped as no higher than 6,500 feet, actually are more than 9,500 ft.—which is something that aviators flying blind would like to know; a night flight out of Yakutsk (Siberia) might have ended the flight in a crack-up, Hughes intimated. This information may spur research on the ultra-high frequency "absolute altimeter" now under development by the U. S. Bureau of Air Commerce in collaboration with the Bureau of Standards; and mentioned by Richard C. Gazely in a recent issue of the Air Commerce Bulletin. (Continued on page 234)



FLIGHT HEADQUARTERS . . .

. . . On the grounds of the New York World's Fair 1939. W. A. Rockefeller, meteorologist and Charles Perrine, radioman, are listening-in for flashes from Hughes.

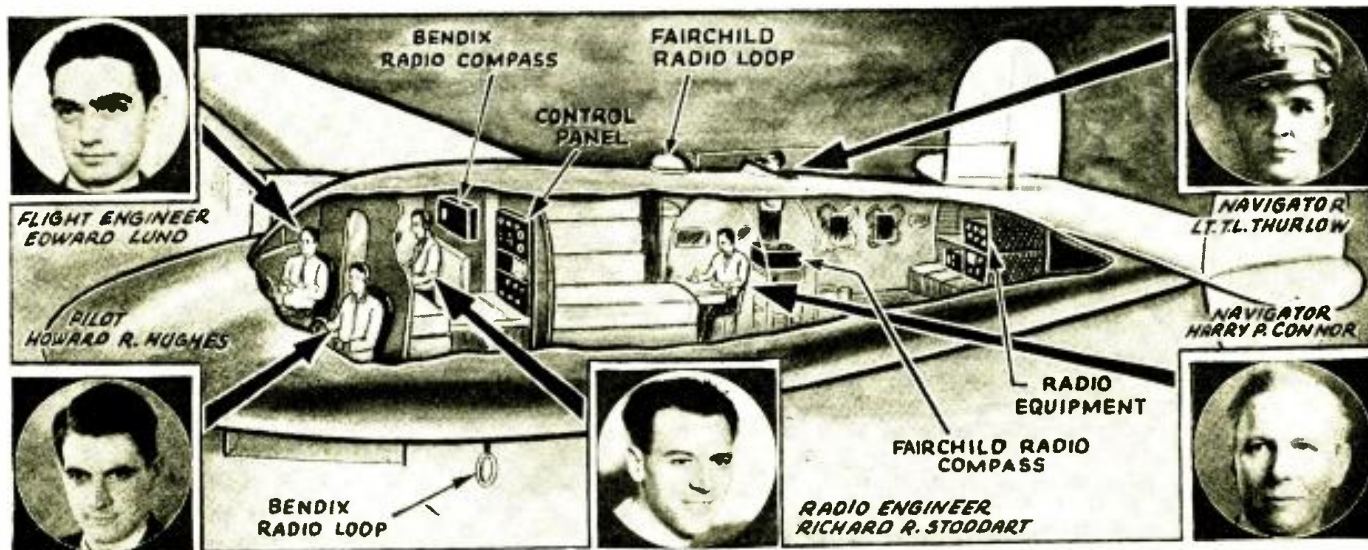

RADIO FACILITIES . . .

. . . Aboard the New York World's Fair 1939 were extensive, as this illustration shows. The homing compass enabled Hughes to come in on the WEAJ broadcast station program to a perfect landing at Floyd Bennett Airport. Automatic equipment proved invaluable.

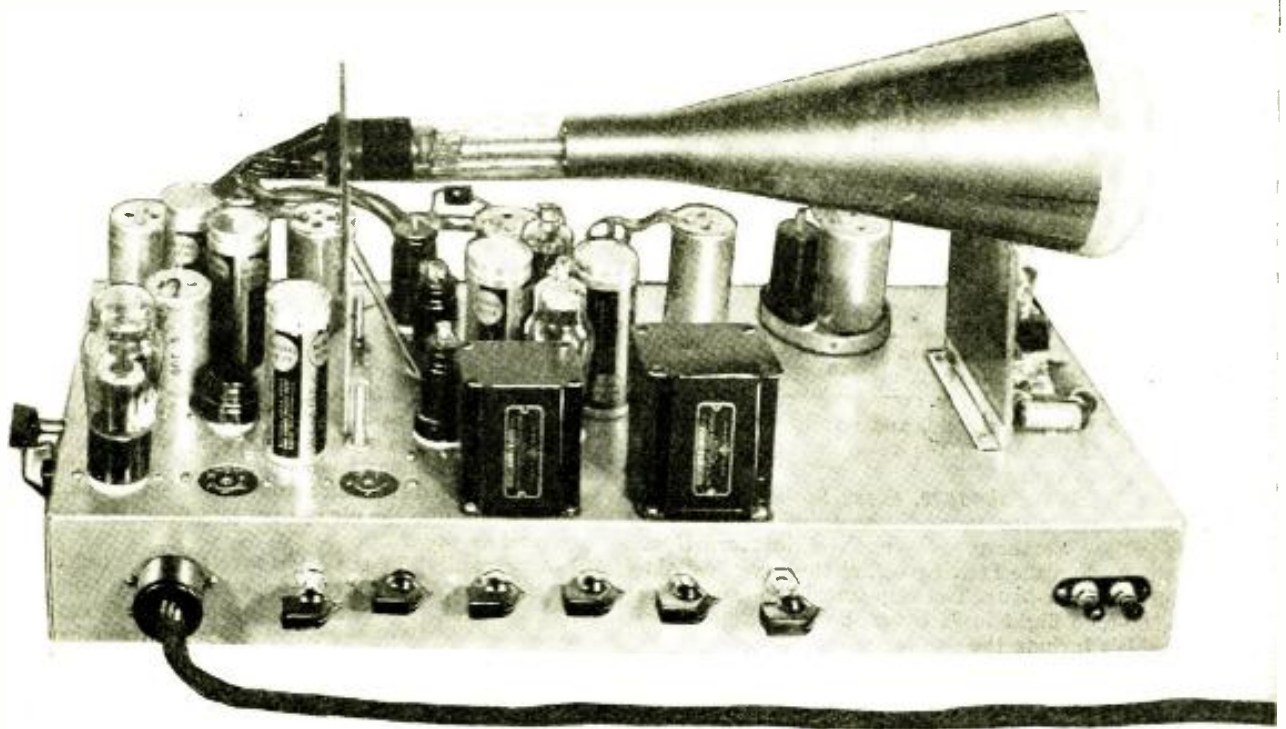

Fig. A. Side view of the completed television receiver. Several extra sockets and an additional I.F. stage will be noticed which were built on as a . . .

CONSTRUCTION DETAILS OF

RADIO-CRAFT is happy to be able to present this first published detail Charles Sicuranza obtained this information in an interview with Mr. M. In this exclusive article Mr. Sicuranza gives the proficient Serviceman

YOUR correspondent, as a practising Serviceman, was recently assigned to attend a showing of the new high-definition television superhet. receiver developed by Mr. M. P. Wilder, who is in charge of the experimental laboratories of the National Union Radio Corporation.

The new set proved to have so many up-to-the-minute features and appeared so easy to build, it seemed certain to the writer that a large number of *Radio-Craft* readers would wish to build this set if constructional details were made available.

COST—UNDER \$100!!

Since the cost of the receiver, complete with *all* tubes, at mailorder catalog prices is well under \$100, it would be money well spent, considering that to actually build and operate the set would be almost the equivalent of going to a television school in order to acquire the same amount of experience. Aside from the valuable experience angle (for Servicemen), imagine having a television set in your shop that *really works*; and one so simple to operate that your customers could twiddle the knobs and tune in television "pictures" (or, more properly, *images*).

With this thought in mind, we will make ourselves very small and take a 1-way tour through this new receiver, entering the dipole or doublet antenna and emerging at the 5-inch screen of the cathode-ray tube. Incidentally, this set uses 16 tubes in all and receives only the "video" or *sight* portion of the modern 441-line television program. (A "separator," and "converter," may be used, as described in "Television Experiments with a Servicing 'Scope," in the

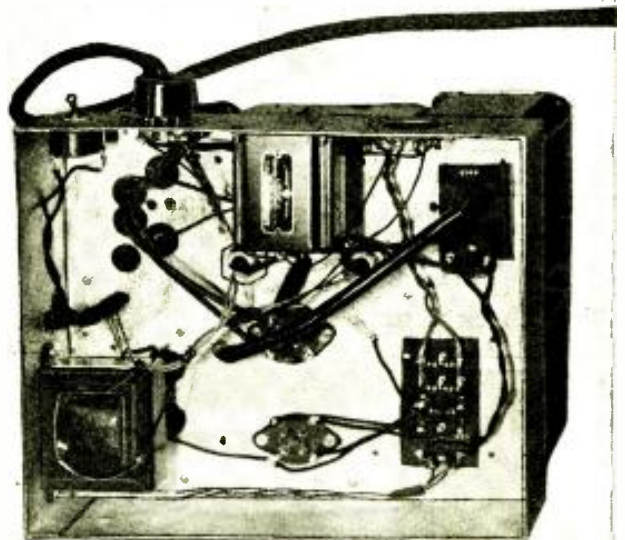
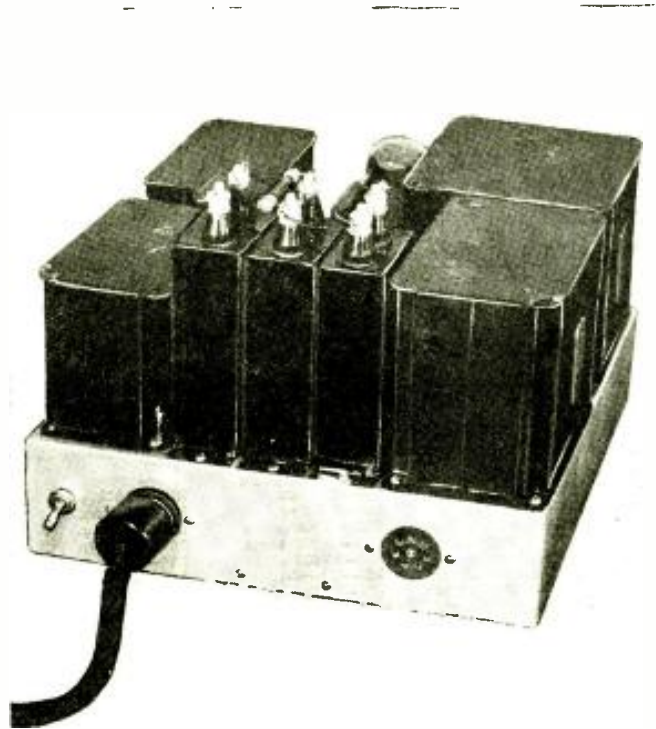

Fig. B. Underside view of the high-voltage power supply and of . . .



... precaution in the first model and later found to be unnecessary.

August, 1938, issue of *Radio-Craft*, to receive the *sound* portion of the television program on a regular broadcast receiver!—*Editor*)

SIGNAL SEQUENCE

ANTENNA

Since the video program is transmitted on a frequency of 46.5 megacycles, any old antenna *will not do* for reception. (See the article in August, '38, *Radio-Craft* on television antennas.)

R. F. AMPLIFIER

We will assume that the antenna we are using is OK, whereupon the signal is transferred to the grid (see schematic circuit, Fig. 1) of a type 1851 tube; this tube is a very-high-gain pentode especially developed for television use.

MIXER

This tube amplifies the signal and then feeds it into a special mixer tube, a type 6K8; the mixer is often referred to as the 1st-detector. At this point the 46.5 megacycle signal is mixed with a 60-megacycle voltage generated in the same tube.

I. F. AMPLIFIER

The resulting or intermediate frequency of 13.5 megacycles is fed into the 1st I.F. transformer. Now we come to the big difference between television and radio reception. In a good high-fidelity radio set, the I.F. band width is adjusted so that a frequency band width of about 15,000 cycles passes through, making it possible to hear every shading of tone from the bass to the highest "highs." We all know what happens to the "highs" when the I.F. is sharply tuned—there just aren't any "highs" left.

(Continued on following page)

A 441-LINE TELECEIVER

description of the National Union 5-inch-image television receiver. Mr. P. Wilder before Mr. Wilder left to study European television at first hand, all the information he needs to duplicate a perfect-working "Teleceiver."

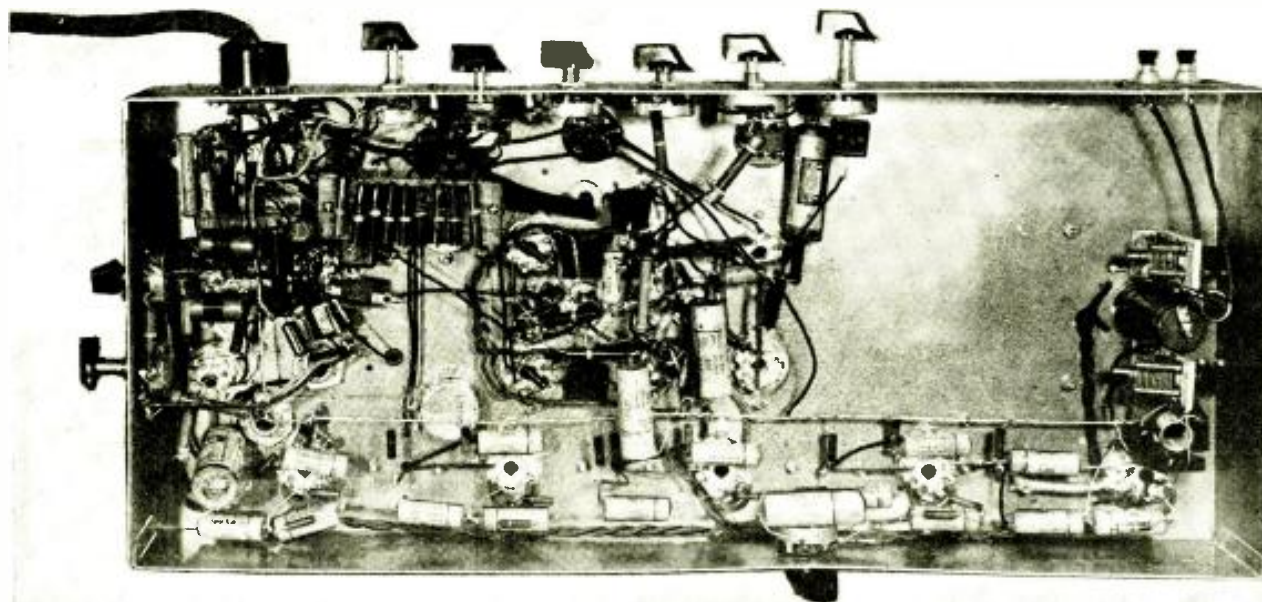

... the television receiver. The controls, left to right, are: Brilliancy Focus, H. F. Sweep, H. F. Distribution, L. F. Sweep, L. F. Distribution.

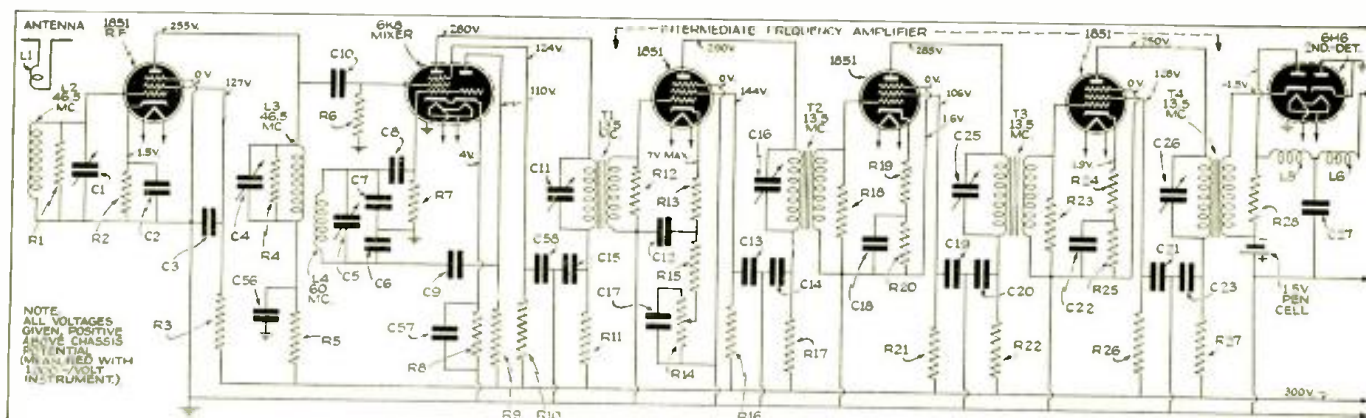

Fig. 1. Tube terminal voltages for this complete television receiver are shown in its above circuit. Note that these voltages—all positive above

R1 — 1,500 ohms	R9 — 50,000 ohms	R17 — 5,000 ohms	R25 — 150 ohms	R33 — 60,000 ohms	R41 — 0.25-meg. pot.	R49 — 60,000 ohms	R57 — 1 meg.
R2 — 150 ohms	R10 — 60,000 ohms	R18 — 1,500 ohms	R26 — 60,000 ohms	R34 — 1,200 ohms	R42 — 5 megs.	R50 — 0.1-meg.	R58 — 2.5 megs.
R3 — 60,000 ohms	R11 — 5,000 ohms	R19 — 10 ohms	R27 — 5,000 ohms	R35 — 5,000 ohms	R43 — 5 megs.	R51 — 0.1-meg.	
R4 — 1,500 ohms	R12 — 1,500 ohms	R20 — 150 ohms	R28 — 2,500 ohms	R36 — 25,000 ohms	R44 — 0.5-meg.	R52 — 2,000 ohms	R60 — 50,000 ohms
R5 — 5,000 ohms	R13 — 10 ohms	R21 — 60,000 ohms		R37 — 5,000 ohms	R45 — 0.5-meg.	R53 — 2,000 ohms	R61 — 0.2-meg.
R6 — 0.25-meg.	R14 — 2,000 ohms pot.	R22 — 5,000 ohms		R38 — 0.12-meg.	R46 — 1,000 ohms	R54 — 50,000 ohms pot.	R62 — 0.3-meg.
R7 — 25,000 ohms	R15 — 150 ohms	R23 — 1,500 ohms			R47 — 1,000 ohms	R55 — 0.1-meg. pot.	R63 — 0.3-meg. pot.
R8 — 300 ohms	R16 — 60,000 ohms	R24 — 10 ohms			R48 — 60,000 ohms	R56 — 3,000 ohms	R64 — 0.5-meg.
		R25 — 150 ohms				R57 — 1 meg.	R65 — 1 meg. pot.
		R26 — 60,000 ohms					R66 — 1 meg. pot.
		R27 — 5,000 ohms					R67 — 2 megs.

(Continued from preceding page)

Now, in a television receiver of the modern type, in order to see every possible shading of color from the darkest to the lightest, it is necessary to pass a frequency band width of 2,000,000 cycles (or 2 mega [million] cycles) or more through the I.F. channel. This in turn would require staggering of the resonance peaks of each transformer to such an extent that the gain of each stage, using ordinary tubes, would be killed. To offset this, 4 I.F. transformers and 3 high-gain, type 1851 tubes are used in the I.F. channel of this receiver. The gain of the entire channel is controlled by the bias potentiometer in the 1st I.F. tube cathode.

2ND-DETECTOR

We have now arrived at the 2nd-detector, a 6H6 diode, where the 13.5 mc. carrier frequency is removed and only the light or video ("picture") modulation signal remains. This corresponds to the audio signal in an ordinary radio receiver except that the variations may be anywhere from 2 to 2,000,000 cycles.

1ST V.F. AMPLIFIER

Since such high frequencies are hard

to amplify, another 1851 is used at this point as a 1st V.F. (or video frequency) amplifier. The special resistance-capacity circuit employed represents a great deal of research work done to keep the gain high and flat over such a span.

2ND V.F. AMPLIFIER

The 1st V.F. tube is followed by a 2nd V.F. tube, a 6V6G.

THE IMAGE TUBE

The output voltage of the 2nd V.F. tube is large enough to modulate the signal grid of the cathode-ray television-image tube—one trade name for which is Videotron—from zero bias to the current cut-off value.

THE MULTIVIBRATORS

LINE-SCAN (Horizontal-Sweep) OSCILLATOR

So far, we have encountered nothing very unusual or baffling, but from here on we will have to pay strict attention to some new and unfamiliar circuits. As we know from experience with our service oscilloscopes, a sawtooth sweep oscillator is used to move the electron beam in the horizontal plane, or from side to side, while the voltage we want to study is moving up and down, thus

producing waveforms and other familiar images. The intensity or brightness of the spot remains the same, no matter where it impinges on the screen. FIELD-FREQUENCY (Vertical-Sweep)

OSCILLATOR

In a television tube, the spot changes in intensity from one moment to another to correspond with the dark and light portions of the viewed subject at the transmitter end. A further difference is that an additional sweep oscillator is required to move the spot up and down at a definite rate (60 times per second, or at field frequency [*See Note at end of article.—Editor]); while the horizontal sweep moves the spot from left to right at the rate of 13,230 times per second (line-scan frequency).

These two oscillators working together produce a rectangle of light on the cathode-ray screen, at no-signal.

SYNCH. PULSE SELECTOR

Now all that is necessary to obtain an image is to make the dark spots on the screen luminous at the appropriate places, and at the right time. This bit of magic is accomplished by transmitting a synchronizing pulse along with the picture.

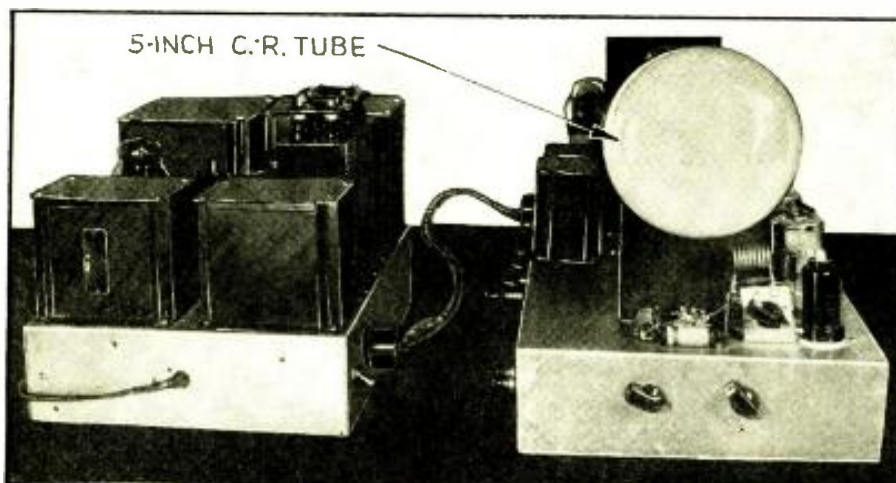

Fig. C. Front view of the completed video receiver and power supply.

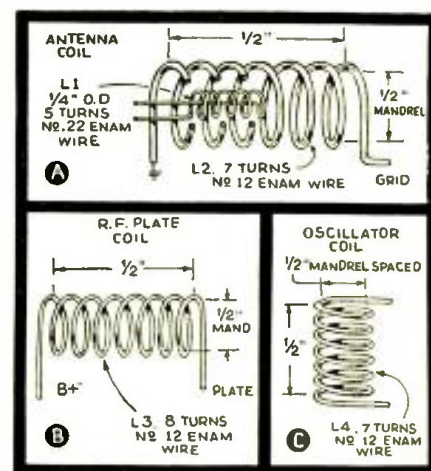

Fig. 2. How to make the teleceiver's coils.

NEW HIGH-FIDELITY HEARING-AIDS

Familiar audio amplifier design, and the use of Rochelle-salt-crystal mikes and ear-units, combine to produce a good sideline item for Servicemen.

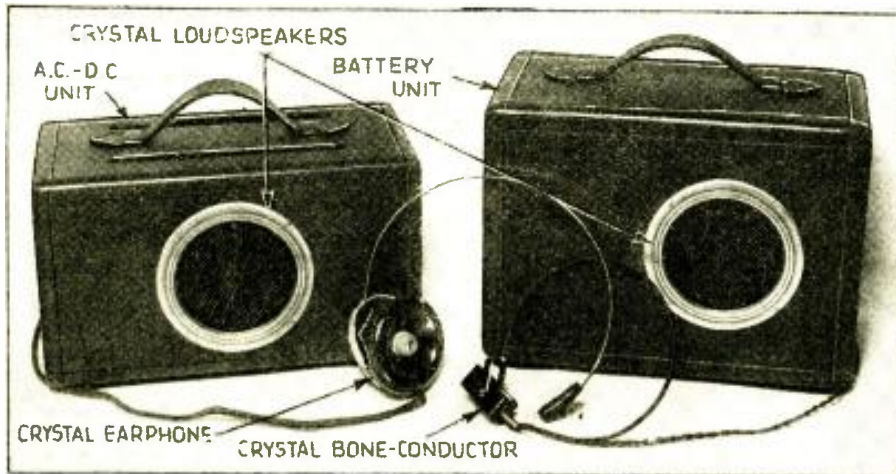

Fig. A. Front view. The line-power unit weighs 4 lbs.; the battery unit, 6.

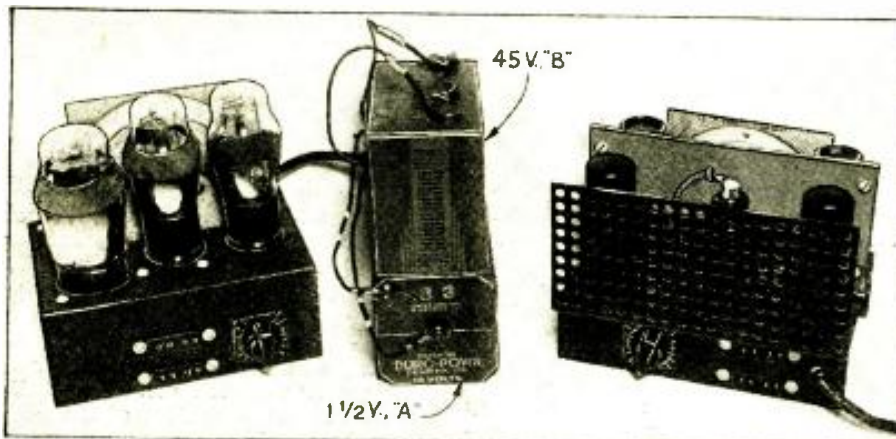

Fig. B. Rear view. Both units have tip-jacks enabling 4 persons to listen-in.

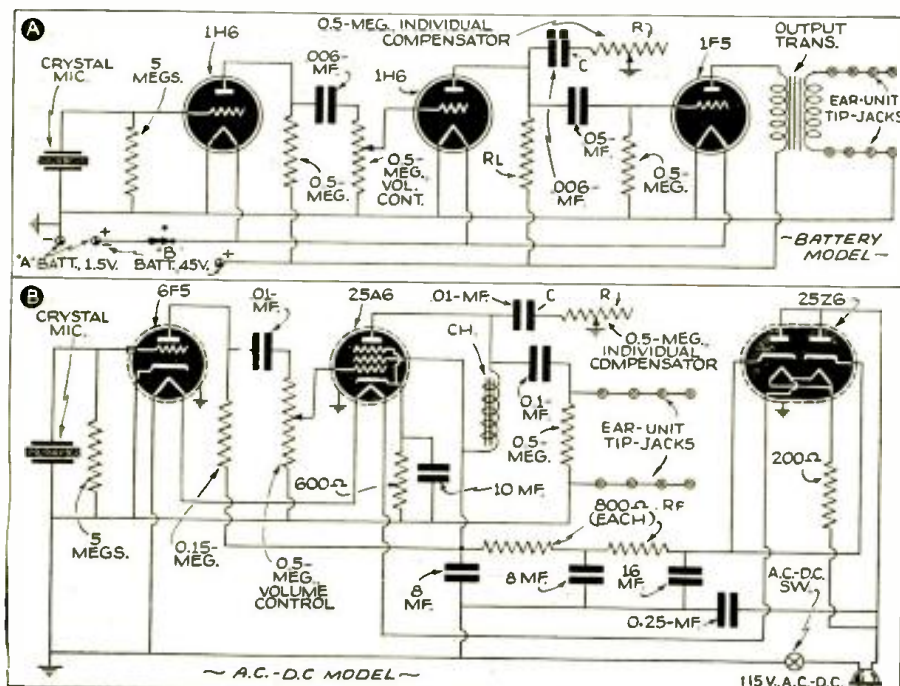

Fig. 1. A frequency compensator affords considerable control of frequency response to suit individual ear-response characteristics.

RADIO technique at long last has come to the aid of the hard-of-hearing. The audio amplifiers that constitute such an essential element in radio reception have been refined to meet the particular needs of those whose hearing is below par. Newest developments in this direction are shown photographically in Figs. A and B, and by circuit in Fig. 1.

BATTERY PORTABLE

Of the 2 types, both of which have their advantages, the battery unit—shown at the right in Fig. A and at the left in Fig. B—meets the need for a high-fidelity hearing-aid which may be used any place without any dependence whatsoever upon a current source other than its self-contained batteries (which are said to last 1 year). This recommends the unit for use at the theatre, at bridge games, etc.

An outstanding feature of the battery unit, which due to its self-contained batteries is a little larger than the A.C.-D.C. unit, is the exceptional fidelity it affords. First step in achieving the outstandingly excellent reproduction exhibited by the models tested in *Radio-Craft* laboratories is the use of a crystal microphone as shown in circuit A, Fig. 1. Resistance-capacity coupled amplification, the 2nd step, helps maintain this fidelity straight through to the output terminals.

The 3rd and concluding link in this high-fidelity chain is the use of a crystal reproducing unit. This may take the form of a standard ear-phone with which almost everyone is familiar and which is shown at the left-center in Fig. A; or, it may be a crystal unit of the bone-conductor type, right-center in Fig. A, which is designed to press against the mastoid bone in back of the ear and ordinarily is readily concealed by the hair.

EAR-RESPONSE COMPENSATOR

No two people have identically the same response characteristics; everyone, even though he may hear exactly the same sounds, mentally interprets these sounds differently. How much different then must be the sound perception characteristics of those whose hearing is impaired; some people hear sounds better in the upper-frequency register, others in the middle register, still others in the lower register, and then of course persons exhibit the numerous possible combinations of these characteristics. For this reason a "compensator" is incorporated in the amplifier circuit. Its terminals are resistor R and condenser C in Fig. 1A. In a radio set this would be called the tone control. In a hearing-aid it becomes an *individual compensator*, and a convenient (Continued on page 256)

RADIO HELPS TEST HEARING-AIDS

This article is devoted particularly to hearing-aids and especially to a newly developed method—using Radio instrumentalities—of making electrically-operated hearing-aids to order in the laboratory. Here's good data for Servicemen interested in sidelines.

E. J. MYERS

It is well-known that hearing impairments differ very materially in their degree, their physiological nature and their variation over the speech frequency range. Some ears have relatively better hearing at the lower frequencies but poor hearing at the higher frequencies. Others have a relatively uniform loss over the entire frequency range. In some cases, the low-frequency hearing is very poor as compared to the high-frequency sensitivity. In any case, the exact nature of a hearing impairment is peculiar to a given individual. These different types of hearing losses can be charted graphically by means of an *audiometer*, which measures the threshold of hearing at different frequencies. It is, therefore, obvious that the same type of "hearing-aid" (microphone, amplifier and earphone) characteristic will not provide the maximum help for different individuals.

It is difficult, and in some cases impossible, to predict from an "audiogram" (the audiometer's graphic record), except in a general way, the type of amplification characteristic a hearing-aid should have to give the most satisfactory hearing-aid service to any given individual. One very important item of information not obtained with the audiogram, is the reaction of any individual to the various types of amplification characteristics which may be available. In many instances, this reaction will be a most important factor in whether or not a hearing-aid is satisfactory.

TEST PROBLEMS

The first problem to be solved in building individual hearing-aids to order in the laboratory was to find a way by which the hearing-aids themselves could actually be made so their characteristics would cover an extremely wide band of entirely different hearing-aid possibilities.

Mere loudness alone does not necessarily help to solve a hearing problem. More often than not, it is a decided detriment. Loudness must be intelligently applied, and it must compensate to the best possible degree for the individual hearing problem of the person who is to use the hearing-aid. This means that hearing-aids must be built to definitely predetermined characteristics in the laboratory.

When a method of accomplishing this was perfected, the next and equally difficult problem was to provide some means by which the one person for whom the hearing-aid was to be made, could determine how he was going to hear with it when it was completed. The Radioear "Selex-A-Phone", by E. A. Myers & Sons, was finally developed after years of research, and is an instrument designed to utilize a large number of predetermined hearing-aid amplification characteristics when making an analysis of an individual's hearing-aid requirements. Thus, from a wide range of possible hearing-aid characteristics, the most suitable characteristics can be determined for any given individual.

PERSONAL TEST

In actual use, 3 different types of carbon microphones are placed on the person of the individual who is having the analysis made. It is important with this type of analysis that these microphones occupy a position similar to that which
(Continued on page 250)

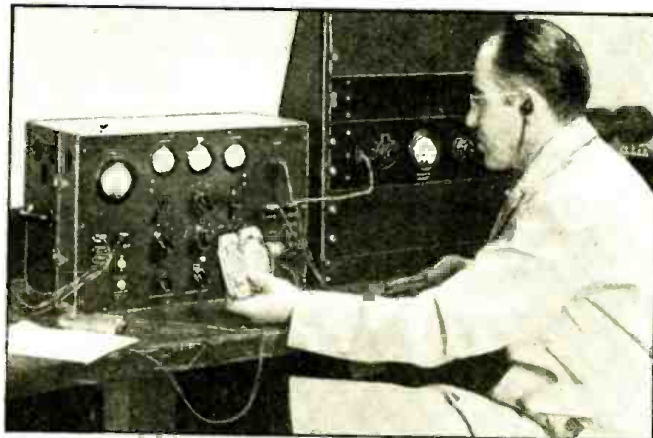

Fig. A. The master "Selex-A-Phone" radio equipment checks hear-aid against human ear for frequency range, intensity, etc.

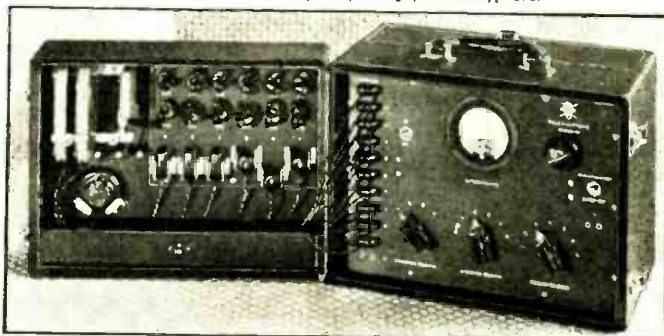

Fig. B. The client's hearing is classified with this portable Selex-A-Phone.



Fig. C. The "intensifier" (electromechanical amplifier) being checked and adjusted against an oscillator and level indicator (decibel meter).

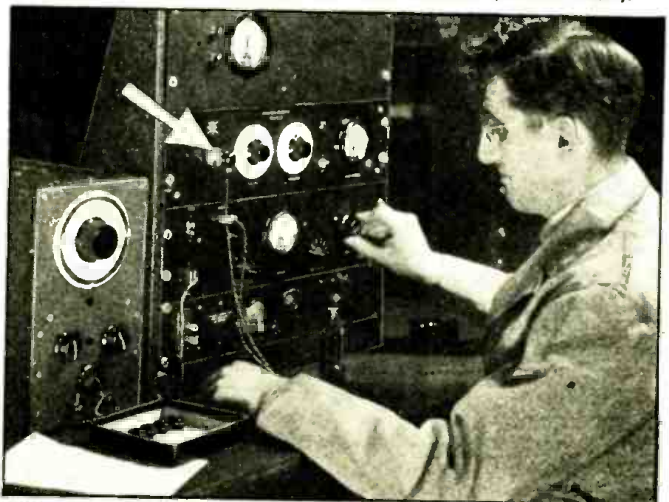

Fig. D. An "artificial ear" (arrow) checks frequency response of completed hear-aid.

"SIGNAL-TEST" SYSTEM

Laboratory test procedure and equipment have been speeded up test (of a faulty radio receiver)—involving audible and visible anal- and simultaneous test of operating voltages—from antenna posts to

JOHN F.

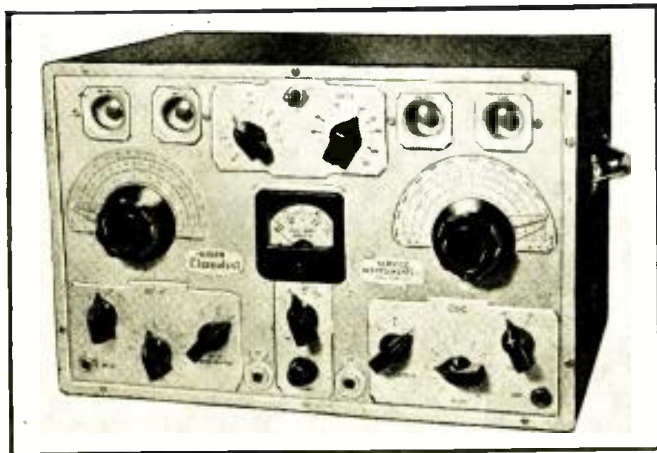

Fig. A. Front view of Rider's "Chanalyst" for signal testing.

SERVICE operations during recent years have shown the increasing need for a systematic method of trouble analysis or localization which would be applicable to all types of receivers—old, new, and yet to come. However, it has been virtually impossible to find what is the equivalent of a "common denominator" that would serve as a basis for such a trouble-shooting system. The writer feels that after 2 years of concerted effort along theoretical and practical lines in a laboratory, such a basis has been found; Servicemen who have witnessed the application of the system concur in that opinion.

SERVICING PROCEDURES

During the process of selecting a basis for this system, every angle of receiver operation, all technical considerations relating to parts used in radio receivers, available testing equipment and actual service procedure were considered. The 3 existing methods of trouble localization, namely *operating voltage measurement, resistance measurement, and probing by means of a signal generator*, were given utmost consideration. While each was found to have its use and to be of value, none of the 3 were found suitable as a *primary* or basic method of test. Of these 3, the Voltage Measurement test was found to be of greatest value as a supplementary or *secondary* test, applicable after the trouble was localized; and this to be followed by the Resistance Measurement test still further for positive identification.

Voltage Measurement was found to be unsuited as a primary test because many types of troubles which may exist in a radio receiver cannot be localized or analyzed with this type of test. This of course is not intended to in any way reduce the value of the voltage test as a means of obtaining much needed information during the process of identifying the defective part.

Resistance Measurement, that is, the determination of the D.C. resistance of certain parts of the receiver, likewise fails as a basic, primary test because, as the experienced Serviceman well knows, many defects may exist in the

modern receiver without manifesting any effect upon the D.C. resistance of the circuit. Furthermore, the fact that the receiver must be in an *inoperative* state (that is, with the ON-OFF switch in the "OFF" position) when the test is made, still further reduces the efficacy of the system because very many defects in a receiver can be identified only when the receiver is in operation!

The Signal Generator Method of probing has been of value in the past but has lost a great deal of its effectiveness in the modern, complicated receiver because a number of sections in the receiver cannot be checked by means of the signal generator—at least not consistent with speed of operation. Judging by the trend of receiver design, the signal generator as a rapid probe will become less and less effective as time passes.

In view of these limitations, it is easy to see that none of these 3 systems constitutes a good, primary basis upon which a systematic method of trouble localization can be founded—particularly so when such a system must fulfill the following 3 requisites.

- (1) Universal Application;
- (2) Positive Identification, and;
- (3) Speed of Operation.

Because of the very wide variety of receivers in use—that is, simple receivers years old, more recent receivers of complicated design, and the very modern receivers with their numerous interlocked circuits—the servicing test procedure chosen must be one that is virtually independent of receiver design; if this can be achieved, the test method can be assumed to be independent of even the complicated receivers to come.

Such a system, founded upon a single item which constitutes a COMMON DENOMINATOR for all receivers, now is available.

WHY "SIGNAL TEST" SERVICING?

A Serviceman is called to repair a radio receiver for a definite reason. This reason, expressed in the simplest manner, is that the "signal" (radio program) listened-to by the customer in the form of music or speech is not satisfactory.

Irrespective of what may be the age of the receiver, or how complicated its wiring, or whether it has 1 tube or 50, the same thing is true . . . the customer does not know what is wrong with the receiver and, for that matter, neither

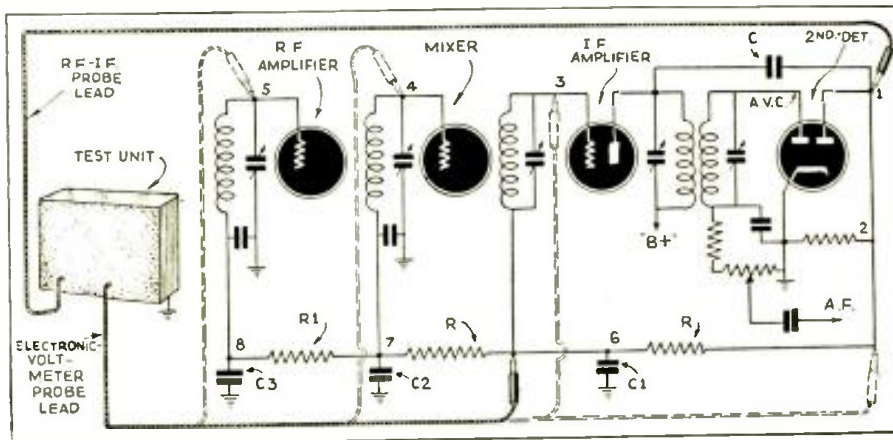

Fig. 1. Example No. 1: The "signal-test" system of locating faults in A.V.C. circuits.

OF TROUBLE-SHOOTING

and simplified, to permit concentrating on a "dynamic" or operating analysis of the incoming signal (radio program or test-oscillator signal) loudspeaker. Hitherto unattainable spot servicing results are secured.

RIDER

does the Serviceman when he is first called, but one thing is certain—something has happened to the signal.

If the receiver has lost its sensitivity, the strength of the signal has suffered; why the receiver has lost its sensitivity is another question, but at the present time we are concerned with the signal only . . . If some condition in the receiver causes distortion, it manifests itself upon the signal. . . . If for some reason the hum in the receiver becomes excessive, it has its effect upon the signal . . . If the receiver is inoperative, there is of course an absence of signal . . .

In other words what is wrong with the receiver, it influences the receiver or kills the signal at so

We doubt we has practiced other than a p the signal! T in all receive remain the i signal (or i has been ch for the sys article.

In connec the system the only t the operat the trouble in the secondary or supplementary as the basis of the receiver; the as the basis of primary, but not that is secondary: first test localizes of the receiver; the positive identifica-

tion of the defective part. As you can see, the reference to the signal in the receiver and the voltages present in the receiver indicate that the system is of the dynamic variety, that is, the receiver is placed in an operative state. By operative state, we do not necessarily mean correct signal transfer, because that may be the defect . . . What we mean is that the receiver is at least connected to the main power supply source; and, if possible, whatever voltages are available are being distributed to the various portions of the receiver.

"SIGNAL TEST" REQUIREMENTS

In order to apply such a method of trouble localization effectively, 5 requirements must be fulfilled, as follows:

- (1) It must be possible to trace the passage of a

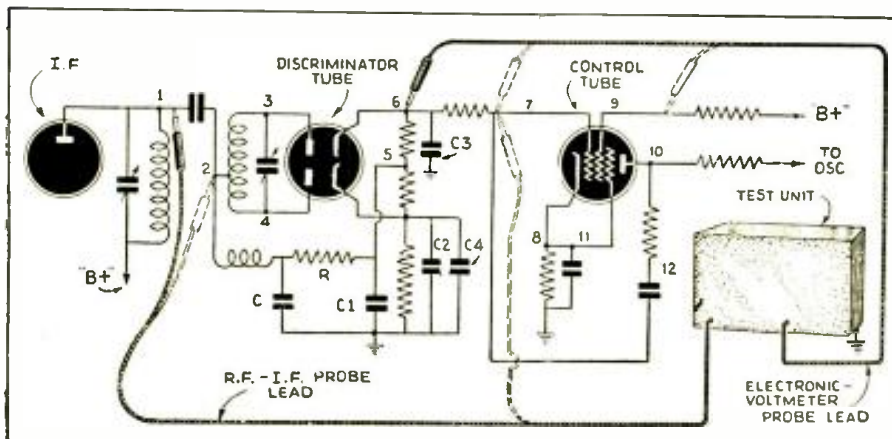

Fig. 2. Example No. 2: The "signal-test" method of finding trouble in A.F.C. circuits.

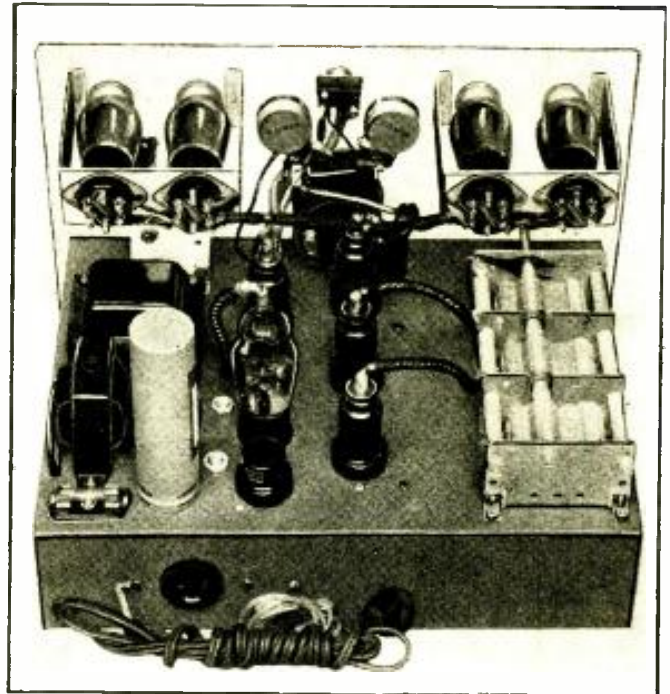

Fig. B. Interior view of "Chanalyst." Note unorthodox set-up.

signal fed into the receiver through the various circuits of the receiver in the various forms the signal may take as, for example, (a) oscillator frequency, (b) radio frequency, (c) intermediate frequency and (d) audio frequency, thus embracing all of the signal circuits between the antenna and the speaker.

(2) It must be possible to trace the signal through the receiver without so altering the constants of the circuit during the test as to impair the operation of the receiver, thus nullifying the observations.

(3) The voltage tests must be of such variety as to embrace not only the operating voltages, but the control voltages developed by the signal.

(4) The method of voltage measurement must be done simultaneously (if so desired) with the observation of the signal and at points common to the signal and the voltage as, for example, the control-grid of a demodulator tube or R.F. tube.

(5) The measurement of the D.C. voltages must be made with reasonable accuracy with respect to the true voltage present at the point tested without altering the constants of the circuit. This means that the voltage measurement method must be substantially free of circuit limitations.

"SIGNAL TEST" TROUBLE-SHOOTING A.V.C. CIRCUITS

You can readily appreciate the value of such a system, if you will consider the following examples. These troubles

(Continued on page 243)

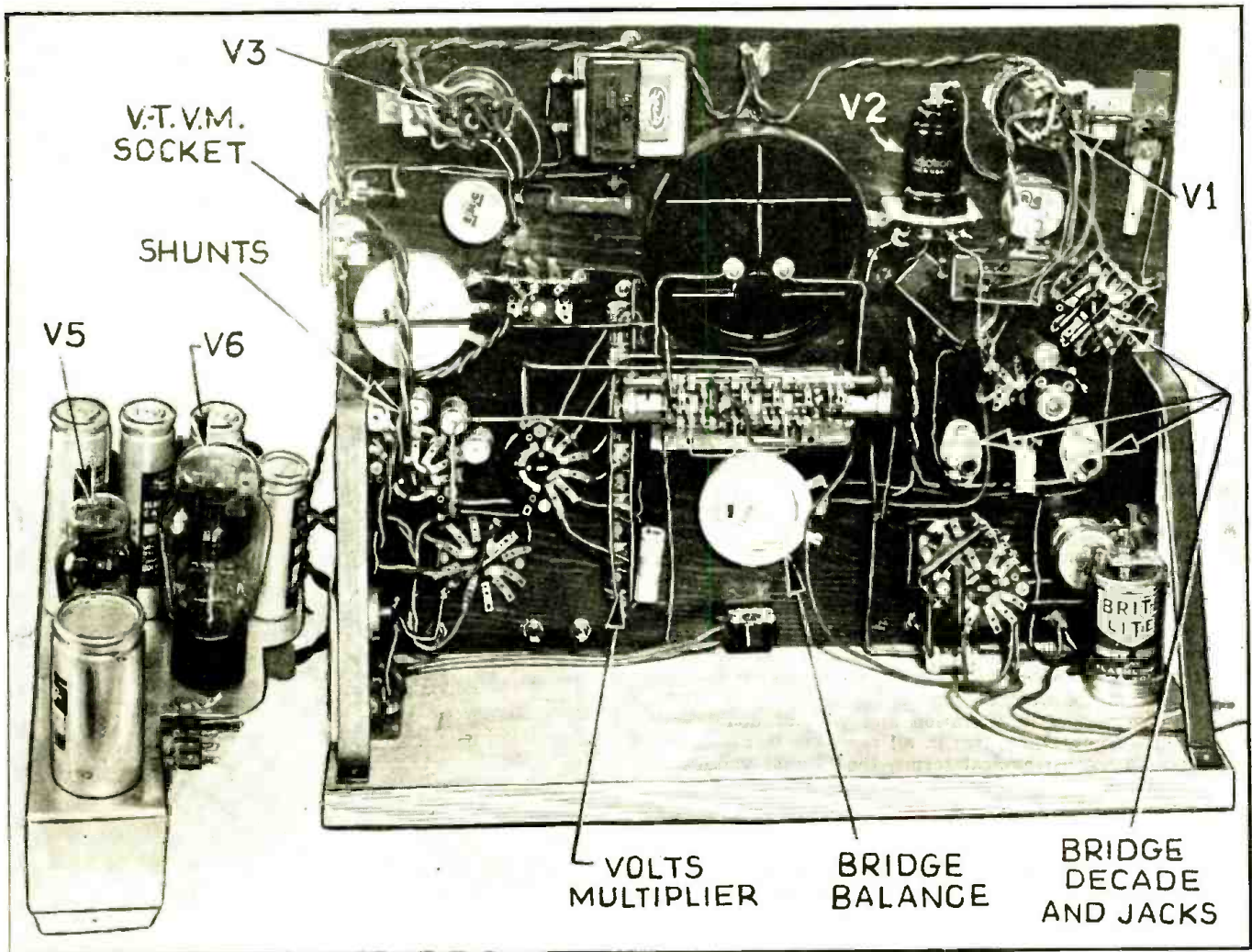

Fig. B. Rear view of the 38-range tester with power supply moved to one side to show the complete panel wiring.

BUILD THIS 38-RANGE

PART II

This easily-built instrument, designed by a practising Serviceman, resistance, inductance and capacity, with a single 38-range meter.

CHARLES

LAST month, we described the functions and uses to which the new tester could be put. A complete parts list was given so that those Servicemen who contemplated building this tester could obtain all or some of the parts required, in advance of the construction article.

Because of the experimental work involved, the writer deemed it advisable to use an inexpensive plywood panel rather than a costly bakelite panel, as a starter. However, the tester performed so well that no changes were required in the drilling layout of the front panel, thus making it possible to utilize the panel drilling layout (Fig. 4) as given in this article for any type of material desired, whether bakelite, wood or metal.

In any case, it would be best to use a thin (3/16-in. or 1/4-in.) plywood panel to mount all the parts on and

then a very thin bakelite panel could be mounted over the wooden panel, concealing all the mounting screws.

The baseboard upon which are mounted the power supply, input A.C. plug and ohmmeter battery, can be a pine or plywood board 7 inches wide, 17 inches long and 3/4-inch thick. Assuming that the front panel has been accurately cut, mark off all the holes required and drill all of them before mounting any parts.

MOUNTING PARTS

Referring to photo (Fig. B) which shows a back view of the tester with power supply removed, mount all the parts as shown, while the panel is still unfastened to the baseboard. The tuning eye brackets as supplied are too long but can be bent as shown. Three hand made items are required for the front panel. One is the socket platform

for the 6F5 tube, another is the socket platform for the V.-T.V.M. cable plug and the third is a 1-inch-wide strip of fibre paper 7 inches long for mounting the precision voltmeter resistors. Six of these resistors are mounted end to end on the strip. This strip is mounted vertically and can be seen near the meter, in Fig. B.

Having completed the mounting of parts on the panel we now turn our attention to the baseboard. At the left-hand end is mounted the detachable A.C. plug and convenience receptacle. The middle of the board is reserved for the power supply. At the right hand end can be seen the flashlight cell and holder. Note (in Fig. 5) that an insulated screw contacts the positive terminal of the cell.

The power supply chassis (see Figs. B and C) is made of thin aluminum sheet. The size of the chassis is 10

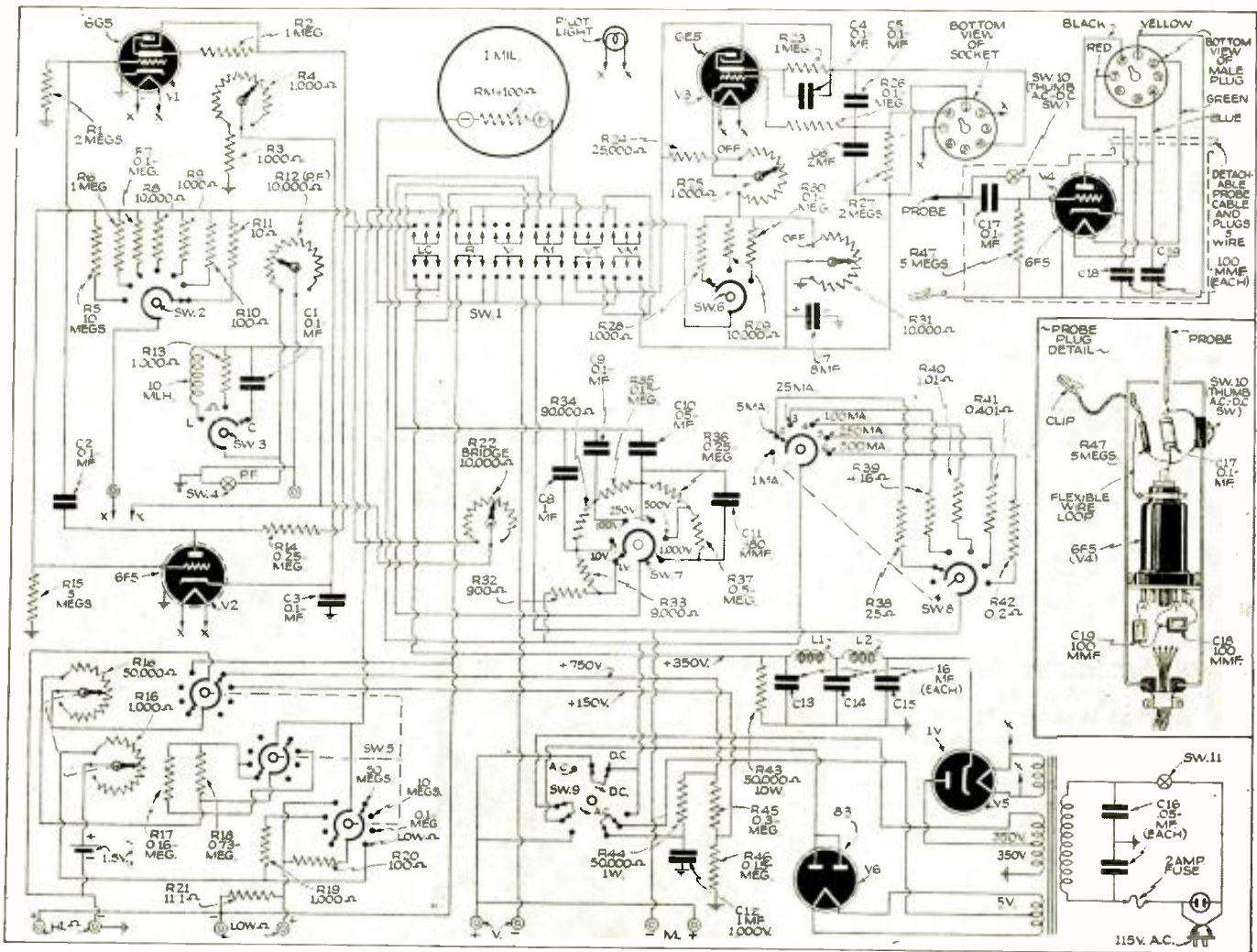

Fig. 3. Schematic diagram of the 38-range bench tester. Details of the vacuum-tube voltmeter probe and the dry-cell holder are also given.

"PUSHBUTTON" BENCH TESTER

affords quick test of A.C. and D.C. voltage and current, and re-Vacuum-tube voltmeter reads to 100 volts, at infinite-ohms/volt.

SICURANZA

inches long, 5 inches wide and 2 1/4 inches high. Cut out the chassis at the right hand corner to clear the 3-gang ohmmeter switch. After mounting all parts on the chassis, wiring should be done and outleads should be left at least 12 inches long to tie-in to the front panel later.

WIRING

Going back to the front panel, it is recommended that the wiring-in of small parts be done in the following order.

First, study carefully the pushbutton switch connections on the schematic diagram (Fig. 3). Wire-in the various jumpers exactly as shown. Complete the outleads from this switch to all their respective terminals. Next, wire-in the "volts multiplier" resistors to the Volts Range switch. The 2-gang Ma.-Range switch should be removed from the front panel and the 5 precision shunts sol-

dered directly to the switch lugs. The A.C.-D.C. switch for "volts-mils" should now be wired as far as possible—adding the power pack wires later on.

The V.-T.V.M. circuit wiring is done next. The filament wiring for all tubes begins at the probe socket platform. The capacity bridge wiring comes next in order. Mount the decade resistors directly to the switch lugs and connect all their free terminals to one common wire. The final wiring stage concerns the ohmmeter circuits.

The front panel should now be fastened to the baseboard and the long leads from the power supply should be left uncut and terminated at the proper points.

The V.-T.V.M. probe handle should be made according to the sketch in Fig. 3. It need not be exactly the same in every detail, but the form shown is very convenient to use in actual service

work. Be sure to mount the 2 small mica condensers within the metal shell of the tube socket. The photo of the probe handle (Fig. D) gives a clear idea of the assembly.

On its initial test, do not plug in the A.C. supply until after trying out the LOW and MEDIUM ohmmeter ranges, the D.C. Volts ranges and the D.C. Mils ranges. If these three function OK, plug in the A.C. cord and try the high and highest ohmmeter ranges. Then try A.C. Volts and A.C. Mils. Finally, push in the L/C button and check condensers for capacity. To test out the V.-T.V.M. be sure to push-in both buttons at the same time, first making certain the "Meter Re-set" knob is at the "off" position.

Operating instructions were given in Part I (September issue). This V.-T.V.M. is so useful once you get (Continued on page 230)

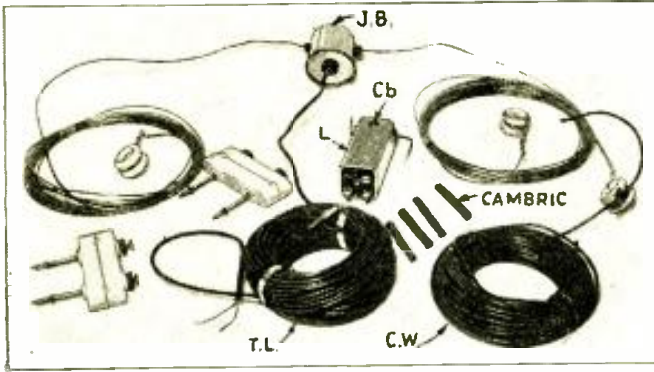

Fig. A. New antenna system has counterpoise wire C.W., and coil L.

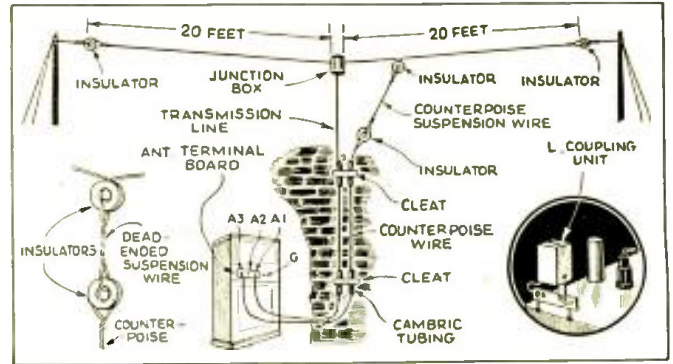

Fig. 1. One method of setting-up the new anti-noise antenna system.

NEW!—ANTI-NOISE COUNTERPOISE ANTENNA SYSTEM

By special permission of the I.R.E. and RCA, RADIO-CRAFT is privileged to present this description of an important development.

NOISE-CURRENT (made static) pick-up by an ordinary antenna is earthed by the ground lead; the impedance (A.C. resistance) of the ground lead however is great enough to place the receiver chassis at an "above ground" potential sufficient to introduce this noise voltage into the receiver.

STATUS QUO

Instead of using a straightaway antenna which does not exhibit any counterbalancing effects with respect to nearby noise radiations a doublet antenna may be used; noise impulses picked up by the 2 halves then are balanced-out at the radio receiver end. Further improvement is obtained by twisting the requisite 2 down-leads (the transmission line) so that equal portions of each down-lead are alternately transposed or changed with regard to their

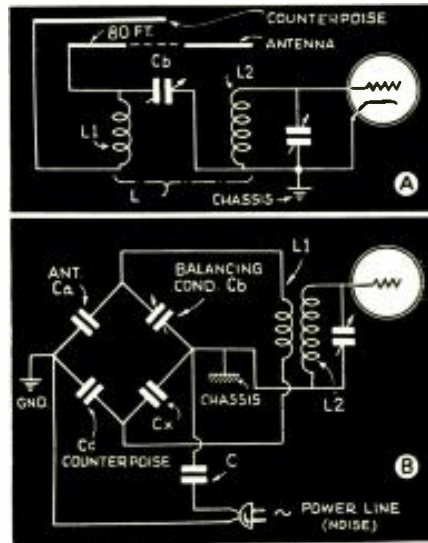

Fig. 2. Theoretical (A) and equivalent (B) circuits.

nearness to the static; the latter expedient is particularly effective where interference pick-up may be due to noise radiations from electrical house wiring within the wall adjacent to the down-lead.

Servicemen are familiar with the arrangement described above. It is effective on shortwaves but leaves the long waves (540 to 1,600 kc.) somewhat out in the cold. (For discussion of the noise-reducing efficiencies of preceding antenna types see "The Principles of Noise-Reducing Antennas," in September, 1938, *Radio-Craft*.—Editor)

This preamble now brings us to the new developments and means for balancing-out the remaining bit of interference which all the preceding experiments have not been able to completely eliminate. In order to appreciate the complete arrangement we will describe (Continued on page 248)

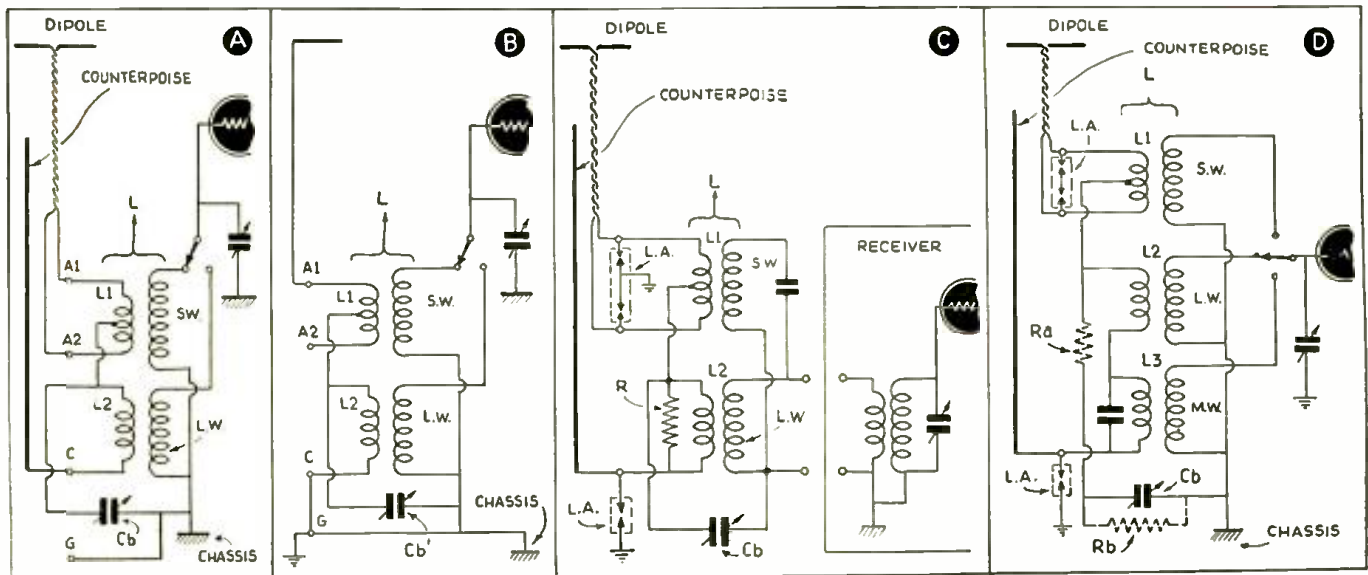

Fig. 3. At A, B, and C are shown dual short-wave and broadcast set-ups; at D, provision also for medium waves. Coil L in Fig. A is shown in Fig. 3C.

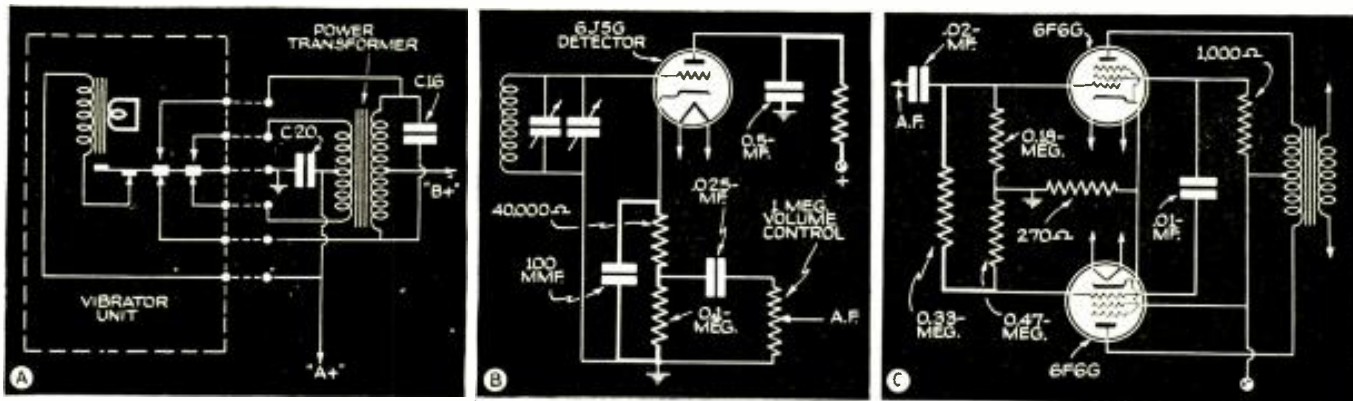

Fig. 1. New circuit features of (A) Silvertone, (B) McMurdo Silver and (C) Westinghouse receivers. Heavy lines accentuate features.

NEW CIRCUITS IN MODERN RADIO RECEIVERS

The details of the modern radio receiver circuits that make them "different" from previous designs are illustrated and described each month by a well-known technician.

F. L. SPRAYBERRY

NUMBER 13

(1) NEW VIBRATOR STABILIZER

Silvertone Models 6070-6170. *Better equalization of the contact strokes of the vibrator armature is provided by a special stabilizing means.*

As will be evident in Fig. 1A the vibrator magnet is provided with a closed secondary winding. It is a winding of very low impedance and resistance. When the magnetism operating on the armature attracts the armature, the primary current is almost instantly broken. Spring tension of the armature would tend to make it return immediately to its original contact, but the collapsing magnetic field induces a voltage in the closed secondary and a heavy current flows. Thus, in spite of the open primary circuit, the armature is urged toward the magnet where it can make contact with the power transformer windings for as much duration as for the unpowered side of the armature.

In this way, the two halves of the primary cycle are made more nearly uniform in value and the power supply efficiency and output are improved.

(2) NEW HIGH-FIDELITY DETECTOR

McMurdo Silver, Model Orpheon. *A new detector with infinite input impedance and a cathode load is used for this high-fidelity "local" receiver.*

Primarily this circuit is designed for the high-fidelity demodulation of local signals. The circuit, Fig. 1B, is preceded by one T.R.F. stage of exceptionally wide band coverage. The input to the detector is low because of lack of gain preceding it and the grid never becomes positive. For this reason, the resistance load on the detector tuned circuit is substantially infinite. The plate circuit is thoroughly filtered so as not to influence the plate supply voltage.

(3) LOW-FREQUENCY PHASE CORRECTOR

Westinghouse Models WR228, WR328. *A method is used to correct for a large phase shift at low frequencies between the grids of push-pull tubes, one acting as a phase inverter.*

At approximately 500 cycles, or above, the reactance of the coupling condenser feeding the lower tube in Fig. 1C is negligible in comparison to the pure resistance load into which it feeds. This means that the phase departure from 180 degrees due to the coupling condenser (0.01-mf.) is negligible (only a few degrees). However, at 50 cycles or in this region, the reactance of this phase inverter coupling condenser (0.01-mf.) has a reactance comparing favorably with the resistance load and

causing a large phase shift between the two grids. The phase departure here would be around 45 degrees, making the phase difference between the push-pull grids around 135 degrees instead of 180. This of course, would produce noticeable distortion of the output at low frequencies.

This tendency is to a great extent overcome by feeding a zero-phase signal into the phase-inverted grid through the 0.33-meg. resistor so that by its phase shift in the opposite direction it will bring the original signal approximately back in-phase. Thus, by the selection of values shown in the diagram, each grid has very nearly the same load, the same signal and is substantially in correct phase for all frequencies in the audio spectrum.

(4) AUTOMATIC TUNING-MOTOR NOISE SILENCER

RCA Victor Models 911K, 910KG, U-126, U-128. *A noise control or "muting" system for the tuning motor and automatic tuning contactors which automatically cuts down the signal at the I.F. tube and applies a cut-off bias to the 1st audio and inverter tubes is described.*

The motor field in Fig. 2A is supplied with an A.C. potential at its
(Continued on page 232)

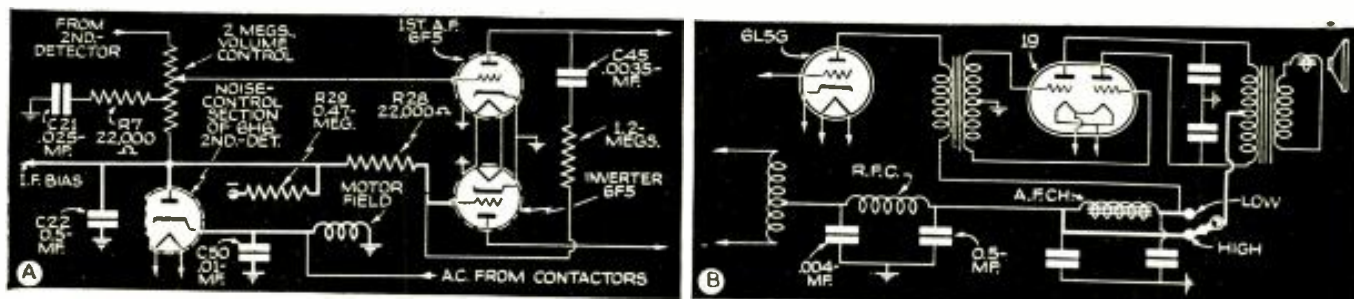

Fig. 2. New circuit features of (A) RCA-Victor and (B) Sentinel-Erla receivers. Heavy lines accentuate the points discussed in the text.

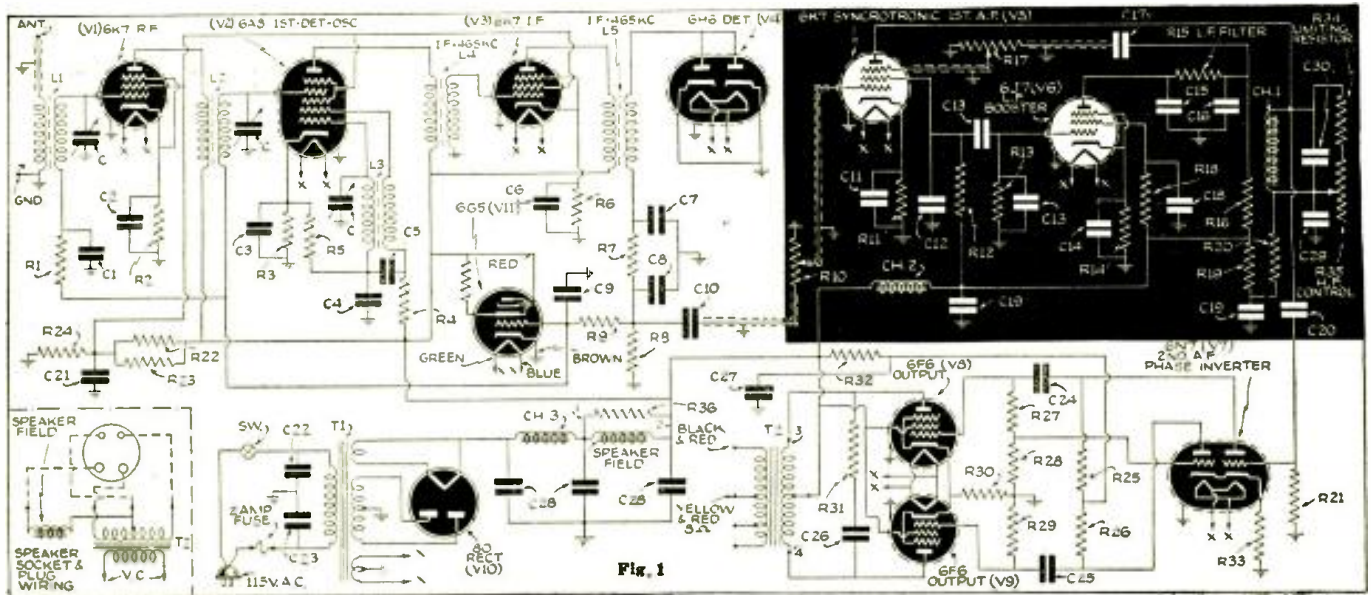

Fig 1

C—365 mmf.
C1—0.05-mf.
C2, C3, C6, C9, C13, C15,
C17, C20, C24, C25, C29
—0.1-mf.
C4—400 mmf.
C5—0.001-mf.
C7, C8—100 mmf.

C10—0.01-mf.
C11, C14—15 mf., 25 V.
C12, C16, C18, C21—0.25-
mf.
C19—8-8 mf., 450 V.
C22, C23—0.02-mf.
C26—0.02-mf.
C27—8 mf., 450 V.

C28—8-8 mf., 450 V.
C30—0.003-mf.
R1, R13—0.25-meg.
R2—900 ohms
R3—300 ohms
R5, R7—50,000 ohms
R6—4,000 ohms
R8—0.5-meg.

R9—1 meg.
R11—200 ohms
R14—600 ohms
R15—10,000 ohms
R20—2,500 ohms
R21—0.1-meg.
R27, R29—0.1-meg.
R28—5,000 ohms

R34—4,000 ohms
R4, R22, R23—30,000
ohms
R16—0.1-meg.
R18—0.5-meg.
R19, R25, R26, R12—50,000
ohms
R24—25,000 ohms

R32—10,000 ohms
R33—800 ohms
R10—1 meg.
R17—0.1-meg.
R35—50,000 ohms
R30—300 ohms
R31—15,000 ohms
R36—3,000 ohms

HOME-BUILT 11-TUBE SET INTRODUCES "SYNCHROTRONIC" REPRODUCTION

States the author: "This set outperformed a 16-tube deluxe console receiver with twin speakers." Patent application has been made for the "Synchrotronic" system it incorporates for improved frequency response.

L. M. BARCUS

THIS receiver is the result of several years of intensive work on the part of the author in determining the basic faults of contemporary radio reception, and in establishing fundamental principles by which radical improvements could be made. Some of his work during this period is evident in several radio sets previously presented in *Radio-Craft*.

While these instruments showed considerable advance, his research made it clear that some of the underlying needs of audio reproduction called for entirely new circuits. Thus was evolved the "Synchrotronic" method of tonal compensation that at last made possible a sound system which was capable of conforming to the specifications laid down.

While but few have so far recognized the fact, the greatest obstacle in the way of achieving utter naturalness in reproduction has been in the heretofore impossibility of bringing up the bass to a required level without such boosting affecting a large portion of the audio scale.

Utilizing the "Synchrotronic" system, however, makes possible

a radio set in which true depth, unusual brilliance, perfect naturalness of voice, and really life-like tone combine. In addition, the entire audio scale may be varied to allow for the wide range of differences which are encountered in present day broadcasting and to compensate for the acoustics of the homes in which this radio receiver is used.

INTRODUCING THE SYNCHROTRONIC CIRCUIT

This method of bass compensation has already been called the first major contribution to audio amplification in several years, for it permits increasing the low frequencies to extremely high levels without distortion and may be designed with attenuations as high as 30 db. per octave.

This is accomplished by the use of a 6K7 as the 1st audio stage. (See black section in Fig. 1.) With the tube in normal operating condition, the screen-grid is used as a virtual anode from which is derived the desired low-frequency component of the incoming signal, without affecting the response of the tube. This output is some 180 degrees out-of-phase in

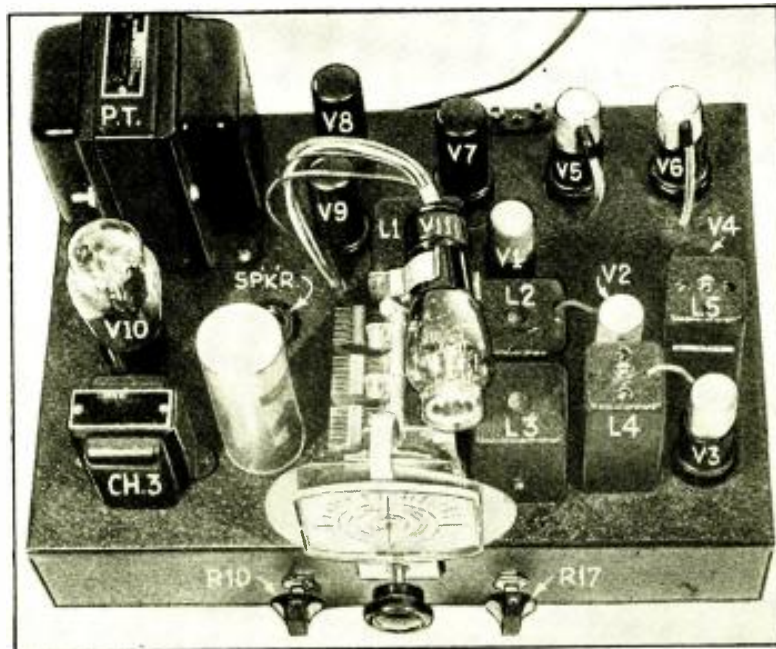

Fig. A. Chassis layout of the 11-tube broadcast set with "Synchrotronic" reproduction.

the required range, but shifts at higher frequencies to become in-phase.

The 6J7 serves not only to provide high gain to this component of the main signal, but to reverse the phase. It is accordingly fed back into the 3rd grid of the 6K7 with the desired range in proper phase with the main electron stream and with cancellation occurring immediately above. This accounts for the extreme attenuation possible.

Additional filtering is provided for by the resistance-capacity network in the booster channel.

It should be noticed in Fig. 2 that the amplifier response curve indicates an attenuation of 21 db. in less than one octave between 100 and 200 cycles. This curve was measured under actual operating conditions and is accurate.

THE SPEAKER

The audio response of this receiver has been designed to supplement the speaker specified. Analysis of the 2 curves of Fig. 2 indicates a disparity between the amplifier response and the actual acoustic output, which is due to such factors as cone resonance, output transformer characteristics and the like.

It is evident that were a different make used with performance at a variance, the final output curve would no longer possess the features necessary for this new type of radio set. No further warning is necessary.

The acoustic curve presented is fairly accurate overall, although the minor peaks have been deleted, and will well serve as a basis of explanation to those of you who will construct this receiver.

Taking up the human voice, first of all, many will wonder why, when the voice in some instances reaches down to 80 cycles, this radio receiver does not make them boomy. Normally, however, the male voice has only a percentage of the fundamental frequency with the harmonics supplying the body of sound, and the fundamental may be somewhat increased, even above normal, without undue difficulty with boom.

As a matter of fact, the voice under such treatment tends to sound richer and more mellow. But when the harmonics, especially the 2nd, are thrown out of balance we encounter the typical symptoms so characteristic of most radio receivers.

Since the output of this radio set is essentially down to reference level at about 180 cycles, this figure indicates the lower limits for the 2nd-harmonic of the voice which in turn gives us a fundamental of 90 cycles. It is upon this basis that the writer states that in normal broadcasts, that is, wherein the station or its associated equipment does not artificially stress the bass below 250 cycles, this radio receiver will not distort the voice save in rare instances!

Musical instruments, on the other hand, contain a much greater percentage of fundamental frequencies which must be brought up to the proper level before they can be expected to sound natural. Having high gain in the useful bass range, this radio set is easily able to do so.

While output is shown in Fig. 2 down to 40 cycles, cone break-up and other factors enter to reduce the fundamental at this point to only a fraction. At useful volume level, 70 cycles is near the lower limit of *faithful* reproduction. Further thought, however, will serve to bring to mind that but little of an orchestra's output lies below this figure, and this radio receiver will still out-perform practically all conventional consoles!

CONSTRUCTION

All essential information with regard to actual building of this receiver is contained in the List of Parts and chassis layout. The placement of the components is easily determined from the chassis photograph, Fig. A.

The tuning condenser should be mounted on rubber grommets which are available for this purpose. The chassis itself is in turn mounted on rubber.

The only source of hum to be encountered will be found in choke Ch.1. This is mounted below the chassis at the end opposite the power transformer and tilted at an angle, determined by trial, which gives no hum.

The output transformer is mounted on the speaker in the space provided.

The high-frequency control, R35, was added after the chassis photograph was

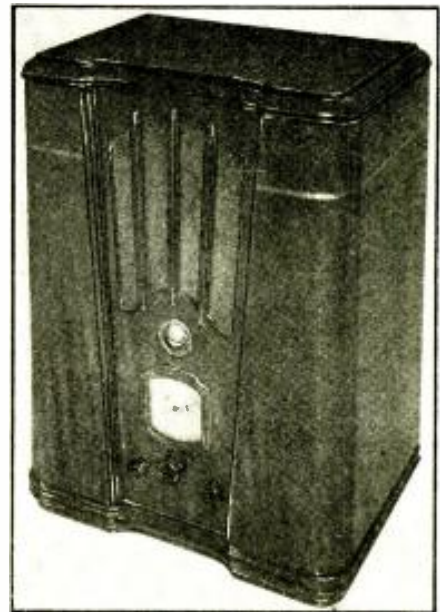

Fig. B. The completed receiver in its cabinet.

taken. It is best placed below the dial knob, there being adequate space at this point.

The shielded leads indicated at several places on the schematic, Fig. 1, were added as a precaution and it is recommended that they be used.

(Continued on page 246)

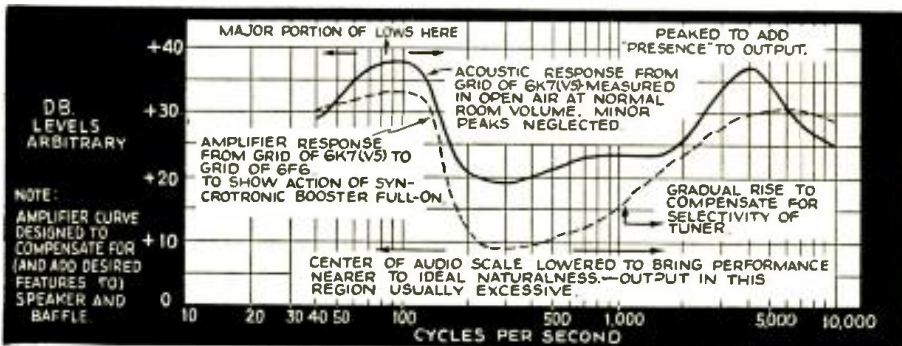

Fig. 2. Response curve of the Syncrotronic audio channel of the 11-tube receiver.

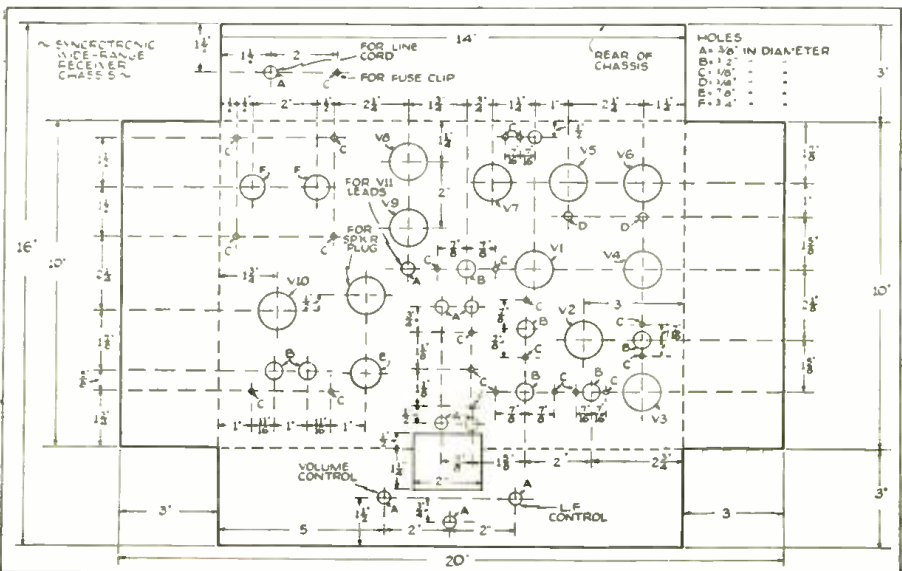

Fig. 3. Exact dimensions for drilling and laying out the chassis.

BELMONT 4-TUBE MODEL 408 (SERIES A) BATTERY "FARM" SUPERHET.

A 6-V. Battery Receiver; Single Band (535 to 1,720 kc.); Pushbutton Tuning; Manual Tuning; A.V.C.; P.M. Dynamic Speaker; Low Battery Drain (2 A.); No "B" Batteries.

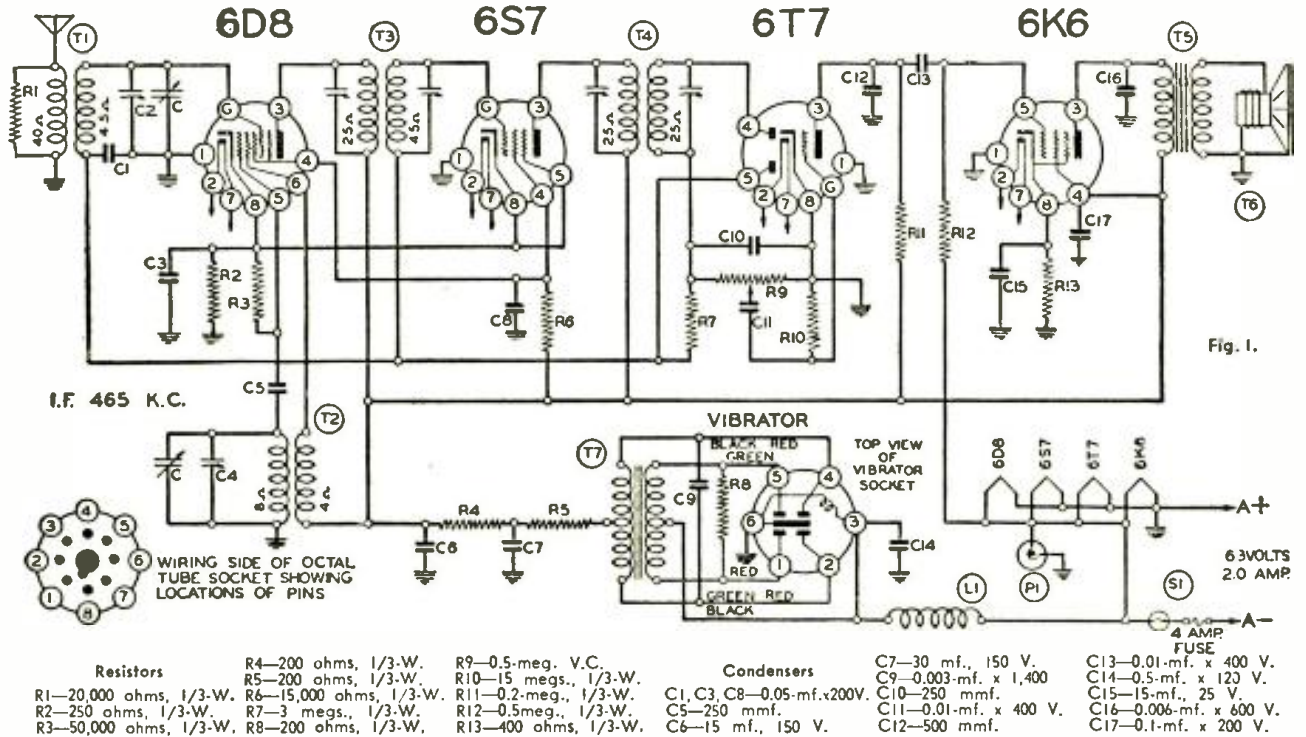

Fig. 1.

ALIGNING INSTRUCTIONS

CAUTION:—No aligning adjustments should be attempted without first thoroughly checking over all other possible causes of trouble, such as poor installations, open or grounded antenna systems, low battery voltage, defective tubes, condensers and resistors. In order to properly align this chassis, an oscillator (generator) is absolutely necessary.

Use as a resonance indicator an output meter connected across the primary of the speaker input transformer, or by means of an adapter between the plate and screen terminals of the type 6K6G output tube. Maximum deflection of the meter indicates resonance. Use only enough signal to get a readily readable output. A low-range output meter or the low scale of a multi-range meter should be used.

Excessive hum, stuttering, low volume and a reduction in all D.C. voltages are usually caused by a shorted electrolytic condenser; open bypass condensers frequently cause oscillation and distorted tone.

I.F. ALIGNMENT (465 kc.)

The I.F. transformers have 2 adjustments, both of which are accessible from the top of chassis (see Fig. 2).

1. With volume control full on (the extreme right of its rotation), and with the variable condenser set to approximately 1,400 kilocycles, make the following adjustments:
 - (a) Connect external oscillator set at 465 kilocycles, in series with 0.1-mf. condenser, to the control-grid cap of the type 6S7G tube, and adjust the output I.F. transformer to resonance.
 - (b) Move oscillator output clip from grid of 6S7G to grid of 6D8G and adjust input I.F. transformer to resonance.
 - (c) With oscillator still connected to 6D8G, readjust output I.F. transformer if necessary.

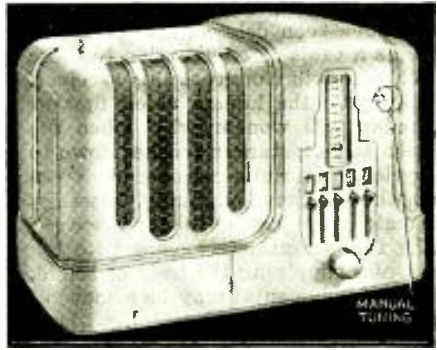

Belmont model 408 in ivory-bakelite case.

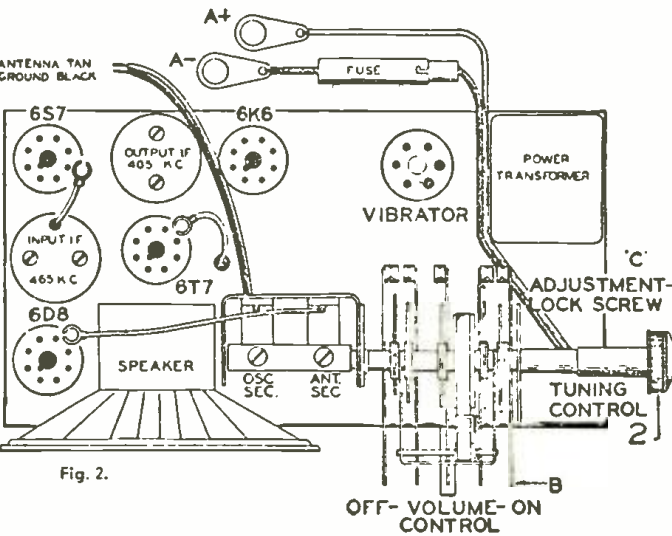

Fig. 2.

R.F. ALIGNMENT (535-1,720 kc.)

1. With gang condenser in its minimum capacity position, plates entirely out of mesh, connect an external oscillator in series with a 100 mmf. condenser to the antenna lead and chassis ground and make the following adjustments:

- (a) With external oscillator set at 1,720 kilocycles, adjust oscillator trimmer to resonance. This adjustment is on the top of rear section of variable gang condenser. (See Fig. 2.)
- (b) Re-set external oscillator to 1,400 kilocycles, rotate condenser, pick up oscillator signal and adjust antenna trimmer to resonance. (Top of front section of gang condenser.)
- (c) Check sensitivity at 600 and 1,000 kilocycles.

VOLTAGES AT SOCKETS

Supply Voltage 6.3 D.C.; vol. control at max.; 1,000 ohms/volt meter; antenna grounded.

T E R M I N A L S							
1	2	3	4	5	6	7	8
	(1)					(1)	
0	6.25	137	80		137	6.25	3.0
0	6.25	137	80	3.0		6.25	3.0
0	6.25	57				6.25	0
0	6.25	130	137			6.25	5.4 (2)

(1) D.C. voltage as read across heater terminals 2 and 7. (2) Bias (11.6 volts) as read across terminals 8 to 7.

STEWART-WARNER 5-TUBE MODELS 97-561 to 97-569 (SUPERHET. CHASSIS 97-56)

Single Band (540 to 1,720 kc.) 117 Volts, A.C.-D.C.; Pushbutton and Manual Tuning.

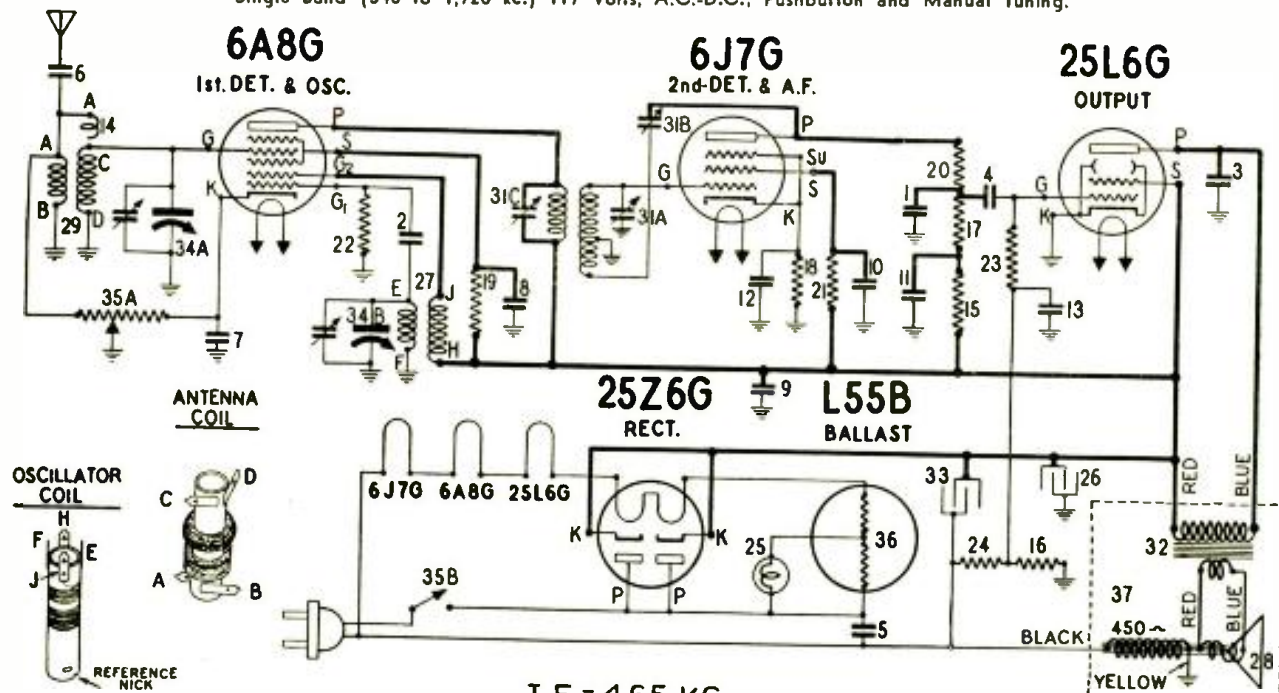

I. F. = 465 KC.

- Condensers**
- 1—260 mmf.
 - 2—110 mmf.
 - 3, 4, 5—0.02-mf., 400 V.
 - 6—0.004-mf., 400 V.
 - 7, 8, 9, 10, 11—0.1-mf., 200 V.

- 12, 13—0.25-mf., 200 V.
 - 14—3 mmf.
 - 26—16 mf., 160 V.
 - 33—40 mf., 150 V.
- Resistors**
- 15, 16—0.22-meg., 1/4-W.
 - 17—0.47-meg., 1/4-W.
 - 18—22,000, 1/4-W.
 - 19—33,000, 1/4-W.
 - 20—10,000, 1/4-W.
 - 21—2.2 meg., 1/4-W.
 - 22—68,000, 1/4-W.
 - 23—0.33-meg., 1/4-W.
 - 24—0.68-meg., 1/4-W.
 - 35A—20,000 V.C.

ALIGNMENT PROCEDURE

FOR ALIGNMENT: An output meter and an accurately-calibrated signal generator with a tuning range from 465 kc. to 1,500 kc. are required.

1. Connect the output meter across the voice coil or between the plate of the 25L6G output tube and ground, depending on the type of meter. (The more sensitive type should be connected across the voice coil.)

2. Connect the ground lead of the signal generator to the chassis of the receiver through a 0.1-mf. condenser and keep it connected in this manner throughout the entire alignment procedure. Failure to do this may have serious results as one side of the power line may be grounded in the signal generator.

3. Turn the volume control to the maximum volume position and keep it in this position throughout the entire alignment procedure.

4. With the gang condenser in full mesh, set the indicator to the last mark on the top end of the dial scale. If the pointer is only slightly off calibration, it may be possible

to slip the dial drum just enough to correct for this slight mis-calibration. If the dial is several divisions off-calibration, loosen the

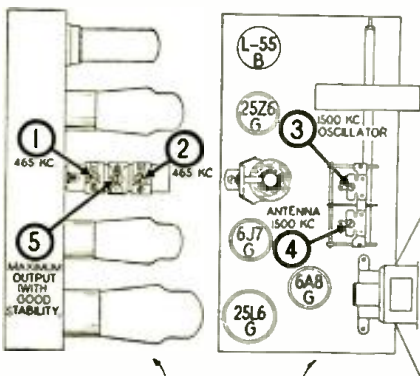

REAR VIEW OF CHASSIS · TOP VIEW OF CHASSIS



Stewart-Warner Models 97-561, 97-562.

set screw on the condenser shaft. Then grasp the end of the tuning shaft and turn the dial until the last division of the scale is directly under the indicator, when the gang is in full mesh. Then retighten the set-screw.

SOCKET VOLTAGES

The voltages shown below are measured between socket terminals (underside view) and chassis unless otherwise shown. Use a high-resistance voltmeter, at least 1,000 ohms/volt. **NOTE A:** Bias control for 25L6G control-grid is 6V. Due to high resistance in the grid circuit, voltage will read low. **NOTE B:** Due to the high resistance in the plate and screen-grid circuits the voltages measured at these terminals will be very small.

The voltage across the speaker field is 27 volts.

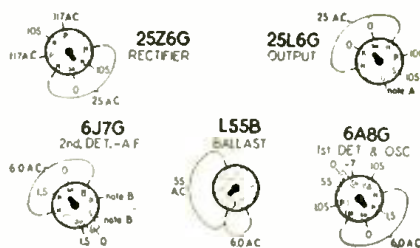

Dummy Ant. in Series with Sig. Gen.	Connection of Sig. Generator Output to Receiver	Signal Generator Frequency	Receiver Dial Setting	Trimmer Number	Trimmer Description	Type of Adjustment
0.1-mf. Condenser	Control-Grid of 6A8G Tube	465 kc.	Any point where it does not affect the signal	1-2	I.F.	Adjust for maximum output. Then repeat adjustment. If oscillation occurs "back-off" (1/4-turn clockwise) regeneration control trimmer No. 5.
200 mmf. Condenser (Blue Wire)	Antenna Lead (Blue Wire)	1,500 kc.	1,500 kc.	3	Broadcast Oscillator (Shunt)	Adjust for maximum output.
200 mmf. Condenser (Blue Wire)	Antenna Lead (Blue Wire)	1,500 kc.	Tune to 1,500 kc. Gen. Sig.	4	Broadcast Antenn. (Shunt)	Adjust for maximum output.
Connect receiver to customer's antenna or to a 50 mmf. mica condenser in series with generator.			Tune in a weak signal on I.F. end of dial. Use weak signal and turn volume control to max.	5	Regeneration Control	Adjust trimmer to give maximum output, consistent with good stability and tone quality.
*0.1-mf. Condenser	Control-Grid of 6A8G Tube	465 kc.	Any point where signal is unaffected.	1-2	I.F.	Adjust for maximum output. Then repeat adjustment.

*This adjustment must again be made after the regeneration control trimmer has been set.

NEW TEST INSTRUMENTS

Features in a new servicing signal generator, and a combined tube tester and multi-meter, are described.

G. N. GOLDBERGER

WITH increasing complexity of modern radio receiver design, the service engineer is confronted with new problems to solve and above all, how to perform the necessary tests and repairs with an economy of time and with need of as few test instruments as is in keeping with his purse limitations. Nevertheless, it is an accepted fact that test procedure and final results are controlled to a very great extent by the performance of test equip-

ment, whatever the equipment may be. The original design features of a piece of test apparatus immediately limit the number of uses to which such an instrument may be put and the manner or efficiency of such performance. Hence considerable forethought and farsightedness must be applied before the actual process of manufacturing begins, so that the circuits and parts layout should be more than adequate to cover all present-day and future needs.



Fig. A. Type E-100 Signal Generator.

This applies, especially, to that equipment most essential to routine radio servicing, namely: Signal Generators, Tube Testers, and Multi-Range A.C.-D.C. Testers.

NEW SIGNAL GENERATOR

For modern service work a signal generator should have an accuracy of within 2% and its construction should be so substantial that this accuracy would be retained under varying climatic conditions and under the usual manhandling that Servicemen give their instruments. Rigid precautions must be heeded to insure frequency stability, close control of output whether modulated or unmodulated, constancy of calibration, complete coverage of fre-

(Continued on page 230A)

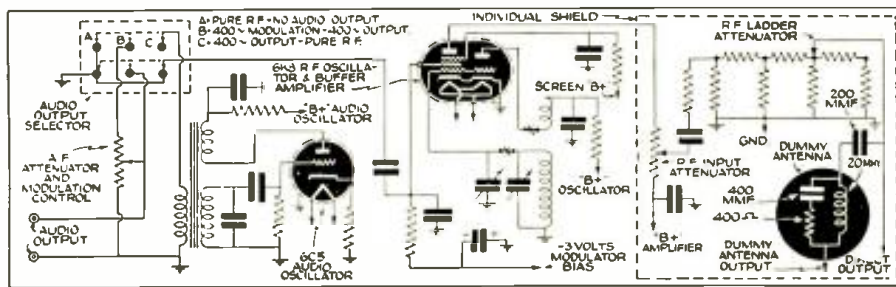

Fig. 1. Circuit highlights of the signal generator shown in Fig. A. Note built-in dummy antenna.

RADIO WITTIQUIZ

FREE — A 1-year subscription to RADIO-CRAFT to each person who submits a Wittiquiz that in the opinion of the Editors is suitable for publication in RADIO-CRAFT. Read the following Wittiquizzes; can you spot the correct answers? Now send in your idea of one or more good Wittiquizzes.

(141) An electrolyte is—
 (a) Another name for an electric light. (b) A field about an electromagnet. (c) A solution in a storage battery.

(142) An armature is—
 (a) A person who sings on Major Bowes' radio hour. (b) The rotating part of a motor. (c) Part of an armchair.

(143) You will find a plate in—
 (a) The dish closet. (b) A vacuum tube. (c) A dynamo. (d) A flashlight.
 JOHN HIEHLER

(144) Every ham should know that *hi mu* is—
 (a) Ham lingo for the equivalent of "hey rube" in circus vernacular. (b) Large amplification factor. (c) High modulation efficiency.
 JEROME A. GANS

(145) A dielectric is—
 (a) A 2-way, radio-controlled electric railway going between Boston and New York. (b) A non-conducting material. (c) A collision between 2 ohms in an electrical circuit. (d) A new type of variable resistor.

(146) Any ham will tell you that a "T.N.T." circuit is—
 (a) A circuit used to set off high explosives by remote control. (b) A self-controlled oscillator. (c) The circuit of a radio set which has been soaked in trinitrotoluene.
 HENRY TAYLOR

(147) In television, *interlaced scanning* will be used—
 (a) To teach women how to knit. (b) So as to reduce the band-width and still retain the same clarity and detail. (c) To obtain new fashion designs. (d) So that the receiver will not miss every other station while scanning the dial.

(148) Video frequency is—
 (a) The name of the 2nd intermediate frequency in a triple-detection receiver. (b) A frequency that is visible like light rays. (c) The frequency of the voltage resulting from television scanning. (d) The number of times each year that a blind person can see.

(149) In television a *frame* is—
 (a) A single complete picture. (b) The border around the cathode-ray tube. (c) An innocent person made to look guilty. (d) The receiver cabinet. (e) A halo around the objects viewed.
 TONY MIANO

(150) A *fixed resistor* is—
 (a) One that has been repaired. (b) One that cannot be moved from its original position. (c) One that has constant ohms-resistance value.
 W. O. CLARK

(Continued on page 241)

All the worthwhile
Radio Trade News
of the Month—Di-
gested for busy
radio men.

RADIO Trade Digest

A PLEDGE: — To
give the important
news of the radio
industry; to review
major news; to help
point a path to
radio profits.

IMPORTANT HAPPENINGS OF THE MONTH IN THE RADIO INDUSTRY

No. 2

OCTOBER, 1938

No. 2

\$1,000,000 SPECULATION

ON June 2, 1938, American Television Corp. was organized for 1,000,000 shares at \$1 par; it acquired all the outstanding common of CSI Development Corp., which owns Communicating Systems, Inc. ATC paid 185,000 shares for this stock, an "arbitrary valuation," which may or may not be justified by the CSI balance sheet. Un-named holders of 154,050 of these shares have agreed to hold them until Dec. 15, '38. This averts dumping and "breaking the market."

The contract with the broker provides a 15c commission. But as this is inadequate in any such operation, the broker has been given 14,250 shares "for services rendered," and is pledged an additional 14,200 shares if he succeeds in peddling 99,500 (thus ducking SEC check on 100,000 share issues) to sapient speculators—giving him a profit of about 40% on the transaction.

In the stock prospectus, though not prominently displayed, are two highly important and completely frank statements. They are:— (1) "No forecasts can be made as to the profits or losses that may accrue to this Corporation. . . ." (2) ". . . the Corporation's earnings, if any, from its Television branch, are problematical and speculative."

(Continued on page 236)

TRADE ANSWERS RTD QUESTIONNAIRE

RESULTS of the first RTD questionnaire, now being tabulated, clarify many facts which the trade has long known; reveal some which are startlingly new. Among the latter are:—



"Have you got a good high-fidelity phonoradio with built-in television for about \$12.00 on an easy payment plan?"

Don't Forget!

New federal Wage-Hour Law becomes effective October 24. Be sure you get a copy (from the RMA if you're a member; from the Labor Dept., Washington, D.C., if you're not) and familiarize yourself with its provisions.

It looks as though Mr. Whiskers means business on this one!

Labor & Legislation

First query on the questionnaire dealt with wage-hour legislation, and the questionee's opinion of its effect upon his own business. Belief had been that large majority of employers, visioning wage rises, hour cuts, would raise loud wails. But by far the greatest part think law will do little (if any) harm or good. A few more think it will do some good. *The figures on Wage-Hour Laws effect on respondent's own business:— No change, 51.5%; Improve 25.7%; Harm 22.8%.*

The effect of the Law on the radio business in general is viewed even more optimistically, although a larger percentage sees business being harmed. *The figures:—No change, 28.5%; Improve, 38.1%; Harm 33.4%.*

Improvements

Another question which brought a rather revealing answer was one which asked, *What is needed to boost radio sales?* Industry took a surprisingly realistic view of itself, nearly ¼ of replies listing better sets—a tie with television. *The figures:—Improve quality, 24%; Television, 24%; Facsimile, (Continued on page 236)*

STREAMLINED SHOP FOR USE & SHOW



As starter in Service Shop Modernization Contest, Hygrade Sylvania has built a model shop in their Emporium, Penna., plant. It includes built-in test panels, shielded oscilloscope room, workbench, storage space, as well as displays. As "fancy package sells goods", prettified store should boost biz— & FHA will advance funds to responsible dealers who want to make improvements in present layouts.

INSURANCE PLAN HELPS INSTALLMENT SALES

When Joe Spivvick has a fire which damages a piece of equipment for which he has not fully paid, the dealer has trouble collecting the balance. Same is true in case of theft, flood, etc.

So G-E Contracts Corp. has made a deal with the Insurance Co. of North America, issuing a certificate to each purchaser of large or small appliances. The dealer is likewise protected, and the policy covers the equipment while in the shop or elsewhere for repair, etc.

Contingencies covered include fire, lightning, windstorm, tornado, cyclone, earthquake, flood, collision, explosion, derailment, "transportation" (!), stranding, sinking, theft and pilferage during life of contract.

Neither dealer nor customer pays extra for this protection.

Other mfrs. might find this plan profitable.

PROOF IT'S WATERPROOF

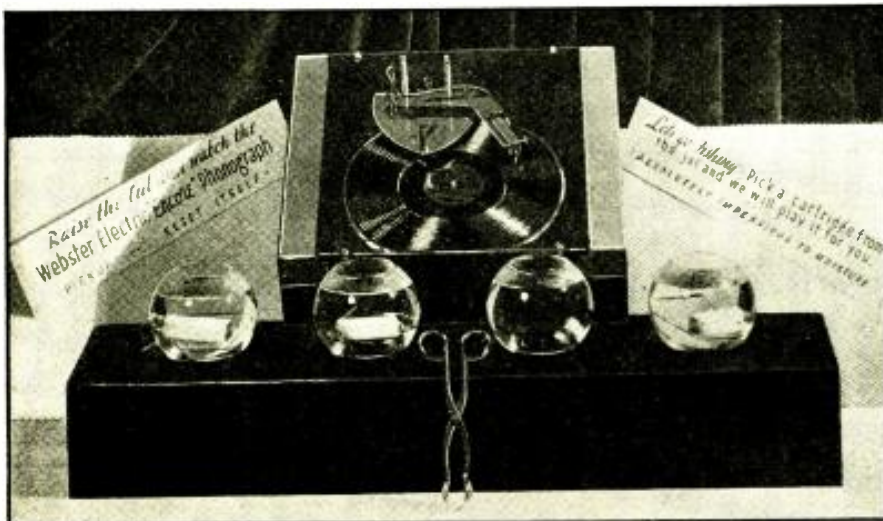

To prove xtal pickup cartridges (X-760) waterproof, Webster Electric Co. submerged 4 in fishbowls, invited visitors to Nat'l Radio Paris Show to undunk & try them. Visitors did, were not amazed; pickups performed perfectly, as expected. Also seen is self-setting xtal pickup transparent cabinet; starts when lid is closed, resets when lid is opened. Can do everything but cook & darn socks.

... SCOOPS & SNOOPS ...

Belden is sponsoring Natl. Antenna check-up week, Oct. 15-22. . . . G-E added an all-purpose household cement to its line; a 25c seller with a glyptal base . . . Maj. Edwin H. ("Regeneration & Supers") Armstrong got a 30-day okay from the FCC to test his 40-kwatter, W2XM, on 42.8 mc. . . . Hygrade Sylvania's 906, a 3-inch C-R tube, will be the first of a line. . . . RMA Credit Committee has been reorganized by Chairman P. C. Lenz, and do you know Teddy Bergman's "chairman" story? It's a wow, but not for here . . .

At least 90 NBC stations will carry 13 weeks of sports writer Eddie Dooley's football comment beginning Sept. 22. How's for a

sales tie-up? . . . Scientific Diathermy Co., N.Y.C., makes a home-use outfit that any radio dealer might sideline, any Serviceman service . . . FCC Examiner M. H. Dalberg thumbs-downed King-Trendle Broadcasting Corp., Grand Rapids, Mich., when they requested a C.P. for a 250 watter on 1,010 kc., tsk tsk . . . WGAL, Lancaster, Pa., 250 watts on 1,500 kc., became NBC's 153rd station on July 1 . . .

FCC Commissioner Thad H. Brown took testimony on radio safety aids for Great Lakes use; mfrs. of such equip. should get copies . . . Hilet Eng. Co., West Orange, N. J., has a new line of 2.5 kva. plate transformers . . . Unit Reproducer Co., Rochester, N.Y., announces a new xtal pickup, & a new magnetic pickup with an Alnico magnet; both have tilted needle to reduce wear . . . Ultimate Transmitter Co., Los Angeles, Calif., is introducing its new \$14.50 speed key at \$10 if you act fast . . .

Browning Labs., Inc., Winchester, Mass., new BL-5 series tuners run from \$11.10 to \$14.70 list, with a sweet discount to hams . . . International Telephone Development Co., of Nyawk, copped that govt. (Continued on page 236)

BULLETIN. Talkies tackle television as Paramount Pix buys slice of Du Mont Labs.

HAVANA TREATY OKAYED

In case you hadn't heard, the Havana Broadcasting Treaty, to become effective next year, was ratified by the U.S. Senate.

RMA committee, under G. E. Gustafson, will attempt to keep the now clear 455 kc. channel open for use as I.F. by set mfrs.

CORRIGAN'S PLANE RADIO

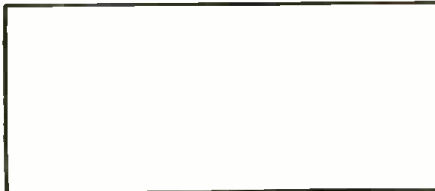

The radio set shown above, used by X-Atlantic Corrigan, enabled him to reach Dublin while en route to Calif. Had he used any standard set, he would have aimed for Calif., reached Calif.—and missed headlines.

AUSTRALIA REMOVES QUOTAS BUT UPS DUTIES

Australia no longer limits import licenses, but all is not rosy. She raised tube duties 6 pence, while decreasing excise tax on them 3 pence; this puts a 9d. (about 18c) differential against U.S. tubes. Electrolytic condensers also suffered.

But there is hope of a reciprocal trade agreement, which may give U.S. mfrs. a better break in the Aussie market.

CHANGES IN NAMES & ADDRESSES

New companies are being formed, new representatives appointed. Here are the latest data for your files.

Service Instruments, Inc., N.Y.C., new \$20,000 Co. Address through attorney, Leon Alpert, 551 5th Ave., N.Y.C.

Standard Transformer Corp., 1500 N. Halsted St., Chicago, has added the following reps:—W. Bert Knight, Inc., 115 W. Venice Blvd., Los Angeles, Calif., for Ariz., Nev., and lower Calif. Brown-Sherill Co., 310 E. Moorhead, Charlotte, N.C., Fan line only, in Ga. and N. and S.C. Hollingsworth & Still, Norris Bldg., Atlanta, Ga., for Ala., Ga., Fla., Tenn. and N. and S.C. J. M. Cartwright, 1288 Vinton Ave., Memphis, Tenn., for La., Miss., Memphis and Jackson, Tenn.; Texarkana and Eldorado, Tex.

(Continued on page 238)

LAUGH OF THE MONTH:

Engineer Factory

If you need any engineers, consultants, etc., you can probably buy them by the gross from a Chicago concern. Anyway, their ad says, "Makers of Telephone and Signalling Apparatus Electrical Engineers, Designers and Consultants." Yoohoo! Poppa!!

Chairside Units and Radiorgan Feature New Zenith Line

Fifteen chairside models, from \$19.95 to \$199.95, feature the new Zenith 82-model (4-15 tube) line, 8 of which are phono-radios. A 6-key radiorgan, also new, affords 64 tonal combinations. PB tuning is included in even the low priced receivers.

SOLVES ANTENNA PROBLEM

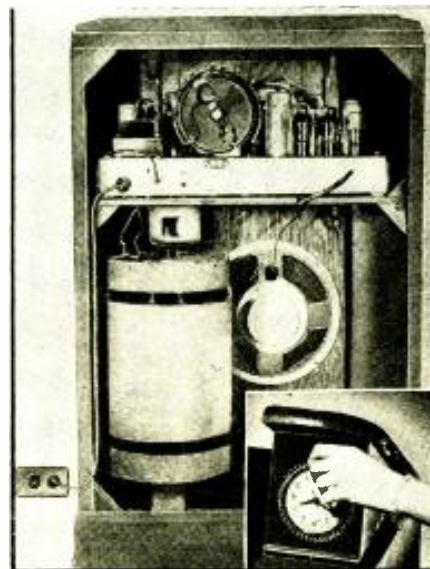

Built-in G-E Beamscope antenna ends antenna service problems, but eliminates sale of antenna kits & jobs. Inset is automatic time tuner, settable for 15-min. intervals throughout the day.

ARTIE DEE SAYS:—

Like other industry, radio biz has its headaches, which are being partially alleviated by pre-election activity, always an aspirin for ill economics.

Like invalids, radio sellers are divided into 2 classes: those who wail of their aches and those who seek a cure. Like other invalids, the former get more sympathy, the latter a speedier cure.

Retail outlets which put on sales drives are suffering least. Several methods are proving effective. A few are:—

Newspaper campaigns to dispose of outdated merchandise at bargain prices, thus eliminating surpluses and dead stock.

Newspaper campaigns on new models with attractive features.

Campaigns to persuade reader that his set is practically junk if over 3-4 years old, but that it has immediate

"deals, to get service into customer's

merchandise: auto-radio, battery-operated sets, tune-up for fall, or new sets and important" bests, as old's Series, foot-

ual efforts, such as would be still ated by Industry. o get together on a business boosters, Radio Trade Digest. ters come in from radio, RTD will invention to lay out siness builder for

GETS THE WIND UP

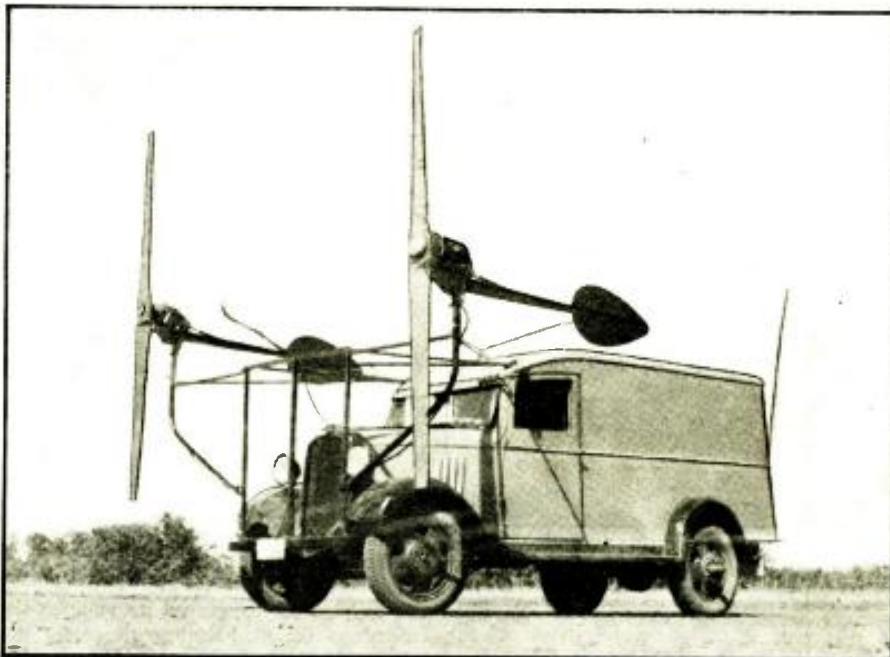

To check its wind-driven generators, Parris-Dunn Corp. mounts them in pairs on special truck, motion of which generates breeze. Seen between them is velometer to check wind speed. Units shown are new 32-volters.

SALES HELPS & DEALS

Here are some winners. Wise dealers will use them; wise mfrs. will emulate them.

TALKING slide-films in color are being used by G-E to help salesmen learn better sales methods.

PHILIP CAPELLI'S shop in Springfield, Mass., offers to take a free photo of every customer making a certain minimum purchase. Although Phil's a colorist, it should work just as well for radio men.

IN BRITAIN, Servicemen offer the following for 3/6 (87c):—Tube tests, switches cleaned, coils checked by oscillator, condensers cleaned and tested for leakage, resistance tests, speaker centering checked, batteries, phono motor and pickup tested, antenna and ground points cleaned, dial and cabinet cleaned. Mfr. of switch-cleaning compound gives Servicemen cards plugging the service when they buy his product.

FIVE TIPS on how to cash-in on N.Y.

World's Fair (also applicable to Frisco Fair) are released by B.B.D. & O., adv. agency. They are:—(1) If exhibitor, strengthen local retail outlets with new stock and adv. campaign. (2) If not (Continued on page 239)

FCC BULLETIN

Copies of proposed revised Rules and Regulations are now available upon request to the Secretary of the Commission. The FCC Bar Assn., other interested practising attorneys, bestg. licensees and others are invited to submit written suggestions thereon to the Rules Committee, which may hold hearings.

On or before Sept. 15, the Committee will report to the FCC.

TICKETS TO PLEASURE

RADIO AT HOME
WITH SUPREME ENJOYMENT
TRUE - NATURAL REPRODUCTION
made possible by new and REVOLUTIONARY DEVELOPMENT
ACOUSTICAL LABYRINTH
Brings original into the home
Exclusive patented by STROMBERG-CARLSON

STROMBERG-CARLSON ORCHESTRA
CENTR 8 10

RADIO AT HOME
WITH FREQUENT DISAPPOINTMENT
POOR TONE QUALITY
caused by deteriorated parts, old tubes, inferior design, or
INADEQUATE ORIGINAL DESIGN
SOLUTION - Visit STROMBERG-CARLSON Dealer or call FACTORY REPRESENTATIVE.

STROMBERG-CARLSON 3rd BALCONY
LEFT 0 13
Behind a part

Get your magnifier & see how Stromberg-Carlson drives home need for adequate equipment to get full radio enjoyment. "Obsolete set equals seat behind post in 16th row; S-C equals center seat down front." That's the message.

SILENT SALESMAN

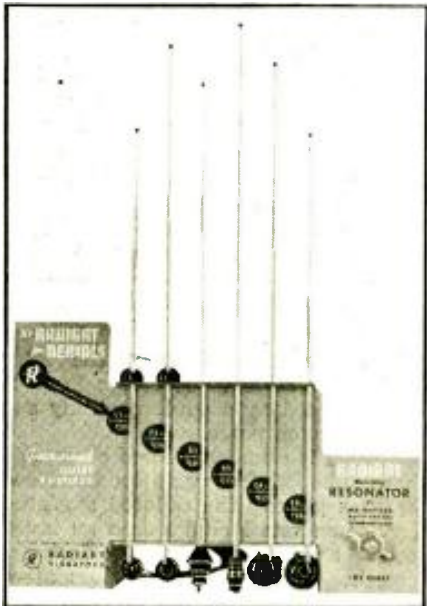

No charge is made for display, with 6 Radiart hinge & cowl antennas & matching resonator. The deal is D-5; discounts are liberal.

EMERSON BOOMING

When Emerson showed its new sets at the N.Y. distributor convention, sample orders for the new line hit nearly \$3,000,000, a record for the co.

For the year ending July 7, Emerson beat the preceding year 34% in number of units sold, 22% in dollar volume.

Throughout depression, according to Pres. Ben Abrams, the co. maintained a full quota of employees, increased wages, reduced prices.

Mass production at popular prices is Pres. Abrams' prescription for keeping business rolling and reducing unemployment.

MONTHLY BIO



LEON L. ADELMAN

Started radio at age of 9 (now 35.) Later edited *Science & Invention*, *Experimenter*, etc. Has been counter salesman, lab. assistant—was with FADA, Freshman, Hammarlund, own co.; is now adv. & sales mgr. of Cornell-Dubilier Electric Corp., whose 1937 sales, under his hand, rose 40%.

OFF THE PRESS

THE CHURCH IN THE SKY. 40 pp. Federal Council of the Churches of Christ in America, 297 4th Ave., N.Y.C. Reprints of talks by noted clerics and others.

TUBE-TYPE RESISTOR REPLACEMENT CHART. 7 pp. Clarostat Mfg. Co., Inc., 285-7 N. 6th St., Brooklyn, N.Y. Specifies Clarostat type no., no. and fil. voltages of tubes in sets served, total fil. voltage, total voltage drop across resistor tube, no. and type of pilot lamps, taps and current in ma., series wiring, base wiring designation, type of base, universal replacement type, and other mfrs. type nos. 25c from Clarostat.

PARTS BY RCA. 16 pp. RCA Mfg. Co., Inc., Camden, N. J. Catalogs more than 100 items, including new tube checker, 2-inch C-R oscilloscope, phono modernizers, etc.

BULLETIN 140. Shallcross Mfg. Co., 10 Jackson Av., Colingdale, Pa. Data on mfr's. resistors and test instruments.

5 KW-RADIO TRANSMITTING EQUIPMENT. 16 pp. Western Electric (Continued on page 238)

AFRA SIGNS NBC AND CBS

Master wage contracts for actors and singers on sustaining shows over NBC and CBS stations in N.Y., Chi., Los Angeles, and NBC in Frisco, have been negotiated by American Federation of Radio Artists, to run for 2 years. AFRA will act as exclusive bargaining agent for artists affected.

Chorus members will get \$8 for 15 minutes on Coast (the low); soloists \$25 for hr. in N.Y. (the high). Weekly pay for singers will range from \$40 in west to \$65 in east.

Hey, Horace Greeley!

CITY STATION AIDS JOBLESS

Unemployed don't buy radio sets or parts; are therefore a problem to the industry. Municipal station WNYC stages a daily 5-min. bea-st to tip off employers about N.Y. State Employment Service and to tell jobless workers about any openings that may occur.

Too early to tell whether plan has much result. But worth trying in other communities. Station mgrs., please note.

GETTING PERSONAL

S. T. Thompson of Chi. remains chairman of the RMA Export Committee. He's working on the Latin America and Australia problems, with the U. S. Bureau of Foreign and Domestic Commerce.

Neville Miller, ex-mayor of Louisville, Ky., made his first public address as President of the NAB at commencement exercises of Peabody Teachers' College, Nashville, Tenn., Aug. 8.

Lieut. E. K. Jett, chief engineer of the FCC, was appointed its rep. on the Interdepartmental Radio Advisory Committee, succeeding Com. T. A. M. Craven. (Continued on page 238)

STATIC WAR SPREADS

RTD's Questionnaire showed 8% of replies stressing need for static elimination to help boost radio business.

Strides in this direction are being made by Frank L. Carter, pres. of Natl. Assn. for the Prevention of Radio Interference, East Rockaway, N. Y. He made a 2-weeks inspection tour of the mid-West; conducted tests at Wright Field, Dayton; conferred with other leaders in the fight against reception's arch foe.

NEW TEST APPARATUS



ABOVE, RCA 154 beat freq. oscillator has less than 5% distortion over entire range. BELOW, new 2-inch C-R Oscilloscope. Both are scheduled for early production; should be out by now.

MIGHTY MIDGET



Designed for small sets, 7 new types of midget tubes have been engineered by Arcturus, & are available. Long used by mfrs., they are now going to jobbers & thence to dealers & public.

\$'s & #'s

SUMMER TIME SALES OFF

Despite statements of station officials, *Printers' Ink* magazine figs. show that sponsored summer programs are dropping off more and more every year. This June was 2.9% below '37, though 12.2% over May; 2nd 1/4 of '38 was 1.2% below '37, though the 1st 1/4 was 11.7% up.

STATION PAY

Government survey of 631 radio stations in '37 shows the following average weekly salaries. Managerial employees, \$17.70; commercial mgrs., \$90.09; part-time executives, \$69.46; chief engineers, \$62.35; program directors, \$62.12; press agents, \$59.89; staff musicians, \$58.74; announcers, \$34.40; technical men, \$23.53 to \$48.45; general average, \$45.17.

SALES RECORD

Emerson Radio Co. increased units sold 34%, dollar volume 22%, during "recession" which started Sept. 1, 1937; at no time reduced force more than 25% from peak payroll. Co's. pres. states industry is showing steady growth particularly for mfrs. who have "priced their merchandise to fit the nation's purse."

RCA UPS JOBS 1200

During June, RCA added about 1,200 (Continued on page 237)

RMA TO START WEEKLY PARTS SURVEY SERVICE

Inaugurated on July 2, the RMA statistics service on receivers is to be supplemented by a similar weekly survey service on parts.

System is confidential and co-op, only those submitting reports on their own business getting the collated statistics. Service on sets includes data on inventories and operations of factories, branches and distribs., with breakdown on auto, battery and electric sets.

Stevenson, Jordan & Harrison, N.Y. statistical agents, are handling the job.

THE LATEST RADIO EQUIPMENT

Manufacturers are invited to utilize these columns to bring improvements and new devices to the attention of technicians interested in every phase of Radio, Electronics and Public Address.

PUSHBUTTON COUNTER TUBE TESTER (1673)

(Supreme Instruments Corp.)

THE INFLUENCE of the pushbutton is certainly manifesting itself in all branches of radio. First the pushbutton-tuned radio set, then the pushbutton test oscillator and now a tube checker with so many pushbuttons on it as to make it look like a cash register. Only 30 seconds to test a tube is the claim of the manufacturer. It is not even necessary to have on hand technical information concerning a tube to be tested. You merely use the standard "adding machine" keyboard—just press the key corresponding to the number appearing over each column on the tube chart (supplied with the machine) and the tube is tested.

Each vertical row of pushbuttons controls a separate function. The first row, for instance, controls the proper setting of the tester's transformer primary, in other words, the line voltage. The second row controls the proper filament voltage for each tube. The next connects the proper test voltage and circuit to the tube and the following 3 rows, the proper standard setting for a good tube. Each pushbutton on the last row connects to a separate tube element and by pressing each in succession, shorts and leakages between any 2 elements are easily detected on a large neon lamp. One of its attractive talking points is that the customer himself can be made to test his own tubes, thereby eliminating his usual skepticism.

FILM RECORDER FOR OFFICE USE (1674)

(Miles Reproducer Co., Inc.)

MODEL D FILMOGRAPH, recording directly on 8 mm. or 16 mm. film, is designed as dictating machine, conversation recorder, etc. Electromechanical head with sapphire stylus impresses soundtrack on film; it plays back, without processing, up to 2,000 times. New unit includes mike, amplifier, phones (or speaker), switches, cord and plug.

COMMUNITY ANTENNA KIT (1675)

(Technical Appliance Co.)

THE new TACO Master Antenna System Foundation Kit incorporates the lightning arrester directly in the aerial unit. Im-

proved antenna-ground circuit and outlet couplers also make for better results, easier maintenance. Mfr. claims tests show 25-30% increase in signal-noise ratio, due to elimination of feedback & ground noise interference.

CONDENSER AND RESISTOR BRIDGE (1676)

(The Aerovox Co.)

NEW Aerovox condenser & resistance bridge measures capacities from 100 mmf. to 100 mf.; power factor from 0 to 50%; resistance from 10 ohms to 1 meg. in 5 ranges; insulation resistance from 350 megs. to infinity at 500 V. and down to 50 megs. at lower voltages. Tests condensers for shorts and leakage; provides V.-T. voltmeter, voltmeter, milliammeter and millivoltmeter for external use; offers continuously-variable voltages from 15 to 600. Reference table mounted inside cover.

NEW BUFFER-DRIVER FOUNDATION KIT (1677)

(Hammarlund Mfg. Co.)

INTENDED for use with Hammarlund PA-300 foundation kit, the BD-40 buffer-driver foundation kit can be assembled with screw-driver and soldering iron. Using an 807 or RK-39 beam tetrode, it can serve as a 40 W. output stage, or as a driver. Kit includes punched chassis, drilled vertical shield, tube shield, hardware, spacers and angle brackets for mounting coils, etc. Measures 8¼x7½x3¼ inches. complete. (Circuit appears on page 256.)

EMERGENCY PORTABLE TRANSMITTER (1678)

(General Transformer Corp.)

THE recently-announced Pee Wee transmitter now has a counterpart—the Pee Wee portable, a complete transmitter and power supply on a single, small, battleship-gray chassis. This new unit, however, operates from a 6-V. storage battery. Primarily intended for rural service where A.C. is not available, it also serves as a portable-mobile or emergency transmitter. Metal tubes are supplied with the unit to withstand hard usage. The current drain is 9 amperes fully loaded with key down and 1.4 A. at standby.

(Continued on following page)

Name and address of any manufacturer will be sent upon receipt of self-addressed, stamped envelope. Kindly give number in above description of device.

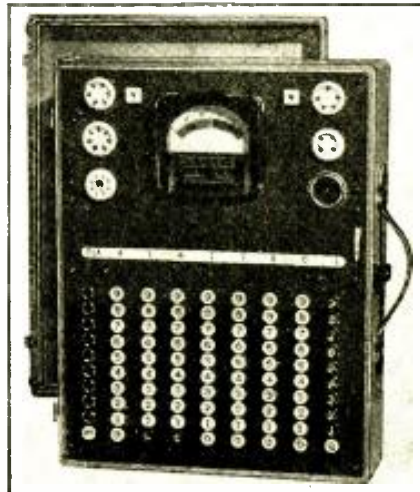

Merely push buttons to test tubes! (1673)



Records dictation, conversation on film. (1674)



High signal-to-noise antenna system. (1675)



New condenser and resistor bridge. (1676)

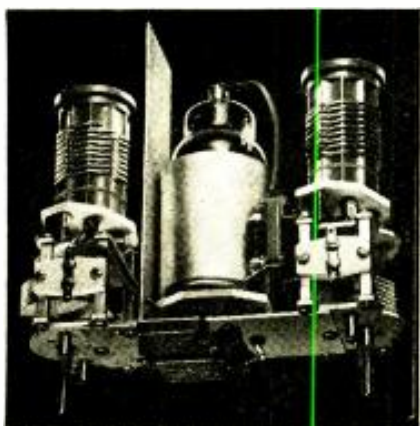

Buffer-driver foundation kit for amateurs. (1677)

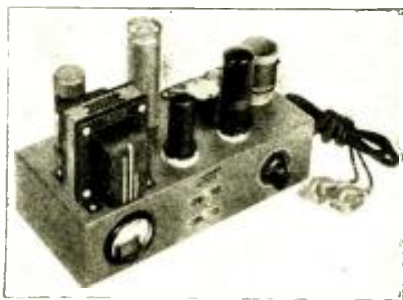

Pee Wee emergency 6-volt portable transmitter. (1678)

• • •

THE LATEST RADIO EQUIPMENT

(Continued from preceding page)

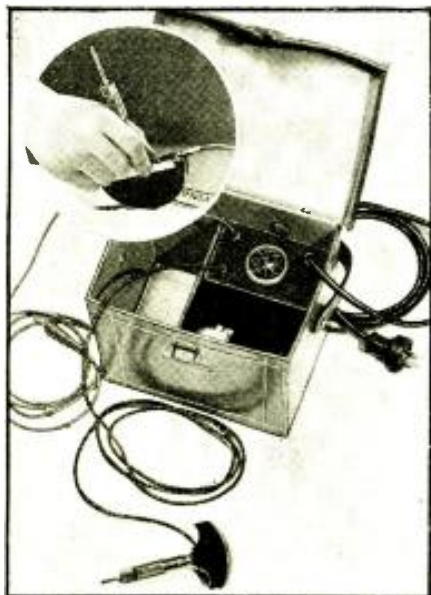

Measures thickness of paint on surfaces. (1679)

"BATHYTROL" MEASURES THICKNESS OF PAINT ON SURFACES (1679)

(Electronic Control Corp.)

THIS instrument called the "Bathytrol" uses an electron tube for measuring the thickness of paint film on metal objects. A small electric current is passed through a steel-pointed stylus pressed against the paint surface. The return circuit is formed by the metal surface itself.

This current (a few microamperes at a few millivolts) suffices to shift the tube grid to positive causing the plate circuit of the tube to energize a sensitive, telephone-type relay. The contacts of the relay in turn energize an ordinary incandescent bulb. The diagram of the circuit appears at the end of this department. The apparatus is furnished complete with a carrying case ready for use on flat, curved or irregular surfaces. (Circuit appears on page 255.)

5-SPEAKER INVENTORY (1680)

(Accurate Electric Co.)

THE MANUFACTURER, in announcing their new line of permanent-magnet speakers, is inaugurating a 5-speaker inventory for the Serviceman. "Any radio set known today can be serviced from this 5 speaker nest," says Leon Levinthal, president of the company.

The new line features "plug-jack" universal transformers which improve the appearance and operating efficiency of these speakers and prevent "solder-sag" of connector board. These transformers are universal matching impedance or line types.

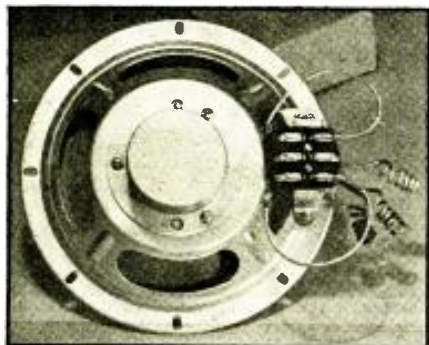

New line of universal output speakers. (1680)

NEW SIGNAL GENERATOR (1681)

(The Hickok Electrical Instrument Co.)

THE FOLLOWING are the characteristics of this new signal generator (Model 18); 5 output selections; namely, frequency-modulated R.F., amplitude-modulated R.F., unmodulated R.F., 100- to 10,000-cycle continuously-variable A.F., 400-cycle fixed A.F. All ranges are controlled by an output attenuator.

Provides a synchronized horizontal sweep voltage for oscilloscope. The frequency modulated output (30 kc. sweep) is available over entire range of signal generator for visual alignment and trouble shooting. It is automatically disconnected when using amplitude modulation. Output voltage from 1 microvolt to over 100,000 microvolts on all ranges. The instrument utilizes over 100 ins. of direct-reading frequency scales—100 kc.



New efficient signal generator. (1681)



545 kc. to 40 mc. communications set. (1682)

to 30 mc. with the claimed accuracy of better than 1 per cent. Self-contained power-level meter with 3 decibel ranges, namely, -10 to ± 6 , ± 6 to ± 22 , ± 22 to ± 38 .

NEWEST IN HAM-RADIO RECEIVERS (1682)

(Howard Radio Co.)

ONE OF the most interesting new communications receivers to be shown at the recent Trade Show was the 6-tube Howard amateur set.

Covering from 545 kc. to 40 mc. in 4 bands. Having iron-core I.F., electric band spreading and a well-filtered power supply for C.W. use. An ideal set for the newcomer in "ham" radio, and a perfect standby and portable for the old-timer in the game.

POWER PACK FOR DRY SHAVERS (1683)

(The Radiart Corp.)

SHAVER PAK, illustrated herewith, is the new unit designed to furnish suitable power for electric shavers where 110-V. electric lines are not available. Automobiles, trucks, trailers, boats, etc., may use the portable or permanently-installed 6-V. model. For farm lighting systems or railway trains there is a 32-V. model. The power pack adds versatility to the electric dry shaver for it is often where the ordinary current supply is not available that the convenience of the dry shaver is most welcome.

Servicemen can move many of these unique units as a sideline proposition.

CORNER RADIO (1684)

(Stromberg-Carlson Telephone Mfg. Co.)

THE DEMAND for corner-cabinet receivers that are acoustically correct has at last been satisfied by an acoustical development that makes good audio quality independent of the cabinet's shape or position in the room. This is made possible by a folded-up tubing which is attached to the back of a loudspeaker and placed in the hollow part of the cabinet. It acts as the necessary baffle which the ordinary console standing against the flat wall has, so that the position in the room does not affect its tonal quality. These new cabinets fit flush in any corner, an ideal location from a decorative viewpoint and from that of saving valuable room space. Further the sound is directed to listeners in all parts of the room, eliminating thereby the "dead spots" which often occur on each side of the orthodox receiver.

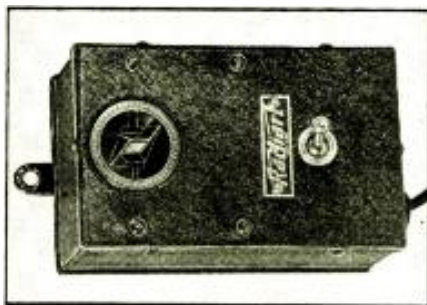

Power pack for dry shavers. Operates from 6- or 32-volt D.C. source; uses vibrator. (1683)



Acoustic development permits construction of corner-type radio cabinet. (1684)

HOW TO MAKE A MODERN V.-T. VOLTMETER

Servicemen!—Clap hands! . . . Here's an optional 100,000 or 1,000 ohms/volt, 2-tube meter, reading to 500 volts, that costs under \$15 to make! Circuit's a "natural" for busy Radio and P. A. men.

HOWARD G. McENTEE

THE Serviceman and experimenter is often in need of a voltmeter of high sensitivity, since for many jobs the now common 1,000 ohms/volt (or ohms-per-volt) meter is inadequate. The new 20,000 ohms/volt units are a step in the right direction but are in many cases quite expensive and even when available are often not high enough in resistance to do the required work.

The next step of course is the vacuum-tube voltmeter. There are many varieties of these instruments, all with certain advantages, but all, unfortunately, with certain inherent disadvantages. Thus some require high-sensitivity meters, others, such as the so-called "slide-back" unit, require several operations for each reading taken. (Many types of V.-T. voltmeters, including the *high-sensitivity meter* and *slide-back* types, have been described in detail in past issues of *Radio-Craft*.—Editor)

CIRCUIT A "NATURAL" FOR SERVICEMEN

The little unit described here is a compromise between the various advantages and disadvantages of other types. Unlike some, it does not have infinite input resistance. This, however, is about its only shortcoming in comparison with other types. The input resistance is 100,000 ohms/volt, which is sufficiently high to measure practically any value found in ordinary radio and P.A. work. The meter is direct reading, both on D.C. and A.C., with a linear scale.

Once the instrument is warmed-up and set, voltages are measured just as quickly as with an ordinary magnetic-type meter. The only indicating instrument required is a 0-to-1 ma. unit, a type which is now available on the open market for \$3 to \$4, or less. Including the meter, all parts may be had for less than \$15 if the low-price carbon resistors are used throughout. It is recommended, however, that the wire-wound types be used where specified for the various voltage ranges since their accuracy of 1% tolerance as against 5% for the special carbon units, or 10% or higher for ordinary carbon types, is much to be preferred.

A handy feature is incorporated in that when switch B is in the "Low" position the 1 ma. meter is connected to a set of resistors affording 1,000 ohms/volt, the ranges being selected by switch A, the same voltage ranges are available whether the apparatus is used as a V.-T. voltmeter or as a 1,000 ohms/volt unit.

A single 6Q7 tube is used, the diodes being utilized as rectifiers when A.C. is to be measured. The triode section is biased by a single grid-bias cell (which never requires replacement) and the circuit is actually a 1-volt meter; higher ranges being obtained by the voltage divider circuit on section 1A of the range switch, as shown in the complete diagram, Fig. 1.

The fundamental circuit was worked out by L. W. Root; the unit shown herewith was found so satisfactory and handy to use that it is thought to be a "natural" for the busy Serviceman.

(Continued on page 252)

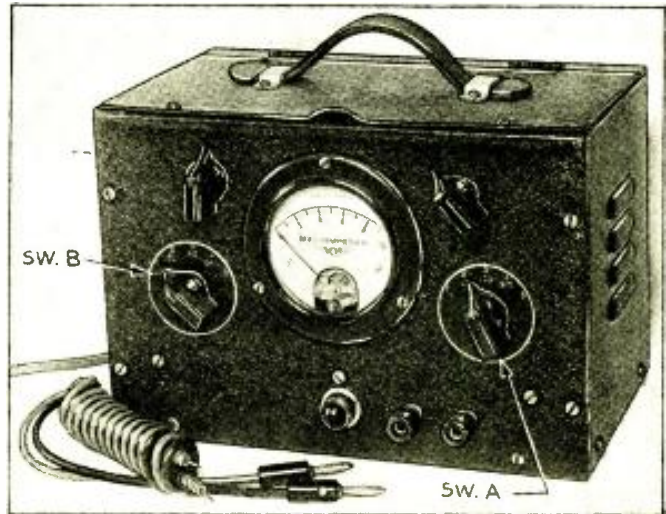

Fig. A. The V.-T. voltmeter uses a 1,000 ohms/volt, 0 to 1 ma. meter.

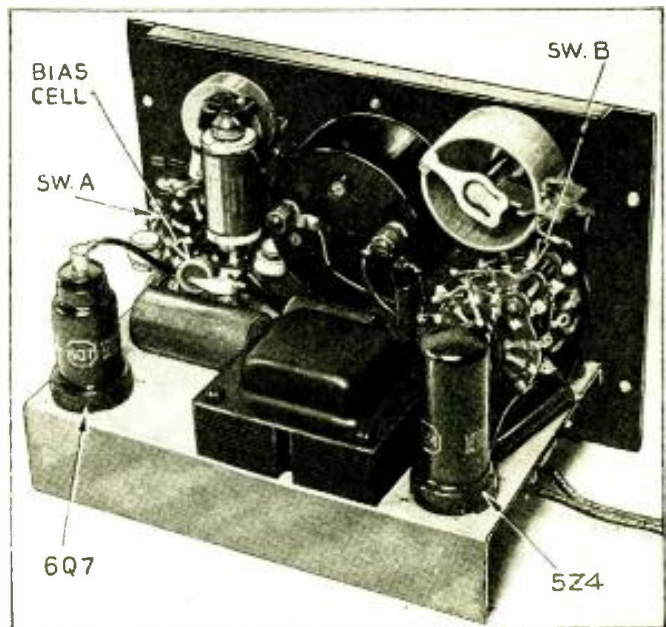

Fig. B. Rear-chassis view of the V.-T. voltmeter. All multiplier resistors are mounted directly to the lugs of switch A on the left.

Mr. Radio-Craft Reader: "American Legion Emergency Unit," and "A Simple Multivibrator," are 2 special articles scheduled for the November issue.

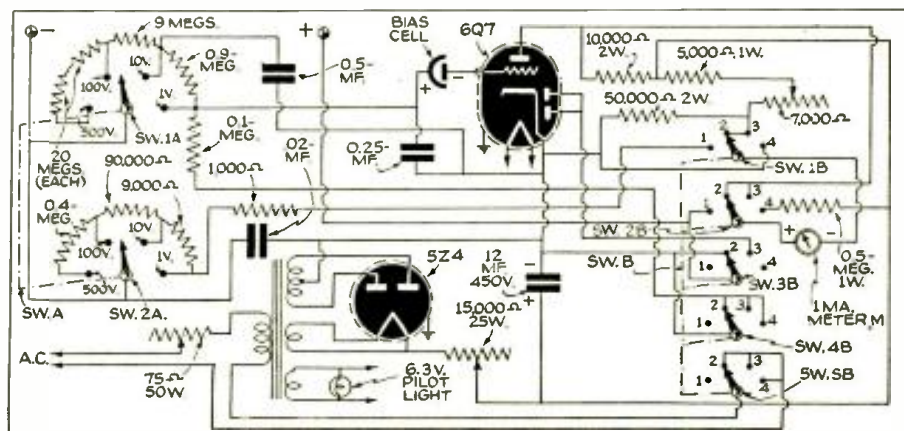

Fig. 1. Schematic diagram of the modern V.-T. voltmeter. The circuit is actually a 1-volt meter, the higher ranges being obtained by the voltage-divider resistors mounted on the range switch.

A 38-RANGE "PUSHBUTTON" BENCH TESTER

(Continued from page 211)

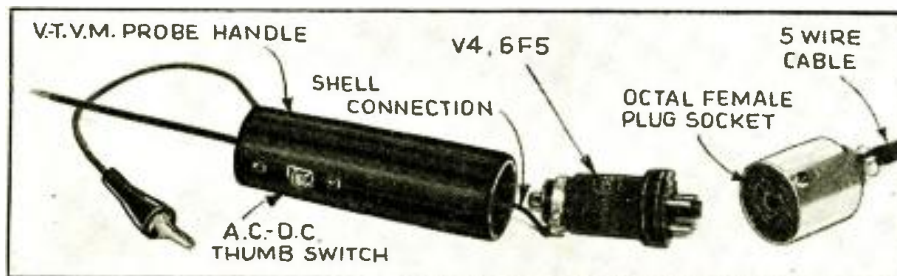

Fig. D. The probe arrangement of the V-T. V.M. The 6F5 fits snugly into the shell.

used to it, that you will feel well repaid for having built the tester, for this one feature alone.

LIST OF PARTS

One power transformer, for 5-tube set with 6.3 V. tubes, P.T.1;
Two filter chokes, 20 henry, 200 to 400 ohms, Ch.1, Ch.2;

RESISTORS

One I.R.C., type BT½, ½-W., 2 megs., R1;
One I.R.C., type BT½, ½-W., 1 meg., R2;
One I.R.C., type BT1, 1 W., 1000 ohms, R3;
One I.R.C., type BT½, ½-W., 10 megs., R5;
One I.R.C., type BT½, ½-W., 1 meg., R6;
One I.R.C., type BT½, ½-W., 0.1-meg., R7;
One I.R.C., type BT½, ½-W., 10,000 ohms, R8;
One I.R.C., type BT½, ½-W., 1,000 ohms, R9;
One I.R.C., type BW½, ½-W., 100 ohms, R10;
One I.R.C., type BW½, ½-W., 10 ohms, R11;
One I.R.C., type BT½, ½-W., 0.25-meg., R14;
One I.R.C., type BT½, ½-W., 5 megs., R15;
One I.R.C., type BT1, 1 W., 0.16-meg., R17;
One I.R.C., type BT1, 1 W., 0.73-meg., R18;
One I.R.C., type BT1, 1 W., 1,000 ohms, R19;
One I.R.C., type BT1, 1 W., 100 ohms, R20;
One I.R.C., type BT½, ½-W., 1 meg., R23;
One I.R.C., type AB, 10 W., 25,000 ohms, R24;
One I.R.C., type BT½, ½-W., 0.1-meg., R26;
One I.R.C., type BT½, ½-W., 2 megs., R27;
One I.R.C., type BT1, 1 W., 1000 ohms, R28;
One I.R.C., type BT1, 1 W., 10,000 ohms, R29;
One I.R.C., type BT1, 1 W., 0.1-meg., R30;
One I.R.C., type AB, 10 W., 50,000 ohms, R43;
One I.R.C., type BT1, 1 W., 50,000 ohms, R44;
One I.R.C., type BT2, 2 W., 0.3-meg., R45;
One I.R.C., type BT2, 2 W., 0.15-meg., R46;
One I.R.C., type BT½, ½-W., 5 meg., R47;
One I.R.C. precision, type WW4, 1,000 ohms, R13;
One I.R.C. precision, type WW4, 11.1 ohms, R21;
One I.R.C. precision, type WW4, 900 ohms, R32;
One I.R.C. precision, type WW4, 9,000 ohms, R33;
One I.R.C. precision, type WW4, 90,000 ohms, R34;
One I.R.C. precision, type WW4, 0.15-meg., R35;
One I.R.C. precision, type WW4, 0.25-meg., R36;
One I.R.C. precision, type WW4, 0.5-meg., R37;
One I.R.C. precision, type WW4, 25 ohms, R38;

One I.R.C. precision, type WW4, 4.16 ohms, R39;
One I.R.C. precision, type WW4, 1.01 ohms, R40;
One I.R.C. precision, type WW4, 0.401-ohms, R41;
One I.R.C. precision, type WW4, 0.20-ohms, R42;
One I.R.C. potentiometer, type 11-108, 1,000 ohms, R4;

One I.R.C. potentiometer, type 11-116, 10,000 ohms, R12;
One I.R.C. dual rheostat, type JS-968, 1,000 and 50,000 ohms, R16;
One I.R.C. potentiometer, type 11-108, 1,000 ohms, R25;
Two Mallory-Yaxley wire-wound potentiometers, 9 W., 10,000 ohms, R22, R31.

CONDENSERS

Six Solar, type MP4140, 0.1-mf., C1, C2, C3, C4, C5, C9;
One Solar, type P1901, 2 mf., 200 V. paper, C6;
One Solar, type DE918, 8 mf., 200 V. elec. C7;
One Solar, type P1901, 1 mf., 200 V. paper, C8;
One Solar, type SO226, 0.05-mf., tubular, C10;
One Solar, type MW1221, 400 mmf., mica, C11;
One Solar, type XC-11, 1 mf., 1,000 V. oil-filled, C12;
Three Solar, type XK16, 16 mf., 450 V. wet elect., C13, C14, and C15;

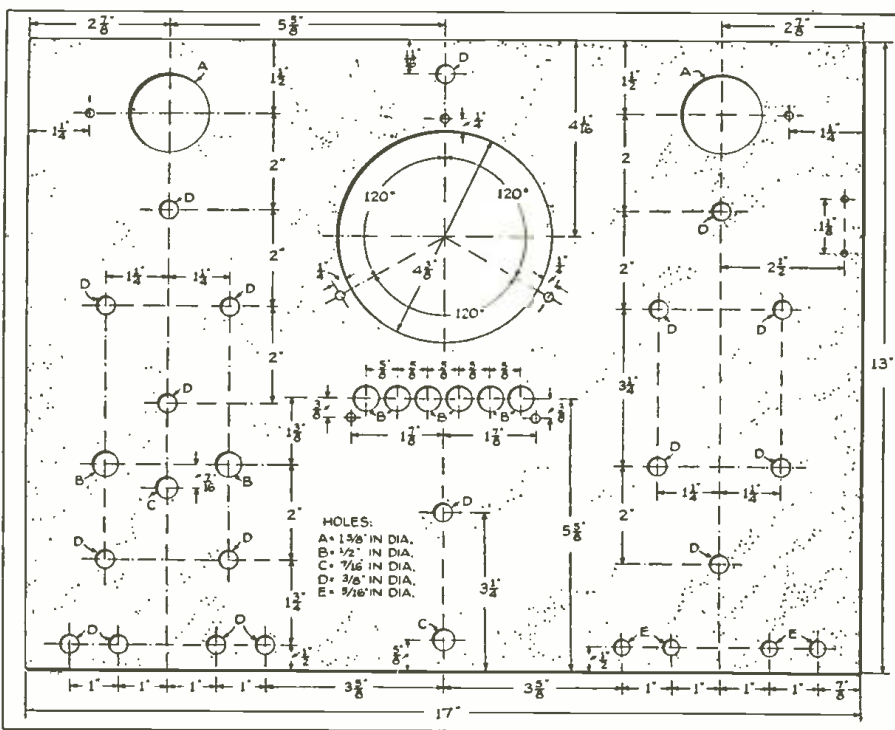

Fig. 4. Drilling layout.

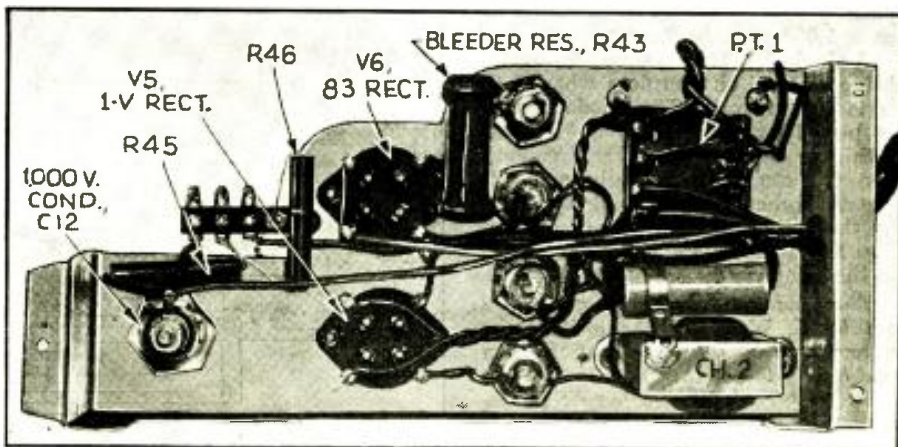

Fig. C. Under-chassis view of the common power supply.

One Solar, type SSO309A, 0.05-0.05-mf., 600 V., C16;
 One Solar, type SO226, 0.1-mf., tubular, C17;
 Two Solar, type MO1416, 100 mmf., mica, C18, C19.

SWITCHES

One Mallory-Yaxley pushbutton, type No. 2160, Sw.1;
 One Centralab Selector, type No. 1403, Sw.2;
 Two Centralab Selector, type No. 1461, Sw.3, Sw.6;
 One Centralab Selector, type No. 1425, Sw.5;
 One Centralab Selector, type No. 1401, Sw.7;
 One Centralab Selector, type No. 1411, Sw.8;
 One Centralab Selector, type No. 1450, Sw.9;
 One thumb type, S.P.S.T. Sw.10;
 Two toggle, for A.C. and P.F. Sw.4, Sw.11.

TUBES

One RCA 83 mercury-vapor rectifier, V6;
 One RCA 1 V. rectifier, V5;
 One RCA 6F5, V4;
 One RCA 6E5, V3;
 One RCA 6F5, V2;
 One RCA 6G5, V1.

MISCELLANEOUS

One Triplett 5-inch meter, No. 521;
 One plywood panel, 13 x 17 x 1/4-in.;
 One baseboard, 8 x 17 x 3/4-in.;
 Six wafer sockets, 2 four-prong, 2 six-prong, 2 octal;
 One I.C.A. octal socket and plug, for V.-T.V.M. input tube;
 One Amphenol octal plug, for V.-T.V.M. cable;
 One piece of bakelite tubing, 4 1/2 ins. long x 1 5/16 ins. inside dia.;
 One piece of tubing for each tuning "eye";
 One alligator clip for probe;
 One 5-wire cable 36-ins. long;
 One adjustable resistor clip to fit neck of 6F5;
 One 3-inch dial scale, zero to 100 in 325 deg.;
 One each, male and female A.C. receptacle plugs;
 One A.C. convenience receptacle;
 One Yaxley panel light, type No. 330;
 Four pairs, phone tip-jacks, 4 red, 4 black;
 One pair standoff insulators, 1 in., with banana jacks;
 Twelve bar knobs, 1/4 ins.;
 One large bar knob;
 One pair test leads, banana tips and alligator clips;
 One pair test leads, phone tips and needle prods;

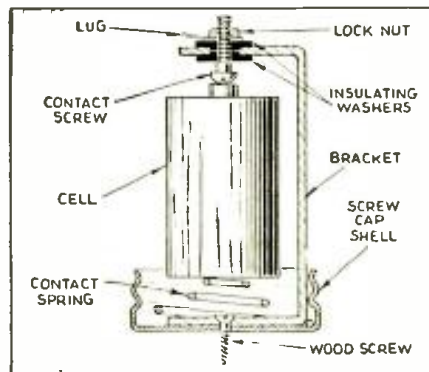

Fig. 5. Details of flashlight-cell mounting.

One pair test leads, phone tips and alligator clips;
 One A.C. line cord, 8 ft. long.

Most Radio mail order houses can supply these items if properly identified as to title of article, issue (month) of *Radio-Craft* and year.

"15 NEW TUBES"

This article, scheduled to appear in the October issue of *Radio-Craft*, due to lack of space has been re-scheduled for the November issue.

NEW TEST INSTRUMENTS

(Continued from page 222)

quency range, frequency-calibrated dial and above all, simplicity of operation.

The signal generator shown in Fig. A embodies many other valuable features above these minimum requirements. It includes a stage of R.F. amplification after the oscillator, and a 400-cycle sine wave audio oscillator with independent variable A.F. attenuation and variable percentage modulation control (thus allowing for a high degree of audibility even with small R.F. signals). A unique oscillator arrangement, called the *unit-oscillator*, allows all oscillator components including the 6K8 tube and 6 coils to be mounted directly onto a special, ceramic-insulated band switch. Double and triple shielding of every single unit, and a built-in output cable, are used to insure low leakage and positive control of A.F. and R.F. output. A convenient and time-saving feature is the built-in *dummy antenna* designed to I.R.E. specifications and shown with other important features in Fig. 1. Close attention to the minutest detail within, is reflected outwardly by the professional appearance of the instrument.

TUBE TESTER AND MULTI-TESTER

The instrument shown in Fig. B. provides the other two essentials for accurate, modern radio service. This instrument combines in one unit an independent push-button-operated dynamic tube tester and a rotary selective multi-range 1,000 ohms/volt A.C.-D.C. tester for measuring volts, ohms, milliamperes, amperes, decibels and condenser leakage.

Figure 2 illustrates the unusual push-button and switching arrangement used in the instrument shown in Fig. B to obtain dynamic mutual conductance tests upon all types of tubes. This method provides complete free-point tube analysis and insures non-obsolence since as can be seen from the sketch, regardless of element pin positions, any combination of tube electrodes may be connected into the appropriate test circuit.

The heavy black dots represent the automatic pushbutton system which ties in with another set of selectors shown above and below this set of pushbuttons.

The multi-range meter circuit, though

not illustrated, provides through an ingenious switching mechanism, ranges adequate for all service demands including a 10-ampere range for auto-radio work and decibel ranges for public address systems.

Thus, with just these two modern instruments, radio servicing can be conducted on an intelligent, efficient and time-saving basis.

This article has been prepared from data supplied by courtesy of Precision Apparatus Corp.

TELEVISION

New Jersey—Television with a mechanical scanner was demonstrated last month to members of I.R.E. by Kolorama Labs. at Irvington. A test news reel was projected upon a 3 x 4 ft. screen from the rear. Images were said to be reasonably clear, and black and white; 225 lines were used, interlaced 2 to 1, giving 112 1/2 lines per field, with 24 fields. When perfected, company claims pictures will be comparable with 441-line electronic television.

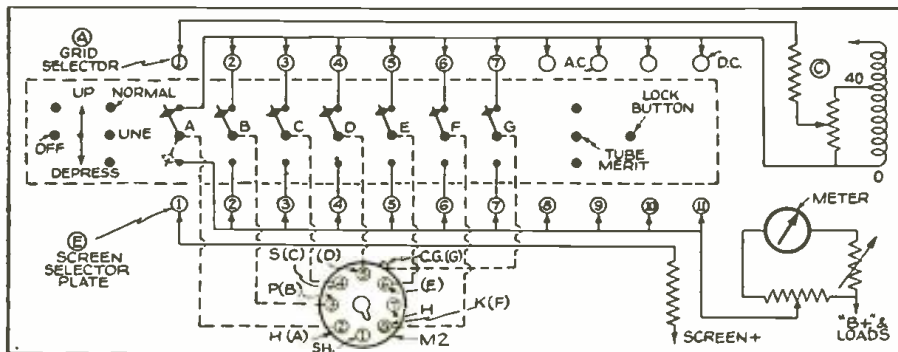

Fig. 2. Diagram of the pushbutton and switching arrangement of the dynamic tube tester.

Fig. B. Combined dynamic tube checker and universal multi-tester. (Model Series 900.)



SERVICING QUESTIONS & ANSWERS

DISTORTION

(89) Linwood Hunter, Wildwood, N. J.

(Q.) I have a Philco 71 series 225 in my shop which is giving me considerable trouble. When first turned on it sounds good but after a couple of minutes it becomes so distorted, and the shadow meter slowly widens its shadow until all the way across and then will not move even when the gang is rotated. All condensers and resistors seem to be in good shape. Hope you can give me a hint as to the trouble.

(A.) From your description, it would seem that the difficulty lies with the A.V.C. circuit. It is advisable to check carefully by substitution the 0.05-mf. R.F. and I.F. grid filters. These condensers are part of separate dual units, bakelite encased. Check also the 0.01-mf. audio coupling condenser in diode detector circuit, after replacing diode 37 tube.

Leakage in any of these condensers tends to remove control bias from the 44-type tubes, hence the distortion.

SETS CUT OFF

(90) B. E. Schultz, Edgewood, Iowa.

(Q.1) I have been servicing radio sets for quite a few years, and never have had this problem before. It seems to have me bluffed. (I do not have as much time to spend on them as I would like to, to experiment.)

Here is headache No. 1. This is an Atwater Kent model 237Q, 6-V. set. The set will play along, then cut out, snap the power switch off and then on again, and

the program will come on, but snap the short-wave switch and it won't come back.

All voltages check OK before and after it cuts off. I can get an oscillator signal through from the oscillator tube. That is from the control-grid of the oscillator tube which is a 1C6 and not from the antenna post, when this set is cut off.

I tried several new oscillator tubes as I didn't think they were oscillating, and the new ones were just as bad. But here is what I did do, I took an old tube out of another set that checks about the same as new ones—and the set works OK! I have changed most of the condensers in the set,—no results; and also changed the oscillator resistor from 50,000 ohms to about 40,000 ohms. Can you give me any clue as to what I may do to put this set back in perfect shape? Could it be that the oscillator coil has changed capacity?

(A.1) The intermittent condition you experienced with the Atwater Kent model 237Q appears to be due to some poor contact in the 1st-detector—oscillator circuit.

We advise checking the resistors in the plate, oscillator-plate and screen-grid circuits. Their values are 2,500, 5,000 and 10,000 ohms, respectively. Check, also, the bypass condensers for these circuits by substitution. Correct voltages on the 1st-detector—oscillator tube elements are as follows: plate, 125 V.; screen-grid, 25 V.; oscillator plate, 110 V.; control-grid, 4 V.

(Q.2) Here is No. 2. This is a Philco model 80 electric set. This receiver will play right along, then snap off and on in about 10 seconds; this of course doesn't give time

enough to test. Sometimes, but not always, when it snaps off the circuit will oscillate; and yet, everything checks OK. I have changed condensers and also put in a new oscillator coil and a new I.F. transformer. Rebalanced the set with oscilloscope and still it cuts off; changed tubes also. And sometimes when it cuts off it will chatter. This seems the best I can describe it to you. Have you had any experience of this kind on this type of set before?

(A.2) With regard to the Philco model 80 receiver, the intermittent condition, sometimes accompanied by oscillation is undoubtedly due to an intermittent dual 0.09-mf., bakelite-encased condenser located between rectifier and detector—oscillator sockets. Replace this block with two 0.1-mf. tubular units. These condensers bypass the screen-grid circuits of both 36 tubes. Check also for an intermittent line bypass. This condenser is one section of a dual unit near the power transformer.

CUTS OFF—DISTORTION

(91) D. DeGennaro, Brooklyn, N. Y.

(Q.) RCA model No. 120—all voltages normal. Checked all condensers, OK; A.F. OK; tried phono pickup and plays OK. When set is cold it will cut out. A flick of the A.C. switch also will cause it to drop out.

I have noticed that when the set is dead and you connect a 10 ma. meter in the plate lead of the 6D6 there is no A.V.C. action although when the set plays there is A.V.C. action on the meter.

(Continued on page 242)

OPERATING NOTES

ZENITH 1937 SUPERHET. MODELS

Any cracklings or frying noises that continue after the antenna and ground connection are removed are invariably caused by the 1st. I.F. transformer. This may be checked by connecting a high-resistance voltmeter across the primary winding and observing fluctuations with set operating. When replacing this transformer be sure that the long plate lead from the 6A8G is as short as possible, and is dressed against the chassis over its whole length. Otherwise circuit oscillation will be present.

C. E. POWERS,
Powers' Radio Shop

RCA-VICTOR 260, 261, 280

When the symptoms of slightly distorted reproduction and lowered sensitivity are encountered, with the condition wherein it is more or less difficult to correctly tune the receiver to resonance, the over-all sensitivity is reduced and tone becomes more distorted as the sensitivity or noise suppressor control is turned to maximum, look for an open-circuited A.V.C. I.F. cathode bias resistor.

An open-circuited A.V.C. coupling condenser of the leaf-clamp type located within the first I.F. transformer, is generally responsible for the complaint of distortion upon resonance of all but very weak broadcast stations. The condenser, a 300-mm.f. unit, is rigidly mounted and subject to the usual stress on the soldered connecting tabs which may snap under vibration. The remedy is replacement with another unit of similar capacity although the value is not critical.

Intermittent reception of these receivers is caused by the failure of the 0.05-mf. grid filter condensers in the R.F., 1st.-detector and I.F. stages. When these units open-circuit, occasioned by faulty internal contact, an abrupt drop in volume level and resonance hiss will be noted.

RCA-VICTOR 330, 331

When the complaint of weak, distorted reproduction is received on these models, and plate and screen voltages are obtained on all tubes, check for an open-circuited 8,800 ohm field coil. Since the field coil is not employed as the customary filter choke, but connected across the rectifier output, an open-circuited condition will not render the receiver inoperative, although plate and screen-grid voltages higher than normal are obtained. A quick diagnosis without disturbing leads or terminal covers may be made with an ohmmeter connected from either rectifier filament to chassis. A reading of approximately 6,000 ohms should be expected if the field coil is intact. Should the ohmmeter disclose a D.C. resistance of approximately 20,000 ohms, across this circuit, then the field coil is open-circuited. This latter reading represents the total value of the voltage divider system.

RCA-VICTOR C6-2, T6-1

Low sensitivity accompanied by resonance hiss is a frequent complaint with these models. (The symptoms are similar to those obtained when no aerial or a very short one is employed with a receiver.) The wire-wound pigtail resistor in the control-grid circuit of the 6A8 detector—oscillator tube

has been found open-circuited. This resistor is employed as the control-grid lead. In almost every case, the open-circuit is at the lug.

RCA-VICTOR T6-9, C6-2, T6-1

An annoying hum, which is heard with the volume control in the extreme minimum position, where not occasioned by faulty filter condensers, has been corrected by reversing either the voice coil or hum neutralizing coil leads.

BERTRAM M. FREED

CANADIAN SERVICE NOTES

ROGERS TYPE R-55

Cutting-off and oscillation at full-volume position are caused by broken pieces of the resistance strip inside the volume control.

PHILCO A-80 CHASSIS

Oscillation until the set is thoroughly warmed up is quite often due to a 77 tube which shorts intermittently, though a similar condition can sometimes be remedied by increasing the screen-grid bypass condenser to 0.5-mf. or more to compensate for the use of quick-heater tubes.

ROGERS TYPE R-561

When "dead," and in the first time for service, analyzer usually shows no plate voltage on the type 47 tube caused by a shorted 0.002-mf., 500 V. condenser at the 47's plate lug.

(Continued on page 239)

DEALERS! SERVICE MEN! SOUND MEN! AMATEURS! SET BUILDERS!

SEE ALL THE NEW RADIO DEVELOPMENTS IN ALLIED'S 1939 CATALOG!

15,000 RADIO ITEMS AT LOWEST PRICES!

180 PAGES • SEND COUPON



EVERYTHING IN RADIO!

Write today for ALLIED's giant new 180-page Catalog for 1939! Whether you service, build, or sell radios, sell or rent sound equipment, or operate an Amateur station, you need this great book. It brings you Radio's most extensive listing of receivers, parts, kits, sound systems, test equipment, Amateur gear, books, tools, and accessories—over 15,000 items at the lowest prices in Radio!

COMPLETE STOCKS—FASTEST SERVICE LOWEST PRICES

ALLIED'S 50,000 square feet of floor space are required to carry our entire stock, which means that you get what you want when you want it. ALLIED's fast, dependable service saves you time and trouble. ALLIED's economical merchandising methods save you money. Thousands of radio men agree that it pays to make ALLIED your one dependable source of supplies, agree that, "Wherever high grade, low cost radio equipment is required, ALLIED is 1st choice!"

ALLIED RADIO
833 W. JACKSON BLVD., CHICAGO

NEW SETS!
62 new 1939 KNIGHT Radios—as low as \$7.95. 4 to 16 tubes, with latest 1939 features — 3 kinds of Push - Button Tuning, new "Tiny Knight" models, new low drain battery sets with 1.4 tubes. Sets for AC, AC-DC, 6 Volt, 32 Volt, battery, and auto operation—and new phono-radios, record players, phonographs . . . all priced to bring you greater sales and profits! Send for the ALLIED Catalog . . . see why these 1939 KNIGHTS are the year's biggest values!

NEW KITS!
Here's Radio's finest and largest Build-Your-Own selection! Many new exclusive ALLIED kits: Beginners' 1, 2, and 3 Tubes; 6 Tube Auto Set; Photo Cell Kit; Electric Fence Controls; 4 Tube Portable; low-cost transmitters—and diagrams and projects for building 100 others! We can supply matched kits for any circuit described in any construction article—write for Free Parts Lists!

NEW P. A. SYSTEMS!
You'll find a complete range of revolutionary new KNIGHT Public Address Systems—both standard and deluxe—from 8 to 65 watts. New Portable System, 30 Watt Mobile System, new Booster Power Stage, Electric Guitar Amplifier, etc. Also, the most complete line of recording equipment in any radio catalog: recorders, record players, record changers, microphones, amplifiers, discs and accessories.

NEW HAM GEAR!
Here's a giant new Ham section—an "Amateur Catalog" in itself! Shows new Hallicrafters Ship-to-Shore, National, Hammarlund, Utah, and G.T.C. transmitters as low as \$15.95; new receivers: National NC-510 and NC-44, Hallicrafters "Dual Diversity" and "Marine", Sargent "Streamliner", Howard 450, etc.

NEW TESTERS!
A new, bigger Service Section, with Radio's most complete Test Equipment listing! All leading lines; new Push-Button type equipment, new Stark Rural Meter, new Rider's Chanalyst-Tube Checkers, Set Testers, Analyzers, Oscillographs, Signal Generators, Meters, etc.—and over 14,000 parts. Every servicing need at your finger tips—and all priced to save you money!

OVER 14,000 PARTS!
ALLIED's new catalog shows more than 14,000 exact duplicate and replacement parts for repairing practically any radio. All leading lines are listed, including the famous KNIGHT brand of parts—they cost less, work better, and earn more! Also books, tools, accessories, etc.—everything in Radio at lowest prices. The ALLIED Catalog is THE Buying Guide for radio men everywhere!

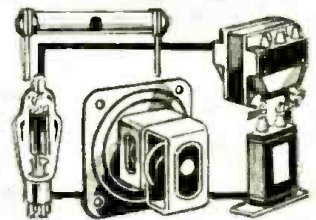
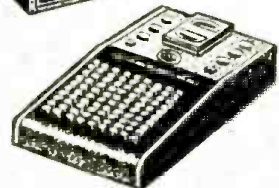
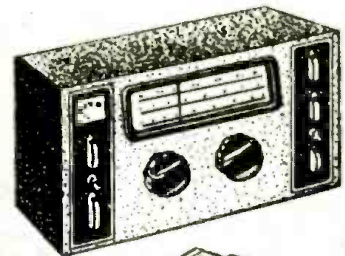
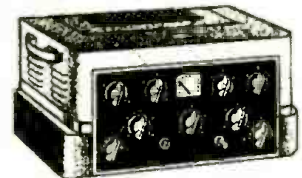
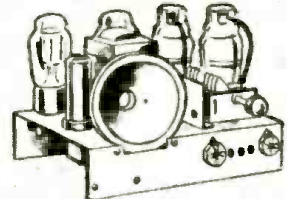
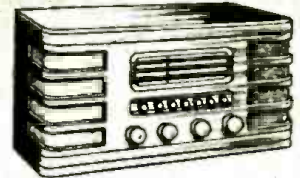

FREE
SEND
COUPON

ALLIED RADIO CORP.
Dept. 2-K-9, 833 W. Jackson Blvd., Chicago, Ill.
Send me your new 1939 Catalog—Free.

Name

Address

City State

Please Say That You Saw It in RADIO-CRAFT

THE RADIO MONTH IN REVIEW

(Continued from page 199)

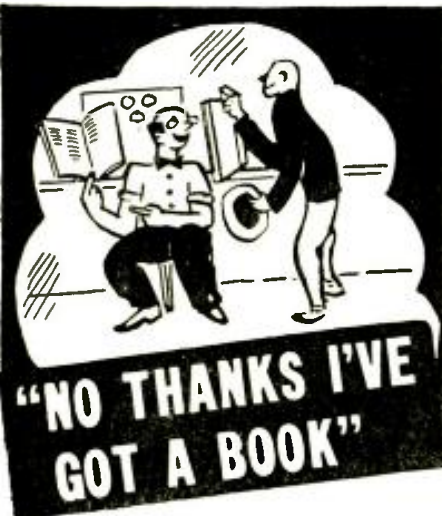

It's always good for a laugh—that gag about the book salesman who was stymied by his prospect's reply: "No, thanks—I don't need any—I've got a book." Yet it isn't funny when someone whose future depends upon his knowledge of radio fails to recognize the importance of Rider Books to his daily progress. Rider Books explain theory—and you need theory if you are to succeed in practice! That's why money-making servicemen recognize the great value of Rider Books. Look over the books described below and order today.

RIDER BOOKS BANISH *Bewilderment*

AUTOMATIC FREQUENCY CONTROL SYSTEMS

With Automatic Frequency Control Circuits in most new higher-priced models, knowledge of "AFC" means money in your pocket! Learn the practical facts, from these easy-to-understand explanations. Get your copy today. Cash in on profitable "AFC" work. Hard covers. 144 pp. \$1.00.

THE CATHODE-RAY TUBE

Written especially so you can understand the subject. With introduction of new, cheaper Cathode-Ray Tubes, this book is even more indispensable for its complete practical information on Oscilloscopes, etc. 336 pp. 450 illustrations. \$2.50

SERVICING SUPERHETERODYNES

Changes, changes, changes! That has been the history of the superheterodyne circuit. Make repairs quickly by analyzing the different parts of the circuit quickly. Rider shows you how in this revised edition which has 288 profusely illustrated pages. \$1.00

"AN HOUR A DAY WITH RIDER" BOOKS — 60¢ each

ON AUTOMATIC VOLUME CONTROL will speed up your AVC work. 96 pp. 65 illus.
ON RESONANCE & ALIGNMENT. You need this! 96 pp. 48 illus.
ON D-C VOLTAGE DISTRIBUTION IN RADIO RECEIVERS. How d-c voltages are led to tube elements, etc. 96 pp. 69 illus.
ON ALTERNATING CURRENTS IN RADIO RECEIVERS—with drawings and diagrams.

JOHN F. RIDER, PUBLISHER
404 Fourth Ave. New York City

Remember
YOU NEED ALL **8**
Rider MANUALS

Radio equipment included a 15- to 200-meter transmitter, and 2 receivers including a direction finder; a visual indicator attachment permitted homing. Direction-finding circuits also were provided on the upper medium waveband of the 1st receiver, for alternative direction finding. The radio installation permitted the 2-man crew (pilot and radio operator) to maintain continuous contact during the Atlantic crossings.

4—*Nordmeer*, the 19-ton, puddle-hopping Diesel-powered Nazi seaplane launched by being shot from a catapult (giant sling-shot) in order to conserve fuel, completed a round-trip transoceanic hop to the United States from the Azores. Its radio installation is one of many factors being checked in a series of 14 test trips.

5—*Hawaii Clipper* pioneering the orient air route disappeared last month en route to Manila and Guam with 6 passengers and a crew of 9. Efforts by the ground operator to re-establish contact with the flying boat 1 minute after receipt of a final report from the ship equivalent to "all is well" were unavailing, despite adequate provisions for emergency operation of the radio system in the event of a forced landing.

California Institute of Technology last month reported an automatic SOS device for airplanes. Anthony Easton, physicist, and Major Daniel F. Ellis, co-inventors, designed a battery-operated fire-proof radio transmitter which sends an automatic SOS if it receives a heavy jolt as would be the case in a crash landing.

\$100 and costs plus a 2-year parole requiring monthly report to the probation officer is what it cost T. V. Fabian of Pitts., Pa., last month, for operating an unlicensed radio station in the ultra-high-frequency amateur bands and without the

required operator's license from the Commission. Hey, fellers, why didn't you lay on with the *rettysnitch* and the *wouff-hong!* Wasn't that what "The Old Man" made 'em for? Quit laying down on the job—costs cheaper if Unky Sam doesn't do the spanking.

\$25,000 per minute is what it cost N.B.C. to tell listeners-in how the Brown Bomber signed finis to Max's title aspirations. Total cost of the 2-minute, 4-second Louis-Schmeling fistic encounter was over \$50,000; includes a 146-station network with S.-W. beams to foreign countries.

\$1,000 and over is the value of 25 prizes being awarded by Weston Electrical Instrument Corp., to radio Servicemen, in their 50th Anniversary contest. Subject to be answered is, "How modern test equipment helped me to solve a difficult servicing problem." Award No. 1 is illustrated below.



Weston Electrical Instrument Co.'s idea of what the well-dressed service shop should look like. Ain't she a beauty?

NEW CIRCUITS IN MODERN RADIO RECEIVERS

(Continued from page 213-214)

ungrounded end, while in operation for automatic tuning. During the negative half-cycle the cathode of the noise control section of the 6H6 2nd-detector is below ground potential to a greater extent than the diode plate, which has a minimum bias supplied from the terminal marked "minus." It is a point on the negative side of the voltage divider. This same terminal supplies a minimum bias to the I.F., 1st A.F. and inverter tubes.

When diode current flows the diode plate will become more negative due to its cathode-to-plate space-resistance ratio to R29 reducing; or, looking at it another way, the drop across R29 increases, as the current through it and the diode increases. Its drop will be such that the plate end will be more negative when current flows.

At this point, the bias values of the 1st A.F. and inverter are driven beyond cut-off values, while the I.F. bias is increased so that its output is somewhat reduced. Scarcely 6 volts bias is needed for cut-off of the former two stages, and the motor field may very well supply 10 volts peak or more, which is substantially the total bias voltage produced.

When the motor circuit is opened by the

contactors, the cathode returns to ground potential and no current can flow in the diode circuit.

(5) HIGH AND LOW OUTPUT CONTROL

Sentinel—Erla Model 88BE. Output is controlled directly by means of adjustment of output plate voltage.

The method of control appears in Fig. 2B. For low output the conventional circuit including the A.F. filter choke is used. The voltage drop across the filter choke is sufficient to appreciably decrease the plate voltage not only to the power amplifier, but to all other tubes as well. Connected to the high output terminal, however, the output plate lead draws current directly from the transformer secondary through an R.F. choke, having substantially no D.C. drop.

Relieving the balance of the plate circuits of the output load, their supply voltage will increase. Adequate filtering is accomplished by the 0.5-mf. and 12-mf. condensers acting as an input filter and the 8-mf. condenser at the output when the choke is used. This is sufficient for high output with a class B or in fact, most any push-pull stage.

Please Say That You Saw It in RADIO-CRAFT

SUPERIOR PRESENTS 4 INSTRUMENTS

from its NEW 1100 series!!!! Never before has Superior offered so much for so little! Always the Best Buy in the Instrument Field, Superior in this new 1100 series gives you even more value! We have incorporated many refinements, many new features . . . all proven to be sound and practical. We urge you to read the descriptions below carefully; see how these instruments fit your needs. Buy direct from manufacturer and save 50%.

ments, many new features . . . all proven to be sound and practical. We urge you to read the descriptions below carefully; see how these instruments fit your needs. Buy direct from manufacturer and save 50%.

**The New
Model 1170-S
Combination
All-Wave
Signal
Generator
and
Complete
Tube-Tester**



FEATURES OF SIGNAL GENERATOR

Generates frequencies, 100 kc. to 22 mc., all on fundamentals, with ranges selected by front-panel band switch, and frequencies in those ranges by dial manipulation.
Front panel switch selection of five bands.
Modulation present or absent by front-panel switching. Dial is direct-reading in frequencies, with band-switch settings identified both by letters (A, B, C, D, E) and by frequencies, with corresponding identifications on the dial scale.
R.F. and A.F. outputs obtainable independently, the separate audio output at two amplitude levels.
Separate posts for testing shorts, opens and leakages, including the leakages of electrolytic and other condensers.
Thus even very high resistance circuits may be tested for continuity.
The R.F. level is subject to attenuation (volume control).
Accuracy 1 per cent on I.F. and broadcast bands, 2 per cent on short waves.
Uses three tubes: one 6A7 rectifier, one 6A7 oscillator and one modulator tube.
Planetary Turneasy drive, with 4-to-1 vernier.

FEATURES OF TUBE TESTER

Tests all 4, 5, 6, 7, 7L and octal base tubes, including diodes.
Tests by the well-established emission method for tube quality, directly read on the Good-Bad scale of the meter.
Affords separate neon test for leakage and shorts between elements.
All services performed by the use of only five controls at maximum, and many tests do not require working all the controls.
Rugged, foolproof construction, with sturdy enclosure in black wrinkle-finished shield cabinet.
Model 1170-S Combination complete with attractive shielded cabinet, with carrying handle, instructions, leads, and tabular data for every known type of receiving tube.
Shipping Weight 19 lbs.

**ONLY
\$1990**

THE NEW MODEL 1150-S SUPER-ALLMETER

Featuring the New Sloping Panel



A genuine achievement! For accurate and rapid measurements. Note the following features: A.C. and D.C. Volts, A.C. and D.C. currents, Resistance, Capacity, Inductance, Decibels, Watts.

SPECIFICATIONS:

D.C. Voltage: 0-15, 0-150, 0-750 volts D.C.
A.C. Voltage: 0-15, 0-150, 0-750 volts A.C.
D.C. Current: 0-1, 0-15, 0-150, 0-750 ma. D.C.
A.C. Current: 0-15, 0-150, 0-750 ma. A.C.
2 Resistance Ranges: 0-500 ohms
500-5 megohms
High and Low Capacity Scales: .0005 to 1 mfd. and .05 to 200 mfd.
3 Decibel Ranges: -10 to +10, -10 to +38, -10 to +53.
Inductance: 1 to 700 Henries
Watts:
Based on 6 mw. at 0 D.B. in 500 ohms, .096000 to 600
Utilizes new 4 3/4" square 0-1 d'Arsonval type meter with precision resistors housed in our newly devised sloping case for rapid and accurate servicing.
Model 1150-S supplied complete with test leads, tabular charts and instructions.
Size 10" x 7 1/4" x 4 1/2", shipping weight 9 pounds. Our net price **\$1185**
Model 1150-A Portable carrying cover 75c additional.

THE NEW MODEL 1180-S SET TESTER

A Complete Laboratory
All in One Unit!

Featuring Our New Type Sloping Panel for
Precise and Rapid Servicing



A complete testing laboratory all in one unit! Combines Superior models 1140-S and 1150-S. For specifications read the description of both these models herewith. Comes housed in sturdy, black case with sloping panel for rapid and simple measurements. Complete with test leads, tabular charts, instructions and tabular data for every known receiving type tube, including many transmitting types. Size 11 3/4" x 9 3/4" x 5 1/2", shipping weight 18 pounds Our net price **\$1785**
Model 1180-A for Portable Cover, add 95c.

THE NEW MODEL 1140-S TUBE TESTER



A really modern tube tester conforming to all standards of good engineering practice. Utilizes a 3" d'Arsonval type meter with calibrated scale. Furnished in a sturdy black case with sloping panel for easy operation. Removable cover and carrying handle for either portable or counter use.

SPECIFICATIONS:

1. Tests all 4, 5, 6, 7, 7L and octal base tubes, including diodes.
 2. Tests by the well-established emission method for tube quality, directly read on the GOOD-BAD scale of the meter.
 3. Affords separate neon test for leakage and shorts between elements.
 4. All services performed by the use of only five controls at maximum, and many tests do not require working all the controls.
 5. Supplied with instructions and reference table so that the filament voltage and emission measuring controls may be properly set for the enumerated long list of tubes, which includes all tubes commonly encountered in servicing.
 6. Works on 90-120 volts A.C. 60 cycle.
- Model 1140-S comes complete with instructions and tabular data for every known receiving type of tube as well as many transmitting types. Shipping weight 10 pounds, size 10" x 7 1/4" x 4 1/2".
Our net price **\$1085**
Model 1140-A with Portable Cover 75c additional

SUPERIOR INSTRUMENT CO. 136 Liberty St., Dept. 1038
NEW YORK, N. Y.

Please Say That You Saw It in RADIO-CRAFT

NEW SENSATIONALLY DIFFERENT!

I CAN MAKE YOU A RADIO EXPERT

Quicker, Easier with the New

SPRAYBERRY

Personalized

TRAINING IN RADIO

Get my FREE BOOK

You Learn by Doing Actual Experiments with Real Equipment

HOW TO MAKE MONEY IN RADIO

I Back You Up All the Way with Close Personal Attention

Don't Fail to Investigate This New Home Training Method.

I ACTUALLY SET YOU UP FOR A BUSINESS OF YOUR OWN

Here's the finest, most up-to-the-minute Radio Education available anywhere. Specially designed to give you intense, practical, quick training . . . for a money-making career in the fast moving Radio Industry. Even equips you for your own business.

TRAINING PREPARES YOU FOR JOBS AT \$40. TO \$60. PER WEEK

NO PREVIOUS EXPERIENCE NEEDED

My Training starts right at the beginning of Radio . . . unfolds each subject in a simplified, logical, understandable style. You easily learn all about Television, Electronics, Police Radio, Ship Radio, Commercial Radio Broadcasting . . . Radio Set Repair and Installation work, etc.

I SHOW YOU HOW TO MAKE GOOD SPARE-TIME MONEY . . . WHILE YOU'RE LEARNING

I supply you with valuable spare-time Business Builders which will show you how and where to get profitable Radio service jobs right in your own neighborhood. You get invaluable practical experience . . . add to your bank account at the same time.

BIG PROFESSIONAL OUTFITS GIVEN

Positively the finest equipment offered with any Radio Course is delivered to you as a regular feature of Sprayberry Training. Enables you to set up your own home laboratory.

The Sprayberry Course Is Sold Under an Iron-Clad, Money-Back Agreement.

SPECIAL SERVICEMAN'S COURSE

I offer advanced Training for those already in Radio. Complete details of this advanced Course and fundamental Course, features, etc., fully described in my new 44-page FREE BOOK. Send for your copy today.

RUSH THIS COUPON for BIG FREE BOOK

SPRAYBERRY ACADEMY OF RADIO
F. L. Sprayberry, President
120-K University Place, N. W.
Washington, D. C.

Please send me FREE copy of "HOW TO MAKE MONEY IN RADIO".

Name Age

Address

City State

(Mail in envelope or paste coupon on postcard)

RADIO ON A GLOBE-CIRCLING DASH

(Continued from page 201)

The device operates on the principle of reflection from a body (water, mountains, etc.); the "echo" time then determines the distance of the reflecting body.

In one of 4 rooms of the Business Systems Building on the New York World's Fair site, a corps of radio engineers maintained almost unbroken contact with the Hughes plane. In one of these rooms an enormous wall map was used to keep track of the plane's progress; as radio position reports came in, a toy plane was moved forward to a new position on the line-of-flight. In another of the rooms, meteorologists and weathermen kept close tabs on incoming weather reports, and from them prepared forecasts for the aviators.

In addition to the official reports given to networks announcers by Hughes' radio staff, listeners-in heard reports by the various press services, and listened to scheduled pick-ups from radio stations en route, as well as actual contact with New York World's Fair 1939. Following are reports supplied to Radio-Craft by the several networks that participated in bringing this epochal event into so many homes, here and abroad.

N.B.C.—

From the moment Howard Hughes and his crew of 4 lifted their silver ship from Floyd Bennett Field to smash the existing round-the-world flight record radio was almost as busy setting records of its own. N.B.C., in fact, began long before the plane left the ground, then as the swift eastward flight astounded the world followed every move of the intrepid aviators for the benefit of its nation of listeners.

Broadcasts began at the New York field, continued from mid-Atlantic, and multiplied when the Hughes crew set their plane down in Paris. The novel 2-way conversation carried on between N.B.C. officials at Radio City and the Hughes plane somewhere east of Newfoundland was broadcast, via the RCA Communications at Rocky Point and Riverhead, L. I.

N.B.C. scored a clean scoop at Le Bourget in Paris when Fred Bate, N.B.C.'s European representative was on the air as the ship landed and continued through the frenzied welcome after the crew stepped from the plane.

The N.B.C. crew, communicating with the United States over A.T.&T. facilities at Netcong, N. J., also reported the take-off from the French capital. As the networks remained open to bring news of the flight's procedure over Germany, N.B.C. again picked up the fliers, including Hughes himself, as they passed Berlin. This was effected through the facilities of the Reichs Rundfunk and RCA Communications, the program originating in the plane and passed out over one of the 3 radio transmitters installed before Hughes left on his historic venture.

At 4:20 A.M., EDST, Tuesday Hughes again came to the microphone, this time at the Moscow airport where he reported over the Russian government radio facilities, in touch with N.B.C. through RCAC.

Then, as Hughes and his crew roared over Siberian wastes and touched at 2 points they were beyond reach of shortwave radio. N.B.C. was forced to rely on relayed reports reaching American listeners through an extension to Flight Headquarters, at the New York World's Fair ground, Flushing, L. I.

It was not until the now-weary crew set foot on ground at Fairbanks, Alaska, that the world next heard the voices of the record smashers. The arrival and take-off was reported Wednesday night (July 13)

over the shortwave facilities of the U. S. Army from Fairbanks to Seattle, where the program was fed into the N.B.C. networks.

Again Hughes and his companions were silent for several hours as they proceeded toward St. Paul. But from that point on reports came thick and fast from all the towns on the course. And as the plane again set wheels on Floyd Bennett Field, N.B.C. had its pack sets, microphones and mobile unit placed strategically about the airport to give a complete, running account of the end of the fastest round-the-world journey in history.

WNYC

Although on the Hughes hop-off and landing WNYC only took "feeds" from N.B.C., the Municipal Station went in for a coverage of the Hughes reception that was as extensive as any station's. WNYC utilized its mobile shortwave transmitter WASJ, housed in a truck and followed the Hughes party from Battery Park to City Hall. Since the parade moved slowly, a WNYC announcer with a mike and several hundred feet of extension cord, was able to hop out during the parade and interview not only Stoddart, Thurlow and Connor, but their wives as well. The WNYC man was the first radio man during the parade to reach the cars of Thurlow, Stoddart, Connor and Lund, and scooped N.B.C. men with their portable pack transmitters. WNYC's announcer also got the first parade interview with young Tommy Thurlow, son of navigator Thomas Thurlow.

After the ceremonies at City Hall, which WNYC covered in full, the parade was again followed by the shortwave truck as far as 5th Avenue and 9th Street.

WOR-M.B.S.

Howard Hughes, his crew of 4 and the great silver-winged monoplane, New York World's Fair 1939, are back in New York.

From Saturday (July 9) WOR and the Mutual network, under the direction of Special Features head G. W. Johnstone, remained on the air 24 hours a day, covering the plane's round-the-world flight almost mile by mile, bringing listeners broadcast after broadcast, either direct from the plane itself, or from one of the foreign airports at which the plane landed, or from the flight headquarters at the New York World's Fair in Flushing, New York.

Included in this coverage—the most complete ever given such an event—were history-making exclusive broadcasts, each of which brought to America the first word of their latest position. These included exclusive broadcasts from the plane's cabin on Sunday (July 10) as it crossed the Atlantic Ocean, on Tuesday (July 12) as it reached Moscow, on Wednesday (July 13) as it landed at the airport at Fairbanks, Alaska, and on Thursday (July 14) when the plane first touched United States territory at Minneapolis on its final lap homeward bound.

The whole series of broadcasts, numbering over 10 a day for 5 days, finally was brought to a conclusion with the breathless description of the end of the trip at Floyd Bennett Field on Thursday at 2:37 P.M. Immediately following that, announcers, engineers and fliers all went to bed.

The Hughes flight which proved radio's boast of almost world-wide coverage did not present as many technical problems as the layman might imagine. WOR and the Mutual network described the take-off from New York's Floyd Bennett Field from the land and from the air. The broadcast was kept on the ground until the plane taxied to the end of the runway for its long dash

Please Say That You Saw It in RADIO-CRAFT

down the field. Control was then switched to Dave Driscoll flying in an Eastern Air Line transport plane overhead. WOR engineers, under the direction of Charles Singer, had installed in the plane the network's regular relay broadcast transmitter, designed by station engineers. An intermediate frequency of 2,790 kilocycles was used for this broadcast. The signal was picked up at the Press Wireless station at Baldwin, L. I., and relayed to the network.

At 2:30 A.M., July 11, Howard Hughes made a dramatic 8-minute broadcast from the *New York World's Fair 1939*, then more than 1,500 miles out of New York. This broadcast originated with the 100-watt composite transmitter aboard the Hughes plane, the signal again being received at Press Wireless with fine quality.

The next contacts with the ship were made early the next day, Tuesday, as it winged its way from Paris to Moscow. Two broadcasts, one from a point over Germany, the other from above Poland, featured 2-way conversations with an English-speaking announcer of the Reich Rundfunk Gesellschaft in Germany. The signal was relayed to Press Wireless over the regular trans-Atlantic channels of the German transmitters.

The landing in Moscow was described by an English-speaking Russian announcer stationed at the field. The Russians failed to make any tests prior to the actual broadcast so the signal was picked up cold at Baldwin, but with good understandable quality. *This broadcast originated with one of the 500,000-watt shortwave Russian transmitters.*

No further phone transmissions either from airport or plane were heard until the ship landed at Fairbanks, Alaska, Wednesday evening. While the Hughes Lockheed was flying from Moscow to Omsk and from Omsk to Yakutsk, Siberia, the flight was covered through bulletins received at flight headquarters in New York. The bulletins were transmitted in C.W. from the ship to Russian ground stations which in turn relayed to Moscow. Moscow forwarded the messages to New York.

Because no wire lines could be made available from the Fairbanks field to the U. S. Army Signal Corps transmitter located some distance away Mutual contacted Pan American Airways and after talking with its Fairbanks manager, Joe Crosson, famous pilot of the North, arranged to have the air line operators and Crosson describe the landing and take-off through their own transmitter. The broadcast was picked up by the Signal Corps and relayed through their regular circuits to Seattle where station KOL of the Don Lee leg of Mutual made arrangements to feed the coast-to-coast network.

Mutual scooped the country on the Minneapolis landing by maintaining flash service with A.T.&T. through Wednesday night and early Thursday so that network lines could be reversed to the Twin Cities if Hughes decided to land there. Arrangements were also made to pick up a shortwave broadcast from a Winnipeg transmitter which was to relay its description from the airport to its 2,000-watt transmitter by means of a mobile unit. This signal would have been picked up by Press Wireless with whom tests had been made. Hughes landed in Minneapolis. A.T.&T. reversed lines instantly and interviews with the crew and a description of the take-off were heard exclusively over Mutual.

For the landing at Floyd Bennett Field 2 positions were used, one in the tower of the Administration Building, the other on the concrete apron to which Hughes taxied. At the latter point a pack transmitter was used in addition to land lines.

The BIGGEST IMPROVEMENT in WIRE WOUND RESISTORS in 20 years!

25, 50, 100 and 200 Watt Fixed Types with Lugs.



25, 50, 100 and 200 Watt Adjustable Types with Lugs and Mounting Brackets.



5 and 10 Watt Fixed Types with Leads.

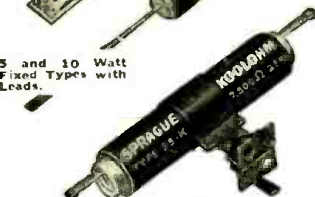

"No Screw" Mounting Clamp furnished with 25, 50, 100 and 200 Watt Fixed Types.



OPERATE COOLER THAN ANY OTHER RESISTORS OF EQUAL RATING

USE THEM ANY TIME . . . ANYWHERE . . . AT FULL WATTAGE RATING

Sprague scores again! This time, the world's largest manufacturer of quality condensers brings you an amazing new resistor development . . . all the quality you've wished for in the past but have never been able to get until now.

Sprague Koolohm wire wound resistors can be used any time, anywhere, up to their full wattage rating. They operate cooler than any other resistors. They are absolutely impervious to moisture. There is no possibility of shorting or shifting of turns.

EVERY INCH OF WIRE INSULATED

No brittle enamel, no overall insulation to chip, break or crack! In Sprague Koolohms the wire itself is coated with Rubencote, the finest insulation ever made. Neither moisture nor red heat will damage it. It conducts heat with amazing rapidity. What's more, Rubencote insulation on the wire permits each turn to be wrapped tightly against the next one—or even layer wound as in the case of fixed Koolohm types. No spreading or shorting of turns. Accuracy is 5%—and it's guaranteed!

10 BIG NEW FEATURES

Start using Sprague Koolohms today! Note their all black metal seal protection—the new no-screw mounting—the handy ball bearing type adjustable slider—the low prices on non-inductive units—the unique Voltage Dividers that save you time and money . . . all of these and many other exclusive Sprague features that make Koolohms far and away the best buy on the market today . . . at prices no greater than you have been paying for old-fashioned wire wounds.

SPRAGUE KOOLOHM RESISTORS

AUTOMATIC OVERLOAD INDICATOR

No more guesswork about overloads! KOOL-OHMS tell you . . . automatically. Just look at the red dot in the end of a KOOL-OHM. If this "Tel-Tale" Indicator is still red, everything is O.K. If the red end has turned brown, however, that is your danger signal. You know the resistor is overloaded.

INVESTIGATE! Sprague KOOLOHMS are made in all sizes and types. Ask your jobber—or write to us for complete catalog and helpful resistor information.

Save time—Save money . . .
WITH THE MIGHTIEST MIDGETS OF ALL

Use Sprague ATOM Dry Electrolytics for those jobs where you've got to save space—where you're got to install a really good condenser at a rock bottom price. ATOMS are made by an exclusive Sprague etched-foli process that guarantees highest quality. And don't worry about "blow-ups." There's not a "firecracker" in a carload! Made in a complete line including DUAL COMBINATIONS. Just the thing for hundreds of "duplicate" replacements. You save real money. List on the 8 mfd. 450 V. ATOM is only 60c. Others equally low. Sold singly or in handy kits by leading jobbers.



SPRAGUE ATOMS
Actual size view of 8 mfd. 450 V. ATOM . . . at a list price of only 60c.

SPRAGUE PRODUCTS COMPANY
NORTH ADAMS, MASS.



New Edition

Thoroughly revised—greatly enlarged—offering a wealth of new up-to-the-minute information

THE RADIO MANUAL



Here's the only complete Handbook for students, amateurs, operators, and inspectors. It covers the entire field of radio in 1,000 pages with hundreds of illustrations and diagrams. It is actually a complete course of training in radio operation and a complete reference book for everyone in the field. It gives instantly the answer to every question

about principles, methods, and apparatus of radio transmitting and receiving.

New 1938 Edition

Covers in full detail the Electron Tube—Vacuum Tube Amplifiers and Oscillators—Modulation and Modulation Analysis—Microphones—Radio and Audio Frequency Measurements—Antenna Resistance Measurements—Latest Broadcast Transmitters with installations, adjustments, operation, and maintenance instructions—Latest Marine Radiotelegraph Transmitters and Receivers—Duties of Ground Station Radio Operators—Theory, Operation and Use of Radio Range and Marker Beacons (localizers)—Landing Beams including Lorenz System of Instrument Landing—Radio Direction Finder—the two U. S. Auto Alarms approved by the F.C.C.—Ultra-high Frequency Police Transmitters and Receivers—All Important Radio Provisions of the Communications Act of 1934 as amended effective 1937—Rules and Regulations of F.C.C.—General Radio Regulations Covering Distress Signals, etc.

This is just a hint of the vast amount of information packed into this great book. It is essential to every student, operator, and inspector.

The author, G. E. Sterling, is Assistant Chief, Field Section, Engineering Dept., Federal Communications Commission. The book is bound in durable flexible Fabrikoid.

EXAMINE THIS BOOK FREE

Send No Money—Mail This Coupon

D. VAN NOSTRAND CO., 250 Fourth Ave., New York
 Send me on approval THE RADIO MANUAL. Within 5 days after I receive the book, I can return it and owe nothing. If I keep it, I will send you \$2.00 as first payment and I will pay \$2.00 monthly thereafter for 2 months—\$6.00 in all. (5% discount for cash.) (R.C. 10-38)

Name

Address

City State

Reference

Address

FOR FREE CATALOG of best books of practical instruction and technical information, check here. If you do not want The Radio Manual cross out para graph above.

RADIO TRADE DIGEST

\$1,000,000 SPECULATION

(Continued from page 223)

Now go back and read that last paragraph again.

Not in the prospectus is a comment made on July 2 by the British publication, *Practical & Amateur Wireless*, describing the CSI 3-inch job:—"The very small picture size makes it more a toy than one for sustained entertainment value."

And, surprisingly, the prospectus does not indicate that ATC owns any television patents.

RMA MEETING

The RMA Television Engineering Committee met in New York in July to discuss television standards, allocation and technical problems.

RCA EXPERIMENTS

RCA, with its N.Y.C. television xmitter shut down for midsummer overhaul, conducted experiments with televans, proving spot pick-ups could be made & relayed to station for rebroadcast.

Du MONT RUMOR

Neither confirmed nor denied is the report that Sachs Furniture Co., N.Y.C., has ordered 6 Du Mont television receivers for Fall delivery. According to report, sets will not be resold, but will be used to attract crowds to store. Sample set performed excellently.

FACSIMILE

WLW, Cincinnati, and WOR, Newark, both were granted authority to continue facsimile experiments on 50 kw. in early morning hours. WLW's FCC okay expired Aug. 1, but renewal was probable at press time.

Most Popular Sets

Survey of 53,124 homes by Scripps-Howard papers in 16 cities shows following ownership percentages:—Philco 22.4; RCA 10.8; Majestic 8.1; A-K 4.8; Zenith 4.5; Crosley 4.5; Silvertone 3.8; G-E 3.7; Sparton 2; Bosch 1.7; Grunow 1.6; Stewart-Warner 1.5; Emerson 1.5; Trutone 1.2; All other brands 27.9.—*Radio Today*.

TRADE ANSWERS RTD QUESTIONNAIRE

(Continued from page 223)

12%; Static elimination, 8%; Cheap remote control, 8%; the remaining 24% was divided about equally among such items as better portables, improved servicing, ultra-short-wave feature, better merchandising and sales methods, fewer "plugs" in sponsored programs, and "Kick out the New-Dealers."

Biz Trend & Why

The report on the trend of the radio business is not cheerful, and the reasons for such trend are diverse. More than 1/2 of those answering see their businesses on the down grade, and nearly 2/3 of these blame Washington. Of those whose biz is improving, none credit Washington, and about 2/3 take credit for the rise.

The question was, *What is the trend of your business?* The figures:—No change, 7.7%; Downward, 51.3%; Upward, 41%...

The reasons given for the trend downward were:—Gov't. and legislation, 65%;

The recession, 17.6%; The CIO, 8.7%; "Fear," etc. 8.7%.

For an upward trend, *Improved merchandising methods*, 16.6%; *elimination of surpluses*, 16.6%; "Hard Work," etc. 16.6%; "Luck," "Chance," etc. 11.25%; "Improved our line," etc., 11.25%; "Less fear," "Change in outlook," etc., 11.25%; *Seasonable rise*, 11.25%; *Good market for exports*, 5.2%.

Note:—Unresponsive and non-committal replies were discarded in computing the results of the questionnaire.

SCOOPS & SNOOPS

(Continued from page 224)

contract for the Indianapolis, Ind. municipal airport installation Papers in 105 key cities, displays, bestds, billboards & direct mail will help build a market for the G-E "Beam-a-scope" Inverse feedback, cutting gain from 10 to 15 db. will kill hum & distortion in RCA "electrical Magic Voice" sets *University Labs.*, N.Y.C., announce new weather-proof reflexed (3-ft. air column in 12-in. length) speaker Period furniture cabinets mark the new *Stromberg-Carlson* line; acoustical labyrinth is retained. . . . There's a giggle in an RCA release: a new triple-cone speaker giving uniform response from 50 to 80,000 cycles; later on it turns out to be 8,000 a means of checking no. of radio listeners; the *Hooper & Crossley* reports don't jibe Whatever happened to that mechano-electrical method? Is A. C. Neilson readying it?

A Unidirectional mike at a price is announced by *Shure Bros.*, of Chi.; also a high output level xtal mike *WMCA*, N.Y.C., is selling gobs of time, including 8 programs for 52 weeks to *Community Opticians* *Radio Engineering Labs.*, L.I. City N.Y., has a new 2-way police radio system Say "May I serve you?", not "What can I do for you?"—it flatters the customer, says *Hardware Retailer's* sales expert FCC gave *WHAZ*, Troy, N.Y., okay to stay off air 6 Mondays beginning Aug. 1; now if only enough stations would do it on enough days *Photobell Corp.*, N.Y.C., is planning a new battery-operated p-e device for factory, office and home use, to sell at \$9.50 Did you notice how Gertie Lawrence's make-up ran, toward the end of the *Susan and God* telecast? Too much heat!

Consolidated Edison Co., N.Y.C., has placed an initial order for 25,000 radio sets from G-E; 125,000 toasters from Westinghouse *WGY's* new 50-kwatter has a main studio that seats 150; another studio will be used for television WHEN AND IF D'you know about the U.S. Dept. of Commerce statistical services? You oughta get the free list of 'em from the Bureau of Foreign and Domestic Commerce, Washington, D.C., if you're out after export

The *Philco-made* job in the Southeast H.S. at Casey Moe has radio, phono, chimes, sound & intercommunicator in a single piece of equipment Mr. of *Molle & Engerine* credit NBC bestds with 39% and 26% (respectively) sales increases *WJJD*, Chi. station, is in hot water over complaints on patent meddy bestds Educational stations have been okayed for *Fla. Southern College & N.Y. Bd. of Education* FCC has okayed *WOR* for 50 kw. on facy instead of 5 kw.

Please Say That You Saw It in RADIO-CRAFT

RADIO TRADE DIGEST

RCA's dividend on 1st pfd stock is 87½¢ for the last quarter; on the "B," its \$1.25; both payable Oct. 1 . . . Crosley is planning a \$20 facsimile reproducer—and there are rumors of a national facsy net with W'LV as a 50 kw. key . . . KTUA, Salt Lake City, becomes NBC's 154th link . . . The Federal Trade Commission is paddling both Philco and Zenith with stipulations to desist from "false and misleading advertising" . . . Japan has clamped down on the importation of radio sets and parts by foreign and Chinese dealers in the invaded parts of T'sin-ah (Yeah, that's China) . . .

Oscilloscope and freq. modulator OFM-1, Tube and set checker TSC-1, Signal generator SG-1, Tube checker TC-1, and multimeter MM-1 are being offered to their tube dealers at special rates by G-E . . . New RSA chapters are at Alton and Quincy, Ill., Fremont and Steubenville, O., Ogden, Utah, and Long Island, N.Y. . . . Snow White and 7 Dwarfs, brightly colored in bas relief, decorate panel of Emerson \$14.95 set. . . . Sculptured model of Mr. Charles McCarthy ornaments speaker orifice of new Majestic 6-tube super, to be displayed in 7,800 movie houses, as tie-up for picture starring Mr. McC.

New 15-ohm professional cutting head, by Universal Microphone Co., Inglewood, Calif., is balanced magnetically, mechanically, electrically . . . 300 Cleveland Retail Appliance Dealers met with wholesalers; outlined merchandising code; denounced chiseling and gypping. Radio salesmen's group in Milwaukee is shopping retailers to wipe out price-cutting and excessive trade-ins. . . .

Meissner Mfg. Co., Mt. Carmel, Ill., has bought Auto Radio Replacement Vibrator Division of Electronic Labs., Indianapolis, Ind. . . . David Davis has replaced former radio buyer of R. H. Macy & Co., N.Y.C. . . . Pauley-James Corp., Chicago, has started production on 20 types of push-pull auto-radio vibrators. Non-synch. list at \$3.95. . . .

Is it true what they say about Philco?: has its back up about labor situ, plans a Horace Greeley to Chi, leaving Philly to cry its eyes out.

\$'s & #'s

(Continued from page 226)

to the payroll of the Camden plant. Not only radio and phono sales have made this necessary; record sales, increasing since '33, have soared 20% over last year.

BUSINESS DROPS OFF

G-E billed \$130,910,638 worth of business in 1st 6 mo. of '38, a decrease of 23% from '37. Profits available for dividends were \$13,176,956 (46c a share), just half of '37.

Also off were exports throughout radio industry, latest U.S. figures being for May, '38—\$1,661,568; same mo. of '37 was \$2,538,104.

Breakdown of export follows, figs. in parentheses being for May, '37; first figs. for May, '38.

- No. of receivers, 33,911 (38,241).
- Value of same, \$705,690 (\$984,058).
- No. of tubes, 521,953 (777,472).
- Value of same, \$213,201 (\$319,299).
- Value of parts, \$530,742 (\$811,911).
- Value of xmitters \$165,766 (\$331,768).
- No. of speakers, 23,154 (45,711).
- Value of same, \$46,169 (\$91,068).

In Canada, too, receiver sales are off, April, '38 being about \$190,000 below April, '37.

(Continued on following page)



\$100.00 Worth of PRIZES to Winners!

THE Radio Junk Shop Era is disappearing, and to speed its passing, Sylvania designed and built a Modern Service Shop at Emporium, Pa. People were interested. People talked about it. People got excited.

To encourage Service Shop modernization, we are offering prizes valued at \$100.00 total to the three servicemen who best adapt the Sylvania Model Service Shop plans to their own shop. A booklet containing complete drawings, to-

gether with explanations, is available at 10c.

And you don't have to have a lot of cash on hand to do this. Financing shop modernization is provided by Title 1 of the Federal Housing Administration plan. Your local bank has complete information.

Clip the coupon below NOW and get full details on this contest. Hygrade Sylvania Corp., Emporium, Pa.

Also makers of famous Hygrade Lamp Bulbs

SYLVANIA
SET-TESTED
RADIO TUBES

HYGRADE SYLVANIA CORP. RC-103
Emporium, Pa.

Send me details on the Modernization Contest.
 Send me a Sylvania Service Shop Plan Book @ 10c.

Name

Address

City State

Amateur Serviceman
 Dealer Experimenter

Name of Jobber

Please Say That You Saw It in RADIO-CRAFT

RADIO

biggest opportunities still ahead

In a decade radio has become a giant industry. The opportunities created are being enjoyed by trained men. The International Correspondence Schools Radio Course, prepared by leading authorities and constantly revised, WILL MAKE YOU A TRAINED MAN! A fascinating book — FREE.

INTERNATIONAL CORRESPONDENCE SCHOOLS

Box 6680-D, Scranton, Penna.

Send me—free—information on subject checked

Radio
 Radio Operator

Radio Service Man
 Electrical Engineer

Name _____

Address _____



In ANSWER to a DEFINITE DEMAND

a wire-wound radiohm

Small size. Bakelite case is 1 3/4" diameter x 9/16" deep—available in values from 2 to 10,000 ohms. Insulated construction... no washers required in mounting. Regular Radiohm switch covers can be attached. Dissipates up to 4 watts without damage or change. Universal shaft for all replacement work. Close Tolerance—± 5%.

In linear curve only

Chief Applications:

1. Instruments
2. In radio receivers where very heavy bleeder current passes through unit in cathode and screen circuits.
3. Filament control.
4. Hum control.

Centralab

MILWAUKEE WISCONSIN

RADIO TRADE DIGEST

(Continued from preceding page)

CANADIAN LICENSES UP

Receiver licenses for the year ending Mar. 31 were 1,104,207 in Canada, 6.3%. Fee of \$2 covered all radios in home, or home and car set.

FARMS LIKE RADIO

On 38 of 46 Rural Electrical Administration projects, radio was most popular appliance; was 2nd on the remaining 8. Radio "saturation" was 90% and up on 8 projects. Popular not only because of entertainment and educational value, but also because it "repays its cost many times" by bringing crop and market info to users.

TAX COLLECTIONS DOWN

Federal excise tax collections on radio and phono apparatus in May, '38, were \$197,050.28, a drop of 40% from same mo., '37. But on mechanical refrigerators, they were down 68%.

EMPLOYMENT UP

April, '38, figs. (the Bureau of Labor Statistics' latest) show first rise since last Sept. Increase in radio factories was 2.3%—which is still 44.4% below April, '37. Payrolls upped 13.7% over March, but were 45.5% below preceding April. Average weekly pay, \$20.91, which is lower than natl. average for mfrs. in other lines. Radio factory workers' average hourly wage was 62.6c, while in durable goods line it was 72.2c.

NETWORK BILLINGS RISE

June billings for networks were:—NBC \$3,200,569 (up 6.6%); CBS \$2,120,235 (down 14.4%); MBS \$202,412 (up 72.4%). For the first half of '38:—NBC \$21,023,674 (up 5.4%); CBS \$15,581,295 (up 5.3%); MBS \$1,342,182 (up 15.1%).

AIR CONDITIONING

Only 31% of last year's airconditioning installations were personal; 65% were commercial and industrial. There's a market!

GETTING PERSONAL

(Continued from page 226)

Commander E. M. Webster was appointed assistant chief engineer of the FCC, to replace Lieut. Jett, when Jett became C.E. B. L. MacPherson, of Ft. Wayne, Ind., has been appointed Clarostat's Ind. sales rep.

Owen D. Young, chairman of G-E's board, said "Destiny of radio rests with the people," when he dedicated the new WGY building at Schenectady on July 9.

Wm. J. Dempsey (not Wm. H., of course) was appointed special counsel for the FCC investigation of chain bestg and monopoly in the radio industry. Hearings are to begin in Sept.

John F. Gilligan will supervise sales and ad campaigns for Philco's farm and phono radios. He's been with the co. for 16 yrs.

New members of the Natl. Assn. for the Prevention of Radio Interference:—R. R. Beal, television research director of RCA (made member of NAPRI's advisory committee); New Zealand DZ Radio Assn.; Radex Pub. Co.; Wide World Dial Club; Cleveland Radio Club; Golden Gate chapter of International DXers' Alliance.

R. E. Potts, of Parkersburg, W. Va., has become sales mgr. of Bell Sound Systems, Columbus, O., and takes over that part of Pres. F. W. Bell's job.

CONGRATULATIONS to Pres. T. P. Robinson, Dallas, Tex. V.-p. A. J. Theriault, Sec. Don H. Stover, Freeport, Ill., & Treas. Lee Taylor, Chicago, Ill., elected June, 1938, to serve as officers of the RSA until June, 1938 (!) according to the RSA release.

E. G. Perkins, formerly of engineering dept. of Supreme Instruments Corp., Greenwood, Miss., has been put in charge of hi-freq. test instrument design. Floyd Fausett, former chief engineer, is out.

JOHN CHESTER WARNER, 42, v.-p. of RCA (in charge of Radiotron Division at Harrison, N. J.) was killed in an auto wreck at West Orange, N. J. The radio trade extends sincerest sympathy to his family, and joins them in mourning the passing of one who was universally loved and respected.

EXTEND SYMPATHY TO:—John Evans, Palmyra, N. J., and A. C. Freeman, San Pedro, Calif., who had their licenses suspended by the FCC; Evans, 6 mo. for using excess power and unauthorized freqs.; Freeman 3 mo. for operating unlicensed station on fishing boat.

OFF THE PRESS

(Continued from page 226)

Co., Inc., 195 Broadway, N.Y.C. Data on Model 405A.

CATALOG 9-S. M Solar Mfg. Corp., 599 Broadway, N.Y.C. Features Minicap dry electrolytics and new CC analyzer. Printed in 5 colors. On request from mfr.

CATALOG SHEETS (2) Shure Bros., 225 W. Huron St., Chicago, Ill. Describe (a) new xtal mikes; (b) pickups and mike stands.

TACO COMMUNITY MASTER ANTENNA SYSTEM. 12 pp. Technical Appliance Corp., 17 E. 16th St., N.Y.C. Description and instructions for installation, with methods of reducing interference.

MEISSNER NET PRICE CATALOG. 44 pp. Meissner Mfg. Co., Mt. Carmel, Ill. Includes new sets, p-b tuners, remotes, parts, etc., with confidential prices.

ARCTURUS TUBE DATA CHART (Revised). 18"x35". Includes technical and application data on 166 receiving tubes and 38 ballast tubes. Sent on request by Arcurus Radio Tube Co., Newark, N. J.

CLAROSTAT CONTROLS. 4 pp. Clarostat Mfg. Co., 285 N. 6th St., Brooklyn, N.Y. Lists exact duplicate and interchangeable controls. (Note: This mfr. also putting out new jobber catalog sheets, available to trade on request.)

GARRARD RECORD PLAYING EQUIPMENT. 16 pp. Garrard Eng. and Mfg. Co., Ltd., 17 Warren St., N.Y.C. Features and prices of turntables, changers and pickups.

CHANGES IN NAMES & ADDRESSES

(Continued from page 224)

Tilton Electric Corp., 15 E. 26 St., N.Y.C., is exclusive world distributor for Transducer Corp's Bullet mikes.

Maitland K. Smith, 635 N. Highland Ave., N.E., Atlanta, Ga., has been appointed sales rep. for Ward Leonard sets, parts and relays in N. and S.C., Fla. and Ala.

Please Say That You Saw It in RADIO-CRAFT

RADIO TRADE DIGEST

SALES HELPS & DEALS

(Continued from page 225)

exhibitor, dress up local show room and publicize its location. (3) If not exhibitor, and have no show room, have local retail outlets well stocked, decorated and publicized. (4) If use mainly institutional adv., use it in Fair areas, to get maximum reader coverage. (5) Immediate sales possibilities to hotels, restaurants, show rooms, etc., now decorating or making improvements preparatory to Fair.

SLIDE film is being used by Philco to demonstrate Mystery Control and other sets to dealers outside of 40 key cities covered by "flesh" demonstrations. Good results are claimed.

VIBRATOR Unipak, colorful display wrapper, encloses (but does not hide) 6 individual cartons. Being used by Radiart Corp., Cleveland, O. Displays stress use of product in police service, "The toughest test."

RAYTHEON has put out a 4-pp. color folder announcing a new line of posters, mats, electros, etc. Many of these are free to dealers.

OPERATING NOTES

(Continued from page 230B)

PHILCO MODEL 86

Dead. Check for a shorted 0.1-mf. condenser which is sealed into a cylindrical container along with the plate resistor. Disconnect the condenser lead and substitute a separate tubular condenser rated at 600 volts.

DE FOREST-CROSLY TYPE 762

Few stations can be received and there is distortion and gradual rising and falling in volume. Analyzer reveals low plate voltage and current on all but the power tubes. Replace the leaking 0.5-mf., 500 V. R.F. plate bypass condenser.

ROGERS 4521 CHASSIS

This little set is difficult to service as the parts and wiring are inaccessible owing to the method of mounting the two large I.F. cans and complete wave-change switch assembly all in one unit at the base. The commonest trouble is a "dead" set with rectifier plates red hot, caused by the shorted 8-mf., metal-cased dry electrolytic C31 in the diagram. As it is impossible to remove this without unwiring half the set, better to clip and tape the dead leads and place a good, well-sealed 8-mf. cardboard electrolytic condenser, no larger than 4 x 1½ ins., in the space at the left underside of the chassis, where it fits nicely.

DE FOREST-CROSLY 707

Intermittent reception is caused by an open-circuiting detector plate choke. Replace with one of 17 mhy.

ROGERS 832

"Dead." Analyzer shows practically zero voltage on the R.F. plates while the rest are normal. There is a dual 0.5-mf. R.F. filter block shunted by a midget 50-ohm resistor. One section of the block connects to the 1st. R.F. plate and this section leaks sufficiently to constitute a short; therefore, although the other section is OK, the resistor in shunt greatly reduces the other R.F. plate voltages. Replace the defective section with a 0.5-mf., 500 V. tubular condenser.

(Continued on page 247)

Quick, Easy Servicing
with the **New** RIDER Chanalyst

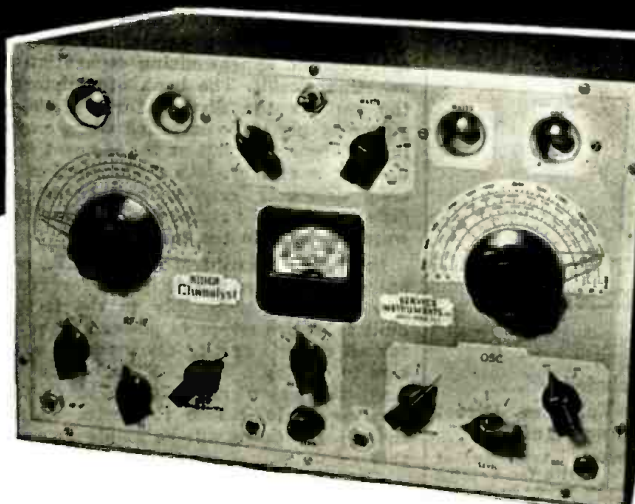

JOHN F. RIDER in whose Successful Servicing Laboratories this revolutionary instrument was developed.

Makes Possible Logical Systematic Method of Testing

Get on the sure road to radio service profits with the revolutionary new Rider Chanalyst—"the greatest advance ever made in the history of service instruments." With it tests are conducted as they should be—by tracing the passage of the signal through the receiver. The Chanalyst incorporates no unknown radio theories . . . it enables every serviceman to save time, make more money . . . it simplifies testing, makes every job easier by locating set troubles in an absolute minimum of time. AND—you can quickly learn to operate the Rider

Chanalyst. Here are but a few of the major tests which you can conduct with the Chanalyst while receiver is in operation:

1. Trace passage of signal through receiver from antenna to speaker in r-f, i-f or a-f stages, establishing points where signal exists, dies, becomes weakened, distorted and where it takes on hum.
2. Check actual operating voltages at any point in the receiver without loading the circuit.
3. Accurately check actual control voltages developed by the signal and present at the tube elements—a.v.c. and a.f.c. characteristics.
4. Check padders and coils in oscillator section in a superheterodyne.
5. Instantly check wattage consumption of the receiver.
6. Quickly locate troubles in intermittent receivers.

HOLD EVERYTHING UNTIL YOU READ ABOUT THE CHANALYST

Free 16 Page Booklet

Tells everything you want to know about the Rider Chanalyst . . . what it is, what it does, how it works. Profusely illustrated with diagrams and clear explanations. This booklet was written by John F. Rider in whose Successful Servicing Laboratories the Chanalyst was developed. Send for your copy immediately. Go to your jobber for a demonstration.

"THERE'S ONLY ONE RIDER CHANALYST"

SERVICE INSTRUMENTS, Inc. 404 FOURTH AVE., NEW YORK CITY



SERVICE INSTRUMENTS, INC. 404 Fourth Avenue, New York City

Please send descriptive booklet on the Rider Chanalyst.

Name.....

Address.....

Serviceman

Please Say That You Saw It in RADIO-CRAFT

A.C. and D.C. VOLT-OHM-MILLIAMMETER
POCKET SIZE only \$12.00

Readrite
RANGER

Size:
 3-1/16" x 5-7/8"
 x 2-1/8"

MODEL
 736



Accuracy
 Guaranteed
 2% D.C. - 5% A.C.

Uses TRIPLETT Precision INSTRUMENT

- Molded Case
- Jacks for All Ranges
- All Accessories Included
- For All A.C.-D.C. Voltages, Direct Current and Resistance Analyses.

Other Readrite-Ranger Testers Available at Money-Saving Prices . . . Write for Catalog

READRITE METER WORKS
 1016 College Ave., Bluffton, Ohio

Please send me more information on
 Model 736 Send Catalog

Name

Address

City State

HEAR THOSE FOOTBALL BROADCASTS CLEARLY!

Be prepared for continuous reception of the big fall broadcasts by using CONTINENTAL (plug-in) Filternoys at source of interference.



Code FOIDH
 volts. Code FOIDH \$1.00 ea.

USE "BI-PASSIT" to quiet radio interference caused by electric shavers, heating pads, and other small appliances by attaching "Bi-passit" to appliances. For use on ground and a-c circuits. Code F18 . . . 35c ea.

Dealers: 24 "Bi-passit" Filternoys suppressors on big blue counter display card. Available from your CONTINENTAL jobber.



Code F18

CONTINENTAL CARBON Inc.

13914 Lorain Ave., Cleveland, Ohio
 Also Toronto, Canada
 Makers of Carbon Resistors, Paper Condensers, and Noise Suppression Filters

CONSTRUCTION DETAILS OF A 441-LINE TELECEIVER

(Continued from page 205)

ode-ray tube is used. The vacant space in the forward right-hand corner of the chassis will allow ample room for a simple 4- or 5-tube, high-frequency or all-wave sound receiver.

In Fig. B, starting in the right-hand corner, the tube in the center (placed upside down to insure short leads) is the R.F. stage. Directly beneath it is the oscillator coil, including condenser. Following along around the side of the chassis are the I.F. transformers and the tubes. Further around the border of the chassis, we come to the video amplifier, 2nd-detector and synchronizing separation and selection circuit. The bank of resistors on the card is the divider for a 6,000-volt power supply to be installed when employing a larger tube but at the moment is not used or necessary. The 2 distribution controls are only employed when magnetic deflection is used; although shown in Fig. B, were not used in the completed job.

In Fig. C, the control for the R.F., mixer and oscillator are visible in the foreground. The husky power supply to the left was built to secure adequate power and voltage for all circuits and to allow future expansion to employ a 9- and 12-inch tube for a magnetic sweep circuit. Should a sound receiver be built into the extra space in the chassis, there will be ample power for this as well.

The fact that this receiver can readily be expanded to take advantage of future requirements and still allow ample room in the chassis for a sound channel allows the Serviceman opportunity to extend his receiver from time to time as his purse or interest increases, with the certainty that obsolescence will not undermine his investment.

When a larger tube of the magnetic type is used to replace the 5-inch electrostatic tube, the latter can then be used as an excellent oscilloscope tube of much finer trace than is generally available.

Recommendations: a superhet. teleceiver of this type, even though its sensitivity is sufficient to set up an image with only 1/10-millivolt input, should be operated with a 30-mile radius of the television transmitter (operating on about 45 mc.); an input video signal intensity of about 1 millivolt, at least, should be maintained in order to prevent having images marred by static-interference (light and dark blotches on the screen).

A teleceiver built as illustrated and described above is giving a Grade A account of itself in reproducing 441-line high-fidelity television images that measure, on the end of the videotron, about 4 1/4 x 3 3/4 ins. high, with excellent viewing characteristics at a distance of about 10 ft.

LIST OF PARTS

Tubes

- One National Union videotron, type 2005;
- One National Union high-voltage rectifier, type 879;
- One National Union low-voltage rectifier, type 5Z3;
- Two National Union high- and low-frequency sweep, type 6F8G;
- Two National Union pulse amplifiers, type 6L7G;
- Two National Union 2nd-detector synchronous selector, type 6H6G;
- One National Union 2nd video, type 6V6G;
- Five National Union R.F., I.F. and 1st video pentodes, type 1851;
- One National Union mixer, type 6K8.

Transformers and Chokes

- One Kenyon Transformer Co. high-voltage transformer, type T-203, T5;
- One Kenyon Transformer Co. low-voltage transformer, type T-244, T6;
- Four Aladdin I.F. transformers, 13.5 mc., T1, T2, T3, T4;
- One Kenyon Transformer Co. choke, 300 henries, L9;
- One Kenyon Transformer Co. choke, 2,000 henries, L10;
- One Kenyon Transformer Co. choke, 1,000 henries, L11;
- One Kenyon Transformer Co. choke, type T-151, 30 henries, L12.

Condensers

- Three Solar or Aerovox mica condensers, 50 mmf., C1, C4, C7;
 - Twenty National Union tubular condensers, type T-405, 0.05-mf., C2, C3, C12, C13, C14, C15, C18, C19, C20, C21, C22, C23, C24, C28, C32, C35, C37, C56, C57, C58;
 - One Aerovox mica condenser, 75 mmf., C5;
 - One Cornell-Dubilier mica condenser, 50 mmf., C6;
 - Three mica condensers, 100 mmf., C8, C9, C10;
 - Three National Union condensers, type T-425, 0.25-mf., C17, C46, C49;
 - One mica condenser, 30 mmf., C27;
 - Seven National Union electrolytic condensers, T-can, 8 mf., C29, C30, C33, C34, C36, C41, C42;
 - Two National Union condensers, type T-410, 0.1-mf., C31, C48;
 - One mica or paper condenser, 250 mmf., C38;
 - One tubular condenser, 0.005-mf., C39;
 - One paper condenser, 2 mf., C40;
 - One mica condenser, 0.002-mf., C43, C44;
 - One mica condenser, 0.001-mf., C45;
 - One National Union electrolytic condenser, T-can, 16 mf., C47;
 - One Cornell-Dubilier condenser, VC-S5, 0.05-mf., 2,000 V., C50;
 - One National Union paper condenser, type U-41, 1 mf., C51;
 - Two National Union condensers, type OX-2001, 1 mf., 2,000 V., C52, C53;
 - Two National Union condensers, T-can, 16 mf., 425 V., C54, C55.
- Note: All condensers not marked National Union may be any other reputable make.

Resistors

FIXED

- Five I.R.C. resistors, 1,500 ohms, 1 W., R1, R4, R12, R18, R23;
- Four I.R.C. resistors, 150 ohms, 1 W., R2, R15, R20, R25;
- Nine I.R.C. resistors, 60,000 ohms, 1 W., R3, R10, R16, R21, R26, R29, R33, R89, R49;
- Eight I.R.C. resistors, 5,000 ohms, 1 W., R5, R11, R17, R22, R27, R31, R35, R37;
- Two I.R.C. resistors, 0.25-meg., 1 W., R6, R41;
- Two I.R.C. resistors, 25,000 ohms, 1 W., R7, R36;
- One I.R.C. resistor, 300 ohms, 1 W., R8;
- Two I.R.C. resistors, 50,000 ohms, 1 W., R9, R60;
- Three I.R.C. resistors, 10 ohms, 1 W., R13, R19, R24;
- One I.R.C. resistor, 2,500 ohms, 1 W., R28;
- Three I.R.C. resistors, 2,000 ohms, 1 W., R30, R52, R53;
- Two I.R.C. resistors, 2 megs., 1 W., R32, R67;
- One I.R.C. resistor, 1,200 ohms, 1 W., R34;
- One I.R.C. resistor, 0.12-meg., 1 W., R38;

(Continued on page 242)

Please Say That You Saw It in RADIO-CRAFT

RADIO WITTIQUIZ

(Continued from page 222)

(151) *Hysteresis* is—
 (a) A mild form of insanity. (b) Heat losses in a conductor due to rapid magnetization and demagnetization. (c) Distortion from overloading a detector. (d) Result of too-small capacity in filter.

(152) A *Baffle* is used—
 (a) In a game of cards. (b) In a wave-trap. (c) In a Serviceman's kit. (d) In a loudspeaker installation.

(153) All radio Servicemen know an *output meter* is used to—
 (a) Align a radio receiver. (b) Measure wavelength of a transmitting antenna. (c) Measure antenna radiation. (d) Count number of people leaving a subway exit.

(154) Radio engineers are well aware a *decibel* is—
 (a) Spanish word for December. (b) Trade name of a new design of S.-W. receiver. (c) A unit of power level. (d) One-tenth of 1 coulomb.

(155) *Translation gain* is the additional gain realized by—
 (a) Exchanging U. S. money for foreign money. (b) Using resistance-coupled circuits. (c) Changing to I.F. in superhets. (d) Using step-up audio transformer.

(156) Anyone who has studied radio theory knows *time constant* is—
 (a) Time required for a condenser to charge or discharge. (b) NAA (Arlington, Va., station) time signals. (c) Trade name of electric clock. (d) Term used to describe D.A.V.C. action.

O. H. Cook,
 Coco Solo, C. Z.

Answers

(141c)	(145b)	(149a)	(153a)
(142b)	(146b)	(150c)	(154e)
(143b)	(147b)	(151b)	(155c)
(144b)	(148c)	(152d)	(156a)

CONTEST RULES

(1) An award of a 1-year subscription to *Radio-Craft* will be given, each month, to each person who submits one or more WITTIQUIZZES that the Editors consider suitable for publication in *Radio-Craft*.

(2) WITTIQUIZZES should preferably be typed; use only one side of paper.

(3) Submit as many WITTIQUIZZES as you care to—the more you submit the more chance you have of winning—but each should be good.

(4) Each WITTIQUIZ must incorporate humorous elements, and must be based on some term used in radio, public address or electronics. Each WITTIQUIZ may have 4 "answers," only one of which of course will be correct; and, only 1 of which is non-radio.

(5) All answers must be grouped, by question number and correct-answer letter, on a separate sheet of paper.

(6) All contributions become the property of *Radio-Craft*. No contributions can be returned.







(7) This contest is not open to *Radio-Craft* employees or their relatives.

**SAVE MONEY
 WITH THIS
 BRAND NEW
 FREE
 RADIO CATALOG!**



**188 PAGES
 OF SUPER
 VALUES**

**1939
 EDITION**

	NEW 1939 LAFAYETTE RECEIVERS		PUBLIC ADDRESS EQUIPMENT
	50,000 PARTS AND TUBES		AMATEUR APPARATUS
	TELEVISION KITS		ELECTRICAL APPLIANCES
			CAMERAS

**SAVE ON EVERYTHING
 YOU BUY IN RADIO**

Cover to cover, this book is the most valuable guide you ever saw in radio shopping — and *saving*. It's brand new and complete right down to the last RF Choke. If you're a radio servicer, you'll find extra profits in this big "silent partner." Over 50,000 profit-packed items listed! If you're a "ham" you'll want this FREE catalog because it has all the latest "wrinkles" in amateur reception. If you're a sound engineer, you'll be more than a little interested in Lafayette P.A. for 1939 — as modern as tomorrow! And if you're just John Q. Jones, American citizen, here's your chance in a lifetime to get that auto radio, that new Console, that camera you've wanted and thought you couldn't afford. Send for this eye-opening FREE catalog now! You'll thank us from this day on.

**VALU-BILL says —
 I wouldn't lose any
 time clipping it!**



WHOLESALE RADIO SERVICE CO. INC.
 NEW YORK, N. Y. • CHICAGO, ILL. • ATLANTA, GA.
 100 SIXTH AVENUE 901 W. JACKSON BLVD. 205 PEACHTREE STREET
 BOSTON, MASS. • BRONX, N. Y. • NEWARK, N. J. • JAMAICA, L. I.

WHOLESALE RADIO SERVICE CO., INC.
 100 Sixth Avenue New York, N. Y.
 Rush FREE 1939 Catalog No. 73-3K8

NAME _____
 ADDRESS _____
 CITY _____ STATE _____

PASTE COUPON ON PENNY POSTCARD

Please Say That You Saw It in RADIO-CRAFT

250,000 DOUBLE FACE RECORDS

Decca, Brunswick, Vocalion, Blue Bird
Victor, Melotone, Perfect

**Standard 10 Inch Size
Double Face Phonograph Records**

swing numbers, waltzes, dance, vocal, instrumental, hill billy, old time, sentimental, &c., &c.; over 1000 different selections, made by Rudy Vallee, Lombardo, Lopez, Nelson, Whiteman, Bernie, Crosby, Mills Bros., Morgan and a host of others.

Each record has been played, tested and guaranteed. All records are electrically recorded.

The regular price of these records is 35c to 75c each. NOW only **9c** each, 12 for \$1. 25 for \$2. No order accepted for less than \$1.

RCA RECORD PLAYER

An all electric machine; plays all 10 or 12 inch records. Connects to any AC radio and the music comes through your loud speaker as clearly and marvelously as your radio is capable of producing. Volume is easily regulated.

RCA VICTOR

Model R-93-C
Regular price
\$14.95

Our special price

\$7.85

Send check or money order—or mail coupon below to address nearest you.



Dept. D-15 **Modell's** Since 1889

56 W. Washington St. | 57 Forsyth St. | 58 Cortlandt St.
Chicago, Ill. | Atlanta, Ga. | New York, N. Y.

MODELL'S Dept. D-15, 58 Cortlandt St., New York City, N. Y.
Enclosed is \$1 for 12 records, \$2 for 25 records, \$7.85 for Victor Player R-93-C. Send me illustrated bulletin.

NAME

ADDRESS

CITY STATE

PASTE COUPON ON PENNY POSTCARD

CONSTRUCTION DETAILS OF A 441-LINE TELECEIVER

(Continued from page 240)

- Two I.R.C. resistors, 5 megs., 1 W., R42, R43;
- Three I.R.C. resistors, 0.5-meg., 1 W., R44, R45, R64;
- Two I.R.C. resistors, 1,000 ohms, 1 W., R46, R47;
- Two I.R.C. resistors, 0.1-meg., 1 W., R50, R51;
- One I.R.C. resistor, 3,000 ohms, 1 W., R56;
- Two I.R.C. resistors, 1 meg., 1 W., R57, R59;
- One I.R.C. resistor, 2.5 megs., 1 W., R58;
- One I.R.C. resistor, 0.2-meg., 1 W., R61;
- One I.R.C. resistor, 0.3-meg., 1 W., R62.

- Potentiometers**
- One I.R.C. or Centralab potentiometer, 2,000 ohms, 1 W, R14;
 - Two I.R.C. or Centralab potentiometers, 0.1-meg., 1 W., R39, R55;
 - One I.R.C. or Centralab potentiometer, 0.25-meg., 1 W., R40;
 - One I.R.C. or Centralab potentiometer, 50,000 ohms, 1 W., R54;
 - One I.R.C. or Centralab potentiometer, 0.3-meg., 1 W., R63;
 - Two I.R.C. or Centralab potentiometers, 1 meg., 1 W., R65, R66.

- Miscellaneous**
- One chassis, 24 x 10 x 3 ins.;
 - One set of coils (see Figs. 2 and 3 for construction details), L1 to L8 (inclusive); sockets, hardware, hookup wire, etc.

Most Radio mail order houses can supply these items if properly identified as to title of article, issue (month) of Radio-Craft and year.

Editor's note: Modern television employs 60 fields per second of 22½ lines each. The 1st field is then interlaced with the 2nd to make one complete frame or image, and then the 3rd field with the 4th, and so on to make 30 complete frames or images per second. Interlacing in this fashion is employed to reduce flicker.

SERVICING QUESTIONS & ANSWERS

(Continued from page 230B)

Also when the set plays and is tuned slightly off-resonance it is very distorted and choppy. The set also has plenty of noise as though there was a loose connection and also a loss of quality when this occurs.

(A.) To correct the trouble, we advise replacement of the three 0.05-mf. grid filter condensers in the R.F., 1st-detector and I.F. circuits. Check carefully all connections to and of the oscillator coil and more especially, the oscillator series condenser. This latter unit has given cause for much complaint.

Upon several occasions, short-circuiting I.F. trimmers have produced symptoms similar to those you have experienced.

POWER TRANSFORMER OVERHEATS

(92) H. G. Tack, Asbury Park, N. J.
(Q.) In Atwater Kent model 75, serial No. 701061, the power transformer becomes so hot, that the set starts smoking and all the pitch runs out like fluid. The speech or music gets distorted. It is a phonograph combination set.

(A.) We advise replacing the power transformer. Replace both resistors connected in series across the field coil. An accurate check will disclose a change in resistance. These resistors supply grid bias for the power tubes.

CASH IN ON YOUR SPARE TIME!

300 WAYS TO MAKE MONEY

ONLY **25c** Per Copy



68 PAGES

BRAND NEW BOOK 40,000 WORDS in TEXT!

SOLD ON A MONEY-BACK GUARANTEE!

In "CASH IN" you get ALL the real money-makers—dozens of profitable tested mail order plans, confidential business secrets, dozens of practical tested formulas, successful tested schemes—actual experiences of men who have started on a shoestring—with less than \$10 capital.

Buyers of This Book Tell Us—

... "Biggest value I've yet to see. Book is worth at least a dollar." S. HUDA, Bklyn, N. Y.

... "Your book is as good if not better than others selling at \$1.00."
GEORGE BRUNET, Montreal, Can.

... "CASH IN is the best value I have yet to see in the mail order field."
LAWRENCE FOX, Brooklyn, N. Y.

"CASH IN" contains only tested ideas covering every type of full—or spare-time enterprise—it's a "masterpiece" in business ventures.

25 CENTS per copy. Sent POSTPAID anywhere upon receipt of 25 cents U.S. stamps or coin.

NATIONAL PLANS INSTITUTE
246-R FIFTH AVENUE NEW YORK, N. Y.

BARGAIN TUBES!

ALL GUARANTEED					
24A	.25	55	.15	5Z3	.30
35/51	.25	71A	.20	25Z5	.30
45	.20	75	.25	G Type	.35
47	.30	80	.25	Metal	.35

and many others. Write for Catalog!
NEW YORK RADIO SUPPLY CO.
152 WEST 42 ST. NEW YORK, N. Y.

PATENTS—TRADE MARKS

All cases submitted given personal attention by members of the firm.

Form "Evidence of Conception" with instructions for use and "Schedule of Government and Attorneys Fees"—Free

LANCASTER, ALLWINE & ROMMEL
PATENT LAW OFFICES
436 Bowen Bldg. Washington, D. C.

FREE TRIAL OFFER

NEW REMINGTON NOISELESS PORTABLE!
AS LITTLE AS

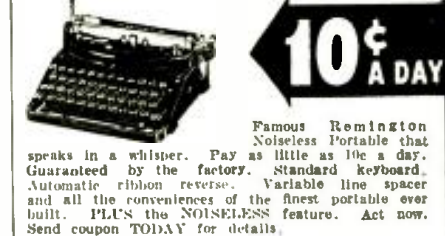

10¢ A DAY

Famous Remington Noiseless Portable that speaks in a whisper. Pay as little as 10¢ a day. Guaranteed by the factory. Standard keyboard. Automatic ribbon reverse. Variable line spacer and all the conveniences of the finest portable ever built. PLUS the NOISELESS feature. Act now. Send coupon TODAY for details.

You don't RISK a Penny

We send you Remington Noiseless Portable for 10 days' free trial. If not satisfied, send it back. We pay all shipping charges.

Typing Course and Carrying Case

You will receive FREE a complete simplified home course in Touch Typing, a handsome sturdy carrying case is included. No obligation. Mail coupon for full details—NOW.

Remington Rand, Inc., Dept. 189-10, 465 Washington St., Buffalo, N. Y.

Tell me, without obligation, how to get a Free Trial of a new Remington Noiseless Portable, including Carrying Case and Free Typing Course for as little as 10¢ a day. Send Catalogue.

Name

Address

City..... State.....

Gentlemen

THE SPEAKER OF THE HOUSE

● Cinaudagraph permanent magnet speakers need no special introduction. America's foremost engineers in radio and sound long recognized the precision engineering and superior workmanship of these speakers. Now YOU can enjoy Cinaudagraph's famed true-fidelity performance at no extra cost. For today, these speakers are competitively priced. Complete details on request.

CINAUDAGRAPH CORPORATION
Speaker Division
STAMFORD CONNECTICUT
EXPORT DEPT., 100 VARICK ST., N. Y. C.

Please Say That You Saw It in RADIO-CRAFT

SKY HIGH PERFORMANCE AT DOWN-TO-EARTH PRICES!

DYNOPTIMUM



RCP's new DYNOPTIMUM Tube Tester is so far ahead in quality, in accuracy and in rock-bottom economy—it's no wonder servicemen say "the best ever"! Its amazing flexibility will help you detect troublesome tubes quicker and more accurately. Measure the advantages of this outstanding tester! Convince yourself of its real money-saving value.

Tests all tubes, including the new OZ4, cold cathode rectifiers, metal and glass tubes. Tests ballast tubes. Hot cathode short and leakage test. Hot cathode leakage test. Tests each section of rectifiers and all multi-purpose tubes. Line voltage checked with indication on meter. 3" D'Arsonval meter accurate -2%. Multi-colored "good-bad" scale. Other features described in new catalog.

Model 307 Dependable Tube Tester... your cost **\$16.95**

Also available in combination portable and counter type (Model 307P) at the low cost of **\$18.95.**



You get twenty-two different instruments wrapped in one package with RCP's AC-DC multimeter. Here is versatility plus quality construction—at a price that's hard to believe. Not easy to take. Multitester is the industry's standout "buy."

Large multi-colored dial. Four range A.C. v. —0/5/50/500/1000. Three range ohmmeter 0/500/50,000/500,000 ohms. Low scale measures in tenths of an ohm. Four range D.C. voltmeter 0/5/50/500/1000 volts. Four decimal ranges: minus 12 to plus 24 db. Three current ranges, 0/1/10/100 ma. Send for new catalog containing details.

Model 444 AC-DC Multitester your **\$9.95** cost only



For those seeking a dependable pocket size tester, we offer "Trouble Shooter"—the lowest priced "legitimate" tester on the market. It weighs only 21 ounces, and fits right in your pocket. Every service man should have one.

Model 432 Trouble Shooter Complete only **\$5.95**

RCP Instruments are the first step in good service. They are carried by all leading distributors. If not stocked by your local jobber, write direct.

FREE!! New catalog, just off the press describing in detail the complete new line of DEPENDABLE RCP Test Instruments. Use convenient coupon.

RADIO CITY Products Co.

88 PARK PLACE NEW YORK CITY

FREE

RADIO CITY PRODUCTS CO., INC. (RC1038)
88 PARK PLACE, NEW YORK CITY.

Rush me free new descriptive catalog on Dependable Instruments.

Name

Address

City State

PASTE COUPON ON PENNY POSTCARD.

"SIGNAL-TEST" SYSTEM OF TROUBLE-SHOOTING

(Continued from page 209)

are not particularly complicated but have nevertheless been quite difficult to localize heretofore.

Suppose, as the first example, that the trouble seems to be in the automatic volume control circuit . . . Suppose, further, that by means of a single probe you could check the presence or absence of the I.F. signal at the anode of the A.V.C. tube, point 1 in Fig. 1 (or at the control-grid, if the A.V.C. tube happened to be of the same type); and simultaneously measure the rectified voltage being developed by the A.V.C. rectifier, point 2 in Fig. 1 (this rectified voltage being the true voltage within a few per cent). The information thus gleaned is definite and is obtained in the amount of time required to place 2 probe points in contact with the circuits under observation. Assuming that voltage is available at the A.V.C. tube, the voltage probe then is placed upon the control-grids of the various control tubes (one tube at a time) and the A.V.C. voltage applied to that grid (if it is being applied) is measured. See points 3, 4 and 5 in Fig. 1.

There is a very definite convenience provided by such ease of operation because there never can be any doubt either (1) about the presence of a signal (the program, for instance) at any point in the signal circuit, or (2) about the voltage (power-supply output) at the point. And if the voltage is developed as the result of the application of the signal, then it is of great importance to be able to establish both simultaneously, so as to obtain positive identification of conditions at the point being tested. (The high resistances in the circuit do not interfere with voltage measurements.)

A. F. C. CIRCUITS

After all is said and done, servicing is a problem when the "difficult-to-find" troubles exist in a receiver and it is then that a system which localizes rapidly proves itself. Take for example, a condition such as this.

The automatic frequency control circuit in a receiver is not functioning due to a defect in the "discriminator" system. Existing systems of trouble analysis would find it extremely difficult to check the signal and control voltages present in such a circuit.

But with the signal as the basis of trouble analysis, and the proper method of voltage measurement as the secondary test, it would be possible to establish simultaneously the presence of the signal voltages being fed into the discriminator transformer and the

discriminator diodes as well as the control voltages developed in the output of the diode.

The signal voltages are checked by placing the probe point in contact with the signal-carrying circuits any place along the line, points 1, 2, 3 and 4 in Fig. 2. Although present-day voltage measurement, if applied to such a circuit, would indicate the presence or absence of control voltage output, it would in no way embrace the remainder of the circuit. If no voltage were available, the conditions in the remainder of the circuit would remain a mystery. The signal generator method of probing would not operate because too many independent, yet associated, elements remain in the circuit and cannot be isolated. But with the signal-tracing method, the signal fed into the discriminator transformer can be checked across each and every part of the transformer assembly.

IMPERFECT-FILTERING CONDITIONS

Still another example of interest and one which is representative of an uncommon trouble is imperfect filtering between associated circuits carrying currents of different frequencies. The signal-tracing method, in contrast to other test systems, allows probing of the various circuits at the different frequencies to establish if the improper operation of the receiver is due to the fact that filter circuits are not intact. Such probing is done by placing a probe in contact with the various elements along the circuit which connects the 2 portions of the receiver as, for example, the I.F. circuit and the R.F. via the A.V.C. system. See points 6, 7 and 8 in Fig. 1. The various feed circuits associated with the A.V.C. system are checked to see if an intermediate

(Continued on following page)

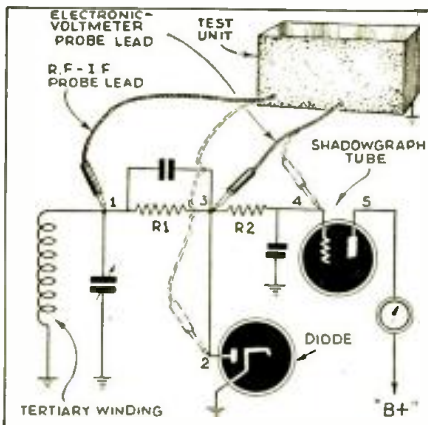

Fig. 3. Testing Shadowgraph circuits.

Please Say That You Saw It in RADIO-CRAFT

RECORD BREAKING VALUES!

RADIO TUBES

All brand new, top-flight RCA licensed radio receiving tubes. Packed in factory sealed cartons—guaranteed for 90 days.

Type	Each	Type	Each
2E5	19c	6B7	15c
50	19c	12A	15c
2A7	15c	27	15c
6A4	15c	56	15c
6A7	15c	57	15c



2A7H 15c

LACQUERED HOOKUP WIRE

Rubber insulated with lacquer braid overall. Strands tinned. Easily soldered and worked.

K16344—100-ft. coil. Your Cost.....**28¢**

K16345—250-ft. coil. Your Cost.....**67¢**

DELUXE PICKUP



New hi-fidelity magnetic pickup with modern

type tangent head—minimizes tracking error, increases record life and reproducing quality. Equipped with 18" shielded cable. For 10" and 12" records. **\$2.86**

K521—Your Cost.....

LAFAYETTE PHONO RADIO COMBINATION

5 tube AC-DC Table Model FS-11—has all the extra-unique features you expect to find only in combinations selling for three times the cost. New beauty, new tone **ONLY**—more amazing performance! **\$19.95**



FREE NEW 1939 CATALOG!

We show you here a very small sample of the values in this new FREE catalog. Page for page, you can't beat it in stock selection and economy prices! Send for your copy today.

FLASH

List price P. A. Catalog available to servicemen. Write to Public Address Division for free copy.

WHOLESALE RADIO SERVICE CO. INC.
NEW YORK, N.Y. • CHICAGO, ILL. • ATLANTA, GA.
100 SIXTH AVENUE • 80 W. JACKSON BLVD. • 245 PRITCHETT STREET
BOSTON, MASS. • BROOKLYN, N.Y. • NEWARK, N.J. • JAMAICA, L.I.

WHOLESALE RADIO SERVICE CO., INC.
100 Sixth Avenue, New York, N. Y.

Rush FREE 1939 Catalog No. 73-3KA

VALU-BILL says: "It's a regular encyclopedia! DON'T MISS IT!"

Name _____
Address _____
City _____ State _____

PASTE COUPON ON PENNY POSTCARD

"SIGNAL-TEST" SYSTEM OF TROUBLE-SHOOTING

(Continued from preceding page)

frequency is feeding into the R.F. or mixer input circuit, because one of the bypass condensers or isolating resistors in the A.V.C. bus is not intact.

SHADOWGRAPH CIRCUITS

The number of hitherto complex troubles which can be easily detected by means of signal tracing is entirely too great to quote in these pages; however, before closing this article, we would like to give just one more specific case, and you will no doubt see the value of knowing whether or not a signal exists at certain points in a receiver. The Shadowgraph circuit in Philco receivers receives its voltage from a diode rectifier, which in turn receives its signal voltage from the tertiary (third) winding in the last I.F. transformer. The diode load is 2 megohms and the shadowgraph tube grid resistor is also 2 megohms. The rectified voltage fed to the shadowgraph tube through the 2 megohm resistor is very low. If the shadowgraph is inoperative and present-day routine tests are applied, a number of tests, at least 6, would be needed to establish that the tertiary winding feeding this tube is not feeding a signal to the diode rectifier.

With the trouble localization method outlined herein and fulfilling the requirements set forth, on the other hand, a single operation would establish this condition and 2 measurements instead of 6 would indicate that the diode was not supplying the bias voltage. The entire circuit could be checked in less than 1 minute to establish complete conditions at the various points in the system. See Fig. 3.

As you no doubt realize, the application of the system to daily, run-of-the-mill servicing is dependent upon operating and control voltage measurements of a type and with a meter hitherto not available. Such a voltmeter would be used to check the D.C. voltages at the control-grids; and the bias voltage applied through the 2-megohm resistor to the shadowgraph tube control grid. This voltmeter would also indicate D.C. voltage of either plus or minus polarity with respect to ground. With it could be plotted the A.F.C. voltage developed by the discriminator tube as the receiver was tuned both sides of the carrier, by simply connecting the voltmeter probe to the control voltage bus. . . . So much for these peculiar troubles.

ETC.—INCLUDING "INTERMITTENTS"

Items such as shorted bypass condensers, open tuning coils, shorted transformers of various kinds, open-circuited or shorted resistors which influence both signal and voltage, are located with the greatest of ease and do not justify extended discussion.

Last but by far not the least is the advantage of such a method of testing when applied to "intermittents." After a prolonged series of tests we feel confident in saying that such a system, when properly applied, is the solution to the "intermittent" problem (unexpected cutting off of reproduction). This has been proved in practice upon a number of receivers. As you read the following description of the method used to trace the signal and note the breakdown of the receiver into various sections, you will see how the "intermittent" situation is solved.

"SIGNAL-TEST" EQUIPMENT

In order to be able to most quickly and conveniently apply this common-denominator method of trouble localization a special

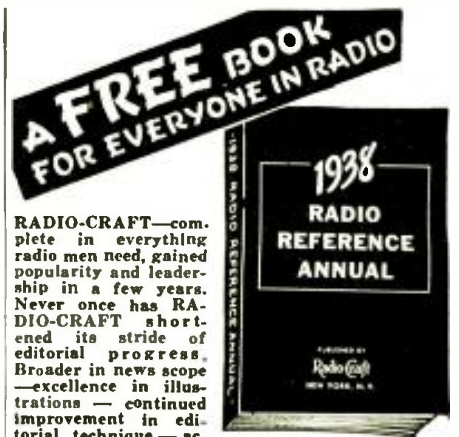

A FREE BOOK FOR EVERYONE IN RADIO

RADIO-CRAFT—complete in everything radio men need, gained popularity and leadership in a few years. Never once has RADIO-CRAFT shorted its stride of editorial progress. Broader in news scope—excellence in illustrations—continued improvement in editorial technique—accuracy in wiring diagrams and schematics—these are the basic ideals upon which RADIO-CRAFT success has been achieved. The publishers of RADIO-CRAFT make you a very liberal offer—they want you to read every monthly issue—they want you to get the benefits as do thousands of other readers—they have arranged a special offer with an attractive premium—and they have made a special price for you.

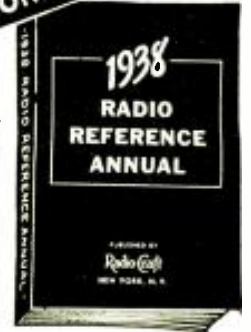

**64 PAGES
6 X 9 INCHES
OVER 90
ILLUSTRATIONS**

To readers of this announcement the SPECIAL OFFER IS . . . A SEVEN MONTHS' SUBSCRIPTION TO RADIO-CRAFT and a FREE COPY of the 1938 RADIO REFERENCE ANNUAL. If you are a regular subscriber at the present time, you may take advantage of this opportunity just the same. The publishers will be glad to extend your present subscription an additional Seven Months, and at the same time send you a FREE copy of this new book. Use the coupon below for entering your subscription to RADIO-CRAFT.

Contents of the

1938 RADIO REFERENCE ANNUAL SET BUILDING

This particular section of the 1938 RADIO REFERENCE ANNUAL contains a description of a number of important, as well as interesting, receivers. They are as follows: A Simplified Converter; A Farm Battery Receiver; An Executive's A.C.-D.C. Desk Set; Handy Book-End Novel Receiver. Other receivers described are: Crystal Set, Portable Battery Receiver, and several others. Each receiver is described accurately, complete with constructional data and list of parts required.

SERVICING

This chapter is devoted to Radio Service Instruments in general. Special emphasis is given to a number of the more essential instruments—they are: Service Oscillator, Mixer Circuits, V. T. Voltmeters and an Interference Eliminator.

PUBLIC ADDRESS

For those who find public address their chief interest, here you will find complete design and construction on a P.A. Tuner; a Handy Amplifier; and an Infinite Baffle Loud Speaker.

TEST EQUIPMENT

Radio Service Men who prefer to build their own equipment will find all the construction details necessary for building the following: Condenser Analyzer, Midset Oscilloscope with 1" and 2" tubes; Service Audio Oscillator.

GENERAL INTEREST ARTICLES

A variety of topics have been selected for their interest and importance. These subjects cover—Home Broadcaster; Remote Set Tuning; Carrier-Type Interphone Systems and a number of others.

MISCELLANEOUS

A comprehensive index of important articles which appeared in RADIO-CRAFT during 1937. This section also includes data on recently developed tubes and many other helpful hints and suggestions.

RADIO - CRAFT

99 HUDSON STREET • NEW YORK, N. Y.

RADIO-CRAFT RC-1038
99 Hudson Street, New York, N. Y.
Gentlemen: Enclosed you will find my remittance of One Dollar (\$1.00) for which enter my subscription to RADIO-CRAFT Magazine for Seven Months. Send me, ABSOLUTELY FREE, and POSTPAID, my copy of the 1938 RADIO REFERENCE ANNUAL.

New Subscriber Extend present subscription

Name _____
Address _____
City _____ State _____

(Send remittance by check or money order. Register letter if you send cash or unused U.S. Postage Stamps.)

Please Say That You Saw It in RADIO-CRAFT

test instrument called the "Chanalyst" has been developed by the writer. It is shown photographically in Figs. A and B. This unit used embraces a number of "pick-up channels," each of these channels being calibrated in reference units and connected to an indicator—actually, a cathode-ray-tube tuning eye.

One pick-up or test channel covers the R.F. and I.F. range from 95 kc. to 1,700 kc. in 3 bands.

Another channel covers the oscillator stage in a superheterodyne and is calibrated over a range from 600 kc. to 15,000 kc. (15 mc.) and a supplementary arrangement provides a check upon the performance of the oscillator up to 70 mc.

Another channel operates over the audio-frequency band of 50 to 50,000 cycles.

A 4th channel is used as a watts power or "wattage" indicator to show the current consumption of the receiver under test.

And 5th, an electronic voltmeter of special design is used. It has an input resistance value of 10,000,000 ohms and is operative over 4 ranges. These are -5 through 0 to +5 volts; -25 volts through 0 to +25 volts; -100 volts through 0 to +100 volts and from -500 volts through 0 to +500 volts—without switching the prods to compensate a polarity change!

Naturally you wonder how the signal is traced without interfering with the normal operation of the receiver. The R.F., I.F. and oscillator channel pick-up is accomplished through a coupling capacity of less than 1.0 mmf. (one micromicrofarad). This minute coupling capacity is located in the probe, which is connected to the unit through shielded cables. Since testing of R.F. channels is done at broadcast frequencies between 600 and 900 kc., the detuning effect is negligible.

This entire R.F. and I.F. band is calibrated in frequency. Checking of the R.F. channels at frequencies above the broadcast band is not provided because monitoring of the other portions of the receiver at frequencies above the broadcast band immediately identifies if the R.F. circuit is inoperative. In other words, if a 3-band receiver operates over the broadcast band and the next band, but is inoperative over the highest band, the trouble is immediately localized as being in the R.F. system, because the I.F. channel in the receiver is not changed and because the oscillator pick-up channel or the voltmeter is used to check the operation of the oscillator.

The detuning effect upon the oscillator at the test frequencies used in the broadcast band is negligible. At the higher frequencies the detuning is more apparent, but it does not interfere with the operation of the unit for any type of test, because the sole purpose of the pick-up channel is to see if the oscillator is operating and to probe through the oscillator circuit in the receiver to see if the circuit is intact.

A pick-up probe is provided for the R.F. and I.F. channel, the oscillator channel; the A.F. channel and the voltmeter. As the result of the design of the unit, each or all of these probes can be used at the same time and placed in contact with any portion of the respective circuits in the receiver.

The uses of these probes, details of the R.F. and I.F. resonant channels, and details of the A.F. channel and of the voltmeter, will be described in Part II; the watts power indicator, an important element in the Chanalyst, will be described in detail.

This article has been prepared from data supplied by courtesy of Service Instruments, Inc.

NATIONAL UNION

QUALITY PRODUCTS

RADIO RECEIVING and TELEVISION TUBES

CONDENSERS

Profitable to Use . . . Profitable to Sell
because National Union Products are well
made, trouble free . . . Radio Service Engineers
have proven it! For prices and sales information
write NATIONAL UNION RADIO CORP., NEWARK, N. J.

Be sure to read the classified section which appears on page 248 of this issue

6-VOLT UNIVERSAL POWER PACK
 LISTS \$15.00
At Less Than Price 6-Prong Synchronous Vibrator Alone!
 Operates 2 volt set from 6 volt storage battery, also operates 5 Volt house sets, auto sets, S.W. transmitters and receivers. Output, 180 Volts at 50 M.A. On 4 Volt cell supplies 120 Volts at 30 M.A. Housed in case 3"x4 1/4"x6 3/4". Ship. Only \$329 NET
 ping Wt. 6 lbs.

456 KC. SUPER COIL KIT BROADCAST BAND ONLY
 KIT CONSISTS OF: 1-2 Gang condenser; 1-Ant. Coil; 1-Geo. Coil; 1-456 KC. Input I.F.; 1-456 KC. Output I.F.; 1-300-600 Padder; 1 Wiring Diagram. All ABOVE PARTS \$149
 SAME AS ABOVE WITH-3 Gang condenser & Presetector coil \$1.99
 25% Deposit Required with Order, Balance C. O. D.
ARROW SALES CO. 27 S. JEFFERSON ST. CHICAGO, ILL

Listen Comfortably
 WITH
BRUSH
"Hushatone"
 (pillow speaker)

Put this radio accessory under your pillow and listen to your favorite programs. Write for details.

THE BRUSH DEVELOPMENT CO.
 3312 Perkins Ave., Cleveland, Ohio

Please Say That You Saw It in RADIO-CRAFT

**WESTINGHOUSE
UNIVERSAL MOTOR**

\$2.55 110 Volts
AC and DC
Shipping
Weight
3 lbs.



Specifications: 1/30 H.P. operates on either A.C. or D.C., 110 volts, 5000 R.P.M. Rheostat can be used to vary speed. Height 3 1/4". Length 3 3/4". Width 1 1/4". Shaft 1/4", one inch long. Can be used to drive Sewing Machines, Models, Buffing Lathes, Tool-holding Head, Drills, Grindstones, etc., etc.

MOTOR only **\$2.55**
MOTOR with Arbor and 1/4" Chuck **\$3.55**
Add 25c for special packing and mailing anywhere in U. S. A.

MICROPHONE and RECEIVER

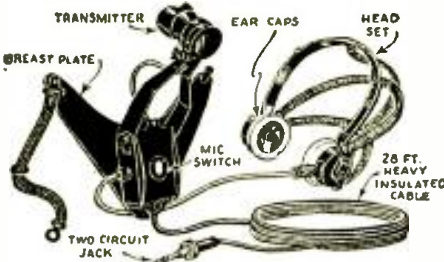

THIS Microphone and telephone headset outfit was built especially for the U. S. Navy Aviation Corps. The Holtzer-Cabot Electric Company constructed the outfit to Government specifications. The outfit consists of a low-impedance carbon microphone (transmitter), securely fastened to a metal breast-plate, and a set of heavy-duty, low-impedance earphones. A specially constructed switch on the back of the breast-plate controls the microphone circuit. The earphones are U.S.N. Utah type, attached to adjustable headband. Twenty-eight feet of very heavy weather and waterproof conductor cable is furnished. Current of not more than 10 volts should be used. A storage battery is the most satisfactory current supply. U. S. Navy Airplane-type Microphone and Receiver as described **\$4.95**
Shipping Weight—9 lbs.

We will forward Shipments by Express Collect if sufficient postage is not included.

WELLWORTH TRADING COMPANY
560 W. Washington Blvd., Dept. RC-1038, Chicago, Ill.

FREE

..tells how to

**SAVE MONEY
ON EVERYTHING YOU BUY!**

.. NOW READY—big new Bargain Bulletin. Describes, pictures hundreds of amazing values. Tell us where to RUSH your FREE COPY:—

YOU can save many dollars on your purchases out of this new Bargain Bulletin—on Radio Sets and Parts, Sporting Goods, Watches, Cameras, Typewriters, Electrical Specialties, Novelties, and scores of other articles. Thousands of smart buyers have discovered this sure way to save money on standard, highest quality merchandise. You get prompt, courteous service, complete reliability. Get PROOF of big savings—take your pick of the amazing values shown to fill your present needs. **YOUR FREE BARGAIN BULLETIN IS WAITING** Fill in and mail NOW the coupon below—or send postal or letter. No obligation. Some bargains offers limited—rush your request while stocks are at their best.

RADIO CIRCULAR CO., Inc.
915 Broadway (Dept. R.C.), New York, N. Y.

MAIL THIS COUPON NOW

RADIO CIRCULAR CO., Inc. Dept. RC-1038
Yes, Rush my Free Bargain Bulletin. No obligation to me.

NAME

ST. & NO.

CITY & STATE

**HOME-BUILT 11-TUBE SET
INTRODUCES
"SYNCHROTRONIC"
REPRODUCTION**

(Continued from page 217-218)

LIST OF PARTS

- One 3-gang tuning condenser, 356 mmf., C;
- One Aerovox condenser, type 284, 0.05-mf., C1;
- Eleven Solar bakelite condensers, type MP-4147, 0.1-mf., C2, C3, C6, C9, C13, C15, C17, C20, C24, C25, C29;
- One Solar padder condenser, 400 mmf., tolerance 3%, C4;
- One Solar mica condenser, MW-1227, 0.001-mf., C5;
- Two Solar mica condensers, MW-1216, 100 mmf., C7, C8;
- One Aerovox mica condenser, type 1450, 0.01-mf., C10;
- Two Solar condensers, type DT-880, 15 mf., 25 V., C11, C14;
- Four Aerovox condensers, type 484, 0.25-mf., C12, C16, C18, C21;
- One Solar electrolytic cardboard condenser, type LG5-88, 8-8 mf., 450 V., C19;
- Two Aerovox condensers, type 484, 0.02-mf., C22, C23;
- One Solar bakelite condenser, MP-4137, 0.02-mf., C26;
- One Cornell-Dubilier condenser, type KR-5888 canned, 8-8 mf., 450 V., C28;
- One Cornell-Dubilier mica condenser, type 1 W., 0.003-mf., C30;
- Two Centralab resistors, type 310, 0.25-meg., 1/4 to 1/2-W., R1, R13;
- One Centralab resistor, type 310, 900 ohms, 1/4 to 1/2-W., R2;
- One Centralab resistor, type 310, 300 ohms, 1/4 to 1/2-W., R3;
- Two Centralab resistors, type 310, 50,000 ohms, 1/4 to 1/2-W., R5, R7;
- One Centralab resistor, type 310, 4,000 ohms, 1/4 to 1/2-W., R6;
- One Centralab resistor, type 310, 0.5-meg., 1/4 to 1/2-W., R8;
- One Centralab resistor, type 310, 1 meg., 1/4 to 1/2-W., R9;
- One Centralab resistor, type 310, 200 ohms, 1/4 to 1/2-W., R11;
- One Centralab resistor, type 310, 600 ohms, 1/4 to 1/2-W., R14;
- One Centralab resistor, type 310, 10,000 ohms, 1/4 to 1/2-W., R15;
- One Centralab resistor, type 310, 2,500 ohms, 1/4 to 1/2-W., R20;
- One Centralab resistor, type 310, 0.1-meg., 1/4 to 1/2-W., R21;
- Two Centralab resistors, type 310, 0.1-meg., 1/4 to 1/2-W., R27, R29;
- One Centralab resistor, type 310, 5,000 ohms, 1/4 to 1/2-W., R28;
- One Centralab resistor, type 310, 4,000 ohms, 1/4 to 1/2-W., R34;
- Three Aerovox carbon resistors, type 1094, 30,000 ohms, 1 W., R4, R22, R23;
- One Aerovox carbon resistor, type 1094, 0.1-meg., 1 W., R16;
- One Aerovox carbon resistor, type 1094, 0.5-meg., 1 W., R18;
- Four Aerovox carbon resistors, type 1094, 50,000 ohms, 1 W., R19, R25, R26, R12;
- One Aerovox carbon resistor, type 1094, 25,000 ohms, 1 W., R24;
- One Aerovox carbon resistor, type 1094, 10,000 ohms, 1 W., R32;
- One Aerovox carbon resistor, type 1094, 800 ohms, 1 W., R33;
- One Centralab volume control with switch type 62-116, 1 meg., R10;
- One Centralab volume control, type 72-122, 0.1-meg., R17;
- One Centralab volume control, type 72-117, 50,000 ohms, R35;
- One I.R.C. resistor, type AB, 300 ohms, 10 W., R30;

The FOURSOME

MULTIPLIES THE CONVENIENCE OF YOUR ELECTRICITY

This sturdy four-way electric outlet is manufactured by the Colt's Patent Firearms Mfg. Co. and is not to be confused with the flimsy outlets sold in chain stores.

Ideal for the radio serviceman's work bench—Test instruments, gets under test. Oscilloscopes, Speakers, Soldering Iron, etc. May be placed flat on the table or floor, also plugs directly into base outlet, as illustrated.

It may be used in homes, factories, offices and wherever several electrical devices, such as floor and table lamps, radios, toasters, percolators, irons and other electrical appliances are used.

Diameter 3 1/4", fitted with five foot flat rubber cable and plug. Weight 1 lb. (Factory List Price \$2.50)

Our special price
F.O.B. N. Y.
75c each
3 for \$1.50

Send 10c for catalog, which includes a Facsimile of the Declaration of Independence, 9" x 10", with buff background, suitable for framing. Regular price of Facsimile alone 45c.

GOLD SHIELD PRODUCTS
Dept. RC 350 Greenwich St. New York, N. Y.

FORMULAS AND RECIPES

For the Practical Man
Here is the Contents of the Book

1. Adhesives: Glues, Cements, Gums, Mucilages, Lubricants.
2. Cleansing: Stain Removers, Paint Removers, Bleaches, Cleaning Fluids.
3. Metal Craft: Coloring, Oxidizing, Plating, Repairing, Welding, Polishes, Alloys, Solders, Amalgams.
4. Paints: Colors, Stains, Varnishes, Enamels, Laminous Paint, Washable Paint, Paint-Remover, Waterproofing, Fireproofing.
5. Glass-Working: Cutting, Drilling, Boring, Bending, Blowing, Etching, Engraving, Frosting, Silvering, etc.
6. Wood-craft: Filters, Fireproofing, Acid-proofing, Waterproofing; Furniture Polishes, Finishes, etc.
7. Inks: Recipes, Erudicators, Ink Stain Removers; Special Inks: Colored, Indelible, Synthetic, Invisible, Hectograph.
8. Photography: Developers, Emulsions, Fixers, Sensitizing, Toning, Printing, Photographic Paper, Blueprint Paper.
9. Antidotes for Poisons, Remedies for Burns and Scalds, Disinfectants, First-Aid in Accidents, Emergency Remedies, Home Remedies.
10. Preparation, Manipulation, Handling, Mixing, Measuring, Weighing, Filtering, Straining Solutions; List of Technical Substances; Emulsifying; Use of Hydrometer; Use of Thermometer; Tables of Weights and Measures, Decimal Systems, Useful Tables.

PRICE 50c POSTPAID
Send check, cash, money order or stamps.

TECHNIFAX
Division RC-1038
558 W. WASHINGTON BLVD., CHICAGO, ILL.

**To Readers of
RADIO-CRAFT**

FREE POSTCARDS MAY BE HAD UPON WRITING TO THE PUBLISHERS

These post cards make it easy to answer advertisements which appear in RADIO-CRAFT, without cutting valuable data which you may wish to save.

Many times manufacturers request you to "clip the coupon" when answering their ads. Often this means destroying part of an article on the reverse page you may need later for reference. Save your RADIO-CRAFT issues complete. If you should ever want to sell bound volumes, or certain copies of RADIO-CRAFT, the resale value of uncut issues is very much higher than that of mutilated ones. So send for a supply of these free post cards and use them in answering all RADIO-CRAFT advertisers.

GET AHEAD IN RADIO TELEVISION

What you should do to win good employment in Radio, Television and broadcasting is told fully in this fascinating free booklet Write now. Dept. RC-10, 3000 S. Figueroa St.

NATIONAL SCHOOLS
LOS ANGELES

FREE BOOK Write Now

Please Say That You Saw It in RADIO-CRAFT

- One I.R.C. resistor, type AB, 15,000 ohms, 10 W., R31;
 - One I.R.C. resistor, type AB, 3,000 ohms, 10 W., R36;
 - One Meissner ferrocart antenna coil, adjustable, type 7413, L1;
 - One Meissner ferrocart R.F. coil, adjustable, type 7558, L2;
 - One Meissner ferrocart oscillator coil, adjustable, type 7560, L3;
 - One Meissner I.F. input transformer, type 5712, L4;
 - One Meissner I.F. output transformer, type 5714, L5;
 - One Thordarson choke, type T-81C15, 0.75-hy., Ch.1;
 - One Stancor choke, type C-1515, 50 hy., or higher inductance, Ch.2;
 - One Thordarson choke, type T-49C91, 4.2 hy., 120 ma., Ch.3;
 - One Thordarson power transformer, type T-70R62, 745 V. C.-T., 105 ma., 5 V. at 3 A., 6.3 V. at 4.5 A. C.-T., T1;
 - One Thordarson output transformer, type T-67S51, primary 14,000 ohms, secondary 4-8-15-500 ohms, T2;
 - One Jensen 10-in. loudspeaker, type ST-164, 1,500-ohm field, 8-ohm voice coil;
 - One Bud black-crackle chassis, 10 x 14 x 3 ins.;
 - One Amphenol tuning eye assembly;
 - Nine Amphenol octal sockets, subpanel type;
 - Two Amphenol 4-prong, subpanel sockets;
 - One Eddie dial;
 - Two Sylvania 6K7 tubes;
 - One Sylvania 6A8 tube;
 - One Sylvania 6H6 tube;
 - One Sylvania 6L7 tube;
 - One Sylvania 6J7 tube;
 - One Sylvania 6N7 tube;
 - Two Sylvania 6F6 tubes;
 - One Sylvania 80 tube;
 - One Sylvania 6G5 tube;
 - Fuse clip, 5 metal tube shields, 5 metal tube clips, 3 ft. shielded wire, 2-ft. 4-wire cable, one 4-prong plug, rubber grommets for mounting tuning condenser and chassis, several tie points;
 - One Patterson Radio Co. cabinet, internal dimensions 15½ x 10½ x 19½ ins. high, heavy construction throughout.
- Most Radio mail order houses can supply these items if properly identified as to title of article, issue (month) of *Radio-Craft* and year.

OPERATING NOTES

(Continued from page 239)

PHILCO 50-A

Dead set with sizzling and flashing in the chassis was caused by a badly carbonized rectifier socket which, in turn, was caused by a terrific rainstorm which blew into the vitals of the set through an open window. (Not a characteristic fault, but interesting.—Editor) With the socket replaced set operated perfectly for a while, then went "dead." Test showed 1 volt on the 47 plate, 50 volts on the screen-grid. Replace the tone control. For a temporary repair leave the tone control out of the circuit.

PHILCO 70-A

No music, just noise of varying intensity, is caused by the defective output transformer primary. Replace the transformer.

PHILCO 345-A CHASSIS

"Dead." An 0.01-mf. condenser from 42 plate often shorts. Replace with a 600-volt unit.

G. ROGAL,
Rogal's Radio Sales & Service,
Paris, Ont., Canada.

Here's YOUR Practical TRAINING for RADIO All in ONE Handy Volume!

HERE AT LAST is a quick, easy, inexpensive way to get the practical radio training you need to qualify for a radio job. Condensed into this one great book, Ghirardi's "Radio Physics Course", you will find the equivalent of THIRTY-SIX easy-to-understand reading courses covering all the essentials of radio, electricity and sound. Here is practical self-instruction that will fit you for many different kinds of jobs.

The Opportunity of a Lifetime!

No longer need you be deprived of the advantage of radio training because of its cost, or the time it usually requires. Think of getting in ONE CONCISE AND COMPACT VOLUME a complete course in ELECTRICITY, a complete course in RADIO, a complete course in SOUND, and in addition thorough instruction in Television, Talkies, Photoelectric Cells and Cathode-Ray Tubes, Testing and Servicing, Automobile, Aircraft and Marine Radio, Short-Wave Reception, and many other special subjects that all go to make up a complete education in the field of radio. And all for the phenomenally low price of \$4.00! This is only a fraction of what you would expect to pay for a course in just one of these essential subjects.

Short-Cut Courses of Self-Instruction Prepared by that World-Famous Authority, ALFRED A. GHIRARDI

Every one of the 36 big sections of "Radio Physics Course" is an expertly prepared home-study course. Each is brief and simplified for time-saving and easy to understand—yet each is so thorough and practical that every minute spent with the book rapidly pushes ahead your preparation for a good-paying radio job. Self-testing review questions and problems for each section make it simple not only to understand everything but also to check your own progress. No previous training or knowledge of mathematics are required. The book is already the most popular book on the market. Because it makes learning radio so very simple, it is praised by students everywhere, and actually used in the courses of more radio schools than any other radio book in the world.

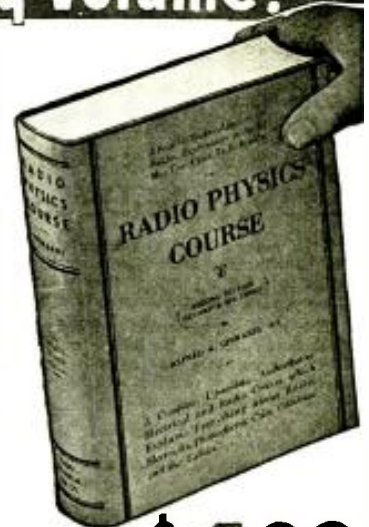

\$4.00
Only **4** **00**
No Further Payments

972 Pages—36 Volumes in One
Radio, Electricity and Sound Complete
Plus Many Other Valuable Special Features
508 Schematic Diagrams, Charts and Photos
856 Review Questions

- | | |
|--|---|
| 1. Radio Broadcasting System. | 19. Construction Features of Vacuum Tubes. |
| 2. Sound, Speech and Music as Related to Broadcasting. | 20. Vacuum Tube Detector and Amplifier Action. |
| 3. Electron Theory, Electric Current. | 21. Radio Frequency Amplification. |
| 4. Electrical Units, Ohm's Law, Resistance. | 22. Superheterodyne Receivers. |
| 5. Electrical Circuits, Batteries. | 23. Design of R.F. Amplifiers and Tuning Coils. |
| 6. Magnetism. | 24. Audio Amplification. |
| 7. Electromagnetism. | 25. Loud Speakers. |
| 8. Electromagnetic Induction. | 26. The Battery Operated Receiver. |
| 9. Inductance and Inductors. | 27. The Power Supply. |
| 10. Capacitance and Condensers. | 28. Electric Receivers. |
| 11. Alternating Current Circuits. | 29. Automobile and Aircraft Receivers. |
| 12. Electric Filters. | 30. Phonograph Pick-ups and Sound Amplifier Systems. |
| 13. Electrical Measuring Instruments. | 31. Short Wave Reception. |
| 14. Electromagnetic Radiations. | 32. Vacuum Tube Applications and Photoelectric Cells. |
| 15. Radio Transmission, the Broadcasting System. | 33. Television. |
| 16. The Receiving Station, Detection with Crystals. | 34. The Antenna and Ground. |
| 17. Elementary Study of the Vacuum Tube. | 35. Testing and Servicing. |
| 18. Vacuum Tube Characteristics. | 36. Sound Motion Pictures. |
- Appendices.

Fit Yourself for a Radio Job Quickly, Easily, at Little Cost

Do it the easy "Ghirardi way" at home with "Radio Physics Course". A few minutes of your spare time daily will give you all the knowledge and training you need to have. Even if you know some of these subjects, you need the book to fill in the gaps of your radio education and bring you up to date.

10-DAY TRIAL

Fill out the coupon below and mail it at once. "Radio Physics Course" will be sent you by return mail. See for yourself its wonderful completeness and simplicity. Keep and read the book for ten days.—Then, if you are not satisfied in every way, return the book undamaged and every penny of your money will be instantly refunded. With this Money-Back Guarantee, you can't lose! So don't delay one moment. This is your big opportunity to get complete training in radio at the amazing price of \$4. Fill out the coupon NOW!

MAIL THIS COUPON TODAY!

RADIO & TECHNICAL PUBLISHING CO.,
45 Astor Place, Dept. RC-108, New York, N. Y.

Enclosed find \$4 for my copy of Ghirardi's "RADIO PHYSICS COURSE", with your 10-day money-back guarantee.

NAME

ADDRESS

CITY STATE

Please send me free descriptive literature about "RADIO PHYSICS COURSE".

A BIG CONTEST! Complete details of the big RADIO-CRAFT TENTH ANNIVERSARY CONTEST appears on page 254 of this issue. Turn to this page NOW for complete details.

CONDENSERS

WRITE US Dealers, servicemen, jobbers and distributors, write us now for catalogue sheet and prices on 1938 line of electrolytic condensers.

ILLINOIS CONDENSER CO., INC.

1160 N. Howe Street
Chicago, Ill., U. S. A.

RADIO COURSES

RADIO OPERATING—BROADCASTING
For Gov't License Preparation

- RADIO SERVICING—including Short Wave
- RADIO PHYSICS—theory and practical
- RADIO AMATEUR CODE—
- TELEVISION ● ELECTRONICS—1 yr. day course 2 yrs. evening

Includes above subjects also Sound servicing—electronic theory, electronic & tube circuits and industrial applications.

Day and Evening Classes. Booklet upon Request

NEW YORK YMCA SCHOOLS

4 W. 64th Street, New York City
Trade & Technical School
Licensed by the State of New York

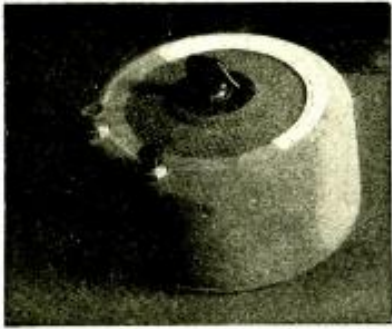

Model TBURS
Size 6½" diameter, 3" high

If it's a Talk-Bak* It's Wright-DeCoster

Even before the latest improvements the Talk-Bak* units were becoming better and better known as the unit that would insure a successful intercommunication system.

The new improvement for simplified installation, greater flexibility and elimination of cross talk has advanced the Talk-Bak* units to a point where their worth is being universally recognized.

Write for Talk-Bak* literature and catalog—include your distributor's name. Wright-DeCoster distributors are always anxious to cooperate.

WRIGHT-DECOSTER, Inc.

2251 University Ave., St. Paul, Minnesota
Export Dept.: M. Simons & Sons Co., New York
Cable Address: "Simonfrice"

Canadian Representatives:
Wm. F. Kelly Co., 1207 Bay St., Toronto, Ontario
Taylor & Pearson, Ltd., Edmonton, Alberta

*Copyrighted.

TRIPLET
Simplified
PUSH-BUTTON TESTING

MODEL 1616
ONLY \$73.34

* Mutual Conductance Per Cent Scale

DYNAMIC MUTUAL CONDUCTANCE
Tube Tester and Volt-Ohm-Milliammeter
Many Claim Dynamic Mutual Conductance...
Triplet Positively Has It.

The hit of the Radio Parts Trade Show was this precise setting push-button tester by Triplet, with its revolutionary advancements. After rotating chart to the tube to be tested, the button to push is clearly marked under each row. Furnished in attractive, all-metal case with lustrous finish. Removable cover for portable or counter use... sloping panel. See it at your Jobbers.

* Rotating Chart Shows Correct Buttons to Push

TRIPLET ELECTRICAL INSTRUMENT CO.
1610 Harmon Dr., Bluffton, Ohio
Please send me more information on
Model 1616
Complete 8 pp. Two-Color Catalog

Name _____
Address _____
City _____ State _____

ANTI-NOISE COUNTERPOISE ANTENNA SYSTEM

(Continued from page 212)

the elementary steps involved and show these by circuit arrangement just as they were recently demonstrated on the stage by engineers V. D. Landon and J. D. Reid of RCA's Advanced Development Receivers Section to members of the Institute of Radio Engineers.

Of especial interest is the fact that it is not necessary to install the antenna in a noise-free area. The Serviceman makes the requisite adjustment of a balancing condenser to compensate local noise conditions (on the broadcast band) when the installation is made. Operating a vacuum cleaner will conveniently supply a noise voltage to aid in making this adjustment.

ANTI-NOISE COUNTERPOISE

The basic circuit of this latest development is shown in Fig. 2A. Suitable only for long-wave operation, the circuit affords balanced adjustment which varies little with frequency, and which places minimum dependence upon perfect balance to secure effective noise reduction. The antenna shown in Fig. 2A consists of an inverted-L about 80 ft. long.

The "new" part of the circuit is the counterpoise wire which extends parallel to and about 6 ins. from the antenna—but only for one-half the antenna's length. Primary coil L1 coupled to L2 has a high inductance. *Small variable condenser Cb is used to balance-out the noise.*

Essentially, the circuit of Fig. 2 is a bridge, as shown in Fig. 2B. In this bridge Cx is the distributed capacity at the lower end of the primary winding to chassis.

CHASSIS NOISE-VOLTAGE

Noise disturbances on the power line cause a voltage from chassis to ground. A small portion of this noise-voltage is transferred to the antenna and counterpoise by capacitive coupling. If the voltages on the antenna and counterpoise are equal, then no current will flow in the primary and no voltage will be induced in the secondary.

The noise-voltage developed between chassis and ground and applied to a receiver is by far the most important when no attempt at noise reduction has been made. With this principle of noise reduction fair results may be secured even if balancing condenser Cb is omitted.

Due to the fact that the antenna inductance becomes an important factor in unbalancing the bridge at antenna resonance this system is not recommended for frequencies close to or above the fundamental resonance of the antenna. With this exception excellent balance is maintained at low frequencies (broadcast band) since the bridge then consists essentially of only the 4 capacities.

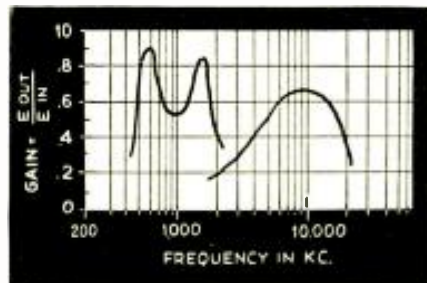

Fig. 4.

OPPORTUNITY AD-LETS

Advertisements in this section cost five cents a word for each insertion. Name, address and initials must be included at the above rate. Cash should accompany all classified advertisements unless placed by an accredited advertising agency. No advertisement for less than ten words accepted. Ten percent discount for six issues, twenty percent for twelve issues. Objections or misleading advertisements not accepted. Advertisement for November issue must reach us not later than September 5th.

Radio-Craft • 99 Hudson St. • New York, N. Y.

ANTIQUES

GLASS, DOLLS, MINIATURES, COINS, STAMPS, various minerals, books, photos, catalog 5c. Indian Museum, Northbranch, Kansas.

AVIATION

AIRPLANE MECHANIC'S LICENSE QUESTIONS, with answers, diagrams, \$1.25. Engine Mechanic's \$1.25. Both \$2.00 remittance. Meyer Engineering, Box 8, Hempstead, New York.

BOOKS AND MAGAZINES

WE HAVE A FEW HUNDRED RADIO ENCYCLOPEDIAS, by S. Gernsback, second edition, originally sold at \$3.98. Book has 352 pages, weight 3 lbs., size 9 x 12 inches. Red covers—Keratin Bookbinding. Send \$2.49 in stamps, cash or money order and book will be forwarded express collect. Technifax, 558 W. Washington Blvd., Chicago, Illinois.

BUSINESS OPPORTUNITIES

YOUR FAVORITE CIGARETTES 69c A CARTON OF 200 CIGARETTES. Plan for 25c and stamp. J. J. Frank, 525-L Palm, Rockford, Ill.

RELIABLE PERSON IN EACH TOWN FOR OWN advertising distributing agency. No selling. Good paying business. Dawson's Advertising, Cape Girardeau, Missouri.

GIANT MAIL-OPPORTUNITIES, INCLUDING 52-page magazine, tips, added income ideas. All for 10c. C. Katz, 1254 N. Kimball, Chicago, Ill.

CAMERAS & SUPPLIES

AMBERTINT 16MM. CAMERA FILM \$1.85 FOR 100 feet including machine processing. Daylight loading. Weston S. Hollywood Studios, South Gate, Calif.

ARGUS EVER-READY CAMERA CASE, GENUINE top grade leather, with shoulder-strap very special with this advertisement. \$1.69. Minotex, 6241 Southwood Street, St. Louis, Missouri.

GENERAL FILM, ANY 8MM. CAMERA, 200 FEET, \$1.75 postpaid. Separates without slitting. Processed with podivers. Sample free. Promadine, Des Moines, Iowa.

CARTOONING

CARTOONING, SKETCHING, ETC.—46 LESSONS, 600 illustrations, including drawing paper, pens, pencils, \$1.00 complete. Frahs Service, Dept. RC, Poplar Bluff, Missouri.

COINS AND STAMPS

INDIAN HEAD, LINCOLN PENNIES, WANTED, ALSO postage stamps. Send 10c for listing and selling lists, 100 commemoratives U. S., Great Britain, etc., only 50c. U. S. imperforates two different sets 25c. Box 194, Gloucester, Mass.

5 SETS FOR 5c—BOSNIA; 3 VAR: KING EDWARD VII, 3 var; Senegal, 5 var; Ivory Coast, 5 var; Guinea, 5 var; Jack Reed, Jr., Houtzdale, Penna.

BATTLE ROYAL BETWEEN GIANT EAGLE AND GORILLAS. Lion pictured on the first stamp issued by Italian East Africa, world's most beautiful stamp, Golden Jubilee, big colored Mozambique, Congo Landscape, Victoria Jubilee, Peruvian Conquistador; all these and large packet of 100 all different, 10c. Gehardt Stamp Company, Dept. R4, San Saba, Texas.

INSTRUCTION

COMPLETE DETAILED SELF-INSTRUCTION COURSE for learning to handle wireless code. Eliminate hours of outcroaching practice for one dollar. Real value. Systems, Box 284, Dallas, Texas.

ARTISTIC TWO-COLOR LETTERING FINISHED AS YOU GO in one operation. Quick work. Samples free. Thompson School, 872R, Pontiac, Michigan.

RADIO ENGINEERING, BROADCASTING, AVIATION and police radio, servicing, marine and Morse telegraph taught thoroughly. All expenses low. Catalog free. Dodge's Institute, Mine St., Valparaiso, Ind.

USED CORRESPONDENCE COURSES AND INSTRUCTION books bought, sold, rented, exchanged, catalog free. V. W. Vernon, Hemar, Ala.

MISCELLANEOUS

MEXICAN DIVORCES; NO PUBLICITY, AMERICAN attorney, Box 1736, El Paso, Texas.

PYRO PANTAGRAPH—THIS ELECTRICAL OUTFIT burns designs permanently on leather, wood, cork, gourds, bakelite, etc. Simply plug pyro electric pencil into any 110 v. A.C. or D.C. line and it is ready to use. Reduce or enlarge any designs with special pantagraph included. Complete kit and instructions, \$2.75. (Add postage for shipping 3 lbs.) Wellworth Trading Company, 560-R West Washington Street, Chicago, Illinois.

MONUMENTS AND TOMBSTONES

GENUINE MARBLE, GRANITE, FREIGHT PAID. Catalog free. \$11 up. United States Marble & Granite Co., A 27, Ocoee, Fla.

PHOTOGRAPHY

ROLLS DEVELOPED—25c COIN, TWO 5 X 7 DOUBLE weight professional enlargements, 8 gloss prints. (Club Photo Service, LaCrosse, Wisconsin)

ROLLS DEVELOPED—8 LARJAPRINTS (ENLARGEMENTS) 35c or 8 regular prints 25c. Star Photo, New Britain, Connecticut.

RADIO

NEW PORTABLE OPERATES ON 20c DRY CELL. Ideal for trailer, boat, farm or car radio. Chassis separate \$12.00. Solter's, 103 N. 7th Street, Minneapolis, Minn.

SONG POEM WRITERS

SONGWRITERS! MELODY FOR WORDS \$1.00. Little, 215 Mason Theatre, Los Angeles, California.

Please Say That You Saw It in RADIO-CRAFT

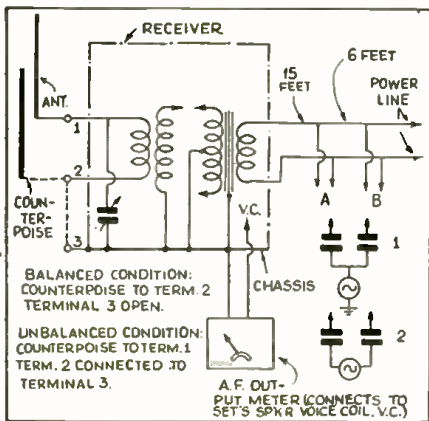

Fig. 5. Circuit for finding noise-reducing efficiency.

An inexpensive and effective multi-wave antenna system is shown in Fig. 3A. The short-wave dipole and its transmission line together act as a broadcast antenna with a B. C. - band noise-reducing counterpoise placed *alongside* the transmission line. The arrangement shown in Fig. 3A calls for a counterpoise "counter" $\frac{1}{2}$ the length of the transmission line plus 10 ft. The short-wave antenna coils (or 540 to 1,600 kc.) require a straightaway are used here the counterpoise may or inverted-L. be used with only as shown in Fig. 3B reception; the path for is then through $\frac{1}{2}$ of L. balancing condenser to ground.

The description was given with the pre that the indicated coils would constitute the only input coil arrangement. However where the radio set has its own R.F. transformer (Lr) not especially designed for this anti-noise system, the circuit arrangement is then as shown in Fig. 3C; and in Fig. 1, and pictorially in Fig. A. (item J.B. is the junction box; T.L., transmission line; C.W., counter wire). Whereupon it may be necessary to shunt the primary of L2 with a resistor, R, in order to flatten the response. Lightning arrestors (L.A.), if required by local ordinances, may be connected as shown.

If you're interested, the response curve of this system is as shown in Fig. 4.

ALL-WAVE DESIGN

A 3-band receiver circuit is shown in Fig. 3D. Coils L3 constitute the additional or *medium-range* portion. It is interesting to note that infinite attenuation of the noise from any given source often may be obtained by resonating the balancing circuit. This is conveniently accomplished by connecting a variable resistor either in parallel or in series with the balancing condenser as shown (dotted) at Ra and Rb, respectively. (The commercial application of this principle however seems to be impracticable since it necessitates retuning to effect noise reduction from a second noise source on a different wavelength.)

Note also that these results may be obtained in receivers having buzzer "B" supply operated from a low-voltage D.C. source as for instance an automobile storage battery.

"PROOF OF THE PUDDING . . ."

A practical demonstration of the effectiveness of this system was given at the I.R.E. meeting. For the readers of *Radio-Craft* the following description is given of the

(Continued on following page)

Announcing the Remarkable New
SCOTT PHANTOM
REVOLUTIONIZES SHORT WAVE AND BROADCAST BAND RECEPTION

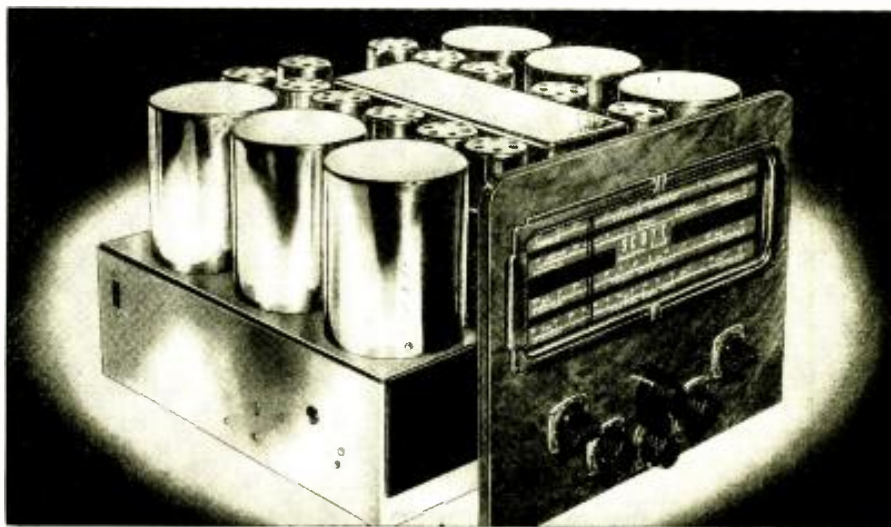

A COMPLETELY NEW RADIO INCORPORATING RADICALLY NEW ADVANCED PRINCIPLES OF RECEIVER AND DOUBLE-DOUBLET ANTENNA DESIGN

Now you can really enjoy foreign short wave radio reception. For, incorporated into the design of the new SCOTT Phantom and the SCOTT Super Double-Doublet Antenna System, are radically new advanced principles that so greatly reduce the effects of "man-made" static that you will find it difficult to realize you are listening to stations many thousands of miles away. Custom-built Scott Radios have been recognized for 11 years as the "World's Finest Radio." Proud owners can be found not only throughout America but in 148 foreign countries. When you hear the magnificent tonal realism of the new Scott Phantom, you'll realize why internationally famous musicians such as Arturo Toscanini, Lauritz Melchior, Gennaro Papi, Eugene Goossens, together with kings, presidents, princes, and hundreds of business and social leaders buy a SCOTT for their personal use and recommend it to their friends.

so tremendous it is difficult for finest laboratory equipment to even measure the extremely weak transmissions which can be tuned in and amplified with this new receiver.

FOR THOSE WHO WANT THE BEST

Scott Radios are custom built by hand in our own Chicago laboratories with the precision of a fine watch, for performance impossible with mass-produced radios. Yet, these amazing instruments cost no more than many production type receivers. They are built to order for DX enthusiasts, musicians, scientists, and critical laymen listeners who want the finest instrument that highly specialized hand craftsmanship can produce.

30-DAY HOME TRIAL

30-day home trial and budget payments in U. S. A. NOT SOLD THROUGH STORES. Write today for all facts and for special introductory offer!

MAIL COUPON FOR SPECIAL OFFER

E. H. SCOTT RADIO LABORATORIES, INC.
4404 Ravenswood Ave., Dept. 248B, Chicago, Ill.
Please send all facts about the new SCOTT PHANTOM and special offer. No obligation.

Name

Street

City State

STUDIOS: NEW YORK • CHICAGO • LOS ANGELES • LONDON

Get a FREE COPY of the 1938 RADIO REFERENCE ANNUAL!
Complete details as to how it is possible for you to get a FREE copy of this big book of the year appears on page 244 of this issue. Read the announcement NOW.

A Sure-Profit Field for Alert Radio Men!
HOME RADIO DIATHERMY
Hundreds of Radio Servicemen are now representing our Home Short wave diathermy line and acting as our agents in all parts of the country. We offer exclusive territory with absolute protection for all agents accepted by us. Our Short wave diathermy line is standard and has been definitely accepted as "fool-proof" by all who have made the most rigid tests possible on Diathermy equipment.
Our agents have averaged better than \$40.00 a week part-time. Full-time agents can easily do better. We show you how! Write for full particulars and details on making a real good income.
SCIENTIFIC DIATHERMY CORP.
200 West 34th Street New York, N. Y.

HAMS—FANS!
The 1938 edition of the famous Hammarlund SHORT WAVE MANUAL is chock full of high and ultra-high frequency receivers and transmitters. No ham or experimenter can afford to be without a copy.
Send 10c for your copy now!
HAMMARLUND MFG. CO., INC.
424 W. 33rd St., N. Y. C. Dept. RC-10.

Please Say That You Saw It in RADIO-CRAFT

AMPLITONE SPECIAL ELECTION OFFER

ELECTIONEERING AMPLIFIER

110 VOLT AC and 6 VOLT DC

26 Watts output
115 DB gain
Tapped output
Two position electronic mixer
Genemotor "stand by" switch
Both power supplies on the same chassis



Completely Wired and Tested

NET PRICE **\$36⁵⁰** Less Tubes
With Cage Cover
Guaranteed One Year

COMPLETE PORTABLE SYSTEM

mounted in carrying case



1—Amplifier as described; 1—Set matched tubes; 1—6 volt DC and 110 volt AC motor and turntable; 1—Crystal pickup; 1—Crystal hand mike; 25 ft cable and plug; 2—12" heavy duty PM speaker. Choice of: (1) "split" speaker carrying case or (2) Aluminum deflector horns; 2—25 ft speaker cables with plugs.

Net price ready to operate **\$93⁵⁰**

Order Now! Write for our new 1939 Catalogue, or Mr. Werner for engineering advice. Give full details.

AMPLITONE PRODUCTS CO., 135 Liberty St., N. Y. C.

IN A CLASS BY ITSELF!

Hot in 1 1/2 minutes. Designed by experts of thermostatically controlled devices. Excellent for radio repairing and similar light work. Listed by Underwriters Labs. Pat. Applied For. Send for Circular.

VANATTA MFG. CO.
ONTARIO, CALIFORNIA

KWIKHEAT

AUTOMATIC



SOLDERING IRON

CAN NOT OVERHEAT
IF LEFT ON CONTINUOUSLY

Be a TELEVISION EXPERT

First National's modernistic method of training is new and different. 75 profusely illustrated lessons in addition to COMPLETE APPARATUS for over 100 Radio and Television experiments will be given you—prepare you for employment in good pay Radio-Television field. You will also be qualified for the examination for your first class Radio-Telephone Operator's License. Get the facts! FREE—WRITE now for free 24-page booklet "Vision" describing this training.

FIRST NATIONAL TELEVISION (Training Division)
Dept. F-10. Fidelity Bldg., Kansas City, Mo.

ANTI-NOISE COUNTERPOISE ANTENNA SYSTEM

(Continued from preceding page)

method used to evaluate the noise-reduction performance of this antenna system. Measurements were made using the set-up shown in Fig. 5. In this circuit a signal generator is shown being applied to the power cord of the receiver. The sensitivity of the receiver to this signal is then measured both with a normal antenna and with the counter wire noise-reducing antenna.

WHEN YOU THINK OF AMPLIFIERS

REMEMBER TO SEND FOR OUR FREE 1938 P. A. CATALOG of Amplifiers Designed by A. C. Sassy

AMPLIFIER CO. OF AMERICA
11-47 West 20th St., New York, N. Y.

RADIO MATHEMATICS

Practical Book for Home Study

Complete training in useful radio mathematics. Explains and interconnects simplified arithmetic and algebra with real everyday radio problems. Covers in detail every phase of radio work. Size: 8 1/2" x 11". Special price, only 50c. postfree.

SUPREME PUBLICATIONS 3729 W. 13th St. Chicago, Ill.

RADIO IN ITS ENTIRETY!

"B-A" serves the trade with every need in radio—complete 160-page catalog of nationally known radio receivers, public address, parts, supplies and equipment. Orders shipped same day received.

COMPLETE CATALOG AVAILABLE

BURSTEIN-APPLEBEE CO. 1922-34 McGEE ST. KANSAS CITY, MO.

RADIO ENGINEERING

RCA INSTITUTES, Inc.
A Radio Corporation of America Service
75 Varick St., New York 1154 Merchandise Mart, Chicago

Service is Made Easier with

RADIO CHASSIS CRADLE!

Service shops need the RADIO GIMBLE (chassis cradle) for efficient servicing, testing and repairing of receivers or amplifiers. Equipment clamps to cradle which can be adjusted to any angle. Accommodates chassis up to 13 x 12 x 2 1/2 inches. Excellent for displaying receivers. Write for illustrated circular RC1

WM. A. THOMAS CO., 321 Caroline St., Neenah, Wis.

RADIO HELPS TEST HEARING-AIDS

(Continued from page 207)

would be occupied by the microphone of the completed hearing-aid. Under these conditions, the response of the microphones is not influenced by any sound reflections which might be present if the microphones were to be used in close proximity to a hard plane surface. Each of these microphones is so arranged that it can be connected with any one of a number of *electromechanical amplifier* units which, in turn, can be connected rapidly with any one of a number of different reproducers of both the *air-conduction* ("earphone") and the *bone-conduction* ("oscillator") type.

Since hearing memory is generally rather short, it is highly desirable that these changes in characteristics be produced very rapidly. Provision is made for changing the complete characteristics of the hearing-aid by throwing a single switch. Also, 3 switches may be thrown simultaneously, changing 3 separate circuits, with a correspondingly larger alteration in the characteristics of the hearing-aid. In this way the individual whose hearing-aid characteristics are being analyzed can make an immediate and direct comparison between widely varying characteristics, selecting the one which gives him the greatest degree of articulation. The method and apparatus used in this system and illustrated by Fig. B are covered by United States Patents.

TESTS ON COMPONENT UNITS

In Fig. E a *microphone testing chamber* is illustrated, with a partially-finished Radioear microphone in place. After it has been made to meet the necessary electrical and acoustical qualifications, it can be accepted for further tests.

An "intensifier" (an *electromechanical, tube-less amplifier*) test is illustrated in Fig. C. This intensifier has been built with certain definite parts designed to produce certain mechanical and electrical results, indicated by the original Selex-A-Phone analysis. One of the adjustments, which is so extremely important that it must be held to within 6/100,000-inch of absolute accuracy (or only 1/67th as thick as a sheet of common writing paper) is made electrically and does not change in service. No attempt is made to change the efficiency or tone quality of the intensifier by adjustment. Changes in tone quality and efficiency are obtained by variations in design and construction which are entirely too complex to be duplicated by means of adjustments.

In the construction of the miniature receivers for use with these hearing-aids, an "artificial ear" as illustrated in Fig. D is employed. This artificial ear reproduces the character and sensitivity of the human ear, so far as its reaction to amplified sound is concerned. "Listening" to each ear-piece, it gives an accurate, measurable indication of its performance under conditions equivalent to those which will be experienced in actual use.

ASSEMBLY TEST

Having completed 3 units for the construction of the desired hearing-aid, the assembly then goes to one of the Laboratory's Master Selex-A-Phones (see Fig. A), where each unit is subjected to checking with the human ear. No part of the laboratory procedure can depend upon the human ear alone but the human ear is a valuable adjunct to the use of the proper test equipment.

Laboratory technicians then make final tests on the completed hearing-aid. So that

In Fig. 6 is shown a curve of attenuation vs. frequency; the ratio of these 2 sensitivities is a measure of the effectiveness of the noise-reducing antenna.

CREDITS

The engineers previously mentioned in this article recognize that considerable work has been done by previous experimenters and acknowledge indebtedness to Messrs. W. L. Carlson, W. H. Conron and D. E. Nason for valuable assistance in this work. Some references to prior art follow:

Fessenden, 742,780; Taylor, 1,468,049; Conrad, 1,513,223; Weinberger, 1,738,337; Miller, 1,872,487; Loftis, 1,995,152; Alexander, 2,054,645; Beverage, Re-19,784; De Monge (British), 455,187; *Wireless Age*, July 1914, pp. 839-842; *Radio Retailing*, June 1936, pg. 63.

This article has been prepared from data supplied by courtesy of RCA Mfg. Co., RCA-Victor Div.

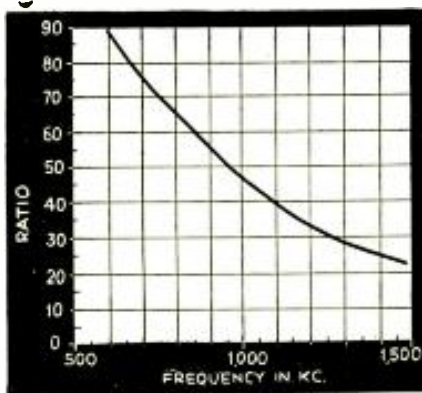

Fig. 6.

Please Say That You Saw It in RADIO-CRAFT

the readings of the various instruments will not be influenced by outside noises, or by improper acoustical conditions within the room itself, the complete hearing-aid is housed within a sound-proof booth. The test frequencies are then introduced within the booth and the efficiency of the hearing-aid is recorded at all of the important frequencies. Frequently instruments which have successfully passed every other test to which they have been subjected fail to measure up to the standards required in this final test.

A-B-C's FOR "AID" USERS

In closing this description of a modern hearing-aid laboratory, it is only fair to mention a few words of caution regarding what even the finest of the modern instrumental aids to hearing can and cannot be expected to do.

- 1st—It won't give *anyone* natural hearing.
- 2nd—It won't supply *normal* hearing.
- 3rd—It will not provide *undistorted* hearing.
- 4th—It can't be expected to operate at *peak efficiency* in group conversations or in auditoriums where acoustical conditions will influence the results.
- 5th—It will never deliver its maximum service unless it is given reasonable care—including a check-up at the laboratory about every year.
- 6th—No aid to hearing is ever the *equivalent* of the unimpaired ear.
- 7th—It will prove to be as great a blessing to the user's family and friends as it will to the individual whose hearing is impaired.
- 8th—Acknowledge your hearing impairment. By attempting to conceal its existence, through a mistaken idea of "pride," you will discover—too late—that you have fooled only the most important individual concerned. That individual is yourself!
- 9th—Everything which can be done to prevent the progress of a hearing impairment or to alleviate an existing impairment should be undertaken with the guidance and upon the advice of a competent medical authority.

If these facts are known and understood, anyone who finds that he can use a high-quality hearing-aid to advantage, should obtain that hearing-aid at once and use it to the fullest extent of its capabilities.

This article has been prepared from data supplied by courtesy of E. A. Myers & Sons.



Fig. E. In a sound-proof chamber, test frequencies are picked up by the hear-aid mike.

FREE!

Get YOUR Copy Without Delay!

BUILD GREATER PROFITS from TUBES and SERVICE!



Here you are . . . a complete array of potent, effective sales, dealer and service helps—many of them available without one cent of cost to you. New, eye-catching display materials; new, up-to-the-minute sales promotion items; new office and service department necessities; new electros and mats. Just the things you need to build better business, more substantial profits.

In short, Arcturus brings you practically everything you need for the business side of your business. New ways of building new business from new customers—new helps to enable you to keep old ones coming to you again and again!

Send the coupon at once for your copy of the ARCTURUS DEALER HELPS folder—just off the press. Modernize your business-getting efforts as well as your shop!

THE ARCTURUS EQUIPMENT DEAL

Lowest Down Payments . . .
Tubes at Standard Prices . . .
Low Tube Requirements . . .
Immediate Delivery—the fairest, easiest and finest Equipment Deal ever offered! Cash in on it! Let your purchases of Radio's finest tubes keep your shop equipment up-to-the-minute.

MAIL the COUPON!

ARCTURUS RADIO TUBE CO., NEWARK, N. J. C-10
 RUSH my copy of the new Arcturus Dealer Helps Folder without cost or obligation on my part.
 Also send full details of your new equipment deal.
 Name
 Street
 City State
 I am a dealer. I am a serviceman. My jobber is
 For your convenience this coupon can be pasted on a penny postcard.

ARCTURUS

INDEPENDENT TUBES FOR DEALERS WHO DO THEIR OWN INDEPENDENT THINKING

NEW! Ghirardi's **WORLD-Indicator** **Speedy!** **RADIO TIME Gadget**

It's marvelous! This handy little gadget shows you exactly when and where to tune in any radio program, any time, anywhere! No more figuring—Ghirardi's gadget does all that work automatically!

Shows in a Flash the correct Standard, Daylight and Greenwich Mean Time for program of any short-wave radio station in the world.
50c POSTPAID

Risk nothing! Your money back if not satisfied after 10 days' trial. Just write your name and address on this ad; mail at once with 50c (60c foreign). We ship postpaid anywhere!

A Turn of the Disc and there's the Time!

RADIO & TECHNICAL PUBL. CO., 45 Astor Place, Dept. RC-108, New York, N. Y.

PHONOGRAPH RECORDS

12-OCCA, BLUEBIRD or VOCALION records-\$1.00
 8-VICTOR, COLUMBIA or BRUNSWICK records-\$1.00
 Each record is the standard 10" and plays both sides. Hot dance numbers, vocal instrumental, waltzes, old times, cowboy, hill billy, etc.
 All popular artists. Hurry while they last. No C.O.D.'s.
 Write for New Radio and Phonograph Catalog
UNITED RADIO COMPANY
 [58-P Market Street, Newark, N. J.]

Correspondence Courses in RADIO ENGINEERING
 Extra fine course in radio, public address, photo-electric work. Trains you to be super-service man, real vacuum tube technician.
ELECTRICAL ENGINEERING

Get good grasp of wide electrical field. Prepare yourself at Low Cost for secure future. Modern course. So simplified anyone can understand quickly. Experiment kits furnished. Diploma given on completion. Tuition, only \$25 either course. Deferred payment plan available.

FREE! Send name quick for free copies of school catalogs, student magazines, complete details.

LINCOLN ENGINEERING SCHOOL Box 931-A4, LINCOLN, NEBR.



This is the latest development in Dry Electrolytics . . . and all the radio world is in favor of it! Ask for catalog.

Solar Mfg. Corp., 599-601 B'way, N.Y.C.

Please Say That You Saw It in RADIO-CRAFT

STOP, LOOK & BUY!

Rockbottom Prices on Surplus, and Army and Navy Merchandise

When prices are low we buy! They're low now—**LOWER THAN THEY EVER WILL BE**—hence this sale. Most of the merchandise is new—never used; some of it reconditioned. 100% satisfaction on each transaction or your money refunded.

ORDER FROM THIS PAGE. Use the convenient coupon below. Be sure to include sufficient extra remittance for parcel post charges, else the order will be shipped express, charges collect. Any excess will be refunded. C.O.D. shipments require a 20% deposit. If full remittance accompanies order deduct 2% discount. Send money order—certified check—new U. S. stamps. No C.O.D. to foreign countries.

ORDER TODAY QUANTITIES LIMITED QUICK SHIPMENTS ASSURED

EDISON 1/50TH H.P. UNIVERSAL MOTOR

Made by Edison Electric Co. for Dictaphone machines. Can be used on 110 volt D.C. or A.C. lines (any frequency on A.C.). Double shaft, 5/16th in. diam. Any speed obtainable with suitable rheostat. Size 9" x 4" high, x 3 1/2" wide overall. Shp. wt. 8 1/2 lbs.

ITEM NO. 10 \$2.25
Your Price



NEW FUEL PUMPS

Known as Sharpe pumps. Brand new never used. Can be used for gasoline, oil, kerosene, and other fuels. Not good for water. Takes standard thread 1/4" input and output pipes. Has 1/4" drive shaft. Measures 4 x 3 1/4 x 3 1/4" diam. overall. Shp. wt. 8 1/2 lbs.

ITEM NO. 24 \$4.45
Your Price



WESTERN ELECTRIC BREAST MIKE

A lightweight aircraft-type carbon microphone with breast plate mounting. Can be adapted for home broadcast or private communication systems. With cord and plug. Shp. wt. 4 lbs. (illustrated at right).

ITEM NO. 14 \$2.45
Your Price

Magnavox Anti-Noise Microphone, also good for home broadcasting etc. With cord and plug. Shp. wt. 2 lbs.

ITEM NO. 15 \$1.80
Your Price



U. S. NAVY BAUSCH & LOMB TELESCOPE

Precision built for U. S. Navy use as finders on large caliber guns. CAMERA FANS—USE IT FOR CLOSE-UPS OF DISTANT PICTURES. Optical system comprises 7 lenses and erector and eyepiece draw tubes. Object lens 2" variable; eye lens 1 3/16"; exit pupil 0.2" to 0.04". Angular field 30°. Power 3 to 10; erect image; cross hairs used. Net wt. 6 lbs. Original cost said to be over \$130. Shp. wt. 10 lbs.

ITEM NO. 25 \$14.95
Your Price



GUARANTEED REBUILT VACUUM CLEANERS

ALL NATIONALLY-KNOWN makes—GUARANTEED FOR 6 MONTHS. All parts, no matter how slightly worn, are replaced with **NEW** ones—we supply new bags, brushes, handles, belts and other parts. Even the chassis itself is replated and polished. We've been selling these rebuilt machines since 1930; and all our customers are satisfied, or money back. **THERE'S NO GRIEF WITH THESE MACHINES!**

EUREKA NO. 9—Straight suction. Fixed brush. Pistol grip handle. Switch in handle. Polished, aluminum housing. 13-inch nozzle. Shp. wt., 20 lbs. List Price, \$52.90.

ITEM NO. 26 \$12.95
Your Price

HAMILTON BEACH—Motor driven brush. Pistol grip handle. Polished aluminum housing. 12-inch nozzle. Switch in handle. Shp. wt., 20 lbs. List Price, \$49.50.

ITEM NO. 27 \$13.95
Your Price

HOOVER NO. 105—Motor driven brush. Foot control switch. Black enameled steel motor housing. 12-inch nozzle. Shp. wt., 24 lbs. List Price, \$35.50.

ITEM NO. 28 \$13.95
Your Price



PREMIER DUPLEX—Motor driven brush. Pistol grip handle. Switch trigger in handle. Polished aluminum housing. 13-inch nozzle. Ball bearing motor. Shp. wt., 20 lbs. List Price, \$60.00.

ITEM NO. 29 \$16.95
Your Price

ELECTROLUX NO. 11—Radical design, cylinder type motor. Complete with all attachments. Foot control switch. Has 101 uses: cleaning upholstery, walls, draperies, curtains, mattresses, etc. Shp. wt., 18 lbs. List Price, \$69.75.

ITEM NO. 30 \$18.95
Your Price

HOOVER NO. 700—Agitator type cleaner. Pistol grip handle. Switch in handle. All high polished aluminum finish. Ball bearing motor. Shp. wt., 25 lbs. List Price, \$74.50.

ITEM NO. 31 \$29.50
Your Price

PORTABLE TELEGRAPH AND BUZZER FIELD SETS

Made for military use by Western Electric. A wonderful buy if only for the parts it contains. Never been used. Good for code practicing, signaling, communications, etc. Contains 2-tone, high-frequency buzzer with platinum contacts, telegraph key, telephone switches, earphone, condensers, transformers, chokes, etc. A \$50 value easily. Complete in wooden case with diagrams and instructions. Shp. wt. 12 lbs.

ITEM NO. 16 \$5.45
Your Price



TELEGRAPHIC TAPE RECORDER

A wonderful buy! Apparatus makes a written record of code and similar messages on paper tape. An ideal machine for learning code or teaching code to groups. Radio men can easily adapt to short-wave receivers for taking permanent records of code messages. Double pen permits simultaneous recording of two messages. Pens are operated by battery and key while tape feeder is spring driven (hand wound). Case made of solid brass on heavy iron base. Completely reconditioned. (Less tape; easily obtained anywhere.) Original cost \$45.00. Shp. wt. 20 lbs.

ITEM NO. 20 \$19.95
Your Price



SPERRY GYROSCOPE LIQUID COMPASS

Made for U.S. Signal Corps; sensitive and accurate. Quick readings easily made from top; accurate readings of graduations through focusing magnifying lens on side of instrument. Complete with level sights and russet leather carrying case. Excellent for boats, boy scouts, campers, hikers, etc. A few turns of wire around its case makes it operate as a galvanometer. Shp. wt. 3 lbs.

ITEM NO. 12 \$1.85
Your Price



ANTI-CAPACITY SWITCHES

Made by Western Electric. Double throw switch with 12 terminals—equivalent to two double-pole, double-throw switches. All contacts are of platinum plate. Original price \$3.50 each. Shp. wt. 1 lb.

ITEM NO. 23 \$1.55
Your Price



WE HAVE NO CATALOG. ORDER FROM THIS PAGE.

HUDSON SPECIALTIES - 40-R West B'way - N.Y.C.

IT'S EASY TO ORDER—CLIP COUPON—MAIL NOW

HUDSON SPECIALTIES CO., 40-R, West Broadway, N. Y. C.

I have circled below the numbers of the items I'm ordering. My full remittance of \$..... (include shipping charges) is enclosed.
OR my deposit of \$..... is enclosed (20% required), ship order (C.O.D. for balance. (New U.S. stamps, check or money order accepted.)

Circle Item No. wanted: 10 12 14 15 16 20 23 24 25 26 27 28 29 30 31

Name Address

City State

Send remittance by check, stamps or money order; register letter if you send cash or stamps.

HOW TO MAKE A MODERN V.-T. VOLTMETER

(Continued from page 229)

CONSTRUCTION

No layout or dimensions are given since it is anticipated that most builders will utilize whatever is on hand just as did the writer. The 5 x 6 x 9 in. case is about the right size, all parts fitting in without crowding. The circuit is arranged so that all switching is handled by 2 controls: one (switch A), which selects the voltage ranges; and the other (switch B), which controls all circuit functions. There are 4 positions on each, switch A reading 1-10-100-500 Volts, and switch B, Low-D.C.-A.C.-Calibrate. When on the "Low" point, the power supply is off, and the 0-1 ma. meter is connected to the binding posts as an ordinary 1,000 ohms/volt meter. The next 2 points are self-explanatory, while the "Calibrate" position is used only when the instrument is first turned on to adjust for changes in line voltage. This adjustment is accomplished by means of the wire-wound resistor in the power transformer primary circuit.

All resistors connecting to switch A are fastened directly to the switch lugs. All these resistors except the 9-meg. and the two 20-meg. units are wire-wound, the latter 3 being special, 5%-tolerance, carbon units. As previously mentioned, all 9 of these resistors may be of the carbon type if economy is necessary, but accuracy will then be sacrificed. Be sure to specify 5% units when buying. The grid-bias cell holder is fastened to the switch and resistors also, and note that the black carbon element of this cell *must* be either vertical or on the bottom. Do not mount it with the carbon upmost.

CALIBRATION

When the instrument has been wired and checked, turn switch B to "Calibrate." In this position the milliammeter is connected in series with a 0.5-meg. resistor directly across the output of the power supply. This means the milliammeter will indicate 500 V. full-scale. The circuit operates properly at about 250 V. so the primary rheostat should be adjusted till this setting is obtained. If the reading cannot be raised to 250 V., the slide on the 15,000-ohm filter resistor may be moved to cut out some resistance. It should not be moved so that less than about 3,000 ohms are in circuit or the filter action will be insufficient. With most power transformers of the midget variety, it will be possible to reach 250 V. with most of the 15,000 ohms in circuit.

Now turn switch B to D.C. position and bring the meter pointer to zero. This is done with the 7,000-ohm plate circuit rheostat. This may be a 10,000-ohm unit (incidentally, 7,000 being the value used simply because it was handy). With switch A at 1 volt, connect a known potential of 1 volt to the input terminals. The milliammeter should just reach full-scale. If it does not, reset the supply voltage 10 volts or so by means of the 15,000-ohm unit, reset the meter to zero with open leads, and try again with 1-volt input. It may be necessary to change the supply voltage in this manner several times until the meter needle can be brought from zero to exactly full-scale with just 1 volt input. The instrument illustrated works properly with 270 volts as the power ("B") supply setting.

When the 1-volt range has been properly set, the apparatus will read all other ranges correctly, both A.C. and D.C. Note that the A.C. ranges are *peak* volts. If r.m.s. indication is desired it may be drawn as a sub-scale on the meter dial.

(Continued on page 255)

BUY DIRECT FROM MANUFACTURER AND SAVE 50% — ORDER DIRECT FROM THIS AD.



NEW TECO TUBE TESTER

Model T-10 A genuine achievement! For accurate and rapid work. Has d'Arsonval moving coil meter. Tests all types of tubes. For use on 110 V., 60 cycle AC.

Features • Tests all 4, 5, 6, 7s, 7L and octal base tubes. • Tests by the well established emission method for tube quality, directly read on the Good / Bad scale of the meter. • Affords separate neon test for leakage and shorts between elements. • All services performed with 5 controls at maximum—many tests not requiring all controls. • Modern attractive etched panel housed in rugged leatherette carrying case with removable hinged cover and handle. • 60 cycle AC operation. • Supplied with instructions and reference table covering all tubes which you will commonly encounter in servicing. Size 11 1/4 x 9 1/2 x 5 1/2". Net Price.....

\$11.75

TECO POCK-O-METER AC and DC

A new pocket size volt-ohm-milliammeter that includes AC measurements and is the lowest priced, full-service instrument ever offered! Has 3" d'Arsonval movement 0-1 milliammeter. Comes with etched panel.

SPECIFICATIONS

5 DC ranges: 0/1.5/15/25/75/500 volts.
5 AC ranges: 0/15/40/75/200/1200 volts.
4 DC current ranges: 0/1/10 100/500 ma.
2 resistance ranges: 0/500/500,000 ohms (low ohms read to 1 ohm)
Pock-O-Meter supplied complete with batteries, test leads, and instructions. Size 6 1/2 x 3 1/2 x 2 1/4"; shipping weight 5 lbs. Our net price.....

\$8.45

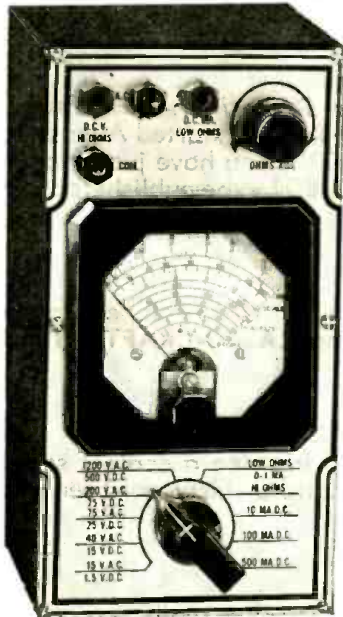

NEW TECO MULTIMETER

MODEL T-15 Here's the unit you need for rapid, accurate measurements. A 1000 ohms per volt type instrument featuring d'Arsonval type movement, 0-1 Milliammeter. Accuracy 2%. Attractive etched metal panel. For use on 110 V., 60 cycle AC. 2 RESISTANCE RANGES, 0-500 ohms, 500-5 megohms. HIGH AND LOW CAPACITY SCALES. 0005-1 mf. and 0.5-200 mf. COMPLETE AC and DC VOLTAGE and CURRENT RANGES. DC Voltage: 0-15, 0-150, 0-750 volts; AC Voltage: 0-15, 0-150, 0-750 volts; 1C Current: 0-1, 0-15, 0-150, 0-750 ma.; AC Current: 0-15, 0-150, 0-750 ma. THREE DECIBEL RANGES. TECO Multimeter comes complete in carrying case with test leads and instructions. Size 11 1/4 x 9 1/2 x 5 1/2". Shipping weight 5 lbs. Our net price.....

\$13.60

THE NEW MODEL T-25 SIGNAL-GENERATOR PLUS BUILT-IN OUTPUT METER



Specifications

Works on 90-130 volts AC. Generates radio and intermediate frequencies, 100 kc. to 60 mc. in six bands, selected by front-panel switch operation. Two audio services, 60 cycle sine-wave, and five saw-tooth switch-selected frequencies, 100, 400, 1000, 5000, and 7500 cycles. The audio is serviceable as modulation on all H.F. and I.F. bands, also may be taken out independently. Features a Crowe 10" full vision oblong dial. Crystalline black finish shield cabinet. Three tubes used: one 6J5G oscillator, one 25Z6 rectifier, and one modulator tube. The TECO T-25 Signal Generator complete with tubes and test leads. Size: 9" x 11" x 5 1/2". Shipping weight, 18 Pounds. Net Price.....

\$17.45

TECO T-20 COMBINATION SET TESTER



Complete Set Analysis at Your Finger Tips

Combines the functions of the Teco T-10 Tube Tester and T-15 Multimeter. A complete testing laboratory for shop use. A portable trouble shooting laboratory which you can take with you on the job. Fast, accurate trouble shooting with a single service instrument. An invaluable asset to modern field servicing. Specifications of the T-20 are the same as those given for the T-10 Tube Tester and T-15 Multimeter.

The TECO T-20 SET TESTER comes complete with an unusually large, 4 1/2" d'Arsonval type meter and attractive etched panel; test leads, black leatherette carrying case and instructions for use on 110 volts, 60 cycles, AC. Size 15" x 10 1/2" x 6". Shipping Weight 17 lbs. Our net price.....

\$21.45

TEST EQUIPMENT COMPANY of America
139 CEDAR STREET RC-10 NEW YORK, N. Y.

Please Say That You Saw It in RADIO-CRAFT

50 PRIZE AWARDS

to Readers of RADIO-CRAFT

Yes —Mr. Radio Man—there's a big prize contest sponsored by RADIO-CRAFT which started August 1, 1938 and will end midnight September 29, 1938. You have just about four weeks to get one of **FIFTY PRIZES OFFERED** by the publishers of RADIO-CRAFT.

You —are invited to compete in the most unique, yet simple contest celebrating **RADIO-CRAFT'S Tenth Anniversary**.

Can —you imagine a contest so easy that you answer only five questions and write a thirty-word sentence—then submit your entry.

Win —a prize that really is a prize. Every award is invaluable to Radio men regardless of the branch of the industry you serve.

Clip Coupon —fill it in carefully and mail to the publishers today. A special 4-page circular giving complete details and listing the awards in this big contest, will be sent to you immediately. This coupon, or a facsimile thereof is your only requirement to enter this great Anniversary Contest.

You Will Want to Enter This BIG CONTEST!

Regardless of the branch of radio in which you are now employed the privilege of entering this contest is open to you. Whether you are president of a manufacturing concern, dealer or Service man, jobber or wholesaler, P.A. engineer or set builder, the publishers welcome you to enter this contest. Every contestant HAS AN EQUAL CHANCE TO WIN ANY ONE OF THE FIFTY AWARDS. Fill in the coupon at the right . . . mail it immediately to the publishers for complete details. Don't delay.

RADIO-CRAFT · 99 HUDSON ST · NEW YORK, N.Y.

OFFICIAL CONTEST ENTRY BLANK

RADIO-CRAFT, Contest Editor
99 Hudson St., New York, N. Y.

I wish to enter the RADIO-CRAFT TENTH ANNIVERSARY CONTEST OF 50 PRIZE AWARDS. Please consider this my application of entry and therefore send me the 4-page circular giving complete details about this contest and the list of awards to be made. The coupon has been filled in properly.

PLEASE CHECK ONLY ONE—THAT WHICH IS MOST APPROPRIATE FOR YOUR OWN CLASSIFICATION.

- | | |
|--|---|
| <input type="checkbox"/> Radio Dealer | <input type="checkbox"/> Radio Experimenter |
| <input type="checkbox"/> Independent Radio Service Man | <input type="checkbox"/> Licensed Amateur |
| <input type="checkbox"/> Service Man for Jobber | <input type="checkbox"/> Public Address Engineer |
| <input type="checkbox"/> Service Man for Dealer | <input type="checkbox"/> Professional Set Builder |
| <input type="checkbox"/> Service Man for Servicing Company | <input type="checkbox"/> Student |
| <input type="checkbox"/> Radio Jobber | |

- Regular Subscriber Newsstand Reader

I purchase approximately \$..... worth of radio material a month.

Name Age

Address

City State

(PRINT INFORMATION IN COUPON CAREFULLY)

Please Say That You Saw It in RADIO-CRAFT

Index to advertisers

A	
Allied Radio Corporation.....	231
American Television Institute, Inc.	Back Cover
Amperite Corporation.....	Inside Front Cover
Amplifier Co. of America.....	250
Amplitone Products Company.....	250
Arcturus Radio Tube Company.....	251
Arrow Sales Company.....	245
B	
The Brush Development Company.....	245
Burstein-Applebee Company.....	250
C	
Capitol Radio Engineering Institute.....	256
Central Radio Laboratories.....	238
Cinaudagraph Corporation.....	242
Classified Section.....	248
Continental Carbon, Inc.....	240
Cornell-Dubilier Corporation.....	256
Coyne Electrical School.....	195
F	
First National Television School.....	250
G	
Gold Shield Products Co.....	246
H	
Hammarlund Manufacturing Company.....	252
Hudson Specialties Company.....	252
Hygrade Sylvania Corporation.....	237
I	
Illinois Condenser Company.....	247
International Correspondence Schools.....	238
L	
Lancaster, Allwine & Rommel.....	242
Lincoln Engineering School.....	251
M	
Modell's	242
N	
National Plans Institute.....	242
National Radio Institute.....	193
National Schools.....	246
National Union Radio Corporation.....	245
New York Supply House.....	242
New York Y.M.C.A. Schools.....	247
R	
Radio & Technical Publishing Co.....	247, 251
Radio Circular Company.....	246
Radio City Products Company.....	243
Radio Servicemen of America, Inc.....	254
Radolek Company.....	255
RCA Institutes, Inc.....	250
Readrite Meter Works.....	240
Remington Rand, Inc.....	242
John F. Rider.....	232
S	
Scientific Diathermy Corporation.....	249
E. H. Scott Radio Laboratories.....	249
Service Instruments, Inc.....	239
Solar Manufacturing Company.....	251
Sprague Products Company.....	235
Sprayberry Academy of Radio.....	231
Superior Instruments Company.....	233
Supreme Instruments Corporation, 195A, 195B	
Supreme Publications.....	250, 256
T	
Technifax	246
Teletran Products Company.....	256
Test Equipment Co. of America.....	253
Triplet Elec. Instr. Co.....	248
William A. Thomas Company.....	259
U	
United Radio Company.....	257
V	
Vanatta Manufacturing Company.....	250
D. Van Nostrand Company.....	236
W	
Wellworth Trading Company.....	246
Weston Electrical Instrument Corp.	Inside Back Cover
Wholesale Radio Service Co., Inc. 241, 244, 197	
Wright-DeCoster, Inc.....	248

(While every precaution is taken to insure accuracy, we cannot guarantee against the possibility of an occasional change or omission in the preparation of this index.)

HOW TO MAKE A MODERN V.-T. VOLTMETER

(Continued from page 252)

On the A.C. one-volt setting it will probably be found that the meter will give a substantial scale indication when the input terminals are shorted. This is unavoidable, but may be compensated for when A.C. readings are made.

If a metal case is used the circuit should not be grounded to it. The negative or ground side of the V.-T. voltmeter is connected to the positive input terminal and complications might arise if the case were made 500 volts or so positive!

It is to be expected that prospective builders will incorporate their own ideas in layout, ranges, and switching, but if the fundamental circuit is followed, no difficulties should be encountered in getting the job to operate in a completely satisfactory manner.

LIST OF PARTS

TUBES

- One Raytheon type 6Q7 tube;
- One Raytheon type 5Z4 tube.

RESISTORS

- One I.R.C. 9,000 ohms, type WW3;
- One I.R.C. 1,000 ohms, type WW3;
- One I.R.C. 90,000 ohms, type WW3;
- One I.R.C. 0.1-meg., type WW3;
- One I.R.C. 0.4-meg., type WW4;
- One I.R.C. 0.9-meg., type WW2;
- One I.R.C. 9 meg., type BT1 (5% tolerance);
- One I.R.C. 20 meg., type BT1 (5% tolerance);
- Two I.R.C. 20 meg., type BT1 (5% tolerance);
- One I.R.C. 15,000 ohms, type DHA;
- One I.R.C. 10,000 ohms, type BT2;
- One I.R.C. 50,000 ohms, type BT2;
- One I.R.C. 5,000 ohms, type BT2;
- One I.R.C. 10,000 ohms, variable.

FIXED CONDENSERS

- One Sprague 0.02-mf., 600 V., paper condenser;
- One Sprague 0.5-mf., 400 V., paper condenser;
- One Sprague 0.25-mf., 400 V., paper condenser;
- One Sprague 12 mf., 350 V., midget electrolytic condenser.

MISCELLANEOUS

- One Triplett 0-to-1 ma. meter;
- One midget power transformer;
- One 2-gang, 4-pole switch;
- One 5-gang, 4-pole switch;
- Two octal wafer sockets;
- One Clarostat 75-ohm, 50-watt rheostat;
- One Mallory grid-bias cell and holder;
- One chassis and case;
- One pilot lamp and socket;
- Hardware, wire, etc.

LATEST IN RADIO

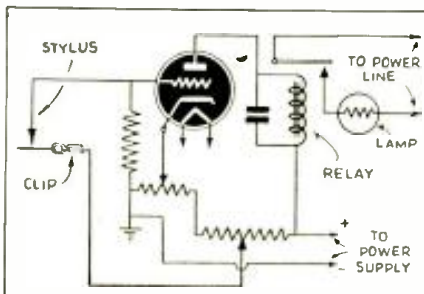

Circuit of Item No. 1679, pg. 228.

Please Say That You Saw It in RADIO-CRAFT

RADOLEK

EVERYTHING IN RADIO

1939
RADIO PROFIT GUIDE
RADOLEK
RADOLEK COMPANY
1511 W. RANDOLPH, CHICAGO

Everything in radio in this Big New 1939 RADOLEK PROFIT GUIDE. Radolek has everything under one roof. When you order, you get just what you want, promptly and economically. Over 25,000 Radio Servicemen now depend upon Radolek Service. Send for your copy of this big book. It will give you new ideas in conducting your service business on a more profitable basis.

Test Instruments—The most complete line ever displayed in any catalog. Latest improved models that provide every conceivable test necessary for thorough radio receiver analysis and repair. New push button tube testers that simplify and speed up testing time.

Over 12,000 Repair Parts, Tools, etc. Parts to repair any radio receiver made. All leading brands are represented. Every item guaranteed! And all at prices that SAVE YOU MONEY!

All Tubes Represented—RCA, Sylvania, Raytheon, Philco, etc. Includes Kellogg, special Majestic types and transmitting tubes.

Complete Public Address Display. New 1939 model public address amplifiers with outputs from 5 to 90 watts. Complete P. A. Systems for permanent, Mobile and Portable installations. Powerful beam power systems attractively designed and priced for greater profits.

Latest Radio Models. The super values of 1939. New Phono-Radio combinations. Automatic tuning sets with strikingly beautiful cabinets that harmonize with all home furnishings. Also new "Ham" receivers and TRANSMITTERS!

Complete Auto Radio Section. Includes vibrator replacement guide, -new auto aerials at new low prices and custom panel control plates for all automobiles. And new Delco Auto Sets that are the easiest to sell with the greatest profits.

Send for FREE catalog

The RADOLEK Co.

601 W. Randolph, Chicago, Dept. C-22

Send the Radolek Radio Profit Guide FREE.

Name

Address

Serviceman? Dealer? Experimenter?

there's more than
**A QUARTER
CENTURY'S**
Experience



wrapped in
that tiny tube

CORNELL-DUBILIER type BR stands at the peak of twenty-eight years of capacitor progress. In over all length the "Blue Beaver" measures just 2 1/8". Yet this mighty midget has been designed to give the kind of dependable service you'd expect to find only in the larger units. The perfect replacement filter for the man who refuses to compromise quality for the sake of saving a few pennies. No fear of free call backs when C-D capacitors are used—because since 1910 C-D has stood for quality in condensers.

Check some of the outstanding features that have made the type BR electrolytic the most popular serviceman's capacitor.

- 1—Electro-chemical etching: eliminates corrosion
- 2—Hi-formation process: affords higher voltage breakdown
- 3—Hi-pressure centrifuge: assures better impregnation; lower power-factor
- 4—Hi-purity aluminum foil: affords better direct current leakage recovery
- 5—Super-purity cellulose separator: gives longer life
- 6—Rigid chemical control: guarantees uniform performance
- 7—Double ageing: assures stable characteristics
- 8—Special vent: guarantees safety under all operating conditions

And most important of all the unit is priced so low that no one can afford not to use this quality capacitor.

Catalog No. 161 just off the press describes these and other capacitors in the complete C-D line in detail. Send for your copy today. And remember when buying capacitors insist on C-D's the pioneer condenser line, copied, imitated, but never duplicated.

PAPER • MICA • DYKANOL • WET & DRY ELECTROLYTICS



**CORNELL-DUBILIER
ELECTRIC CORPORATION**
1014 Hamilton Boulevard, South Plainfield, New Jersey
Cable Address: CORNOL

**NEW HIGH-FIDELITY
HEARING-AIDS**

(Continued from page 206)

means of adjusting the response characteristic to suit individual ears. Potentiometer R, set by means of a screw-driver from underneath the chassis, when once adjusted to suit the owner of the hearing-aid, does not require further adjustment.

A.C.-D.C. HEARING-AID

The electric model shown schematically in Fig. 1B has all the circuit elements and features mentioned above in connection with the battery model; except that load resistor RL in Fig. 1A is replaced by an impedance, Ch., in the circuit shown in Fig. 1B. The electric model of course may be operated on any 115-V., A.C.-D.C. power line but a power outlet must be conveniently available in order to operate this unit. The economy, compactness and efficiency of this unit recommended it for use by the bed-ridden and for use in offices. In order to reduce the weight to a minimum, filter resistors Rs are used in place of the iron-core chokes that would otherwise be needed in the power supply.

In conclusion we wish to point out that these hearing-aids do not have the annoying background noise that has accompanied most preceding types of hearing-aids. Furthermore both units are amazingly sensitive with sufficient output to rattle either the earphone or the bone conductor. In practice however the load upon these reproducers afforded by wearing them prevents such rattling (which of course would only occur with the volume control near maximum). A soft-rubber stud, center-perforated, improves the performance of the earphone unit.

Both units can be recommended by Servicemen as being particularly suitable, because of their exceptionally fine response characteristics, for listening to orchestral and other wide-range programs being reproduced by radio sets or electric phonographs.

This article has been prepared from data supplied by courtesy of CrystalEAR, Inc.

LATEST IN RADIO

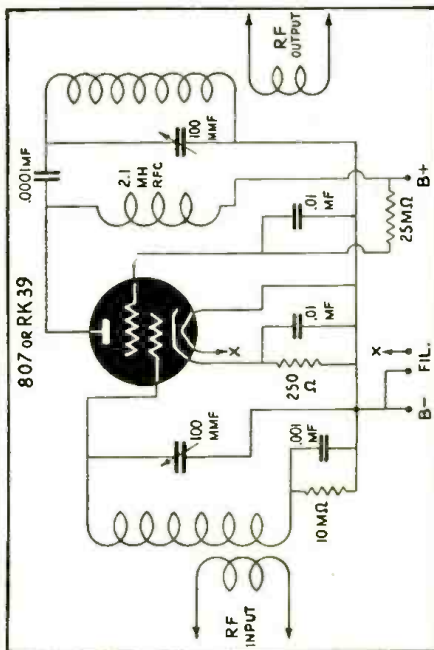

Circuit of Item No. 1677, pg. 227.

Please Say That You Saw It in RADIO-CRAFT

TELETRAN

!!!

**MOST COMPLETE
LINE OF P.A.
and ACCESSORIES
ON THE MARKET
TODAY.**



Write for 20-page Catalog.

*

Licensed by ERPI under patents owned or controlled by A. T. & T. and Western Electric

TELETRAN PRODUCTS CO.

2233 University Ave.

St. Paul

Minnesota



E. H. RIETZKE

PRES. OF CREI

**Is Radio . . .
Just A Job to You?**

If you can equip yourself with the necessary training . . . Radio can offer you an excellent future. Continuous new developments have created a need for technically trained men, who have kept their knowledge up with Radio's fast pace.

YOU CAN'T BLUFF YOUR WAY

CREI courses are planned only for serious-minded men who know that it takes Training to qualify for and to hold the big jobs and salaries that go with them. Let us suggest the course best suited for you and the easy ways of paying for it.

Just Off the Press!

Write for **FREE**
New illustrated booklet

"A Tested Plan for
A Future in Radio"



**CAPITOL RADIO
ENGINEERING INSTITUTE**

Dept. RC-10, 3224-16th St. N.W., Wash., D. C.

Refrigeration

Text-Book for Home Study
This complete, up-to-the-minute, practical book will teach you quickly how to service all types of refrigerators. Page after page of useful, easy to understand facts. Refrigeration is the big money field and you can get into it after studying this textbook. Size 8 1/2 x 11 in. Priced at only \$1.00, postpaid. Send for this book today.
SUPREME PUBLICATIONS 3727 W. 13th St. Chicago, Ill.

IN TEST EQUIPMENT

SUCCESSFUL SERVICE MEN

Stick to fundamentals!

WESTON Model 697 *Pocket Size Volt-Ohm-Milliammeter*. Complete ranges for radio servicing. A dependable, low-priced analyzer for all field tests.



WESTON Model 772 *Super-Sensitive Analyzer* (sensitivity 20,000 ohms-per-volt). Big, dependable 50 microampere WESTON meter. Broad ranges meet every test requirement for receivers, transmitters, auto testing, television, sensitive relay circuits, etc.



WESTON Model 665 *Selective Analyzer*. A broad range volt-ohm-milliammeter, used with the WESTON system of selected analysis which eliminates obsolescence, permits rapid, accurate analysis. Truly universal in its capacity to analyze receivers.



WESTON Model 669 *Vacuum Tube Voltmeter*. Direct reading, measures gain per stage—r.f. amplitude in oscillator circuit of superhets—all tests on AVC circuits, PA systems, and all measurements where high frequency is a factor.



WESTON Model 663 *Volt-Ohmmeter*. Ideal for resistance analysis and point-to-point testing. Measures .1 ohm to 10 megohms—DC voltage measurements .1 to 1000 volts—DC current measurements .1 to 100 milliamperes. A compact, dependable radio servicing tool.

Successful servicemen stick to test equipment which measures in fundamental quantities. The reasons are obvious:

Fundamental test equipment *never* grows obsolete . . . eliminates those frequent, costly equipment replacements due to circuit changes. The pointer on a good instrument tells, *exactly*, the true condition in the circuit under test . . . leaving nothing to chance or guesswork. In addition, *it's simple for any serviceman to check a fundamental instrument for accuracy.*

Remember, when buying your next equipment, that all WESTON test units measure in radio fundamentals. That's why WESTON radio instruments remain serviceable for years . . . *never discarded, never idle*, because of changes in receiver circuits. Remember, too, that WESTON instruments are used by practically all leading manufacturers because of their greater dependability . . . greater economy. This name also is *your* best assurance of dependability and satisfaction in radio test instruments.

Let us send you complete data on the instruments featured above and on all other WESTON fundamental instruments for radio testing. Return the coupon today.

WESTON Radio Instruments

WESTON ELECTRICAL INSTRUMENT CORPORATION
599 Frelinghuysen Avenue, Newark, N. J.

Send literature on all WESTON fundamental radio instruments.

NAME

ADDRESS

CITY.....STATE.....

TELEVISION

Cannot Be Properly Mastered With Just Texts Alone...You Need ACTUAL Experience WORKING With Real Equipment!

THAT'S WHY WE GIVE YOU THIS Professional Television EQUIPMENT INCLUDED WITH YOUR TRAINING AT NO EXTRA COST

Get In on the Ground Floor Now!

Already there are 16 Telecasting Stations in America. Television Programs are on the air. Television Receivers are on sale. These facts are undisputable indications that the beginning of Television has arrived. Wide-awake men who are alert to the great possibilities of a career in Television are preparing NOW! Don't wait until the field is crowded. Get in on the ground floor first! The A.T.I. method of training is new, startlingly different. No dull, hard-to-understand, monotonous texts. We train you as you never thought you could be trained . . . you get ACTUAL EXPERIENCE with YOUR OWN TELEVISION APPARATUS just like on the real job . . . RIGHT IN YOUR OWN HOME!

Prepare Now for the Big Pay Television Jobs

A.T.I. Training prepares you for good paying jobs in these fields: Television Engineer, Radio Station Operator, Laboratory Technician, Radio-Electronic Engineer, Sound Camera Technician, Public Address Engineer, Electrician and many other fascinating profitable positions. A.T.I. Training qualifies you during the first few months to take your RADIO TELEPHONE FIRST CLASS GOVERNMENT LICENSE EXAMINATION. A complete Radio Servicing Course is also included.



Edward Gibbons, W9TAK, says, "I have worked with A.T.I. equipment. It lends itself perfectly to experimental work and hundreds of tests which give you a first hand practical knowledge of television."



E. F. Wiechmann, W9RLA, says, "I am tremendously impressed by the size and quality of your equipment. The cathode ray tube and four photo electric cells alone are worth the entire price you ask for the complete machine and training."

A.T.I. TRAINING WITH COMPLETE EQUIPMENT IS AVAILABLE ON AMAZINGLY LOW EASY MONTHLY PAYMENTS

AMERICAN TELEVISION INSTITUTE

433 E. Erie St., Dept. RC-1938, Chicago, Ill.

Gentlemen: Please send me your free book on Television and literature describing A.T.I. Training. It is understood that this is FREE. No obligation.

Name Age

Address

City State

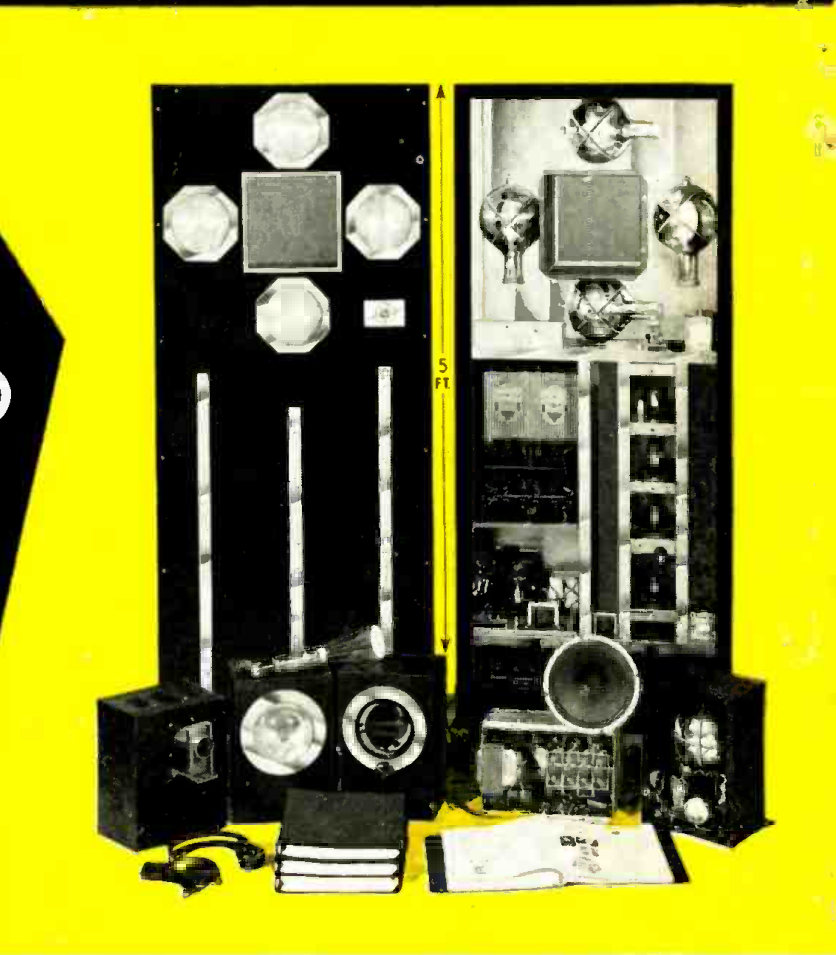

Here's What You Get . . .

Television cannot be properly mastered by texts alone. That's why we give you all this genuine Television equipment along with your A.T.I. training AT NO EXTRA COST. It is sent to you at home and is yours to keep. Includes a complete professional Television Transmitter and Receiver 5 ft. high; 50 Watt Radio Transmitter; Superheterodyne Receiver; 7" x 21" Cathode Ray Tube with 7" screen; 4 Giant Photo-Electric Cells; Hi-Gain Transmission Amplifier; Projector; Mazdas; Lenses; Phones; R.C.A. Tubes; and all other necessary apparatus. We give you a full engineering course in Television, Electronics, Radio Servicing and Electricity, with final training in Chicago in our laboratories (transportation to Chicago paid).

Here's What You Can Do . . .

With your A.T.I. Equipment you can make over 350 amazing, interesting experiments right in your own home. You can produce your own Television program for a local audience . . . transmitting and receiving the faces of your friends. You can build complete Television Transmission and Reception Systems, Television Amplifiers, Radio Transmitters, Television Pick-ups, Photo-Electric Relays, Light Beam Telephone, Grid-Glow Alarms, Sound Amplifiers, Photo-Electric Photometers. You can make hundreds of comparison tests that show you Television and Radio in a quick, simple way . . . much easier to understand than just mere words in a book. The entire A.T.I. course with the above equipment is remarkably low in price and on terms arranged to suit you. It costs you nothing to thoroughly investigate. SEND Coupon Now!

GET THE REAL *Inside* FACTS ON TELEVISION