

RADIO'S LIVEST MAGAZINE

OVER 175 ILLUSTRATIONS

# Radio-Craft

SPECIAL  
PUBLIC  
ADDRESS  
NUMBER

May  
25 Cents  
in United States  
and Canada

HUGO GERNSBACK Editor



*Santa Anita's  
300-Watt Voice!*

See Page 737



New Robot Monitor for P. A. Systems — Making Home Movies Into Talkies  
Beginners' 1-Tube Loop Set — Phono Pickups on Parade — Television Today

OVER 50,000 RADIO MEN READ RADIO-CRAFT MONTHLY



# ONLY THIS NEW WESTON OSCILLATOR

gives you **ALL** these features!

Constant signal level at all frequencies (A.A.C.)  
 . . . Constant frequencies—no padders—no trimmers . . . Guaranteed accuracy at all frequencies ( $\frac{1}{2}\%$  on I.F.—B.C.)—( $1\%$  on Short Wave) . . . Constant impedance attenuator (100 ohms) . . . Permanent hand calibration—large  $330^\circ$  fully visible dial . . . Output readings directly in microvolts . . . Signal strength 100,000 microvolts . . . Fundamental frequencies fifty kc—30 meg.—6 individually hand calibrated scales . . . Freedom from drift and feedback . . . For use with all standard oscillographs and frequency modulators . . . Rapid band selection . . . Accurate alignment . . . Fifty percent modulation on all bands . . . Stable operation.



**WESTON**  
*Instruments*

Weston Electrical Instrument Corp.  
 599 Frelinghuysen Ave., Newark, N. J.  
 Send me bulletin describing Model 776 Oscillator.

Name.....

Address.....

City..... State.....



# A FREE LESSON SHOWED BILL HOW HE COULD MAKE GOOD PAY IN RADIO



BILL, YOU'RE ALWAYS FOOLING WITH RADIO-- OUR SET WON'T WORK-- WILL YOU FIX IT?

I'LL TRY, MARY, I'LL TAKE IT HOME TONIGHT



I CAN'T FIND OUT WHAT'S WRONG-- GUESS I'LL MAKE A FOOL OF MYSELF WITH MARY



HELLO, BILL-- GOT A TOUGH ONE TO FIX? LET ME HELP YOU



HELLO JOE-- WHERE'VE YOU BEEN LATELY-- AND WHERE DID YOU LEARN ANYTHING ABOUT RADIO?



I'VE BEEN STUDYING RADIO AT HOME, BILL, WITH THE NATIONAL RADIO INSTITUTE. YOU OUGHT TO TAKE THEIR COURSE. I'VE GOT A GOOD RADIO JOB NOW. LET'S MAKE A CIRCUIT DISTURBANCE TEST-- STARTING WITH THE AUDIO OUTPUT STAGE AND TESTING EVERY STAGE RIGHT BACK TO THE ANTENNA. LISTEN FOR THE CLICKS WHEN I TAP THE GRID LEADS



SAY-- WHERE DID YOU LEARN THAT TEST? IT'S A GOOD ONE

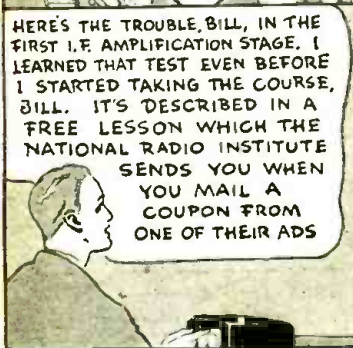

HERE'S THE TROUBLE, BILL, IN THE FIRST I.F. AMPLIFICATION STAGE. I LEARNED THAT TEST EVEN BEFORE I STARTED TAKING THE COURSE, BILL. IT'S DESCRIBED IN A FREE LESSON WHICH THE NATIONAL RADIO INSTITUTE SENDS YOU WHEN YOU MAIL A COUPON FROM ONE OF THEIR ADS



I'VE SEEN THEIR ADS BUT I NEVER THOUGHT I COULD LEARN RADIO AT HOME-- I'LL MAIL THEIR COUPON RIGHT AWAY

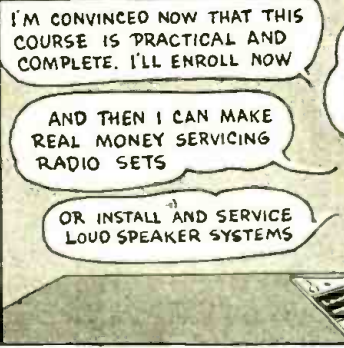

I'M CONVINCED NOW THAT THIS COURSE IS PRACTICAL AND COMPLETE. I'LL ENROLL NOW

AND THEN I CAN MAKE REAL MONEY SERVICING RADIO SETS

OR INSTALL AND SERVICE LOUD SPEAKER SYSTEMS



OR GET A JOB WITH A RADIO BROADCASTING OR TRANSMITTING STATION

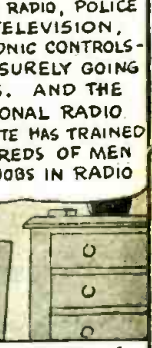

AVIATION RADIO, POLICE RADIO, TELEVISION, ELECTRONIC CONTROLS-- RADIO IS SURELY GOING PLACES. AND THE NATIONAL RADIO INSTITUTE HAS TRAINED HUNDREDS OF MEN FOR JOBS IN RADIO

## I will send you a Lesson on Radio Servicing Tips FREE TO SHOW HOW PRACTICAL IT IS TO TRAIN AT HOME FOR GOOD JOBS IN RADIO



**J. E. SMITH**  
President  
National Radio Institute  
Established 1914  
The man who has directed the home study training of more men for the Radio Industry than any other man in America.



YOU CERTAINLY KNOW RADIO SOUNDS AS GOOD AS THE DAY I BOUGHT IT.

THANKS! IT CERTAINLY IS EASY TO LEARN RADIO THE N.R.I. WAY. I STARTED ONLY A FEW MONTHS AGO, AND I'M ALREADY MAKING GOOD MONEY.

THIS SPARE TIME WORK IS GREAT FUN AND PRETTY SOON I'LL BE READY FOR A FULL TIME JOB

Do you want to make more money? I'm sure I can train you at home in your spare time for a good Radio Job. I'll send you a sample lesson FREE. Examine it, read it, see for yourself how easy it is to understand even if you have no knowledge of Radio or electricity.

tant Radio principles. My training gives you practical Radio experience while learning.



I Also Give You a Professional Servicing Instrument

Here is the instrument every Radio expert needs and wants--an All-Wave, All-Purpose, Set Servicing Instrument. It contains everything necessary to measure A.C. and D.C. voltages and current; 10 test tubes, resistance; adjust and align any set, old or new. It satisfies your needs for professional servicing after you graduate--can help you make extra money servicing sets while training.

Get My Lesson and 64-Page Book FREE-- Mail Coupon

In addition to my Sample Lesson, I will send you my 64-page Book, "Rich Rewards in Radio." Both are free to any fellow over 16 years old. My book points out Radio's spare time and full time opportunities and those coming in Television; tells about my Training in Radio and Television; shows my Money Back Agreement; shows you letters from men I trained, telling what they are doing, earning. Find out what Radio offers YOU! MAIL THE COUPON in an envelope, or paste it on a penny postcard--NOW!

**J. E. Smith, Pres., National Radio Institute  
Dept. 8EX Washington, D. C.**



OH BILL-- I'M SO GLAD I ASKED YOU TO FIX OUR RADIO. IT GOT YOU STARTED THINKING ABOUT RADIO AS A CAREER, AND NOW YOU'RE GOING AHEAD SO FAST

OUR WORRIES ARE OVER. I'M MAKING GOOD MONEY NOW, AND THERE'S A BIG FUTURE AHEAD FOR US IN RADIO

Many Radio Experts Make \$30, \$50, \$75 a Week

Radio broadcasting stations employ engineers, operators, station manager, and pay up to \$5,000 a year. Spare time Radio set servicing pays as much as \$200 to \$500 a year. Full time Radio servicing jobs pay as much as \$30, \$50, \$75 a week. Many Radio Experts operate their own full time or part time Radio sales and service businesses. Radio manufacturers and jobbers employ testers, inspectors, foremen, engineers, servicemen, paying up to \$6,000 a year. Radio operators on ships get good pay, see the world besides. Automobile, police, aviation, commercial Radio, and loud speaker systems offer good opportunities now and for the future. Television promises many good jobs soon. Men I trained have good jobs in these branches of Radio.

Many Make \$5, \$10, \$15 a Week Extra in Spare Time While Learning

Almost every neighborhood needs a good spare time serviceman. The day you enroll I start sending you Extra Money Job Sheets. They show you how to do Radio repair jobs, how to cash in quickly. Throughout your training I send you plans and ideas that have made good spare time money--from \$200 to \$500 a year--for hundreds of fellows. I send you special Radio equipment, show you how to conduct experiments, build circuits illustrating impor-

**J. E. SMITH, President, Dept. 8EX  
National Radio Institute, Washington, D. C.**

Dear Mr. Smith: Without obligation, send me a sample lesson and your free book about the spare time and full time Radio opportunities, and how I can train for them at home in spare time--about the N.R.I. Set Servicing Instrument you give me. (Please write plainly.)

Name ..... Age .....

Address .....

City ..... State .....

14X-1

Please Say That You Saw It in RADIO-CRAFT



HUGO GERNSBACK, Editor-in-Chief  
 N. H. LESSEM Associate Editor  
 ROBERT EICHBERG Associate Editor  
 R. D. WASHBURNE, Managing Editor

**CONTENTS — MAY 1938, ISSUE**

Volume IX Number 11

Editorial: .....Hugo Gernsback 725  
 The Radio Month in Review..... 726  
 Waves Flow Like Water Through Tube!..... 728  
 37 Hours of Sound on 16 Mm. Reel!..... 728  
 Texas Centennial's Sound System..... 729  
 It's Easy to Build This "Browning 83" 4-Band Super-  
 het.—Part II.....Glenn H. Browning 730  
 A New Remote Robot-Monitored Public Address  
 Amplifier .....A. C. Shaney 732  
 As Predicted!—Daily Newspaper Now Printed in  
 Your Home—by Radio!.....Robert Eichberg 734  
 Sliderules!—For Public Address and Service Work 736  
 Santa Anita's New 300-Watt Voice..... 737  
 Dual-Input A.C.-D.C. Preamplifier....McMurdo Silver 737  
 Phono Pickups on Parade.....Clifford E. Denton 738  
 A Home-Made Infinite-Resistance Tube Checker—  
 Part I.....Louis F. B. Carini 740  
 New Circuits in Modern Radio Receivers—No. 8  
 .....F. L. Sprayberry 741  
 Television—Here and Abroad.....W. E. Shrage 742  
 Beginners!—Make This 1-Tube Loop Receiver  
 .....N. H. Lessem 744  
 "Learn-by-Experimenting" Beginners' Practical Radio  
 Course—Experiment No. 6.....Sol D. Prensly 745  
 Make Your "Silent" Movies into Home Talkies..... 746

Operating Notes ..... 747  
 Service Men!—"Pushbutton-ize" Old Receivers..... 748  
 Television Students Learn by Making Cathode-Ray  
 Tubes—Part VI.....U. A. Sanabria 748  
 Canada's "Interference Detectives"—Part II..... 749  
 The Latest Radio Equipment..... 750  
 Recent Radio Tubes.....R. D. Washburne 751  
 RADIO SERVICE DATA SHEETS:  
 No. 226—Wells-Gardner Series B-1 4-Tube Home  
 Radio Set—Battery Operated..... 752  
 No. 227—Crosley "Prestotune" Models 1217 and  
 1227 ..... 754  
 No. 228—Ditto (continuation)..... 755  
 Servicing Questions & Answers..... 753  
 Useful Circuit Ideas..... 756  
 Book Reviews ..... 723A



June *Radio-Craft* will be an issue YOU CANNOT AFFORD TO MISS! This Special Moneymaker Number will be *different!*—unusual! PROFITABLE! All the branches of Radio—set building, servicing, etc., Public Address and Electronics—will be covered as usual, but, unlike any previous issue, special consideration will be given to many new ideas, methods, equipment, and so-on—only a few of which would occur to the average radio man—for making extra dollars—extra CASH.

Scores of manufacturers and authors are collaborating with *Radio-Craft* in helping make the June issue the most "moneymaking" number you've ever seen in the entire radio magazine field. If the May issue is well worth a quarter to you, JUNE RADIO-CRAFT WILL BE WORTH DOLLARS!

—Reserve your copy today!

Published by Radcraft Publications, Inc. Publication office: 29 Worthington Street, Springfield, Mass. Editorial and Advertising Offices: 99 Hudson Street, New York City. Chicago Advertising Office: RADIO-CRAFT, 520 North Michigan Avenue, Chicago, Ill.

Foreign Agents:

London—Gorrings American News Agency, 9A Green St., Leicester Square, W. C. 2, England.  
 Paris—Messageries Dawson, 4 Rue Faubourg, Poissonniere, France.  
 Melbourne—McGill's Agency, 179 Elizabeth St., Australia.  
 Dunedin—James Johnston, Ltd., New Zealand.

RADIO-CRAFT is published monthly, on the first of the month preceding that of date; subscription price is \$2.50 per year in U. S. and Canada. (In foreign countries, \$3.00 a year to cover additional postage.) Entered at the post office at Springfield as second-class matter under the act of March 3, 1879.

Text and illustrations of this magazine are copyright and must not be reproduced without permission of the copyright owners.

Copyright 1938 Radcraft Publications, Inc.



# TRAIN FOR RADIO IN 12 WEEKS

## BY MY QUICK, EASY "LEARN BY DOING" METHOD



Prepare today to enter a real money-making field by my quick, easy way to learn Radio. Here in my school you are trained in **12 weeks** for your start for a better job and a real future. You do actual work on a great outlay of Radio equipment. The remarkable "**Learn-By-Doing**" methods used in the great Coyne Shops train you in **Radio, Television** and sound equipment servicing. Not by books . . . Not by Correspondence . . . But all under the individual guidance of skilled instructors, and only on similar kind of work you will meet out on a real job. My methods make it **easy to learn**—First you are **told** how to do a thing—then you are **shown** how to do it—then you **do the work yourself**. WHERE ELSE CAN YOU FIND SO QUICK AND EASY A WAY TO GET PRACTICAL TRAINING IN THIS GIANT INDUSTRY?

# I'LL FINANCE YOUR TRAINING

**DON'T LET LACK OF MONEY** keep you from sending in the Coupon **TODAY**. Learn how you can get training first and take more than a year to pay for it after graduation. Make your first payment 60 days after your regular 12 weeks' training period ends. Then take over a year to pay the balance of your tuition in easy monthly payments. Hundreds of ambitious fellows have used this method to get Coyne Training. **FILL IN THE COUPON AND MAIL IT TODAY**. It will bring you the details of this amazingly quick and easy way to get your start towards a good pay job.



*H. C. Lewis*

### Radio—Television—Sound Equipment

Your training at Coyne is in wonderful, modern daylight shops on the finest kind of **RADIO, TELEVISION and SOUND EQUIPMENT**. Television is sure to come as a commercial industry, whether this year or next. Talking Picture and Public Address Systems offer opportunities for the trained man. Everything possible has been done to make you stay at Coyne happy and healthful as well as profitable.

### Electric Refrigeration Training Included at No Extra Cost

This combination Training (Radio and Refrigeration) can be of great value to you. Whether you go into business for yourself or get a job working for a Radio Sales and Service organization, the fact that you are trained in servicing Electric Refrigerators should be profitable to you. Many Radio Manufacturers also make Electric Refrigerators and men with this combination training are much more valuable to these employers. You can **NOW** get this training without extra cost.

### No Advanced Education or Previous Experience Needed

If you can read and write simple English and are ambitious you can be trained the Coyne way—by actual experience on a wide variety of up-to-date Superheterodyne sets, oscillators, analyzers, and test instruments. You learn how to operate television receiving and transmitting equipment and how to install, test and service public address systems and sound picture equipment. Coyne training also helps prepare you to qualify for a government license examination as Amateur Broadcast or Telegraph Radio Operator and to know Code and Department of Commerce rules. Send coupon for all details.

### Part Time Work While Learning Employment Service after Graduation

If you need part time work to help pay living expenses while training, my Employment Department will help you get it. They will also give you Life-time Employment Service after you graduate.

### Mail Coupon Today I'll Send You All the Facts

Get the new "Coyne Opportunity Catalog," giving all facts about Coyne Training. Photographs of Shops showing students at work on modern radio equipment under the personal supervision of Coyne Expert Instructors. Also details of my Part Time Employment Offer, Pay After Graduation Plan and Graduate Employment Service. Yours without cost. Simply Mail the Coupon.



**H. C. LEWIS, President RADIO DIVISION Founded 1899**  
**COYNE ELECTRICAL SCHOOL**  
 500 S. Paulina St., Dept. 58-8H Chicago, Ill.

-----

H. C. LEWIS, President,  
 Radio Division, Coyne Electrical School,  
 500 S. Paulina St., Dept. 58-8H, Chicago, Ill.

Send me your big FREE Book about Coyne Training and give me all details regarding your, "Part Time Employment Offer" and "Pay After Graduation Plan" of easy, monthly payments.

NAME.....AGE.....

ADDRESS.....

CITY.....STATE.....

Please Say That You Saw It in RADIO-CRAFT



## BOOK REVIEWS

**YOU'LL NEVER  
LOSE A  
CUSTOMER**

*...by giving him  
the best.*



**INSULATED  
Metallized TYPE BT  
RESISTORS**

Almost any piece of carbon is a resistor . . . but a really good resistor, scientifically designed to meet every requirement of Radio, is something else again.

IRC Resistors may cost a little more to buy . . . But they actually cost far less to use in all replacement work. There's no come-back when you use IRC's. They never let you down . . .

*"They Stay  
Put!"*

**INTERNATIONAL  
RESISTANCE COMPANY**

401 N. Broad St., Philadelphia, Pa.

**VIBRATION AND SOUND**, by Philip M. Morse. (1936.) Published by McGraw-Hill Book Company. Size, 6½ x 9¼ ins., cloth covers, 351 pages, illustrated. Price \$4.00.

This book on the theory of vibrations and sound will be of particular interest to workers in the field of acoustics and to communications engineers. The book aims to give a general introduction to the theory of vibration and sound, emphasizing newer applications and the more recent points of view, and to give a series of examples in the method of theoretical physics—how a theoretical physicist attacks a problem and how he finds its solution.

During the recent rapid change in the science of sound, certain parts of the subject have gained and other parts have lost importance. The present book attempts to follow this change in emphasis and to discuss the new developments as well as those portions of the older theory which are still of importance.

Some of the special topics discussed are: propagation of sound in tubes; propagation of sound in horns; radiation from cylinders; radiation from spheres; loudspeakers and microphones; speech, music and hearing. Chapter headings: Introduction; The Simple Oscillator; The Flexible String; The Vibration of Bars; Membranes and Plates; Plane Waves of Sound; The Radiation and Scattering of Sound; Standing Waves of Sound.

The treatment is mainly mathematical and hence is not recommended to the tyro.

**BOTH SIDES OF THE MICROPHONE**—Training for the Radio, by John S. Hayes and Horace J. Gardner. (1938.) Published by J. B. Lippincott Company. Size, 5¼ x 7¼ ins., cloth covers, 180 pages. Price \$1.25.

This book has a two-fold purpose: first, to enlighten those who are interested in various phases of broadcasting from a vocational angle; second, to detail the fundamentals of radio for that vast, unseen audience, young and old alike, who are on the other side of the microphone.

This book forms an excellent reference to almost the complete procedure of broadcasting as is indicated by the following list of contents: Part I—One Side: The Station—The Network—and Time. The Program Department, What It Is, The Announcer, Continuity, The Musical Division, Sound Effects, Program Research, The Audition, The Producer, The Artist Bureau, The Sales Department, What It Is, The Salesman and Selling Radio Time, Sales Promotion, The Publicity Department, What It Is, What the Publicity Department Does, Special Events, What the Publicity Man Knows, The Engineering Department, What It Is, In the Studio, In the Master Control Room, At the Transmitter, Remote Control Engineering, Maintenance and Construction, Recording and Transcription, The Traffic Division, The Office, What It Includes.

Part II—The Other Side: The Other Side of the Microphone; What the Listener Should Expect From His Radio Set; From the Dance Orchestra on the Air; From a Program of News Comment; From an Educational Program, From the Special Event and Its Announcer; From Radio Drama; From the Symphonic Broadcast; From the Announcer; From a Variety Show; From the Broadcast of the Sporting Event; From the Non-Commercial Broadcaster; From a Religious Broadcast; A Catholic Viewpoint; Religion on the Air; The Value of the Radio Sermon; North American Broadcasting Stations.

**THE INTERNATIONAL BROADCAST & SOUND ENGINEER (1937 Year-Book)**, Published by I. Davey, London (available in U.S.A. from Pilgrim Electric Corp.). Size, 5½ x 7¼ ins., 226 pages, 105 illustrations, paper covers. Price \$1.50.

A welcome addition to the meagre library of publications for the sound specialist. A fact of special interest and importance—which will be appreciated by readers who possess only a slight knowledge of the English language—is that the various subject matters, discussed at length in English, are condensed in 6 foreign languages. The technical range and international scope of

the book is indicated by the following listing of its contents: Belgium—Scanning the World's Technical Literature; England—A New Design of Transformer; U.S.A.—Sound Reinforcing Systems; Germany—Reverberation Times of Concert Halls and Absorption of Sound by the Audience; Switzerland—Acceptance Tests for Broadcasting Stations; Germany—Power Requirements of the Final Stage of a Transmitter with Push-Pull B-Modulation; Holland—Ultra-Shortwave Transmission at High Power; Germany—Amplifier Valves for High-Power Broadcasting Stations; Italy—The Plotting of the Characteristics of Transmitting Valves; Germany—The High Dipole Fading-Reducing Aerial; France—Television over Cable; U.S.A.—100-watt Transmitter (RCA); U.S.A.—350-watt Transmitter (Marine Radio Corp.); Brazil—20-kw. Transmitter (Philips); Argentine—38-kw. Transmitter (Telefunken); Argentine—50-kw. Transmitter (RCA); Finland—150-kw. Transmitter (Marconi).

**B.B.C. ANNUAL 1937**, Published by The British Broadcasting Corp. Size, 7½ x 10 ins., cloth covers, 176 pages, over 100 illustrations. Price 2s.6d. (approximately 75c plus postage).

Prepared in the usual perfection characteristic of publications of the British Broadcasting Corporation, this book presents a cross-section of radio programs in Great Britain and the Empire during the year 1936. Technical, semi-technical and non-technical aspects of British radio are delineated.

**TELEVISION THEORY AND PRACTICE**, by J. H. Reyner. Second Edition (1937). Published by Chapman & Hall, Ltd. Size, 6 x 8¼ ins., cloth covers, 224 pages, 126 illustrations. Price 12s.6d. (approximately \$3.25 plus postage).

In this book the author has considered the subject from the first principles and an attempt has been made to convey fundamental information which will be of real value to the student of television. *Radio-Craft* recommends this book to the consideration of readers who want factual material that will be of real help to them in understanding modern television theory and practice.

In any art which is so rapidly changing, detailed descriptions of actual methods and systems are liable to become out of date in a very short time. For this reason the descriptive matter has been reduced to a minimum, only those examples having been included which are likely to point the way to future developments. It is hoped that by this means the book will prove a useful contribution to the literature on the subject.

In this Second Edition the matter has been rearranged in more logical form and to exclude some of the non-technical descriptive matter in the First Edition.

The range of contents is indicated in the following chapter headings: Part I—Receiving Technique; What Is Television?; Simple Mechanical Systems, The Eye in Television, The Cathode Ray Tube, Time Base Circuits, Cathode Ray Reception, High-Definition Mechanical Systems, The Television Receiver, Ultra-Shortwaves; Part II—Transmitting Technique; Photocells, The Television Transmitter, Film Transmission, Velocity Modulation, Color Television.

### REGARDING MARCH RADIO-CRAFT (JUBILEE NUMBER)

A discrepancy in the March, 1938, issue of *Radio-Craft* has been called to the attention of the editors. Referring to page 561 in the article, "Reminiscences of Old-Timers," we are advised by Mr. Priess he never was in the employ of Kolster; instead, he developed reflex receivers while with the De Forest Radio Company.

In the April, 1938, issue of *Radio-Craft*, pg. 675, appears a caption—for Fig. C in the article, "The Du Mont Television System"—which may require further comment. It may not be clear to the casual reader that the Pasmajector is not an essential component of the Du Mont television system, per se. Instead, it may be used with any television system to illustrate the principles involved.

Please Say That You Saw It in RADIO-CRAFT



# Be a RADIO EXPERT

## THE ONE MAN IN 1000 WHO CAN SERVICE MODERN RADIO RECEIVERS

**RADIO SERVICE WORK NOW OFFERS GREATEST OPPORTUNITIES SINCE RADIO BEGAN.....**

Radical changes have taken place in radio receiver design during the past year. Circuits and construction are very different from the receivers with which the radio service industry has had its greatest experience. Even more sensational developments with further complications are coming next season. Who will service these receivers? Certainly not the "old timer" who knows nothing about modern receivers! He can't do it. That is why, right now, there is an urgent demand for reliable service men with up-to-the-minute knowledge of modern radio receivers. Such men can step right out and earn up to \$3 an hour doing nothing but pleasant service work in the better homes around town.



Important and far-reaching developments in Radio create sudden demand for specially equipped and specially trained Radio Service Men.

**THIS CIRCUIT ANALYZER AND POINT-TO-POINT RESISTANCE TESTER INCLUDED FREE OF EXTRA CHARGE.**

*Also*  
**FOUR LARGE KITS OF HOME PRACTICE EQUIPMENT.....**



**No Past Experience Needed**

Past experience actually counts for little at this time, because the swift changes in receiver construction have made knowledge of old equipment practically useless. Even though you may not know one tube from another today . . . still, you can take R.T.A. training and make more money servicing modern radios than most of the "old timers" are making. R.T.A. graduates are doing it every day. Many of them are making more money as R.T.A. Certified Radio Technicians than they ever made in their lives before!

**Be An R. T. A. Man and You'll Be the One Man in 1000**

R.T.A. training will equip you to give fast, complete service to any radio receiver built. The jobs that puzzle and sometimes baffle the usual service man will be simple as "A.B.C." to you . . . when you become an R.T.A. Certified Radio Technician. It is very possible that you will be the only service man in your locality able to quickly diagnose and quickly repair the new types of radio receivers. Be the one man in 1000! You can.

**IT'S JUST AS SIMPLE AS THIS**

<p>OF COURSE I CAN FIX IT!</p>	<p>NOW THE SET SOUNDS GREAT! TWO OTHER MEN HAVE TRIED TO FIX IT BUT COULDN'T DO IT</p>	<p>I MADE \$18 TO-DAY! THERE'S NOBODY ELSE IN TOWN WHO CAN FIX THESE NEW SETS</p>
--------------------------------	--	---

**R. T. A. Membership Valuable**

With your course of training, and as long afterward as you may need help, you always have available, without extra cost, valuable consultation service on any problem that may arise in your radio service work or on any of the newer developments that may appear in new radio receivers from time to time.

**To Help You Make Money Quickly**

R.T.A. supplies you with an excellent and reliable Circuit Tester and Point-to-Point Resistance Checker as is illustrated above—one of the handiest pieces of portable service equipment. It quickly helps you locate trouble in any type of radio receiver, old or new.

**RADIO TRAINING ASSOCIATION of AMERICA**  
4525 Ravenswood Avenue CHICAGO, ILLINOIS

**SEND COUPON**

A. G. Mohaupt, Engineer  
Radio Training Ass'n. of America  
Dept. RC-58, 4525 Ravenswood Ave., Chicago, Ill.

Dear Mr. Mohaupt: Please send me your free book of facts about radio opportunities and how I can make big money quickly. Also tell me how I can obtain your Circuit Analyzer and four big experimental outfits.

Name .....

Address .....

City ..... State .....

*Please Say That You Saw It in RADIO-CRAFT*



# A New Policy!

## FREE INSPECTION PLAN

You can buy any Gernsback Manual on Three Days' Approval

Perhaps you're new in Radio—or probably, in previous years you missed one of the Gernsback OFFICIAL RADIO SERVICE MANUALS. Now then, this is your opportunity to buy any edition you need—get it in a way differently than ever before offered. Under a new policy—FREE INSPECTION PLAN—you can buy any Gernsback Manual on Three Days' Approval. There are thirteen Manuals and books from which to choose—every man in Radio should take advantage of this privilege.

### Here Is How It's Done!

Order any GERNSBACK MANUAL illustrated and described on this page—the publishers will ship it to you immediately POSTPAID. When it reaches you, inspect its contents thoroughly. If, after three days' inspection, you decide to keep the Manual, then mail your remittance to the publishers. Should the volume prove unsuitable, return it postpaid.

This plan is simple—there's no mystery or red tape—it gives you every opportunity to inspect the Manual of your selection. It costs you only a few cents return postage if you decide not to keep it.

### Latest Volume 7 Manual Included

Volume 7 of the OFFICIAL RADIO SERVICE MANUAL—the edition which stamped the Radio industry this past year because it was published in a new way—in twelve monthly installments, is included under this new policy. This volume is now complete—twelve installments, totaling 1,800 pages, are bound in a hardcover binder and just packed with information you need today—and in the years to come. The coupon below gives you the privilege of inspecting this Manual also before you buy it.

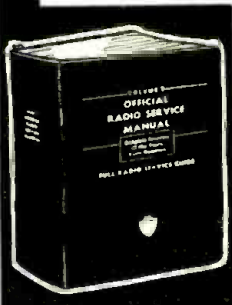

#### ★ VOLUME 7 ★

Newest of GERNSBACK MANUALS, contains schematic diagrams and service data on 1936-37-38 receivers. More up-to-date than any service guide published. 1,800 pages of material which radio men use every day. Wiring diagrams of over 1,200 different manufactured sets. Over 3,000 different illustrations. Bound in hard-  
looseleaf covers—mechanism permits pages to be removed and replaced. Size—9 x 12 inches.

PRICE \$10.00



#### ★ 1936 MANUAL ★

Contains 1,200 pages (over 2,500 illustrations) packed with service data of 1935-36-37 sets. Diagrams of over 1,500 receivers. Shows speaker connections, power transformer connections. Alignment procedure included with diagrams. Operating voltages for over 80% of sets are recorded. Assembly diagrams show relationship of separate units to each other. Size—9 x 12 inches; hard cover, looseleaf binder.

PRICE \$7.00



#### ★ 1935 MANUAL ★

An authentic radio service guide of over 1,000 pages with more than 3,000 illustrations—contains schematic diagrams of 1934-35 receivers. Features many old sets never previously described, early all-wave and short-wave sets, auto-radios, midset and cigar-box receivers. Includes data on P.A. amplifiers, servicing instruments, tube information and FREE QUESTION AND ANSWER SERVICE. Size—9 x 12 inches; flexible, looseleaf covers.

PRICE \$7.00

★ 1935 AUTO-RADIO MANUAL ★  
OVER 240 PAGES  
OVER 500 ILLUSTRATIONS  
Looseleaf Binder—Flexible Covers  
PRICE \$2.50



★ 1934 MANUAL ★  
Contains over 400 pages—over 2,000 illustrations. The schematic diagrams cover 1933-34 receivers. Features voltage readings, I.F. transformer values in superhets, valuable tube data and FREE QUESTION AND ANSWER SERVICE. A handy index makes it easy to find any information on service problems. Master index includes diagrams published in previous MANUALS. Size—9 x 12 inches; flexible, looseleaf covers.

PRICE \$3.50



★ 1933 MANUAL ★  
This 700-page Manual, with over 2,000 illustrations, contains page after page of operating notes—schematics showing location of parts on chassis—values of I.F. peeks, resistors and condensers. A complete section on construction of various types of test equipment, plus money-making ideas for radio men. Includes auto-radio installation and servicing. Size—9 x 12 inches; flexible, looseleaf covers.

PRICE \$5.00



#### ★ 1932 MANUAL ★

This Manual contains a full radio service guide of 1931-32 receivers. With over 1,000 pages and over 2,000 illustrations, it features a step-by-step analysis in servicing a receiver—chart showing operation of vacuum tubes—schematic diagrams with color coding indicated—commercial short-wave receivers and adapters and servicing public address equipment. Size—9 x 12 inches; flexible, looseleaf covers.

PRICE \$5.00

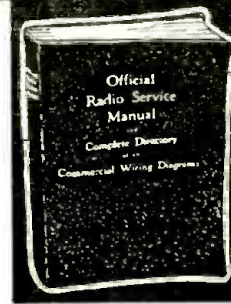

#### ★ 1931 MANUAL ★

The first of the famous GERNSBACK MANUALS—contains all available wiring diagrams of nearly every receiver manufactured since 1927, and many prior to that year. This particular edition contains 850 pages (including supplements) with over 1,500 important diagrams. Most valuable to radio men is the RADIO SERVICE COURSE published in this edition. Size—9x12 inches; flexible, looseleaf covers.

PRICE \$4.50 including supplements.



#### OFFICIAL RADIO SERVICE HANDBOOK

Here's the sensational book on servicing. Covers over 500 topics. Contains a special section of 250 pages of Operating Notes. The book covers: Circuit Theory and Analysis; Modern Servicing and Test Equipment; Practical Trouble Shooting; Specialized Receiver and Installation Data; Modernization and Conversion Data, etc. Over 1,000 pages—over 1,000 illustrations; hard covers. Size 6 x 9 inches.

PRICE \$4.00

### This Policy Includes

- OFFICIAL REFRIGERATION SERVICE MANUAL (Volume 1) — \$5.00
- OFFICIAL REFRIGERATION SERVICE MANUAL (Volume 2) — \$5.00
- OFFICIAL AIR CONDITIONING SERVICE MANUAL — \$5.00

### How To Get Any Manual You Need!

After you have definitely decided which Manual you want, fill in completely the coupon at the right. Clip it to your letterhead or paste on a penny post card and mail to the publishers. In a few days your Manual will reach you—Don't lose time—send coupon, TODAY, to

**RADCRAFT PUBLICATIONS, Inc.**  
99 Hudson Street New York, N. Y.

**RADCRAFT PUBLICATIONS, Inc.** RC-538  
99 Hudson Street, New York, N. Y.

Please send me, POSTPAID, \_\_\_\_\_ for three days' examination on approval. In three days I will remit to you the full cost of the Manual or book selected, or return the volume to you postpaid.

Name \_\_\_\_\_ (Name of Manual or Book)

Address \_\_\_\_\_

City \_\_\_\_\_ State \_\_\_\_\_

Name of company or employer \_\_\_\_\_  
(This offer is good only in continental United States.)

Please Say That You Saw It in RADIO-CRAFT





"Takes the Resistance out of Radio"

Editorial Offices: 99 Hudson St., New York, N. Y.

HUGO GERNSBACK, Editor

Vol. IX, No. II, May, 1938

## PUBLIC ADDRESS DEFICIENCIES

An Editorial by HUGO GERNSBACK

THAT branch of radio termed Public Address, has already become a huge industry, and in time to come will outrival many other branches of radio. It is not possible to give exact figures in dollars and cents as to the extent of the Public Address industry, but it is known that in 1937 *the value was well over 25 millions of dollars*, and while this is only an estimate, it indicates the rise and healthy growth of this comparatively new industry.

Public Address goes into so many phases today that it is almost impossible to keep track of all the new applications that are made almost daily, in order to bring the human voice or music to an ever-widening circle of listeners; be it in the music halls, motion pictures, theatres, at the race-tracks, football field or ocean liner.

Great as have been the strides made in Public Address, a tremendous amount of work still remains to be done to satisfy not only the technician but also the public.

If you look back only a few short years and try to remember the blaring, nasal sounds that were supposed to be reproductions of the human voice, and compare those effects with present-day results, you might well smile at the improvement. On the other hand, however, critical sound engineers do not smile so happily because they know of the many shortcomings still present, which will take many years of painstaking labor and research to overcome in order to achieve the goal of clear articulation of the human voice, no matter how far removed from the loudspeakers, or whether subject to conditions indoors or outdoors. That, today, is still a large order, and many question marks still crop up along the road of development of Public Address—all questions to which no satisfactory answer can be given today.

While *music* which is satisfying to the average person can be fairly well transmitted today via Public Address, the music critic—who often has to listen to a Public Address system, say 100 yds. away from the loudspeakers—still shakes his head and complains that the reproduction in most cases is poor. But the biggest stumbling block is the *articulated* human voice, in satisfactorily reproducing which, it is admitted, a tremendous amount of progress must be made in order to achieve really satisfactory results.

In a large closed hall, we are still beset by many perplexities such as echoes. In the most up-to-date theatre in the world, Radio City Music Hall, you can find many spots in the balcony where echoes and double sound effects are extremely annoying to the listener. Of course, the layman might say this is not the fault of the Public Address system, but rather due to the peculiarities inherent in the physical construction of the theatre. This however is not true because proper placement of speaker units can and *will* overcome many echo deficiencies. These echo deficiencies are particularly noticeable in large churches where the walls, of stone, make excellent sound reflectors. This particularly aggravates the problem and has baffled our best sound engineers, who so far have not made much headway along these lines. If the

conditions in a theatre or hall are bad, they become a much greater problem outdoors, where the engineer has to contend with a great many other factors of sound projection in addition to those found indoors.

It is almost impossible today to listen to the human voice from the average outdoor Public Address system, because of the bad distortion due to the motion of the open air, constantly changing temperatures, variations in the atmosphere, and many other factors. For example, we recently listened to a Public Address system at a dog track, and it was quite impossible to understand the announcements that were made by the speaker. Once in awhile a few words could be understood, but generally the announcements were wholly unintelligible. This particular system had only 2 loudspeakers which of course were not sufficient. The more modern systems have a multiplicity of horns facing in all direction which give some improvement but is a compromise still far from the goal.

It has always been my personal opinion that a loudspeaker system designed for indoors, cannot be used outdoors, and vice-versa. I do not think the present type of horn speaker is of great value and I do not believe they will be used in the future. The peculiar effects of moving atmosphere make it necessary that as large a moving diaphragm as possible be in contact with the air in order to reproduce great volumes of sound with a minimum of distortion. I can visualize 5- to 10-foot diaphragms or a sonorous unit which will obtain a grip on the surrounding atmosphere sufficient to overcome the loss of clarity so noticeable in Public Address outdoors.

Years ago, experiments were made by sound engineers with compressed air being forced into horns in order to disperse the sound more widely, but to the best of my knowledge, this has not been tried on outdoor Public Address systems. I believe this would be a good thing to try, particularly when it becomes necessary to vibrate thousands of cubic feet of air in order to project sound satisfactorily to large gatherings outdoors or other public meetings. Our present puny horns, unaided, cannot of course be expected to handle such volume of reproduction, and by way of analogy, I might say that you cannot hope to push the *Normandie* through the ocean by equipping the huge ship with only 4 small motorboat propellers. Instead, it is necessary that huge propellers be used, of the kind 12 to 15 feet in height. These large propellers are essential simply that a sufficient grip may be obtained on the surrounding water, and the same reasoning must hold true when you try to impart sound vibrations to the outdoor atmosphere.

The engineer therefore has at the present time 2 means at his disposal, (1) to force sound with compressed air or (2) to use huge diaphragms or large vibrating surfaces. Either, I believe, will in time overcome the problem of distortion in Public Address, where high-volume reproduction of the human voice is desired over large areas and that our present-day reproducers do not satisfactorily cover.





Fig. A. To do honor to Guglielmo Marconi, late Italian wireless wizard, the Italian government has a series of stamps which bear his likeness.

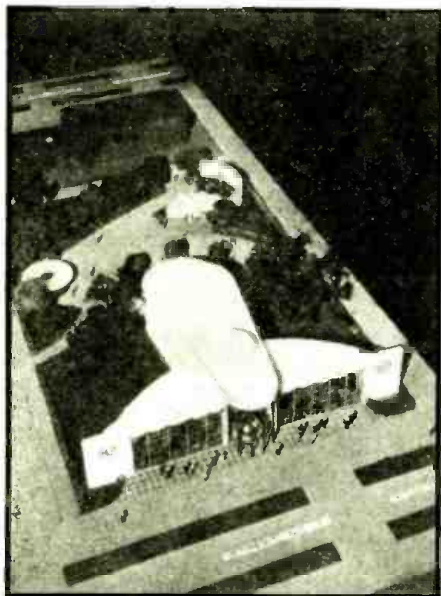
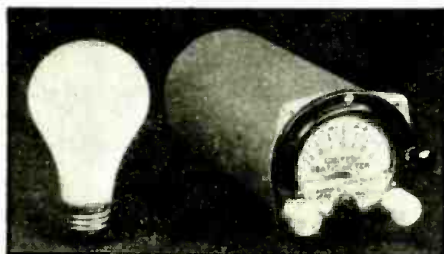

Fig. B. Architect's model of the RCA building at the coming New York World's Fair.



This device is the new snow and rain "static detector" developed by research engineers of United Air Lines and now being tested on 3 of its planes. It records either positive or negative charges of static and measures their intensity (even though inaudible in pilot's earphones). Compare static meter size with that of photoflood bulb, left. Essentially a vacuum electrometer, range of device (as per the series of "Snow Static" articles in *Radio-Craft*) is 10,000 to 1,000,000 peak volts.



Fig. E. How BBC televises—with sound—an indoor event. The shapely miss is "Koringa, the world's only female Yoghi."

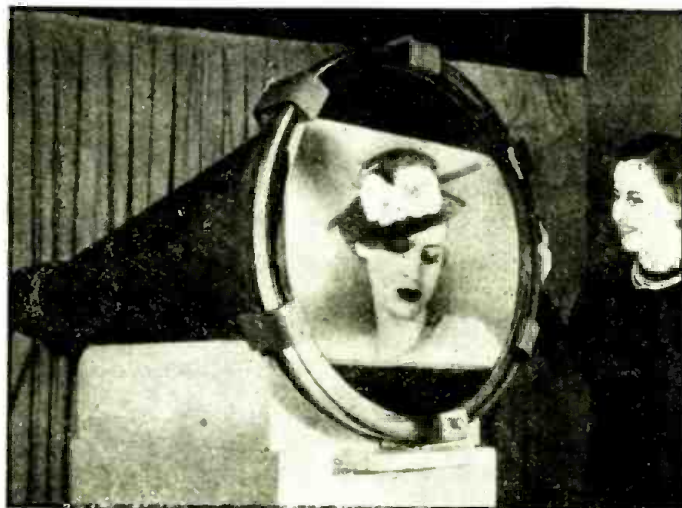

Fig. D. At right — the granddaddy of television tubes. Don't expect to have a television tube like this in your home some day. It weighs about 600 pounds, costs more dollars, and needs a lot of space. But in the RCA laboratories this tube permits study of giant-size television pictures. Air presses, on the surface of its big glass top, with a weight of more than 6 tons. After being sealed a pump needs 48 hours to exhaust the air and create a vacuum in this tube!



Fig. F. And outdoors, the BBC televises the demonstration of a penalty kick. Looks like a bad season, from the grandstand.

# THE RADIO MONTH

## RADIOFFICIAL REGULATIONS

**M**UCH has come out of Washington in the last month, some of it valuable. Among the latter are several announcements from the F.C. Commission. One ruling permits Police transmitters, though licensed to communicate to police cars, to increase their scope in order that they may send messages to fire department vehicles, private ambulances, and public utilities' repair units. However, the same bulletin presents a ruling which forbids Police transmitters to send messages to points they cannot reach! Nor may they handle messages requiring radiophone relay. Nor may they, save when "the messages to be transmitted are of immediate importance to mobile units," use point-to-point communications "between stations in the same local telephone exchange area"! For this the telephone companies should be duly grateful.

A good ruling requires stations in the Aviation service to maintain a continuous listening watch on the airplane calling frequency of 3105 kc., 24 hours a day, unless specifically exempted. Such stations are also required to be ready to operate a non-public communication service during the same hours.

Rule 443, governing the classes of

operators, was amended to permit 3rd-Class Radiotelephone Operators to operate any stations using Type A3 or A4 emission as long as the station is so designed that he can not get it off frequency. He is not permitted to make adjustments which might affect operation; these must be done by 1st- or 2nd-Class Operators. He cannot operate broadcast stations, other than relay, nor coastal stations, nor ship-to-coastal stations.

Second-Class phone men can work Type A3 or A4 stations, but the only sort of broadcasting stations he may operate are television, facsimile, high frequency, relay and experimental. He may not operate a ship station of more than 100 watts, licensed for communication with coastal phone stations.

The 1st-Class phone man can do practically everything his heart desires, save that the last proviso of the 2nd-Class regulation applies to him, too.

All the Classes may operate licensed experimental stations above 30,000 kc.; may (with the above limitations) operate a point-to-point or coastal phone station using A1 or A2 emission, for testing or other incidental service; may operate aircraft stations on domestic flights if his license certifies that he can handle 16 words per minute in code.

There are also new regulations on Radiotelegraph Operators, but they are too long to cite.



# IN REVIEW

Radio is now such a vast and diversified art it becomes necessary for *Radio-Craft* to present a survey of important general-interest monthly developments.

## NAUGHTY, NAUGHTY RADIO

**T**HE cries of those who would reform radio are as loud as ever, both here and abroad. Here, Senator Herring saw something fishy about the writings of one Edgar Allan Poe, last month objecting specifically to a broadcast of "The Evil Eye," which he thought too frightening for children.

Neither Mr. Herring nor anyone else objected when a fill-in orchestra leader sang a ditty which, in underworld jargon, invited radio listeners to smoke some marijuana!

In England, last month, a worried mother started writing to the papers about a skit, in which an unmarried girl was about to become a mother. Her objection was that as the B.B.C. had not tipped off the listening public that some hot stuff was due, her children had listened and then asked embarrassing questions. That, madam, is what comes of not teaching children the Facts of Life.

A poll, last month, by the American Institute of Public Opinion in the U.S. showed that 41% of America's citizens believe that government censorship of broadcasting would be beneficial; 59% think it would be harmful.

At the meeting of the National Association of Broadcasters in Washington, a few days later, a move was made for the radio industry to wash behind its own ears, in order to avoid further demands for government censorship. The day after such a resolution was adopt-

ed, F.C. Commission Chairman McNinch told the N.A. Boys that they should police their own programs. This suggestion was extremely timely, coming only a day late.

A rather foo bill proposing that radio stations under the Public Service Commission was presented, in the New York State Assembly last month, to give the P.S.C. authority to regulate N.Y. Stations' rates, adequacy of service, etc.

## OOOH, LOOKY! TELEVISION!

**G**ROVER WHALEN remarked, last month, relative to the N. Y. World's Fair, "We shall have . . . a television broadcast that will signalize the first use of the device as a public facility rather than an invention . . ." Mr. Whalen was pictured in last month's issue, losing 2 rounds to a lie detector. There will be no decision on this round until (a) 1939, or (b) television breaks before then.

In London, a Baird television station sent a 120-line, 9- x 12-foot image in color last month. It was reported successful. (The Bell Labs. color-television transmissions in 1924, remember, were over wire lines.)

In New York, C.B.S. had planned to start experimental television transmissions, from Chrysler Building's 74th floor, early in 1938. Last month's reports to *Radio-Craft* were that RCA would not make delivery until April 15.

(Continued on page 760)



Fig. G. Three years ago this month, Hugo Gernsback predicted this. Now look below.



Fig. H. So that the voice of the Marshal could direct his smoke-eaters in action, Chicago has equipped its fire trucks with 100-watt RCA speakers.

(Photo below—Allen B. Du Mont Labs.)



Fig. K. Ten frequencies are available in the 50-watt transmitter and receiver designed by Western Electric for coastal vessels. Unit shown is remote control. Insert, transmitter, which user's voice automatically turns on. Circle, phone rings on calls.



Fig. J. The Grace Line's new emergency address system uses speakers that also act as mikes for communications all over ship! Pressing the button does it. Insert, the master switchboard getting final test. Total cost for equipping line is \$100,000.

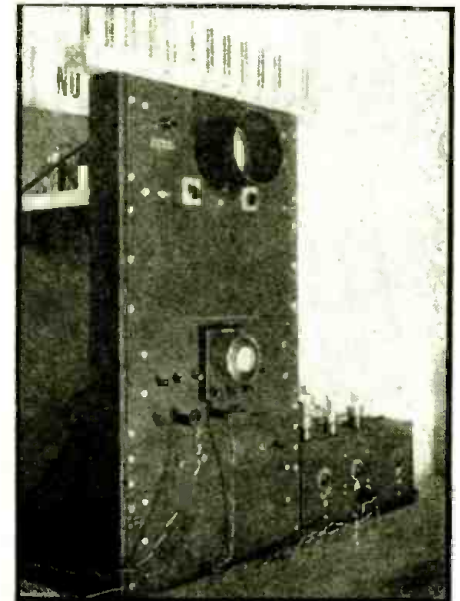

Fig. I. Frequency counter for checking-up resonoscopes. Amplified notes from electrically-driven tuning forks beat against the unknown frequency. An electromagnetic counter indicates the beat; pitch difference is shown on C-R. tube.



# WAVES FLOW LIKE WATER THROUGH TUBE!

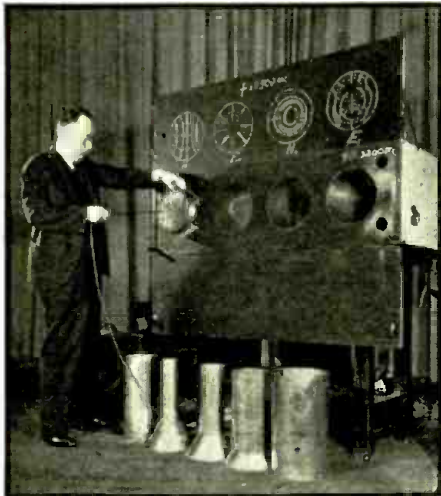

Fig. A. Dr. G. C. Southworth, of Bell Labs., shows how fins in proper plane pass waves.



Fig. B. Then he illustrates how spiral partition makes some short waves rotate.

**E**LECTRIC WAVES that flow through pipes were demonstrated before the Institute of Radio Engineers last month by George C. Southworth, research engineer of Bell Telephone Laboratories. Holding a receiver at the end of a long flexible tube, Dr. Southworth showed that energy was flowing, regardless of how the tube was bent. But when the tube was interrupted, the tone from the receiver stopped, thus showing that the signal came through the tube and not through free space.

Standing in front of a blackboard, Dr. Southworth demonstrated by an electric probe that energy was coming through the blackboard at 4 different

points. By moving the probe he was able to delimit the energy-areas and by holding up a reflector a foot or so away from the blackboard, he was able to set up standing waves. Measurements made on the spot showed that the wavelength was about 20 centimeters, corresponding to a frequency of 15 hundred million cycles per second.

That the waves coming through the 4 different areas were not all alike was shown by two distinct methods. In the first of these, it was shown that certain of the waves would pass through relatively small pipes whereas others could be transmitted only through relatively large pipes. In the other

*(Continued on page 782-84)*

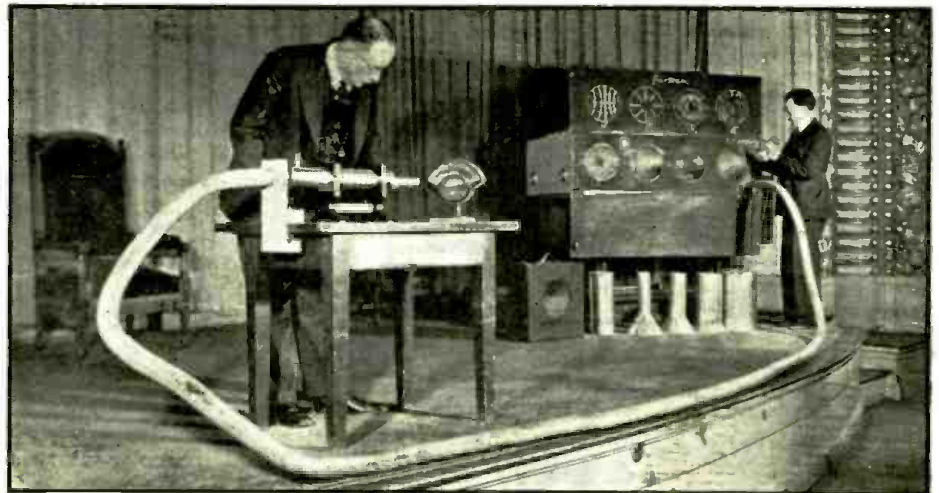

Fig. C. With an assistant, he demonstrates the passage of a 4-inch wave through a flexible metal pipe. This may be the answer to a major problem of television!

# 37 HOURS OF SOUND ON SINGLE 16 MM. REEL!

**A** REMARKABLE new sound recording and reproducing device, invented by J. Ripley Kiel, has been demonstrated in New York. Using 16 mm. unperforated film this device will record 40 sound tracks side by side and permit instant high-fidelity reproduction. The entire record of a court trial, political convention, complete

books, or the whole daily program of a broadcasting station can be given by this device without even the necessity of changing a reel of film. One reel will give 37 continuous hours of reproduction or any part thereof. Used in movie studios, it prevents costly delays because it will enable the directors to check up on the sound immediately,

without waiting for their regular film to be developed. The device causes the film to pass beneath a diamond-pointed stylus suspended on an axis in an electric field, which causes the sound waves picked up by a microphone to become indelibly pressed into the film. By the turn of a switch, another diamond-

*(Continued on page 781)*

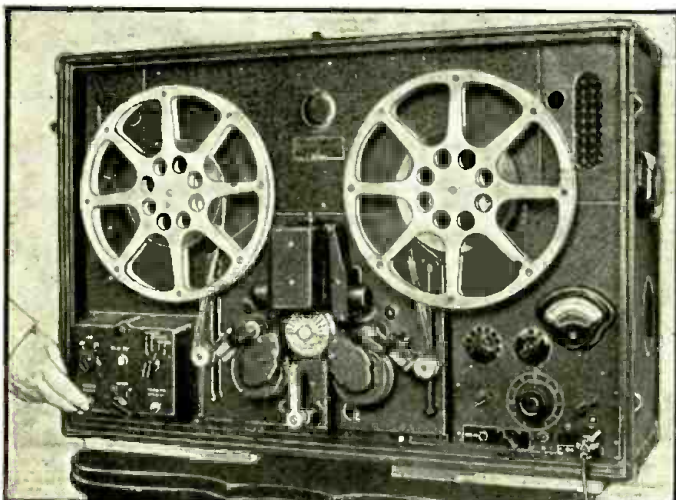

Fig. A. This recorder puts 40 sound tracks side by side on 16 mm. film, which plays 37 hours without change or rethreading!

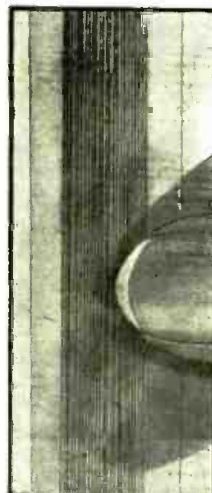

Fig. B. No emulsion needed on this film.

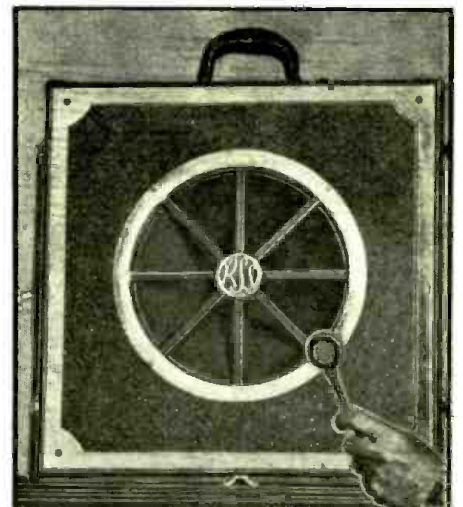

Fig. C. Reproducer and microphone. Note size; "mike" may easily be concealed.



# TEXAS CENTENNIAL'S SOUND SYSTEM



**1** TWELVE ACTORS TOOK 300 PARTS at the Texas Centennial, where a *stereophonic* sound system was used to enable the outdoor audience to hear as well as see the mammoth pageant, "Cavalcade of Texas". Five microphones, 3 of which are seen above, were used in conjunction with separate sound channels and loudspeakers in the scenery to make the cast's voices "move" about the set.

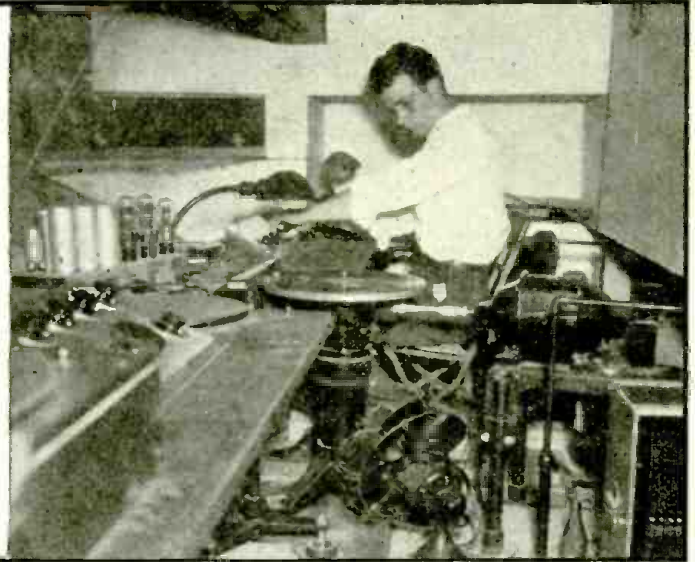

**2** THUNDERING HERDS OF BUFFALO roam the prairies again when Sound Technician Melvin La Krapes starts the turntable which supplies the sound effects for the open-air drama at the Texas Centennial. Two turntables were used for the show's music, which was recorded on 16-inch discs. Lateral recordings were used for sound effects, and vertical recordings for the musical selections.

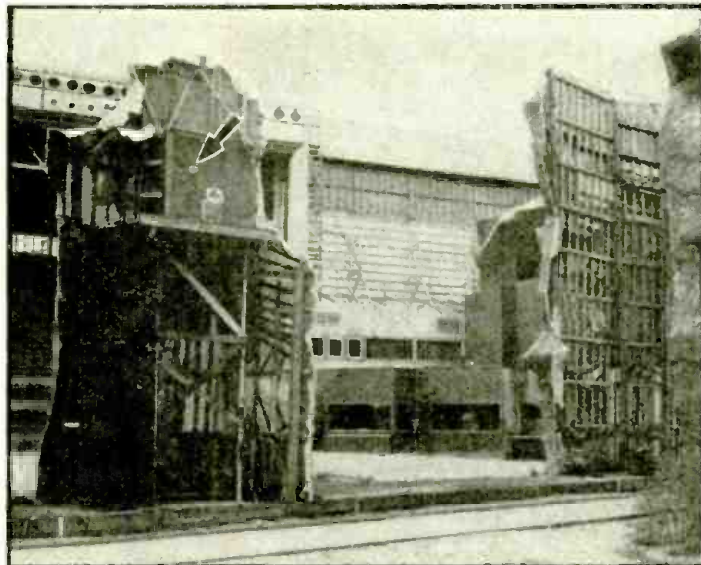

**3** A "ROCK", WIRED FOR SOUND, was one source of voice and music, as this backstage view shows. The papier-mache rock in the foreground conceals a loudspeaker and a spotlight from the audience. Control men, in the booths visible at right of center, faded mikes and amplifiers in and out, to make sound come, stereophonically, from the portions of the stage where action was taking place.

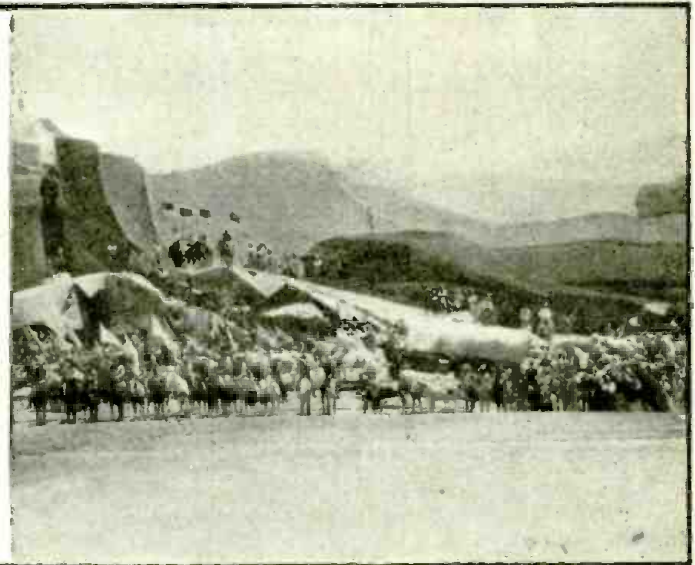

**4** CAN YOU SPOT THE SPEAKERS? Neither could the audience, so cleverly were they hidden. The drama of the old West was re-created through the ingenuity of modern science, which permitted audiences of thousands to hear the voices of the unseen cast that portrayed vocally the scenes which were enacted visibly, with amplifiers, Indians, mixing panels, and ox teams all working together!

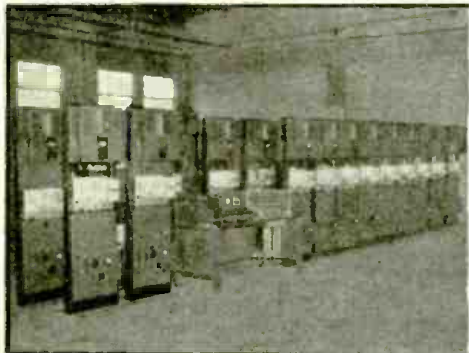

**5** Besides the sound for the pageant, there was a public address system at the Texas Centennial. Here are 19 P.A. amplifier racks, each of which was later installed in a pylon to distribute radio and P.A. programs.



**6** The Central control room, where the material piped to the pylons is monitored and distributed. Engineers here can direct the sound all over the grounds, or confine it to the radius of a single pylon, at will.

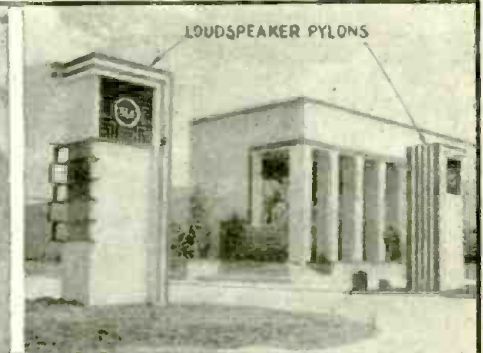

**7** The finished job. Each of the pylons now houses one of the amplifier racks shown in the preceding picture! Radio programs, studio music and the voices of speakers are thus carried to points throughout the grounds.



## HIGHLIGHTS OF THE "BROWNING 83" 4-BAND SUPERHET. RECEIVER

Complete 4-band tuner assembled, wired prealigned;  
 4-band range, 0.54- to 22 megacycles (13.6 to 555 meters);  
 10 tubes employed, viz: 2-6K7's, 1-6A8, 1-6H6, 1-6F5, 1-6CS, 2-6F6's, 1-80, 1-6G5;  
 All tuning circuits individually shielded;  
 Large high-ratio vernier dial, accurately calibrated in megacycles for each band;  
 High signal-to-noise ratio;  
 Diode detection;  
 Automatic volume control;  
 Push-pull 6F6 output with phase inversion;  
 Triple-tuned I.F. circuits with variable gain controllable from front of panel;  
 Visual tuning indicator;  
 High-quality speaker to match receiver.

# IT'S EASY TO BUILD THIS "BROWNING 83" 4-BAND SUPERHET.

**MR. RADIO SET BUILDER:** Have you been "holding off" the construction of an all-wave receiver in the hope that a more simplified, efficient design would soon be offered? Well, here it is—the kit-set you build from a pre-fabricated tuner, and wire in accordance with a picture diagram. Its circuit, as described theoretically this month, combines all the newest features for best DX reception.

**MR. SERVICE MAN:** Here's a set which you can quickly build, and install at a handsome profit. Build a demonstration set. Show your customers how it works rings around their old set. Replace their old chassis with the Browning 83; or build the "83" into some special niche in the home as here illustrated.

## GLENN H. BROWNING PART II

IN last month's issue of *Radio-Craft*, fundamental design features of the Browning 83, a new high-grade 4-band kit receiver, were discussed. This new receiver covers a frequency spectrum of from 0.55- to 22 megacycles and, as did the Browning 35, employs a tuning catacomb which incorporates the antenna, R.F. and oscillator coils together with the tuning, trimming and padding condensers.

The Tuner includes: Trimming, padding and tuning condensers as well as an antenna, R.F. and oscillator coil for each of the 4 bands covered. Thus, L1 in the diagram, Fig. 1, represents one of the 4 antenna transformers, L2 represents one of the 4 R.F. transformers, and L3 represents one of the 4 oscillator coils. The 3 condensers marked CT are the 3-gang tuning condensers, and the 3 condensers marked CP represent 3 of the 12 trimmer condensers (each of these trimmer condensers is connected to its associated coil). CS represents one of the 4 sets of padders used, and CO represents the bypass condenser on the antenna circuit which is included in the tuning catacomb. A 6-gang switching system allows the selection of any band, and short-circuits the other 9 coils in the tuning catacomb not being employed.

In the design of this kit set, *high signal-to-noise ratio was made a fundamental consideration.* One of the fea-

tures of the Browning 35 which evoked considerable favorable comment was its extremely high signal-to-noise ratio, and it was determined to make the Browning 83 a worthy successor to the 35 in this respect.

### "MAXIMUM SIGNAL—MINIMUM NOISE"

It has long been known that the maximum signal-to-noise ratio which can be obtained in the design of a receiver is that obtained when all of the noise in the receiver is generated by thermal agitation due to current flowing in the antenna circuit ahead of the grid of the first tube.\* Stated another way, this means that the maximum signal-to-noise ratio which can be obtained is that which results when no noise is generated in the receiver itself beyond the grid of the first tube.\* No receiver, of course, accomplishes this state of perfection, but the nearest to which this ideal condition is approached may be measured in a simple manner. It can be shown that if a signal generator supplying a pure R.F. signal is connected through a suitable dummy antenna to the input of the receiver, the ratio between the noise level when the receiver is tuned to resonance with the incoming signal and that obtained when the receiver is detuned from the signal is a reliable measure of signal-to-noise ratio. Such measurements made on the

\*Llewellyn—*Proceedings*, I.R.E., March, 1931.

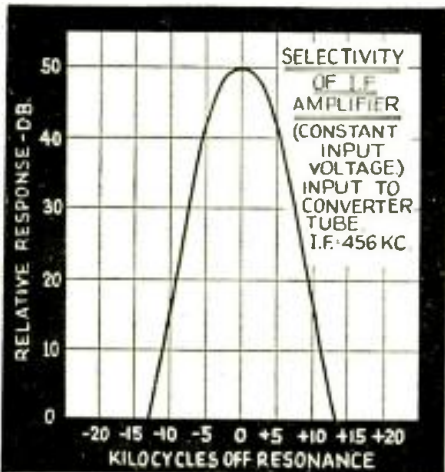

Fig. 2. Constant voltage to converter-tube grid.

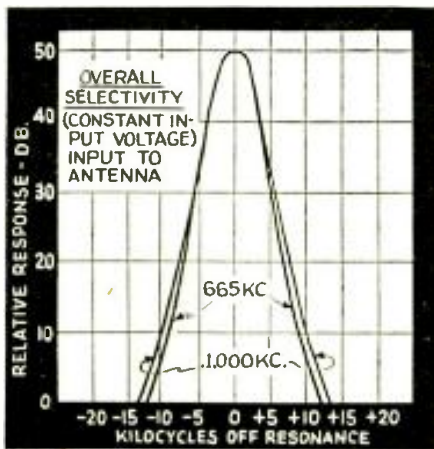

Fig. 3. Constant voltage input to antenna circuit.

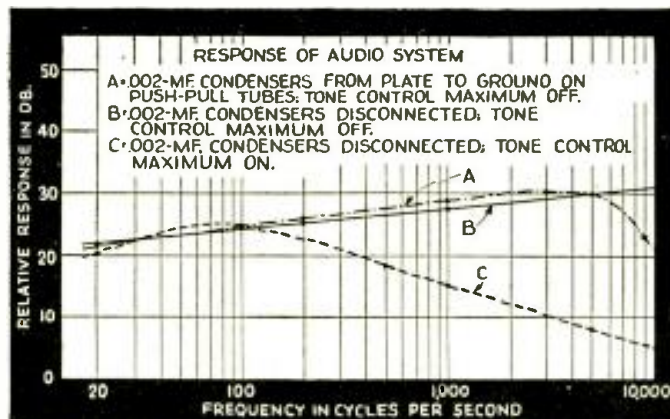

Fig. 4. Relatively flat response of A.F. stages for frequencies to 10,000 cycles.

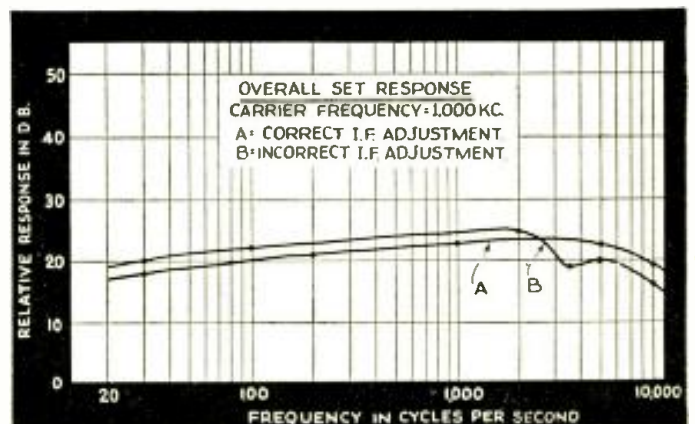

Fig. 5. What happens to over-all response of set if I.F. is incorrectly aligned.



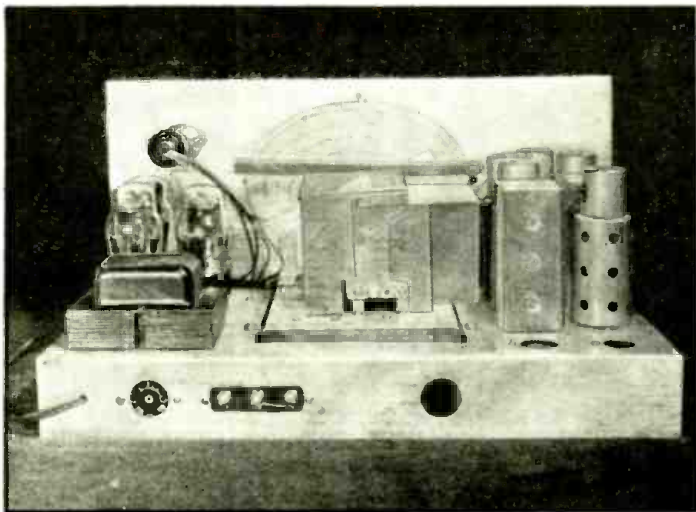

Fig. C. Rear view of chassis of completed "Browning 83" 4-band receiver.

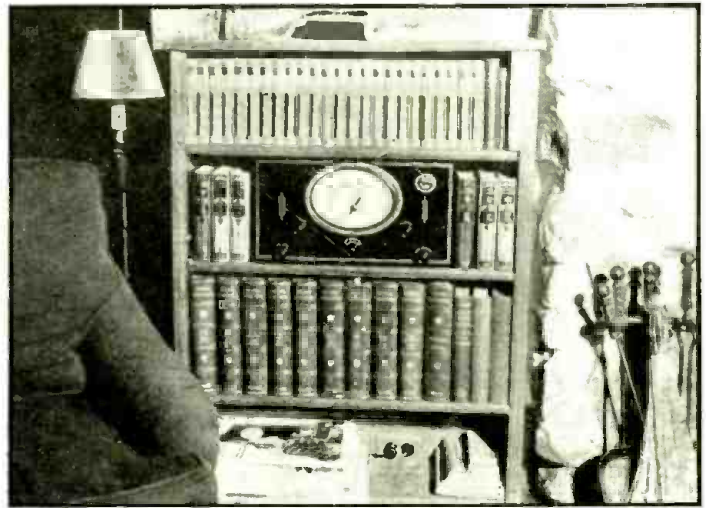

Fig. D. The set, as mounted in a book case, with remote loud speaker.

high-frequency band of the Browning 83 give a difference in noise level of approximately 13 decibels (db.) between the resonant and non-resonant condition. This ratio is considerably higher (more favorable) than that obtained on most factory-built communication receivers of the better type.

Since the maximum which can be obtained in the way of signal-to-noise ratio is directly dependent on the noise generated in the antenna stage itself, careful consideration has been given to the design of the antenna coils employed in this receiver.

#### ANTI-NOISE CONSIDERATIONS

A discussion of some of the design features which contribute to high signal-to-noise ratio might at this time be of interest to the reader. One important item to be considered in this respect is the minimizing of chassis currents. As pointed out in the previous article, the tuning catacomb chassis in the Browning 83 is completely insulated from the remainder of the set chassis and is grounded to the main chassis at one point only. In addition to this precaution, the R.F. and I.F. amplifiers are carefully shielded. In this connection,

the 3-gang tuning condenser which tunes the antenna R.F. and oscillator circuits is completely shielded by a metal housing which locks securely to the chassis and which extends a considerable distance beyond the condenser itself so as to adequately shield the grid leads from the R.F. and pentagrid-converter tubes. Thus, when a metal base is employed with the kit receiver, there is practically no pickup of either signal or noise except through the antenna input.

To reduce the effect of noises entering the receiver from the 110-volt supply line, the power transformer employs an electrostatic shield between the primary and all other windings. In addition a 0.05-mf. condenser is placed across the 110-volt supply line. It was not found necessary to either shield or filter the speaker leads since the effect of pickup on these leads is negligible with speaker leads of the length commonly used. In special cases where the speaker leads are extremely long and are exposed to strong fields generated by some types of electrical appliances near the receiver, it may be found advisable to shield these leads and to thoroughly ground the shield to the

chassis. If this does not completely eliminate the effects of man-made interference, additional relief may be obtained by placing R.F. chokes in the plate leads of the push-pull output tube.

When these precautions are taken and the receiver chassis is mounted on a metal plate, it will be found that very little interference will be picked up even when an electric razor is brought close to the receiver. In making such tests, of course, the antenna is disconnected, and the antenna terminals are shielded since these terminals themselves will act as an antenna. Placing the receiver in a metal cabinet, of course, provides added protection against noise interference which is locally generated.

The antenna input system to the receiver is so arranged that antennas employing either single lead-in or a doublet system may be used. The fundamental purpose of the doublet type of interference-reducing all-wave antenna systems is to provide noise-free reception in localities where considerable interference exists. The basis of the design of this type of antenna system

(Continued on page 758)

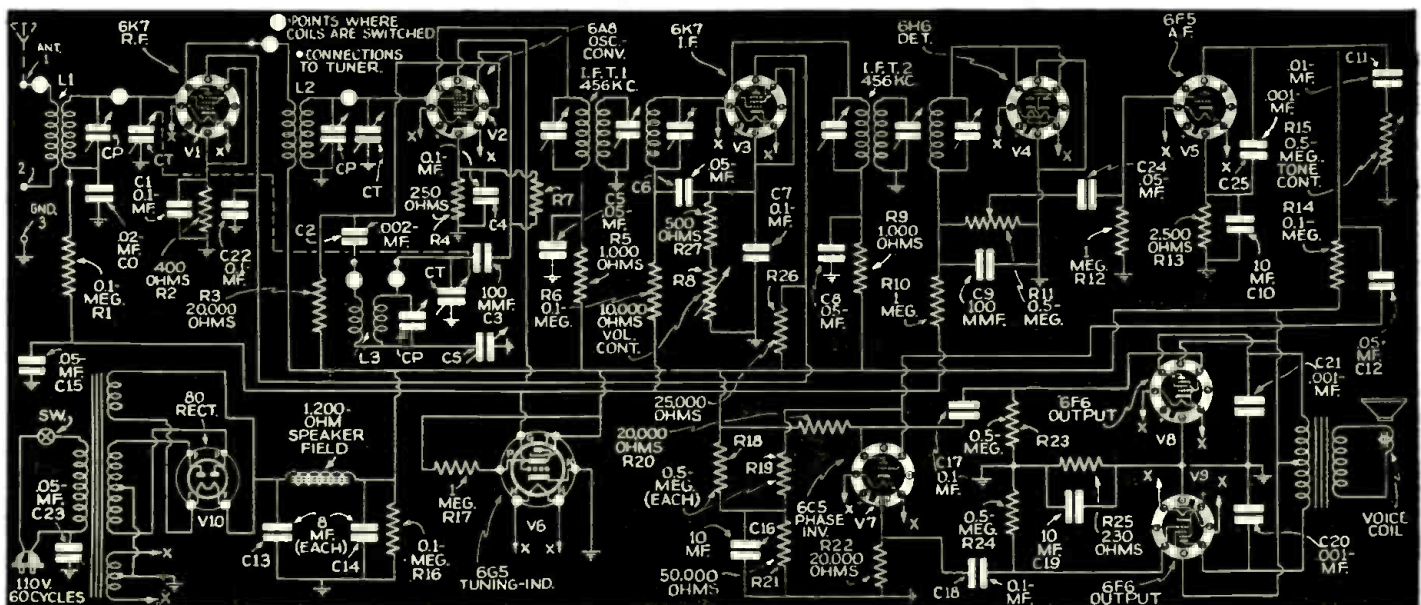

Fig. 1. Diagram of "Browning 83". Tuning unit comes factory assembled, wired and prealigned. (A complete List of Parts, itemized by make and model number, was given in Part I.) A picture diagram will be given, next month, for those who prefer more simplified wiring instructions.



# A NEW REMOTE ROBOT-MONITORED PUBLIC ADDRESS AMPLIFIER

An entirely new system of automatic audio monitoring for auditoriums and theatres which offers marked improvement over conventional remote, manual and A.V.C. systems.

A. C. SHANEY

**T**HE PROBLEM of adequate sound coverage within any given indoor or outdoor area has always been greatly complicated by conditions preventing uneven sound pick-up. No matter how carefully the required power was calculated to adequately fill a given room, it was usually found, in practical application, that some variable factor in the sound pick-up or sound projection system was upsetting basic calculations and preventing attainment of sufficient power for desirable results. In the majority of cases, unfavorable conditions were prevalent because the sound input level varied over a considerable range. This naturally caused a varying output level having an average sound intensity inadequate for proper coverage.



## THE REMOTE ROBOT MONITOR

This device consists essentially of a suitable microphone properly placed within the field of the audience so as to pick up a signal of predetermined intensity, and feed it into an auxiliary amplifier, wherein it is subsequently amplified and rectified, and then supplied back as a variable bias to a remote cut-off audio amplifier, which in turn, controls the sensitivity of the main amplifier to compensate for wide variations in audio signal being picked up by the main microphones.

## PREVIOUS "SOLUTIONS" TO A P.A. PROBLEM

Previous attempts to solve this annoying condition have included a number of automatic volume controls which maintained a relatively constant audio output regardless of whether or not a suitable amount of power was being delivered to the audience. In field tests, it was soon discovered that an operator adjusting volume level at or near the microphone was laboring under a severe handicap as he was unable to gauge the exact amount of sound being delivered in other parts of the auditorium or outdoor area. To offset this handicap, a system of remote monitoring was developed which, of course, required the services of an operator situated somewhere within the auditorium or outdoor field, so as to more accurately gauge the intensity of sound at some point remote from the microphone. (See Fig. C1.)

## THE HUMAN ELEMENT

Needless to say, operators, unless performing after a rehearsed program, find it exceedingly difficult to "ride the gain" with sufficient speed to suitably compensate for unexpected and rapid reductions of signal input. It was because of this limitation that the Remote Robot Monitoring system, illustrated in Fig. C2, was developed.

## ADVANTAGES OF REMOTE ROBOT MONITOR

Naturally, this type of a system provides for instantaneous compensation of any degree of fluctuation in sound intensity, the exact speed of which may be predetermined by selecting proper constants for the resistor-condenser filter circuit included in the grid-return circuit of the first two 6U7G preamplifiers. This form of compensation is of course far superior to any type available with a human monitor, as it does not depend upon reflex stimuli for its operation; neither does the human element, with its insensitive sound intensity measuring mechanism enter into its operation. Of course, the elimination of an operator provides marked economy in the actual maintenance of an amplifier during performances. By correctly placing one or more microphones in any given room, hall, auditorium, or outdoor field, the system can easily be adjusted to maintain a given level for any desired area. **THIS TYPE OF AUTOMATIC CONTROL HAS HERETOFORE NEVER BEEN ATTAINED.**

Naturally, the proper selection of the remote microphone is of vital importance for proper operation of the system. Proper compensation for reverberation and other annoying acoustic phenomena can easily be made in a preliminary field test so that it becomes a relatively simple matter to properly place the loudspeakers, main microphone and robot microphone in correct position for automatic compensation of objectionable acoustics inherent in any given installation.

Certain rooms and studios possess peculiar characteristics

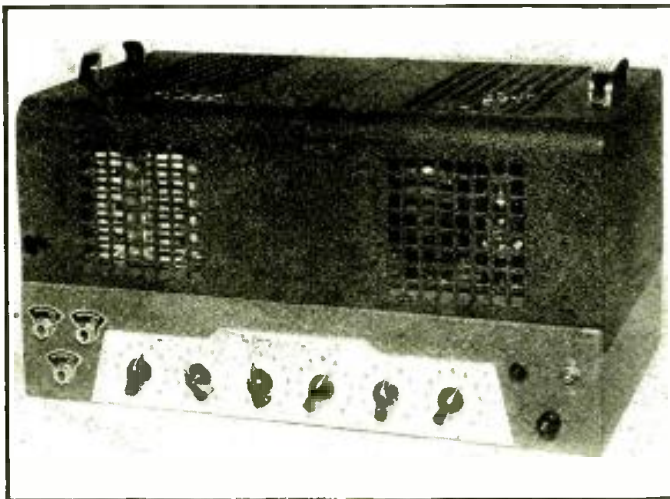

Fig. A. The remote Robot-Monitored Amplifier. The case is equipped with handles, for portability. Also notice the control panel, and especially the 3 jacks at left. Two are the conventional microphone input circuit, while the third is for the remote robot input. The controls include those for input level for these 3 stages, tone, output volume and variable impedance. The ON-OFF switch is at the extreme right. Large perforations provide adequate ventilation for the unit's 12 tubes.



Fig. B. Same, with carrying-cover removed. Note the "floating" construction.









Fig. A. Mr. Finch, at his home facsimile receiver.

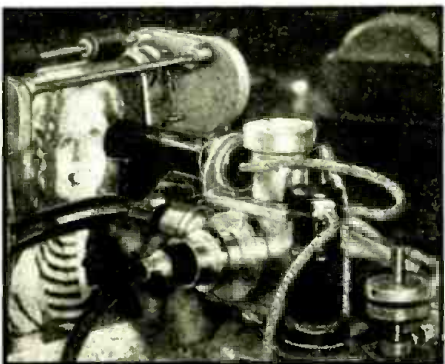

Fig. B. Transmitter open, showing scanner and feed.

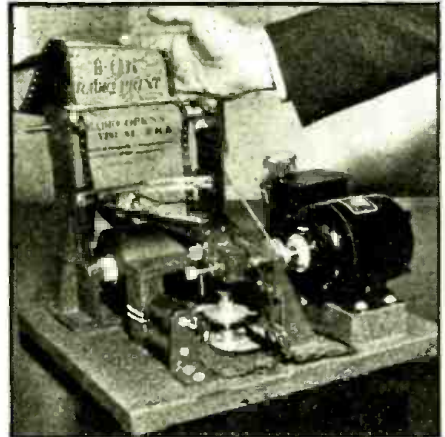

Fig. C. Receiver, housing off and showing mechanism.

# AS PREDICTED!— DAILY NEWSPAPER NOW PRINTED IN YOUR HOME —BY RADIO!

As Hugo Gernsback predicted 4 years ago, home facsimile now prints small newspaper from radio receiver. No ink needed; self-synchronizing apparatus makes permanent print on dry paper.

ROBERT EICHBERG

**A**FTER years in the laboratory, Home Facsimile suddenly burst upon a startled world, causing much comment among newspapers, most of which see it as a supplementary service offering a new and defective medium for increasing their circulation.

Among the systems ready for use are those developed by RCA-Victor, Finch Telecommunications Laboratories, Capt. Otho Fulton, and John V. L. Hogan. The two first named have made startling progress in commercializing their systems. RCA has orders from stations scattered about the country, as has Finch, and the latter system is actually being given tests in service. It has been tried by mid-Western stations, and early in February, WOR, New York key of the Mutual Broadcasting System, inaugurated tests over the air between the hours of 2:00 and 6:00 A.M.

### FINCH SYSTEM

In the Finch system, first to be tried by a New York commercial station in this way, the receiving equipment, which can be connected to the output of any radio receiver, just as is a loud-speaker, turns out copy of the exact size shown in Fig. H, at the rate of one inch (depth) per minute. The copy shown took 6½ minutes to reproduce. A system of this sort was predicted by Hugo Gernsback in the April, 1934, issue of this magazine! (See Fig. I.)

The size of the receiving equipment is indicated in Fig. A. It will be available in a metal cabinet, as shown, or in a handsome wooden cabinet, to match the radio set upon which it may be set. At first it is expected that the receivers will sell for about \$125, but Finch executives, where they are designed and manufactured, hope that mass production methods will eventually reduce the cost to about \$35 per unit.

A special paper is needed for reproduction. It is as shown in Fig. H, the background being a bright red-orange, and the type appearing upon it in black. The Laboratory believes that the user's cost for the specially sensitized paper will be about 20c per week, and the electric current, about 10c per week.

The effect is to print, in the user's home, a miniature newspaper, consisting of a strip 2 columns wide and 25 feet long, if the apparatus is run for 5 hours a night. This is roughly equal to the amount of material appearing in 3¼ pages of a standard-size newspaper.

Figure 1 shows, diagrammatically, the arrangement of the Finch transmitting equipment. The material to be sent is arranged in strip form, and may include photographs, drawings, printed or written matter.

A spot of light is made to swing back and forth across the copy to be scanned and transmitted. This action is similar to the human eye sweeping

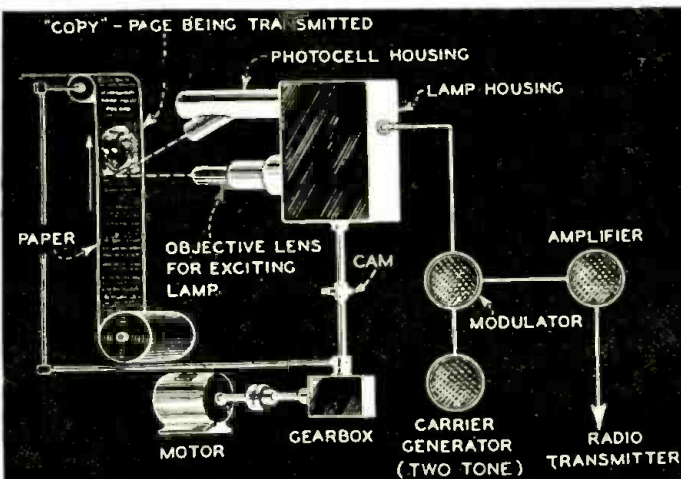

Fig. 1. Block diagram showing connections of Finch home facsimile transmitter.

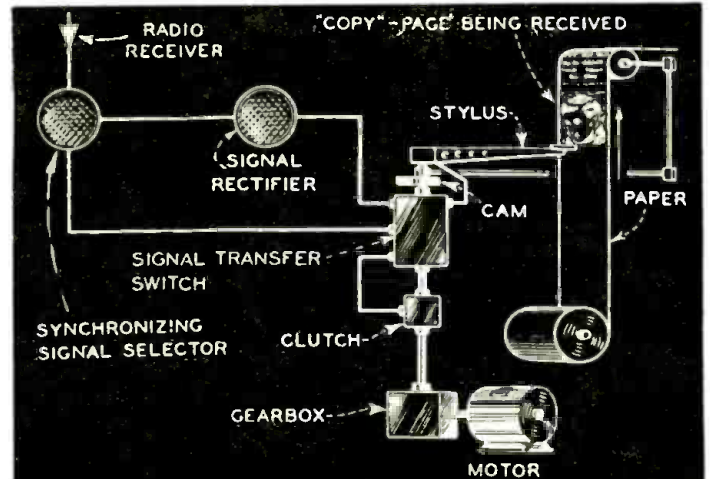

Fig. 2. Block diagram showing Finch method of reproducing facsimiles.



from left to right along the line of type, recording black characters upon a white background. In its movement across the copy, a spot of light is reflected back to a light-sensitive photoelectric cell. When the scanning light strikes the white it returns a full reflection; on the densest black there is no reflection; while for the varying shades, only a partial reflection is returned. Through the action of the photoelectric cell, these reflections are changed into electric energy or impulses. On the receiving end, these impulses are employed to operate a stylus sweeping in synchronism with that of the light beam in the transmitter. Figure B is a picture of the transmitter scanner, as it looks when in use.

The receiving apparatus, which is synchronized with it, is indicated schematically in Fig. 2 and pictorially in Fig. C. The means of reproducing used in the Finch models under test, employs a receiving stylus which moves with a continuous motion, a "black" impulse causing current to flow and blackening a place on the record sheet.

In this system, the paper roll is treated with a special chemical (giving the effect of ink); the stylus rests upon it continually and forms one pole of a circuit, the other being the plate over which the sheet travels. The voltage used varies from 50 to 225. The "black" impulse causes current to pass through the "ink," discoloring it and leaving a black mark. The stylus travels from left to right at the rate of 100 strokes per minute, and the paper is fed upward 1/100 of an inch between strokes. The same cam that controls the stylus sweep, controls the electrochemical paper's movement, so that skipping is avoided.

The device can be used with radio waves of any frequency, or with signals sent over land lines. The marking signal has a frequency of from 2,000 to 3,000 cycles; the synchronizing frequency is 500 cycles. Incidentally, though the device normally operates at 100 lines per minute, the one which WOR is using operates at but 60 lines per minute.

The radio receiver, of course, cannot operate the facsimile equipment while an audible program is being heard. This can be done only if separate receivers are employed. Most of the stations now experimenting with facsimile are sending it on their regular broadcast waves during their usually silent periods, late at night.

Several broadcasting stations have applied to the Federal Communications Commission for permission to start testing immediately for transmission of facsimile to homes in their service areas. In fact a number of stations now are on the air, with a number of sets in executives' and engineers' homes. In the East, WOR, in Newark, N. J., on 710 kc., will begin a facsimile service just as soon as its testing period has been completed. Other stations which have applied to the Federal Communications Commission and which are now about to test facsimile are WGN in Chicago, 50,000 watts; KSD, St. Louis, 50,000 watts; WHO, Des Moines, 50,000 watts; WLW in Cincinnati; WHK in Cleveland; and KSTP in St. Paul, Minn. The Finch system is being used by many of the broadcasters. Other broadcasters who intend to transmit facsimile, but who are awaiting permission from the F.C.C. have already ordered W. G. H. Finch's equipment.

#### OTHER SYSTEMS—RCA, HOGAN, FULTON

Finch is by no means the only usable facsimile system in existence. Various telephoto systems, used for the wire transmission of photographs from coast-to-coast for newspaper and other use, have been in existence for years. One of these, as developed by Capt. Ralph Ranger for RCA, was employed by the writer to send copies of *The Evening World*, a New York newspaper, from New York to Atlantic City, by radio, in 1930.

That apparatus was cumbersome—not of the home type—but RCA has recently divulged plans for a carbon process home receiver, to sell complete with radio set for about \$240. This, engineers state, will print a home newspaper with pages 8½ by 12 inches at the rate of 3 feet per hour. They add that facsimile transmitters and receivers have been ordered by such broadcasting stations as KFBK in Sacramento, Calif.; KMJ, Fresno, Calif.; KHQ, Spokane, Wash.; KGW, Portland, Ore.; WTMJ, Milwaukee, Wis.; WBEN, Buffalo, N. Y.; and WOR, Newark, N. J. Experimental licenses have been granted by the F.C.C.

(Continued on page 764)

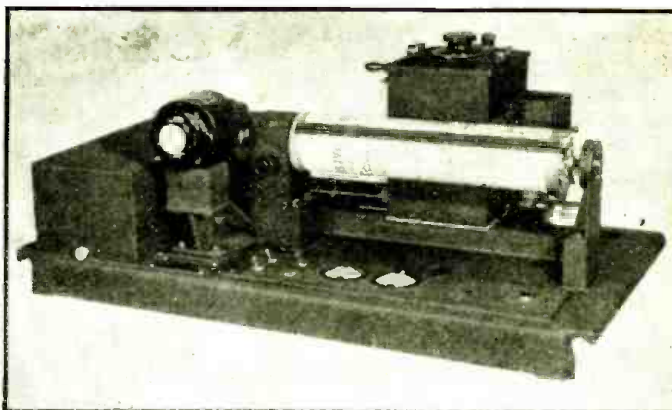

Fig. D. This RCA facsimile transmitter sends an 8½ x 12 inch Radio size page in 18 minutes.



Fig. E. RCA-Victor engineer C. J. Young, developer of RCA's home facsimile system, poses beside his new receiver, which is opened to show its working parts.



Fig. F. How the RCA home facsimile receiver looks; a time clock turns it on and off.



# SLIDERULES!— FOR PUBLIC ADDRESS AND SERVICE WORK

Progressive radio men will find in this 2-Part article something new and useful. The old adage that "Time is Money" holds special significance for specialists in sound and radio design and service work, and these men will find the Radio Sliderules real time-savers and, hence, money-makers.

## PART I

**I**N the design and servicing of Public Address equipment, mathematical problems frequently arise. These, while not necessarily beyond the ability of the Service Man, are a tiresome task for him to perform, and are not always completed with a desirable degree of accuracy.

To simplify his task, the Service Division of RCA has prepared a special 10-inch sliderule, the face of which, illustrated and described in this article, permits the user to convert power ratios to decibels, positive or negative power levels to watts, current or voltage ratios to decibels, and vice versa, to determine positive or negative power levels, to log and anti-log numbers, and to raise numbers to any powers, or to extract any roots from them.

The back of the rule, to be considered in the next instalment, is used to secure accurate alignment and dial calibration of multi-band receivers.

The rule is sturdily made in transparent plastic, and is flat to fit the pocket. Its face scales are as shown in the column at the left. This illustration may be clipped from the book, mounted on cardboard and carefully cut into 3 strips. The two outer scales (A and D) are then remounted on another piece of board, leaving room for the slide (scales B and C) to work between them. The utmost precision must be used in doing this, or the indications will be inaccurate; and of course, in time, the home-made sliderule will become dog-eared with wear which the inexpensive commercial rule is designed to withstand.

With the rule in hand, a few minutes' practice will enable the Service Man to save many long and laborious calculations in the future. The following are RCA's instructions, on the use of the rule, reproduced here by special permission.

### COMMERCIAL SOUND APPLICATIONS OF THE SLIDERULE

- (1) Conversion of Power Ratios to Decibels.—Reduce ratio by division to obtain denominator of 1. Slide scale "B" so that the number corresponding to the numerator is opposite "1" of scale "A." The correspond-db. value will be read on scale "C" opposite the arrow on scale "D." Example:  $W_2 = 32$  watts, and  $W_1$

$= 0.04$ -watt. What is the equivalent db. value of the ratio of  $W_2$  to  $W_1$ ?  

$$\frac{32}{0.04} = \frac{800}{1}$$

Adjust rule until 800 on scale "B" coincides with "1" of scale "A." The arrow of scale "D" then coincides with 29 on scale "C" (power figures).

Therefore, a power ratio of 32 to 0.04 is equivalent to 29 db.

- (2) Conversion of Decibel Values to Power Ratios.—Slide scale "C" until number corresponding to db. value is opposite arrow on scale "D." The equivalent power ratio appears on scale "B" opposite "1" of scale "A."

Example: 33 db. equals what power ratio?

Adjust rule until 33 on scale "C" is opposite arrow on scale "D," "1" of scale "A" then coincides with 2,000 of scale "B."

Therefore, 33 db. is equivalent to a power ratio of  $\frac{2,000}{1}$ .

- (3) Determination of Positive Power Levels. (A positive power level is one where the output power is greater than the reference power.)—Reduce ratio

$\frac{W_2}{\text{Reference Power Level}}$  by division and convert this ratio to db. by means of the radio sliderule, using procedure given under (1).

Example: 24 watts is equivalent to what db. power level (reference level 0.006-watt)?

$$\frac{24}{0.006} = \frac{4,000}{1}$$

Using the procedure outline under (1), this ratio is found to be equivalent to a db. value of 36. Therefore, 24 watts is 36 db. above the reference level of 0.006-watt, or 24 watts represents a power level of +36 db.

- (4) Conversion of Power Levels to Watts.—Use radio sliderule to obtain power ratio as given under (2).

Use formula, watts power = ratio  
(Continued on page 770)

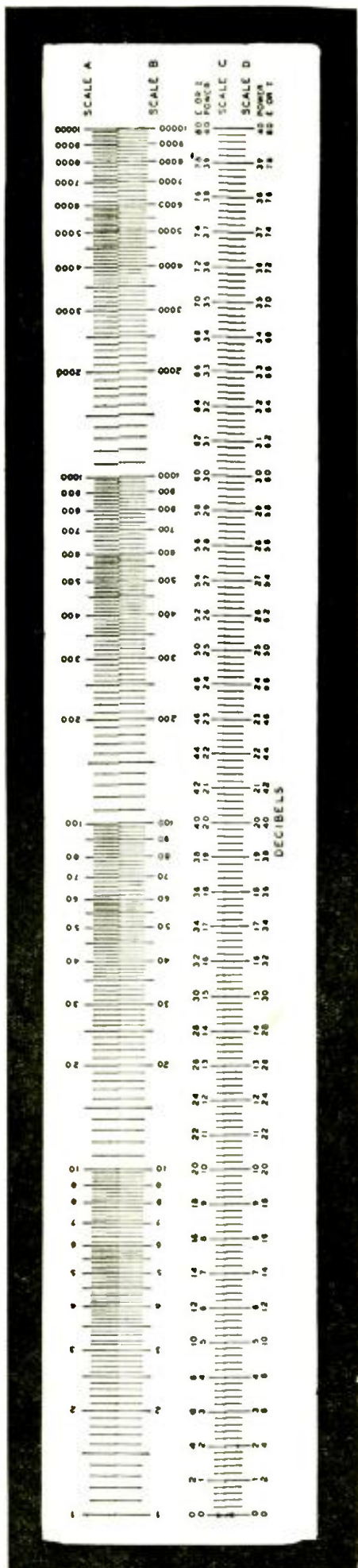

Fig. 1. "Public Address" side of RCA Radio Sliderule.



# SANTA ANITA'S NEW 300-WATT VOICE

When *Stagehand* won the \$100,000 Santa Anita Handicap, last month, 50,000 race fans depended upon the superlative, 250- to 500-watt sound system here described.

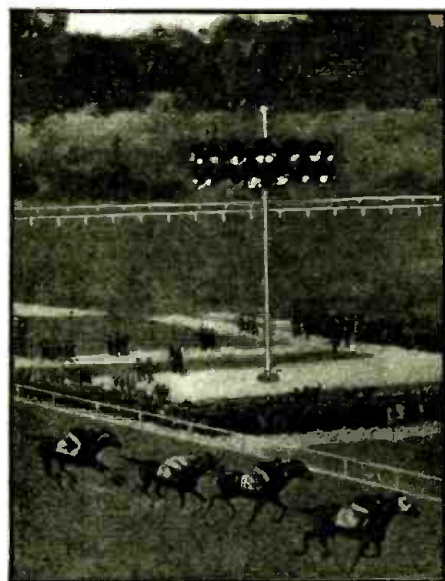

Fig. A. Note placement of horns in speaker cluster.

THE Santa Anita track, owned by the Los Angeles Turf Club, had its inaugural race on Christmas Day, 1934. It opened with a complete Western Electric sound system, installed and operated by C. C. Langevin Co., over which announcements were made of an informative nature as to changes in jockeys, changes in weights, etc., as well as a running call of the race while it was in progress.

From the offset, the success of Santa Anita was phenomenal. For the 1937-'38 meeting, which opened Christmas Day, 1937, the Management of Santa Anita enlarged the grandstand to more than double its former size. This necessitated the installation of a new and much more powerful W. E. sound system. Previously-made sound measurements at various parts of the grandstand elicited information as to exactly what levels were required to thoroughly cover every human being during the races.

The system, when installed, exceeded the expectations of the Santa Anita Management in that it was capable of



Reproduction of cover painting.

over-riding the crowd noise, even during the stretch runs.

A condensed block diagram of the system is shown in Fig. 1. A description of it follows:—

A self-supporting steel mast was erected about 100 feet inside of the inside rail. This mast is 48 feet high and supports the horn cluster. At the top of this mast are rigidly mounted 20 exponential horns of the W. E. 11-A type. Twelve of these horns face the grandstand and ramp, and 8, into the infield. Facing into the grand-

(Continued on page 777)

## DUAL-INPUT A.C.-D.C. PREAMPLIFIER

Multi-purpose, midget-size preamplifier provides high gain of low input signal, operates on A.C. or D.C. and has great stability. Constructional details are given here.

McMURDO SILVER

DESPITE its low cost and simplicity, the small unit illustrated and described herewith is an extraordinarily useful little gadget to 3 kinds of radio users:—(1) The public address operator, (2) The transmitting amateur, and (3) The experimentally-inclined broadcast listener. In a space just 7 ins. long, 6 ins. high and 3½ ins.

deep, it provides a 2-channel audio mixer and preamplifier.

(1) For the public address man, the advantages of having a good preamplifier handy are too apparent to need reiteration. This unit will deliver over 20 volts to drive a following class A stage amplifier.

(Continued on page 769)

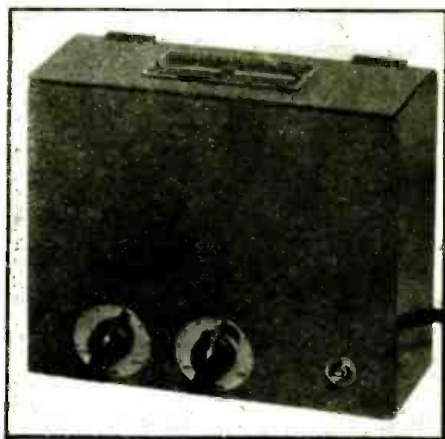

Fig. A. Completed dual-input amplifier unit in case.

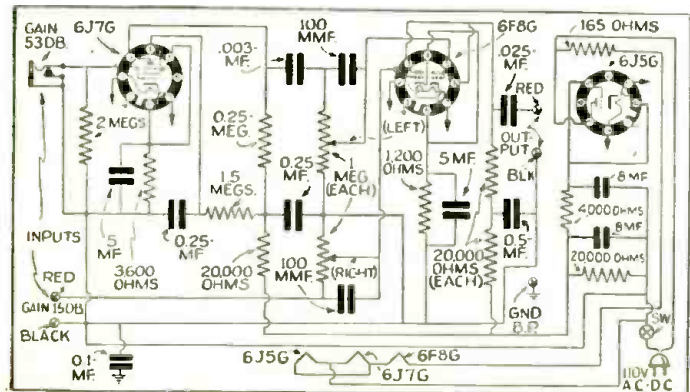

Fig. 1. Schematic diagram of amplifier unit, showing values of all components.

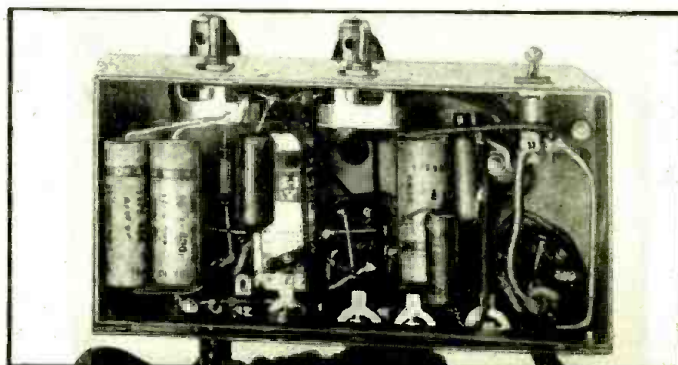

Fig. B. Under-chassis view, to illustrate placement of major amplifier parts.



# PHONO PICKUPS

With improved amplifiers and reproducers, the phonograph industry, temporarily dormant, has surged to the fore again. Engineers are concentrating on higher-fidelity pickups, which incorporate such other desirable features as reduced record wear. So simple a development as tilting the needle

CLIFFORD E. DENTON

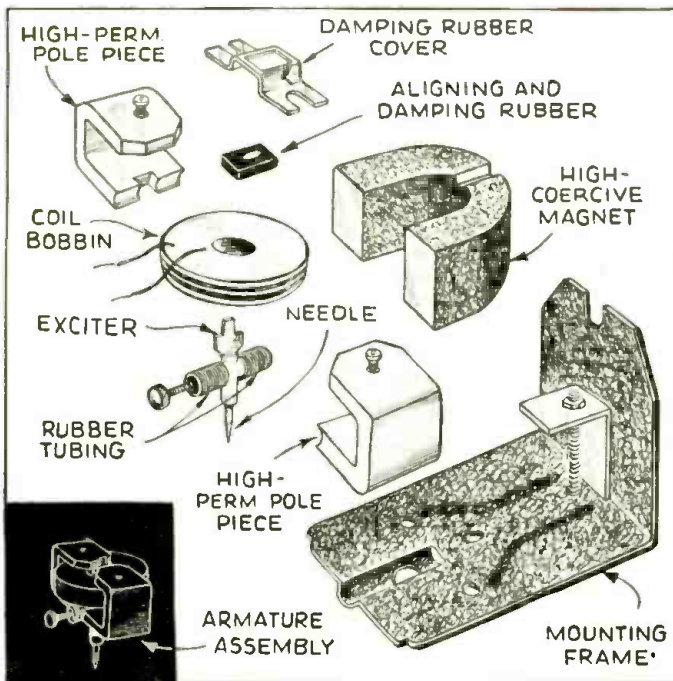

Fig. 1. The parts of a magnetic pickup, separated.

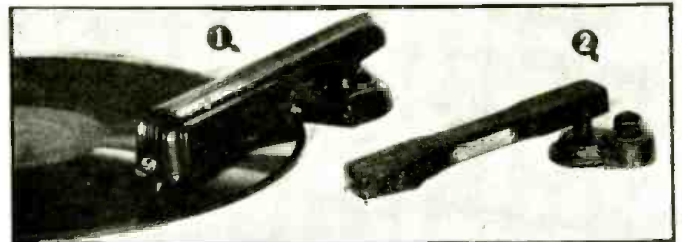

Fig. C. Two modern pickups. The one at the left is a Shure, the other an Upco.

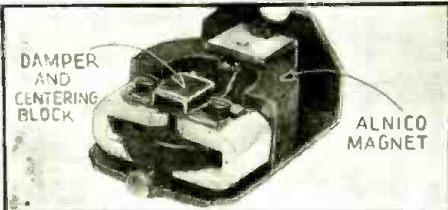

Fig. A. Magnetic pickup, with cover removed.

**T**HE reproduction of recorded music is dependent on 3 major factors: (1) the pickup, (2) the amplifier, and (3) the reproducer, or, as most of us call it, the loudspeaker.

So much information and space has been devoted to the amplifiers and the speakers used in such equipment that one would be tempted to be lax when considering the pickup. Needless to say, the importance of the pickup is distinctly comparable to that which is attached to the amplifier and other associated components.

### PICKUP MUST MATCH AUDIO SYSTEM

To illustrate, let us assume that we have an amplifier, flat in frequency characteristic and low in harmonic content at the volume levels involved. A speaker with satisfactory "highs" and well baffled so that the low-frequency response is adequate. With this system let us test a pickup that is "down" at the low-frequency end. If we want good reproduction it will be necessary to incorporate one or more of the following means of correction which will surely take time and increase the cost.

- (1) Equalize the pickup:—  
This will drop the output voltage of the pickup and require more gain from the amplifier.
- (2) Put a "bass booster" in the amplifier:—  
Means at least one extra tube,

- (3) Change the speaker to one that has a high degree of efficiency at the lower frequencies:—

Here cost is a great factor. A speaker with good over-all frequency characteristics and a reasonable degree of sensitivity is much more expensive than the average good-quality pickup available on the market today.

While the above paragraphs are common knowledge to many, it was felt that the information contained would be helpful to those who have been struggling to make poor pickups sound good.

In passing, do not try to use the tone control of the average amplifier as a means of compensation. The tone control will only cut "highs" and with a pickup deficient in lows the resultant frequency response of the system will look like an ant hill (high in center).

### WHAT CONSTITUTES A "GOOD" PICKUP?

The qualifications of a good pickup can be stated very simply.

#### FREQUENCY RESPONSE—

50 to 10,000 cycles? Forget it, unless you can spend more than \$75.00 for the unit. Remember, every 500 cycles over 5,000 cost at least \$25 to get!

50 to 5,500 cycles. This is the range

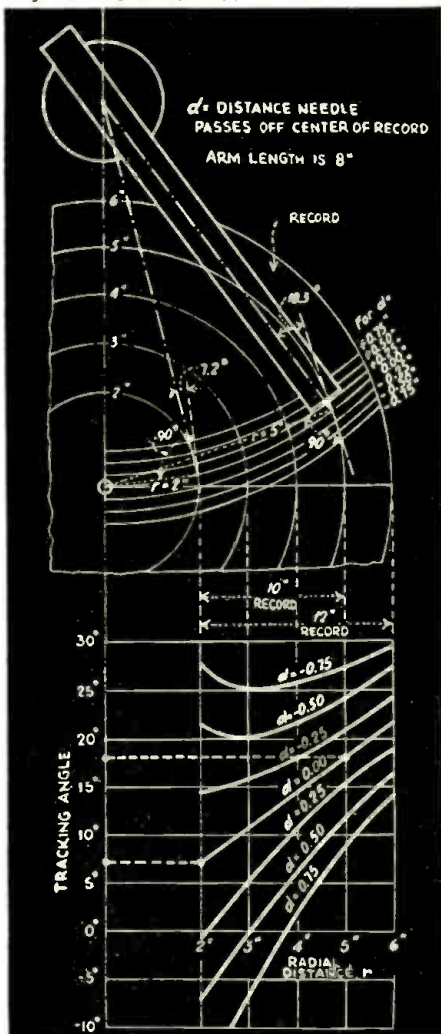

Fig. 3. Relation of tracking angle to radial distance.

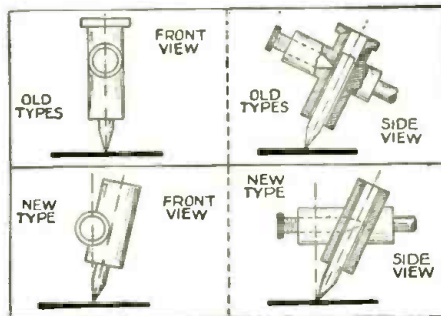

Fig. 4. Top; old needle position. Bottom; new tilt.

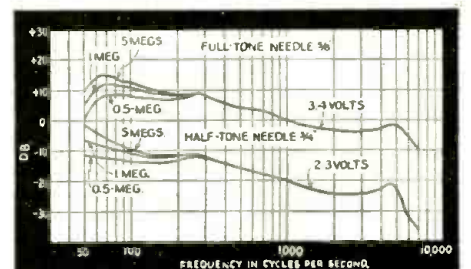

Fig. 5. Curves on Shure crystal pickup, model 998. Input resistor controls L.F. response over 10 db.



# ON PARADE

sideways, makes a surprising difference, as the author shows. The new improvement is adapted to both crystal pickups and magnetic types. A further refinement also affords a lighter armature in pickups of the latter sort, and an explanation of this is likewise given in considerable detail.

## PART I

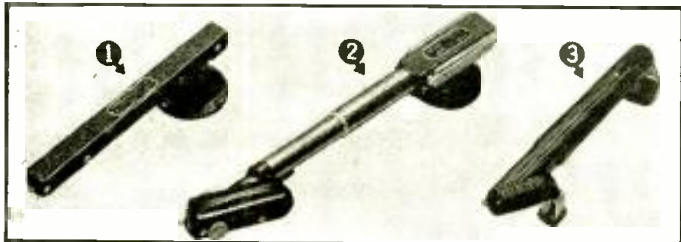

Fig. D. Three types of Astatic crystal pickups in general use for phono work.

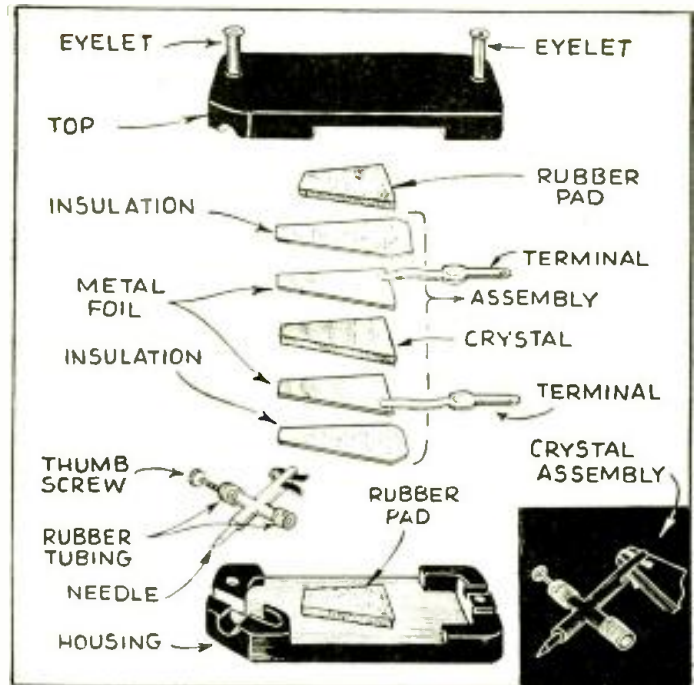

Fig. 2. The parts of a crystal pickup, separated.

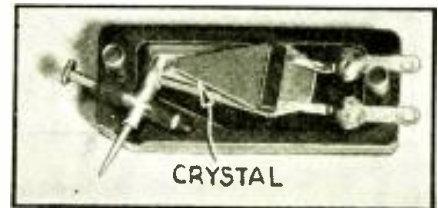

Fig. B. Crystal pickup, with cover removed.

that can be obtained without high cost. There are many pickups available that will cover this range, and at reasonable prices.

70 to 4,500 cycles. The better low-cost units have frequency characteristics within this range.

### NEEDLE-POINT IMPEDANCE—

Should be as low as possible.

### NEEDLE PRESSURE ON RECORD—

Not more than 4 ozs., maximum. Preferred weight, 2½ to 3 ozs.

Stability of performance with changes in temperature, ability to maintain response under conditions of wide amplitude variations, plus an arm design that is free from natural vibration periods that will affect the response characteristic are also desirable. The arm should have free vertical and horizontal motion without side sway or chatter.

### CRYSTAL PICKUPS

Two types of pickups are being used today, both of which have their own good points. They are the *crystal* (Figs. B and 2) and the *magnetic* (Figs. A and 1), operating on principles which have been described time and time again. Both have found acceptance and have staunch backing in discussions as to which is the superior type.

In crystal pickups, the development of the "bimorph" crystal was the key to successful operation on a commercial scale.

The crystal element is essentially a capacity, and the impedance across it increases as the frequency decreases and the voltage drop through it increases with the impedance. As most records are amplitude recordings, in the lower frequency ranges it is apparent that the crystal pickup has the highest output in the range of frequencies where the record output is lowest.

This point is well illustrated in the curves of Figs. 5 and 8. Note the effect on the low-frequency response of various values of loading resistance.

### EFFECT OF NEEDLE TYPES AND TRACKING ANGLE

In the curves of Fig. 5 the variation in response caused by differences in needle type as well as resistive load is shown. Here the change from a full-tone to the half-tone needle alters the response at both ends of the frequency range. Note the difference in voltage output of the two types of needles.

A great deal of attention has been devoted to the elimination of record wear by minimizing the *tracking angle* or *error*. The two most popular solutions will be found using the *bent arm* or the *needle tilt* principles.

"Tracking error" is caused by the fact that, in recording, the cutting head is moving radially across the record and cuts a close-pitch spiral groove which can be considered as a series of

(Continued on page 771)

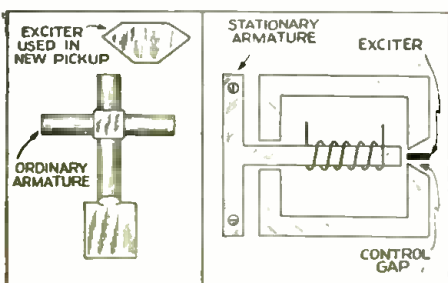

Fig. 7. Lighter armature design, showing flux path. Compare with exciter shown in Fig. 1.

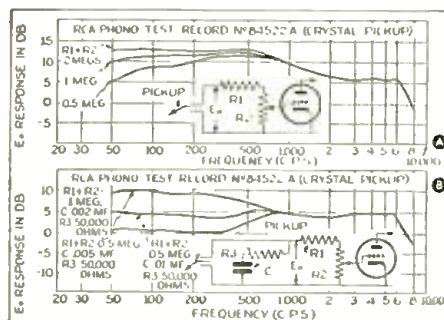

Fig. 8. Curves on Astatic Tru-Tan pickups B10 & B16.

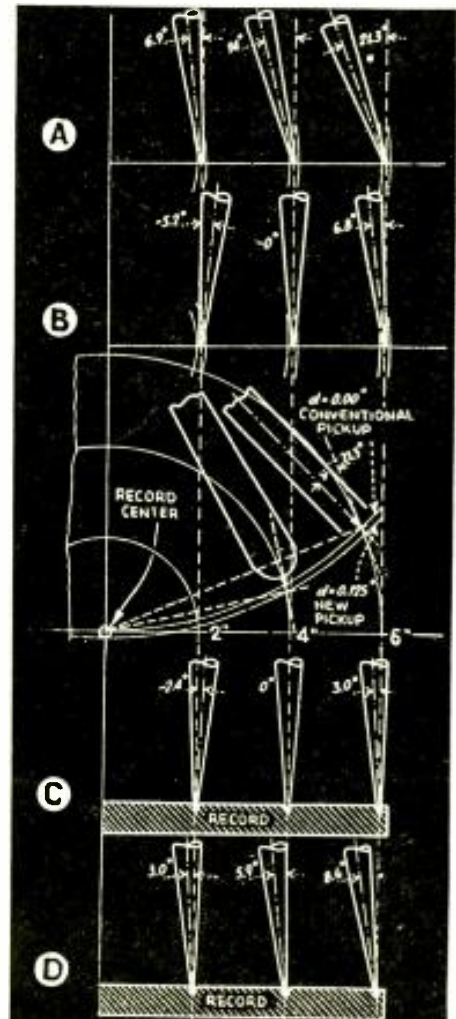

Fig. 6. Relation of needle tilt to pickup position.



# A HOME-MADE INFINITE-RESISTANCE TUBE CHECKER

A practical tube tester, developed by a Service Man who has his own service laboratory, is described in this article. It has infinite resistance, making accuracy possible, and gives both visual and audible indications of various tube defects. It can be used for any type of tube now sold.

PART I LOUIS F. B. CARINI



Fig. A. The infinite-resistance tube checker as operated in conjunction with a conventional tube tester. The leakage and resistance indicator is in the top center; below is the filament voltage selector switch. The 6 pin jacks are for point-to-point tube electrode checking (such as diodes). The 9 pin-jacks are also individual terminals and the numbers above them correspond to the respective socket terminals indicated about the left section of sockets. At bottom are the midget switches.



Fig. B. A back-of-panel view of the tube tester.

**W**ITH modern use and constant introduction of a multitude of various types of vacuum tubes employing a plurality of elements, the task of determining the condition of these various tubes has become a most intricate one for the Service Man. The rapidly changing art of radio design has furthermore introduced a new and serious problem upon which one is at one time or another obliged to deliberate if he is to maintain his position abreast his competitors in the profession. Thus the important question of apparatus investment becomes a serious problem for consideration because of a number of reasons, chief among which is the matter of obsolescence.

With this problem in mind, we set about to design and construct a non-obsolescent universal tube checker for positively determining the conditions of all faulty tubes likely to be encountered in our service department.

## "HIDDEN" TUBE DEFECTS

Because of the intricacies of construction of multi-element tubes we

were anxious to determine just where these tubes were at fault when the conventional testers failed to divulge such troubles. Although many of the tubes that were tested in the standard checker read "fair" or "good," it was certain from their performance in the receiver that they were defective. One of our greatest sources of trouble has been tubes which become noisy after some time in the receiver; it was desired to predetermine these in the checker under normal operating conditions and not by substitution in the set. In addition, many tubes possessing very-high-resistance shorts between internal electrodes and openings would often test OK in the conventional checker, but again for some reasons failed to perform satisfactorily in the receiver. A reliable means for determining such shorts and opens was also required to eliminate these discrepancies.

All of these objectives have been attained in our recent development, which enables anyone to check all types of tubes now in use or that will probably be introduced for future use in radio receiving. As an example of its versatility of application to tube types, we mention the following tubes that may be checked, viz., the acorn, overhead heater or Kellogg, Majestic, and as a matter of fact all glass, glass-metal, and metal tubes; and even including foreign makes! Its possibilities of obsolescence are so remote that we predict that it will be able to check practically any type of new tube that may be introduced in the future and which operates on contemporary electronic principles.

## TESTING TUBES FOR EFFICIENCY

Of particular interest is the simplicity of design of the entire instrument, enabling it to be used in conjunction with any conventional tube tester with which it is to be operated. We found it desirable to construct this checker on a panel to which the tester used for determining the transconductance, emission, or output of a tube was also affixed. The tester used for checking tube efficiency need not necessarily be a modern affair, although this would be the most desirable layout. In several of our custom instruments, we found it satisfactory to remodernize Jewell and

(Continued on page 782-84)

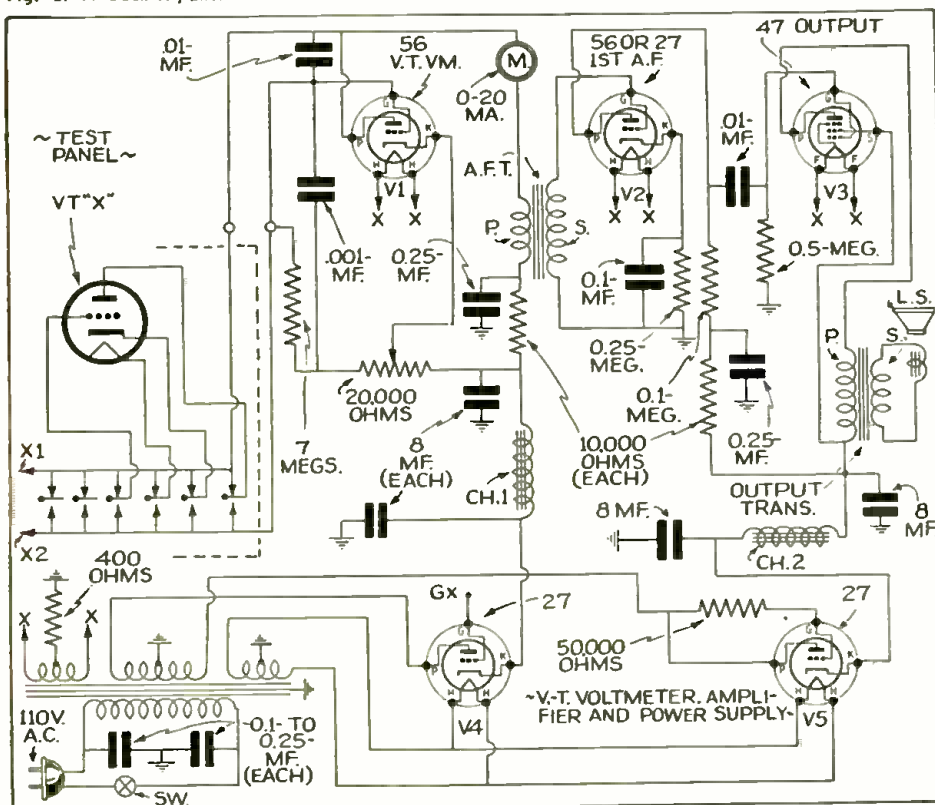

Fig. 1. Circuit of infinite-resistance tube checker.



# NEW CIRCUITS IN MODERN RADIO RECEIVERS

The details of the modern radio receiver circuits that make them "different" from previous designs are illustrated and described each month by a well-known technician.

F. L. SPRAYBERRY ..... No. 8

## (1) NEW "GAS GATE" CIRCUIT

Stewart-Warner models 1821 to 1829; and Others. For the benefit of high-impedance loading of the I.F. output it is desirable to use only one diode plate of a double-diode tube. A good use has been found for the other diode plate, hitherto connected to the cathode.

It is now connected to the A.V.C. line beyond the A.V.C. filter as in Fig. 1A, and functions as a "gas gate" for possible gas affecting the grids of any of the controlled tubes. The presence of gas tends to make the grids positive, which would ordinarily cancel the A.V.C. voltage. This diode provides a leakage gate or path for the positive potential to be shorted out of the A.V.C. circuit in the event of the presence of gas.

## (2) ADJUSTABLE I.F. EXPANSION SUBSTITUTED FOR A.F.C.

Crosley model 1137. Various early forms of pushbutton, and dial automatic tuning were discarded until automatic frequency control provided the essential compensation for mechanical inaccuracy. It now has been found practicable to have the automatic tuning feature without the use of A.F.C. circuits.

Instead of correcting the I.F. with an automatic oscillator frequency adjustment as for A.F.C., the I.F. amplifier is simply made more broad in its tuning characteristics so that it may take care of slightly "off-resonance" tuning conditions. The adjustable, wide-band I.F. amplifier is shown in Fig. 1B. The first I.F. transformer is provided with a tertiary winding for "flat-top" band-pass characteristics with auxiliary coupled coils allowing selection between two bandwidths. The second I.F. coupling arrangement is a resistance-capacity circuit having essentially no frequency discriminating ability over the I.F. band, while the third coupling means is composed of a conventional, single peaked transformer. The pushbutton and motor tuning circuits are not shown, as they are largely conventional in design.

## (3) COMBINING THE A.V.C. FILTER AND TONE CONTROL

Sparton model 727X, 727XD and 877X. A novel case in which apparatus is made to serve two purposes without partially sacrificing one for the other, is shown in Fig. 1C.

The first filter resistor at the A.V.C. output usually furnishes most of the A.F. drop in the A.V.C. filter circuit. In this system as the condenser slider is moved toward the volume control connection, increasing A.F. is shunted around the volume control. As for a tone control connected in any circuit, its effect is maximum at the high frequencies, tapering down into the audio range.

## (4) NEW PRINCIPLE IN VOLUME EXPANDER CIRCUIT

H. H. Horn Radio Mfg. Co. model 17MT. The new idea used in this volume expander circuit as in Fig. 1D, consists in coupling into the signal circuit at the plate of the first A.F. a component of the same signal in reverse phase by a controlled bias tube.

At low signal levels the direct and reverse-phase signal components entering the second A.F. grid are practically equal, due to the choice of constants in the super control

(Continued on page 777)

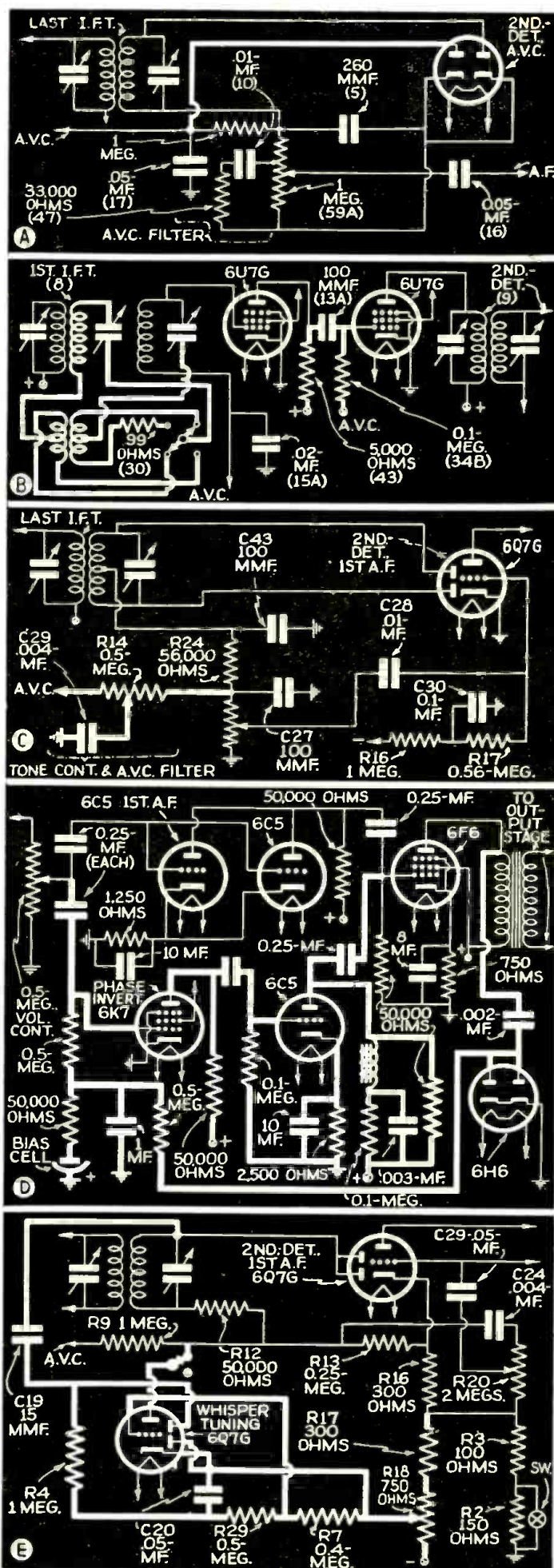

Fig. 1. The heavy lines in the circuits are the points discussed in the text.



# TELEVISION—

"Television in Europe but not in America," say the newspapers. Are Americans, famed for science and invention, falling behind? Read why Mr. Shrager says "No!"

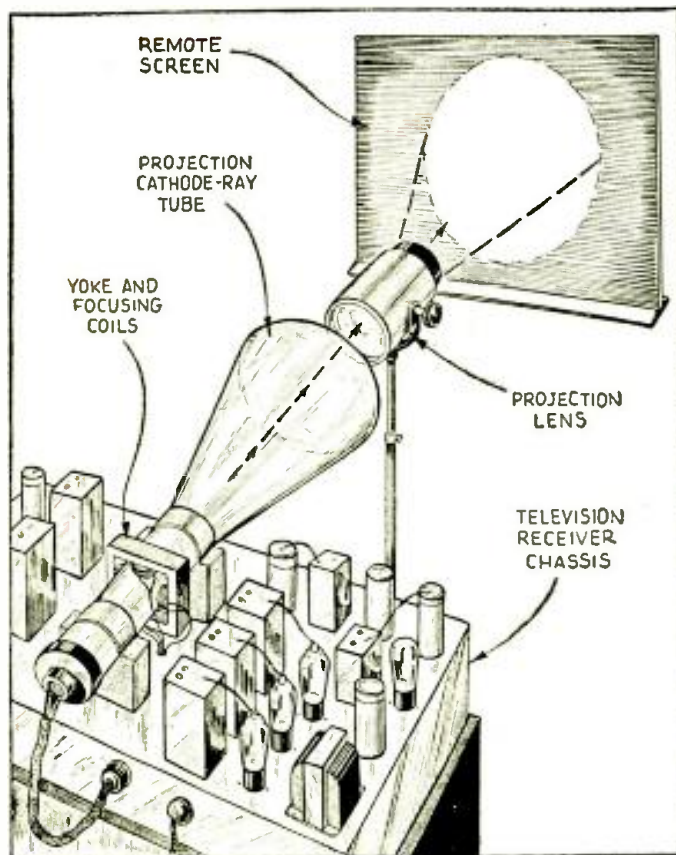

Fig. 1. Arrangement of cathode-ray tube and lens system for image projection.

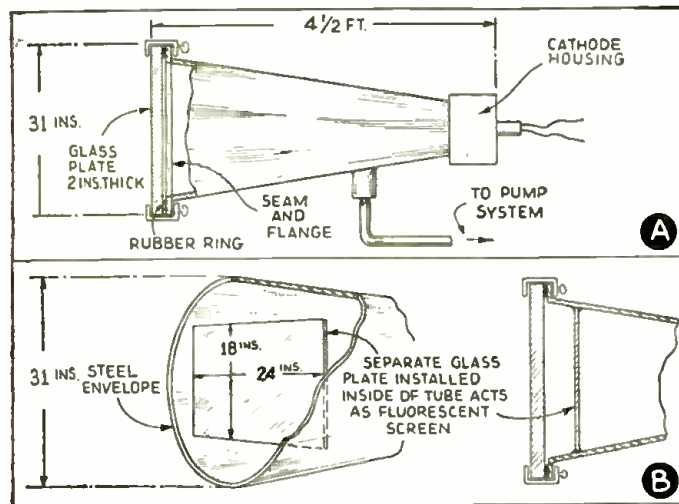

Fig. 2. A—Glass end sealed to metal C.-R. tube body. B—End view of new distortionless-vision tube.

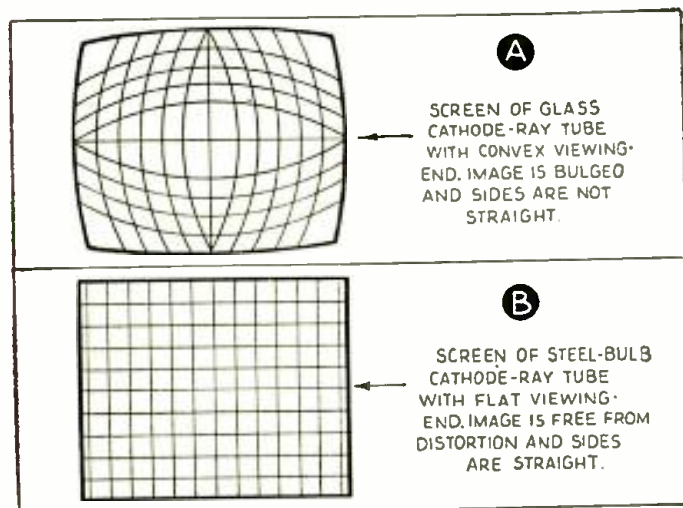

Fig. 3. Distortion on screen of all-glass C.-R. tube (A) is absent in new tube (B).

IN spite of the prediction that "Christmas of 1937 will be the start of real American television," voiced last summer by a well-known radio writer, laymen as well as experts are skeptical that television will be in general use before Christmas of 1942. One guess is as good as the other!

Disregarding the publicity stunts of some of the smaller companies, which are financially embarrassed, and some stock-sharks (not extremely rare in the realm of television), nobody seems to be too eager to plunge America into a doubtful television adventure.

*The reason is quite obvious. The European example is an urgent warning not to foster an unhealthy growth of television, or to start radiating television programs without considering the fundamental requirements necessary to provide the entertainment value expected by the public.*

## EUROPE TRIED TO CUT CORNERS

Let's see what happened abroad. We frequently read: "Europe has regular television transmission," and then the description goes on to tell about all the beautiful images which American radio listeners cannot see. But nobody informs us that England has changed the method of transmission and the number of lines per frame a few times in the past years. News dispatches from abroad report that Germany is on the verge of changing the number of lines transmitted from 180 to 441. While this change has not yet been completed, a very active television company at Berlin demonstrated a 731-line transmission method, with much improved quality, thus indicating that the newly-installed 441-line transmitter was already obsolete before its actual inauguration!

This is not the only factor which should keep us from the temptation to "cut corners." European radio listeners who bought television sets in the past years "were out of luck" every time the method of transmission changed. This sounds surprising to us, because we are accustomed to think in terms of sound broadcasting, and know by experience that we are still able to use an old-fashioned crystal set with headphones for the most modern broadcast transmission. This adaptability is not true as far as television receivers are concerned. A television set of 1933, for example, cannot be used for 1938 television transmission or reception.

## EUROPE PLAYS BEFORE AN EMPTY HOUSE!

However, those who believe European listeners must have gone crazy to buy receivers under those circumstances are mistaken. Many people abroad are, of course, interested in reading and in talking about television and its problems, but from unofficial estimates, one can assume that so far hardly more than 5,000 receivers have been produced in all European countries engaged in television transmission. A great percentage of these receivers has become already obsolete. But most of these sets were not used in private homes. They were given away to be installed in observation posts, etc., and the bill was paid by the various manufacturers or by the semi-official broadcasting companies involved.

The last-mentioned fact, indicating that the general public has not bought many receivers, is of considerable interest, since England as well as Germany claim to be the foremost countries in television activities. Both countries have collected—at terrific expense—a great deal of practical field experience which we are lacking, but boiled down to essentials, "They are playing before an empty house."

## PICTURES ARE TOO SMALL

What are the obstacles which hold the general public away from television, and what are the reasons why American



# HERE AND ABROAD

W. E. SHRAGE

broadcasters are so cautious about putting a full-time program on the air? The main obstacles are (1) the small size of the image presented, and (2) the insufficient illumination.

First, let us deal with the size of television images obtainable and the remedies available: There are two possible ways of solving the problem, viz., (1) the direct-viewing cathode-ray screen of large size, and (2) the projection principle. (See Fig. 1.)

No one here or abroad knows which of the two systems will finally be accepted as the standard. The projection receiver has been developed to a high degree in Europe, and has recently been demonstrated in this country in similar make-up by RCA, but one needs a room without stray light to appreciate television transmission presented in this manner.

Another method to obtain large-size pictures with enough power of illumination to be observed in dimly-illuminated rooms is to build giant cathode-ray tubes. But these large tubes, 30 inches or more in diameter, are quite dangerous pieces of equipment for a private home, considering the fact that they are made of glass, and carry an outside pressure of between 2 and 5 tons. A little crack, and all the furniture in the room attempts to "fly" into the vacuum of the giant bulb.

## STEEL INSTEAD OF GLASS

Since large glass bulbs seem to have, in reverse, the properties of dynamite, experiments have been made recently by RCA to use instead a "funnel" made of welded steel (see Fig. 2). Such a steel container, which presents an important step forward in the direction of large-size television, is conical in shape, and is about 4½ feet long; the "viewing-end" measures 31 inches in diameter. The viewing-end is covered with a glass plate 2 inches thick. This enormous thickness is required in order to withstand the total atmospheric pressure of about 5.5 tons.

In short, this cathode-ray tube (which permits the reproduction of 18 x 24 inch images) is in actuality the counterpart of the metal tube so familiar in modern radio broadcast receivers. However, while the radio tube in metal envelope has seemingly little chance to become a unit of remaining importance, this cannot be said in regard to the television image reproducer installed into a steel bulb.

It may be years until the metal envelope will become standard design for cathode-ray tubes, because of the problem of finding a cheap method to obtain air-tight joints between the glass cover plate and the steel body—which (and this is of great importance) is suitable for mass production. Considering the fact that nobody thought that radio tubes in metal envelopes would ever become an actuality, the idea seems not too remote. At present we are, of course, far from this goal since, as Fig. 2 indicates, a continuously-operating pump system is required to keep the tube under constant vacuum.

## IMAGE DISTORTION ELIMINATED

The steel envelope is not the only feature which makes the new television cathode-ray tube so interesting. Of much more importance is the fact that this tube demonstrates a very interesting means of eliminating unpleasant optical effects which cause the sides of the television picture to bend outwardly, and which are responsible for bulging of the image (as shown in Fig. 3A) when a glass tube is used.

Compare this type of image presentation with the straight lines of Fig. 3B; then let us see how this important improvement was obtained. The diagram of Fig. 2B tells the story.

(Continued on page 768)

## TOPICS ON 1938 TELEVISION IN THIS ARTICLE:

Europe Tried to Cut Corners.  
Europe Plays Before an Empty House!  
Television Pictures Are Too Small.  
Steel C.-R. Tubes Instead of Glass.  
Image Distortion Eliminated.  
Images Brighter Than Movie Screen.  
Television "Eye" Grows More Sensitive.  
More Efficient S.-W. Transmitters.  
Single-Sideband Transmission.

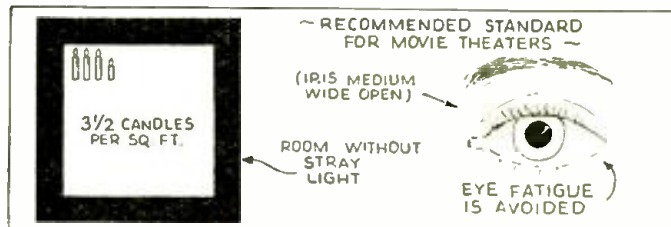

Fig. 4. Adequate illumination on movie screen eliminates fatigue of eyes.

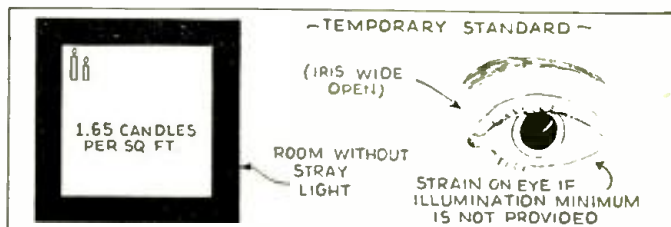

Fig. 5. Some fatigue present with compromise illumination used in many theatres.

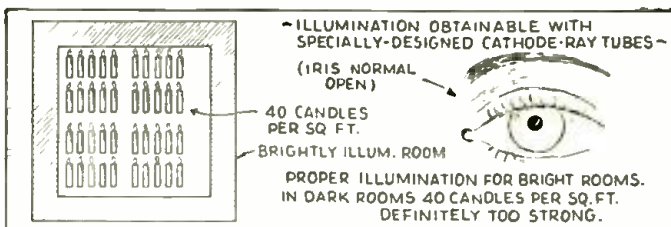

Fig. 6. Illumination obtainable in television adequate for lighted rooms.

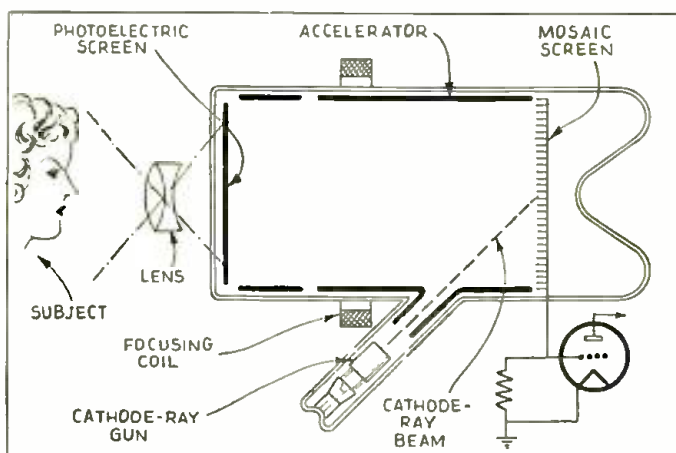

Fig. 7. New "Super-Emitron" pick-up combines iconoscope and electron multiplier.

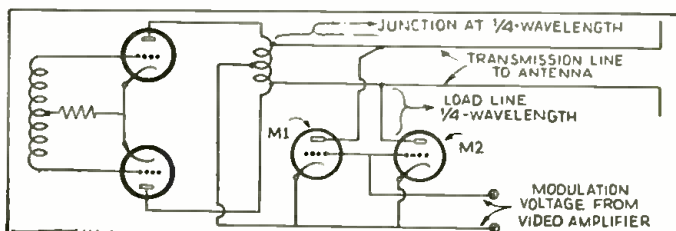

Fig. 8. Circuit of new ultra-shortwave transmitter for high-fidelity television.



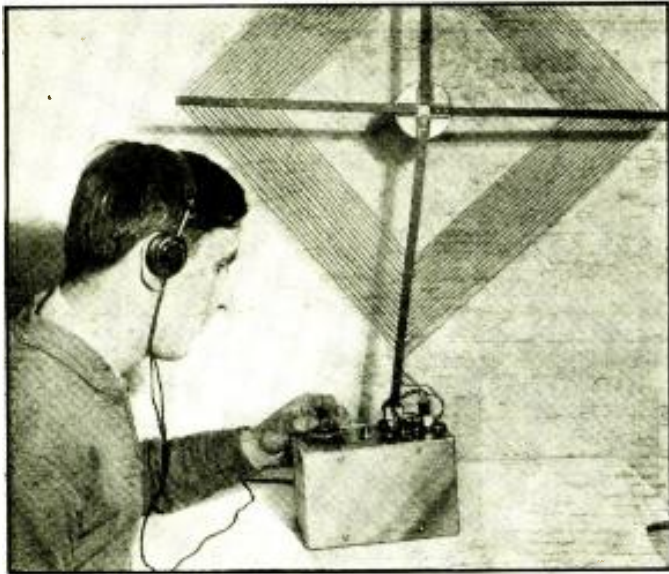

Fig. A. The 1-tube loop receiver being used. Tried out in a modern steel building, the volume was sufficient to rattle the earphones.

# BEGINNERS!— BUILD THIS 1-TUBE LOOP RECEIVER

For a simple 1-tube set this job "takes the cake." It is the loudest, best-performing 1-tube receiver we've ever heard and constitutes a practical, easy-to-build receiver for beginners. Its loop construction makes it useful for interference location, too.

N. H. LESSEM

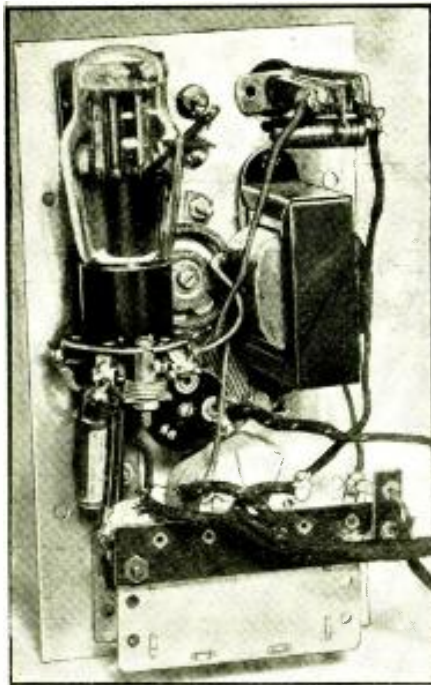

Fig. B. Internal view of the compact 1-tube set. All parts are mounted behind the top panel of the box and are therefore readily accessible.

**N**O originality is claimed for either the circuit or style of this receiver. Its main claim to existence is merely to provide a sample receiver which beginners in radio may easily follow. Employing a simple non-tricky circuit, 1 tube, dry batteries, and the familiar "loop antenna," it will afford many pleasant hours of construction crowned by the thrill and satisfaction of ultimate success when radio programs come ringing through.

The receiver is easily portable, making itself especially useful at picnics and similar outings;—it may be used at sport arenas to hear as well as see play-by-play descriptions. Finally (although not designed specifically for this purpose), it makes an excellent interference locator.

### INTERFERENCE LOCATOR

Myriad types of electrical equipment now in use all over the world tend to radiate radio waves when they are used. These waves manifest themselves in the form of noise (called man-made static) in receivers. To trace the origin of such

noise, a receiver only of the loop type must be used because of its highly directive reception characteristics. In other words, the loop antenna is rotated in its socket until the noise (as heard in the phones) is at its greatest volume. In this position, the end of the loop points in the approximate direction from which the noise is emanating. If you walk in that direction you will notice that the noise intensity increases until, when you come to the electric sign or other electrical apparatus which is causing the disturbance, the noise in the ear-phones is at its maximum and you then have located the source.

### CONSTRUCTION OF THE SET

Reference to the schematic diagram, or the pictorial diagram, both shown in Fig. 1, will show that a single tube, type 19, is used. However, this tube performs as 2 separate tubes inasmuch as it contains a double set of triode elements. *The first section of the tube is used as a detector, the second section as an audio amplifier.* This affords excellent earphone reception.

(Continued on page 758)

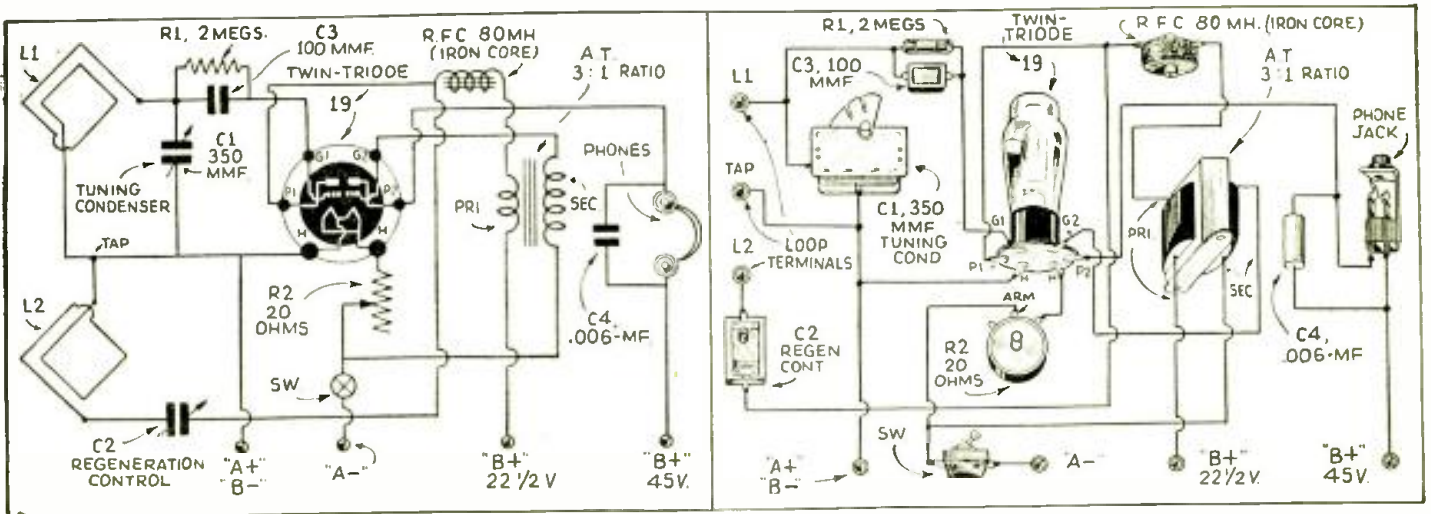

Fig. 1. Left—schematic circuit of the 1-tube loop receiver. An outside antenna may be used in place of the loop by substituting a standard antenna coil and adding several turns as a tickler winding. Right—pictorial diagram of the receiver for those who find it inconvenient to follow a schematic.







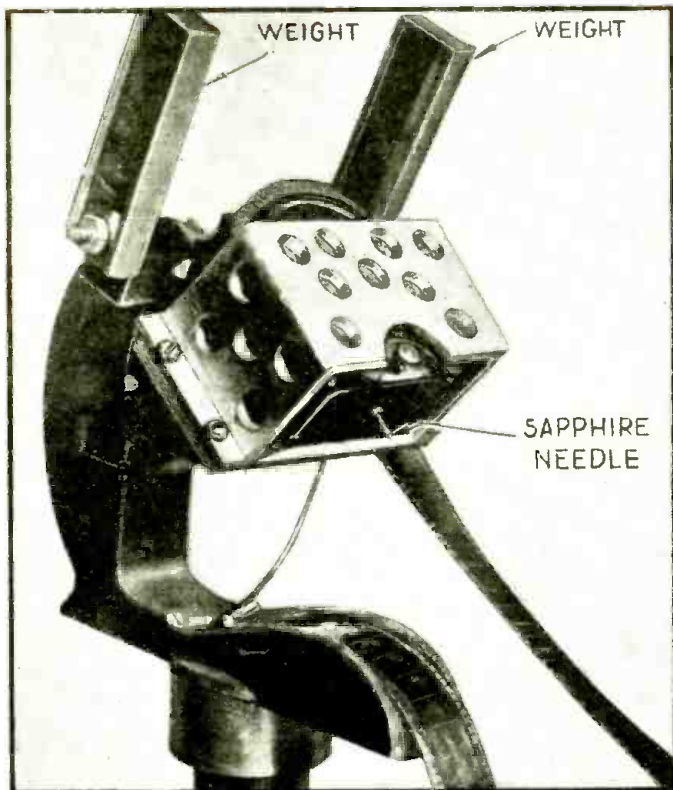
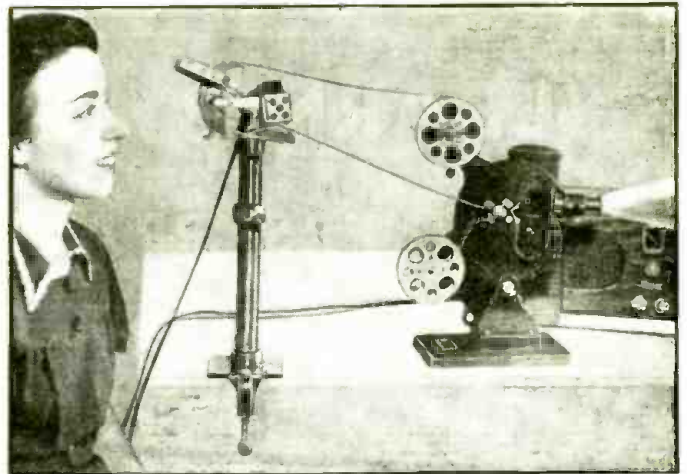

Fig. A. The head, opened for threading. Weight raised for playback, lowered for recording.



## MAKE YOUR "SILENT" MOVIES into HOME TALKIES

Describing a new recording process, in which a magnetic pickup is used to indent sound track directly on film.

**S**OUND-ON-FILM pictures in the home become an easy possibility for any home movie maker who owns a microphone, a home movie projector, a radio receiver and a new recording and play-back device called the Filmograph.

Essentially, this device consists of a magnetic pickup, mounted in a special fitting which is provided with a film track. It is used in conjunction with a standard home movie projector, which draws the film under the needle of the pickup at the same time the picture (23 frames, or sprocket holes, away) is projected upon the screen.

For recording, a microphone is connected to the audio amplifier input of the radio receiver, the output being connected to the pickup head instead of to the loudspeaker. Thus the audio frequencies, generated in the microphone and amplified in the set's audio stages, operate the pickup.

A sapphire-point needle, placed in the pickup, impresses a channel 2/1,000-in. deep in the *non-emulsion* side of the film. The groove is but 1/1000-inch wide, and the audio frequency impulses cause the corresponding pattern to be indented upon the sides of the groove. Nothing is cut from the film—no celluloid curls from the "cutting" head during recording. The groove is so small as to be unnoticeable when the film is projected upon the screen. Pivoted weights afford the necessary pressure for recording. (See lower film, Fig. C.)

Playback is similarly accomplished, the weights being raised. The delicately balanced pickup exerts enough pressure to cause the needle to follow the groove, but not enough to cause appreciable wear on the film. In fact, the manufacturer claims that, instead of making it weaker, the slight corrugation it makes actually strengthens the film!

Models are available for use with 8, 16 and 35 mm. film, and the standard which supports the head is adjustable, so that the device may be employed with any make or model of projector. Synchronization can, of course, be had as the recording is actually on the film.

In addition, the Filmograph can be employed for straight recording on film, in which case blank or spoiled film may be used. It can be set to record 28 parallel grooves on a strip of 16 mm. film, and the economy of this is obvious when one realizes that a total of 4 hours and 40 minutes of sound

(Continued on page 777)

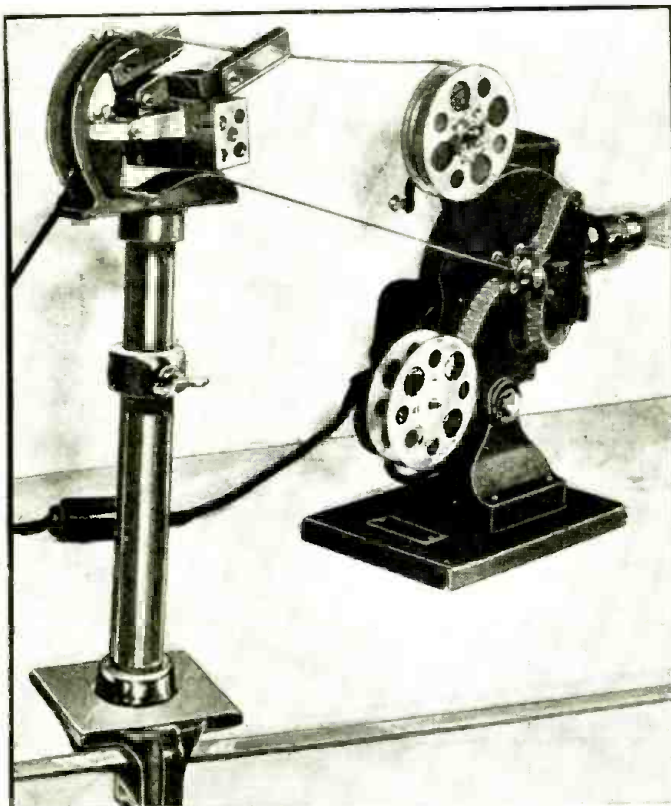

Fig. B. The unit, as set up for playback. Note position of head and weight.



Fig. C. "Wavy"-type groove is indented directly on the surface of the film.



## SERVICE MEN—

What faults have you encountered in late-model radio sets? Note that *Radio-Craft* will consider your Operating Notes provided they relate to CHARACTERISTIC (repeatedly encountered) faults of a given set model. Illustrations are desirable. Payment is made after publication of the Operating Note.

# OPERATING NOTES

## —ANALYSES of

# RADIO RECEIVER SYMPTOMS

**Edison R4, R5.** Very weak and choked reproduction. The only clue to this trouble was a high cathode voltage on the type 27 1st A.F. stage. Everything else checked OK. Condenser C21, Fig. 1, was finally disconnected and found to be the guilty member. This condenser was leaking just enough to supply the high cathode voltage to the 1st A.F. stage. According to all data this is a hum-balance condenser but no difference in performance or hum could be noted with a new condenser or none at all so it was left out.

**Grunow 7-A.** Absence of screen-grid voltage in this chassis ordinarily is due to failure of the 14,700-ohm section of the Candohm resistor. See R2, Fig. 2.

Mushy reproduction of bass notes is caused by a rubbing voice coil. This one warps easily. Recentering will usually effect a satisfactory repair.

Choked and distorted reception is caused by a leaky 0.25-mf. condenser in the 2nd-detector plate resistance network. See C1, Fig. 2. This is one of 6 condensers in a block and is identified by a black and yellow lead.

Intermittent dropping of volume is found almost every time to be in one or both of the dual 0.1-mf. condensers between the lower end of the R.F. coils and ground. Condensers are in the small can attached to the R.F. coil shields and are connected by wires leading directly into coil shields. Lugs on can are blank.

**Jesse French G.** Complaint: Reception weak. Try bridging the 1.0-megohm resistor in the detector screen-grid lead with a new resistor. This resistor frequently goes bad and a voltage analysis may not indicate the trouble.

**Kennedy 42-B.** A gradual building up of volume ending in a sudden "pop" and then normal operation for a short period, were the symptoms for this receiver. The trouble was finally located in the R.F. cathode and screen-grid bypass condensers. They are 0.1-mf. and 0.25-mf., respectively.

**Kolster K-90.** Motorboating on strong signals can be eliminated by bypassing the 3,000-ohm bias resistor in the amplifier with an 0.1-mf. condenser.

**Midwest 9-34.** A lot of grinding and crackling with the volume control at minimum is nearly always found to be in the push-pull input transformer.

**Motorola 75.** This model found "dead" with all operating voltages OK.

After considerable checking and testing the 0.01-mf. audio coupling condenser was removed and replaced and the set worked fine. This condenser tested perfectly and it was only by removing it entirely from the circuit and installing a new one that any indication of the trouble was found.

**Philco 18.** Intermittent reception in this set is usually caused by one or more of the 3 bypass units as indicated in Fig. 3. The 2 grid-return condensers marked (6) comprise a dual unit and the condenser marked (12) is a single unit. Touching any of these condensers with a test prod is quite liable to restore normal operation and rather than waste several perfectly good hours trying to find the offender it is better to replace all 3.

**Philco 20.** Where bypass condensers and voltages check OK but circuit still oscillates, connect a 0.5-mf. condenser from the center-tap of the 71A filament winding to ground. This addition will not introduce a hum as will bypassing the 71A bias resistor, recommended by many as a cure.

**Philco 80.** A noisy volume control in this and other Philco models using a similar style control, wherein a small sliding disc is used on the rotating arm, may be made very quiet in operation by simply removing this slider, cleaning it, and putting it back with the other side next to the resistance strip.

**Philco 89.** Several of these models have been encountered in which acoustic feedback would cause a howl on strong signals. The easiest remedy is to remove the speaker and place several thin pieces of rubber between the cabinet and the speaker rim. (Pieces cut from an old inner tube may be used with excellent results.) This is best accomplished with the cabinet lying on its face. The mounting nuts are turned up not too tightly but firm enough so that any vibration will not jar them loose.

**Philco 620, 630.** Frequent complaints on the tone control are found to be either a coating of sealing compound on the switch contact points or an open condenser. This condenser is a semi-shielded affair and may be replaced with an ordinary tubular condenser providing the old one is pried out of its shell and the new one clamped in its place. If the new tubular condenser is placed in the open the circuit is sus-

(Continued on page 781)

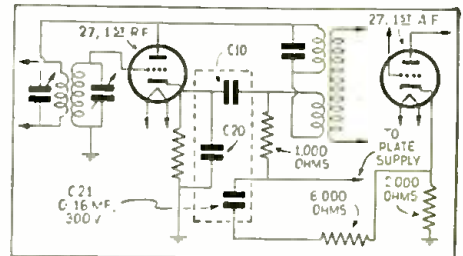

Fig. 1. Weak and distorted reproduction in Edison R4 and R5 receivers may be caused by defective C21, 0.16-condenser.

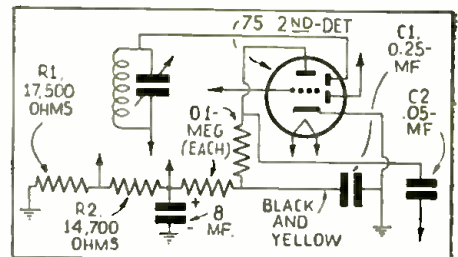

Fig. 2. No reception or distortion in Grunow 7-A sets may be caused by an open 14,700-ohm resistor or leaky 0.25-mf. bypass condenser.

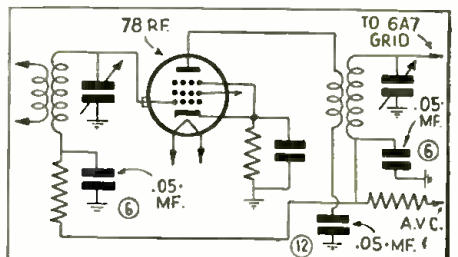

Fig. 3. Intermittent reception in Philco Model 18 sets may be due to either one or more of the above shown 0.05-mf. bypass condensers.

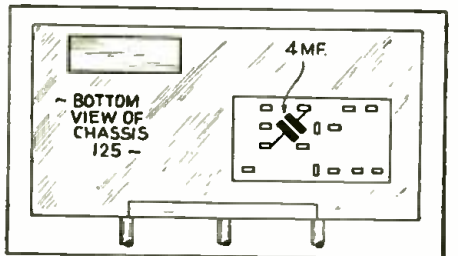

Fig. 4. The condenser shown in the above circuit of an RCA 125 will sometimes be responsible for distortion. It is a 4 mf. electrolytic.

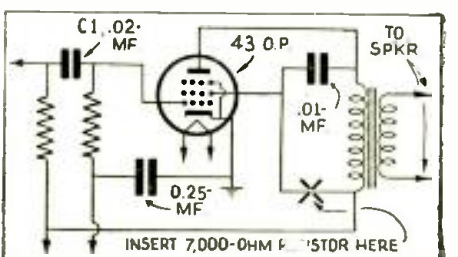
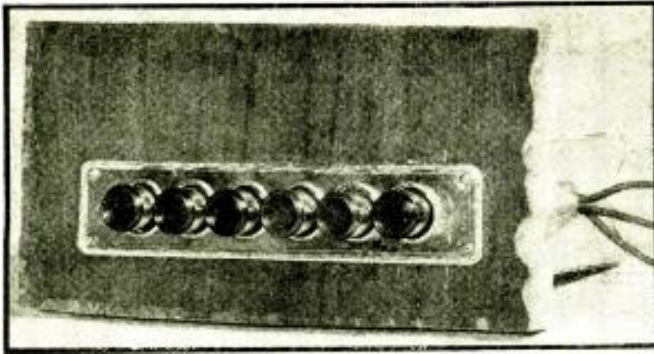

Fig. 5. Fading and distortion in Trav-Ler 50-A receiver has been cured by a 7,000-ohm resistor (2 to 5 watts) inserted as shown above.





An embossed escutcheon for panel mounting is included with the pushbutton unit. Each button may easily be marked with the name of a different station, to make tuning still easier.

## SERVICE MEN?— "PUSHBUTTON-IZE" OLD RECEIVERS

The latest radio improvement, pushbutton tuning, can be added to any set in a few minutes by a skilled Service Man. This article suggests a new path to profits.

**W**HEN battery eliminators replaced batteries—when power packs replaced eliminators—when A.C. tubes came into existence—Service Men made additional money by modernizing old sets.

Now that Pushbutton Tuning has come to ease the task of the tuner, another golden pathway to profits unfolds before the eyes of the Service Man. Nor is the task an especially difficult one, for these pushbutton units, which use no motors, are especially designed for quick, convenient and fool-proof installation.

The unit illustrated and diagrammed in this article consists of a rigidly constructed assembly of anti-capacity pushbutton switches and specially designed variable (trimmer-type) condensers. All the contacts in each switch are silver coated to minimize wear, eliminate corrosion, and provide a positive, low-resistance contact surface. The contacts are of the self-cleaning wiping type.

The operation of the switching unit is completely automatic, so that when one button is pressed it remains in that position until released automatically by pushing any of the remaining buttons. In operation, the pushbutton switches

*(Continued on page 779)*

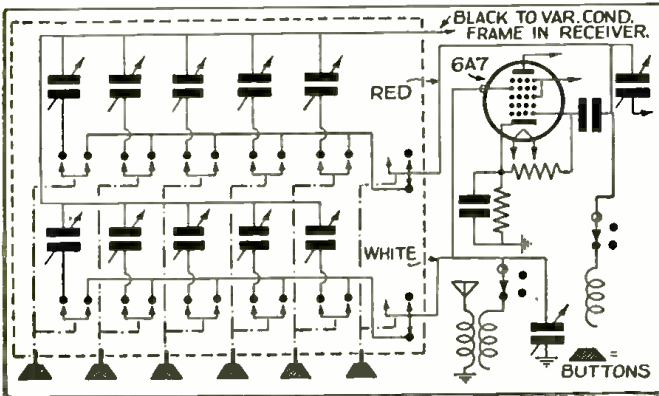

Fig. 1. Schematic diagram of the pushbutton tuner. Note the simplicity of connection; only 3 wires connect the unit to the chassis of the set to which it is added by the wide-awake Service Man.

## TELEVISION STUDENTS LEARN BY MAKING CATHODE-RAY TUBES

This Part concludes the series of articles—published here for the first time in any popular radio magazine—on constructing experimental C.-R. tubes for television.

U. A. SANABRIA

### PART VI

**I**N preceding installments we described the construction of the electron gun and various tests applied regarding the brilliancy of the cathode-ray "spot" and methods of focusing same. We found that the spot could be focussed fine enough for television purposes and that the intensity of the beam could be varied to give sufficient contrast for a television picture without changing the focus appreciably. We now approach the final test (which will conclude this series of articles), namely, that of obtaining an elementary trace on the screen. If a satisfactory trace is obtained then we know that the tube will be suitable for television purposes.

#### OBTAINING HORIZONTAL BEAM-SWEEP

First, we must have a horizontal sweep circuit which will swing the spot of light from one end of the tube to the other and back again.

The first circuit with which we experimented was that shown in Fig. 5. The glow lamp, G, had a striking potential of 150 volts. That is, when the potential between the electrodes becomes strong enough to ionize the gas within the tube, an arc would form between the electrodes and current would continue to flow until the voltage dropped to such a value that ionization within the tube ceased and the arc

*(Continued on page 757)*

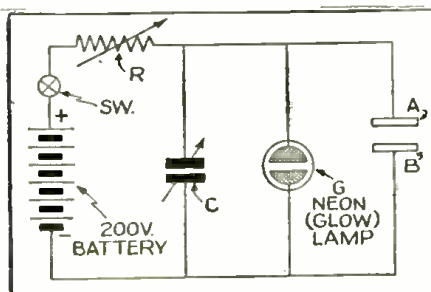

Fig. 5. The horizontal sweep circuit first used to test the C.-R. tube. Condenser C charges up to 150V. and then discharges through the neon tube.

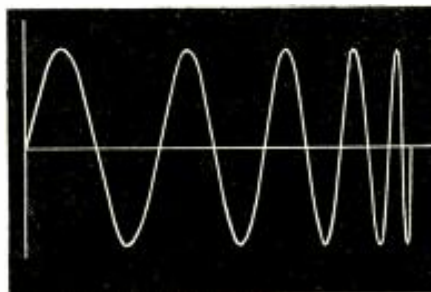
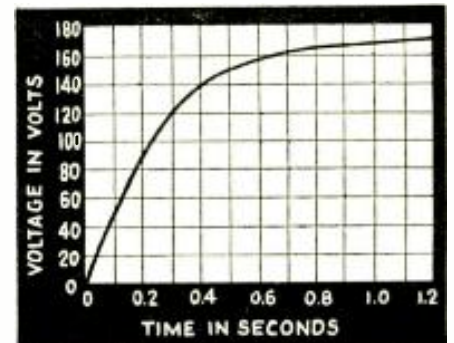

Fig. 6. Above—trace of the familiar sine wave, using the horizontal sweep circuit diagrammed at left. Fig. 7. Right—voltage build-up of C in Fig. 5.





In the preceding issue of *Radio-Craft*, the work of Canada's "Interference Detectives" in locating and suppressing sources of man-made interference was described. This month's installment tells what "sense" and shows how efficient filters and noise suppression may be built.

# CANADA'S "INTERFERENCE DETECTIVES"

Without "sense" finding equipment much difficulty is usually experienced in isolating the particular line section responsible for interference; in this and similar cases, isolation by the intensity method alone would involve a considerably greater amount of patrol work, much of it on foot with portable receiving apparatus.

The "sense" feature is advantageous in the investigation of intermittent faults and defects which give rise to interference of continuously varying intensity. Single bursts of interference for instance, occurring at irregular intervals, present a difficult problem inasmuch as the duration of the noise is not sufficiently long to permit location by patrol for the point of maximum intensity. Sense readings, however, may be taken in the space of a few seconds, and from indications at various points on the line it is possible to work progressively closer to the source until its exact location is established.

### USE OF SENSE FINDING EQUIPMENT

The wavefront of radiation close to power wires, as a general rule, progresses from the source, in a plane perpendicular to the power wire. This condition exists where the surge originates at a single point and is conducted along a line free from discontinuities for a considerable distance, and where the magnitude of any reflected wave is small compared with that of the original wave.

### Location of Faults on High-Tension Lines

The "sense" finding equipment is of great value where the line is paralleled for its entire length by highways; faults giving rise to radio interference may be located at normal touring speed, since the equipment indicates reversal of "sense" immediately the fault is passed en route.

It is also of value in locating line faults occurring at points on the system inaccessible to the radio interference patrol car. Where a line deviates through rough country, over marshes and wooded territory and comes close to the patrol route or crosses it only at interval points, "sense" readings taken at these points will show the particular section of line in which the interference source is included.

Without "sense" finding equipment much difficulty is usually experienced in isolating the particular line section responsible for interference; in this and similar cases, isolation by the intensity method alone would involve a considerably greater amount of patrol work, much of it on foot with portable receiving apparatus.

The "sense" feature is advantageous in the investigation of intermittent faults and defects which give rise to interference of continuously varying intensity. Single bursts of interference for instance, occurring at irregular intervals, present a difficult problem inasmuch as the duration of the noise is not sufficiently long to permit location by patrol for the point of maximum intensity. Sense readings, however, may be taken in the space of a few seconds, and from indications at various points on the line it is possible to work progressively closer to the source until its exact location is established.

In the case of interference which varies continuously in intensity as a result of rapid changes at the source, patrol for the point of maximum radiation is difficult. So long as the noise is active, however, "sense" readings can be obtained regardless of the intensity value and the source located by the procedure adopted in the case of intermittent sources.

### Distortion of Wavefront

The direction of radiation from a power line is distorted by discontinuities of the conductor, transpositions, sharp turns and taps. Dead ends, and changes in the electrical characteristics of the line such as terminals between cable and overhead line are apt to cause a reflection of the surge and thus considerably distort the wavefront. This condition may also be noted in close proximity to wiring networks. Where the reflected wave is of the same order of intensity as the original wave, standing

(Continued on page 766)

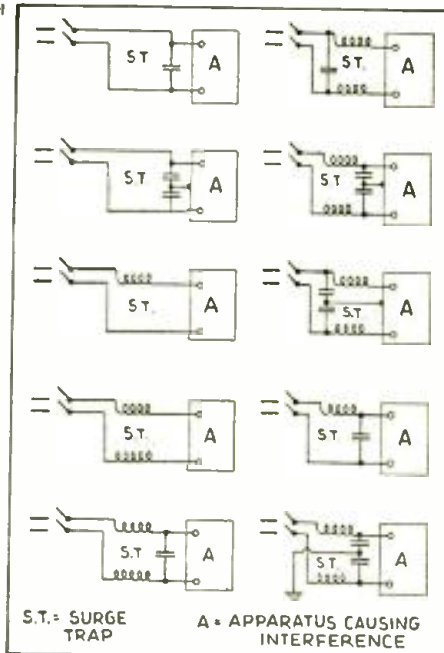

Fig. 4. Various trap circuits, as applied at sources.

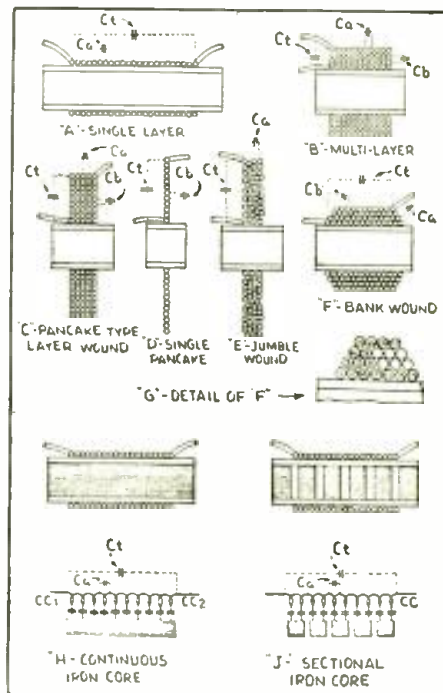

Fig. 5. Distributed capacities in choke windings.

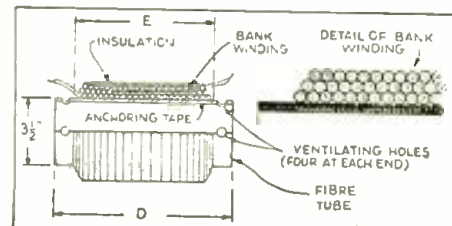

Fig. 6. Method of winding a bank-wound choke coil.

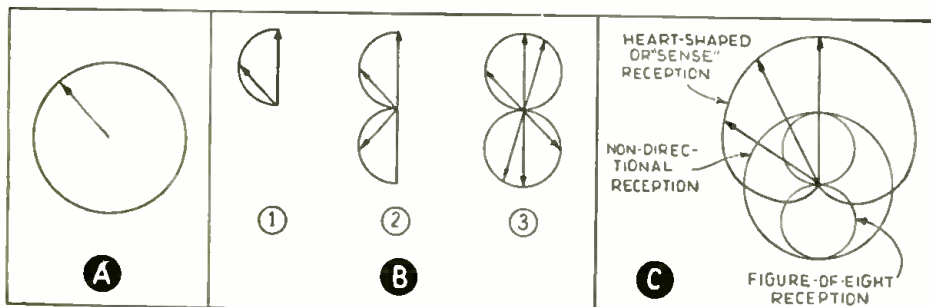

Fig. 3. Lengths of arrows indicate relative signal strength for various positions of loop.



# THE LATEST RADIO EQUIPMENT

Technicians utilize  
keep posted on the  
ways of doing thing  
tronics, and Public Ad

This department to  
newer and

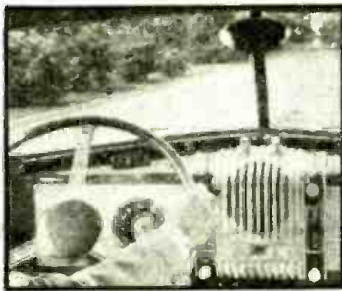

Custom-built car set. (1580)

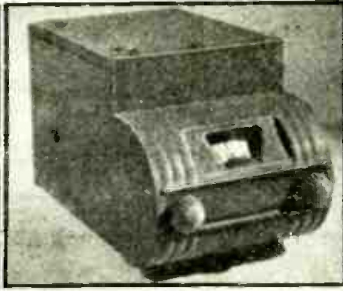

Universal-mount car set. (1581)

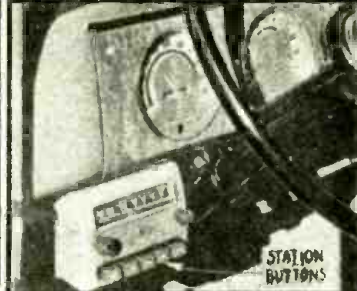

"Safety tuning" car-radio set. (1589)

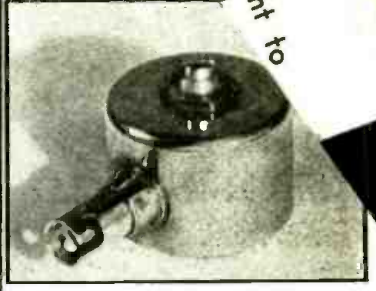

New set "sensitizer." (1590)

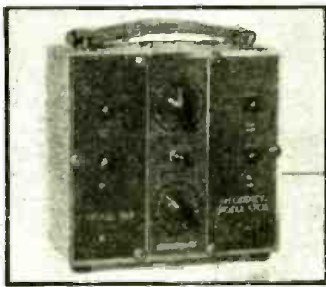

Frequency modulator. (1582)

## INSTRUMENT-PANEL CAR-RADIO SET HAS DUAL CONTROLS (1580)

**N**EWEST in the car-radio sets is a so-called custom-built instrument designed to meet the acoustic requirements of the automobile. According to the car maker the built-in loudspeaker has been set on the instrument panel at the best level for audibility for the back- as well as front-seat passengers.

Another innovation is the use of dual controls for simple and easy operation by either the driver or the alongside passenger.

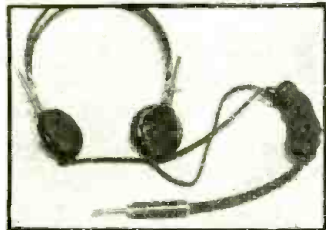

Modernized headphones. (1583)

## NEW UNIVERSAL-TYPE CAR-RADIO SET (1581)

(RCA Manufacturing Co., Inc.)

**T**HE MOST striking of 5 new car-radio sets in one make is illustrated. Lowest-priced of the line, the model 8M incorporates in a single unit a 5-tube superhet. chassis, loudspeaker, dial and controls. Outstanding feature is its universal mounting—can be installed, without drilling holes, on any make of car independent of instrument-panel design; and is equipped with a single universal mounting bracket. Dial has special translucent diffuser to insure even, non-glare illumination.

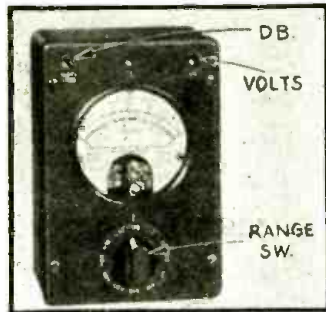

Decibel meter. (1584)

## SERVICING FREQUENCY-MODULATOR (1582)

(Supreme Instruments Corp.)

**T**HIS handy unit can be used with any signal generator or oscillator regardless of make so that, in combination with a cathode-ray

oscilloscope, visual alignment of receivers is possible.

All that is required is to connect the Service Man's present signal generator or oscillator to the model 529 and connect the model 529 output to the radio set. The cathode-ray oscilloscope is then connected to the output of the set's 2nd-detector and the set tuned for proper alignment and band-width.

## IMPROVED MAGNETIC HEADPHONES (1583)

**M**AGNETIC headphones have seen but little improvement since the advent of broadcasting. However an insistent demand for a head-set incorporating the newest developments has resulted in the new "commercial" line here illustrated. The low-impedance or 600-ohm head-set may be used to monitor on transmission lines; the high-impedance or 17,000-ohm, super-sensitive headphones are ideal for the discriminating amateur. These headphones incorporate many new design features.

## VOLTAGE AND CONSTANT-IMPEDANCE DB. METER (1584)

(Weston Electrical Instrument Corp.)

**T**HIS rectifier-type power level indicator and voltmeter, in which a new circuit network provides improved uniformity of operating characteristics, has a constant internal resistance of 20,000 ohms, both into the instrument from the line under test, and from the instrument into the network toward the line.

Instrument has 2 voltage scales (one each for the 2 and 5 volt full-scale ranges and multiples thereof) and one decibel scale. Voltage ranges are: 2, 5, 8, 20, 50, 80, and 200 V., full-scale; power-level indications: -8, -4, 0, +4, +8, +12, +16, +20, +24, +28, +32 db.

## WATERPROOF DYNAMIC MIKE (1585)

(American Microphone Co., Inc.)

**T**HE NEW "clipper" dynamic microphone may be waterproofed at the factory for permanent outdoor installations. The head here illustrated has built-in transformer to match into 200, 500 or 10,000 ohms. Versatile design permits use as desk unit, hand-mike, floor stand or overhead suspension. Sensitivity about -48 db.; frequency range about 50 to 10,000 cycles.

## 16-ROOM SCHOOL P.A. SYSTEM (1586)

(Webster-Chicago)

**H**ERE is a remarkably efficient piece of sound equipment for schools. Although small its output is sufficient for requirements up to 16 rooms. Features are: all-wave radio set, master call and return speech interphone, permanent-magnet speakers with wall-mounting baffle, and provision for using phonograph transcriptions.

## COMPLETE P.A. SYSTEM (1587)

(Wholesale Radio Service Co., Inc.)

**S**ERVICE MEN and sound men will find in this portable P.A. system all the equipment they need

(Continued on page 775)

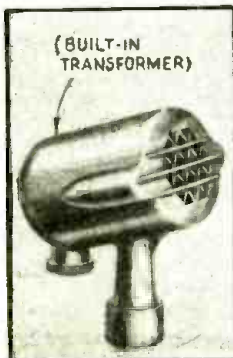

Newest mike. (1585)

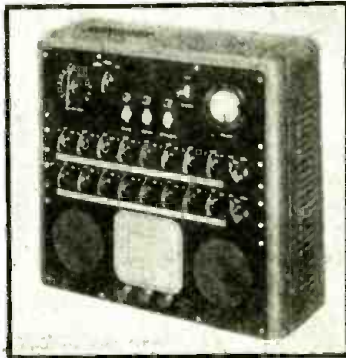

School sound system. (1586)



Portable public address. (1587)

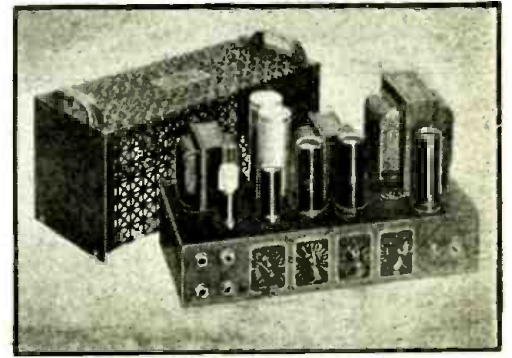

Public-address amplifier has new features. (1588)

Name and address of any manufacturer will be sent on receipt of self-addressed, stamped envelope. Kindly give (number) in above description of device.



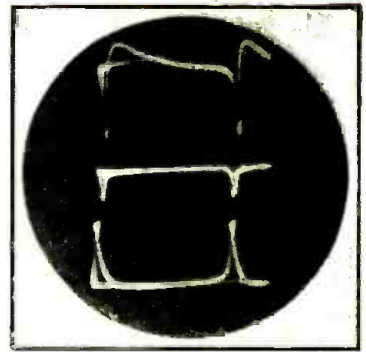
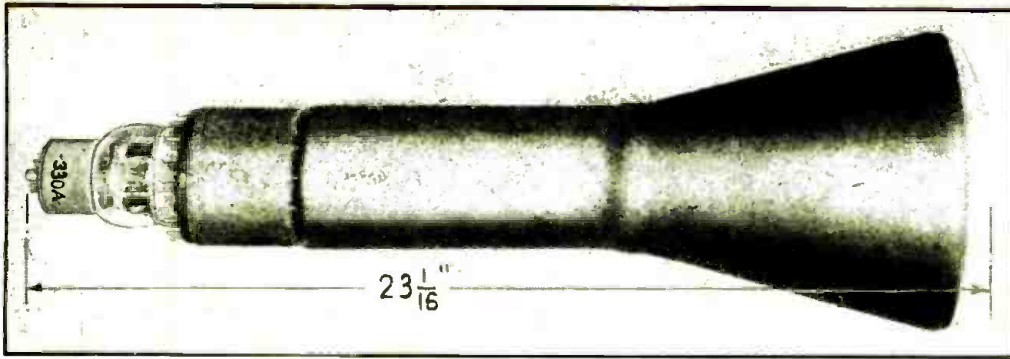

Fig. B. At no additional expense for tubes, 2 additional voltages may be visually supervised, as . . . . Fig. C, above, showing 3 waveforms, indicates.

# RECENT RADIO TUBES

In March *Radio-Craft* (Jubilee Souvenir Number) we chronicled several unique developments. We add to the list.

R. D. WASHBURNE

**R**ADIO men who must or should keep abreast with developments in the electronic field will find in this month's presentation of tube data much information that is of far-reaching importance.

## SPECIAL RADIO TUBES

"Bantam" ("T"-Type) Tubes. In Fig. A is illustrated—in comparison with the equivalent standard type—a representative tube in what is one of the most interesting developments since the introduction of metal tubes. This tube is the type 6J7GT, the G indicating a glass envelope and the T representing the tinier dimensions as compared with the preceding type of tube for the same service.

Characteristics data, on these tubes, will not be given in detail in view of the fact that they closely approximate the characteristics of tubes in the larger size having the same code numbers except for the small-size identification suffix T. New T-type tubes just announced and their services are given in Table I. It will be observed that except for two

25-V. heater tubes the present series all utilize 6-V. heaters.

These new tubes will have widespread application where space economy is required and especially in so-called "vest pocket" radio receivers as their extremely small size makes it possible to use them in a 4-tube receiver having dimensions of only  $5\frac{3}{4} \times 4\frac{1}{4} \times 3\frac{3}{4}$  ins. deep. (Equivalent-type metal tubes however have roughly the same sizes as the "T's".)

(Manufacturer's name given upon request.)

**330A 3-Trace Cathode-Ray Tube.** This tube—and its companions B and C, in the 330 series, which are physically similar but render different color images—"keeps tabs" simultaneously on 3 different A.C. voltage sources. The "330"-class tube is shown in Fig. B. Alluding to the 3 patterns, which this tube will simultaneously trace (see Fig. C), the writer dubs this tube the "trioscope."

Radio men daily utilize a multiplicity  
(Continued on page 773)

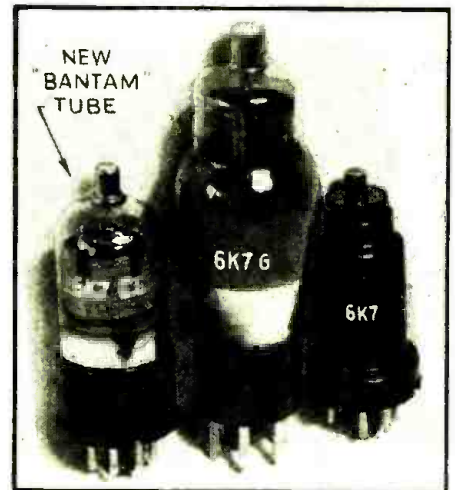

Fig. A. New small-space tube (left), replaces its older counterpart (center), but not metal type (right).

## IN THIS ISSUE—

- A series of Small-Space Tubes
- A series of 3-Trace Cathode-Ray Tubes
- Frequency Converter for A.C.-D.C. Sets
- Pentode Amplifier featuring sharp cut-off and low filament drain
- Electrometer Triode
- Sputtered-Carbon "Megamegohm" Resistor
- Mercury-Vapor Grid-Control Rectifier
- And 4 new Amateur-radio Tubes

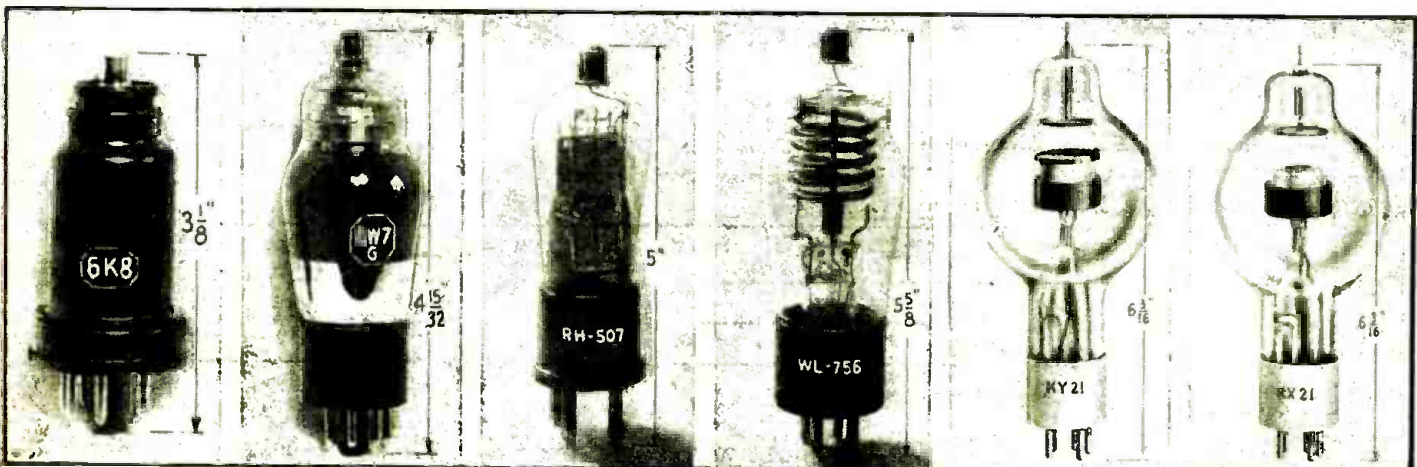
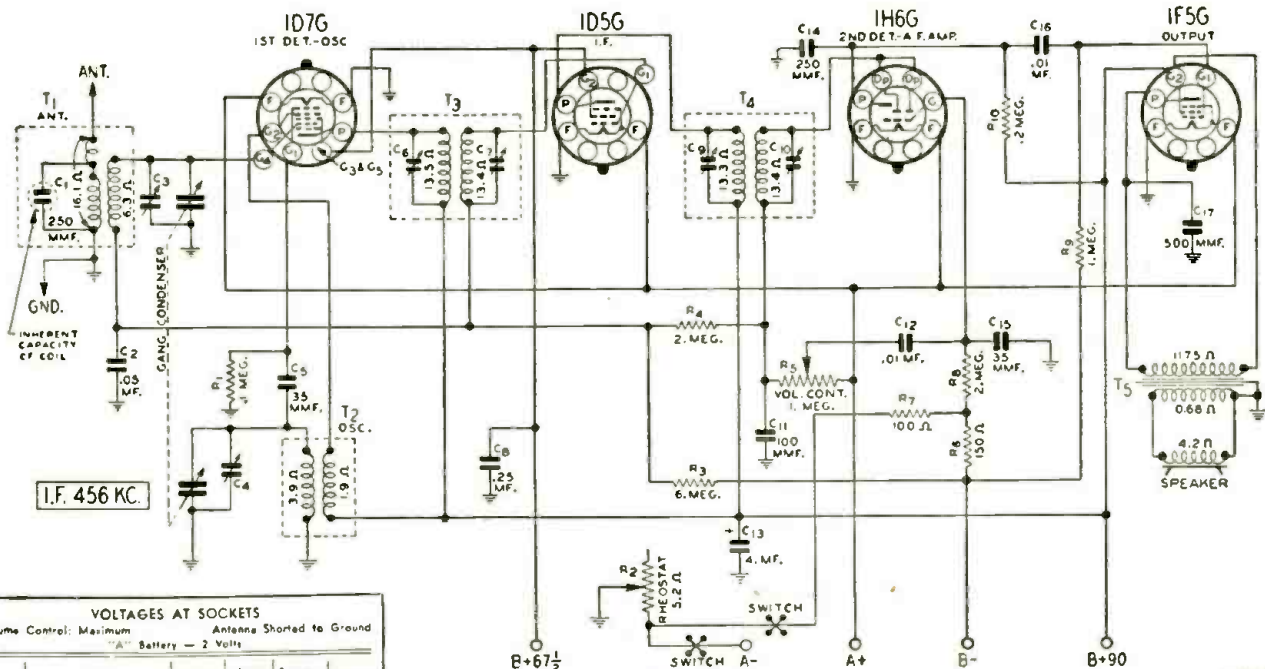

Fig. D. New tubes, in this group of 6, include special types for use in regular radio receivers, in industrial applications, and in amateur radio.



## WELLS-GARDNER SERIES B-1 4-TUBE HOME RADIO SET—BATTERY OPERATED

4-Tube Superhet.; 456 kc. I.F.; 135 milliwatts undistorted output; Range, 528 to 1,730 kc.; "A" Drain 0.3-A. at 2 V.; "B" Drain 11.5 to 15 Ma. at 90 V.



**VOLTAGES AT SOCKETS**  
Volume Control: Maximum      Antenna Shorted to Ground  
"A" Battery — 2 Volts

Tube	Function	Across Filament	Plate to Ground	Screen to Ground	Control Grid
1D7G	1st Det.-Osc.	2.0	87 87(1)	64	3.5(2)
1D5G	I.F.	2.0	87	64	3.5(2)
1H6G	2nd Det.-1st Audio	2.0	32(3)		1.25(4)
1F5G	Power	2.0	82	87	3.5(2)

- (1) Anode Grid (G2) to ground
- (2) As read across R6 and R7
- (3) As read on 100 volt scale (1000 ohm per volt meter). Subject to variation.
- (4) As read across R7

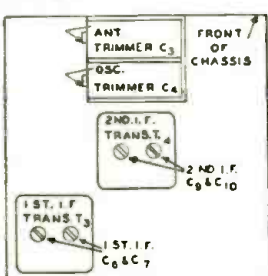
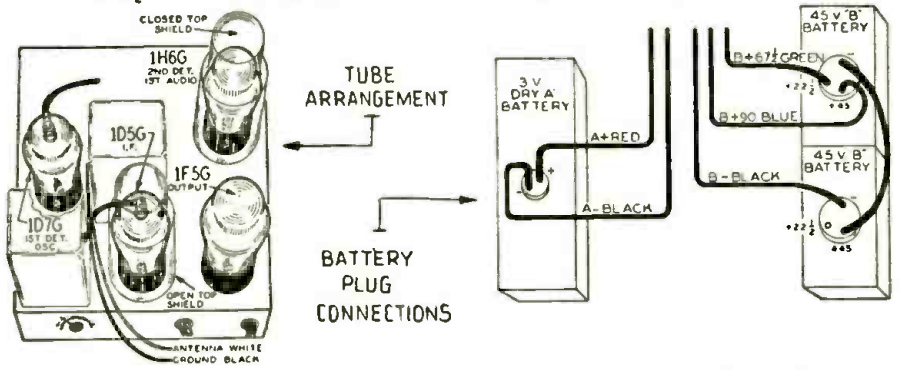

TRIMMER LOCATION

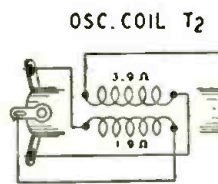

COIL TERMINALS

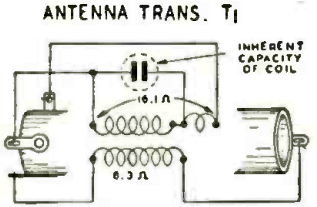

### ALIGNMENT PROCEDURE

Volume Control—Maximum All Adjustments.  
Connect Radio Chassis to Ground Post of Signal Generator with a Short Heavy Lead.  
Allow Chassis and Signal Generator to "Heat Up" for Several Minutes.

The following equipment is required for aligning:  
Signal Generator which will provide an accurately calibrated signal at the test frequencies as listed.  
Output Indicating Meter; Non-Metallic Screwdriver.  
Dummy Antennas — .1 mf. and 200 mmf.

STEP [Follow Order at Given]	DUMMY ANTENNA	SIGNAL GENERATOR		TRIMMERS ADJUSTED [See Illustration]	PROCEDURE	
		FREQUENCY SETTING	CONNECTION AT RADIO		INITIAL STEPS	ADJUSTMENT
I. F.	.1 mf.	456 KC	Grid of 1st Det.	2nd I. F. (C9) & (C10) 1st I. F. (C6) & (C7)	Turn rotor to full open	Adjust to Maximum Output
1730 KC Adj.	200 mmf.	1730 KC	Antenna Lead	Osc. (C4)	Turn rotor to full open	Adjust to Maximum Output
1500 KC Adj.	200 mmf.	1500 KC	Antenna Lead	Ant. (C3)	Turn Rotor to Max. Output	Adjust to Maximum Output

Attenuate the signal from the signal generator to prevent the leveling-off action of the AVC.

the position of the pointer and remove the chassis from the cabinet. Loosen the pointer screw and set the pointer, so that it will be at the 800 KC. mark. Tighten the pointer screw and replace the chassis in the cabinet. If the pointer is not at the 800 KC. mark another adjustment will be necessary.

NOTE—To obtain dial scale calibration, tune in an 800 KC. signal. The pointer should be at the 800 KC. mark on the dial. If it is not, note



Service Men may write, requesting answers to specific service questions. Address inquiries to Service Editor. For questions answered by mail, a service fee of 25c per question is made. Only questions of wide interest can be published. In view of the "rush" character of most service calls an effort is made to maintain 48-hour service on mail inquiries. Let us help you solve your service problems.

# SERVICING QUESTIONS & ANSWERS

## NOISE AT HIGHEST VOLUME AND SENSITIVITY

(48) A. Centanino, Freeport, Pa.

(Q.) I have in my shop a Halli-crafter "Sky Chief" receiver which has developed a crackling noise. When the A.F. gain control is turned to maximum and the R.F. gain control is employed to control volume, this noise is not heard until the R.F. control is turned almost to maximum. Both controls are in good condition, as are all tubes. Condensers and resistors check OK. I noticed that the magic eye keeps blinking when the noise is present. Is there any way to correct this?

(A.) The fact that the magic eye or tuning eye responds to the noise or interference eliminates the audio portion of the receiver as a possible source for the trouble reported. The symptoms described appear to be due to some inductive or direct pick up by the antenna system. Some aerial adjacent to the antenna system may be contacting same at some point along its length or grounding to some object, thus producing the interference.

In the event the antenna system is found in perfect order, check the 1st I.F. transformer primary for a noisy condition. This may be accomplished quite simply by shunting a D.C. voltmeter of at least 1,000 ohms/volt sensitivity, across the I.F. primary, as shown in Fig. Q.48, with the receiver in operation. The presence of the test leads should materially reduce the volume or sensitivity, but reception should be heard. Turn gain controls high.

The 50-volt range of the voltmeter (although a 10-volt range is preferable) should be used. The D.C. voltage drop across the I.F. primary will be indicated upon the meter. This indication should remain constant. Any substantial variation in the reading obtained during operation is the result of a noisy I.F. primary. The transformer, of course, must then be replaced.

While you are at it, it might be an excellent idea to check the other I.F. transformer primary windings in similar manner.

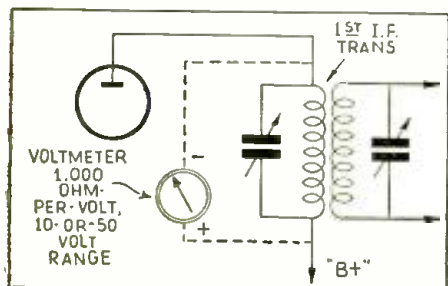

Fig. Q.48. A novel method for determining whether an I.F. primary is "noisy". Suggested in this instance for a Halli-crafter set.

## BROADCAST BAND INOPERATIVE

(49) Mr. John Unrich, McClusky, N. D.

(Q.) I have an Atwater Kent Model 145 receiver for repair which operates satisfactorily on the short-wave bands, but does not function on the broadcast band. By connecting both orange and black leads to ground, reception is obtained around 900 kc. At 550 kc., reception is exceedingly noisy and distorted. I have checked the 2A7 tube, bias resistor and bypass condenser and found all OK. Other coils have been tried with no result. What may possibly be the trouble?

(A.) From the information supplied in your letter, there is little doubt but that the trouble reported lies with the broadcast band series condenser, a 730 mmf. unit. This is the long, flat paper-covered condenser riveted to the rear wall of the chassis near the 2A7 socket. This condenser has been found to open-circuit intermittently, thus causing the symptoms mentioned. In the event a factory replacement cannot be procured, substitute a 700 mmf. mica condenser and re-adjust the padder condenser in the usual manner, i.e., for maximum output at 600 kc.

## OVERHEATING POWER TRANSFORMER

(50) Mr. John Hemmert, Newark, N. J.

(Q.) I recently replaced the power transformer in a Philco receiver, model 66, code 121, with a new unit. The high-voltage secondary is 700 volts with a rating of 90 ma. With this transformer, all voltages are excessive and the screen-grid of the 42 output tube becomes red-hot. The receiver operates satisfactorily but the power transformer overheats considerably, probably due to excessive voltage. What would you advise to correct the trouble?

(A.) The transformer which you have employed for replacement purposes in the Philco 66 will serve, provided the voltage delivered to the filter and tubes is reduced. There are two

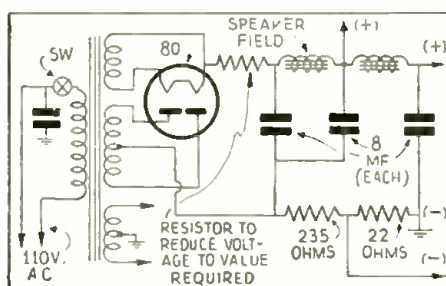

Fig. Q.50. The resistor indicated above, will reduce the voltage output in a receiver where an incorrect power transformer has been installed.

simple methods of accomplishing this. The first means consists of disconnecting the input filter condenser (one section of dual 8 mf. unit) and substituting a 1 or 2 mf., 450-volt condenser. An alternative method is that of introducing a suitable resistance between the 80 filament and filter as shown in Fig. Q.50. Since the exact voltages now obtained are not specified it is impossible to state the exact value of such resistor. However, the carrying capacity of the unit should be at least 50 watts. In all probability, a wire-wound resistor between 150 and 500 ohms should suffice, but this must be determined by trial and depends upon the voltages now obtained. Adjust the value of this resistor until the screen-grid voltage of the 42 tube is approximately 250 volts.

## CHANGING FROM 60 CY. TO 25 CY.

(51) Mr. John Kovaco, Jr., Depew, N. Y.

(Q.) I am having trouble with an 8-tube Silvertone receiver model 1806. Due to a change in location, it was necessary to replace the 60-cycle power transformer with a 25-cycle unit. Before transformation, the receiver was in good operating condition, but since the transformer has been replaced with a proper Thordarson type, no reception can be obtained.

The 80-rectifier tube was replaced with a perfect tube and all other tubes were tested and found to be good. With the exception of the 75 tube, all voltages are below normal. A reading of 90 volts is obtained on the plate of the 75 tube, whereas the chart calls for 75 volts. The R.F. 78 and detector-oscillator 6A7 plate and screen-grid voltages are 155 volts and 25 volts, respectively. The plate voltage on the 47 cut-p tubes is 150 volts.

Filter condensers test OK, but the voltage output at the filter is 162 volts. The chart indicates 235 volts. What do you suppose the trouble to be?

(Continued on page 779)

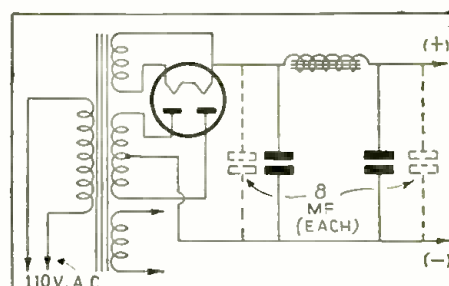

Fig. Q.51. This illustration shows how to increase the voltage output by adding capacity, before the filter, in a rectifier circuit.







## CROSLY "PRESTOTUNE" MODELS 1217 AND 1227

12-tube A.C. superhet.; pushbutton tuning; 3 bands (535-1,725 kc., 2.0-6.8 mc., 6.6-22 mc.); Q.A.V.C.; 455 kc. I.F.; Local-Distance switch, 6K6 push-pull-parallel 12-watt output.  
(See Data Sheet No. 227 for diagram.)

### SOCKET VOLTAGES

Tube socket voltages are measured from tube socket contacts to chassis with a 1000 ohms/volt 500-volt D.C. voltmeter (except filaments) with receiver in operating condition and no signal input. Volume control should be turned full "ON," tone control to "TREBLE" (counter-clockwise), Local-Distance switch to "Distance" position and condenser gang to minimum capacity position. Filament voltages should be measured with an accurate low range A.C. voltmeter (approximately 0-10 volts). Readings may vary plus or minus 10% of values given.

#### TUBE SOCKET VOLTAGE READINGS

Tube No.	H	P	S.-G.	Sup.-G.	K	Go	Ga
6U7G 52A	6.3	255	95	0	0	—	—
6A8G 53	6.3	255	95	—	0	95	95
6K6G 56A	6.3	125	125	—	0	—	—
6U7G 52B	6.3	255	95	3	3	—	—
6Q7G 55A	6.3	0	—	—	0	—	—
6Q7G 55B	6.3	185	—	—	0	—	—
6K6G 56B, C, D, E	6.3	245	255	—	22	—	—
5Y3G 57A, B	5.0	—	—	—	255	—	—

(In above Table, Go=osc. grid, Ga=amp. grid.)  
Power consumption approximately 120 watts at 117.5 volts.

Power output approximately 12 watts.

Voltage drop across speaker field 72 volts.

6U7G, R.F. amplifier (52A); 6A8G, modulator (53); 6K6G, oscillator (56A); 6U7G, I.F. amplifier (52B); 6Q7G, det., A.V.C. and "squelch" (55A); 6Q7G, first A.F. amplifier (55B); 6K6G, output (56B, C, D, E); 5Y3G, rectifier (57A, B).

### ALIGNMENT PROCEDURE

Connect output meter to plates of two 6K6G output tubes. Protect meter from D. C. by condenser (0.1-mf. or larger—not electrolytic) in series with one of leads.

#### Tuning I.F. Amplifier to 455 Kilocycles

(a) Connect output of signal generator through a .02-mf. condenser to top cap of 6U7G 1st I.F. Amp. tube, leaving tube's grid clip in place. Connect ground lead from signal generator to ground terminal of receiver. **KEEP GENERATOR LEADS AS FAR AS POSSIBLE FROM GRID LEADS OF OTHER SCREEN-GRID TUBES.**

(b) Set station selector so tuning condenser plates are completely out of mesh. Turn volume control knob to right (ON) and turn tone control knob to left (TREBLE).

(c) Set band selector switch on Broadcast Band.

(d) Turn Local-Distance Switch to "Distance" position (right).

(e) Set signal generator to 455 kilocycles.

(f) Adjust both trimmer condensers located on top of 2nd I.F. transformer for maximum output. (See Fig. 1.)

(g) Transfer signal generator lead to top cap of 6A8G tube, leaving tube's grid clip in place.

(h) Close middle trimmer of 1st I.F. transformer. (Do not force adjustment screw.)

(i) Adjust top and then bottom trimmers of 1st I.F. transformer for maximum output.

(j) Adjust middle trimmer of 1st I.F. transformer for maximum output.

**DO NOT ADJUST TRIMMER CONDENSERS LOCATED ON 2ND I.F. TRANSFORMER WITH SIGNAL GENERATOR LEAD CONNECTED TO 6A8G TUBE.**

**ALWAYS USE LOWEST SIGNAL GENERATOR OUTPUT THAT WILL GIVE A REASONABLE OUTPUT METER READING.**

#### Aligning R.F. Amplifier

When aligning R.F. amplifier, output lead from signal generator is connected to "ANT." terminal of receiver. For Broadcast Band a 200 mmf. condenser should be connected in series with output lead of signal generator; and for High-Frequency and Police Bands, a 400-ohm carbon resistor should be used in place of the condenser.

Each band should first be SHUNT ALIGNED and then SERIES ALIGNED where provision is made for series alignment (Broadcast Band). Band selector switch should be set for band being aligned and signal generator should be set to the frequency indicated for each adjustment. \*See Table 1 below.

(a) With station selector adjusted so tuning condenser plates are completely out of mesh, adjust "OSC." shunt trimmer until MINIMUM CAPACITY SIGNAL \* is heard (it is not necessary that receiver tune through this signal).

(b) Adjust station selector so SHUNT ALIGNMENT SIGNAL

\* is tuned-in with maximum output. Then adjust R.F. and "ANT." shunt trimmers for maximum output. Readjust station selector slightly so generator signal is tuned-in with maximum output and check adjustment of R.F. and "ANT." trimmers. **DO NOT READJUST OSCILLATOR TRIMMER.**

**NOTE:** When shunt aligning the Police and High-Frequency Bands care must be exercised so that the circuits will be aligned on the correct frequency rather than on the image frequency which is approximately 910 kilocycles less than the fundamental.

(c) To align series trimmer (see Fig. 1), set signal generator to frequency indicated \*. Then tune-in this signal with station selector, for maximum output. To obtain best adjustment for series trimmer, rotate station selector back and forth slightly while adjusting trimmer for maximum output. Minor tolerance variations in series alignment: at 2,500 kilocycles in Police Band and at 7,000 kilocycles in High-Frequency Band may be compensated for by slight repositioning of the grid lead of antenna coil in Band affected.

#### \*Table 1—SIGNAL INPUT FREQUENCIES

Band	Min. Cap. Signal	Shunt Align.	Series Align.
American Broadcast	1,850 kc.	1,700 kc.	600 kc.
Police & Amateur	6,600 kc.	6,000 kc.	—
High-Frequency	22 mc.	18 mc.	—

### SETTING PUSHBUTTONS

The 1st pushbutton on the left as you face the front of the cabinet works with No. 1 disc, and the 2nd pushbutton works with No. 2 disc, etc. (See Fig. 2.)

To set electric tuning system, turn receiver "ON" and press No. 1 pushbutton. When dial pointer stops rotating, key slot in No. 1 disc on the selector switch will be in the "UP" position. Remove key from mounting and place it (knob up) through No. 1 hole in the disc identification bracket. If it does not drop into slot in disc, push it in.

Turn Local-Distance switch to "Distance" position. By means of station selector knob, tune-in **AS ACCURATELY AS POSSIBLE**, station whose call letters have been placed in No. 1 pushbutton. Then remove key.

**NOTE:** The pushbutton which will ordinarily be used for POLICE calls does not lock in depressed position. It serves as a release for all other pushbuttons and should be depressed before operating the manual tuning control. (The first sets of this model were built with non-lock type pushbuttons.)

By means of manual tuning knob, turn dial pointer to some other position. Then check setting by pressing button which has been set. If pointer stops too soon or goes too far, a second setting will be necessary.

The electric tuning system is now correctly set for the 1st station. Follow through with same procedure until the proper adjustments have been made for all 8 stations. When tuning receiver by means of pushbuttons, Local-Distance switch should be turned to "Local" position.



Fig. A. Crosley Model 1217-M.

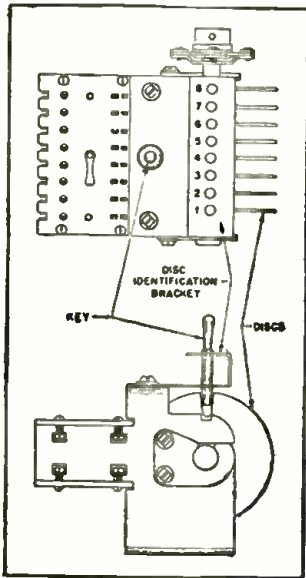

Fig. 2. Pushbutton setting.

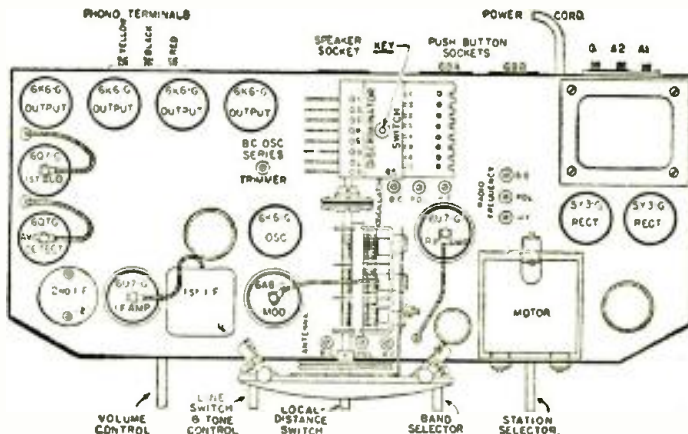

Fig. 1. Top view, chassis, models 1217 and 1227.



AWARDS IN THE CONTEST  
**FIRST PRIZE** ..... \$10.00  
**SECOND PRIZE** ..... 5.00  
**THIRD PRIZE** ..... 5.00  
 Honorable Mention

# USEFUL CIRCUIT IDEAS

Experimenters: Here is your Opportunity to win a prize for your pet circuit idea, if it is new, novel, and useful.

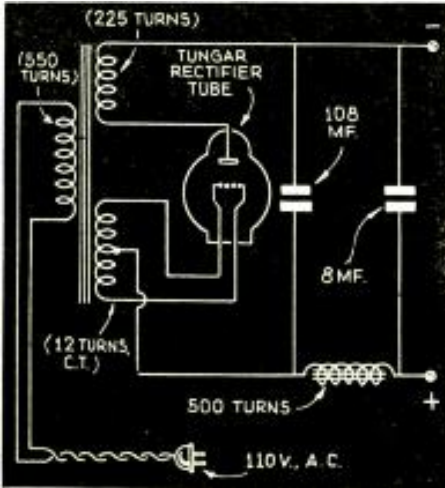

Fig. 1. A converter to change 110 volts A.C. to 32 volts D.C. is quickly made with a few old parts.

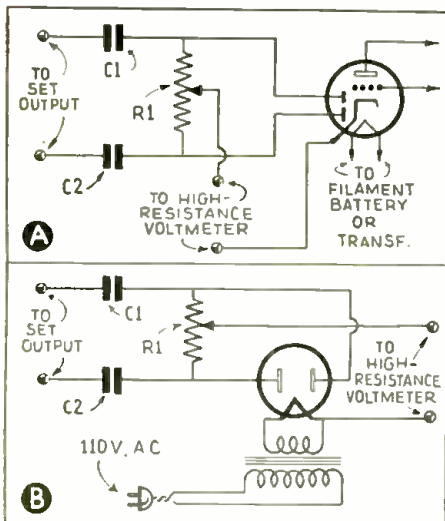

Fig. 2. A compact rectifier, to use a standard D.C. meter for testing output of radio receivers.

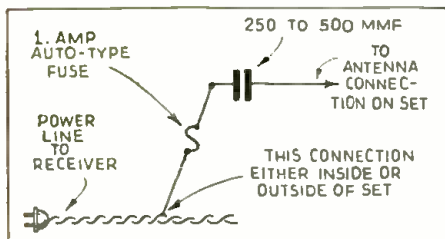

Fig. 3. A means of installing a safely-fused antenna eliminator in any A.C., D.C., or A.C.-D.C. set.

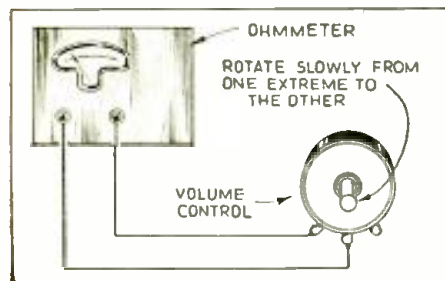

Fig. 4. Ohmmeter helps sell new variable resistors by demonstrating defects in old units.

## FIRST PRIZE—\$10.00

**A** 110-VOLT A.C. to 32-VOLT D.C. CONVERTER. After seeing a 32-volt farm radio set without any source of 32-volt D.C. "juice" I said, "never again." I started out to find a step-down transformer and metallic rectifier, that was capable of changing 110 volts A.C. to about 36 volts D.C. at 3 amps., that did not cost a young fortune. But none was obtainable, so the converter shown in Fig. 1 was homemade, the details of which follow.

In making the 110-volt A.C. to 32-volt D.C. converter, a tungar-type rectifier bulb, which had a rating of 6 amps. at 45 volts D.C. with a 2.2 volt and 18 amps. filament was obtained for 95c. It had been used in motion picture work. The local power company gave me a small power transformer which they had thrown in the scrap heap.

After the old windings were taken off and the core cleaned, a primary of 550 turns of No. 20 D.C.C. wire was wound on a form which would slip over the center leg of the core. Over the primary were wrapped and glued 3 layers of heavy brown wrapping paper; then 225 turns of No. 18 D.C.C. wire were wound on; and again 3 more layers of paper. Finally 12 turns of No. 12 enam. & S.C.C. wire center-tapped for the filament were put on, and the core assembled around the coils. The 108 mf. condenser is composed of 2 quadruple electrolytics of the 9-9-18-18 mf. variety. The choke was made by winding 500 turns of No. 20 D.C.C. wire on the core of an old burned-out power transformer, from a 7-tube set, which was in the junk box. The other condenser is only an 8 mf. electrolytic.

The total cost was \$15.92 not counting labor. No doubt it could be made cheaper if all or part of the material is already on hand.

The outfit works good except for a slight A.C. hum which I believe is due to insufficient capacity in the filter condenser. I understand that there is a more desirable type of 6 amp. tungar bulb on the market that is used in battery chargers which should be more easily obtained than the one described.

Roy E. Dooley

## SECOND PRIZE—\$5.00

**A** RECTIFIER FOR OUTPUT TESTS. A simple rectifier for making output tests on radio sets when only a D.C. meter is available, is shown in Fig. 2. It uses tubes which may show up "dead" in a tester or fail to function perfectly in a receiver. In Fig. 2A, the tube may be any diode, such as the 75, 85, 2B7, or 2A6, etc. The 6H6 is ideal for this service. Figure 2B shows the use of any power rectifier, such as the 80, 5Z3, 25Z5, etc. The meter may be

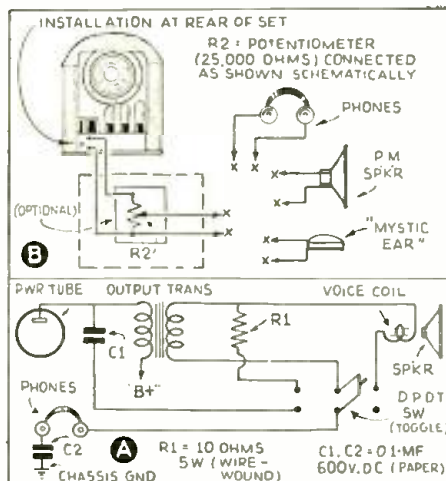

Fig. 5. Safe output jacks adapt receiver to use phones, remote speaker or "mystic ear."

any volt-, ohm-, or milliammeter, working as a 50 to 100 volt meter or lower, or a 1 to 10 ma. meter with a resistance of 50,000 to 100,000 ohms in series. Resistor R1 may be any potentiometer of 1,000 ohms or more (set on center), or two resistors of equal value (i.e., two 2,000-ohm resistors). Units C1 and C2 may be 0.5-mf. condensers.

HERBERT JOHNSON  
 WZGNV.

## THIRD PRIZE—\$5.00

**B**UILT-IN ANTENNA ELIMINATOR FOR MIDGET RECEIVERS. I have often been called upon to install a small midget-type radio set for a family whose members could not quite agree where they wanted the receiver. Perhaps the father wanted it in the parlor or the library, the mother might want it in the kitchen or the sewing room, and the son or daughter might want it in the bedroom. Of course it would be a rather large job to bring a lead-in from the outside antenna system into all these different rooms, so in order to save time for myself and money for my customers, I figured out the arrangement shown in Fig. 3.

Take a small fixed condenser and connect it between one side of the power line leading into the set and the antenna binding post, using a fuse in series for safety. It can be placed inside the receiver where it will be out of sight, or can be left outside, just as you prefer. If you connect it as shown in the drawing, the only thing necessary to do when moving the set from one room to another will be to pull out the plug and carry it in away. When you insert the plug in another receptacle you automatically connect your aerial at the same time.

While this type of antenna is not as good as an outside one, it will work very well. This arrangement is sure to please all the family and satisfied customers are what we all want. You have to watch polarity in D.C. or A.C./D.C. receivers, connecting the condenser to the "high" (ungrounded) side of the line. In A.C. sets, the plug can be reversed. Note that it may be necessary to "clean up" the line—eliminate motor, refrigerator and other line noises—before the job can be considered completely OK.

Wm. H. Clark

## HONORABLE MENTION

**D**EMONSTRATING VARIABLE RESISTANCE FAULTS. Figure 4 shows a way to demonstrate to the customer that a volume control or other variable resistance is defective. When testing volume controls from your "junk-box" for being "noisy," and when wishing to demonstrate the defectiveness of a noisy unit (Continued on page 760)

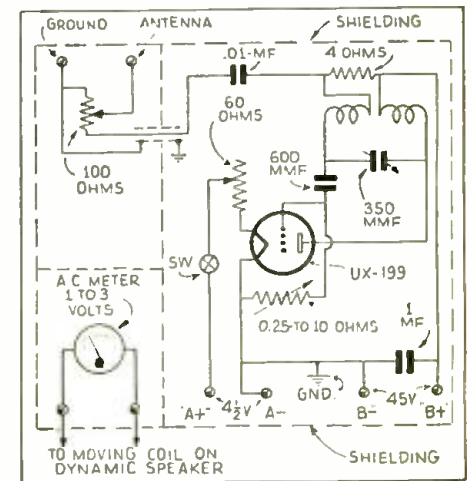

Fig. 6. Portable self-powered signal generator aids in aligning I.F. and A.V.C. stages.



## TELEVISION STUDENTS LEARN BY MAKING CATHODE-RAY TUBES

(Continued from page 748)

would disappear. Therefore, with this in mind, let us proceed to analyze the operation of the circuit shown in Fig. 5.

### THE "HOW" OF NEON OSCILLATORS

As switch S is closed, placing 200 volts across the circuit, current starts to flow through resistor R into condenser C in its attempt to charge condenser C to the same potential as the battery. However, when condenser C has charged up to 150 volts, the gas in the glow lamp, G, becomes sufficiently ionized and an arc forms within the tube; which acts essentially the same as placing a short circuit across C causing discharge.

If we couple the variations of voltage across C to the deflector plates of our cathode-ray tube, we will then have a simple method of causing the electron beam to be deflected, because as C is charged, deflector plate B of the cathode-ray tube becomes more negatively charged with electrons with the result that these electrons in turn repel the electrons of the electron beam away from them. The electron beam is repelled more and more as the voltage across C increases until the arc forms in the neon glow lamp, discharging the condenser and likewise relieving the stress across the deflector plates and thereby allowing the electron beam to return to its original position.

As the resistor, R, is varied, it varies the charging rate or amount of current flowing into the condenser. In other words, when the value of R is high, only a small amount of current can flow into C, and consequently, it takes a comparatively long time for the condenser to charge up to a voltage sufficient to cause the neon bulb to strike. As the resistance is lowered, more current can flow into the condenser, and thereby, charge it faster.

### SOURCE OF DEFLECTION VOLTAGE

The neon bulb continues to discharge C until the voltage drops to 60 volts (for this particular glow lamp) where the stress across the electrodes is no longer sufficient to maintain ionization of the gas. When ionization ceases within the tube, it then becomes a non-conductor and C again starts to charge.

The building up and discharge of condenser C produces a similar build up and discharge of voltage across deflector plates AB at a rate which is dependent upon the rate at which C charges up to the striking potential of the neon glow lamp. This rate can be varied by varying the resistance of R, or by changing the capacity of C. That is, the smaller we make C, the more rapidly it will charge up.

This, then, gives us 2 methods for varying the rate of frequency with which the electron beam may be caused to sweep across the end of the cathode-ray tube when a sine wave is impressed upon the vertical deflector plate and the resistance in the previously described sweep circuit is adjusted until the beam sweeps across the screen at a rate which produces several complete cycles upon the screen.

### NEON SWEEP VOLTAGE IS NON-LINEAR

When a sine wave variation is applied to the vertical deflector plates, the result, however, is that shown in Fig. 6 which clearly shows how the beam is moving at a comparatively rapid and given rate on the left, and decreases in speed as it approaches the right side thereby causing the cycles in that section to become cramped or pushed together. This indicates that the speed with which the electron beam is deflected horizontally across the screen is not constant. This is technically spoken of as *non-linearity* of the sweep circuit. It is a result of the nature with which a condenser charges when placed across a D.C. potential.

### CAUSE OF NON-LINEARITY

The voltage rise across the condenser in Fig. 5 is plotted graphically in Fig. 7. Between 0 and 0.2-second, the rise in voltage is very rapid. As the time increases, the rise becomes less and less until between 1.1 and 1.2 seconds there is no further rise in voltage and the condenser is

(Continued on page 759)

Almost as quick as a lightning flash—the Supreme 502 Tube and Radio Tester, or any other Supreme instrument is yours on Supreme S.I.C. terms—the world's easiest installment terms! No long questionnaires! No red tape! Only a few dollars and then a little more than \$1 a week for ten months!

Think of it! The added business alone you will get will surely pay for it! And when you try the 502, you'll be amazed!

Wait until you test its razor-edge accuracy and all its other outstanding features! You'll agree it's the biggest value in the entire instruments industry! Go to your parts jobber—test it—and be your own judge. And when you buy Supreme instruments—not only will you be proud to own them—but you'll have the best equipped, most efficient shop in your community! Write for colorful new 1938 catalog!

### LOOK AT THESE AMAZING FEATURES!

MODEL 502 tube and radio tester is 7 instruments in one! It tests every tube made and electrolytic capacitors on "Good-Bad" scales. It tests electrostatic capacitors for leakage on neon lamp, plus a complete DC volt meter with ranges from 0.2 to 1400 volts in 4 ranges, plus a complete AC volt meter with ranges from 0.2 to 1400 volts in 4 ranges, plus a complete ohmmeter with ranges of 0.1 ohms to 20 megohms (self-contained power supply), plus a 4 range output meter with ranges from 0.2 to 1400 volts AC! Only \$49.95, Cash Price or \$5.50 down and 10 monthly payments of \$4.95.

# SUPREME INSTRUMENTS CORP.

GREENWOOD, MISSISSIPPI • U. S. A.

Export Dept.: Associated Exporters Co., 145 W. 45th St., New York City

Cable Address: LOPREN, New York

## NEW B9 CRYSTAL MICROPHONE



LIST PRICE  
\$ 22.50

A SMALL, lightweight, crystal microphone, with good response and high output. It is semi-directional and notably free from feedback. This unit has a wide range of applications, enhanced by the available accessories. The B9 is singular in that it is equipped with a plug at the microphone, thus making cable replacement a simple operation. Chrome finish. Complete with plug and 8' cable. Standard 5/8-27 fitting.

Request Catalog No. 27 for Complete Details

ALL CRYSTAL MICROPHONES LICENSED UNDER PATENTS OF THE BRUSH DEVELOPMENT CO.



AMERICAN MICROPHONE CO., INC.

Los Angeles, Calif.

Please Say That You Saw It in RADIO-CRAFT



# IT'S EASY TO BUILD THIS "BROWNING 83" 4-BAND SUPERHET.

(Continued from page 731)

lies in the fact that interference radiation is usually not transmitted through the air for more than 50 to 75 feet from the appliance which generates it. However, this radiation is transmitted readily along power lines, steel-framed buildings and other metallic structures. Thus, if an antenna is placed a considerable distance away from such structures, it will not pick up the interfering radiation. The radio signal can then be transmitted from the antenna to the receiver by means of a twisted-pair lead-in which will not in itself contribute to the signal or pick up the undesired noise.

The mechanical layout of the receiver itself has an appreciable effect on the signal-to-noise ratio obtained. Considerable care has been given to this item in the design of the Browning 83 and while the chassis layout is such as to afford ample space for the various components, the length of all important leads has been kept to a minimum.

## DESIGN DETAILS

The component parts used in the kit receiver have been carefully selected for quality. For example, the mica blocking condenser used to couple the oscillator circuit to the oscillator grid of the 6A5 is of the high Q stabilized low-loss type. This same type of condenser is used for the 2,000-mf. condenser which blocks the direct current from grid No. 2 of the 6A5, and for the radio frequency bypass condenser used across a 0.5-megohm resistor in the diode circuit of the 6H5.

The performance of various types of intermediate frequency transformers was thoroughly investigated before the I.F. transformers used in the kit set were finally chosen. Iron-core transformers with their associated high Q circuits were given special consideration and finally eliminated because of the fact that overall receiver fidelity was considerably impaired while little advantage, if any, was obtained from the

standpoint of adjacent-channel interference. Air-core transformers having an especially high Q were finally decided upon. These transformers are triple-tuned and of the band-pass type which provide good selectivity and, in addition, make possible satisfactory overall audio response characteristics.

A single I.F. stage is employed since sufficient gain can readily be obtained and internal set noise is materially lower than would be obtained with a 2-stage I.F. amplifier of equal gain characteristics. The chassis of the set is so laid out that any individual so desiring may experiment readily with various forms of I.F. amplifiers utilizing either 1 or 2 stages.

## SELECTIVITY CURVES

The selectivity of the single-stage, 456 kc. I.F. amplifier is given in Fig. 2, where *kilocycles off-resonance* figures are plotted against *relative response in decibels*. In obtaining the selectivity curve a constant input voltage was fed into the grid of the converter tube and the output voltage was determined in the diode detector circuit. As will be noted, the top of the curve is relatively flat and the sides are quite steep. In order to give a better idea of the performance, the scale used for kilocycles off-resonance is considerably spread out. The band-pass feature is evident in that the response of the I.F. amplifier to a signal 10 kc. off-resonance is "down" approximately 35 db, while the response to audio frequencies of 5 kc.'s is only down approximately 7.5 db.

Figure 3 shows the *overall selectivity* obtained with a constant voltage being fed into the antenna circuit at various frequencies away from that to which the set is tuned. The top of the resonance curve is considerably more pointed than that of Fig. 2, while the base of the curve is not a great deal narrower than that of the intermediate frequency amplifier itself. The difference between the curves shown in Figs. 2 and 3 indicate the selectivity characteristics of the

tuned antenna and R.F. amplifier systems. It will be noted that there is very little difference between the resonance curve obtained when the set is tuned to 665 kc. and to 1,000 kc., since a great deal of the selectivity at 10 kc. off-resonance resides in the intermediate frequency amplifier. Thus, the overall selectivity curve at higher frequencies differs but little from those shown.

## FREQUENCY RESPONSE CURVES

To satisfy the recent trend toward better quality reproduction, the audio response characteristics of the 83 have been given special consideration. Phase inversion has been incorporated, employing push-pull 6F6's, thus providing a high-quality audio system with power output more than ample for home reception.

So as to obtain an overall response characteristic that would meet the approval of the most critical, the audio system was given a rising characteristic with frequency. This is shown in Fig. 4 where *relative response in decibels* is plotted against *frequency in cycles per second*. Curve B shows the relative response in decibels of the audio system. In obtaining this curve a signal was fed into the grid circuit of the 6F5 and the output voltage was measured from plate to plate of the 6F6's. During these tests the speaker was connected in the circuit rather than using non-inductive plate loads on the 6F6's. It will be noted that curve B was obtained with no condensers from plate to ground on the power output tubes.

When 0.002-mf. condensers were used between the plate circuit and ground of the power tubes, curve A resulted, which shows the same general characteristics with the exception that the frequency response begins to drop off at about 5,000 cycles.

With the tone control turned to its maximum "on" position curve C was obtained. In this case, frequencies of 1,000 cycles can be attenuated.

(Continued on page 769)

# BEGINNERS!— BUILD THIS 1-TUBE LOOP RECEIVER

(Continued from page 744)

Now, by adding *regeneration* to the detector stage (we do it in the simplest manner imaginable), we can strengthen the signal sufficiently to operate a loud-speaker with fair volume! This speaker, a magnetic type, is connected in place of the earphones.

At the end of this article is appended a List of Parts. Collect all this material, lay out the components in the approximate positions which they will assume when mounted on the panel, and then decide upon the measurements of the aluminum box in which the receiver will be

housed. It is not necessary to adhere strictly to the author's measurements, merely choose a size which will permit both the receiver and the "A" and "B" batteries to be housed in the same metal container. See Fig. 1.

The loop is held in an upright position by means of a bracket. See Fig. 2.

## ANALYSIS OF CIRCUIT

The action of the circuit is as follows: That part of the loop, marked L1, in combina-

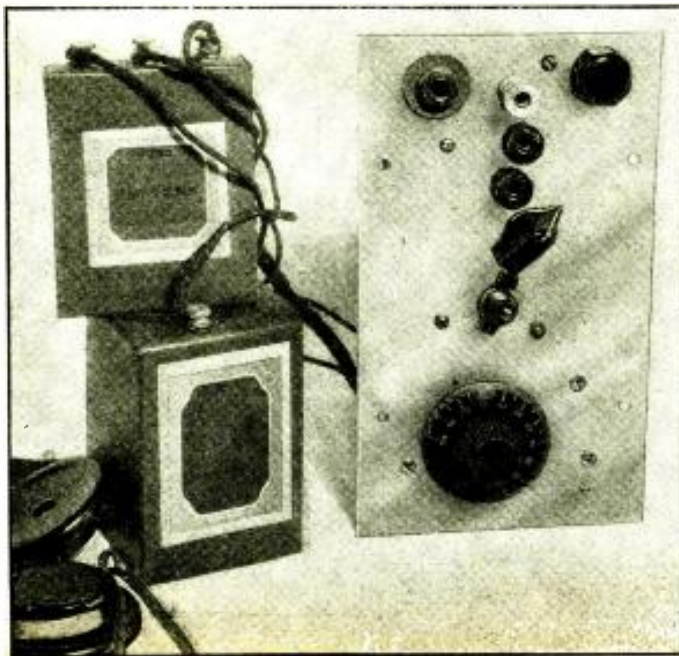

Front view of the Beginners' 1-Tube Loop Receiver. Notice that the panel was not laid out with an eye towards perfect harmony. The primary thought in the design of parts was that of shortest possible leads; which makes for circuit stability. The 2 batteries shown are new miniature type "A" and "B" units. When not used they are contained in the same box which houses the set. Upper-left on the panel is the headphone jack; upper-right, regeneration control. The tuning dial is at the bottom of the panel.

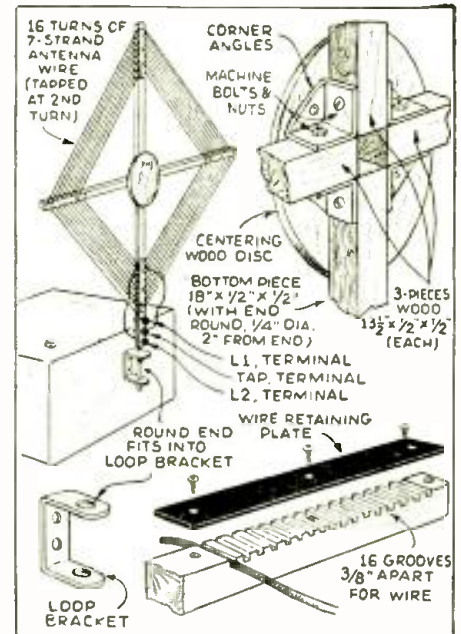

Fig. 2. Details of the collapsible loop.

tion with variable condenser C1 constitutes the tuned circuit which "pulls in" the signal. This signal is fed to the *detector section* of the tube which rectifies it, i.e., separates the "voice" part from the "carrier" part and amplifies it to a certain extent. Some of this signal is then "fed-back" through the medium of condenser C2, into that section of the loop called L2, thereby once more impressing it upon the detector section of the tube. This *regeneration* action increases

(Continued on page 781)



## TELEVISION STUDENTS LEARN BY MAKING CATHODE-RAY TUBES

(Continued from page 757)

charged to a value equal to that of the source. Due to the rapid rise in voltage during the first few instances, the beam would move rapidly from left to right across the first few divisions on the screen. As the rise in voltage becomes less, we find that the rate with which the beam is moving to the right is likewise becoming less, until between 1.0 and 1.1 seconds there is practically no movement of the beam to the right.

While this sweep variation is sufficient, to a certain degree, for wave analysis its non-linearity would make it completely useless for television. Hence, it was necessary to devise a circuit which would give a linear variation. The striking potential of the neon glow lamp being comparatively constant caused the deflection of the beam to traverse only a limited, definite distance across the tube. It was desirable, therefore, to have in addition to linear sweep a means for varying the deflection of the beam completely across the screen.

### THYRATRON OR "GRID GLOW" SWEEP

A thyratron or, as it is more popularly known, "grid glow," tube, was employed, at first without an amplifier, in an effort to accomplish linear and complete sweep. The thyratron is similar in operation to the above-mentioned neon tube, but in addition to the latter it has a grid. By changing the bias on the grid, the striking potential between the cathode and the plate is likewise changed. This made it possible to more closely approach linearity as we were then able to cause the thyratron to strike at a lower voltage on the curve in Fig. 7.

However, operating on this lower voltage reduced the total deflection of the beam considerably and it was necessary to amplify this signal with a stage of amplification. (True linearity cannot be attained unless the rate of the charging current remains constant.) We had achieved linearity but lacked sufficient width of sweep.

It was necessary, therefore, to develop a horizontal sweep circuit which would produce a constant current flowing into the condenser even though the voltage across the system was varying. See Fig. 8. A type 58 vacuum tube was used since it was capable of producing only little variation in plate current for wide voltage variations on the plate.

The rate with which the current flows into condenser C (Fig. 8) can be controlled by varying the grid bias on the 58 tube. The negative

(Continued on page 761)

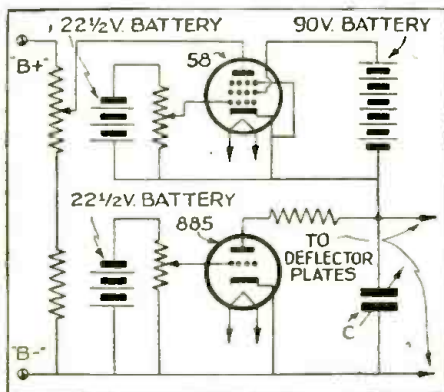

Fig. 8. The horizontal sweep circuit used.

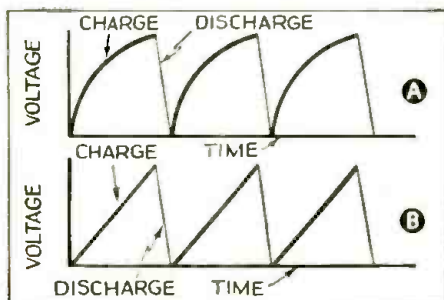

Fig. 9. In A, the waveform of a neon sweep circuit and in B, that of a constant-current sweep circuit.

# HIGH END AND LOW END



## WEBSTER-CHICAGO 30-WATT DE LUXE SYSTEM MODEL CPX-A-30

- Adjustable to Variable Auditorium Acoustic Conditions.
- 1 Stage Class A 30-Watt Amplifier Using 12 Tubes.
- Flexible Output for Multiple Speaker Arrangement.
- Twin Sound Cell Type Crystal Microphone.
- Improved High Efficiency Super Power P.M. Speakers.
- Dual Input Electronic Mixer for Microphone and Phonograph.

Although primarily designed for large installations for 5000 to 8000 people, the extremely low internal noise level of this system makes it adaptable to the smallest gatherings.

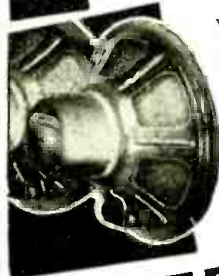

Webster-Chicago manufacture a complete line of public address systems, sound equipment and accessories. Line includes all variations of inter-office communications hook-up. Send for Free Catalogue.

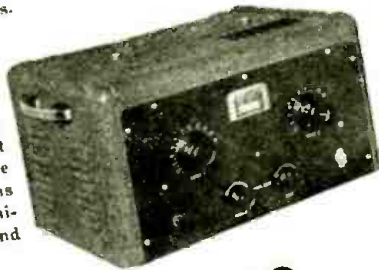

## WEBSTER-CHICAGO

WEBSTER-CHICAGO—Section MY-10  
5622 Bloomingdale Ave., Chicago, Ill.  
Please send me more information on  
System CPX-A-30  
Free Catalog.

STRICT DEALER POLICY

Fully Licensed Under All Important Patents

Name \_\_\_\_\_ State \_\_\_\_\_  
Address \_\_\_\_\_  
City \_\_\_\_\_

### Something New!



### They're Ultra Compact!

Cornell-Dubilier type BR dry electrolytics (illustrated here actual size) are the last word in efficient compact filter capacitors. Hermetically sealed aluminum case gives absolute protection against heat and humidity. Write for catalog flyer No. 154A. TODAY!

CORNELL-DUBILIER ELECTRIC CORP.  
1014 Hamilton Blvd., So. Plainfield, N. J.

### THE PHASMAJECTOR . . . .

Latest DU MONT Achievement featured editorially in April RADIO-CRAFT

The PHASMAJECTOR TYPE No. 1 provides a standard video signal source to promote Television developments.

The Du Mont Phasmajector Type No. 1 eliminates the dependence of the television experimenter on erratic and variable signals from the scattered television transmitters. This tube generates a video test signal with an output of 0.2 volt across a 10,000 ohm load. The signal is produced by varying secondary emission resulting from the scanning of a picture on a metal plate by the electron beam. In the Phasmajector Type No. 1 a fine cut of Abraham Lincoln is used.

The Phasmajector Type No. 1 may be used with two Du Mont types 164 or 168 oscillographs with minor circuit changes for a demonstration of the principles of television.

LIST PRICE \$40.00

ALLEN B. DU MONT LABORATORIES, INC.  
542 VALLEY ROAD UPPER MONTCLAIR, N. J.

Please Say That You Saw It in RADIO-CRAFT



# NEW Standardized Test Bench Panels

**Model 1404**  
(Complete as Shown  
Less Lamp)  
**\$95.50**



Standard Size Panels Accommodate Any Master or DeLuxe Models

Panel Cabinets Can Be Bolted Together if Desired

Handy Lamp Diffuses Light Over Complete Front Panel

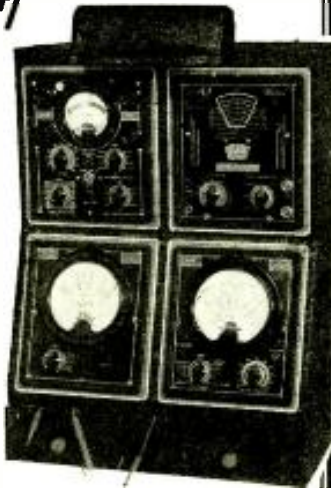

### MODEL 1404 AS SHOWN CONTAINS THE FOLLOWING MODELS

Model	Single Unit Price
1210-A Tube Tester	\$22.00
1209-D D.C. Volt-Ohm-Milliammeter	20.00
1209-A A.C. Voltmeter	16.00
1232 Signal Generator	27.50
Model 1404 Cabinet only \$10.00	

Triplet offers for the test bench the same kind of standardization that has made Triplet Master Models outstanding among portable testers. You can start with cabinet and one tester and build up as circumstances dictate.

Testers are held firmly in the panel compartments by flexible rubber grommets with compression fit. Testers are in regular metal cases and can be removed for portable use when necessary.



Model 1181-E Portable Laboratory combines: Models 1125-A Volt-Ohm-Milliammeter, 1151 All-Wave Oscillator, 1166-A Free Point Auxiliary Set Tester. Quartered oak case size 16 1/2" x 7 1/2" x 4 1/4" deep. Cover is removable. Complete with necessary batteries and accessories.

DEALER NET, \$41.83



THE TRIPLET ELECTRICAL INSTRUMENT CO.  
165 Harman Dr., Bluffton, Ohio

Please send me more information on  
 Model 1404     Model 1181-E  
 Send Catalog

Name .....  
 Address .....  
 City ..... State .....

## RADIO MONTH IN REVIEW

(Continued from page 727)

RCA-controlled N.B.C. is also using RCA television equipment.

The RCA-N.B.C. television transmitter atop the Empire State Building, has been shut down for conversion to D.C. operation; scheduled to resume operation some time in March.

In Britain, the B.B.C.'s Television Director gave radio listeners a pep talk, saying among other things that:— (a) you really shouldn't mind the smallness of the image; (b) financing the broadcasts is a problem; (c) the receiver is "quite easy to handle"; (d) "One should resist the temptation to compare television programs too closely with what you see on the stage or films." He expressed his faith in the future of television. He still has his job.

### LAST MONTH'S IMPROPA-GANDA

THE nations of the world continue to cram juicy gobs of propaganda into the ears of their neighbors, far and near.

Germany, according to N. Y. Times correspondent Turner Catledge, is the master of radio for this use, and is flooding South America with programs, many of which are definitely hostile to America. South American residents complain that German static generators are used to blot out American news broadcasts.

However, the U. S. station W1XAL, of Boston, has commenced transmission in English and



HIRAM PERCY MAXIM MEDALLION. The splendid watch-fob trophy here shown is the A.R.R.L.'s prize for which CW-DX and Phone-DX radio amateurs competed, last month, in the 10th International DX Competition.

Photo—QST Magazine

Spanish of goodwill messages, directed to South America on the 15.13 and 11.73 mc. channels. Secretary of State Hull and Director-General of the Pan-American Union Rowe inaugurated the service on the latter wave. Others of similar importance also spoke.

Britain's House of Commons voted unanimously to augment her propaganda machine in order to combat anti-British propaganda. But no propaganda "in the bad sense of the word" is to be used, according to the honest Britishers, who simply plan "widespread dissemination of straightforward information and news based on enlightened, honest public policy," as doubtless do all other great nations.

While the Commons stressed that there would be no "retaliatory" broadcasts, it is known that work is being speeded to cover South America in order to combat Italian and German propaganda there.



Photo—Wholesale Radio Service Co.

A NEW IDEA FOR THE SOUND SPECIALIST! The "smoke eaters" of the Poughkeepsie, N. Y., Fire Department have a new plaything that is practical, no end. The old bell-ringing wiring was commandeered for the services of an inter-stationhouse fire alarm system employing a Lafayette audio amplifier; an audio oscillator gives a stand-by signal when alarms are to be sent over the P.A. system. Police Headquarters, too, is tied in.

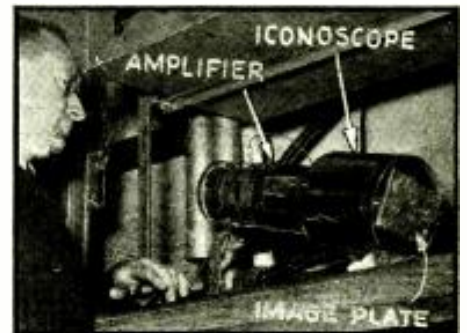

THE SUPER-ICONOSCOPE—TELEVISION'S NEWEST AID. The difference between this new RCA development and previous Iconoscopes lies in the use of a built-in single-stage secondary-emission amplifier, built-in image plate (carrying a permanent scene for repeated viewing, or scanning, under regulated conditions), and an Iconoscope (scanner system), all in one envelope.

### USEFUL CIRCUIT IDEAS

(Continued from page 756)

In a customer's set, connect your ohmmeter to one end of the volume control and to the arm. When the arm is slowly rotated, noisy spots will show up by a jumping one way or the other of the instrument needle, instead of a gradual swing. The psychology is the same as in using a "Good-Bad" scale on a tube-tester. When the customer can "see what is wrong" he is more impressed than when he is told merely that the unit is defective.

LOUIS A. BEER

### HONORABLE MENTION

OUTPUT JACKS FOR BROADCAST RECEIVER. Here is a truly versatile connection which is applicable to any radio receiver, old or new. This installation was conceived and developed in a hospital where no speakers were allowed on our receivers and the commercial types of phone connections failed to satisfy the demand for tone quality and safety. An ex-

amination of Fig. 5 (diagram) will reveal the following facts:

The connection is absolutely safe. There is no great amount of current flowing in the external circuit. This prevents shocks or burnouts which might otherwise be caused by wires being accidentally short-circuited.

Any number of pairs of earphones or an external speaker of the magnetic or permanent-magnet dynamic types can be connected with excellent results. Also the new "mystic ear" (semi-bone conductor) may be connected with as good results.

The tone quality is limited only by the receiver and/or the type of reproducer used. If the set already has a tone control, it will, of course, control the tone of the device which is connected to the tip-jacks and no circuit changes are necessary. If none is incorporated in the receiver, a 0.5-meg. potentiometer connected in series with a 0.1-mf. paper condenser and placed across the jacks will do the trick.

(Continued on page 775)

Please Say That You Saw It in RADIO-CRAFT



## A NEW REMOTE ROBOT-MONITORED PUBLIC ADDRESS AMPLIFIER

(Continued from page 733)

bias through the full-wave action of the coupling transformer (T7RT) which couples the output of the 6T7G triode back into its duplex diodes in a full-wave arrangement so as to generate bias across the 1/4-meg. load. This voltage is in turn fed through a time-delay resistor-condenser combination back into the control and suppressor-grids of both 6U7G preamplifier tubes.

**Inverse Feedback Circuit.** Inverse feedback is applied from the output of the transformer back to the 6C8G electronic mixer. This type of circuit minimizes hum and tube noises, and compensates for distortion in the electronic mixer, phase inverter, push-pull drive, driver transformer, output stage, and output transformer. It can be readily seen that the high-fidelity design of this unit provides for easy attainment of a flat frequency response within the entire audio range.

### CONCLUSION

This type of Remote Robot Monitoring may be applied to any conventional amplifier and will undoubtedly facilitate the attainment of ideal sound coverage, under the most adverse conditions, by comparatively inexperienced Public Address technicians. In fact, this application to monitoring problems normally encountered in everyday installations, will undoubtedly shortly lead to popular demand for this type of Robot Monitoring.

The author will be pleased to answer all questions relative to the design and application of this type of Remote Robot Monitored Amplifier. Address all communications in care of *Radio-Craft*.

## TELEVISION STUDENTS LEARN BY MAKING CATHODE-RAY TUBES

(Continued from page 759)

bias, however, must not be reduced too much or a constant flow of current will no longer exist.

The frequency of the sweep circuit is further dependent upon the grid bias of the 58, the output voltage of the power pack across the circuit, the grid bias of the thyratron, and the capacity of the charging condenser.

Figure 9A shows the waveform set up by a sweep circuit such as produced by the combination shown in Fig. 5. Figure 9B shows the waveform produced by a circuit using a constant-current device. Notice how the upper parts of the waveforms in Fig. 9A depart from true linearity and curve to the right. The waveforms of Fig. 9B show desired linear or sawtooth waveform.

The deflector plates charge up and deflect the electron beam with the rise in voltage developed by the sweep circuit. When the gas in the thyratron or glow discharge tube arcs, the output of the sweep circuit is discharged very rapidly which in turn produces a very rapid voltage decrease across the deflector plates and the beam is very rapidly returned to its starting point as shown by the steepness of the discharge part of the waveforms shown in Fig. 9. The speed with which this discharge takes place determines the rate at which the electron beam will snap back to the starting point, and hence, determines whether this return-trace is made with sufficient rapidity to prevent it registering on the screen sufficiently long to come within the observer's persistence-of-vision response.

This concludes our series of practical articles on how the television-type cathode-ray tube is made. Schools or individuals wishing to obtain back copies may secure them, for a limited time, at the regular price per issue. No radio man who has read this series of highly informative articles—believed to be the first in any popular radio magazine—need be stumped by any questions concerning the bases of cathode-ray tube design and construction as they apply to television.

This article has been prepared from data supplied by courtesy of American Television Institute.

# BUILD A QUALITY RECEIVER



## ASSEMBLE THIS SET!

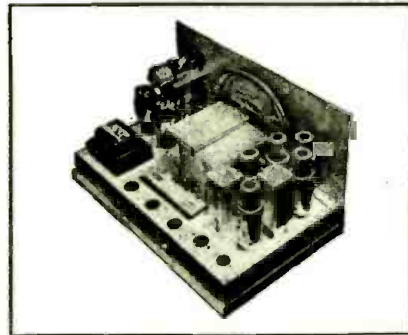

### Ideal for the Experimenter — For Home and Camp

Announced less than two months ago, the Browning 83 has already received nation-wide acclaim.

A reliable easy-to-build 10-tube all-wave kit for experimenters and short-wave fans. Covers a continuous frequency spectrum from .54 to 22 megacycles (13 to 550 meters) in 4 bands. No skips. Extremely high signal-to-noise ratio. Sensitivity less than 1 microvolt on all bands. Triple tuned band pass IF transformers. High fidelity. Phase inversion. Push-pull audio amplifier. 4-band Tuner used in the kit completed wired, aligned, and tracked at the Laboratory. Ample chassis space for individual experimentation.

BROWNING LABORATORIES, INC.  
Winchester, Mass.

Please send me, free of charge and without further obligation to me, circuit diagram of Browning 83 together with complete descriptive literature.

Name .....

Street and Number .....

City ..... State .....

RC

## BROWNING LABORATORIES, Inc., WINCHESTER, MASS.

### To Readers of RADIO-CRAFT

FREE POSTCARDS MAY BE HAD UPON WRITING TO THE PUBLISHERS

These post cards make it easy to answer advertisements which appear in RADIO-CRAFT, without cutting valuable data which you may wish to save.

Many times manufacturers request you to "clip the coupon" when answering their ads. Often this means destroying part of an article on the reverse page you may need later for reference. Save your RADIO-CRAFT issues complete. If you should ever want to sell bound volumes, or certain copies of RADIO-CRAFT, the resale value of uncut issues is very much higher than that of mutilated ones. So send for a supply of these free post cards and use them in answering all RADIO-CRAFT advertisers.

## Save 15% on AMPLIFIERS

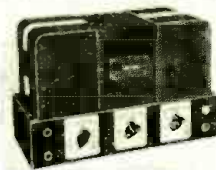

**New!**  
20 WATT BEAM  
POWER 6L6  
AMPLIFIER

Your Price \$19.50 Less Tubes speakers, Inverse feedback, Ultra-modern streamline chassis, ONE YEAR FULL GUARANTEE. Tubes used: 2-6F5, 1-6N7, 2-6L6, 1-83.  
**SPECIAL!** 32 Watt 6L6 Amplifier with 3 position electronic mixer and full range tone control... \$31.50 less tubes. Buy direct and save 15%. Write for Catalogue.

**AMPLITONE PRODUCTS CO.**  
135 Liberty St., N. Y. C.

Please Say That You Saw It in RADIO-CRAFT



**\$30<sup>00</sup> FOR YOUR OLD RADIO DURING THIS MIDWEST FACTORY-TO-YOU SALE!**

**FACTORY-TO-YOU PRICE \$69<sup>25</sup> LESS ALLOWANCE \$30<sup>00</sup>**

**You Pay Only \$39<sup>95</sup> ABSOLUTELY COMPLETE**

**16-TUBE TOUCH BUTTON MIDWEST TERMS AS LOW AS 50¢ A WEEK**



**TOUCH A BUTTON ... ZIP... AND YOUR STATION FLASHES IN!**

LET us send this marvelous new 1938 Midwest 16-tube radio to your home on 30 days FREE trial. Use it for four weeks before you make up your mind! If you decide to keep it, you secure \$30.00 credit on your old radio, and Midwest will call for it at your home!

Just imagine a radio so fine, so powerful, so luxurious—in a big, beautiful, richly-finished walnut console—selling at such an amazingly low factory-to-you price. You'll be delighted with its glorious new tune, 10,000-mile tuning range, and brilliant world-wide reception.

Take advantage of Midwest's successful factory-to-you plan—save 60¢ of every \$1.00—by buying at wholesale prices!

**Send for FREE 1938 Catalog MIDWEST RADIO CORPORATION Dept. MM-12 Cincinnati, Ohio**

**30 DAYS FREE HOME TRIAL**

POSTAL COUPON ON 1¢ POSTCARD... OR WRITE TODAY!

**MIDWEST RADIO CORPORATION**  
Dept. MM-12 Cincinnati, Ohio

Name

Address

City  State

Town

Special offer and prices prevail only when dealing direct with factory by mail.  Check Here for 1938 BATTERY catalog



**★ ★ ★ ★**

**ATLAS MARINE "STORM PROOF" BAFFLE \$10.29**

(Dealer's Net)

Outdoor weather conditions are no longer a problem in P. A. work. This horn will resist the force of a driving rain while in operation. The cone speaker is mounted in a novel inverted reflex position, which is a revolutionary step in exponential baffle design, and which also provides absolute protection against mechanical damage to the cone. Two sizes are available for 8" and 12" cone speakers. A sturdy cast mounting bracket is available for sound truck or any type mounting.

Model WX-8 for 8" speakers. List \$17.50  
Model WX-12 for 12" speakers. List \$30.00

New Spring and Summer Catalog brings you the latest P. A. developments: Baffles, Enclosures, Mike Stands, P. A. Units, and other accessories. Send for this helpful catalog now.

**ATLAS SOUND CORPORATION**  
1447 39th Street Brooklyn, New York

**"LEARN-BY-EXPERIMENTING" BEGINNERS' PRACTICAL RADIO COURSE**

(Continued from page 745)

"All-wave" operation, that is, reception of broadcast and short waves, is provided for by the plug-in arrangement of the coils. In addition to the regular coil used for the broadcast band, a set of 4 short-wave coils allows reception on the various short-wave bands.

**(2) Principle of Detection**

The function of the tube acting as a detector is to rectify the high-frequency wave into "pulsating direct current," which still retains the audible frequency variations. This process goes farther than the method of rectification explained in the Experiment on the power-supply (Exp. 3—Dec. 1937 issue), in that, in addition to changing the alternating type of current to direct current, there is also a separation of the radio-frequency (R.F.) from the audio-frequency (A.F.) variations.

This complete process is also called demodulation. It is accomplished efficiently for weak signals by the grid leak and condenser action (R1 and C3) in the grid circuit of the tube. The resulting R.F. variations are filtered and bypassed by the action of the condenser (C4) in the plate circuit, in conjunction with the radio-frequency choke (R.F.C.). Thus the remaining audible variations are made to appear separately in the plate circuit, after detection, in a form that is able to actuate the phones, according to the music or speech that was originally impressed on the radio wave.

The power supply for the type 76 detector tube must supply 6.3 volts A.C. for the "A" or heater circuit, and about 90 volts D.C. for the "B" or plate circuit. (For this, any voltage between 45 and 180 volts D.C. may also be used.)

**(3) Principle of Regeneration**

To make the receiver more sensitive to the radio signals, the method of regeneration is employed in Part B of this Experiment. This method feeds back part of the plate circuit signal to the grid circuit, giving the apparent effect of a much stronger signal. When the amount of this feed-back is increased, sustained oscillations take place, in a manner similar to that explained in the Experiment on an audible note generator (Exp. 1—Oct. 1937 issue). In using regeneration in a receiver it is therefore necessary that the amount of feed-back be controlled so that it is kept large, but is not great enough to cause oscillation, which results in squeals. This regeneration control is the potentiometer (P1), which governs the amount of feed-back impressed on the so-called "tickler coil" (L2).

**(4) Principle of Amplification**

To make the received signal much louder in volume, another tube may be added to serve as an amplifier of the audible signals, that is, an audio-frequency amplifier. (This use was provided for in the previous Experiment on the microphone amplifier (Exp. 2—Nov. 1937 issue), where a combination microphone and audio transformer was used.) When used as a 2-tube set in this way, the volume will be found sufficient to use a loudspeaker instead of the phones.

The filament of the type 76 amplifier tube is supplied with the same 6.3 volts A.C., as was used on the detector tube heater, and if available from the same power supply, a plate voltage of about 180 volts D.C. (This plate voltage may be as high as 250 volts if desired, or the same value as that applied to the detector may also be used. The Power Supply discussed in Exp. 3—Dec. 1937 issue—furnishes all these voltages.)

Connections are made as shown schematically in Fig. 1A and pictorially in Fig. 2. The filament circuit is wired first to the binding post strip.

Next the cathode (k) is connected to the ("B-") post, which is also common to the chassis. All chassis connections are to be bonded together by a wire connection.

The grid circuit follows. Here, care must be taken to keep a short lead between (g) of the tube socket (S1) and the joint connection to (R1) and (C3). Also note that the terminal for the movable plates (C1) is connected to the chassis.

The plate circuit follows last, completing the wiring. Condenser C4 is adjusted for full capacity. Note that L2 and its associated P1 are not connected in the circuit in this part of the Experiment.

**(2) Operation**

Plug in the broadcast coil and connect the antenna and ground to the binding posts. Turn the adjustment for (C2) all the way in (full capacity). Connect the phones and then the power supply. Turn the power supply on. (Caution—if it is necessary to handle the phone connections, be sure to turn off the power supply first.)

Tune for broadcast stations and RECORD the dial settings and approximate loudness. (Try for 3 stations.)

**Part: (B) Operation of tube as regenerative detector**

**(1) Reception of broadcast waves**

With the power off, break the connection from the P terminal of the tube socket S1 and connect it to middle arm of P1. Complete the wiring from terminal 1 of the tickler coil (L2) to R.F.C. The final wiring will be that shown in Fig. B.

Put the set into operation again. Advance the regeneration control, P1 (to the right), with one hand while tuning with the other until a squeal is heard. At this point the tube circuit is oscillating. Back down on the P1 knob until the squeal just disappears, and readjust the tuning dial for the best reception. The P1 dial must be moved very carefully with one hand, while the tuning dial is slowly moved back and forth with the other, to find the point of best volume without poor quality.

**NOTE**—The squeal, which is first obtained, denotes that the tube circuit is in an oscillating, and not in a proper detecting, condition. This oscillation of the tube circuit interacts with the incoming wave to produce the audible squeal, which is also sent out on the air and which may cause interference with other sets in the vicinity. Therefore avoid any excessive squealing while trying to get the proper tuning.

Compare the results obtained with regeneration with those obtained on the same stations as found in PART A, and RECORD the loudness and the dial setting for each.

**Optional Tests**

Try the effect on selectivity (ability to separate stations) of switching the antenna connection from terminal 3 of the coil socket to terminal 2 of that socket.

**(2) Reception of short waves** (Stations below 200 meters or 1,500 kilocycles.)

Plug in one of the short-wave (S.-W.) coils and loosen the adjusting screw of C2 by 1 or 2 turns. After a station has been received, re-

**EXPERIMENT NO. 6—VACUUM-TUBE RECEIVER**

**OBJECTS**—To Construct a Vacuum-Tube Receiver.

- PART:** (A) Operation of tube as a simple detector.  
(B) Operation of tube as a regenerative receiver on broadcast and short waves.  
(C) Addition of second tube to provide one stage of audio-frequency amplification

**PROCEDURE AND RESULTS**

**Part: (A) Operation of tube as a simple detector**

- (1) Connections**  
The parts are mounted as shown in photos Fig. A and B.

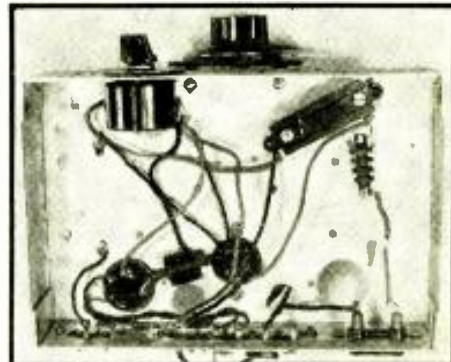

Under-chassis view of the simple vacuum-tube receiver showing placement of parts.

Please Say That You Saw It in RADIO-CRAFT



adjust C2 for the best reception. With a set of short-wave coils, the range of the receiver may be extended from 250 meters (1,200 kc.) down to 17 meters (17,600 kc. or about 18 mc.).

Tune for a station in one of the following bands: Police Band, about 120 meters (2,500 kc.)  
Amateur bands, about 160 meters (1,475 kc.)  
80 meters (3,750 kc.)

Foreign or American Short-Wave  
Broadcasting Stations, about  
50 meters (6,000 kc.)  
31 meters (9,700 kc.)  
25 meters (12,000 kc.)

Try to identify the station and RECORD dial setting and identification.

**Part: (C)—Adding audio amplification**

The connections for adding another tube for one stage of audio-frequency amplification are shown in Fig. 1C. After the connections to the phone terminal strip are removed, the output connections are wired to this position. The "B+ amplifier" ("B+ amp.") connection may be made common with the "B+ detector" ("B+ det.") if desired. When all connections, including phones, have been made, turn power on.

**CONCLUSION**

The vacuum tube may be used as an efficient detector of radio waves, which consist of the carrier wave (R.F.) and the audible part (A.F.) impressed on it. The tube operates by rectifying and passing on the A.F. part of the R.F. wave.

**QUESTIONS**

1. Another name for detection is (modulation; amplification; or demodulation).
2. The phones (or loudspeaker) of a radio set respond to (radio-frequency variations; audio-frequency variations; or steady current).
3. The principle of detection is also illustrated by (a crystal; a radio-frequency amplifier; or an audio-frequency amplifier).
4. Regeneration increases the sensitivity of a receiver by feeding back energy to the tickler coil from (the filament circuit; the grid circuit; or the plate circuit).
5. Best reception is obtained when the set (squeals as the dial passes the station; squeals continuously; or does not squeal after the station has been located).

Answers to Questions will be found on page 772.

**LIST OF PARTS**

- One Hammarlund 4-prong broadcast plug-in coil, type BCC-4, L1, L2;
  - One Hammarlund 4-prong set of 4 short-wave plug-in coils, type SWK-4 (optional);
  - One Hammarlund variable condenser, type SM-140, 140 mmf. (or 0.00014-mf.), C1;
  - One adjustable condenser, 20 to 100 mmf., type G1, G2;
  - One Solar mica condenser, 100 mmf. (or 0.0001-mf.), C3;
  - One adjustable condenser, 300-1,000 mmf., C4;
  - One grid leak resistor, 2 megs., 1/2-W., R1;
  - One Centralab potentiometer, midget volume control type, 20,000 ohms, P1;
  - One Hammarlund R.F. choke, type CH-X, 2.1 mhy., R.F.C.;
  - One 5-prong subpanel wafer socket (for tube), S1;
  - One 4-prong subpanel wafer socket (for coil), S2;
  - One dial, 2 3/4 ins.;
  - One pointer knob, numbered 1-10, 1 1/4 ins., and dial plate;
  - One panel bakelite, 3 x 3 1/4 x 1/4 ins.;
  - One metal chassis, universal punched, 6 x 9 x 2 ins. (see Exp. No. 2, Nov. 1937 issue);
  - Hardware-bakelite strip with 2 binding posts; bakelite strip with 5 binding posts; double tip-jack strip; and 2 angle brackets, 1/2-in.;
  - One Raytheon, type 76 tube;
  - One power supply, furnishing 6.3 V. A.C. and 90 or 180 V. D.C. (see text);
  - One pair headphones, 2,000 ohms.
- Additional Parts for Audio Amplifier**
- One transformer, general purpose, microphone and audio, T;
  - One Centralab potentiometer, 500,000 ohms (0.5-meg.) volume control, Rp;
  - One resistor, 2,500 ohms, 1 W., R2;
  - One Solar electrolytic condenser, type DT379, 10 mf., 25 V., C5;
  - One 5-prong subpanel socket, S3;
  - One Raytheon type 76 tube;
  - One Wright-DeCoster permanent-magnet dynamic loudspeaker, 5 ins. Permag.
- Parts so marked were used in preceding Experiments.

\*Most Radio mail order houses can supply this item if properly identified as to title of article, issue (month) of Radio-Craft and year.



**GET THIS EQUIPMENT ALMOST FREE!**



**ARCTURUS HELPS YOU SELL!**

One of the most complete lines of Sales Helps in the tube industry is available to Arcturus Dealers. Every one designed to help you increase tube and service profits. Get the details!

**EXTRA PROFITS FOR YOU!**

The record over a period of many years proves that no tubes offer you as much as Arcturus in the way of true quality. You owe it to your business to feature Arcturus Tubes. NOW, with the ARCTURUS EQUIPMENT DEAL, you have the opportunity of a lifetime to modernize your shop with the latest standard equipment—at almost no cost. You obtain possession of the equipment AT ONE!—and finance it by your purchases of Radio's finest, best engineered tubes. Thus you profit twice from every tube you sell. You can't lose!

**MAIL THE COUPON!**

**ARCTURUS**

INDEPENDENT TUBES FOR DEALERS WHO DO THEIR OWN INDEPENDENT THINKING

**... with Purchases of ARCTURUS TUBES!**

**DOWN PAYMENTS as Low as \$3.00**

A bargain if there ever was one!... that's the ARCTURUS EQUIPMENT DEAL! It gives you the finest, fairest and easiest way ever devised to make your shop a model of efficiency—IMMEDIATELY—at almost NO COST!

**DOWN PAYMENTS ARE LOWER!**... as little as \$3.00 in some cases! On an average, you pay only ONE-SIXTH the amounts required by other deals!

**TUBES AT STANDARD PRICES!**... less standard discounts. Not one cent has been added. To pay more than these standard prices on a deal probably means you are actually paying cash for your equipment. Think it over!

**LOW TUBE REQUIREMENTS!** Almost half the units included in the ARCTURUS DEAL, require the purchase of less than one tube per day!

**HIGH QUALITY EQUIPMENT** offered in the Arcturus Plan includes: Tube Testers, Oscilloscopes, Analyzers, Signal Generators, Combination Units, Portable Typewriters, a genuine Neon Sign... In short, everything you need to make yours the "best equipped shop in town"!

ARCTURUS RADIO TUBE CO. C-5  
Newark, N. J.  
Without cost or obligation on my part, send details of your new equipment deal.  
Name \_\_\_\_\_  
Street \_\_\_\_\_  
City \_\_\_\_\_ State \_\_\_\_\_  
 I am a dealer  I am a serviceman  
My holder is \_\_\_\_\_  
For convenience, paste coupon on penny postcard.

**LEADING SERVICING ORGANIZATIONS**

**Use this combination VOLT-OHM-MILLIAMMETER AND FREE POINT TESTER**



Precision built throughout, yet designed to withstand rough field work. That's why you find Readrite-Ranger testers used by so many leading service organizations. Volt-Ohm-Milliammeters, Tube Testers, Free Point Testers, Oscillators, available in combinations or in single units. No extra cases to buy. Today's biggest values in Precision Testers. The Readrite-Ranger Model 640 Free Point Tester has eight automatic switch type and ten single action jacks. Five sockets will handle any type radio receiving tube. Model 710 Volt-Ohm-Milliammeter has 3" Square Triple Precision Instrument. Scale readings: 10-50-250-500-1000 At and Dt Volts at 1000 Ohms per Volt (D.C. Accuracy 2%; A.C. 5%); 1-10-50-250 D.C. M.A.; 0-300 Low Ohms; High Ohms to 250,000 at 1 1/2 Volts. (Rheostat adjustment for 13 1/2 Volts for Ohms readings to 2 1/2 Megohms. Batteries may be added permitting such readings in 250,000 Ohms steps.) Low Ohms to 1/2 Ohm with 25 Ohms in center of scale. Backup circuit used. Current draw is only 1 M.A. Batteries, accessories and instructions included.

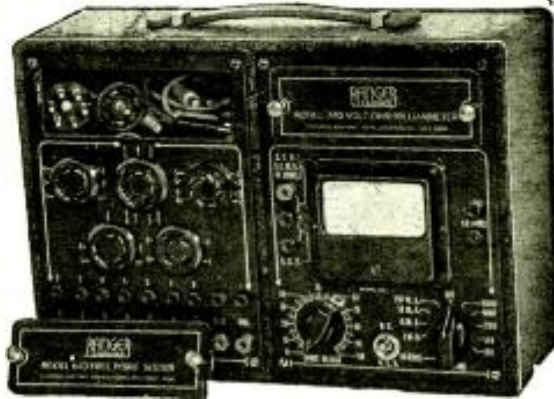

Model 640-740

Also Available in Single Units... No Extra Cases to Buy



**READRITE METER WORKS**  
516 College Ave., Bluffton, Ohio  
Please send me more information on Model 640-710: I am also interested in \_\_\_\_\_  
Name \_\_\_\_\_  
Address \_\_\_\_\_  
City \_\_\_\_\_ State \_\_\_\_\_

Please Say That You Saw It in RADIO-CRAFT



## AS PREDICTED!—DAILY NEWSPAPER NOW PRINTED IN YOUR HOME—BY RADIO!

(Continued from page 735)

John V. L. Hogan, famed inventor, has a home facsimile system upon which he has been working for some years. Likewise has Capt. Otho Fulton, whose methods were given field tests by the British Broadcasting Company some 10 years ago. The Fulton system then made use of an electro-chemical method of re-producing, much like that now employed by Finch, save that the paper used was moist. At that time, too, the Fulton system printed a single sheet of paper, about 5 by 7 inches. It came off the roller in approximately 5 minutes and, being in brown and white, looked much like rotogravure. The system Fulton now offers to lease to stations at \$4 per day transmits an 8 1/2 x 11 inch sheet in 3 minutes. His receivers will sell at about \$150 each.

Newspapers are frankly alarmed at this new competitor, which will be able to print advertisements as well as news, thus cutting into the papers' revenue. Whether their fears are justified, it remains for time to tell. The apparatus doubtless has considerable novelty value, and certainly affords its users a means of getting "flash" news. However, figured at Finch's estimated 30c per week operating cost per home, it costs more than having a morning and Sunday paper delivered to the door daily, yet provides less reading matter. If it can be made to provide more attractive reading matter than the news-

papers, and is not overcrowded with advertising, it will doubtless win a merited share of the public's attention.

The Finch laboratories state that subsequent models will be able to print pages of tabloid newspaper size. These should be even more interesting than the present model, meritorious as it is.

### DETAILS OF RCA SYSTEM

RCA, after 10 years of laboratory work, offers 2 models to broadcasters. One, rather elaborate, cuts the reproduced material to page size; the other, less expensive, delivers it in a continuous strip.

The first demonstration of the newly-developed facsimile apparatus was made last month for the benefit of the radio broadcasting executives and engineers attending the annual convention of the National Association of Broadcasters, at the Willard Hotel, in Washington, D. C.

The F.C.C. requires each station to install a minimum of 50 receiver-printers for each facsimile scanner-transmitter. The experimental programs will determine, among other things, public reaction to facsimile broadcasting as a radio service, the best type of program material, and the technical requirements for both scanner and receiver.

Radio facsimile service, as it is being con-

# Centralab conquers 8 months of Rain!



... "climatic conditions here are severe... Since changing to Centralab we have replaced only three controls... and we recommend Centralabs 100%"

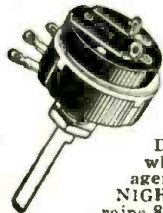

H. H. Wright  
Gen. Mgr.  
DAY & NIGHT  
GARAGE CORP.  
Panama City,  
Rep. of Panama

Down in Panama City where Mr. Wright is manager of the DAY AND NIGHT GARAGE CORP. it rains 8 months in the year... and the humidity plays havoc with radios. That's why Old Man Centralab is happy to quote from Mr. Wright's letter.

# Centralab

MILWAUKEE WISCONSIN  
BRITISH CENTRALAB, LTD.  
Canterbury Rd., Kilburn  
London N.W. 6, England  
FRENCH CENTRALAB CO.  
118 Avenue Ledru-Rollin Paris XI, France

## SIMPLE as A.B.C.

RADIO  
PHYSICS  
COURSE

A. A. Ghirardi  
972 PAGES  
508 ILLUS.

only \$4

THIS 1 BOOK  
TEACHES YOU EVERYTHING

Ghirardi's book makes learning radio EASIER than it has ever been before. Its many exclusive features and plain, understandable language will make everything about RADIO, ELECTRICITY, SOUND and TELEVISION perfectly clear to you at once. That's why students and radio schools all over the world use it more than any other radio book.

HERE'S WHAT YOU GET:

Sound—Electrical Theory and Principles—Electric Currents—Electromagnetism—Transformers—Inductance—Condensers—Measuring Instruments—Radioactivity—Broadcasting—Receiving—Vacuum Tubes—Amplification—Supernets—Coils—Speakers—Receivers of all types—Short-Wave—Auto-Radio—Aircraft Radio—Public Address—Photoelectric Cells—Cathode-Ray Tubes—Television—Testing and Servicing—Sound Motion Pictures—Reference Tables—856 Review Questions for Self-Study—and DOZENS of other subjects!

TRY IT!

It's the equal of 36 ordinary radio books rolled up into one—and you get it all for only \$4. Grab this bargain—get started right now. Write your name and address on this ad, and send it in with \$4 today (\$4.50 foreign) for your copy. Your money back if not satisfied! Free Circular—no obligation. Write at once!

RADIO & TECHNICAL PUBLISHING CO.  
45 Astor Place, New York, Dept. RC-58

### LEARN RADIO the "Easy" way!



... as a facsimile and, moreover, an economical art, soon it will become a household word. Facsimile receivers already are within the reach of any average family's pocketbook, and the cost will continue to dwindle. The latest in world events, pictures, sports, drawings.

... routine operation upon a daily basis. The Finch System WOR engineers have selected several of the most advanced methods of facsimile transmission yet devised for this new experimental service.

BENAY VENUTA  
WOR Alumna Singing Star

education, literature brought directly to your living room—this is facsimile's contribution to the life of the nation. The first to be employed will be the system designed by W. G. H. Finch, following years of painstaking re-

Fig. H. Nearly full-size reproduction of a Finch transmission. Background is red, printing is black.

Please Say That You Saw It in RADIO-CRAFT



# EXPERIMENTAL FACSIMILE

NEW YORK, N. Y.      FRIDAY      SEPT. 10, 1937



MAJOR GENERAL FRANK R. MCCOY



Lee's Army  
Burnside's Army

count in plants in the opinion to existing lines. Although minimum cost, yet the be fully discharged as cost about the power. It is not infrequently and in every other way assembly the is uneconomic by reason of excessive trans- spects to lead centers, whereas of existing high voltage stations in respect to city distribution systems. may become a credit rather than a charge. If, for example, a large power station be served eco- nomy in transmission cost compared with a more distant source, or if nearby railroad lines are electrified, there may be a distinct saving in the expense of energy because of the decrease of the electric load. It also because where the railway operators employ single-phase system. Lower spe- ed converting equipment of transmission or large rail- way

TRANSMITTED BY R C A CARBON FACSIMILE PROCESS

Fig. G. Photographs, half-tones, line drawings, and type, as reproduced by RCA's process.



Fig. 1. Reproduction of the *Radio-Craft* cover of April, 1934, on which Hugo Gernsbach predicted and illustrated a newspaper-printing radio set! Today it is an accomplished fact.

sidered by broadcasters, will probably supplement existing sound broadcast programs. It is planned to broadcast pictures and text, on standard broadcast wavelengths during the early morning hours, between midnight and dawn, so that a complete bulletin will be ready for the user when he arises in the morning. The F.C.C. has also set aside a number of ultra-short wavelengths for day and night facsimile service.

The RCA facsimile system, which was developed by Charles J. Young, RCA-Victor research engineer, and his associates, utilizes ordinary white paper, or newsprint paper, and ordinary carbon paper, at the receiving end. The width of the paper roll on which the facsimile material is printed is 8 1/4 inches. The proposed length of each page is 12 inches on a continuous roll. Printing speed is at the rate of 3 feet of record per hour. A time clock arrangement at the printer-receiver automatically turns the apparatus on and off in accordance with a pre-determined transmission schedule.

The facsimile receiver-printer is encased in a simple wood cabinet measuring only 18 by 18 by 12 ins. All the mechanism and controls are inside so that they may not be tampered with once they have been properly adjusted. The paper rolls out through a slit in the front of the cabinet. Two designs of facsimile receiver-printers have been developed by RCA-Victor. One is fairly elaborate and automatically cuts the paper into 12 inch pages and deposits them

(Continued on page 772)

Please Say That You Saw It in RADIO-CRAFT

**CHUCK FULL OF VALUABLE INFORMATION YOU'VE NEVER HAD BEFORE!**

- Imagine! An amazing new book with receiver tube data previously obtainable only by a limited number of receiver design engineers!
- A wealth of information on tube applications and uses—maximum ratings, values of essential characteristics and the more important characteristics in operating curves for each active tube—from the oldest to the newest!
- In a compact 200-page pocket size book with definitions, terms, and explanations; simple circuit diagrams even of the most modern receivers; convenient charts for determining circuit constants and operating voltages. You'll wonder how you ever got along without it! Get one at your Raytheon jobber now! Enclose the coupon to Raytheon—today!

RAYTHEON

Chicago   New York   Newton, Mass.   Atlanta   San Francisco  
"WORLD'S LARGEST EXCLUSIVE RADIO TUBE MANUFACTURERS"

DATABOOK

Price 25 cents

Announcing

A NEW 200-PAGE

RAYTHEON  
DATABOOK

MAIL THIS COUPON

RAYTHEON PRODUCTION CORP.  
420 Lexington Ave., New York, N. Y.  
Please send me a copy of your new "DATABOOK." I enclose 25c.

Name \_\_\_\_\_  
Address \_\_\_\_\_  
City \_\_\_\_\_ State \_\_\_\_\_  
 Serviceman       Amateur  
 Experimenter       Dealer





Have all the radio equipment you want when you want it! A few dollars down will bring you the latest and finest equipment. Everything for the "Ham", Service Man and Experimenter. All at rock-bottom prices—All sold on convenient Time Payments. Send for your FREE copy of Wards 1938 Radio Catalog NOW and see for yourself.

**MONTGOMERY WARD**



Sound Systems, Inter-Office Communication Systems, Radio-Phonographs, Auto Radios, Etc.

Testing Instruments, "Ham" Transmitters and Receivers, Kits, Parts, Accessories, Tools, Etc.

**MONTGOMERY WARD**  
Dept. RZ-9, CHICAGO  
Please send me my FREE copy of Wards 1938 Radio Catalog. I have checked items above in which I am especially interested.

NAME \_\_\_\_\_

ADDRESS \_\_\_\_\_

CITY \_\_\_\_\_ STATE \_\_\_\_\_



● If you want that velvety, easy, silent twist of the V.C. knob, then it's CLAROSTAT for you. ● The latest development in carbon elements, a newly designed contact shoe, and an alloy based on years of research, provide an entirely new conception of how good a volume control can really be.

**Let's Prove It!**

Don't waste time on loose claims. Just try a CLAROSTAT for yourself. Meanwhile, ask your jobber or us for that new CLAROSTAT (208 page) pocket-sized Service Manual.

**CLAROSTAT**  
MANUFACTURING CO.  
Incorporated  
285 North Sixth St.  
Brooklyn, N. Y.

**CANADA'S "INTERFERENCE DETECTIVES"**

(Continued from page 749)

R.F. voltage surges may occur on the power line which will prevent the sense finder giving a clue as to the absolute direction of the source. Where interference surges on a high-tension line are distributed more or less uniformly along the line, as in the case of normal "high-tension fry," or, where similar surges originate on the line at both sides of the point under investigation, the direction finder will not indicate absolute direction or "sense."

**Limitations of Use of "Sense" Finder**

In a network of wires it frequently happens that false indications are given by the "sense" finding equipment. The interfering surge divides between the conductors of a network inversely according to the impedance of each circuit. The "sense" finding receiver may be located near a conductor which is carrying the surge in a different direction to the most direct air line from the source, as illustrated by the following example:—

**Sense Finding from Passing Street Car.**—The interference car was parked under a feeder at the side of the road while the trolley line in the centre of the road about 30 feet from the feeder was tied into the feeder at a point 50 yards in front of the interference car and, also, 500 yards behind the interference car. The "sense" finding equipment indicated a forward "sense" from a passing street car until it reached a point about 200 yards in the rear. The radio "sense" finder then showed a reversal of "sense." This would indicate that the surge from the street car, when opposite the radio car, reached the radio receiver by way of the tie-in from trolley to feeder 50 yards in front of the interference car and then via the feeder, thus, indicating a forward "sense." The reversal of "sense" did not occur until the surge reached the interference car along the feeder from behind.

**EARN MORE \$\$\$**  
Read the special June issue of Radio-Craft and see how! Reserve your copy now! They'll be sold out fast!

Reverse "sense" indication is sometimes caused by the surge traveling along a power line with comparatively low radiation until it reaches a network of wiring or dead end favorable to greater radiation. If the interference car is near this network of wiring a stronger signal will be picked up from this radiating network than from the power line carrying the surge.

**Magnetic Field of the Power Line**

The "sense" finding equipment will not operate satisfactorily if the loop is so close to the power wire that it will be greatly influenced by the magnetic field of the surge. Under this condition the strength of the loop reception will be excessive, preventing the necessary balance and correct phase relation between loop and aerial reception required to give "sense."

The next item for discussion is the use of the neutralized probe, which was outlined in the preceding installment.

This information should enable the operator to locate any common cause of man-made interference.

Once located, however, it must be stopped or, if that is impossible, prevented from getting onto the power lines, whence it might be carried and radiated through an entire district.

Combinations of chokes and condensers, known as "surge traps" are recommended in the Department's *Bulletin 2*, extracts from which follow. A number of ways in which such traps may be used are shown in Fig. 4.

**DISTRIBUTED CAPACITY OF CHOKE COILS**

Choke coils for the suppression of inductive interference should be designed to have very

low distributed capacity. This capacity is equivalent to a condenser connected in parallel, with an ideal choke coil having no distributed capacity. Distributed capacity forms a bypass circuit which will conduct the interfering surge to the line. For interference suppression, it is, therefore, necessary to keep the distributed capacity as low as possible and in no case should it exceed 75 micro-microfarads (0.000075-mf.).

The ideal choke coil is made by winding insulated wire in a single layer on a cylinder of insulating material. As this type of construction, however, takes up considerable space, the coils may be wound according to the method known as *bank winding*. Ordinary *multiple-layer winding* is practically useless for construction of surge traps, as the distributed capacity between adjacent layers is excessive. Another type of choke coil may be described as the *pancake type*, in which there are a few turns per layer and many layers.

Choke coils should not be impregnated with wax or other dielectric, as the dielectric constant of these substances is greater than air, and, thus, increases the distributed capacity. As a general rule, no iron core is required for choke coils since the inductance does not require to be great. In exceptional cases, however, iron is used in the construction of absorption-type choke coils, to absorb the energy of the interfering surge. The iron core in such choke coils must be made in sections so that the total distributed capacity of the coil will not be increased by the presence of the iron.

The effect of different designs on the distributed capacity of choke coils is illustrated in Fig. 5 in which

Ca represents the capacity between Turns, Cb represents the capacity between Layers, Cc represents the capacity from the Winding to the Core, Ct represents the Total Distributed Capacity.

When condensers are connected in parallel, the total capacity of the bank of condensers is equal to the sum of the capacities of the individual condensers, as expressed by the formula  $C_t = C_1 + C_2 + C_3$ , etc. When condensers are connected in series, the total capacity is less than the capacity of any individual condenser and may be calculated by the formula—

$$C_t = \frac{1}{\frac{1}{C_1} + \frac{1}{C_2} + \frac{1}{C_3}} \text{, etc.}$$

Where  $C_t$  equals total capacity of the bank of condensers.  $C_1$ ,  $C_2$ ,  $C_3$ , etc., equals capacity of individual condensers.

In Fig. 5.

- A—represents the single-layer choke coil, which has the lowest total distributed capacity.
- B—represents an ordinary multi-layer wound choke coil which is usually unsuitable for the suppression of inductive interference due to the distributed capacity being too great, particularly if there are many turns per layer and few layers.
- C—represents a pancake-wound choke coil, which is a particular form of a layer-wound coil, but has few turns per layer and many layers.
- D—represents a special form of pancake-wound choke coil, in which there is only one turn per layer and many layers. In this case, its total distributed capacity is somewhat similar to the single layer wound coil shown in illustration A of this figure.
- E—represents a random-wound choke coil, in which the wire is put on at random, care, however, being taken that an inside turn does not come in close proximity to an out-

TABLE I

Type 100 turns	BANK-WOUND CHOKE COILS							Type 150 turns	Length D
	Amps.	Wire B. & S.	Dimension (inches)			Coil			
			A	B	C	D	E		
B.M. 14	6	14	6	12	6	5 7/8	4 1/2	B.M. 14-S	7 7/8
B.M. 12	8	12	8	12	6	7 7/8	5	B.M. 12-S	9 3/4
B.M. 10	12	10	8	12	6	7 7/8	6	B.M. 10-S	9 7/8
B.M. 8	18	8	10	12	6	9 7/8	7	B.M. 8-S	11 7/8
B.M. 6	24	6	10	12	6	9 7/8	8 1/2	B.M. 6-S	13 7/8
B.M. 4	32	4	11	14	6	13 7/8	11 1/2	B.M. 4-S	19 7/8

\*This box is a recommended metal housing for the Coil.

Please Say That You Saw It in RADIO-CRAFT



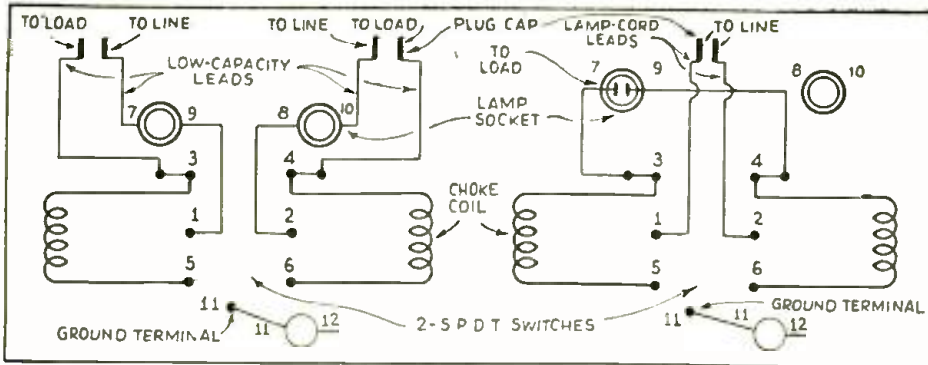

Fig. 7. Schematic diagram of the experimental surge trap described in the text.

side turn. This type of coil should take the general form of the pancake type shown in illustration C of this figure. In this case, the distributed capacity is less than with the layer-wound, pancake coil of similar length along the axis, as the capacity between turns is less on account of the increased air space. A further reduction in distributed capacity can be obtained by the honeycomb type of winding, but the honeycomb coil is difficult to wind by hand, and is usually manufactured with special machinery.

- F—represents a bank-wound choke coil of 4 layers. The order of the turns is indicated in the enlarged section.
- G—Figure G, from which it is seen that the distributed capacity will be similar to a pancake type of coil of 4 turns per layer.
- H—represents a single-layer choke coil with an iron core. This type is usually unsatisfactory for the suppression of inductive interference, as the interfering surge will pass through the capacity C<sub>el</sub> from the end turns of the winding to the iron, be conducted along the iron, and then pass through the capacity C<sub>e2</sub>, and thus, reach the line beyond the choke coil.
- J—represents an absorption type of choke coil having a laminated iron core built in sections and a sufficient space between the sections, so that the capacity from one section to the next may be considered negligible.

**SIZE OF CHOKE COILS**

The size of wire used in choke coils must be sufficient to carry the maximum load of the apparatus without overheating, which would cause a fire risk; or without causing excessive voltage drop, which would interfere with the operation of the apparatus. The maximum voltage drop in most of the choke coils is usually from 1 to 3 volts. This is, usually, negligible on circuits of 110 volts or more, but must be considered when dealing with lower-voltage apparatus. Particulars of standard choke coils and current ratings are given in Fig. 6 and in Table 1.

**INSULATION OF CHOKE COILS**

The insulation of the choke coil to ground or to other lines must withstand the voltage of the line with the necessary factor of safety. The insulation of the wire between turns is practically independent of the voltage of the line and ordinary cotton-covered wire is usually sufficient for the winding, provided the choke coil as a whole is well insulated from ground and wires of different voltage. Care must be taken, however, in constructing bank-wound choke coils, not to damage the insulation of the wire where the wires of the choke coil are required to cross, and double-cotton-covered wire is recommended in this case.

Greater insulation between turns and particularly between the end turns is required where the wavefront of the surge is unusually steep, such as in the case of rotary spark rectifiers for X-rays and precipitators.

**INDUCTANCE AND MUTUAL INDUCTANCE OF CHOKE COILS**

The surge on a power wire which causes radio interference was previously described as a sudden change of voltage. In order that this surge may travel along the conductor, it is necessary that a corresponding sudden change of charging current flow along the conductor. Any choke coil, therefore, that will retard this sudden change in current will reduce the suddenness of the voltage

surge (or steepness of wavefront) and, thus, reduce the interference radiating from the conductor beyond the choke coil. The retardation effect of the coil is caused by the counter electromotive force (e.m.f.) which opposes the surge voltage.

Inductance is that property which opposes any change in the flow of current. The inductance of a choke coil without an iron core is approximately proportional to the square of the number of turns and the length of wire per turn. The effect of a choke coil in suppressing interference is proportional to the counter e.m.f., which, in turn, is dependent on the coil inductance and the steepness of the surge wavefront.

When coils are placed in close proximity, in such a position that the changing magnetic field caused by the varying current in one coil influences the other coil so that an electromotive force is set up between the terminals of the second coil, the coils are said to be "magnetically coupled." When 2 coils are magnetically coupled and connected in series, the inductance of the two coils is greater than the sum of the inductances of the individual coils, and the difference between the sum of their individual inductances and the total inductance of the two coils, so placed, is called their *mutual inductance*.

When coils are in a circuit, for the suppression of inductive interference, their mutual inductance plays an important part in the suppression of interference. Where pancake-type coils are placed parallel and not more than 2 or 3 inches apart, and so arranged that their mutual inductance, with regard to the flow of the surge current, is added to the inductance of the individual coils, they are each more effective.

**EXPERIMENTAL SURGE TRAP**

A portable surge trap consisting of choke coils and condensers, as illustrated in Fig. 7, has proved very useful to interference investigators in finding the most effective and economical method of suppressing interference from small types of electrical apparatus.

The surge trap may be connected in circuit, as shown in the diagram of Fig. 7, at the fuses protecting the apparatus causing the interference. The fuses may be removed and suitable fuses inserted in the surge trap at 7-9 and 8-10. Where the fuse is of the plug type, plug bodies may be inserted in the fuse block and the surge trap connected thereto by means of plug caps and special low-capacity leads. The line and load side of the service fuse block should be carefully noted and the surge trap connected as shown in the diagram. The lead- of the surge trap may be distinguished by the special marking. The red side of the plug body is connected to the center contact.

Where it is not convenient to connect the surge trap to a screw plug type of fuse block, a cord connector may be used to connect the leads of the surge trap to the line supplying the apparatus, by means of spring clips attached to the cord connector. These spring clips may be applied to the terminals of an open switch or cartridge type fuse block, the fuses being removed.

If it is desired to put the surge trap in the circuit between the apparatus and the service outlet, it should be connected as shown in the righthand diagram.

When the apparatus is connected to the supply by means of a flexible lead and standard plug, the plug should be inserted in the plug body at 7-9 of the surge trap, and the flexible lead and plug of the surge trap should be connected to the service outlet.

Where the standard plug is not used the surge (Continued on page 772)

**A Brand New Training Idea!**

**I'LL SHOW YOU THE SECRET OF MAKING REALLY BIG MONEY IN RADIO!**



**I Actually Set You Up For Business**

Here's the opportunity of a lifetime to get into the world's fastest-moving industry. I can train you quickly for a good-paying, full-time or part-time job in RADIO. My Training plan is altogether new and different.

**NO EXPERIENCE NEEDED**

Sprayberry Training starts right at the beginning of Radio... thoroughly and interestingly covers all branches. So simple are the lessons, you require no previous experience to easily grasp their meaning.

**EARN WHILE YOU LEARN**

At the outset of your Training, I offer you complete, professional Radio equipment so you may set up your own home laboratory. I show you how to get profitable, spare-time jobs... also I show you how to do them efficiently. Thus, you gain real, practical experience... easy cash to your bank account while you're learning.



**Farm Boy Makes \$100. per Month Spare Time**

Merryn Hansen, Iowa, writes: "I am well satisfied with your Course. A large battery company has asked me to locate my shop at their place of business. Other men, without your Training, wanted to locate there, but the owner of the business did not think they knew enough about Radio. I expect to work into full-time servicing and I will be able to make more in full-time servicing than the \$100.00 a month I have been averaging sparetime."

**Get Busy... Make a Future For Yourself**

Fellows... don't pass up the fine, money-making possibilities right here within your grasp. Splendid, fascinating jobs await you in Radio Service Work, Commercial Broadcasting, Wire- (less or land and sea), Sound Work, etc. Be assured of a steady job with good pay. Quit dreaming. Cash in right now.

**Sprayberry Course is Sold With Iron-clad, Money-back Agreement**

**BIG PROFESSIONAL OUTFIT GIVEN**

Positively the finest equipment offered with any Radio Course. Consists of All-Wave, All-Purpose Analyzer, Rider Manuals (7,078 pages), Tool Kit, Electric Eye Outfit, Experimental Apparatus.

**More Complete Than Any Other Training Course**

Over a hundred simplified lessons. Plenty of diagrams and charts, which will come in handy long after you have completed your Training. Close personal supervision.

**SPECIAL SERVICEMAN'S COURSE**

... Of an advanced nature for men already in Radio work. Explains newest methods, circuits and short cuts. Terms low as \$8.00 per month.

**GET THE FACTS!**

*Mail Coupon Now*

Sprayberry Academy of Radio, F. L. Sprayberry, Pres., 120-E University Place, N. W., Washington, D. C.

Dear Sir: Please send me free copy of "More Money in Radio".

Name ..... Age .....

Address .....

City ..... State .....

Mail in envelope or paste coupon on postcard. If interested in Service Course only, check here ( )

Please Say That You Saw It in RADIO-CRAFT



## FREE EQUIPMENT given with purchases of NATIONAL UNION

### Radio Tubes and Condensers

KEEPS THOUSANDS OF  
SERVICE ENGINEERS

### AT THE HEAD OF THE PROFIT PARADE!

You can be up in the front lines for more business, more profits, too. You have to be well equipped to do it, though. You need testers, analyzers, circuit data, technical information! These things would cost you lots of money if you had to buy them. Fortunately, you don't . . . You can get them Free the Easy National Union way. Here's all you have to do. Select what you need. Contract to purchase National Union radio tubes and/or condensers. Make a small deposit, which is refunded when your purchase contract is complete. You get the equipment right away . . . use it while you complete your purchases . . . then, it's yours free and clear. Easy . . . Isn't it? Why not start on the N. U. free equipment plan . . . Now?

### N. U. TUBES and CONDENSERS are QUALITY PRODUCTS

Thousands of top-notchers in the Radio Service Engineering profession are depending on National Union quality. It's the kind of precision and value that makes good friends for you. National Union quality will never let you down . . . The National Union guarantee is your assurance.

NATIONAL UNION RADIO CORPORATION  
570 Lexington Avenue RC-538  
New York City

Who is the nearest N. U. distributor?

Name .....

Address .....

City ..... State .....



## Noise ANALYZER

- ★ Provides choice of several line-noise filters in line of any electric appliance or set.
- ★ Dial indicates which AEROVOX noise eliminator to use for maximum noise suppression.
- ★ Handsome steel case. Black crackled finish. Compartment for connection cords. Only \$7.50 (your net cost).
- ★ Ask your AEROVOX jobber to show you this analyzer and the noise filters. Ask him or write us for descriptive literature.



## TELEVISION—HERE AND ABROAD

(Continued from page 743)

The "viewing-end" of the tube is not a single thickness of glass, functioning as a combined cover-plate and image screen. Instead, these two functions are allotted to separate plates. The fluorescent substance has been applied to a separate glass-plate installed inside the tube, and an inch or so behind the convex cover plate through which it is viewed.

This fluorescent screen consists of an absolutely flat glass-plate which is fastened to the walls of the steel envelope. The excellent optical correction obtainable with this design induces us to believe that all cathode-ray tubes of the future, regardless of their construction (glass or metal), will be equipped with this type of screen,

### BRIGHTER THAN MOVIE SCREEN

The other obstacle mentioned in the beginning is the insufficient illumination of the image presented. But what is "bright"—"normal"—"insufficient"? The sensation caused by one and the same source of light, in the eyes of 3 people may result in 3 entirely different opinions! We have scientific means to measure the power of illumination very precisely, but the accepted standard of illumination or "candlepower per square foot," does not mean much to the man in the street. A much better "standard" and one which means something to everyone of us, may be obtained from the screen of the movie theatre which has many points of similarity to the television screen.

Measurements made, by the Society of Motion Picture Engineers, in thousands of American movie theatres have indicated that  $3\frac{1}{2}$  candlepower per sq. ft. is required if fatigue of the eye is to be avoided completely. (See Fig. 4.) This power of illumination has been recommended by the S.M.P.E. as standard for movie theatres. But "recommended" is not "accepted." The accepted standard is much lower, namely 1.65 candlepower per sq. ft. (see Fig. 5). The reason for this "help of the S.M.P.E. to the oculist" is the fact that most of the smaller theatres in the country try to save electricity, and those small theatres are important customers to Hollywood and thus to the S.M.P.E.

One can perhaps fool people who visit a movie theatre once a week, but not customers who buy a television set and are inclined to use it constantly. The conclusion is quite simple:—The minimum requirement for a television screen would be  $3\frac{1}{2}$  candlepower per sq. ft. But it only seems so simple, because the power of illumination mentioned has a conditional value only, and concerns rooms without any stray light; i.e., without any other source of light.

Television will never attain any importance as long as a dark room is necessary for acceptable entertainment value, and while everybody there must look at the picture. In other words, we need television screens far brighter than the best movie screens. As far as projection receivers are concerned not even the  $3\frac{1}{2}$  candlepower per sq. ft. is at present attainable.

But we have, already, direct-viewing tubes which produce a power of illumination of 40 candlepower per sq. ft. (see Fig. 6), which is more than enough to operate such a tube in a brightly-illuminated room. The tubes which do this trick are of the type shown in Fig. 2. This little flight in arithmetic has shown us that, at least at present, the projection type is inferior to the direct-viewing television receiver.

And finally a word about the size of these bright pictures. According to data presented at the 1937 Fall Meeting of the I.R.E., the dimensions of the screen used were 18 x 24 inches. These dimensions were more than sufficient, but the plate voltage of 10,000 volts applied, and the giant size of the cathode-ray tube required, are serious drawbacks.

### TELEVISION EYE BECOMES MORE SENSITIVE

Until now we have only scanned the progress made on the receiving end of television in the past year. Equally important improvements have been attained at the transmitting end.

Reports from England indicate that Marconi-E.M.I. has developed a new pick-up camera which is about twice as sensitive as previous types. The new camera, the diagram of which is shown in Fig. 7, is called the "Super-Emitron," and is in principle a variation of the well-known Iconoscope. The main trick of design is the combination of an Iconoscope with an elec-

tron multiplier, similar in make-up to the one Dr. Zworykin showed a few years ago.

The picture to be transmitted is focused, as customary, on the photoelectric screen at the left. However, the photoelectric charge, produced on this new tube's screen as the light rays impinge upon it, is not scanned at once by a cathode-ray beam, as it is done in the Iconoscope. Instead, the charge is first "pulled" through a metal cylinder which is called an "accelerator." This accelerator speeds up the flight of the electrons and "throws" them with powerful impact against a mosaic screen. The surface of the mosaic screen is treated to cause it to release secondary electrons at the instant of impact. This "secondary emission" is much stronger than the initial photoelectric effect obtained from the photoelectric screen.

The secondary emission is "picked up," as in the case of the Iconoscope, by means of a cathode-ray beam and directed, in the form of electrical impulses, to the control-grid of the preamplifier tube. The great advantage of the Super-Emitron is its ability to operate with less light and under less favorable conditions than the Iconoscope! Or, in other words, artists placed in front of the new camera need not be "broiled" by the amount of light which was required in the beginning of television.

### MORE EFFICIENT SHORT-WAVE TRANSMITTERS

It is well known that extremely wide frequency channels are required to transmit television images consisting of many lines. The handling of such broad frequency bands is quite difficult with the transmitters formerly used, because the resonance circuits required in these transmitters tend to cut sidebands. This trouble can be overcome by "loading" the resonance circuits; i.e., by broadening the resonance curves, but this decreases the efficiency of the transmitter. In short, television transmitters used until now did not operate very efficiently.

The circuit of the new television transmitter developed by W. N. Parker of Philco is shown in Fig. 8. The fundamental trick consists of modulating the antenna and not the grids or plates of the U.-S.W. (ultra-shortwave) transmitter, as customary.

Modulation in the antenna is an old method, but it took Mr. Parker to call attention to the fact that this old-fashioned principle is well able to solve a great number of problems which have puzzled television engineers for a long time.

Now let us see how the "antenna-modulation system" operates. The two modulator tubes, M1 and M2, of Fig. 8, act as a "variable resistor," the value of which changes with the strength of the video signal applied to the grids of the tubes. This "variable resistor" (the modulator tubes) is connected to the antenna by means of a quarter-wavelength line. This line, called the "load line," ends at the transmission-line which connects the output stage of the U.-S.W. transmitter with the antenna.

The "load line" and the antenna transmission line are joined at a point which is a quarter-wavelength from the plate circuit of the output stage. As Fig. 8 illustrates, the new modulation system is based on a simple but very efficient principle, which permits video modulation up to 80 per cent whereby the bandwidth of the channel modulated may be as broad as 4 megacycles.

### SINGLE-SIDEBAND TRANSMISSION

The desire to present to the public the best possible television performance has caused a steady increase in the number of lines per frame, and thus a steady increase in the bandwidth of the channels which are required to radiate these high-definition video signals.

The time when the range between 40 and 100 megacycles was so sparsely utilized that anyone who had the desire could have occupied all of the channels in this range without finding any other interested party has gone forever. The Army, the Navy, Aviation, Amateurs, etc., now try to secure in this range as many channels as possible. It is highly commendable that the Chairman of the R.M.A. Television Committee, Mr. A. F. Murray, was able to secure 7 channels in this part of the wave spectrum. Each channel is 6 megacycles wide, and exclusively reserved for television transmission. In the range from 150 to 294 megacycles, television received an allotment of 12 other chan-

(Continued on page 776)

Please Say That You Saw It in RADIO-CRAFT



## DUAL-INPUT A.C.-D.C. PREAMPLIFIER

(Continued from page 737)

(2) For the phone operating amateur, it represents the complete isolation of the sensitive high-gain, low-level speech amplifier circuits from the frequently intense R.F. fields of the transmitter itself, and the location of these circuits upon the operating desk to give the maximum of flexibility of control. From this position its output is fed to the main power amplifier and modulator sensibly located at or in the transmitter proper.

(3) For the experimentally-inclined broadcast listener the unit described will, when simply connected to the phono pickup terminals of his fine all-wave receiver, turn it into a complete P.A. system limited in output only by the power of the receiver itself—and most good receivers have ample audio power output to serve as excellent P.A. systems, if they only had enough gain to allow use of dynamic or crystal microphones. Besides such serious uses for dances, club and lodge gatherings and the like, much fun can be had with one's friends by hooking such a preamplifier to one's receiver, placing its microphone in another room, and when friends call, amazing them with what seems to be a regular broadcast especially to them coming through the radio set. With the unit described, one's voice may be superimposed on phono records, or even upon radio programs.

Figure A shows the completed unit. At its left are 2 gain knobs, one for the high-gain 53 db. channel which uses one 6J7 and one triode of a 6F8 tube for low-level microphone operation. The second knob controls the 15 db. gain channel through the other section of the 6F8 dual triode (2 entirely separate 6J5's in 1 bulb). Mixing is accomplished electronically, through paralleling of the two 6F8 plates across the output load resistor. The toggle-switch at the right turns the preamplifier-mixer on and off—for it is universally self-powered from A.C. or D.C. mains. This is accomplished through a resistor-cord and plug, a 6J5 as a rectifier, a dual 8-mf. dry electrolytic condenser unit and one resistor as a filter, "choke"—all without any hum whatsoever.

Parts placement is seen in Fig. B. At the upper-left are the two audio volume controls, with on-off switch at the right. At the lower left are the 6J7 screen-grid and plate bypass condensers, with the 6J7 socket partly visible between them and the electrolytic cathode bypass condenser for the bias resistor for the 6J7. To its right is the 6F8 socket, then the 6F8 cathode

bias bypass condenser, and finally the 6J5 rectifier tube socket.

Figure 1 shows the simplicity of the circuit—in which lies a large portion of its efficiency. The standard 2-circuit phone jack at the upper-left (directly on which is mounted the 2-megohm grid resistor), is of the closed-circuit type, grounding the 6J7 grid and thereby preventing any hum due to a "floating" grid from coming through this channel when the jack is not in use. Any standard 2-circuit shielded microphone plug will fit the jack. The gain control for the high-gain channel is after the 6J7 amplifier, where it will not contribute contact noise in operation. The second channel, of 15 db. gain, uses the remaining section of the 6F8 dual triode, with its input and output connections to the 4 tip-jacks on the rear skirt of the chassis, since it is far less hum-sensitive than the high-gain input jack. It is of 1 megohm input, for use with crystal or magnetic phono pickups, carbon microphone input transformers, or radio receiver inputs if desired. Output is across the 20,000-ohm 6F8 plate load resistor at the right of Fig. 1, insulated from what will usually be a following grid circuit to which the preamplifier will be connected in a following power amplifier by the 0.025-mf. output coupling condenser.

Note here one "trick" of making high-gain resistance-coupled amplifiers stable—the use of dissimilar sizes of grid coupling condensers—a very good point to remember. Note also the 100 mmf. mica condensers from the "hot" ends of volume controls to 6F8 grids—a means of holding up treble brilliance at low volume.

The power supply is so simple as to require no comment, except that "B—" or "ground" returns are to a common bus-wire, not to the metal chassis. This bus connects to the chassis, and its ground binding post, only through the Underwriters-specified 0.1-mf., 200-volt condenser seen at the lower right of Fig. 1. This prevents blowing any fuses or getting shocked due to possible grounding of "B—" (one side of the A.C. or D.C. power line) when the case is also grounded, or both it and a grounded object simultaneously touched. Any trace of "floating" hum is eliminated when the case is grounded through this binding post, while the 0.1-mf. condenser prevents short-circuits or shocks.

Remember to keep leads short and direct and A.C. away from the 6J7 grid jack.

This article has been prepared from data supplied by courtesy of McMurdo Silver Corp.

## IT'S EASY TO BUILD THIS "BROWNING 83" 4-BAND SUPERHET.

(Continued from page 758)

ated approximately 10 db. while frequencies of 5,000 cycles can be attenuated 18 db. Thus, by connecting condensers in the plate circuits of the 6F6's and by the use of the tone control, the response characteristics of the audio amplifier can be shifted to any desired intermediate positions between curves B and C.

Curve A, Fig. 5, shows a rather unusual overall response characteristic inasmuch as the response from 20 to about 7,000 cycles is relatively flat with the proper adjustments of the I.F. transformers. This curve was taken with no condensers across the plate circuits of the power tubes and with the tone control set at its maximum "off" position. It will be noted that the response still has a slightly rising characteristic with frequency. This is very desirable inasmuch as the tone control may be used to attenuate the high frequencies and make the curve relatively flat. The maximum deviation from linearity between frequencies from 20 to 9,000 cycles is less than 7 db. This curve was obtained by feeding a carrier of 1,000 kc., modulated with audio frequencies of from 20 to 10,000 cycles, into the antenna circuit of the receiver and measuring the output voltage from plate to plate of the 6F6's with the speaker transformer connected.

Curve B, Fig. 5, shows an overall response characteristic which was obtained by incorrect adjustment of the I.F. transformers. It will be noted that at about 1,150 cycles a peculiar dip in the curve occurred. The complete curve was checked a number of times and this dip is not due to errors in measuring apparatus, for when making other incorrect adjustments of the I.F. transformers similar curves were obtained.

The audio and overall response characteristics were obtained by means of an "audiograph"

which is used to obtain continuous response characteristics of audio or radio amplifiers, speakers, filters, etc. Thus, curves which would take hours to plot point-by-point were obtained in a few minutes and this greatly facilitated design work on the overall response characteristics of the receiver.

### OVERALL SENSITIVITY

The overall sensitivity of the receiver for 50-milliwatts output is less than 1 microvolt on all of the frequencies covered.

On band 4 the sensitivity is less than 0.5-microvolt from 5.5 mc. to 1.5 mc. On band 3 the sensitivity varies from 0.9-microvolt at approximately 1.6 mc. to 0.6-microvolt at 3.8 mc. Band 2 has the greatest variation of sensitivity of any of the bands, being 0.9-microvolt at 3.5 mc. to 0.5-microvolt at 8.5 mc. As is to be expected, the R.F. amplifier gives the least amount of gain on the high-frequency band (band 1). The overall sensitivity is 0.98-microvolt at 8.5 mc. and 0.8-microvolt at 22 mc.

In practical operation the sensitivity is considerably greater than can be utilized under normal atmospheric conditions. Due to the extremely good signal-to-noise ratio, however, the DX fan will find that the kit set, when properly built and aligned, will receive distant stations which are completely drowned out by noise in many receivers. In fact, it was a very great personal satisfaction to the writer, not only to have so many favorable comments on the Browning 35 receiver, but to have almost everyone speak of the high signal-to-noise ratio which was obtained. These commendations were a factor in endeavoring to make the Browning 83 a worthy successor to the "35" not only in regard to quality but also in signal-to-noise ratio.

# Everything NEW IN RADIO at Lowest Prices!



**NEW SETS**



**NEW KITS**

**OVER 12,000 PARTS**



**NEW SOUND EQUIPMENT**



**NEW TEST EQUIPMENT**

**FOR DEALERS, SERVICE MEN  
SOUND MEN, AMATEURS, SET BUILDERS**

## IN ALLIED'S NEW 164 Page Spring Catalog

Here's news! Whether you service, build, or sell radios, sell or rent Sound Equipment, or operate an Amateur Station—you need ALLIED'S big, new Spring Catalog! It brings you everything new in Radio—months ahead—at sensationally low prices. Over 12,000 parts; revolutionary new P.A.—10 to 70 watts—portable, mobile, permanent; all types of latest Testers, Analyzers, Tube-Checkers, Set Testers, Meters, Signal Generators; new Amateur Receivers, Transmitters, Transceivers; Build-your-own Kits; books, tools, etc.—and 56 amazing KNIGHT Radios with newest features—Push-Button Tuning, etc., at new low prices. Auto Sets, Phono-Radios, etc. Radio men everywhere say: "ALLIED'S Catalog is the place to shop—it saves you time and money!" Get this FREE book of values now—just send Coupon.



Builder's Parts Lists Free! We supply Free Parts Lists of matched kits for building any circuit described in this or in any other magazine. Just specify where seen.

**FREE SEND COUPON**

**ALLIED RADIO CORP.**  
Dept. 2-E-8,  
833 Jackson Blvd., Chicago, Ill.

Send your new Spring-and-Summer Catalog—**FREE.**

Name

Address

City  State

Please Say That You Saw It in RADIO-CRAFT



# AMPERITE

presents  
**THE ACOUSTIC COMPENSATOR**



**3 IMPORTANT USES**

(1) The Acoustic Compensator enables you to lower or raise the response of the microphone by the mere flip of the finger! (2) Makes the Velocity immediately adjustable to close talking or distant pickup. (3) Immediately adjustable to any type of job or occasion.

MODELS RBHk, RBMk. with acoustic compensator. Frequency range 40 to 11,000 CPS. Output.—65 db. Switch, cable connector, 25' of cable. **\$42.00 LIST**

MODELS RBHn, RBMn. without acoustic compensator **\$42.00 LIST**

MODELS RAH-RAL. excellent for speech and music. Reduces feedback. Output.—88 db. **\$22.00 LIST**

**NEW!** AMPERITE CONTACT MICROPHONE for use on all string instruments. ... **\$22.00 LIST**

AMPERITE "HAND-I-MIKE." smallest velocity made; used as hand, desk, or stand mike. **\$22.00 LIST**

Write for new Illustrated Bulletins.  
FREE: Window Decal & Window Display; also new sales helps.

**AMPERITE** 561 BROADWAY, N. Y.

**AMPERITE Velocity MICROPHONE**

## RED HOT SPECIALS!

### BRUNSWICK 6 TUBE

2-6 Volt Battery Console Receiver  
1 set:—5-30 and 1-31 tube or 4-201-A and 1-71 A tubes, 4 gaug. 4 tuned currents, single control.

Brand new. Factory sealed cases. size of console. 4x21x14 1/2" —shipping weight, 70—no C.O.D. **\$3.95**  
Express or Freight only.  
A) 6689 No C.O.D. Shipments

### 13 WATT BEAM POWER AMPLIFIER KIT

A beautifully designed amplifier conservatively rated at 13 watts (in push pull) 2 stages, one 6J7G high gain stage and a pair of the Beam Power 6V8G tubes using a 82 type rectifier for any be used for crystal velocity or ribbon mike and magnetic or crystal pickup—complete kit with all necessary parts (less tubes) with pictorial wiring diagram and drilled chassis size 10 1/2 x 7 1/2 —shipping weight, 10 lbs.

AD-112-A. 10 watt amplifier kit complete less tubes. Wiring and testing. **\$4.49**  
\$2.00 extra.

AD-112-B. 13 watt amplifier kit complete less tubes. Wiring and testing. **\$4.95**  
\$2.00 extra. No C.O.D. shipments.

KIT OF TUBES, 1-82, 1-6J7G, 2-6V8G, **\$2.75**

### KOLSTER 7 1/2-20 WATT

Public Address Amplifier Transmitter Power Supply

This 210 or 250 tube amplifier unit with 12 1/2" 25 Watt speaker, brand new in factor, sealed cases, costing over \$100.00, ready to use as amplifier and tapped power supply. Conversion diagram for making 20 Watt High gain amplifier furnished free. Shipping wgt 80 lbs. No C.O.D. shipments. Send for our new money saving catalogue. Containing over 1000 red hot radio items at bargain prices.

**UNITED RADIO CO.**  
Dept. Z-Drawer 1000 NEWARK, N. J.

## SLIDERULES!—FOR PUBLIC ADDRESS AND SERVICE WORK

(Continued from page 736)

reference level in watts, to obtain watts output.

NOTE: Refer to paragraph (11) for a discussion on handling ratios and db. values greater than the values printed on the rule.

Example: +27 db. equals what power in watts (reference level 0.006-watt)?

Using procedure under (2), 27 db. is found to be equivalent to a power ratio of 500.  $Watts = 500 \times 0.006 = 3.0$ .

Therefore, +27 db. is equivalent to 3.0 watts.

- (5) Conversion of Current or Voltage Ratios to Decibels.—Use procedure given under (1), but use "E" or "I" figures of scales "C" and "D."
- (6) Conversion of Decibels to Current or Voltage Ratios. Use procedure outlined under (2), but use "E" or "I" figures of scales "C" and "D."
- (7) Determination of Negative Power Levels. (A negative power level is one where the reference power level is greater than the power under consideration).—

Reference Power  
Reduce ratio \_\_\_\_\_ by division  
W<sub>2</sub>

and convert this ratio to db. using procedure outlined under (1). Example: 0.00003-watt is equivalent to what power level (reference power level 0.006-watt)?

$$\frac{0.006}{0.00003} = 200$$

$$= 1$$

Using procedure outlined under (1), this is found to be equivalent to 23 db.

Therefore, 0.00003-watt is 23 db. below a reference level of 0.006-watt, or 0.00003-watt represents a power level of -23 db.

- (8) Conversion of Negative Levels to Watts.—Using procedure given under (2) to determine the power ratio, then determine watts from formula:

$$Watts = \frac{\text{Reference level in watts}}{\text{Power ratio corresponding to negative db. value}}$$

Example: -27 db. equals what power in watts (reference level 0.006-watt)?

Using the procedure outlined under (2), the power ratio is found to be 500.

$$\text{Therefore, watts} = \frac{0.006}{500} = 0.000012$$

Therefore, -27 db. (0.006-watt reference level) is equivalent to 0.000012-watt.

- (9) Logarithms of Numbers (to base 10) and Antilogs.—

(a) To obtain the logarithm of a number: Adjust rule until that number on scale "B" is opposite "1" on scale "A." Divide by 10 the number which appears on scale "C" opposite the arrow on scale "D" to obtain the logarithm of the number.

Thus, the  $\log_{10} 4.000 = 36 \div 10 = 3.6$ .

(b) To obtain the antilog of a number, reverse the procedure, i.e., multiply the logarithm by 10, set the number corresponding to the product on scale "C" opposite the arrow on scale "D," and obtain the antilog on scale "B" opposite "1" on scale "A."

- (10) Raising a Number to Some Power and Extracting the Root of a Number.—

(a) To raise a number to the power "n". Obtain the logarithm as outlined under (9a); multiply the logarithm by "n", and obtain the antilog using procedure outlined under (9b).

Example: What is the cube of 20 (i.e., what is  $20^3$ )?

Using procedure outlined under (9a), the log of 20 is found to be 1.3.

$$1.3 \times 3 = 3.9$$

Using the procedure outlined under (9b), the antilog of 3.9 is found to be 8,000.

Therefore,  $20^3 = 8,000$ .

(b) To extract the root of a number, first obtain the logarithm using the procedure outlined under (9a). Divide this logarithm by the number of the root

(Continued on page 776)

## BE SURE TO READ THE ANNOUNCEMENT WHICH APPEARS ON PAGE 724 OF THIS ISSUE

## Formulas and Recipes FOR THE PRACTICAL MAN

### CONTENTS OF BOOK

1. Adhesives: Glues, Cements, Gums, Mucilages, Lubricants. 2. Cleansing: Stain Removers, Paint Removers, Bleaches, Cleaning Fluids. 3. Metal Craft: Coloring, Oxidizing, Plating, Repairing, Welding, Polishes, Alloys, Solders, Amalgams. 4. Paints: Colors, Stains, Varnishes, Enamels, Luminous Paint, Washable Paint; Paint-Removing, Waterproofing, Fireproofing. 5. Glass-Working: Cutting, Drilling, Boring, Bending, Blowing, Etching, Engraving, Frosting, Silvering, etc. 6. Wood-craft: Fillers, Fireproofing, Acid-proofing, Waterproofing; Furniture Polishes, Finishes, etc. 7. Inks: Recipes, Eradicators, Ink Stain Removers; Special Inks: Colored, Indelible, Sympathetic, Invisible, Hectograph. 8. Photography: Developers, Emulsions, Fixers, Sensitizing, Toning, Printing, Photographic Paper, Blueprint Paper. 9. Antidotes for Poisons, Remedies for Burns and Scalds, Disinfectants, First-Aid in Accidents, Emergency Remedies, Home Remedies. 10. Preparation, Manipulation, Handling, Mixing, Measuring, Weighing, Filtering, Straining Solutions; List of Technical Substances; Emulsifying; Use of Hydrometer; Use of Thermometer; Tables of Weights and Measures, Decimal System, Useful Tables.

Price 50c Postpaid

## TECHNIFAX

Division RC-538

550 W. WASHINGTON BLVD. CHICAGO, ILL.

## FREE TRIAL OFFER

NEW REMINGTON NOISELESS PORTABLE! AS LITTLE AS



**10¢ A DAY**

Famous Remington Noiseless Portable that speaks in a whisper. Pay as little as 10¢ a day. Guaranteed by the factory. Standard keyboard. Automatic ribbon reverse. Variable line spacer and all the conveniences of the finest portable ever built. PLUS the NOISELESS feature. Act now. Send coupon TODAY for details.

You don't RISK a Penny

We send you Remington Noiseless Portable for 10 days' free trial. If not satisfied, send it back. We pay all shipping charges.

Typing Course and Carrying Case

You will receive FREE a complete simplified home course in Touch Typing, a handsome sturdy carrying case is included. No obligation. Mail coupon for full details—NOW.

Remington Rand Inc., Dept. 189-5  
405 Washington St., Buffalo, N. Y.  
Tell me, without obligation, how to get a Free Trial of a new Remington Noiseless Portable, including Carrying Case and Free Typing Course for as little as 10¢ a day. Send Catalogue.

Name .....  
Address .....  
City..... State.....

Please Say That You Saw It in RADIO-CRAFT



## PHONO PICKUPS ON PARADE

(Continued from page 739)

closely-spaced concentric circles. When reproducing from this record with the ordinary straight arm which is pivoted at one end and carries the reproducing head and needle at the other, it would be impossible to obtain the same degree of tangency (as that of the cutter) unless the arm were infinite in length. In the finite arm, the needle describes an arc of a circle across the record, and the projection of the needle on the record makes an angle with the tangent to the groove at the point of contact. It is this departure of the needle projection from tangency which is called the tracking error or angle.

The actual value of the tracking angle depends on the length of the arm, the distance between the arm pivot and the center of the record; and, the radial distance from the center of the record to the needle point. In Fig. 3, the tracking angle for an ordinary straight arm has a rapid change when the distance from the pivot to record center is equal to or greater than the arm length. Conventional arms are placed so that the arc of needle travel passes through the center of the record ( $d=0$ ). This gives the maximum tracking angle at the outside of the record and a straight-line decrease in angle as the needle traverses the record. This rapid change in tracking angle is objectionable since the needle point wears out to fit the groove. The constant reshaping of the needle point is done at the expense of the record, causing excessive wear.

The curves of Fig. 11 of tracking-angle improvement for off-set heads (model B).

Figure 6 shows a comparison between needle

orientations obtained with the conventional and the newer needle-tilt reproducers. Details A and D indicate conventional pickups and B and C show needle-tilt feature.

In the needle-tilt method, an angular displacement of the needle relative to the working axis of the reproducer head is employed. The head is mounted in any suitable straight arm.

The length of the arm is selected and an operating curve of Fig. 3 is used to determine the tracking angle which is to be compensated. The compensating angular displacement is made about equal to the average tracking angle, thus determining the required tilt angle. Figure 4 shows end-on and side views of the needle-chuck used. (The idea of merely using a bent needle to get the desired tilt has been suggested; but although such bent needles are suitable for recording and are so used they do not satisfactorily solve the problem in reproducing. In recording, the conditions of arm length, disc diameter, recording arc, etc., are parameters that do not obtain in reproducing and which therefore make the idea commercially impracticable in connection with the reproducing pickup.)

While the tangent and needle-tilt types of construction are used by crystal pickup manufacturers at the present time there is no reason that these methods cannot be incorporated into the magnetic types.

### MAGNETIC PICKUPS

A magnetic pickup operating on the principle of a relay or trigger action has been on the market for a short time and has excellent response characteristics. In action a small amount of motion, imparted to the armature by the needle, is made to control large flux paths with the result that the bulky armature of the ordinary pickup is eliminated. Figure 7 shows the magnetic circuit of the unit and the relation in size between the average armature and the new exciter.

In operation, the exciter relays the flux to the fixed armature. The elimination of the armature mass places its resonance point above audibility, and insures freedom from shock excitation. A reduction in the damping mass lowers the needle-point impedance and results in better transient response. Such pickups as described have low output when compared to the ordinary types but have an excellent frequency range as will be noted in Fig. 10.

The standard type of magnetic pickup found everywhere has been improved in design and construction so that today it is possible to obtain at low cost a degree of realism in reproduction far superior to the results obtained from the same type a few years ago.

Figure 9 shows how the frequency characteristic of a typical magnetic pickup can be varied by changing the value of resistance shunted across it.

In conclusion, it can be stated that the art of building pickups has been advanced, particularly in the last 2 years. The manufacturers who continued in this particular branch of the business have not been asleep even though the general public turned from the phonograph to the radio for their entertainment. The renewed interest in phonograph record reproduction will bring further improvements in the years to come, but don't wait for improvements, because the quality of reproduction obtainable today with low-cost pickups is far superior to the accepted standard of 2 years ago.

The writer is indebted to Astatic Microphone Lab., The Audak Co., Shure Brothers and the Upco Mfg. Co. for their permission to use their confidential information and photographs in the preparation of this article.

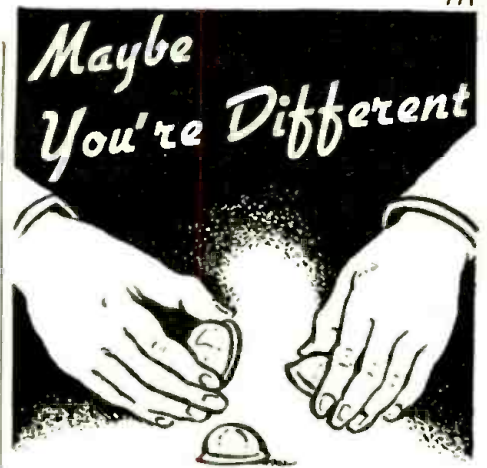

## But Most People Lose by Guessing

Whether you are a serviceman whose profits depend upon the speed of your work—or an amateur whose pleasure depends upon the performance of your instruments—you know the value of a thorough grounding in theory and the importance of having factual information constantly at your fingertips.

Know the underlying theory of Radio (and Television). Know "how" and "why" a set performs. Get the most from your effort today and be prepared for the developments of tomorrow! Order the Rider Books you need—RIGHT NOW!

### RIDER BOOKS BANISH Bewilderment

#### AUTOMATIC FREQUENCY CONTROL SYSTEMS

With Automatic Frequency Control Circuits in most new higher-priced models, knowledge of "AFC" means money in your pocket! Learn the practical facts, from these easy-to-understand explanations. Get your copy today. Cash in on profitable "AFC" work. Hard covers. 144 pp. \$1.00.

#### THE CATHODE-RAY TUBE

Written especially so you can understand the subject. With introduction of new, cheaper Cathode-Ray Tubes, this book is even more indispensable for its complete practical information on Oscillographs, etc. 336 pp. 450 illustrations. \$2.50

#### SERVICING SUPERHETERODYNES

Changes, changes, changes! That has been the history of the superheterodyne circuit. Make repairs quickly by analyzing the different parts of the circuit quickly. Rider shows you how in this revised edition which has 288 profusely illustrated pages. \$1.00

### "AN HOUR A DAY WITH RIDER" BOOKS —60¢ each

- ON AUTOMATIC VOLUME CONTROL will speed up your AVC work. 96 pp. 65 illus.
- ON RESONANCE & ALIGNMENT. You need this! 96 pp. 48 illus.
- ON D-C VOLTAGE DISTRIBUTION IN RADIO RECEIVERS. How d-c voltages are led to tube elements, etc. 96 pp. 69 illus.
- ON ALTERNATING CURRENTS IN RADIO RECEIVERS—with drawings and diagrams.

JOHN F. RIDER, PUBLISHER  
1440 Broadway, New York City

Remember  
**YOU NEED ALL 8  
Rider  
MANUALS**

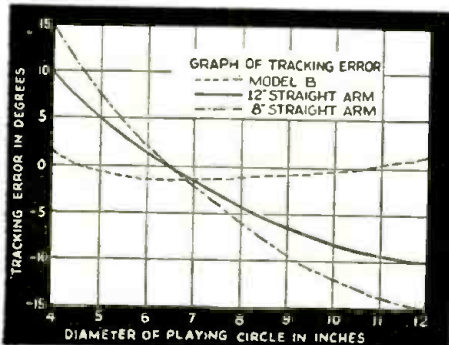

Fig. 11

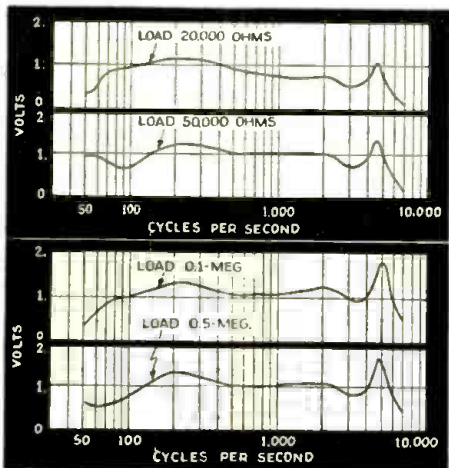

Fig. 9

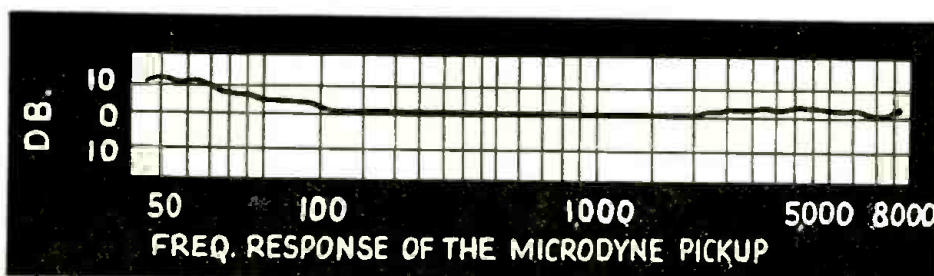
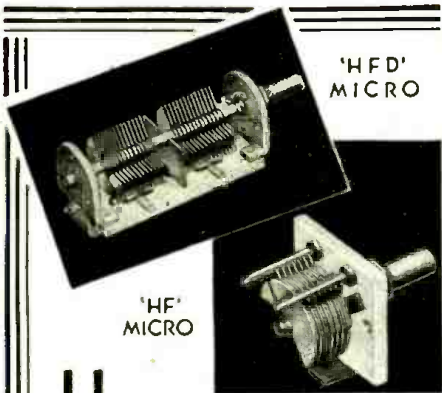

Fig. 10. Curve of the Microdyne pickup showing its frequency response.

Please Say That You Saw It in RADIO-CRAFT





# ULTRA MIDGETS!

HAMMARLUND "HF" micro condensers are ideal for that new receiver. They conserve space, permit a more compact lay-out, shorter leads, and greater efficiency. "HF" midgets are especially suited to portable apparatus, because of their small size, and their ability to withstand rough treatment.

HAMMARLUND MFG. CO., INC. RC-5-38  
424-438 W. 33rd St., N. Y. City.

Please send me new "38" catalog.  
Name .....

Address .....

City ..... State .....

Canadian Office: 41 West Ave., No. Hamilton, Ont.



**HAMMARLUND**

**Save Money**  
on everything  
you buy ...



**The New BARGAIN BULLETIN**

Your Guide to Hundreds of Outstanding Values.

**FREE** Write today for this outstanding new BARGAIN BULLETIN—there is no obligation on your part. High quality merchandise at sensationally low prices! Radio Sets, Parts, Sporting Goods, Watches, Clocks, Typewriters, Cameras, Novelties and many other items at real savings to you. Fair Dealing—Prompt and Courteous Service, always. Send for your Free BARGAIN BULLETIN now, try us, and be convinced of our superior values and service.

**RADIO CIRCULAR CO., INC.**  
DEPARTMENT RC  
915 Broadway New York, N. Y.

**DO YOU LIKE RADIO & TELEVISION**

If you want to know employment opportunities and requirements in radio and related industries, get National's book of facts. Send for YOUR FREE COPY TODAY Dept. RC-5 4000 S. Figueroa

**NATIONAL SCHOOLS**  
Los Angeles

## AS PREDICTED!— DAILY NEWSPAPER NOW PRINTED IN YOUR HOME—BY RADIO!

(Continued on page 765)

neatly in a tray. The other is much simpler, and does not cut the paper into strips. It is felt that for experimental purposes the home apparatus should be as simple and inexpensive as is consistent with good reproduction.

The new, simplified, home facsimile system was developed in the RCA laboratories after years of experimentation with many different types of facsimile apparatus, some of which were employed for commercial transmission of weather maps and information to ships at sea, and for the transmission of photographs and other material across the Atlantic. The new equipment was developed by Mr. Young and his assistants as the most practicable for home use, because of its extreme simplicity.

The picture, drawing or text to be transmitted is placed on the roller drum of the "scanner." A beam of light travels horizontally across the page as the drum revolves. The light is reflected and focused on a sensitive photoelectric cell in the various degrees of shading corresponding to the picture. The photoelectric cell transforms the light into electrical impulses which are flashed through the air.

The receiver is synchronized to the transmitter-scanner. The signals are picked up exactly as in sound broadcasting, but instead of passing through the loudspeaker, they are made to actuate the printer mechanism. Continuously-feeding rolls of ordinary white paper and ordinary carbon paper are led past a metal cylinder drum, on which a single spiral of wire projects a fraction of an inch above the surface. The fluctuations in the intensity of the incoming signals press the paper and carbon together against the spiral to make marks corresponding to the light and shade of the original at the scanner.

The facsimile signals may be heard on the loudspeakers of ordinary radio sets, when broadcast wavelengths are used, as high-pitched tones of varying intensity.

As we go to press, we are sorry to learn of the untimely death of Capt. Otho Fulton, facsimile pioneer.

## CANADA'S "INTERFERENCE DETECTIVES"

(Continued from page 767)

trap may be connected in service by means of the cord connectors and spring clips at the switch, or by cutting the supply wires.

After the surge trap has been connected in the circuit, a wire should be run from point 12 of the surge trap (called the ground terminal) to either ground or frame of apparatus, as required. A small fuse is to be inserted in 11-12 to serve the double purpose of switch and protective fuse.

Either or both of the choke coils may be cut in or out of the circuit by means of the double throw switches. With switches closed to 3-4, the coils are out of circuit; with switches closed to 5-6, the coils are in circuit.

Condensers of various sizes may be connected to any points of the surge trap.

The investigator is, thus, able to quickly conduct a series of tests and try all the recommended arrangements of choke coils, condensers and groundconnections in a comparatively short time.

### ANSWERS TO QUESTIONS ON PAGE 763

1. Another name for detection is (demodulation).
2. The phones or loudspeaker of a radio set respond to (audio-frequency variations).
3. The principle of detection is also illustrated in (a crystal).
4. Regeneration increases the sensitivity of a receiver by feeding back energy to the tickler coil from (the plate circuit).
5. Best reception is obtained when the set (does not squeal after the station has been located).

Please Say That You Saw It in RADIO-CRAFT

## BLUEPRINTS

### POCKET VOLT-OHM-MILLIAMMETER

ALL the rage these days is the pocket-sized volt-ohm-milliammeter. Our Blueprint No. 381 shows how to build such an instrument, using a perfected circuit invented by H. J. Bernard. It is based on a 0-1 milliammeter and permits use of the scale as it exists on the meter for all a-c and d-c voltages and d-c currents. Data for the two resistance ranges are given. The instrument size is 3x5 1/4 x 3 inches and the ranges are: 0/10/100/1,000 volts d.c. at 1,000 ohms per volt, 0/10/100/1,000 volts a.c. (linear scale, same as for d.c.) 0/1/10/100/1,000 milliamperes d.c. 1/500 ohms, also 0/1,000,000 ohms.

A twelve-position, single deck switch is used, four binding posts, an on-off switch and an ohms adjuster. The instrument circuit is of highly advanced design and thoroughly engineered.

### SIGNAL GENERATOR

COVERING from 120 kc to 40,000 kc (40 mc), the Signal Generator covered by our Blueprint No. 382 has all the finest features for practical servicing. The generator operates on 90-130 volts a.c. or d.c., provides two forms of amplitude modulation and also built-in frequency modulation. Both the line frequency and a 400-cycle note are available for modulation. The output attenuator (volume control) is effective on all bands, as leakage, or line-cord feedback, is at minimum.

The r-f oscillator is a 6J6G, the rectifier a 37, 76 or 1A.

This is a highly perfected and expertly engineered signal generator designed and developed by H. J. Bernard.

**25c**  
Each  
(Postpaid)

## RELIABLE RADIO CO.

143 W. 45 St., New York, N. Y.

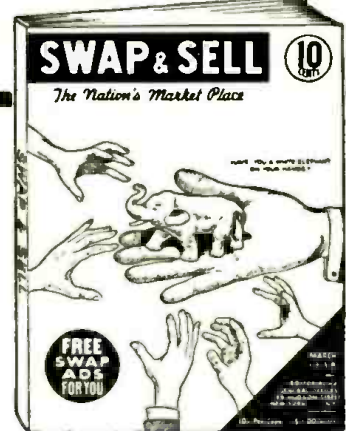

## SWAP & SELL

is the great, big, new magazine that shows you how to get more than 1000 different articles, such as cameras, rifles, books, magazines, clothing, tools, pets, etc., WITHOUT HAVING TO BUY THEM!

It runs your own swap ad free!  
It prints letters from men and women who seek new friends!  
It publishes true experiences from real life!  
It tells you how to swap and how to make money!  
It helps you get all the things you've always longed for, yet never could afford!  
You need a copy to help you get more out of life!

**NOT SOLD ON NEWSSTANDS** Send only 10c for sample copy, or get all twelve big issues for the coming year—only \$1.00 if you order at once!

**SWAP & SELL**, 99C HUDSON STREET, NEW YORK, N. Y.

## PATENTS—TRADE MARKS

All cases submitted given personal attention by members of the firm.

Form "Evidence of Conception" and instructions  
"How to Establish Your Rights"—Free  
**LANCASTER, ALLWINE & ROMMEL**  
PATENT LAW OFFICES  
436 Bowen Bldg. Washington, D. C.



## RECENT RADIO TUBES

(Continued from page 751)

of meters to obtain instantaneous and simultaneous D.C. or low-frequency A.C. voltage and current readings of a given piece of apparatus under test. These same technicians, however, could not afford to purchase, nor would they put up with the annoyance of operating, a multiplicity of oscilloscopes for visually analyzing A.C. waveforms, of any frequency, no matter how useful such analyses might be.

Thus we see that the new line of multiple-trace cathode-ray tubes fills a most useful niche in the field of test equipment. It is possible, for instance, to watch on a single screen the gyrations of each of the 3 voltages in a 3-phase power system; or to observe the individual waveform of each of 3 A.C. voltages occurring at separate locations in a piece of equipment under test. Terminals are shown in Fig. 1.

Each tube has 3 individual beams, which provide 3 separate patterns simultaneously, without switching. A total of 12 separate connections to deflector plates provides flexibility and balanced input; and 3 modulators provide individual intensity control or suppression of each beam.

The heater voltage is 5 V., heater current 1.65 A., accelerating potential 1,000-5,000 V., deflection characteristic with accelerating potential of 2,000 V., is 80 volts/inch. Maximum screen size is 7½ ins. Overall dimensions appear in Fig. B. The 330A tube has a green fluorescent characteristic (medium persistence) and is used for visual observation and photography with green-sensitive film.

**330B 3-Trace C.-R. Tube.** (Except for its image color this tube is equivalent to the previously-described 330A.) This tube has a blue-green fluorescent characteristic (long persistence) and is used for visual observation, and photography of non-recurrent and low-frequency phenomena.

**330C 3-Trace C.-R. Tube.** (Equivalent, except for image color, to type 330A.) The 330C has a blue fluorescent characteristic (highly actinic) and is used for photography with blue-sensitive film.

(Name of manufacturer given upon request.)

**6K8 Frequency Converter.** The 6K8, shown in Fig. D, is a metal-type frequency converter designed for use in superheterodyne receivers where good frequency stability is desirable. It may be used satisfactorily in A.C.-D.C. receivers inasmuch as the screen-grid, oscillator plate, and mixer plate may all be operated from the same 100-V. supply. This combined oscillator and mixer has a common cathode and No. 1 grid. It is designed for use in superheterodyne receivers where good frequency stability is desirable. Terminal connections are shown in Fig. 1. Characteristics data are given in Table II.

**6W7G Pentode Amplifier.** The 6W7G (see Fig. D) is a pentode-type amplifier tube with sharp cutoff characteristics designed for service in applications requiring a low heater current tube. This type is a counterpart of the type 6J7G and may be used in similar applications where the reduced heater drain is advantageous. Characteristics data are given in Table III. Terminal connections are shown in Fig. 1.

(Data courtesy Raytheon Production Corp.)

### MEASUREMENT TUBES

Scientific people are always seeking more sensitive and more accurate methods of doing things. Especially is this true of fundamental investigations in electrical phenomena and in the researches revolving around the new studies and concepts of nuclear physics. For such pioneering work and for other tasks just as delicate and important, new tubes have been developed.

**RH570 Electrometer Triode.** Here is a tube, Fig. D, which may be used in precision-type electrometers. The development of such a sensitive triode along with improvements in precision instruments has resulted in electrometers (the tube and its meter) which are much more satisfactory than the earlier types of gold leaf electrometers (or electroscopes) and Geiger counters. In general, electrometers are specially adapted to the measurement of small voltages and minute electrical charges. This tube has exceptional value for specialists in the photoelectric field. Ionization currents may be measured and chemical processes tested. Such an electrometer setup is so sensitive it even permits reading the potential drop across substances usually classed as non-conductors.

An electrical contact with the inside of the

bulb augments the shielding effect of the internal construction and minimizes the influence of charges on the glass which might otherwise produce undesired electric fields.

Due to the design features of the tube the amplification factor is rather low in comparison with ordinary triodes. It is, therefore, advisable to use a sensitive galvanometer in the plate circuit to measure the small current changes, or the output should be fed directly into a voltage amplifier. The extreme sensitivity of this tube requires careful shielding to protect it from extraneous electrical fields. Characteristics data are given in Table IV. Terminal connections are shown in Fig. 1.

**WL756 Sputtered-Carbon "Megamegohm" Resistor.** Advances in photometric measurements depend upon the unchanging character of the sputtered carbon resistor—up to values of thousands or even millions of megohms—which makes itself useful as a grid coupling resistor in such applications where stability is of prime importance.

The type WL756 sputtered carbon resistor tube, as shown in Fig. D, provides just such a stable, high-resistance unit. Due to the fact that the active parts of the resistance unit are all enclosed in an air-tight or sealed-off chamber, the tube has a very constant resistance value over a long period of time. (Because of its high-resistance capabilities the writer has called it the "megamegohm" tube.)

The resistor tube has a radically new and distinctive design which comprises a helical glass rod mounted and sealed in a glass bulb. A thin film of carbon is deposited on the glass coil during the process of manufacture. Due to the high resistivity of carbon the required deposit has an appreciable cross-section and thickness, which results in improved constancy and reliability of the resistor.

The final stage of sputtering is delayed, so that the tube can be made to the specified resistance value within close tolerances. Partially processed tubes are carried in stock, and shipment is made as soon as the final treatment is completed.

Before the tube is finally sealed off, it is filled with an inert gas which facilitates cooling and tends to keep the resistance value from changing due to the temperature coefficient of the carbon coating. The tube may be obtained without the gas filling when it is to be used at potentials in excess of 150 V. Characteristic data are given in Table V. Tube terminal connections are shown in Fig. 1.

(Manufacturer's name given upon request.)

### AMATEUR RADIO TUBES

**KY21 Mercury-Vapor Grid-Control Rectifier.** Here is a mercury-vapor tube to which has been added a control electrode or grid. The control electrode prevents passage of current through the tube until the negative potential on the grid reaches a certain minimum critical value. The grid will not regain control until after the voltage existing between filament and anode has reached approximately zero.

If the grid remains slightly negative in respect to the cathode but not sufficient to prevent the passage of anode current it will be found that the anode current does not start over the initial portion of the cycle.

These characteristics make possible the use of the KY21 tube as both a rectifier and power control tube. The KY21 tube permits of the control of 5 kw. of power (3,500 V. at 1.5 A.) at the highest possible speeds found in manually keyed transmitters. The control power is negligible and can be either supplied by means of the D.C. or tone. Properly used, the KY21 tube effectively eliminates "key clicks," permitting high-power operation in congested areas. Characteristics data are given in Table VI. Terminal connections are shown in Fig. 1.

**RX21 Mercury-Vapor Rectifier.** The RX21 is a mercury-vapor rectifier tube having ratings and capabilities that place it in a field which was heretofore only covered by far more expensive tubes. The use of a tantalum plate, the high vacuum, and unique construction give this tube unusually high inverse voltage capabilities for operation in amateur radio transmitters. In order to carry the 10-A. current required by the tube the adjacent pins have been connected in parallel within the base; to maintain balanced load, each filament lead connects to the center of its respective pin-jumper. Similar connections

(Continued on following page)

**TWO NEW SPEAKERS**



**A 3½" P. M. DYNAMIC**

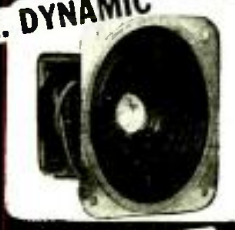

**A 3½" ELECTRO DYNAMIC**



The very next time you have trouble with a small speaker, replace it with one of these new UTAH models. Hear for yourself the vast improvement UTAH has made over the usual performance of small speakers. UTAH engineers have so proportioned the generated harmonics in the cone surface that tone quality is exceptionally good. The efficiency of all component parts results in a new top in the performance of 3½" speakers. Use these UTAH speakers wherever space is limited. Your jobber has them.

### ELECTRO-DYNAMIC SPEAKER

Field coil, 450 ohms  
Voice coil, 3½ ohms  
Output, 5 watts  
Frequency Range: 200-8,000 cycles  
Order No. R-345

### THE UTAHFLUX PERMANENT MAGNETIC DYNAMIC SPEAKER

The permanent magnet is designed to give a flux density in the air gap that gives this speaker practically the same performance as the electro dynamic—with a saving of from 6-9 watts.

Order No. 3-P

**UTAH RADIO PRODUCTS CO.**  
CHICAGO, U. S. A.

TORONTO ONTARIO, CANADA      BUENOS AIRES UGCA RADIO PRODUCTS CO.

"16 YEARS OF LEADERSHIP"

Please Say That You Saw It in RADIO-CRAFT





# "BUT

## —WHAT CAN CREI TRAINING DO FOR ME?"

CREI offers a complete course in Practical Radio Engineering, written for the man who is serious about getting ahead in Radio. It can help you to progress from the "mechanic" stage to that of an expert specialist. It gives up-to-the-minute advanced instruction on modern radio apparatus, so you can look at it with the eyes of the engineers who design it, and appreciate the results they are trying to obtain. If you realize the importance of training for success, send for our Free Booklet that describes our courses and your future in detail.

**CAPITOL RADIO ENGINEERING INSTITUTE**  
Dept. RC-5 14th & Park Rd. N. W.  
WASHINGTON, D. C.

### MAIL THIS COUPON TODAY!

Please send me complete details and FREE illustrated 48-page booklet—"A Tested Plan for a Future in PRACTICAL RADIO ENGINEERING."

Name .....

Address .....

City .....

## Listen Comfortably WITH BRUSH "Hushatone" (pillow speaker)

Put this radio accessory under your pillow and listen to your favorite programs. Write for details.

**THE BRUSH DEVELOPMENT CO.**  
3312 Perkins Ave., Cleveland, Ohio

## SHORT WAVE CONVERTERS FOR CAR RADIOS



MODEL 600

Can be attached to any car radio. Has on and off switch and does not affect the reception on the standard broadcast band. MODEL 600 covers 40-31.25-20.19 and 16 meter bands. Designed for American and Foreign short wave broadcast. Distance range 5000 to 10,000 miles. Especially adapted for use in tropical countries as these bands are almost free from heat static. Now being used successfully in Canada, Alaska, Mexico, Panama, Colombia, Cuba, India, Indo-China, Netherlands and many other countries. List Price ..... \$24.95

MODEL 800—Super Sensitive police converter with fixed condenser. Covers 1500 to 2800 kilocycles. Two metal tubes. Exceptional distance range. List Price \$15.95

**FIVE OTHER POLICE MODELS AVAILABLE**  
Jobbers and Dealers wanted

**ABC RADIO LABORATORIES**

3334 N. New Jersey St., Indianapolis, Indiana, U.S.A.

**WE HAVE THE RADIO YOU WANT**

How would you like to save up to 50% on Nationally advertised Radios, such as Stromberg Carlson, Philco, RCA, Zenith, G. E. etc. etc. for home, farm and auto, over 400 models to choose from. Also hundreds of electric appliance items for the home. Write today for the new 1938 giant catalog FREE.

MODEL'S Dept 57, Cortlandt St., N.Y.C.

**GUARANTEED 6 MONTHS SYLVANIA SET-TESTED RADIO TUBES**

## RECENT RADIO TUBES

(Continued from preceding page)

should be made on the sockets. Characteristics data are given in Table VII. Terminal connections are shown in Fig. 1.

(Manufacturer's name given upon request.)

A new line of 4 tubes in the RK series has been specifically designed, by one manufacturer, for the amateur who wants low-cost triodes with long life and the ability to withstand heavy surges. Heavy, thoriated filaments are used to give these tubes extra power.

**RK11 Triode Power Amplifier.** This tube has a mu of 20. It is designed for use as power amplifier, oscillator and frequency multiplier. Has excellent R.F. characteristics. Power output, 55 W.

**RK12 Zero-bias Modulator.** Here is a tube which offers extremely low distortion, even at 100 W. Has excellent R.F. characteristics, and is particularly suited to buffer amplifier applications. Power output, 55 W.

**RK51 Triode Power Amplifier, Oscillator, or Frequency Multiplier.** The RK51 has 170 W. output. Amplification factor is 20. Incorporates hard-glass bulbs, carbon plates and isolantite bases.

**RK52 High-mu Zero-bias Triode, Power Amplifier, Modulator, Oscillator or Frequency Multiplier.** The RK52 has low idling current. Power output, 135 W. Incorporates hard-glass bulbs, carbon plates and isolantite bases.

Further characteristic data, curves and terminal connections of the above 4 tubes are available from the manufacturer. (Data courtesy Raytheon Production Corp.)

### CHARACTERISTICS DATA

#### BANTAM TUBES—Table I

- 6Q5GT—Electron-ray tuning indicator without triode amplifier section.
- 6A8GT—Pentagrid converter
- 6K7GT—Variable-mu R.F. pentode
- 6J7GT—High-mu R.F. pentode
- 25A6GT—Output pentode (25 V. heater)
- 25Z6GT—High-vacuum full-wave rectifier (25 V. heater)
- 6J5GT—Detector-amplifier triode
- 6Q7GT—Diode high-mu triode
- 6X5GT—High-vacuum full-wave rectifier
- 6K6GT—Output pentode

#### 6K8—Table II

Direct Interelectrode Capacities (Approx.: Shell Connected to Cathode)

- Hexode grid No. 3 to hexode plate 0.03-mmf.
- Hexode grid No. 3 to triode plate 0.01-mmf.
- Hexode grid No. 3 to triode grid 0.1-mmf.
- Triode grid to triode plate 1.1-mmf.
- Triode grid & hexode grid No. 1 to hexode plate 0.05-mmf.
- Hexode grid No. 3 to all other elements (R.F. input) 6.6 mmf.
- Triode plate to all other elements (osc. output) 3.2 mmf. (except triode grid and hexode grid No. 1)
- Triode grid & hexode grid No. 1 to all other elements (osc. input) 6.0 mmf. (except triode plate)
- Hexode plate to all other elements (mixer output) 3.5 mmf.

#### Ratings

- Heater voltage (A.C. or D.C.) 6.3 volts
- Heater current 0.3-amp.
- Max. plate voltage (hexode) 250 volts
- Max. plate voltage (triode) 200 volts
- Max. screen-grid voltage (hexode) 100 volts
- Min. control-grid bias (hexode) -3 volts
- Max. cathode current 16 ma.

#### Frequency Converter

- Mixer plate voltage (hexode) 100 250 volts
- Mixer screen-grid voltage (hexode) 100 100 volts
- Mixer control-grid bias (hexode) -3 -3 volts
- Osc. plate voltage (triode) 100 100 volts
- Osc. grid resistor (triode) 50,000 50,000 ohms
- Mixer plate current (hexode) 2.3 2.7 ma.
- Mixer screen-grid current (hexode) 6.9 6.5 ma.
- Osc. plate current (triode) 3.5 3.5 ma.
- Osc. grid current (triode) 0.15 0.15-ma.
- Mixer plate resistance (hexode) (approx.) 0.3 0.6-megohm
- Conversion transconductance 360 400 micromhos

## 3 NEW 64-PAGE BOOKS!

added to the famous

**RADIO-CRAFT LIBRARY SERIES**

**PRACTICAL RADIO CIRCUITS**

**SERVICING WITH SET ANALYZERS**

**POINT-TO-POINT RESISTANCE ANALYSIS**

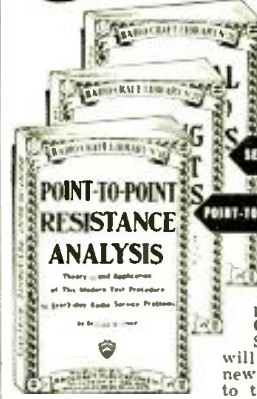

HERE are three NEW TITLES just added to the popular RADIO-CRAFT LIBRARY SERIES. Radio men will want to read these new books and refer to them often for reference. Each volume contains 64 pages, bound between stiff, flexible covers, and measures 6x9 inches to conform with others in the series. Dozens of illustrations appear in each volume. A resume of the contents of each book appears below.

No. 16

### PRACTICAL RADIO CIRCUITS By David Bellare

INTRODUCTION • BROADCAST RECEIVERS—Crystal Receivers; Regenerative Circuits; T.R.F. Circuits; etc. • ALL-WAVE RECEIVERS—Superhet with Phase Inverter and Colorant Tuning; Circuit with AFC System; etc. • SHORT-WAVE SETS, CONVERTERS AND ADAPTERS • AUTOMOBILE RECEIVERS—Superhets with AVC; Custom-built; Battery-operated; etc. • PUBLIC ADDRESS—A Variety of P.A. Systems Are Described; Anti-howl; Magic-Eye; Volume Expansion; etc. • POWER PACKS • TELEVISION RECEIVERS • SIMPLE LOW-POWERED TRANSMITTERS • TEST EQUIPMENT • MISCELLANEOUS APPARATUS for many needs.

OVER 100 ILLUSTRATIONS

No. 17

### SERVICING WITH SET ANALYZERS By H. G. McEntee

INTRODUCTION • FUNDAMENTAL ANALYZER PRINCIPLES—Various Types and Uses of Switches; Elementary Set Analyzer Circuits • TROUBLE SHOOTING WITH SET ANALYZER—Preliminary Checking; Testing Tubes under Operating Conditions; Point-to-Point Testing; Checking Individual Components • ASSOCIATE TESTING EQUIPMENT—Vacuum Tube Voltmeter; Test Oscillator; Output Meter; Oscilloscope • COMMERCIAL TESTING EQUIPMENT • RMA SOCKET NUMBERING SYSTEM.

OVER 80 ILLUSTRATIONS

No. 18

### POINT-TO-POINT RESISTANCE ANALYSIS By Bertram M. Freed

Value of Resistance Method of Servicing • Basic Principles Involved in Point-to-Point Analysis • Methods and Instruments Employed in Resistance Measurements • Point-to-Point Testing Equipment • Easily Constructed Multi-Range Volt-Ohmmeter • Resistance in Radio Receivers • Typical Point-to-Point Analysis of a Modern Receiver • Combination Voltage and Resistance Point-to-Point Analysis • Actual Service Problems • Appendix. OVER 65 ILLUSTRATIONS

\* Two NEW BOOKS will be ready for distribution by May 1st.  
No. 20—The Cathode-Ray Oscilloscope.  
No. 21—Breaking into Radio Servicing.

**RADCRAFT PUBLICATIONS, Inc.**  
99 Hudson Street, New York, N. Y.

### CLIP AND MAIL COUPON BELOW!

**RADCRAFT PUBLICATIONS, Inc. RC-538**  
99 Hudson St., New York, N. Y.

Gentlemen: Enclosed you will find my remittance of \$..... for which please send me, POSTPAID, the books checked below, at FIFTY CENTS (50c) per copy.

- No. 16—PRACTICAL RADIO CIRCUITS
- No. 17—SERVICING WITH SET ANALYZERS
- No. 18—POINT-TO-POINT RESISTANCE ANALYSIS

Name .....

Address .....

City .....

State .....

(Remit by check or money; register letter if you send cash or unused U. S. Postage Stamps.)

Please Say That You Saw It in RADIO-CRAFT



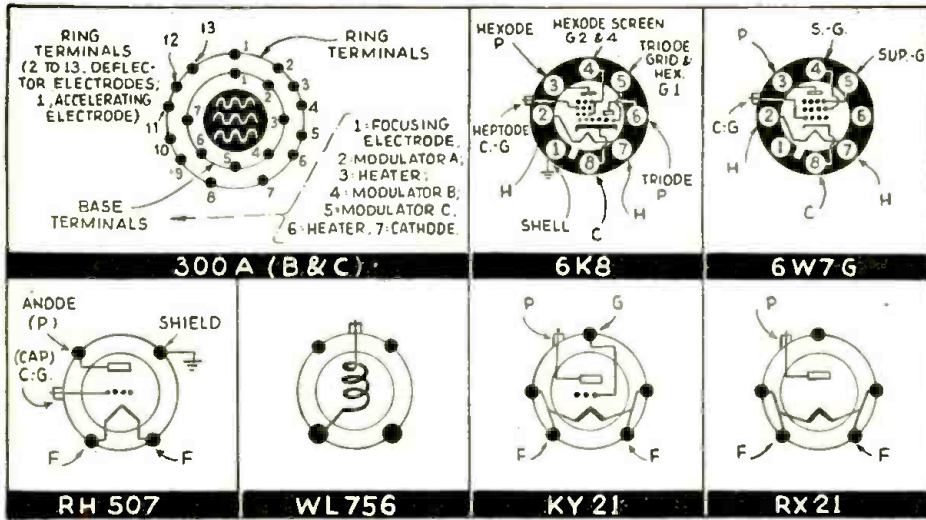

Fig. 1. Underside view of socket connections.

Conversion transconductance (approx.) 2 2 micromhos (At mixer control-grid bias = -30 volts)  
The transconductance of the oscillator section (not oscillating) is approximately 2,400 micromhos, with oscillator plate voltage of 100 volts and oscillator grid bias of 0 volts.

**6W7G—Table III Ratings**

Heater voltage (A.C. or D.C.)	6.3 volts
Heater current	0.15-amp.
Maximum plate voltage	250 volts
Maximum screen-grid voltage	100 volts
Direct Interelectrode Capacities—With tube shield to cathode	
Grid to plate	0.007-max. mmf.
Input	5.0 mmf.
Output	8.0 mmf.

**Amplifier—Class A**

Plate voltage	250 volts
Screen-grid voltage	100 volts
Control-grid bias	-3 volts
Suppressor-grid	Connected to cathode at socket
Amplification factor	1,850 approx.
Plate resistance	1.5 approx. megohms
Transconductance	1,225 micromhos
Plate current	2 ma.
Screen-grid current	0.5-ma.
Control-grid bias (for cathode current cutoff)	-7 approx. volts

**Detector—Biased Type**

Plate voltage	250 volts
Screen-grid voltage	100 volts
Control-grid bias	-4.3 approx. volts
Suppressor-grid	Connected to cathode at socket
Plate resistor	0.25-megohm

**RH507—Table IV Data and Ratings**

Filament potential	2.0 volts
Filament current	0.06-amp.
Filament type	Coated
Average characteristic values:	
Plate potential	4.0 volts
Plate current	0.06-amp.

Control-grid bias (approx.) negative	3.0 volts
Amplification factor	0.8
Grid-plate transconductance	60 micromhos
Filament socket style	766732 Industrial
Maximum control-grid current in tube	2 x 10-12 amp.
Ratings:	
Maximum plate potential	6 volts
Maximum plate current	0.2-ma.
Maximum control-grid bias	4 volts

**WL756—Table V Technical Data**

Main use	grid resistor
Max. voltage drop in tube	150 volts
Resistance in tube	10 megohms to 1,000,000 megohms
Temp. coefficient, negative	0.7% / C°
Max. dissipation	1 watt

**KY21—Table VI Characteristics**

Filament voltage	2.5 volts
Filament current	10 amps.
Peak inverse voltage	11,000 volts
Peak plate current	3 amps.

**RX21—Table VII Characteristics**

Filament voltage	2.5 volts
Filament current	10 amps.
Peak inverse voltage	11,000 volts
Peak plate current	3 amps.

In concluding this description, of all the new tubes for which we have editorial space, we want to hammer home to the practical radio man one important fact. **DO NOT OVERLOOK THE MONEYMAKING POSSIBILITIES RAPIDLY BEING OPENED-UP** through the introduction of heretofore unavailable tube types. Old radio apparatus may be redesigned to utilize the advantages afforded by the newer types of tubes; and, new equipment may be built for specialists in the several fields represented by certain special types of tubes.

**USEFUL CIRCUIT IDEAS**

(Continued from page 760)

The volume can either be controlled with the receiver's control or by a control (indicated by dotted lines in the picture diagram) which can be mounted in a small box near the phones or in the speaker cabinet in the event that an external speaker is used. Volume is more than ample for these purposes.

The double throw-double pole switch may be mounted, together with the tip-jacks, in any convenient place at the back of the chassis, making the job neat and convenient.

GEORGE GELLATLY

**HONORABLE MENTION**

**A PORTABLE SIGNAL GENERATOR.** The shielded signal generator shown in Fig. 6 was designed to enable dealers and Service Men to check and align ganged condensers accurately.

It can also be used to determine the sensitivity of receivers, and to check the output of tubes, speakers or audio transformers, as well as to check the calibration of any set. The oscillator consists of an R.F. generator operating over a range of 550 to 1,500 kilocycles; a 199-type of tube is used and means are provided to modulate the output of the oscillator over the required musical range. In the lower section of this shielded compartment there is space for the necessary batteries. A fractional part of the output of the oscillator is tapped off and, by means of a shielded cable, is carried over into the attenuator compartment. This output may be varied to suit the requirements. The meter, connected across the voice coil of the speaker, indicates the output in volts. The meter can also be used for measuring low A.C. voltages, such as the heater voltages of tubes.

M. J. FEIGENBAUM

Please Say That You Saw It in RADIO-CRAFT

Mr. Serviceman . . .  
**SUPERIOR INSTRUMENTS**  
LIVE UP TO THEIR NAME

**BUY DIRECT FROM THE FACTORY AND SAVE THE DIFFERENCE!**

Why pay fancy prices when you can buy direct from the factory and save 50% or more? Here are but three outstanding values in the Superior Line!

**This New ALLMETER**  
Really Is 27 Instruments in 1

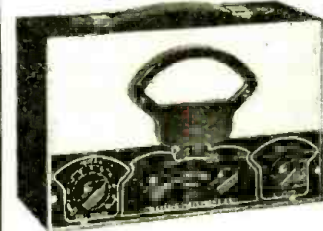

**1000 OHMS PER VOLT**

The ALLMETER permits both A.C. and D.C. measurements for volts and currents, also low resistance measurements from below one ohm, also high resistance capacities, henries and decibels, comprising 27 instruments in one.  
1—A.C. Currents, 15-150-750 ma. This extremely valuable service is practically never afforded by multi-test instruments. Instruments, 3.  
2—A.C. Volts, 15-150-750 volts. Affords also output meter service. Instruments, 3.  
3—CAPACITY, .01-50 mfd., all condensers, including electrolytics. Instruments, 1.  
4—5-1,000 Henries, coil loaded or not. Instruments, 1.  
5—LOW ohms, .03-500 ohms. Extremely valuable. Instruments, 1.  
6—HIGH ohms, to 0.5 meg., covering all practical values. Instruments, 1.  
7—D.C. Volts, 15-150-750 volts. Simplified scale uses same calibration as for a.c. Instruments, 3.  
8—D.C. Currents, 15-150-750 ma. The same scale simplification, also 0-1 milliamperes. Instruments, 3.  
9—Decibels, -12 to +10. Instruments, 3 + 8 = 30 (by interpolation) + 8 = + 50 by interpolation.  
10—Vacuum-tube voltmeter, 0-15-150-750 volts A.C. D.C. Instruments, 6.  
11—Continuity tester. Instruments, 1.  
Shipping wt. 8 lbs. Net price. . . . . **\$10.40**

**GENEMETER**



**With Variable Audio Frequencies \$14.40 Complete with Four Tubes**

• Combination R.F. and Audio Signal Generator, R.F. 100 KC. to 105 MC. A.F. 25-10,000 cycles, all direct reading, all by front panel switching.  
• R.F. and A.F. outputs independently obtainable alone, or with A.F. (any frequency) modulating R.F.  
• Output meter for connection across primary of receiver's output transformer for peaking with modulation "on."  
• R.F. is subject to attenuation, and oscillation leakage is minimum.  
• Condenser and other leakages tested to 100 megohms.  
• Main dial protected on 7 1/2" diameter, and 4-to-1 vernier planetary drive.  
• All services on 00-150 volts a.c. or d.c.  
Shipping weight 10 lbs.

**TUBE TESTER**

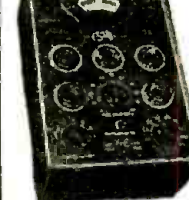

**MODEL V-45**  
Emission type perfected tube tester for any and all type receiver tubes, including metal and metal-glass. Tests shorts and leakage. Accurate, simple, sturdy, direct English reading (Bad-Good) . . . . . **\$10.40**  
Shipping weight 9 lbs.

**FREE!! CATALOG**

Is yours for the asking! Lists the entire Superior Line and quotes factory-to-you prices that make it really worth your while to "Buy Superior."

**SUPERIOR INSTRUMENTS CO.**  
136 Liberty St. Dept. RS-5 New York City, N.Y.







## SANTA ANITA'S NEW 300-WATT VOICE

(Continued from page 737)

stand area, the 4 center horns are equipped with 4 Permanent-magnet 707-B speaker units. The 4 horns on either side of these center 4, covering the areas to the left and right respectively, are each equipped with two of the above type of units, making a total of 12 horns and 20 units to cover the grandstand and ramp areas, which, by the way, are approximately 1,400 feet long. The 8 horns, to cover the infield area, are equipped with type 555-W units. The giant horns at Santa Anita's famous race track are 40% efficient. When fed with 250 watts, the total harmonic is but 1%; when fed 500 watts, the total harmonic content is only 4%.

At Santa Anita, the Announce and Control Booth is located on top of the grandstand. In the Control Booth, at this location, is installed a 4-position mixer, feeding a type 81-A amplifier; then, through a main gain control, to an 82-A amplifier. The output of the 82-A amplifier is fed across the track to the power amplifier banks, located in the infield in the tote board.

A volume level indicator is provided in the grandstand Monitor Booth, so that the control operator can determine the levels which are being fed to the main amplifier bank. These levels vary with the size of the crowd and the position of the call. Each operator is constantly informed of the number of people attending the track, and through experience, the levels are maintained at various levels, depending upon the attendance. Normally, when the race is being run, the crowds are reasonably quiet until the horses are coming down the stretch. When the noise level in the crowd rises tremendously,

the Monitoring operator, through his monitor speaker, follows the call and, as the horses enter the stretch for the stretch call, the volume is raised considerably to overcome competitive noise from the crowd.

In the totalizer board across the track are installed the following amplifier banks. The output from the 82-A amplifier is brought in and feeds two 92-A amplifiers through a resistive network. One of the 92-A amplifiers feeds 3 87-B amplifiers through resistive networks which are also volume controls. The other 92-A amplifier feeds 2 87-B amplifiers and 2 M-43A amplifiers through similar networks. Each of the 87-B amplifiers feeds 4 of the 707-B units and each of the M-43A amplifiers feeds 4 of the 555-W units covering the space inside the track. The volume controls on the final stage amplifiers permit the adjustment of volumes in groups of horns so that levels may be uniform through the entire listening area.

The operation of the entire system consists of the Announcer and two operators, one in the Monitor Control Room, the other at the Power Amplifier Bank. By careful observation and tabulation, it has been possible to work out the correct volume levels for the various attendance figures, so that the sound is always uniform irrespective of crowd size.

The record crowd at Santa Anita was last New Year's Day, when there were over 60,000 people in attendance. Sixty thousand people can make a lot of noise at a race-track. The system has been capable of over-riding this noise and producing an intelligible call under this condition, which is probably one of the worst to be encountered by any public address installation.

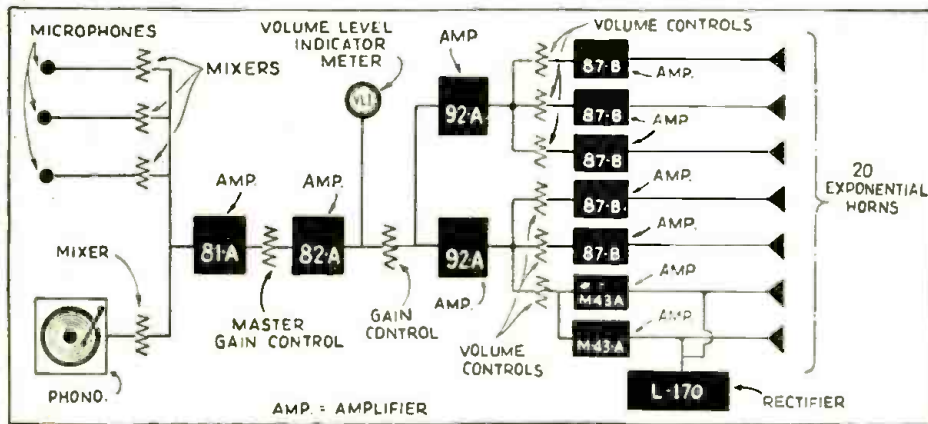

Fig. 1. Block diagram of the 300-watt P.A. system of the Santa Anita race track.

## NEW CIRCUITS IN MODERN RADIO RECEIVERS

(Continued from page 741)

phase inverter tube 6K7. The signal output is, therefore, extremely low. As the signal volume at the 2nd-detector output is increased, some of the A.F. component will be rectified by the 6H6 bias control tube, which rectified current will build up a bias on the 6K7, thus diminishing its output. Accordingly, the opposing reverse-phase signal will be diminished and more "direct-phase" signal will be reproduced. The circuit action is delayed until the peak audio signal reaching the 6H6 diode plates exceeds the negative voltage of the bias cell impressed on them.

### (5) WHISPER TUNING CIRCUIT

Silvertone models 4680 & 4790. A new type of intercarrier noise suppressor or muter circuit is included in this and other Silvertone models. In conjunction with the A.V.C., it operates in the high-frequency section of the set instead of the customary audio muter circuit.

The schematic circuit is shown in Fig. 1E. To the 6Q7 2nd-detector diode section is attached the conventional audio and A.V.C. output and in addition, another output through C19 to one diode plate of another 6Q7G operating as the "whisper tuning control."

When connected and no signal is being received, the grid of the whisper tuning 6Q7G tube will be at zero potential with respect to cathode and the plate being somewhat more positive than the cathode, plate current will flow. The drop across the volume control, R13, will be considerable and will be positive at the detector cathode with respect to the end which connects to the whisper tuning plate. This nega-

tive voltage is on the A.V.C. line and reduces the sensitivity of the set accordingly.

As soon as a signal comes in, it is induced onto one diode plate of the whisper tuning tube through C19, the rectifier action of which is arranged to bias the grid of this tube practically to the signal peak value at the 2nd-detector diode plates. This reduces or completely cuts off the whisper tuning tube plate current, allowing the signal to operate the 2nd-detector and A.V.C. normally. The slightest signal will quickly render the whisper tuning tube inoperative.

## MAKE YOUR "SILENT" MOVIES INTO HOME TALKIES

(Continued from page 746)

may be recorded on and reproduced from a 300-foot length of film! The recording on a 300-foot roll of film is the equivalent of that possible on 51 discs, each 12 inches in diameter. (See upper film, Fig. C.)

Portability is another point featured in the new recording device, which weighs but 6 pounds, complete. It can be furnished with pickup units of any standard impedance, to match the output of the set with which it is to be used, and is said to give fidelity of reproduction of audible frequencies from 50 to 5,000 cycles.

Our Information Bureau will gladly supply manufacturers' names and addresses of any items mentioned in RADIO-CRAFT. Please enclose a stamped and self-addressed envelope.

Please Say That You Saw It in RADIO-CRAFT

# OVER 1500 CASE HISTORIES

## TO SPEED UP YOUR SERVICE WORK

Get the world's greatest collection of "Case Histories"—Ghirardi's time-saving "loose-leaf" RADIO FIELD SERVICE DATA Book. Each one tells you exactly what part of the set is causing the trouble—and how to remedy it! No fussing, no casing—you get directly to the seat of the trouble in a few moments! Think of the work you'll save by having these servicing short-cuts at your elbow. Once you get into the habit of first referring to Ghirardi's "Case Histories" before starting every service job, you may save over 50% of the time you are now spending in trouble-shooting.

But that's just one feature of this great Data Book. You'll also get the list of over 6,000 superhets, 40 Car-Wiring Diagrams, Auto-Radio Installation and Ignition System Interference data for all cars, and over 25 other indispensable tables and charts for shop and job reference. This book is kept always up-to-the-minute by a regular Supplement Sheet Service.

**Get the Servicing text, too!** Get the DATA Book together with Ghirardi's famous MODERN RADIO SERVICING—a clear, complete and comprehensive explanation of everything about modern servicing instruments and practice. It gives you a whole big 420-page section on Test Instruments theory, operation, construction, with diagrams, etc.; Trouble-Shooting and Repair methods; Noise-Elimination; Auto-Radio Installation and Servicing; AVC and QVC Circuits; Aligning Superhets, etc., etc. All "417 Essentials" of successful radio service work are explained fully—and illustrated!—in this amazing collection of practical quick-use servicing information.

These 2 books give you "the whole works"—shop reference data and knowledge you really have to have. Get them today! Sent Postpaid Anywhere!

### MODERN RADIO SERVICING

### RADIO FIELD SERVICE DATA BOOK

1800 PAGES, 813 ILLUS. \$6

Both Books for \$6

**ORDER NOW! MONEY-BACK GUARANTEE**

To: Radio & Tech. Pub. Co., Dept. RC-58, 45 Astor Pl., N. Y. C.

Here is \$6 for MODERN RADIO SERVICING and RADIO FIELD SERVICE DATA (including 37 Supplements to Data Book) postpaid (\$8.50 for foreign).

Please send free descriptive literature about these 2 books.

NAME.....

ST. & CITY..... STATE.....

## SPEED UP

Your Service Work with GHIRARDI'S GADGETS

In a flash these amazing Pocket Trouble Shooters spot over 800 different troubles—Give YOU exact TESTS and REMEDIES. One each for HOME and AUTO radios. See Trial. Write for FREE Circular—no obligation! Write RADIO & TECHNICAL PUBL. CO., 45 Astor Pl., N.Y.C. Dept. RC-58.

### 6-VOLT UNIVERSAL POWER PACK

At Less Than Price 6-Prong Synchronous Vibrator Alone!

LISTS \$15.00

Operates 2 volt set from 6 volt storage battery, also operates 6 Volt house sets, auto sets, S.W. transmitters and receivers. Output, 180 Volts at 50 M.A. On 4 Volt cell supplies 120 Volts at 30 M.A. Housed in case 3"x4"x6 3/4". Shipping Wt. 6 lbs. **ONLY \$3.95 NET**

ARROW SALES COMPANY  
27 S. Jefferson St. Chicago, Ill.



# SOUND ENGINEERS

Indoor and Outdoor Installations are made reliable and dependable with Wright-DeCoster Reproducers.

Write for literature and name of our nearest distributor. Wright-DeCoster Distributors are always anxious to cooperate.

## WRIGHT-DECOSTER, Inc.

2251 University Ave., St. Paul, Minn.  
Export Dept.: W. Simmons & Son Co., New York  
Cable Address: "Simontrick"  
Canadian Representatives:  
Wm. F. Kelly Co., 1207 Bay St., Toronto, Ont.  
Taylor & Pearson, Ltd., Edmonton, Alta.

# MILLION MODEL S

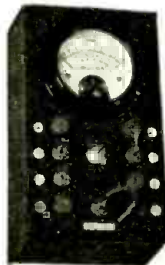

## Pocket Volt-Ohmmeter

0-5-50-500-1000 volts @ 1000 ohms per volt.  
0-1000 ohms  
0-500,000 ohms.

Cash Price **\$7.95**  
Dealers Net

Write for literature on full line.

**MILLION RADIO & TELEVISION**  
559 N. Union Chicago

# RADIO ENGINEERING,

broadcasting, aviation and police radio, servicing, marine radio telegraphy and telephony, Morse telegraphy and railway accounting taught thoroughly. Engineering course of nine months' duration equivalent to three years of college radio work. All expenses low. Catalog free. School established 1871.

Dodge's Institute, Hudson St., Valparaiso, Ind.

# G.E. PHONOGRAPH MOTOR

Formerly Sold for \$15.00

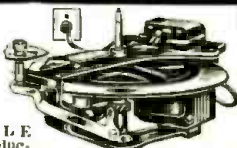

Only **\$4.95**

**VARIABLE** speed induction type self-starting, 110 volt, 25 to 60 cycle, AC, with speed control. Plug and cord. Speed range from 5 to 200 RPM. Can be installed in place of old-fashioned, hand-winding speed motor. Also ideal for display turn table, and a hundred other uses. These General Electric Motors are brand new. In original factory cartons. **\$4.95**

Shipping Weight—12 lbs.

# MICROPHONE and RECEIVER

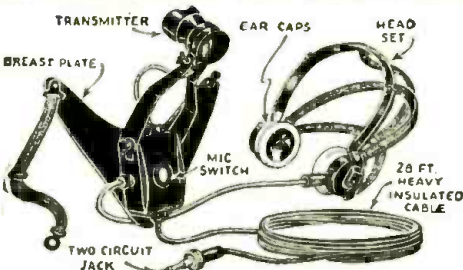

**THIS** Microphone and telephone headset outfit was built especially for the U. S. Navy Aviation Corps. The Holtzer-Cabot Electric Company constructed the outfit to Government specifications. It consists of a low-impedance carbon microphone (transmitter), fastened to a metal breastplate, and a set of heavy-duty, low-impedance ear-phones. A switch on the back of the breastplate controls the microphone circuit. The earphones are U.S.N. Utah type, attached to adjustable headband. Twenty-eight feet of heavy weather and waterproof conductor cable furnished. Current of not more than 10 volts should be used. **\$4.95**

The shipping weight is 9 lbs.

We will forward Shipments by Express Collect if sufficient postage is not included.

## WELLWORTH TRADING CO.

560 W. Washington Blvd., Dept. RC-538, Chicago, Ill.

# THE LATEST RADIO EQUIPMENT

(Continued from page 750)

to stage a 15- to 20-watt set-up. Gain of amplifier unit is 140 db.; dual low-gain and one high-gain channel; mixing, fading and tone controls; variable output impedances. Includes velocity mike and stand, two 12-in. electrodynamic speakers.

## 19-WATT BEAM AMPLIFIER (1588)

(Amplifier Company of America)

**THIS** unit is one of a series of economical amplifier units designed for maximum performance at minimum weight and bulk. Employs a new anti-heater emitting circuit to provide for high-gain and low-hum level. Incorporates self-healing condensers, ceramic-insulated resistors and tropically-treated transformers. Over-all gain is 110 db. Mike and phono. inputs, electronically mixed. Frequency response, 40 to 10,000 cycles  $\pm 1$  db. Utilizes 1-6J7, 1-6N7, 1-5T4, and 2-6L6s. Weight, 25 lbs.

## "SAFETY TUNING" PUSHBUTTON CAR-RADIO SET (1589)

(Crosley Radio Corp.)

**STATES** the manufacturer: "The safety factor alone has obsoleted all automobile radio sets that have to be dialed. There are more than 22 million automobiles registered in the United States, and the production of automobiles in 1937 was slightly under 5 million cars. Of these 22 million automobiles in use, only about 6 million are equipped with radio receivers. This makes a potential market for at least 16 million auto-radio sets—not counting further sales of new and used cars and the obsolescence of auto sets now in use, as a result of the development of safety tuning in auto radio. It is the greatest sales opportunity in radio since radio sets were introduced."

## ANTENNA MATCHING RESONATOR (1590)

**HERE** is a compact, simple device called the "matching resonator" which, at last, gives the Service Man or, for that matter the owner himself, ready means to match the auto-radio set to the aerial. Installed in a second, without tools, the "matching resonator" increases the sensitivity of the set in any segment of the dial desired by the owner. Mismatched aerial and set combinations are brought into resonance. No longer need a radio set be condemned, nor the aerial be blamed for disappointing performance. This unit is a tapped inductance giving a choice of 7 inductance values. The principle involved which follows standard radio theory will be evident to the Service Man.

## CONDENSERS FOR PUSHBUTTON TUNING (1591)

(Cornell-Dubilier Electric Corp.)

**FIXED** mica-dielectric condensers for use in shunt to the trimmers used in pushbutton tuning. Have a tolerance well within 3 per cent. Extremely high "Q" and excellent "retrace" (return to original value upon cooling). These characteristics have been achieved by silver-

plating the mica instead of using foil. Capacities range from 10 mmf., to 0.0011-mf.; rated at 1,000 V. D.C. test. Bakelite encased, these units have a temperature coefficient of +0.003-deg. C.

## SMALL VOLT-OHMMETER (1592)

(Million Radio and Television Labs.)

**A** SMALL, 1,000-ohms/volt meter recently added to a line of test equipment is illustrated. Ranges: 0/5/50/500/1,000 V. D.C.; 0.1-ma.; 0/1,000 ohms/0.5-meg. Instrument measures 2 x 3 1/4 x 5 1/2 ins. long.

## MARINE-TYPE SPEAKER (1593)

(Atlas Sound Corp.)

**THIS** LATEST loudspeaker is said to be "absolutely 100 per cent weatherproof," and is recommended for all outdoor installations such as freight and lumber yards, amusement parks, etc. The inverted position of the motor unit helps protect it. The acoustic output is said to take the form of a high-pressure sound beam.

## PLUG-IN RESISTORS (1594)

(Clarostat Mfg. Co.)

**THESE** precision, plug-in type resistors provide maximum flexibility as to resistance values and range. Likewise, they offer a rapid method of building up any desired sequence of values together with low contact resistance. With this method, 20 wire-wound, 1-W. resistors, accurate within 1/10 to 1/4 of 1%, provide a range from 1 ohm to 0.1-meg. in 1-ohm steps, as compared with 50 resistors necessary in the usual decade box.

## HIGH-VOLT CONDENSERS (1595)

(Solar Mfg. Corp.)

**NEWEST** in an established line of high-voltage condensers is a solarex unit available in 11 ratings from 1 mf. at 1,000 D.C. operating volts to 2 mf. at 3,000 D.C. operating volts.

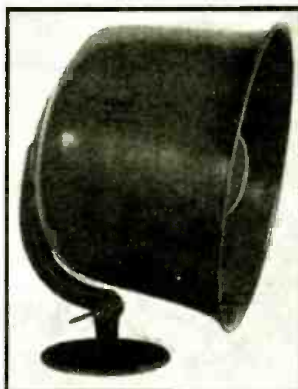
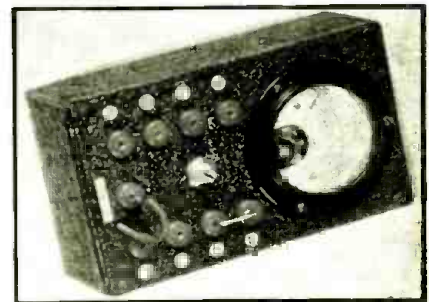
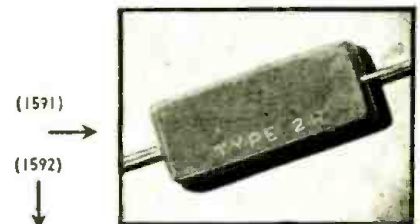

(1593)



(1594)



(1595)

Please Say That You Saw It in RADIO-CRAFT



The Completed Edition of Volume 7 of the  
**OFFICIAL RADIO SERVICE MANUAL**

totals 1,800 pages. So up-to-the-minute is this volume, you will find receiver schematic diagrams, servicing data, and other essential radio information only a few weeks old. **NEWER IN CONTENTS THAN ANY OTHER RADIO MANUAL PUBLISHED, Volume 7 is today's super value in modern radio books.**

**GET THIS GREAT RADIO SERVICING GUIDE ON APPROVAL — JUDGE FOR YOURSELF HOW COMPLETE IT IS — See Page 724 for the details.**

**NOW READY!**

**SERVICING QUESTIONS & ANSWERS**

(Continued from page 753)

(A.) When a receiver is rewired from 60-cycle to 25-cycle operation, other changes in addition to power transformer replacement are essential. In almost every case, the capacity value of the input or first filter condenser must be increased. There are instances where additional capacity for the second filter condenser is important. In your case, we would suggest that an 8 mf., 450-volt electrolytic unit be shunted across the first and second filter condensers, as shown in Fig. Q.51. This procedure will increase operating potentials to normal values. The low voltages obtained now are probably the cause for inoperation. Also, check to determine whether the center-tap of the 6.3 volt filament winding has been grounded. Omission of this connection, after making the transformer change, may be the cause for your trouble. Another possibility is the center-tap connection from the 2.5 volt winding which supplies filament power to the type 47 tubes. Are you sure that proper connections to this point have been made? This 2.5 volt center-tap is the source for "C"-bias for the power tubes. An error in connections at this point may remove the bias to the power tubes, which, in turn, will increase the plate current of the power tubes and reduce the overall voltage as well as the voltage to the 47s' plates.

**SERVICE MEN!—"PUSHBUTTON-IZE" OLD RECEIVERS**

(Continued from page 742)

connect the small variable condensers to the oscillator and antenna circuits (see Fig. 1) of the superhet. radio receiver; or to the R.F. and detector tuning condensers of a T.R.F. receiver.

It is quite simple to set up the various broadcast stations; it is merely necessary to push any button, then adjust the oscillator and antenna variable condenser in the unit to the desired station. This operation is performed with a screwdriver. The adjustment of any set of condensers does not affect the alignment of the other condensers.

The variable condensers are mounted on specially treated, non-hygroscopic, low-loss ceramic bases. The condenser plates are designed to give a wide range of capacity together with a high degree of stability and freedom from drift. The screw adjustment of each condenser is extremely fine, so that it is possible to tune even the most selective radio receivers to exact resonance.

It is not necessary to use any auxiliary switch for the purpose of changing from automatic to manual tuning. One button on the switch is provided for manual operation and when this button is pressed, the condensers in the automatic unit are completely disconnected and the radio receiver is operated in the usual manner.

The unit is completely shielded and enclosed in a duralac-finished metal container. It is a compact, simple and foolproof unit for installation in any receiver where automatic tuning is desired.

This article has been prepared from data supplied by courtesy of Automatic Devices Manufacturers.

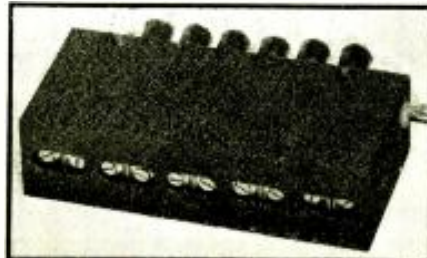

Rear view of the pushbutton unit showing the trimmer-condensers' alignment screws.

**NOTICE**

The JUNE issue of Radio-Craft will be especially profitable for you. Don't miss it.

**FREE** *Spring Catalog*

**new spring catalog**

**READY, FANS!** New Spring number of the radio catalog supreme! Read about new Lafayette super receivers for 1938—advanced line of Lafayette Public Address—real "buys" in famous name cameras—everything in radio! Prices you can't beat anywhere. Send for this amazing **FREE catalog TODAY!**

**LAFAYETTE RECEIVERS**  
**CAMERAS**  
**LAFAYETTE PUBLIC ADDRESS SYSTEMS**

Get **FREE** parts list on circuits described in this or any other magazine. Write now.

**MAIL COUPON NOW**

**WHOLESALE RADIO SERVICE CO. INC.**  
NEW YORK, N.Y. • CHICAGO, ILL. • ATLANTA, GA.  
120 SIXTH AVENUE NEW YORK, N.Y. 242 PRITCHETT STREET BOSTON, MASS. • BRONX, N.Y. • NEWARK, N.J. • JAMAICA, L.I.

**WHOLESALE RADIO SERVICE CO., INC.**  
901 W. Jackson Blvd., Chicago • 100 Sixth Ave., New York  
(MAIL TO NEAREST WAREHOUSE)

Rush the **NEW SPRING** Catalog No. 71—3E8   
Send **FREE** parts list

Name.....  
Address.....  
City..... State.....

PASTE COUPON ON PENNY POST CARD

**NEVER BEFORE**  
so much performance for so little money

**MODEL 407 ONLY \$9.95**  
**AC-DC Multitester**

\* Large multicolored dial, 3 1/2 inch Bakelite case. D'Arsonval meter, accuracy within 2%.  
Four range AC Voltmeter 0/3/7.5/30/300 volts—ideal for measuring output voltages, filament and line voltages. Three range ohmmeter 0/100/10,000/100,000 ohms. Low range ohmmeter reads 0.05 ohm for each of first four dimensions.  
Four range D.C. voltmeter 0/7.15/30/300/750.  
Four decibel ranges. Four output ranges. Two current ranges 0/3/30 milliamperes. 21 complete instruments in one compact case.

Write for Catalog C-5

**RADIO CITY PRODUCTS CO.**  
88 PARK PLACE NEW YORK CITY

**Better - Quicker - More Profitable Servicing with RADIO CHASSIS CRADLE**

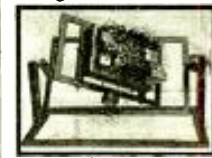

Service shops need the **RADIO CHASSIS CRADLE** for efficient servicing of testing and repairing of receivers or amplifiers. Equipment clamps to cradle which can be adjusted to any angle. Accommodates chassis up to 13 x 12 x 23 inches. Excellent for displaying receivers. Write for illustrated circular RC1

WM. A. THOMAS CO. 321 CAROLINE ST., NEENAH, WISCONSIN

Please Say That You Saw It in RADIO-CRAFT



# RADIO ENGINEERING



RCA Institutes offer an intensive course of high standard embracing all phases of Radio and Television. Practical training with modern equipment at New York and Chicago schools. Also specialized courses and Home Study Courses under "No obligation" plan. Catalog Dept. RT-38.

**RCA INSTITUTES, Inc.**

A Radio Corporation of America Service  
75 Varick St., New York 1154 Merchandise Mart, Chicago

## You need our 1938 Catalog

It illustrates and describes our complete line of

**RACKS • PANELS • CABINETS**  
FOR ALL RADIO AND P.A. NEEDS  
Write for your Free Copy Today!

**PAR-METAL PRODUCTS CORP.**  
3527 41st St., Long Island City, N. Y.

## MODERNIZE YOUR OBSOLETE TUBE CHECKER OR SET ANALYZER with "PRECISION"

Write for details. Mention make and model number of your old instrument.

**PRECISION APPARATUS CORP.**  
1821 EAST NEW YORK AVE., BROOKLYN, N. Y.

## Complete Electric Plants



Onan A. C. plants furnish same current as city lines, 110 Volt, 60 Cycle. For farms, camps, construction jobs. Operate radio, water system, all appliances. New models, 350 to 5000 watts. 6, 12, 32 and 110-volt D.C. Models \$57.50 and up. Also combination A.C. - D.C. units. Shipped complete, ready to run.

Write for details.  
**D. W. ONAN & SONS**  
665 Royalton Ave., Minneapolis, Minnesota



# BRINGS YOU ANY ONE OF THESE 4 FAMOUS RADIO BOOKS

**RADIO FANS!** Help yourselves to a radio education for the price of 10c per book. These books give you a good foundation towards the study of radio. You'll be amazed at the wealth of information contained in them. They are especially written for beginners but are useful review and reference books for all.

Each book contains 32 pages, profusely illustrated with clear, self-explanatory diagrams. They contain over 15,000 words of clear legible type. They are an education in themselves and lay the groundwork for a complete study of radio and electricity.

### HOW TO BUILD FOUR DOERLE SHORT-WAVE SETS

Due to a special arrangement with the publishers of **SHORT WAVE CRAFT**, we present in this book complete details for building the Doerle sets, also an excellent power pack if you plan to electrify any of the sets. Contains **EVERYTHING** that has ever been printed on these famous receivers. These are the famous sets that appeared in **SHORT WAVE CRAFT**: "A 2-Tube Receiver that Reaches the 12,500 Mile Mark," by Walter C. Doerle, "A 3-Tube 'Signal Gripper,'" by Walter C. Doerle, "The Doerle

### HOW TO MAKE THE MOST POPULAR ALL-WAVE 1- AND 2-TUBE RECEIVERS

This book contains a number of excellent 1- and 2-tube sets, some of which have appeared in past issues of **RADIO-CRAFT**. These sets are not toys, but have been carefully engineered. They are not experiments. To mention only a few of the sets the following will give you an idea. The Megadyne 1-Tube Pentode Loudspeaker Set, by Hugo Gernsback—Electrifying The Megadyne—How to Make a 1-Tube Loudspeaker set, by W. F. Chesney—How to Make a Simple 1-Tube All-Wave Electric Set, by F. W. Harris—How to Build a Four-in-Two All-Wave Electric Set, by J. T. Bernsley, and others. Each set is fully described in simple language so that anyone can build with limited means and with practically no experience worth-while all-wave radio set. Has 30 illustrations.

### ALTERNATING CURRENT FOR BEGINNERS

This book gives the beginner a foothold in electricity and radio. Electric circuits are explained. This includes Ohm's Law, alternating current, sine waves, volts, amperes, watts, condensers, transformers, motors and generators. A.C. instruments, house-wiring systems, electrical appliances and electric lamps. Here are some of the practical experiments which you can perform. Simple tests for differentiating between A.C. and D.C.; how to light a lamp by induction; making a simple electric horn; demagnetizing a watch; testing motor armatures; charging storage batteries from A.C. outlet; testing condensers with A.C. making A.C. electromagnets; frying eggs on a cake of ice; making a simple A.C. motor and many others. Has 42 illustrations.

### ALL ABOUT AERIALS

In simple, understandable language this book explains the theory underlying the various types of aerials; the inverted "L," the Doublet, the Doublet, the Doublet, etc. It explains how noise-free reception can be obtained, how low impedance transmission lines work; why transposed leads are used. It gives in detail the construction of aerials suitable for long-wave broadcast receivers, for

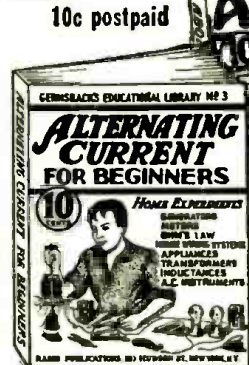
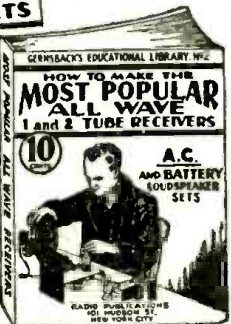
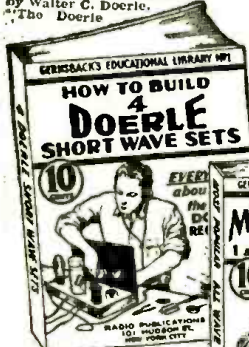

2-Tube" Adapted to A.C. Operation, "The Doerle 3-Tube 'Signal Gripper' Electrified," and "The Doerle Goes 'Band-Spread.'" Has 30 illustrations.

10c postpaid

10c postpaid

10c postpaid

Remember that each book has 32 pages and contains over 15,000 words. Each book has from 30 to 66 fine illustrations. **POSITIVELY THE GREATEST 10c VALUE IN RADIO BOOKS EVER OFFERED TO THE PUBLIC.**

If you do not think that these books are worth the money asked for them, return them within 24 hours and your money will be instantly refunded.

Send for our FREE circular listing 48 new 10c Publications

**RADIO PUBLICATIONS**  
99A Hudson St., New York, N. Y.

## SLIDERULES!—FOR P.A. AND SERVICE WORK

(Continued from page 776)

If the corresponding voltage ratio for a db. difference of more than 80 is desired, then 60, 120, 180, etc., should be subtracted and the ratio corresponding to the remainder established. This result, likewise, must be multiplied by 10<sup>3</sup>, 10<sup>6</sup>, or 10<sup>9</sup>, depending on whether 60, 120, or 180 was subtracted.

Tables A and B which follow this discussion provide a quick means of making an approximate check on the accuracy of the results obtained with the methods given.

Examples:

(a) Given a power ratio of 4,000,000 to 70. What is the equivalent db value?

$$\frac{4,000,000}{70} = \frac{57,143}{1} \times 1,000 = \frac{57,143}{1} \times 10^3 \quad (n=3)$$

What is the equivalent db value? Adjust rule until 57.14 on scale "B" coincides with "1" on scale "A." Then the arrow on scale "D" will coincide with 17.6 on scale "C." However, the correction factor  $10 \times n$  is  $10 \times 3 = 30$ , and since this factor is additive, the correct db. value is  $30 + 17.6 = 47.6$  db. Thus, power outputs with the ratio of 4,000,000 to 70 represents a difference of 47.6 db. in power level.

(b) 66 db. equals what power ratio? Subtract 30 from 66. The remainder is 36. Adjust the rule until 36 on scale "C" is opposite the arrow on scale "B." The number 4,000 on scale "C" then will be opposite "1" of scale "B." Since the original value was reduced by 30, the multiplying factor will be 10<sup>3</sup>, or 1,000. Thus the power ratio corresponding to a db. difference of 66 =  $4,000 \times 1,000 = 4,000,000$ .

TABLE A

Power in Watts	Decibel Values
600,000,000	+110
60,000,000	+100
6,000,000	+90
600,000	+80
60,000	+70
6,000	+60
600	+50
60	+40
6	+30
.6	+20
.06	+10
.006	0
.0006	-10
.00006	-20
.000006	-30
.0000006	-40
.00000006	-50
.000000006	-60
.0000000006	-70
.00000000006	-80
.000000000006	-90
.0000000000006	-100
.00000000000006	-110

TABLE B

Power Voltage or Current Ratios	Corresponding DB. Value For Power Ratios	For E or I Ratios
1	0	0
2	3	6
5	7	14
10	10	20
50	17	31
100	20	40
500	27	54
1,000	30	60
5,000	37	74
10,000	40	80
20,000	43	86
50,000	47	94
100,000	50	100
500,000	57	114
1,000,000	60	120
5,000,000	67	134
10,000,000	70	140
100,000,000	80	160
1,000,000,000	90	180
10,000,000,000	100	200
100,000,000,000	110	220

**RADIO PUBLICATIONS**  
99A Hudson Street, New York, N. Y. RC-538

Please send immediately POSTPAID the books checked:

No. 1—How to Build 4 Doerle Short Wave Sets.....10c

No. 2—How to Make the Most Popular All-Wave 1- and 2-Tube Receivers.....10c

No. 3—Alternating Current for Beginners.....10c

No. 4—All about Aerials.....10c

I am enclosing.....c: the price of each book is 10c

Send me FREE circular listing 48 new 10c publications

Name .....

Address .....

City ..... State .....

(U. S. Coin or U. S. Stamps acceptable.) Books are sent postpaid.

Please Say That You Saw It in RADIO-CRAFT



**ADVERTISERS' INDEX**

<b>A</b>	
ABC Radio Laboratories.....	774
Aerovox Corporation.....	768
Allied Radio Corporation.....	769
American Microphone Co.....	757
American Television Institute.....	Back Cover
Amberlite Corporation.....	770
Amplifier Co. of America.....	781
Amplitone Products Co.....	761
Arcturus Radio Tube Co.....	763
Arrow Sales Company.....	777
Atlas Sound Corporation.....	762
Automatic Devices Manufacturers.....	782
<b>B</b>	
Browning Laboratories, Inc.....	781
The Brush Development Co.....	774
Burstein-Applebee Company.....	776
<b>C</b>	
Capitol Radio Engineering Instit.....	774
Central Radio Laboratories.....	764
Charostat Mfg. Company, Inc.....	766
Cornell-Dubilier Corp.....	779
Cosne Electrical School.....	725
<b>D</b>	
Dodges Instit.....	778
Allen B. Du Mont Laboratories, Inc.....	759
<b>E</b>	
Electric-Eye Devices Company.....	782
Electronic Products Company.....	776
<b>H</b>	
Hanmarlund Mfg. Company.....	772
Hygrade Sylvania Corp.....	773
<b>I</b>	
Illinois Condenser Company.....	776
International Resistance Co.....	723A
<b>L</b>	
Lancaster, Allwine & Round.....	772
Lincoln Engineering School.....	776
<b>M</b>	
Midwest Radio Corp.....	782
Million Radio & Tel. Labs.....	778
Moldell's.....	774
<b>N</b>	
National Plans Institute.....	782
National Radio Institute.....	721
National Schools.....	772
National Union Radio Corp.....	768
<b>O</b>	
D. W. Onan & Sons.....	780
<b>P</b>	
Par-Metal Products Corp.....	780
Precision Apparatus Corp.....	780
<b>R</b>	
Radio Circular Company.....	772
Radio City Products Company.....	775
Radio Constructors Labs.....	782
Radio Publications.....	780
Radio & Tech. Publ. Co.....	774
Radio Training Assoc. of America.....	72314
Radolek Company.....	781
Raytheon Production Corp.....	765
R.C.A. Institutes, Inc.....	780
Readrite Meter Works.....	763
Reliable Radio Company.....	772
Remington Rand, Inc.....	770
John F. Rider.....	771
<b>S</b>	
Solar Mfg. Company.....	782
Sprayberry Academy of Radio.....	787
Superior Instrument Company.....	775
Supreme Instruments Corp.....	757
Swad & Sell.....	772
<b>T</b>	
Tavella Sales Company.....	782
Technifax.....	770
Test Equipment Co. of America.....	Inside Back Cover
William A. Thomas Company.....	779
Triplet Elect. Instrument Co.....	760
<b>U</b>	
United Radio Company.....	770
Utah Radio Products Co.....	773
<b>W</b>	
Montgomery Ward & Co.....	766
Webster-Chicago.....	759
Wellworth Trading Company.....	782
Weston Elec. Instr. Corp.....	Inside Front Cover
Wholesale Radio Service Co.....	779
Wright-DeCoster, Inc.....	778

(While every precaution is taken to insure accuracy, we cannot guarantee against the possibility of an occasional change or omission in the preparation of this index.)

**BEGINNERS!—  
BUILD THIS I-TUBE  
LOOP RECEIVER**

(Continued from page 758)

the strength of the signal, which is then transformer-coupled (for further voltage gain) into the audio amplifying section of the type 19 tube.

If the diagrams are followed carefully and the batteries connected as shown in the pictorial diagram, then, the receiver will work "right off the bat." **Caution.**—At no time must the tube be permitted to get over 2 volts on the filament. A voltmeter will be useful to you.

Turn condenser C2 until you hear the purring sound which is characteristic of a regenerative receiver, or a whistle. If you hear a whistle turn the loop to such a position as to make the whistle loudest and then manipulate condenser C1 to bring in the whistle louder still. Now turn condenser C2 until the whistle just about disappears and your station will come in with amazing clarity.

**LIST OF PARTS**

- One variable condenser, midget type, 350 mmf., C1;
- One loop antenna (see text);
- One filament rheostat, 20 ohms, R2;
- One Meissner type 17028 trimmer-type (regeneration) condenser, 80-225 mmf., C2;
- One fixed mica condenser, 100 mmf., C3;
- One fixed paper condenser, 600 mmf., C4;
- One Meissner type 6846 R.F. choke, 80 mhy., R.F.C.;
- One Kenyon audio transformer, 3-to-1 ratio, A.T.;
- One I.R.C. carbon resistor, 2 megs., ½-W., R1;
- One filament on-off switch, Sw.;
- One 6-prong wafer socket;
- One single-circuit phone jack;
- One National Union type 19 tube;
- One Eveready "B" battery, No. 733, 45 V.;
- One Eveready "A" battery, No. 723, 3 V.;
- One metal box, any suitable size.

**OPERATING NOTES**

(Continued from page 747)

ceptible to oscillation due to feedback to the 2nd-detector.

RCA 125. Distortion in a number of cases may be found due to a leaking cathode bypass condenser on the 6B7 2nd-detector. This trouble is hard to identify and the condenser is hard to find. (See Fig. 4.) It is a 4-mf. electrolytic located between the resistor panel and chassis and may successfully be replaced with a 5-mf. electrolytic. The only indication of trouble in this case seems to be a slight lowering of plate voltage on the 6B7 2nd-detector.

Trav-Ler 50-A. Plays for about 5 minutes then fades slightly accompanied by distortion. The type 43 amplifier tube circuit goes into oscillation. The remedy is to reduce the screen-grid voltage on the 43 by inserting a 7,000-ohm resistor in the screen-grid lead. (See Fig. 5.) This will effectively block any tendency to oscillate.

Distortion and choked reproduction may also be due to failure of the audio coupling condenser C1, as described for the Grunow 7A receiver (see Fig. 2).

VICTOR I. DUMLEY,

**37 HOURS OF SOUND ON  
SINGLE 16 MM. REEL!**

(Continued from page 728)

pointed stylus will instantly reproduce the recordings. After one sound track has been impressed on the film, the machine is so designed that the diamond stylus will move over slightly to cut the next track. This applies to the entire reel of 2,000 feet or any part of it. The recordings are practically indestructible, for after 1,000 renditions there is no appreciable wear or loss of quality of reproduction. A test strip of this sound film was first frozen, then heated to 160 deg. Fahrenheit, and then scrubbed with a stiff brush without causing any ill effects. The film has no photographic emulsion, is not perforated, and is a specially-prepared acetate cellulose base.



Just a child's game that manufacturers never stop playing.

Leaders are known by their "firsts." Among the outstanding developments of the ACA laboratories are:

- First Audio Spectrum Control; First Audio Expander; First Remote Robot Monitor; First Automatic Audio Frequency Control; First Commercial Beam Power Amplifier; First Automatic Anti-Howl Amplifier; First Automatic Volume Compressor; First F.V.F.S. Beam Power Amplifier; First Automatic Audio Volume Control; First Floating Audio Power; First Self-Contained Volume Expander; First Direct-Coupled Beam Amplifier; First Synchronous H.F. and L.F. Control; First Cathode Ray Overload Indicator; First Anti-Microphonic Chassis Design; First Electric Chopper Amplifier; First Commercial Cathode-Drive Amplifier.

These outstanding features, plus our Five-Year guarantee and Mr. A. C. Shaney's expert advice, makes ACA your logical source for public address amplifiers.

WRITE FOR FREE LATEST CATALOG.

**AMPLIFIER CO. of AMERICA**  
37-47 West 20th Street New York, N. Y.



● Everything you need in radio. It's all in this new RADOLEK RADIO PROFIT GUIDE. Every repair part for every receiver. Newest radio receivers. Test instruments. Technical books. Special equipment. Leading standard brands. Every item guaranteed. It must be right or we make it right. And everything under one roof. You get what you want promptly, and exactly what you want. Radolek's immense stock, plus Radolek's efficient organization, insures you fastest service. 25,000 service men depend on this service and benefit by Radolek's Radio Profit Guide. It will help you make more money.

● Radolek has everything in Public Address. New 1938 model P.A. Amplifiers of 5 to 100 watts output and with complete input mixing facilities.



New high power mobile systems. Fully portable P. A. equipment. And complete selection of P.A. accessories including: Microphones, Phonograph Equipment, Carrying Cases, Speakers, and Cables. Also new universal type Inter-Communication systems using up to nine sub-stations.

**----- RADOLEK -----**

601 W. Randolph, Chicago, Dept. C-17

Send me the 1938 Radolek Radio Profit Guide FREE.

Name .....

Address .....

Service man? Dealer? Experimenter?

Please Say That You Saw It in RADIO-CRAFT



# NOW!

## PUSH BUTTON TUNING

### for EVERY Radio



Every customer you have is a prospect for a push button installation. This device makes ANY radio a modern, up-to-the-minute push button set. Installed in a few minutes. Increase your profits by selling this compact, fool-proof unit! Write today for complete details!

**Model 86 for 2 Gang Var. Cond. Receivers**  
LIST \$660  
Serviceman's Net Price \$395

**Model 86JA for 3 and 4 Gang Var. Cond. Receivers**  
LIST \$725  
Serviceman's \$425 Net Price

- Only 3 leads to connect.
- 6 Push Buttons.
- Compact 5 1/4" wide, 1 1/2" high, 2 1/2" deep.
- Adaptable for remote control.
- Manual control of receivers as well as push button control.
- Completely shielded by metal container.
- Unit complete with instructions, es-catchoon, station tabs, hardware, etc.

**AUTOMATIC DEVICE MANUFACTURERS**  
Dept. R.R. 4243 West Ogden Ave., Chicago, U. S. A.

## A HOME-MADE INFINITE-RESISTANCE TUBE CHECKER

(Continued from page 740)

Weston tube testers of the better type and build this noise and short checker together with the above on a new panel. New sockets, of course, have to be provided and the dial must also be calibrated with values representative of the maximum tube efficiency readings of the new-type tubes added and suitable gauge points applied on the scale wherever required. Where inadequacy of dial space prevents the application of additional gauge limit points, it becomes necessary either to prepare a new scale to accommodate these limits or else to make a simple index or legend upon which may be listed the new values as represented by respective numerals or the original gauge points of older types of tubes, as compared to the new tubes.

### SIMPLICITY OF OPERATION

The procedure in testing a questionable tube is first to test it for efficiency on the standard transconductance checker and then to determine its integral fitness on the noise and short tester. For several reasons, it was found desirable to conduct these tests on individual sockets (and circuits) although it is possible to design the unit so that all checks can be made on one given socket. This would entail additional switches, as it is important that all of these tests be made solely in their own circuits, in order that no extraneous voltages, such as might leak through, may influence it.

Thus, when checking the tube for noise all elements must be isolated from other circuits, inasmuch as each is independently "tried" in the test circuit. It is important that no remote coupling effects exist which would readily lend accentuation and exaggerated indications.

Furthermore, when testing the tube for transconductance (or efficiency), the heater must be heated, whereas tubes checked for shorts must be cold, excepting whenever a test between cathode and heater is made in anticipation of a short between these elements. A heated cathode is then necessary, due to the heat expansion which causes such inter-electrode shorts. Such tests should always be made as heater against cathode.

Part II will discuss the V-T. voltmeter circuit, operation of the noise-and-short checker, etc., and will carry a complete list of parts.

## 300 WAYS TO MAKE MONEY

SPECIAL INTRODUCTORY OFFER

68 PAGES

Good Only For A Short Time

10c PER COPY



SOLD ON A MONEY-BACK GUARANTEE!

A Brand New Book 1938 Copyright

In "CASH IN" you will find all the real money-makers—dozens of profitable tested mail order plans, confidential business secrets, dozens of practical tested formulas, successful, and honest tested schemes—many actual experiences of men who have started on the proverbial shoestring—with less than \$10 capital.

"CASH IN" contains 68 pages of tested ideas covering every type of full-or spare-time enterprise—it is really a "masterpiece" in business ventures—OVER 40,000 WORDS IN THE TEXT.

Special Introductory Offer—10 CENTS per copy. (Regular Price 25c). Sent POSTPAID anywhere in U. S. upon receipt of ten cents in stamps or coin.

### NATIONAL PLANS INSTITUTE

246R FIFTH AVENUE NEW YORK, N. Y.



## LOOK! YOU DX HOUNDS FREE

### NEW RAGO CATALOG OF LONG DISTANCE RECEIVERS

Kits, receivers, converters, valuable antenna information—everything you'd expect to find in a complete short-wave catalog—at prices astoundingly low. Write today for RAGO'S LATEST SHORT-WAVE CATALOG—illustrating and technically describing RAGO'S complete line of long distance receivers. Address Dept. RC-5

**RADIO CONSTRUCTORS LABORATORIES**  
136 LIBERTY ST. NEW YORK, N. Y.

## WAVES FLOW LIKE WATER THROUGH TUBE!

(Continued from page 728)

method, the probe was held close to the blackboard and orientated into various positions to give maximum signal. A plot of these positions, drawn with chalk on the blackboard showed patterns of distinguishing characteristics. From one of these, for example, it could be deduced that if the wave were visible to the eye, it would look like a series of smoke rings blown from a pipe.

A striking demonstration was that in which Dr. Southworth held in front of one of the areas a brass grating perhaps an inch deep made of sheet brass strips on edge and spaced about an inch apart. In one position, this grating offered no barrier to the waves but if given a quarter-turn it would almost completely suppress them.

To show how the waves could be transmitted over appreciable distances, Dr. Southworth had a flexible metal pipe some 25 feet long leading to a receiver on the opposite side of the platform. When the other end was plugged into the transmitter a strong tone was given off by the receiver.

To make the point that the waves demonstrated, while they originate with high-frequency electric currents are decidedly different from radio waves, Dr. Southworth showed that radio waves move with the velocity of light through free space. His "guided" waves, however, are constrained by a surface where the dielectric constant of any material differs from that of the surrounding air. Such a discontinuity would be found at the surface of glass, rubber or other insulating material. Dr. Southworth plugged a solid rod of rubber into his oscillator and showed that the waves followed it vigorously down to the end.

## A new way to EXTRA PROFITS with PYRO PANTAGRAPH



Size of box: 12 1/2" x 8 1/2"

With this PYRO PANTAGRAPH turn leisure time into profitable hours. Make money a novel, easy way—"Burn Your Way to Extra Dollars with Pyro, Pantagraph."

**\$2.75**  
Shipping weight, 3 lbs.

This electrical outfit is especially designed for burning designs permanently on Leather, Wood, Cork, Gourds, Bakelite, etc. Simply plug the Pyro-electric pencil in any 110-volt AC or DC outlet and it is ready to be used. Plug and cord furnished as part of equipment.

By the use of a special Pantagraph included in the outfit, any design may be reproduced either in original, reduced or enlarged form.

Outfit consists of: one Pyro-electric Pencil; one Pantagraph; three hardwood plates; one bottle of Varnish; one Brush; one tracing tip and four-page instruction sheet.

Outfit will be forwarded by Express Collect if not sufficient postage included with your order.

**WELLWORTH TRADING CO.**  
558 W. WASHINGTON BLVD., Dept. RC-5, Chicago, Ill.

QUALITY recommends

# Condensers by SOLAR

WET... DRY PAPER  
MICA... THUMMER

Please Write for Details  
**SOLAR MFG. CORP.** 599-601 Broadway New York City

## ELECTRIC EYE

### Control Unit Kit

Complete kit, with wiring instructions \$5.98. Completely wired ready for installation \$8.95. Operates on 110 V. AC-100 (Not a toy but proven equipment). Used for light controls, alarms, signals, door openers, and many other electronic applications. Terms 1/3 cash with order, balance C.O.D. Consult us on your electronic needs. We build to your specifications. Electric Eye Devices Co., Dept. RC, 51 E. 125th St., New York, N. Y.

## Vest Pocket Adding Machine



Sturdy Steel Construction. Lifetime Pocket Companion. Adds, Subtracts, Multiplies, Divides. Capacity, 999,999.99. A real machine—guaranteed 5 years. Send name and address. We ship immediately. On delivery, pay postman \$2.50 (plus few cents postage). (Foreign countries send cash.) Your money back after 10 days trial if not satisfied. Thousands of satisfied users. Send for Special Offer to agents.

Free Trial \$2.50 Total Cost

**FAVELLA SALES CO.,** 21 West Broadway, New York, N. Y.

Please Say That You Saw It in RADIO-CRAFT



# 10 DAYS FREE TRIAL!

and this  
**SMASHING  
 GUARANTEE**  
*Stands Behind These*  
**INSTRUMENTS!**

**GUARANTEE:** We guarantee each and every instrument manufactured by us to be exactly as represented. We guarantee that it will reach you in perfect condition. We guarantee to exchange or repair any merchandise returned to us that contains any mechanical or electrical defect in accordance with the standards of honest and sincere manufacturing policies. We pledge ourselves to strict adherence to this guarantee.

TEST EQUIPMENT COMPANY of America

No line of test equipment is better than the company behind it! That is why TECO is the choice of so many servicemen! Now for the first time YOU can buy TECO equipment DIRECT FROM THE MANUFACTURER AT PRICES THAT SAVE YOU 50%. Our years of engineering ability, the experience of our trained technicians, our factory-to-you method of selling—

all combine to make TECO the best "buy" on the market. Remember, you may buy the TECO Instruments you need and try them for 10 days! If you find one does not meet your specific requirements, YOU MAY RETURN IT TO US FOR FULL CREDIT ON ANY OTHER TECO EQUIPMENT WHICH WE MAKE! Could anything be more fair?

## TECO MULTIMETER T-15



Here's the unit you need for rapid, accurate measurements. A 1,000 ohms per volt type instrument featuring d'Arsonval type movement 0-1 milliammeter. Accuracy 2%. Attractive etched metal panel. For use on 110 V. 60 cycle A.C.

2 RESISTANCE RANGES  
 0-500 ohms, 0-5 megohms

HIGH AND LOW CAPACITY SCALES  
 .0005-1 mf. and .005-200 mf.

COMPLETE AC and DC VOLTAGE and CURRENT RANGES

DC Voltage: 0-15, 0-150, 0-750 volts DC  
 AC Voltage: 0-15, 0-150, 0-750 volts AC  
 DC Current: 0-1, 0-15, 0-150, 0-750 Ma., DC  
 AC Current: 0-15, 0-150, 0-750 Ma., AC

THREE DECIBEL RANGES

TECO Multimeter comes complete in leatherette carrying case with cover, etc.  
 Size 11 1/2 x 9 1/2 x 5 1/2".  
 Shpg. wgt. 8 lbs.  
 Our net price.....

**\$13.60**

## The New TECO T-25 SIGNAL GENERATOR

A new R.F. and A.F. Signal Generator with d'Arsonval output meter built in.

### SPECIFICATIONS

Radio and intermediate frequencies, 100Kc to 60Mc in 6 bands. All on fundamentals (no harmonics used).

Accuracy is within 1% on I.F. and Broadcast Bands and 2% on Higher Frequencies.

Audio frequencies in 6 bands: 60 cycle sine wave, with percentage modulation control; 100, 400, 1000, 5000 and 7500 cycles, saw-tooth modulation.

R.F. and A.F. independently accessible. Switch selection of all R.F., I.F. and A.F. and all direct reading on panel and dial.

Built-in 3" d'Arsonval type output meter of exclusive design, 5-2 volts r.m.s. in newest molded square Bakelite case. Flat characteristics: 20-7500 cycles; down 2 db. at 10,000 cycles. Operates directly from voice coil of set or may be used generally as 2 volt AC meter. Accuracy 2%.

Attenuator for R.F. and I.F. works on all bands. Leakage is extremely low.

Operates on 90-130 volts AC or DC. Sine wave modulation not present when Generator is worked on DC but saw tooth modulation is present in both instances.



Black shielded cabinet trimmed with crystalline panel featuring German silver escutcheon plates; test leads. Uses 1-6J5G R.F. Oscillator, 1-25Z6 Rectifier and 1 modulator tube.

Latest Crowe 10" oblong vernier dial with full vision and six indications of calibrations.

Model T-25, complete with 3 tubes, test leads, handle, instructions. Size: 9x11x5 1/2". Shpg. wgt. 18 lbs. Our net price . . . .

**\$17.45**

## TECO T-10 TUBE TESTER

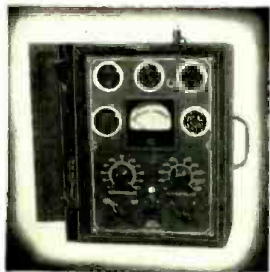

A genuine achievement! For accurate and rapid work. Has d'Arsonval moving coil meter. Tests all types of receiving tubes. For use on 110v. 60 cycle AC.

### FEATURES

- Tests all 4, 5, 6, 7, 8-7L and octal base tubes.
- Tests all Diodes, Triodes, Pentodes and Triode receiving tubes, as well as many transmitting types.
- Separate Neon Test for leakage or shorts between elements.
- English reading meter, with calibrated "BAD-?-GOOD" scale.
- Minimum number of adjustments, without impairing efficiency or accuracy of test.

- Stugged, foolproof construction. Built for a lifetime of use.
- Attractively designed etched panel, leather carrying case and cover.
- Compact and lightweight. Ideal for service laboratory or field servicing.
- Supplied with complete instructions and tabular data for every known receiving type of tube, including many transmitting types.
- Size: 11 1/2 x 9 1/2 x 5 1/2". Shpg. wgt. 9 lbs. Our net price.....

**\$11.75**

## TECO T-20 SET TESTER



A whole testing laboratory all in one unit. Combines TECO Model T-10 Tube Tester and TECO Model T-15 Multimeter. Specifications are exactly the same as on both of the models mentioned. Never before such a sensational value! Comes complete with unusually large 4" d'Arsonval type meter and attractive etched panel; test prods, carrying case and instructions. For use on 110v. 60 cycles. AC. Size: 14x9 1/2 x 5 1/2". Shpg. wgt. 20 lbs. Our net price

**\$21.45**

## THE NEW AC-DC TECO POKK-O-METER

A new pocket size volt-ohm-milliammeter that includes AC measurements and is the lowest priced, full-service instrument ever offered! Has a 3" d'Arsonval movement 0-1 milliammeter. Comes with attractive etched panel.

### SPECIFICATIONS

- 5 DC voltage ranges: 0/1.5/15/25/75/500 volts
  - 5 AC voltage ranges: 0/15/40/75/200/1200 volts
  - 4 DC Current ranges: 0/1/10/100/500 Ma.
  - 2 Resistance ranges: 0/500/500,000 ohms. (low ohms read to 1 ohm)
- Pock-o-meter supplied complete with batteries, test leads and instructions. Size: 6 1/2 x 3 1/2 x 2 1/2". Shpg. wgt. 5 lbs. Our net price.....

**\$8.45**



**TEST EQUIPMENT COMPANY of America**

139 CEDAR STREET

RC-5

NEW YORK, N. Y.



For Practical Television Training

# WHICH WOULD YOU CHOOSE

As The Best Value For The Money?

THIS OR THIS

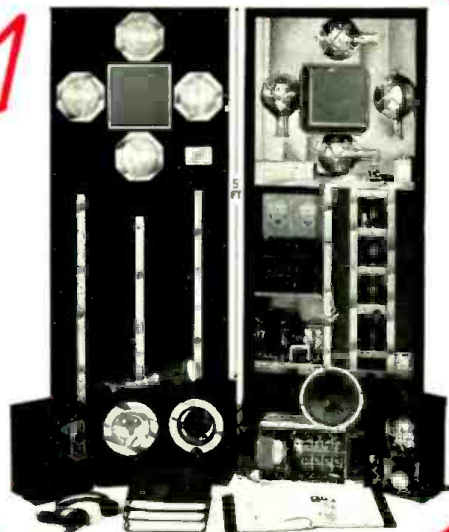

Why be satisfied with just a set of books and perhaps a small dab of instruction equipment? Why attempt to develop a career with the above when for the same price you can get all the equipment shown at the right? We are not condemning or belittling others . . . we just offer you MORE for your money . . . this comparison gives you an idea of how much more you get from American Television Institute. You be the judge!



BE YOUR OWN JUDGE

Illustrated above is the equipment you receive from the American Television Institute. A remarkable offer, not equalled anywhere in Radio-Television today! In addition to a superior course of Television-Radio Training with all necessary text books, you get, AT NO EXTRA COST, this full sized professional Television Transmitter and Receiver, regularly used for public exhibitions, with a steel rack nearly six feet high and two feet wide; R.C.A. Amplifier and Modulator Tubes throughout; 50 Watt Radio Transmitter, Superheterodyne Receiver, Speaker, Meters, Phones, Four of A.T.I.'s Giant Photo-Electric Cells; a 7" x 21" Cathode Ray Receiving Tube; together with all other parts too numerous to list here, to make a complete Television Transmitter and Receiver that will receive any modern 441 line signal.

## AMERICAN TELEVISION Definitely OFFERS YOU MORE!

### YOU CAN MAKE OVER 350 DIFFERENT EXPERIMENTS WITH A. T. I. EQUIPMENT!

With this A.T.I. Television Equipment you can make Over 350 amazing, interesting experiments right in your own home. You can produce your own Television program for a local audience . . . transmitting and receiving the faces of your friends. You can build complete Television Transmission and Reception Systems, Television Amplifiers, Radio Transmitters, Television Pick-ups, Photo-electric Relays, Radio and Television Receivers, Projection System, Light Beam Telephone, Magic Lantern, Grid-Glow Alarms, Scanning Systems, Sound Amplifiers, Current-Levers, Photo-electric Photometers. You can make hundreds of experiments and comparison tests that show you the phenomena of Television and Radio in a quick, simple way . . . much easier to understand than just mere words in a book. Get all the facts about this amazing offer . . . SEND THE COUPON NOW!

There is no doubt as to which of the above is the best value for the money. The American Television Institute offers you the most complete Television Training Course in the world, today. The A.T.I. system of teaching Television, Radio and Electronic Engineering is as new and advanced as Television itself. Not mere theory from texts, not experimental work performed by an instructor with you looking on, not the wiring of a few panel boards or the construction of a small dab of equipment. The A.T.I. method is thorough . . . you learn with ACTUAL TELEVISION EQUIPMENT that really works . . . all training is under the exacting supervision of Mr. U. A. Sanabria, one of the world's foremost Television authorities. American Television Institute is now training more Television Engineers than all other organizations combined. There's a definite reason for this . . . the above comparison shows it very simply.

### TELEVISION COMMERCIAL IN ENGLAND! ARE YOU PREPARED?

Television Engineering will be the next high salaried profession. Get in on the ground floor and cash in on the great profit possibilities of this fascinating new industry. Trained Television men will command from \$2,500 to \$25,000 a year. A.T.I. gives you complete recognized training in Television and Radio Engineering . . . qualifies you during the first few months to take your RADIO TELEPHONE FIRST CLASS GOVERNMENT LICENSE EXAMINATION and get into a good paying job in radio while completing your Television instruction. Write for complete details and further information. *Entire Training and Equipment is available on amazingly low, easy payments.* SEND COUPON NOW . . . NO OBLIGATION WHATSOEVER!

### FREE BOOKLETS! INSIDE FACTS!

We have compiled, what we believe is, the most interesting and authentic data on Television you've ever read. It's yours FREE for the asking. Gives you real INSIDE FACTS . . . Technical details . . . diagrams . . . illustrations . . . cathode ray tube construction . . . Television operation . . . and hundreds of other important, interesting FACTS. We will send this data without cost or obligation so you may determine how to qualify for entrance into the American Television Institute and how A.T.I. training will benefit you and equip you for a future in Television. Clip coupon and mail it to us, NOW!

### AMERICAN TELEVISION INSTITUTE

433 E. Erie St., Dept. RC-538, Chicago, Ill.  
Gentlemen: Please send me your Free Television Lessons and literature described on this page. No obligation.

Name . . . . . Age . . . . .  
Street . . . . .  
City . . . . . State . . . . .

4 Free LESSONS in TELEVISION  
THIS OFFER GOOD FOR A LIMITED TIME ONLY!  
DON'T DELAY! SEND THE COUPON NOW!