

RADIO'S LIVEST MAGAZINE

OVER 175 ILLUSTRATIONS

Radio-Craft

Special
Beginner's
Number

HUGO GERNSBACK EDITOR

March
25 Cents

in United States
and Canada

**MAKING A
SNOW LOUDSPEAKER**

See Page 526

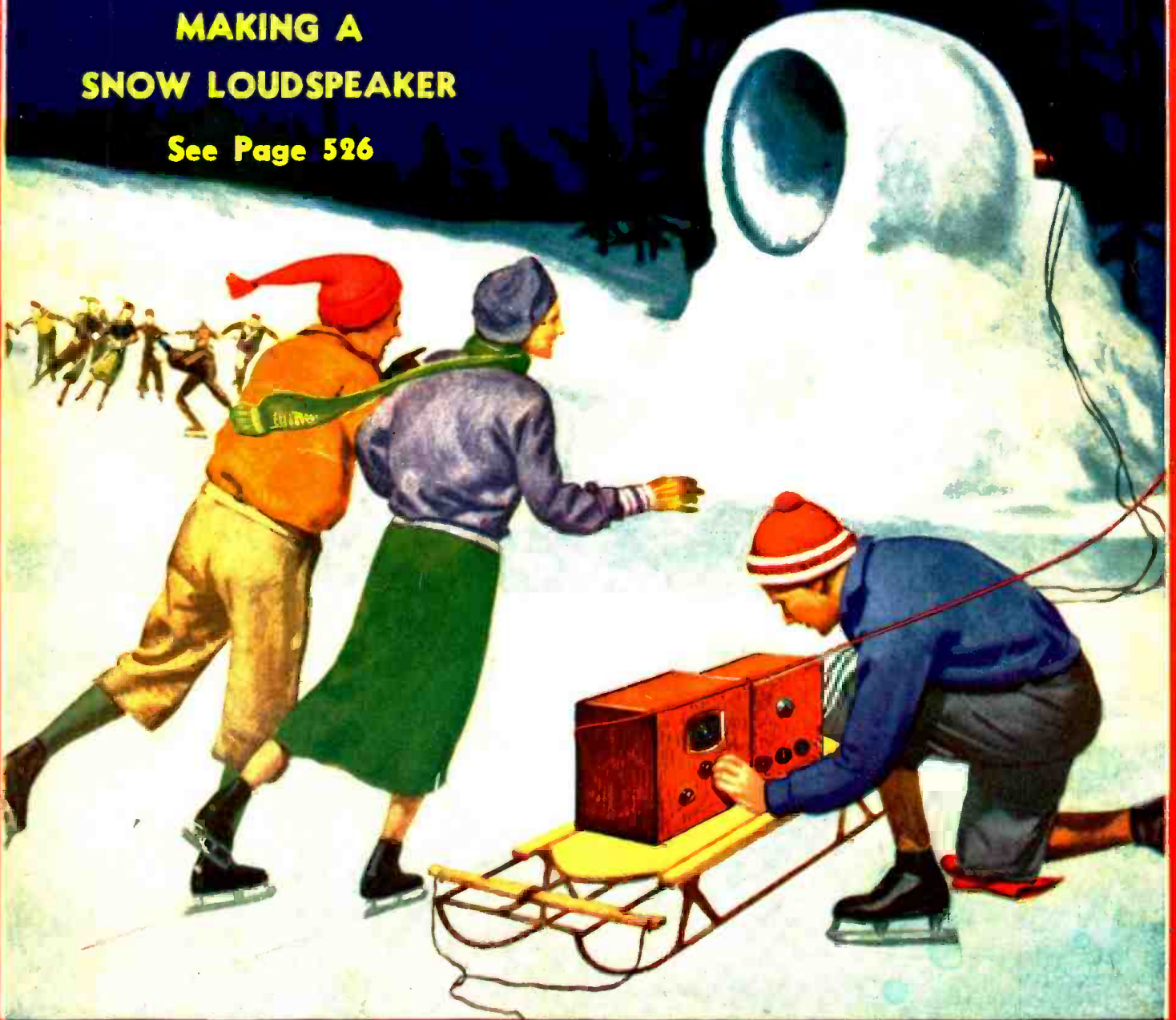

Making "The Beginner's 'Book-End 3'" — How to Make a "Junior" Oscilloscope
The A B C of A. F. C. — Radio Debunked for the Beginner — Novel 1-Tube Set

OVER 50,000 RADIO MEN READ RADIO-CRAFT MONTHLY



NOW!

*I Can Make
IMMEDIATE
DELIVERY...*

of any **NEW 1937 SUPREME INSTRUMENT!**
— *Your Parts Jobber*

Where
SHOULD
THE RADIO SERVICE MAN
LOCATE HIS PLACE OF
BUSINESS?

Get this free booklet
from *Your Parts Jobber*

“Where should the radio
serviceman locate his
place of business?”

The Supreme Instruments Corporation has made a comprehensive nation-wide survey to find out where is the best place for a serviceman to locate his business. Your parts jobber has a free copy for you — which he will gladly give you. Write or see him today!

● In spite of the fact that the demand for Supreme instruments forced us to double the size and capacity of our plant in 1935 . . . in spite of the fact that approximately one-half of the servicing instruments sold in 1936 were Supreme instruments . . . we were entirely unprepared for the smash hit made by our new 1937 line! The unprecedented demand for our new line put us in the biggest production jam ever experienced in our history!

Because of this tremendous flood of orders we have added still more space . . . and hired new, but highly experienced, men from various parts of the country. With this new set-up, production is now keeping step with demand. To those servicemen who were forced to wait for delivery of our instruments, we wish to express our deepest appreciation for their patience and loyalty.

IMMEDIATE DELIVERY FROM YOUR PARTS JOBBER

Your parts jobber can now make immediate delivery. Go see him today. Look at the new Supreme designs and models. You'll marvel at their business-like beauty! Their space-saving compactness! Their downright efficiency! You'll discover, too, that every model has been designed to make servicing for you easier, quicker and more profitable!

BUY ON S. I. C. EASY TERMS

And remember — you can buy each and every Supreme instrument from your parts jobber, on the S. I. C. time payment plan on easy monthly terms you'll never miss!

SUPREME

**INSTRUMENTS
CORPORATION**
GREENWOOD, MISSISSIPPI, U. S. A.

Remember — **YOUR CREDIT IS GOOD WITH SUPREME!**

OPPORTUNITIES *are many* for the Radio Trained Man



Don't be an untrained man. Let me show you how to get your start in Radio—a fast growing, live money-making industry.

Prepare for jobs as Assembler, Inspector and Tester—Radio Sales or Service and Installation Work—Broadcasting Station Operator—Wireless Operator on a Ship or Airplane, Talking Picture or Sound Work—**HUNDREDS OF OPPORTUNITIES** for a real future in Radio!

12 Weeks of Shop Training Pay Your Tuition After Graduation

We don't teach by book study. We train you on a great outlay of Radio, Television and Sound equipment—on scores of modern Radio Receivers, actual Broadcasting equipment, Television apparatus, Talking Picture and Sound Reproduction equipment, Code and Telegraph equipment, etc. You don't need advanced education or previous experience. We give you—**RIGHT HERE IN THE COYNE SHOPS**—the actual practice and experience you'll need for your start in this great field. And because we cut out all useless theory and only give that which is necessary you get a practical training in 12 weeks. Mail coupon for all facts about my school and training methods.

TELEVISION *and* TALKING PICTURES

Television is sure to come as a commercial industry. Whether this year or later, it will offer opportunities to the man who is trained in Radio. Here at Coyne you learn Television principles, and work on actual Television equipment. Talking Picture and Public Address Systems offer opportunities to the Trained Radio Man. Here is a great new Radio field which is rapidly expanding. Prepare NOW for these wonderful opportunities! Learn Radio Sound Work at COYNE on actual Talking Picture and Sound Reproduction equipment.

ARRANGE TO FINANCE YOUR TUITION

Mail the Coupon below and I'll tell you about my finance plan which has enabled hundreds of others to get Coyne training with very little money. On this plan you can get your training first, then take 18 months to complete your small monthly tuition payments starting 5 months after you begin training. Not a home study course.

Mail the coupon for all details of this "Pay Tuition after Graduation Plan."

ELECTRIC REFRIGERATION—AIR CONDITIONING—DIESEL ENGINES

To make your training more valuable, I include—at no extra cost additional instruction in Electric Refrigeration, Air Conditioning and Diesel Engines, taught you by personal instruction and actual work on real equipment.

PRACTICAL WORK At COYNE in Chicago

ACTUAL, PRACTICAL WORK. You build and service radio sets. You get training on real Broadcasting equipment. You construct Television Receiving Sets and actually transmit your own Television images over our Television equipment. You work on real

H. C. LEWIS, Pres. RADIO DIVISION Founded 1899

Coyne Electrical School
500 S. Paulina St., Dept. 37-8H, Chicago, Ill.

Talking Picture and Sound equipment. You learn Wireless Operating on Actual Code Practice apparatus. We don't waste time on useless theory. We give you the practical training you'll need for your start in Radio—in 12 short weeks. If you desire code, this requires additional time for which there is no extra charge.

MANY EARN WHILE LEARNING



If you need part-time work to help pay living expenses while at school, tell us your problems and we may be able to help you as we have hundreds of other students. Then, after you graduate, our Free Employment Department will give you life-time employment service. Every Coyne graduate also receives a Life Scholarship, with free technical and business service and privilege of review at any time without additional tuition charge.

Mail Coupon Today for All the Facts

H. C. LEWIS, President
Radio Division, Coyne Electrical School
500 S. Paulina St., Dept. 37-8H, Chicago, Ill.

Dear Mr. Lewis:—Send me your Big Free Radio Book, and all details of your tuition offer, including additional instruction in Electric Refrigeration, Air Conditioning and Diesel Training and your "Pay After Graduation" offer.

Name.....
Address.....
City..... State.....

Please Say That You Saw It in RADIO-CRAFT



HUGO GERNSBACK, Editor-in-Chief
 C. W. PALMER Technical Editor
 R. D. WASHBURNE, Managing Editor
 C. P. MASON Associate Editor

CONTENTS-MAR., 1937, ISSUE

Volume VIII Number 9

Editorial: The Radio Newcomer.....	Hugo Gernsback	517
The Radio Month in Review.....		518
My First Transatlantic Wireless Signal	Guglielmo Marconi	520
New Information About Antennas....	R. D. Washburne	521
Radio Debunked for the Beginner..	Wilhelm E. Shrage	522
How to Make the Beginner's "Book-End 3"	Raymond P. Adams	524
How to Make a Snow Loudspeaker.....	J. H. Green	526
Marconi—E.M.I. High-Definition Television at Alexandria Palace		526
How to Make a "Junior" Oscilloscope	William Filler	527
International Radio Review.....		528
Analysis of Fidelity Controls in the 1937 "Super Pro"	Eli Martin	529
Novel I-Tube Set Uses "Body" Antenna.....		529
How to Make the RADIO-CRAFT 1937 Television Receiver—Part III.....		530
How to Equip a Sound Truck.....	H. W. Paro	532
Loudspeaker Baffles and Cabinet Resonance	McMurdo Silver	532
The ABC of A.F.C.....	C. P. Mason	533
Direct-Coupling in a 30-W. Beam-Tube Amplifier!—Part I.....	A. C. Shaney	534
The Capacity Meter as a Servicing Aid	O. J. Morelock, Jr.	534
Information Bureau.....		535
Interference—Radio's "Old Man of the Sea"	Frank L. Carter	536
How to Use V.-T. Voltmeters in Radio and P.A. Servicing—Part I.....	Kendall Clough	537

A 5-Band 11-Tube Rack-and-Panel Receiver	J. T. McCabe	537
How to Make the RADIO-CRAFT Set Analyzer—Part II.....		538
Make This Pocket-Size Multi-Test Unit	Milton Reiner	539
Pitfalls of the Radio Service Beginner....	R. B. Lawton	539
The Latest Radio Equipment.....		540
Make "The Executive"—A Business Man's A.C.-D.C. Set—Part II.....	N. H. Lessem	542
The Much-Abused Ballasts for A.C.-D.C. Radio Receivers	Samuel Rutenberg	543
Is It Economy to Connect Cells in Parallel?..	L. S. Fox	543

RADIO SERVICE DATA SHEETS:

No. 192—Philco Model 37-604.....	544
No. 193—American Bosch Model 640.....	545
No. 194—Delco Models R-3208 (table) and R3209 (console); Wilcox-Gay Model A-17 (chassis Model 3JQ6 and 3JM6).....	548
Operating Notes.....	546
ORSMA Members' Forum.....	546
Technicians' Data Service.....	550

FORTHCOMING ISSUES WILL TELL YOU—

- How to make an up-to-date short-wave diathermy machine!
- How to make the RADIO-CRAFT tube checker that tests all the tubes now on the market!
- How to make a combined "color organ" and "color-tuning" adapter for any superhet. receiver!
- How to design your own short-wave coils by chart!
- How to make a beginners' radio set that entails only about one evening's work and only a small cash outlay!

ASK YOUR NEWSDEALER, TODAY, TO ORDER YOUR COPY OF APRIL RADIO-CRAFT.

Published by Radcraft Publications, Inc. Publication office: 29 Worthington Street, Springfield, Mass. Editorial and Advertising Offices: 99 Hudson Street, New York City. Chicago Advertising Office: L. F. McClure, 919 North Michigan Avenue, Chicago, Ill. Western Advertising Office: Loyd B. Chappell, 511 So. Alexandria St., Los Angeles, Calif.

Foreign Agents:

London—Gorrings's American News Agency, 9A Green St., Leicester Square, W. C. 2, England.
 Paris—Messageries Dawson, 4 Rue Faubourg, Poissonniere, France.
 Melbourne—McGill's Agency, 179 Elizabeth St., Australia.
 Dunedin—James Johnston, Ltd., New Zealand.

RADIO-CRAFT is published monthly, on the first of the month preceding that of date; subscription price is \$2.50 per year in U. S. and Canada. (In foreign countries, \$3.00 a year to cover additional postage.) Entered at the post office at Springfield as second-class matter under the act of March 3, 1879.

Text and illustrations of this magazine are copyright and must not be reproduced without permission of the copyright owners.

Copyright 1937. Radcraft Publications, Inc.

A FREE LESSON SHOWED BILL HOW HE COULD MAKE GOOD PAY IN RADIO

BILL, YOU'RE ALWAYS FOOLING WITH RADIO -- OUR SET WON'T WORK -- WILL YOU FIX IT?

I'LL TRY, MARY, I'LL TAKE IT HOME TONIGHT

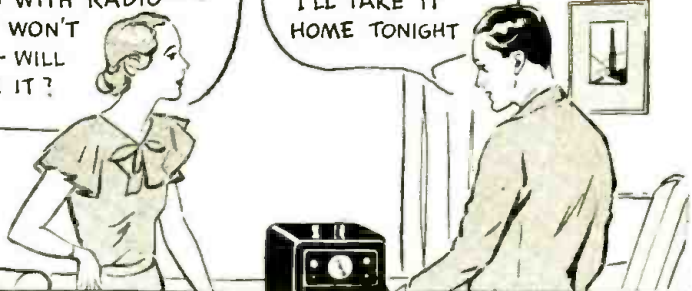

I CAN'T FIND OUT WHAT'S WRONG -- GUESS I'LL MAKE A FOOL OF MYSELF WITH MARY

HELLO, BILL -- GOT A TOUGH ONE TO FIX? LET ME HELP YOU

HELLO JOE -- WHERE'VE YOU BEEN LATELY -- AND WHERE DID YOU LEARN ANYTHING ABOUT RADIO?

I'VE BEEN STUDYING RADIO AT HOME, BILL, WITH THE NATIONAL RADIO INSTITUTE. YOU OUGHT TO TAKE THEIR COURSE. I'VE GOT A GOOD RADIO JOB NOW. LET'S MAKE A CIRCUIT DISTURBANCE TEST -- STARTING WITH THE AUDIO OUTPUT STAGE AND TESTING EVERY STAGE RIGHT BACK TO THE ANTENNA. LISTEN FOR THE CLICKS WHEN I TAP THE GRID LEADS

SAY -- WHERE DID YOU LEARN THAT TEST? IT'S A GOOD ONE

HERE'S THE TROUBLE, BILL, IN THE FIRST I.F. AMPLIFICATION STAGE. I LEARNED THAT TEST EVEN BEFORE I STARTED TAKING THE COURSE, BILL. IT'S DESCRIBED IN A FREE LESSON WHICH THE NATIONAL RADIO INSTITUTE SENDS YOU WHEN YOU MAIL A COUPON FROM ONE OF THEIR ADS

I'VE SEEN THEIR ADS BUT I NEVER THOUGHT I COULD LEARN RADIO AT HOME -- I'LL MAIL THEIR COUPON RIGHT AWAY

I'M CONVINCED NOW THAT THIS COURSE IS PRACTICAL AND COMPLETE. I'LL ENROLL NOW

AND THEN I CAN MAKE REAL MONEY SERVICING RADIO SETS

OR INSTALL AND SERVICE LOUD SPEAKER SYSTEMS

OR GET A JOB WITH A RADIO BROADCASTING OR TRANSMITTING STATION

AVIATION RADIO, POLICE RADIO, TELEVISION, ELECTRONIC CONTROLS -- RADIO IS SURELY GOING PLACES. AND THE NATIONAL RADIO INSTITUTE HAS TRAINED HUNDREDS OF MEN FOR JOBS IN RADIO

YES, I WILL SEND YOU MY LESSON ON RADIO SERVICING TIPS FREE TO SHOW YOU HOW PRACTICAL IT IS TO TRAIN AT HOME FOR A GOOD RADIO JOB



YOU CERTAINLY KNOW RADIO SOUNDS AS GOOD AS THE DAY I BOUGHT IT.

THANKS! IT CERTAINLY IS EASY TO LEARN RADIO THE N.R.I. WAY. I STARTED ONLY A FEW MONTHS AGO, AND I'M ALREADY MAKING GOOD MONEY.

THIS SPARE TIME WORK IS GREAT FUN AND PRETTY SOON I'LL BE READY FOR A FULL TIME JOB

OH BILL -- I'M SO GLAD I ASKED YOU TO FIX OUR RADIO. IT GOT YOU STARTED THINKING ABOUT RADIO AS A CAREER, AND NOW YOU'RE GOING AHEAD SO FAST

OUR WORRIES ARE OVER. I'M MAKING GOOD MONEY NOW, AND THERE'S A BIG FUTURE AHEAD FOR US IN RADIO

I HAVE TRAINED MANY MEN TO START A SPARE TIME OR FULL TIME RADIO SERVICE BUSINESS WITHOUT CAPITAL

Do you want to make more money? I'm so sure that I can train you at home in your spare time for a good radio job that I'll send you a sample lesson absolutely FREE. Examine it, read it, see for yourself how easy it is to understand even if you've never had any technical experience or training.

Many Radio Experts Make \$30, \$50, \$75 a Week

Radio broadcasting stations employ engineers, operators, station managers and pay up to \$5,000 a year. Spare time Radio set servicing pays as much as \$200 to \$500 a year. Full time Radio servicing jobs pay as much as \$30, \$50, \$75 a week. Many Radio Experts own and operate their own full time or part time Radio sales and service businesses. Radio manufacturers and jobbers employ testers, inspectors, foremen, engineers, servicemen, paying up to \$6,000 a year. Radio operators on ships get good pay and see the world besides. Automobile, police, aviation, commercial, Radio, and loud speaker systems offer good opportunities now and for the future. Television promises many good jobs soon. Also I have trained and holding good jobs in all these branches of Radio.

Many Make \$5, \$10, \$15 a Week Extra In Spare Time While Learning

Practically every neighborhood needs a good spare time serviceman. The day you enroll I start sending you Extra Money Job Sheets. They show you how to do Radio Repair jobs that you can cash in on quickly. Throughout your training I send you plans and ideas that have made good spare time money -- from \$200 to \$500 a year -- for hundreds of fellows. I send you special Radio equip-

ment and show you how to conduct experiments and build circuits which illustrate important Radio principles. My training gives you practical Radio experience while learning.

Get My Lesson and 64-Page Book FREE--Mail Coupon. In addition to my Sample Lesson, I will send you my 64-page Book, "Rich Rewards in Radio." Both are free to any fellow over 16 years old. My book describes Radio's spare time and full time opportunities and those coming in Television; tells about my Training in Radio and Television; tells about my Money Back Agreement; shows you actual letters from men I have trained, telling what they are doing and earning. Find out what Radio offers YOU! MAIL THE COUPON in an envelope, or paste it on a handy postcard -- NOW!

J. E. SMITH, President National Radio Institute Dept. 7CX Washington, D. C.

MAIL THIS NOW

J. E. SMITH, President, Dept. 7CX National Radio Institute, Washington, D. C.

Dear Mr. Smith: Without obligation, send me a sample lesson and your free book about the spare time and full time Radio opportunities, and how I can train for them at home in spare time. (Please write plainly.)

Name Age.....

Address

City State..... 141



Please Say That You Saw It in RADIO-CRAFT

9 x 12
INCHES

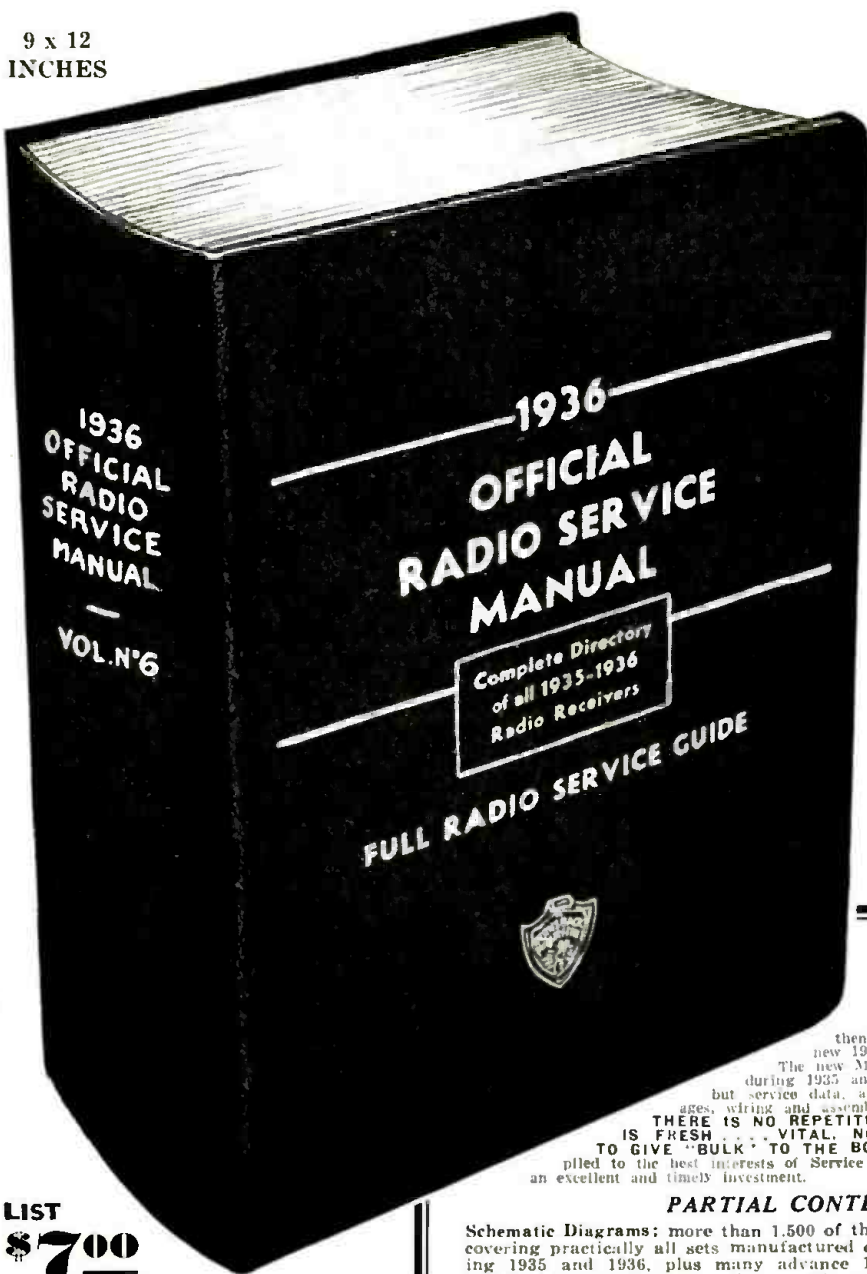

**YOUR JOBBER
OR FAVORITE
MAIL ORDER HOUSE
HAS COPIES OF THE**

1936 OFFICIAL RADIO SERVICE MANUAL

**ORDER YOUR COPY NOW—
OR WRITE TO
THE PUBLISHERS DIRECT**

Bigger and Better than Ever!

more diagrams, more data, more pages, more essential service material and considerably greater value for your money. If the sale of previous Gernsback Manuals is any indication then many thousands more Service Men will be using this new 1936 Manual than any of the previous volumes. The new Manual incorporates all available diagrams of sets manufactured during 1935 and 1936, plus many advance 1937 models. Not only diagrams, but service data, alignment procedure, intermediate frequency peaks, socket voltages, wiring and assembly diagrams, etc., etc., are included.

THERE IS NO REPETITION IN THIS MANUAL! EVERY BIT OF INFORMATION IS FRESH, VITAL, NO REMASH . . . AND NO USELESS MATERIAL JUST TO GIVE "BULK" TO THE BOOK. The entire contents has been carefully edited and compiled to the best interests of Service Men. The 1936 OFFICIAL RADIO SERVICE MANUAL is an excellent and timely investment.

PARTIAL CONTENTS OF 1936 MANUAL

Schematic Diagrams: more than 1,500 of them, covering practically all sets manufactured during 1935 and 1936, plus many advance 1937 models. Many of them have the operating voltages of the various tube elements printed directly on them.

Wiring Diagrams: wherever they have been obtainable, the wiring diagrams of the more complex receivers, such as the all-wave and high-fidelity sets, have been included.

Miscellaneous Diagrams: these include speaker connections, optional phonograph connections, power transformer connections, R. F. and I. F. coil connections, complete phonograph motor connections on combination receivers, etc., etc. Wherever these diagrams were available they have been included in the 1936 Manual.

Intermediate Frequency Peaks: all set models (with few exceptions) have their respective intermediate frequency peaks marked either directly on their schematic diagrams or in their notes on alignment procedure.

Alignment Procedure: even if space permitted, it would not have been advisable to print the alignment procedure on all the similar sets for one would have been a repetition of the other. On the more complex receivers, however, the all-wave and high-fidelity sets, complete alignment procedures, step-by-step, have been included.

Service Data: wherever the information was made available to us, such data as typical faults in a given receiver, their symptoms and remedies, was included in the 1936 Manual.

Assembly Diagrams: on combination models, i. e., sets combined with phonographs (either the manual or automatic types), complete assembly diagrams are given. These diagrams show the relationship of the separate units to each other and the way they are inter-connected.

Operating Voltages: the operating voltages given in this Manual (for more than 80% of the sets listed) are the normal voltages; any deviation from these values indicates trouble in the associated circuits.

Trade Name Index: in the back of the book, is a complete index of trade names and their respective manufacturers.

Complete Tube Chart: in the back of the Manual will be found the latest, and most complete tube chart of all type tubes ever manufactured for receivers.

Large Cumulative Index: includes all sets printed in the 1931, 1932, 1933, 1934, 1935 volumes as well as the present 1936 Manual. The sets in this volume have been listed in the index in an entirely new and more convenient manner so that the busy Service Man need no longer thumb through an entire manufacturer's section in order to find some particular piece of information. He need but consult the index.

If your jobber or mail order house cannot supply you, order any of the OFFICIAL RADIO SERVICE MANUALS or the OFFICIAL RADIO SERVICE HANDBOOK from the publishers. Send your remittance in form of check or money order—or, if you send cash or unused U. S. Postage Stamps, be sure to register your letter. ALL ORDERS ARE FILLED PROMPTLY. BOOKS ARE SENT TO YOU POSTAGE PREPAID.

Address Dept. RC-337

RADCRAFT PUBLICATIONS, INC., 99 Hudson St., New York, N.Y.

LIST
\$7.00

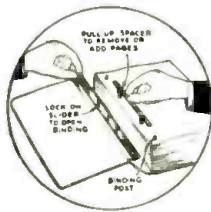

New Practical Binder
Note, at the left, the details of the new binder used on this manual. It not only securely locks the 1200 pages into the stiff leatheroid covers, but facilitates removal and replacement of individual pages.

**1,200
PAGES**
**OVER
2,500
ILLUSTRATIONS**

*Looseleaf Binder
Hard Covers*

GERNSBACK RADIO SERVICE MANUALS ARE AVAILABLE FROM JOBBERS AND MAIL ORDER HOUSES

Please Say That You Saw It in RADIO-CRAFT



“Takes the Resistance out of Radio”

Editorial Offices: 99 Hudson St., New York, N. Y.

HUGO GERNSBACK, Editor

Vol. VIII, No. 9, March 1937

THE RADIO NEWCOMER

An Editorial by HUGO GERNSBACK

EVERY YEAR radio attracts a new crop of people who sooner or later come into the fold and stay for many years.

Believe it or not, radio still holds a great lure for thousands of people who suddenly develop a burning interest in radio, which must be satisfied at all costs. *Nor are all these people youngsters or schoolboys*; frequently we see mechanics, bankers, dentists, lawyers, etc., who, intrigued by the mysteries of radio wish to know more about it, and they soon fall prey to the allurements of the art.

This process has been going on ever since radio started—when it still was called “wireless” in the early days after the turn of the century. The movement is still going on unabated, new recruits being gathered every day of the year.

And, believe it or not, there are still many of these radio beginners who start in as did their fathers with a modest crystal set. The radio crystal set still presents a tremendous attraction to tens of thousands of radio beginners. If this were not so, it would be impossible or at least difficult to purchase crystal detectors these days. They are still sold, however, in great variety—proof of the popularity of the crystal detector. And, indeed, the radio beginners are still hoping some day to find the *ideal crystal circuit* which will be both selective and sensitive. Also, if you are located within a mile or so of a powerful broadcast station, you can dispense with earphones, as a good magnetic type of loud-speaker or new-type magneto-dynamic reproducer will bring in the broadcast program from that station, not only fairly loud, but clear as well.

And, in our correspondence with hundreds of readers, we find that the single-tube radio set still holds a great deal of attraction for the beginner who wishes to explore the mysteries of radio. In this he has a vast advantage over the radio beginner of 10 years ago, because he now has at his disposal dozens of new and very efficient radio tubes—many of which do wonders, not only for long-distance (“DX”) reception but for bringing in local stations with good loud-speaker volume, and all on a single tube. In addition, the present-day beginner has a tremendous library of radio information to choose from; the cost of his experiments is much less than that of his brethren of 10 years ago; practically all parts, including the tools, can be bought at much lower prices than was the case a decade ago—besides, the tubes and the parts are much better in quality than they were years ago.

The small, portable 1- or 2-tube set as well as the miniature pocket set are another item which constantly intrigues the radio beginner and keeps him occupied for weeks and months on end. In the daily correspondence that we receive is the proof of this popularity. Then, of course, these modern little sets are good for real distance work—and in short waves (something that the experimenter of 10 years ago had not dreamed-of).

Then we have radio beginners whose interest lies chiefly in audio-frequency amplification. They do not “go in” for radio sets, but they will take a standard set and begin to

build amplifiers for different purposes. They will tinker with public-address systems, either for fun or for profit. Thus, we know a banker whose hobby it is to build inter-communication systems which he uses in his bank so he can talk to his different departments—all by means of small, compact outfits, which look like radio sets but nevertheless, are solely amplifiers.

Lately, there has developed a small boom among technically-minded *physicians and dentists* who are now beginning to test the possibilities of short-wave radio therapeutical apparatus.

Now, of course, this is nothing new. The point is that heretofore doctors and others bought their equipment complete. Such physicians, as a rule, do not know much about the intricacies of radio; whereas those physicians who are technically-inclined build their own equipment for their own, individual needs.

There are not many short-wave therapeutical sets available to dentists because ready-made machines do not suit the dentists' particular requirements. It is one thing to treat a boil or abscess on the neck by means of short waves, but quite another thing to treat an infected tooth. For this reason, a number of experimenting dentists have found it advisable to build their own machines to suit their particular purpose. Of course, this art is, as yet, new and a good deal of pioneering work remains to be done. So far, short-wave therapy has proven its worth, particularly, in the treatment of infections, especially, where we have to do with pus accumulation. The application of short waves here does wonders.

Another branch which holds a steady and increasing interest to beginners is what often is erroneously called radio “treasure” finding. By means of new and sensitive radio equipment, it is possible today to do not only real *geophysical prospecting* (oil and ore locating) but also serious work in commercial fields. Finding treasures is, to be sure, a romantic as well as a practical magnet to the beginner. The same instrumentality, however, has its utilitarian, though more prosaic, uses when it comes to locating hidden pipes, wires in walls, etc.—all of which, because of its recognized value to professional men in several fields, is becoming of increasing interest to a special class of beginners in radio.

The use of short waves for industrial purposes always attracts new people to radio. Thus many good engineers who have read an article or notice that short waves can be used for certain baking processes, for curing cheese, for killing insect pests in cigars, food, etc., frequently find it necessary to take up a study of radio in order to build certain radio devices for experimental research work.

The list could thus be drawn out almost indefinitely, because as soon as one new radio application becomes known, there are two new ones in the offing ready to be pounced upon by the radio experimental fraternity.

And this process is destined to increase in scope as the years go on!

THE RADIO MONTH



An action view of the new Marconi-E.M.I. television camera.

TELEVISION NEWS SHORTS

AS usual, the past month has brought out many new facts in the erratic and somewhat haphazard movement of television toward its inevitable though somewhat obscure goal of practical scheduled transmissions.

The Crystal Palace—long known as the center of television activity in England, until the newer Alexandra Palace equipment was installed by the B.B.C.—burned to the ground, taking with it the research laboratories of Baird Television, Ltd. Fortunately, however, most of the transmission equipment of this company had been previously moved to the newer locality.

The English television transmissions which had been alternating on weekly schedules between the Marconi-E.M.I. and the Baird transmitters changed to a daily schedule, alternating daily.

At the annual convention of the Institute of Radio Engineers at Rochester, N. Y., some interesting facts were disclosed, including the news that although the present television channels are "quasi-optical" or "line-of-sight"

in their characteristics, *trans-continental interference occurs* even on these channels! This may result in the television channels moving out of the 7-meter band into the 3-5 meter channels. And, what is more, it may be the solution to rural distribution of television service!

The Columbia Broadcasting System announced that their new "Columbia Broadcasting Center" which will be erected in New York will be designed especially for the accommodation of television broadcasting.

The *coaxial cable* between New York and Philadelphia which was completed last month by the Bell Telephone Labs. was given its first test. Dr. Frank A. Jewett, president of the Laboratories said: "This is not a television circuit as we are demonstrating it, but it is a necessary step toward television. We think we know how to use it for television, but *that is several months off.*"

David Sarnoff stated, last month, that: "In the world of creative and expressive art the hardest question which television propounds is that of supplying talent. Unlike a play on the stage or a motion picture which may run for a year, the television program, once it has been shown to a national audience, is on the scrap heap. Television will call for a whole new generation of artists."

The prediction that television will be a commercial fact by 1938 was voiced by Dr. Alfred N. Goldsmith.

The British Broadcasting Company made a pretentious scale model of the route of the Coronation which will be used soon to broadcast views of the fete in London. This is one way of avoiding the pitfalls of direct outdoor pick-up!

Farnsworth Television, Inc. was granted an experimental license for their television transmitter, in Philadelphia, by the F.C.C. The new station will be known as W3XPF.

LIVING PHOTOCELLS

IN the annual report of the Carnegie Institution of Washington, some work done by Dr. Gordon Marsh at the Tortugas Laboratory of the Institution were disclosed.

These experiments concerned photocells in the form of genuine living plant cells which do, to some extent, the same work as the glass-and-wire P.E. cells known to the radio profession.

These plant cells were of the species of strange sea plant—Valonia. These plants consist of a single giant cell, ranging in size from the size of a pea to that of an egg. In the experiments these plant cells had wires attached to their opposite ends. They were kept in light-tight boxes and illuminated through openings in the boxes with strong electric lamps. The cells generated weak electric currents which varied with the light intensity.

Dr. Marsh does not consider the Valonia a substitute for commercial P.E. cells, but believes his experiments give a promising lead for further study.

WATERPROOF SPEAKERS

THE fragile radio loud-speaker — that device which transforms electrical impulses into sounds—has taken on new ruggedness according to information received from Germany, last month.

A new type of speaker which will actually perform when totally immersed in water and which is not injured by the immersion was demonstrated in Berlin. This type of speaker would be ideal for the "snow speaker" shown on the cover of this issue.



The Crystal Palace which burned last month. The television tower is at left.

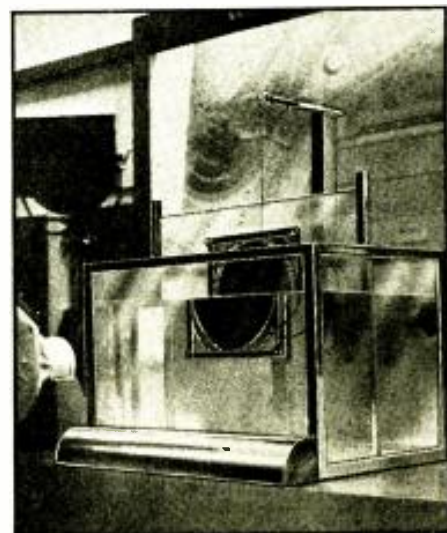

The waterproof speaker being demonstrated.

IN REVIEW

Radio is now such a vast and diversified art it becomes necessary to make a general survey of important monthly developments. RADIO-CRAFT analyzes these developments and presents a review of those items which interest all.

SPEAKER TALKS TO SOME RADIO CONVENTION VIA DX 'PHONE

AT the Cleveland convention of the Institute of Radio Service Men, last month, John Rider caused a wild scramble when he failed to make an appearance at the time at which he was scheduled to speak before the gathered Service Men.

John, who had planned to reach Cleveland by plane, was grounded at Kylerstown, Pa. Hurriedly, arrangements were made for a long-distance telephone hook-up, only to find that the emergency crew of the telephone company was out on another call.

Fortunately some one at the Convention knew something about telephone circuits and an amplifier was finally rigged up to the line and the scheduled talk, sounding somewhat "tinny" but intelligible, was delivered.

We wonder if anyone thought of calling John "a grounded remote speaker" on that occasion?

MOTOR FOR RADIO METEOROGRAPHS

IN connection with its work on radio meteorographs, which are carried aloft by small balloons and are used to send out automatic radio signals giving information on weather conditions, the National Bureau of Standards disclosed, last month that they had developed a tiny electric motor which weighs less than 100 grams and operates on 8 milliamperes at 4.5 volts.

This tiny electric motor will be used to replace the spring-driven clock motors formerly used for the purpose.

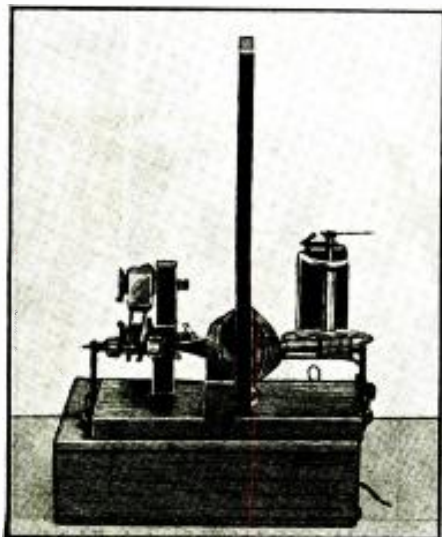

One of the tiny meteorograph motors.

SOME RADIO STATISTICS

ACCORDING to the RMA report, issued last month, there are 24,269,000 families equipped with radio receivers, in the U. S. in January of this year. The year 1936 was a record one for radio set manufacturers—7,600,000 receivers being the total production which eclipsed the previous high mark of 6,300,000 set in 1935.

Over 70 per cent of the sets in use in the U. S. are obsolete—indicating good business ahead in set replacements.

American broadcast stations made over \$2,000,000 on the National Election last fall—according to final figures just made available.

The Hollywood studios of the NBC which were opened only last year—and were ballyhooed as the most elaborate and best thus made, have become too small and large extensions are planned.

The network advertising rates of the CBS have just been increased by 9 per cent which is justified according to CBS officials by the increase of 30 per cent in Columbia's audience.

The Federal government, feeling the vast interest displayed by the American people in radio, has just set up the first government studio in the new Department of Interior building in Washington. According to Secretary of the Interior Harold L. Ickes—"there is a definite place for government radio programs, just as there is a definite place for government publications.

"The government has no more desire to compete in the broadcasting industry than it has to preempt the printing business or to edit all commercial publications"—said Secretary Ickes. The Dept. of Interior controls the *National educational activities!*



One of John Bull's new motor torpedo boats.

BRITISH NAVY'S TORPEDO BOATS

THE first three of a new type of motor torpedo boat were commissioned last month by the British Admiralty.

These new naval boats contain a veritable super-power radio station so that they can, at all times, keep in direct contact with the "mother ship" or supply base.

The importance of radio equipment to these comparatively small, though powerful ships can be readily understood, when it is realized that they are not self-supporting either from a fuel or food supply standpoint, over long periods of time. They must, therefore, keep in constant touch with their supply base or ship. Their effectiveness as fighting boats also depends on immediate response to instructions from the intelligence service.

A NEW PSYCHO-GALVANOMETER

A NEW type of "lie detector" depending on the minute electrical currents generated in the body under condition

(Continued on page 550)

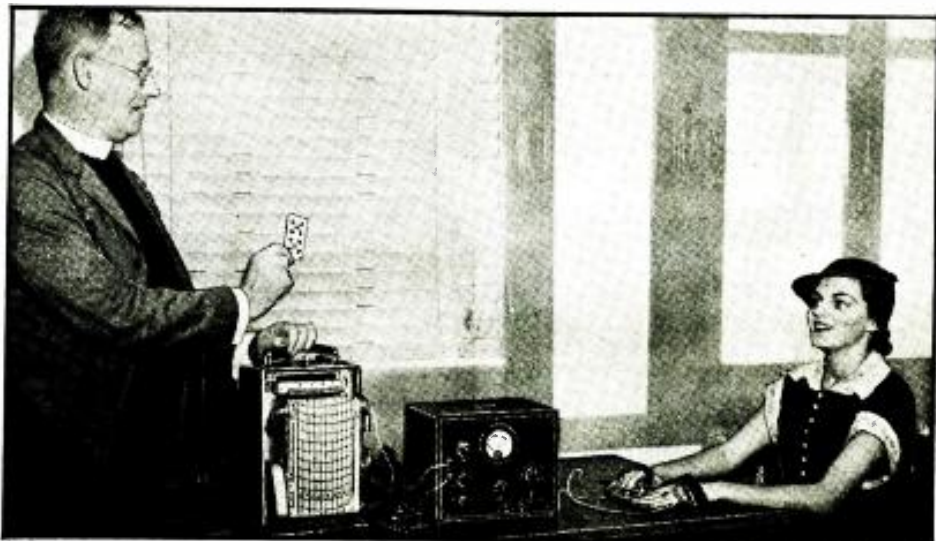

Father Summer's psychogalvanometer in operation at Fordham University.

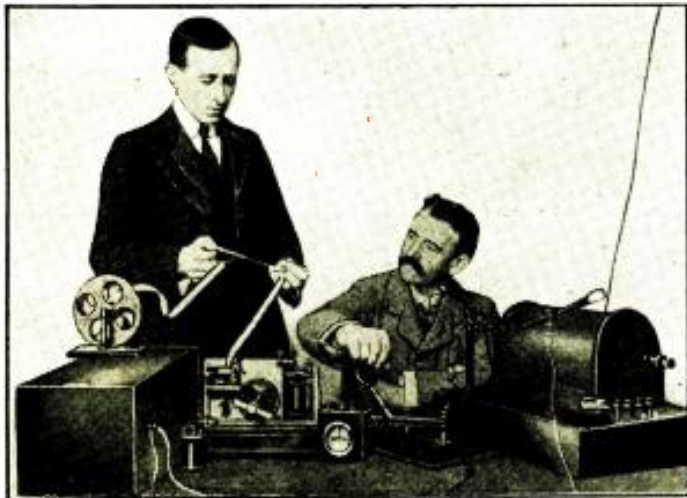

Marconi standing in front of the receiving and recording apparatus, and his assistant G. S. Kemp (seated at the massive key of the spark transmitter), at the time of his memorable reception of the letter "S" across the Atlantic from Poldhu, England to St. Johns, Newfoundland.

MY FIRST TRANSATLANTIC WIRELESS SIGNAL

December 12, 1936, was the 35th anniversary of the first transatlantic transmission of radio signals which took place in 1901.

GUGLIELMO MARCONI



A reconstruction of the kite used by Marconi in receiving the signals from England. This was an emergency aerial which replaced the large aerial blown down by a gale.

FROM THE time of my earliest experiments I had always held the belief—almost amounting to an intuition—that radio signals would some day be regularly sent across the greatest distances on earth, and I felt convinced that Transatlantic Radio Telegraphy would be feasible. Very naturally I realized that my first endeavor must be directed to prove that an electric wave could be sent right across the Atlantic and detected on the other side.

What was at that time a most powerful wireless (today, the word "radio" is ordinarily used instead of "wireless"—*Editor*) station, was built at Poldhu, in England, for this purpose, and an antenna system was constructed, supported by a ring of 20 wooden masts, each about 200 ft. high. In the design and construction of the Poldhu Station, I was assisted by Sir Ambrose Fleming, Mr. R. N. Vyvyan and Mr. W. S. Entwistle. A similar station was erected at Cape Cod, in Massachusetts, U.S.A.

By the end of August, 1901, the erection of the masts was nearly completed, when a terrific gale swept the English coasts, with the result that the masts were blown down, and the whole construction wrecked. I was naturally ex-

tremely disappointed at this unforeseen accident, and for some days had visions of my test having to be postponed for several months or longer, but eventually decided that it might be possible to make a preliminary trial with a simpler aerial attached to a stay stretched between two masts 170 ft. high and consisting of 60 almost vertical wires. By the time this aerial was erected another unfortunate accident, also caused by a gale, occurred in America, destroying the antenna system of the Cape Cod Station!

AERIAL ELEVATED BY BALLOONS AND KITES

I then decided, notwithstanding this further setback, to carry out experiments in Newfoundland, with a receiving aerial supported by a balloon or kite, as it was clearly impossible at that time of the year—owing to the wintry conditions, and the shortness of the time at our disposal—to erect high masts to support the receiving aerial.

On November 26, 1901, I sailed from Liverpool, accompanied by my two technical assistants, G. S. Kemp and P. W. Paget. We landed at St. Johns, Newfoundland, on Friday, December 12, 1901.

(Continued on page 554)

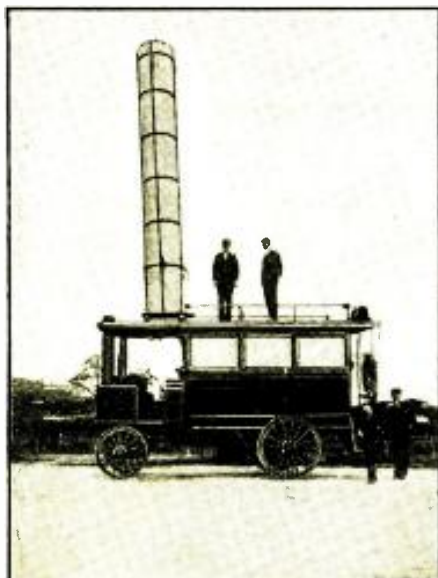

This is, perhaps, the first auto-radio installation ever made! The "Car" was equipped with both transmitting and receiving apparatus. It was used by Marconi in some of his early experiments in the year 1901!



Marconi is shown at the extreme left of this photo as he went to aid some of his assistants in flying the aerial kite in the teeth of a heavy gale. This kite aerial was the one used to pick up the signals from Poldhu, England, on December 12, 1901.

NEW INFORMATION ABOUT ANTENNAS

In this semi-technical discussion the radio beginner is given a hasty insight into the commercial set-up of antennas and antenna systems of comparatively recent designs.

R. D. WASHBURNE

A SURVEY has revealed that the larger set manufacturers appear to have declared a moratorium on new antenna-system designs!

Although laboratory workers in the bigger radio companies are industriously investigating the radio antenna situation there have been few changes in the antenna-system "picture" since the writer's article in the July and August 1934 issues of *Radio-Craft*; however, such subsequent developments as have taken place will be outlined further along in this story. We refer you, meanwhile, to the following short discussion of the several new and novel antennas, here illustrated in Figs. A, B, and C, recently brought out by some of the smaller radio concerns for the owners of car-radio receivers and all-wave radio sets.

Note, before we proceed further, that a line of demarcation has been drawn between "antennas" and "antenna systems." The former, for the purpose of this discussion, is taken to mean a simple antenna without provision of any sort for noise reduction; the latter, is more comprehensive, and usually includes an antenna coupler as an essential element in completing the "system."

NEW "ANTENNAS"

The "Topper"—for Automobiles. One of the most recent additions to the field of automobile antennas, is the "Topper" illustrated in Fig. A. It mounts, as the name implies, on top of the car. (The top-type development, to overcome the

shielding effect of the car-body, is an outcome of the introduction of the all-steel or "turret-top" automobile.)

It will be noted that this antenna introduces a new idea; it can be used in either a semi-vertical position or a nearly horizontal position. For normal pick-up in and around large cities or near broadcast stations, the antenna is deflected downward, and then locked in this position, so that it is parallel with the top of the car (to clear garage doors, etc.). Out in the country and away from broadcast stations, the antenna is permitted to ride almost vertically in order to obtain added sensitivity. The "Topper" aerial consists of the antenna proper and the shielded staff; this construction reduces fire static to a minimum. The lead-in staff is permanently attached to the car, as shown by the illustration, while the antenna proper can be removed at will since it merely "snaps" into the lead-in.

The "Streamline." Another of these top-mounting antennas for turret-top cars is illustrated in Fig. B; we have dubbed it the "Streamline." The attractive antenna fits-in with the streamline design and the styling of modern automobiles. It consists of 2 chromium-plated metal tubes, mounted one on top of the other, and attached to the car by means of special cement blocks that eliminate the need for drilling.

The "Fishpole." The automobile "fishpole" antenna, although not as new (See *Radio-Craft*, January 1937, pg. 414) as some others, should be men-

tioned here, since it is becoming increasingly popular. The new type by Tobe Deutschmann Corp. will be used as reference.

This antenna consists of 4 telescoping sections of steel tubing. The effective length, when extended, is 96 ins. and, when telescoped, 36 ins. The lower end is provided with a mounting clamp which fits all automobile bumpers. High-quality rubber insulation prevents

(Continued on page 552)

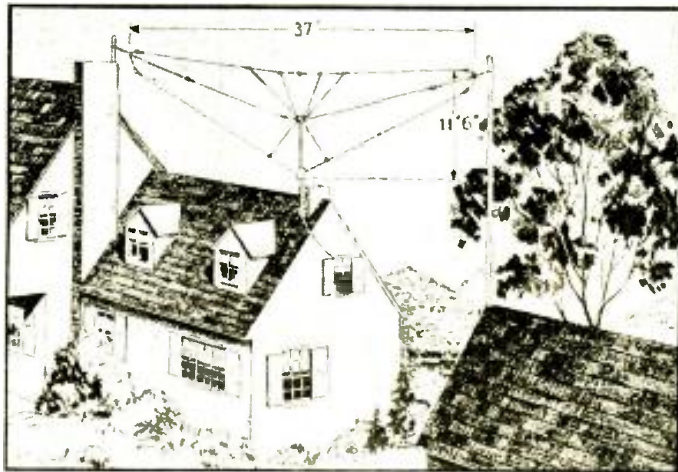

Fig. D. The RCA multiple-doublet "Spiderweb" set-up.

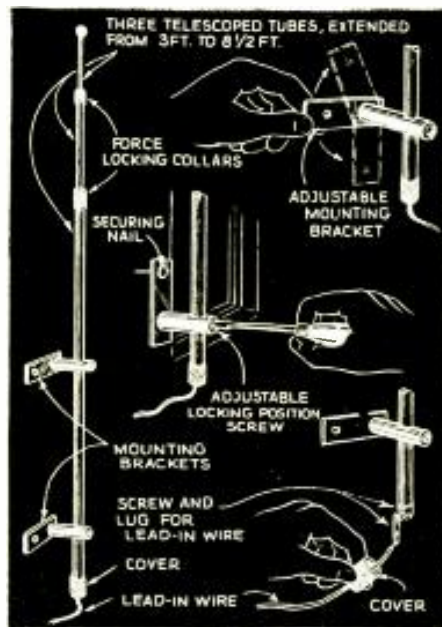

Fig. C. The A.R.H. Co's. "Window-Tenna."

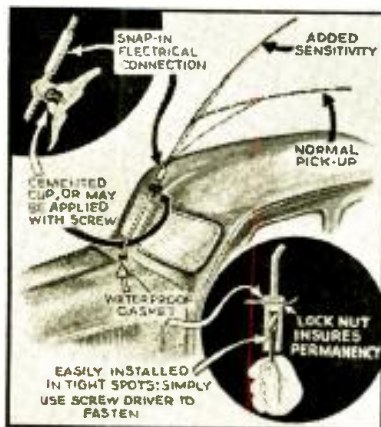

Fig. A. The Motorola "Topper."



Fig. B. A "streamline" type by Ward.

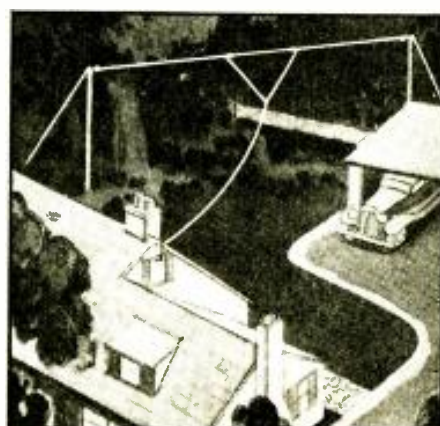

Fig. E. The "V-Doublet" of General Electric.



Fig. 1. The beginner can understand what's in it!

RADIO DEBUNKED FOR THE BEGINNER

Radio is not so very difficult for the beginner to understand if certain fundamentals are kept in mind. The author explains these and gives some advice on circuit reading.

WILHELM E. SHRAGE

NEWCOMERS into the realm of radio amateur activity are often quite discouraged after inspecting the inside of a modern radio receiver. The "shell" or outside appearance of present-day radio sets appears to be streamline-smooth and simple, but the "interior-decoration," if we are allowed to say so, is full of confusing elements and wires which often so frighten the radio beginner as to induce him (or her!) to turn disgustedly to other activities and hobbies.

The oldtime amateurs are quite shocked by this trend, because in their opinion radio has not become more complicated since its early days, but rather, more simple. They recall very well the days, 20 years ago, when not only dexterity and knowledge but also *luck* was required to squeeze from an antenna wire enough radio "juice" to produce a faint whisper in a pair of headphones.

That their point of view is correct is easy to verify by recalling how a radio receiver used to look in the old times. Simply, it was a reversed edition of our present radio receivers. That is, one saw much outside, but very little "inside story," in connection with oldtime "wireless reception devices."

Upon a panel of wall-size dimensions one saw arranged in the time-honored switchboard manner a breathtaking labyrinth of various parts and connecting "ropes," and our friends (the early

birds in the realm of radio amateur activity) jumped continuously from the switchboard's left to its right in order to persuade this veritable monster to show at least *some* good will!

And what was the final result of all this effort? A few lonely Morse signals came in once in a while, in a mass demonstration of electrical interference; and a few broken sounds (representing "wireless telephony") if and when successfully picked-up, were celebrated as events which made the world shake.

LOW-LOSS AND GREENBACKS

That was all the pleasure oldtimers obtained by spending day and night hours in tickling their almost gigantic switchboards. Considering the money they had to invest in their tubes, coils and condensers, and measuring their financial and mental efforts against the results obtained, one can truly say that radio amateurs of today have no reason to kick. It sounds like a fairy tale today if we are told that in former times a single triode tube of doubtful quality was priced at figures as high as about \$20.00-30.00; and a 450 mmf. tuning condenser of so-called "low-loss" quality was sold for about 12 nice greenbacks or more.

TODAY'S CIRCUITS

However, there are always some doubters left who are not convinced by

the facts presented to show that radio experimenting of today is much more simple than in the old days. They will argue: "But what about the radio circuits of today?" Well, this sounds at first to be a good argument, but it only *sounds* this way. Rome was not built in a day, and it would be foolish to compare the oldtime receiver with a modern 25-tube Ultrahypo-Reflex-Highfidelity-Superheterodyne Receiver. No one will expect a beginner to start with such a complex device.

One should keep in mind that the good old 1-tube-regenerative receiver, which was, and still is, the backbone of all radio circuits regardless of what make and kind, is the very thing with which to start an expedition into the realm of radio activity.

Early radio amateurs have used it, modern short-wave amateurs are still using these simple sets which seemingly have no limitations whatsoever as far as DX reception is concerned. This good old feedback circuit makes the world shrink to the size of a ball a few feet in diameter, and one can see no reason why newcomers should not be able to assemble and operate such sets without encountering difficulties.

It is no waste of time to begin with this circuit, because the experience collected will be very useful in case the oscillator circuit of a modern superhet. does not show the required signs of co-

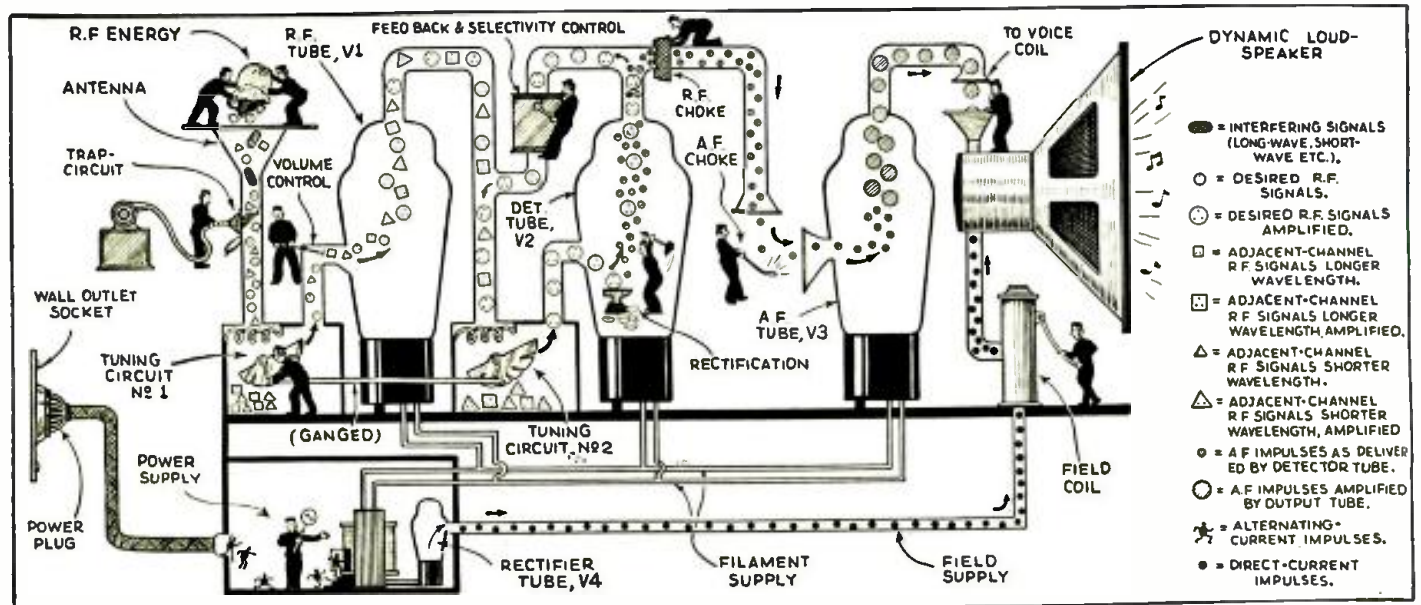

Fig. A. Another way of picturing the action in a 3-tube regenerative set—the camouflage will help the beginner to follow the action..

operation. And furthermore it is today much simpler to make such a circuit operate than at any time before. The reason is quite obvious. Tubes are much better and of more uniform quality. The parts available are of practically foolproof design, and all this despite the fact that today parts cost as many *dimes* as in former times they cost *dollars*.

DEBUNKED RADIO CIRCUITS

However, there is one thing about radio circuits which must be explained to radio amateurs of the "greenhorn" variety:— that is the doubtful method by which some publications present so-called "brand-new-radio-circuits" to the inexperienced beginner. Rather than use many words we will refer now to a few diagrams which tell the story much more impressively.

In Fig. 3A we see our friend the 1-tube-regenerative receiver. This circuit is extremely simple and needs no explanation whatsoever. Millions of beginners have built it, and obtained with this fundamental circuit stunning results, and we hope millions more will do the same. Now, let's see what the magic of the drawing board is able to do to this simple circuit. (Note that in all these circuits it may be desirable to augment, by means of a 0.001-mf. condenser, C, in shunt to the phones, the bypass capacity afforded by the head-phone cord. *Editor*)

Figure 3B shows what an *inexperienced* "circuit-magician" has done to the diagram of Fig. 3A. The circuit looks already more "substantial" and more complicated, but nevertheless, only a real greenhorn will be bluffed by this method of presentation.

However, the same circuit when re-drawn by a *master* "circuit-magician," as shown in Fig. 3C, really looks like something, and in case one or two stages of an A.F. amplifier (audio-frequency amplifier) are presented in similar makeup, our familiar regenerative receiver looks like a brand new, cracker-jack job of scientific research.

ANOTHER INSIDE TRICK UNVEILED

Now, let's study Fig. 3D. One must say this circuit seems to be a very brainy example of radio-circuit camouflage. This circuit could not be presented much more impressively. But what is actually new in it? Just a simple change of a single part. A change of minor importance has been effected—the grid resistor, R, is connected in a little different way, and all that we need is a fancy name for this circuit.

If the diagram nevertheless appears to be different from the circuits familiar to him, he still has a chance to try it out. Similar examples of what an ingenious hand is able to do, with a pencil and a drawing board, for a simple circuit are demonstrated in Fig. 3E to H. All the tricks applied in the example shown in Fig. 3A to Fig. 3D in camouflaging a fundamental circuit will be observed again. Only the circuit of Fig. 3H involves an actual change, namely, a variation in connecting the grid resistor into the circuit.

CAMOUFLAGE, BUT A USEFUL ONE

That camouflaging of diagrams may be of great value to explain the function of a set is demonstrated in Fig. 2 and Fig. A. In Fig. 2 we see a simplified 3-tube regenerative receiver, with an R.F. (radio-frequency) "input stage" equipped with a screen-grid tube. This stage is followed by a triode-type regenerative detector, similar in its design to the circuit shown in Fig. 3E. Finally we see the output stage which feeds the voice-coil of a dynamic speaker. That is quite simple, isn't it?

Now, let's see how the one and the same circuit looks when shown in a different make-up as it appears, pictorially, in Fig. A. This masterpiece of useful camouflage was used a few years ago by the Telefunken Co. in one of their advertisements, but is here presented with some little changes. At the very left we see the antenna which is fed by 2 gnomes that are dumping out

(Continued on page 549)

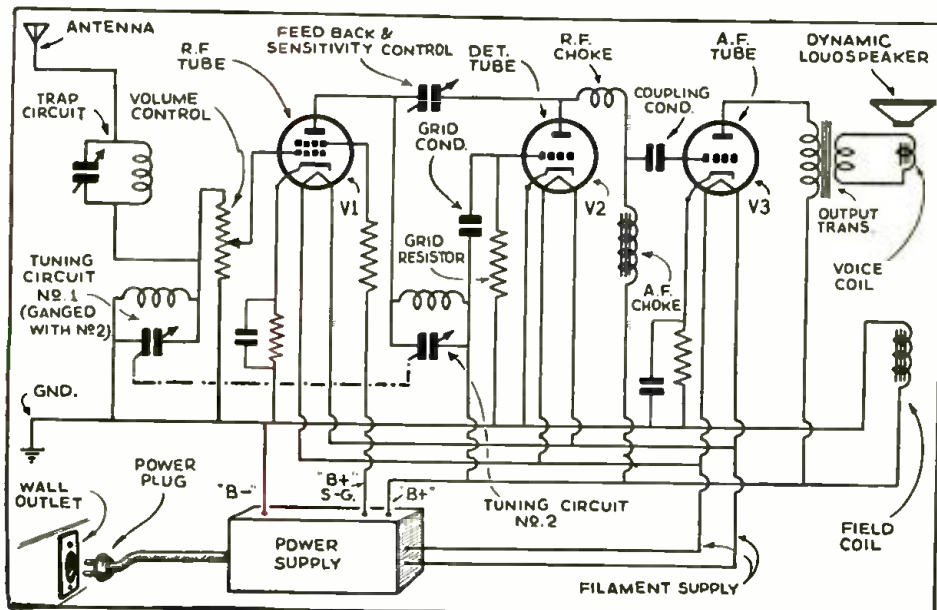

Fig. 2. This schematic is the equivalent of the pictorial circuit shown in Fig. A, at the left.

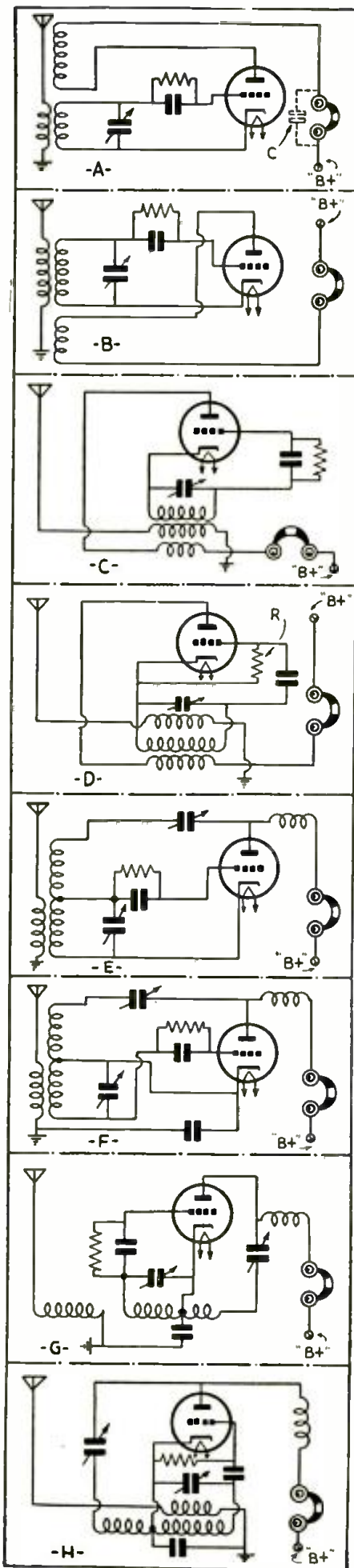

Fig. 3. Two circuits—upside down and backwards.

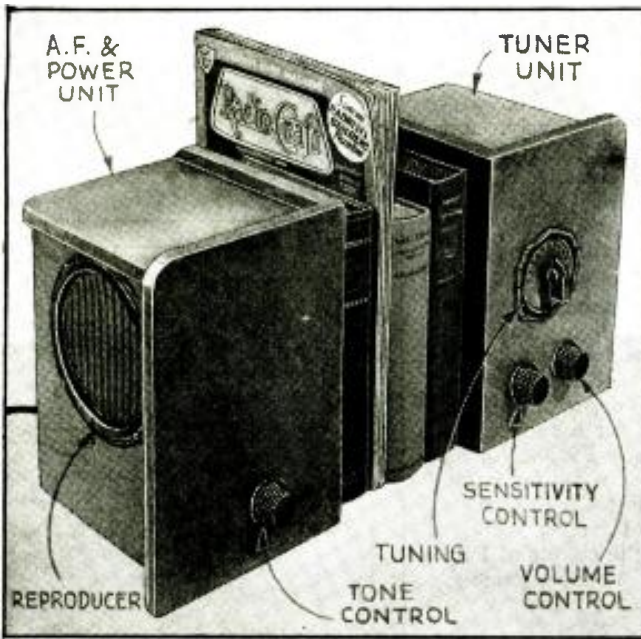

Fig. A. Here is the set doing its double duty of book-rack and radio receiver.

HOW TO MAKE THE BEGINNER'S "BOOK-END 3"

This "beginner's" set is not only unusually simple to construct, but introduces a novelty dual-cabinet design easily duplicated.

RAYMOND P. ADAMS

As an instrument of "home utility" value and as an illustration of custom application, the design becomes a "book-end" or 2-piece receiver, with (a) the power supply and loudspeaker in one unit and with (b) the tuner in the other.

The cabinets shown are small, lending themselves readily to installation on one's library or bedside table, on a wall shelf, or on the arm of one's favorite easy-chair.

They have been simply, quickly built by the author—who is certainly no carpenter—primarily to suggest the general idea, and no exact constructional data will be given for them, as the individual builder will undoubtedly prefer designs of his own choosing. (The cabinets illustrated have been finished, by the way, with an antique glaze.)

THE CIRCUIT

The circuit schematic shows 3 tubes—a 6K7 R.F. amplifier, a 25A6 power detector, and a 25Z6 rectifier—in what at first glance will appear to be a rather complex and unusual line-up but which on careful inspection will prove itself to be an extremely simplified arrangement.

Let's begin with the rectifier which is connected conventionally in an A.C.-D.C. power-supply hookup. Switch Sw.1, ganged to tone control R5, connects the A.C. or D.C. 110 V. line to the "B minus" lead. The "B minus" is NOT connected directly to chassis ground but is wired to chassis through condenser C17. The chassis, therefore, is not "hot". (It is recommended, although not specified by the author, that both sides of the line be fused as shown in the schematic and pictorial diagrams of the power unit. If desired a "fused plug", available from practically any electrical supply house, may be used.—Editor)

Resistor R6 is the 180-ohm filament dropping resistor in the 3-lead line cord and connects to the 25Z6 filament and out to one prong of the power-supply cable for connection to the tuner unit. The rectifier plates are tied together and to the 110-V. line, as shown. One output element feeds the 3,000-ohm speaker field which is filtered by parallel-connected electrolytic condenser C13, and one provides the D.C.

A CONSTRUCTION article particularly written for the radio beginner should describe in simple, non-technical language the business of building some novel, elemental and instructive design. One written for the newcomer in radio or "advanced beginner" interested in learning something about practical custom set-building should do more than this: it should present and describe, as a subject-receiver, a job which when completed will have unusual utility appeal, and thus a definite sales value.

It is the author's hope that the following descriptive story will meet with the approval of the serious-minded beginner aware of the present-day importance of custom activity, and that the design projected will not only serve as a "suggested circuit" receiver for more or less exact reproduction by the reader but that it will stimulate the exercise of individual initiative in directing instructive and experimental effort into practical channels.

The Book-End 3 becomes, therefore, as much an illustration of application possibilities, for the beginner, as a simplified, inexpensive, novel, educational design that may be built-up "over night."

GENERAL DESCRIPTION

As a basic, fundamental circuit, this design may be called the "least common denominator" in A.C.-D.C. jobs—and perhaps the limit in practical simplification extremes. It requires only 3 tubes, is powered directly from the line, provides full dynamic reproduction of broadcast signals, and can be made quite selective and sensitive when carefully built. Volume, of course, is limited, but will be found entirely adequate where loudspeaker reception of mainly local stations is the primary requirement.

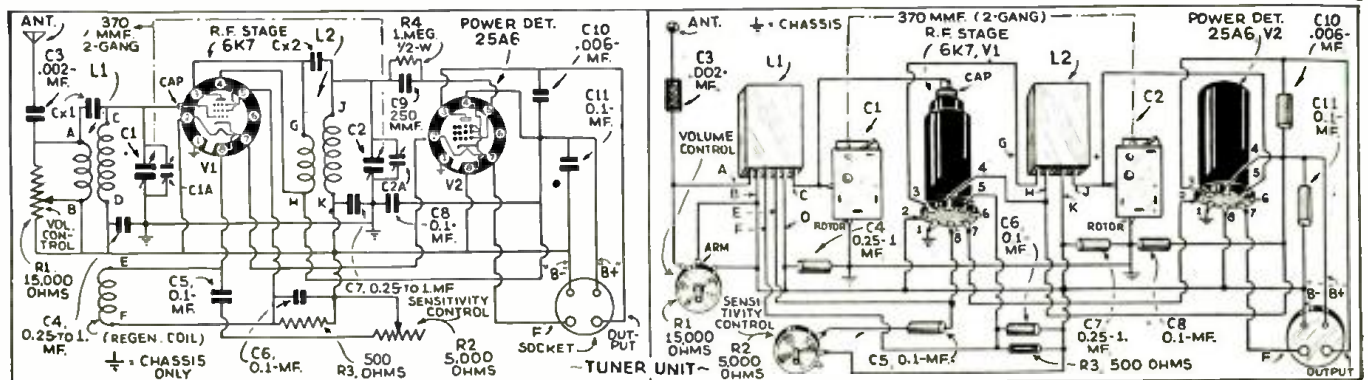

Fig. 1. The circuit of the "receiver" chassis is shown in both schematic and picture form—to make the wiring as easy as possible for everyone.

voltage for the receiver proper. Units Ch.1, and C14-C15 are collectively the necessary filter system for smoothing out the "B" supply and permitting humless operation. By substituting either a magnetic or a permanent-magnet dynamic speaker, for the electrodynamic type specified, both the field coil and C13 may be eliminated; in the event of such substitution terminals 8 and 4 of the 26Z6 socket (the output terminals) may be tied together, with some increase in "B plus" output likely.

Connection from the power and speaker circuit to the receiver circuit is made through a 4-wire cable which plugs into a receptacle on the power-supply chassis.

Moving to the receiver unit we find the final stage to be a combination power output and detector set-up—very much a departure from conventional practice. And perhaps some few technical explanations may be desirable here.

THE COMBINED DETECTOR-AMPLIFIER

There are two major types of detectors—(1) grid, and (2) plate.

In the latter, the detection action takes place in the tube output or plate circuit. The cathode is properly biased for as near linear detection as possible, in the interests of distortionless reception, and the grid or input circuit acts somewhat as an R.F. amplifier.

In the former, detection takes place in the grid circuit, with the output portion of the tube performing as a separate A.F. amplifier.

The actual R.F. "gain" or amplification in a "plate" detector is not particularly great, but the actual A.F. gain in a "grid" detector may be quite appreciable; and the overall tube sensitivity of the grid detector is considered higher than the plate type as its A.F. output is at greater level for R.F. signals of equal input strength.

Now if we were to use "plate" detection with our 25A6—that is, grid-bias detection—the audio level of rectified signals would not be very great, certainly not great enough to properly actuate a loudspeaker. There would be no advantage in using a 25A6, as we would probably have to employ an additional power output stage anyway. But by using "grid" detection (in which a grid condenser and leak are utilized), we put the output circuit to work as audio amplifier, and as the pentode is a tube of high power sensitivity it provides an A.F. signal at least strong enough to afford us reproducer volume on local-station broadcasts.

The input circuit of the 25A6 is tuned to the desired signal by the C2-C7-L2 combination. Coil L2 is an ordinary shielded midget R.F. transformer, matched to the antenna transformer, L1. Capacity Cx, in L1 and L2, is built-in. Condenser C2 is one section of the 2-gang variable condenser C1-C2. Condenser C7 is required to complete the I. C circuit; the secondary of L2 is brought to "B -" (which is not directly grounded to chassis), while the variable condenser is mounted on that chassis with rotors grounded via the condenser frame. Condenser C10 is a small bypass across the output to smooth out the tone, and its use may or may not make R5, the *tone control*, an unnecessary refinement. Unit C11 bypasses "B +" to "B -", and C8 bypasses "B +" to chassis.

The power detector in this receiver is a sensitive affair.

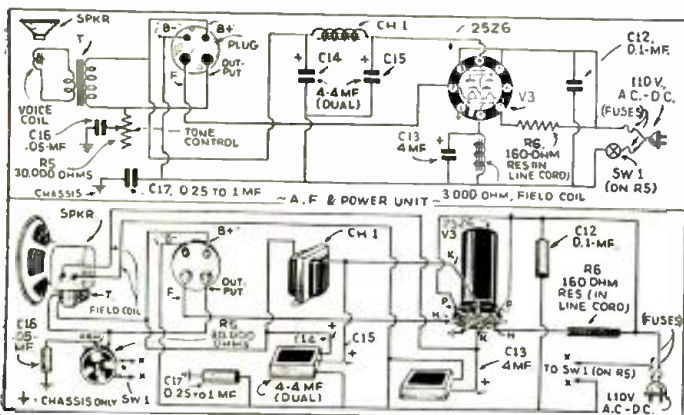

Fig. 2. The circuit of the "power" chassis—schematic and picture.

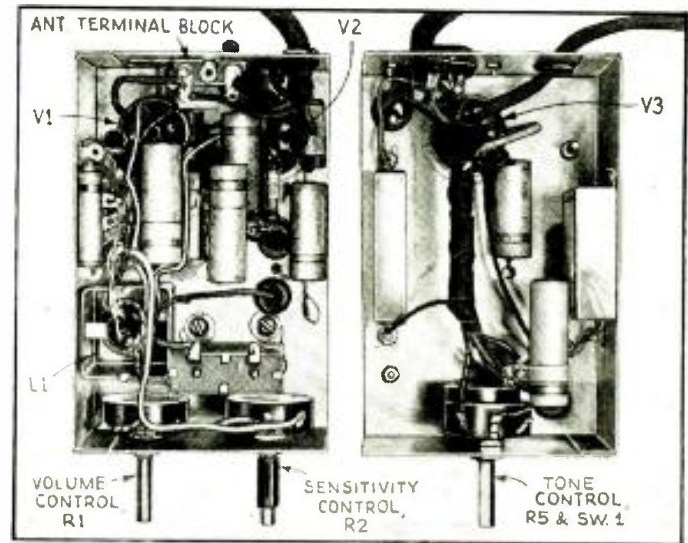

Fig. B. The 2 chassis removed from their "book-end" cases.

Nevertheless, in order to provide its control-grid with signals strong enough for speaker volume audio output, it becomes advisable to get as much R.F. amplification as possible out of our single R.F. stage. And this is achieved through the use of our old standby, *regeneration* or *feedback*.

ADVANTAGES OF REGENERATION

Feedback in the 6K7 circuit increases the strength of the amplified signal directly and effectively, as follows: *directly*, by reason of the regenerative action itself; and *effectively*, by reason of the increased selectivity which regeneration gives to an R.F. stage.

Note the connections here carefully. The suppressor-grid, ordinarily directly wired to the cathode, is tied to "B -" through the bypassed bias resistor, R3. The suppressor-grid side of R3 is then brought to cathode through a small feedback coil. This arrangement permits the proper biasing of both cathode and suppressor-grid but keeps the R.F. out of the suppressor-grid circuit.

The cathode-coil method of regeneration involves what is known as *electron coupling* and the builder should remember this admonition: NEVER TIE SUPPRESSOR-GRIDS AND CATHODES DIRECTLY TOGETHER WHEN ELECTRON COUPLING IS EMPLOYED WITH TUBES OF THE TYPES 6K7, 6D6 and 58; the suppressor-grid should be always wired as shown, connected directly to ground or "B -", or tied to the screen-grid. In "EC" (electron-coupled) circuits for regeneration, direct connection between cathode and suppressor-grid will nullify the effect of internal shielding and cause instability.

(Continued on page 560)

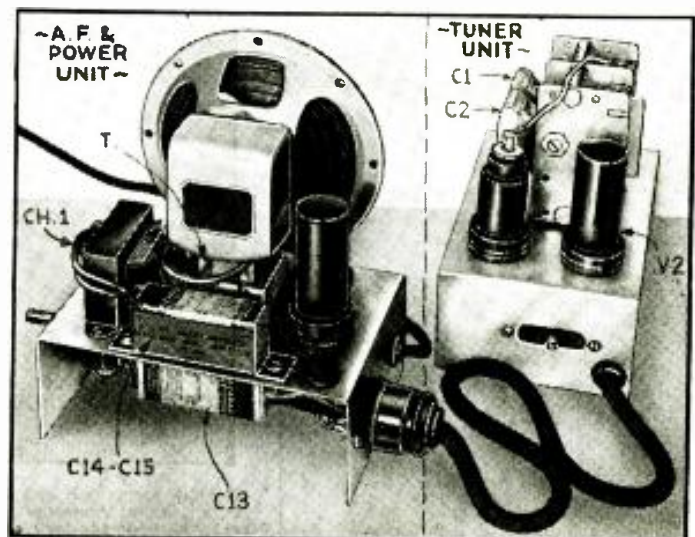

Fig. C. The underside of the 2 chassis showing parts layout.

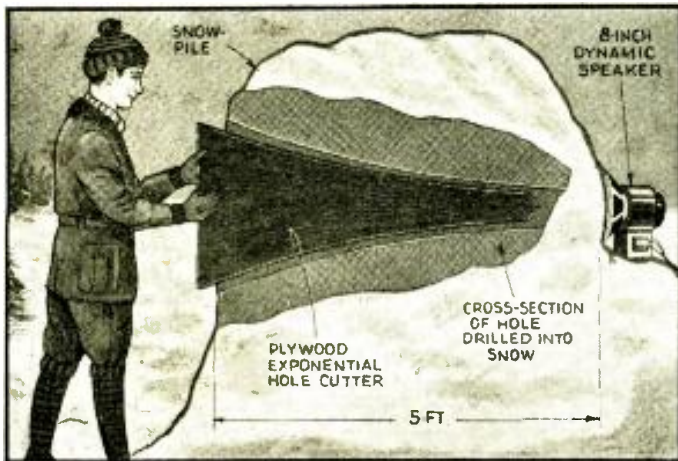

Fig. A. The board is turned like a drill through the snow.

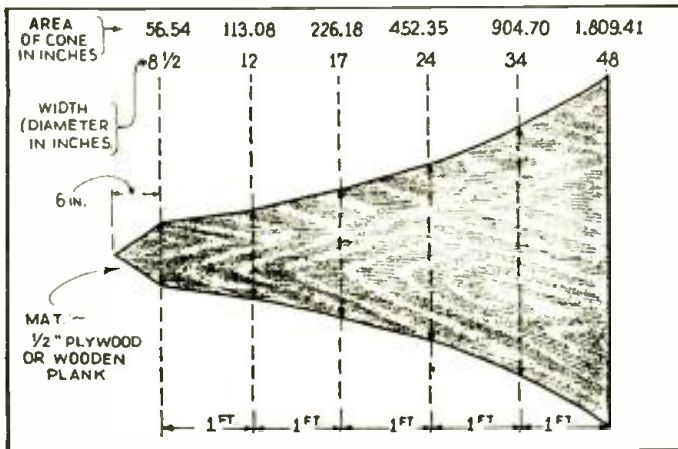

Fig. 1. The "snow drill" is exponential in shape.

HOW TO MAKE A SNOW LOUDSPEAKER

"When in Rome do as the Romans do"—is well applied in this novel speaker, for the snow months.

J. H. GREEN

THE REMARKABLY rapid development of radio communication from the early crude spark transmitters and crystal, electrolytic and coherer type receivers, to the present complex systems has been due almost entirely to the ingenuity and inventive ability of some of the men who have devoted their lives to this art, either as amateurs or professionally.

This inventive spirit has spread like a germ from one to another—old timers and raw beginners alike—and none can tell where it will pop out next.

An example of such inventiveness was observed recently when a public-address worker who, wishing to supply radio music to a certain skating rink, originated the novel idea of making a real exponential horn out of snow.

At first thought this may seem fantastic, but actually there are several technical reasons why such a reproducer should have good characteristics. In the first place, the packed snow will have no resonant frequencies so that the over-all frequency characteristic should be more uniform than speakers made from rigid materials. Second, the packed snow can be formed into any desired shape, so that a true exponential curvature rather than the usual "7 or 10 per cent" increment found in most horn type reproducers can

(Continued on page 561)



The tapering tower for the 2 transmitter aeriels.

MARCONI-E. M. I. HIGH-DEFINITION TELEVISION AT ALEXANDRA PALACE



A typical English television receiver in use.



Control room and amplifier racks for the Baird installation at Alexandra Palace. Note the monitor cathode-ray image tube on the control desk (right) and the acoustically treated walls and ceiling. The Baird installation is alternated with the Marconi-E. M. I. system. Each station is usually on the air one day while the other is silent.



The Marconi-E.M.I. studio showing two Emitron television cameras in use—one ready for a "fade-in."

THE LONG-HERALDED television station at Alexandra Palace, London, began operating on an experimental basis several months ago with a twice-daily program. From a hill 306 ft. above sea level the BBC's new television station dominates London and a large portion of the suburbs. It is built into the south-eastern corner of Alexandra Palace—a north London land-

(Continued on page 562)

HOW TO MAKE A "JUNIOR" OSCILLOSCOPE

Here is a complete metal-oscilloscope-tube cathode-ray analyzer—sweep oscillator, amplifier and power supply.

WILLIAM FILLER

WITH THE introduction of the new type 913 cathode-ray tube (See *Radio-Craft*, January 1937, pg. 395.—*Editor*) any number of suggestions have been made regarding the manner in which it may best be employed by the Service Man. The accompanying illustrations and (Fig. 1A) circuit diagram, covering the fundamentals of a device of this nature, will provide almost every necessary facility at the lowest cost. The 1-in. image the 913 affords is adequate for almost all servicing needs and very nicely meets the demands of a portable instrument.

Certain specific uses for a servicing oscilloscope, such as the alignment of the various stages in an intermediate-

frequency amplifier, can best be accomplished by the addition of a stage of amplification. The circuit diagram for such an arrangement and the suggested changes from the fundamental circuit will be found in Fig. 1B. There is plenty of room in the cabinet for the installation of the necessary resistors and condensers for the additional amplification stage. The tube may best be located by moving the 885 back toward the power transformer and placing the 6J7 in the position now occupied by the 885. Of course, this will necessitate the cutting of another hole in the subpanel, but that is not a very serious matter since the material from which the subpanel is made is comparatively light.

So much has been said about the design, construction and operation of various types of oscilloscopes (See "How to Make an Oscilloscope," July-Aug.-Sept.-Nov., 1936 *Radio-Craft*.) that we believe it is necessary to cover nothing more than a few suggestions concerning construction and the recommendation that for specific information regarding the most suitable manner for applying this oscilloscope that the Service Man pay particular attention to John Rider's very complete book, "The Cathode Ray Tube At Work", which covers the subject in splendid fashion. (Still another "slant" on the service angle of oscilloscopes may be obtained by reference to J. T. Bernsley's book, "Official Radio Service Handbook."—*Editor*)

CONSTRUCTION

A complete kit of parts for the

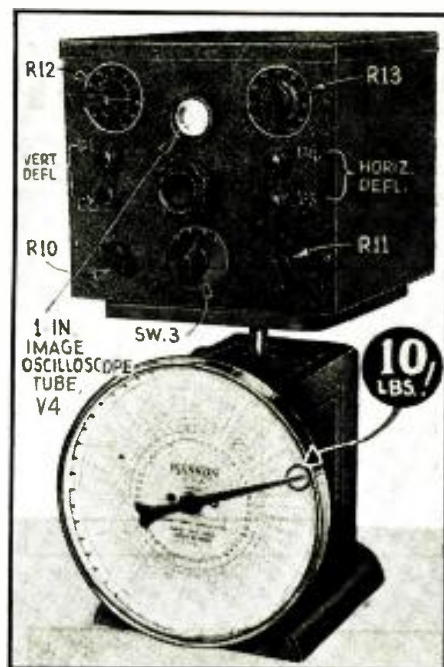

Fig. A. The complete unit weighs only 10 lbs. Cabinet dimensions—8 x 7¼ x 8¾ ins. deep.

"Junior" Oscilloscope, with front panel, subpanel and other portions of the cabinet punched and drilled, is available.

It is recommended that a small bakelite tube or visor be placed over the "eye" of the 913 tube where the oscilloscope is to be used in bright light. Except for this ferrule, hardware, binding posts, knobs, dials and everything else necessary for the making of this unit is included in the kit.

The first step in the assembly is to mount the sockets, potentiometers, tap switch, power transformer and filter condenser as illustrated.

It will be seen that the resistor strip, which carries resistors, R19, R1, R2, R3, and R9, and condenser C2, is mounted under the sub-base with one bracket on the bolt for the 913 tube support and the other bracket bolted through the hole approximately 2 ins. nearer the front of the panel.

The next operation is to wire the power supply, keeping in mind that the POSITIVE side of the circuit is grounded. This is in accordance with usual oscilloscope practice. After building the power and filament wiring proceed with

(Continued on page 551)

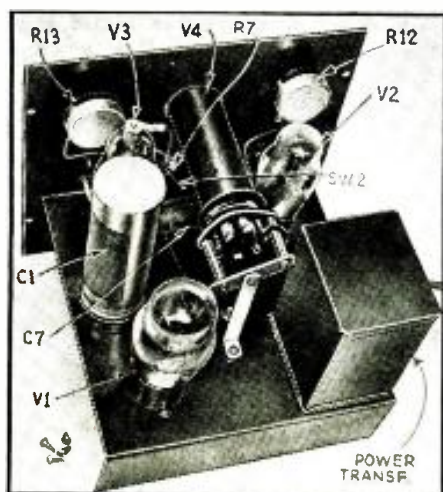

Fig. B. The chassis layout. Note tube support.

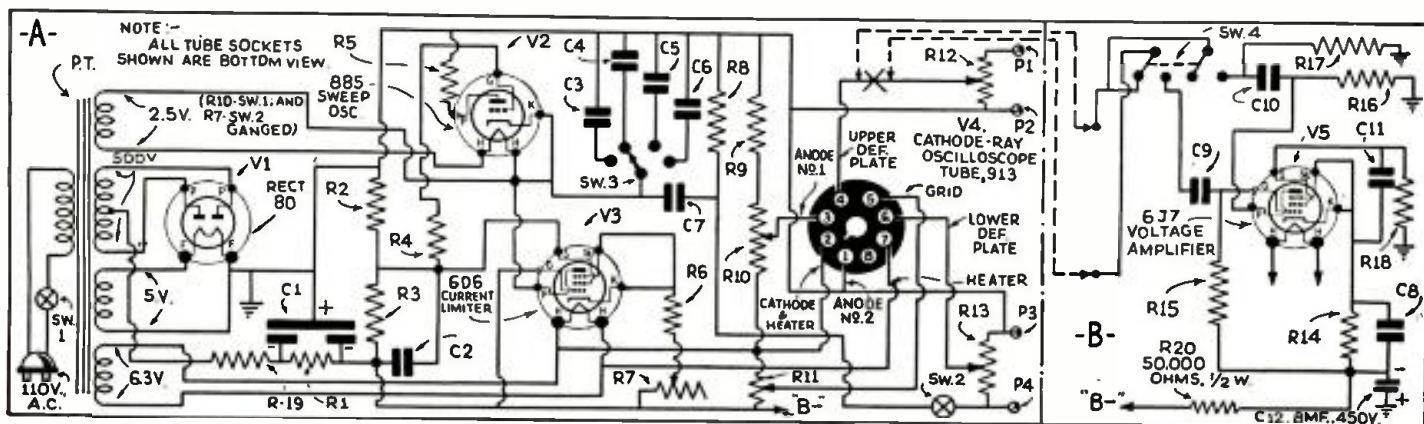

Fig. 1. The circuit of the "Junior" Oscilloscope. The unit at the right is the vertical plate amplifier which makes it a complete servicing unit. Controls: resistor R7—horizontal-sweep-frequency; R10—focus; R11—intensity; R12—vertical-sweep; R13—horizontal-sweep.

INTERNATIONAL RADIO REVIEW

RADIO-CRAFT receives hundreds of magazines from all parts of the world. Since the cost of subscribing to each of these would be prohibitive for most radio men, we have arranged with technical translators to prepare reviews for our readers.

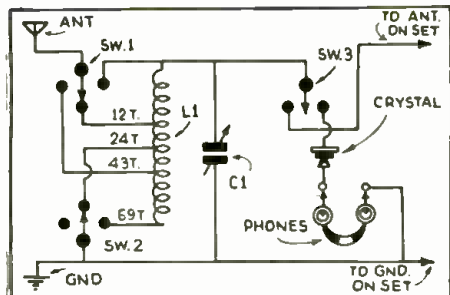

Fig. 1. The circuit of the combined crystal receiver and antenna wavetrap.



Fig. A. Notice the squat appearance of this television receiver—for seated viewers.

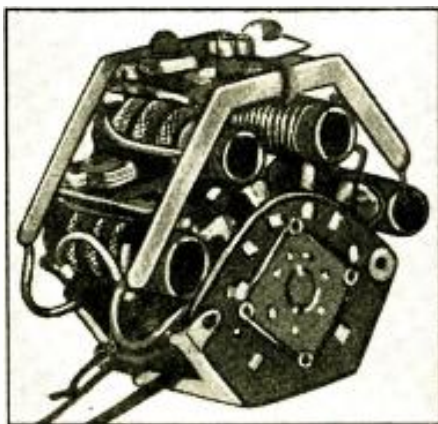

Fig. 8. An Italian all-wave tuner mechanism. The unused coils are short-circuited.

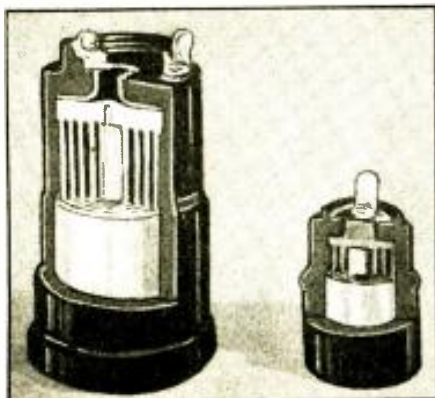

Fig. C. Air-dielectric trimming condensers are now available in Europe.

A CHINESE CRYSTAL SET

THE LATEST issue of *The China Radio* (Shanghai), a magazine published in Chinese, contained the circuit and description (if we can believe our Chinese translator—Hi!) of a handy crystal set which serves the dual purpose of stand-by radio receiver and wavetrap for removing interference on the regular vacuum-tube set.

As shown in the circuit, the unit contains a coil of 69 turns of No. 22 cotton-covered wire, on a 3-in. cardboard tube, with taps for changing the wavelengths covered; a 500-mmf. variable condenser; a crystal detector; headphones; and 3 tap switches—two for changing the wavelength (Sw.1 and Sw.2) and one for changing the unit from a crystal set to a wavetrap (Sw.3).

As a crystal radio receiver, Sw.3 is moved to the right-hand contact. The switches Sw.1 and Sw.2 are moved about and the variable condenser is adjusted until broadcast stations are picked up.

As a wavetrap, Sw.3 is turned to the left-hand contact. By adjusting the switches Sw.1 and Sw.2, the unit can be used either as a "series"- or "parallel"-type trap circuit. In other words, if Sw.1 is in the right-hand-end position and Sw.2 on the middle or right-hand contact the tuner works as a simple parallel-tuned circuit (as found in almost every radio receiver) while if Sw.2 is in the extreme left position and Sw.1 is rotated to tune to the correct band, the circuit is a "series-tuned" trap circuit.

By thus changing the circuit, the trap circuit can be used to eliminate an interfering station, or to aid in picking up one particular station (such as a weak one) by tuning the antenna circuit to resonance with the receiver.

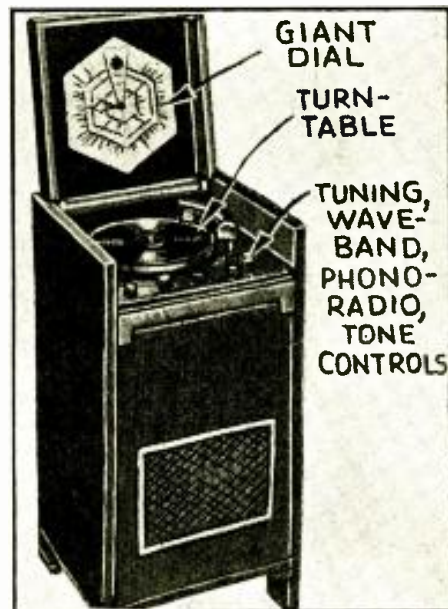

Fig. E. Short-wave tuning is greatly simplified by this giant tuning dial.

The terminals A and G connect to the aerial and ground binding posts of the receiver to which the wavetrap is to be connected. The regular aerial and ground wires are connected to the correct points on the trap, as shown in Fig. 1. (It may be desirable to connect a condenser of about .001- to .006-mf. in shunt to the headphones.)

A GERMAN TELEVISION RECEIVER

A NOVEL construction for a cathode-ray television receiver of German make was recently shown in the Austrian radio magazine *Radio Amateur* (Vienna).

The tube in this receiver, which was made by the D. S. Loewe Company of Berlin, is mounted in an inclined (Continued on page 555)

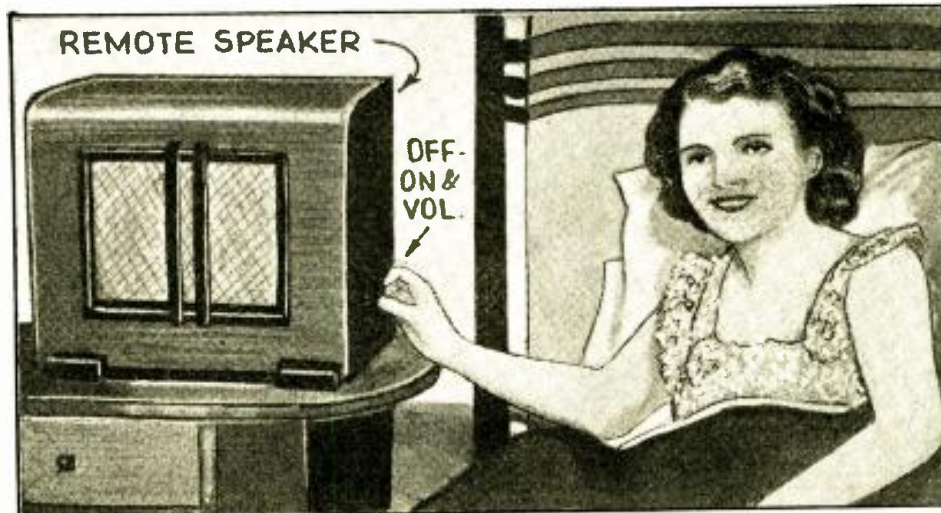

Fig. D. With this "long arm" you can retire early and turn the radio receiver off without getting out of bed. The remote speaker is equipped with a control box for the purpose.

ANALYSIS OF FIDELITY CONTROLS IN THE 1937 SUPER "PRO"

The efficiency of a modern "communication type" receiver can be well appreciated by the graphs and data given here.

ELI MARTIN

IN a RECEIVER with laboratory-calibrated controls, such as the new "Super Pro", extremely skillful design and construction were imperative to achieve the necessary perfect circuit and mechanical synchrony.

How many difficult problems were solved to permit the production of such a precision instrument are explained in this article.

The selectivity of the intermediate-

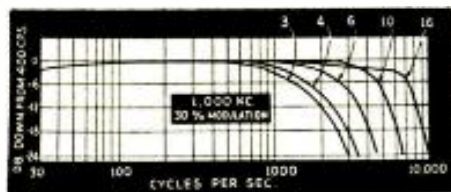

Fig. 2. Audio characteristic for 5 I.F. "band widths."

frequency amplifier of the new "Super Pro" is continuously variable by means of a control in the front panel. This control simultaneously varies the coupling between the primaries and the secondaries of the first three I.F. transformers. Since both the primary and secondary of each transformer are tuned, this variation of coupling changes the response characteristic from a single sharp peak in the minimum coupling position to a wide double humped curve in the position of the maximum coupling. The total range of the coupling provided by this panel control is from approximately 1/3 optimum in the narrow position to about three times optimum in the wide position. The control being continuously variable, any intermediate value be-

(Continued on page 562)

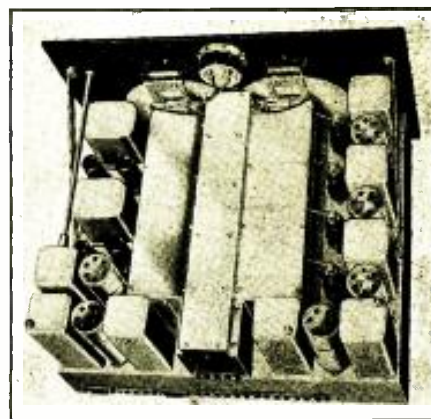

Fig. A. The rear view of the chassis described.

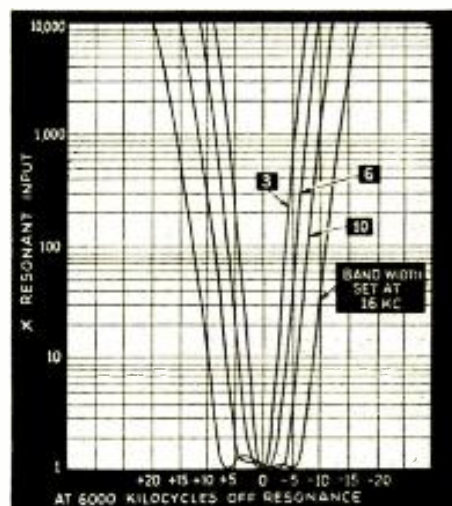

Fig. 1. Selectivity at 4 "band width" settings.

The radio beginner and experimenter will find this novel little set a fine one to tax his ingenuity and mechanical ability—try it!

NOVEL 1-TUBE SET USES "BODY" ANTENNA

COME ON all you experimenters and beginners, here's something for which you've been looking to try your hand at. This "gadget" is a radio set! It smacks of the good ol' days when radio sets assumed all sorts of grotesque shapes and sizes . . . and, surprisingly enough, worked.

This instrument is a combined radio receiver and flashlight, the "A" batteries being common to both. The "B" batteries, consist of a series of pen-flashlight cells contained in another flashlight housing at the "head" of the instrument. Only 12 V. of "B" are used, but the greater the voltage (and, necessarily, the housing) the better and louder will be the operation. The instrument is readily portable since it requires no aerial. The hand (and consequently the entire body) which holds the set serves as an aerial. To tune the set, the lower flashlight handle has to be moved up and down, slowly, until the desired station is obtained. Regeneration is controlled by rotating the cap of the phone which is ingeniously connected to the upper flashlight housing.

The circuit of the set is the usual regenerative type. Instead of an aerial, however, a "hand-contact" coil is used. Beneath this coil are three additional pieces of thin bakelite (hard rubber or cardboard will do) tubing. The first two are lined with tinfoil, thereby serving as a condenser, the aerial condenser. The other one serves as a coil form for the primary, secondary and tickler windings which constitute the antenna coil. Beneath (inside of) this coil are two metal cans separated by some insulating material such as sheets of mica or cellophane. These cans "telescope" into each other, thereby serving as a variable tuning condenser. The type 30

tube is mounted bottom-side-up (to keep all wires as short as possible) inside the inner metal can. Since the available

(Continued on page 566)

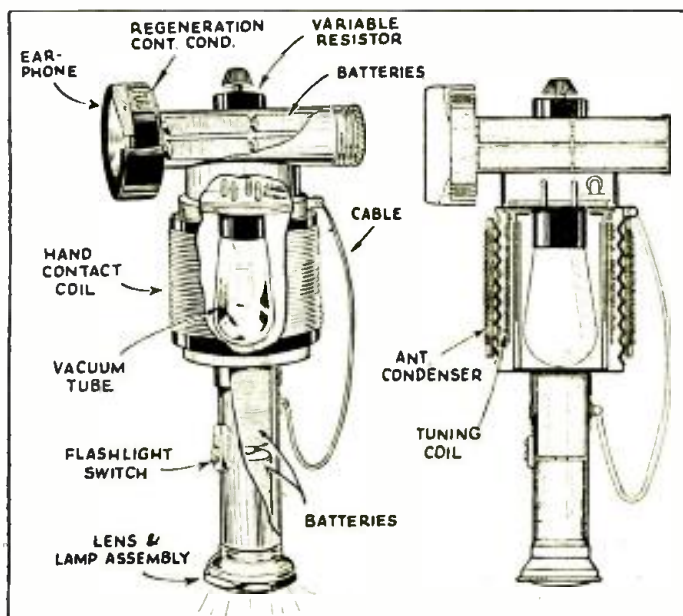

Fig. 1. The mechanical make-up of the flashlight-radio set.

HOW TO MAKE THE TELEVISION

In this, Part III of the series of television receiver constructional articles, the cathode-ray equipment, sweep circuits and amplifier are included. This equipment will be tied up, in Part IV, with the previously described chassis.

PART III

Let us digress for the moment and review the construction of our set thus far. First, we made an ultra-short wave receiver of the superheterodyne type. This was used for picking up the accompanying sounds which are being sent out with the images; and signals of amateurs working on the channels adjacent to the television band. Actually, this tuner will be used as the video or image tuner and so, Part II contained details and the circuit of a second I.F. amplifier, detector and audio amplifier which couples into the output of the frequency changer of the tuner and is used for picking up the accompanying sound transmissions of the television broadcasts. By correctly tuning the two I.F. amplifiers as described in Part II, it is only necessary to tune in the weird sounds of the video transmissions on the vision channel, and the sounds which accompany the images are heard from the sound channel of the set.

The third part of the system consists of the C.R. tube and its associate equipment for scanning the image or reconstructing the visual images from the high-frequency impulses received.

In Part IV, we will tell how to make the cabinet which houses the receiver and tie-up all the individual parts of the system which, through necessity, we have left in a rather loose-ended condition.

CONSTRUCTION

The first thing to do, of course, is to obtain all the parts called for in the List of Parts at the end of this article. This includes the chassis which can be obtained already bent, or can be made by the constructor from sheet aluminum.



Fig. H. The C.R. chassis is the stages of construction.

PART III of this series contains the circuit and details for making the cathode-ray equipment of the television receiver. This includes the high-voltage power supply for the C.R. tube, the voltage dividing system to apply the correct potentials to the C.R. tube, the vertical and horizontal sweep circuits which carry the cathode-ray beam back and forth and up and down across the image end of the tube (in synchronism with the scanning of the transmitter) and the wide-range A.F. amplifier which permits the rectified signals from the video channel to modulate the control-grid of the C.R. tube to cut-off.

This sounds like a big bite to make at one time—and perhaps it is the most difficult job involved in the construction of our vision receiver. However, the unit does not break down readily as all of the above functions are so closely correlated that one is not complete without the others.

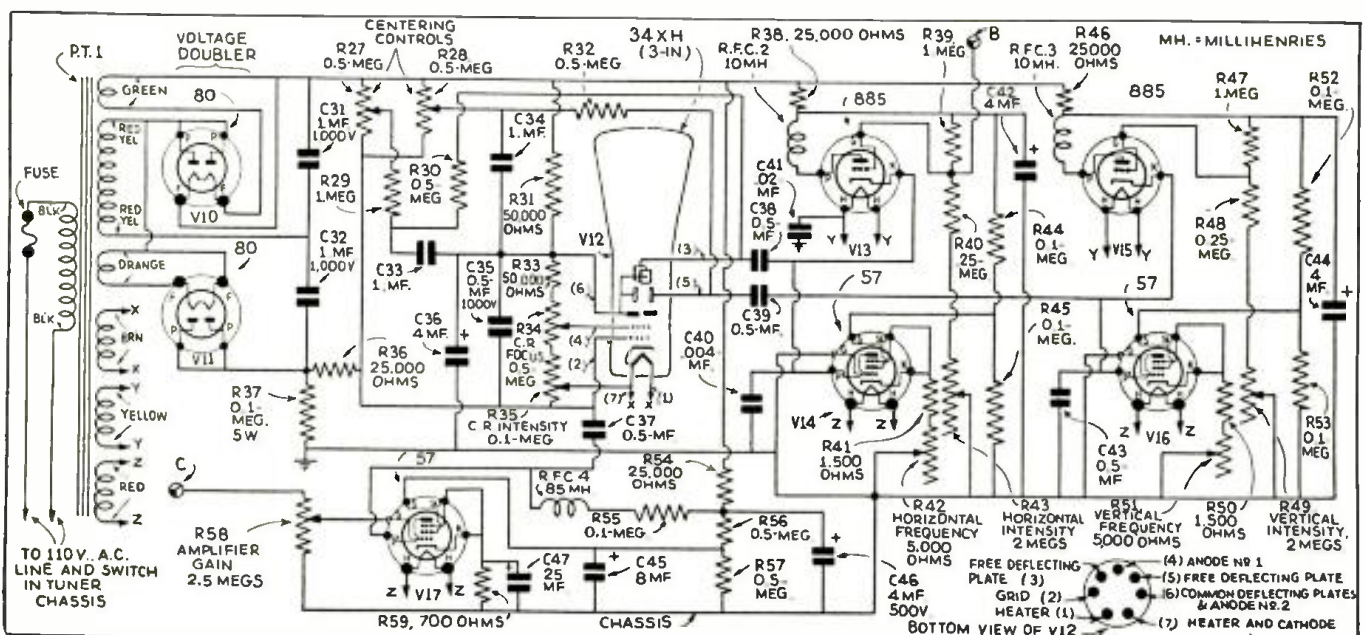

Fig. 5. The tubes services are as follows: V10, V11, power supply; V12, image tube; V13, V15, sweep oscillators; V14, V16, constant-current discharge tubes; V17, wide-range A.F. amplifier.

RADIO-CRAFT—1937 RECEIVER

In a letter to RADIO-CRAFT, G. M. Fox of Hayes, Middlesex, England, writes: "The picture transmissions which are now a daily feature of the BBC service are being well received. Receiving equipment is being used as an attraction at some of the smart restaurants, also at the Science Museum and at Waterloo Station. As far as I can learn, there is no important difference between the Baird and E.M.I. systems and those of Farnsworth and Zworykin."

The dimensions for this chassis, including the positions of the large holes for tube sockets and electrolytic condensers, etc. are shown in Fig. 6. The cathode-ray tube is supported on two vertical supports, as shown in Figs. H and I which show the unit in the stages of construction and completed, respectively.

The upright brackets for the support of the cathode-ray tube are shown in Fig. 6. The back, or U-shaped upright is drilled for the socket of the cathode-ray tube which is mounted at a 10 degree angle from horizontal by cutting a triangular slice from each side of the support and bending the flat, front portion back until the sides meet. Slots are cut for the screws supporting the socket for the C.R. tube, V12. This permits rotating the tube to make the images "straight" on the front of the tube.

The flat or front support for V12 consists of a strip of aluminum with a 1 5/8 in. hole at the top through which the tube passes. The two holes which secure this strip to the chassis, at the bottom are elongated so that the tube can be raised or lowered to center it in the line of the lens system. (More will be said about this lens in Part IV.)

When all the holes shown in the chassis and supports shown have been cut or drilled, the parts may be mounted. Where holes are not shown, they should be drilled to fit the parts in question. These holes have been omitted since the parts used will control the positions of these holes. The photos, Figs. H, I and J show the positions of the parts above and below the chassis.

When all the parts have been secured in place, with the exception of those which are mounted on the wiring (such as fixed resistors, small condensers, etc.) the wiring can be started.

A point of warning must be given here since ordinary precautions to insulate parts from each other and from the chassis will be entirely inadequate. The total voltage of the power supply is over 1,200 V. and special precautions must be taken to carefully insulate all parts. Use well insulated wire and rubber grommets wherever any wires project through the chassis. Otherwise, trouble, "fireworks" and breakdown of some of the parts will result, when the power is turned on.

Also, it may be well to repeat, at this time, a warning which was given in Part I—that is, do not touch the chassis or any parts or wires of this unit when the current is on. The high voltage used is DANGEROUS! Always make sure that the line plug is out of its socket before touching any metal parts of this chassis!

ANALYSIS OF THE CIRCUIT

When all the wiring is completed according to the circuit, Fig. 5, the entire wiring should be checked, wire by wire—and it would be well to have a

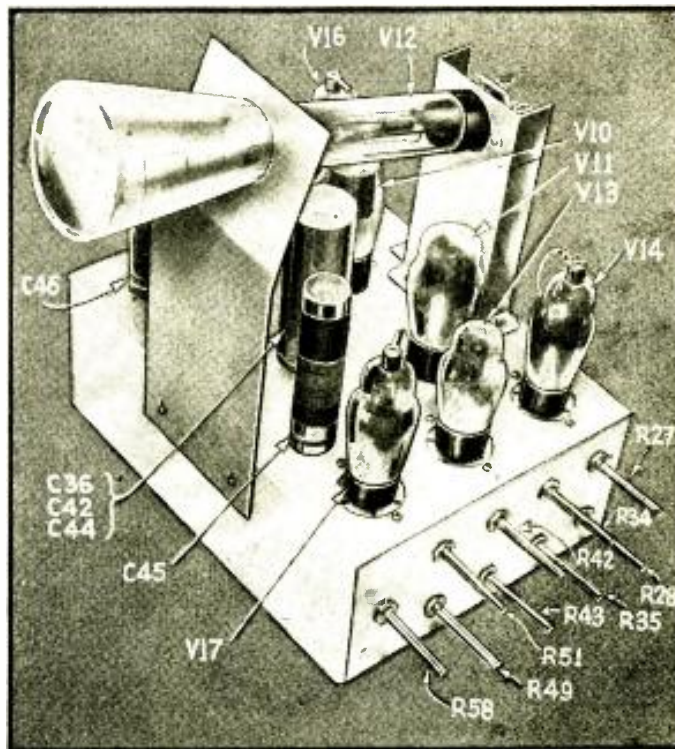

Fig. 1. The completed chassis ready to be tied to the tuner.

second person check the wiring for you to be absolutely sure that everything is OK.

The unit can then be tried out and preliminary adjustments can be made to prepare it for its task in converting electrical impulses into living, moving images.

First, however, it may be advisable to do a little explaining about the circuit which we are using, so that the constructor will know something about it and thus be more able to use it correctly.

The power supply is of the type known as a voltage doubling circuit. Two type 80 tubes are used with a power transformer supplying some 600 V. on its high voltage winding. The voltage applied to the two rectifiers which are connected as half-wave tubes by shorting the plates together are fed to two series, high-voltage dykanol condensers, C31 and C32 which alternately store up the applied voltage and discharge it into the output circuit. Thus the voltage of 600 from the transformer is doubled and a voltage of some 1,200 V. is actually applied to the C.E. tube, V12.

The reason for this voltage doubling is to use an available transformer which has a very concentrated field so that the

(Continued on page 563)

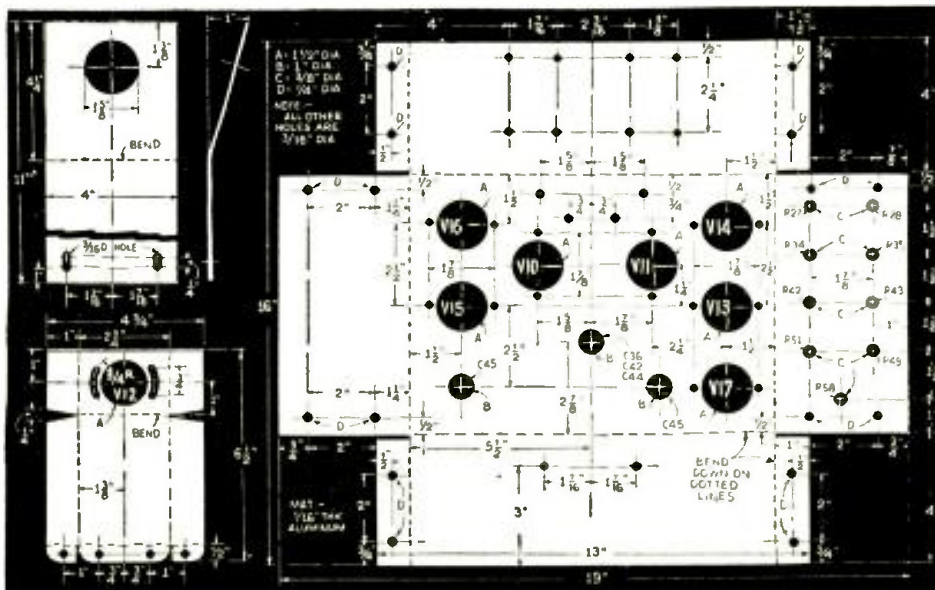

Fig. 6. The forming and drilling layout of the chassis and tube supports.

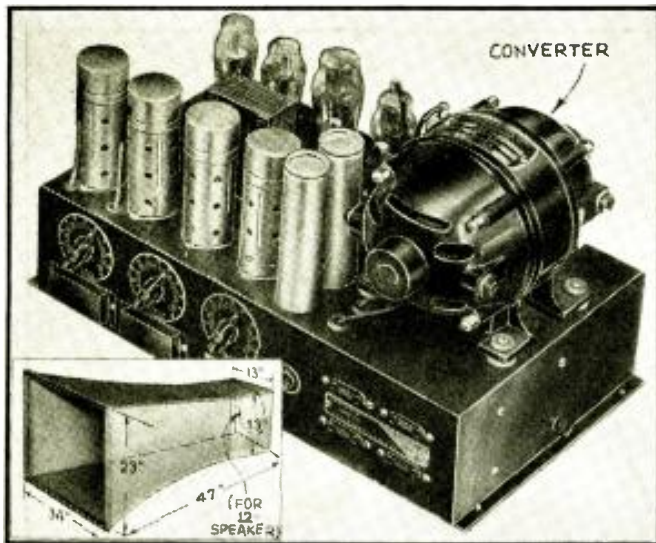

Fig. A. A 30-W. truck amplifier; and (insert), a truck trumpet.

THE SERVICE MAN or the beginner in Public Address who considers equipping a sound truck has first of all to determine whether the truck is to be used for general rental purposes, or whether his ultimate object will be to sell it to some user who will want it to serve a specific function. His decisions in the matter of apparatus to be installed will depend to a considerable degree upon the answer to that question, since the general-purpose rental truck will need more flexible facilities. The P.A. truck that is to be sold to meet one definite object may be limited, in equipment, to a sound system capable of serving one purpose only.

Subject to this broad division between a general-purpose rental truck and a single-function truck for re-sale, the Service Man or the P.A. beginner installing mobile equipment has 5 general factors to keep in mind when choosing his apparatus. These are: (1) The sound volume needed; (2) The amplification needed; (3) The type of sound to be

HOW TO EQUIP A SOUND TRUCK

The beginner in Public Address work will find much instructive data in this lucid article.

H. W. PARO

reproduced; (4) The degree of high quality that will be required in the sound; and, (5) The nature of the power supply to be used.

It will be seen, by a brief inspection of these factors, that they interlock; the extent of sound volume desired will have an important bearing upon the type of power supply chosen, the nature of the sound to be amplified will in some ways govern the amount of amplification needed, and so on.

SOUND TRUCK VOLUME

In determining the amount of volume needed from any sound truck, one important point to remember is that outdoor work in general, and with exceptions as indicated below, needs more volume than indoor work serving a crowd of the same size, in an area of the same size. The reason is that sound indoors is reinforced by reflection from walls and ceilings, while in much outdoor work, particularly at fairs, athletic fields, and other open places, sound that once passes the ears of the listeners is lost; it is never reflected back to anyone who can hear it.

An important exception to this statement will be found in narrow city streets, especially streets lined with high buildings, where pavement and walls introduce a considerable degree of reflection, and provide some sound reinforcement. In such work, however, the background noise of traffic is likely to be heavy, and what has been gained by reflection

(Continued on page 565)

LOUDSPEAKER BAFFLES AND CABINET RESONANCE

The subject of loudspeaker baffles is, perhaps, one of the most mystifying to radio beginners. By considering the cone as a piston the need can be readily understood.

McMURDO SILVER

THE WRITER is so regularly and continuously surprised by daily correspondence which indicates such a lack of understanding of what a loudspeaker baffle is that he is taking occasion to dispel the many false impressions regularly met with. Even many radio Service Men do not know the "ABC" of baffles.

A dynamic cone loudspeaker functions over most of the audio range as a piston, driven by the A.F. output of any amplifier through the agency of its voice coil, which may best be considered as a "motor" driving the piston (cone). When the cone is so driven by an audio-frequency signal, it moves forward and backward, thus displacing surrounding air both in front of as well as behind

the cone. It is this displaced air which the ear perceives as sound.

In such operation, the air pushed out in front by the cone moving forward must go somewhere, and as a partial vacuum is created at the rear of the cone as it moves forward, the displaced air in front finds it most easy to flow toward the partial vacuum at the rear, which needs new air to fill the semi-vacuum left by the forward movement of the speaker cone. The net result of this action in theory is the generation of sound waves in only the air very near the cone.

This is true for very low frequencies, but not for high frequencies. Thus in practice, an unbaffled speaker will reproduce high tones, but will lack almost

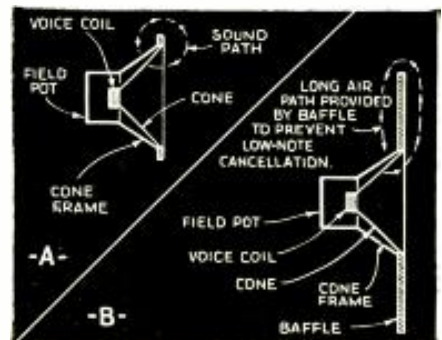

Fig. 1. The lengthening of the sound path.

entirely all low tones, due to this cancellation described above. (See Fig. 1A.)

DEFINING THE TERM "BAFFLE"

A baffle is any means at all placed between the cone front and the cone rear which lengthens the distance the air must travel from front to rear to cause cancellation of front pressure by rear vacuum, as the cone moves forward in its reproducing cycle. For high frequencies, the "baffle" provided by the size of the cone itself is sufficient to prevent cancellation. The low-tone reproduction range is dependent upon the size of the baffle, or more exactly, the length of the air path from the center of the cone in front to the center of the cone at the rear. (See Fig. 2.)

(Continued on page 558)

THE ABC OF A.F.C.

A simple explanation of "automatic frequency control" for the beginner. This new set refinement is dissected to show the basic principles.

C. P. MASON

THE DEVELOPMENT of automatic frequency control (or "A.F.C." as it is called), known by several different trade names in recent receivers, is the latest of a series of refinements which have been added to radio design. Specifically, it is the addition of a tube (and associated circuits) which corrects an error in the setting of the tuning condensers, in a *superheterodyne*, by bringing the oscillator setting to a frequency such that the incoming signal will be mixed (or first-detected) to give the exact I.F. to which the set's amplifier is peaked.

The advantage is, not so much to find a station by hasty or mechanical tuning, as to eliminate audio distortion and other undesired consequences of inaccurate frequency selection.

If an A.F.C. set, therefore, is turned to within 7 kilocycles of a strong signal, it will adjust its oscillator's tuning until the signal is brought within 500 cycles. A weak signal can be pulled in

from, say, 3 kc. (kilocycles) away; in each case, the final accuracy is increased as the receiver is more correctly tuned. So, in A.F.C. sets, tuning by hand, and then cutting-in the A.F.C. circuit with a switch, results in a correction which improves the quality. Of course, if one should set an A.F.C. receiver half-way between two strong signals, say 10 kc. apart, and turn on the A.F.C. control, the set might be puzzled to choose, like the donkey between two loads of hay; but this is not a common condition, in listening to domestic broadcasting. In some new receivers, when the tuning control is turned to "preset" stations, the A.F.C. is cut out automatically until the dial stops rotating.

EVOLUTIONARY STAGES

To explain the principle, it will be of interest to look back at the methods of set tuning which have been in use, at various times, since the manufacture of broadcast receivers began. Every circuit is tuned by the presence of a cer-

tain amount of *capacity* and *inductance* (as well as *resistance*, which can never be entirely eliminated); the higher their product, numerically, the higher the wavelength, and the lower the frequency. The combined action of the capacity, pulling electricity ahead, and the inductance, holding it back, determine the frequency which will build up the greatest voltage in the
(Continued on page 572)

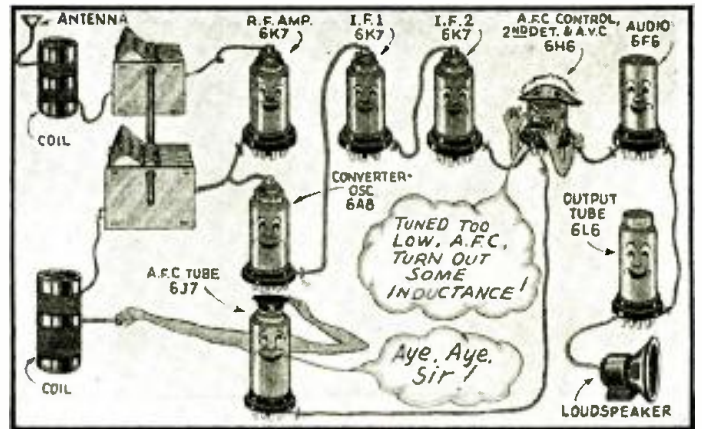
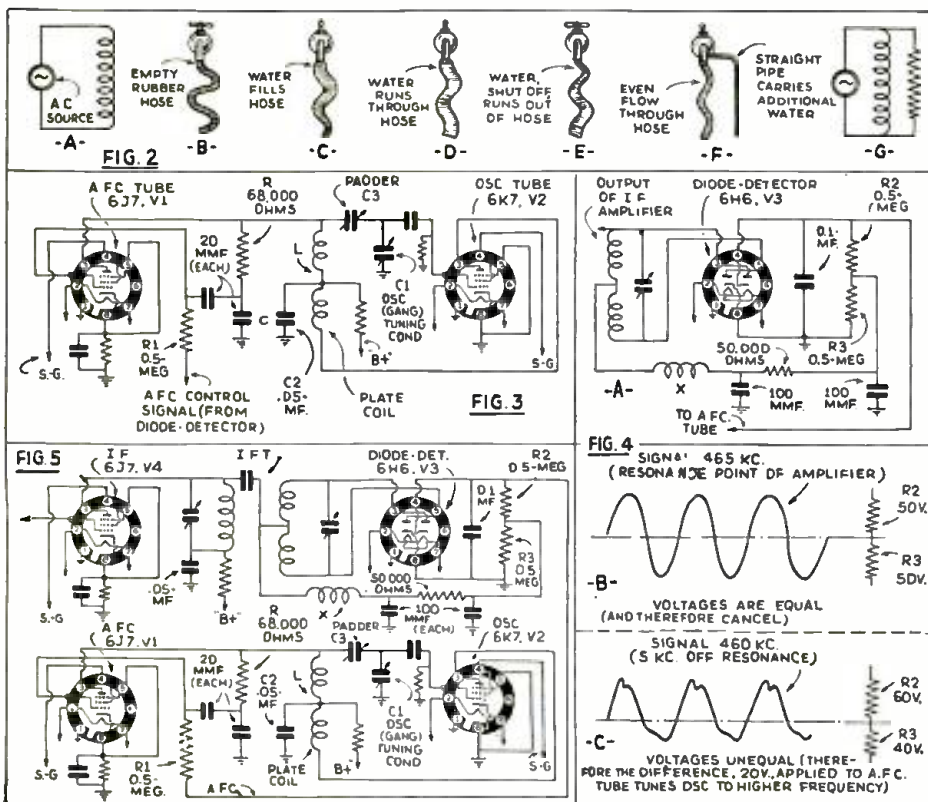

Fig. A. "Admiral" 6H6 gives orders for correcting poor tuning!



Figs. 2, 3, 4 and 5. Analogies to show the action and the breakdown details of a typical circuit.

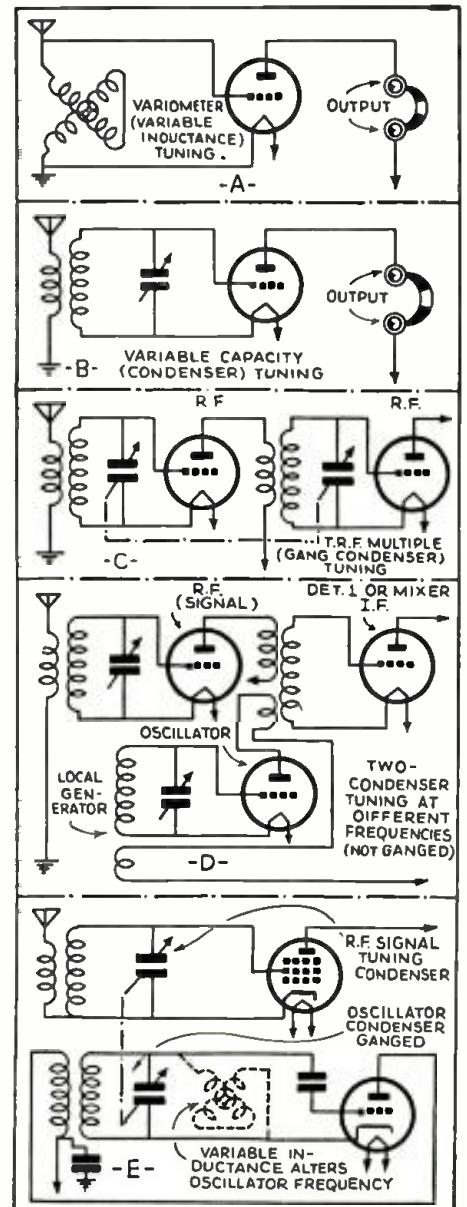

Fig. 1. Well-known principles govern A.F.C. operation.

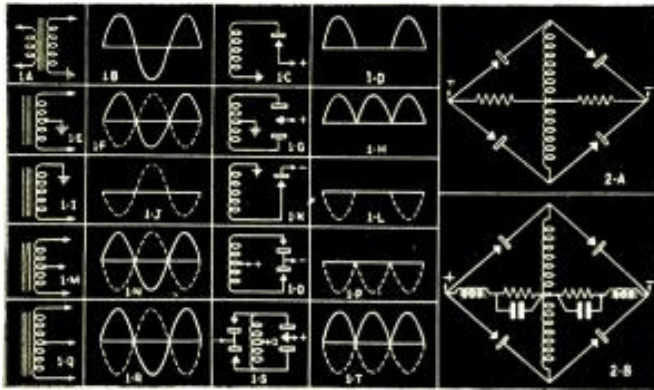

Fig. 1. A breakdown of the rectifier circuit operation.

DIRECT COUPLING IN A 30-W. BEAM-TUBE AMPLIFIER!

Direct coupling, by eliminating coupling coils and condensers, affords higher-fidelity amplification. An old idea modernized.

A. C. SHANEY.....PART I

TABLE I

The amplifier described in this article features such modern innovations as:

- (1) Non-Reactive Signal Division;
- (2) Unrestricted Frequency Response;
- (3) Non-Reactive Dynamic Coupling;
- (4) Two-Phase Bridge Rectification;
- (5) Stabilized Power Supply.

The bullet microphone employed offers the following advantages over the conventional types:

- (1) May be operated up to 4,000 ft. from the amplifier without preamplifiers;
- (2) High-level output (average-45 db.);
- (3) Variable Polar Response Characteristics;
- (4) High Sensitivity;
- (5) Acoustically-compensated Dampening Chambers.

IT IS quite generally agreed among sound-system engineers—particularly those who have been specializing in high-fidelity designs—that the major objections to transformer coupling (core saturation and magnetic lag) and resistance coupling (short-circuiting of weak signals and grid blocking of strong signals) are completely avoided by utilizing DIRECT COUPLING!

This type of circuit is actually capable of producing equal-potential amplification at all frequencies, within the limits set by the interelectrode capacity of the tubes, and equal-frequency amplification at all potentials within the audio band.

Although the idea of direct-coupled amplifiers is not new (it was first in-

troduced by Messrs Loftin and White about the time the first type 24 screen-grid tube made its appearance), it has from time to time been revived and built in great numbers only to fall by the wayside whenever the announcement of a new super-triode or pentode served to take the technician's interest away from this circuit.

DIRECT-COUPLED AMPLIFIER FAULTS

As the circuit was originally introduced (and built by the thousands) it had the following 2 major drawbacks:

- (1) The circuit was subject to "trigger" action;
- (2) An adequate push-pull output circuit was unavailable.

(Continued on page 556)

THE CAPACITY METER AS A SERVICING AID

The use of a direct-reading capacity meter covering a range of 100 mmf. to 200 mf. greatly simplifies servicing.

O. J. MORELOCK, JR.....

SEVENTY-FOUR condensers in a single receiver—that is what a circuit diagram reveals in a typical all-wave model that sooner or later is going to require some Service Man's attention! And a check-up would show that many others exceed this startling figure. In addition to tuning condensers, trimmers, and the like, the receiver mentioned above contains 40 fixed condensers, ranging from 100 mmf. to 18 mf. in capacity, including paper, mica and electrolytic types.

If every fixed condenser continued indefinitely to live up to its name, there is no doubt that the troubles (as well as the business, of course) of the Service Man would be considerably reduced. As it is, they constitute not only a frequent direct cause of receiver failure, but a secondary cause of lack of balance with critical circuits that hopelessly complicates effort to stabilize the receiver or make other necessary adjustments.

Like other faulty elements in a receiver circuit, a bad condenser may

sometimes be located indirectly from potential, resistance or current measurements in the standard analyzing routine, such as is often the case with a complete short-circuit. Generally, however, the problem is not so simple.

ELUSIVE CONDENSER FAILURES

For instance, it is not unusual to encounter a receiver which, according to the owner, "begins to howl badly after it's been on for a while". Tube tests and resistance measurements may reveal no defects. The Service Man sooner or later arrives at the conclusion that a condenser in one of the bypassing circuits open-circuits when the receiver is hot. Then the question is: "Which one?" and a laborious substitution job is in prospect unless means are available for direct capacity readings. If the condenser opens only intermittently, due to the effect of "thermal expansion" on a weak internal connection, the job may be one of those that brings gray hairs to the heads of Service Men.

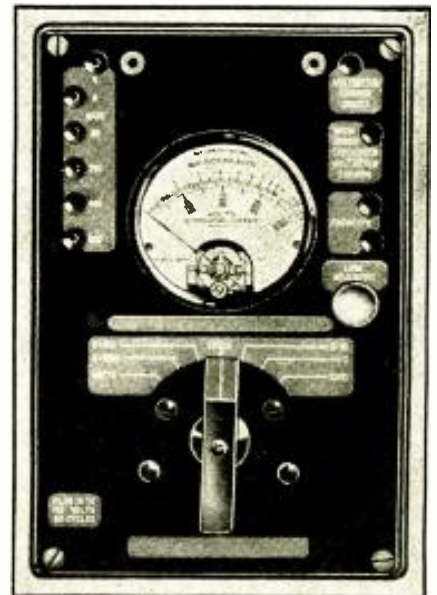

Appearance of the direct-reading capacity meter.

Often, the effects of thermal expansion or of dampness may merely result in a change from rated capacity, seemingly slight, but sufficient to throw a critical circuit hopelessly out of balance. Too frequently, as well, the Service Man encounters a condenser block or individual condenser on which the nominal capacity rating is missing or obliterated. Whether such a condenser be good or bad, the problem is equally unsolvable

(Continued on page 557)

SPECIAL NOTICE

Those questions which are found to represent the greatest general interest will be published here, to the extent that space permits. (At least 5 weeks must elapse between the receipt of a question and the appearance of its answer here.) Mark such inquiries, "For Publication."

Replies, magazines, etc., cannot be sent C.O.D. Back issues of RADIO-CRAFT prior to January, 1935, are available at 50c per copy; except the following issues: 7/29, 1, 2, 3, 4, 6, 7, 9 and 11/30; 5, 6, 8 and 9/31; 6, 7, 9/32; 7/33; 8/34; and 1/35 which are out of print. Issues following January, 1935, are still available at the regular price of 25c per copy.

Inquiries to be answered by mail MUST be accompanied by 25c (stamps) for each separate question; answers are subject to subsequent publication if considered of exceptional interest.

Furnish sufficient information (in reference to magazine articles, be sure to mention issue, page, title, author and figure numbers), and draw a careful diagram (on separate paper) when needed to explain your meaning; use only one side of the paper. List each question. Be SURE to sign your name AND address.

Enclose only a STAMPED and self-addressed envelope for names and addresses of manufacturers; or, in connection with correspondence concerning corrections to articles, as this information is gratis.

Individual designs can be furnished at an additional service charge. The fee may be secured by addressing the inquiry to the SPECIAL SERVICE department, and furnishing COMPLETE specifications of desired information and available data.

RESISTANCE-CAPACITY ANALYZER CORRECTION

(382) William M. Reed, Baltimore, Md.

(Q.) Recently I began to assemble the "Free reference-point Resistance-Capacity Analyzer" as a companion unit for the "Set Analyzer" described in the January 1936 issue of Radio-Craft, but I found that at least one connection was not completed in the diagram. Will you please supply this information so that I may complete my outfit?

I thoroughly enjoy the splendid and very enlightening articles found in your magazine and every time I see useful equipment (useful to me) I begin building it or remodeling my older ones.

(A.) We are reprinting here Fig. Q.382, the circuit of the test unit in question for Mr. Reed and other readers of Radio-Craft who have tried to build this unit. The circuit has been checked over carefully, by the author, Mr. W. C. Bellheimer, and the only error is the one found by Mr. Reed. The center upper blade of the switch Sw.4 should be connected to the positive test jack, thus completing this circuit. The added wire is shown on the circuit heavier than the other wiring which appeared in the original article.

Figure Q.382 also shows the remaining wiring of the analyzer, with the exception of the adapter units which are in the original circuit.

RADIO-CRAFT'S INFORMATION BUREAU

DIRECTION OF CURRENT?

(383) John H. Watson, Toronto, Ont. Canada

(Q.) In reading text books and magazine articles, a question has popped up which to me becomes increasingly confusing as I delve further into the subject. I refer to the subject of current flow.

In many electrical and radio texts, the assertion is made that current flows from the positive terminal of a battery to the negative terminal, through the external circuit. In books on vacuum tube action, the statements are made that the current flow is from the cathode or filament to the plate. Now since the battery current is from positive to negative how can the current possibly flow from cathode which is connected to the negative side of the "B" battery to the plate which is at the positive end of the battery?

Many conflicting statements are made in the different books and I can find no concise explanation of the apparent paradox. Undoubtedly there is a simple explanation—and I am turning to you for it. Can you help me?

(A.) Mr. Watson has run across a problem which has confused many students of electricity and radio.

To give an answer, we must turn back to the early days of radio—to the time of Maxwell and Hertz. In delving into the mysteries of the then little known subject of electricity, the early physicists conducted several experiments which apparently proved to the satisfaction of everyone that the current in a battery circuit flowed from the positive terminal, out through the external circuit and back to the negative terminal.

Later, other experiments began to cast some doubt as to the veracity of the early experiments but teachers, and authors of text books stuck to the early findings since they had nothing better to offer their pupils.

In the early 1900s, when the electron theory was first evolved the question of the direction of current flow came up again—and laboratory work by such men as Thompson and Sir Oliver Lodge disclosed the fallacy of the earlier statements.

According to the electron theory—which has since been proven by innumerable experiments in research laboratories and universities to be basically correct (though the limits of experiment and research have not been reached in this work by any means)—electrical currents are the drifting or motion of electrons through a conductive circuit or medium. Thus, since it is known that the electrons are "negative" in their charge—and tend to re-unite with the positively charged nuclei of the atoms from which they were removed—it can be logically deduced that current flow (electron flow) is from the negative to the positive terminals of a potential-developing device.

The confusion which has arisen from this conflict of statements has been caused by two facts. First, teachers of electricity have found from experience that it is easier to explain that current flows from positive to negative (according to the old school) in early work with beginning students, depending on an understanding of the electron theory as the students advance in knowledge to dispel the early error in their learning. Second, human nature abhors change, and certain of the instructors and text book authors cannot bring themselves to make the break from the old to the new.

The fallacy of such a system is evident—and many modern teachers are doing everything possible to eliminate this confusion by teaching the correct method right from the beginning. This, of course, is the correct and logical procedure to follow.

We are glad that Mr. Watson brought up this problem at this time so that it could be answered in the Beginner's issue of Radio-Craft. Perhaps at a later date, a more detailed explanation of the various problems, together with some experiments which the student can perform himself, can be printed in Radio-Craft.

PORTABLE SET DIAGRAM

(384) Everett P. Jones, Norfolk, Va.

(Q.) Some time ago, I saw in a radio store in Washington, D.C. a radio receiver which was called the Sportsman. It was completely self-contained having batteries and aerial, in the small case. The set was equipped with a carrying handle which slipped over the shoulder to facilitate carrying it over some distance.

I believe the set was made by the Simplex Radio Co.

(Continued on page 566)

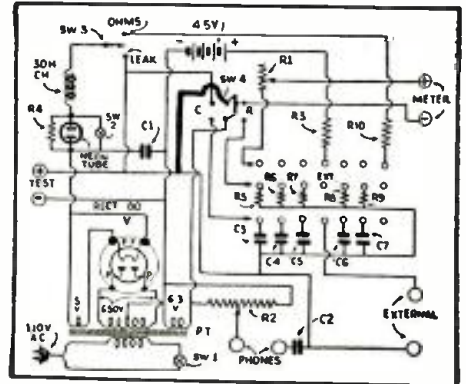

Fig. Q.382. A correction for the "Free-reference-point" Resistance-Capacity Analyzer.

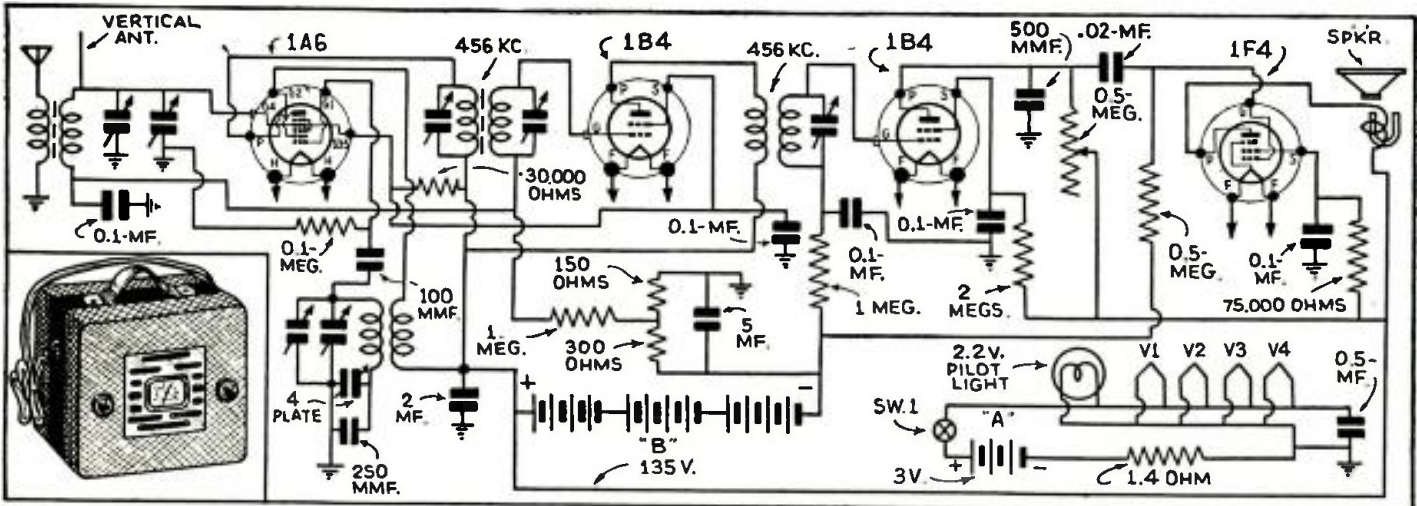
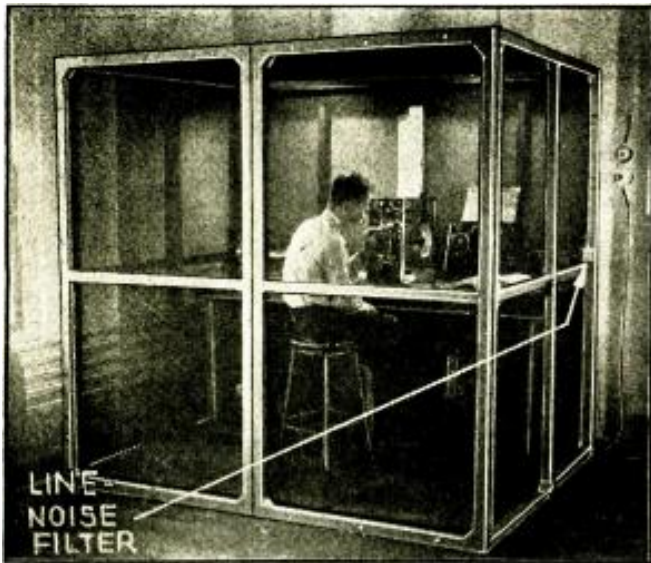

Fig. Q.384. The circuit and values for the "Sportsman" receiver. Note that either a short vertical rod aerial or an outside aerial may be used.



Photo—Tobe Deutschmann Corp.

If the Service Man wishes to have a really up-to-date service shop he must have an effective shielded test room in which he may fully utilize modern test equipment without interference from strong local fields of either man-made static or broadcast stations. Such a test room (on which specification data are available), measuring approximately 6 ft. each way, is here shown. But unless such a room includes a suitable noise filter, installed at the point at which the power supply line enters the screen, the outside interference would be carried, as "wired radio", inside the test room and its benefits would be nullified. The correct positioning of a suitable-type filter is illustrated.

RADIO interference, which the early radio fans dismissed as "static," "strays" and "X's", is as old as radio reception. Due to the expansion of radio facilities, however, the problem, now rapidly become acute, has received national and international attention.

The older types of radio receiving sets didn't reproduce a very wide audio-frequency range and thus inherently served to eliminate a large portion of the man-made static, but as radio sets improved they began to pick up more and more disturbance. Now, in the last 2 years, all of the medium- to high-quality receiving sets manufactured incorporate not only an "extended" or widened broadcast band but also several short-wave bands in which all types of man-made interference raise havoc. It is of course possible to eliminate any of the existing types of electrical disturbance, as voluminous reports from private and commercial interests have shown, but in certain instances it may be questioned, at least for some time to come, whether the cost justifies the necessarily almost exorbitant expense incident to complete elimination of certain types of trouble when, instead, a far less expensive procedure affords an excellent palliative.

With the foregoing points in mind, *Radio-Craft* readers may be interested in the following report of conditions, typical of other thickly-populated sections of the country, that have been encountered in the area in and around New York City.

The recent, rapid, universal acceptance and adoption of police radio systems for use on patrol cars have been moving factors in bringing the problem of interference to the attention of public officials. (See the article, "WPA Police-

RADIO'S "OLD MAN OF THE SEA"

Television and high-fidelity radio reception must mark time until Public Nuisance No. 1 —man-made static—is laid by the heels. Beginners and old-timers must fight shoulder-to-shoulder in the crusade for interference-free radio reception. Present day conditions are intolerable and inexcusable.

FRANK L. CARTER

Radio "Noise Detectives", in the January, 1937 issue of *Radio-Craft*.—Editor) There are many sections in the so-called Metropolitan area of New York, for example, where radio-equipped police squad cars are completely blanketed. These "radio policemen" in attempting to receive signals from headquarters are able to get nothing but "noise."

The pernicious effects of interference are reflected, in private homes, in the use of domestic receiving sets. Thus, the average family has found by experience that interference so mars reception from certain stations that only about 20 per cent or less efficiency from their sets can be realized. Radio reception in many sections of Manhattan and the Bronx, for instance, thus is confined to 2 or 3 stations instead of the 40 or 50 which, it has been shown, could be heard plainly in the absence of local electrical interference!

By way of illustration, on East 180th St., N. Y. C., there is no station that is generally received entirely above the noise level; and in the Dyckman St. section, for instance, a sub-station radiates commutator ripple and accompanying hash. Reception throughout this area is especially poor.

Numerous complaints have come from the Bay Ridge section of Brooklyn, where interference is largely traceable to trolley wires; while on the other side of Brooklyn, in the vicinity of Nostrand Avenue, the noise level at times is greater than the signal strength of any of the local broadcast stations. So far as is known nothing has been done to improve local conditions.

The outlying sections are subject to indigenous types of static. There are numerous cases of severe interference that sounds like an approaching thunder storm. This is often due to local electric light wires rubbing against the limbs of trees. Such cases will be promptly corrected by the electric company, if informed of them, because if allowed to continue the situation will cause a disruption of the service.

As an example of what may be accomplished, if local radio men and interested citizens organize for the elimination of (Continued on page 554)

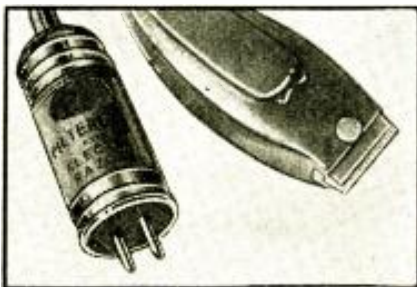

Photo—Tobe Deutschmann Corp.

Electric shaving devices and other small electrical appliances generate static that this tiny filter, which fits on the line plugs, reduces about 70 to 90 per cent.

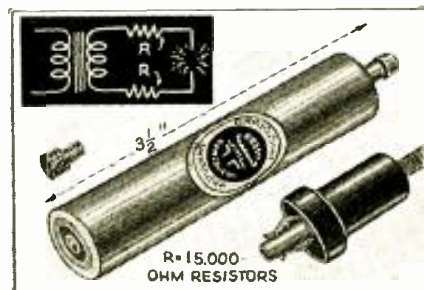

Photo Continental Carbon Co.

One each of these interference suppressors is required in each high-tension lead of an oil burner.

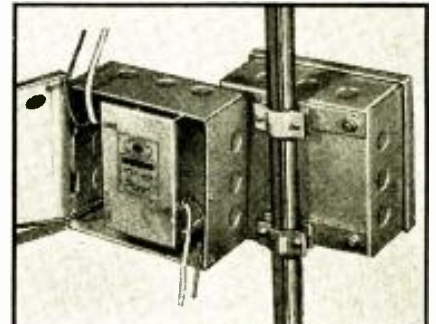

Photo Tobe Deutschmann Corp.

This heavy-duty inductance-capacity power-line filter effectively squelches oil-burner interference.

HOW TO USE V.-T. VOLTMETERS IN RADIO AND P.A. SERVICING

Measurement of (1) root-mean-square (effective), (2) peak, and (3) D.C. voltages by means of V.-T. voltmeters is covered in this multi-part article.

KENDALL CLOUGH..... PART I—R.M.S. MEASUREMENTS

ONE OF the most useful and yet perhaps one of the least applied of service instruments is the vacuum-tube voltmeter. Many Service Men are either entirely without such an instrument or if they have used one,

they have found it inadequate for their needs, since the early varieties of these instruments required continual recalibration and adjustment in order to be dependable.

However, recent developments in circuit design have eliminated the ills of the earlier types. It is no longer necessary to completely recalibrate such a

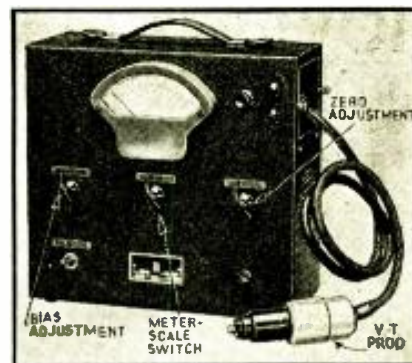

Fig. A. The appearance of the V.-T. meter discussed.

(Continued on page 568)

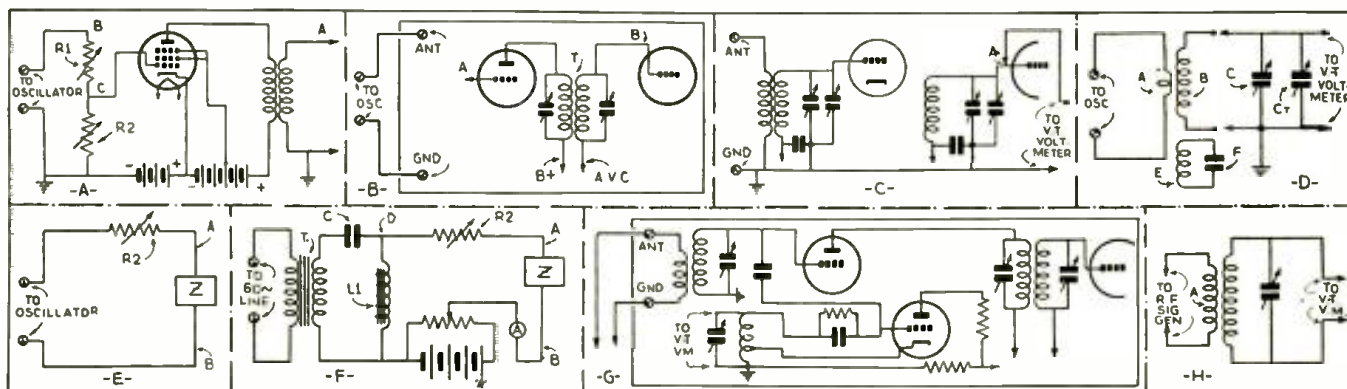

Fig. 1. Detail connections of the meter for numerous tests in radio receiver checking. Note the wide variety of "hard-to-make" tests.

A 5-BAND 11-TUBE RACK-AND-PANEL RECEIVER

The 1937 Super Skyrider receiver, described here, includes all the latest receiver advancements.

J. T. McCABE.....

THE NEW 1937 all-wave receiver shown in Figs. A and B is a 5-band 11-tube superheterodyne set, arranged for rack-and-panel mounting, and covering the following frequency ranges:— No. 1 band, 545 kc. to 1,230 kc. (550 to 243 m.); No. 2 band, 1.18 mc. to 2.85 mc. (254 to 105 m.); No. 3 band, 2.75 mc. to 6.82 mc. (109 to 44 m.); No. 4 band, 6.75 mc. to 16.4 mc. (45 to 18.3 m.); No. 5 band, 15.4 mc. to 38.1 mc. (19.5 to 7.85 m.).

The coil range in use is indicated by the pointer on the main dial. This pointer moves vertically when the band-change switch is moved. The calibration on this dial is in megacycles on all but Band No. 1 on which it is in kilocycles. This calibration will hold only when the "band-spread" condenser is set at 200 deg., or minimum capacity position.

The tube lineup is as follows: one 6K7—preselector, R.F. amplifier; one 6L7—1st detector—mixer; one 6C5—signal-frequency oscillator; one 6K7—1st I.F. amplifier; one 6K7—second I.F. amplifier; one 6R7—2nd-detector; A.V.C.; first audio; two 6K7—beat oscillator; one 5Z3—full-wave

(Continued on page 564)



Fig. A. The set's panel showing the controls which provide flexibility.

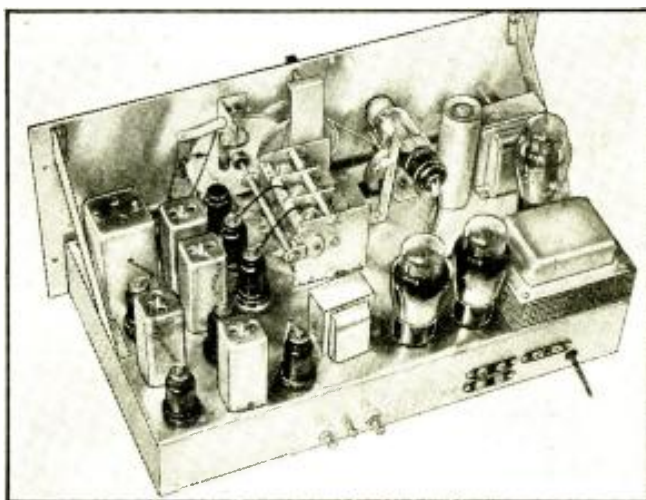

Fig. B. The rear of the chassis. Note the careful placement of parts.

HOW TO MAKE THE RADIO-CRAFT SET ANALYZER

This article presents requisite details for concluding the construction of the RADIO-CRAFT Set Analyzer. An interesting tabulation of decibel conversions to volts and watts is given. The servicing beginner should save this article.

PART II

THE FIRST Part of this article (See *Radio-Craft*, July, 1936, pg. 18.) was devoted to the design and construction of The *Radio-Craft* Set Analyzer, and included a complete analysis of its operation in receiver circuit testing. This, Part II, is devoted to comments on the operation and construction; plus the design of a low-cost method of determining condenser capacity, a method of reading and checking the peak voltages in rectifier circuits, and a DB.—Voltage chart which increases the range of application for the sound specialist.

Some constructors did not mount the voltage multipliers properly; in other instances high-resistance connections developed due to poor soldering. Both these points should be watched very carefully. The use of separate sets of multiplier resistors for the A.C. and D.C. scales should not offer a problem; but of course in other instances where A.C. multipliers were used in the D.C. circuits the meter would not read properly.

When using the meter for external measurements be sure that the setting of Sw.2 is not the same as that of Ref. Switch No. 10. Otherwise, there will be a short across the meter; the meter will not read and it is possible to damage some external component in the circuit under test. (Particularly, if the current or voltage in the circuit under test is high.)

Be very careful in wiring. Use the best grade of insulated wire that you can buy. Try to space all wiring as much as possible. This will minimize the possibility of high-resistance leaks which cause serious meter errors when measuring high-resistance circuits.

MEASURING CAPACITY

The simplest method of capacity measurement involves the use of an A.C. voltmeter connected in series with the unknown capacity across a 110 V. A.C., 60-cycle line. Figure 2A illustrates the circuit. Here the capacity Cx can be considered as a "multiplier" of the voltmeter reading. The voltmeter, especially when it is desired to measure condensers having a capacity of 1 mf. or more, as indicated in Fig. 2A, cannot be used directly.

Figure 2B shows the final circuit used for capacity measurements. Condenser C may have a capacity of 0.5-mf. and condenser C1 a capacity of 2 mf. These condensers function as capacity shunts across the voltmeter and are superior for this purpose as their use tends to make the capacity formula more direct reading and simplifies determination of the capacity as represented by the voltmeter reading. When the switch Sw.1 is open only capacity C is shunted across the voltmeter terminals. The capacity Cx is then in series with the A.C. line and the shunt capacity C. Closing switch Sw. shunts condenser C1 across C and extends the capacity range of the meter up to 8 mf.

It is apparent from a study of Fig. 2 that the A.C. line voltage will divide in direct proportion to the reactances of the two condensers. It can also be stated that the voltage divides in inverse proportion to the condenser capacities (providing that the frequency remains constant). For example, if a 1 mf. condenser is connected in series with a 2 mf. condenser across a 100 V. line then 66 2/3 V. will appear across the 1 mf. condenser and 33 1/3 V. across the 2 mf. condenser.

(Continued on page 574)

TABLE III—VOLTS VS. DB.

POWER LEVEL in DB.	POWER IN WATTS (0.006-W. at 0 db.)	VOLTS (at 0.006-W. across 500 ohms)
-10	0.00060	0.55
-9	0.00075	0.61
-8	0.00095	0.69
-7	0.0012	0.77
-6	0.0015	0.87
-5	0.0019	0.97
-4	0.0024	1.00
-3	0.0030	1.20
-2	0.0039	1.37
-1	0.0048	1.50
0	0.006	1.73
1	0.007	1.90
2	0.009	2.20
3	0.012	2.40
4	0.015	2.70
5	0.019	3.0
6	0.024	3.4
7	0.030	3.9
8	0.039	4.3
9	0.037	4.9
10	0.060	5.5
11	0.075	6.1
12	0.095	6.9
13	0.119	7.7
14	0.15	8.7
15	0.19	9.7
16	0.23	10.9
17	0.30	12.2
18	0.38	13.7
19	0.47	15.4
20	0.60	17.3
21	0.75	19.4
22	0.95	21.8
23	1.2	24.5
24	1.5	27.4
25	1.9	30.8
26	2.3	34.5
27	3.0	38.7
28	3.8	43.5
29	4.7	48.8
30	6.0	54.7
31	7.5	61.4
32	9.5	69.0
33	11.9	77.3
34	15.0	86.8
35	18.9	97.4
36	23.8	109.2
37	30.0	122.6
38	38.7	137.5
39	47.6	154.0
40	60.0	173.2

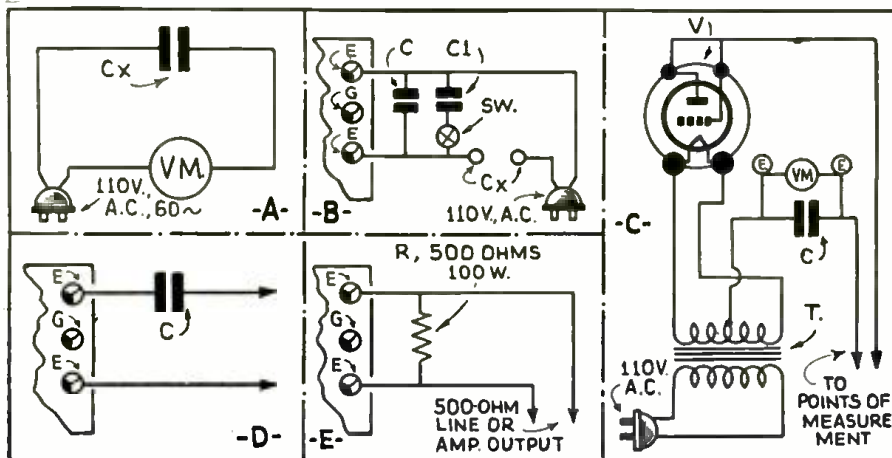

Fig. 2. Circuit details included in the description of the unit.

MAKE THIS POCKET-SIZE MULTI-TEST UNIT

The trend toward compact, efficient testing equipment has resulted in the development of this useful pocket unit.

MILTON REINER

RECENTLY, there has been a trend to build test equipment in miniature or pocket size and this is indeed commendable because it fills a definite need in the service field. Two important advantages are convenience and economy, although if these are achieved at the expense of accuracy, limitation of ranges, sensitivity and types of measurements necessary, then of course the value of the pocket size instrument becomes doubtful.

Pocket instruments cannot by any means take the place of large, multi-purpose, multi-range testers which are necessary in every well-organized service shop. On the other hand, it might also be added at this point, there is no reasonable excuse for building test equipment in heavy, bulky units such as have appeared lately where the increased size, weight and fancy frills add absolutely nothing to the number of useful measurements that can be made; or, otherwise, does not improve the accuracy or convenience.

This pocket meter therefore has been designed to give increased sensitivity, more useful ranges and greater economy than similar meters which are available today. It may be completely assembled and wired very easily and quickly at the surprisingly low cost of about \$8 to \$9. Nevertheless, all voltage measurements are made at approximately 2,000 ohms-per-volt (1,800, to be exact)! Current measurements are available in microamperes, milliamperes, and amperes. These features have never before been

(Continued on page 575)

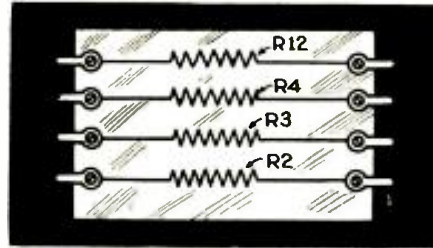

Fig. 2. The way in which the resistors are mounted.



Fig. A. The size and appearance of the tiny volt-meter-ohmmeter-milliammeter-microammeter.

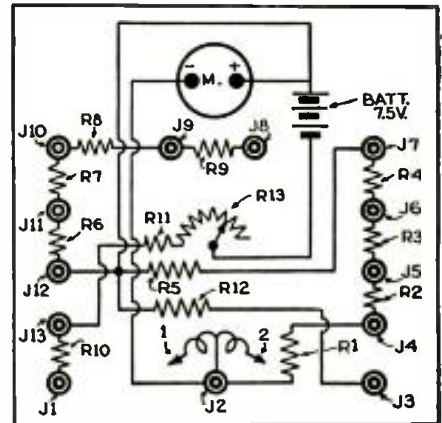

Fig. 3. The circuit of the complete meter.

A few reasons why some Service Men do not make a living are included in this colorful description.

PITFALLS OF THE RADIO SERVICE BEGINNER

R. B. LAWTON

QUICK-SERVICE JOHNNY gets a call from Mrs. Jones—"Come quick, my 'radio' smokes, and smells something awful."

"Shut it off," says Johnny, "and I'll be there at once."

He finds a bad case of power transformer fever, usually caused by malicious, cooperating, internal short-circuits, and almost invariably fatal.

"A new transformer will cost you four dollars and the labor will be three twenty-five," says Johnny, "that makes a total of seven dollars and twenty-five cents."

"Oh! that's terrible," replies the owner of the "radio," which can be smelled farther than it can be seen.

"It certainly is a very bad smell," says Johnny. This comeback knocks the wail about the price for a loop and he gets the job with the demand that the set be as good as new, no static, no fading, and have advertising elimination.

Johnny fixes the set. The transformer nets him \$2.40, it costs him 2c to order it, 30c to have it delivered, and 30c to return it because it was the wrong one;

10c for a Special Delivery "mad" letter to the supply company and he had to throw in a condenser that cost 40c. On returning the set, one of the type 45 tubes loosened in the socket and went "Pow!" on the Jones' front porch. It was an old-style 45. Says, Mrs. Jones,

UNFORESEEN

—circumstances precluded publishing, in this issue of RADIO-CRAFT, certain of the items promised, on pgs. 450 and 477 of the February, 1937, issue of RADIO-CRAFT, for the March issue. Specifically, we refer to the mention, on pg. 450, of data concerning photoelectric equipment experiments and applications and the 12-tube high-fidelity receiver; and the mention, on pg. 477, of the broadcasters' mobile unit. However we plan to present this material in forthcoming issues.

Surprise! Read April RADIO-CRAFT for complete details for building an amazing adapter, that connects to any superhet. receiver, which not only changes color with variations in loudspeaker output but also changes color when tuned to station resonance!

"The news broadcaster that talks for that big radio company says my tubes must be 'matched and balanced to work right'. I don't want different-shaped tubes."

So Johnny has to put in two new 45s—at the same time he curses his luck, he is thankful for the shields that hide the other "old bottles". Forty-fives are 75c each—mark up \$1.50. Johnny mechanically screws in a new dial light—just another good old shop custom—chalk up another 10c.

While this is going on, the new puppy in the house takes a fibre neutralizing wrench from Johnny's tool bag and runs off with it. When found it is in very, very small pieces. "Ain't he too cute, the little dear," says the Madam.

"That cost another 60c," thinks Johnny.

"I have just \$7.00 here—I'll stop in when I'm by sometime, and give you the quarter," says Mrs. Jones.

Johnny departs with the seven bucks and wisely thinks no more about the quarter.

It cost a total of 60c car expenses to

(Continued on page 558)

THE LATEST RADIO EQUIPMENT

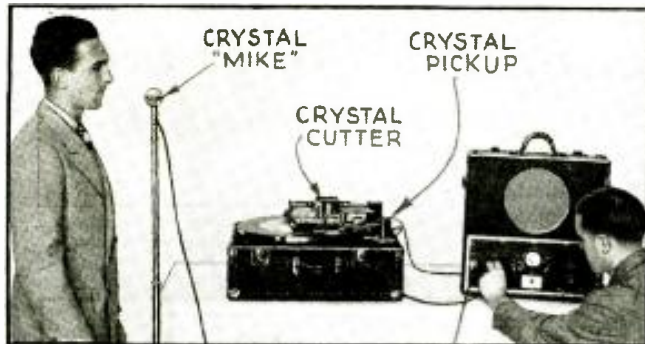

High-fidelity sound recorder utilizes crystal components throughout! (1288)

A 2-CASE PORTABLE RECORDER (1288)

COINCIDENT with the acquisition by one prominent manufacturer in the sound-recording field of the manufacturing and sales rights of another company in that field, a new series of sound-recording units has just been announced. One of the first of these is the type F-26 recorder here illustrated in operation.

The crystal cutter and pickup are set to enable recording and playback over a frequency range of 40 to 8,000 cycles. This certainly is "something to write home about." The complete set-up includes a "unit 199" recorder mechanism (center), and a "unit 219" recorder amplifier (extreme right), in two separate portable trunks. The recorder mechanism incorporates a 16-in. turntable turning at optional speeds of 33 1/3 and 78 r.p.m.; the feed unit cuts 90, 110, 130 and 150 lines per inch either inside or out. A cutting head is available for embossing aluminum or cutting acetate discs. The recorder amplifier incorporates a 10-in. dynamic reproducer, output meter, control panel and 8 tubes; the gain is 115 db. and the output is 12 W.

CUTTING LUBRICANT, PRESERVATIVE AND CONDITIONER FOR SOUND RECORDING (1289)

(Universal Microphone Co.)

THREE new chemical products are recommended by a well-known

sound-recording equipment manufacturer for best results in making spot recordings on aluminum. The cutting lubricant, a liquid, is applied before the cutting process; the wax preservative is applied after cutting; and, finally, the conditioner, a salt, is applied as a preservative—or, it may be used on old records as a reconditioner.

6-V. ELECTRIC PLANT (1290)

(D. W. Onan & Sons)

HERE is a compact and lightweight gasoline-driven electric plant that delivers approximately 175 W. at 6 V., D.C. This unit operates 12 to 15 hrs. on a gallon of gasoline. It is operated in conjunction with a 6-V. storage battery shunted across the line. This tiny power unit (it measures only 12 x 13 x 14 ins. high) weighs only 45 lbs.

Service Men looking for sideline items should not find it very difficult to merchandise this unit. It is recommended by the manufacturer as "ideal" for portable P.A. installations, cottages, trucks, busses, fire departments, construction work, wrecking cars, trailers, garages, roadside stands, boats, filling stations, night repair crews, etc.

RADIO SET AUTOMATIC TIMER (1291)

IN ADDITION to its immediate use to the radio man as an automatic switch for controlling the on-off operation of a radio set this switch may be handled by the Service Man

as a side-line item that will be useful in connection with other electrical appliances such as sun lamps, etc. It may be set to go on and off at any predetermined periods during 12 hours. The case is of brown bakelite molded with bright chromium dial face.

PRECISION PLUG-IN RESISTORS (1292)

PRECISION resistors in handy plug-in form, and selected resistance ratings permitting of various combinations for any total resistance value, are now available. These plug-in resistors, of non-inductively-wound (bifilar) manganin wire, were originally developed for use in resistance bridges and other test equipment employed in the laboratory and plant. Housed in a standard 4-prong tube base, they are available in values of 1 to 10,000 ohms, with any accuracy up to 1/10 of 1 per cent. Due to the ingenious design, they are quite inexpensive.

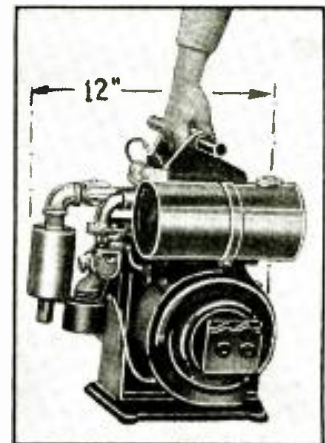

A 1-cu. ft. 6-V. unit. (1290)



Automatic on-off switch. (1291)

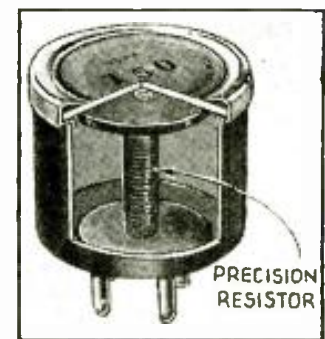

Plug-in precision resistor. (1292)

CABINET TOUCH-UP KIT (1293)

(General Electric Co.)

NEWEST in kits for cleaning-up the scratches, discolorations, etc., that eventually appear on even the best-kept radio cabinets, and so-on, is the modern layout illustrated (in its limp-fabri-oid carrying case). It includes: walnut penetrating stain, A; camel-hair brush, B; spatula, C; stick shellac (2 colors), D; wet and dry sandpaper (may be used with oil or water), E; polishing compound, F; felt rubbing block, G; and, cleaning oil, H.

ALL-WAVE PRECISION SERVICE OSCILLATOR (1294)

NUMEROUS features combine to make this service oscillator or signal generator a product of which the owner may be proud. The frequency range is 50 kc. to 60 megacycles. The accuracy on the I.F. and broadcast bands is said to be accurate with 1/2 to 1 per cent; each band is checked at 6 points against



Proper sound recording requires these items. (1289)

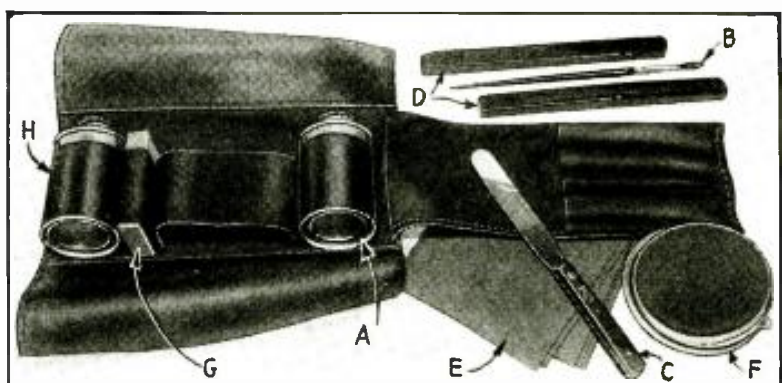

A cabinet touch-up kit for both the beginner and expert radio man. (1293)

Name and address of any manufacturer will be sent on receipt of self-addressed, stamped envelope. Kindly give (number) in above description of device.

precision crystal-control frequency standards. A special color combination of black etched characters on a silver background combined with a red knife-edge pointer provides speed and accuracy in selecting frequencies. A 400-cycle A.F. signal at a modulation level of 35 per cent is provided by a separate modulator tube controlled by a demodulation switch. The A.F. modulation is available at the output lead and may be attenuated. The 1-piece cast aluminum case provides excellent shielding and reduces strays and leakage to a minimum. Signal may be reduced below the level at which the A.V.C. action starts in even the most sensitive receivers; this affords extreme accuracy of alignment. The vernier control is graduated so that receiver sensitivities may be accurately compared. Utilizes one 14 $\frac{1}{2}$ -V. "C" battery and one 22 $\frac{1}{2}$ -V. "B" battery; and two type 30 tubes.



New all-wave test oscillator. (1294)

MULTI-RANGE PORTABLE METER (1295)

(Triumph Mfg. Co.)

A SELECTOR switch is used to choose any one of 11 ranges in this new A.C.-D.C., 4 lb. test instrument (which is available from the manufacturer through what is known as the "factory-direct plan") which is said to be accurate to within 2 per cent. Ranges: D.C. voltage 0-10-100-500 V. at 1,000 ohms-per-volt; A.C. voltage: 0-10-500-1,000 at 850 ohms-per-volt (approx.). D.C.: 0-50-500 ma. Resistance: 0-1,000 ohms-1-10 megs. Note that this instrument will read from $\frac{1}{4}$ -ohm; a special, lance-type pointer is used.



An 11-range portable meter. (1295)

DUAL-METER TEST UNIT (1296)

(The Triplett Electrical Instrument Co.)

HERE is a combination volt-ohmmeter that utilizes separate scales for the D.C. and A.C. movements. A copper-oxide rectifier is built into the latter. The ohmmeter section is of back-up type for checking with a minimum of contact error low values of resistance. All scale markings are in straight lines. Scale readings: D.C. 10-50-250-500-1,000 V. at 2,000 ohms-per-volt; current: 1-10-50-250 ma.; A.C. voltage: 2-10-50-250-500-1,000 at 1,000 ohms-per-volt; low resistance: 0.5- to 500 ohms; high resistance: 1.5 and 3 megs. Note that resistance measurements have individual zero adjustments.

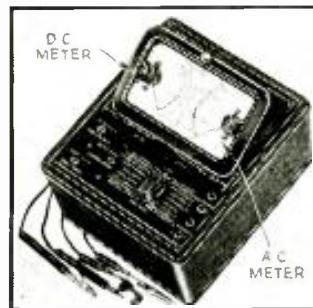

Separate meters for D.C., A.C. (1296)

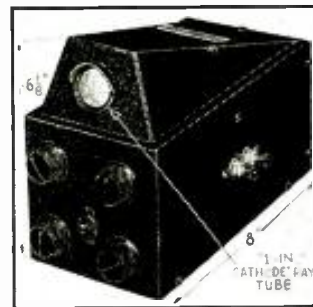

A 1-in. image oscilloscope. (1297)

NEW OSCILLOSCOPE USES 1-IN. C.-R. TUBE (1297)

ALTHOUGH specially designed to meet the needs of the transmitting amateur this new cathode-ray tube may be utilized in any type of radio receiver service or experimental work in which trapezoidal or detector output waveform readings will suffice. Incorporates the new 1-in. cathode-ray tube illustrated and described in the January, 1937 issue of *Radio-Craft*; its general circuit arrangement and uses closely approximate those given for the midjet oscilloscope described in the February, 1937 issue. Type 913 tube; 60-cycle sweep; weight, 11 lbs.



Improved-fidelity mantel set. (1299)

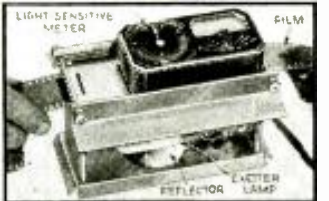

Electronics aids the photographer. (1300)

NEWEST PERMANENT-MAGNET DYNAMIC SPEAKER (1298)

(Wright-DeCoster, Inc.)

THE permanent-magnet reproducer shown as item No. 1104 in September, 1936 *Radio-Craft* has been "modernized" to include the output transformer under the housing that encloses the "nocoil" or high-coercive permanent magnet. This feature, and the "para-curve" diaphragm and air-gap dust cover are illustrated in 2 views. This 12-in. permanent-magnet dynamic reproducer is recommended not only for its wide frequency response but also as having high sensitivity.

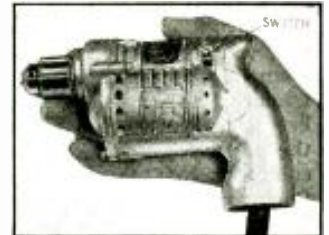

Radio man's electric drill. (1301)

ACOUSTICALLY-TREATED CABINET HOUSES NEW SET (1299)

MANTEL radio sets may now include not only compactness and beauty but also, as incorporated in this new majestic set, greatly improved tone quality as compared to previous designs. The cabinet interior is acoustically treated and thus the undistorted power output of 8 W. is utilized to best advantage. The receiver chassis utilizes 9 tubes including a 6G5 "eye" and two type 6F6G output tubes in push-pull. Tuning range: 16-50, 50-171, and 171-550 meters. The chassis incorporates A.V.C., tone control, 16-to-1 ratio high-speed pyro tuning. Cabinet dimensions, 22 $\frac{1}{2}$ x 12 $\frac{1}{2}$ x 12 $\frac{1}{2}$ ins. deep.

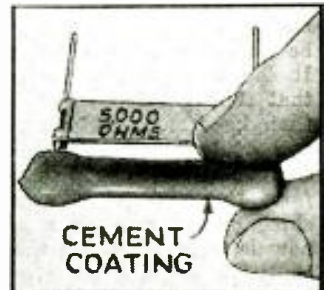

New cemented resistor. (1302)

NEW NEGATIVE INTEGRATOR USES PHOTOCELL (1300)

A LIGHT-SENSITIVE cell of the oxide type which does not re-



New crystal mike for voice. (1303)

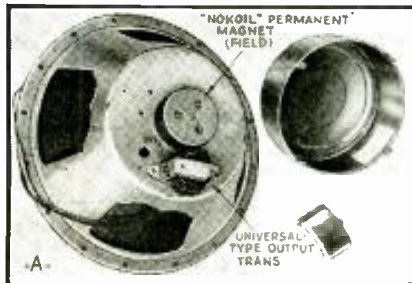

A well-known reproducer manufacturer has developed the 12-in. unit here illustrated. The frequency response graph submitted to RADIO-CRAFT indicates variations of only about 5 db. \pm from 80 to 1,000 cycles, with a slight rise to 3,000 cycles, and a gradual drop to approximately 7,000 cycles and rapid drop to cut-off at about 8,500 cycles. At the low frequency end the drop is rapid from about 70 cycles to cut-off at about 50. (1298)

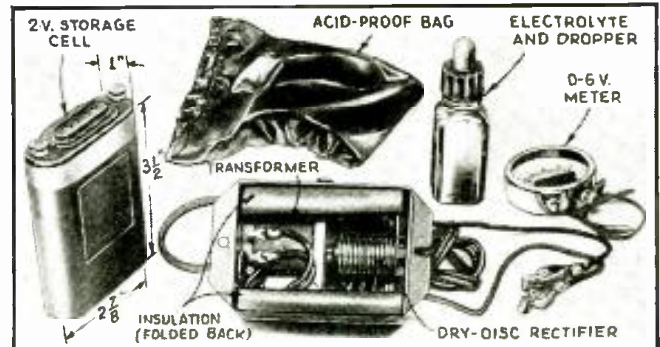

Storage cell for portable units. (Same-size case for 2, 4, and 6V.) Note that a rectifier is available for charging from the A.C. power line. (1304)

The construction of the attractive desk stand which houses The Executive Set is presented in this Part. This case—with its marble finish—must be fabricated in a special way.

MAKE "THE EXECUTIVE" —A BUSINESS MAN'S A.C.-D.C. SET

N. H. LESSEM

PART II

TO CONTINUE with the story, the author will now discuss the essential details pertaining to the construction of the base and cabinet of the Executive's Desk Set. (Part I, in the February issue, treated with the design, layout and wiring of the chassis.)

The material used to make the base and cabinet is one of the popular phenolic resin plastics sold under the trade name "marblette". No attempt has ever before been made (so far as the author knows) to build a radio cabinet out of sheets of this material. Commercially, the practice is to mold the complete cabinet through the medium of expensive molding forms.

Fortunately, the same tools used to machine, drill and cut hardwood, may be employed in working in marblette. It should be borne in mind however, that this plastic material heats faster than hardwood; therefore, the sawing and drilling operations should be executed commensurately slower. Do not force the material in any of the machine operations.—So much for that; now let's get down to the actual construction work.

FIRST, GET ALL MATERIALS TOGETHER

The marblette material used for the cabinet can be bought in sheet form, already cut to size, directly from the fac-

tory. Figure 4 gives you the exact dimensions of all the panels. The base piece should be 1-in. thick; all the others, 1/4-in. thick.

The electric clock should be of the self-starting type, as specified in the List of Parts, to avoid the nuisance of restarting after accidental interruptions of the electric current. The hand-setting shaft should be extended sufficiently to protrude through the dust screen which forms the back of the cabinet. The method of accomplishing this is left entirely to the ingenuity of the constructor.

A pair of fountain pens and holders can be obtained from any stationery store. The holders should have ball and socket joints.

Finally, obtain a suitable desk lamp. The one used by the author has a short, gun-metal stem and a heavy base. The base was removed and the lamp, with its switch, mounted directly on the top panel of the cabinet, as illustrated in Fig. 4.

MACHINING THE PLASTIC MATERIAL

The initial step in manipulating the plastic should be to make the base. The pencil groove as shown in Fig. 4, can be cut out either by hand, using a mark-gauge and a curved chisel; or, as the author did, by machine, using an end

mill bit in the chuck of a drill press. To rout-out a straight groove make sure you use a straight-edge gauge clamped to the table of the drill press. When this is done chamfer all four top edges to any desired angle. A 1/4-in. beveled surface at a 45° angle looks very well.

Next, on a routing machine, rout-out the large 3 3/8-in. hole for the clock on the front panel. The size of this hole should be exact since the clock, as shown in Fig. 4, is held in place only by virtue of this tight fit. The two other holes on the front panel as well as those on top for mounting the lamp and those on the base for mounting the pen holders may be drilled with an ordinary metal-drilling bit and a hand-drill.

The speaker grille opening should be exactly 5 ins. square. The best method for cutting out the grille pattern is as follows: First, make a template of the design to be used. (Use thin cardboard such as Bristol drawing board). Then paste this template on the sheet of plastic material to be used as the speaker grille side. It is then a simple matter to follow the pattern of the template with the business end of a routing machine. Smooth all rough edges with a fine file.

(Continued on page 553)

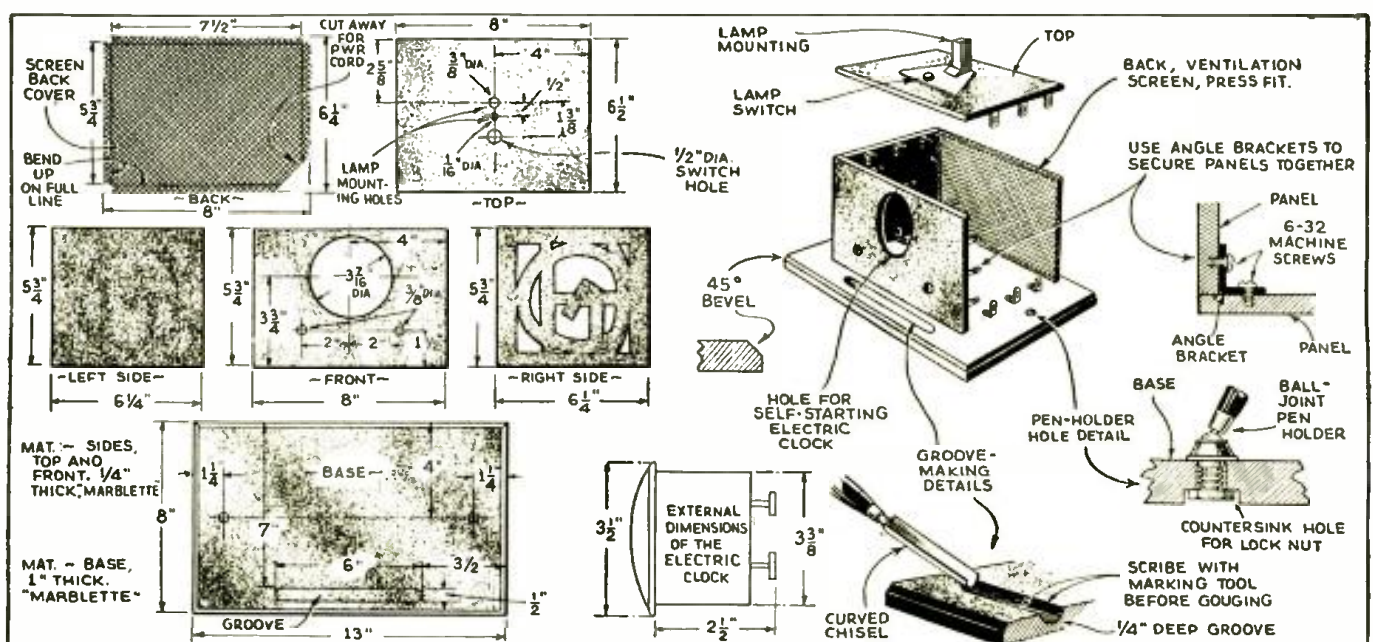

Fig. 4. Details for cutting, drilling and fabricating the cabinet. Note the use of angles for fastening the panels together.

THE MUCH-ABUSED BALLASTS FOR A.C.-D.C. RADIO RECEIVERS

The author discusses the need for over 100 types; why the "tube" type is best; and introduces to Service Men a new anti-surge ballast unit.

SAMUEL RUTTENBERG

"WHY SHOULD there be over 100 types of A.C.-D.C. ballasts?" is a question many technically-inclined Service Men ask themselves.

The answer is, "there really is no good reason."

Every time a manufacturer designed a new

A.C.-D.C. set the ballast supplier thought he would get all the replacement business by changing the number and specifications of the ballast so that it could not be easily replaced. As a result many ballasts of identical specifications have different numbers—or different

(Continued on page 559)

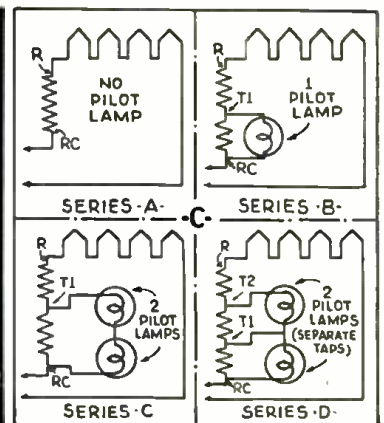
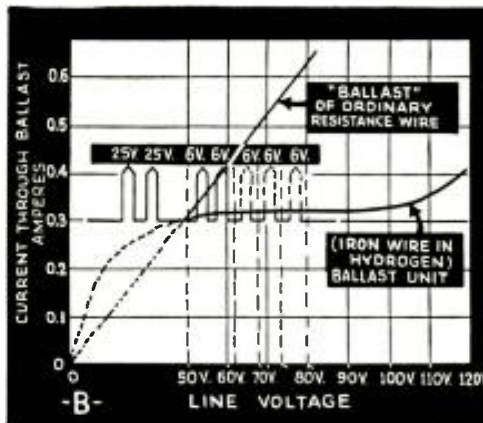
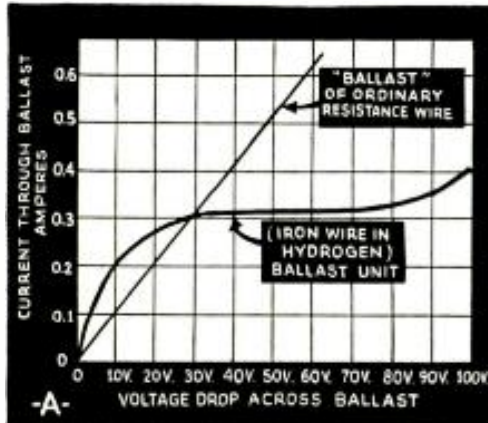
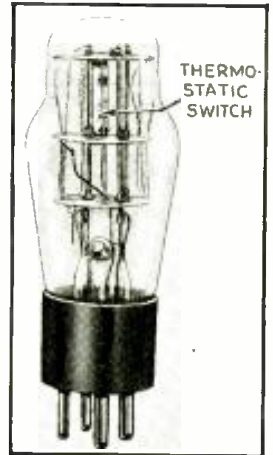

Fig. 1. Details A, B, and C, apply to the "tube type" ballasts such as the one shown in heading.

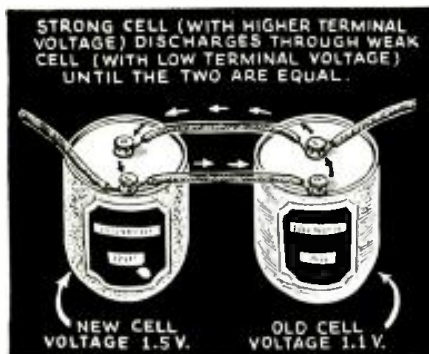

Fig. 1. Cross currents travel from one cell to the other!

IS IT ECONOMY TO CONNECT DRYCELLS IN PARALLEL?

Schoolbooks seldom discuss an important fault, expertly analyzed by the author, of drycells connected in parallel

L. S. FOX

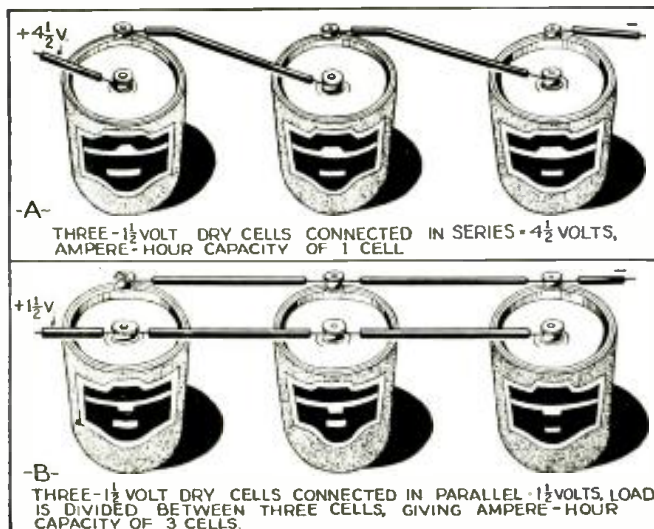

Fig. 2. The two common connections for drycells—series (A) and parallel (B).

OF THE TWO ways of connecting drycells, the most common is the *series connection*—positive to negative—which multiplies the *voltage* by the number of cells in the series (Fig. 2A.). Less used, and so less well known, is the *parallel connection*—all terminals of like polarity connected together—which multiplies the *current* by (approximately, as we shall see) the number of cells so connected. (Fig. 2B.) With parallel connection, the voltage remains that of the single cell; the result is that current drain is equally divided between each cell in the group.

In general, it is more economical to use a larger size of cell than to connect several small cells in parallel, and so cells smaller than the largest size made, the No. 6 cell (standard, "doorbell" size), are seldom found in parallel connection. Whether or not it is more economical to connect two or more cells in parallel as compared with the more frequent replacement of a single cell depends on the 3 major factors which govern all drycell service:

(1) Rate of discharge; (2) Frequency and duration of discharge; and (3) End-point voltage.

The rate of discharge is, of course, the amount of current which the battery is called upon to deliver. If the current

(Continued on page 564)

PHILCO MODEL 37-604

5-tube super., A.C.-D.C., glass tubes, 2 ranges (530-1,750 kc., 6-18 mc.); top-tuning table type. Output, 3/4-W.



As illustrated and described in RADIO-CRAFT Oct. 1936, pgs. 204 and 205, this set has loudspeaker grilles on 2 sides of the cabinet. Set has a "glowing beam station indicator."

This receiver, as shown, tunes from above, condenser gang being mounted vertically, C2 beneath. The pilot lamp is attached to this. When condenser is fully meshed, glowing-beam indicator under dial must center on first index of scale.

Adjustment of I.F. circuit is made with signal generator adjusted to 470 kc., receiver at maximum B.C. setting. Condenser (0.1-mf.) connects generator to control-grid of I.F. tube, V2; and then trimmers C12 and C7 are set for max. output on output meter. Then the generator is connected to control-grid of V1, and C10 and C9 are similarly adjusted for max.

Adjustment of S-W. R.F. circuit is made by then connecting generator to terminals 1 and 3 on input panel, and shorting 4 and 5 with link. Generator and receiver are tuned to 18 mc., and oscillator trimmer C7 adjusted for max. output.

Adjustment of antenna compensator C3 detunes oscillator slightly. Overcome this by connecting a 350-mmf. condenser (vernier drive) across C2, oscillator tuning condenser. Tune this external condenser until second-harmonic of oscillator beats against signal generator and brings in signal; adjust C4 to max. Remove external condenser and turn C7 max. distance clockwise—then back until a second peak is found on output meter. (First peak is image frequency, not to be used). Adjust C7 here to max.

On 6 mc., C8 is adjusted for max.; then tuning condenser "rolled" back and forth for max. output; and C8 retuned, until

max. falls as near as possible to 6 mc. C7 and C4 are then retuned with aid of external condenser, as in previous paragraph.

Broadcast adjustment is made with signal generator at 800 kc.; receiver at 1,600 kc., working on 2nd-harmonic. C5 and C3 are adjusted for max. Then generator and receiver are tuned to 600 kc.; and C6 is adjusted, rolling tuning condenser back and forth. Vary C6 until max. output is reached at or near 600 kc. Then 1,600 kc. readjustment is made and, finally, C3 is adjusted for max. at 1,400 kc.

Figures in parentheses on schematic, ohmic resistances. Figs. on diagrams, socket voltages (1,000 ohms/volt) Vol. at min., line voltage 115; B.C. switch setting.

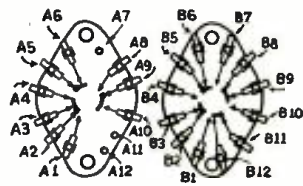

SWITCHES SHOWN IN POSITION No. 1. (BROADCAST) LETTERS INDICATE POSITION OF SWITCH WAFER FROM BOTTOM OF CHASSIS

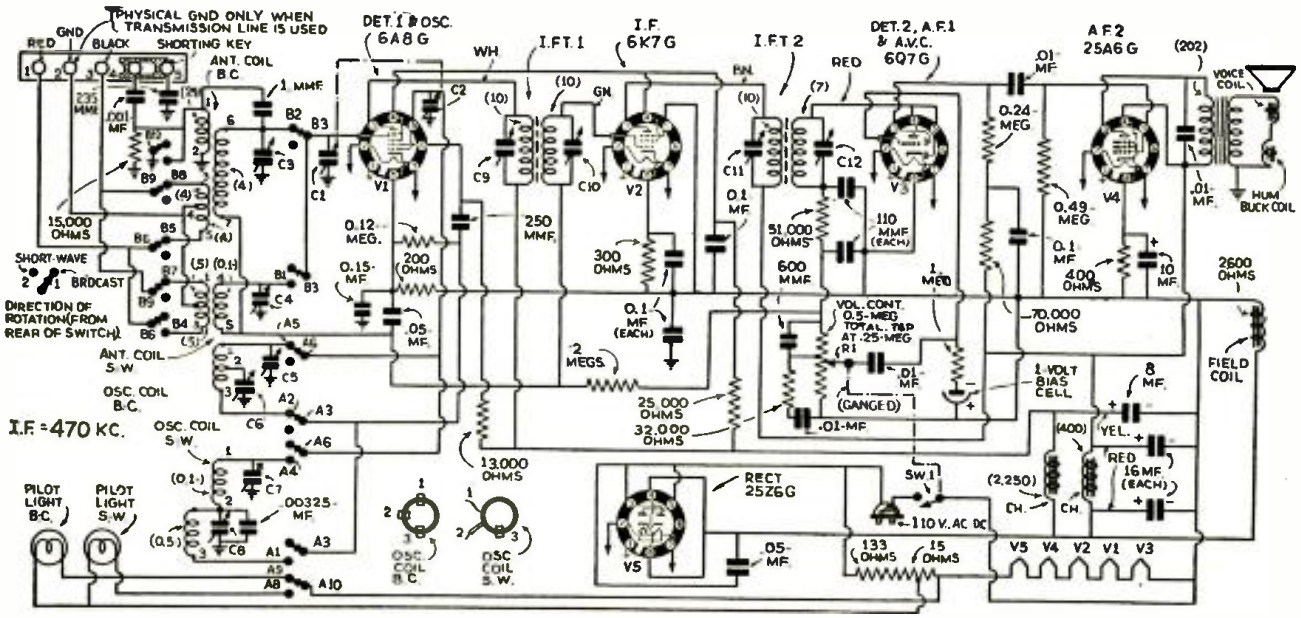
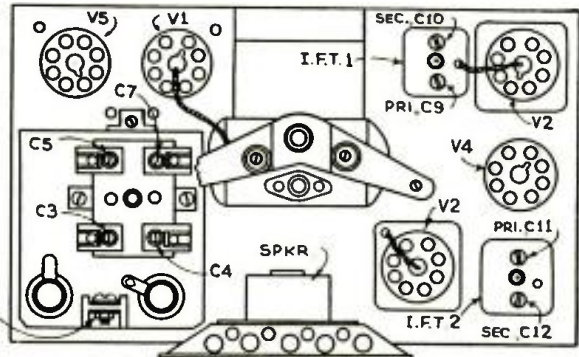
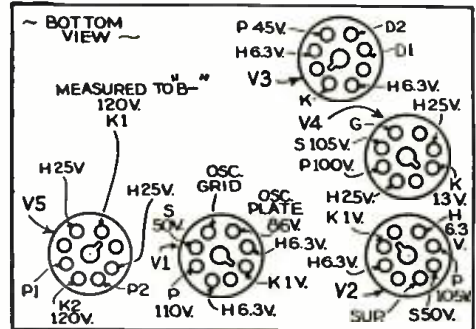
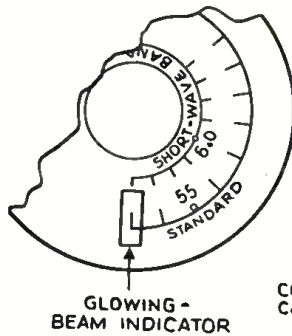
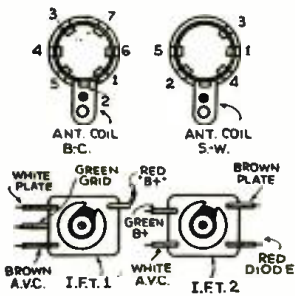

AMERICAN-BOSCH MODEL 640

6-tube super., 3-band (540-1,550 kc., 1,500-4,500 kc., 5.5-16.5 mc.), A.V.C., 3-watt output, "Semaphore Tuning," and "Automatic Maestro."

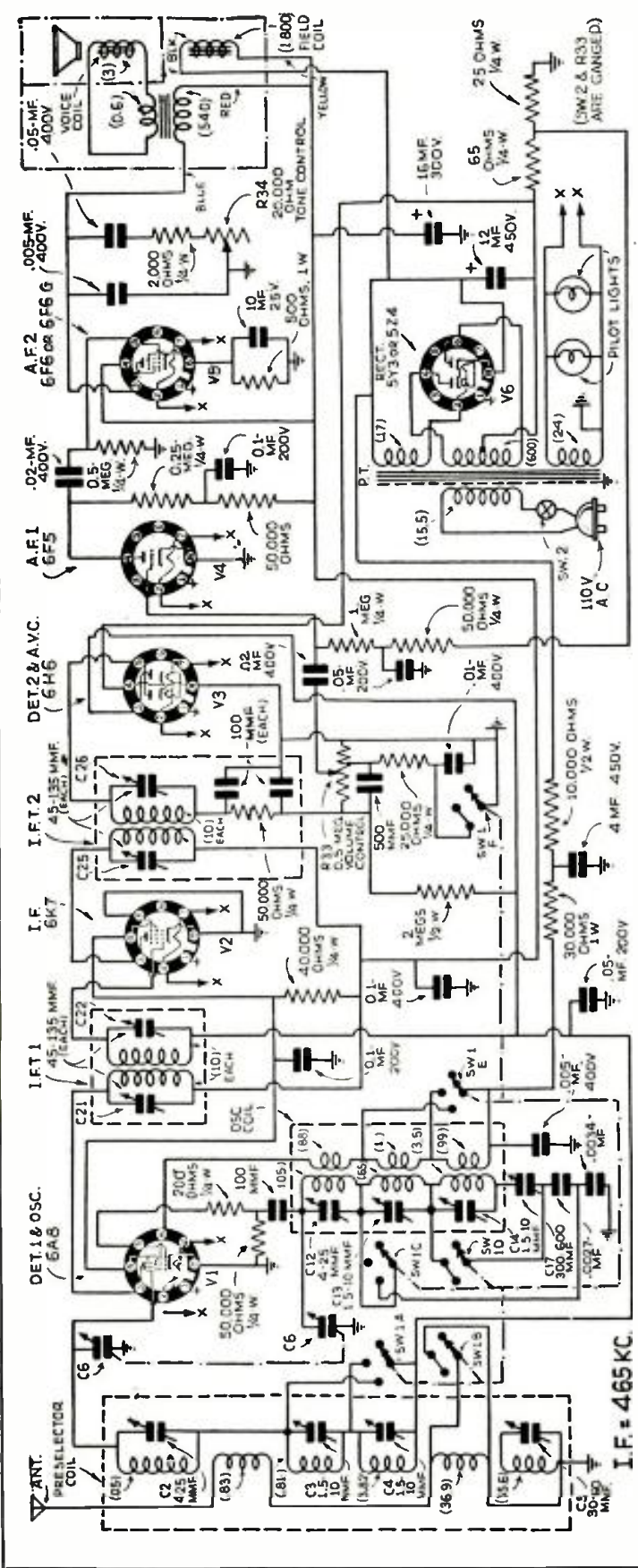

This receiver, shown at left in schematic diagram, and at the bottom of the page in chassis layouts (top and bottom) has an intermediate frequency of 465. kc. The I.F. amplifier is adjusted in the standard manner: first sending signal through control-grid of V2 through a blocking condenser (with Vol. control at maximum), and adjusting trimmers C25 and C26 to max. output. Then apply signal to V1, and similarly trim C21 and C22 for maximum. Finally, with signal applied to antenna, C5 (wavetrap trimmer) is adjusted to minimum signal, to reduce interference by code, or otherwise, to a minimum on this I.F.

Broadcast-band adjustment is made at 1,400 kc., applied through a condenser to the antenna; the oscillator trimmer C14 is adjusted for reception, and then the preselector trimmer C4 to maximum. The signal is then set to 600 kc., the variable condenser to this frequency, and C17 is adjusted for maximum sensitivity. It is then tried at a slightly lower frequency, and readjusted; and so on until highest sensitivity is found (it may be necessary to try a frequency slightly higher than 600 kc. to find this point.)

On the intermediate (green) band (Police and Amateur) start at 4,000 kc. and adjust C13 to bring in signal; then adjust preselector trimmer C3 for maximum. The sensitivity is then checked over the scale.

On the highest (red) band (Foreign) the adjustment is made at 15 mc., and trimmer C12 adjusted. If 2 points of sensitivity are found, use that with the lower capacity setting of the trimmer (screw turned farther out). Then preselector trimmer C2 (bottom) is adjusted, and the receiver checked over the band.

With a line voltage of 115 V., switch in B.C. position, and a high-resistance voltmeter, readings are (across pins stated in parentheses):

- V1, plates (3-1) 238, (6-1) 130; screen-grid (4-1) 83; control-grid, reading equals 0.6 times that between pins 5-1 on V3 socket.
- V2, plate (3-1) 238; screen-grid (4-1) 83; control-grid, same as V1.
- V3, cathode (4-1), -3.7.
- V4, plate (4-1) 100 on 600-V. scale; control-grid (cap to 8) -1.06.
- V5, plate (3-1) 225; screen-grid (4-1) 238; control-grid (8-1) 15.2.
- V6, plates, 310 V. The filament voltage across this tube is 5—across each of the others in the set, 6.0.

Tube Voltages

- V1—plates (3-1) 238, (6-1) 130; screen-grid (4-1) 83; control-grid, reading equals 0.6 times that between pins 5-1 on V3 socket.
- V2—plate (3-1) 238; screen-grid (4-1) 83; control-grid, same as V1.
- V3—cathode (4-1), -3.7.
- V4—plate (4-1) 100 on 600-V. scale; control-grid (cap to 8) -1.06.
- V5—plate (3-1) 225; screen-grid (4-1) 238; control-grid (81) 15.2.
- V6—plates, 310 V. The filament voltage across this tube is 5—across each of the others in the set, 6.0.

Resistance values of coils, etc., are noted in parentheses on the schematic diagram. See photo, pgs. 204 and 205, Oct. '36 *Radio-Craft*.

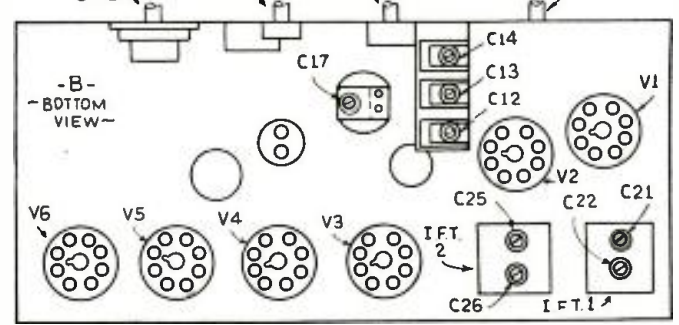
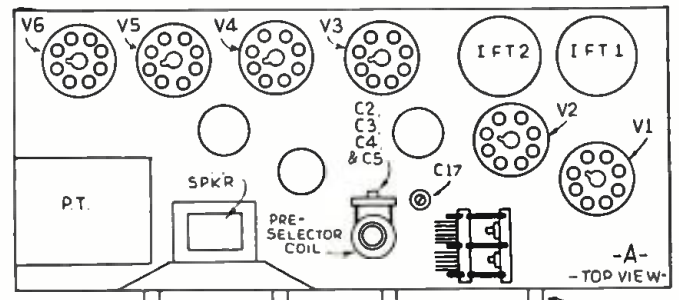

These two views of the American-Bosch model 640 receiver carry all necessary servicing references as to locations of the various types of variable condensers.

ANALYSES of RADIO RECEIVER SYMPTOMS OPERATING NOTES

Intermittent Operation. One of the most difficult and often encountered troubles in radio receivers and amplifiers is really not so difficult if tackled in the proper manner, and with the equipment explained below. I am referring to the causes of intermittent reception due to high-resistance shorts in bypass and filter condensers.

Although an ohmmeter does not indicate a short of this type, it may be found by setting it on the high scale. By connecting one lead as shown in Fig. 1A and touching the other on the condenser, the meter will give a slight kick, indicating that the condenser has taken a charge. If this is again touched there should not be a second kick of the meter unless there is a high-resistance leak in the condenser. Once the condenser is charged it should not take another charge unless it has been discharged.

Still another and equally accurate, if not better method, is shown in Fig. 1B. The neon tube is connected to one side of the high-voltage supply and the other is touched to one terminal of the condenser to be tested. The other terminal of the condenser is grounded to the chassis which is the negative side of the power supply. If the condenser is good, there will be one flash of

the neon bulb when the condenser charges, but if the condenser is leaky there will be intermittent flashes each time the condenser breaks down.

It is not necessary to remove the condenser to test it but just remove the leads to it.

Intermittent reception is likely to be found in a circuit such as shown in Fig. 1C where the voltage reaches the condenser through a high resistance. Due to the small current passed by the resistor the short will not burn itself out, but with surges such as snapping on a light, etc., the short clears for a short time.

Figure 1C is taken from the model 90 Lyric, where the voltage is fed to the detector through a resistance-filter circuit.

DONALD G. BUCK

Radiola 44, 46 and 47. A very common cause of complaint on Radiola 44, 46 and 47 receivers is weak volume and interference between stations. This points to the fact that the set is out of alignment. The experienced Service Man has learned, however, to completely check a receiver before coming too quickly to the decision that it is out of alignment. After coming to this deci-

sion when working on one of these sets you doubtless will be considerably puzzled if adjustment of the trimmer condenser does not overcome the trouble.

Due to some peculiarity in material or construction of these sets, a very great movement is often found in the tuning condensers. Usually it is let go until it is quite bad before calling in a Service Man. In fact, some of these sets have been found in which the plates touched enough to almost prevent turning the condensers, let alone the noise the owner must have put up with for a long time.

Luckily this condition may be checked quite easily by examining the tuning condensers. One of the sections of the tuning condensers is unshielded and the shields on the other 2 sections are quickly removed by simply loosening a metal bar across the top of the shields, removing it and then lifting up the shields. Turn the rotors into the stators and then with the aid of a good light, to prevent shadows, examine carefully to see if each rotor plate is midway between the stator plates on each side of it.

Due to some warping or shifting action in
(Continued on page 566)

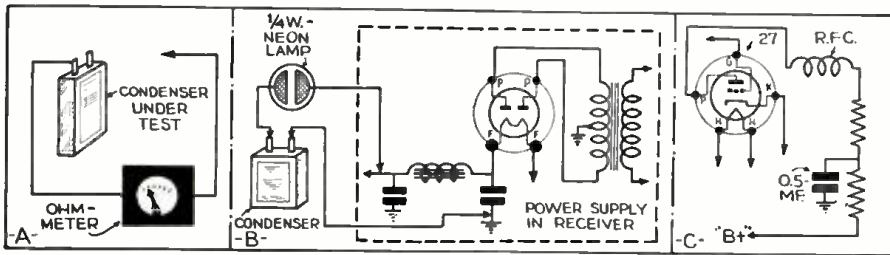

Fig. 1. Several methods for checking leaky condensers.

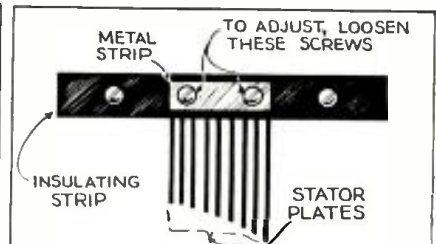

Fig. 2. Loosen the screws to adjust rotor plates.



A department devoted to members and those interested in the Official Radio Service Men's Association. For mutual benefit, contribute your kinks, gossip and notes of interest to Service Men, or others interested in servicing.



Photo—Radolek Co.

Since the advent of crystal and velocity microphones, radical changes in engineering design have been necessary to compensate for the increased gain required by these mikes. The designing and testing of circuits has become more intricate than ever before. Expensive precision laboratory equipment (such as illustrated above) is required to insure fast, accurate production.

MAINE: WANTS "LIGHT ORGAN" DATA

RADIO-CRAFT, ORSMA Dept.:

I have tried about all the radio magazines and have always come back to *Radio-Craft*. I am an experimenter and have had fine results on all its set designs I tried.

If possible would you please print a diagram of a simple "light organ"? This should have about 5 or 6 colored lights.

ROBERT HARRISON.
State Theatre,
Waterville, Me.

Thanks, Mr. Harrison. We're certainly glad to receive the commendation of a radio man who has "tried 'em all."

And as to the "light organ"—well, read the construction details, in April *Radio-Craft*, of a "super"-color organ!

SO. AFRICA: JOINS ORSMA

RADIO-CRAFT, ORSMA Dept.:

Being a regular reader of *Radio-Craft* I feel that I can write you for some information of great importance to myself.

I am employed as chief radio Service Man by a large firm of engineers in Johannesburg, South Africa. I understand that you set an examination for Service Men, and if they pass one examination you issue to them a certificate stating that they are qualified to operate as Service Men. Will you please be good enough to let me have information. I am very desirous of sitting for your examination, and feel sure that I have sufficient knowledge on the subject to pass the examination.

In the course of my duties I have the following makes of receivers for
(Continued on page 573)

**RCA ALL
THE WAY**

RCA Radio News

RCA Manufacturing Company, Inc. • Camden, New Jersey
A Service of the Radio Corporation of America

**EVERYTHING IN
RADIO-MICROPHONE
TO LOUDSPEAKER**

To the consumer, RCA means high quality performance at low cost . . . To the radio man, RCA means easier selling, higher profits

RCA VALUES FOR MARCH!

New RCA Test Equipment . . . at prices never before so low!



RCA Cathode Ray Oscillograph
Stock No. 151 Net Price \$17.50

FEATURES

- 1 COMPLETE oscillograph using new RCA-913 Cathode Ray Tube.
- 2 High sensitivity—1.75 volts R.M.S. for full-scale deflection.
- 3 Both vertical and horizontal amplifiers—individual gain controls—Flat 30-10,000 cycles.
- 4 Linear Timing Axis—30-10,000 cycles.
- 5 Light shield and calibration screen.



RCA Electronic Sweep Test Oscillator
Stock No. 150 Net price \$64.50

FEATURES

- 1 No moving parts. Variable electronic sweep—1 to 40 kcs.—at any r-f or i-f frequency—sweep rate, 120 times per second, eliminates screen flicker.
- 2 Wide frequency range 90 kcs. to 32,000 kcs.—fundamental frequencies—400 cycle modulation—**JACK FOR EXTERNAL MODULATION.**

- 3 Large direct-reading dial—4 inches diameter—indirect illumination—projected zero indicator lines eliminates parallax—two vernier ratios, 2:1 and 5:1.
- 4 AC operated—no batteries or motor.

ACR-155
**A New, Moderately-Priced,
General Purpose
Communication Receiver**
Amateur's Net \$74.50 f.o.b. factory



The ACR-155 is a moderately-priced communication receiver capable of superior performance under modern operating conditions. It provides a number of features not usually found in receivers of its price class.

- 1 Continuous frequency coverage from 520 to 22,000 kcs.
- 2 Nine Metal RCA Radiotrons for improved high-frequency performance.
- 3 Improved, large tuning knob with crank handle for smooth, easy tuning. 100 to 1 band-spread tuning drive.
- 4 Improved, adjustable, air-dielectric trimming capacitors. Magnetite core i-f transformers.
- 5 Calibration-spread dial for accurate logging.
- 6 Electrically stabilized oscillators.

In addition to the performance and convenience features shown above, this receiver also provides antenna rejection filter to reduce interference . . . A.V. C. at will . . . Six-inch, dustproof electrodynamic speaker for high-quality reproduction . . . Preselection for better signal to noise ratio, lower image response.

Please Say That You Saw It in RADIO-CRAFT

Small, Low-Cost Record Player Converts Radio into Phonograph-Radio!

The smart looking RCA Victor Record Player, R-93, shown at right, is ideal for the radio owner



who also desires recorded music. Attaches quickly and easily to any electrically operated radio, and converts the set into a phonograph-radio!

It's small in size, can be placed in any small space—costs less than \$20—available in a walnut finish, or, at slightly higher prices, in red, black, ivory.

In the field of radio, RCA Victor offers you more for your money in 1937 than ever before! Model 9K-3, shown below, is typical of the entire new line. It's easy to look at . . . easy to buy . . . and a real pleasure to hear!

These radios offer you, in addition to the many great features led by Magic Voice, Magic Brain, Magic Eye and Metal Tubes—the magic of radio that's RCA ALL THE WAY. Designed by men equally familiar with broadcasting and reception (for RCA designs most of the broadcasting equipment used by radio stations), they are the finest radios you can buy. Hear them today! There's a model and a price to please you. Easy payments through C. I. T. Corp.

RCA Victor Console Model 9K-3, with Magic Voice, Magic Brain, Magic Eye and Metal Tubes. Tuning range from 530 to 22,000 kcs. Beam Power Amplification. Selector Dial. 9 tubes. Automatic Volume Control. Automatic Tone Compensation. 12 watts output. Superb Cabinet. Price \$129.95 F.O.B., Camden, N.J.

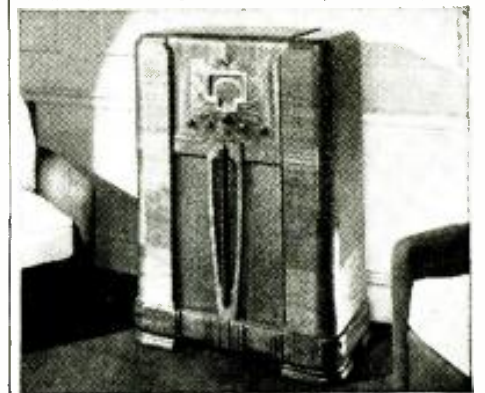

DELCO MODELS R-3208 (table) and R-3209 (console)

32 V. D.C., 9-tube, 4-band (5.9-15.3 mc., 1,590-4,500 kc., 540-1,600 kc., and 148-400 kc.)

The sensitivity control, across antenna, helps prevent overloading the R.F. amplifier, in view of low plate voltage; which also requires use of 4 power tubes in push-pull parallel. The set is to be grounded only through terminal strip connected by condenser to chassis, to avoid a short with a 32-V. system where (+) is grounded.

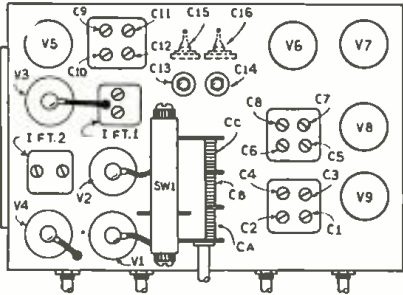

The I.F. stages are adjusted in the usual manner, with insulated screwdriver, and 450-kc. signal. The I.F. trimmers are not designated as Pri. and Sec. but can be determined by use of a metal screwdriver.

Blue (Long-Wave) band is adjusted at 400 and at 150 kc. If interference is strong, it can be reduced during test with added 5 to 10 mf. capacity between chassis and ground terminal.

Yellow Band (Broadcast) is adjusted at 1,400 and at 600 cycles.

Green Band (Police and Amateur) is adjusted at 4,000 and at 1,700 cycles.

Red Band (Foreign S.-W.) is adjusted at 15 and at 6 megacycles.

Model R-3208 has a 6 in. dynamic speaker; Model R-3209 a 10 in. speaker. Electrical output rating, 900 milliwatts. Sensitivity of receiver, 20 microvolts at 50 milliwatts.

G2 of V2 has also 30.5; the G1 terminal of V2 varies from -1 at low-frequency tuning to -3 at higher. Gs of 48s, 1.6 V.; Ks, 5.2 Fil., 6.4 V.; except 48s, 25.2; drain, 2A.



Tube voltages are as follows (supply at 32 V.):

Tube	Plate	Screen-grid
V1	30.5	30.5
V2	30.5	17.6
V3	30.5	30.5
V4	9.0	—
V5	30.0	—
V6 to V9	30.0	30.5

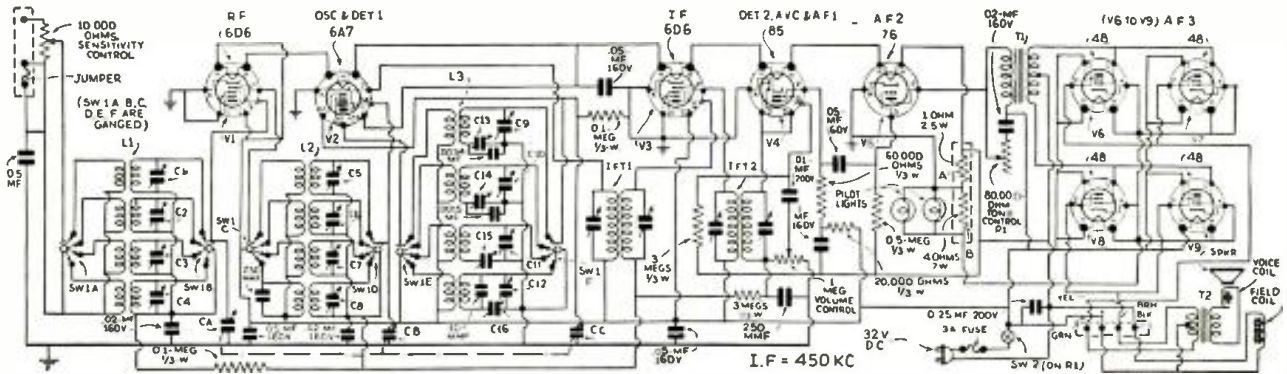

WILCOX-GAY MODEL A-17 (Chassis Model 3JQ6 and 3JM6)

6-tube, 3-band (540-1,500 kc., 4-1.5 mc., 5.5-15.5 mc.), A.C.-D.C. super., A.V.C.

This set operates on any commercial power supply down to 30 cycles; for voltages over 120, special ballast cord is obtained. Note: tone control not used on Model 3JM6.

Voltages are as follows: speaker field 110, "B-L" 105, as read to ground:

Tube	Plates	S.-G.	K
V1	105	50	1.3
V2	105	50	2.0
V3	45	—	1.2
V4	98	105	15.0
V5	Line Drop		

A 12-in. wire attached at chassis rear should be connected to aerial, and NO GROUND should be used.

Grid of V4, 0; second grid of V1, 4.4. Drop across ballast tube (L-49-B) 49 V.

I.F. amplifier peaks at 175 kc. The 2nd I.F. transformer (right rear chassis skirt) is trimmed; then 1st I.F. transformer (right front chassis) which has secondary trimmer left and primary right, as seen from front.

The B.C. circuits are adjusted at 1,400 and 600 kc.; if necessary bending slotted plates of oscillator gang condenser to correct scale

reading. The preselector circuits (center and front of gang condenser) are then trimmed to resonance.

Foreign-band circuits are adjusted at 15 mc.; there is no trimming adjustment on oscillator coil, to permit greatest extension of tuning range. Pre-selector trimmer on this band is at center of front chassis skirt (left side). This band should also be checked at 10 and 6 mc.

Police band is adjusted at 4 mc. The pre-selector trimmer is the right of two in front center chassis skirt.

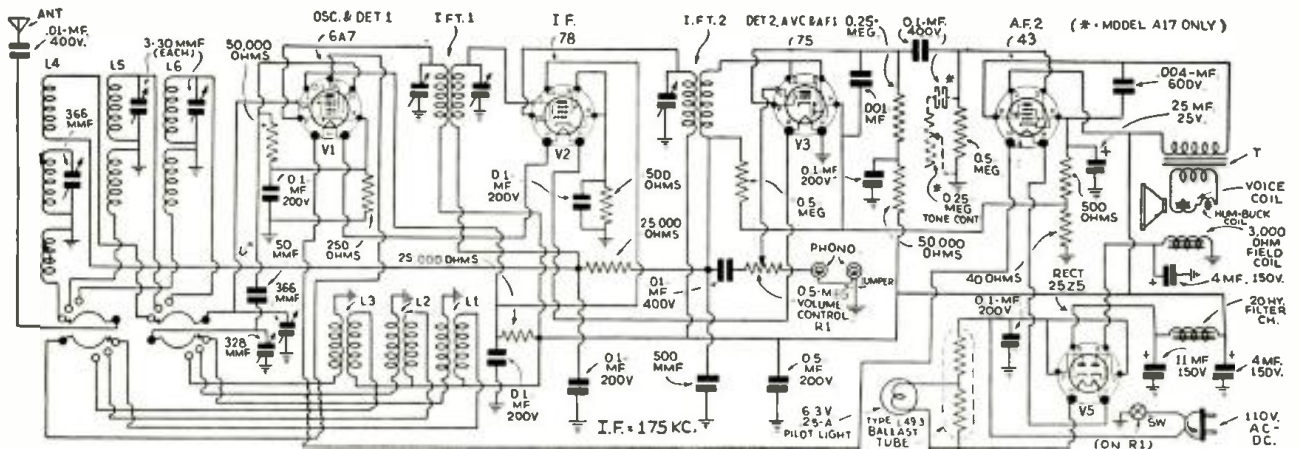

RADIO DEBUNKED FOR THE BEGINNER

(Continued from page 523)

the "radio-energy" contents of a bag. As the diagram indicates, their "atmospheric-bag" is filled with wavelengths of various "sizes," and of course contains some interfering wavelengths and also disturbing electrical impulses as well.

For the trap circuit installed into the antenna of Fig. 2 a vacuum cleaner is substituted which sucks the "coarse-pieces" into a container. This comparison is one of the best the author ever came across, since the operation of a trap circuit, to explain its function to a beginner, may be compared very well with the function of a vacuum cleaner.

After this process of "pre-cleaning" the incoming radio signal the radio energy is fed into the first tuning circuit, where a number of "blocks," representing wavelengths larger or smaller than desired, are "arrested." All the other "pieces" which pass towards the radio tube, V1, are shown larger or "amplified" after they leave the R.F. tube.

SOMETHING ABOUT FEEDBACK

The pictorial diagram explains with great simplicity how the amplified radio impulses proceed into the second tuning circuit or "detector stage", where another quantity of undesired wavelengths is filtered out, and kept away from entering the following detector tube, V2. The rectification process of the detector tube is presented in a very amusing manner. The radio-frequency component of the incoming signal is broken into pieces, and only the desired A.F. signal (audio-frequency signal) remains intact, with exception of a few "pieces of R.F. energy" which are needed for feedback purposes. The feedback condenser of Fig. 2 is presented in the form of a box with a valve or similar device. Depending upon size of the "opening" of this feedback condenser—pardon me, of the "valve" of the box—more or less feedback energy is sent back into the tuning circuit.

A frame covered with a wire mesh (presented as substitute for the R.F. choke used at this place in the diagram of Fig. 2) prevents the R.F. energy from entering the following or "output" stage. An amusing method has been chosen by Telefunken to demonstrate the function of the A.F. choke. We are probably all familiar with the fact that such an iron-filled choke bounces an A.F. signal back, but lets D.C. impulses pass with great ease. The bouncing of the A.F. impulses is left to a hockey player who executes his task with great elegance.

Now, let's accompany the A.F. impulses into the tube, V3, of the output stage. Diagram Fig. A demonstrates, by increasing the size of the tiny balls, that the incoming impulses are amplified by the tube. And we learn furthermore how the amplified impulses are directed by means of a funnel into the voice coil of the dynamic loud-speaker. The field coil of the speaker, via a good old fashioned pump, is fed with the electrical energy that makes the speaker work.

There remains only the power supply or "power stage". We see the wall outlet of the powerline and the little fellows (representing A.C. energy) entering the power transformer. A rectifier tube, V4 in Fig. A, makes them "smooth" and even, or in other words, converts the A.C. energy into D.C. energy, and our trip through the labyrinth of a modern radio receiver for powerline operation has come to an end.

This amusing trip into the secrets of radio receiver operation has shown us that there is practically nothing mysterious about the function of a radio receiver. Anyone gifted with common-sense can understand it. Everyone can, at least, try to build a simple receiver.

Radio beginners who want to delve a little deeper into the subject of circuit analysis in general, and the connections of 1-tube circuits in particular, should refer to the following articles in the March, 1935, issue of *Radio-Craft*: "How to Read Radio Diagrams," pg. 526 (chart of symbols appears on pg. 527); and, "Famous 1-Tube Circuits." Numerous small, simple receivers appear in *Radio-craft* from time to time which are particularly suitable for the beginner to start on. Refer particularly to "The Beginner's Book-End 3" in this issue.—Editor.

Mr. Service Man..



Earn WHILE YOU PAY

•

Buy New Test Equipment on Wards MONTHLY PAYMENT PLAN

"Nothing breeds success like success" . . . and in the Radio Service business your success depends upon your ability to give speedier, more efficient service to your customers. You can't do it with old, obsolete equipment. You need the best, most up-to-date instruments and supplies that the market can offer.

And that's where Wards can help you. Wards new 1937 Radio Catalog offers you a complete line of the finest, most modern testing equipment . . . books that explain today's servicing problems . . . countless other service supplies—in addition to America's finest line of PA systems. ALL these may be bought on Wards Convenient Monthly Payment Plan, enabling you to buy what you need TODAY, and pay for it while using it.

Wards prices are always surprisingly low. Yet it is often inconvenient to pay cash or inadvisable to disturb working capital. Wards Monthly Payment Plan aids you in getting that business-building equipment into your shop NOW, so it can be working for you, increasing your profits while you are paying for it. You pay just a small amount down, and the balance in monthly payments. Terms for \$10 orders are only \$2 down, \$2 monthly with a small carrying charge.

Don't put off investigating this convenient buying plan any longer. Fill out the coupon TODAY for your copy of Wards 1937 Radio Catalog!

MONTGOMERY WARD

CHICAGO • BALTIMORE • ALBANY • KANSAS CITY
ST. PAUL • DENVER • PORTLAND • OAKLAND • FT. WORTH

Terms As Low
As \$2 Down
\$2 Monthly

•
TRIPLETT
READRITE
RANGER
RCA
WESTON
HICKOK
MILLION
SOLAR
MONARCH
SIMPSON
TOBE
TRIUMPH
CLOUGH-
BREngle
SUPREME

Assure yourself of a copy by mailing coupon to nearest Ward House TODAY.
MONTGOMERY WARD, Dept. RZ-1
Yes, I want your new 1937 Radio Catalog with details on Monthly Payment Plan.

Name.....
Street or Box Number.....
City..... State.....

Please Say That You Saw It in RADIO-CRAFT



**CAN
YOU
USE
\$600
CASH**



ALL YOU HAVE TO DO IS ANSWER A QUESTION. YOU KNOW THE ANSWER NOW—YOU TELL IT TO A CUSTOMER TWO OR THREE TIMES A WEEK. YOUR CHOICE OF EITHER \$600 CASH OR A NEW V-8 SERVICE TRUCK WITH A COMPLETE BUILT-IN SOUND SYSTEM IS THE FIRST PRIZE. THERE ARE 500 OTHER PRIZES!

ASK YOUR JOBBER



RAYTHEON PRODUCTION CORPORATION
 420 Lexington Ave. 55 Chapel Street
 New York, N. Y. Newton, Mass.
 445 Lake Shore Drive 555 Howard Street
 Chicago, Illinois San Francisco, Cal.
 415 Peachtree St., N. E.
 Atlanta, Ga.

RAYTHEON IS THE MOST COMPLETE LINE—ALL TYPES OF GLASS, OCTAL BASE, METAL, RESISTANCE AND AMATEUR TRANSMITTER TUBES.

TECHNICIANS' DATA SERVICE

JOSEPH CALCATERRA DIRECTOR

A special arrangement between RADIO-CRAFT magazine and the publishers of this literature, which permits bulk mailings to interested RADIO-CRAFT readers, eliminates the trouble and expense of writing to each individual organization represented in this department.

2. HAMMARLUND CATALOG. Contains complete specifications, illustrations and prices on the Hammarlund line of variable and adjustable condensers; intermediate frequency transformers, coils and coil forms; sockets; shields; chokes and miscellaneous parts for broadcast, short wave and ultra short wave reception and transmission. Also contains description and prices of the Hammarlund line of "Comet Pro" and "Super Pro" receivers.

5. ELECTRAD 1936 VOLUME CONTROL AND RESISTOR CATALOG. Contains 12 pages of data on Electrad standard and replacement volume controls. Truvolt adjustable resistors, vitreous wire-wound fixed and adjustable resistors and voltage dividers, precision wire-wound non-inductive resistors, center-tapped filament resistors, high-quality attenuators, power (50- and 150-watt) rheostats and other Electrad resistor specialties.

20. THE KEY TO SUCCESSFUL SERVICING. Four different types of combinations of courses on Radio Servicing, Public Address Work, and Television, developed by the Radio Service Institute, are described in this 24-page booklet. Complete information, including outlines of the courses and costs, is given. Two of the courses are designed for the more advanced and more ambitious Service Men who are anxious to get to the top of their profession. The other two courses are for less-experienced Service Men who want to advance more rapidly in the Radio Servicing Field. Please do not ask for this booklet unless you are interested in taking a course in these subjects.

53. POLYIRON COIL DATA SHEET 536. This folder contains complete catalog descriptions, specifications, prices, performance curves and circuits showing applications of the complete line of Polyiron radio components made by the Aladdin Radio Industries, Inc.

57. RIBBON MICROPHONES AND HOW TO USE THEM. Describes the principles and operating characteristics of the Amperite velocity microphones. Also gives a diagram of an excellent humless A.C. and battery-operated preamplifier.

65. THE 1937 LINE OF SUPREME TESTING INSTRUMENTS. This 24-page catalog gives complete information on the entire Supreme line of testing instruments, including the Model 585 Diagonometer; the Model 540 and 550 Radio Testers; the Model 500 Automatic; the Model 505 Tube Tester; the Model 555 Diagonoscope and other Supreme oscilloscopes, tube testers, signal generators and multimeters. Complete details of the Supreme Easy Payment Plan for purchasing testing equipment on the installment plan are also given.

66. SUPREME DESIGN MANUAL "A" OF TUNE AND RADIO TESTING CIRCUITS. This interesting and useful 60-page handbook covers the fundamental principles of meters, measuring instruments and test circuits and illustrates, with detailed explanations, the basic circuits used in Supreme Testing Instruments. Every Service Man who is interested in the "why" of testing circuits should have a copy of this handbook in his kit.

73. HOW TO ELIMINATE RADIO INTERFERENCE. A handy folder which gives very complete information on how to determine and locate the sources of radio noise by means of the Sprague Interference Analyzer. A description of the analyzer and method of using it is included, to-

Radio-Craft Technicians' Data Service
 99 Hudson Street,
 New York City, N. Y. RC-337

Please send to me, without charge or obligation, the catalog, booklets, etc. the numbers of which I have circled below.

2	5	29	53	57	65	73
71	75	76				

My radio connection is checked below:

- Service Man operating own business.
- Service Man for manufacturer.
- Service Man for jobber.
- Service Man for dealer.
- Service Man for servicing company.
- Dealer.
- Jobber.
- Experimenter.
- Professional Set Builder.
- Amateur Set Builder.
- Short Wave Work.
- Licensed Amateur.
- Station Operator.
- Radio Engineer.
- Laboratory Technician.
- Public Address Worker.
- Manufacturer's Executive.
- Student.

I am a: Subscriber Newsstand reader
 I buy approximately..... of radio material a month. (Please answer without exaggeration or not at all.)

Name

Address

City State
 (Please print name and address)

Avoid delay. The catalogs and booklets listed are now in stock and will be sent promptly as long as the supply lasts. Please use this coupon in ordering. The use of a letter causes delay.

gether with data on how to eliminate interference of various kinds once the source is located.

74. SPRAGUE 1936 ELECTROLYTIC AND PAPER CONDENSER CATALOG. Gives specifications, with list and net prices on a complete line of wet and dry electrolytic, and paper condensers made by the Sprague Products Co. for radio Service Men, set builders, experimenters and engineers. Information on the Sprague Capacity Indicator, for making capacity tests on condensers and in servicing receivers, is included.

75. SPRAGUE TEL-U-HOW CONDENSER GUIDE. A valuable chart, compiled by the Sprague Products Co. which tells the proper types, capacity values and voltages of condensers required in the various circuits of radio receivers and amplifiers, and how to locate radio troubles due to defective condensers. Includes data on condenser calculations.

76. FACTS YOU SHOULD KNOW ABOUT CONDENSERS. A folder, prepared by the Sprague Products Co., which explains the importance of various characteristics of condensers, such as power-factor, leakage, capacity and voltage in determining the efficiency or suitability of a given condenser to provide maximum filtering and safety in operation.

THE RADIO MONTH IN REVIEW

(Continued from page 519)

tions of emotion was demonstrated last month, for the first time, by Father Walter G. Summers, head of Fordham University's department of psychology.

In the demonstration given by Father Summers, a pack of cards was first given to the subject who picked one card out of the pack and then returned the entire pack including the card in question. The entire pack was then run

through by the questioner and the subject denied that each card was the one picked out. By means of the instrument, the card formerly picked out of the pack could be determined by the "lie" marks on the recording tape.

The instrument contains vacuum tube amplifiers and a recording mechanism to amplify and record the tiny currents generated in the body by varying emotions.

Please Say That You Saw It in RADIO-CRAFT

HOW TO MAKE A "JUNIOR" OSCILLOSCOPE

(Continued from page 527)

the wiring of the D.C. and sweep portions.

OPERATION

When the wiring is completed all of the controls should be in the extreme counter-clockwise position before the current is applied. The first thing to be done is to turn the current on and then focus the tube by manipulating the left-hand and the right-hand controls (at the lower portion of the unit), indicated in the illustrations as R10 and R11. Focusing is accomplished by securing a spot in the direct center of the cathode-ray tube. Care must be taken to prevent this spot becoming too bright or the surface of the tube will become permanently damaged from burning. This precaution may be taken by manipulating R10 and R11 in such a way that this brightness is avoided. Even though the spot may not be particularly brilliant it is a good idea not to leave the spot on for very long without any movement and plenty of movement is obtained as follows.

Once the spot has been secured, as outlined above, the sweep is thrown into play by throwing the switch Sw.2 which is attached to the center control, potentiometer R7. At the time that this adjustment is made a green light, in the form of a straight line, will appear across the cathode-ray tube. Resistor R13, which is the horizontal sweep control, is advanced to approximately the half-way position. The width of the line may be increased or reduced by changing the position of the control knob, R13.

If the line is not in a perfectly horizontal plane it may be adjusted by the simple expedient of rotating on its bracket the socket of the type 913 tube.

For 60-cycle and trapezoid sweep patterns rotate the center control R7 all the way counter-clockwise, which automatically opens switch Sw.2 and disconnects the linear sweep from the horizontal deflection plates.

When it is desired to use this oscilloscope for aligning the I.F. section of a superheterodyne receiver the additional stage of amplification to be incorporated in the oscilloscope is shown diagrammatically in Fig. 11. An A.F. modulated service oscillator will be required.

When this oscilloscope is to be used for the checking of radio transmitters—as for instance the 5-meter and other ultra-short wave units occasionally described in past issues of *Radio-Craft*—the procedure is as follows. First connect the 3-turn pick-up coil by means of a twisted-pair to the left-hand binding posts which are in turn connected to the vertical plates of the 913 tube. For observing all envelope patterns the linear sweep is used, as outlined previously. However, for trapezoidal patterns the sweep is thrown out by rotating the central knob to the extreme counter-clockwise position which automatically opens switch Sw.2. Connect the A.F. output of the transmitter—by means of the 2 binding posts at the right-hand end of the front panel—to the vertical plates.

(Continued on page 572)

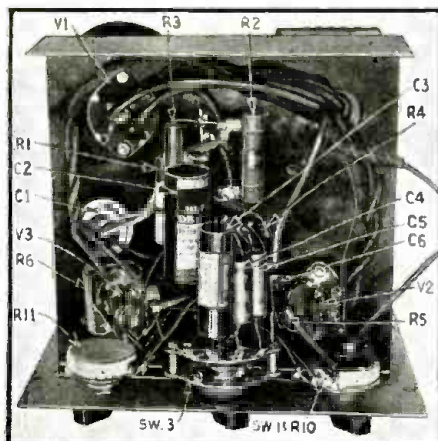
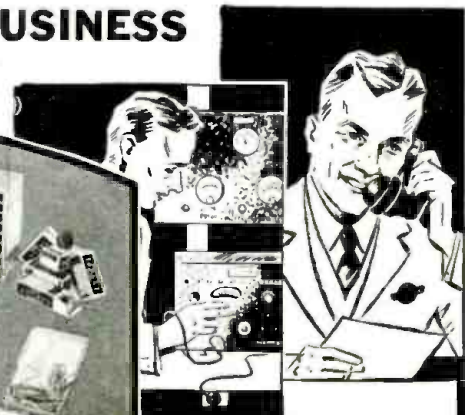
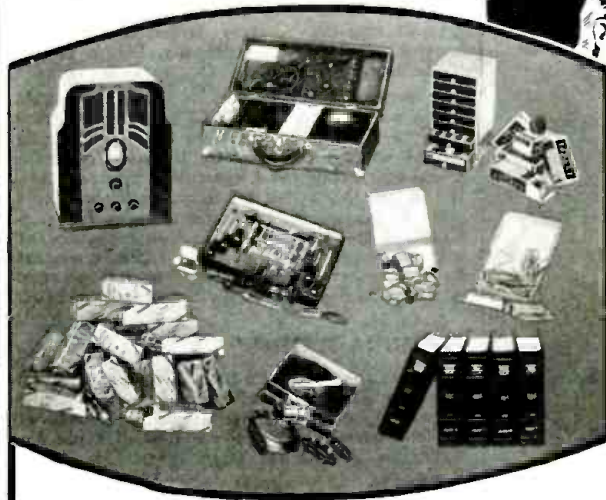

Fig. C. The under side of the chassis. The parts designations conform with the schematic circuit, Fig. 1, and the list of parts.

I WILL PROVE That Sprayberry Training SETS YOU UP FOR BUSINESS ...for Only 17c a day!



This PROFESSIONAL RADIO EQUIPMENT is Yours!

Sprayberry's is the ONLY training that furnishes COMPLETE, PROFESSIONAL equipment with your course. That is why it is so practical—so easy to learn.

GET STARTED NOW IN AN INDUSTRY THAT IS PROVIDING FORTUNES FOR WIDE-AWAKE MEN!

This new and different kind of Training does more than teach you about all branches of Radio. It teaches you business methods—it sets you up ready for an actual start in business—and it backs up every step of your training with REAL PROFESSIONAL RADIO EQUIPMENT!

No matter what kind of Radio Training you take, it is ABSOLUTELY NECESSARY that you have equipment of this kind BEFORE you are ready to start making REAL money.

Sprayberry Training brings it to you almost at the start—teaches you just how to use it under actual working conditions. That is why it's so easy to learn—why students make extra money on Radio work even before completing their training. Then, upon grad-

uation you have COMPLETE business and technical training PLUS the needed equipment to enter business at once for full or spare time profits—or to start off on a career in any one of Radio's specialized fields such as aviation radio, movie sound work, broadcasting, etc.

ACT TODAY!

Radio was one of the very first industries to lead the way out of the depression. It is going ahead by leaps and bounds. And now TELEVISION is on its way! Today is the time to get started—and Sprayberry Training will start you right. Investigate at once! Let us show you how an investment of only 17c a day—just about the cost of a pack of cigarettes—can mean a real future for you in one of the fastest growing businesses in the world.

Fill in the coupon below RIGHT NOW

SPRAYBERRY ACADEMY OF RADIO

F. L. Sprayberry, President
2545 University Place, N. W., Washington, D. C.

Without obligation on my part please rush your free book "MY FUTURE IN RADIO" and other details of the famous Sprayberry Training.

NAME AGE

ADDRESS

CITY STATE

Paste this coupon on penny post card and mail TODAY. RC-3-37

SERVICEMEN!

For those already in • Radio, Sprayberry offers an ADVANCED Training Course that has proved invaluable to hundreds of servicemen. Saves you time—saves money—teaches you the easiest way to do the hardest jobs. Get details. Mark an X here (X) and we will send our ADVANCED Radio Training Booklet free.

Announcing the SKY CHALLENGER

A New and Outstanding Communications Receiver at a Sensationally Low Price

Never before has the radio amateur and short wave listener been offered such an outstanding value. Think of it—a genuine Hallicrafters engineered 9-tube superheterodyne communications receiver with every feature and control for efficient short wave reception at this amazingly low price. Complete coverage from 40 MC to 535 KC. Five Band 338° dial. Compare its performance and features with other receivers at twice the price.

69⁵⁰

LESS SPEAKER

FEATURES

- * 6 Metal—3 Glass Tubes
- * 40 M C to 535 K C in 5 Bands
- * 338° Main Tuning Dial
- * Electrical Band Spread
- * Iron Core I. F. for improved selectivity
- * Direct Calibration Tuning—No Charts or tables.

the hallicrafters, inc.
2619 INDIANA AVE. CHICAGO, ILL.



SEE IT AT YOUR DEALERS OR WRITE FOR COMPLETE INFORMATION

Please Say That You Saw It in RADIO-CRAFT

UNIVERSALLY ACCEPTED...

RADIO SERVICING INSTRUMENT

Accuracy 2%

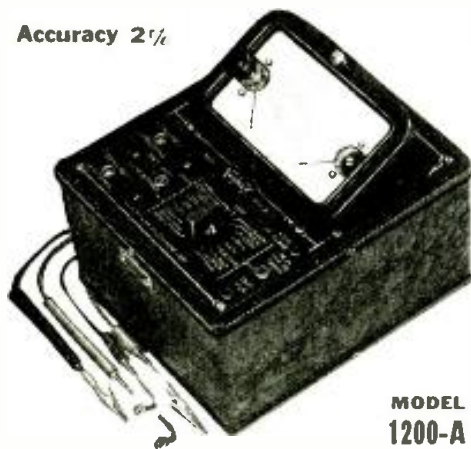

MODEL 1200-A

This Most Essential Radio Servicing Instrument Has:

- Separate Low Ohms Scale
- Ohms Scales Individually Adjusted
- Separate A.C. and D.C. Instruments
- Tilting Feature for Accurate Reading
- Low Loss Switch
- Aged Resistors with Sustained Accuracy

Dealer Price \$21.67

Scale Reads: A.C. and D.C. 10-50-250-500-1000 Volts, the D.C. is at 2000 Ohms per volt; 1-10-50-250 Milliamperes; 1/2 to 500 ohms, 15-1500 ohms, 1.5 and 7.3 Megohms. Model 1200-C same as above except the D.C. is at 5000 Ohms per volt, also has readings of 250 Microamperes and 7 1/2 Megohms.

Dealer Price \$24.33

Model 1200-B same as 1200-A but in addition uses copper oxide rectifier: A.C. volt readings 2-10-50-250-500-1000 at 1000 Ohms per volt.

Dealer Price \$26.67



Triplet Electrical Instrument Co.
163 Harmon Ave., Bluffton, Ohio
Without obligation please send me more information on Model 1200-A; Model 1200-C; Model 1200-B. I am also interested in

Name

Address

City State

NEW INFORMATION ABOUT ANTENNAS

(Continued from page 521)

leakage in all weather conditions. The adjustable feature of this "fishpole" antenna aids the response in certain short-wave bands.

Window-Tenna. Figure C illustrates the new type of antenna, recently developed by a well-known radio hardware company, known as the "Window-Tenna."

It consists of 3 telescoping aluminum tubes which permit the antenna to be extended from 3 ft. to 8 1/2 ft. The antenna mounts vertically on the window casement on the outside of the window to either wood, cement or brick surface. It is admirably suited for apartment houses and other places where roof antennas are not permitted. Because of the telescoping feature of this antenna, its length can be adjusted so that its usefulness extends to the short-wave and television bands as well as the broadcast band.

"ANTENNA SYSTEMS"

Despite the mass of advertising literature and magazine articles describing the merits of the various types of antennas (perhaps because of it), the question "Which aerial shall I use for best radio reception?" doggedly persists.

Recently, there appeared in a newspaper, a statement, by a well-known radio authority, condemning all types of coupling transformers used in connection with the various special antenna systems. "We have found," to quote one of the sentences, "that these gadgets invariably cut down the signal strength."

It is interesting to note the reactions, to this statement, of some of the radio engineers of the larger companies. One engineer writes:

(1) "The real purpose of these special antenna systems is to give an improved signal-to-noise ratio in radio reception. The engineer naturally attempts to give this improvement without a sacrifice in signal strength, but because the band is so wide—from 6 to 18 megacycles—exact matching for all frequencies is impossible and so signal reduction results. However, the noise pick-up is usually greatly reduced, resulting in ratios of signal-to-noise which may be as high as 100 times the original value." (Italics ours.) Here, you see, the en-

gineer makes it quite clear that the problem is not one of, merely, DX reception, but DX reception without noise (static). (Or, as he phrases it, "high signal-to-noise ratio.")

(2) Another engineer states: "Mr. X says that gadgets, such as antenna couplers, invariably cut down the signal strength. We are entirely in agreement with Mr. X in this respect because the antenna system about which he is talking is evidently not a standard engineered system such as supplied by large radio companies. When the antenna coupler and the set transformer are properly engineered and designed the efficiency is much greater with them than without them." (Italics ours.) The chief engineer of this big company feels the "antenna system" should use an antenna coupler—but it must be of the proper type—for best results.

(3) A third engineer makes the following comment: "He is not considering the noise reduction feature of short-wave antenna, which feature is only possible through the use of a coupling unit. There are of course arrangements of antennas which may be advantageous on one signal frequency during a particular period without an antenna coupler. However, the coupler gives a much better efficiency over a greater range of frequencies. . . . Also, mere listening tests are deceptive due to the A.V.C. action of the set; and, antenna effectiveness is difficult to determine in localities where S.-W. listening conditions are ideal. The use of an antenna system is often based not only on sound mathematical analysis but the real necessity is proven by experimental observations and measurements which eliminate the human error."

Let us now discuss two of the better types of antenna systems.

The "Spiderweb." The new RCA "Spiderweb" antenna system consists of a series of doublet antennas and an improved transmission line to the receiver, as shown in Fig. D and Fig. 1A.

This system gives excellent signal pick-up over the frequency range from 140 to 23,000 kc. and, by adding an additional doublet, sold separately as a "High-Frequency Kit", this range may be increased to 70,000 kc. with full noise reduction. This feature is especially important because of the increased frequency range of modern all-wave receivers. This "High-Frequency Kit" may be added at any time, not necessarily when the antenna is first installed. The balanced doublets, together with the transposed transmission line, eliminate all noise pick-up on the lead-in in the short-wave bands. This system is considerably easier to install than its predecessor the "double-doublet" antenna system since double supports are not required. A span of only 38 ft. and a vertical clearance of 12 ft. are the entire space requirements of the "Spider-Web" antenna system. Furthermore, the system is completely assembled and soldered at the factory and comes to you ready to be "hung."

The "V-Doublet." The General Electric "V-Doublet" antenna system incorporates a doublet, the center portion of which takes the form of a "V". See Fig. E and Fig. 1B.

It is contended that the factor responsible for the non-uniform sensitivity of a conventional single-wire or doublet antenna is the development of "standing waves" along its length, which results in points of high and low sensitivity at different frequencies. The "V-Doublet" reduces the standing waves because the center portion is tapered, making the system somewhat aperiodic (equally resonant to all frequencies). The first high-impedance point is thereby extended to such a high frequency that efficient pick-up is obtained on the antenna

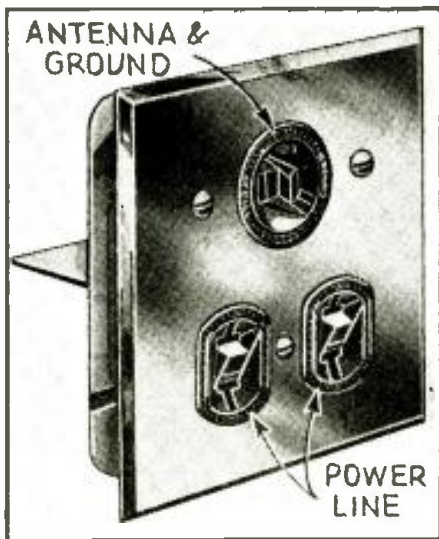

This wallplate has an antenna-ground outlet (provided with an antenna coupler), and power outlets. Fine for apartments, etc. (No. 1308)

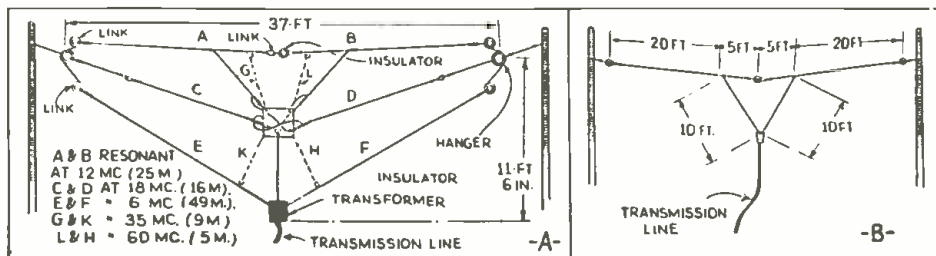

Fig. 1. Details of 2 antenna systems. At (A), RCA "Spiderweb"; (B), G.E. "V-Doublet."

Please Say That You Saw It in RADIO-CRAFT

proper, and the high-impedance point does not have the usual derogation (reducing effect) of signal strength experienced with conventional doublets. The result is a doublet of better uniform sensitivity over the short-wave points.

A further function of the tapered "V" is to couple efficiently the fairly high impedance antenna to the low-impedance transmission line, in which case the taper performs the function of a transformer. The length of the transmission line and the coupling ratio of the transformer are correct to afford proper electrical matching for greatest energy transfer from the antenna to the receiver.

The transmission line is coupled to the receiver through a specially constructed receiver-coupling transformer. The transmission line is immune to signal pickup, either that of noise or the desired signal. Therefore, if the antenna proper is kept well out of the field of noise, the signal will be quite free from noise.

There is yet another consideration involved. With an all-wave receiver the antenna must not sacrifice performance in the standard broadcast and other low-frequency bands in order to obtain good short-wave reception. At the lower frequencies, therefore, this antenna is automatically converted, by the electrical action within the receiver-coupling transformer, from its "V-Doublet" form to one approximating the conventional "T-type", so that the transmission line acts as part of the effective antenna length.

MAKE "THE EXECUTIVE"—A BUSINESS MAN'S A.C.-D.C. SET

(Continued from page 542)

POLISHING AND ASSEMBLING

In working with plastic materials, all parts must be polished before assembly. After checking all surfaces for flatness and seeing that the edges are true and square, remove all tool marks by buffing on an 18-in. rag wheel with the aid of pumice powder (size 000) in water. Continue this operation until all traces of scratches are gone. Patience and care at this point are important to the ultimate attainment of the high lustre and rich hues possible with this material. The next operation is to apply a high polish by using a second 18-in. rag buffing wheel dressed with rouge or tripoli. This last buffing requires only a few seconds if the preliminary polishing has been properly done.

If the constructor carefully examines the detail illustration, Fig. 4, very little need really be said about the assembly operation. All parts of the cabinet are held together by means of 1/2-in. angle brackets and 3/16-in. machine screws. Three angle brackets are used on each side. The holes which engage the machine screws for these brackets are drilled only 3/16-in. deep into all the panels except the thick base. These holes are drilled 1/4-in. deep and 1/4-in. machine screws are used.

Assemble the front and two side panels together first; then attach the top and finally the base. Use machine screws with a 6/32 thread. If the holes for these screws are drilled just a trifle smaller than 6/32, the screws will cut their own threads in the holes as they are screwed in. No tapping of the drilled holes is necessary.

For the benefit of constructors who wish to know "where they stand," financially, before engaging in the construction of this distinctive radio set, the following supplementary listing of materials has been prepared to include approximate market prices.

LIST OF PARTS

—SUPPLEMENTARY MATERIALS

- *One set of "marblette" sheets, cut to size as per sketch in the text (cost, approx. \$5.00);
- *One "Emeralite" radio lamp No. 0884 (cost, approx. \$5.00);
- *One electric clock, Type "S" movement (cost, approx. \$3.00);
- Two fountain pens and holders (available from stationary dealer, cost approx. \$4.00);
- *Hardware.

*Names and addresses of manufacturers will be supplied upon receipt of a stamped and self-addressed envelope.

By ordering from Allied's catalog, I save time and make more money!

Says Mr. Serviceman

"The ALLIED Catalog is always handy on my work bench, right where I can reach it when I need it. I get a lot of haywire sets in my shop and I know that my customers want speedy reliable work. Whenever I need a part in a hurry I order from ALLIED—my 'silent partner'—and get it in a jiffy. ALLIED furnished my initial equipment at a cost much lower than I dreamed of, and I've been a steady customer ever since. Take a tip—if you want those good, satisfied customers, worry-less service and real profits—order from your ALLIED Catalog!"

ALLIED'S expert radio technicians carefully test stock for quality and performance, assuring you of dependable repair parts and instruments. Our tremendous purchasing power enables us to buy for less and sell for less. You save time, trouble and money when you order from ALLIED—Radio's Leading Supply House. This means faster service, more satisfied customers, lower prices and bigger profits for you!

EVERYTHING IN RADIO AT LOWEST PRICES

If you don't have a copy of the great 1937 ALLIED Radio Catalog send for it today! It includes more than 10,000 exact duplicate and replacement parts; leading lines of test instruments—analyzers, tube-checkers, testers, oscillographs, meters, etc.; complete Amateur transmitting and receiving gear; 38 models of the amazing Knight Radios; P.A. Systems from 8 to 60 watts—for 110 volt, 6 volt and universal operation; Set-Builders' kits; tools, books, etc. You'll find all your Service needs answered in the ALLIED Catalog—Radio's most complete Supply Guide!

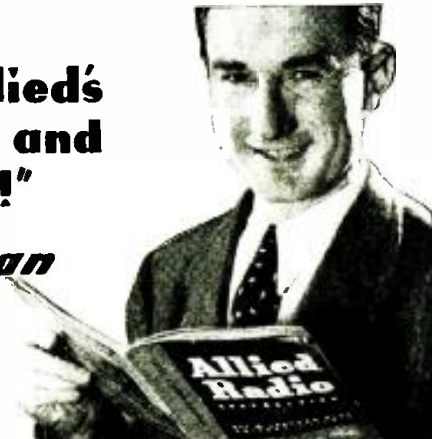

Typical ALLIED Values

PORTABLE SIMPLEX VOLT-OHMMETER

Here's a remarkably low-priced test unit with a thousand different uses! Pocket-sized. It has a scale marked 0-3, 0-30, 0-300 volts, D, and 0-10,000 ohms—cover practically every type of measurement needed in radio work. Walnut-finished, beige-line case measures 1 3/4" x 2 1/4" x 7/8". Has pin jacks for quick selection of desired scale. Supplied with self-contained batteries, 30" polarized test-leads and instructions for only



A2892
\$3.23

New CAPACITY ANALYZER

A sensational new instrument for quickly and accurately determining the worth and capacity of any condenser between .001 and 70 mfd. Also measures power factor, and detects defective condensers. No headphones, meters, etc., are required; compactly built in sturdy, attractive cabinet, with handle for carrying. Available in 110 volt 50 cycle (A7708) and 110-220 volt 25-60 cycle (A7709) models. Only



\$18.82

FREE CATALOG

ALLIED RADIO CORPORATION

833 W. JACKSON BLVD., CHICAGO

ALLIED RADIO CORP., Dept. 2-C
833 W. Jackson Blvd., Chicago, Ill.

Rush me your 1937 ALLIED RADIO Catalog.
 Enclosed find \$..... for:
 Portable Volt-Ohmmeter. Capacity Analyzer

Name

Address

Be a RADIO EXPERT—Learn AT HOME

RADIO SPECIALISTS NEEDED

Modern receivers with their complicated circuit systems have knocked out the old time cut-and-try radio fixer. Trained men with up-to-the-minute knowledge are needed to service these new sets.

HERE IS YOUR OPPORTUNITY

Your possibilities of making money and getting ahead are limited only by your ability and skill—but you must know more than the other fellow. You must be a radio service specialist, as R.T.A. can train you.



FREE OF EXTRA COST

To start you making money without delay we equip you with this Circuit Analyzer and Point to Point Resistance Tester.

PRACTICAL TRAINING AT HOME

Our home study course is practical "shop and bench" training combined with a thorough set of practical lessons prepared by an experienced radio service engineer. Four working outfits are also furnished.

MAKE SPARE TIME MONEY

Our training is complete and practical. We show you how to make money almost from the start. The course can easily be made to pay its own way. Investigate now, write for free book of details.

WHAT R.T.A. STUDENTS SAY

Norwood, Ohio
I have connected with a large firm as Radio Service Manager and wish to extend my thanks for your help.
Joseph Radden, Jr.
Yorkville, Ohio
From Aug. 1 to Dec. 7, 1936, I repaired 163 radios and put up 43 aerials which is very good for part time work while studying your course.
Chas. Koerber.

RADIO TRAINING ASS'N OF AMERICA

Dept RC-73, 4525 RAVENSWOOD AVE., CHICAGO

Please Say That You Saw It in RADIO-CRAFT

417

THINGS EVERY RADIO SERVICE MAN MUST KNOW

Ghirardi gives you all 417 in his remarkable MODERN RADIO SERVICING and handy FIELD DATA book—all clearly explained and illustrated. For instance—

- How to use all kinds of test instruments. How they work. Complete construction data. Circuit diagrams. Latest models.
- How to use the most successful modern methods in repairing receivers. "Case Histories" of over 1,500 receivers and time-saving, money-making short-cuts in service work.
- How to align any make of superhet, and—
- How to use the Cathode-Ray Oscilloscope method in alignment work.
- How to track down and eliminate every type of noise and interference.
- How to save time on all difficult trouble-shooting and repair jobs. New dope on tests and remedies for hum, intermittent reception, distortion, etc.
- How to install and service all makes of auto-radio receivers in all makes of cars and eliminate ignition interference.
- How to master all the complexities of AVC and QAVC circuits and trouble-shoot them.

These are but a few scattered items among the 417 essentials of modern radio servicing of which these books will give you easy mastery. Your shop is only half-equipped without them. ORDER THEM TODAY on our money-back guarantee offer.

1300 PAGES 706 ILLUS.

MODERN RADIO

Servicing
\$4 alone

Together with 436 p.

RADIO FIELD SERVICE DATA

\$6



MAIL TODAY!

To: Radio & Technical Publ. Co., Dept. RC-37, 45 Astor Pl., N. Y.

Enclosed find \$4 for Combination Offer, including Jan. & June '37 Supplements to FIELD DATA book. Postpaid (Foreign \$6.50).

Enclosed find \$4 for MODERN RADIO SERVICING alone. Postpaid (Foreign \$1.50).

Encl. find \$2.50 for DATA BOOK alone, with Jan. & June '37 Supplements. Postpaid (For \$3.).

Please send free circular S.

Name

Address

Also—RADIO PHYSICS COURSE—\$4

MY FIRST TRANSATLANTIC WIRELESS SIGNAL

(Continued from page 520)

the 6th, and before beginning operations. I visited the Governor, Sir Cavendish Boyle, and the Prime Minister, Sir Robert Bond, and other members of the Newfoundland Government, who promised me their heartiest cooperation in order to facilitate my work. After taking a look round at the various sites, I considered that the best one was to be found on Signal Hill, a lofty eminence overlooking the Harbor. On the top of this hill was a small plateau, which I thought suitable for flying either balloons or kites. On a crag of this plateau rose the Cabot Memorial Tower, and close to it was an old Military Barracks. It was in a room of this building that I set up my receiving apparatus in preparation for the great experiment.

On Monday, December 9th, barely 3 days after my arrival, I and my assistants began work on Signal Hill. The weather was very bad and very cold. On the Tuesday we flew a kite with 600 ft. of antenna wire as a preliminary test, and on the Wednesday we had inflated one of our small balloons, which made its first ascent during the morning. Owing, however, to the strength of the wind, the balloon soon broke away and disappeared in the mist. I then concluded that perhaps kites would answer better, and decided to use them for the crucial test.

I had arranged with my assistants in Cornwall to repeat the letter "S" at a pre-arranged speed, during certain hours of the day. I chose the letter "S" (3 dots) because it was easy to transmit, and with the very primitive apparatus used at Poldhu, I was afraid that the transmission of other Morse signals, which included dashes, might perhaps cause too much strain on it and break it down. Mr. Entwistle, Mr. George and Mr. Taylor were in charge of the English Station at Poldhu during the transmission of signals to Newfoundland.

On the morning of Thursday, the 12th of December, the critical moment for which I had been working for so long, at last arrived; and in spite of the gale raging, we managed to fly a kite carrying an antenna wire some 400 ft. long. I was at last on the point of putting the correctness of my belief to the test. Up until then I had nearly always used a receiving arrangement including a coherer, which automatically recorded signals through a relay and a Morse instrument. I decided in this instance, to use also a telephone connected to a self-restoring coherer—the human ear being far more sensitive than the recorder. Suddenly, at about half past twelve, a succession of 3

faint clicks on the telephone, corresponding to the 3 dots of the letter "S" sounded several times in my ear—beyond the possibility of a doubt! I asked my assistant, Mr. Kemp, for corroboration, if he had heard anything. He had in fact heard the same signals as I had. I then knew that I had been justified in my anticipations!

The electric waves, which were being sent out into space from Poldhu had traversed the Atlantic unimpeded by the curvature of the earth—which so many considered to be a fatal obstacle—and they were now audible in my receiver in Newfoundland!

Today, wireless telephony over world-wide distances is now a reality together with transmission of photographs and already we are entering the Television Era. It may even be that the transmission of power over moderate distances may be developed in the not far distant future. I must leave to your imaginations the uses which can be made of these new powers. They will probably be as wonderful as anything of which we have experienced so far.



The Newfoundland stamp commemorating Marconi's success.

RADIO'S "OLD MAN OF THE SEA"

(Continued from page 536)

tion of interference, at the time a complaint was first lodged against the Long Island Railroad for maintaining a prolific source of radio interference, a survey was made by the Public Service Commission and the inspector found that out in the open country and at a distance of less than 7 miles from WEAF's transmitter at Bellmore, L. I., WEAF, key station of the National Broadcasting Company, was completely blanketed at a distance of 600 ft. from the railroad!

A prevalent source of local radio interference is the neon sign, particularly if it is blinking, or if the glass tubing has a heavy coat of dirt where the wires come out of the tubing. As a rule the noise emanating from these signs can be eliminated by a thorough cleaning.

Often times the use of special aerials, if they are properly installed, will reduce the interference. But this is just putting the cart before the horse. The proper place to work is at the source of the interference.

Diathermy machines, which are finding increasing use in doctors' offices and hospitals, have been heard over a distance of 7,000 miles and can completely disrupt reception in a community. There are instances in the Metropolitan area, on the other hand, where proper filtering has been so adequately accomplished that the tenants in the same apartment building were not aware when the diathermy equipment was in operation!

At present, in the Metropolitan area of New York, which is no different from populous areas in the rest of the country, there is no modern radio set that doesn't experience some avoidable

interference. Owners of one-half of the better-grade sets in New York City have legitimate cause to complain of interference with reception from the 4 high-power broadcast stations in the area.

The wide-awake Service Man will do well to buy or build a portable receiving set which will enable him to track down sources of interference, and acquire as much knowledge as he can as to the many types of interference that can be eliminated at a very small cost. For ordinary requirements the writer has found that a car-radio set or a midget battery set with self-contained current supply is quite adequate, since a loop antenna is not needed for such service.

Radio men will be interested to know that the increasing hue and cry of listeners-in has resulted in the formation of a national organization that plans to do, with the strength of "union," what individual effort could not achieve in combatting "Old Man Static."

This organization, the National Association for the Prevention of Radio Interference ("NAPRI") already has received wide and enthusiastic support. Public officials, broadcast network executives, wholesale and retail organizations, Service Men, the experimental fraternity, and the entire lay public have evidenced keenest interest in the progress that has so far been made.

Radio-Craft readers who may care to have NAPRI take up the cudgel against some particularly objectionable form of man-made interference in their own locality may write to NAPRI in care of Radio-Craft.

Please Say That You Saw It in RADIO-CRAFT

INTERNATIONAL RADIO REVIEW

(Continued from page 528)

position to face directly toward a person sitting in an easychair. The cabinet itself is low and is supported on short legs, for the same reason.

It will be noticed in Fig. A that the number of controls in this receiver have been reduced to 2. on the front panel! These are the only controls which need adjustment after the set has once been placed in operation, according to the description in *Radio Amateur*.

The cathode-ray tube in this set is approximately 12 ins. in diameter, producing images about 9 ins. square.

AN ITALIAN ALL-WAVE TUNER

EXTENDED-BAND—or as they are more frequently called, all-wave—tuners have been made in a great variety of forms. Every designer has his own ideas of how to keep the leads short and the coils free from mutual coupling or coupling to grounded metal parts which reduce their over-all efficiency.

The latest issue of *Radio Industria* (Milan) showed an example of how Italian engineers consider the job should be done. A metal frame is secured to the waveband switch and the coils for the various bands are suspended between the two ends of the frame. The long-wave coils are universal-wound while solenoids are used for the short-wave bands (See Fig. B.).

This method of mounting keeps the leads short, and since the coils not in use are short-circuited, the losses are kept at a minimum.

AIR-DIELECTRIC TRIMMER

AIR-INSULATED trimmers, similar in principle though somewhat different in mechanical structure to the American units of the same type, have made their appearance on the markets in France, according to *Toute la Radio* (Paris).

These trimmers, which come in 2 sizes (as shown in Fig. C) for trimming I.F. and R.F. circuits, are products of that Dutch organization—the Philips Lamp Company. They consist of interleaving open-ended cylinders of metal which are moved into and out of the meshed position by means of a screw. Their advantage is in reduced losses and stability of setting which prevents the "drift" often encountered in short-wave receivers of the superhet. type.

THE "LONG ARM"

A WELL-KNOWN manufacturer of radio speakers, in England, has recently placed on the market a remote-controlled speaker cabinet for use with any radio receiver. The speaker can be placed wherever desired in the house, away from the receiver itself, and the set can be turned on or off as desired. The volume at the reproducer can also be changed to suit the program and room conditions, independent of the volume of the sounds emanating from the speaker in the radio set (which may be located elsewhere).

This deluxe-type remote speaker, shown in Fig. D, was described in the latest issue of *Wireless Retailer and Broadcaster* (London).

The installation of the "Long Arm" includes the speaker cabinet itself and a small control box (which evidently contains relays etc.) for turning the set on and off from the combined remote speaker switch and volume control.

SIMPLIFIED TUNING

THE DIFFICULTIES of tuning and recording short-wave stations on the ordinary radio receiver are obviated in one new English radio receiver by means of a giant dial which is mounted on the inside of the hinged lid! The set is a combined phono-radio and the turntable as well as the tuning knob, volume control and wave-band switch knob are located on a recessed horizontal panel which is exposed by raising the lid. See Fig. E.

The dial is quite large, so that the pointer position can be seen and recorded with much greater ease than with the ordinary all-wave set dial. This set was shown in a recent issue of *Practical and Amateur Wireless* (London).

They say "It's tremendous!"

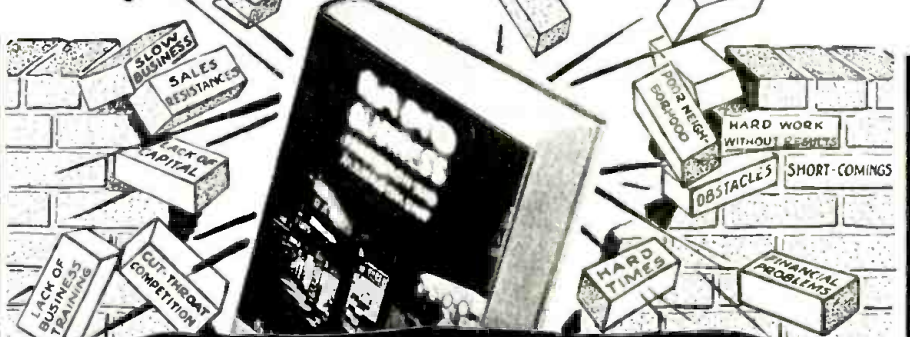

CRASH THROUGH TO BUSINESS SUCCESS WITH THIS GREAT BOOK OF EXPERIENCE!

RADIO BUSINESS Promotion and Management

By A. A. GHIRARDI and T. S. RUGGLES

This remarkable new book will put money in your pocket! The business-building Ideas—Plans—and Methods it gives you have been proved thoroughly sound, practical and successful. They'll work for YOU as they have for others!

Think of it!—here between the covers of one big book you get the cream of the business experience of the country's most successful radio organizations.

This book tells you HOW!

All this experience is applied to your own business. This great book tells you just exactly WHAT to do and HOW to do it. It covers every phase of your business. Tells you how to start a radio business. How to run one efficiently and profitably. How to promote it through order-pulling advertising and sales methods. Not with theoretical "book-talk", but with actual examples you can put right to work today! Examples of successful advertising, sales talks, business methods—publicity stunts, merchandising tricks, etc., etc. Applies to sale of radio sets, servicing, Auto Radio, P.A. work and home appliances.

It's a hard-hitting, straight-from-the-shoulder book of facts you should know and ideas you should use in order to get the most out of your business. In 1937 and the years to come.

The first and ONLY book of its kind

No man can afford to pass up this "million dollars' worth of ideas and experience!" Send no money now. But be sure to send the coupon—or postcard—for a FREE CIRCULAR giving you full details. **And do it now!**

Over 400 Pages Over 200 Illus.

FOR DEALERS AND SERVICE MEN

WANT IDEAS? Here are

2,199

Pre-tested IDEAS on SELLING

Why people buy. Market analysis. How to get leads and prospects. How to get people into your store. Principles of selling. Store selling. Selling by phone. Outside selling—how to get by the door—following up leads. Selling talks. Sales resistances and how to break them down. Making business contacts.

ADVERTISING

How to plan your promotional program. How much to spend. Costs. How to write your advertising. Tested appeals. How to get action. Preparation and production. Forms of advertising—Display—Direct Mail—Newspaper—Broadcast—Phone book—Other Media. Publicity. Merchandising. Premiums. Contests, etc. Follow-ups.

BUSINESS METHODS

How to set yourself up in business. Shop equipment. Store layout. Managing the business. Employee and customer relations. Financial data. Cost accounting. Sales and service forms and records. House policies.

CLIP and MAIL

Today

Radio & Technical Publ. Co. Dpt. RC-37 45 Astor Pl. New York Please send me FREE CIRCULAR BB.

Name _____

Address _____

Free Circular

FACTORY-TO-YOU SAVES 50%

New **14-TUBE 5-BAND WORLD-WIDE RADIO**

\$39.95

14 TUBES FOR THE PRICE OF 8

EASY PAY PLAN

Write today for the new FREE 40-page catalog describing this bigger, better, more powerful radio. Over 40 advanced features! Glorious tone realism. Easy terms—1/2 a day. Money-back guarantee.

30 DAYS FREE TRIAL

MIDWEST RADIO CORPORATION
DEPT. K-12 CINCINNATI, OHIO

SPECIAL OFFER APPLIES ONLY TO MAIL ORDER.

HEADSET ADAPTER KIT

Now available a headset adapter kit providing "QUIET RADIO" reception with the minimum of expense and installation work.

Ideal for the bedside radio, providing reception with the least disturbance to others—the short wave fan will find it a great boon—and the hard of hearing will find a new world of sound.

Write today for complete information

TRIMM RADIO MFG. CO.
1770 W. Berneau Ave. Chicago, Ill.

Please Say That You Saw It in RADIO-CRAFT

Do You Want the HIGHEST Resistance Voltmeter?

(10 Megohms on all ranges)

Clough-Brengle MODEL 88 Vacuum-Tube Voltmeter

FREE

How to Use
the
Vacuum-Tube
Voltmeter

There is only ONE way to accurately measure voltage in high resistance circuits! Use the new MODEL 88 Combination Vacuum-Tube and Peak Potential Voltmeter. Three scales 0-1.2-10-100 volts, all draw absolute zero current from circuit under test. Over ten times the input resistance of other HIGH resistance voltmeters.

Send for FREE booklet just off the press, giving test procedure for over fifty important measurements such as: r-f and a-f stage gain, checking pre-selector and oscillator stages, matching coils, impedance measuring, amplifier gain, and response curves.



Send a copy of the new C-B Application Bulletin, "Use of the Vacuum-Tube Voltmeter in Receiver and Amplifier Servicing."

Name

Address

Ask your jobber to demonstrate

The CLOUGH-BREngle CO.

2809 W. 19th St.,

Chicago, U. S. A.

New! Auto-Top Aerial for Turret Top Cars



U. S.
Pat.
97447

THE common sense aerial for steel top automobiles. Puts the aerial OVER THE TOP where it belongs. Outstanding performance, plus keen streamlined appearance—highly polished aerial—semi-round—die formed like decorative body trim—mounted on top of rubber vacuum posts—carries center trim line of hood, windshield, and rear window right over top of car. Extremely efficient—not damaged by weather—works in rain, ice and snow anywhere, anytime. Steel car top shields against interference from ignition and lighting. Easy to install—shipped straight, no kinks—no holes to drill in top—easy on car finish. A fast seller—users like the smart appearance—greater volume—more distance—and reduced noise.

SOLD BY LEADING JOBBERS. \$3.85

RADIO SERVICE MEN—If your jobber can't supply you send his name for COMPLETE INFORMATION and SPECIAL INTRODUCTORY OFFER. Write today. Be the first to show Auto-Top, the perfect auto aerial. Clean up before the others wake up.

WEDGE MANUFACTURING CO.
2336 S. Michigan Avenue, Chicago

See Page 516 for Complete Details on the 1936 Official Radio Service Manual

DIRECT COUPLING IN A 30-W. BEAM-TUBE AMPLIFIER!

(Continued from page 534)

"Trigger action" was the term then applied to the action of the amplifier which "blocked" and became inoperative when a very strong and maintained signal was fed into its input. This effect was caused by a surge in plate current which in turn affected the grid-bias voltage (lowered it) so as to throw the bias off its normal Eg-1p curve and maintain itself in this blocked state. Naturally, the amplifier was inoperative during these periods and had to be "shut off" in order to release the trigger action. This effect is now avoided in a new amplifier (to be shown pictorially and by diagram in a forthcoming Part) utilizing a stabilized, 2-phase rectification system. (The innovations of this sound system are outlined in Table I.)

The fact that the original circuit was single-tube-ended (at a time when the advantages of push-pull were well known) proves that a suitable push-pull output circuit was not of simple design. After the circuit had gained in popularity, many attempts were made later on, with varying degrees of success, to convert the single-ended (1-output-tube) amplifier to one of the push-pull variety.

None were really perfect and few lived up to their anticipated performance. The reason for this is now evidenced in the faulty phase-inversion systems attempted. As all of these inverter systems used a coupling condenser, true inversion did not take place at all frequencies and amplitudes.

Critical adjustments were particularly annoying to the many experimenters who first attempted to build the amplifier because (1) no special attention was paid to the regulation of the power supply or (2) compensation for variations in plate current of different power-output tubes. These 2 factors contributed greatly to the unjust condemnation of this really revolutionary high-fidelity circuit.

Because of the tremendous advances made in modern amplifier engineering it becomes a relatively simple matter to design a 2-phase, stabilized, bridge-type rectifier capable of supplying a fixed voltage to a 3-stage non-reactive-coupled amplifier utilizing a non-reactive signal divider (this is not to be confused with the conventional type of phase inverter) which drives two 6L6 tubes in true push-pull fashion.

In order to simplify the discussion of this new type of circuit, each basic portion will be treated individually.

ANALYSIS OF THE RECTIFIER SYSTEM

Before explaining the action of the stabilized 2-phase rectifier system, perhaps a brief review

of existing rectifying systems will clarify its operation.

If one end of a single winding is grounded (Fig. 1A) and an A.C. voltage plotted from ground as the reference point the curve shown in Fig. 1B would result. If this single-phase voltage is rectified as in Fig. 1C only half of the wave is passed through the rectifier and its plotted output approximates Fig. 1D.

If this same coil is center-tapped and grounded at this point (Fig. 1E) and voltage plotted from ground to both extremities the 2-phase voltage of Fig. 1F would result. The dotted lines are used to indicate another voltage of equal amplitude but opposite in phase (180 deg. out-of-phase). If a conventional rectifier circuit be applied as in Fig. 1G, the resultant rectified voltage would approximate the curve shown in Fig. 1H. This is known as full-wave rectification but actually is a *single-phase* full-wave rectifier for the dotted curve, which represents a voltage 180 deg. out-of-phase with the voltage being rectified, is unused. This circuit will be recognized as the conventional rectifier arrangement.

If the coil in Fig. 1A has its upper terminal grounded as in Fig. 1I and a curve plotted of its voltage, it would approximate the one illustrated in Fig. 1J. If this single-phase voltage is rectified as in Fig. 1K, the resultant rectified voltage resembles the curve plotted in Fig. 1L. Here again, if the coil is center-tapped as in Fig. 1M, the same 2 phase voltages are present (Fig. 1N) as in Fig. 1F. By utilizing the full-wave circuit of Fig. 1O, complete rectification results of only one of the phases, and a rectified voltage is produced somewhat similar to the one illustrated in Fig. 1P. This full-wave rectifier circuit may be recognized by some as the conventional bias rectifier arrangement used in fixed-bias circuits. It will be noted that here, too, only one phase is rectified (the voltage indicated by a solid line is unused).

By utilizing the same coil (Fig. 1Q) with its 2 phase voltages (1R) and combing both rectifier systems of Fig. 1G and Fig. 1O into a 2-phase rectifier Fig. 1S, the resultant rectified voltage resemble the curves of Fig. 1T. Many will recognize this circuit as the conventional bridge-type rectifier.

In Part II, this consideration of the power supply will be continued, including practical circuits of the bridge arrangement. Further discussion of the amplifier will also be presented.

This article has been prepared from data supplied by courtesy of Amplifier Company of America.

Please Say That You Saw It in RADIO-CRAFT

THE CAPACITY METER AS A SERVICING AID

(Continued from page 534)

by the Service Man without means for capacity measurements. All in all, there is plenty of practical evidence that capacity measurement is no longer a secondary servicing requirement.

100 MMF. TO 200 MF.—DIRECT-READING!

The most logical answer to this growing requirement for rapid and accurate capacity determination appears to lie in the use of the direct-reading capacity meter, powered directly from a 60-cycle, 105-150 V. line, and covering a complete range of values from 0.001-mf. (100 mnif.) to 200 mf. Among the first to recognize the need for an instrument of this type were the manufacturers of condensers themselves. Consequently, the instrument as developed was of the fundamental type, equally applicable to paper, mica, air or electrolytic condensers, with an accuracy which exceeds by several times that of the condenser ratings themselves.

The low-range setting of the instrument permits measurements from 100 mmf. to 0.02-mf., thus covering practically all of the condensers of extremely low capacity in any modern receiver. Other ranges, available at the turn of a switch, include 0.01- to 0.2-mf., 0.1- to 2 mf., 1 to 20 mf. and 10 to 200 mf.

ACCURACY OF INSTRUMENT

Service Men sometimes ask: "Can an A.C. measurement of this kind give accurate capacity measurements on electrolytic condensers designed for high-potential D.C. circuits?" The question is a reasonable one, for such condensers are known to be affected by abnormal polarization effects under certain A.C. potentials. With the capacity meter described, however, all measurements in the capacity ranges above 0.1-mf. are made at a potential of but 4 V. Tests upon which the design of the meter was based confirmed the accuracy of measurements at this low potential on all types of wet or dry electrolytic condensers.

Essentially, the direct-reading capacity meter consists of a permanent-magnet movable coil type of indicating instrument, together with a copper-oxide rectifier and suitable network, adjusted for full-scale deflection at 250 micro-amperes.

The operation is based on the fundamental relationship between reactance at fixed frequency and the deflecting current, in a circuit of fixed resistance and potential. Reactance, in turn, depends upon capacity under fixed frequency conditions. Since the meter is powered from service lines closely regulated at 60-cycles per second for electric clock accuracy, then, the capacity of the condenser under test is the only variable causing deflection of the instrument pointer over the calibrated scale.

SECONDARY USES

Obviously, this same fundamental circuit will have equal capabilities as an A.C. voltmeter, simply by providing jacks for introducing an external potential across various fixed resistances correlated to voltage ranges on the scale. In the instrument described, ranges of 4-40-200-400 and 800 V. are provided, at a sensitivity of 1,000 ohms-per-volt. Thus the Service Man has at his command a double-duty instrument of wide flexibility. A self-contained condenser for blocking any D.C. component is connected through a separate pin-jack for use in output-voltage measurements when desired. In connection with the 0-4 V. range, this provides the Service Man with a spare output meter that can readily be brought into service when the shop's regular output meter is in use elsewhere.

This article has been prepared from data supplied by courtesy of Weston Electrical Instrument Corporation.



The fundamental scale of the capacity meter.

NATIONAL UNION AUTHORIZED BY JOHN F. RIDER TO OFFER MANUALS FREE



MR. JOHN F. RIDER,
Noted Author of Service Books



A necessity of modern service work is complete technical data on all makes of radio receivers. Mr. John F. Rider recognized this need years ago and compiled a great library of radio set circuits and information. National Union also knew how important service manuals would be. National Union decided that every service specialist in the country must have the chance to own the manuals compiled by Mr. Rider. National Union therefore makes it possible to get this library FREE. All seven volumes are given with the purchase of N.U. tubes . . . and N.U. is officially authorized by Mr. Rider to offer his great service library FREE. If you want any one or all of the Rider Service Manuals write now, ask how to get them or consult with your National Union distributor!

FREE SHOP EQUIPMENT TOO!

No need for the alert and aggressive service expert to read about all the fine scientific instruments which service equipment manufacturers are making and wish that he might own them. Why? He can own them! How? By getting them Free with the purchase of National Union radio tubes.

National Union has given servicemen throughout the United States more than 50,000 pieces of fine equipment. If you're not taking advantage of National Union's service dealer plan, you're miss-

ing the greatest opportunity in the radio industry today.

All you do is contract to purchase a few tubes per week, place a small deposit, which refunded to you after the tube purchase is completed and the instrument you have selected is yours "for keeps," without any strings attached. Meanwhile, remember that you have the use of the instrument all during the time tube purchases are being made.



ABOUT N. U. RADIO TUBES

National Union manufacturers a complete line of radio tubes in glass, metal and G type. National Union's high quality has made them the outstanding favorites in the radio service profession. All sales policies have been formulated with the idea of making National Union radio tubes the ideal replacement tube for the radio dealer. This has been backed up with a selling program that means real support and help to the wide-awake dealer. Dealers and jobbers handling National Union radio tubes are the leaders in repair parts and service.

NATIONAL UNION RADIO CORP., RC-337
570 Lexington Ave., New York City
Tell me how to get Rider Service Manuals and other free equipment.

Name

Street

City State

Two-Tube Short Wave \$3.00 Radio only

less tubes, phones, unwired
A REAL, powerful 2 tube short wave set that readily brings in amateurs, police calls, broadcast stations, experimental and foreign stations under far conditions. **THE WORLD AT YOUR DOOR!**
A DEPENDABLE RECEIVER which is guaranteed to give results. Operates entirely from the AC or DC house current. Simple to build and easy to operate. Beautiful, black shroud finished cabinet and instructions furnished. Wavelength range 10 to 600 meters.

TWO TUBE BATTERY SET.
less tubes, phones, batteries, unwired \$2.00
Kits wired, extra \$0.75. Tubes, each \$0.75
Cannonball double headphones \$1.35

FREE Catalogue of short-wave receivers and kits. Send for your copy.
EILEN RADIO LABORATORIES

Dept. RC-3, 136 Liberty Street, New York, N. Y.

New Du Mont Cathode Ray Tube TYPE 34XH TUBE

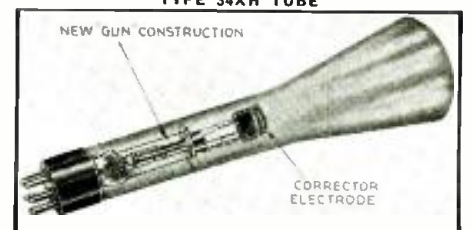

This new type cathode ray tube is the "heart" of RADIO-CRAFT'S new 1937 Television Radio Receiver. Everyone interested in Television developments is invited to write to ALLEN B. DU MONT LABORATORIES, Inc., Upper Montclair, N. J., for latest television tube developments.

Please Say That You Saw It in RADIO-CRAFT

LOUDSPEAKER BAFFLES AND CABINET RESONANCE

(Continued from page 532)

The purpose of the baffle is to so lengthen the front-to-back air path so that air displaced by the forward movement of the cone cannot reach the rear-vacuum at the rear until the "vacuum" has ceased to exist by virtue of the cone having had time to pull backward.

The baffle can be of anything from limburger cheese to paper—anything at all that will lengthen the air path from cone-center front to cone-center rear. It should be of some acoustically "dead" (non-vibratory) material, such as softwood, celotex or the like. If it is hard and stiff (or thin) it will vibrate in itself, which it should never do, for if the baffle vibrates, it contributes tones to reproduction which were not intended to be in it, thereby causing distortion.

There is a simple rule for figuring sizes of baffles to reproduce down to any desired frequency, below which however they will cut off rapidly. It is based upon the speed of sound traveling in air (1,130 ft. per sec., approx.) and the number of oscillations (complete neutral to forward to neutral to back, to neutral again). By this same "rule of thumb," we get the path lengths, for different low-frequency cut-offs below which our speaker will not reproduce, shown in Table 1.

*CUT-OFF FREQUENCY (IN CYCLES)	**LENGTH OF PATH (IN FEET)
100	5.65
60	9.416
40	14.125
30	18.83
20	28.25

(*Lowest frequency to be reproduced.
**Measured from front-of-cone center to rear-of-cone center.)

Remember that these are figures in feet for the shortest distance from the cone center at front to the cone center at rear. If our baffle is to be a flat, soft board 1 to 1½ ins. thick, we will need the air path lengths given in the Table in order to reproduce down to the frequencies given. If the baffle is a square, flat board with the reproducer at the center, then these figures are for size of the square baffle, since if the speaker is at the center, sound must travel half of each figure from front to baffle edge, and again this same distance around to the cone rear. (See Fig. 1B.)

Let us take 40 cycles as the lowest tone to be reproduced. On a 40-cycle note, the cone will move from neutral to forward, back through neutral to rear, and then to neutral again 40 times per second. It will take one-half this time, or 1/80-sec., to move from the front to the rear, so we want the baffle to delay the front sound 1/80th of a second before it is allowed to reach the rear, so that it will add to the rear

sound, and not cancel it out. If we now multiply the speed of sound in air, (1,130 ft. per second) by 1/80, we will get the path length that must be interposed between the cone front and cone rear in order for our loudspeaker to reproduce all tones down to 40 cycles. Then 1,130 divided by 80 gives 14.125, which tells us that the shortest path from speaker cone front to cone rear must be 14.125 ft. long if our speaker is to reproduce down to 40 cycles.

The baffle can be a box as well as a flat board, as in a radio cabinet. Thus, some of the edges of the baffle can be bent backward to save space. In this case the baffle area will effectively be the total distance from front to back, but still measured from speaker cone center around the *shortest side* of the cabinet, and back in to the speaker cone center at the rear.

Thinking now of your own radio cabinet, and measuring it you will probably find it smaller than the size given above, and you know, it gets down to below 100 cycles, maybe even to 60, yet the figures say it can't do it! How then is this seeming paradox accomplished?

The answer is that it reproduces frequencies below its own cut-off largely through cabinet resonance, or the resonances caused by the width, height and depth of the cabinet cavity in which the speaker is installed. If these resonances are sharp, as in a thin-veneer or entirely closed-in cabinet, "boominess" results. Thus it appears that cabinet resonance is not undesirable, as is usually thought, but is very necessary to low-note reproduction; this is true, but only if it is obtained from a solid, heavy cabinet, and in carefully regulated and controlled degree.

Our Information Bureau will gladly supply manufacturers names and addresses of any items mentioned in RADIO-CRAFT. Please enclose stamped return envelope.

PITFALLS OF THE RADIO SERVICE BEGINNER

(Continued from page 539)

make 3 round trips to the customer's home—one to get the set, one to return it, and one to tell the owner that he couldn't take out the squeal caused by the nextdoor neighbor who still enjoyed (?) a 1-tube "whooper". Also he could mark up 50¢ shop overhead for the job.

Fine—"step up the gain" on the calculating department of the upper story and we find we have:

Total receipts \$7.00
Total costs 6.82

Profits \$.18
WATTA LIFE — WATTA LIFE!

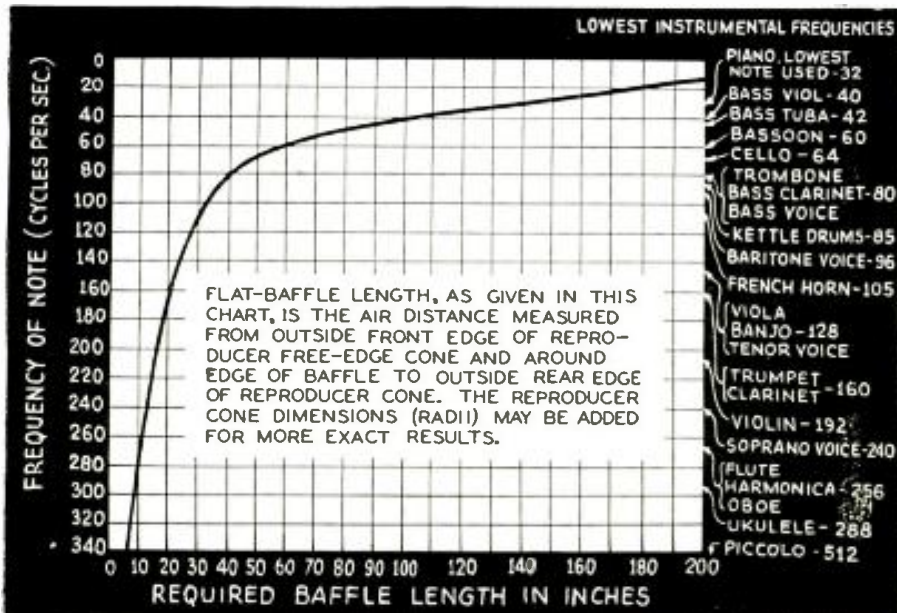

Fig. 2. Note how, without taking into account the bass-emphasis effect of a cabinet, good low-note reproduction requires large-flat-baffle length. (Redrawn from RADIO-CRAFT Library Book No. 8—"Radio Questions and Answers"; originally compiled by A. A. Ghirardi for RADIO DESIGN magazine.)

Please Say That You Saw It in RADIO-CRAFT

BIG FREE ELECTRICAL BOOK TELLS YOU HOW

MANY TRAINED MEN EARN \$30-\$40-\$50 A WEEK AND MORE IN Electricity

YOU TOO can train for a BETTER JOB and MORE MONEY IN ELECTRICITY

Do you want a BETTER JOB—MORE MONEY and a future free from Job Worry? Then send for my big free Electrical Book Today and learn the FACTS about the amazing opportunities in Electricity—AND—how this new modern, up-to-date Practical Home Shop Training can help you qualify for these opportunities.

PRACTICAL SHOP TRAINING ON REAL ELECTRICAL EQUIPMENT AND APPARATUS—RIGHT IN YOUR OWN HOME

"Learn-by-Doing" becomes a fact with this fascinating, new, modern, up-to-date Practical Home Shop Training in Electricity. With your instruction material, you get Electrical Equipment, Apparatus, Tools and Supplies with which you learn to do REAL PRACTICAL WORK—just like you would do out on the job. Don't you agree that this is without question the most PRACTICAL Home Training in America?

OPPORTUNITIES TO EARN UP TO \$5.00, \$10.00 A WEEK AND MORE WITH SPARE TIME WORK WHILE TRAINING

Will you how to DO these jobs, find real electrical equipment and many of them, and give you valuable Sales and Advertising helps to show you how to Sell Your Services. In fact, it should take only one or two small jobs a month to more than make the training PAY FOR ITSELF.

TRAINING IN RADIO, REFRIGERATION, AIR-CONDITIONING, DIESEL ELECTRIC POWER and MANY OTHERS INCLUDED

My book also tells how E. I. Training helps YOU to INCREASE YOUR EARNING power still more by including training in these big, important branches of Electricity. Each one practically an industry in itself—each one a complete field—yet you get all of these and more in E. I. Practical Home Shop Training.

GET INTO A GROWING FIELD FOR A BIG PAY FUTURE

GET INTO ELECTRICITY—get into a field that is growing and expanding—get into a field where opportunities for REAL JOBS and REAL MONEY await the TRAINED MAN.

Naturally, to qualify for these jobs you MUST BE TRAINED. In fact you want the BEST, the most Thorough and Complete, the most PRACTICAL Training, money can buy. We believe E. I. Practical Home Shop Training To Be That Kind Of Training. But, we don't want you to take our word for it. We want you to judge for yourself the value of this new modern up-to-date Training method—where you learn on Real Electrical Equipment and Apparatus—right in your own home. So send for my Big Electrical Book TODAY for full information on this new easy, interesting and Profitable Practical Home Shop Training. Remember this book cost you nothing—puts you under no obligation and NO SALESMAN WILL CALL ON YOU.

SEND FOR THIS BIG ELECTRICAL BOOK FREE

H. W. Petersen, President
Dept. 157C, ELECTRIC INSTITUTE, Inc.
Hinsdale, Illinois

Send Free Book and full details of E. I. Home Shop Training.

Name.....Age.....
Address.....
City.....State.....

INVESTIGATE - GET THE FACTS

Practical Shop Training on REAL Equipment

E. I. Training in DIFFERENT Branches will get you Real Electrical Equipment, Apparatus, Tools and Supplies to work on. This material comes to you as a regular part of your training at NO extra cost.

"Learn By Doing" in Your Own Home

With this big outfit of equipment you perform many interesting experiments, conduct important tests and do many real Electrical jobs, to make your training easy, interesting and PRACTICAL.

Use Equipment for Many Money Making Jobs!

A great deal of this equipment can be USED in doing many profitable spare time jobs, profitable because you will have no expense for the material used. My big free book tells you more of this valuable feature of E. I. Training.

Your Own Electrical Shop

This equipment comes to you throughout your entire training, starting the very DAY you enroll, so that as you progress with your training, you are building your own Home Electrical Shop with the Equipment, Apparatus, Tools and Supplies I give you.

Get this Interesting Valuable Book TODAY!

Doesn't what I've told you sound interesting? Isn't it worth investigating? Ask yourself, could any method of Training be more interesting or profitable to the ambitious man or woman anxious to get into the BIG PAY field of ELECTRICITY?

Send for this Interesting Valuable Book TODAY!

SEND FOR THIS BIG ELECTRICAL BOOK FREE

THE MUCH-ABUSED BALLASTS FOR A.C.-D.C. RADIO

(Continued from page 543)

prong connections! Some manufacturers have gone so far as to purposely change the prong connections of the ballast so that ballasts now on the market would short across the line or short the line across the pilot light resistors, and in that way burn out some part of the ballast! This is something that Service Men will have to look out for—and the only way out is for them to be guided by a good replacement chart.

If ordinary resistance wire is used in the ballast, the amount of wire must be changed, depending upon the number of tubes in the set. This, therefore, would require approximately 10 different "ballasts" using ordinary resistance wire to take care of the variation in total tube voltages.

It is really incorrect to call units using either nichrome or ordinary resistance wire "ballasts." A real ballast resistance is one whose resistance changes very rapidly with small changes in current.

If a real ballast is used and the sets wired uniformly, the number of ballasts required for A.C.-D.C. sets could be reduced to practically one each for total filament voltages of 15 to 40 V.; 40 to 75 V.; and 75 to 105 V. The resistance of the amperite automatically varies to make up the variation in line voltages as well as the variation in the number of tubes used (Fig. 1B.). For example one such ballast can be used for any set having a total tube filament voltage of 40-75 V. This practically takes care of most A.C.-D.C. sets. As shown in Fig. 1A the voltage drop across the amperite itself varies from 30-80 V., taking care of a variation of 50 V.

Circuit details series A to D in Fig. 1 show the various arrangements in pilot light combinations used in most A.C.-D.C. sets.

By putting two pilot light resistances in the ballast, as shown in Fig. 1, series D, it could be used for either 1 or 2 pilot lights. The same ballast can of course be used without pilot lights. If not used, the small pilot light resistances will make no material difference in the circuit. The same amperite could therefore be used for (a) none, (b) 1 or (c) 2 pilot lights and for a set having a total filament voltage of 40-75 V.

A series of octal-base ballasts are numbered K42A, K42B, L45A, etc. The A, B, C, or D refers to the wiring diagram of pilot lights as shown in the series in Fig. 1. The K refers to 0.150-A. pilot light and L to 0.250-A. pilot light. Center number refers to the voltage drop across the ballast.

The amperite KL45 for example is designed as shown at D of Fig. 2 and will take care of either the A, B, C, or D arrangement, and any set with a total filament voltage drop between 40 to 75 V. It will therefore replace any octal-base ballast starting with K or L, ending with A, B, C, or D and having a center number of anything between 40 and 75.

The unusually low resistance of the 6 V. tubes causes an unusual surge when the set is first turned on. In order to eliminate this surge the amperite regulator (see photo) is equipped with a patented starting resistance which allows only approximately 70 V. on the set when it is first turned on, and is automatically shorted out when the tubes warm up. It is an ideal combination since it starts the tube at a low voltage, takes care of any voltage variation of the line from 90 to 135 V. and also takes care of variation in the number of tubes in the set.

This article has been prepared from data supplied by courtesy of Amperite Corporation.

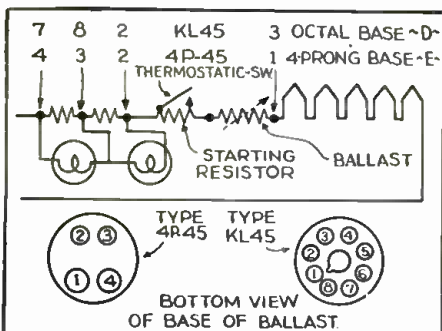
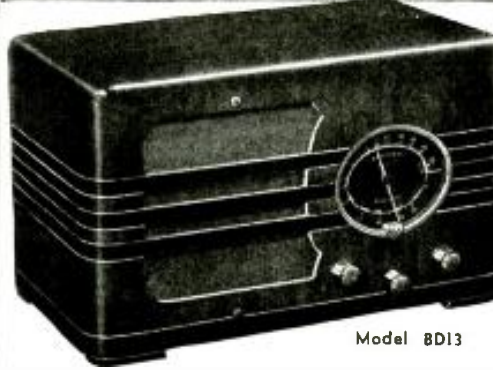

Fig. 2. Circuit details for KL45 Amperite.

YES! WORLD-WIDE Reception YEAR ROUND Enjoyment



Model 8D13

Lafayette 5-TUBE A.C. 2 BAND SUPERHET

YOUR MONEY BACK . . .

if this LAFAYETTE 2 band AC superhet. doesn't give you double the THRILL—and double the

VALUE!—of any other similar set on the market, BAR NONE. Modern, simple lines . . . polished walnut cabinet . . . new oval shaped illuminated dial. Outwardly a masterpiece of the radio designer's art. Inside, a triumph of LAFAYETTE engineering! REAL "in-the-studio" reception . . . American, Foreign and Short-Wave broadcasts at the twist of the dial! No wonder we say—Try this set in your OWN HOME—FOR A 30 DAY FREE TRIAL. NOW! CONVINCE YOURSELF! CLIP COUPON BELOW!

ONLY \$14.50 Model 8D13

COMPLETE WITH TUBES, CABINET ETC. NOTHING ELSE TO BUY.

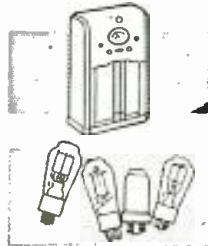

LAFAYETTE RADIOS Every LAFAYETTE Radio carries the guarantee of a great name backed by a quarter of a century of leadership in its field. From the 4 tube midget to the 24 tube giant, each model presents a distinct value to the radio buyer. All carry the 30 DAY FREE TRIAL OFFER. YOUR MONEY IMMEDIATELY REFUNDED IF NOT SATISFIED!

PARTS AND TUBES The great WHOLESALE Catalog is crammed with more than 50,000 radio items. Everything you need in radio at unbeatable prices. Enormous stocks of special items always on hand. Get prompt delivery of your special parts at WHOLESALE. Five fully stocked branches, Teletype-connected, assure you of prompt delivery. Always remember . . . WHOLESALE WILL NOT BE UNDERSOLD . . .

USE COUPON FOR YOUR RADIO ORDER BLANK

SEND FOR THIS FREE 156 PAGE CATALOG LISTING 10,000 RADIO BARGAINS

FREE CATALOG

WHOLESALE RADIO SERVICE CO.
NEW YORK N.Y.
100 SIXTH AVE.
CHICAGO, ILL. ATLANTA, GA.
901 W. JACKSON BLVD. 430 W. PEACHTREE ST NW

MAIL COUPON AT ONCE

WHOLESALE RADIO SERVICE CO., INC.

100 SIXTH AVENUE, NEW YORK, N. Y.
or 911 W. JACKSON BLVD., CHICAGO, ILL.
Please send me FREE Catalog No. 65-3C7.
Enclosed find check money order for model 8D13 Receiver.

NAME

ADDRESS

CITY STATE

To Readers of RADIO-CRAFT

FREE POSTCARDS MAY BE HAD UPON WRITING TO THE PUBLISHERS

These post cards make it easy to answer advertisements which appear in RADIO-CRAFT, without cutting valuable data which you may wish to save.

Many times manufacturers request you to "clip the coupon" when answering their ads. Often this means destroying part of an article on the reverse page you may need later for reference. Save your RADIO-CRAFT issues complete. If you should ever want to sell bound volumes, or certain copies of RADIO-CRAFT, the resale value of uncut issues is very much higher than that of mutilated ones. So send for a supply of these free post cards and use them in answering all RADIO-CRAFT advertisers.



Precision CAPACITOR ANALYZER

Capacity, power factor, leakage, resistance, directly on the panel. Highly sensitive No. 6E3 cathode ray tube used for balancing. Dials color-coded to match settings. A refined and extended Wien bridge, instantly usable in shop and field. Two models, low priced.

QUICK as a WINK! write for full details

SOLAR MFG. CORP.
599-601 BROADWAY NEW YORK CITY

Please Say That You Saw It in RADIO-CRAFT

MORE FEATURES FOR LESS MONEY

IN THE MODEL 409 DEPENDABLE POCKET-SIZE MULTITESTER

COMPLETE WITH BATTERIES \$9.95



The only pocket-size instrument with all these large-size tester features

Sensitivity of 2000 ohms per volt
 ● Microampere Range ● Ampere Range ● Ohmmeter with high range of 1,000,000 ohms with self-contained batteries ● Ohmmeter with low range reading 5 ohms at center of scale and 1/10 ohm for each first ten divisions ● Twelve meters in one compact tester with many advantages described below ● Accuracy within 2% . . . D'Arsonval meter with knife-edge pointer.

Four Range Voltmeter
 0-5/50/300/1000 volts
 Five Range Current Meter
 0-5/50/300 milliamperes
 0-550 microamperes
 0-5 amperes

Three Range Ohmmeter
 0/500/50,000/1,000,000 ohms.

Special design eliminates external leads for balancing ohmmeter circuits on all ranges

Also in "Build-Your-Own Kit" form - \$8.50

Model 6018 AC converter unit provides all voltage readings at AC - \$3.95

Compact to fit snugly along side of 408, panel size 1 1/2" x 3"

See Your Jobber
 Write to Dept. C for Catalog

RADIO CITY PRODUCTS CO.
 88 PARK PLACE NEW YORK CITY "DEPEND ON DEPENDABLE"

TERMINAL introduces

A REAL BUY!



The TERMINAL Junior Cathode Ray Oscilloscope is portable and complete for the serviceman and amateur. Suitable for:

- Analysis of wave forms.
- Visually determining the amount of distortion in A.F. amplifiers.
- Seeing percentage of modulation in x-mitter.

Complete kit contains cabinet, chassis, panel, all parts, including special power trans. \$11.95 former

Tube kit contains 1-913, 1-885, 1-606 and 1-80 \$8.45

Write to Bill Filler for complete information!

TERMINAL RADIO CORPORATION
 80 CORTLANDT ST., NEW YORK, N. Y.

HOW TO MAKE THE BEGINNER'S "BOOK-END 3"

(Continued from page 525)

Condenser C1 is the first section of the 2-gang variable condenser, with C4 the means of completing the circuit between condenser rotor (chassis connected via the frame) and the "B-" return for the L1 secondary. Units C5 and R2 provide means for controlling feedback and may be eliminated where a fixed adjustment for maximum regeneration and selectivity (without circuit oscillation anywhere in the tuning range) is desired and can be effectively attained. Potentiometer R2 might be simply called our *sensitivity control*.

Potentiometer R1, wired across the L1 primary, shorts the winding; and thus, by varying voltage applied to the control-grid of V1, functions as a *volume control*.

CONSTRUCTION

Two separate chassis are required, and these may be cut and formed individually from aluminum sheeting or obtained from a single, standard-size base measuring 8 x 6 x 2 1/4 ins. high, cut through as shown on the chassis layout diagram. If the one chassis is to be used, it may be punched and drilled before it is split in two.

All socket holes are 13/16 ins. in dia. For proper installation of the specified sockets they should be punched out with the special laboratory die, developed by the manufacturer of the sockets specified in the List of Parts, designed to cut a hole exactly sized for the retainer-ring-mounted sockets.

In constructing the power unit, the tone control (if required), the socket for the 25Z6, the socket for the cable plug, and the various filter components are first mounted. Condenser unit C14-C15 is placed above the chassis and C13 below; both units are fastened by one set of mounting bolts. Two small, right-angle brackets mount the loud-speaker.

Bring the 3-lead line-power cord through the hole in the back of the power unit chassis and connect the red wire to the switch, the black to the 25Z6 Nos. 3 and 5 terminals, and white (resistor lead) to the No. 7 terminal. The free switch terminal is connected to the "B-" point on the output socket and will be a convenient tie terminal for all "B-" connections (returns for C12, C13, field coil, C14 and C15) to be made in the power unit. The rectifier socket terminal No. 4 is wired to feed the field-C13 combination. The No. 5 terminal feeds the "B+" to filter choke Ch.2; the latter is wired for "B+" to the output socket. The reproducer voice coil is connected between the "B+" and the fourth terminal on the output receptacle. Place C17 wherever convenient.

In assembling the receiver unit, first mount the 2 sockets, then the volume and selectivity controls. Coil L1 is now placed under the chassis, open end upward, and bolted to the right-side wall by means of the assembly supporting the coil within its shield can. Coil L2, its open face pointed toward the 25A6 side of the chassis, is similarly mounted near the sockets. The 2-gang variable condenser is supported on the chassis, in some convenient manner, so that its shaft will align properly between the volume and

selectivity controls. (The shaft will probably have to be extended.)

A 4-lead cable, its length dependent upon the desired maximum separation, will be required for the connection between the two units. One end of it is connected to a male 4-prong plug, for power supply plug-in. The receiver-end leads are then traced for proper continuity, brought through the 3/8-in. hole near the antenna terminal strip cutout and wired as follows: "B-" to the 25A6 cathode or to a tie point; "B+" to the screen-grid terminal of the 25A6; output to the plate terminal of the 25A6; and, filament to the No. 7 terminal of this same tube. Anchor the cable solidly so that it will not work the socket terminals loose.

The No. 2 terminal of the 25A6 is wired to No. 7 of the 6K7; and No. 2 of the latter tube is then tied to "B-" to complete the filament circuit. A tie point is mounted near the antenna terminal to support C3. A lead is then brought to R1 and to the primary of L1; then the returns (arm and one end of the resistance) for (a) R1, (b) both primary and secondary windings of L1, and (c) the secondary of L2 made to "B-". DO NOT GROUND "B-" TO THE CHASSIS. And as for condensers C4 and C7, connect them *right* at the return points for the R.F. transformer secondaries. Use the two specified, even though they are electrically paralleled.

ALIGNMENT DATA

With R1 at the maximum-right position, tune for a signal. If signals are heard, back up R1 and align C1 and C2 at both high- and low-frequency ends of the tuning range by means of the variable condenser trimmers. If signals are not intercepted, recheck the wiring, and if you have a voltmeter test for "B+" voltage at the tube plates and screen-Grids. The voltage will (or should) be somewhere in the neighborhood of 100, with the screen-grid readings approximately that of the plates.

If following proper alignment the circuit breaks into oscillation or shows signs of instability, try increasing the size of R3 by 100 ohms or so. Do not make this resistor too large, however, as sensitivity will suffer—and if squeals and whistles still persist, check over C4 and C7. These two condensers have much to do with stability. Increase their size if necessary. And above all, see to it that they make good contact to chassis and that they are tied to the coils *right* at the secondary-return lugs.

If hum is in evidence, increase the capacity of C14 or C15 or both to 8 mf. If the hum can be traced to the reproducer, similarly increase the size of C13. In the laboratory model, 4-mf. units at all three points proved entirely adequate, with no hum trouble whatsoever experienced.

If the speaker hums just enough to prove that it is receiving proper excitation, or if about 100 V. can be measured across its field, and yet no "B" is measurable or the "B+" output is abnormally low, interchange the 4-to-8 terminal connections on the 25Z6. If the "B+" to the receiver jumps to normal and the field excitation disappears or drops off appreciably, the rectifier tube is faulty, one set of its output elements

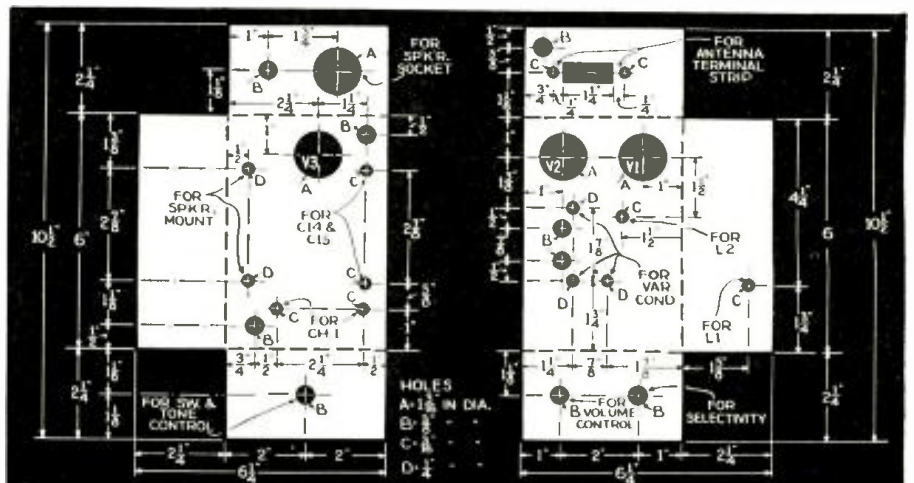

Fig. 3. Details of the two chassis needed for the "Book-End 3".

Please Say That You Saw It in RADIO-CRAFT

alone giving proper service. The author has found many of the 25Z6s troublesome in this respect. (WHEN BUYING THIS OR ANY OTHER TYPE OF METAL TUBE INSIST UPON FULL AND COMPLETE TESTS.)

With the receiver properly aligned and with all voltages correct and all tubes in operation, there should be little difficulty in picking up stations all along the tuning range and reproducing them at speaker volume. The R.F. tube, however, is working under fixed conditions affording maximum possible conductance. The volume control is across the input transformer primary, with its center or variable arm connected to "B-", and changes in the position of the arm effect changes in signal input only.

They do not effect changes in the mu of the 6K7. Consequently there may be cross-talk or running together of some stations, and in spite of the additional selectivity (additional to that afforded by the R.F. stage alone) given by the detector tuned circuit. Two tuned circuits—with the R.F. stage non-variable in gain—are particularly good on discrimination between signals of high power and close frequency.

So the next job, not only in the interests of increased amplification and a louder audio signal but also to give us the selectivity required, is to work in the regeneration feature.

INSTALLING REGENERATION FEATURE

First, unsolder the temporary connection between the 6K7 cathode and suppressor. Bring a lead from the cathode up to one lug of a 4-point tie strip. Mount C5 conveniently near and follow C5 out to the left-hand-taper potentiometer, R2. The R2 center arm goes to "B-".

Now for some trial and error experiment. The L1 coil core is not very large in diameter. As a matter of fact it is only about 1/2-in. across. Consequently, our feedback coil must have a smaller diameter in order to fit inside. (In the laboratory model, here illustrated, such a coil was wound on a small celluloid core not much larger across than a lead pencil.)

No hard and fast "turns" rules will, nor can, be given for the feedback coil. Begin by winding the maximum possible number of turns along the length of your "tickler" (regeneration-coil) core, dropping the wound form into L1, and bringing the leads out to 2 tie points—one connecting to cathode, one to suppressor-grid. Adjust R2 for maximum selectivity (knob turned completely to the right), and turn on line switch Sw.1. If enough turns have been wound on the feedback form, the circuit will undoubtedly oscillate—a condition which we won't exactly want but which will serve at least to show us now that regeneration is being had. If no shrill carriers on signals is obtained just increase the number of turns. Or reverse either the position of the feedback coil or the lead connections.

With oscillation obtained, back off R2 slightly. The oscillating condition should disappear; if not, remove turns from the feedback coil until the circuit will break into oscillation only when the R2 knob is at extreme right-hand position.

Tune to a signal with R2 adjusted for minimum selectivity or regeneration. Move the variable arm to the right. The signal should grow definitely stronger and sharper. With the R2 knob turned as far to the right as possible and the circuit just under the point of oscillation—as indicated by increased noise level between stations—tune across the band. Signals will come in sharply and clearly.

LIST OF PARTS

- *One shielded, midget antenna coil, type 2436, L1;
- *One shielded, midget R.F. coil, type 2437, L2;
- One Wholesale Radio Service or Allied Radio Corp. 2-gang variable condenser, 370 mmf. (max.) per section, C1-C2;
- One Aerovox condenser, type 284, 0.002-mf., C3;
- Three Aerovox condensers, type 284, 0.25- to 1-mf. (not critical), C4, C7, C17;
- Four Aerovox condensers, type 284, 0.1-mf., C5, C6, C8, C11;
- One Aerovox mica condenser, 250 mmf., C9;
- One Aerovox condenser, type 284, 0.006-mf., C10;
- One Aerovox condenser, type 484, 0.1-mf., C12;
- One Aerovox single electrolytic condenser, type PBS2, 4 mf., C13;
- One Aerovox dual electrolytic condenser, type PBS-2, 4-4 mf., C14, C15;
- One Aerovox condenser, type 284, 0.05-mf., C16;
- One Electrad potentiometer, type 201, 15,000 ohms, R1;

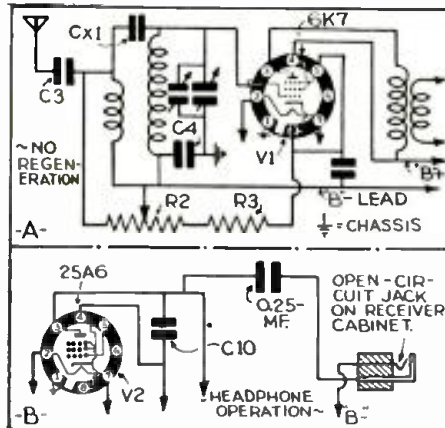

Fig. 4. The tuner without regeneration and (B) connecting a phone jack for DX.

- One Electrad potentiometer, type 278, 5,000 ohms, R2;
- One Continental resistor, 500 ohms, 1/2-W., R3;
- One Continental resistor, 1 meg., 1/2-W., R4;
- One Electrad potentiometer, type 241, 30,000 ohms, R5;
- *One resistor-line cord, 160 ohms, R6;
- One switch (on Electrad 241 potentiometer; or, *rotary S.P.S.T.), Sw.1;
- *One length 4-wire heavy-duty shielded cable (desired size);
- *One 5-in. dynamic speaker, equipped with output transformer for 25A6, 3,000-ohm field;
- *One choke, type 466-420, Ch.1;
- One Allied Radio Corp. aluminum chassis, size 6 x 8 x 2 1/4 ins. (or 2 pieces of aluminum sheeting; see layout data);
- One National Union type 6K7 tube, V1;
- One National Union type 25A6 tube, V2;
- One National Union type 25Z6 tube, V3;
- *Three sockets, type S8, for V1, V2 and V3;
- *One socket, type S4 (used as "output" socket);
- *One chassis plug, type CP4;
- Miscellaneous (direct-drive dial, pointer knob, 2 round knobs, hardware, etc.).
- *Names of manufacturers will be sent upon receipt of a stamped and self-addressed envelope.

HOW TO MAKE A SNOW LOUDSPEAKER

(Continued from page 526)

easily be obtained.

The method of making the horn (shown as the cover illustration of this issue) is to secure a piece of ply-wood about 1/2 or 3/4-in. thick and about 5 1/2 ft. long x 4 ft. wide. A pattern is then marked out on the board, following the dimensions given in Fig. 1. This form is then cut out of the board, using a coping saw, and making a sharp point on the narrow end as shown.

A large pile of snow is then made by rolling a ball of snow around until it "grows" to about 5 ft. in diameter.

Next, the small pointed end of the exponential-shaped board is pushed into the snowball and rotated until a cone-shaped hole is cut through the middle of the ball. Finally the inside of the "cone" is smoothed by hand and an 8 in. dynamic speaker is placed against the small opening (at the back of the snowball), using waxed paper or cloth to separate the speaker unit from the snow so that the moisture will not injure it.

In large P.A. installations—as for example at a large skating rink—a number of snow speakers can be made and connected to a radio set and P.A. amplifier of suitable size.

The latter units can be operated from storage batteries or from a 110 V. line (if one is available for lighting purposes, etc.).

The use of snow speakers at such outdoor affairs attracts a good deal of interest; produces fine quality of reproduction; and is very appropriate for such outdoor winter gatherings as ski jumps, skating rinks, hockey games, toboggan slides, winter carnivals or at any place where people gather in the open during the "snow months."

Please Say That You Saw It in RADIO-CRAFT

Learn RADIO from REAL RADIO ENGINEERS!



- Kendall Clough
Chief Engineer,
Clough-Brengle Co.
- E. E. Gramer
Chief Engineer,
Standard Transformer Co.
- Karl E. Massel
Chief Engineer,
Zenith Radio Corp.
- F. M. Schnell
Radio Engineer,
Grunow Radio
- Dr. C. M. Blackburn
P. R. Mallory & Co.

Train Now at Home for Good Pay Spare-Time and Full-Time Jobs that Pay Up to

\$75 a Week

If you're dissatisfied with small pay—and an uncertain future—here's an opportunity that's too good to miss. Get my big brand new FREE book, "RADIO'S FUTURE AND YOUR OPPORTUNITY." This book tells how you can learn at home under the supervision of factory engineers, to make more money almost at once in Radio—how to make Radio your life's work, or use it to pick up \$5 to \$20 a week extra in your spare time.

MORE OPPORTUNITIES THAN EVER BEFORE

Radio is still forging ahead, 1936 beats all other years. Over 6 million new sets sold. Over 30 million dollars paid for service alone this year. Where only a few hundred men were employed a short time ago, thousands are employed today. And where a hundred jobs paid up to \$75 a week—there are thousands of such jobs today—many paying even more. New full time jobs and spare time jobs are being created all the time. Get my book and see how easy you can get started.

"SHOP TRAINING" FOR THE HOME

R-T-I Training is different. It comes to you right from the heart of the Radio Industry—right out of the factories where Radio sets and other vacuum-tube devices are made. It was planned and prepared and is supervised by big radio engineers IN these factories—by men appointed for the purpose. R-T-I will train you as the Radio Industry wants you trained.

TELEVISION, PHOTO ELECTRIC CELLS, PUBLIC ADDRESS SYSTEMS INCLUDED

Radio service work is plentiful but it's only the starting point in R-T-I Training. From there you'll go through the whole field of Radio and Electronics. You will learn about every new development, including Television so you'll be ready when Television breaks.

MAKES \$600 IN ONE MONTH

Herbert B. Thomon, German, Texas, started making money with 12 lessons, finished. He says, "Because of my R-T-I Training I made \$450 in September and over \$600 in October 1935. It pays to be R-T-I Trained."

BIG MONEY IN AUTO AND POLICE RADIO WORK

W. H. Carr, 402 N. 16th St., Kansas City, Kans., R-T-I student, has charge of 35 radio equipped Police and Fire Department cars. He gets \$230.00 a month and free auto, gas, oil, etc. He says, "If I had not taken your course I would not be able to hold this job."

4 WORKING OUTFITS FURNISHED

Start almost at once doing part time radio work. I furnish 4 outfits of apparatus that you build into test equipment with which you can do actual jobs and earn extra money. My Training pays its own way and you get your money back if not satisfied. Age or lack of experience is no handicap.

FREE BOOK

Find out why R-T-I Trained men get "Quick Results" and "Big Results." Send for "Radio's Future and Your Opportunity" today. It tells about Radio's amazing opportunities. It describes my approved training, what R-T-I students are doing and making. It gives the names of 50 firms who endorse and recommend R-T-I. It's FREE!

RAY D. SMITH, President
RADIO AND TELEVISION INSTITUTE

Dept. 223
2150 Lawrence Ave.
Chicago



MAIL COUPON FOR FREE BOOK

RAY D. SMITH, President
Radio and Television Institute (R-T-I)
2150 Lawrence Ave., Dept. 223, Chicago, Ill.

Without obligating me, send me FREE Book about spare-time and full-time Radio opportunities and how I can train for them at home.

Name

Address

City State

MARCONI-E.M.I. HIGH-DEFINITION TELEVISION AT ALEXANDRA PALACE

(Continued from page 526)

mark and pleasure resort for more than 60 years—and from the large bay windows of the upper offices, below the aerial, nearly all London can be taken in at a glance.

Surmounting the reconstructed east tower, itself 80 ft. high, is the tapering lattice mast, rising to a height of 220 ft. Thus the aerial array for image transmissions, which is mounted at the summit of the mast, is more than 600 ft. above sea level. Immediately below the video aerial is the aerial for the accompanying sound transmissions.

The new station fulfills the recommendations of the Television Advisory Committee appointed to consider the development of television in Great Britain. Provision has accordingly been made for alternate experimental transmission by the systems developed by the Baird Television Co. and the Marconi-E.M.I. Television Co. respectively. Each company has provided a complete television system, including both image and sound pick-up apparatus and the television transmitter itself.

In its main essentials, therefore, the equipment comprises a television studio for each system, with an associated control room and ultra-short wave television transmitter; and, in addition an ultra-short wave sound transmitter common to both systems.

To these bare necessities, however, much has been added to provide, in the words of the Television Committee, "an extended trial of two systems, under strictly comparable conditions, by installing them side by side at a station in London where they should be used alternately—and not simultaneously—for a public service."

The entrance hall is at the base of the tower. Nearest to the entrance hall is the Marconi-E.M.I. television transmitter which, like its Baird equivalent, operates on a frequency of 45 megacycles (6.67 meters). All the apparatus at the station is finished in grey cellulose and chromium.

The Baird transmitter hall, with its control

panel and array of generators and amplification stages, is at the southwest end of the corridor. Beyond this, at the southwest extremity of the B.B.C. section of the Palace, is a large area, intended either for scenery construction or for televising such objects as motor cars and animals which cannot be brought into the studio or televised outside. Lorries can drive straight in. A large opening in the roof enables it to be lighted and, if necessary, televised from above. Lifting tackle can take up scenery and properties weighing a ton through a trap door in the roof of the second dock, 25 ft. above.

An interesting feature at this point is the ramp or sloping runway down which the television camera can travel to a concrete "apron", approximately 1,700 square ft., on the terrace outside, forming a platform for televising open-air performances or special experimental programs.

The two main studios, one for use with each of the television systems, are 70 x 30 x 25 ft. high. Acoustically, the studios are rather more "dead" than is general practice for sound broadcasting, since the introduction of scenery necessary for television will, in effect, control the acoustic characteristics. The walls of the studios are covered entirely, except for door and window openings, with sheets of asbestos compound which has a high degree of sound absorption. As this material has a rather rough surface, it is covered up to about 10 ft. from the floor with a protective fabric which is designed not to affect the sound absorbing properties of the compound. The ceilings of the studios are treated with building board, as commonly used in ordinary broadcasting studios. The floors are covered with black linoleum over which can be laid any type of flooring which may be required.

All the lighting in both studios is at present of the incandescent lamp type, using spot and flood lighting, on similar lines to that employed in theatres and film studios, but modifications are contemplated with developments in television technique.

ANALYSIS OF FIDELITY CONTROLS IN THE 1937 "SUPER PRO"

(Continued from page 529)

tween these two extremes is readily obtainable. Thus with the aid of a carefully engineered group of transformers and a special measuring instrument, the selectivity or band widths were both calibrated and the calibrations noted directly on the panel as 3, 4, 6, 10, 16 kc. The accuracy of this control is evident from Fig. 1. This curve was made with the input (at resonance) 1 microvolt, 30 per cent modulated at 400 c.p.s., with a 50-ohm resistor in series with each "A" post. The sensitivity was adjusted to produce a 6 milliwatt output with 1 microvolt input at resonance. The band width control was set as indicated on the curve. The signal frequency was set at 6 megacycles, the A.F. gain at 10. The band widths at two times the input or 6 db. down, are actually 2.6, 5.6, 9.9 and 15.6 kc., with settings of the band width at 3, 6, 10 and 16, respectively.

The A.V.C. system used is of the amplified and delayed type using the 6B7 as both amplifier and rectifier. A single tuned circuit link coupled to the primary circuit of the 4th I.F. transformer feeds it to the control-grid.

The audio components of the 6B7 second-detector diode circuit is capacitatively coupled to the A.F. gain control. This first A.F. stage is resistance-capacity coupled to the control-grid of the driver stage which uses a 6F6 in class "A". The output stage is a transformer coupled to the driver and consists of two 6F6s operated as triodes in class AB. A special curve was made for the fidelity of this receiver with the results shown in Fig. 2. The test was made with the input at 100 microvolts modulated 30 per cent from 30 to 10,000 c.p.s., with a 50-ohm resistor in series with each "A" post. The sensitivity was adjusted to produce 2 W. (4 V. across 8-ohm load) at a modulation frequency of 400 c.p.s. The A.F. gain was set at 10, and the signal frequency was 1,000 kc.

Taking the 6 db. loss as the cut-off point, it

is seen that the fidelity follows closely the settings of the band width control with settings of 3, 4, 6, 10 and 16. The "A F" cut-off occurs at 1,400, 1,750, 2,750, 4,800 and 7,500 cycles, respectively.

The sensitivity of the receiver was found to be so great that weak-signal response was limited only by the noise pick-up of the antenna system.

This article has been prepared from data supplied by courtesy of Hammarlund Manufacturing Co.

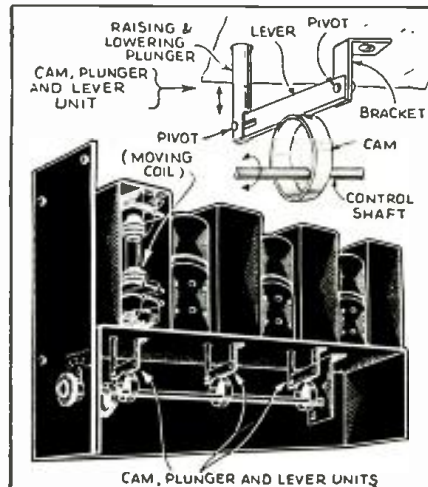

The mechanical method of controlling band width.



New Radio Developments Create a Demand for More Highly Trained Men

A pair of pliers and a screwdriver were all you needed to repair one of the old 5-tube battery sets... but today, with "Automatic Tuning, Focused Tone, Mystic Hand, Magic Brain, Telematic," etc. the serviceman must have adequate modern training to be able to competently diagnose and repair the complex troubles that the new receivers can develop.

ADVANCED TRAINING IN
RADIO SERVICE
AND PUBLIC ADDRESS
IS THE KEY TO SUCCESSFUL
SERVICING
TERMS AS LOW AS \$5 MO.

STUDY AT YOUR OWN HOME

Years of actual service experience went into the planning of this complete course for professional Serviceman. Available with or without Television. Start any time—take up to 3 years to complete. Low cost and easy terms available. Get complete details now!

WRITE TODAY FOR Free BOOKLET

the Key to SUCCESSFUL SERVICING

RADIO SERVICE INSTITUTE
 SUBSIDIARY OF CREI
 Dept. RC-3, 3308 14th St., N. W. Wash., D. C.

25-Pc. Radio Experiment Kit

Almost a "University in itself". Finest apparatus. Everything for scores radio hookups. Contains variable low-loss condensers, polarized test receiver, crystal detector, many SPECIAL special resistors, condensers, sockets, test clips, coil form, wire, bolts, screws, nuts, test sheet, etc. (Retail price \$15) **\$3.99**

FREE! 6 Books, value \$5.50, with kit. "Short Course in Radio", "Short Course in Electricity", "Electric Arc Manual", "Fun with Electricity", "Motor Transformer Manual", "Plans for Exper. Lab.", **ORDER NOW!** 3c Stamp brings Electrical-Radio-and-Tool bargain catalog!

ELECTRICAL SALVAGE CO., Box 524-A28, Lincoln, Nebr

"HAM" SPECIAL Standard Teleplex

A highly efficient code teacher using heavy specially prepared waxed paper tape, having two rows of perforations. Write for Free folder A3. We are the originators of this type instrument

TELEPLEX CO.
 complete course, all for \$11.95. Without Oscillator. 72-76 Cortland St., N. Y. C.

Please Say That You Saw It in RADIO-CRAFT

HOW TO MAKE THE RADIO-CRAFT-1937 TELEVISION RECEIVER

(Continued from page 531)

magnetic field will not affect the very sensitive electron beam in V12. The cathode-ray tube V12 is then fed with the full 1,200 V. with the free deflecting plates connected to the positive end of the power supply through resistor networks which permit adjusting the position of the "spot" in the center of the screen before sweeping it back and forth and up and down by means of the thyatron oscillators.

Thus far, we have the equivalent circuit of a cathode-ray oscilloscope—as used in the adjustment of radio receivers, etc. The sweep circuits, however, must be unusually linear as otherwise, the images will be distorted and bent by the curvature of the sweep circuits.

The sweep system finally chosen for both vertical and horizontal deflectors is the circuit developed by Mr. Allen B. Dumont and all credit is given to Mr. Dumont for it. The condenser which develops the sweep voltage is connected in series with the thyatron tube instead of the usual way of connecting it across the thyatron. The condenser is then discharged by means of the constant-current (pentode) tube. Thus instead of the condenser being charged through the constant-current tube and discharged through the thyatron, it is charged through the thyatron and discharged linearly through the constant-current tube. This produces a much more linear sweep, the back trace is more rapid and no distortion is caused by the synchronizing impulse applied to the grid of the thyatron.

Two of these sweep circuits are used in our unit. One of these—the horizontal sweep—operates at a rate of some 10,000 cycles, depending on the scanning frequency used at the individual transmitter being received. The other operates more slowly thus carrying the spot down across the screen of the tube at a frequency of some 60 per second, also depending on the number of frames being transmitted and the type of interlacing being used, if any.

This completes the description of our unit with the exception of the amplifier which is connected to the modulation- or intensity-control grid of the C.R. tube.

This amplifier must have an extremely wide frequency range in order to allow the extremes of light and dark to be shown in the images at the fluorescent end of the C.R. tube. Unusually good bypassing is required in all circuits and all wiring must be as short and direct as possible. Also, a good R.F. choke is important in the plate isolating circuit—to prevent the high-frequency response from falling off. These requirements are answered in the circuit shown.

It will be noticed that the sweep circuits and the amplifier are not connected across the full output of the power supply, but are connected from a resistor, R37, which places the chassis of the entire unit at a potential a few hundred volts above the negative end of the power supply unit. This limits the voltage applied to these tubes which are not designed to operate at the high voltage supplied by the power supply.

ADJUSTMENT

The first adjustment to make after the unit has been completed, checked and double checked is to adjust units R34 and R35 (focus and intensity controls) to the minimum position. This is the end which is nearest to the negative side of the power supply unit. Next, open one wire from each of the sweep condensers C10 and C43. This makes the sweep circuits inoperative and the power can then be turned on. Allow a few seconds for the tube to heat up, and turn focus and intensity controls up a little at a time until a light spot appears on the screen of the tube. Then adjust this spot until it is small and clear, but do not turn up the intensity too far or the screen of the tube may be burned.

After the spot has been focused, it may be noticed that it is off center a little. The centering controls R27 and R28 can then be varied until the spot is in the very center of the fluorescent end of the tube.

The power should then be turned off and condensers C40 and C43 re-connected into the circuit. Then, when the power has been turned on, a white blur will be seen on the end of the

tube instead of the spot which was noticed before. The intensity control can be turned up until the square of light is quite bright and the intensity controls of the vertical and horizontal sweeps can be varied until the white blur assumes definite straight-line borders on all sides.

The adjustments are then completed as far as we can go until the unit is connected to the tuner chassis. This will be described in the next part.

LIST OF PARTS

- One Allen B. Dumont Labs. special power transformer, P.T.1;
- Two Cornell-Dubilier Dykanol A condensers, 1 mf., 1,000 V., C31, C32;
- Two Aerovox paper condensers, 1 mf., 500 V., C33, C34;
- One Cornell-Dubilier Dykanol A condenser, 0.5-mf., 1,000 V., C35;
- One Cornell-Dubilier electrolytic condenser, 3-section, 4 mf., 500 V., C36, C42, C11;
- Three Aerovox paper condensers, 0.5-mf., 500 V., C37, C38, C39;
- One Aerovox mica condenser, 0.02-mf., C41;
- One Aerovox electrolytic condenser, 8 mf., 150 V., C45;
- One Cornell-Dubilier electrolytic condenser, 1 mf., 500 V., C46;
- One Aerovox electrolytic condenser, 25 mf., 50 V., C47;
- One Cornell-Dubilier paper condenser, .001-mf. (for 441-line scanning), C40;
- One Cornell-Dubilier paper condenser, 0.5-mf. (for 30-frame interlaced scanning), C43;
- Three Centralab potentiometers, universal taper, 0.5-meg., R27, R28, R34;
- Three Continental Carbon resistors, 1 meg., 1 W., R29, R39, R47;
- Four Continental Carbon resistors, 0.5-meg., 1 W., R30, R32, R56, R57;
- Two Continental Carbon resistors 50,000 ohms, 1 W., R31, R33;
- One Centralab potentiometer, universal taper, 0.1-meg. R35;
- Four Continental Carbon resistors, 25,000 ohms, 1 W., R36, R38, R16, R54;
- One Continental Carbon resistor, 0.1-meg. 5 W., R37;
- Two Continental Carbon resistors, 1 meg., 1 W., R39, R47;
- Two Continental Carbon resistors, 0.25-meg., 1 W., R40, R48;
- Two Continental Carbon resistors, 1,500 ohms, 1 W., R41, R50;
- Two Centralab potentiometers, cathode-bias taper, 5,000 ohms. R42, R51;
- Two Centralab potentiometers, universal taper, 2 megs., R43, R49;
- Five Continental Carbon resistors, 0.1-meg. 1 W., R44, R45, R52, R53, R55;
- One Centralab potentiometer, universal taper, 2.5-megs., R58;
- One Continental Carbon resistor, 700 ohms, 1 W., R59;
- Two Hammarlund 4-prong isolantite sockets;
- Two Hammarlund 5-prong isolantite sockets;
- Three Hammarlund 6-prong isolantite sockets;
- One Hammarlund 7-prong isolantite socket;
- Two Hammarlund R.F. chokes, 10 mhy., type CH-10-S, R.F.C.2, R.F.C.3;
- One Hammarlund R.F. choke, 85 mhy., type R.F.C.-85, R.F.C.4;
- Three tube shields;
- *One chassis and upright tube supports, per text;
- One cartridge fuse, 2A., 110 V. type, with holder;
- One Allen B. Dumont 3-in. "white and black" hard cathode-ray tube, V12;
- Two Allen B. Dumont thyatron tubes, type 885, V13, V15;
- Two National Union type 89 tubes, V10, V11;
- Three National Union type 57 tubes, V14, V16, V17;
- *As needed rubber grommets, grid clips, insulated terminals, anchors, etc.;
- As needed, wire, screws, etc.
- *Names and addresses of manufacturers will be sent upon receipt of a stamped, self-addressed envelope.

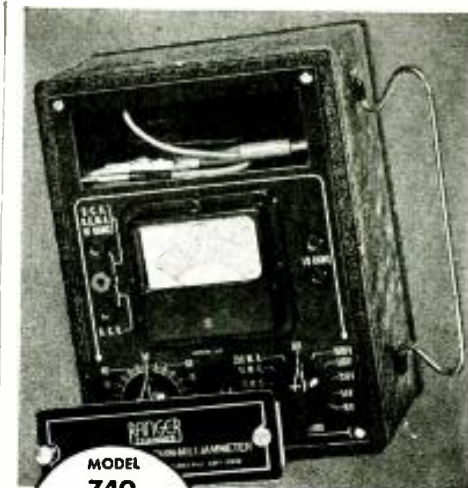

MODEL 740
VOLT-OHM-MILLIAMMETER
DEALER PRICE
Only \$18.60

NOW... RADIO
SERVICING IS
MORE PROFITABLE
... EASIER



AVAILABLE NOW IN SINGLE TESTERS ALSO
COMBINATIONS TO SUIT YOUR NEEDS

EYE APPEAL... PRECISION ACCURACY

Yes, Ranger-Examiner Equipment definitely means that Radio Service work can be done more profitably and easier. More profitably because considerably less money is required for precision equipment, and easier because Ranger-Examiner is a completely new line designed from scratch with all the latest improvements for quick and accurate service. (Cases are of all-metal, sturdy yet light.) Model 740 Volt-Ohm-Milliammeter has a Triplett 3" square Precision Instrument. Scale readings: 10-50-250-500-1000 A.C. and D.C. Volts at 1000 Ohms per Volt (D.C. Accuracy 2%; A.C. 5%); 1-10-50-250 D.C. M.A.; 0-300 low ohms; high ohms to 250,000 at 1.5 volts. Rheostat adjustment for 13 1/2 volts for ohm readings to 2.5 megohms. Batteries may be added permitting higher resistance readings in 250,000 ohms steps. Low Ohms to 1/2 ohm—with 25 ohms in center of scale. Backup circuit used. Current draw is only 1 M.A.



FREE! BOOKLET Lists 101 most frequent radio troubles, how to detect and how to cure. Nothing like it before, greatly simplifies every day servicing. Send Coupon Now.

READRITE METER WORKS
316 College Dr. Bluffton, Ohio

Without obligation please send your Free Booklet, "101 Radio Troubles and Their Cures" with complete Ranger-Examiner catalog.

Name

St. Address

City State

Please Say That You Saw It in RADIO-CRAFT

TUBULAR ELECTROLYTICS



Dry electrolytics mounted in cardboard tube containers.

The most capacity and voltage rating for the least money.

Light and compact. Completely sealed. Bare wire leads 2 1/2 inches long.

25, 50, 100, 150, 200, 300 and 450 v. working. Capacities of 2 to 50 mfd.

Write . . . Copy of latest catalog sent on request. Covers most extensive line of condensers and resistors.

AEROVOX CORPORATION
70 Washington St. : : Brooklyn, N. Y.

BARGAIN BULLETIN
SAVE MONEY ON EVERYTHING YOU BUY!

SPORTING GOODS
WATCHES-CLOCKS
TYPEWRITERS
OPTICAL GOODS
CAMERAS-NOVELTIES

RADIO SETS AND REPLACEMENT PARTS

SEND AT ONCE FOR OUR FREE CATALOG!

Buy efficiently, economically, safely! Hundreds of high quality items—leading lines and standard brands—at prices amazingly low! Real bargains! Square dealing! Write today for your big, free copy of this new catalog hot off the press.

RADIO CIRCULAR CO., INC.
915 BROADWAY Dept. RC NEW YORK, N. Y.

On broadcast as well as shortwave frequencies, in any location, you can eliminate "man-made" static with

CORWICO NOISE-MASTER ALL-WAVE ANTENNA

Send for complete literature
CORNISH WIRE CO., 30 CHURCH STREET, NEW YORK CITY

A 5-BAND 11-TUBE RACK-AND-PANEL RECEIVER

(Continued from page 537)

rectifier; and one 6G5—tuning indicator. Separate coils are used to cover each band. Inductive coupling of the signal picked up by the antenna permits the maximum transfer of energy from each separate primary to the particular secondary range in the circuit. The unused coils are shorted.

The 6K7 R.F. stage gives maximum gain in relation to frequency and provides pre-selection which gives an image ratio of 80 to 1 on the highest frequency range.

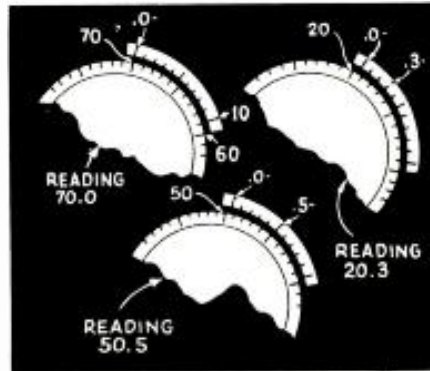

The novel micrometer tuning scheme.

The first detector-mixer is a 6L7. The output from the 6C5 signal-frequency oscillator is electron coupled to the injector-grid, of the 6L7. Because no oscillator plate current flows in the 1st detector, the ratio of translation to noise is more favorable than that obtained in a composite tube, or in circuits where the cathodes of two tubes are tied together.

The 6C5 oscillator has separate coils for each band. The superior overall performance is the result of not using any harmonics of the signal-frequency oscillator throughout the tuning range of the receiver.

All intermediate frequency transformers are of the iron-core type and resonate at 465 kc. This type of transformer has so definitely demonstrated its superiority over the air-core type as to warrant its use. Tremendous gain, better signal-to-noise ratio, extreme selectivity are but a few of the advantages of the iron-core system.

The 6R7 2nd detector gives half-wave diode detection, A.V.C., and the triode section of this tube is used as the first stage of A.F. amplification. The plate of this section of this multi-purpose tube is transformer-coupled to the grids of the push-pull 6L7s.

The push-pull 6L7 stage running straight class A delivers 14 W. of undistorted audio power. Before actually drawing any grid current the output is in the neighborhood of 17 W.

The total consumption of power by this receiver is 127 W.

This article has been prepared from data supplied by courtesy of The Hallifaters, Inc.

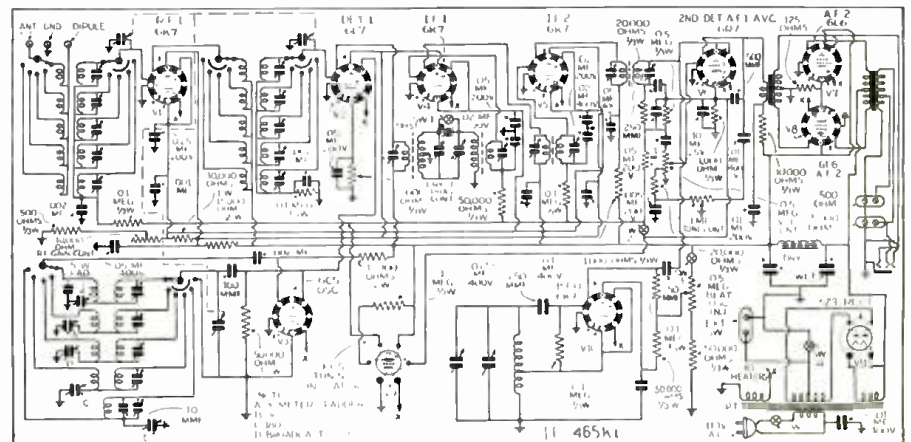

The circuit of the set with values of parts. The flexible and efficient operation can be realized from this circuit.

IS IT ECONOMY TO CONNECT DRY CELLS IN PARALLEL?

(Continued from page 543)

is too small in proportion to the size of the cell, the time required to discharge it will be so great that the natural depreciation which is characteristic of all drycells consumes a measurable proportion of the cell's capacity, leaving less than the full amount for useful service. On the other hand, if the current is too great for the size of the cell, then the cell will be overloaded, and this, too, reduces its capacity.

A cell which is discharged continuously will have no idle period for recuperation and so its capacity will be considerably reduced. In the opposite direction, discharge for short periods of time with long intervening idle periods will permit maximum recuperation and consequent long useful service until a point is reached where the discharge periods are so short and the idle periods so comparatively long that natural depreciation results in decreased service life.

End-point voltage is simply the lowest voltage at which the battery is still useful. A single cell, starting at 1 1/2 V. may be discharged to as low as 1/2 V. before it is completely used up. If whatever the cell is connected to becomes inoperative at 1 V. then the maximum possible capacity of the cell cannot be made useful.

With the general-purpose type of No. 6 cell,

the following table gives a rough approximation of various conditions, at given ampere-hour (A.H.) drains, for maximum capacity to an end point of 1 V.

Service hours per day . . .	2	4	8	24
Current drain, A.50	.25	.20	.10
Capacity, A. H.	40	37.5	35	30

It will be seen that no economy would result from parallel connection until the current drain is at least double. For example at 4 hours per day the current drain would have to be 0.5-A. or more to make it worth while to connect 2 cells in parallel.

Note: Only cells of the same grade, size and condition should be connected in parallel to avoid the possibility of having one cell discharge through another. (See Fig. 1.)

When new cells of the same type are connected in parallel, they will automatically share the load and keep each other in balance throughout their service life. However if an old, partly-used dry cell is connected up with a new one, this balance cannot take place and, because of its higher voltage, the new cell will slowly discharge itself through the old one!

This article has been prepared from data supplied by courtesy of National Carbon Co.

Please Say That You Saw It in RADIO-CRAFT

POWERTONE

Model 801—Pocket Volt-Ohmmeter

A sensitive, compact and accurate volt-ohmmeter that will be the busiest instrument in your "lab," or out on jobs.

DC voltage readings—0.5-50-500 and 1000. Resistance readings from $\frac{1}{2}$ to 500 and 200 to 500,000 ohms. Will read from 0 to 1 Ma. Low resistance range direct reading.

Meter has 1000 ohm per volt sensitivity. Battery is self contained. Panel is clearly lettered. Compensator provided for zero adjustment. Measures only $5 \times 3 \frac{1}{4} \times 2 \frac{1}{4}$. Your price complete with battery **\$5.75**

Send for complete literature on a variety of test instruments

Send 10c for Information Short-Wave and P.A. Manual

POWERTONE ELECTRIC CORP.
179 Greenwich Street New York City

Distributor
TRY-MO RADIO CO., Inc.
85 Cortlandt St. New York City

HOW TO EQUIP A SOUND TRUCK

(Continued from page 532)

may be lost or more than lost through the presence of competing noises which the sound system must override. In general, then, the radio man consulting his experience in indoor sound work should allow a margin of at least 50 per cent for loss of power in outdoor work, and judge his volume requirements on that basis. He must bear in mind always the exact conditions under which his system must work, the extent of reflection present, the extent of background noise present, and the concentration or scattering of the crowds he wishes to reach.

In most sound trucks the problem of securing adequate volume properly placed calls for the use of trumpet-type loudspeakers rather than baffle-type reproducers. Trumpets will direct the sound over the heads of the crowd closest to the truck, giving that portion of the audience the spillage of the sound, which will be enough and more than enough; while the main beam is projected toward more distant auditors.

A method commonly used in trucks is to reduce the amplification (turn down the volume control) and speak very close to the mike. This produces the unpleasant boominess of sound so characteristic of many truck installations.

To avoid such boominess as far as possible, it is desirable to use directional or beam-type velocity microphones, set the tone control for best effect, and particularly to position and point the trumpets very carefully with reference to the orientation of the mike, taking every advantage of its directional response to reduce feedback. Further, special types of beam velocity microphones are available that have less boominess than most when used in close-talking work.

Sound trucks nearly always include phonograph equipment, and often include more than one microphone. Radio-sound is less often used in truck work.

It is always impressive to the layman to fake 2 sources of sound, using phonograph music as a background for microphone speech, and so on. The commercial advantages of simple, inexpensive mixer facilities are very great, and other things being equal, are often the deciding factor in closing a sale or a rental contract.

There is no inherently good reason why truck sound quality should be as bad as it often is. Truck amplifiers operating from 6-V. power sources are available with characteristics of quality equal to those of any other amplifiers. Good dynamic reproducers mounted in good trumpets sound as well as any good dynamic loudspeakers anywhere. The phonograph pickup used is no different from any other phonograph pickup. The boominess that was inescapable with earlier types of microphones if feedback was to be avoided can now be largely or completely overcome by proper choice of microphones for this type of work, as indicated above.

Figure A illustrates a 30-Watt sound truck amplifier, the rotary converter being conspicuous at the right. The remainder of the amplifier follows standard lines of construction. A mixer-fader input circuit permits connection of 4 sources of sound, and simultaneous use of any two sources in any desired degrees of relative volume. Two of the input channels are of high gain—120 db. from 0.15-meg.—and two of low gain for use with phonograph equipment or, in rarer cases, with radio apparatus.

The quality of this amplifier is as high as that of any good P.A. equipment, not lowered in the least because the amplifier is designed for truck operation. Frequency range is from 50 to 10,000 cycles within 3.2 db., and harmonic content only 6 per cent at maximum output.

The Service Man finds economy in many P.A. installations by using the same system, at times, for other work, dismantling it from the truck and operating it indoors from 110 V. A.C. Truck P.A. systems can be obtained on the open market which, while primarily designed for storage battery power, are converted without difficulty to 110-V. line operation. This is true of the amplifier shown in Fig. A. Simple arrangements are incorporated for changing power sources, and the amplifier can be bought, as desired, with or without a separate power pack to drive it from a standard 50- or 60-cycle line.

This article has been prepared from data supplied by courtesy of Wholesale Radio Service Company.

THE ANSWER TO A SERVICEMAN'S PRAYERS...AND PROBLEMS



● Sylvania's famous Technical Manual is right up to the minute with the newest developments in radio . . . answers questions, solves problems, saves time and money! And it costs only 15c!

This gives you an idea what it contains:

184 pages bound in a neat, handy size that slips right into your pocket.

Lists 193 tube types with important circuit application information on each.

Tells all about glass, metal and "G" type tubes including those for Majestic receivers. Also full information on SYLVANIA "Ballast Tubes."

You'll need this Manual on your very next job! So clip the coupon and mail it today.

Hygrade Sylvania Corporation, makers of Sylvania Radio Tubes and Hygrade Lamps. Factories at Emporium, Pa.; Salem, Mass.; and St. Mary's, Pa.

SYLVANIA

The Set-Tested Radio Tubes

HYGRADE SYLVANIA CORP. RC-37
EMPORIUM, PA.

Please send me the Sylvania Technical Manual. I enclose 15c in stamps or coin.

Name

Address

City State.....

14—32—64—128 WATT UNDISTORTED

● **6L6 BEAM AMPLIFIERS** ●

DEAL DIRECT With Manufacturer AND SAVE BIG MONEY

ULTRA-QUALITY PERFORMANCE and FLAWLESS REPRODUCTION GUARANTEED FOR 5 YEARS!

WRITE TODAY FOR OUR VALUABLE

FREE CATALOG

INDUSTRIAL

AMPLIFIER SYSTEMS COMPANY

16-R HUDSON STREET NEW YORK, N. Y.

A New Line of . . .

DRY ELECTROLYTIC CONDENSERS

SMALL, COMPACT — REASONABLY PRICED

Dealers, Distributors, Jobbers and Service Men Write for Information and Price Sheets Unconditionally Guaranteed

ILLINOIS CONDENSER COMPANY

3252 W. NORTH AVE., CHICAGO, ILL.

BUY RADIOS WHOLESALE

5 TUBE **695**

30 Days Trial!!

Get politics, news, music, market and weather reports on a new Zephyr world-wide all electric, battery or auto radio. All latest improvements—MONEY BACK GUARANTEE—one year FREE service. Write for FIVE catalogue and agent-user plan.

ZEPHYR RADIO COMPANY
13141 Hamilton Ave. Detroit, Michigan

NEW GUIDE NOW READY!

Most complete volume control facts ever assembled in one book. Free with tou (showing spec. number) of one Electrad volume control carton.

Write Dept. RC-3
175 Varlick St., New York, N.Y.

ELECTRAD

INC.

OXFORD

PERMAG SPEAKERS

PERMANENT MAGNET

Get the facts about the new OXFORD PERMAG (Permanent Magnet) SPEAKERS. Write today for Permag Bulletin!

OXFORD-TARTAK RADIO CORP.
915 W. VAN BUREN ST. CHICAGO, U.S.A.

Learn SOUND RECORDING
TALKING PICTURE PROJECTION
TELEVISION-RADIO

Master training courses qualify you for good jobs. Practical, easy to learn. Newest equipment. 40,000 graduates. Earn room and board while learning. Cash R. R. fare allowed to L. A. Write for FREE BOOK. Address Dept. E.R.C. 4040 S. Figueroa St.

NATIONAL SCHOOLS—Los Angeles

Please Say That You Saw It in RADIO-CRAFT



"Cornell-Dubilier sales just hit a new high"

THE WORLD'S MOST COMPLETE CONDENSER LINE
WET & DRY ELECTROLYTICS
MICA • PAPER • DYKANOL

CORNELL-DUBILIER CORPORATION
1014 Hamilton Blvd., So. Plainfield, N. J.

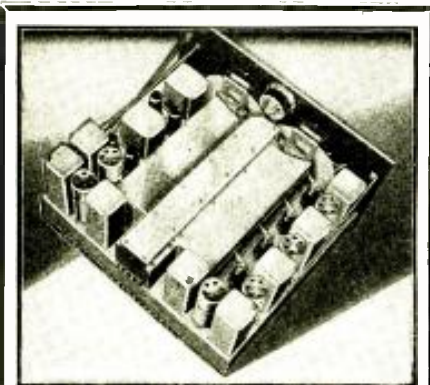

THE ULTIMATE IN RADIO

HAMMARLUND'S new "Super-Pro" receiver, enthusiastically acclaimed by critical radio authorities, has many unusual electrical and structural features—never before incorporated in any receiver. The "Super-Pro" has continuously variable selectivity from 3 to 16 kc. with directly calibrated band-width panel control. Exclusive "Super-Pro" band-spread system with a 12-gang condenser. Direct reading megacycle and kilocycle dial, accurate to within 1/2%, and dozens of other features. Here is a 16-tube precision receiver that is the ultimate in radio! Write Dept. RC-3 for the new "Super-Pro" booklet with further details!

HAMMARLUND MANUFACTURING COMPANY, Inc.
424-438 WEST 33rd ST., NEW YORK

- Check here for new "Super-Pro" Leaflet.
- Check here for new "S.P." Hammarlund General Catalog.

Name

Address

City State

NOVEL 1-TUBE SET USES "BODY" ANTENNA

(Continued from page 529)

"A" voltage is 3 V. and that required for the filament of the tube is only 2 V., a rheostat must be used. This is attached to the upper flashlight housing. The regeneration condenser consists of 2 thin strips of tin foil; one attached (cemented) to the bakelite cap of the phone and the other to the phone frame. They are insulated from each other with a piece of mica. By turning the cap, these two strips of foil coincide with each other in varying degrees, thereby serving as a small-capacity variable condenser.

The results obtained will of course vary with the ingenuity of construction, the amount of "B" voltage used and the locality in which it is used. At any rate, you'll have lots of fun building and operating this "flashlight-radio set". (This is all the data available.)

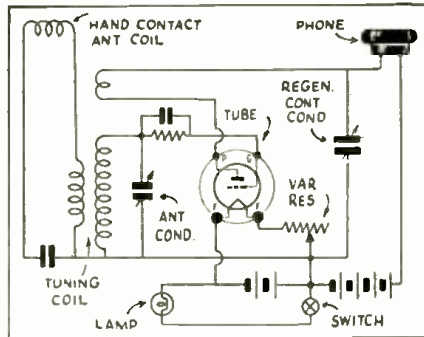

The circuit of the novel little set.

INFORMATION BUREAU

(Continued from page 535)

I wonder if the circuit of this set is obtainable, so that a similar set—to be used in a different way than in the portable case mentioned above? I would like to try my hand at making such a set for a particular use as there is no receiver available, to my knowledge, that will be suitable for my needs.

(A.) We are printing here, Fig. Q384, the circuit of the Simplex Sportsman receiver which you requested. The values of condensers, resistors, etc., are shown on the diagram. The coil details can be worked out by experiment or you can obtain suitable coils from one of the well-known manufacturers of such devices.

OPERATING NOTES

(Continued from page 546)

these sets considerable movement of the plates will often be found. Examining the rotors, they will be found to be solidly in place, and with no adjustments provided. The stators, however, may be moved. They are suspended at each end on short insulating strips. At each end of this strip will be found screws which hold it to the metal frame. Near the middle of this strip will be found two more screws holding down a bright, short metal strip, as shown in Fig. 2. If these two screws in the middle are loosened, it will be found that the stators may be moved. Do not try to move the screws and the metal strip, which at first would appear the proper thing to do, but move the stator itself. It is advisable to loosen up only one end of the stator at a time.

The trimmer adjustments may now be made. There is a trimmer adjustment screw for each condenser section. They are located on the front of the condenser assembly. It is necessary to move the set back from the front of the cabinet or remove it altogether to get at them.

ALAN R. QUACKENBUSH

Freed-Eisemann 50. Sensitivity and selectivity of this 7-tube T.R.F. receiver may be greatly improved by making a few changes in the original arrangement of the detector input section (Fig. 1A); the modified circuit is shown in Fig. 1B. Service Men in making this change should replace the original choke, R.F.C., with one of larger size; this improves reception at the high-wave end of the dial.

J. M. CANESTORP

Please Say That You Saw It in RADIO-CRAFT

UNIVERSAL
Velocity and Carbon Microphones

Universal's latest achievement—Ideal for stage use—Not affected by temperature or humidity—Flat frequency response curve from 40 to 10,000 cps—Output-63 D.B. Low impedance or direct to grid types. Compact, 2 3/4 x 4 3/4 in. by 1 1/2 in. thick—Weight, less than 18 oz.—Herald awards to any desired angle—Beautifully finished in black enamel and artistic chrome plate—ask for new catalog sheet describing models RL, RLH and CR—List \$22.50—Latest model must have sectional stand for above microphones—List \$10.00.

UNIVERSAL MICROPHONE CO., Ltd.
424 Warren Lane Inglewood, Calif., U. S. A.

RADIO COURSES

RADIO OPERATING: Prepare for Gov't License Exam. ● RADIO SERVICING: Including Short Wave ● AMATEUR CODE ● ELECTRONICS ● TELEVISION ●

Day and Evening Classes—Booklet Upon Request

New York YMCA Schools
4 W. 64th Street, New York City

COMPLETE ELECTRIC PLANTS

ONAN ALTERNATING CURRENT PLANTS furnish same as city current anywhere. Operate on gasoline. Run Radio, Water System, Refrigerator, all Appliances. Complete, ready to run.

SIZES 350 WATTS UP
Easy to install. Available from stock. For Farms, Camps, Commercial use. Sizes for any purpose. Write for details.

D. W. ONAN & SONS
684 Royalston Ave. Minneapolis, Minn

YOU CAN SELL
Motion Picture Equipment

Here's a brand new field for radio men. Take orders for our complete line of 8mm, 9.5mm, motion picture equipment for theaters, last-minute clubs and home use. Tremendous field, liberal profits. Write fully, giving experience, territory desired, business references.

S. O. S. CORP. 636-RA ELEVENTH AVE
NEW YORK, N. Y.

2 BAND SUPER COIL KIT

Tunes from 6 to 15 Megacycles
1700 to 550 KC. Tunes with 456 I.F.

KIT CONSISTS OF:
1 Shielded antenna coil
1 Shielded Oscillator coil
1 Band Switch

99¢

TAKE ADVANTAGE OF THIS GREAT VALUE
NO C.O.D. SHIPMENTS Shipping Wt. 1 lb.

ARROW SALES COMPANY
631 Washington Blvd., Chicago, Illinois

6L6 TRANSFORMER KIT
30 WATTS

Power Trans., 800 VT CT—250 mls 5 V., 2 Amp. 6.3 Volts at 6 Amp. Net \$1.50. Input Trans., High Fidelity type \$3.00 net. Output 500 ohm and tapped voice coil \$3.00 net. Diagram of 6L6 30 Watt Amplifier with all latest circuit improvements and full parts list 25¢ special for above kit, \$2.00 net. Any Transformer Built to Specifications

ALLOY TRANSFORMER CO., Inc. 135R Liberty St., N.Y. City

RADIO REPAIR CEMENT
"THE ORIGINAL SPEAKER CEMENT"

Used for replacing speaker cones, mending old, rattling, or torn cones, repairing, cementing loose tube bases, grid caps, coils, leads etc. Dries fast. Vibration proof waterproof. Invaluable aid to Service Men. See your jobber, if he cannot supply you, write us. List price 50¢ for large bottle. Send for FREE circular of complete line.

GENERAL CEMENT MFG. CO.
(Radio Div.) Rockford, Illinois

RADIO ENGINEERING

RCA Institutes offer an intensive course of high standard, embracing all phases of Radio, Practical training with modern equipment at New York and Chicago schools. Also specialized courses and Home Study Courses under "No obligation" plan. Catalog Dept. RT-37.

RCA INSTITUTES, Inc.
75 Varick St., New York 1154 Merchandise Mart, Chicago
Recognized Standard in Radio Instruction Since 1909.

DYNAMIKE!

A real velocity, high quality microphone for speech or music. Exceeds instruments selling for three times the price. Response substantially flat from 40 to 10,000 cps. P. S. Cavity resonance eliminated through special design. High impedance. Output, 60 D.B. Equipped with six feet of shielded cable. Send \$9.95 (plus postage) today or request free circular.

ELECTRO-DYNE MFG. CO., Benton Harbor, Mich.

NEW — a low cost C-B Oscillograph MODEL 105 with Linear Sweep, Dual Amplifiers, etc.



You Need Every One of These Exclusive Features

Uses the new Type 913 one-inch Cathode-ray tube and provides every feature of the most expensive oscillographs, such as: Linear Sweep with synchronizing circuit using the Type 885 Thyatron; separate High Gain Amplifiers for horizontal and vertical plates; Beam Centering Controls; and adjustable light shield for Cathode-ray tube screen.

Compact, easily portable — yet the most complete instrument ever offered using the Type 913 tube. Not one of these features can be omitted without so limiting the utility of the oscillograph that any saving is wasted by limited performance. Write for bulletin describing this instrument in detail.

Complete with five tubes, net cash \$48.90
Pay-As-You-Earn. \$5.50 down

Oscillators for Use with MODEL 105

This instrument now makes it possible for you to secure complete Cathode-ray Receiver Servicing equipment for only \$9.50 down (MODELS 81-A and 105). Designed for use with either the MODEL OM-A Frequency Modulated Oscillator or the MODEL 81-A Frequency Modulator, to produce calibrated selectivity curve images by single or double trace method.

See Your Jobber Today — Or Use This Coupon

The CLOUGH-BREngle CO.

2809 W. 19th St., Chicago, U.S.A.

Send at once full description of the new MODEL 105 Cathode-ray oscillograph and time payment order blank.

Name _____
Address _____

THE LATEST RADIO EQUIPMENT

(Continued from page 541)

quire a battery, and which is capable of recording on a voltmeter calibrated directly in exposure factors is now available to the camera owner who makes his own prints. As applied to photography, this oxide-type photoelectric cell and associated equipment enable the photographer to determine correct printing time, grade of paper required, the amount of fog and to obtain other useful information about miniature negatives.

MIDGET ELECTRIC DRILL (1301)

SAID to be the "smallest, lightest-weight electric drill ever built" this unit will appeal to almost every radio man. It will speed, immeasurably, the work of laying out small metal chassis; and in handling all sorts of radio and electrical woodwork—where the size of hole need not exceed 1/4- or 3/16-in. (type U17A, 1/4-in. capacity; U15A, illustrated, 3/16-in. capacity). This drill weighs only 2 1/2 lbs., yet it will drill through a 1/4-in. steel plate in 5 seconds.

CEMENTED WIRE-WOUND REPLACEMENT RESISTOR (1302)

NEWEST in wire-wound resistors is a replacement type, impregnated with waterproof cement, which is said to be "noiseless, compact and accurate." Available in 5- and 10-W. rating; a removable metal tag clearly identifies each resistor value. A kit of 57 units in 27 different values is said to meet 80 per cent of average needs.

ADJUSTABLE DESK-TYPE CRYSTAL "MIKE" (1303)

SEVERAL unusual features have been emphasized by the manufacturer of this new crystal microphone. Although specially designed for voice modulation of a transmitter the head of this microphone assembly may be swiveled on the lightweight stand to meet almost any pick-up need. The aluminum case is finished in black crystalline and the stand is rubber-black and chrome. The output level is -55 db. A 6-ft. length of microphone cable is used to prevent the

resonant characteristic that would be inherent in an 8-ft. cable when used in a 5-meter rig.

2-V. CHARGER AND NON-SPILLABLE STORAGE CELL (1304) (H. E. Clarke Co.)

TECHNICAL men will be delighted to know there is now available a 2-V. storage cell that is not only portable but which also may be conveniently recharged. The complete kit, illustrated, includes the lead-type storage cell (of miner's lamp non-spillable construction with rubber expansion chamber); oiled-silk safety bag; 110-V. A.C. to 6 V. D.C. charger with copper-oxide rectifier; bottle of electrolyte and dropper; and the battery-testing meter.

A.C. OPERATED MICROPHONE PREAMPLIFIER (1305)

A 2-STAGE amplifier; the first stage tubes are in anti-microphonic mountings. Incorporates electronic mixer for 2 microphones of velocity or crystal type; and tone control for shading. Two of these amplifiers may be connected as a 4-position electronic mixer and pre-amplifier.

PANEL NAME-TAGS (1306) (Lynch Mfg. Co., Inc.)

A NEW type of flexible metal name tag with bright silver chrome letters on a black background is available in a series of 30 names, a few of which are illustrated. Use these on your receiver, transmitter, P.A. equipment, experimental apparatus, etc. Just moisten the adhesive and stick them in place.

PORTABLE STEEL CABINET (1307)

SPECIALIZING in shield cans, cabinets and racks of metal for the experimenter, amateur and equipment builder, a well-known company has brought out a steel cabinet (also available in other metals) measuring only 11 x 6 x 14 ins. high, which is equipped with a handle and 2 decks with attached brackets.

Ol' Man Centralab broadcasts -



That genial chap... the friend of servicemen and experimenters takes time out to remind you that every control problem can be met (better and easier) with CENTRALAB CONTROLS.



Smoother — because of the long, no-rubbing contact, they give "profitable" service for a long time.

Change to CENTRALAB

A mere handful will service practically any set—old or new.

Volume Controls
Fixed Resistors
Selector Switches

Centralab

MILWAUKEE WIS.

BRITISH CENTRALAB, LTD.
Canterbury Rd., Kilbourn
London N.W. 6, England

CENTRALAB
118 Avenue Ledru-Rollin
Paris XI, France

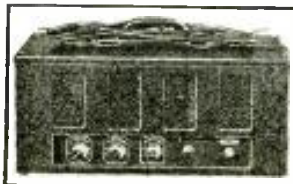

Two-stage amplifier. (1305)



Metal name tags. (1306)

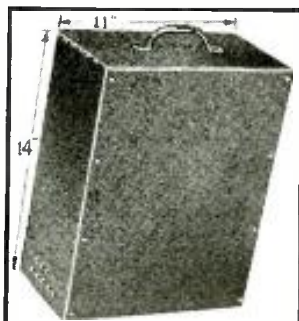

Metal cabinet. (1307)

Please Say That You Saw It in RADIO-CRAFT

On page 576 of this issue will be found a full-page advertisement giving complete information about many of the service books published by the House of Gernsback.

NEWLY IMPROVED! **Model T-37 SIGNAL GENERATOR**

- Accuracy 1/2 of 1% on I.F. Bands, 1% on Broadcast Band, 2% on S.W. Bands.
- We are now using a new hair-line pointer which enables reading to within 1/10 of 1%.
- Nearly one thousand satisfied owners, since its introduction less than a year ago.



Complete . . . only \$12⁴⁰

- 110 Volts A.C. or D.C.
- 100 kc.—22 megacycles all on fundamentals.
- Dial is direct reading in frequencies.
- R.F. output may be taken from a high impedance or a low impedance post, in with attenuation present for either.
- Separate audio output at 2 amplitude levels, so that tone may be used for checking public address systems, audio amplifiers in receivers, and speech amplifiers in transmitters.
- Two extra posts on front panel enable leakage tests. Condensers may be checked for leakage, so may tubes and other potentially high resistance currents, otherwise difficult to test.

Model T-37 All-Wave Signal Generator, wired in shielded cabinet with carrying handle and calibrated tests; complete with 2 Tubes & Neon Tube, \$12.40 instructions (shipping weight 7 lbs.).....

SUPERIOR INSTRUMENTS COMPANY, 136 LIBERTY STREET NEW YORK, N. Y., Dept. 6A

LATHE DATA BOOK FOR TECHNICIANS

A new book describing a new line of lathe equipment which should interest all Service Men and technicians is now available from South Bend Lathe Works. This book gives much interesting technical data on the operation of small back-geared lathes as well as describing the new equipment of this company. The many uses of lathe equipment in radio repair and construction will be better appreciated by those who read this brochure. A copy of this catalog can be obtained by writing to Radio-Craft and asking for booklet No. 1309.



FOR THE RADIO SERVICE MAN, DEALER AND OWNER

The man who enrolls for an I.C.S. Radio Course learns radio thoroughly, completely, practically. When he earns his diploma he will KNOW radio. We are not content merely to teach the principles of radio, we want to show our students how to apply that training in practical, every-day, radio service work. We want them to make good, to make money, to be successful radio experts.

INTERNATIONAL CORRESPONDENCE SCHOOLS
 Box 6679-C, Scranton, Penna.
 Explain fully about your course in the subject marked X:

RADIO
 EXPERIMENTAL TELEVISION
 SOUND TECHNICIANS
 AVIATION SECTION OF RADIO OPERATING

Name _____ Age _____
 Address _____

REALISM IN SOUND by AMPLITONE!

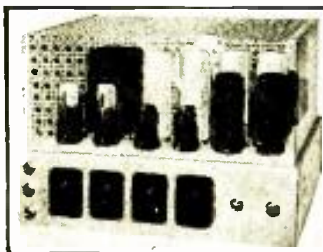

ONE OF OUR FASTEST SELLERS

DE LUXE BEAM POWER AMPLIFIER—This unit, shown in adjacent photo, is intended for quality installations. It has a conservative power output rating of 60 watts, peak power of 80 watts. It is a hi-fidelity amplifier, incorporating howl suppression, 3-channel inputs, beam-power tubes, etc. Full details mailed upon request.

NET PRICE, less tubes, \$49.50

AMPLIFIERS OF ALL TYPES

FREE CATALOG contains the greatest values ever offered. Consult us on your P.A. Problems.

Amplifone Products Company
 135 LIBERTY ST. NEW YORK, N. Y.

HOW TO USE V.-T. VOLTMETERS IN RADIO AND P.A. SERVICING

(Continued from page 537)

unit when the tube in the unit is changed or when the power line voltage changes. These variations in tube characteristics and voltage are automatically compensated-for by the circuits used.

There are 3 general classifications of measurements to which a V.-T. voltmeter may be applied in the design and servicing of modern electronic circuits:—

(A) **Measurement of Root Mean Square or "Effective" Voltage.** This is the reading indicated by ordinary voltmeters less what error occurs in the circuit through added resistive drop due to the current drain added by the introduction of the voltmeter into the circuit being measured.

(B) **Determination of the Value of Voltage Wave Peak.** The so-called "slide-back" peak voltmeter has long been a favorite of leading engineers and laboratories for measurement of the peak value of voltage waves, and is now available for the first time in a commercial instrument with an internal source of buck-out potential.

(C) **Measurement of Direct-Current Voltages.** As in the first classification of measurements, the indications of the peak voltmeter are secured without drawing current from the circuit under measurement.

(A) MEASUREMENT OF R.M.S. VOLTAGE

General. The top scale of the instrument illustrated, is calibrated directly in r.m.s. or effective voltage, with full-scale deflection indicating 1.2 V. Potentials as low as 0.1-V. may easily be read with an instrument of this sensitivity.

The r.m.s. (root mean square) value of an alternating-current voltage wave is, by definition, exactly the same as the value of direct-current voltage which will produce an equal amount of heating in a circuit composed solely

of resistance (no capacity or inductance). When considering a pure sine-wave alternating voltage, the r.m.s. value will be equivalent to 0.707 times the peak voltage value of the waveform. However, if a wave has other than a pure sine form this relationship will not hold true.

The r.m.s. scale of the vacuum-tube voltmeter is very valuable for many measurements of non-sinusoidal voltages, such as the checking of stage or overall gain of radio- and audio-frequency and high resistance.

It is necessary that this instrument be connected in such way that the voltmeter tube control-grid circuit is conductive to direct current, otherwise the grid may accumulate a charge which will cause an incorrect potential value to be indicated.

If it is necessary to take measurements in circuits where there will not be a D.C. path from the voltmeter control-grid to ground, a leakage path for the control-grid charge may be established either by leaving the tube prod within the instrument case (which has a built-in resistor) for low-frequency measurements or by placing a 3-meg. resistor from the voltmeter tube control-grid to ground, and capacity-coupling the voltmeter tube control-grid, to the circuit it is desired to measure, with a 0.01-mf. (mica) condenser.

With a connection made to the circuit from the free end of the condenser, the instrument will now show either peak A.C. voltage values or r.m.s. voltages. To secure true r.m.s. values from peak-voltage readings multiply the peak-voltage indications by 0.707, although this need not be done in measuring gain, as all readings are proportional.

(1) GAIN MEASUREMENTS IN GENERAL

A typical set-up is illustrated in Fig. 1A, wherein a signal generator is connected to a

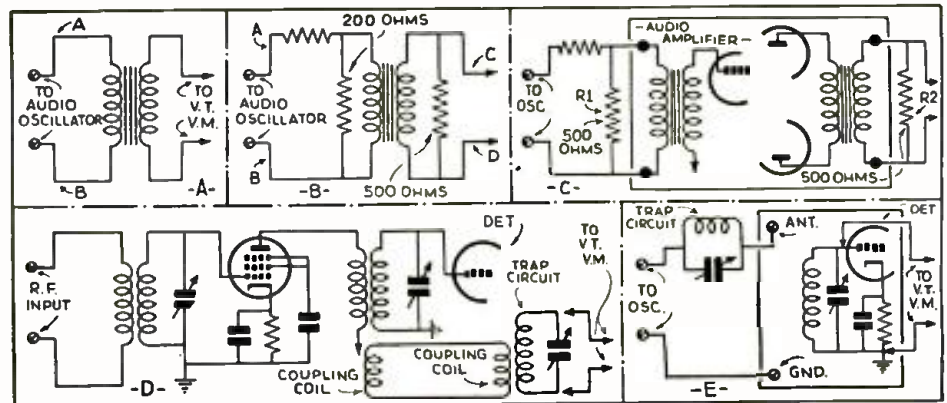

Fig. 2. Circuit connection details for various applications.

Please Say That You Saw It in RADIO-CRAFT

FACTORY TO YOU

LATEST MODEL REMINGTON TYPEWRITERS



10¢ A DAY

BRAND NEW latest model Remington Portable for only 10¢ a day! Amazingly low price direct from the factory. Every essential feature of large office typewriters—standard 4-row keyboard, standard width carriage, margin release, back space, automatic ribbon reverse. Act now, while this special opportunity holds good.

You don't RISK a Penny
We send you this genuine Model 5 for 10 days' free trial. If not satisfied, send it back. We pay all shipping charges.

FREE Typing Course and Carrying Case
You will receive FREE a complete simplified home course in Touch Typing. Also FREE, a handsome, sturdy carrying case. No obligation. Mail coupon for full details—NOW.

Remington Rand Inc.: Dept. 189-3
315 Fourth Ave., New York, N. Y.

Tell me, without obligation, how I can get a New Remington Portable, plus Free Typing Course and Carrying Case, for 10¢ a day. Send Catalogue.

Name.....
Address.....
City..... State.....

HAVE YOU SOME SPARE ROOM

a basement or garage where you can do light work? We can offer you a profitable proposition consisting of and the Novelties, A-trass, Toy Automobiles, etc. as Branch Manufacturer for firm of many years standing. No experience necessary as we furnish full instructions with moulds. If interested in devoting your spare or full time to profitable work and you mean strictly business write AT ONCE for full details as we are now closing 1937 arrangements for supply of our goods.

METAL CAST PRODUCTS CO.
Dept. 26, 1696 Boston Road, New York, N. Y.

CLASSIFIED ADVERTISEMENTS

Advertisements in this section are inserted at the cost of twelve cents per word for each insertion—name, initials and address each count as one word. Cash should accompany all classified advertisements unless placed by a recognized advertising agency. No less than ten words are accepted. Advertising for the April, 1937, issue should be received not later than February 6th, 1937.

RADIO

RADIO ENGINEERING, BROADCASTING, AVIATION and police radio, servicing, Marine and Morse Telegraphy taught thoroughly. All expenses low. Catalog free. Dodge Institute, Pine Street, Valparaiso, Indiana.

FOR SALE: CLOUGH-BREngle ALL-WAVE OSCILLATOR. Supreme 89 Tube Tester, brand new. Rider's Manuals volumes I to IV. Best cash offer. P. Kroutzburk, Dolton, Illinois.

BUILD IT YOURSELF

You can build this Trailer with ordinary tools easily from our step-by-step constructional sheets and large sized blueprints. Finest designed Trailer in existence, sleeps 4. Toilet, Shower, Electric Light, etc. Save 25% of the cost by building it yourself. Send 25c for plan sheet, illustrations and details.
THE PLAN SHOP, 910 Palmolive Bldg. Chicago, Ill.

PATENTS—TRADE MARKS

All cases submitted given personal attention by members of the firm.
Form "Evidence of Conception" and instructions.
"How to Establish Your Rights"—Free
LANCASTER, ALLWINE & ROMMEL
PATENT LAW OFFICES
436 Bowen Bldg. Washington, D. C.

RADIO ENGINEERING,

broadcasting, aviation and police radio, servicing, marine radio telegraphy and telephony, Morse telegraphy and railway accounting taught thoroughly. Engineering course of nine months' duration equivalent to three years of college radio work. All expenses low. Catalog free. School established 1874.
Dodge's Institute, Hudson St., Valparaiso, Ind.

tube circuit. The same procedure would hold for a multi-stage circuit if desired to measure its gain as a unit.

(a) **Connections.** Fig. 1A is a typical circuit, and is the basis for the specialized measurements described in later paragraphs. Units R1 and R2 are resistors, either fixed and of known value, or variable and of known calibration. For low intermediate radio frequencies and audio frequencies, these may be small commercial units of the variable or fixed type. For higher intermediate frequencies, broadcast and short-wave frequency measurements, it is necessary to use resistors of such construction that capacity and inductance effects have been reduced to a minimum.

The effect of the internal capacity and inductance of any resistor may be determined by applying to the circuit of Fig. 1A a voltage of the frequency at which it is desired to take the gain measurement, and comparing the value of voltage indicated on the vacuum-tube voltmeter at point B with the voltage at point C. This ratio of voltages should correspond accurately with the ratio of resistances R1 and R2 if the capacity and inductance effect is negligible at this frequency.

(b) **Audio-Frequency Circuits.** For testing such, it is necessary to have as a voltage source, an audio signal generator of the continuously-variable-frequency type. Set this instrument to the desired frequency and the actual gain in the circuit can be evaluated in two ways. One is to read the voltage at point B, Fig. 1A, and transfer the vacuum-tube voltmeter to read the voltage at point A, in which event, the gain of the circuit will be given by the formula.

$$\text{GAIN} = \frac{(R1 \text{ plus } R2) (VA)}{(R2) (VB)}$$

The other method is usable only on circuits where it is permissible to vary the value of R1 and R2 without upsetting bias and load matching. In this case, the voltage at point B is first measured, and resistors R1 and R2 are then adjusted to bring the voltage at point A to the same value. When this has been done, the gain of the circuit will be given by the formula.

$$\text{GAIN} = \frac{(R1 \text{ plus } R2)}{R2}$$

As stated above, these procedures are general in nature and more specific procedures will be outlined in following paragraphs.

(c) **Radio-Frequency Circuits.** Here a radio-frequency signal generator is used as voltage source. If the circuit is tunable, adjust it to resonance with the oscillator, or if untunable, adjust the oscillator to resonance. The measuring procedure will then be identical to that described above for audio-frequency circuits.

(2) CHECKING R.F. GAIN IN RECEIVERS

It is not always convenient to remove the inter-stage transformer or coupling unit in order to check its gain. For this reason the following procedure is frequently employed. In the case of an intermediate-frequency transformer "T", the operation of which is in doubt, Fig. 1B may be taken as representing the typical condition.

Connect an R.F. signal generator to the antenna and ground posts of the receiver as shown, and the vacuum-tube voltmeter to the control-grid of the tube preceding the transformer in doubt (at point A in Fig. 1B). Tune the receiver to the test oscillator output frequency and adjust the input to the receiver by means of the attenuator on the signal generator until a small reading, say 0.5-V., is obtained on the vacuum-tube voltmeter. If the receiver has automatic volume control, all operations should be made at a signal level that is below the A.V.C. actuating voltage.

Should point A be located in a tuned circuit of the receiver, and such will usually be the case, it may be necessary to slightly re-adjust its resonance after the vacuum-tube voltmeter is connected to compensate for input capacity of the vacuum-tube voltmeter.

After taking the reading at point A, transfer the voltmeter to point B and adjust the trimmers in both circuits A and B until the greatest voltage is indicated on the meter. The ratio of the voltage read at point B to the voltage read at point A, is the gain of the amplifier stage under test.

FREE

A NEW ILLUSTRATED BOOK EVERY ONE INTERESTED IN RADIO SHOULD OWN



It tells, and shows, how batteries are made, how they should be used to best advantage, what you should expect from them. It contains performance curves, charts and helpful technical information. Profusely illustrated. If you want to be "up" on the latest in battery-operated sets, get this book. There's dope in it every ham will want.

SEND US THE COUPON WE'LL SEND YOU THE BOOK



NATIONAL CARBON COMPANY, INC.
P. O. Box No. 600, Grand Central Station
New York, N. Y.

Please send me free of charge the new book, "The Inside Story of Radio Batteries."

Name.....
Address.....

RC1

New! AC-DC AMPERITE

WITH STARTING RESISTOR!
Prevents Untimely Burnouts

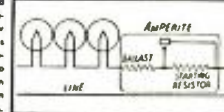
When your set is turned on, the Patented Automatic Starting Resistor allows only 75 volts to pass through... Then it increases the voltage to normal as the tubes warm up, thus preventing sudden overloading and burnouts.

Only 3 types of AC-DC AMPERITE are required to replace any of the 10 types of AC DC ballast tubes. NEW LOW PRICE List \$1.25 (Also new low price on replacements for 2-Volt Battery Sets, List \$1.25)

WRITE FOR CHART CVS

AMPERITE Company, 361 BROADWAY NEW YORK

The 1936 OFFICIAL RADIO SERVICE MANUAL is now ready. Full details about this edition appear on Page 516 of this issue.

Please Say That You Saw It in RADIO-CRAFT



"LISTENING IN" is the latest way to sell tubes. Customer simply listens thru phone to audible proof for intermittent contacts or steady leakages — actually hearing how such tube troubles ruin radio reception. It's the most effective way imaginable for selling tubes. And it's exclusively RADIOTECHNIC! Ask about this and other R-T-L features!

Ask for Folder

Portable Tester. Compartment for tools, tubes and repair parts. Overall size of case, 5" x 12" x 17 1/2".



THE RADIOTECHNIC LABORATORY
1328 Sherman Ave. Dept. RC Evanston, Ill.

A Complete Line of
Tube Test R-T-L Equipment

RADIOTECHNIC

Be an
INTERFERENCE
expert!

AUTO RADIO HOME SETS

CONTINENTAL Carbon has prepared the latest information on interference elimination in the form of a booklet entitled, "Handy Pocket Data on Radio Interference Elimination," price 10c. This booklet describes each form of interference encountered in home and auto radio installations and the method of reducing such noises with interference suppression or rejection devices. You need this booklet to enjoy a profitable summer's business. Order it now!

SEND THIS COUPON!

CONTINENTAL CARBON INC.
13914 Lorain Ave., Cleveland, O.

Enclosed find 10c for "Handy Pocket Data on Radio Interference Elimination."

Name

Address

Jobber's Name

(3) CHECKING PRESELECTORS

Ordinary methods of alignment do not readily solve the problem of adjusting preselector or tuned-radio-frequency ("T.R.F.") stages of the superheterodyne receiver. Difficulty is frequency encountered in correcting the alignment of the receiver to agree with the printed dial scale calibration.

Figure 1C shows a typical circuit, to which an R.F. signal generator should be connected at the antenna and ground binding posts in the usual manner. The vacuum-tube voltmeter is then connected (voltmeter tube control-grid directly, without long leads) to the tuned circuit which normally connects to the control-grid of the 1st-detector or frequency changer tube (Point A). In making this test it is advisable to short-circuit the control-grid coil of the oscillator circuit.

It will now be possible to adjust the pre-selector or first R.F. stage as one would handle an ordinary T.R.F. receiver.

(4) MATCHING OF COILS

A typical set-up for such tests is shown in Fig. 1D. A small coil (A), consisting of about 10 bundled turns, of a diameter approximately equal to that of the coils to be tested, is made up and connected to the highest voltage output that is available from the R.F. signal generator at hand for the tests. This inductance is for coupling to the coils under test. It should be coupled to coil B only as close as needed to get a satisfactory reading on the vacuum-tube voltmeter. Unit C is a variable condenser with small vernier (Ct) in parallel, such as is used in any radio receiver. The vernier condenser should be fitted with a pointer and dial, reading zero at one-half capacity. If a 3- or 4-plate condenser is used, it will have a range of roughly 10 mmf. each way from the half-capacity setting, making it easily possible to distinguish 1. mmf. each way!

The coil B (under test) is connected to the vacuum-tube voltmeter and to the condensers C and Ct as shown in Fig. 1D. The small condenser Ct should be set at zero on the scale (approx. half-capacity). The circuit is then tuned to resonance with the R.F. signal generator output which is of that frequency at which it is desired to match the coils by means of the condenser C.

The coil B is now removed and a second coil substituted, with as little disturbance of the connecting leads as possible. The condenser C and the signal generator are left with their settings unchanged and resonance re-established by adjustment of the condenser Ct.

When matching a coil that is coupled to another coil, such as in the case of an antenna coil with the primary "E" wound on the same form, it is necessary that the circuit of this second inductance be closed through a capacity "F" similar to that which is present in the actual circuit. In this case, it would be that of the dummy antenna recommended for use when aligning the receiver, usually 100 to 250 mmf.

(5) IMPEDANCE CHECKING

It is frequently necessary to check the impedance of various devices such as chokes, condensers, voice coils, etc. A typical set-up for these tests is shown in Fig. 1E. An oscillator is used to supply voltage of the frequency at which it is desired to know the impedance of the unit under test. The variable resistor R2 should be non-inductive and have greater impedance than that of the impedance Z, and be calibrated in ohms.

The procedure of this test is to adjust resistor R2 until the voltage across R2, as indicated by the vacuum-tube voltmeter, is equal to the voltage existing from A to B. When this condition has been obtained, the value of R in the circuit is equal to the ohms impedance of Z.

(6) CHOKES CARRYING D.C.

Frequently, it is necessary to measure the inductance of chokes carrying direct current when employed in the circuit for which they are intended. Tests should then be made with a direct-current flow of this value as shown in Fig. 1F, which is an adaptation of the tests shown in Fig. 1E. Here a test voltage is supplied from the power line, although a test signal of any other frequency can be used if the choke is to be employed in circuits of such frequency. A 10 mf. condenser C is used to isolate the input transformer T from the direct-current circuit. The choke L1 should be of generous proportions and

G. E. PHONOGRAPH MOTOR

\$4.95



Formerly Sold for \$15.00

VARIABLE speed induction type self-starting, 110 volt, 25 to 60 cycle, AC, with speed control. Plug and cord. Speed range from 5 to 200 RPM. Can be installed in place of old-fashioned, hand-winding speed motor. Also ideal for display turn table, and a hundred other uses. These General Electric Motors are brand new, in original factory cartons. G. E. Phonograph Motor, as described **\$4.95**
Shipping weight—12 lbs.

ONLY \$4.96 U. S. NAVY AIRPLANE-TYPE Microphone and Receiver

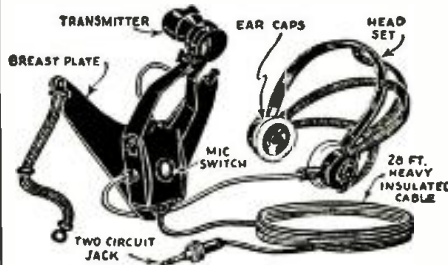

THIS Microphone and telephone headset outfit was built especially for the U.S. Navy Aviation Corps for Plane-to-Plane and Plane-to-Ground communication.

The Holtzer-Cabot Electric Company constructed the outfit to Government specifications and under rigid Navy Department supervision.

The outfit consists of a low-impedance carbon microphone (transmitter), securely fastened to a metal breast-plate, and a set of heavy-duty, low-impedance earphones. A specially constructed switch on the back of the breast-plate controls the microphone circuit. The earphones are U.S.N. Utah type, attached to adjustable headband. Twenty-eight feet of very heavy weather and waterproof conductor cable, terminating in a special brass plug, is furnished with this complete outfit. Current of not more than 10 volts should be used. A storage battery is the most satisfactory current supply. Talk in a natural tone of voice, when using the outfit, with the lips close to the mouth-piece. Shouting and loud talking should be avoided.

We understand that the U.S. Government paid more than \$40.00 for each of these outfits. We have bought the whole lot at a low price and are offering them, as long as the supply lasts, at \$4.96 each, complete as shown in illustration. The shipping weight is 9 lbs.

All merchandise in original packages—never used. Money-back guarantee.

All Shipments will be forwarded by Express Collect if not sufficient postage included.

WELLWORTH TRADING CO.
560 W. Washington Blvd., Dept. RC-337, Chicago, Ill.

Please Say That You Saw It in RADIO-CRAFT

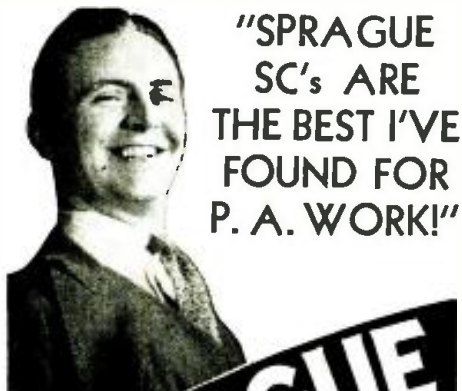

"SPRAGUE SC'S ARE THE BEST I'VE FOUND FOR P. A. WORK!"

SPRAGUE

The Standard of Condenser Quality

Of all the thousands of Sprague Inverted Aluminum Can Type Dry Electrolytics (Type SC's) sold last year, I'm convinced that MORE THAN HALF were used in Power Amplifier equipment where exceptionally good filtering and the ability to stand sudden surges are absolutely essential. Servicemen themselves will tell you they build up to 650 to 670 volts—and with extremely low leakages. We have done our best to give you the finest replacement condensers. We challenge competitors to equal their quality and electrical characteristics. Let me send the new Sprague Catalog today to help you on your next condenser order.

SPRAGUE PRODUCTS CO., North Adams, Mass.

preferably of inductance several times larger than the choke Z, being measured.

Adjust the direct current in the circuit by means of the control shown, to give the choke's normal current rating on the ammeter (the D.C. flow in the circuit to which Z is to be applied). Then employ the same procedure for measurement and calculation of the impedance of Z as given in the preceding illustration.

(7) SUPERHET OSCILLATOR STAGES

One of the most important uses of the combination vacuum-tube voltmeter and peak voltage indicator, is that of checking performance of the oscillator circuit in a superheterodyne receiver by means of the procedure outlined below.

The vacuum-tube voltmeter should be connected across the variable condenser in the oscillator stage of the radio receiver.

With the receiver turned on as shown in Fig. 1G, a voltage ranging from 5 to 15 V. will appear across the dial, its value depending upon the circuit constants and upon the type of tube used in the oscillator stage. As the receiver is tuned across the dial any variations in voltage output should be observed. Some variation will be due to the difference in sensitivity of the set at various frequencies within the same tuning band. However, the potential indicated on the vacuum-tube voltmeter should never vary more than 40 per cent from the highest value found on that band.

"Dead-spots" or points where the voltage drops abnormally low indicate defects, in the oscillator stage operation, and a careful examination of the receiver should be made to locate their cause and effect a remedy.

(8) A.F. TRANSFORMER RATIOS

A typical set-up for the determination of transformer ratios is given in Fig. 2A. Here an audio-frequency oscillator is used as a source of voltage to be applied across points A-B.

Check the A.F. voltage applied to the transformer input (which may be either the primary or secondary) and the ratio between it and the voltage indicated across the output of the transformer will then be the transformation ratio of the unit under test. The impedance ratio = $\frac{E_p^2}{E_s^2}$

where $\frac{E_p}{E_s}$ equals the ratio of primary turns to secondary turns.

The frequency characteristic of an A.F. transformer may be determined by loading each side of the transformer with its characteristic impedance and making use of a variable-output audio-frequency oscillator and the vacuum-tube voltmeter, as shown in Fig. 2A. Now by keeping the input voltage across the points A-B at a constant value we may vary the input frequency and obtain the output voltage.

(9) AMPLIFIER A.F. RESPONSE

This test requires the use of a variable-frequency audio-signal generator of good sine-wave output whose voltage output is uniform over the frequencies at which determinations are to be made.

In Fig. 2C there is shown a typical amplifier, having 500-ohm input and 500-ohm output. Amplifiers with other input and output impedances can be checked with suitable loading. For this amplifier, a 500-ohm-output A.F. oscillator may be directly connected without the resistor R1.

With the input voltage to the amplifier maintained constant either through the assumption that the audio-signal generator output is linear over the frequencies covered, or by checking with the vacuum-tube voltmeter and consequent adjustments, the frequency response of the amplifier can be plotted from the voltage read across the output at the various frequencies. Such the output at the various frequencies.

If the overall gain of the amplifier is desired, it may be secured by measuring the input voltage and determining its ratio to the output voltage at that frequency. Such gain measurements are usually made at 400- or 1,000-cycle points. The gain of the amplifier may be expressed in decibels when the input voltage and input impedance are known. First it is necessary to convert the input voltage to decibels by the following equation:

$$N \text{ (in db.)} = 20 \text{ Log. } \frac{V_1}{V_2} + 10 \text{ Log. } \frac{R_2}{R_1}$$

where V₁ is input voltage and V₂ is the output voltage. Also R₁ is input resistance and R₂ is output resistance of the amplifier.

This article has been prepared from data supplied by courtesy of the Clough-Brengle Co.

"... Right you Are, Buddy

... AND SPRAGUE SMALL PTM'S CAN'T BE BEAT AS INEXPENSIVE SERVICE REPLACEMENTS!"



CONDENSERS

USE SPRAGUES... and Note the Difference

Fellows, you'll find these small Cardboard Dry Electrolytic ETCHED FOIL Condensers (Sprague Type PTM) are built to take everything the rectifier will give them. They mean more pep for the set plus better tonal quality. Both you and your customers will quickly note the improvement. Conservatively rated at 525 volts, yet servicemen themselves say they'll take surges as high as 560 and even 580 volts! Won't break down because you can't reach the sparking point. FAMOUS SPRAGUE HUMIDITY-PROOF SEALING and other features at no additional cost.

Henry Salsbery
Sales Manager

SPRAGUE PRODUCTS CO., North Adams, Mass.

Build Your Own Shallcross Universal Tester



VOLTS
A.C.-D.C.
5-25-100-250-
1000 ohms per
volt.

MILLIAMPERES
D.C. 1-10-100-
1000

CAPACITY
.001-10 Mfd.
Paper or elec-
trolytic con-
densers.

INDUCTANCE
1-10,000 Hen-
rys. .5-5,000,000 ohms D.C. resis-
tance.

Send 6c in stamps for the new Bulletin No. 611-PL containing the complete wiring diagram and operation instructions for this modern serviceman's instrument.

SHALLCROSS MFG. COMPANY

Electrical Measuring Instruments and Accurate Resistors

700 MAC DARE BOULEVARD
COLLINGDALE, PA.

BE WISE— KENYONIZE

Three New Innovations!

Power Transformer Type T-207 Specially Designed For Oscillograph Circuits Utilizing The New Miniature 913 Tube.

End Power Supply Obsolescence With A Triple Winding Transformer. Over 30 Voltages Are Available Ranging From 400 To 3200 Volts.

- Type T-658 175 MA
- Type T-654 250 MA
- Type T-659 350 MA

Our Transmitter Manual Is Practically A Hand-Book. Obtainable For Twenty-Five Cents From Your Local Dealer.

Ask For Our New 1937 "T" Line Catalog.

Chief Engineer — P. A. Division

KENYON TRANSFORMER CO., Inc.

846 Barry St., New York, N. Y.

Please Say That You Saw It in RADIO-CRAFT

A NEW

Non-Reactive Dynamic Beam-Power Amplifier and Stream-Lined Bullet Electro-Dynamic Microphone . . .

Available at an almost unbelievable Low Price!



Provides 32 watts with unrestricted frequency response, non-reactive signal division, two-phase bridge rectification, stabilized power supply, variable polar response, etc., etc.

Write for Circular No. 3713 for complete details and prices of this amazing sound system development by A. C. Shancy.

AMPLIFIER CO. of AMERICA
37 West 20th Street New York, N. Y.

THE ABC OF A.F.C.

(Continued from page 533)

circuit from a given signal.

In the older sets, a high inductance was used, with little or no capacity except that inherent in the wire coil used for an inductance (self-capacity). In early sets, such as those used with a crystal, tuning was effected by sliding a contact along the coil and cutting-in a greater or lesser number of turns. Then (Fig. 1A) a *variometer* was used; that is, a coil of two sections, one of which could be rotated inside the other, to assist or to "buck" it. Different inductance values, and consequently different tuning, were obtained by turning the variometer knob. Theoretically, the variometer method of tuning has advantages, which it has been impossible to realize in modern sets; and it has been supplanted by the variable condenser method (Fig. 1B) which lends itself better mechanically to control of several circuits at once. After the single-circuit set, the gang-tuned R.F. receiver became standard (Fig. 1C); its competitor was the superheterodyne in which, originally, one knob tuned the R.F. circuit to the incoming signal, and a second knob tuned the oscillator. If the first was a little off, the second could correct the condition (Fig. 1D).

But, ever since the days when radio reception was turned over from "hams" and set builders to the public, the demand has been for receivers which tune as automatically as possible. Improved manufacturing methods have made gang condensers increasingly accurate. The new A.F.C. development increases this, by making the set correct errors of setting (just as A.V.C. has overcome fading and similar conditions). What it amounts to is putting a *variometer* across the oscillator inductance, and raising or lowering the oscillator frequency as many as 7 kc.

The purpose of inductance is to slow up the rate of change in any current which is pulsating or alternating; that of capacity to speed it up. Suppose we had a coil of rubber hose—very elastic, attached to a water tap (Fig. 2B). When we turn on the water, the hose would oppose the flow of water (C). It would fill up before the full flow appeared (D). When we shut the water off again, the hose would keep squeezing water out of itself (E), and maintain the flow till empty. With a given pressure, we could get only so much water into the hose in a given time. With a given size of tap, if we kept turning it on and off, we could get a certain amount of water through the hose in even spurts, in equal periods of time. That is something like our inductance-capacity circuit. It might take 15 seconds to fill the hose, during which there would be maximum pressure in it, but very little water would run out; then, when the tap was shut off, water would stream out of the lower end till the hose was empty. The amount of water flowing into the hose at any instant would not necessarily be the amount flowing out; nor would the pressure at the top correspond to the pressure at the bottom. Flow (current) and pressure would vary, but not simultaneously—as they would in a large, straight pipe, corresponding to ohmic resistance.

It is not possible to carry the water analogy too far. (Electricity is more like compressed air, pressing in all directions, than like water, which presses down only by its own weight.)

If we put two inductances, side by side, in an electrical circuit, the two will present less obstruction (less reactance) to a current; just as two pipes will carry more water than one. Similarly, if we put a resistance in parallel across an inductance (Fig. 2G) we lower the effective reactance; just as though we had decreased the inductance.

If, instead of putting a variometer across our oscillator tube's control-grid inductance, in the superheterodyne which we are considering, we put a resistor across the coil, we draw current when the inductance should hold it back, thus weakening the effect of the inductance. But, on the next quarter-cycle, the resistor would pass current when the inductance was also forcing it along, instead of bucking the inductance. The same would be true, in the case of a vacuum tube uniformly biased (positively) which can also be considered a special form of resistance.

But the trick of the A.F.C. is to make the tube V1 alter the frequency at which the circuit of tube V2 (Fig. 3) oscillates, regardless of the setting of the oscillator circuit L-C1-C2-C3. By making the tube act either in opposition to, or together with, the tuned grid inductance L, (Continued on next page)

HOW TO MAKE A "JUNIOR" OSCILLOSCOPE

(Continued from page 551)

- *One (special) cathode-ray-type transformer, P.T.;
- *One resistor, 5,000 ohms, 2 W., R1;
- *One resistor, wire-wound, 40,000 ohms, 20 W., R2;
- *One resistor, 6,000 ohms, 1 W., R3;
- *One resistor, 30,000 ohms, 1/2-W., R4;
- *One resistor, 1,000 ohms, 1W., R5;
- *One resistor, 1,500 ohms, 1 W., R6;
- *One potentiometer, 50,000 ohms (with switch, Sw.2, attached), R7;
- *One resistor, 10 meg., 1/2-W., R8;
- *One resistor, 0.125-meg., 2 W., R9;
- *One potentiometer, 50,000 ohms (with switch, Sw.1 attached), R10;
- *One potentiometer, 25,000 ohms, R11;
- *Two potentiometers, 3 meg., R12, R13;
- *One potentiometer, 5,000 ohms, 2 W., R19;
- *One resistor, 50,000 ohms, 1/2-W., R20;
- One Cornell-Dubilier dual condenser, 8-8 mf., 450 V., C1;
- One Cornell-Dubilier condenser, 8 mf., 200 V., C2;
- Two Cornell-Dubilier condensers, 0.1-mf., C3, C7;
- One Cornell-Dubilier condenser combination, 0.02- and 0.005-mf. (connected in parallel), C4;
- One Cornell-Dubilier condenser, 0.005-mf., C5;
- One Cornell-Dubilier condenser, 0.001-mf., C6;
- One RCA Radiotron type 913 (cathode-ray) tube, V4;
- One RCA Radiotron type 885 (sweep) tube, V2;
- One RCA Radiotron type 6D6 (current-limiting) tube, V3;
- One RCA Radiotron type 80 (rectifier) tube, V1;
- *One 4-point switch, Sw.3;
- One Terminal Radio Corp. basic kit: complete panel, cabinet and sub-base, all drilled and punched, ready for assembly; as well as all knobs, dials, binding posts, sockets, hardware, etc.).
- *One resistor, 1,000 ohms, 1/2-W., R14;
- *Three resistors, 1/2-meg., 1/2-W., R15, R16, R17;
- *One resistor, 2 meg., 1/2-W., R18;
- One Cornell-Dubilier electrolytic condenser, 10 mf., 25 V., C8;
- Two Cornell-Dubilier condensers, 0.1-mf., 400 V., C9, C10;
- One Cornell-Dubilier condenser, 0.5-mf., 400 V., C11;
- One Cornell-Dubilier condenser, 8 mf., 450 V., C12;
- One RCA Radiotron type 6JZ (voltage amplifier) tube, V5;
- *One D.P.D.T. switch, Sw.4;
- Misc. hardware.
- *Names of manufacturers will be sent upon receipt of a stamped and self-addressed envelope.

MILLION TUBE TESTER



- FEATURES**
1. Emission
 2. Metal Tubes
 3. Shorts HOT
 4. Leakage HOT
 5. Resistance
 6. Electrolytics
 7. By-Pass Condensers
 8. Neon Alignment

MODEL CN
\$9.95 NET

Here's what the Service Men say about the New Million Tube Tester! "Most valuable purchase of test equipment we made during the last year." "It shows up weak tubes better than my expensive—tester."

If your jobber cannot supply you—order direct—90¢ deposit required on C. O. D. orders. Tear out this ad and send it to us NOW for information on complete line.

MILLION RADIO AND TELEVISION LABORATORIES
361 W. SUPERIOR ST., CHICAGO, ILL.

RADIOS

ALL NEW 1937 MODELS

SAVE UP TO 50%



A penny post card brings you our new full color 48-page BARGAIN CATALOG free. Many models to choose from. 4 to 11 tubes; AC-DC; All-Wave and new Farm sets that operate like city radios! Send post card for complete catalog. For full details of 30-day interest trial and 30-day return privilege, write now.

30-DAY NO-RISK TRIAL

\$6.98

MAIL COUPON



Enjoy it a month, then decide. Write!

GOLDENTONE RADIO CO. Dept. B, DEARBORN, MICH. Without obligation, send me your 1937 Catalog and 30-day trial 1937. Name _____ Address _____

FREE Correspondence Courses in RADIO and ELECTRICAL ENGINEERING

ELECTRICAL ENGINEERING covers complete electrical field. Most modern course. So simplified anyone can grasp it quickly. LOW COST! Only \$25. Deferred payment plan.

RADIO ENGINEERING Ultra-modern course in radio, public address, photo-electric work. Training you to be super-service man, real vacuum tube technician. Diploma given. Exper. Kit—on limited time offer. Tuition only \$25. Deferred payment plan.

Write today for free copies of school catalogs, student magazines, etc. Get started at once. SEND NOW!

LINCOLN ENGINEERING SCHOOL, 931-15 So. 37th St., Lincoln, Neb.

WESTINGHOUSE

Universal Motor
110 VOLTS AC AND DC



\$2.95

Shipping Weight 3 lbs.

These Motors are manufactured by the Westinghouse Electric Co. They have never been used and are absolutely new. Specifications: 130 H.P. operates on either A.C. or D.C., 110 volts, 5000 R.P.M. Rheostat can be used to vary speed. Height 3 3/4". Length 3 3/4". Width 1 1/2". Shaft 3/8" one inch long. Can be used to drive Sewing Machines, Models, Drills, Grindstones, etc. etc.

MOTOR only **\$2.95**
MOTOR with Arbor and 1/4" Chuck .. **\$3.95**

Add 25c for special packing and mailing anywhere in U. S. A. Money back Guarantee.

WELLWORTH TRADING CO.
Dept. RC-337
560 W. WASHINGTON BLVD., Chicago, Ill.

Please Say That You Saw It in RADIO-CRAFT

IN 1937 USE

**Imprinted
THREE-COLORED
ADVERTISING
PENCILS
AS BUSINESS CARDS**

In 1937 hand your customers and prospects a modern, impressive business card, a white pencil with your name, type of business, address, city and telephone number clearly printed in black with a decorative red flash border. Imprinted advertising pencils (instead of old-fashioned paper business cards) are becoming more and more popular. Pencils are useful, and very effective business boosters. They bring prospects back, and help make sales. As one consistent user of advertising pencils says, "Every time an imprinted pencil is used by a prospect, his or her thoughts turn to the advertiser. Sooner or later a sale is made."

Imprinted advertising pencils are used by thousands of firms. THEY ARE INEXPENSIVE AND EFFECTIVE SILENT SALESMEN.



Enlarged View of Imprint

REGULAR 5c GRADE HARDWOOD PENCILS

RED PARA ERASER

GILT TIP FERRULE

WHITE, FULL-LENGTH PENCIL

Imprint Consists of Four Lines Printed in Black Ink with Red Flashes on Each Side

PROMPT SERVICE

Every order receives immediate, careful attention. You are also guaranteed a perfect printing job with every assurance that your imprint will be correct in every respect. ALL ORDERS ARE SHIPPED F.O.B. New York City. One hundred pencils, packed for shipping weighs 2 lbs.

GRENPAK COMPANY
99 Hudson St., New York

CLIP COUPON—NOW!

GRENPAK COMPANY RC-337
99 Hudson St., New York, N. Y.

Gentlemen: Enclosed you will find my remittance of \$..... for which you are to imprint the number of pencils checked below.

100 for \$4.00

200 for \$6.50 300 for \$8.25 400 for \$9.50
 500 for \$11.25 750 for \$13.50 1,000 for \$17.00

The copy is to be imprinted as follows:

..... (Print carefully name of company or individual)

..... (Number of six words)

..... (Address) (Telephone Number)

..... (Town or City) (State)

Send remittance in form of check or money order. Retain letter if you send cash or currency. (N.O.D. Orders Accepted.)

effective inductance of the circuit is raised (lowering the frequency) or lowered (raising the frequency) so far as the R.F. voltage on the control-grid of V2, and its consequent voltage output, are concerned. And this, correspondingly, affects the I.F.

In order to do this, it is necessary to make the plate voltage of V1 oppose the oscillator control-grid voltage, set up in the oscillator tuned circuit, whenever the receiver's I.F. amplifier is getting signals "off peak." This is done by feeding the regulatory signals to V1 from the resistance-capacity voltage divider R-C, which is across the oscillator coil. The presence of the small condenser C "lags" the voltage behind the current (just the reverse of an inductance's action); and the output of the tube V1 thus opposes the action of the tuned coil (L), the voltage of which is also applied to the control-grid of V2. (If the amplification of V1 were sufficiently high, it would completely neutralize the oscillation; but it is not.) This carefully-made adjustment, and the action of the diode-detector of the receiver, biasing V1, change the frequency of V2; just as though we were turning the rotor of a variometer coil in parallel across L, as sketched in our first diagram (Fig. 1, at E).

SOURCE OF A.F.C. VOLTAGE

The next question is, where does the regulating voltage, for the grid of V1, come from? We turn to Fig. 4, which shows the standard double-diode detector of a receiver. As will be seen, the output of the I.F. amplifier is across the plates of this diode, which serves as a full-wave rectifier, one plate and cathode functioning on each half-wave. If the signal received is converted to the proper I.F. by the action of the oscillator, the waveform passed through the tuned I.F. amplifier comes out symmetrical (Fig. 4B); as it is a product of the signal carrier wave and the equally symmetrical wave from the oscillator tube. But, if these two waves do not blend to make one which the I.F. amplifier is peaked to handle, there will be distortion—as shown at Fig. 4C, which represents the figure shown in an oscilloscope.

The result when the 2 halves of the waves, rectified respectively by the 2 diodes P1-C1 and P2-C2 of the detector tube, are unequal, is to build up different voltages across their corresponding resistors, R2 and R3 (Fig. 4A). Now, when the waveform is symmetrical, these voltages are equal and opposite and therefore cancel each other; but if they are unequal, either a positive or a negative total voltage results, and this is fed by a lead from the upper end of R2 to the control-grid of the A.F.C. tube V1 which we showed in Fig. 3. We now reproduce the whole of this part of the receiver in Fig. 5.

When a positive R2-R3 voltage (as the result of the unequal detection of V3) reduces the bias on the control-grid of V1, the A.F.C. tube, V1 draws more current. This is equivalent to having a smaller inductance across the oscillator tube, V2; and the frequency of its oscillations will rise. This, in turn, will increase the frequency of the mixed signal which is passing through the I.F. amplifier.

If the I.F. signal frequency is instead, too high, the difference in voltage becomes greater on the negative side.

There are numerous details, in the adjustment of the A.F.C. circuits, required to give proper results; but the above presents a simplified explanation of the principle.

ORSMA MEMBERS' FORUM

(Continued from page 546)

servicing: General Electric (both U.S.A. and English makes), Atwater Kent, Philco, Airline, Philips, Telefunken (German), Scott, Majestic (last models), and several others.

I should like to mention that *Radio-Craft* is a good magazine, and full of "the goods" for fellows like myself. I wish you continued success always.

NORMAN KING,
30 Edinburgh Court,
Von Brandis St.,
Johannesburg, South Africa.

Since writing the above Mr. King has passed his tests, with flying colors, and been duly enrolled as a full-fledged ORSMA member.

It certainly is interesting to note the wide variety of radio sets a Service Man in such a cosmopolitan center as Johannesburg is called upon to recondition.

"BULLET" DYNAMIC MICROPHONES



AT LAST an ALL-PURPOSE Microphone . . .

T. R. 2—Standard model "Bullet" . . . the ultimate in dynamic microphone design . . . List price \$39.50.

T. R. 3—New model "Bullet" . . . smaller than T. R. 2 but with relatively the same characteristics . . . List price \$24.50.

Consider these outstanding "BULLET" features combined in one microphone . . .

- Maximum sensitivity
- Effective at long distance from amplifier
- Wide choice of impedances
- Remarkable tone quality
- Attractive, modern appearance
- Unequaled for severe outdoor work

Send for circular and technical data

TRANSDUCER CORPORATION

30 Rockefeller Plaza
New York, New York

for 1937



SELL TUBES ON "Velvet"

In the Tung-Sol consignment plan there's no tied-up capital. A stock of Tung-Sol radio tubes on your shelves means "velvet" sales. You pay only for tubes sold. Orders—not cash investment—keep your stock replenished.

Desirable locations are still open for independent service organizations which can qualify. Write for the name of your nearest Tung-Sol tube wholesaler today.

TUNG-SOL

Tone-flow radio Tubes
TUNG-SOL LAMP WORKS, INC.
Radio Tube Division
NEWARK, N. J.

Please Say That You Saw It in RADIO-CRAFT

EDUCATIONAL 10 CENTS RADIO BOOKS



RADIO FANS! . . . Help yourselves to a radio education for the price of 40c. (10c per book). These books will give you a good foundation towards the study of radio. You'll be amazed at the wealth of information contained in them—and you'll wonder how we can sell them at the low price of 10c each. Each book contains 32 pages written in simple, understandable language and profusely illustrated with circuit diagrams and illustrations. They are especially written for beginners but are useful review and reference books for the old timers as well.

ALL ABOUT AERIALS

In simple, understandable language this book explains the theory underlying the various types of aerials: the inverted "L," the Doublet, the Double Doublet, etc. It explains how noise free reception can be obtained, how low-impedance transmission lines work; why transposed lead-ins are used. It gives in detail the construction of aerials suitable for long-wave broadcast receivers, for short-wave receivers, and for all-wave receivers. The book is written in simple style. Various types of aerials for the amateur transmitting station are explained, so you can understand them.

ALTERNATING CURRENT FOR BEGINNERS

This book contains everything to give the beginner a foothold in electricity and Radio. Electric circuits are explained. Ohm's Law, one of the fundamental laws of radio, is explained; the generation of alternating current; sine waves; the units—volts, amperes, and watts are explained. Condensers, transformers, A.C. instruments, motors and generators—all these are thoroughly discussed. Housewiring systems, electrical appliances and electric lamps.

Here are some of the practical experiments which you can perform at home. Simple tests for differentiating between alternating and direct current; how to light a lamp by induction; making a simple electric horn; demagnetizing a watch; testing upon armatures; charging storage batteries from A.C. outlet; testing condensers with A.C.; making A.C. electro magnets; frying eggs on a cake of ice; making simple A.C. motors and many others.

HOW TO MAKE THE MOST POPULAR ALL-WAVE 1- and 2-TUBE RECEIVERS

There has been a continuous demand right along for a low-priced book for the radio experimenter, radio fan, radio Service Man, etc., who wishes to build 1- and 2-tube all-wave sets powerful enough to operate a loudspeaker.

This book contains a number of excellent sets, some of which have appeared in past issues of RADIO-CRAFT. These sets are not toys but have been carefully engineered. They are not experiments. To mention only a few of the sets the following will give you an idea.

- The Megadyne 1-Tube Pentode Loud-speaker Set, by Hugo Gernsback.
- Electrifying The Megadyne.
- How to Make a 1-Tube Loud-speaker Set, by W. P. Chesney.
- How To Make a Simple 1-Tube All Wave Electric Set, by F. W. Harris.
- How To Build A Four-In-Two All-Wave Electric Set, by J. T. Bernsley, and others.

HOW TO MAKE FOUR DOERLE SHORT WAVE SETS

Literally thousands of radio fans have built the famous DOERLE Short Wave Radio Receivers. So insistent has been the demand for these receivers, as well as construction details, that this book has been specially published.

Contains **EVERYTHING** that has ever been printed on these famous receivers. These are the famous sets that appeared in the following issues of SHORT WAVE CRAFT: "A 2-Tube Receiver that Reaches the 12,500 Mile Mark," by Walter C. Doerle (Dec., 1931-Jan., 1932). "A 3-Tube 'Signal Gripper,'" by Walter C. Doerle (November 1932). "Doerle 2-Tube" Adapted to A. C. Operation" (July 1933). "The Doerle 3-Tube 'Signal-Gripper' Electrified," (August 1933) and "The Doerle Goes 'Band-Spread'" (May, 1934).

Due to a special arrangement with SHORT WAVE CRAFT, we present a complete 32 page book with stiff covers, printed on an extra heavy grade of paper with numerous illustrations. **Nothing has been left out.** Not only are all the DOERLE sets in this book, but an excellent power pack if you wish to electrify any of the DOERLE sets, also described.

Each book contains 32 pages, profusely illustrated with clear, self-explanatory diagrams. *It contains over 15,000 words of clear legible type.* It is an education in itself and lays the ground-work for a complete study of radio and electricity.

If you do not think that this book is worth the money asked for it, return it within 24 hours and your money will be instantly refunded.

Radio Publications
99A Hudson St., New York, N. Y.

Send for our **FREE circular listing**
48 new 10c Publications

RADIO PUBLICATIONS RC-337
99A Hudson Street, New York, N. Y.

Please send immediately books checked:

How to Build Doerle Short-Wave Sets, No. 1 10c

How to Make the Most Popular All-Wave 1- and 2-Tube Receivers, No. 2 10c

All About Aerials, No. 4 10c

Alternating Current for Beginners, No. 3 10c

I am enclosing the price of each book is 10c. (U. S. Coin or U. S. Stamps acceptable.)
Books are sent postpaid.
Send me also your **FREE circular listing** 48 new 10c publications

Name

Address

City State

RADIO-CRAFT FARM SET — ADDITIONAL DATA —

The original Lamb noise suppressor and our adaptation of it, suggest in effect a "rapid fire" A.V.C. system so adjusted that it will follow and attenuate especially brief noise impulses of the electric motor-auto ignition variety. In rural communities, where, this type of noise does not become of appreciable importance, therefore, a suppressor system of the high-speed type and used primarily to control static interference, cannot be expected to perform as it would in an A.C. receiver installed in a noisy city location.

If the circuit as shown is used and static suppression is expected of it, efficient attenuation of only the briefest noises—or of noises made up of extremely brief impulses, may be expected.

Frankly, this and other noise systems where used in a farm receiver call for some timing adjustment particularly suitable to conditions and location. Sufficient lag should be introduced by means of trial and error resistor-condenser com-

binations connected (a la A.V.C. filter) into the suppressor line to the 6L7 second I.F. until we have good control of an "average" static crash. Of course the system in operation may disturb the quality of the signal desired to some extent, but if the timing is correct this effect will be negligible.

With lag introduced, some method of controlling the noise amplification is desirable if not definitely necessary so that adjustments may be made to suit conditions, and so that the gain may be turned down to prevent the desired signal itself from affecting the I.F. circuit. We already have one A.V.C. system. Another, speedy one working on the signal might have a nice "mince-meat" effect. Another, slow one might cause plenty of trouble.

Don't put in too much lag. The idea, let us repeat, is to follow the static, not the signal level.

Please Say That You Saw It in RADIO-CRAFT

HOW TO MAKE THE RADIO-CRAFT SET ANALYZER

(Continued from page 538)

Thus, knowing the capacity of one condenser, C, and the voltages across the two condensers, C (or C and C1) and Cx, it is an easy matter to determine by means of the following formula the capacity of the "unknown" (Cx). Substitute the readings taken from the voltmeter and substitute them in the following formula

$$Cx = \frac{Em X Cs}{El - Em}, \text{ where}$$

Cx is the unknown capacity under test.
El is the line voltage (read with the terminals of Cx, Fig. 2A, shorted).

Cs is the capacity of the voltmeter shunt.
Em is the voltage read on the voltmeter with the unknown capacity connected to the test terminal.

While this circuit arrangement requires, and this may be an objection to its use, a certain amount of arithmetic to determine the value of the unknown capacity, the advantages of low cost and a capacity measurement range of 80 to 1 are well worth the simple calculation necessary. (The 0-250 V. A.C. scale is used for these measurements.)

The high-sensitivity voltmeter used in this instrument lends itself to a very satisfactory and simple set-up for peak-voltage measurements in filter circuits.

The circuit is shown in Fig. 2C. Here a 3-element tube, V, is used, as a half-wave rectifier, in series with the condenser C; which must be rated at a voltage greater than the possible circuit peak voltage. Tube V should be selected for its ability to withstand any possible voltage from the circuit under test.

In operation the circuit will permit current to flow in one direction only and the condenser C will become charged to the peak value of the voltage appearing across the test terminals. (As this particular voltmeter has a high internal resistance there will be a very slight discharge from the condenser during that time of the cycle when the voltage is less than the peak value. If condenser C is selected to have a capacity of 4 mf. then the error will be about 5 V. in 500.) Voltages will be read on the 750 V. D.C. scale.

The next time that you encounter breakdowns in filter circuits use this simple method to determine the "peak" voltage, in this portion of the circuit, before replacing the defective units. The only requirement for filament transformer T is that it deliver the correct voltage to tube V. (Most of the better filament transformers available today are well-insulated between windings and consequently the probability of break-down is slight.)

POWER OUTPUT METER

A circuit, that is familiar to most Service Men, showing the use of the A.C. voltmeter as an output meter will be found in Fig. 2D. Condenser C in this figure has a capacity of 2 mf. or larger and, rated at 600 V. (working) when used in radio receiver testing and 1,000 V. (working) for P.A. work, should be of the non-inductive type. This condenser eliminates the danger of D.C. flowing in the meter rectifier circuit. Any voltage scale may be used when the "A.C.-D.C." switch is in the A.C. position.

DB. METER

The A.C. voltmeter scales also may be used to determine the power output of audio amplifiers by reference to Table III, which lists Volts versus DB. The circuit of Fig. 2E shows the method of connecting across the meter a fixed resistance, R, of 500 ohms.

After connecting the resistor as shown, place the test prongs on the 500-ohm output winding of the amplifier, pass a signal and read the peak swing of the meter. Refer to the chart and, on the equivalent Volts line, read the value in Watts; and the level in "DB. above (or below) '0' level of 0.006-W. (6 milliwatts)." A range of -10 to +9 db. can be obtained on the 5-V. scale. Up to +29 db. on the 50-V. scale and over 40 db. on the 250-V. scale. Do not permit D.C. to flow through the meter when the rectifier is in the circuit.

This concludes the construction article on an efficient Set Analyzer.

ADVERTISERS' INDEX

A	
Alloy Transformer Co., Inc.	566
Aerovox Corporation	564
Allied Radio Corporation	553
Amperite Corporation	569
Amplifier Co. of America	572
Amplitone Products Co.	568
Arrow Sales Corporation	566
C	
Central Radio Laboratories	567
Classified Section	569
Clough-Brengle Company	556, 567
Continental Carbon, Inc.	570
Cornell-Dubilier Corp.	566
Cornish Wire Company	564
Coyne Electrical School	513
D	
Dodge's Institute	569
Allen B. Dumont Labs., Inc.	557
E	
Ellen Radio Laboratories	557
Electrad, Inc.	565
Electric Institute	558
Electrical Salvage Company	562
Electro-Dyne Mfg. Company	566
G	
General Cement Mfg. Co.	566
General Electric Company	Back Cover
Goldentone Radio Company	572
Grempark Company	573
H	
Hallcrafters, Inc.	551
Hammarrund Mfg. Company	565
Hysgrade-Sylvania Corp.	565
I	
Illinois Condenser Company	565
Industrial Amplifier Systems Co.	565
International Correspondence Schools	568
K	
Kenyon Transformer Co., Inc.	571
L	
Lancaster, Alvine & Rommel	567
Lincoln Engineering School	572
M	
Metal Cast Products Company	569
Midwest Radio Corp.	555
Million Radio & Television Labs.	572
N	
National Carbon Company	569
National Radio Institute	515
National Schools	565
National Union Radio Corp.	557
New York YMCA Schools	566
O	
D.W. Onan & Sons	566
The Oxford-Tartak Radio Co.	565
R	
RCA Institutes, Inc.	566
RCA Mfg. Company, Inc.	547
Radio & Technical Publ. Co.	554, 555
Radio & Television Institute	561
Radio Circular Company	564
Radio City Products Co.	560
Radio Publications	574
Radio Service Institute	562
Radioteknic Laboratory	570
Radio Training Assoc. of America, Inc.	543
Radolek Company	575
Raytheon Production Corp.	530
Readrite Meter Works	563
Remington Rand, Inc.	569
S	
S. O. S. Corporation	566
Shallross Mfg. Company	571
Solar Mfg. Company	559
Sprague Products Co.	571, 571
Sprayberry Academy of Radio	551
Superior Instrument Co.	568
Supreme Instruments Corp.	Inside Front Cover
T	
Teleplex Company	562
Terminal Radio Company	560
The Plan Shop	569
Transducer Corporation	573
Trinn Radio Mfg. Company	555
Triplet Elect. Instrument Co.	552
Try Mo Radio Company	565
Tung Sol Lamp Works, Inc.	573
U	
Universal Microphone Co., Ltd.	566
W	
Montgomery Ward & Co.	549
Wedco Manufacturing Co.	556
Wellworth Trading Company	570, 572
Weston Elect. Instruments Corp.	Inside Back Cover
Wholesale Radio Service Co.	559
Wright-DeCoster, Inc.	575
Z	
Zephyr Radio Company	565

(While every precaution is taken to insure accuracy, we cannot guarantee against the possibility of an occasional change or omission in the preparation of this index.)

MAKE THIS POCKET-SIZE MULTI-TEST UNIT

(Continued from page 539)

available in commercial pocket testers. The ohmmeter portion of the tester is entirely self-contained and is designed to accurately measure values of resistance that are considerably lower and also higher than the ranges of any similar instrument available. The scales are not "forced" at the extreme upper and lower ends as is sometimes done for the purpose of claiming ranges that are available technically, but not practically. The low-ohm range is of the "reverse" type using a back-up circuit; the middle of the scale reads only $5\frac{1}{2}$ ohms and the very first 10 divisions each read 1/10-ohm. The complete instrument, which measures only $3 \times 5\frac{7}{8} \times 2$ ins. deep, can be conveniently slipped into a coat pocket for that hurry-up job. It will also be a very handy and useful tester in the shop. The panel, which is made of 1/8-in. thick bakelite, is drilled and lettered as per Fig. 1. This layout gives symmetry and compactness. The meter is a D'Arsonval movement, bakelite case, $2\frac{3}{4}$ in. microammeter, range 0-500, accurate within 2 per cent. To use as an ohmmeter the zero-adjust control is varied by means of a screw-driver for full-scale meter reading; it is unnecessary to short the test prods during this balancing procedure. Nothing else is necessary for high-range (H.O.) measurements. When the medium (M.O.) range is used, one of the contact leads (either 1 or 2) is inserted in the lower-right-hand jack. In order to use the low range (L.O.) both contact leads are used; one is inserted in the lower-left-hand tip-jack and the other is connected to the lower-right-hand jack.

Altogether the tester serves as 12 independent meters having the following ranges:

Ohmmeter	Milliammeter	Voltmeter
0-500 ohms	0-555 microamps.	0-5
0-50,000 ohms	0-5 ma.	0-50
0-1. meg.	0-50 ma.	0-500
	0-500 ma.	0-1,000
	0-5 A.	

LIST OF PARTS

- One Radio City Products Co. engraved panel;
- One "Dependable" meter, 0-500 microamps. (with special, No. 408 dial); M;
- One Radio City Products Co. kit of 4 shunt resistors: 0.125-ohm, R1; 1.125 ohms, R2; 11.25 ohms, R3; 112.5 ohms, R4;
- One Radio City Products Co. kit of 4 circuit resistors: 1,000 ohms, R5; 11,000 ohms R10; 5.25 ohms, R11; 5.92 ohms, R12;
- One Radio City Products Co. kit of 4 multiplier resistors: 9,000 ohms, R6; 81,000 ohms, R7; 0.81-meg., R8; 0.9-meg., R9;
- One tapered, zero-adjust potentiometer, 0-250/4,000 ohms, R13;
- Two flat batteries (one $4\frac{1}{2}$ V. and one 3 V.);
- Thirteen tip-jacks, J1 to J13;
- Two phone tips with flexible leads, 1, 2;
- Three fibre strips cut as follows: $1 \times 6\frac{3}{4}$ ins.; $1\frac{1}{2} \times 5\frac{1}{2}$ ins.; $2 \times 1\frac{1}{2}$ ins.

This article has been prepared from data supplied by courtesy of Radio City Products Company.

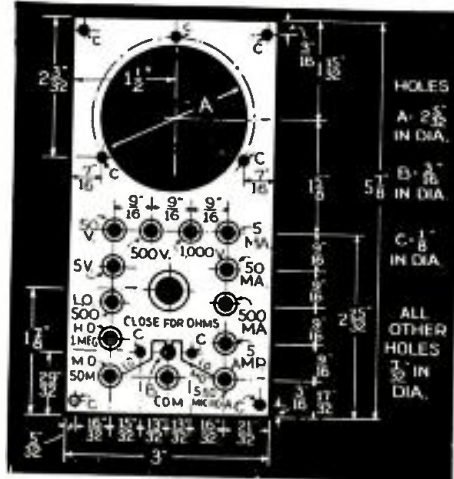

Fig. 1. The panel drilling and engraving details. Please Say That You Saw It in RADIO-CRAFT

NOKOIL

The Recognized Standard of Comparison for Permanent Magnet Speakers



Model 980 8" Nokoil

RADIO PUBLIC ADDRESS INTERCOMMUNICATION SYSTEMS

"A NOKOIL Speaker for Every Purpose"

Send for prices and catalog describing the 10 different Nokoil models.

Ask for the name of our nearest distributor. Wright-DeCoster distributors are always anxious to cooperate.

WRIGHT-DECOSTER, Inc.
2251 University Ave., St. Paul, Minnesota
Export Dept.—M. Simons & Son Co., New York
Cable Address: "Simontrice."
Canadian Office, Associated Sales Co., Guelph, Ont.



DRESS UP!

... your profits with Radolek's Radio Supply Service! Radolek Service is "tailored" to exactly fit your every radio requirement... and purse. Radolek SPECIALIZES in giving the radio-man what he wants, when he wants it, and at the right prices. The 1937 Radolek Radio Profit Guide is just off the press... Completely new! Over 12,000 values! Hundreds of new items. Merchandise you've never seen before.

Repair Parts, Radio Sets, Amplifiers, Test Instruments, Tubes, Tools, Books, "everything in Radio and Public Address." You need this complete "guide" to greater profits. Send for yours today. FREE!

RADOLEK

601 W. RANDOLPH, CHICAGO, DEPT. C3
SEND ME THE RADOLEK RADIO PROFIT GUIDE FREE

NAME _____
ADDRESS _____
Serviceman? Dealer? Experimenter?

GERNSBACK RADIO MANUALS AND SERVICE HANDBOOK ARE AVAILABLE FROM JOBBERS AND MAIL ORDER HOUSES

Your nearest radio jobber and mail order house carries a complete stock of Gernsback Official Radio Service Manuals and Service Handbooks. For quick, efficient service visit or write them today. There is no delay. Your Manual or Handbook will be in your hands in a day or two. Our vast distribution network permits us to offer you the rapid, intelligent service you have a right to expect from your publisher.

Here's the New Book for Radio Men!

Official Radio Service Handbook by J. T. Bernsley



HERE'S the new book on radio servicing that contains everything Service Men must know. The book, OFFICIAL RADIO SERVICE HANDBOOK, is edited by J. T. Bernsley, foremost radio service authority. This 1936 service guide is the only book of its kind—its editorial material is so well prepared that the technical information can be understood by even beginners in radio servicing. Every page contains new material, new illustrations—no reprinted literature. The OFFICIAL RADIO SERVICE HANDBOOK covers thoroughly over 500 radio topics. It tells you how to analyze the latest commercial receiver circuits; how to really make money servicing midget sets; and, how aligning supers can be made easy. It stresses the many uses of different types of test equipment; it gives you short cuts in trouble-shooting and repairing; and, contains over 250 pages of operating notes on 1,000 manufactured receivers. So up-to-date is the OFFICIAL RADIO SERVICE HANDBOOK that it explains thoroughly the features and innovations in the most modern of receivers.

Partial Contents of This Great Book!

PART 1—CIRCUIT THEORY AND ANALYSIS

R.F. Fundamentals; Superheterodyne Receiver Theory; A.V.C. and Tuning Indicator Circuits; A.F. Fundamentals; Power Supply Theory and Circuits; Speakers, Reproducers and Pick-Ups; Commercial Receiver Circuits of All Types, How to Analyze.

PART 2—MODERN SERVICING AND TEST EQUIPMENT

Fundamentals of Metering and Test Equipment; Standard Servicing Instruments; The Cathode Ray Oscilloscope and Associate Instruments; How to Build Essential Servicing Test Instruments.

PART 3—PRACTICAL SHORT-CUTS IN TROUBLE SHOOTING AND REPAIRING

Localizing Trouble by Inspection Methods; Short-Cuts with Test Instruments; How to Quickly and Properly Perform All Types of Repairs; Unusual Servicing Experiences; Tube Troubles and Characteristics.

PART 4—SPECIALIZED RECEIVER AND INSTALLATION DATA

All-Wave and High Fidelity Receiver Servicing and Installation Data; Auto-Radio Receiver and Installation; Specialized Servicing and Installation (Remote Tuning Controls, Home Recording, Automatic Record Changers, Apartment House Antennae, etc., etc.); Eliminating Noise Interference.

PART 5—MODERNIZATION AND CONVERSION DATA

Modernizing and Improving Methods for All Types of Receivers; Converting A.C. Receivers for D.C. Operation and Vice Versa.

PART 6—SOCIAL AND ECONOMIC PROBLEMS OF THE SERVICE MAN

Improving Knowledge and Technique; Social Problems—How to Organize, Listing of Servicemen's Organizations; The Future of the Servicing Profession.

PART 7—OPERATING NOTES AND PRACTICAL DATA LISTINGS

Operating Notes on Over 1,000 Receivers; I.F. Peaks of Approximately 3,000 Receivers; Voltage Dividers for 300 Receivers, Speaker Field Listing; Radio Mathematics and Measurements.

OVER 250 PAGES OF OPERATING NOTES

Whether it is a fading job, lack of sensitivity, noise within the receiver, aligning a chassis, poor A.V.C. action, a "cockeyed" Magic Eye tuning indicator or any other trouble that is usually the "bugaboo" of most Service Men, you will find the symptoms and remedy clearly described in OFFICIAL RADIO SERVICE HANDBOOK. The exact procedure for repairing, as well as the characteristic trouble in almost all models of manufactured sets, will be found in this section on OPERATING NOTES—over 250 pages of this data, the most important information to any radio man in the servicing field. The author takes nothing for granted. The procedure for aligning supers, whether one, two, three or more bands, is clearly and practically explained. You can quickly grasp the ideas and put them into successful practice. The material in this section has been arranged, as well as classed, so there is no difficulty in immediately locating the necessary information.

OVER 1,000 PAGES
OVER 1,000 ILLUSTRATIONS
Beautiful Linen, Gold-Stamped Cover 6 x 9 Inches

THE
1936 MANUAL
IS READY
See Page 516

If your jobber or mail order house cannot supply you, order any of the OFFICIAL RADIO SERVICE MANUALS or the OFFICIAL RADIO SERVICE HANDBOOK directly from the publishers. Send your remittance in form of check or money order—if you send cash or un-used U. S. Postage Stamps, be sure to register your letter. ALL ORDERS ARE FILLED PROMPTLY. BOOKS ARE SENT TO YOU POSTAGE PREPAID. Address Dept. RC-337.

RADCRAFT PUBLICATIONS, INC.
99 HUDSON STREET
NEW YORK, N. Y.

OVERSEAS READERS
These books can be obtained from the following houses:

GREAT BRITAIN
Garrino's, 9a, Green Street, Leicester Square, London, England

FRANCE
Editions Radio, 42 Rue Jacob, Paris

AUSTRALIA
McGill's 183-195, 218 Elizabeth St., Melbourne, C. I

NEW ZEALAND
James Johnston, Ltd. 393 Princes St., Dunedin, C. E.

WHICH OF THESE OFFICIAL RADIO SERVICE MANUALS DO YOU NEED TO COMPLETE YOUR FILES?

There's perhaps one or more of these great service manuals which you might need to complete the set. Collectively they represent the largest collection of service data ever compiled. Evidence of their importance to Radio men is shown by the fact that over 80,000 OFFICIAL RADIO SERVICE MANUALS have been sold during the past few years.



1935 OFFICIAL RADIO SERVICE MANUAL
Over 1,000 Pages, 9 x 12 Inches Over 3,000 Illustrations
Flexible, Looseleaf, Leatherette Cover
List Price \$7.00

1934 OFFICIAL RADIO SERVICE MANUAL
Over 400 Pages, 9 x 12 Inches Over 2,000 Illustrations
Flexible, Looseleaf, Leatherette Cover
List Price \$3.50

1933 OFFICIAL RADIO SERVICE MANUAL
Over 700 Pages, 9 x 12 Inches Over 2,000 Illustrations
Flexible, Looseleaf, Leatherette Cover
List Price \$5.00

1932 OFFICIAL RADIO SERVICE MANUAL
Over 1,000 Pages, 9 x 12 Inches Over 2,000 Illustrations
Flexible, Looseleaf, Leatherette Cover
List Price \$5.00

1931 OFFICIAL RADIO SERVICE MANUAL
650 Pages (Including Supplements) 9 x 12 Inches
Over 1,500 Illustrations
Flexible, Looseleaf, Leatherette Cover
List Price \$4.50
(Including Supplements)



For Car-Radio Servicing—Get These AUTO-RADIO SERVICE MANUALS

1935 Official Auto-Radio Service Manual
Over 240 Pages 9 x 12 Inches
Over 500 Illustrations
Flexible, Looseleaf, Leatherette Cover
LIST PRICE \$2.50

1933 Official Auto-Radio Service Manual
Over 240 Pages 9 x 12 Inches
Over 500 Illustrations
Flexible, Looseleaf, Leatherette Cover
LIST PRICE \$2.50

THE
1936 MANUAL
IS READY
See Page 516

Please Say That You Saw It in RADIO-CRAFT

RECTIFIED RF SIGNAL CURRENT
 HIGH-MU TRIODE PLATE VOLTAGE
 AFC (AUTOMATIC FREQUENCY CONTROL)
 DIODE BALANCING CIRCUITS

OSCILLATOR AND POWER
 TUBE GRID CURRENTS

POWER DETECTOR BIAS

AVC DIODE CURRENTS

PHOTO-CELL CURRENTS
 AND PLATE VOLTAGES

*measure
 them* **ALL**
 WITH THE
 Super-Sensitive
WESTON
 Model 772

(20,000 OHMS PER VOLT
 50 MICROAMPERES
 FULL SCALE)

\$46⁵⁰
 NET

TO DEALERS
 IN U. S. A.

and remember . . .

you can buy this famous 20,000 ohms per volt analyzer, and other WESTON radio instruments, through the convenient WESTON INVESTMENT PLAN.



No instrument yet offered the serviceman has met with such overwhelming response as Model 772. The reasons are obvious. With its sensitivity of 20,000 ohms per volt, Model 772 is not only ideal for all usual testing routine . . . but it also enables you to get into and thoroughly check circuits which cannot be tested with former servicing instruments. And being built to high WESTON

standards, servicemen know that Model 772 will serve dependably for years. Before you consider the purchase of test equipment be sure to get all the facts on Model 772 and other WESTON instruments for radio servicing. Ask your jobber for full particulars or return the coupon today . . . Weston Electrical Instrument Corporation, 599 Frelinghuysen Avenue, Newark, New Jersey.

WESTON
Radio Instruments

Weston Electrical Instrument Corporation
 599 Frelinghuysen Avenue, Newark, N. J.
 Send full data on Model 772 and other WESTON Instruments.
 NAME
 ADDRESS
 CITY STATE

MEASURE G-E METAL TUBES

UNDER ANY BUYING INDEX YOU CHOOSE

.... and you'll
find them your
first choice for

QUALITY

LONG LIFE

DEPENDABILITY

PRECISION

PERFORMANCE



For Customer Satisfaction

USE G-E METAL TUBES

GENERAL  ELECTRIC

THE ORIGINAL METAL TUBE

APPLIANCE AND MERCHANDISE DEPARTMENT, GENERAL ELECTRIC COMPANY, BRIDGEPORT, CONNECTICUT