

RADIO'S LIVEST MAGAZINE

OVER 175 ILLUSTRATIONS

Radio-Craft

Special
BROADCAST
Number

February

25 Cents

In United States
and Canada

HUGO GERNSBACK EDITOR



2-WAY
"BROADCASTING"
FROM A
PARACHUTE!

See Page 456

Inside Facts on American Broadcasting — New "F. V. F. B." Beam Amplifier
A Farm Battery Set — Midget Servicing Oscilloscope — Executive's A. C. Set

OVER 50,000 RADIO MEN READ RADIO-CRAFT MONTHLY

A NEW SUPREME ACHIEVEMENT!

The 555 DIAGNOMSCOPE
Combines 4 instruments in ONE



Now you can have all the equipment necessary for modern up-to-date cathode ray service work—complete in one impressive unit! The Diagnoscope is actually four instruments in one . . . a complete testing laboratory in itself! [1] Cathode Ray Oscilloscope [2] Frequency Modulator [3] Audio Oscillator [4] All-Wave Signal Generator which may be used [a] Unmodulated [b] Frequency Modulated Internally [c] Amplitude Modulated Externally [d] Amplitude Modulated Internally by 400 Cycle Fixed Frequency.

Before you buy any instruments, see the 555 Diagnoscope at your parts jobber. Its many new outstanding features . . . its simplicity of operation . . . its conveniently arranged controls . . . and its beautifully designed streamlined case will astound you! Contains 10 tubes. Completely A. C. operated.

Your parts jobber offers you convenient time payment terms on any SUPREME instrument, making it easy for you to purchase them *now!* You don't have to wait until you are ready to pay all cash.

See your parts jobber today. Ask him to show you the Diagnoscope. He will give you full details on how you can purchase it on the S.I.C. easy payment plan.

500 AUTOMATIC

Combines 12 essential servicing instruments:
A. C. Tube Quality Checker, Tube Hot Leakage, Short and Open Tester, Electrolytic Filter Capacitor Leakage Tester, Paper and Mica Capacitor Leakage Tester, Complete Point-to-Point Radio Analyzer, Multi-Range D. C. Voltmeter, Multi-range Ohmmeter, Multi-range Megohmmeter, Multi-range A. C. Voltmeter, Multi-range Decibel Meter, Multi-range Milliammeter, Multi-range Output Meter. \$7.50 Down—\$6.61 per Month for 10 Months. Cash price . . . \$66.95



550 RADIO TESTER

Performs the operations of 13 essential servicing instruments with 43 functions and ranges: Radio and P. A. Analyzer, Electrolytic filter and electrostatic capacitor leakage, also Electrolytic and Electrostatic capacitor tester, Multi-range ohmmeter, Multi-range D. C. Voltmeter, Multi-range A. C. Voltmeter, Multi-range milliammeter, Multi-range decibel meter, Multi-range output meter, D. C. ammeter. \$6.00 Down—\$5.55 monthly for 10 months. Cash Price . . . \$55.95



\$15.00 Down
\$12.05 per month
for 12 months
Cash Price \$147.95



WHERE SHOULD THE RADIO SERVICE MAN LOCATE HIS PLACE OF BUSINESS?

"This interesting booklet is the result of a nationwide survey made for your benefit. Write me today and I will mail you a copy free of charge."

Your Parts Jobber
Remember—YOUR CREDIT IS GOOD WITH SUPREME!

SUPREME INSTRUMENTS CORP.
GREENWOOD, MISSISSIPPI, U.S.A.

OPPORTUNITIES *are many* for the Radio Trained Man



Don't be an untrained man. Let me show you how to get your start in Radio—a fast growing, live money-making industry.

Prepare for jobs as Assembler, Inspector and Tester—Radio Sales or Service and Installation Work—Broadcasting Station Operator—Wireless Operator on a Ship or Airplane, Talking Picture or Sound Work—**HUNDREDS OF OPPORTUNITIES** for a real future in Radio!

12 Weeks of Shop Training

We don't teach by book study. We train you on a great outlay of Radio, Television and Sound equipment—on scores of modern Radio Receivers, actual Broadcasting equipment, Television apparatus, Talking Picture and Sound Reproduction equipment, Code and Telegraph equipment, etc. You don't need advanced education or previous experience. We give you—**RIGHT HERE IN THE COYNE SHOPS**—the actual practice and experience you'll need for your start in this great field. And because we cut out all useless theory and only give that which is necessary you get a practical training in 12 weeks. Mail coupon for all facts about my school and training methods.

TELEVISION *and* TALKING PICTURES

Television is sure to come as a commercial industry. Whether this year or later, it will offer opportunities to the man who is trained in Radio. Here at Coyne you learn Television principles, and work on actual Television equipment. Talking Picture and Public Address Systems offer opportunities to the Trained Radio Man. Here is a great new Radio field which is rapidly expanding. Prepare NOW for these wonderful opportunities! Learn Radio Sound Work at COYNE on actual Talking Picture and Sound Reproduction equipment. Not a home study course.

PAY TUITION ON EASY PAYMENT PLAN

Mail the Coupon below and I'll tell you about my payment plan which has enabled hundreds of others to get Coyne training with very little money. On this plan you can get your training first, then take 18 months to complete your small monthly tuition payments starting 5 months after you begin training. Not a home study course.

Mail the coupon for all details of this "Pay Tuition after Graduation Plan."

ELECTRIC REFRIGERATION—AIR CONDITIONING—DIESEL ENGINES

To make your training more valuable, I include—at no extra cost—valuable instruction in Electric Refrigeration, Air Conditioning and Diesel Engines, taught you by personal instruction and actual work on real equipment.

PRACTICAL WORK At COYNE in Chicago

ACTUAL, PRACTICAL WORK. You build and service radio sets. You get training on real Broadcasting equipment. You construct Television Receiving Sets and actually transmit your own Television images over our Television equipment. You work on real

H. C. LEWIS, Pres. RADIO DIVISION Founded 1899

Coyne Electrical School
500 S. Paulina St., Dept. 27-8H, Chicago, Ill.

Talking Picture and Sound equipment. You learn Wireless Operating on Actual Code Practice apparatus. We don't waste time on useless theory. We give you the practical training you'll need for your start in Radio—in 12 short weeks. If you desire code, this requires additional time for which there is no extra charge.

MANY EARN WHILE LEARNING



If you need part-time work to help pay living expenses while at school, tell us your problems and we may be able to help you as we have hundreds of other students. Then, after you graduate, life-time employment service will be available to you. Every Coyne graduate also receives a Life Membership, with free technical and business service and privilege of review at any time without additional tuition charge.

Mail Coupon Today for All the Facts

H. C. LEWIS, President
Radio Division, Coyne Electrical School
500 S. Paulina St., Dept. 27-8H, Chicago, Ill.

Dear Mr. Lewis:—Send me your Big Free Radio Book, and all details of your tuition offer, including valuable instruction in Electric Refrigeration, Air Conditioning and Diesel Training and your "Pay Tuition After Graduation" offer.

Name.....
Address.....
City..... State.....

Please Say That You Saw It in RADIO-CRAFT



HUGO GERNSBACK, Editor-in-Chief
 C. W. PALMER Technical Editor
 R. D. WASHBURNE, Managing Editor
 C. P. MASON Associate Editor

CONTENTS - FEB., 1937, ISSUE

Volume VIII Number 8

Editorial: The Future of Broadcasting Hugo. Gernsback 453
 The Radio Month in Review..... 454
 Interesting Information about "Spot" Broadcasting R. D. Washburne 456
 Novel Ideas in Radio Sets..... 457
 How to Make the RADIO-CRAFT "Country Gentleman" Battery Set..... 458
 Inside Facts About American Broadcasting Wilhelm E. Shrage 460
 Features in Radio Sets for 1937..... 462
 Make "The Executive"—A Business Man's A.C.-D.C. Set—Part I..... N. H. Lessem 463
 The Dynamic Loudspeaker "Goes Headphone" C. P. Mason 464
 NBC-RCA Television "On the Air" I..... 465
 How to Make the RADIO-CRAFT 1937 Television Receiver—Part II..... 466
 "Precision" Controls in a 16-Tube 1937 DX Radio Set Eli Martin 468
 A Tube Tester that "Talks"..... S. M. Harper 468
 Modern Trains are Radio-Equipped..... F. E. Gould 469
 Make This Midget Servicing Oscilloscope! J. B. Carter 470
 How to Add "Variable-Selectivity" to Superhets. W. J. Vette 471
 Mixer Circuits You Should Know.. Alfred A. Ghirardi 471

International Radio Review..... 472
 A New 60-W. Beam Amplifier.....McMurdo Silver 474
 Radio Sets for Export and Marine Use Milton B. Sleeper 474
 Modern Short-Wave Diathermy—Part II Leon C. Bunkin 475
 The New 60-Watt "F.V.F.B." Beam Power Amplifier A. C. Shaney 476
 A Simplified Converter for the Short-Wave Beginner—Part II.....Raymond P. Adams 477
 The Latest Radio Equipment..... 478
 RADIO SERVICE DATA SHEETS:
 Nos. 191 and 192—Grunow Models 1291 and 1297 (Chassis 12B and 12W)..... 480
 No. 193—Sparton Models 517, 517B, 517W, 517X; 557 and 567 (Console); Emerson Models H-130; H-137 (Chassis Model H)..... 484
 Operating Notes 482
 ORSMA Members' Forum..... 482
 Technicians' Data Service..... 486

SPECIAL BEGINNERS' NUMBER

Beginners in radio servicing, public address, radio set building, electronics and other branches of the highly diversified business called "radio" will find many things to interest them in the forthcoming issue of RADIO-CRAFT. Easily-built servicing equipment will be described; and, simplified servicing procedure. The wishes of those who are eager to attempt the construction of a simple radio set will be gratified. This receiver, by the way, introduces an entirely new thought in radio set design. The article describes, in detail, the construction of a 2-section instrument, under the title, "How to Make the Beginner's Book-End 3". In other words, whether your interest is immediate or future you will want the forthcoming March, 1937, issue of RADIO-CRAFT—at your newsdealer about February 1.

Published by Radcraft Publications, Inc. Publication office: 29 Worthington Street, Springfield, Mass. Editorial and Advertising Offices: 99 Hudson Street, New York City. Chicago Advertising Office: L. F. McClure, 919 North Michigan Avenue, Chicago, Ill. Western Advertising Office: Loyd B. Chappell, 511 So. Alexandria St., Los Angeles, Calif.

Foreign Agents:

London—Gorrings American News Agency, 9A Green St., Leicester Square, W. C. 2, England.
 Paris—Messageries Dawson, 4 Rue Faubourg, Poissonniere, France.
 Melbourne—McGill's Agency, 179 Elizabeth St., Australia.
 Dunedin—James Johnston, Ltd., New Zealand.

RADIO-CRAFT is published monthly, on the first of the month preceding that of date; subscription price is \$2.50 per year in U. S. and Canada. (In foreign countries, \$3.00 a year to cover additional postage.) Entered at the post office at Springfield as second-class matter under the act of March 3, 1879.

Text and illustrations of this magazine are copyright and must not be reproduced without permission of the copyright owners.

Copyright 1937. Radcraft Publications, Inc.



J. E. SMITH
President
National Radio
Institute
The man who has directed the home study training of more men for the Radio Industry than any other man in America.

I WILL TRAIN YOU TO START A SPARE TIME OR FULL TIME RADIO SERVICE BUSINESS WITHOUT CAPITAL

**HERE ARE A FEW EXAMPLES
OF THE KIND OF MONEY
I TRAIN MY MEN TO MAKE**



**EARNED \$50 FIRST MONTH
IN SPARE TIME**

"I knew nothing about Radio. After four lessons I began servicing Radios, earning \$50 the first month. Last winter I made as high as \$100 a month in spare time."—**G. F. WALTON**, 808 West Olney Road, Norfolk, Va.

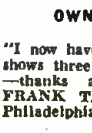

**OWN BUSINESS PAYS \$300
A MONTH**

"I now have my own Radio business which shows three hundred dollars a month profit—thanks again to National Radio."—**FRANK T. REESE**, 39 N. Felton St., Philadelphia, Penna.



**CHIEF OPERATOR IN BROADCASTING
STATION**

"When I completed 20 lessons, I obtained my Radio Broadcast Operator's license and immediately joined Station WMPC, where I am now Chief Operator."—**HOLLIS F. HAYES**, 85 Madison St., LaPeer, Mich.

**Get My LESSON on
Radio Servicing Tips FREE**

I'll prove that my Training gives practical, money-making information, that it is easy to understand—that it is just what you need to master Radio. My sample lesson text, "Radio Receiver Troubles—Their Cause and Remedy," covers a long list of Radio receiver troubles in A.C., D.C., battery, universal, auto, T. R. F., super-heterodyne, all-wave, and other types of sets. And a cross reference system gives you the probable cause and a quick way to locate and remedy these set troubles. A special section is devoted to receiver check-up, alignment, balancing, neutralizing and testing. Get this lesson Free. No obligation.



**MAIL
COUPON
NOW**

**The Tested Way
to BETTER PAY**

Do you want to make more money? The worldwide use of Radio has made many opportunities for you to have a spare time or full time Radio service business of your own. Three out of every four homes in the United States have Radio sets which regularly require repairs, servicing, new tubes, etc. Many sets are old and will soon be replaced by new models. I will train you at home in your spare time to sell, install, service, all types of Radio sets—to start your own Radio business and build it up on money you make in your spare time while learning. Mail coupon for my 64-page book. It's Free—it shows what I have done for others.

**Many Make \$5, \$10, \$15 a Week Extra
In Spare Time While Learning**

Practically every neighborhood needs a good spare time serviceman. The day you enroll I start sending you Extra Money Job Sheets. They show you how to do Radio repair jobs that you can cash in on quickly. Throughout your training I send you plans and ideas that have made good spare time money—from \$200 to \$500 a year—for hundreds of fellows. My Training is famous as "the Course that pays for itself."

**There's a Real Future in Radio
for Well Trained Men**

Radio already gives jobs to more than 300,000 people. In 1935 over \$300,000,000 worth of sets, tubes and parts were sold—an increase of 20% over 1934! Over 1,100,000 auto Radios were sold in 1935, 25% more than in 1934! 22,000,000 homes are today equipped with Radios, and every year millions of these sets go out of date and are replaced with newer models. Millions more need servicing, new tubes, repairs, etc. Broadcasting stations pay their employees (exclusive of artists) more than \$23,000,000 a year! And Radio is a new industry, still growing fast! A few hundred \$30, \$50, \$75-a-week jobs have grown to thousands in less than 20 years.

**Get Ready Now for Your Own Radio Business
and for Jobs Like These**

Radio broadcasting stations employ engineers, operators, station managers and pay up to \$5,000 a year. Spare time Radio set servicing pays as much as \$200 to \$500 a year—full time jobs with Radio jobbers, manufacturers and dealers, as much as \$30, \$50, \$75 a week. Many Radio Experts own and operate their own full time or part time Radio sales and service businesses. Radio manufacturers and jobbers employ testers, inspectors, foremen, engineers, servicemen, paying up to \$6,000 a year. Radio operators on ships

get good pay and see the world besides. Automobile, police, aviation, commercial Radio, and loud speaker systems are newer fields offering good opportunities now and for the future. Television promises to open many good jobs soon. Men I have trained are holding good jobs in these branches of Radio. Read their statements in my 64-page book. Mail the coupon.

**I Send You Special Radio Equipment
to Give You Practical Experience**

My Course is not all book training. I send you special Radio equipment and show you how to conduct experiments and build circuits which illustrate important principles used in modern Radio receivers, broadcast stations and loud speaker installations. I show you how to build testing apparatus for use in spare time work from this equipment. You work out with your hands the things you read in the lesson books. My Free Book tells you about this 50-50 method of training—how it makes learning at home interesting, quick, fascinating, practical. Mail coupon.

**Save Money—Learn At Home
Money Back Agreement Protects You**

I am so sure that I can train you at home successfully that I agree in writing to refund every penny you pay me if you are not satisfied with my Lessons and Instruction Service when you finish my Course. I'll send you a copy of this agreement with my Book.

**Find Out What Radio Offers You
Get My 64 Page Book Free Now**

Act Today. Mail the coupon now for my Free Lesson and my book, "Rich Rewards in Radio." Both are free to anyone over 16 years old. My book describes Radio's spare time and full time opportunities and those coming in Television; tells about my Training in Radio and Television; shows you actual letters from men I have trained, telling what they are doing and earning. Find out what Radio offers YOU! MAIL THE COUPON in an envelope, or paste it on a penny post card—NOW!

**J. E. SMITH, President
National Radio Institute
Dept. 7BX
Washington, D.C.**



**GOOD FOR BOTH 64 PAGE BOOK
SAMPLE LESSON FREE**

J. E. SMITH, President, National Radio Institute, Dept. 7BX, Washington, D.C.

Without obligating me, send your service manual "Radio Receiver Troubles—Their Cause and Remedy" and free book about spare time and my spare time. I am particularly interested in the branch of Radio checked below.

- Radio Service Business of My Own
- Spare Time Radio Service Work
- Retail Sales of Radio Sets and Equipment
- Service Expert for Retail Stores
- Broadcasting Station Operator
- Television Station Operator
- Loud Speaker Systems, Installation and Service
- Ship Radio Operator
- Aviation Radio Operator
- Auto Radio Installation and Service
- Designing and Constructing Testing Equipment
- Service Expert with Radio Factory
- Commercial Radio Station Operator
- All-around Servicing Expert

(If you have not decided which branch you prefer—mail coupon now, for information to help you decide.)

NAME AGE

ADDRESS 14x1

Please Say That You Saw It in RADIO-CRAFT

9 x 12
INCHES

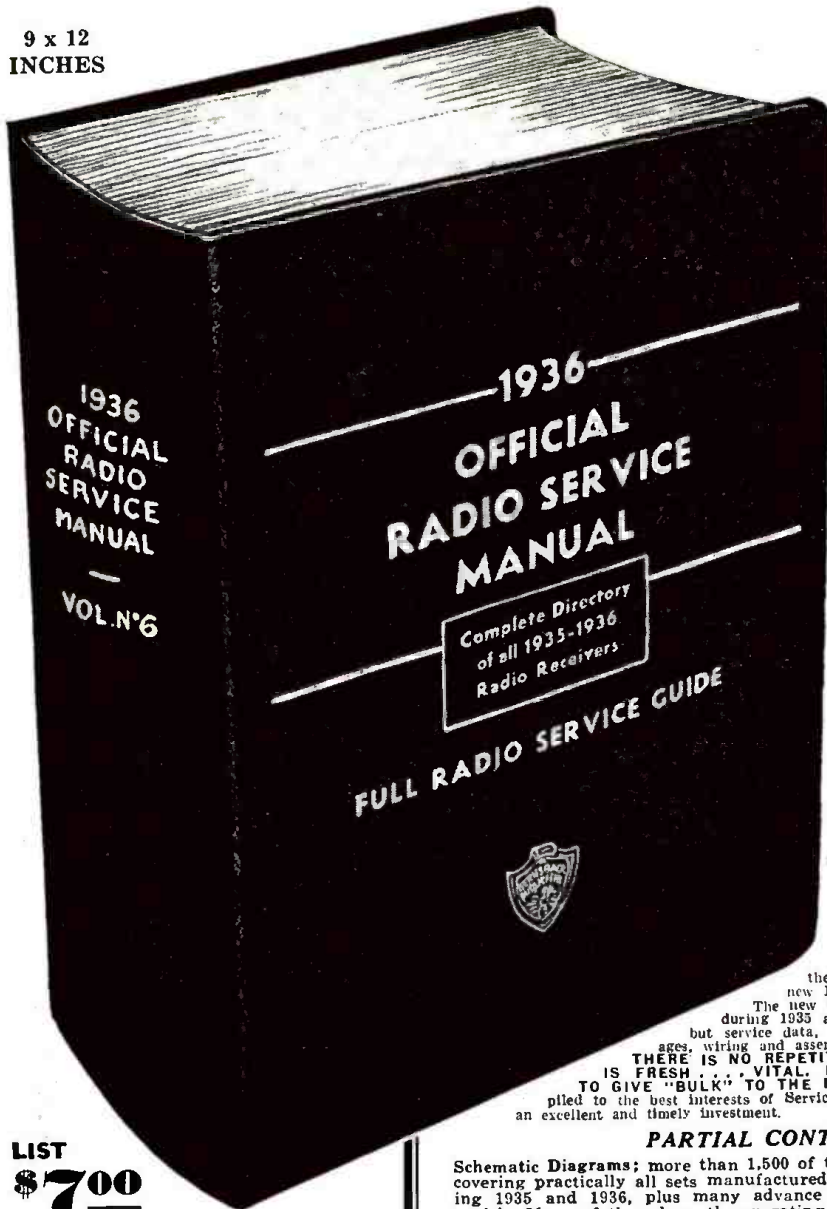

**YOUR JOBBER
OR FAVORITE
MAIL ORDER HOUSE
HAS COPIES OF THE**

1936 OFFICIAL RADIO SERVICE MANUAL

**ORDER YOUR COPY NOW—
OR WRITE TO
THE PUBLISHERS DIRECT**

Bigger and Better than Ever!

more diagrams, more data, more pages, more essential service material and considerably greater value for your money. If the sale of previous Gernsback Manuals is any indication, many thousands more Service Men will be using this new 1936 Manual than any of the previous volumes. The new Manual incorporates all available diagrams of sets manufactured during 1935 and 1936, plus many advance 1937 models. Not only diagrams, but service data, alignment procedure, intermediate frequency peaks, socket voltages, wiring and assembly diagrams, etc., etc., are included. **THERE IS NO REPETITION IN THIS MANUAL! EVERY BIT OF INFORMATION IS FRESH, VITAL, NO REHASH . . . AND NO USELESS MATERIAL JUST TO GIVE "BULK" TO THE BOOK.** The entire contents has been carefully edited and compiled to the best interests of Service Men. The 1936 OFFICIAL RADIO SERVICE MANUAL is an excellent and timely investment.

PARTIAL CONTENTS OF 1936 MANUAL

Schematic Diagrams; more than 1,500 of them, covering practically all sets manufactured during 1935 and 1936, plus many advance 1937 models. Many of them have the operating voltages of the various tube elements printed directly on them.
Wiring Diagrams; wherever they have been obtainable, the wiring diagrams of the more complex receivers, such as the all-wave and high-fidelity sets, have been included.
Miscellaneous Diagrams; these include speaker connections, optional phonograph connections, power transformer connections, R. F. and I. F. coil connections, complete phonograph motor connections on combination receivers, etc., etc. Wherever these diagrams were available they have been included in the 1936 Manual.
Intermediate Frequency Peaks; all set models (with few exceptions) have their respective intermediate frequency peaks marked either directly on their schematic diagrams or in their notes on alignment procedure.
Alignment Procedure; even if space permitted, it would not have been advisable to print the alignment procedure on all the simpler sets for one would have been a repetition of the other. On the more complex receivers, however, the all-wave and high-fidelity sets, complete alignment procedures, step-by-step, have been included.

Service Data; wherever the information was made available to us, such data as typical faults in a given receiver, their symptoms and remedies, was included in the 1936 Manual.
Assembly Diagrams; on combination models, i. e., sets combined with phonographs (either the manual or automatic types), complete assembly diagrams are given. These diagrams show the relationship of the separate units to each other and the way they are inter-connected.
Operating Voltages; the operating voltages given in this Manual (for more than 80% of the sets listed) are the normal voltages; any deviation from these values indicates trouble in the associated circuits.
Trade Name Index; in the back of the book, is a complete index of trade names and their respective manufacturers.
Complete Tube Chart; in the back of the Manual will be found the latest, and most complete tube chart of all type tubes ever manufactured for receivers.
Large Cumulative Index; includes all sets printed in the 1931, 1932, 1933, 1934, 1935 volumes as well as the present 1936 Manual. The sets in this volume have been listed in the index in an entirely new and more convenient manner so that the busy Service Man need no longer thumb through an entire manufacturer's section in order to find some particular piece of information. He need but consult the index.

If your jobber or mail order house cannot supply you, order any of the OFFICIAL RADIO SERVICE MANUALS or the OFFICIAL RADIO SERVICE HANDBOOK from the publishers. Send your remittance in form of check or money order—or, if you send cash or unused U. S. Postage Stamps, be sure to register your letter. ALL ORDERS ARE FILLED PROMPTLY. BOOKS ARE SENT TO YOU POSTAGE PREPAID.

Address Dept. RC-237.

RADCRAFT PUBLICATIONS, INC., 99 Hudson St., New York. N. Y.

LIST

\$7.00

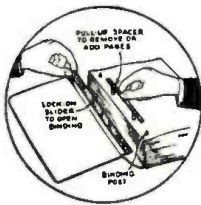

New Practical Binder
Note, at the left, the details of the new binder used on this manual. It not only securely locks the 1200 pages into the stiff leatheroid covers, but facilitates removal and replacement of individual pages.

**1,200
PAGES
OVER
2,500
ILLUSTRATIONS**

*Looseleaf Binder
Hard Covers*

GERNSBACK RADIO SERVICE MANUALS ARE AVAILABLE FROM JOBBERS AND MAIL ORDER HOUSES

Please Say That You Saw It in RADIO-CRAFT



"Takes the Resistance out of Radio"

Editorial Offices: 99 Hudson St., New York, N. Y.

HUGO GERNSBACK, Editor

Vol. VIII, No. 8, Feb. 1937

THE FUTURE OF BROADCASTING

An Editorial by HUGO GERNSBACK

WHILE broadcasting started during the early 20th century, the idea of linking stations together by means of land lines such as telegraph or telephone wires did not come about until early in 1925. And not until 1926 was a commercial network attempted. The National Broadcasting Company, a pioneer in this field, this year is celebrating its 10th anniversary, commemorating the occasion of the first commercial network in 1926. While it was possible for a large audience to listen to a single station in 1924 and 1925, it was not possible for practically the entire country to listen-in to the President of the United States (as, for instance, the public did this year). Since that time, commercial broadcasting in this country has advanced by leaps and bounds, and it is now possible for the country's two largest networks to tie-up between them a total of 205 stations on a coast-to-coast hook-up whenever necessary. Considering the fact that there are now in use close to 25,000,000 radio sets in homes, plus 5,000,000 radio sets in automobiles, it becomes apparent that practically the entire country can easily be reached nowadays by a single speaker or a single broadcaster, whenever the necessity arises.

What of the future for broadcasting? Last month the National Broadcasting Company, in commemoration of its 10th birthday, tendered a dinner to some 1,600 men who had been active in the furtherance of radio broadcasting. The dinner was given at the Waldorf-Astoria in New York City, and a number of the speeches by radio luminaries and others were broadcast over the NBC network on a coast-to-coast hook-up.

In a notable address, David Sarnoff, President of the Radio Corporation of America, described the rise of broadcasting, and he, too, delved into the future of broadcasting. Noted for his conservatism, particularly when it comes to making predictions, Mr. Sarnoff electrified his audience by stating definitely that within the next 10 years broadcasting no longer would appeal to the ear only but that it would have sight, too—television, in other words. Coming from such a source, it behoves us to take the prediction most seriously. And it would be strange indeed if in 1946 we should not have television. The reason for this statement is simple.

Look back 10 years, and you will observe the very crude radio facilities that we had at that time. Our radio tubes, for instance, were still in the early development stage. We were still using headsets to a large extent, and loudspeakers of the old metallic horn type were then the rage. The dynamic speaker had not even been dreamed of. Practically all of the sets of that day had a fearful array of knobs and controls. Most of the sets had 3 dials and at least 2 other controls, and many of the sets had as many as 8 controls. The radio circuits for the radio receivers of that day were chiefly "tuned radio frequency." Such circuits as we use today, notably the superheterodyne, had, as yet, not made their practical appearance. But most important, we were still using batteries in great profusion, also "B" eliminators; and electric chargers of all types to recharge our storage batteries. The all-electric set was still in the dim future; short-wave programs from other lands were then fantastic predictions only indulged-in by dreamers. Moreover, all of the sets, with few exceptions were exceedingly noisy, and man-made static as well as natural static was often intense enough to make listening impossible.

All these are things of the past—things only dimly re-

membered but worthwhile to look back upon and to be used as a yardstick for what is to come in the next 10 years. Radio broadcasting today enters into every phase of our lives. We have radio receivers in almost every room from the pantry to the bathroom. The children have a set in their playroom, and they listen to the radio in their school. The busy executive has a set on his desk; and many cars are radio equipped. And, whether we are on a transatlantic steamer or a transcontinental train, or 10,000 ft. up in an airliner, the radio broadcast is always with us. In other words, there is no time when we are deprived of radio.

In the next 10 years, the personal radio receiver, that is, the pocket set or, as David Sarnoff predicted only a few months ago, the *wrist-watch radio receiver* will probably be a reality. Indeed, such a wrist-watch receiver can be built today, and it is only a matter of commercializing it during the next decade. The combination of television and sound receivers will, of course, open entirely new fields for radio broadcasting. You will hear and see at the same time the events which the radio broadcasters will present from hour to hour. *Indeed, it will be possible during the next 10 years to enjoy two programs at the same time whenever that becomes necessary.* Suppose, for instance, there is an important horse race at Miami, suppose also that at the same time there is being broadcast by another station or network an important symphony to which you wish to listen. It will then be possible merely to view the horse race, shutting off the sound part; while on the same set another wavelength (without "video" or vision facilities) can be tuned-in on the audio band, making it possible to enjoy two performances simultaneously. At present, television is usually in one color, either in a greenish tone or a black and white tone. At the end of the next 10 years, we will no doubt have television not only in its natural colors but most likely in *stereoptical* as well. In other words, the images will have *depth*.

The long-heralded *facsimile broadcasting* will probably also be an accomplished fact by the year 1946. It will be possible on your home radio set to receive photographs of the artists and even a small newspaper giving a digest of the day's news so that when you awaken in the morning the little newspaper will be ready so that it can be lifted right from your set. (The writer has illustrated and described this idea in past issues of *Radio-Craft*.) Our big networks will find it most profitable to provide such a service because it will not only maintain interest in radio, but the printed advertising word will also be transmitted, as, for instance, in the small newspaper, making it possible for you to receive it free of charge exactly as you receive sound broadcasting today, and as you will receive television in the future.

All this is, of course, possible under our American system of broadcasting where the individual is not taxed by a \$2.00 or higher monthly fee on his radio set, as is the case in European and other countries. The necessary amount of advertising to sustain the broadcasts will, of course, continue, in television. During the next 10 years tremendous strides will be made to make the advertising less blatant than it is today, and, rather than incense the listener or "viewer," more subtlety will be used to make whatever advertising there is more entertaining and less obtrusive.

And if you should happen to see these lines at the end of 1946 and find that, in the main, they have become actualities, you will begin to marvel at all the radio wonders that we, of today, did not even dream of.

THE RADIO MONTH



The transceiver installed in the Cuban plane.

TRANSCIVER IN CUBAN ARMY PLANE

THE 5-meter transceiver (which has been finding so many applications in amateur communication for portable and mobile use) has a new use, according to reports received last month.

A U. S. Army flier installed one of the units in a Cuban Army plane as an experiment—and the results were so gratifying that additional transceivers are being ordered for other planes in the Air Corps.

The transceiver, which has been looked-down upon by most radio engineers as being inadequate for anything but amateur use, appears to be coming into its own as a legitimate 2-way radio-telephone apparatus!

"HAND-WHEEL" RADIO IN INDIA

RADIO broadcasting in India has been seriously handicapped by the cost of batteries to keep the "community" sets operating. According to *Electrical Review* (London), last month, hand-wheel generators to be operated by the villagers will replace the batteries. Incidentally, the Marconi Co. is installing a high-power station equipped for television, at Hyderabad.

TELEVISION NEWS SHORTS

THE leaps and bounds which television has been taking, throughout the world, toward that elusive "corner," have not abated during the past month according to reports received.

Dr. H. W. Leverenz of RCA announced the development of a new fluorescent screen for television tubes having much greater intensity of light than others to date. *The new screens are made in air-controlled laboratories!*

At a recent RMA convention, A. F. Murray, television research director for a large firm, made the statement that television will be a commercial reality in 1938. The corner draws close!

Guglielmo Marconi in a four-way S. W. radio conversation (with David Sarnoff in New York and a group of foreign broadcast executives traveling in two planes between Niagara Falls and Washington) stated that television will soon "span the Atlantic."

The yacht "Elettra" on which Marconi has been doing some intensive television experimentation was partially destroyed by fire. Marconi stated that the experiments will not have to be interrupted and the yacht will be repaired.

In speaking about the Empire State experimental television transmissions, David Sarnoff, President of RCA, said: "During the next few months we will expand the engineering field tests into a series of dress rehearsals of various types of programs . . . we have recommended to the F.C.C. the adoption of 441-line definition as a standard for commercial operation . . . our New York transmitter will be rebuilt to conform to these newer standards."

Alfred Clark, Chairman of the Electrical and Musical Industries, Ltd. in London, prom-

ised that the price of television receivers in England will soon be much cheaper.

Sir Noel Ashbridge, Controller of Engineering for B.B.C. explained that the reason why two different systems using a different number of "lines" is being used in England on alternate weeks is to determine whether high definition or medium definition is to be preferred for television broadcasting.

The Television Corp. of America was haled into court by Supreme Court Justice Joseph M. Callahan on a charge of fraudulent sales of stock. A temporary injunction preventing sale of stocks was handed down, at the closing of this issue.

PALEY PRESENTS AMATEUR AWARD

WILLIAM S. PALEY, President of CBS appointed last month a board of 5 noted men to select each year the individual, who through amateur radio has contributed most to the American people.

An award, permanently in the custody of the American Radio Relay League, will be presented each year on the basis of either research, technical development or operating achievement.

The members of the Board are Rear Admiral Cary T. Grayson, Chairman of the American Red Cross; C. P. Edwards, director of radio for the Canadian Department of Marine and Fisheries; Anning S. Prall, Chairman of the F.C.C.; J. H. Dellinger, Chief of the Radio Section of the Bureau of Standards; and A. E. Kennelly, Professor Emeritus of E.E. at Harvard.

Here is a chance for some productive work on the part of radio men everywhere in competing for this notable award. Let's see what YOU can do!

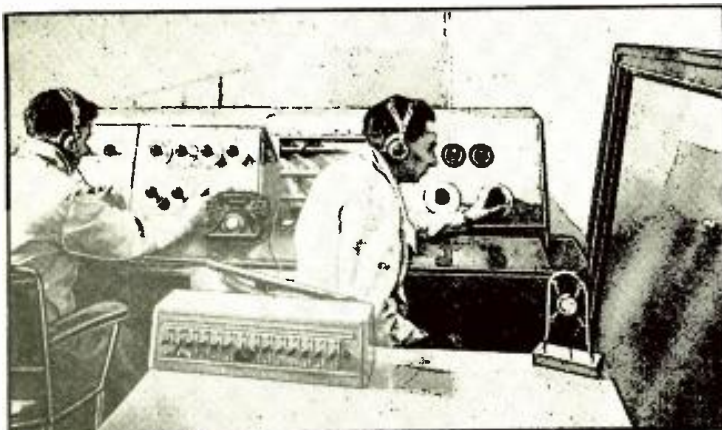

Above and right. Views in Alexandria Palace of the Marconi E.M.I. television studio and control room showing the transmission of an orchestra. Note the camera at the right of the studio.

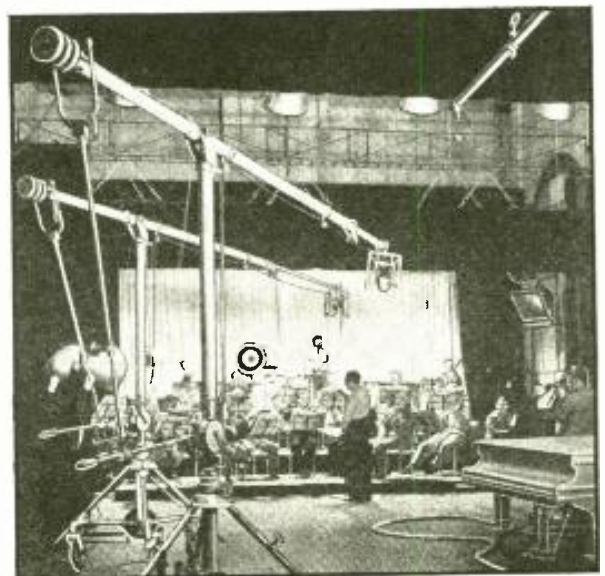

IN REVIEW

Radio is now such a vast and diversified art it becomes necessary to make a general survey of important monthly developments. RADIO-CRAFT analyzes these developments and presents a review of those items which interest all.

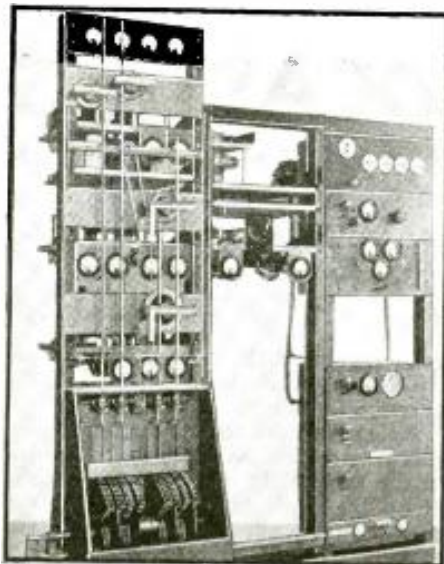

Variable-frequency ionosphere installation.

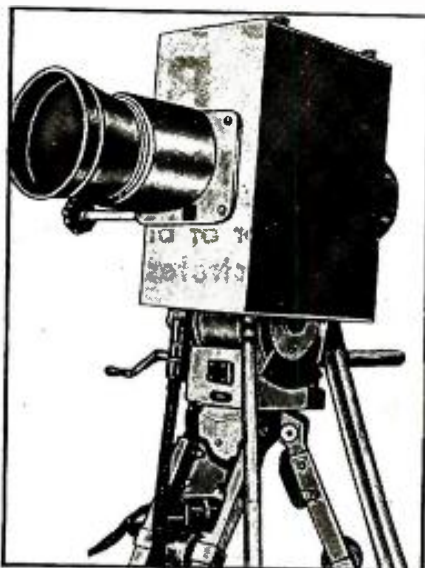

The European version of Farnsworth's camera.



The small size of the flat Arcotron vacuum tube.

MULTI-FREQUENCY IONOSPHERE TESTS

AS a means for continuously checking the height of the reflecting layers of the upper atmosphere, the Department of Research in Terrestrial Magnetism of Carnegie Institute of Washington set into operation, last month, a new multi-frequency transmitter sending out signals which automatically sweep the wave-band between 516 and 16,000 kc. every 15 min. during day and night.

By an ingenious circuit, the same antenna system and tuned circuits are used for both transmitter and receiver which are installed at the same location. The tuned circuits are swept through the desired wave-range by means of motor mechanisms which are synchronized with a film recorder so that a permanent record of the ionospheric height at different times in the day and year (at different frequencies) is obtained.

The quick change of frequency prevents interference of the transmitter with other transmissions on the same frequencies.

NEW WJZ ANTENNA DEDICATED

THE new ultra-modern 640 ft. antenna for station WJZ, which has been mentioned before on these pages was dedicated with due ceremony last month, in conjunction with NBC's 10th anniversary.

While the station will remain at 50,000 watts output for the time being, the new antenna will increase the radiated power equivalent to an increase to 110,000 watts (or 110 kw.).

EUROPEAN VERSION OF FARNSWORTH'S TELEVISION CAMERA

THE effectiveness of American developments in television was amply proven last month when word came that the German firm of Fernseh A.G. had completed a new television pick-up camera for outdoor pick-ups, following the design developed by Philo T. Farnsworth.

This new pick-up camera will be used by the German Broadcasting Co. for interesting outdoor events, such as sports, news items, etc.

SUPER-POWER CAUSES FIGHT

A CONFERENCE called last month by the F.C.C. to aid in serving the millions of radio listeners scattered over the 3,000,000 square miles of our country was the cause of a heated dispute between two factions among the broadcasters.

The first, headed by Edwin W. Craig of the National Broadcasting Co. and known as the "clear channel group" wants the existing cleared channels kept as they are, with permission to increase the power of these stations. Only with such increased power, they claim, can remote sections be served completely.

The second group, headed by William S. Paley, president of the CBS warns that many small local stations would of necessity be obliterated if super-power stations were introduced. Mr. Paley stated that the proposal had "dangerous implications for many independent and smaller broadcasters."

THE ARCOTRON—A NEW TUBE

AN interesting new type of tube was brought to light, last month, in Germany. This new tube, known as the Arcotron tube is simpler in design and thus easier to make on a production basis than the present types.

The plate electrode of the Arcotron is in the form of a wire mesh which envelops the filament. Sputtered in the surface of the flat-shaped glass envelope is a metallic layer. This metal coating influences the electron emission through the wire mesh (plate) by means of an electrostatic field created by the signal current which is applied to the coating (grid). Multi-element tubes are made by dividing the sputtered coating into sectional "rings."

This tube thus comes under the class of "grid-less" tubes.

Coincidentally, the Harries Thermionics, Ltd. in England, who developed the "critical-distance" tube mentioned several months ago in *Radio-Craft* announced a new "UNIVERSAL TUBE." This tube can be used as frequency changer, power output tube, R.F. and I.F. amplifier, A.F. amplifier and detector and has good characteristics in all positions. Considering the 375 or so radio receiving tubes available now in the U. S., it must be admitted that Mr. Harries has enclosed a good many tubes in his "magic bottle."

The new tube utilizes the principles discovered by Harries in developing the critical-distance beam tube—that is, the placement of electrodes in the positions with respect to cathode is at the particular distance which produces the least secondary emission and greatest controlling influence.

INTERESTING INFORMATION ABOUT "SPOT" BROADCASTING

Tremendous progress has been made in radio broadcast technique during the last 10 years. A general description by the author of broadcasts made outside the studio dramatically illustrates this progress.

R. D. WASHBURNE



Fig. A. A parachute 2-way spot broadcast—a special-feature suggestion to the networks.

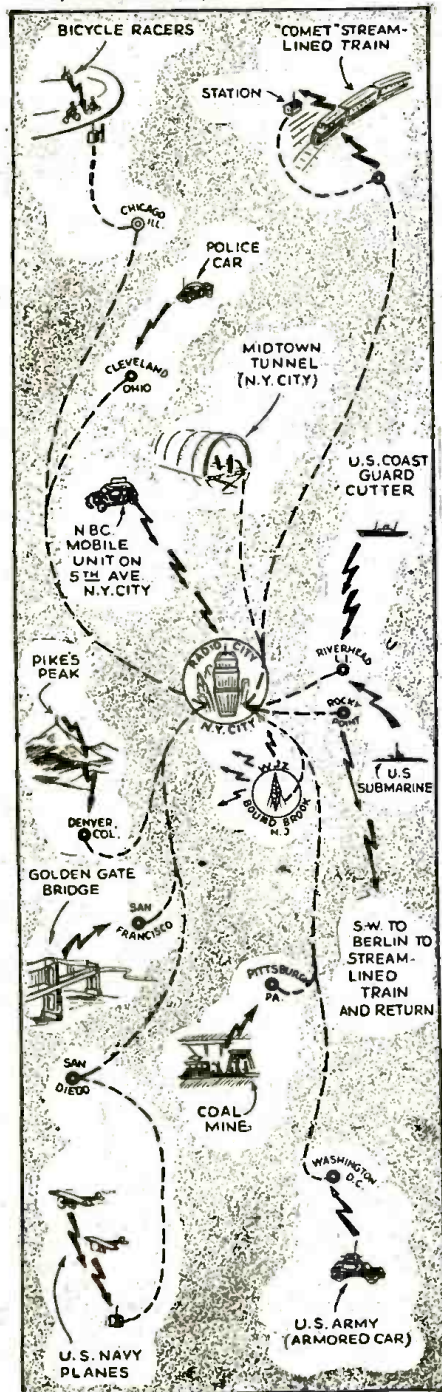

Fig. E. A recent NBC network program.

NOVEMBER, 1936, was a transcendental month in the annals of "spot" or on-the-spot broadcasting. During this month spontaneous pick-ups established a record for diversity and scope that may be conservatively described as colossal.

It is these action programs outside the studio that have packed the "wallop" for broadcast listeners ever since that first spot broadcast from Boyle's 30 Acres (Jersey City, N. J.), in 1920, of the Dempsey-Carpentier heavyweight championship bout. Intervening years have seen program after program put on the air; each with its split-second timing and long moments of suspense for the technician, and its ephemeral period of exciting entertainment for millions of broadcast fans. A review of the most recent spot programs, and a short description of a portion of the equipment involved, may be of interest to *Radio-Craft* readers; but before we paint a word description of the latest developments in the broadcast saga let us jump still further ahead to some date, at present unknown, in the future.

In Fig. A is illustrated a suggestion, which *Radio-Craft* offers to the NBC, CBS and MBS networks, for a thrilling spot broadcast; the cover illustration expresses the same idea in colors.

It is nothing new to broadcast from a parachute—NBC, in 1929, broadcast the sensations of a parachute jumper—but, it is a new idea to hold a 2-way

conversation with the parachutist as, "with the greatest of ease, he floats through the air."

Aside from the novelty angle the idea has its practical aspects; one of which is the probability of war-time application. You have probably read in the papers that Russia now claims to have available about 7,000 airplanes. Couple this with the fact that U. S. Army
(Continued on page 490)

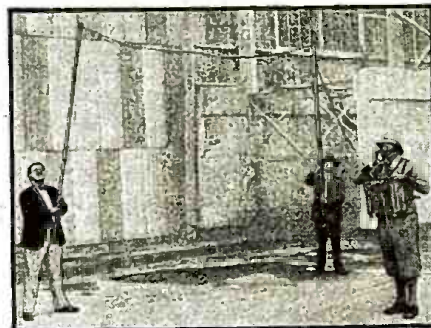

Fig. B. Floyd Gibbons at the "mike," in 1929.



Fig. D. Mobile Unit No. 3 of NBC in action.

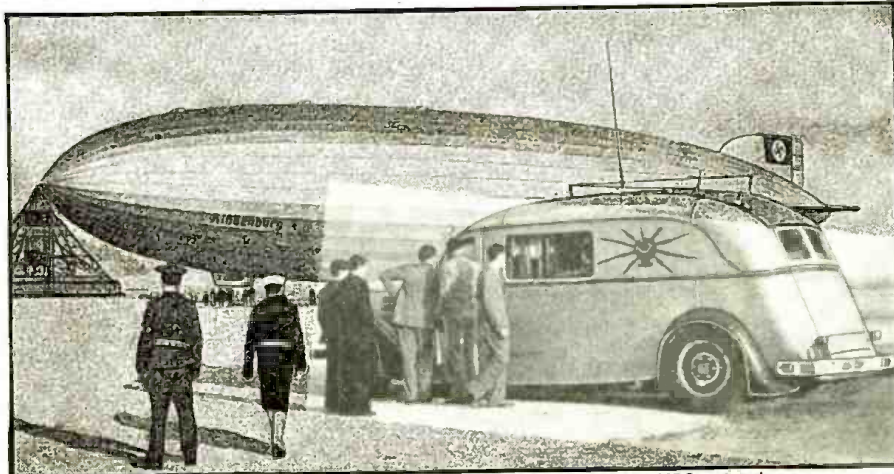

Fig. C. Mobile Unit No. 2 makes a spot broadcast over the NBC network.

NOVEL IDEAS IN RADIO SETS

Several unusual radio set designs have just been announced. Three unusually novel types are here described. Their diagrams reveal interesting circuit variations.

"Clockette" Receiver (1273). In Fig. A is shown the exterior, and in Fig. B the interior view of an instrument that introduces to radio set owners several new and novel ideas in midget receiver construction. (List price is slightly under \$20.)

The most obvious departure from usual practice is the use of a full-visibility scale calibrated in kc., over a tuning range from 540 to 1,600 kc., around a complete circle; and with large figures made to simulate, at first glance, the hour markings of a clock. This "clock" idea is further accentuated in the diminutive size of the cabinet which measures only 8 x 7½ x 5 ins. deep. (The weight of complete set, 6 lbs.)

Incidentally some one of its 3 available finishes will match the color scheme
(Continued on page 496)

"Golfbag" Radio Set (1274). Here is a portable radio set, finished in mauve suede, that except for its smaller dimensions closely resembles a golf bag. Its dimensions are 22 x 5½ ins. square; (total weight, 18 lbs.). Amazing sensitivity is an outstanding feature of this superheterodyne. These two features of portability and exceptional sensitivity result in unusual utility.

Used with earphones and a short length of trailing wire antenna the receiver may be used in hospitals or other places where loudspeaker operation might well be annoying to others; or in trains, buses, and other places where, due to lack of pick-up, ordinary loudspeaker equipment would be inoperative. Two single earphones with individual headbands are supplied with the receiver so that two persons may listen in simultaneously.

The loudspeaker mounted on the side of the case is a particularly convenient arrangement when the set is to be used in camp; in an airplane, until more permanent equipment is installed; afloat, in rowboat or motorboat; during
(Continued on page 503)



Fig. C. Entertainment while you walk!

Dual-Speaker Improved-Fidelity Midget Set (1275). Termed erroneously a "twin-speaker" set, actually, the dual reproducers of the radio set shown in Fig. E are not twins; instead, one is of magnetic type and the other is a dynamic unit as shown in Fig. 3).

As is generally known, the magnetic type of reproducer tends to reproduce higher frequencies than does the dynamic type; the latter, on the other hand, tends to reproduce low notes more satisfactorily than does the magnetic type. By using one 5-in. reproducer of each type the resultant audio range is "extended" as compared to the usual midget receiver designs.

Most midget sets are noticeably lacking in low-note response. The new dual speaker designs make it convenient to resonate the low-note reproducer (dynamic unit), by proper selection of the
(Continued on page 500)

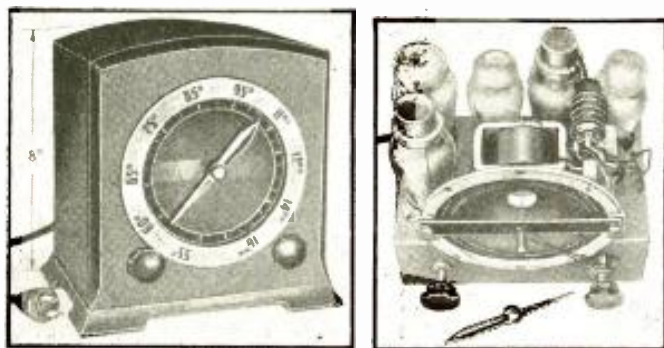

Fig. A. Exterior of clock-style set; and, Fig. B. Interior view.

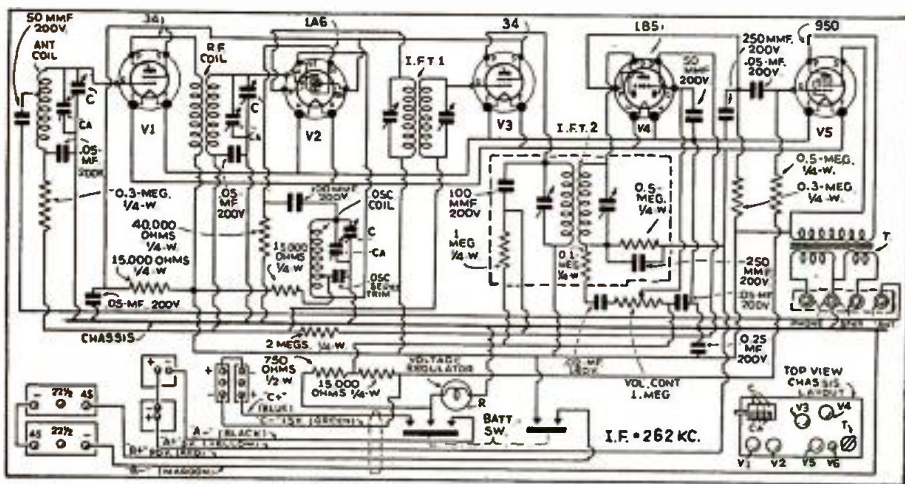

Fig. 2. Here is the schematic circuit of a radio set that incorporates not only an exceptionally high-gain chassis but also a completely self-contained power supply. A tube-style voltage-regulating resistor is used as R. Automatic volume control is incorporated in this set; tube V4 functions as combined A.V.C. diode, 2nd-det. diode, and A.F.1 triode; the A.F. output of V4 is fed into A.F.2 pentode V5. Note that output transformer T connected in the plate circuit of V5 has 2 secondary windings; one is of high impedance, for matching into headphones, while the other is of low-impedance for matching the voice-coil.

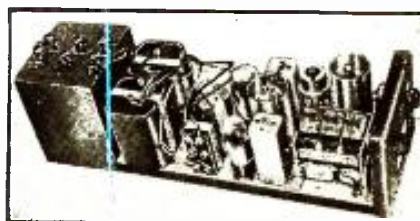

Fig. D. Interior view of "golfbag" portable.

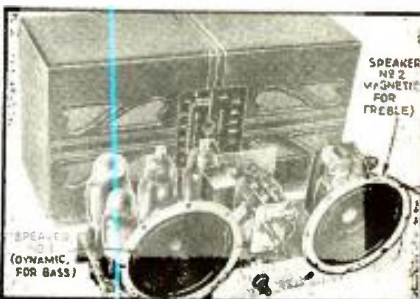
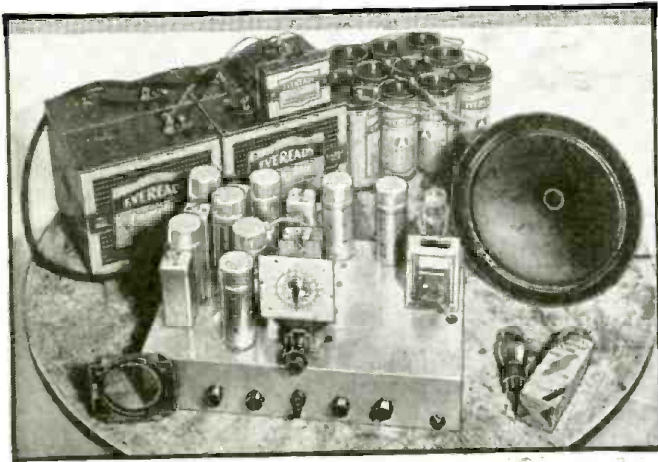

Fig. E. A 2-speaker mantel radio set.

Name and address of any manufacturer will be sent on receipt of a self-addressed, stamped envelope. Kindly give (number) in above description of device.



HOW TO MAKE THE RADIO-CRAFT "COUNTRY GENTLEMAN" RADIO SET

IN DESIGNING the new *Radio-Craft* battery superheterodyne for the farmer, the listener in localities where A.C. is not available, and for the fan who enjoys truly quiet operation and complete freedom from power-line interference, several objectives, among others aimed at, were first set forth as definitely prerequisite—that we might engineer the practical "last word" in battery receivers. The complete set is shown in the heading illustration, above. (This is Fig. A.)

These were: (1) all-wave operation to practical limits and using a standard coil assembly; (2) adequate sensitivity and a good overall R.F.-I.F. gain; (3) effective A.V.C. action; (4) sufficient power output to permit full speaker reproduction of all signals; (5) reproduction approaching as nearly as possible the theoretical perfect fidelity; (6) some means for suppression of lightning surges and static and other noises more obnoxious in remote communities than in localities close to broadcasting stations because of the higher relative gain and sensitivity required for speaker reception; (7) economy of operation—with leeway in favor of the first 6 objectives if necessary.

All 7 objectives are to every prac-

tical degree attained in this receiver, with the above-mentioned compromise in effect. The "A" battery current drain is 0.8-A. for nine 2-V. tubes—a little greater than the limit of 65 ma. permitted for air-cell operation. The "B" current drawn by all tubes, with the noise amplifier-rectifier section and second I.F. section working at full efficiency, is no more than 28 ma. at no-signal, with an upper limit of approximately 50 ma. at full signal input. In the laboratory model, separate "C" batteries have been used, but builders may economize by tapping from one 22.5-V. supply.

The all-wave assembly is a standard construction, manufactured by a well-known coil producer and available through most jobbing houses to the trade. Tuned by a 3-gang variable condenser of 420 mmf. max. (recommended) each section, the assembly will cover a range of from 540 to approximately 25,000 kc., with overlapping on all bands. The manufacturer suggests this capacity. In the laboratory model, a somewhat lower value was employed, as 405 mmf. max. condensers were on hand, with complete coverage to every practical degree realized. The constructor may use either of these capacities

or simply the more standard 370 mmf. in which case adequate coverage of all frequencies normally tuned to will be attained.

Performance on all bands is excellent, the R.F. sensitivity increasing, of course, as we switch toward the lower frequency ranges. On the 20-meter band, we must be exceptionally careful with our wiring if we are to enjoy good reception, as we are limited here by the use of a necessarily high tuning capacity (effecting a lower high-frequency Q) and by the physical design of the coil assembly—which represents, as do ALL commercially available units, a compromise affording most efficient operation on frequencies most used. Here we do not admit a deficiency either in our design or in the coil assembly. Actually, we can realize a high enough 20-meter R.F. gain for every practical purpose if we watch the R.F. wiring, keeping leads short and direct, and use a selected R.F. tube.

By using ferrocarr iron-core transformers in the first I.F. stage along with a tube which has a reasonably high mutual conductance and amplification factor at 180 V. plate supply, we effect enormous gain—so much gain that the same precautions must be taken to as-

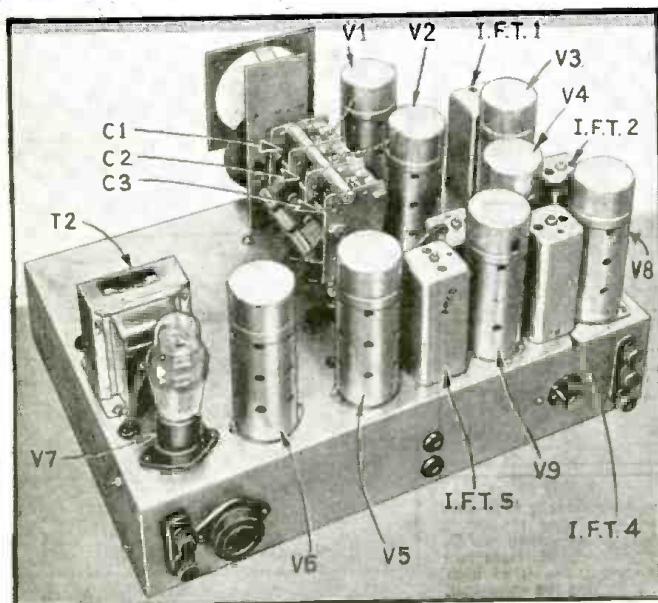

Fig. B. The rear view of the set chassis. The layout is important.

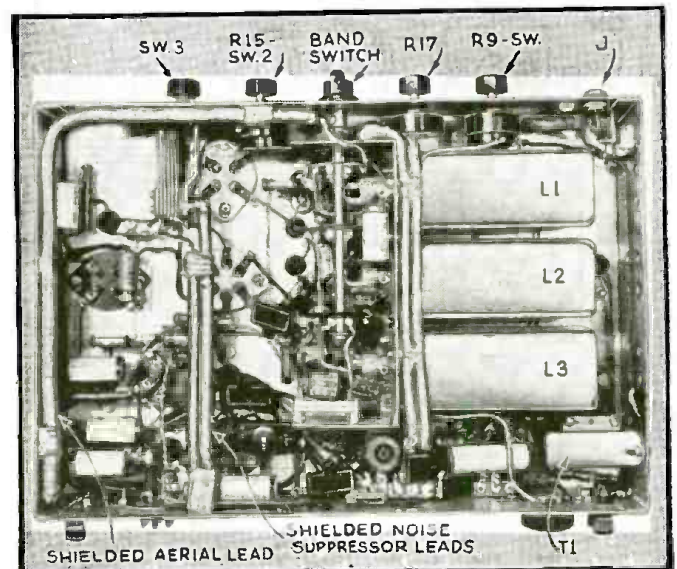

Fig. C. The under-side of the chassis. Note the shielded leads and the compact layout of the parts.

There have been innumerable requests from radio enthusiasts, experimenters and Service Men in rural districts for a really modern, efficient all-wave receiver operating from batteries. This receiver is RADIO-CRAFT'S answer to the problem—do not overlook this article!

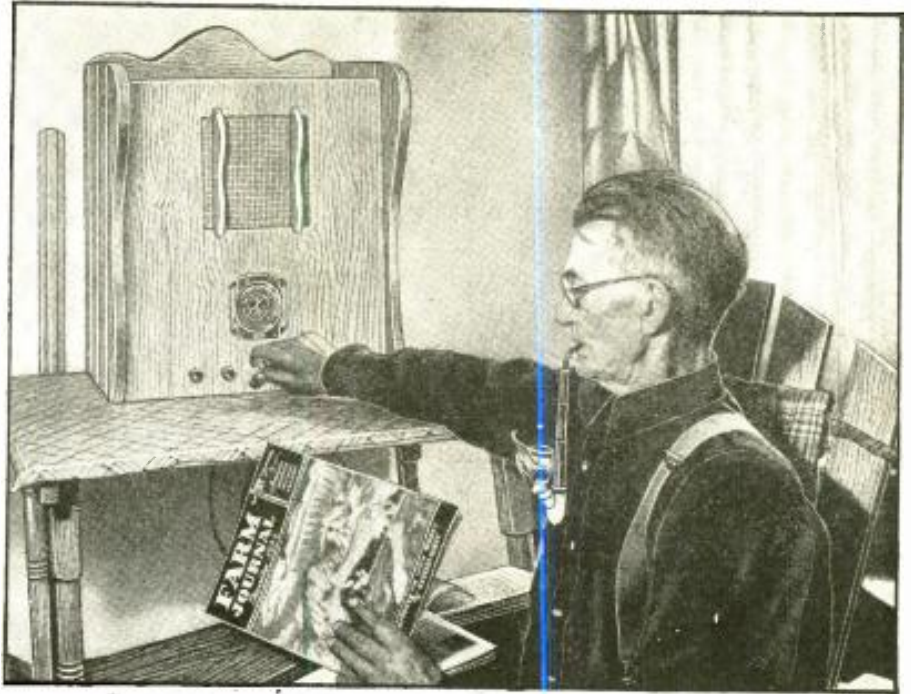

Fig. D. This farmer made his own cabinet for his RADIO-CRAFT "Country Gentleman."

sure stability which are recommended practice with iron-core I.F. circuits using higher supply voltages and more efficient tubes in A.C. operation. A second stage increases this gain somewhat but is used primarily for purposes of noise suppression, more on which will be said later.

By using a type 19 final A.F. tube in class B, we not only provide for more economical operation at no signal input, but assure a high enough output (2 W.) for speaker operation at all times. By matching this tube into a high-grade output transformer, itself adjusted for proper matching into the speaker, the quality of reproduction is made very high indeed.

The A.V.C. system is similar to that used in the farm portable, pg. 147, in the September, 1935 issue of *Radio-Craft*, and will be discussed as we analyze the circuit. Noise, and the effects of lightning surge are eliminated by a noise amplifier-rectifier-suppressor system which though it does not, because of tube limitations, approach in effectiveness similar systems using A.C. tubes and described recently in this and other magazines, yet adequately does the required job. This system is adapted from the original Lamb circuit and presumes amplification of signal and noise in a separate broad-band I.F. amplifier, rectification of the instantaneous and amplified noise voltages, and the injection of the D.C. components as negative voltages into the I.F. circuit proper

to momentarily block the action of one I.F. tube and thus make the receiver inoperative.

THE CIRCUIT

A stage of tuned R.F. is in operation on all bands. This stage uses a 1A4 tube—a semi-remote cutoff type with a lower grid-plate capacity than its predecessor (the 34) and providing a greater degree of stability. See Fig. 1. The amplification factor is 720 and the mutual conductance 750 micromhos—as compared to the 620-620 figures for the earlier tube. It is supplied with a plate potential of approximately 176 V. through the decoupling resistor R2 fed from 180 V. of "B." (Decoupling resistors, by the way, with their associated bypass capacities, are used in all R.F.-I.F. stages where advisable to prevent common-lead regenerative effects and any possibility of instability and wandering R.F. currents—a refinement which high orders of gain make necessary and which becomes good practice anyway.) Grid-return bypass to ground at a point of common ground-

ing for the R.F. circuit has been made.

The 1st-detector—oscillator or mixer tube is a type 1C6, though a type 1A6 may be substituted without circuit changes and with some economy in "A" current. The cutoff for the 1A6 at 67.5 V. screen-grid supply is -22.5 V.; with the 1C6 it is something like -14 V. (Continued on page 492)

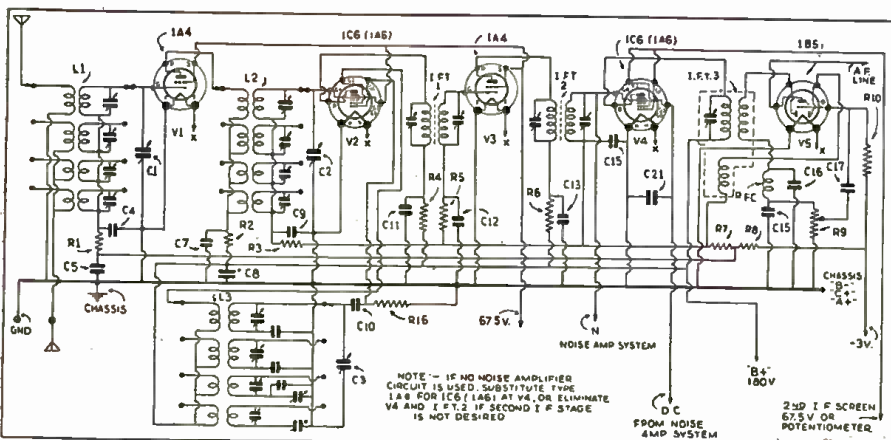

Fig. 1. The circuit of the receiver up to the A.F. amplifier wiring. The unmarked trimmer condensers and fixed condensers in the circuit are part of the coil assembly.

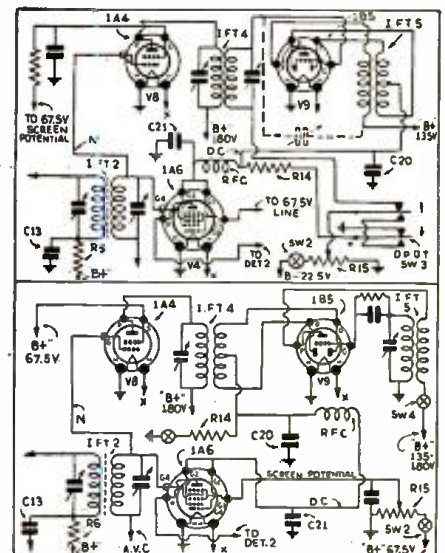

Fig. 3. The noise-suppressor circuits.

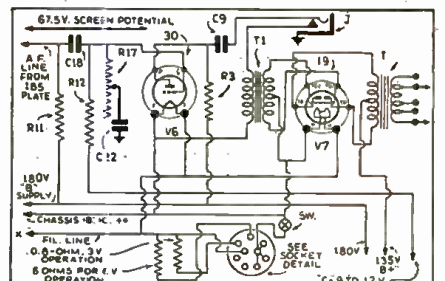

Fig. 2. The A.F. amplifier circuit.

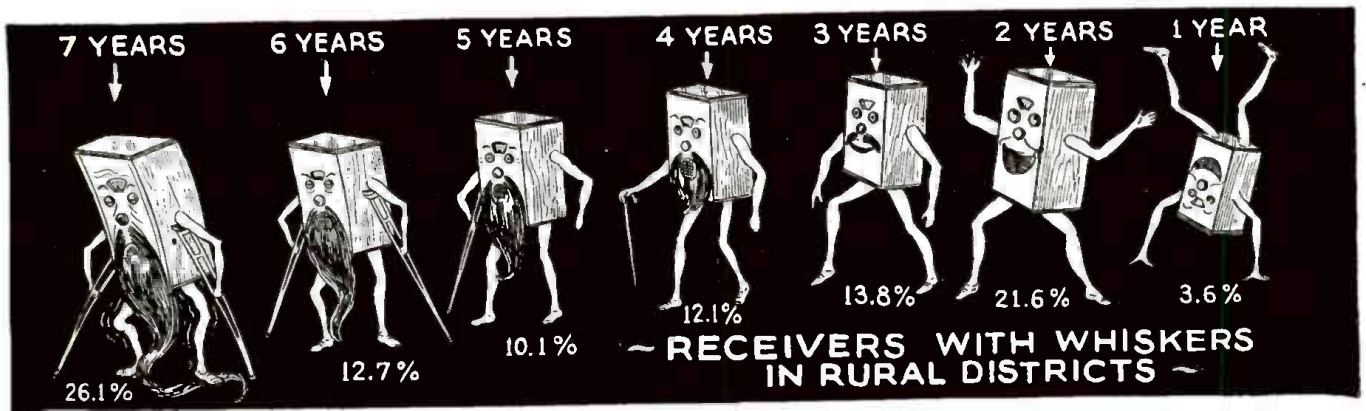

Fig. 1. The basis of this breakdown of the age of sets in use are F.C.C. figures. Note the large number which must shortly be replaced!

INSIDE FACTS ABOUT AMERICAN BROADCASTING

An up-to-the-minute compilation of useful and interesting facts about the ever-changing condition of broadcasting in the U. S.

It is interesting to compare these statistical facts with "Milestones in Broadcasting" in the February 1936 issue, and "A Modern Picture of Broadcasting" in the February 1935 issue.

WILHELM E. SHRAGE

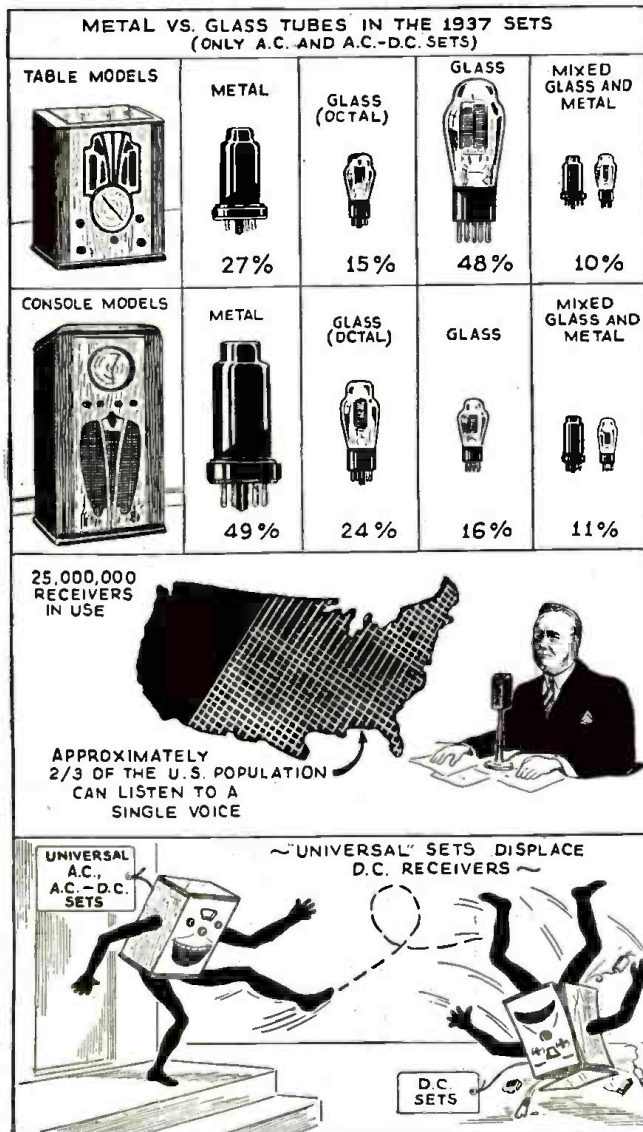

Fig. 2. The "metal-tube" situation can be seen at a glance.

EXACTLY 40 years ago (in 1896) a young technician, Guglielmo Marconi, surprised the world with the first practical method of communication by means of radio waves, or, as contemporary scientists termed them, "Hertzian Waves." Considering the important role radio plays today, it sounds worse than a bad joke, that Heinrich Hertz's discovery was considered before Marconi's time as "just one of these impractical aims of the physicists"!

Professor Hertz's electromagnetic waves were of as much importance to the average man during his life as Einstein's Relativity Theory is today. But the most tragic note about Heinrich Hertz is the fact that he died long before Marconi converted his theoretical ideas into "something practical."

Einstein, at least, had the privilege of witnessing how his theory provided science with valuable information in developing a means of controlling cancer. His "brilliant uselessness," as some ignorant persons called his life work a few months ago, is today the cornerstone of our understanding of the atomic nuclei, and these nuclei (which are the origin of a number of extremely hard radiations) have opened up new possibilities in combatting the worst disease ever to confront mankind. But this is not all that has been derived from his theory. New types of radio and electronic tubes—at present under research—utilize in the final analysis, Einstein's theory, and in a few years every one of us may have this great scientist's brainchild "installed" in his own radio set.

BROADCASTING AN OLD I. O. U.

Old Europe, without doubt, has given us radio. But America paid this gift back with 1,000 per cent interest in the form of radio broadcasting. Without America's daring engineering, radio would probably still be "Wireless Telegraphy"! But radio broadcasting as it is today serves everyone—everywhere. It is the one universal means of communication. It comes into our home, whether we live in the lonesome woods, or in a city apartment. It connects us with the far-flung corners of the globe. It brings us entertainment, information, and education!

Broadcasting was born on November 2, 1920, in Pittsburgh, Pa., when Dr. Frank Conrad broadcast the returns of the Harding-Knox election to a handful of excited amateurs. It was a simple beginning. A small garage, housing transmitter, studio, and what not, and a large amount of optimism were the initial investments. But broadcasting,

and its idea, has grown since then to gigantic dimensions. It is not necessary to search the globe to realize this fact. An excellent proof is found in the past presidential election, which marked the 16th birthday of broadcasting progress. This election has shown better than many thick books the tremendous power of radio, today. Let us look only at one figure which explains everything: we have approximately 25 million radio receivers in use, and because of this vast distribution approximately 75,000,000 persons (or about two-thirds of our population) could listen to a single voice.

600,000,000 "LISTENING HOURS" WEEKLY

But this example demonstrates only the tremendous size of the radio audience on certain occasions. Of much more importance is the regular or average radio audience. Since American broadcasting is an important advertising medium, the larger the audience the better the programs. According to Professor Allport of Harvard we spend weekly a billion hours listening to the radio. We do not know how Professor Allport obtained this figure, and even if we consider only 60 per cent of his estimate as correct there are still left 600,000,000 hours to be reckoned with. Since figures of this vast size are far above our horizon of conception, let us convert them into something more digestible. We remember that recently a New York reporter traveled around the world in 18 days and 11 hours. For the sake of simplicity let us assume that the average citizen provided with the necessary amount of money would need at least 20 days, or 480 hours for the same trip. Well, the time spent weekly by the American radio audience would be sufficient to send 10,000 reporters around the globe—125 times over.

RADIO AN EXTENSIVE EMPLOYMENT FACTOR

However, this is only one side of the story. American radio broadcasting created a completely new industry which provides about 150,000 persons with jobs. There are at present approximately 25,000,000 radio receivers in use in the U.S. with a value of about 1.5 billion dollars, though the initial investment of the American public in radio will probably amount to more than 3 billion dollars. These 3 billions are, according to David Sarnoff, President of RCA, more than 10 times the investment in broadcasting stations and manufacturing plants.

The "oil" which greases this vast machine is provided by the radio sponsors who spent during 1936 approximately \$100,000,000 to buy "time" from the radio stations, and \$40,000,000 for talent to put their advertising over.

INCREASE IN RADIO PRODUCTION AND QUALITY

Despite the fact that American radio production increased steadily during the past few years, conditions within the industry were far from ideal. However, this year's balance sheet indicates that the radio industry made real money in 1936, and this for the first time since the great boom of 1929. Approximately 7.5 million receivers were produced (and sold for decent prices) in 1936. Even if we consider the respectable number which went abroad, there remains still an all-time record of domestic radio business.

About 75 per cent of all retail sales went to listeners who already had a receiver (an old-fashioned one, of course). The increase in purchasing power, and the education of the

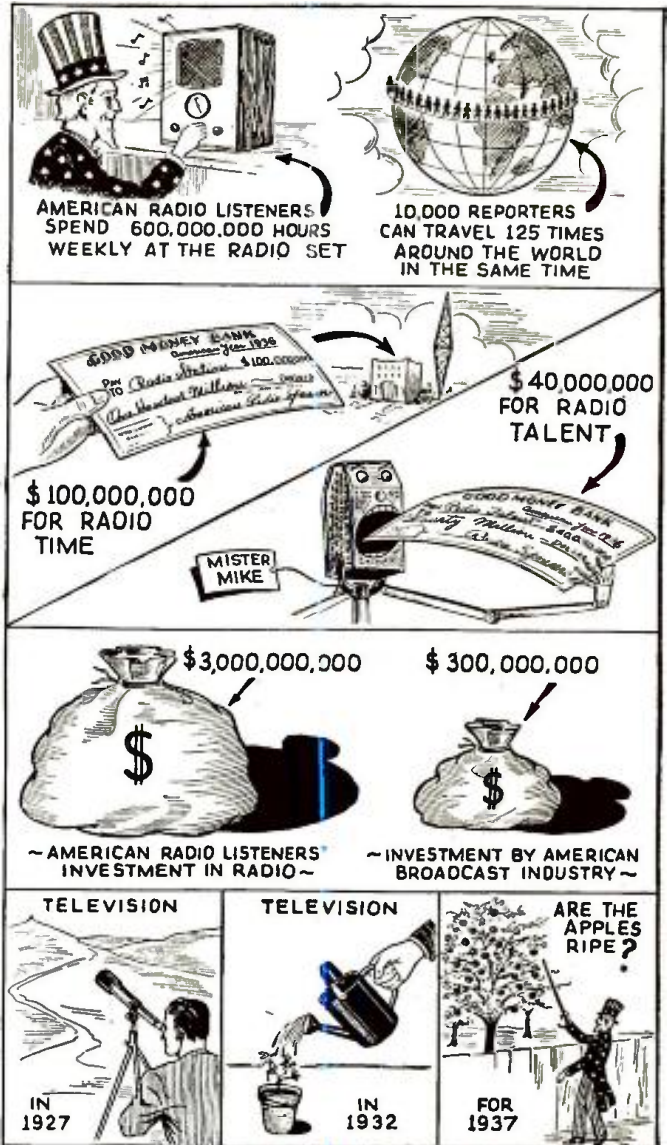

Fig. 4. A few figures and forecasts on broadcasting.

listeners to appreciate high-class radio performance induced the American public to buy larger and better sets. This trend towards high-quality receivers cut a considerable slice from the cake of the "cheap set" manufacturers. The year 1937 will probably bring us receivers even a little more expensive but with a performance which will overcompensate for the increase in price by its superb quality.

RECEIVERS WITH WHISKERS

The improving economic conditions of the country, and an
(Continued on page 488)



Fig. 3. What will be the sales figure for 1937? Every estimate made shows a record year ahead for manufacturers and sales organizations.



Fig. A. Dials that operate like railroad signal semaphores.

FEATURES IN RADIO SETS FOR 1937

Mechanical ingenuity has attained new heights, in the radio set designs of 1936 and 1937, as indicated in the special Radio Show Number of RADIO-CRAFT (Oct. 1936). Intensive laboratory work has resulted in new tuning arrangements, and reproducer compromises; of these, three of the most interesting are described in this article.

Semaphore Tuning Dial. Several successful efforts have been made to overcome the confusion that every person unacquainted with multi-wave receiver operation encounters during the early stages of trying to tune an all-wave set that includes a full-vision multi-wave scale. One of the most interesting solutions is a development of Fairbanks, Morse & Co. A unique mechanical system is utilized by means of which any requisite scale is available at the turn of a selector knob; and these scales take the semi-circular form with which almost everyone who has ever operated a radio set is familiar. At the same time, and by means of a tab, the band designation appears in a small window over the center of the dial.

The general idea of this so-called Semaphore Tuning Dial is here illustrated in phantom, Fig. A. (The details of the leverage and selecting means required are too complex to permit of convenient illustration in this article.)

Acoustic Adapter. Almost everyone is familiar with the fact that the relation of the loudspeaker to its cabinet, and the dimensions of both, have direct bearing on the over-all frequency response of a radio receiver. However it has remained for Zenith Radio Corp. to introduce a variable element, in this acoustical relationship, in the shape of a device that the manufacturers term an Acoustic Adapter, shown in Fig. B.

The major purpose of this assembly, which is located at the rear of the reproducer and within the cabinet, is to vary the load impressed upon the rear of the loudspeaker cone, by varying the response characteristic.

The large outer cone of the Acoustic Adapter is attached at its periphery to an inner cone having a much more acute angle that more nearly parallels the loudspeaker cone. By pulling or pushing on a knob the apex of the outer-inner cone assembly is made to approach or recede from the cone diaphragm; thus varying air-space A. This varies the degree of suppression of the acoustic wave radiated by the speaker cone; increased suppression ("damping," is the technician's term) results in diminu-

tion of the low-frequency response. The resonant chamber formed by the inner-outer cone assembly also plays an important part in the overall frequency response.

This control of the lower register or bass notes affords compensation for the

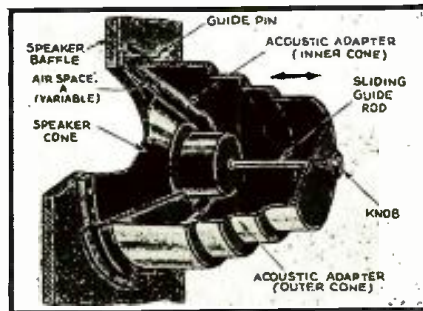

Fig. B. A movable air-chamber that caps the back surface of a loudspeaker improves reproduction by removing boominess.

type of poor room acoustics which result in over-emphasis or boomy bass response. The frequency response of many radio sets is greatly influenced depending upon whether it is placed against the wall or removed some distance from it. In this connection the Acoustic Adapter affords a convenient and permanent means of adjusting for either placement of the radio set. At the same time, the tone control on the radio set is free to afford its requisite flexibility in matching the receiver output to the characteristics of a particular program.

Movie Dial. Few radio receiver manufacturers seem to realize that complexity in the operation of a radio set is a definite sales handicap. However one manufacturer has achieved very nearly the ultimate in tuning dial simplicity by means of a projection system that

(Continued on page 485)

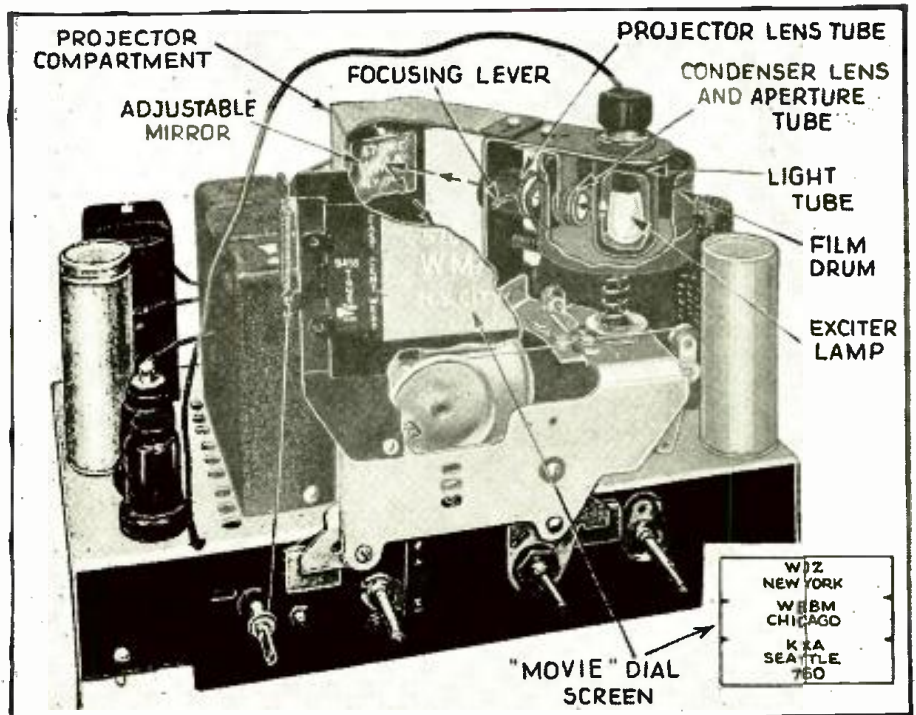

Fig. C. Turning the tuning condenser control knob automatically rolls call letters, of 150 broadcast-band and short-wave domestic and foreign stations, across a new radio set's "movie screen"

MAKE "THE EXECUTIVE" —A BUSINESS MAN'S A.C.-D.C. SET

An attractive unit for home or office, combining a radio set, lamp, clock and pens.

N. H. LESSEM, PART I

"WANT YOU to construct a radio receiver, suitable for use on my desk, so that I may keep posted on important news items and other things over the air. This set must not be too large and must combine harmonious design and utmost utility. Perhaps you can combine with the receiver an electric clock, or a desk lamp, or even a fountain-pen set . . . or, come to think of it, I believe it would be a good idea to have *all* these useful devices . . . yes, I want a radio receiver with an electric clock in the center of the front panel, a desk lamp on top and a fountain pen protruding from a common base on each side. Incidentally, the cabinet should be made of one of those new plastic materials, preferably in a jade green color with a marble effect, in order to harmonize with the color scheme of my office."

So spoke the "ol' man," Mr. Hugo Gernsback, in assigning the author to this task, thereby providing the necessary germ from which finally evolved "The Executive" desk set. Views of the finished product shown on this page hardly do justice to the receiver. Only expensive 4-color printing could bring to you the delicate translucent hues and the veined and marbled effects of the polished plastic material used in the

construction of the executive's desk-type radio set.

(Complete details for building the base and cabinet will be given in a subsequent article, Part II, which will appear in the forthcoming issue.)

CHASSIS LAYOUT

Referring to Fig. B, it will be noticed that the reproducer is mounted on the right-hand side of the chassis. This was necessary to make room for the electric clock which fits in the center of the front panel and extends over the chassis between the loudspeaker and the tuning condenser. The center of the chassis was purposely left clear so that the time-setting shaft of the clock could be extended through the screen which forms the back of the cabinet. The R.F. and detector stages are on the left-hand side of the chassis while the A.F. and power circuits are located on the right. The type 25B6G output tube was too big to fit the space between the top of the cabinet and the chassis, making it necessary to lower its socket about 1/2-in. beneath the surface of the chassis. The socket hole was enlarged sufficiently to permit the entire base of the tube to pass through.

Figure 3 gives the complete physical dimensions of the chassis, and all the necessary holes and cutouts. It will be seen that the loudspeaker, too, had to be recessed a little way into the chassis in order to clear the top of the cabinet. Both the volume control and the 2-gang tuning condenser mount half-way under the chassis. The antenna coil (the one with the large primary winding) mounts on top of the tuning condenser while the R.F. coil mounts under the chassis. Thus both coils are shielded from each other. All parts are so positioned that

leads are short, to prevent spurious pick-up between components.

THE CIRCUIT . . . NEW 25B6G TUBE

For a set of this type, the circuit had to be unusually reliable and stable. Hence, a straight-forward T.R.F. circuit of the universal A.C.-D.C. type was chosen.

Given such a circuit, plus excellent-quality parts, there is practically nothing to throw the set out of its state of stability except the aging of the tubes. It is therefore suggested that the constructor, if he wishes to enjoy the same measure of success as the author, use only the parts specified in the List of Parts; or, at least, equal-quality substitutes. Above all, do not use parts manufactured especially for the cheap A.C.-D.C. ridget sets now flooding the market and selling for about \$6.00 to \$8.00. Such components have a safety factor of close to zero.

A type 6K7 all-metal tube is employed as the R.F. amplifier. The positive cathode bias of this variable-mu tube is varied by means of a 25,000-ohm potentiometer in order to control the output (volume) of the set. A 300-ohm "stopping" resistor prevents too small a bias being applied, which condition would cause circuit oscillation.

The detector stage utilizes a type 6J7 all-metal tube in the role of power detector. This tube has a fixed-bias obtained by virtue of the voltage drop across the 25,000 ohm resistor in its cathode circuit. It is important, for the sake of good tone quality and circuit

(Continued on page 506)

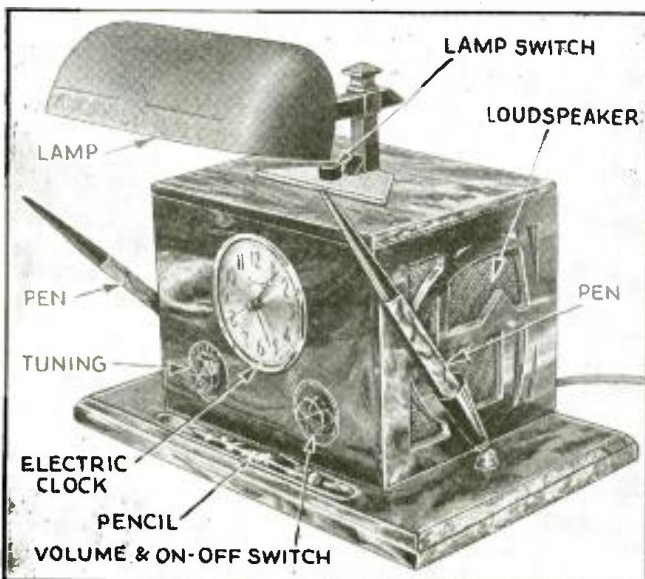
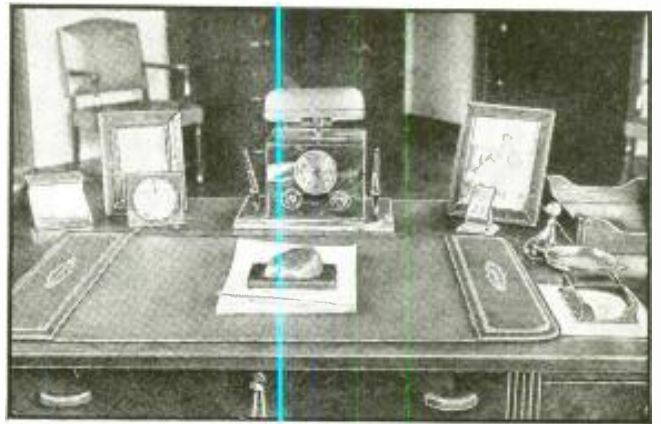

Fig. A. This illustration shows how an executive's radio set differs from ordinary broadcast receivers. It must supply the maximum of usefulness in a minimum of space.

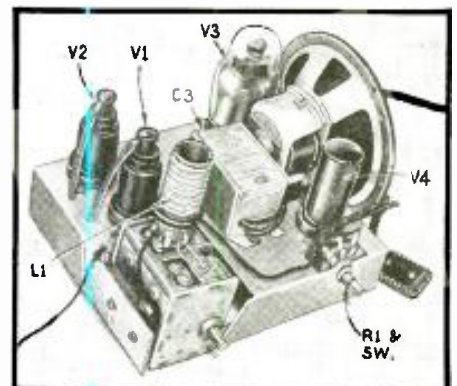

Fig. B. The chassis of the tiny set showing the positions of parts and mounting details.



Fig. A. A "trick" to illustrate dynamic-type phones used as transducers. Whispering into one phone can be heard with good volume in the other.

THE DYNAMIC LOUDSPEAKER "GOES HEADPHONE"

Mother Necessity has a new offspring in the guise of magnetodynamic headphones designed to afford high-fidelity response.

C. P. MASON

RADIO SETS, loudspeakers, tubes, testing equipment, circuits, all these and many more component elements in the broad field we call "Radio" have undergone considerable change in the last few years, but the "forgotten device" has been the *headphone*. True, considerable impetus was given to the use of headphones by the recent introduction of the piezoelectric or "crystal" type, but, only last month did a capable laboratory develop the moving-coil principle of operation; so familiar in our so-called "dynamic loudspeaker," for efficient application in headphones.

As *Radio-Craft* recently illustrated ("Streamlined 'Mike' is also a loudspeaker!"; November, 1936), the moving-coil or "dynamic" principle of operation very readily lends itself to reversible or optional use as either microphone or loudspeaker.

It is of interest to note, therefore, that the newest in sound reproducing devices—headphones that use a moving voice-coil (connected to a matching transformer)—is also capable of acting as a "mike" for sound pick-up. Like the previously-mentioned microphone which also is capable of functioning as a loudspeaker, the new headphones, inversely, are capable of functioning as a microphone unit (as shown in Fig. A.); in other words, both are *transducers*.

Many years ago the idea of using a voice-coil moving in a strong magnetic field was put into practice. However, the magnetic systems then available were comparatively weak;

and facilities were lacking for economically machining to sufficiently close tolerance. Both these problems have been overcome; in addition, important facts have been learned regarding several phases of acoustics that relate to headphone operation.

High-coercive cast magnets (of which *alnico* is one type) are now available that have several times the strength of older types. A magnet of this general nature affords the requisite high-intensity magnetic field for the voice-coil of the new dynamic headphones; this magnet takes the form of a cylindrical plug, drilled through the center for a mounting screw, as shown in Fig. B. The magnetic circuit is completed through a U-shaped iron yoke, and a pole-piece in the form of a large iron washer.

Exceptionally close machining, and the use of a very light diaphragm and voice-coil construction, assist greatly in producing a headphone unit that is amazingly efficient in transforming electrical energy into sound energy.

Of material assistance in maintaining maximum response fidelity across the working audio range is an "acoustic network" consisting of air chambers with numbers of small openings provided on both sides of the diaphragm. The resulting arrangement being highly damped serves to control the frequency-response characteristic. This construction is clearly shown in Fig. B.

Few radio men realize that ordinary "magnetic" (or, more correctly, *magnetomagnetic*) headphones are unsuited to precise work in checking high-fidelity programs and equipment. In addition to having a limited frequency-response characteristic they also readily overload when ad-

(Continued on page 496)

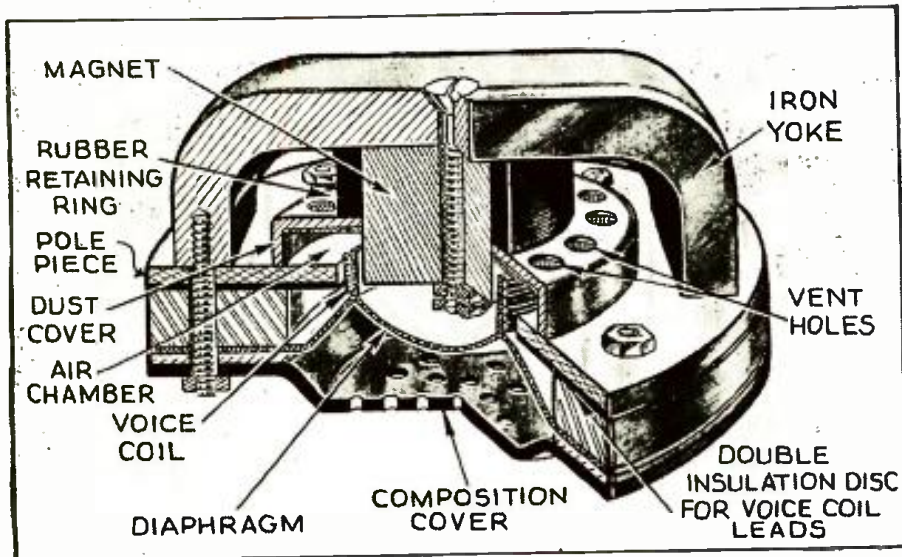

Fig. B. Detail illustration of the new permanent-magnet dynamic phones.

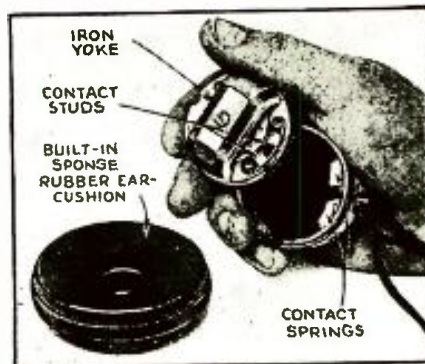

Fig. C. Here the "dynamic" earphone is seen removed from its case; the hand affords excellent size comparison. Springs and contact studs eliminate the nuisance of flexible leads from unit to case. Another ingenious development is the built-in sponge rubber ear-cushions that prevent "corns on the ear." These headphones were designed by Bell Telephone Labs. and built by Western Electric Co.; they are used by Electrical Research Products Co. ("ERPI") in monitoring high-fidelity sound equipment.

NBC-RCA TELEVISION "ON THE AIR"

A SAMPLE of television program transmission was demonstrated last month in New York by the National Broadcasting Company in a special program illustrating RCA experimental developments. The pictures were broadcast from the trans-
(Continued on page 485)



FIRST—MAKE-UP. The artists prepare to be televised by a complete theatrical make-up — though using materials particularly suited to the lighting effects and characteristics of the televising cameras.

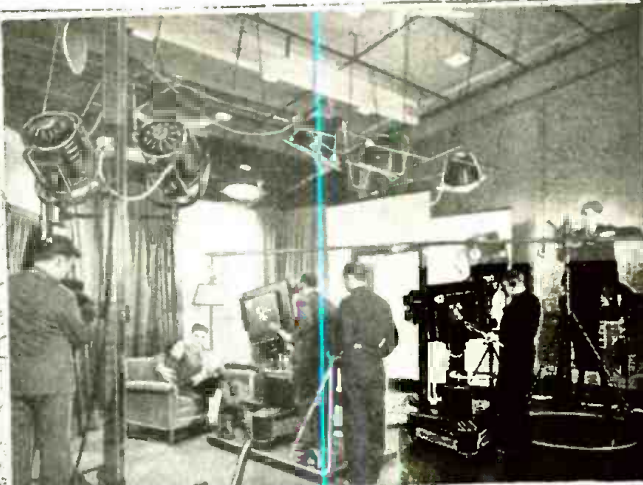
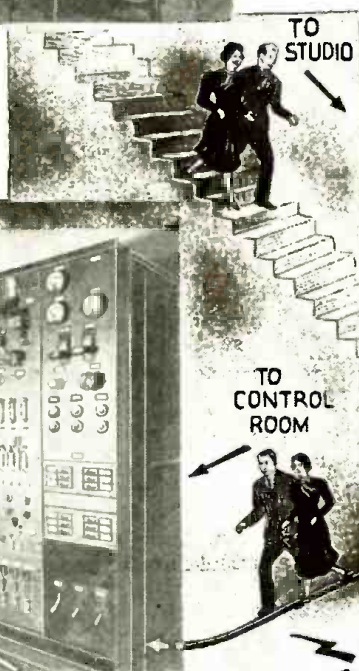

SECOND—SCANNING. The artists present their program before television cameras and sound microphones which transform light and sound into electrical currents which are passed on to the control and amplifier equipment.

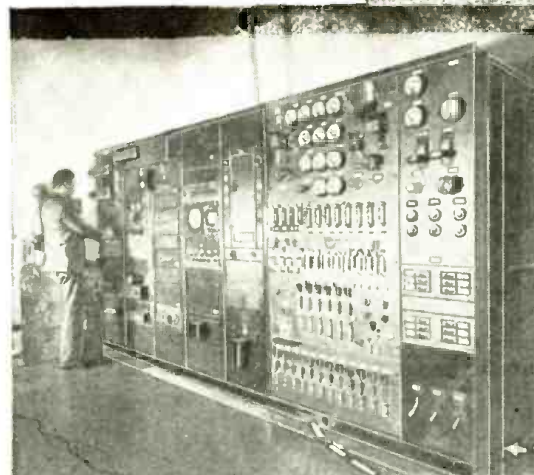

THIRD—AMPLIFYING. The signals from cameras and microphones are properly mixed and amplified in special amplifiers which have exceedingly wide frequency characteristics so that the minute variations of light and shadow are not lost in transmission. These are also controlled to the proper levels.

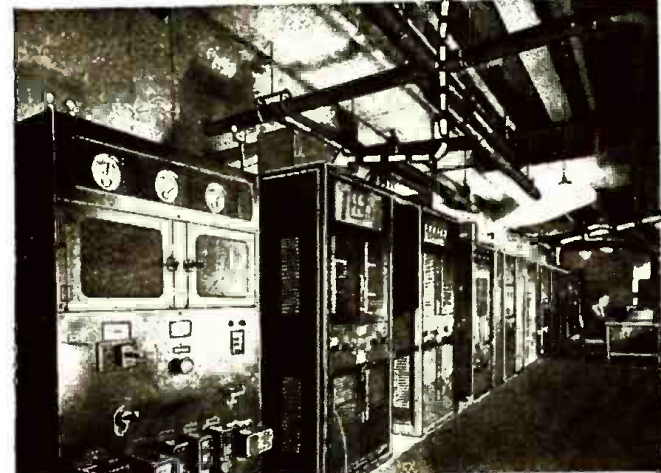
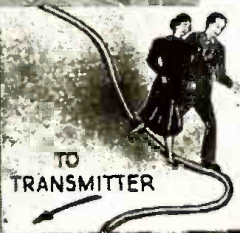

FOURTH—TRANSMISSION. The amplified image and sound impulses are then sent over the air on ultra-high frequency transmitters especially designed for the purpose. These are located on the top of the Empire State Building.

FIFTH—RECEPTION. The images and accompanying sounds are picked up in special cathode-ray television receivers which are synchronized with the scanning of the transmitter. Images 7 1/2 x 10 ins. can be obtained.
(Receiver details appear on page 74 of August 1936 RADIO-CRAFT.)



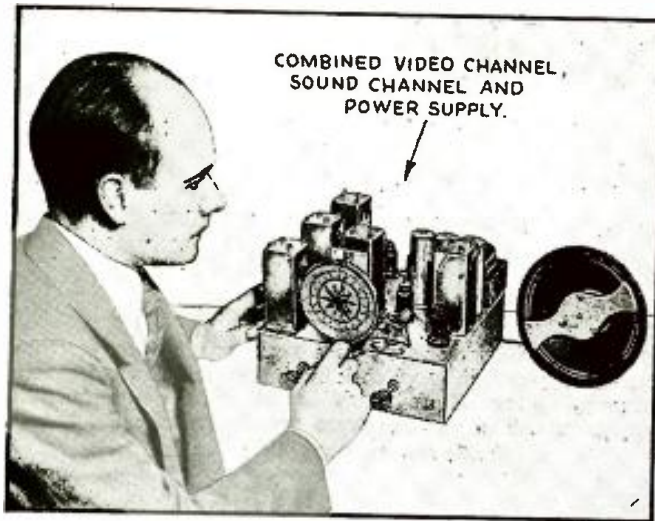

Fig. D. The chassis including video and sound units.

HOW TO MAKE THE TELEVISION

During the past month, David Sarnoff, president of RCA, made the statement that the transmissions from the Empire State television transmitter would now be a series of "dress rehearsals" to give the staff the needed practice in studio technique. A "rehearsal" is shown on page 465.

PART II

THE PROBLEM of designing and constructing a television receiver is one which differs in many ways from the ordinary broadcast set. First, in order to record or interpret the variations from high-light to deep shadow at the comparatively high definition used in the present experimental transmissions of RCA, Philco, Don Lee and others, a very wide band of frequencies must pass through the video channel, including both the R.F., I.F., and A.F. portions of the receiver. This must be accomplished by extremely careful design and construction of those portions of the circuit which ordinarily would cut off at much lower frequencies.

When it is considered that a pass-band of over 1,000,000 cycles is necessary in I.F. and A.F. units, the difficulties of design can be realized.

These problems have been dealt with in the *Radio-Craft* 1937 Television Receiver by carefully considering each portion of the set as an individual unit and by keeping the number of tubes, tuned circuits and A.F. stages to an absolute minimum consistent with satisfactory results. For example, only 2 stages of I.F. are used so that the amount of "loading" needed in the tuned circuits can be kept down. To compensate for the lowering of gain (circuit Q reduction) caused by this loading of the tuned circuits, unusually high-efficiency I.F. transformers of the "iron-core" type are used.

The R.F. selectivity is kept "down" by the use of a minimum number of tuned circuits and by the elimination of a pre-selector stage (even though this may cause some "image reception" in some localities).

The A.F. pass-band has been widened to the required extent by carefully adjusting the time-factor of the coupling circuits to reduce the high-frequency attenuation usually encountered in resistance-capacity circuits. The reduction of the number of A.F. coupling circuits in the video amplifier to an absolute minimum also aids in widening this band.

Incidentally, it might be well to explain (for those builders who are not well versed in the requirements of a television receiver of the cathode-ray type) the various components of such a television receiver. Such a set consists of a tuner (designed to operate on the frequencies of about 5 to 7 meters or so) followed by a frequency changer and an I.F. amplifier, tuned to a rather high frequency (in our set it is 3,100 kc.), which has a wide-frequency response characteristic. This I.F. amplifier feeds into a diode detector followed by a resistance-coupled A.F. amplifier and the output of this amplifier controls the bias on the control-grid of the cathode-ray tube (thus increasing and decreasing the intensity of the "spot"). Part of the I.F. signal is fed through another amplifier tube which acts as a synchronizing control, locking the sweep amplifier with the signal frequency.

The output of the frequency changer also feeds into a second I.F. amplifier tuned to a different frequency than the first I.F. amplifier (in our set it is 5,350 kc.) followed by a second detector and A.F. amplifier for the sound accompaniments for the television programs. This second channel, known as the Sound Channel, is automatically tuned to the frequency of the sound transmitter, when the images are tuned-in.

The cathode-ray tube is fed with a high voltage on its accelerator plates from a power supply unit. The deflector plates of the C.R. tube are swept back and forth to scan the image end of the tube in synchronism with the transmitter, scanning by the use of two thyatron-type saw-tooth oscillators, one of which is locked in with the signal by means of the synchronizing tube.

THE SOUND CHANNEL

In this part of the construction, we are filling-in the empty space left last month in the Video Channel chassis. It will be remembered that we reserved this space for the sound channel, which, in our set, consists of an I.F. amplifier stage,

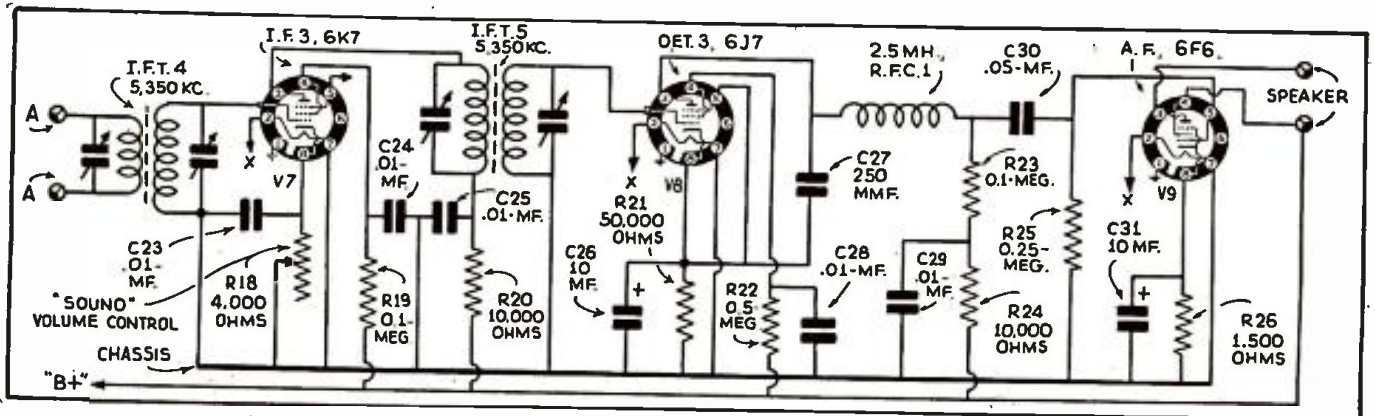

Fig. 4. The circuit of the I.F. amplifier, detector and A.F. amplifier which comprise the sound channel.

RADIO-CRAFT—1937 RECEIVER

Part II of this series of constructional articles explains the parts which make up the modern cathode-ray television receiver, as well as giving details for making the section for picking up the sounds which accompany the television transmissions. By this breaking up the construction of the set into parts, each of which has a definite and complete function in the complete receiver, the Technical Editor—C. W. Palmer—who designed the set, hopes to make the building of the set easier for the experimenter who might otherwise be lost in the maze of wires and circuits involved.

a pentode detector and a pentode output tube.

The parts mentioned are placed as shown in the photos, Figs. D, E and F. The filament and plate potentials are obtained from the special humless power supply unit which we made last month for the video amplifier. The wiring of the sound channel is shown in Fig. 4. This should be executed with care, to keep the wires short, direct and yet as far from those of the video circuits as possible. An examination of Fig. G will show the relative positions of the wires.

The wires marked A A on the schematic circuit, Fig. 4, connect to the suppressor-grid wire of the first-detector tube, V1 in Fig. 1 (Part I). This suppressor-grid wire is broken and the leads to the transformer I.F.T.4 are connected, one to the suppressor-grid of the 956 and the other to the cathode of V2. This inserts the sound channel in the "output" of the frequency changer, without affecting the characteristics and tuning of the video channel.

When the wiring has been finished and carefully checked, the set can be turned on and with phones connected to the video amplifier the image signals from the television transmitter should be tuned-in to greatest volume. Then, the speaker should be connected to the sound channel output tube, the volume control of this section turned to the maximum position and the trimmers on the I.F. transformers, I.F.T.4 and I.F.T.5 should be turned toward the lowest capacity position, slowly, a little at a time until the sound accompaniment to the images is heard in the speaker. Then careful adjustment for loudest signals is all that is required.

If I.F. oscillation is encountered in this amplifier when the volume is turned on full, it may be necessary to insert a limiting resistor in series with the cathode lead of V7, be-

(Continued on page 495)

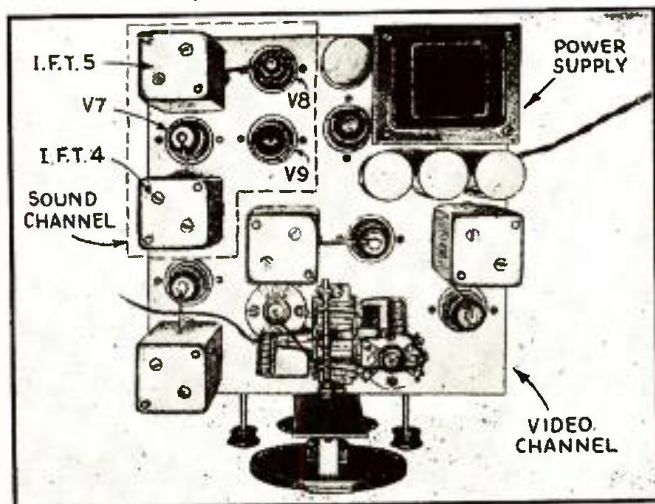

Fig. F. Top view. Dotted lines indicate the new section.

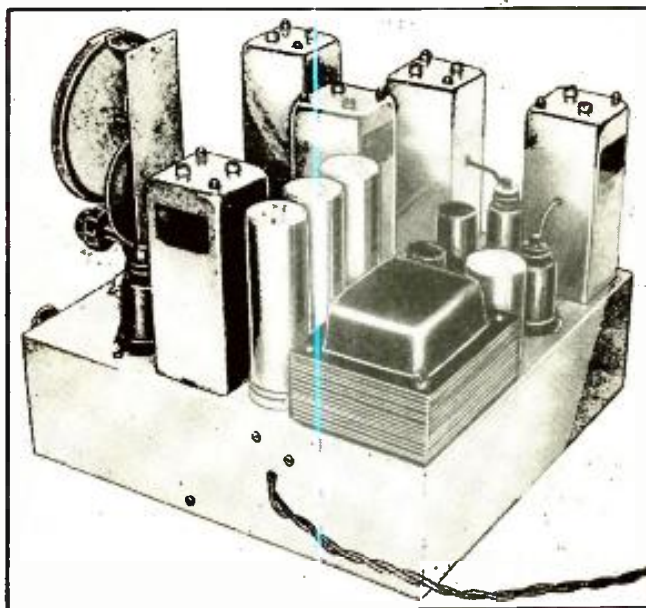

Fig. E. The rear view of the chassis as described.

LIST OF PARTS

- Two Meissner Ferrocart Aalignaire type 6239 I.F. transformers, I.F.T.4 and I.F.T.5;
- Five Cornell-Dubilier mica condensers, 0.01-mf., C23, C24, C25, C28, and C29;
- Two Cornell-Dubilier electrolytic condensers 10 mf., 50 V., C26, C31;
- One Cornell-Dubilier mica condenser, 250 mmf., C27;
- One Cornell-Dubilier mica condenser, 0.05 mf., C30;
- One Electrad variable resistor with power switch, 4,000 ohms, R18;
- Two Continental Carbon resistors, 0.1-meg., R19, R23;
- Two Continental Carbon resistors, 10,000 ohms, R20, R24;
- One Continental Carbon resistor, 50,000 ohms, R21;
- One Continental Carbon resistor, 0.5-meg., R22;
- One Continental Carbon resistor, 0.25-meg., R25;
- One Continental Carbon resistor, 1,500 ohms, 2W., R26;
- One Hammarlund R.F. choke, 2.5 mhy., R.F.C.1;
- Three Hammarlund Isolantite octal sockets;
- *One loudspeaker with 6F6 coupling transformer;
- One Raytheon type 6K7 metal tube, V7;
- One Raytheon type 6J7 metal tube, V8;
- One Raytheon type 6F6 metal tube, V9.

*Names and addresses of manufacturers will be sent upon receipt of a stamped and self-addressed envelope.

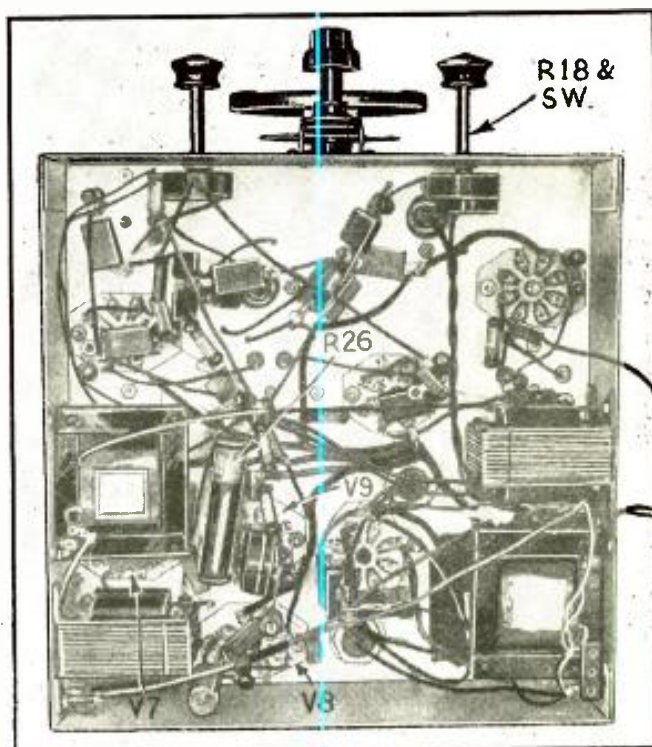
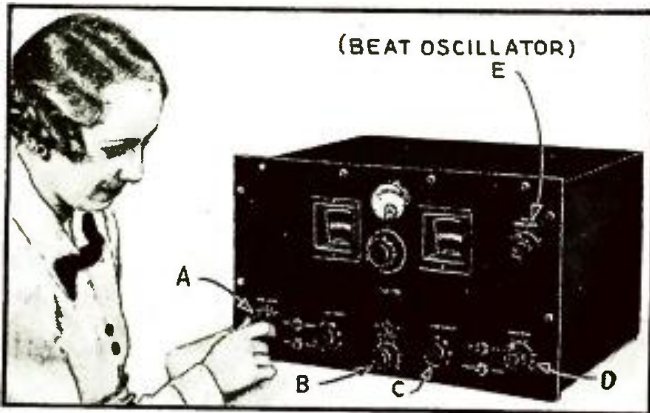

Fig. G. The under-side view. Note the direct wiring.



PRECISION CONTROLS IN THE 16-TUBE 1937 DX "SUPER PRO"

This communications-type receiver has controls not found in the ordinary "garden variety" of radio receiver—as described.

ELI MARTIN

AN IMPROVED model of the professional receiver, the "Super Pro" with many new unusual features, has just been developed. In this latest model, 8 metal tubes are used in conjunction with 8 glass tubes to achieve the combined high efficiency afforded by both types.

One of the outstanding features of this improved model is a *band-width scale*, Fig. 1A, engraved on the front panel. With the aid of this exclusive tuning device it is possible to accurately select the actual band-width required.

That is, if the operator wishes to tune to, let us say, a band-width of 10 kilocycles he can actually turn the tuning control to the calibration "10 kc." on the panel. In this manner, not only is the highest technical precision achieved, but

also the most effective result; for now, for the first time, it is possible to select, at will, band-widths of definite values.

Another important feature is a new, *calibrated sensitivity control*, Fig. 1B. The calibrations also appear directly on the panel and enable the operator to select the proportionate sensitivity required for each signal. Thus, an actual

table can be made, for the signals from that particular broadcasting station. A *calibrated audio gain control*, Fig. 1D, is also included on the panel. For the operator interested in code, an additional important new feature is a *calibrated beat-oscillator control*, Fig. 1E, also with a scale engraved on the panel. This
(Continued on page 487)

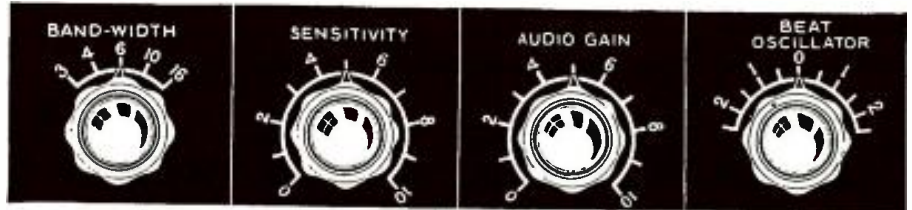

Fig. 1. The various "precision" controls described above; left to right—A, B, C and D.



Fig. A. Professional appearance is an added feature.

A TUBE TESTER THAT "TALKS"

This tube tester is designed to overcome the defects of the ordinary "emission" or conductance tester.

S. M. HARPER

MOST tube checkers fail to give the correct answer at least 95 per cent of the time; which is detrimental to the dealer or Service Man, and a source of annoyance and disappointment to the customer. Realizing that tube defects such as *cathode-heater leakage* and *intermittent contacts* will cause trouble in a radio set even though the tube tests "good" in a checker has led to the development of a new tube tester that will give audible proof of a tube's merit.

This tube tester is not of the emission or dynamic mutual conductance type. Instead, it gives a reading affected simultaneously by the grid's ability to control plate current and by the ability

of the cathode to furnish plate current.

If the grid lacks effective control (a condition reflected in amplification) rejection takes place even with a tube which may show high total emission. If the cathode is worn out, or spotty or otherwise defective, rejection takes place even though mutual conductance might read high when measured with small currents.

MUTUAL EMISSION READINGS

The meter readings are proportional to something like an average of the dynamic mutual conductance and the filament or cathode emission. That is—a tube with high emission and low mutual will read higher than one with the same mutual combined with low emission; one with high mutual and low emission will read low and usually will be rejected. High mutual and high emission will read "very good" while both being low will cause a very poor reading. This is preferable to either straight dynamic mutual or straight emission

alone, for the reasons mentioned above.

This "twin test," mutual emission system of measurement has been perfected without sacrificing operating simplicity. You simply set 3 pointers from a chart having readings much easier to remember than any telephone number. Then you move the single test switch through its respective positions for the complete answer regarding: shorts; leakage; noise, and output.

The great majority of tube testers on the market today are of the "emission" type. The highly positive control-grid in emission testing draws abnormally high cathode current. This abnormal current must be delivered by any tube which is to test Good. High-resistance tubes, which in actual service carry but very small currents, often test Bad because they cannot deliver the excessive test current, though perfectly good in normal service.

Emission testing checks all tubes as rectifiers, tying all elements together to
(Continued on page 489)

MODERN TRAINS ARE RADIO EQUIPPED

Passengers traveling in the new high-speed trains of the New York Central and other lines are not deprived of hearing special radio programs, en route, for radio receivers are installed on these trains whenever special programs are broadcast.

F. E. GOULD

THE FAMOUS Twentieth Century Limited, Southwestern Limited and other crack New York Central Trains are now giving passengers the opportunity of listening to all important radio broadcasts through the medium of the same type radio sets as are used in their homes. Using this type of set was a problem, at first, because railroad lighting systems operate on 32 V. D.C., whereas home radio receivers require 110 V. A.C. Another problem was the electrical disturbances caused by the air-conditioning systems, electric fans, generators, relays, etc. Motor-generator sets are used to increase the voltage and change it from D.C. to A.C., and a unique antenna system and filters solve the noise problem. The result is that passengers now listen to high-fidelity radio reproduction, all along the line, unimpaired by any serious interference. At the present time the radio receivers are not left on the trains permanently, but are placed there when important sporting or other events are being broadcast.

A unique installation system is used. A number of receivers with knockdown aerial equipment, filters, motor-generator sets, etc., are kept instantly available at a central point. An order is given to place a radio set on a certain train and within 1½ hours it is completely installed including the aerial on the roof of car! Later, it is removed to await the broadcasting of some other important event.

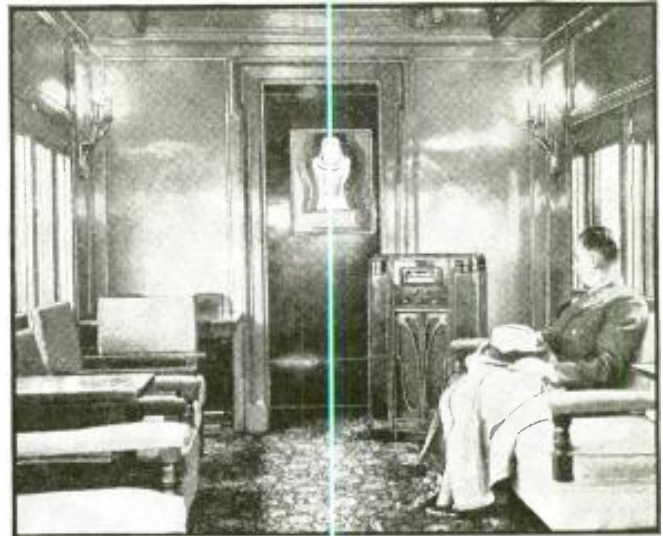

One of the radio sets in the observation car of the 20th Century Limited.

SOURCES OF TRAIN-RADIO INTERFERENCE

Radio sets have been installed for special events on certain through trains for the past 3 years. Trouble was experienced at first with some interference at high speeds, but most of this has been removed with condenser filters on all electrical apparatus, including regulator carbon piles, and an inductive-capacitive filter in the A.C. line at the radio set. A little noise is still experienced at high speed, which may be caused either by static from friction of air on car surfaces, or by the car wheels breaking minute signal circuits as they cross rail joints. Possibly a counterpoise mounted under, (Continued on page 487)

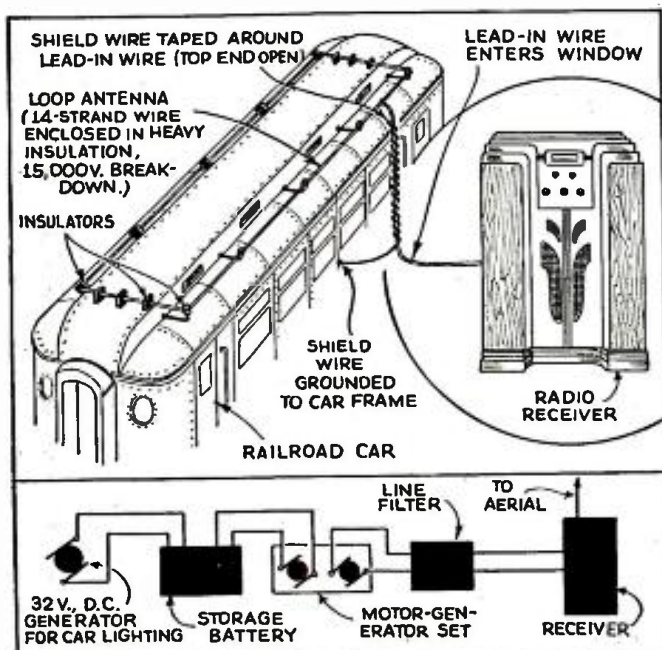

Details of the aerial and receiver installation. Note the lead-in.

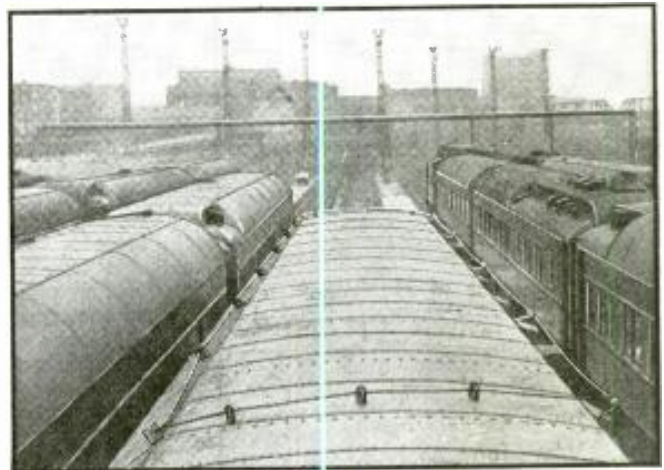

The roof-top (closed loop) aerial installed at the same time as the set.

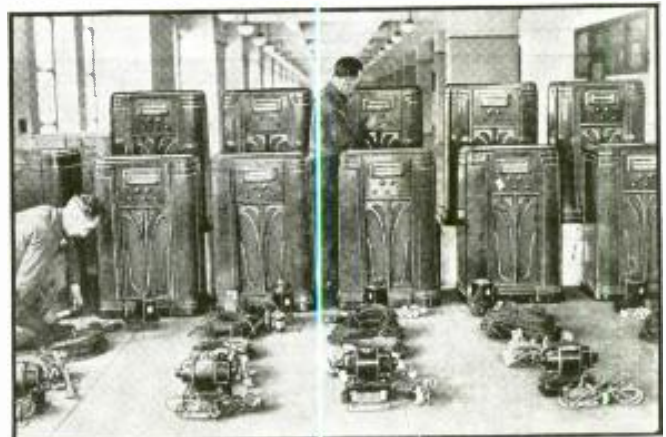

A group of the receivers and generators in the Installation Dept.

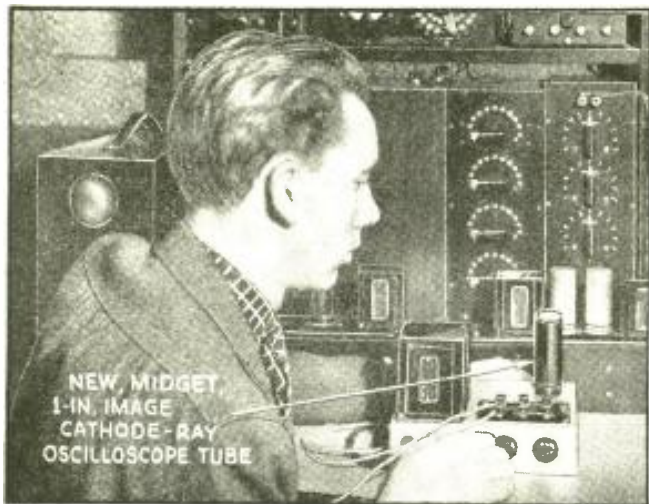

Fig. A. The oscilloscope in use during alignment of a set.



Fig. B. Note the small size of the tube.

USES OF THE MIDGET OSCILLOSCOPE

1. Voltage measurements A.C. or D.C.
2. Distortion in A.F. amplifiers.
3. Receiver output.
4. Frequency measurement (low frequencies).
5. Alignment of receivers.
6. Power factor and phase relations.
7. Visual alignment (with saw-tooth oscillator).
8. Wave-form analysis.
9. Percentage of modulation (transmitters).

THE INTRODUCTION of the type 913 metal oscilloscope tube which was announced to the public last month in *Radio-Craft* has opened up an entirely new field for Service Men and technicians in the visual repair and alignment of radio sets.

The new tube, being small in size and requiring only 300 to 500 volts on the anodes can be incorporated in portable servicing equipment, thus permitting the technician to do a "service bench" job in the customer's home. This is especially useful for the modern all-wave and high-fidelity receivers which require very careful alignment in order to perform correctly.

In spite of its small size (being the same size as the 6L6 beam power tube) the 913 tube provides an image sufficiently large for all service work. The screen is 1 in. in diameter, but larger images can be obtained by the use of a lens. (Incidentally, it was found that a large reading glass would supply a very clear image when placed at the correct focal point, and an increase to twice the size or 2 ins. was obtained.) This lens can be mounted permanently at the correct point.

CONSTRUCTION

The unit described here was built up for the laboratory bench, and is thus not sized correctly to fit into a portable

carrying case. However, by rearranging the chassis layout slightly, it can be easily enclosed in such a case. In making the layout, the important points are to keep the power transformer as far as possible from the tube, to prevent pick-up of 60-cycle ripple and to keep the deflector plate leads clear of all other wires, for the same reason.

This unit was not designed with a saw-tooth sweep oscillator as an integral part, though such a unit as well as vertical and horizontal amplifiers can be made if desired. Previous articles in *Radio-Craft*, notably the series on building a cathode-ray oscilloscope by C. Sicuranza in the July, Aug. and Sept.

1936 issues; and the articles by A. A. Ghirardi on the subject of cathode-rays will be of assistance to the Service Man who wishes to expand this little unit.

Even without sweep amplifiers and saw-tooth oscillator, there are many uses to which an oscilloscope can be put. A few of these will be mentioned later. The tabulation at the left includes these uses.

The photos, Figs. A and C show the positions of the parts in the unit. The chassis layout, Fig. 2, gives all details for making the chassis. Two cutouts are made in this layout. One of these is for the power transformer and the other for the output leads. These are 6 in (Continued on page 497)

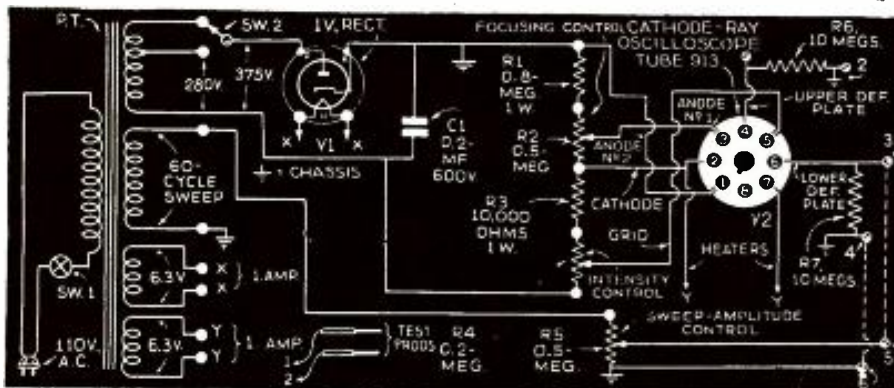

Fig. 1. The circuit of the unit with values of parts.

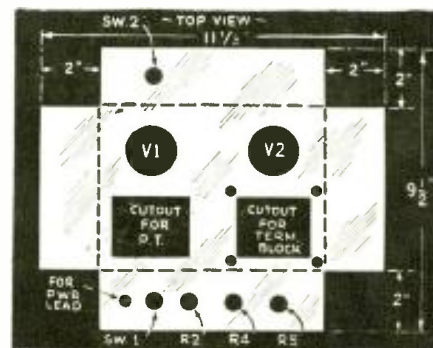

Fig. 2. The chassis layout and drilling dimensions. The small size of the unit can be seen from this drawing.

HOW TO ADD "VARIABLE-SELECTIVITY" TO SUPERHETS.

An "electrical" system for broadening the band-width of the I.F. circuits in existing superhet. receivers.

W. J. VETTE

WITH THE present trend toward improved audio systems, and with the installation of superior studio equipment in the major broadcast stations, many set builders and Service Men are turning their attention toward receivers allowing higher fidelity of

reproduction of the received signals. Usually, such a receiver evolves from an old T.R.F. set, revamped for modern tubes, and to allow the use of a diode detector. For purely local reception, such a receiver, properly revamped, will usually provide excellent reception of quite satisfactory tonal quality, assuming that the audio system is capable of the higher quality of reproduction. However, the average listener does, at times, wish to "fish" for more distant stations, and with the revamped T.R.F. set, this is usually hard to do, because of the lack of sensitivity usually encountered in this type of receiver, and, because of the intentional destruction of selectivity to permit the reception of a broader frequency band. And even if the set has sufficient sensitivity, if the station desired is at all near in frequency to a local station, the reception

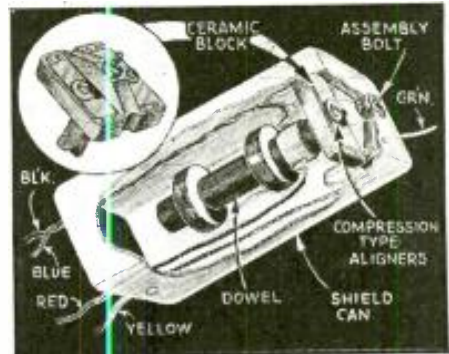

Fig. 1. The appearance of the I.F. transformers.

of the distant station is an impossibility. In such alterations and revamping operations, the Service Man or builder invariably steers clear of superheterodynes, since, with the average super., the selectivity as a rule cannot be sufficiently reduced without introducing repeat tuning points, images and the like. So the T.R.F. job is brought in, and altered. In some cases this is all right, as some listeners have another good set which will allow them to go ahead and fish for DX, keeping the R.F. receiver for local, high-fidelity reception. However, the ideal setup would seem to be a receiver which would tune broad enough for "high-fidelity" reception; and at the same time sufficiently selective and sensitive for normal reception from distant stations. Such a receiver, in simple form, doesn't seem possible when

(Continued on page 495)

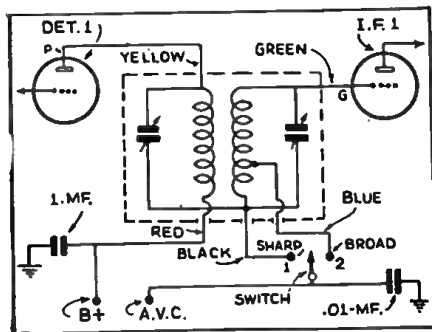

Fig. 2. The basic circuit of the band widener.

MIXER CIRCUITS YOU SHOULD KNOW

The very basis of superhet. reception is the mixing of signals with local oscillations—learn about mixers.

ALFRED A. GHIRARDI

IN THE January issue of *Radio-Craft*, on page 410, we discussed various methods of producing circuit oscillation by means of vacuum tubes—as used by Service Men in testing receivers and in the local-oscillator of superheterodyne receivers.

Now, for testing, we desire not only to have a source of R.F. oscillations, or "waves," but to *modulate* it, as a transmitting station's carrier wave is modulated. This enables us to test the R.F. amplification better, and also the audio stages and the reproducer of our set.

A.F. MODULATION

We may, for instance, take a regenerative set and introduce into the control-grid circuit an A.F. transformer (Fig. 1D) through the secondary of which we increase and decrease the voltage existing between control-grid and plate; superimposing thus A.F. variations on the R.F. oscillations already set up. This is done when we cut a microphone or a phonograph pickup into a control-grid circuit; except that, normally, we do not permit the tube circuit to oscillate when

(Continued on page 498)

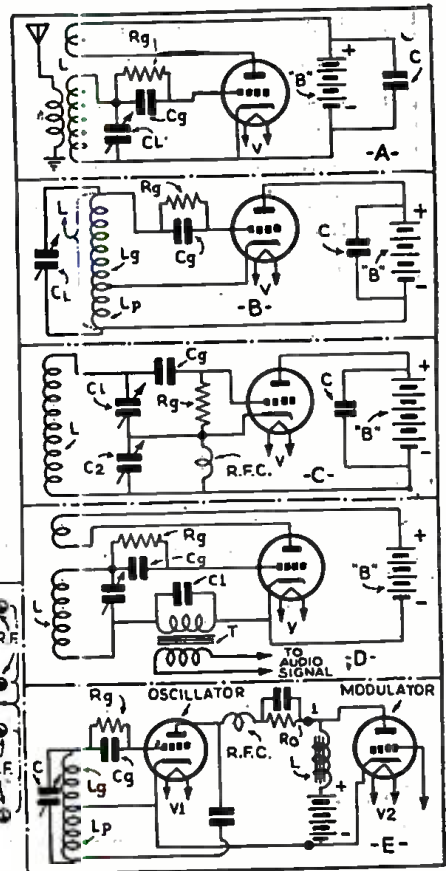
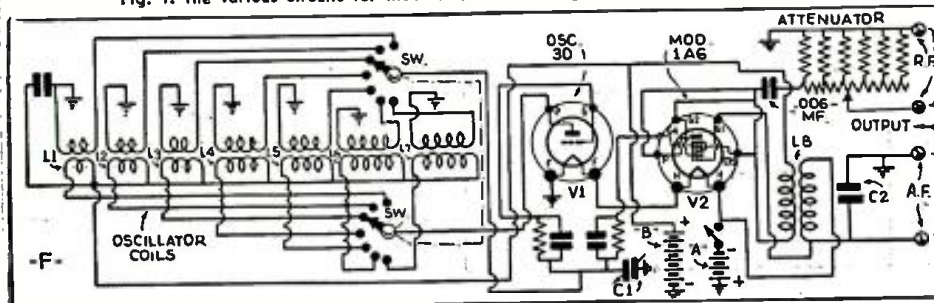

Fig. 1. The various circuits for modulation and mixing referred to in the text.



INTERNATIONAL RADIO REVIEW

RADIO-CRAFT receives hundreds of magazines from all parts of the world. Since the cost of subscribing to each of these would be prohibitive for most radio men, we have arranged with technical translators to prepare reviews for our readers.

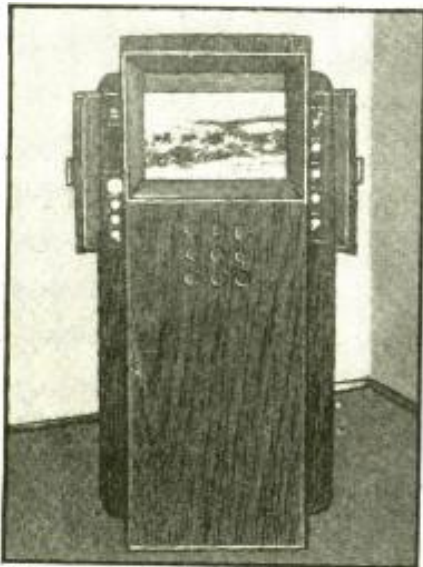

Fig. A. The English Ekco-Scophony vision set.

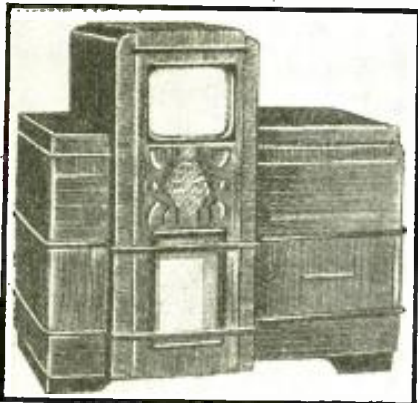

Fig. B. The English Pye television receiver.

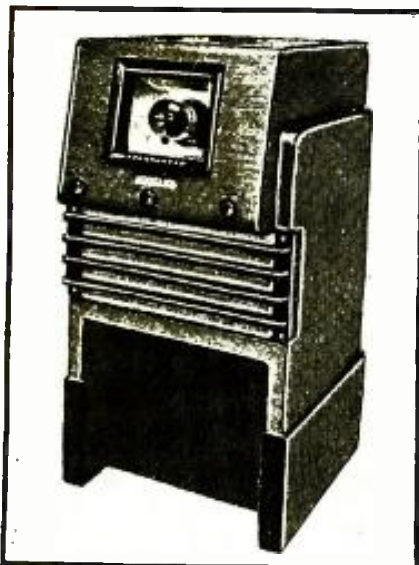

Fig. D. The Telefunken "projector" set.

TELEVISION ABROAD

WHILE television broadcasting has now reached the point of "field tests" and experimental reception in the U.S., high-definition and semi-high definition television in England and Germany has reached the point where commercial receivers are being offered for sale.

The recent radio exhibit at Radiolympia reveals the fact that practically every large manufacturer of radio receivers in England has made a set capable of receiving the views being sent out by the B.B.C. and the Baird Co.

An outstanding point of interest in these sets is the lack of standardization or similarity between sets of different makers. Each manufacturer has evidently decided what is right in his own eyes and gone ahead without fear of criticism.

For example, there is the large Ekco-Scophony set—the largest shown at the exhibit. This set is not a cathode-ray receiver, mechanical methods being used for scanning (small mirror drums driven by motors controlled by synchronizing vacuum tubes). The images are 12 x 16 ins. See Fig. A.

Then, there is the Pye set which gives images 8 x 10 ins. on a horizontal cathode-ray tube. Separate receivers are used for vision and sound—the two sets are semi-fixed tuned thus reducing the number of controls to a minimum. The odd appearance of the cabinet housing this set is seen in Fig. B. The chassis is shown in Fig. C.

Besides these two, views of which are reprinted from *World-Radio* (London) and *Wireless World* (London) respectively, receivers were demonstrated and displayed by the following companies in the Radiolympia exhibit: Baird; Coscor; Ferranti; G.E.C.; Halcyon; H.M.V.; Marconiphone; Phillips, and several others.

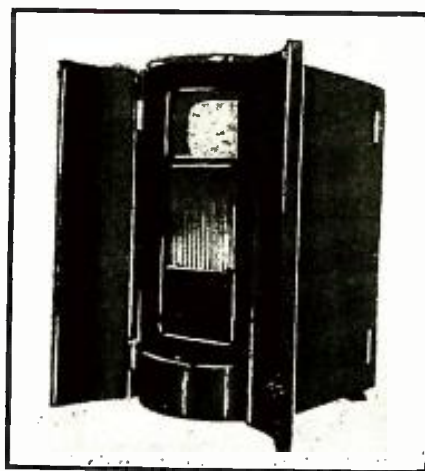

Fig. E, above; Fig. C, right.

Of the German sets recently placed on the market, the outstanding one is perhaps the Telefunken "projector-type television receiver" which uses a tube sufficiently brilliant to project a 3 ft. square image on a screen. This set, which is described in greater detail elsewhere in this issue, was shown in a recent issue of *RAFA* (Stuttgart). See Fig. D.

The appearance of another German image and sound receiver made by the firm of Fernseh A.G. is seen in Fig. E. This set uses a large cathode-ray tube mounted in a horizontal position. The images are viewed directly on the fluorescent end of the tube.

A FRENCH "SUPER" REFLEX WITH F.C.T. DETECTION

SEVERAL articles, both practical and theoretical, concerning the F.C.T. detection scheme have appeared in recent issues of *Radio-Craft*. In the latest issue of *Toute La Radio* (Paris) a superhet. type receiver built around the F.C.T. principle was described by the author (Jean Dieuzy) of the original article which appeared in *Radio-Craft*.

The circuit (see Fig. 1) uses a European tube comprising a pentode and triode (somewhat similar to the pentagrid converter tubes—6A7, 6A8, etc. available in the U.S.) for the 1st-detector and oscillator. The coils used to tune this converter actually comprise an all-wave tuner and band switch, but for simplicity's sake only one set of coils is shown.

The converter tube feeds into the F.C.T. "pentode" tube through an iron-core 456 kc. I.F. transformer. The output (taken from the screen-grid and suppressor-grid—tied together) feeds into the primary of the second I.F. transformer. The secondary feeds the

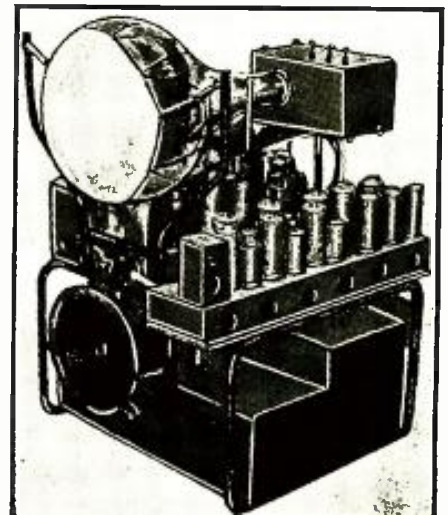

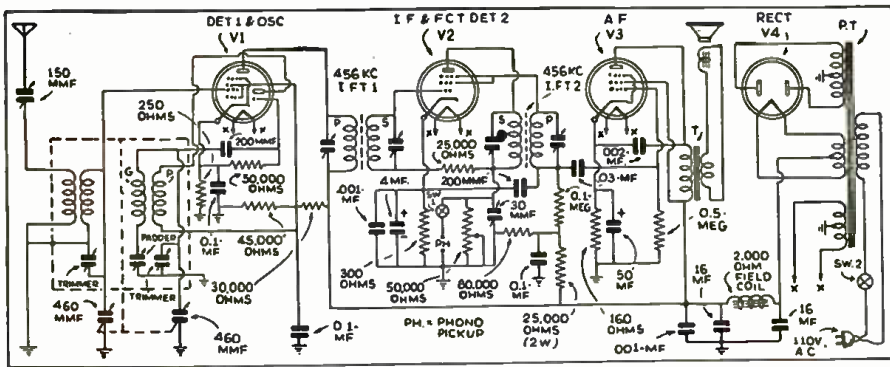

Fig. 1. The French reflex-superhet. with F.C.T. detection.

I.F. signal back into the control-grid and plate circuit (which is the input circuit of the F.C.T. detector—it will be remembered). The detected signal is then fed from the anode of the tube (actually the screen-grid and suppressor-grid tied together) and then through the 0.03-mf. condenser to the control-grid of the pentode A.F. amplifier.

The values of the parts are indicated on the circuit and should present no difficulty for the advanced experimenter.

A GERMAN "TEA-WAGON" RADIO SET

AN interesting radio set designed for clubs, hotels, etc., was recently placed on the market in Germany, according to our Berlin Correspondent.

The set is equipped with small rubber wheels so that it can be moved conveniently from place to place. Also, the loudspeaker is not an integral part of the set but is mounted in a separate cabinet, as shown in Fig. F, so that it can be used either with the receiver or in another part of the room, as desired.

A NOVEL OSCILLOSCOPE

THE South American magazine *Ciencia Popular* (Buenos Aires) recently ran a photo of a novel shape of oscilloscope which may be of interest to Service Men and technicians in the U.S.

Instead of mounting the C.R. tube in the usual horizontal position which dictates that the case of the oscilloscope shall be rather large in length and

width, the tube is mounted vertically. This is shown in Fig. G. and it will be noticed that the images may be seen either directly on the top of the tube's fluorescent screen or in a mirror mounted on the inside of the cover.

The usual controls are mounted on a panel on the front of the instrument. It will be noticed that the space required on the lab. table or bench is much smaller than for the ordinary instrument.

AN ENGLISH "HIGH-FIDELITY" SET

THE receiver shown in Fig. H is an example of the latest set trend in England. The set is a superhet. having an I.F. band-width control, an unusually fine speaker unit and triode A.F. amplifier.

The combination of these characteristics produces a fidelity which is well above the general run of sets available in that country, according to the report which was printed in *Wireless Retailer and Broadcaster* (London).

The set covers the usual broadcast band of 195 to 575 meters and in addition has a band from 750 to 2,000 meters. The tuning dial is in the form of a vertical scale with 2 pointers moving up the 2 calibrated strips. At the top of the dial is a tuning "eye" of the European type having 4 shadow bands in place of the single one found in the American 6E5 and 6G5 tubes.

The cabinet of the set is moulded bakelite with a walnut grain which presents a very pleasing appearance.

(Continued on page 486)

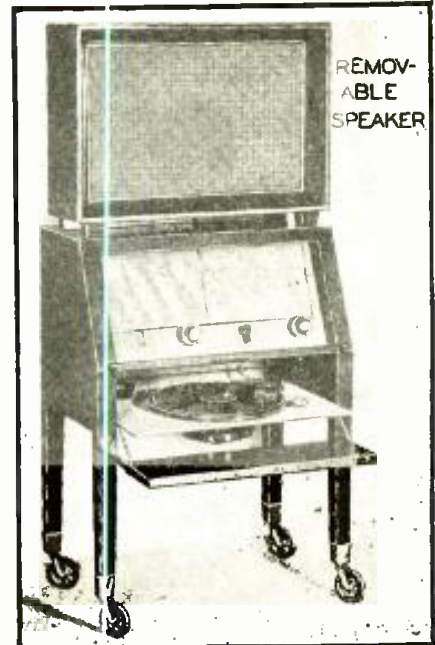

Fig. F. A set on wheels with separate speaker.

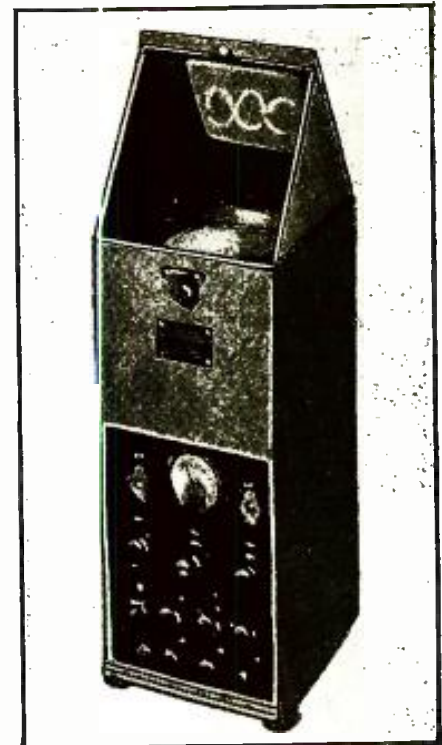

Fig. G. This oscilloscope tube is upright.

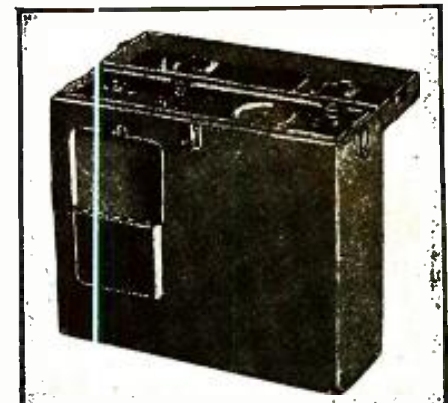

Fig. J. The German portable "peoples" set.

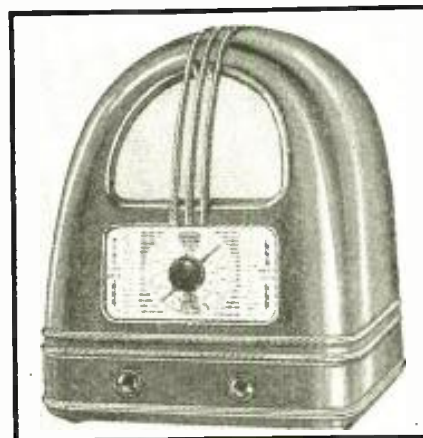
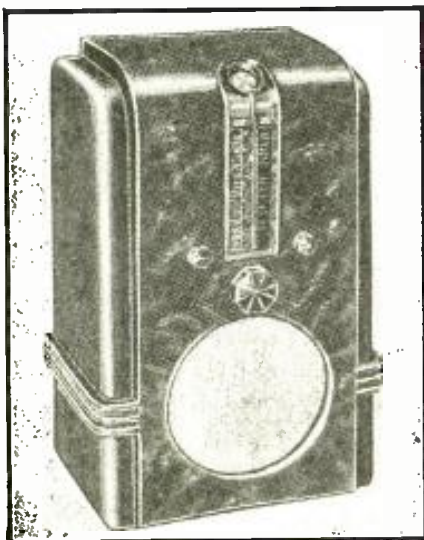
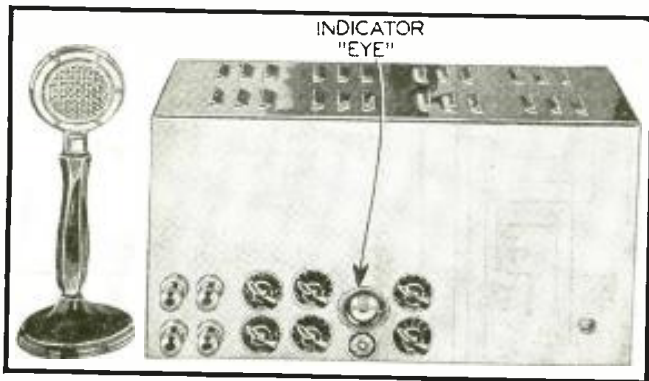

Fig. H, left. An English high-fidelity set with a tuning eye indicator and "moulded" case.
Fig. I, above. The English "peoples" radio receiver.



A NEW 60-W. BEAM AMPLIFIER

This amplifier is easily adjusted to meet any P.A. need, from Soldiers' Field (Chicago) to home use! The diagram of the amplifier, with an explanation of its action, is given.

McMURDO SILVER

REPEATED inquiries for P.A. amplifiers in the past 4 years have elicited the response from the writer that there were hundreds of good ones available, so why bother him. A couple of not-easily-downed inquiries

finally forced him to a critical survey of the amplifier market of today, to find that *amplifier design is about where it was 4 years ago; that it has not even kept up with radio receiver A.F. design advances!* All of which, briefly, explains the reasons for the amplifier here described.

Suffice it to say that it was designed to provide in a single unit all the modern features, of recognized importance, in the amplifier installation field.

FLEXIBILITY

This amplifier is not only "universal" electrically but also *mechanically*. A pair of chrome handles makes its 16 1/2 x 8 1/2 x 8 3/4 in. size easily portable; a pair of rack adapter angles fit it to a standard relay rack in a jiffy with only a screwdriver; or, turn the one-piece

panel and ends front to back, bolt on the two rack angles, and it mounts on a projection-room wall. Its solid construction of 3/32-in. steel with all corners arc-welded, the whole finished in pol-
(Continued on page 499)

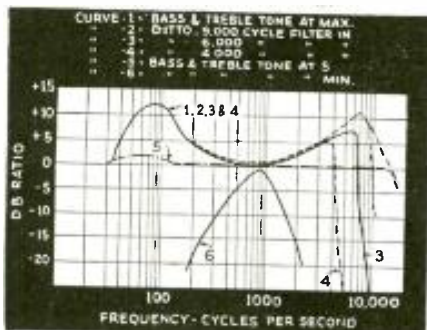

Fig. 1. Effect of filters on frequency response.

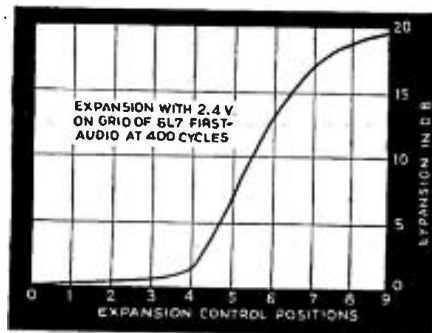

Fig. 2. Effect of the expander control.

RADIO SETS FOR EXPORT AND MARINE USE

MILTON B. SLEEPER

Radio sets to be used in any part of the world must be engineered to withstand extremes of climate.

WAIT a minute! Before you unpack that brand new radio set of yours, set it down at the top of a long flight of stairs, and give it a kick swift enough to send it bouncing down, end over end, at a good clip!

What? You don't want to do it? You think it might be damaged? Well, if it's a radio receiver that has been properly designed for export you needn't worry. In fact, one well-known manufacturer of sets of this type builds them to withstand more abuse than that; they are, in fact, thrown down concrete stairs simply to test the strength of the packing carton! "Is such an extreme test necessary?", you may ask. Indeed, it is.

SHIPMENT

You see, when sets are traveling all over the world, they encounter pretty rough treatment while they are on the docks, and being loaded and unloaded from the freighters. In many ports, the ships do not tie up at docks, but unload in the harbor onto lighters; then, in rough weather, the cargo is handled very roughly indeed.

However, it may surprise you to know, as it amazed one manufacturer to learn when, many years ago, he began to ship radio sets to far-distant

lands, that the slight vibration, day after day, set up by the throbbing of the ship's engines can do more harm than
(Continued on page 491)

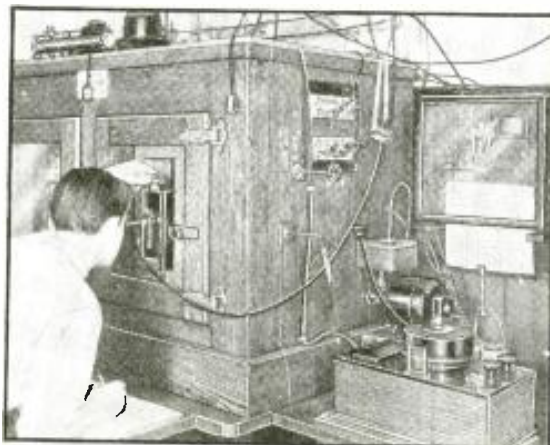

Fig. A. A "torture" chamber used by Bell Tel. Labs. for testing equipment under wide climatic changes. Temperature and humidity may be varied to simulate conditions in Alaska, Florida, Africa, or any other point on the globe you may care to name. Telescopes, microscopes, scales and recording devices are used to check performance under all extremes.



Fig. B. An "export" and "marine" set such as described by the author. This set is designed to withstand unusual climatic and temperature changes as well as shipment in "freighters."

MODERN SHORT-WAVE DIATHERMY

In this Part, a discussion of the different types of diathermy machines is included. The methods of mounting the electrodes are also outlined and a short description of the applications of S.-W. diathermy is given. Part III will contain construction details for building a short-wave diathermy machine.

LEON C. BUNKIN.....PART II



Fig. C. The mechanical support of the electrodes is shown. (No. 1276)

IN THE production of the necessary deep heat for therapeutic purposes, two types of machines are now being used. One is the *vacuum-tube* type, and the other is the *spark-gap* type. In either machine, insulated metal electrodes or insulated flexible cables are used to apply the generated energy to the patient.

"CONDENSER-ELECTRODE" METHOD

The metal-plate electrode application is known as the "condenser-electrode" method, since the portion of the body to be treated is placed between the two insulated metal plates which form one section of a condenser, and the body tissues which act as the dielectric, form the other section.

The electrodes are not placed in direct contact with the body; instead, they are separated from the skin surface by a certain amount of absorbent material (cotton, toweling, etc.), so that any accumulation of moisture may be absorbed. This precaution is taken since the presence of any moisture on the skin due to perspiration may cause serious burns when the energy is applied. A recent method is to hold the electrodes in position by mechanical means as illustrated in Fig. C.

The condenser-type electrode may take various forms in order to effect certain results. The plates may be of

equal size for even heating; or one plate may be larger than the other so that the current will be concentrated to the area beneath the smaller plate. They may also be in the form of cuffs which encircle an arm or leg, the area to be treated lying between the two cuff electrodes. The length of the leads to the electrodes is predetermined for a given type (wavelength) of machine; slight changes in the electrode-circuit constants are corrected by adjustment of this (load) circuit's tuning condenser (C4, in Fig. 1, Part I).

"INSULATED-CABLE" SYSTEM

The insulated-cable method is generally referred to as the "electromagnetic induction" system. Here the application of energy is by means of the flexible cable which is coiled about the part to be treated, or the cable can be coiled and placed upon the area requiring treatment. (This coil thus becomes an "electrode".) (See Fig. E.) Absorbent material is also used here to separate the coils from the body.

Within certain limits, it is good practice to separate the electrodes from the skin some certain amount, as this will result in improved heat-depth effect. In this system, too, slight changes in output, due to variations in the coil-type "electrode," are corrected by re-tuning (C4).

Of the two usual methods of application employed, the consensus of opinion is definitely in favor of the coil-electrode or electromagnetic induction type, because the "penetration" is greater; that is, the amount of heat induced in the body before the patient's skin tolerance is reached is higher than in the condenser-electrode method.

Figure 2 A and B illustrates the flow of energy in the two methods.

There is another scope of usefulness with S.-W. radio-therapy apparatus. That is, their use in *electro-surgery*, *cautery*, *desiccation*, and *coagulation*. The accessories for performing these different functions are, in most machines, plugged into the same receptacles provided for the diathermy electrodes.

CIRCUIT CONSIDERATIONS

Let us consider first the *vacuum-tube S.-W. diathermy machine*. This consists simply of one or more tubes in an oscillatory circuit. In order to cheapen manufacture, some designers of S.-W. therapy machines use half-wave, self-rectified oscillator circuits. As a result, the plates of the tubes are supplied with raw A.C. and cause the power output of the oscillator to be modulated by the A.C. line frequency. For greatest efficiency it is necessary to keep the peak
(Continued on page 500)

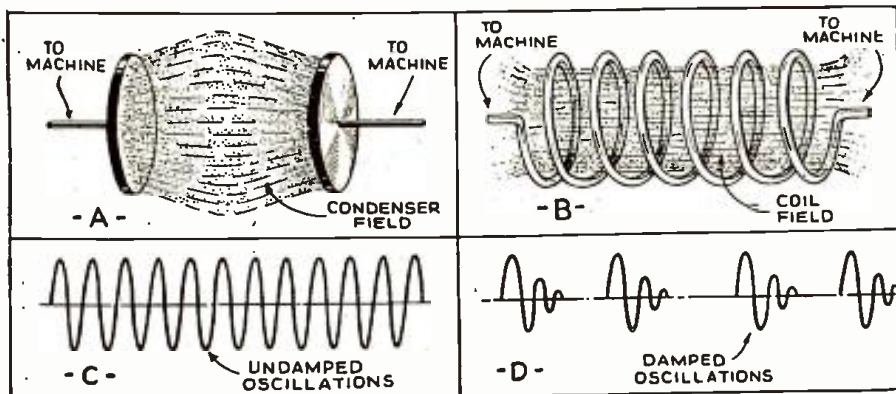

Fig. 2. A and B, flow of energy when using electromagnetic and capacitative application; C and D, comparison of the waveform produced by undamped (C.W.) and damped (spark-gap) oscillators.



Photo—Diathermy Co. of America
Fig. D. A "spark"-type diathermy machine. The wavelength is 18 to 20 meters—diathermic capacity is 1,500 milliamperes. Uses a multi-section gap.

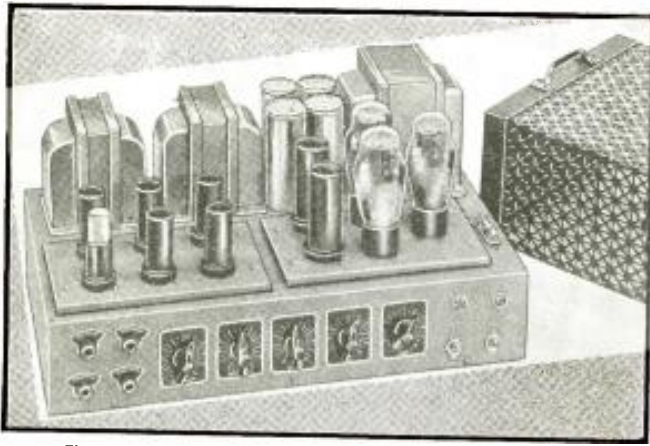

Fig. A. The appearance of the "F.V. F.B." 60-W. amplifier.

THE NEW 60-WATT "F.V.F.B." BEAM POWER AMPLIFIER

This exclusive article deals with a new type Fixed-Voltage, Fixed-Bias Beam-Tube Unit.

A. C. SHANEY

WIDE-SPREAD use of the 6L6 beam power tubes by amateur experimenters may have tended to dampen their ardor displayed when first reading about the "60-watt power output of two 6L6 tubes" —in accordance with data supplied by tube manufacturers. Unfortunately, or possibly fortunately, few experimenters attained the rated output without running into a considerable amount of difficulty. Many so-called designers have attempted to use spare output transformers, input transformers, power transformers, which they happened to have on hand. So much popular tribute has been paid to junk-box radio sets and amplifiers, that many experimenters have been led to believe that ideal beam power conditions can easily be obtained from miscellaneous equipment.

A careful study of the recommended operating conditions for the 6L6 tubes using fixed bias for the production of 60 W. discloses the following interesting facts:

"BEAM" RATING

The plate current of both tubes increases from 120 ma. (at no-signal) to 230 ma. at full-signal. This condition represents an increased plate current drain of 128 ma. Likewise, the zero signal screen-grid current increases from 6 ma. to 20 ma. at full-signal. Besides these astounding changes, it should be borne in mind that tube manufacturers usually supply tube ratings as based upon "ideal" conditions. This means that the plate and screen-grid supplies as well as the control-grid supply must have perfect regulation or practically no equivalent series resistance. *Few experimenters know that batteries are used to supply the required voltages while making tests. Naturally, this "ideal" condition is rarely duplicated by the experimenter or practical manufacturer of high-power amplifiers, because, A.C. power supplies are nearly always used.*

In view of the fact that a great number of other factors enter into the attainment of 60 W. from a pair of 6L6s, it becomes necessary to review the effect of variable regulation in the plate, screen-grid, and control-grid current supply.



First, however, let us discuss the problem of regulation.

REGULATION

Although it is desirable to have a practically constant output of a fixed voltage from all power supplies, regardless of the amount of current drawn, it is essential that certain limits of voltage drop (under full-load conditions) be maintained in both the plate and screen-grid power supply so that large increases of current will not cause undue drop in voltage. As the 6L6 tubes will draw considerable current over short periods of time, an inadequate power supply of 400 V. may drop to 250 V. during the period of increased consumption. A proportionate drop will take place with the screen-grid voltage. This undue lowering of voltage introduces two undesirable effects: (1) decreased power output; and, (2) increased plate-circuit distortion.

These conditions are particularly noticeable when triodes are used. Naturally, these effects are still more predominant when screen-grid tubes are used, such as the 6L6 or the 6F6 (pentode operation).

The problem of voltage regulation is a complex one and will not be discussed in this limited space. Suffice it to say, however, that the resistance of the high-voltage winding of the power transformer, design of the swinging choke, design of the output transformer, all have definite effects upon the voltage regulation. In addition to this, the design of the driver transformer is dependent upon the voltage regulation of the power supply system. This design is also affected by the biasing arrangement of the driver tubes.

As the optimum plate load of the output tubes is correlated to the regulation of the bias supply, this factor again influences the design of the output transformer. In addition to this, the design of the output transformer is also affected by the biasing arrangement of the driver tubes. It can therefore be readily seen how the design of a high-fidelity beam-

(Continued on page 501)

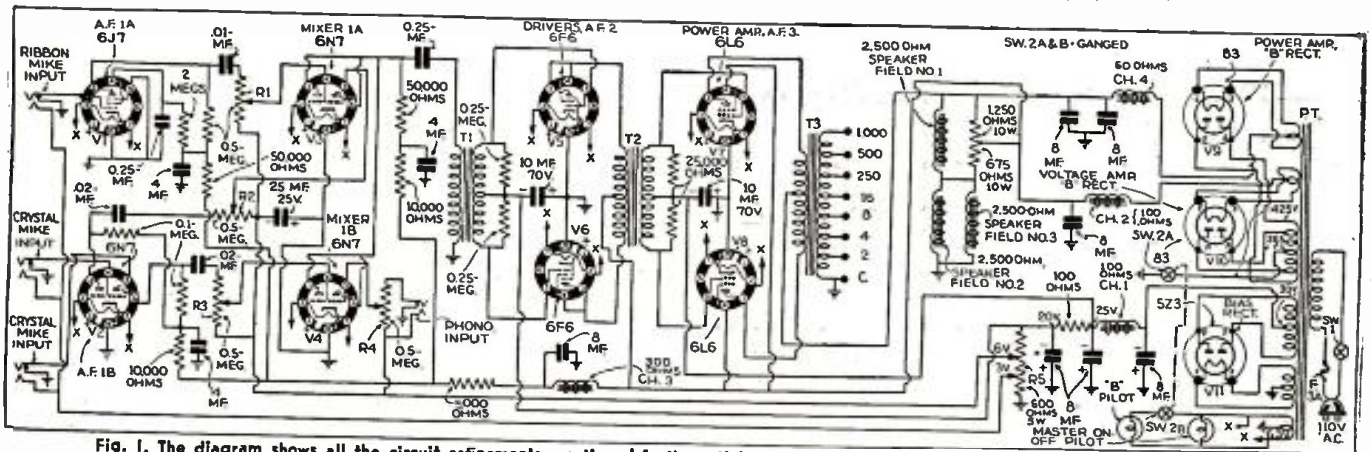

Fig. 1. The diagram shows all the circuit refinements mentioned in the article. The 6L6s are operated under practically ideal conditions.

A SIMPLIFIED CONVERTER FOR SHORT-WAVE BEGINNERS

Part I contained constructional and aligning details for making this advanced yet simply constructed short-wave converter. Part II contains details for making the coils.

RAYMOND P. ADAMS

PART II

MAKING a modern short-wave converter, containing metal tubes, and built-in power supply; and with a range of 19 to 200 meters, was made easy, last month, in Part I of this article, which contained all the basis data. However, more complete data concerning the coils required, are desired by those who wish to make their own inductance units; and, consequently, we "go on with the story":

Before building the high-frequency coils, the constructor should first decide just which bands he wishes to cover; then estimate the desired coverage for each set of coils, and the required number. The fewer the coils, of course, the more simplified the business becomes.

If the converter is to cover a band, say, from 19 to around 50 meters, there is no advantage in using more than one set of coils. One oscillator and one detector coil, wired permanently into the circuit, will do the job; and the switch may be dispensed with. One more "coil set" should run the coverage well up into the 100-meter band, with the band

switch required. Another will hit the high-frequency end of the broadcast band, and another will tune from 7 meters (if it can be made to work at the really high frequencies) up to 20 or 25. The single set, or the dual—perhaps the triple—is suggested as practical. The 4- or 5-band assembly is advised only where the builder has an experimenter's complex and confidence in his ambitious efforts.

DESIGN

The first move is to estimate, on paper, the diameter of the forms, number of turns, width of windings, and sizes of wire. This seems like going at the business backwards, but, it's the only way we can go at it.

Suppose we are to build a single set of coils for greatest coverage. We want to hit the 19-meter B.C. band and go as high as possible.

An imaginary coil is wound, 1 in. wide, with 12 turns of wire, in ½-in. of form length. Our job is to now calculate the inductance of this coil.

$$0.2A^2N^2$$

$$\text{Inductance in microhenries} = \frac{0.2A^2N^2}{3A+9B}$$

Where

A equals coil diameter, in inches;
B equals length of winding, in inches;

N equals the number of turns.

Substituting our imaginary values we get an inductance figure of 3.8 + microhenries.

Looking up our copper wire tables, we find 12 turns of No. 20 wire will take up ½-in. length.

We should now refer to some suitable chart giving straightedge relations between inductance in microhenries, capacity in micromicrofarads, and frequency.

To the minimum capacity figure for the condenser (12 mmf.) is added an estimated trimmer capacity and an estimated circuit wiring capacity. Figure the total of these added capacities at 18 mmf. (This seems high, but is actually a low estimate, based on short leads and the lowest practical value of trimmer capacity). Thus, 18 plus 12 gives actual capacity minimum of 30; 18 plus the 360 mmf. maximum gives

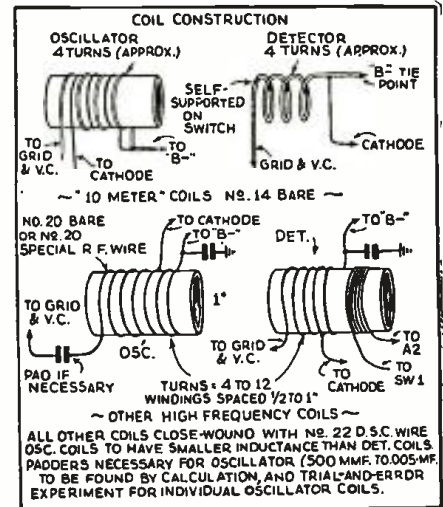

Fig. 4. Coil details for oscillator and detector.

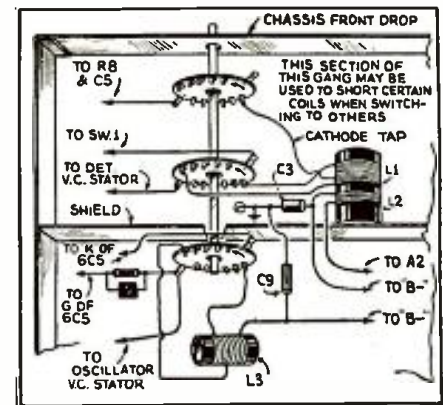

Fig. 5. Circuit detail for coils L1, L2 and L3.

us an actual or overall maximum of 378 mmf.

The straightedge is now lined up between mmf. on the "capacity" vertical and 3.8 microhenry on the "inductance" vertical. The line crosses the kc. scale at approximately 15 megacycles or 20 meters.

We know our theoretical coil will not hit 19 meters; so we must do one of two things to cut down its effective inductance: trim it down physically, or reduce self-capacity by spacing turns. Whatever we do, however, we know fairly well (at least from calculation) that a coil built to these specifications, with perhaps half a turn less, and winding stretched out to cover about an inch of form space, will meet minimum range requirements.

The straightedge applied similarly for maximum capacity of 378 gives the upper frequency limit, well up toward 4,000 kc.

Actually, such a coil in a four-band system would be used to cover the 9,000 to 4,000 kc. range. The many leads add to the minimum capacity to make tuning above 9,000 kc. impossible; what is more, the minimum is deliberately trimmed high, for maximum stability and minimum interaction between coils, especially in oscillator circuits. In a single-band, wide-range converter, however, such a coil, provided with a close-wound 5- or 6-turn primary of No. 24 wire, spaced about ½-in. from the

(Continued on page 504)

"A TIP TO THE WISE—"

Did you build that high-fidelity, 12-tube radio receiver described in February and March, 1936, RADIO-CRAFT? Then, you will surely want to read the directions, for improving the A.F. response of this set, in—March RADIO-CRAFT. Or, maybe you would like to build a little 3- or 4-tube loudspeaker set of simple design? Then read—March RADIO-CRAFT.

If you are interested in more fundamental elements as for instance the factors involved in the elementary 1-tube set you will find a breakdown analysis of 8 basic circuits in—March RADIO-CRAFT.

Also, look for Part III of the construction article on a modern, low-price television receiver—in March RADIO-CRAFT. Do you know about recent developments in antenna design? Much that is new on this important topic appears in—March RADIO-CRAFT.

Beginners in all branches of radio will find information of interest to them; and experts, in these numerous divisions of the radio field, will learn of time- and money-saving developments in—March RADIO-CRAFT.

THE LATEST RADIO EQUIPMENT



The lamp pedestals are semi-exponential horns. (1255)

"TALKING LAMPS" (1255)

THE use of vertical loudspeaker horn units is not new but one manufacturer has carried the idea several degrees further, topping the horn with a lamp and arranging an ingenious control for one or more of these horn lamp units. By using horns of different lengths several audio ranges may be accentuated, apart from the reproduction of the set's regular loudspeaker, to any desired degree by means of individual reproducer volume controls contained in a control box. One variation of this idea includes a radio set (not illustrated) with these remote reproducer controls built-in.

ULTRA-MODERN 5-TUBE "1937" TABLE SET (1256)

HERE is a receiver that combines colorful crystal glass, chrome finish and fine woods in an attractive ensemble. Frequency range: 5.9 to 17.5 mc. and 540 to 1,720 mc. Note the end-mounted reproducer. (The 5-tube circuit of this receiver appears elsewhere in this issue in a *Radio-Craft* Data Sheet.) The receiver measures 8 3/4 x 18 x 8 ins. deep.

"UMBRELLA" LOUDSPEAKER (1257)

WHERE uniform sound distribution is desired from numerous low-level reproducer units the "um-

rella" type of reproducer is recommended. It eliminates costly speaker clusters with their beam effects that cause microphone feedback. The heavy cast aluminum unit illustrated may be suspended by its hook or supported by a pillar. The speaker housing accommodates a 12-in. dynamic cone. Back-pressure is equalized and the construction is rain-proof. Dimensions: 14 x 36 ins. dia.

A 20-OZ. POCKET VOLT-OHMMETER (1258)

(Triumph Manufacturing Co.)

A COMPACT instrument that incorporates the following features: selective range switch; direct-reading scales; easy reading angle; universally required ranges (0-10-100-500 V. D.C.; 0-1,000 ohms and 0-0.5-meg.); reversed low-resistance range; maximum battery drain, 1 ma. A 50-millivolt meter movement is used.

A "MIDGET CONSOLE" (1259)

WE HAVE dubbed this deluxe instrument a "midget console" inasmuch as it is a 5-tube midget superhet. receiver chassis incorporated in a console cabinet; however, unlike the former, a large (size not stated) dynamic reproducer is used. Effective all-wave operation is secured on wavelengths from 16 to 500 meters. The cabinet is finished "all around" so that it may be placed in

the center of the room. A tilted control panel is provided.

ALL-WAVE ASSEMBLY TUNES TO 3.8 METERS! (1260)

(Meissner Mfg. Co.)

COMPLETE with air-dielectric trimming condensers this new multi-wave assembly features high efficiency, which is obtained by mounting each coil unit close to its respective switch contacts. Supplied for 260 mmf. or 410 mmf. tuning condensers; and in 3, 4 or 5 bands ranging from 3.8 meters to 2,140 meters.



Tiny volt-ohmmeter. (1258)

PORTABLE POWER PLANT (1261)

THIS "junior power station" delivers 600 W. at 6 V. and yet weighs only 57 lbs.; and sells for less than \$60.00. It is of the gas-electric type and driven by a single-cylinder, 4-cycle gasoline engine that operates 10 hours on one filling (2 qts.). The output is constant at controlled voltages from 6.6 to 8. This semi-automatic unit starts at the push of a button. Dimensions: 15 x 15 (baseboard) x 12 3/4 ins. high.

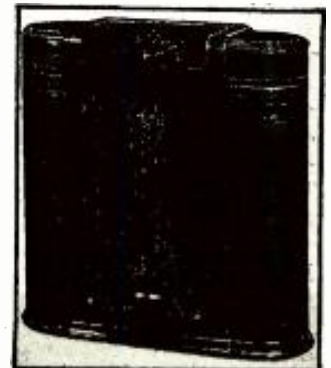

Tilted-top radio set. It is 33 ins. high and wide, and 1 ft. deep. (1259)

PRIVATE FLIERS' RADIO REMOTE CONTROL (1262)

THE convenience of remote volume and tuning control, long available to car-radio owners, has now been designed to meet the radio needs of fliers. The radio set which this new unit (here illustrated) is designed to control was shown in Oct. 1936 *Radio-Craft*, page 223, item No. 1137. The control measures only 7 1/2 x 4 1/2 x 2 ins. deep and affords adequate control of the receiver's 4 frequency ranges, the R.F. and A.F. gain, tuning, manual and A.V.C. control, and the anti-static or "varistor" unit. Worm-gear ratio is 100-to-1. Control cable extends 32 ft.

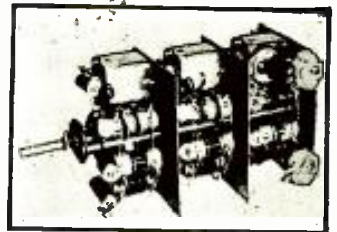

Efficient coil unit. (1260)

MODERNISTIC COUNTER-TYPE TUBE TESTER (1263)

EYE APPEAL is recognized and incorporated in the modernistic tube-test instrument here illustrated. The metal cabinet is in 2-color tone—gray and black crackle finish. Features: proper load, and tests for shorts, leakage, noise and characteristics, of all tubes; resistor readings up to 0.4-meg.; voltage range 0-100-1,000 V. D.C.; point-to-point volt-ohmmeter scale. Size 13 x 13 3/4 x 4 ins. high.

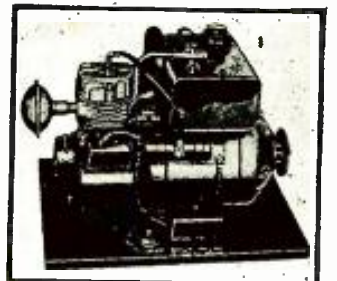

Featherweight power plant. (1261)

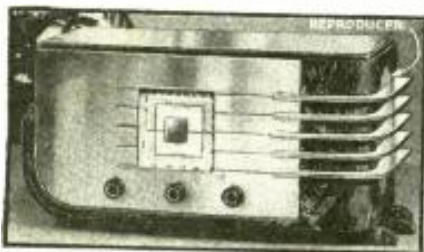

Glass-and-chrome radio set. (1256)

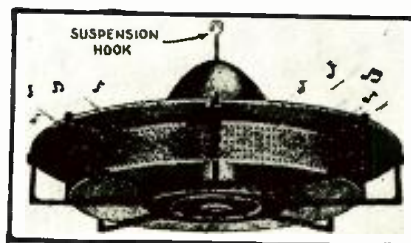

An "umbrella" loudspeaker. (1257)

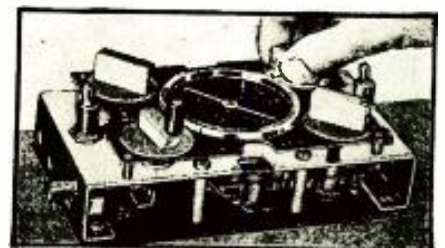

Controlling remote "plane radio. (1262)

Name and address of any manufacturer will be sent on receipt of a self-addressed, stamped envelope. Kindly give (number) in above description of device.



Test equipment, gone "modern." (1263)

NEWEST VELOCITY MICROPHONE (1264)

A REAL commercial-appearing microphone that embodies excellent mechanical construction. The manufacturer rates the frequency response as "substantially flat from 40 to 10,000 c.p.s." Output level is -69 db. The instrument, of high-impedance type, is designed to be without cavity resonance; 4 tiny, high-coercive magnets supply the ribbon's field.

MASTER CONDENSER TESTER (1265)

(The Triplett Electrical Instrument Co.)

HERE is a unit that combines practically every service you have wanted in a condenser testing unit. Features: complete tests of all condensers, from 100 mmf. to 10 mf.; for shorts, leakages and capacities; all reading directly. Break-down test voltages, 2-20-60-200-600-1,000 V., A.C. and D.C. A line voltage regulator affords accurate capacity test. Includes a Good-Bad scale for electrolytics. Size 7 1/2 x 6 1/2 x 4 1/2 ins. high.

ULTRA-CONSERVATIVE PHONO-RADIO (1266)

CLOSE the top of this combined radio set and electric phonograph, tilt the radio set back into the cabinet, and there is nothing left except the reproducer grille to indicate that it is anything but a beautifully-finished wooden cabinet. The phonograph unit in this cabinet is equipped with an A.C.-D.C. motor and a special crystal pickup whose light weight reduces record wear to minimum. The 7-tube radio set is a high-quality unit of A.C.-D.C. type. Its wavelength range is 19 to 50 and 185 to 550 meters. The 12-in. reproducer has a rated frequency range of 50 to 7,500 cycles. (Automatic phonograph operation is available in one model.)



Improved ribbon microphone. (1264)

AUTOMATIC MULTIPLE AERIAL SWITCH (1267)

THIS new device, which plugs into the regular power-line wallplate outlet, serves to automatically connect an all-wave antenna (that is wired to its two lettered, red and black, terminals) to the radio set when the latter is turned on. A built-in relay accomplishes this automatically; thus, the antenna connects only to one of several sets as long as only one set is in operation. Dealer-Service Men. and radio fans who own more than one set, need this ingenious gadget.

MULTI-PURPOSE 30-W. P.A. AMPLIFIER (1268)

THIS versatile power amplifier will drive 60, 6- or 8-in. permanent-magnet dynamic reproducers in classroom or other services of low-level operation requiring not more than about 1/2-W. per speaker; or, two 14-in. auditorium-type reproducers requiring 30 W. field excitation. (This field current is available from the amplifier at 300 V. D.C.) Amplifier includes input for 2 microphones or phono. pickups; input volume and mixing controls; adjustable output impedance; and a 2-scale meter calibrated in watts and db.; and, tone control. This amplifier, which measures 23 1/4 x 7 1/4 x 8 1/2 ins. deep, utilizes 7 tubes with two 6A6s. in parallel push-pull, in the output stage.

INSTITUTIONAL SOUND SYSTEM (1269)

(Allied Radio Corp.)

INCLUDED in a complete line of sound systems designed to meet the sound distribution needs of schools, hospitals, hotels, department stores, etc., is the typical set-up illustrated. Built-in equipment includes a high-quality amplifier; all-wave tuner; 2-speed phonograph; program and speaker selection and



Complete condenser tester. (1265)

distribution controls; volume-level indicator, and monitor speaker.

PORTABLE RECORDER (1270)

(Universal Microphone Co.)

A DISTINCTLY high-quality instrument that affords spot recording at high fidelity and without waver at either 33 1/3 or 78 r.p.m. Records equally well in either direction and cuts lines at 90, 110 and 130 r.p.m. This professional device contains a complete switching arrangement for head-set monitoring during cutting or playback. The self-starting synchronous motor operates on 110 V. A.C. and starting without shock or impact drives an endless belt at the periphery of the turntable. Metal work is polished chromium; table top, engraved bakelite. Dimensions 20 x 24 ins. table space; weight, 60 lbs. The separate amplifier case with microphones, cables and tubes weighs about 40 lbs.

UNIVERSAL-CURRENT PORTABLE RADIO-AUTOMATIC PHONOGRAPH (1271)

PROBABLY the most versatile portable entertainment unit so far available is here illustrated. It operates on current supplies of 110 to 250 V. A.C. or D.C. It "plays" eight 10-in. or seven 12-in. records automatically with the lid open or closed, at 6 W. output. The built-in radio set is a 7 metal-tube superhet. covering broadcast and short-wave ranges. The audio reproduction is exceptionally good; needle scratch is practically non-existent. Unusual cabinet finishes are available: fabricoid waterproof and washable, in alligator grain finished in red, blue, green or white; shark, in black or brown; or airplane luggage linen. (A record carrying case to match is shown in background.)

(Continued on page 502)



Simplicity in phono-radio. (1266)

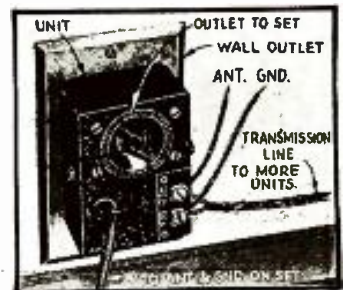

Automatic antenna switch. (1267)

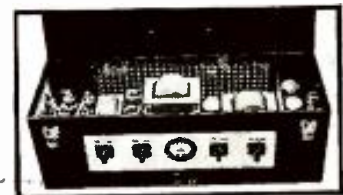

"Professional" P.A. unit. (1268)

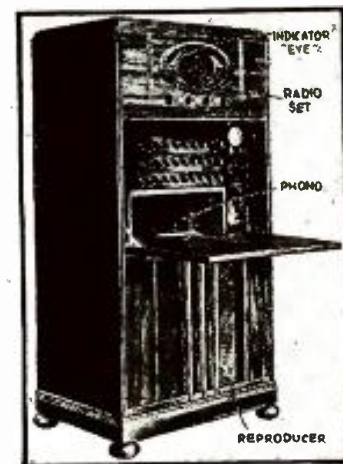

School sound system. (1269)



Portable sound recorder. (1270)



Portable phono-radio. (1271)

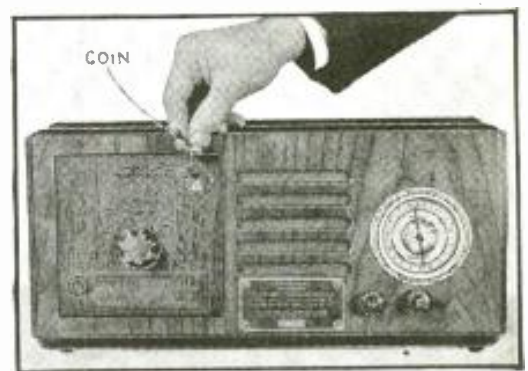

Pay-as-you-go radio set. (1272)

GRUNOW MODELS 1291 AND 1297 (Chassis 12B and 12W) See Data Sheet 190 for schematic
 [12-tube, 3-band, 545 kc.-18.2 mc., with Teledial automatic tuning, A.F.C., A.V.C.]



The 12W uses two 6L6 output tubes, instead of two 6F6s, as in the 12B; and minor changes are shown on the circuit diagram. Early models use litz-wire, where the later use solid wire, in the "B"-band detector coil. Substitutes should not be made. Other alterations are noted on the diagram.

The tone-control switch has 2 ranges of settings: at the left, the A.F.C. is cut out, and the receiver has standard tuning, with 3 tone ranges—"Low," "Medium," and "High" response. At the right, the A.F.C. is cut in, but the same tone range is afforded. In this setting, the Teledial automatic tuning may be used on as many as 15 selected stations.

The dial scale, in addition to 3 tuning bands, shown in kilocycles and megacycles, has a "minute" hand, which indicates, on a 60-division circle around the edge, a finer division of tuning. For accurate logging, the position of the single "minute" pointer is logged, as well as that of the double pointer which indicates the frequency.

To set the receiver for the Teledial, the escutcheon is removed. If any unwanted stations are on the dial, the rings holding the station discs are removed. A list of stations, with their expected settings, is made. The station corresponding to the lowest frequency setting is tuned in, with the

A.F.C. cut out. Then the operator looks at the circle of small holes nearest the bottom of the dial (see illustration at center, left) and notes the position of the vertical red pin behind them. It will intersect two or three holes. Whichever is most squarely in front of it (that is, has most light cut off by the pin behind it) is to be used for the setting. This is either in a red circle or a black circle of holes. If it is in a red circle, a narrow red index key is taken, the station's call disc assembled into it, and the guide pin of the key is inserted into this hole.

If the hole is in a black circle, a black index key is used in the same manner.

The second station, with the next lower frequency, is then located; and so-on. If it is found that one station is too near one previously determined to permit inserting key, this cannot be helped. A choice must be made. If there are any blank stations after locating all possible desired channels, blank discs are inserted; and the key heads are so turned that all call letters will be right-side-up when at the bottom. The escutcheon is now replaced.

To tune-in a station with the Teledial, the tone-control switch is turned to the right, or "Dial" position. A finger is inserted in the hole—just as with a dial telephone—and the dial is turned, either left or right, toward the bottom position. When a click is heard, the finger is removed, and the receiver is then set to the station; the A.F.C. correcting any minor error in the setting. This could be used on the higher frequency bands only if the station were sufficiently strong for the A.F.C. to discriminate in its favor.

Voltage measurements, at the sockets, as taken with exactly 115-V. on the A.C. line, are given on the schematic diagram. An extra primary lead (brown) on the power transformer is provided in case of unduly high local voltages.

The bands covered by the coils are: "B" (broadcast) 545-1,750 kc.; "P" (police-amateur) 1,750-5,300 kc.; "F" (foreign broadcast) 5.5-19.2 mc. Positions of the trimmer condensers are shown on the physical diagrams. They are in units of three ("Ant.," "Det.," and "Osc.") and one separate, the 600-kc. "Ant." padder C10.

In adjusting the Discriminator circuit (3rd I.F.) the signal generator is set to exactly 465 kc. and connected through an 0.05-mf. condenser to the

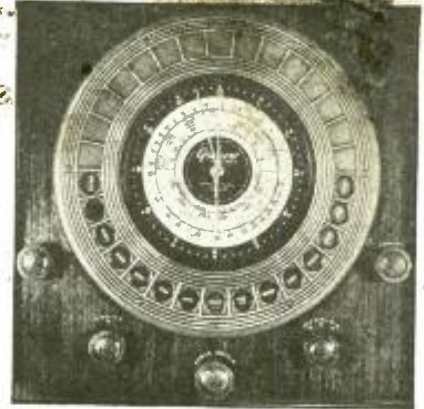

control-grid of V5; and a galvanometer across the two cathodes of V6. The primary and secondary of the discriminator coil are then verified, by touching the screws of the trimmers with a metal screwdriver. When the metal touches C1, the galvanometer will fluctuate. The trimmer is then opened with an insulating alignment tool; and the primary C2 is adjusted to maximum swing. Then C1 is realigned to zero current. The signal generator is then varied to show that galvanometer pointer will be at zero at just 465 kc.; a check is made to determine maximum current on each side of resonance—the peaks should be equal.

If a signal generator of at least 0.1-V. output is not available, the signal may be introduced through V2 control-grid, with A.F.C. cut out.

The dial is calibrated so that, when condensers are fully meshed, "hour" hand (double pointer) is horizontal—between 6 and 3; while "minute" hand (single pointer) is at 12.

R.F. alignment on the "B" band is made at 1,500 kc. The trimmers C7, C8, and C9 are successively set to maximum output. The set and signal generator are then turned to 600 kc.; and C10 is adjusted for signal increase, rocking back and forth to find exact resonance (This does not have to be exactly 600 kc. on the dial.) Then realignment is made at 1,500 kc.

For the "P" band, alignment is made at 5,000 kc., adjusting C11, C12 and C13 to maximum. When adjusting C11, use signal with least capacity—that is, trimmer farthest open.

For the "F" band, 18 mc. frequency is used. The trimmer C14 is screwed down tightly; then backed off till signal is heard, and adjusted to maximum. Unit C15 is adjusted, rocking tuning condenser back and forth through resonance until exact point of maximum output is determined. Then C14 is again readjusted. Finally, C16 is adjusted for maximum output.

This receiver is recommended for use with a doublet antenna; if not available, a regular single-wire outdoor antenna, about 50 ft. over all, may be used in a good location. Under no circumstances should a "light-socket" antenna be used.

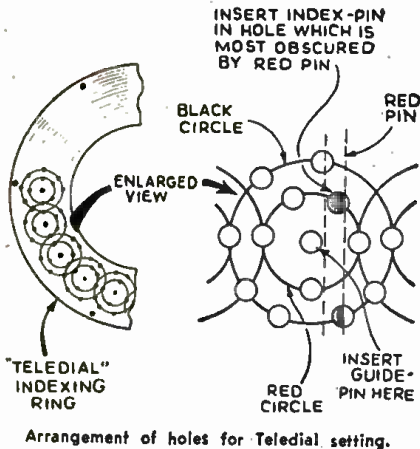
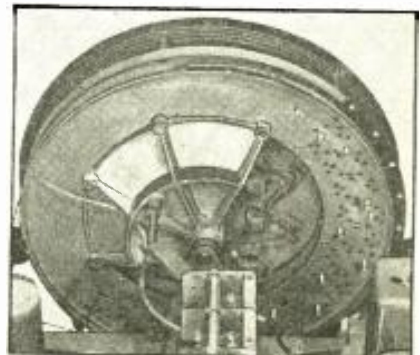

Arrangement of holes for Teledial setting.

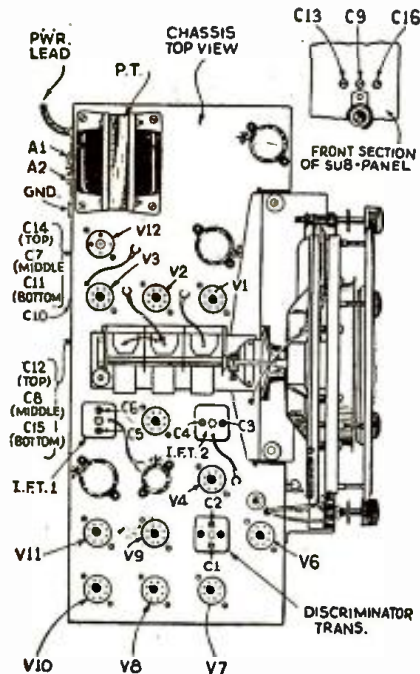

ANALYSES of RADIO RECEIVER SYMPTOMS OPERATING NOTES

Freed-Eisemann 50. Sensitivity and selectivity of this 7-tube T.R.F. receiver may be greatly improved by making a few changes in the original arrangement of the detector input section (Fig. 1A); the modified circuit is shown in Fig. 1B. Service Men in making this change should replace the original choke, R.F.C., with one of larger size; this improves reception at the high-wave end of the dial.

J. M. CANESTORP

Majestic 303, 304, 307, 324, 344, 363. An inoperative receiver with lack of plate voltage on the R.F.,

1st-detector and I.F. tubes as disclosed by a voltage analysis, is usually the result of an open-circuited center winding of the pilot-light reactance transformer which is in the plate-supply circuit of these stages.

When the pilot light which is the resonance indicator in these models, does not dim upon station resonance, check the low-voltage 20-mf. electrolytic bypass condenser connected across the center leg or plate winding of the reactance transformer for a short-circuited or leaky condition. The pilot bulb will light only dimly when this condenser short-circuits, since the reactance

of the two outer legs of the transformer will be quite high.

The complaint of line fuses constantly burning out when this trouble is not occasioned by short-circuited electrolytic filter condensers, has almost invariably been traced to a carbonized 82-type rectifier socket. Poor or insufficient insulation, as well as moisture between the plate contacts of the socket, produce an arcing across the contacts which soon carbonizes the socket. The carbonized path cannot be seen in some cases unless the two wafer sections of the socket are dismantled. The characteristic "burned" odor is a good guide here.

A peculiar rushing or arcing type of interference commonly associated with high-tension apparatus, that is heard during operation of the receiver is commonly caused by close relationship between the high-voltage and filament leads to the type 82-mercury-vapor type rectifier. While the receiver is in operation, try moving these leads apart with some insulated object until the interference ceases or is at a minimum. This should be done with the noise-suppressor control adjusted for maximum sensitivity. It seems that this trouble often develops after the receiver has been serviced for one reason or another and the wiring under the chassis has been disturbed.

Majestic 411, 413. "Inoperation over a part of the broadcast band" is a common complaint with these models and is caused by failure of the type (Continued on page 509)

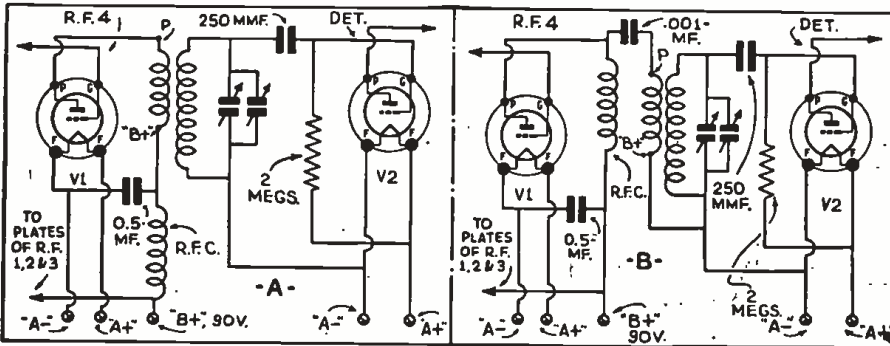

Fig. 1. "Before" (A), and after (B) circuits of a Freed-Eisemann 50.



A CANADIAN "VOICE"

RADIO-CRAFT, ORSMA Dept.:

As I am in the sound business I feel that I should drop you a line to tell you how much I appreciate your articles on Public Address; and, particularly, the Public Address Numbers of *Radio-Craft*.

An illustration of the equipment I use is enclosed (reproduced, at right, on this page—Editor). The amplifier is a 20-W. job, installed in a Chevrolet automobile. Large, electrodynamic units are used on the exponential horns.

Public Address systems are being used more and more each year and to keep in step with the march of time, a man must keep reading. Toward this end, I find that *Radio-Craft* is the foremost magazine in the field.

In closing, may I wish you continued success, and that additional interesting articles, on P.A. equipment and their uses, appear.

K. C. MCBANE, manager and owner,
Giant Voice Sound Service,
Toronto, Ont., Can.

We are always glad to hear from Service Men and specialists in all branches of that far-flung field—"radio." It is gratifying to learn that the work we are doing in scouting up new ideas, new material, new authors, new developments, etc., meets the approval of *Radio-Craft* readers; we are even more pleased when such letters contain constructive criticisms, as well as suggestions of general benefit. So come on, fellows, let's hear from you whether you live in China, or right down the street from our Editorial Offices on Hudson St., New York. Let's hear, too, from *Radio-Craft* readers, everywhere, who are associated with groups of technicians; what would you, and they, like to see in "our" magazine?

PROPOSING—A "NATIONAL SOUND TRUCK ASSOCIATION" COOPERATION WITH A.S.C.A.P.

RADIO-CRAFT, ORSMA Dept.:

Although this is the first time I have ever written to you, I have been

reading your articles and editorials for so long, it seems that we are close friends!

But to get down to the reason for my writing at this time:

I am in the advertising business, getting most of my business by the use of direct mail, novelties and P.A. installations, and a sound truck. I am not a radio Service Man nor do I have a business of that kind, therefore I am not a member of ORSMA (I am sorry to say), but I take great interest in that department of your publication—as well as all the rest of it. I am however in a business that ties me very close to the service industry—I rent out and install P.A. systems, and am an acoustic engineer.

The letters of Russel C. Nace of Perkasio, Pa., and Victor Hasio of New York City, respectively, interested me very much. The letters appearing in *Radio-Craft* for April.

Mr. Nace thinks he is abused because A.S.C.A.P. demands a revenue. (Continued on page 508)

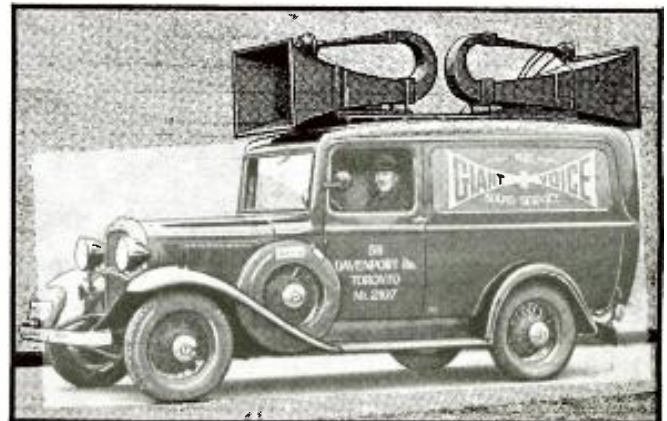

WE'LL TRAIN YOU *Quickly* FOR SPARE-TIME AND FULL-TIME JOBS IN **ELECTRICITY**



BY PRACTICAL SHOP METHODS

right in your own home

IN YOUR SPARE TIME

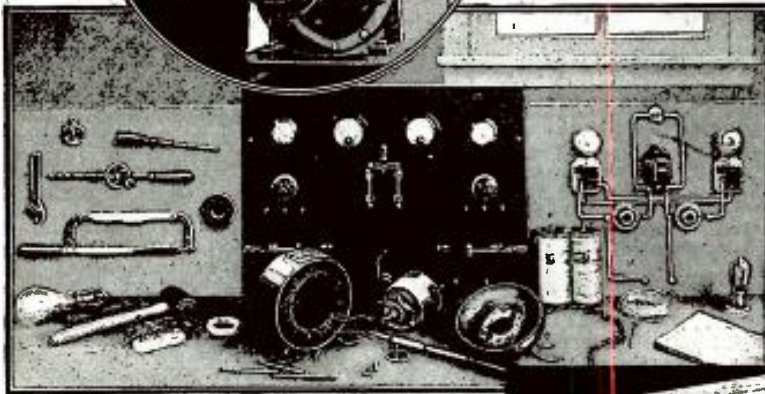

Let us show you how we train you for your start in the fascinating, well paid field of Electricity. Electricity today offers opportunities undreamed-of a few years ago... good jobs...interesting work...good pay...a real future. And now Electric Institute brings—to your very door—the practical training necessary to qualify for the rich rewards that are waiting. There is no need to give up your present job... no need to leave home, family and friends... no need to travel hundreds, perhaps thousands, of miles to some distant city; or pay out large sums of money for traveling and living expenses. Now, you can learn Electricity by a simple, easy, practical method... right at home... at a fraction of the cost of going away to school... and with full assurance of your money back if you're not entirely satisfied.

LEARN BY DOING ACTUAL JOBS IN YOUR OWN ELECTRICAL WORK SHOP... WE FURNISH EQUIPMENT

Electricity is a practical subject which must be taught in a practical way. That's why we furnish each of our students with dozens of items of real electrical equipment and apparatus in addition to his course of study... so you can do the actual work on real electrical jobs... make tests... perform your own experiments. This equipment is furnished without extra cost, not only to aid your training, but to be used to go out and do real jobs... real installations and repairs that you can get real money for. In fact, by doing only two or three such jobs a month your training can actually be made to pay for itself... and the opportunities for extra spare-time earnings are simply amazing!

YOU DON'T NEED PREVIOUS EXPERIENCE OR A LOT OF BOOK LEARNING TO PREPARE FOR JOBS LIKE THESE:

New electrical projects, constantly increasing use of electric power, means more jobs for men with practical training. There is scarcely a large industry today that does not use trained electrical men in some part of their work. Maintenance work, lighting and illumination, automotive electricity, manufacturing, service and repairs, power plant work, switch-board operation, sub-station operation... all offer real opportunities to trained men who can qualify. Or, if you prefer to own and operate an electrical business of your own, Electric Institute training and the equipment furnished will give you a start.



H. W. PETERSEN
President, Electric Institute

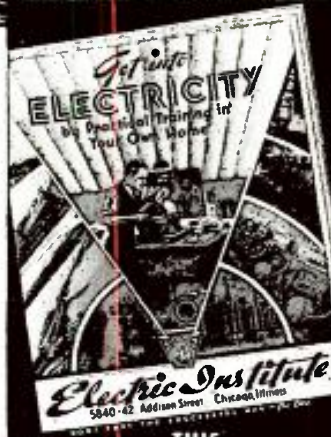

THIS FREE BOOK TELLS YOU HOW

DIESEL ELECTRIC POWER, RADIO and REFRIGERATION

Complete course includes additional training in Diesel Electric Power, Radio, Electric Refrigeration and Air Conditioning. Start NOW and prepare to take advantage of the opportunities that are waiting for trained men in these fields and many other branches of Electricity. It's easy to get all the facts about Electric Institute Training... it takes only a postage stamp to mail the coupon... and that little coupon may be the turning point in your life, if you'll give it a chance.

—EARN EXTRA MONEY BY DOING PART TIME JOBS WHILE LEARNING!

Opportunities to make \$5, \$10 or more a week while training. By the most practical, most amazingly easy method of home shop training, the fascinating mystery of electricity is unfolded to you step by step in a way that anyone can quickly understand and which is intended to make you a real practical trained man. We have designed this course so that it is possible for our students to start earning money almost at once. Do not confuse Electric Institute Training with a theoretical course, with dry text books and tiresome theories. By this new method, you are told—in plain, simple words—exactly what to do, and why... then you do the actual jobs, with real, full-size electrical equipment which we furnish without extra cost as a regular part of your training. That's the modern, easy Electric Institute way to become a practical electrical man in your spare time without leaving your present job until you are ready to step into a real electrical job.

GET INTO A GROWING FIELD FOR BETTER PAY AND A FUTURE

There is no better way to succeed in life than to train for specialized work in an industry that is expanding. Such opportunities are waiting in the great and growing field of Electricity, where the services of trained men are required. And Electric Institute is ready to show you the way. Mail the coupon now—TODAY—for Big, New, Free Book and all facts about this revolutionary plan of home shop training. There is no obligation, and no salesman will call on you. The book costs nothing... but it may be worth a YOU!

RUSH THE COUPON...TODAY!

H. W. Petersen, President
ELECTRIC INSTITUTE, INC.,
Dept. 157B, Hinsdale, Illinois
Send Free Book with all facts about E. I. Home Shop Training.

Name..... Age.....

Address.....

City..... State.....

ELECTRIC INSTITUTE, Inc. H.W.PETERSEN
DEPT. 157B HINSDALE, ILLINOIS
PRESIDENT

Please Say That You Saw It in RADIO-CRAFT

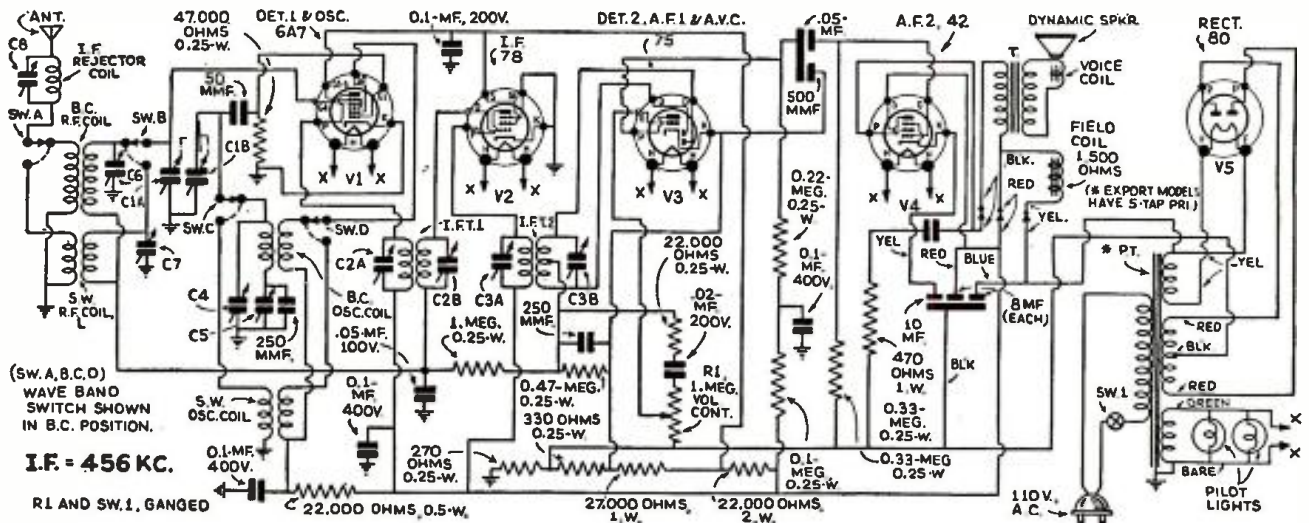

SPARTON MODELS 517, 517-B, 517-W, 517-X, 557, 567 (Console)

[5-tube (glass), 2-band—540-1,720 kc. and 5.9-17.5 mc., 6-in. dynamic reproducer, A.V.C.]

Normal voltage readings, "Vol." full on, antenna disconnected, "Sel." at B.C., are:

V4	40,000	40,000	*0.3	600
V5	450	450	40,000	—

Tube	Prong No.			
	2	3	4	5
V1	280	115	270	—
V2	275	118	0	0
V3	110	0	0	0
V4	850	355	0	0
V5	350	350	0	—

Resis. readings, also to ground (ohms or. *megs.)

Tube	Prong No.			
	2	3	4	5
V1	40,000	24,000	60,000	47,000
V2	40,000	24,000	0	0
V8	*0.35-	*0.46-	*0.46-	550

Resistance to ground, 40,000 ohms at prong 1 of V5. No readings at unlisted terminals of the other tubes. Tolerance, 15 per cent ±.

The only trimmers are those shown in the diagram, including the wavetrap, or rejector trimmer C8 set to 456 kc., or local interference. Condenser C7 trims L to correct antenna differences.

Alignment is made on the B.C. band at 1,500 and 600 kc.; checked at 900. Foreign band at 15 mc., checked at 7½ mc. Care must be taken, at 15 mc., to avoid tuning C7 to the "image frequency" (912 kc. above the fundamental) which will cause a "dead spot" to appear near the center of the waveband.

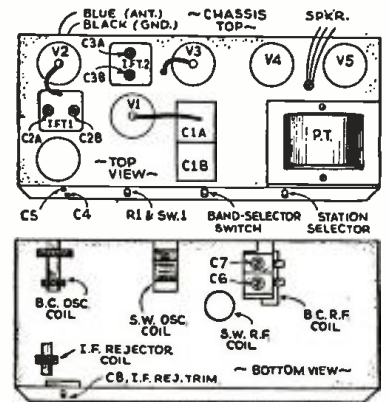

EMERSON MODELS H-130, H-137 (Chassis Model H)

[5- and ballast-tube, 2-3 V. battery op. 540-1,700 kc., A.V.C.]

This receiver is designed for a 3-volt battery supply (dry cell); if a 2-volt storage battery is used, a jumper shorts out the 1B1 ballast tube. Caution must be used in applying 3 V., to note condition of this resistor. Drain is 0.3-A. filament, 23 ma. (with no-signal) on "B" battery. Life should be 150 service hours.

The I.F. transformers are snap-on type and may be lifted out by unsoldering leads and pinching the snap prongs. Color code is: green, grid; black, grid-ret.; blue, plate; red, "B+ ". First I.F.T., top of chassis at speaker's right; 2nd I.F.T., behind V3. Trimmer of C1 at front, atop gang; C3, center; C2, rear. Align I.F. at 456 kc., and then on 1,500 kc. signal. Adjust trimmers of C3, C2, and C1 (in that order) for output-meter maximum response.

With 3 V. "A," 135 V. "B" and 4.5 V. "C," no-signal, R1 on full, each plate should read 135 V. to ground, except for V4, 85 V. and V5, 125 V.; V1, V2, V3, 67½ V. on screen-grids. Filament, 2 V.

The receiver is equipped with an attached antenna wire, which folds into the case, and a ground connection. Better results may be obtained by attaching aerial to an outdoor antenna as lead-in. Wire is supplied for battery connections.

Model H-137 (portable) illustrated in carrying case, weighs 26 lbs. with batteries. Speaker is alnico permanent-field type, drawing no field current.

Switch Sw 1A and B opens "A," "B" and "C" circuits.

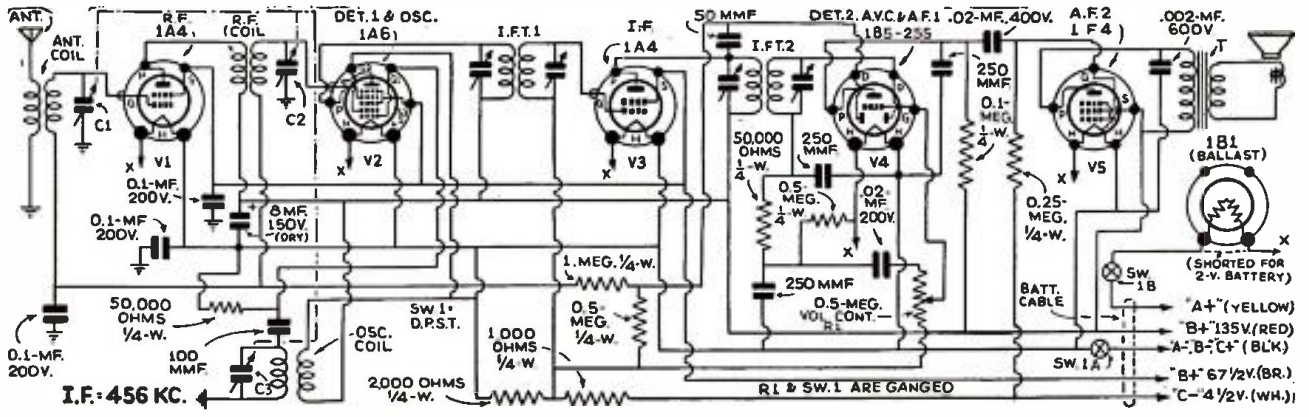

FEATURES IN RADIO SETS FOR 1937

(Continued from page 462)

utilizes the principle of the motion picture, in which a strong light focused through a film image appears sharply outlined on a screen. The sequence of operations is shown by Mr. Pentz of Radio-Craft Art Department, in Fig. C. Thus at any given time the frequency, call letters and geographical location of any radio station to which the receiver will tune, up to 130 stations, appear on ground-glass screen in the front of the newest Montgomery Ward radio sets. The call letters, alone, are about 3/4-in. high!

The dial scale, photographed on a strip of motion-picture film, is mounted on a drum which makes several rotations in synchronism with the tuning condenser. The rays from a special projector lamp, mounted in the center of the drum (as shown), pass successively through a condenser lens and a projector lens (adjustable, for securing a sharply-focused image), and then are reflected from a mirror onto the screen. (The optical magnification thus obtained in this length of light path, is about 10 times. It may be of interest to note that if the entire length of the enlarged scale were made visible at one time it would be more than 7 ft. long!)

When the band-change switch is rotated the entire film drum is moved vertically by means of a screw thread (seen underneath the exciter lamp) so that a new scale is projected onto the screen. At the same time a color filter (immediately next to the film drum; and removable, but not shown) is changed to provide either green or amber coloring on either of two short-wave bands. A large number of the principal short-wave stations are listed with their respective frequency, call letters and country.

Note that only one station in the 550 to 1,500 meter range is shown on the screen. This was done only for purposes of illustration. Instead, in actual practice, 3 station groups appear on the screen—one for radio stations in the Eastern part of the United States, one for those in the Central, and one for stations in the West—simultaneously, as shown by insert at lower-right.

(Additional, fixed markings appear outside of the screen area; to wit, at left-hand margin, TONE [Bass, and Treble-High-Fi.], and, right-hand margin, VOLUME [Loud, and soft-off]).

NBC-RCA TELEVISION "ON THE AIR"

(Continued from page 465)

mitted on top of the Empire State Building, and were received in the RCA Building at "Radio City," New York.

David Sarnoff, President of RCA, reported on the results of the field tests which have been conducted by the company engineers since September 1, 1936, and discussed the future of television. Lenox R. Lohr, President of NBC, told of the practical problems presented in staging performances for the air.

The demonstration possessed four features not included in previous demonstrations of television. It was the first made by RCA and NBC under practical working conditions, although previous demonstrations of laboratory television have been given. It represented the first showing of a complete program built for entertainment value as well as a demonstration of transmission. It also included the first showing of a new 12-in. cathode-ray receiving tube, which reproduces a picture on a 7 1/2 x 10-in. screen. This is the largest screen yet employed which is capable of commercial adaptation.

The watchers in front of the line of receivers installed for the demonstration at Radio City saw the processes whereby performances by "live" talent are transformed into pictures through the air, witnessed the scanning of moving picture films, and observed in detail the intricate television apparatus in actual operation.

The demonstration was the first showing of RCA experimental television under practical field conditions since RCA assigned the task of setting up a television transmitter to NBC.

This assignment included the construction of studios adapted to television technique, the installation of equipment in those studios and at the transmitter atop the Empire State Building, the determination of workable engineering methods for the transmission of pictures, and the training of a staff to take over the operation of the station.

Test The 6A4 Completely



MODEL 1504

on The P.O.E. Tester

● Normally the function of most tubes is to amplify a signal. But when tubes are required to deliver power such as the 6A4, the amplification may test up and yet the tube may distort badly, particularly at low frequencies. Reason . . . weak emission . . . Such tubes demand both amplification and emission tests.

● Radio tubes have three functions: to amplify, to deliver power, to rectify. Triplett's new power output emission test provides for a full test of all three types . . . available in no other commercial tube tester. It is just as simple to operate as any single purpose tester. For Amplifiers . . . The Power Output Test is absolutely the final word in determining the worth of the tube.

For Power Tubes . . . The Power Output Test determines the amplification, the emission test determines the Power Handling ability . . . (Available in no other Tester).

Diodes rectify current . . . Here the emission test only determines the condition. The P.O.E. tester tests these under voltage and current load. The proper high voltages used will detect flashovers. P.O.E. stands for Power Output Emission.

Includes FREE POINT TESTER

Model 1504 combines in the one tester the following servicing instruments:



MODEL 1503, same as 1504 but without Free Point Tester. DEALER PRICE \$46.67

MODEL 1502 P.O.E. Tube Tester DEALER PRICE \$36.67

1. Power Output Test for All Amplifying Tubes
2. Emission Test for All Tubes
3. Free Point Tester
4. Neon Short Test
5. Separate Diode Test
6. D.C. Voltmeter
7. D.C. Milliammeter
8. A.C. Voltmeter
9. Ohmmeter
10. Condenser Test for Shorts
11. Electrolytic Condenser Leakage Test
12. Decibel Meter

Complete in quartered oak case with all necessary accessories. DEALER PRICE **\$56.67**

SEE YOUR JOBBER WRITE FOR CATALOG



TRIPLETT ELECTRICAL INSTRUMENT CO.
162 Harman Ave., Bluffton, Ohio
Without obligation please send me more information
.....Model 150415031502
.....I am also interested in

Name

St. Address

City State



Please Say That You Saw It in RADIO-CRAFT

FACTORY CAPACITY
Increased
35%

RAYTHEON
TRADE MARK
MAKERS OF THE FAMOUS 4 PILLAR TUBES

In order to take care of the constantly increasing demand and to protect the tremendously growing manufacturers' requirements for Raytheon Tubes, new equipment and new production machinery have been installed in a new building giving an additional unit which increases Raytheon's production capacity by 35%! With these increased facilities, Raytheon guarantees continued promptness to all its customers even during the season of peak demand!

No wonder Raytheon Tubes are used and demanded by all leading radio parts dealers and servicemen for greater tube profits.

RAYTHEON PRODUCTION CORPORATION
420 Lexington Ave. New York, N. Y.
445 Lake Shore Dr. Chicago, Ill.
55 Chapel Street Newton, Mass.
555 Howard St. San Francisco, Cal.
415 Peachtree Street, N. E. Atlanta, Ga.

TECHNICIANS' DATA SERVICE

JOSEPH CALCATERRA

DIRECTOR

A special arrangement between RADIO-CRAFT magazine and the publishers of this literature, which permits bulk mailings to interested RADIO-CRAFT readers, eliminates the trouble and expense of writing to each individual organization represented in this department.

2. **HAMMARLUND CATALOG.** Contains complete specifications, illustrations and prices on the Hammarlund line of variable and adjustable condensers; intermediate frequency transformers, coils and coil forms; sockets; shields; chokes and miscellaneous parts for broadcast, short wave and ultra short wave reception and transmission. Also contains description and prices of the Hammarlund line of "Comet Pro" and "Super Pro" receivers.

5. **ELECTRAD 1936 VOLUME CONTROL AND RESISTOR CATALOG.** Contains 12 pages of data on Electrad standard and replacement volume controls. Truovolt adjustable resistors, vitreous wire-wound fixed and adjustable resistors and voltage dividers, precision wire-wound non-inductive resistors, center-tapped filament resistors, high-quality attenuators, power (50- and 150-watt) rheostats and other Electrad resistor specialties.

29. **THE KEY TO SUCCESSFUL SERVICING.** Four different types of combinations of courses on Radio Servicing, Public Address Work, and Television, developed by the Radio Service Institute, are described in this 24-page booklet. Complete information, including outlines of the courses and costs, is given. Two of the courses are designed for the more advanced and more ambitious Service Men who are anxious to get to the top of their profession. The other two courses are for less-experienced Service Men who want to advance more rapidly in the Radio Servicing Field. Please do not ask for this booklet unless you are interested in taking a course in these subjects.

53. **POLYIRON COIL DATA SHEET 536.** This folder contains complete catalog descriptions, specifications, prices, performance curves and circuits showing applications of the complete line of Polyiron radio components made by the Aladdin Radio Industries, Inc.

57. **RIBBON MICROPHONES AND HOW TO USE THEM.** Describes the principles and operating characteristics of the Amperite velocity microphones. Also gives a diagram of an excellent humless A.C. and battery-operated preamplifier.

65. **THE 1937 LINE OF SUPREME TESTING INSTRUMENTS.** This 24-page catalog gives complete information on the entire Supreme line of testing instruments, including the Model 585 Diagonometer; the Model 540 and 550 Radio Testers; the Model 500 Automatic; the Model 505 Tube Tester; the Model 555 Diagonoscope and other Supreme oscilloscopes, tube testers, signal generators and multimeters. Complete details of the Supreme Easy Payment Plan for purchasing testing equipment on the installment plan are also given.

73. **HOW TO ELIMINATE RADIO INTERFERENCE.** A handy folder which gives very complete information on how to determine and locate the sources of radio noise by means of the Sprague Interference Analyzer. A description of the analyzer and method of using it is included, together with data on how to eliminate interference of various kinds once the source is located.

74. **SPRAGUE 1936 ELECTROLYTIC AND PAPER CONDENSER CATALOG.** Gives specifications, with

Radio-Craft Technicians' Data Service
99 Hudson Street,
New York City, N. Y. RC-237

Please send to me, without charge or obligation, the catalog, booklets, etc. the numbers of which I have circled below.

2	5	29	53	57	65	73
74	75	76				

My radio connection is checked below:

- Service Man operating own business.
- Service Man for manufacturer.
- Service Man for jobber.
- Service Man for dealer.
- Service Man for servicing company.
- Dealer.
- Jobber.
- Experimenter.
- Professional Set Builder.
- Amateur Set Builder.
- Short Wave Work.
- Licensed Amateur.
- Station Operator.
- Radio Engineer.
- Laboratory Technician.
- Public Address Worker.
- Manufacturer's Executive.
- Student.

I am a:

Subscriber Newstand reader
I buy approximately _____ of radio material a month. (Please answer without exaggeration or not at all.)

Name

Address

City State.....
(Please print name and address)

Avoid delay. The catalogs and booklets listed are now in stock and will be sent promptly as long as the supply lasts. Please use this coupon in ordering. The use of a letter causes delay.

list and net prices on a complete line of wet and dry electrolytic, and paper condensers made by the Sprague Products Co. for radio Service Men, set builders, experimenters and engineers. Information on the Sprague Capacity Indicator, for making capacity tests on condensers and in servicing receivers, is included.

75. **SPRAGUE TEL-U-HOW CONDENSER GUIDE.** A valuable chart, compiled by the Sprague Products Co. which tells the proper types, capacity values and voltages of condensers required in the various circuits of radio receivers and amplifiers, and how to locate radio troubles due to defective condensers. Includes data on condenser calculations.

76. **FACTS YOU SHOULD KNOW ABOUT CONDENSERS.** A folder, prepared by the Sprague Products Co., which explains the importance of various characteristics of condensers, such as power-factor, leakage, capacity and voltage in determining the efficiency or suitability of a given condenser to provide maximum filtering and safety in operation.

INTERNATIONAL RADIO REVIEW

(Continued from page 473)

THE "PEOPLES' RECEIVER"

SOME time ago, it became the vogue in Europe—Germany, Norway, etc.—to market small receivers which were low in cost and adequate for the reception of local signals, with a view toward increasing the listening public.

The "peoples' receiver in Germany, particularly, became very popular and many thousands of these sets were sold to new radio enthusiasts.

The British Philco company has now placed a "peoples' set on the English market. This set is sold in two sizes, one using 5 tubes and the other using 4. Both sets cover the "interme-

diate" and "long-wave" broadcast bands and both sets are sold on a time payment plan which makes their original low cost even more attractive. One of the sets, in its moulded case, is shown in Fig. I—as reproduced from *Wireless Retailer and Broadcaster* (London).

A new German "peoples' set has also been introduced, in the form of an A.C. powered portable receiver which is both small in size and light in weight. The appearance of this set can be seen from the photo in Fig. J. This set uses two tubes, a regenerative detector and a pentode output tube. The photo is reproduced from *Europa Stunde* (Berlin).

Please Say That You Saw It in RADIO-CRAFT

PRECISION CONTROLS IN A 16-TUBE 1937 DX RADIO SET

(Continued from page 468)

latter unit affords a beat note of between 0 to 2,000 cycles on either side of the band, with intermediate values available, too.

By adjusting the band-width control it is possible to secure the proper tone control at the same time since the high or low notes can be cut off or heard at will (dependent upon the band selected).

With the band-width control at the minimum setting or with the primaries and secondaries of the I.F.s. farthest away, the selectivity with a signal 10 times the input is only 5.5 kc., and at 1,000 times the input, only 11.5 kc. With the band-width control at maximum (or, actually, at "minimum selectivity"), at 10 times the input, 15 kc. band-width is available; and at 1,000 times the input, a 25 kc. band width is available.

An additional feature of this improved "Super Pro" is the special cam switch—a model of mechanical and electrical engineering. In this switch are 4 shielded sections with 5 silver-plated bakelite knives in each unit. Each knife slides into 4 silver-plated phosphor bronze spring clips. Each spring clip is broken into two sections, and thus a 6-point positive contact is made every time one knife is moved (by turning a special brass cam). This switch is so positive that even heavy jars cannot upset it. Leakage is also impossible since the coils not in use are short-circuited.

The receiver covers 5 ranges; 2.5 to 5 mc.; 5 to 10 mc.; 10 to 20 mc.; 540 to 1,160 kc.; and 1,160 to 2,500 kc. It uses the following tubes—2-6K7s in two tuned R.F. stages; 1-6J7 as a high-frequency oscillator; 1-6L7 1st-detector, 3-6D6s as I.F. amplifiers; 1-6B7 combination 4th I.F. and diode 2nd-detector; 1-6C6 low-frequency beat oscillator; 1-6B7 for A.V.C.; 1-6C5 as a resistance-coupled A.F.; 1-6F6 as a class A driver; 2-6F6s operated as triode class AB; 1-5Z3 rectifier; and, 1-80 rectifier.

The signal-to-noise ratio of this improved model on 14 megacycles is only 8 db. at a 0.7-microvolt input with 30 per cent modulation at 400 cycles.

This article has been prepared from data supplied by courtesy of Hammarlund Mfg. Co.

MODERN TRAINS ARE RADIO EQUIPPED

(Continued from page 469)

and insulated from the car will clear up this trouble.

Tunnels cause some drop in signal strength and increase in noise but steel bridges and signal-tower crossing bridges are the greatest offenders. They only cause momentary inconvenience, however. Highway-crossing warning-bell circuits in some localities announce their presence with regular loud clicks while the train is in the isolated section of rail carrying the circuits. In one section, several miles in length, the block signal circuits are picked up as a rushing sound of low intensity at the beginning of the block, increasing to a maximum as the end of the section is reached and suddenly stopping, to start again at minimum and repeat.

It has been found that while fair reception can be attained with a short antenna on one side of the roof, the signal-noise ratio is much better if a closed loop extending entirely around the top edge of car roof is employed. (See illustrations.) The present lead-in is a twisted-pair with one wire open at top and grounded at bottom. Good results have also been obtained using a low-impedance shielded lead-in with transformers at antenna and at radio end, but the loss in the transformers, etc., is probably as great as the capacity losses in the twisted-pair type. (When permanent installations are made, the antenna will be run in heavy-walled bakelite tubes clamped in steel and wood brackets, giving protection against high potential wires dropping onto the aerial. At present, 15,000 V. insulation is used on the antenna for this purpose.)

The reception to date has included Nuevo Laredo, Mexico; Los Angeles, Calif.; and, Dallas, Texas, while travelling at high speed in the vicinity of Buffalo, New York.

The 11,000-V. transmission lines on the electric division out of New York do not seem to have bad effects. Several foreign short-wave stations have been received there while running.

**AMERICA OK'S
MIDWEST FOR 1937**

**... HALF the Cost
(FACTORY-TO-YOU SAVES 50%)**

**only \$39⁹⁵
BUYS A NEW 1937
MIDWEST**

**TWICE the Performance
(14 TUBES FOR
THE PRICE OF 8)**



**FACTORY-TO-YOU,
EASY-PAY PLAN
SAVES YOU 50%**

When you buy the Midwest factory-to-you way, you deal directly with the factory that makes radios—instead of paying extra profits to wholesalers, distributors, retailers, etc. Remember! Nothing of value is added to a radio just because it is handled many times. You have a year to pay terms as low as 10c a day... you secure the privilege of 30 days' FREE trial in your own home. In addition, you are triply protected with Foreign Reception Guarantee... One-Year Warranty and Money-Back Guarantee.

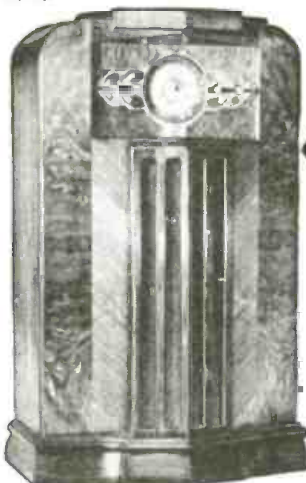

I WAS AMAZED
AT THE CLARITY
OF RECEPTION
AND ABUNDANCE
OF POWER
Glen Gray

30 DAYS FREE TRIAL

Only MIDWEST RADIOS offer
DIAL-A-MATIC TUNING • ELECTRIK-SAVER
• DUAL-AUDIO PROGRAM EXPANDER •
• AUTOMATIC AERIAL TUNING •
6 WAVE BANDS (4½ TO 2400 METERS)
and scores of other features
at SAVINGS UP TO 50%

Your radio enjoyment is doubled with Dial-A-Matic Tuning* (*optional), the amazing new Midwest feature that makes this radio practically tune itself. Zip! . . . Zip! . . . Zip! . . . Stations come in instantly, automatically, perfectly . . . as fast as you can push buttons. The exclusive Midwest Elektrik-Saver* (*optional) cuts radio wattage consumption 50%, enables Midwest radios to use no more current than ordinary 7-tube sets.

SEND FOR FREE 40-PAGE CATALOG

Why be content with an ordinary 6, 8, 10 or 12-tube set when you can buy a 14-tube deluxe Midwest for the same money! Scores of marvelous features like Dial-A-Matic Tuning* and Elektrik-Saver* give you magnificent new world-wide reception and glorious crystal-clear concert realism. You can roam the whole world in a minute . . . switching instantly from American programs to police, amateur, commercial, airplane and ship broadcasts . . . to the most fascinating foreign programs.

MIDWEST RADIO CORPORATION
DEPT. H-12 CINCINNATI, OHIO

MAIL COUPON TODAY FOR FREE 30-DAY TRIAL OFFER AND 40-PAGE FOUR-COLOR FREE CATALOG

MIDWEST RADIO CORP.
Dept. H-12, Cincinnati, Ohio
Send me your new FREE catalog and complete details of your liberal 30-day FREE trial offer.
(Special offer and prices prevail only when dealing direct with factory by mail.)

Name _____
Address _____
Town _____ State _____
User-Agents Make Easy Extra Money. Check Here for details



Please Say That You Saw It in RADIO-CRAFT

KENYON *Again Leads!*

New Oscillograph Power Transformer for the 913 Cathode Ray Tube

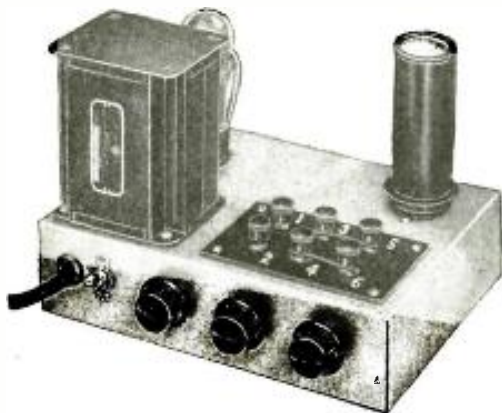

Realizing the need for a suitable low cost power transformer for the new RCA Cathode Ray Tube our engineers have developed a power transformer that is applicable to all Cathode Ray oscillograph applications. This unit will adequately power a complete oscillograph. Designed with three separate filament and two high voltage windings. Adaptable to supply power for a type 885 linear sweep circuit, or for a basic circuit utilizing a 60 cycle sweep. The list price of this unit is only \$4.00. Thus again typifying KENYON'S ACCEPTED STANDARD—THE BEST FOR THE LEAST MONEY. When ordering this unit specify Kenyon type T-207.

IMPORTANT FEATURES IN OUR NEW AMATEUR AND P. A. COMPONENTS!

Low in cost yet consistent with Kenyon dependable quality! Adaptability to all needs is provided by the new universal mounting case that permits top or bottom mounting. All units are sprayed with a durable black egg-shell enamel.

INPUT TRANSFORMERS

Multiple line input transformers provide perfect coupling for single and double button microphones. Transformers with hum cancellation windings permit mounting them on the chassis of high gain amplifiers!

OUTPUT TRANSFORMERS

All output transformers for P.A. applications include 500 and 200 ohm windings for matching transformers, and windings of 15, 8 and 4 ohms for speaker voice coils!

COMBINATION PLATE AND FILAMENT TRANSFORMERS

An electrostatic shield is incorporated between the primary and secondary of plate and filament transformers for P. A. and low power transmitters.

FILAMENT TRANSFORMERS

A large variety of single and multiple winding filament transformers provide filament supply for all types of tube combinations.

PLATE TRANSFORMERS

Kenyon plate transformers are engineered to meet the rigid requirements imposed in amateur service. Many of these units incorporate the exclusive Kenyon Triple Winding. The voltages available from the triple winding transformers range from 400 to 3000 volts. Made in three sizes supplying 175, 250 and 350 M. A. from each winding. Applicable to over eleven types of rectification circuits.

MODULATION TRANSFORMERS

Modulation output transformers for transmitters are designed with tapped secondaries which adequately carry the full Class "C" current without saturation!

TRANSMITTER MANUAL

Our new transmitter manual contains complete up-to-date transmitter circuits ranging in size from five watts to one kilowatt. Fourteen pages are entirely devoted to full page Ken-O-Grams which cover most of the calculations used in radio in a modern and painless method. Obtainable from your local dealer for 25 cents. If unable to secure a copy of this transmitter manual from your dealer send 25 cents and include the name of your favorite jobber or dealer and address your inquiries to

Chief Engineer — P. A. Division

KENYON TRANSFORMER CO., INC.

846 Barry Street

New York, N. Y.

Export Department:
25 Warren Street,
New York, N. Y.

Cable Address:
SIMONTRICE—NEW YDRK



14 SCIENTIFIC BOOKS COMBINED IN ONE VOLUME!

Dozens of Chapters Covering Many Branches of Science
Hundreds of Scientific Illustrations and Photos

Here are all the modern wonders of physics, chemistry, biology, astronomy, engineering, electricity and other scientific subjects included in ONE VOLUME . . . and just crowded with pictures. SCIENTIFIC WONDERS OF THE WORLD describes the world in which we live and the universe all around us. It explains how man has tamed the powers of nature. We see the oddities of biology, the wonders of plants and animals. The marvels of geography and geology are explained. We learn about the radio, the telephone and the talkies and many other interesting scientific projects.

Even the few topics just described indicates clearly the dazzling profusion of text and illustration which you will find in this book.

Here are a few chapters from the contents: The Enigma of Evolution; Dust Storm Dankers; Uses of Bromine; Reflections of Light; Land and Sea Breezes; The Wonderful Telegraph; Earth's Nearest Neighbor; Wonders of Television; Mystery of Light; Meteors and Comets; Wonders of the Radio; All About Power; and many other interesting articles.

Sent POSTPAID anywhere in U.S.A. **\$1.95**
Check or money order accepted.

GRENPAK COMPANY, 101R Hudson Street, New York, N. Y.

INSIDE FACTS ABOUT AMERICAN BROADCASTING

(Continued from page 461)

interesting report called "Allocation Survey" compiled by the Federal Communications Commission, Washington, is the basis for a very optimistic forecast of the American radio industry in 1937. This interesting survey, compiled from 32,674 returns (concerning rural districts, exclusively), is presented in the form of a diagram in Fig. 1!

Despite the fact that this F.C.C. survey was executed in 1935, but not released in Washington until the fall of 1936, nobody will doubt the value of this report, because the receivers have not grown younger in the meantime. Even considering the large percentage of replacement sales in 1936 there remain to be replaced plenty of sets with long whiskers. These "must-replacements" and the considerable increase of cash money, due to the improving purchasing power, gives us a good indication of what we may expect in the year 1937. (See Fig. 3.)

WHERE ARE THE METAL TUBES?

Considering the great selling power of metal-tube-equipped receivers, it is disappointing to comb the price lists and sales ammunition concerning the new receivers of the 1937 line. The disappointment is due to the small gain metal tubes have made after 2 years of intensive sales propaganda.

Before going deep into the matter, some short explanations are necessary. Statistics of this kind cannot be made by simply comparing the sale figure of sets equipped with glass tubes against the number of metal-tube-equipped receivers. The reason is quite simple. Philco, which still sells about 40 per cent of the entire production of receivers, offers only glass-tube-equipped receivers to the public.

A more correct method is to add sets with metal or glass tubes separately, and to present the figures obtained in a percentage relation. The percentages obtained by this method are given in Fig. 2. To avoid misunderstandings, and to make the trend in American radio engineering towards metal-tube applications more obvious, only A.C. and A.C.-D.C. sets are included in this compilation. Battery and automobile receivers are omitted, since these types of sets are mainly offered glass-tube-equipped. And last, but not least, rectifier tubes and tuning indicators are also kept out of our tabulation.

Figure 2 indicates clearly that glass tubes are still favored by American designers, especially, for table models. This is of great interest considering the fact that the type of customers who buy these small sets usually "fall" for novelties like metal tubes, etc. The reason for this trend in radio engineering is probably the problem of the heat dissipation vs. electrolytic-condenser life, and the ventilation puzzle in general, which obviously can be solved much more easily by the use of glass tubes. This does not speak entirely against metal tubes, and in favor of glass tubes, but nobody can close his eyes to the facts.

Nevertheless, metal tubes have a much better chance to survive than glass tubes, but the present "design principles" for radio sets (especially, for the midget type) need a thorough revision. This revision will come, and pretty soon, too. The public does not ask at present for low price as it did during the depression. We have a complete "new deal" in radio retailing. The times are past when a "combination" of an electric stove and radio receiver could be sold to the public, and it is to be hoped that a certain class of radio sets, produced only for "price-appeal," will disappear from the market.

"UNIVERSALS" DISPLACE D.C. SETS

Another design trend of great interest is the decreasing number of 110 V. D.C. sets. There was never any special reason for manufacturing these sets, and the surplus stocks of some factories speak for themselves. But the number of 2-, 4-, 6- and 32-V. D.C. receivers showed a considerable increase; a fact which does not surprise those who know that about 80 per cent of all farms are still without radio sets, and 5,000,000 farms without electricity.

The 6-V. D.C. receivers, operated in connection with wind-driven battery chargers, is

Please Say That You Saw It in RADIO-CRAFT

one of the new fields which will make the radio year 1937 as profitable as was the one of 1936.

WHAT ABOUT TELEVISION?

On June 29, 1936 television experiments on a large scale were started from the television station atop the Empire State Building in New York City. A number of receivers had previously been installed in the homes of a number of RCA engineers and NBC officials. Motion pictures as well as talent have been successfully transmitted and received. Due to the unusual height of the New York television station, the transmissions have been received as far as 45 miles from the Empire State Building. In these experiments an image definition of 343 lines has been used. But since the adoption of the 441-line definition has been recommended by the R.M.A. to the F.C.C. it will be necessary to change the New York transmitter in 1937 to conform to recommended standards, and a great number of new experimental transmissions will be made in the next two years.

Just when television will enter our homes depends on the outcome of these field tests and, last but not least, on the results achieved in trying to reduce the price of the receivers. The present price of about \$750.00 is prohibitive. As long as an image-sound receiver cannot be sold for about \$150.00 television is still "around the corner."

A TUBE TESTER THAT TALKS

(Continued from page 468)

form the "plate" of a 2-element tube.

During normal use of a tube its control-grid is at negative or zero potential which restricts or prevents electron flow from the cathode areas directly back of grid wires, while allowing flow from areas in-between. In emission testing the control-grid is highly positive, drawing most electron flow from previously protected cathode areas. Areas used in normal operation may be worn out, yet if emission-tested the tube will test "good" due to portions practically unused in actual service!

When testing with this new meter it will be noted that shorts or leakages will show simultaneously on (a) the meter, (b) the neon indicator and (c), be audible in the headphones (if used). For example, changes in the position of the test switch will cause the meter pointer to move from zero into the red area of the scale on any short of 5 megohms or less resistance. The greater the resistance the higher the meter reading.

The neon indicator glows only if the short is 1 megohm or less in resistance. Thus on a short of more than 1 megohm the neon bulb does not light but the meter pointer will rise. This adjustment of the neon sensitivity gets rid of false flashes on "short" tests while using a hot cathode. A headphone connected to the Noise Test jack will buzz if there is a permanent short of resistance low enough to light the neon tube.

All leakages, however small, are shown by the meter and the amount of leakage is proportional to the meter reading. No short, however great, will cause a Good reading. All leakages will cause the meter to read Bad. All intermittent shorts, leakages and intermittent contacts can be listened-to by the customer; and, last but not least, all shorts in all tubes are checked with just one switch.

While every variety of tube which has appeared can be tested by this unit ample provisions have been made to give complete protection against changes caused by future developments in tubes.

A polarized test voltage furnished through panel jacks may be used for checking leakage in electrolytic, paper and mica condensers, and for making continuity or point-to-point tests. Current flow is indicated by the meter and by the neon tube at the same time.

This tester is available in two models both of which are extremely modern in appearance. They are finished in ivory, red and chrome. In the portable tester tools, tubes and repair parts can be conveniently carried in the two large compartments having 320 cubic ins. of storage space. The overall size of the portable case is 5 by 12 by 17½ ins. The counter-type tester (illustrated) has a base 14½ by 16½ ins. and with its glass display top stands 15½ ins. high.

This article has been prepared from data supplied by courtesy of Radiotechnic Laboratory.

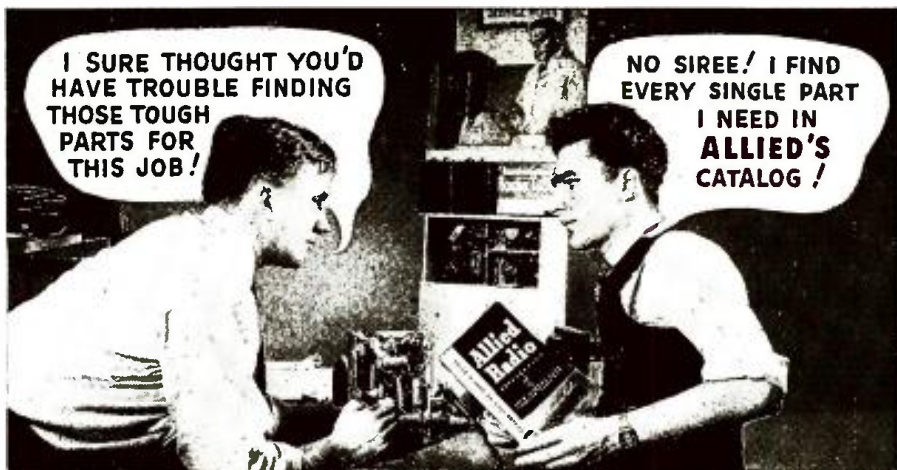

"Everything in Radio" UNDER ONE ROOF -to Save you Time-Trouble-and Money

Wise servicemen—trouble shooters who have been through the mill—know that they can't afford to waste time exploring for hard-to-get parts, prospecting for low prices. That's why busy servicemen everywhere are turning to ALLIED—and the ALLIED Catalog—for their radio requirements. Everybody in radio knows that only ALLIED offers the complete stocks, the fast service, the high quality and the low prices that spell S-A-V-I-N-G-S to every radio buyer.

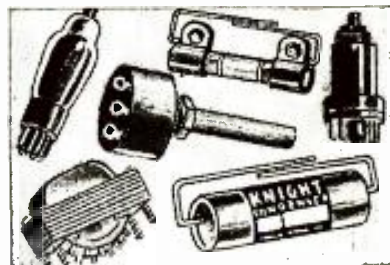

COMPLETE RADIO STOCKS

ALLIED'S huge stocks—the most complete in Radio—include more than 10,000 exact duplicate and replacement parts, the products of the leading radio manufacturers. You're sure of highest quality and fastest service when you order from ALLIED—Radio's Leading Supply House!

The whole ALLIED organization is keyed to meet your needs, Mr. Serviceman; our huge stocks, our central location, our speedy shipping department eliminate costly delays and inconveniences—assure you of savings in time, trouble and money. For bigger profits and more satisfied customers—order from your ALLIED Catalog!

EVERYTHING IN RADIO AT LOWEST PRICES!

ALLIED'S 152-page Catalog shows more than 10,000 duplicate and replacement parts; 38 models of the Knight Radios; dozens of Build-Your-Own kits; latest SW receivers and transmitters; newest P.A. Equipment, test instruments; Rurlpower units and Windchargers; books, tools, etc. Everything in Radio at lowest prices. If you haven't a copy, send for this time-saving, money-saving Catalog today!



ALLIED RADIO CORPORATION
833 W. JACKSON BLVD. CHICAGO, ILL.

ALLIED RADIO CORP. Dept. 2-B
833 W. Jackson Blvd., Chicago, Ill.
Rush me your 1937 ALLIED Radio Catalog.

Name

Address

City State

THERE'S A GOOD JOB FOR YOU IN RADIO

We Will Train You Quickly to Qualify

The servicing of modern radio receivers requires experts—men trained for this work are needed everywhere.

RADIO

RADIO OFFERS BIG OPPORTUNITIES

Your possibilities of making money are limited only by your ability and skill. There is no room for the soldering iron "quesser." But you must be trained—the sooner you begin the quicker you'll cash in.

LEARN AT HOME

We will train you at home to service and repair radio receivers of all types. Invest for future success in R.T.A. training.

NO EXPERIENCE NEEDED

You need no previous experience in Radio. We show you how to make money almost from the start. Hundreds of men are enjoying the rewards of R.T.A. training.



FREE
of extra cost

This time saving trouble-finder and circuit analyzer included.

Full details of this great opportunity are explained in a helpful book that is **FREE**. Send for it today. It will be mailed at once.

RADIO TRAINING ASS'N OF AMERICA
Dept. RC-72, 4525 RAVENSWOOD AVE., CHICAGO

Please Say That You Saw It in RADIO-CRAFT

INTERESTING INFORMATION ABOUT "SPOT" BROADCASTING

(Continued from page 456)



Here's your chance to get BOTH of Ghirardi's widely-acclaimed books for radio service men! They go hand in hand together—one to explain to you everything about up-to-date servicing practice, test instruments, repair methods, etc.—the other to give you instantly just the receiver and servicing reference data you need when you're out on a job or in the shop. Service men all over the world are using Ghirardi's books these days—they save time and money. Get this essential equipment into your shop without further delay. Mail today the coupon below!

MODERN RADIO SERVICING

Partial Contents

- ☆ Complete details on the theory, construction and operation of all forms of Test Equipment, with circuit diagrams, construction data etc.
- ☆ Latest Test and Repair methods. Receiver analysis. AVC and QAVC circuits. Aligning sets with test oscillators and by latest Cathode-Ray Oscilloscope methods. All explained in detail with copious diagrams.
- ☆ Special Servicing Problems. Auto-Radio Installation and servicing. Location and elimination of noise and interference. All-Wave sets. High-Fidelity sets. Etc.

Over 1300 pages
706 illustrations
\$4.00

RADIO FIELD SERVICE DATA

2nd Revised Edit.

Partial Contents

- ☆ New, loose-leaf, greatly enlarged edition. Supplement Sheets twice a year.
- ☆ "Case Histories" of over 1,500 receivers. Actual Trouble Symptoms and Remedies for each. Tabulated for quick reference.
- ☆ Table of "I.F.'s" of 5,424 superhets, old and new.
- ☆ Ignition Interference for over 80 models of cars. 62 automobile electrical wiring diagrams.
- ☆ Time-saving Trouble-Shooting chart: RMA Color Codes; wire tables; etc., etc.

436 pages
107 illustrations
\$2.50
with Jan. & June '37 Supplements

Accept this Double-Barrelled

SPECIAL OFFER

BOTH BIG BOOKS NOW



#6
Including Jan. & June '37 Supplements to RADIO FIELD SERVICE DATA

CLIP and MAIL TODAY

RADIO & TECHNICAL PUBL. CO.
43 Astor Pl., New York, Dept. RC-27
[] Enclosed find \$6 for both books, including Jan. & June '37 Supplements to Data Book #1. (Foreign \$ 6.50)
[] Enclosed find \$4 for MODERN RADIO SERVICING alone, including Foreign \$4.50.
[] Enclosed find \$2.50 for RADIO FIELD SERVICE DATA alone, incl. Jan. & June '37 Supplements. PP. (Foreign \$3) [] Please send free circulars SS.

NAME: _____
ADDRESS: _____

MONEY BACK GUARANTEE!

planes drop as many as 10 parachutists from one airplane. If each of these 70,000 men, dropped to earth in the security of a smoke screen, was to be equipped with a short-wave 2-way, transmit-receive radio set or transceiver, it is seen that a formidable intelligence corps capable of being able to immediately report to the home office would be available in enemy territory. The practicability of this idea will become evident as we now return to a short discussion of modern spot-broadcast equipment, and a review of recent programs in which such short-wave equipment has prominently figured.

Back in 1929, when Floyd Gibbons broadcast interesting highlights during arrival from Germany of the *Graf Zeppelin*, a crew comprising G. W. Johnstone (left, Fig. B), W. B. Miller (right) and Floyd Gibbons (extreme right) was needed to operate the packback S.-W. transmitter.

Today, when the Hindenburg pays Uncle Sam its visits, on schedule, a veritable studio-on-wheels is run right up along-side the overgrown cigar, as shown in Fig. C, and, presto, another spot program is "on the air."

Such a "mobile unit" is able to travel wherever an automobile can, and serving as a base for all remote-control broadcasts, represents the "last word" in this type of equipment.

Mobile Unit No. 3 (a 5-ton car, capable of traveling 70 m.p.h.), for instance, shown in Fig. D, includes 4 separate transmitters, as follows: WMEF, a 150-W. transmitter licensed for 2 frequencies (6½ and 195 meters) in the intermediate wave band (sending range: stationary, 100 miles; moving, 50 miles); W10XS, assigned 5 frequencies in the ultra-high band; W10XV, a 15-W. emergency unit, and W10XAL, a tiny 1-W. pack transmitter.

One or another of these is used on programs, depending on prevailing conditions. The pack transmitter is included to make the unit even more mobile. If it is desired to originate a program at some spot inaccessible to the 5-ton car, the car is driven as close as possible, and then an announcer with the pack transmitter on his back makes his way to the desired location.

In this way a program may be relayed from the pack transmitter by short-wave to the mobile unit, which in turn relays it on a different short-wave to the pick-up point for the NBC networks.

All this equipment, transmitters—suitable receivers and power plant—is housed in the main body of the car. The "studio" portion of the mobile unit is in the driver's section.

The seat is wide enough to hold 4 men in comfort. On the dash-board, on the side opposite the driver, is a folding desk, which may be let down when not in use. When up, it serves to hold microphones and a typewriter. Under the desk are 6 connections where microphones and ear-phones may be plugged-in. There is a 100-ft. lead on the microphones, so that announcers may move about freely outside the car.

Above the announcer's seat is a trap-door in the ceiling, so that when desirable the announcer may stand with his head and shoulders above the top of the car and have an unobstructed view in all directions even while the car is in motion.

Compact, efficient, portable and universally operable equipment of this type, manned by technicians who have become expert in using this equipment and maintaining it at peak efficiency, have made possible the almost magical results achieved in 8 November spot broadcasts of national and international interest.

3 THRILLING SPOT PROGRAMS

The "Earth-Sea-Sky" Broadcast. On November 8th NBC successfully staged an air show—one in a series of special programs arranged to commemorate the 10th Anniversary of the National Broadcasting Co.—that packed excitement in almost every second of its 45-minute duration.

Opening as a studio broadcast from Radio city, the program then switched from one spot-pick-up to another, as illustrated in Fig. E.

First on the bill was a pick-up from a cruising squad car of the Police Department at Cleveland picking up police orders from headquarters. Then a jump to U. S. Navy submarine S-20 cruising underneath the surface of the water off Sandy Hook, N. Y. From under-sea level the program then flashed to the top of Pike's Peak, Colo., for a word-painting of the scenery.

A 2-way international inter-train conversation was then held between railroad officials on the *Comet* speeding at 80 m.p.h. between Boston, Mass. and Providence, R. I., and the *Hamburger* streaking at 90 m.p.h. between Berlin and Hamburg, Germany!

The circuit then was transferred to the "black pit" below-ground in Carnegie Coal Mine, Pittsburgh, Pa. Then to street-level in N.Y.C. for a description of Sunday fashions on 5th Ave. as seen from a traveling automobile.

An action pick-up from one of the bicycles in Chicago's 6-day race was then followed by a word description of U.S. tank maneuvers at Washington, D.C. Preceded by a pick-up aboard the Coast Guard Cutter *Ponchartraine* cruising in Long Island Sound, N. Y., was a pick-up from the uncompleted New York-New Jersey vehicular Midtown tunnel.

Concluding this earth-sea-sky network jam-boree was a descriptive broadcast from a vantage point high up on the Golden Gate Bridge—San Francisco-Oakland's new connecting link; and, from an NBC unit aboard a U. S. Navy plane flying with a squadron of fighting ships over San Diego, Calif. (the West Coast Naval Base), the roar of fighting airplanes in a power dive.

The "Transoceanic" Broadcast. "We will 'soon' be able to see each other by transatlantic television," radioed Guglielmo Marconi near Genoa, Italy, to David Sarnoff in N.Y.C., in opening an Armistice Day broadcast.

After this ocean-hopping tête à tête, November 11th, between radio's Wizard No. 1 and RCA's prexy, the NBC network program became a 4-way free-for-all to include a total of 26 guests aboard two U.S. cabin planes 5,000 ft. in the air.

This broadcast—rebroadcast to Germany, France, Denmark, Austria and Italy—linked spot pick-ups aboard Marconi's yacht cruising in the Mediterranean Sea; Sarnoff's office on the 53d floor of the RCA Building, Radio City, N. Y.; and American Airways planes, flying between Niagara Falls, N. Y., and Washington, D.C., carrying a group of foreign broadcast executives (who, in connection with NBC's 10th Anniversary fiesta, were making a study of American broadcasting technique).

The "Business Revival" Broadcast. In a whirlwind 1-hour survey, by NBC, broadcast over network and short-wave stations last November 27th, microphones painted a vivid, kaleidoscopic picture of business recovery. A story of increasing profits, and rising wages and employment, was told by industrial heads, small business men and workers in many fields; accompanying spot-action sounds constituted the "music of American prosperity."

The itinerary was as follows: Detroit—automotive industry; New York—garment plant, railways (Pennsylvania Station), marine (a pick-up in the hold of an ocean liner in the harbor), gasoline (Am. Petroleum Inst. offices); Boston—New England cotton (Nat'l. Cotton Mfrs. Assoc. offices); Cleveland—city employment (Chamber of Commerce); East Pittsburgh—Westinghouse plant; Hollywood—cinema (Laskey studios); Schenectady—General Electric plant; Chicago—grain and meat-packing; Brighton—Colorado's beet-sugar industry; San Fernando Valley—Californian fruit industry (description from an airplane, and from a small farm); Seattle—airplane factory; San Francisco—the fishing fleets (by a trawler's representative); Philadelphia—street interviews regarding national business conditions.

At times the occupational sounds formed a background to pertinent comments; at others, microphone close-ups made these sounds a thrilling solo of one or another of America's many booming businesses.

In conclusion, the writer calls attention to President Roosevelt's Inauguration broadcast scheduled for Wednesday, January 20th, 1937. The plans of NBC (those of CBS and MBS are not available at this writing) include the use of 10 or more short-wave mobile, blimp, and airplane transmitters, micro-wave sets operating among the crowds, and numerous strategically-located microphones. The operation of all these spot pick-ups will be regulated by initial use of a new "master control unit."

Please Say That You Saw It in RADIO-CRAFT

RADIO SETS FOR EXPORT AND MARINE USE

(Continued from page 474)

a few severe shocks. Long experience has taught methods of construction and assembly to overcome the effects of vibration, but if an average radio set, intended for sale in this domestic market, is shipped to South Africa or Australia, for example, half of the parts will be lying in the bottom of the cabinet when the radio receiver has reached its destination!

Even if the packing of such a set is still intact, you will be ready to swear that someone had attacked the bolts and nuts with a screwdriver and a wrench, for such is the mysterious effect of long-continued vibration.

CLIMATE

Experience in overcoming climatic conditions has helped greatly in some parts of the U.S.A. Year-round residents of Florida, for example, have experienced all kinds of trouble with their radio sets during the rainy season. Florida climate may not be a problem at all, for there are thousands upon thousands of properly designed radio sets—in at least one make—operating successfully under the extreme conditions of the tropics.

To give you an idea of conditions which these sets are able to meet successfully: two months after the last Stratosphere flight from Black Hills, So. Dakota, we had a letter from a civil engineer, working in the interior of the Gold Coast section of Western Africa, telling us how he had received the transmission from the balloon, relayed from England. He reported that his set was maintaining its peak efficiency on both broadcast and short waves right through the tropical rainstorms. "Only twice," he added, "the set had been affected by the dampness, and this was remedied by setting an ordinary kerosene lantern behind the set, to dry it out!"

Extreme dryness, too, is a foe of high-efficiency reception. It attacks transformer insulation and, by causing ordinary coil forms to shrink, alters the electrical characteristics of R.F. and I.F. coils. This condition is particularly severe when accompanied by high temperatures.

The most destructive atmospheric conditions are encountered on the sea coast, where the corrosive effect of salt water dampness is encountered. Radio sets have been designed that overcome the faults which develop under the influences of salt water, and these sets have become the choice of officers and men who buy sets for their own amusement while they are at sea.

The first step, based on 28 years of experience, was to determine what kinds of failures were caused by atmospheric conditions. An effort was then made to reproduce those conditions in the research department, and speed up the action, so as to obtain the equivalent of 2 to 4 or 6 years' use within a month or two of laboratory testing.

This work required elaborate investigation for if, in the "dry, hot weather" test, for example, too much heat was used, the results obtained were unfair to the radio sets, and if too little heat was used, the sets did not receive an adequate test.

Now, however, it is known exactly how much heat to use, and the length of the test required, to reproduce fairly the dryness of Egypt, Peru, or Arizona. Similarly, the way to observe accurately the effects of cold, humidity, and salt air have been learned.

All new parts are put through these tests, standard parts are given routine checks from time to time, each new cabinet is tried out for effects upon the joints and the veneered surfaces, and complete sets, with the current turned on, are given the "Torture Chamber" treatments. (One of several different types of such test rooms, as used in a large commercial laboratory, is shown in Fig. A.—Editor)

By such tests, and by the use of equally elaborate scientific control of all the parts and methods of the assembly adjustment, and inspection throughout the factory, it is possible to deliver radio sets to any country on the face of the globe with definite assurance that each receiver will perform at peak efficiency, no matter what local conditions it may encounter.

Our Information Bureau will gladly supply manufacturers' names and addresses of any items mentioned in RADIO-CRAFT. Please enclose a stamped return envelope.



A Million Dollars worth of Ideas and Experience!

This sensational new book shows you just what to do to build up your business. Everything in it has been proved sound, practical and successful. Any man who uses it is bound to make more money.

RADIO BUSINESS

Promotion and Management

By A. A. GHIRARDI and T. S. RUGGLES

Experience—the greatest teacher of all—really wrote this book. Not just one man's experience, but the experience of hundreds of aggressive radio dealers and service men, whose combined contributions have made this the greatest body of factual sales, advertising and management information the radio business has ever had. This remarkable new book opens up new opportunity for all. No matter what your present set-up is, it will show you exactly what steps to follow and what mistakes to avoid to improve it. How to start a radio business. How to run one. How to sell radio sets and service. How to advertise them. *Everything you want to know.* It's shy on theoretical discussions, but heavy on practical examples of successful plans.

And it's chock full of business-building, money-making ideas—2,199 of them to be exact! *Ideas you can put to work today.* Examples of order-pulling advertising—sales talks—business methods—merchandising tips—etc. Applies to sale of radio sets, servicing, Auto Radio, P.A. work, home appliances, etc. *It is positively the first and only book of its kind—one you should not miss!*

Take this book as your business partner—the best sales-producer you ever had! **MAIL THE COUPON TODAY!**

Over 400 pages
Over 200 illus.

CLIP and MAIL

Today

Radio & Technical Publ. Co.
45 Astor Pl., New York
Dept. RC-27
Please send free circular BB.

Name

Address

Free Circular

FOR DEALERS AND SERVICE MEN

NEW Du Mont CATHODE RAY TUBE SPURS TELEVISION

A SENSATIONAL advancement in Television has been made possible by a new type Cathode Ray tube perfected by Allen B. Du Mont Laboratories, Inc. Experimenters, service experts and engineers are invited to write to Allen B. Du Mont Laboratories, Inc., Upper Montclair, N. J. for information on the new tube. It is also suggested that those interested in television receiver construction follow the series of articles on this subject, running in Radio-Craft.—Adv.

RADIOS

SAVE UP TO 50%

ALL NEW 1937 MODELS



A penny post card brings you our new, full-color 16-page BARGAIN CATALOG free. Many models to choose from: 4 to 19 tubes, AC-DC, All-Wave and new Farm sets that operate like city radios! Send post card or coupon below for full details of 30-day no-risk trial and Agent-User proposition. Write now!

30-DAY NO-RISK TRIAL

\$6.98

MAIL COUPON



Enjoy it a month, then decide. Write!

GOLDENTONE RADIO CO., Dept. B, DEARBORN, MICH. Without obligation, send me new 1937 Catalog and 30-day trial plan.
Name

Please Say That You Saw It in RADIO-CRAFT

HOW TO MAKE THE RADIO-CRAFT "COUNTRY GENTLEMAN" RADIO SET

(Continued from page 459)

Builders substituting the "A" type should remember this fact, as the extension of the cut-off presumes a different characteristic curve and a somewhat changed A.V.C. control for this stage.

The I.F. uses two stages, with the first giving really high gain and bearing most of the gain-selectivity burden. Both stages are biased -3 V. and are acted upon by the A.V.C., as separate and increased bias for the second would (as analysis of the schematic proves) simultaneously afford an increased bias on the first noise amplifier tube thus prohibiting any effective means for separately controlling I.F. and noise amplifier circuits. The first I.F. stage uses ferrocart iron-core transformers in input and output service with a type 1A4 tube. The second in the I.F. line-up uses a type 1C6 (the 1A6 may be substituted with decreased gain and increased cutoff, though with a 6 ma. saving in "A" current), selected after experiments with various battery tubes adaptable to 2nd-I.F. service in receivers having noise suppression. Forgetting for the moment its primary job, which is to instantaneously cut off during moments of severe noise disturbance, and considering it as a straight I.F. amplifier, we find it is nothing more or less than a screen-grid tube with the No. 1 and 2 mixer grids tied together and either floating or used for purposes of manual volume control. Referring to Fig. 3A, we see that with the D.P.D.T. switch thrown one way and the 22.5 V. "C" bias switch (on control R15) turned on, these mixer grids receive a negative bias up to 22.5 V., the amount of bias being determined by the position of the arm of potentiometer R15. Thus we can manually control this second I.F. stage with the noise amplifier off, since by increasing the negative bias on the mixer grids we simply shift the operating point farther toward cut-off. In Fig. 3B, showing an alternative noise circuit, we find that manual control of the second I.F. stage is had at all times, whether or not a noise D.C. is being impressed on the two mixer grids. Here actual control of the stage is effected by varying the screen-grid potential—permitting either manual selection of overall set R.F. gain (effective) or setting of the second I.F. amplification to that point which affords best possible control by negative D.C. impulses from the noise circuit.

The third I.F. transformer is a broad-band type with tuned primary and with two untuned secondary windings, one feeding the R.F. signal to one diode of the 1B5 second-detector for rectification and amplification of the audio component and one feeding the signal to the other diode for rectification, audio and R.F. bypass, and pumping of an A.V.C. negative D.C. component into the gain-control line. The latter diode is biased -3 V. to permit delay action, without, of course, biasing the first and

hampering the action of the detector at low signal inputs. The circuit was selected after serious thought and experimentation, and every credit is extended to J. T. Bernsley for initial work in developing this system. (See September, 1935, issue of *Radio-Craft*.)

The A.V.C. voltage is built up across R7 and R8, the two resistors in series being used so that we might impress approximately 1/2 the developed A.V.C. potential on the first R.F. stage—thus keeping our R.F. tube working at best efficiency on weak signals and putting the burden of full A.V.C. control mainly upon the mixer and succeeding stages. All grid returns are bypassed to ground and isolating resistors are used where necessary. The filter system may be changed to permit increased or decreased timing meeting individual fancy—but care should always be exercised, nevertheless, to provide an adequate filtering action (See the A.V.C. articles in the June and July, 1936, issues of *Radio-Craft*.)

The triode section of the second-detector is connected as an A.F. amplifier in the usual manner and feeds a type 30 driver stage, whose output is fed via a combination impedance and transformer coupling arrangement to the type 19 class B tube. This arrangement permits easy installation of a jack for D.C. isolated phone plug-in into the 30 output and keeps D.C. out of the driver transformer primary winding. The set-up is ideal, but builders should remember that C19 must be of greater value than for capacities usually used in impedance coupling systems if adequate bypassing of the lower audio frequencies is to be had. The class B output transformer has taps for 2,000, 15, 8, and 4 ohm connections, the 15-ohm being used for proper matching to the 15-ohm voice-coil of the speaker.

Now back to the noise-suppressor circuits. The original laboratory model was first built using the circuit shown in Fig. 3A. We had no choice at the time but to use a type 1B5 as noise-voltage rectifier, which presumed the use somewhere of the triode section. The extra triode would call for no additional "A" current for operation, and little additional "B" current, and so we built it into the noise amplifier circuit as an additional stage. By shifting its bias, we controlled its amplification and thus varied the effective efficiency of the noise system as a whole.

Unfortunately, two stages of amplification, with the second tube a triode and not too perfectly isolated from the rectifier elements in the same envelope, resulted in instability. Builders should be advised, therefore, that the circuit will oscillate the moment it is properly aligned at any frequency, if the wiring isn't just right, and however well it is isolated and shielded from the I.F. circuit proper. If the frequency to which it is tuned is other than that of the I.F. circuit



Ceiling unlimited for Ol' Man Centralab

He's flying high these days . . . and the service man who is throttled to Centralab's speed is bound to be well satisfied with 1937's possibilities. '36 has been a big year for Old Man CENTRALAB. The famous smooth control with the long resistor has the place of honor on thousands of service benches and in as many service kits. Fly with CENTRALAB again in '37.



The Famous CENTRALAB Smooth Control

Centralab

MILWAUKEE WIS.
BRITISH CENTRALAB, LTD.
Canterbury Rd., Kilbourn
London N.W. 6, England
CENTRALAB
118 Avenue Ledru-Rollin
Paris XI, France

BARGAIN BULLETIN

SAVE MONEY ON EVERYTHING YOU BUY!

SPORTING GOODS
WATCHES-CLOCKS
TYPEWRITERS
OPTICAL GOODS
CAMERAS-NOVELTIES

RADIO SETS AND REPLACEMENT PARTS

SEND AT ONCE FOR OUR FREE CATALOG!

Buy efficiently, economically, safely! Hundreds of high quality items—leading lines and standard brands—at prices amazingly low! Real bargains! Square dealing! Write today for your big, free copy of this new catalog hot off the press.

RADIO CIRCULAR CO., INC.
915 BROADWAY Dept. RC NEW YORK, N. Y.

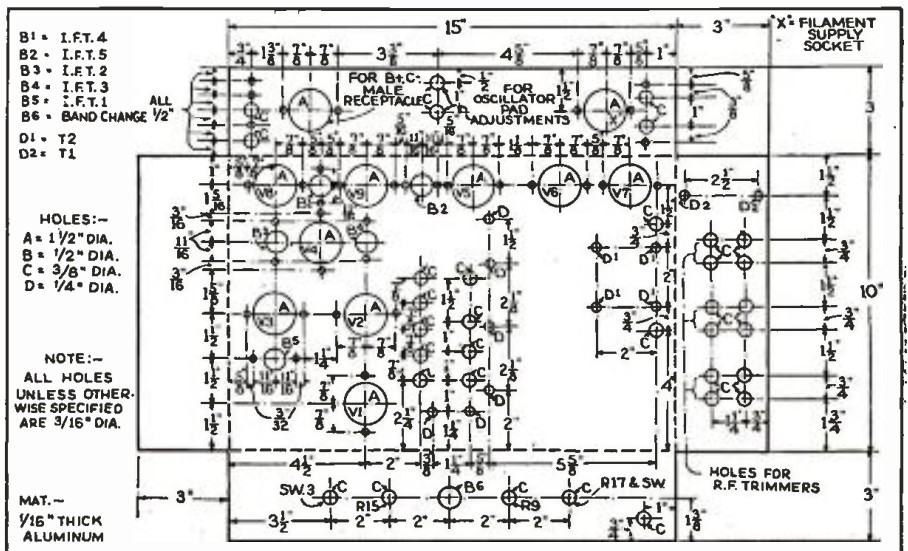

Fig. 4. Chassis drilling and fabricating details including the sizes of all holes.

Please Say That You Saw It in RADIO-CRAFT

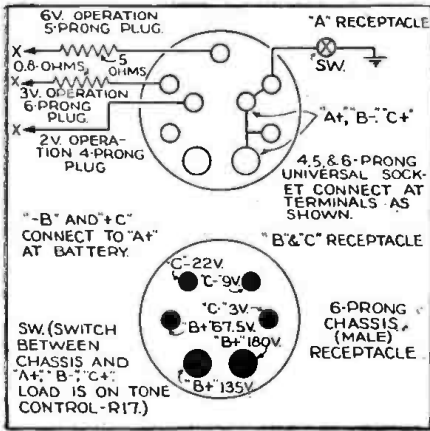

Fig. 5. Details of plug and socket for battery connection.

and the difference frequency is in the audible range, the noise system simply acts to all effects like a rather complex beat oscillator, feeding back to V4 through the common grid connection (N) or through an improperly bypassed output connection to grids 1 and 2 of the same I.F. tube. If the noise circuit frequency is "right on the I.F. nose" and oscillation persists, the self-generated R.F. is rectified by V9 just as an amplified noise voltage would be rectified, and is fed as negative D.C. to the mixer grids of the 1C6 second I.F. The strength of this D.C. is generally enough to cause cutoff of the 1C6 or at least serious attenuation of I.F. amplification.

Here, in other words, we are confronted with the problem of so adjusting and wiring the noise circuit that it cannot oscillate. This may, in the end, involve detuning or reduced "B" supply on the triode section and, as a last resort, neutralization of the triode. The last becomes rather tricky business—and the first may so impair the operation of the noise amplifier as to cause ineffective noise suppression. All this, of course, is said merely in warning. *Do not let the noise circuit oscillate.* We need all the amplification we can get in the noise circuit to provide noise voltages healthy enough to build a D.C. component sufficient to send V4 to cutoff.

One thing more about this circuit. Granted that it is working properly—it still has one disadvantage. It presumes a noise D.C. strong enough to cut off V4 with the latter tube ordinarily operating at -3 V. or full-efficiency bias. We cannot increase the lower bias limit on V4 without simultaneously increasing the bias on V8—and the effect of decreasing the gain of V4 for proper operation in conjunction with the action of V9 and for cutoff with noise D.C. is practically balanced out by the decreased gain of V8 and the consequent lessening of noise-amplifier efficiency. The remedy here would be to simply add another control bridged across the 67.5 V. screen-grid "B" supply and to wire the screen-grid of the second I.F. tube, properly bypassed, to the variable arm of the additional potentiometer. In this way we can control the amplification of V4 without hampering the operation of the noise circuit.

The circuit in Fig. 3A will work:—we'll say that much for it. But it will not work at full efficiency and thus effectively unless the builder makes absolutely sure that the noise amplifier does not oscillate.

The circuit in Fig. 3B, applied in experimental models of the laboratory job but not yet to the completed set, is simpler and certainly easier to adjust. We have not had the opportunity of testing it out over a long enough period of time to iron out the bugs, but it is apparent that if the noise amplification is sufficient to give us a high enough rectified D.C. to send V4 to cutoff, efficient noise suppression will be had. Here we have pulled out the triode stage—using this section of the noise detector as B.F.O. (beat-frequency oscillator) tube. The burden of noise amplification falls entirely upon the 3Z, which works at all times at full efficiency and which is not controllable. The Nos. 1 and 2 grids of V4 receive the D.C. as usual, and the amplification of this tube is controlled by varying its screen-grid potential. For effective noise suppression, the screen-grid voltage

(Continued on page 494)

F. L. SPRAYBERRY Broadcasting:

LET ME TELL YOU ABOUT MY 2-WAY MONEY-MAKING RADIO TRAINING PLAN

Whether you are a young man or an older one—whether you've got a job or are looking for a really worth while future—whether or not you have ever had any previous radio experience, you owe it to yourself to investigate my unique new Radio Training method. It is a 2-Way Money-Maker. I'll teach you to make spare time profits while you learn. I'll fit you out with complete standard equipment, teach you to use it on all kinds of Radio work and teach you modern business methods, too. Investigate today! It will cost you nothing to get the facts—it may mean the turning point in your life toward the successful future of which you've dreamed!



I WILL PROVE THAT 17c A DAY

ACTUALLY SETS YOU UP IN BUSINESS ...

It can be done! I am already doing it for hundreds of ambitious fellows like you. I know I can do it for you. You'll actually be set up for a profitable business of your own—or ready for a flying start in a full or part-time job in any one of radio's fascinating branches such as aviation radio, auto radio, broadcasting, public address, etc. There is no other training like it. You learn at home in spare time—and you'll be pleasantly surprised how quickly you are ready for a real future in a rapidly growing industry that is providing fortunes for well-trained men.



THIS PROFESSIONAL EQUIPMENT IS YOURS

REMEMBER: No matter what kind of Radio Training you take, it is ABSOLUTELY NECESSARY that you have real professional equipment such as that shown here BEFORE you are ready to start making real money. Sprayberry Training brings it to you almost at the start—teaches you how to use it under actual working conditions.

SERVICEMEN!

For those already in Radio, Sprayberry offers an ADVANCED Training Course that has proved invaluable to hundreds of servicemen. Saves you time—saves money—teaches you the easiest way to do the hardest jobs. Get details. Mark an X here () and we will send our ADVANCED Radio Training Booklet free.

SPRAYBERRY ACADEMY OF RADIO

F. L. Sprayberry, President
2545 University Place, N. W., Washington, D. C.

Without obligation on my part, please send your Free Book, "YOUR FUTURE IN RADIO," and other details of famous Sprayberry Training.

Name RC 2-37
Address
PASTE COUPON ON PENNY POSTCARD AND MAIL TODAY

RADIOS WHOLESALE!



30 DAYS TRIAL

Tune in on politics, news, music, market and weather reports with a new ZEPHYR WORLD-WIDE RADIO. All the latest improvements. MONEY-BACK GUARANTEE, one year FREE service.

All electric, farm, battery and auto radios, buy direct and SAVE UP TO 50%. Ask about our User-Agent Plan EARN EXTRA MONEY, be a ZEPHYR salesman.

Write for FREE Illustrated Catalogue

ZEPHYR RADIO CO.

13141 Hamilton Ave., Detroit, Michigan.

New AC-DC AMPERITE WITH STARTING RESISTOR! Prevents Untimely Burnouts



WRITE FOR CHART CV5

When your set is turned on, the patented Automatic Starting Resistor allows only 75 volts to pass through. . . Then it increases the voltage to normal as the tubes warm up, thus preventing sudden overloading and burnouts.

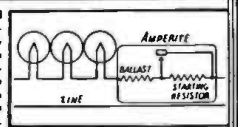

Only 3 types of AC-DC AMPERITE are required to replace any of the 60 types of AC-DC ballast tubes. NEW LOW PRICE: List \$1.25 (Also new low price on replacements for 2-Volt Battery Sets, List \$1.25.)

AMPERITE Company 561 BROADWAY NEW YORK

Please Say That You Saw It in RADIO-CRAFT

NEWLY IMPROVED! **Model T-37 SIGNAL GENERATOR**

- Accuracy $\frac{1}{2}$ of 1% on I.F. Bands. 1% on Broadcast Band. 2% on S.W. Bands.
- We are now using a new hair-line pointer which enables reading to within 1/10 of 1%.
- Nearly one thousand satisfied owners, since its introduction less than a year ago.



Complete . . . only \$12⁴⁰

- 110 Volts A.C. or D.C.
- 100 kc.—22 megacycles all on fundamentals.
- Dial is direct reading in frequencies.
- R.F. output may be taken from a high impedance or a low impedance post, in with attenuation present for either.
- Separate audio output at 2 amplitude levels, so that one may be used for checking public address systems, audio amplifiers in receivers, and speech amplifiers in transmitters.
- Two extra posts on front panel enable leakage tests. Condensers may be checked for leakage, so may tubes, and other normally high resistance currents, otherwise difficult to test.

Model T-37 All-Wave Signal Generator, wired, in shielded cabinet with carrying handle and calibrated, tested; complete with 2 Tubes & Neon Tube. \$12.40 instructions (shipping weight 7 lbs.)

SUPERIOR INSTRUMENTS COMPANY,
136 LIBERTY STREET
NEW YORK, N. Y., Dept. T.-A.



Your Pick!



★ **AEROVOX** Type GLS metal-can electrolytics. 1" dia. Half usual height. 250 and 450 v. D.C. working. 4 to 16 mfd. Just the thing for dependable service in tight places.

★ **AEROVOX** Type PBS cardboard-case electrolytics. Inexpensive. Compact. Handy mounting flanges. 2 to 12 mfd. Also dual and triple units. Ideal all-purpose space-saver units.

New CATALOG More pages. More items. More choice. Popular prices. Ask your jobber for copy, or write us direct.



OXFORD
NEW SPEAKERS

... with "Changeable Fields" and Universal Transformer, bring you new convenience, performance and economy in Speaker Replacements. Ask your Jobber or Write today for Bulletin 361C.

OXFORD-TARTAK RADIO CORP.
915 W. VAN BUREN ST. CHICAGO U.S.A.

YOU CAN SELL
Motion Picture Equipment

Here's a brand new field for radio men. Take orders for our complete line of 16mm. and 35mm. motion picture equipment for theatres, institutions, clubs and home use. Tremendous field, liberal profits. Write fully, giving experience, territory desired, business references.

S. O. S. CORP. 1600 RA-BROADWAY
NEW YORK, N. Y.

is reduced to that point where the amplification of V4 is of such value that the D.C. component of rectified noise voltages of certain strength will effectively block its action for the instantaneous period of time during which the noise impulse is being received.

(Since the construction of the laboratory model and the drawing of the circuit used, a new tube has been released—the 1F6. This tube is a dual diode-pentode and used instead of the 1B5 as noise-amplifier-rectifier will no doubt increase the noise amplification for circuit 2A while at the same time permitting full and efficient operation without feedback and oscillation. The usual precautions to insure against possible instability must be taken however, with plate and screen-grid supply decoupling and bypassing recommended.)

CONSTRUCTION

In the Radio-Craft "Country Gentleman" receiver, the R.F.—Mixer coil assembly is mounted beneath the chassis, both because the functional layout of parts made room for installation in this manner and because such an arrangement permitted really short R.F. leads.

The first job is to mount all sockets, small parts, and the two audio transformers. Refer to photographic illustrations for proper placement. Transformers I.F.T.-1 and I.F.T.-2 may now be mounted, then I.F.T.-4 and I.F.T.-5 after these last two components have been removed from their shield cans, the windings pushed fairly close together for broad-band service, and the cans put in place again. Transformer I.F.T.-3 must first be removed from its shield before installation, and the center-tap between the two secondary coils (which are placed one on each side of the primary winding) broken. The lead from one coil remains tied to the terminal to which the center-tap or junction was originally wired, the free lead being brought out through the top of the can. This unit having been replaced in its can and installed on the chassis, we now turn our attention to the R.F. assembly.

This assembly, is provided with a mounting plate designed to permit upright installation above the chassis, and in an oblong cutout. The plate has holes at intervals along its length on both sides, and $\frac{1}{2}$ -in. right-angle brackets should be bolted to the plate at these holes. The unit is now installed beneath the chassis by bolting the angles to the chassis itself—rigidly and securely. (Remember that all variable controls should be first installed and that the coil assembly must be set back sufficiently far to permit wiring to the controls without danger of electrical contact with the assembly shield cans.) A brass coupling and an extension shaft will be necessary to permit knob control of the band-selector switch, which is integral with the coil assembly.

ADJUSTMENT

Align the I.F. and noise-amplifier circuits to 456 kc. "on the nose." Test both circuits for oscillation. If, in turning-on the noise amplifier, the set output drops appreciably the suppression action is working. That is, V4 is

getting a D.C. negative voltage on Nos. 1 and 2 grids. Remove the grid cap from V8. If the noise amplifier is not oscillating, the output will immediately rise to normal (we are presuming a generated I.F. signal impressed on the first I.F. grid circuit). If there is no rise to normal, the noise amplifier circuit is oscillating and this condition must be remedied.

Now align the R.F. end. Each coil is bridged by a trimmer condenser which should be adjusted for proper tracking with associated coils at both high-and-low and then middle-range frequency settings.

With the R.F. end aligned and the set performing efficiently, turn on the noise amplifier again. Adjust the amplification of V4 so that noises of a selected level will be suppressed—which presumes cutoff for V4 when the D.C. noise voltage fed to the Nos. 1 and 2 grids reaches a high enough value.

LIST OF PARTS

- One Meissner all-wave assembly, No. 5780, L1, L2, L3;
- Two Meissner ferrocarril I.F. transformers, No. 5740, I.F.T.1, I.F.T.2;
- One Meissner I.F. transformer, No. 5714, I.F.T.4;
- One Meissner I.F. transformer, No. 3736, I.F.T.5;
- One Meissner I.F. transformer, No. 6762, I.F.T.3;
- *One output transformer, No. 3302, T2;
- *One input transformer, No. 4401, T1;
- *One micromaster dial, type 318;
- *One 3-gang variable condenser, 370, 405, or 420 mmf. max. capacity each section, close right, $\frac{1}{4}$ -in. shaft, No. 819, C1, C2, C3;
- One Aerovox mica condenser, 50 mmf., No. 1468, C21;
- Two Aerovox mica condensers, 250 mmf., No. 1468, C15, C16;
- Two Aerovox mica condensers, 100 mmf., No. 1468, C10, C20;
- Seven Aerovox condensers, 0.05-mf., 200 V., type 284, C4, C5, C9, C12, C17, C18, C14;
- Two Aerovox condensers, 0.25-mf., 200 V., type 284, C6, C19;
- One Aerovox condenser, 0.01-mf., 200 V., type 284, C22;
- Four Aerovox condensers, 0.1-mf., 200 V., type 284, C7, C8, C11, C13;
- One Electrad potentiometer with switch, 0.25-meg., log, taper, type 208, R15;
- One Electrad potentiometer with switch, 1 meg., log, taper, type 206, R17;
- One Electrad potentiometer less switch, 0.5-meg., log, taper, type 208, R9;
- Fourteen Continental carbon insulated resistors, $\frac{1}{2}$ -W. rating, in quantities and values of:
 - Four 0.1-meg., R1, R3, R5, R14;
 - Two 0.25-meg., R7, R8;
 - Three 50,000 ohms, R11, R13, R16;
 - Two 0.5-meg., R10, R11;
 - Three 1,500 ohms, R2, R4, R6;
- One Electrad resistor for filament drop at selected "A" voltage, type A;
- *One D.P.D.T. switch, senior type;
- *Four round knobs, type 586;
- *One pointer-knob, type 588;
- *One electrolytic or steel chassis, closed ends, 10 x 15 x 3 ins.;
- Two R.F. chokes, operating frequency 456 kc.;
- *Eight tube shields;
- *One brass coupling;
- *One universal socket;
- *One 6-prong male chassis receptacle;
- *One 6-prong female plug;
- *One 4-, 5-, or 6-prong male plug;
- *One 3-post antenna assembly;
- *One 2-post output assembly;
- *One 4-prong isolantite socket;
- *One 6-prong isolantite socket;
- Four 6-prong laminated sockets;
- Three 4-prong laminated sockets;
- Five feet 6-wire shielded cable;
- Fifty feet pushback hooking wire, No. 18;
- Four feet low-capacity shielding;
- *One permanent-magnet dynamic speaker, type 10-10;
- *Four layerbilt batteries, type 486;
- *One "C" battery, type 768;
- *One "C" battery, type 771;
- *Twelve cells, 1.5 V., No. 7111;
- One National Union tube, type 19;
- One National Union tube, type 80;
- Two National Union tubes, types 1C6 or 1A6;
- One National Union tube, type 82;
- Two National Union tubes, type 1A4;
- Two National Union tubes, type 1B5 (optional one 1F6).

*Names of manufacturers will be supplied upon receipt of a stamped and self-addressed envelope.

Please Say That You Saw It in RADIO-CRAFT

HOW TO ADD "VARIABLE-SELECTIVITY" TO SUPERHETS.

(Continued from page 471)

we consider that for really satisfactory reception of weak distant stations, the selectivity should be better than 10 kc., and for true high-fidelity reception, the selectivity should be no less than 15 kc.; 17 kc. is a better value. Of course, commercial receivers are now available which permit a variable-band width of from 8 kc. to 17 kc. or more, but the means they employ to achieve these results are not easily procurable, and cannot be just added to any set.

There is, however, now available a new I.F. transformer to fit any superheterodyne, which, by a simple electrical method, permits either normal selectivity or broad, as desired. There have been transformers available for some time which employ mechanical means to vary the I.F. coupling for increasing or decreasing the band width, but the mechanical adjustments necessary make it impractical to attempt to add them to existing receivers. With the new transformer the coupling is varied for either "broad" or "sharp" tuning by a very simple arrangement, which permits the use of the transformer in almost any existing superheterodyne having 175 kc. or 456 kc. I.F. stages. Two may be used in sets having two I.F. stages; only 1 is required in single I.F. stage receivers. The only equipment necessary for changing the band width is a single-pole, double-throw switch for each variable transformer used; a 2-gang switch for 2 units, or a single switch for 1 unit. The transformers are available with the new iron cores, for higher gain and selectivity (in the "sharp" position), or with ordinary air cores, for replacing the usual run of I.F. transformers.

By using these transformers, the listener has available the extreme selectivity of which his set is capable, or a broad-band width for the reception of full high-fidelity band-widths, by merely flipping a switch.

In the "broad" position the band width passed by the I.F. section will be approximately double that of the receiver under normal conditions. In other words, if the normal selectivity of your receiver is 10 kc., the I.F. stage will then pass a 20 kc. band; thus the selectivity is adequate to separate local stations, and will permit of the full reception and passage of even the highest of audio frequencies of which the broadcast station is capable of transmitting.

Installation is simple and easy; a glance at the diagram will show that only the simple switching arrangement is necessary to adapt it to your own receiver.

If the leads from the transformer to the band-width switch must be more than 2 ins. in length, they should be twisted together, to prevent feedback effects.

This article has been prepared from data supplied by courtesy of Allied Radio Corporation.

HOW TO MAKE THE RADIO-CRAFT—1937 TELEVISION RECEIVER

(Continued from page 467)

tween the variable resistor and the connection to the cathode and cathode bypass condenser. A resistance of about 200 ohms will usually be ample.

In the alignment of the amplifier, we have explained how a "listening" adjustment can be made—in doing so, we have assumed that the builder does not have a calibrated oscillator available which tunes to the high frequencies being used for these television transmissions. If such an oscillator is obtainable, the alignment, using either an output meter or even better an oscilloscope and wobbler, will be much easier and a more precise job can be done.

The listener will be delighted with the quality of the musical background and musical selections which are received on the sound channel of the set. This is not entirely due to the set, since the actual transmissions are really "high fidelity" from the transmitter.

In the next part of this constructional series, the cathode-ray tube equipment and sweep circuits will be considered.

LET NATIONAL UNION EQUIP YOU FOR 1937's SERVICE PROFITS

The well equipped Radio Service Expert will cash in most on 1937's business! FREE EQUIPMENT!

TIME PAYMENTS ON DEPOSITS
 N.U. has made arrangement with Clough-Brengle and the Supreme Instruments Corporation so that the initial deposit on the new 1937 models made by these great equipment manufacturers can be financed. Remember, initial deposits are refunded when tube purchases are completed. Get complete details from your distributor.

INSTRUMENTS MADE BY THESE MANUFACTURERS
 Study the catalogs and advertisements of leading service equipment manufacturers listed below, select the instruments you want—then find out how you can get them FREE the easy National Union way!
CLOUGH-BREngle
SUPREME INSTRUMENTS CORPORATION
TRIPLETT
RANGER
HICKOK
WEBSTER-CHICAGO
J.F.D.
PRECISION
COMMUNICATION INSTRUMENTS INC.
RADIO CITY PRODUCTS
ALLEN B. DUMONT LABS.

In addition to instruments, you can get Shop Coats, Radio Tube Carrying Cases, Multi Drawer Steel Cabinets for small parts storage, etc. Be sure to find out how!

About National Union Radio Tubes



National Union manufactures a complete line of radio tubes in glass, metal and G-type. National Union's high quality has made them the outstanding favorite in the radio service profession. All sales policies have been formulated with the idea of making National Union radio tubes the ideal replacement tube for the radio dealer. This has been backed up with a selling program that means real support and help to the wide-awake dealer. Dealers and jobbers handling National Union radio tubes are the leaders in repair parts and service.

No need for the alert and aggressive service expert to read about all the fine scientific instruments which service equipment manufacturers are making and wish that he might own them. Why? *He can own them!* How? *By getting them Free* with the purchase of National Union radio tubes.

This means that you and every other service specialist who hopes to capture a big share of the profit to be made in the service business in 1937 can equip yourselves with the meters, testers and analyzers so necessary in modern radio servicing.

National Union has given servicemen throughout the United States more than 50,000 pieces of fine equipment. If you're not taking advantage of National Union's service dealer plan, you're missing the greatest opportunity in the radio industry today.

All you do is contract to purchase a few tubes per week, place a small deposit, which is refunded to you after the tube purchase is completed and the instrument you have selected is yours "for keeps," without any strings attached. Meanwhile, remember that you have the use of the instrument all during the time tube purchases are being made.

Make 1937 your biggest profit year by tying up with the National Union Selling Program. Talk it over with your distributor or send the coupon below for complete details.

---Clip . . . Mail—Now!---

NATIONAL UNION RADIO CORP., RC-237
570 Lexington Ave., New York City

Rush free circular telling how to get instruments the easy N.U. Way.

Name

Street

City State.....

To Readers of RADIO-CRAFT
FREE POSTCARDS MAY BE HAD UPON WRITING TO THE PUBLISHERS

These postcards make it easy to answer advertisements which appear in RADIO-CRAFT, without cutting valuable data which you may wish to save.

Many times manufacturers request you to "clip the coupon" when answering their ads. Often this means destroying part of an article on the reverse page you may need later for reference. Save your RADIO-CRAFT issues complete. If you should ever want to sell bound volumes, or certain copies of RADIO-CRAFT, the resale value of uncut issues is very much higher than that of mutilated ones. So send for a supply of these free post cards and use them in answering all RADIO-CRAFT advertisers.

New 

Molded Bakelite . . .
"DOMINO"
 paper condensers

Small, flat, easy to use, better in appearance! Heat- and moisture-resistant! Wide range of capacities! Permanent capacity! Full voltage protection! 10 in standard carton . . . COMPARE!

SOLAR MFG. CORP.
 559-601 Broadway, New York City.

Please Say That You Saw It in RADIO-CRAFT

Now—a high-powered—



Radio Engineering Library

New
The Library now comprises a revised selection of books culled from latest McGraw-Hill publications in the radio field.

—especially selected by radio specialists of McGraw-Hill publications
—to give most complete, dependable coverage of facts needed by all whose fields are grounded on radio fundamentals
—available at a special price and terms.

These books cover circuit phenomena, tube theory, networks, measurements, and other subjects—five specialized treatments of all fields of practical design and application. They are books of recognized position in the literature—books you will refer to and be referred to often. If you are practical designer, researcher or engineer in any field based on radio, you want these books for the help they give in hundreds of problems throughout the whole field of radio engineering.

5 volumes, 3064 pages, 2000 illustrations

1. Glasgow's PRINCIPLES OF RADIO ENGINEERING
2. Hund's PHENOMENA IN HIGH-FREQUENCY SYSTEMS
3. Chaffee's THEORY OF THERMIONIC VACUUM TUBES
4. Terman's MEASUREMENTS IN RADIO ENGINEERING
5. Henney's RADIO ENGINEERING HANDBOOK

10 days' examination. Special Price. Monthly Payments. \$25.00 worth of books cost you only \$23.50 under this offer. Add these standard works to your library now; pay small monthly installments, while you use the books.

SEND THIS ON-APPROVAL COUPON

McGraw-Hill Book Co., Inc.
330 W. 42nd St., New York, N. Y.

Send me Radio Engineering Library, 5 vols., for 10 days' examination on approval. In 10 days I will send \$23.50, plus few cents postage, and \$3.00 monthly till \$33.50 is paid, or return books postpaid. (We pay postage on orders accompanied by remittance of first installment.)

Name
Address
City and State
Position
Company RC-2-37

MILLION TUBE TESTER ANALYSER



1. All Emission
2. Shorts Hot
3. Leaks Hot
4. 0-5M Ohms
5. 0-3 Megohms
6. .01 to 3 M.F.
7. 0-10-50-500 V. D. C. 1000 ohms per volt
8. Electrolytics

MODEL TA

26.95
NET

MORE TESTS, MORE SPEED, MORE PROFITS is what service men say of MILLION test equipment. If your jobber cannot supply you—order direct—20% deposit required on C. O. D. orders. Tear out this ad and send it to us NOW for complete information on the entire MILLION line.

MILLION RADIO AND TELEVISION LABORATORIES
361 W. SUPERIOR ST., CHICAGO, ILL.

NEW GUIDE NOW READY!

Most complete volume control facts ever assembled in one book. Free with top (showing spec. number) of one Electrad volume control carton.

Writes Dept. RC-2
175 Varick St., New York, N. Y.

ELECTRAD

THE DYNAMIC LOUDSPEAKER "GOES HEADPHONE"

(Continued from page 464)

justed for moderate sensitivity (diaphragm close to pole-piece). Although blessed with an excellent frequency-response characteristic, "crystal" (or, more correctly, piezoelectric) headphones, too, share with "magnetic" phones a low overload factor. The "dynamic" (or, more correctly, magnetodynamic) phones, on the other hand, have the following advantages: (1) high-fidelity response; (2) high sensitivity; and, (3) high overload factor.

There are a great many elements that enter into a complete discussion of the topic of relative headphone efficiencies; therefore, it would not be fair to consider as dogmatic any of the statements made above. Each type of headphone is, in some degree, desirable. For this reason we will skip the remaining details and review in the foregoing words only the topics embraced in Figs. 1 and 2.

In Fig. 1 we see the frequency-response characteristic of the 3 types of headphones—magnetic, crystal and dynamic—mentioned in this article. No attempt has been made to plot these graphs on a quantitative scale.

In general, though, it may be mentioned that the figure for magnetic-type headphones takes as standard the Western Electric magnetic unit; its response over the range indicated is said to be "± 2 db. at +60 db. above 1 bar per watt." (The range of 300 to 2,000 cycles for a representative magnetic unit may be considered inaccurate but when it is recalled this is practically distortionless response the official figure quoted may be taken as accurate.) The new dynamic unit varies about 2½ db.± at about 62.5 db., it is believed.

Note that the response of the dynamic type is secured at very low values of impedance. This makes it quite convenient to work one earphone into the other, in transducer fashion, as optional microphone and reproducer, as shown in heading illustration Fig. A, and sketch Fig. 2. The latter figure also presents a qualitative method of illustrating the amazing overall efficiency of the new dynamic headphones.

In Fig. 2 is shown, at A, the manner in which the headphones are matched into an audio circuit. Matching transformer T, has a high-impedance primary that connects to the audio equipment; the secondary of this transformer has an impedance sufficiently low to match into the voice-

coils of the dynamic headphones. (The equivalent electrical circuit is shown, detailed, at 2C.) In practice, a jack-and-plug arrangement is usually used, as shown. By shorting this plug, as shown at 2B, and talking into earphone No. 1 or No. 2, the voice will be heard clearly reproduced in the remaining earphone; and far louder than if this same "stunt" is attempted with a pair of magnetic-type headphones. The low impedance of the voice-coil circuit permits distance x between the two phones to be increased to over 1,000 ft. without undue attenuation or noise pick-up.

These headphones, be it noted in passing, introduce to technicians what is probably a new idea in achieving mechanical convenience. Referring to Fig. C it will be seen that the molded case being held in the hand is recessed to accommodate the iron yoke; and is provided with 2 springs that make contact with studs on the actual unit. This scheme enables units to be interchanged in the cases "quick as a wink"; and if the contact system is properly designed, as in the ones examined by Radio-Craft, the assembly will be noise-free. Another point of interest is that a sponge-rubber ring is recessed into the outside of the case and acts as an ear cushion.

In concluding this article the writer wishes to emphasize that the new "dynamic" headphones (actually, any headphone which is operating is "dynamic"; and ceases to be so only when it is no longer being energized, whereupon, it becomes "static" or inoperative) described in this article are a high-grade product, built to a quality and not a price standard.

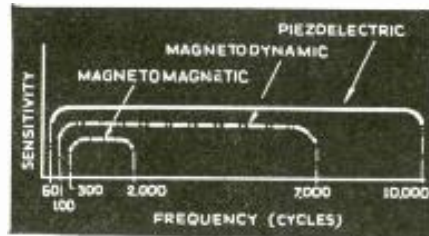

Fig. 1. Comparison of three types of phones.

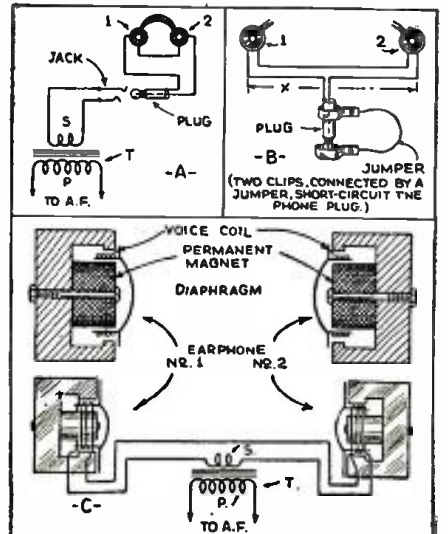

Fig. 2. Detail circuits mentioned in the text.

NOVEL IDEAS IN RADIO SETS

(Continued from page 457)

"Clockette" Receiver

in almost any home. These finishes are: model "Modern," type 21 chassis—figured and straight-grain walnut, gold-color dial and ebony-finish cradle; model "Colonial," type 22 chassis—solid maple top and sides with quartered, matched-figure maple front and brushed-gold dial; and, (illustrated), model "Sheraton," type 23 chassis—matched-grain, polished-mahogany veneer with golden dial.

The mounting arrangement that permits the

pointer to pivot in the center of the reproducer grille is illustrated in Fig. B.

(Service data. A 220-V. adapter is available. Voltages: Plate, V1, 100 V.; V2, 20 V.; V3, 92 V.; V4, 115 V. A. C. Cathode, V1, 4 V.; V2, 2 V.*; V3, 0; V4, 100 V. Screen-grid, V1, 100 V.; V2, 5 V.; V3, 100 V.; V4, —. Suppressor-grid, V1, 4 V.; V2, 2V.*; V3, V4, —. Use 1,000-ohms-per-volt meter, on 250-V. scale (except*); * on 50-V. scale. Aligning frequencies: 1,500 kc., 1,000 kc. and 600 kc. (in this order).

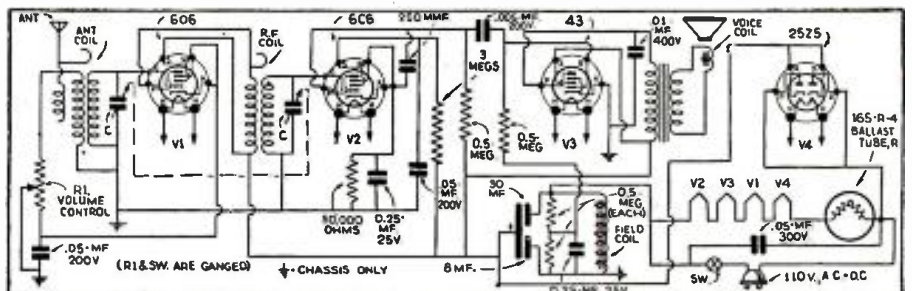

Fig. 1. The schematic circuit of the "Clockette" receiver—a T.R.F. set.

Please Say That You Saw It in RADIO-CRAFT

MAKE THIS MIDGET SERVICING OSCILLOSCOPE

(Continued from page 470)

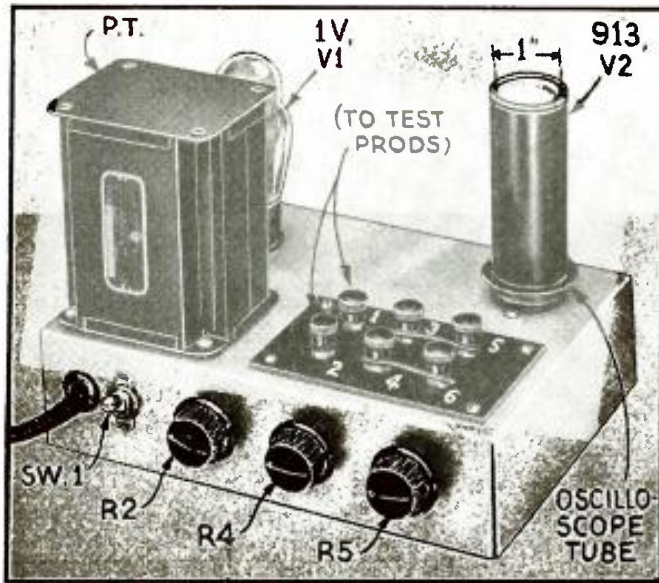

Fig. C. The chassis in its completed form, showing positions of controls.

number. Two of these are for the vertical deflector plates; two for the horizontal plates; and the remaining pair is for the 60-cycle sweep voltage delivered by the power transformer specified.

Ordinarily, the horizontal deflector plates are connected to this sweep supply by the use of shorting wires on the terminal block.

In making the unit, special care should be taken to insulate all leads carefully and, as mentioned before, to keep the leads to the free sides of the deflector plates clear of all other wires.

An examination of the circuit diagram, Fig. 1, shows that, in common with other oscilloscopes, the positive side of the power supply is grounded to the chassis and the negative end is left floating. This places the deflector plates at chassis potential, so that shocks and short-circuits across the C.R. "B" supply will not be encountered.

The List of Parts at the end of this article shows the required items needed for the construction of the unit. These should be adhered to carefully, to avoid "bugs" in the operation of the instrument.

OPERATION

In operating the instrument, the switch Sw. 1 should be turned on with R2, R4 and R5 in their minimum positions. Then, the focusing control should be moved about 1/3 toward the maximum position, after waiting a few minutes for the tube to heat up. Next, the intensity control R2 should be advanced until a spot of green light appears on the screen. Then the sweep-amplitude control, R5, should be advanced until the horizontal line of light just covers the width of the screen.

Now, to try the unit, the terminals 1 and 2 can be connected to the output of a radio set, across the voice coil or across the primary of the output transformer. The wave-form of the signals received, swept by the 60-cycle potential, will then be seen.

Terminals 1 and 2 can then be used for connecting any A.C. potential to the unit.

The oscilloscope, using the 60-cycle sweep, can be used for frequency measurements and measurements of distortion, amplitude, etc., in A.F. amplifiers and the audio section of radio receivers, or any frequency not exceeding several thousand cycles per second.

The unit can be used for voltage measurements of either A.C. or D.C. Since the tube with 280 volts on anode 2 has a sensitivity of 125 volts per inch, the fluorescent end of the tube can be marked off with a cellophane or other transparent scale calibrated in volts. A few standard voltages from batteries and A.C. from transformers which are checked with an A.C. voltmeter will provide the necessary calibrations for the scale. The actual sensitivity of the tube depends on the voltage supplied to the plates; therefore calibra-

tion will have to be made on the individual instrument against standards. The A.C. voltage measurements made on the oscilloscope are r.m.s. (root mean square) values.

The oscilloscope can be used to measure the voltages in a set which cannot be measured with ordinary meters. Such values as cathode voltage (grid bias) and detector plate voltage which are ordinarily incorrect as measured on a D.C. voltmeter can be measured accurately with the oscilloscope since it draws a negligible current from the source. (In other words, as a voltmeter the instrument has a very high power sensitivity.)

In the alignment of receivers, without the addition of a neon or thyratron saw-tooth oscillator and a wobbler, the unit can be used as an output meter, measuring the output voltage, so that peak alignment of R.F. and I.F. trimmers can be seen visually and with greater accuracy than with other output meters.

The Service Man who makes this instrument either as described or with the added refinements of saw-tooth oscillator and amplifiers will find it a useful and rugged unit which will have many useful applications in his work.

LIST OF PARTS

- One Kenyon power transformer, type T-207, P.T.;
- *One 1 W. resistor, 0.8-meg., R1;
- *One resistor, 1 W., 10,000 ohms, R3;
- *Two resistors, 1 W., 10 meg. R6, R7;
- Two Electrad potentiometers, 0.5-meg., R2, R5;
- One Electrovar potentiometer, 0.2-meg., R4;
- One Aerovox condenser, 0.2-mf., 600 V., C1;
- One Hammarlund isolantite octal socket;
- One 4-prong socket;
- *One chassis, 1/8-in., stock, per dimensions in Fig. 2;
- One RCA Radiotron type 913 tube, V2;
- One RCA Radiotron type 1V tube, VI;
- Six binding posts, 1 to 6;
- One single-pole, double-throw switch, Sw. 2;
- One single-pole, double-throw switch, Sw. 2;
- As needed, wire, screws, etc.

*The names of manufacturers will be supplied upon receipt of a stamped and self-addressed envelope.

A NEW TRANSFORMER CATALOG

One of the foremost manufacturers of transformers for radio and P.A. applications has recently made available to the radio industry a new catalog listing their complete line of units for all applications.

The booklet, in addition to the listing of transformers, contains some very useful and interesting data on the construction of amplifiers for different services. All P.A. and radio Service Men will find much useful information in this complete catalog and data booklet.

Send a card, now, to Radio-Craft for your copy—ask for booklet No. 1287.

CONCERNING "GRIDLESS TUBES"

The author of the article "Gridless vs. Grid Tubes" in the January 1937 issue has received many inquiries as to where these tubes can be obtained. They are not yet available commercially. The experimental models were made for the author by the Allen B. Dumont Labs.

Please Say That You Saw It in RADIO-CRAFT

Learn RADIO from REAL RADIO ENGINEERS!



Kendall Clough
Chief Engineer,
Clough-Branzco Co.
E. E. Gramer
Chief Engineer,
Standard Tr'of'r Co.
Earl E. Hasset
Chief Engineer,
Zenith Radio Corp.
F. H. Schneit
Radio Engineer
Grunow Radio
Dr. C. M. Blackburn
P. R. Mallory & Co.

Train Now at Home for Good Pay Spare-Time and Full-Time Jobs that Pay Up to

\$75 a Week

If you're dissatisfied with small pay—and an uncertain future—here's an opportunity that's too good to miss. Get my big brand new FREE book, "RADIO'S FUTURE AND YOUR OPPORTUNITY." This book tells how you can learn at home under the supervision of factory engineers, to make more money almost at once in Radio—how to make Radio your life's work, or use it to pick up \$5 to \$20 a week extra in your spare time.

MORE OPPORTUNITIES THAN EVER BEFORE

Radio is still forging ahead. 1936 beats all other years. Over 6 million new sets sold. Over 30 million dollars paid for service alone this year. Where only a few hundred men were employed a short time ago, thousands are employed today. And where a hundred jobs paid up to \$75 a week—there are thousands of such jobs today—many paying even more. New full time jobs and spare time jobs are being created all the time. Get my book and see how easy you can get started.

"SHOP TRAINING" FOR THE HOME

R-T-I Training is different. It comes to you right from the heart of the Radio Industry—right out of the factories where Radio sets and other vacuum-tube devices are made. It was planned and prepared and is supervised by big radio engineers IN these factories—by men appointed for the purpose. R-T-I will train you as the Radio Industry wants you trained.

TELEVISION, PHOTO ELECTRIC CELLS, PUBLIC ADDRESS SYSTEMS INCLUDED

Radio service work is plentiful but it's only the starting point in R-T-I Training. From there you'll go through the whole field of Radio and Electronics. You will learn about every new development, including Television so you'll be ready when Television breaks.

MAKES \$600 IN ONE MONTH
Herbert B. Thomson, Gorman, Texas, started making money with 12 lessons, finished. He says, "Because of my R-T-I Training I made \$450 in September and over \$600 in October 1935. It pays to be R-T-I Trained."

BIG MONEY IN AUTO AND POLICE RADIO WORK

W. H. Carr, 402 N. 16th St., Kansas City, Kans., R-T-I student, has charge of 35 radio equipped Police and fire Department cars. He gets \$230.00 a month and free auto. gas, oil, etc. He says, "If I had not taken your course I would not be able to hold this job."

4 WORKING OUTFITS FURNISHED

Start almost at once doing part time radio work. I furnish 4 outfits of apparatus that you build into test equipment with which you can do actual jobs and earn extra money. My Training Pays its own way and you get your money back if not satisfied. Age or lack of experience is no handicap.

FREE BOOK

Find out why R-T-I Trained men get "Quick Results" and "Big Results." Send for "Radio's Future and Your Opportunity" today. It tells about Radio's amazing opportunities. It describes my approved training, what R-T-I students are doing and making. It gives the names of 50 firms who endorse and recommend R-T-I. It's FREE.

RAY D. SMITH,
President

RADIO AND TELEVISION INSTITUTE
Dept. 222
2150 Lawrence Ave.
Chicago



MAIL COUPON FOR FREE BOOK

RAY D. SMITH, President
Radio and Television Institute (R-T-I)
2150 Lawrence Ave., Dept. 222, Chicago, Ill.

Without obligating me, send new FREE Book about spare-time and full-time Radio opportunities and how I can train for them at home.

Name

Address

City State

MIXER CIRCUITS YOU SHOULD KNOW

(Continued from page 471)

we do this. But a system was worked out, some years ago, rather successfully when receiving sets were of less power, to apply the pickup to an oscillating R.F. tube, and pass a modulated wave through the whole set, like a station signal.

We do not, however, need a phonograph or a microphone. We may, instead, introduce into the circuit a resistor R_g with a condenser across it (Fig. 1D); so proportioning the values that the condenser will continually charge up, and discharge through the resistor. A given pair of values corresponds to a given frequency; as with a condenser-coil combination, the time lengthens with the increased capacity and increased resistance. (There is an effect of this kind in every gridleak detector circuit; but the value of the usual grid condenser is too low to allow the note thus created to disturb the ear of the listener, or to check oscillation, in a tube provided for that purpose.)

However, in a circuit of the voltage-modulated type, just discussed, the audio modulation of the control-grid voltage changes the bias on the control-grid too much, for good modulation. So, like the transmitting amateurs before him, the Service Man looks for a combination which will maintain the signal at the proper oscillation frequency, yet give a good, pure audio note.

The Heising Circuit. We find, for instance, the Heising circuit (Fig. 1E) in which there is a split tuning coil, as in Fig. 1B; but, attached to the plate of oscillator tube V1 is a source of A.F. variations, in the form of modulator tube V2. The high-impedance choke, L, keeps a fairly constant D.C. plate voltage on both tubes. The resistor, R1, lowering the voltage on the plate of the oscillator, makes the ratio of V2's output to V1's, and thereby the percentage of modulation higher; an important matter in broadcasting, as well as in testing. This circuit, therefore, is much in favor in test apparatus.

However, these methods require changes in the D.C. voltages applied directly to the grids and the plates of the oscillator tube, and these tend to change the frequency and create instability of operation. But, with the introduction of the modern multi-element tubes, it became possible to apply the modulating voltage to other elements, located between cathode and plate, and thereby alter the flow of electrons inside the tube, with the minimum of disturbance to the regularity of R.F. oscillation.

Electron Modulation. The basic method is shown in Fig. 1F; the audio modulation may be obtained from a tube circuit oscillating at audio frequency (by the use of a circuit of suitable resistance-capacity values) or from any other desired source. The plate and signal-grid circuits of the tube are oscillating at the radio frequency determined by the grid capacity-inductance of the tuned circuit; but the amount of the current flow is varied, without altering the regularity of the oscillations, by the A.F. voltage introduced between the cathode and the second grid to which the input is connected. This form of *electron modulation* is preferred for work of great accuracy.

It is to be explained that, just as a high percentage of modulation is desired in a broadcast station (since it gives more signal in proportion to the power of the station), so it is desirable

in a service oscillator used to adjust a receiver for reception of this type. By 100% modulation (since the modulation is the proportion of A.F. current variation to R.F. current variation in the wave) the audio system and reproducer of a receiver may be fully tested without overloading in the R.F. and I.F. sections. In addition an instrument operated from an A.C. line (Fig. 3) may be used to modulate the output of the oscillator tube at 60 cycles, with a single tube and great simplicity of equipment. (This is a very low frequency for audio aligning work, however). Since the plate is connected, not to a D.C. source, but to one side of the line which varies in potential, half the time it is negative with respect to the cathode, and no current can flow; but, whenever positive, the tube is functioning, and can even oscillate up to its filament-emission limit at radio frequency. At 1,500 kc., for instance, it can be seen that there is time for 12,500 R.F. impulses in the tube during the positive half of each cycle. (Fig. 2C)

For the sake, also, of economy, oscillators are made whose tuned circuits do not cover all bands; these depend on harmonics.

Just as a violin does not give off a pure tone, but with it others of higher pitches (which give

(Continued on page 499)



CORNELL-DUBILIER

In response to repeated requests from Servicemen, has rounded out the C-D line of condensers by the addition of the KR series of etched foil Dry Electrolytics. Hermetically enclosed in inverted round aluminum containers with colored coded wire leads, these new condensers have everything built into them that Servicemen have learned to expect from C-D. In addition, they have been designed with an eye to more symmetrical assembly. KR's are compact—approximately the size of the average metal tube—they make for ease of replacement—they fit into those "hard-to-get-at" spots which present difficulties where larger sizes are used—they make possible a much neater appearing job.

STANDARDIZE ON CORNELL-DUBILIER CONDENSERS

They are Quality condensers.

Complete listing and data available Write for Catalog No. 134A today!

MICA * WET AND DRY ELECTROLYTIC DYKANOL * PAPER

CORNELL-DUBILIER CORPORATION
1014 HAMILTON BLVD., SO. PLAINFIELD, N. J.



POWERTONE

Model 801—Pocket Volt-Ohmmeter

A sensitive, compact and accurate volt-ohmmeter that will be the busiest instrument in your "lab," or out on jobs. DC voltage readings 0-500 and 1000. Resistance readings from 1/2 to 500 and 200 to 500,000 ohms. Will read from 0 to 1 Ma. Low resistance range direct reading. Meter has 1000 ohm per volt sensitivity. Battery is self-contained. Panel is clearly lettered. Compensator provided for zero adjustment. Complete with test probes. Measures only 5"x3 1/4"x 1/2". Your price complete with battery.



\$5.75

Send for complete literature on a variety of test instruments

JOBBERS WRITE IN FOR PROPOSITION

POWERTONE ELECTRIC CORP.

179 Greenwich Street New York City

Distributor
TRY-MO RADIO CO., Inc.

85 Cortlandt St. New York City

RADIO MEN! GRAFOLINE

Insures correct terminal results for all air expressed contacts and screw parts. Ideal for all types of electrical work. Would you like to know more? Easy to apply, insures better wear for parts. Lubricates electrical contacts, screws, nuts, bolts, etc. Full size 1 bottle 3¢. From your Radio Parts Dealer. If you cannot supply—WRITE for free circular complete information. **GENERAL CEMENT MFG. CO., Rockford, Illinois.**



RADIO ENGINEERING

RCA Institutes offer an intensive course of high standard embracing all phases of Radio. Practical training with modern equipment at New York and Chicago schools. Also specialized courses and Home Study Courses under "No obligation" Plan. Catalog Dept. RT-37.

RCA INSTITUTES, Inc.
75 Varick St., New York 1154 Merchandise Mart, Chicago
Recognized Standard in Radio Instruction Since 1909.

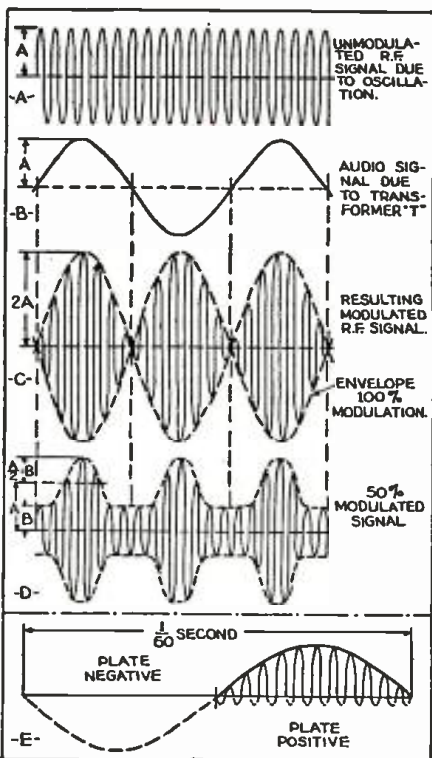

Fig. 2. The modulation of an R.F. current.

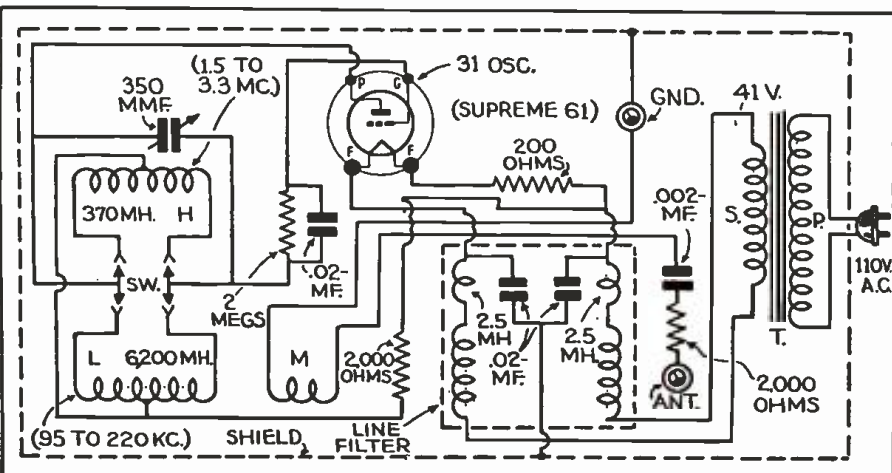

Fig. 3. A typical "A.C. line modulated" R.F. service oscillator.

Please Say That You Saw It in RADIO-CRAFT

A NEW 60-W. BEAM AMPLIFIER

(Continued from page 474)

ished chromium, not only gives it the eye-appeal of expensive custom-built radio sets, but aids it to withstand the abuse of portable usage.

The electrical design also is very flexible. Two or more low-level inputs (such as velocity or crystal microphones, or P.E. cells) may be fed, by means of polarized sockets and plugs, into a zero-center dual-input "volume-control fader"; the available gain is then 125 db. Two similar sockets and plugs feed a similar dual-input volume-control and fader unit for two 85-db. gain inputs, such as phonograph and radio sources. Through these 4 plugs and input sockets or jacks, as many inputs can be handled as the operator can manipulate plugs, or 4 sources may be permanently connected and locked by the screw-lock collars of the plugs.

Outputs are equally universal. The output level may be changed from 60 W. to 30 W. by removing the 3rd and 4th 6L6s and the second 5Z3, all voltage and impedance shifts being automatically made through this operation. Output impedances are: 2, 4, 6, 8, 12 and 16 ohms from one secondary, and 250, 500 or 1,000 ohms from an additional secondary of the output transformer.

One 18-in. 30-W. (continuous load) loudspeaker having about 35 per cent efficiency is supplied with the amplifier, and 1 to 8 more can be connected to it. (Contrast this figure with those of other makes; many of which do not achieve much over 5 per cent efficiency.) Two of these reproducers, taking the full 60-W. output of the amplifier, are capable of "covering" Madison Square Garden, while 4 such units would easily cover Soldiers' Field in Chicago, or the Yale Bowl; or, the amplifier gain may be reduced—until the output is only a few watts—for home use, and deliver high-fidelity output (and with hum level equivalent to that of high-quality home radio sets).

The circuit, Fig. 3, indicates that the two high-gain inputs feed a 6J7 voltage amplifier, which feeds one triode of the 6N7 electronic mixer. The second, or "85 db. input" fader feeds the second triode of the 6N7. This tube, in turn, feeds a 6L7 expander. The volume expansion of which is controlled through potentiometer R3, which regulates the gain of the 6C5 expander amplifier and 6H6 rectifier. The 6L7, with the 6C5 phase inverter, then feeds 2 push-pull (or 4 push-pull-parallel) 6L6s which are operated in a safe and dependable manner, as class AB¹ amplifiers. The net result is 32 or 64 W. of audio power at 2 per cent or less total harmonic distortion; and no hysteretic distortion at all, since all coupling is resistance-capacity, and there are

no audio transformers to add their mite of hysteretic distortion (equivalent to much more than a mite in a good 6L6 system).

A low-pass filter, which in many P.A. installations good engineering dictates is desirable for sharp and definite high-frequency cutoff, is built-in. A 3-section filter precedes the loudspeaker, having a sharp cutoff at 4,000, 6,000, 9,000 or 15,000 cycles, as selected by the "filter knob." (Previously, such a filter alone cost \$25.00!)

In many installations a monitor speaker is not available, nor may the operator always hear the sound output. Here again good engineering dictates a level indicator. A 6G5 cathode-ray indicator "eye" is included, which by a toggle switch can be shifted to indicate visually both the output level and the degree of volume expansion.

Such then, is what can be done in P.A. amplifier design today to secure operation that will precisely suit any special installation requirements. In purchasing a modern amplifier we see, then, that the purchase must be not on a basis of "watts per dollar," but "watts-service per dollar."

This article has been prepared from data supplied by courtesy of McMurdo Silver Corp.

MIXER CIRCUITS YOU SHOULD KNOW

(Continued from page 498)

the instrument timbre, color or quality) called harmonics, so an oscillating circuit, because it is not perfectly simple, has harmonics in its output. These are frequencies which are multiples (and designated by this factor) of the fundamental frequency to which the principal circuit is tuned; and, while they are feeble in comparison with the fundamental, they can be recognized by sensitive apparatus. The 13th harmonic of a long-wave (European) broadcast station has been heard on a short-wave set!

For instance, suppose the fundamental of the oscillator is 150 kc. or 2,000 meters: the harmonics could be recognized at: (2) second-harmonic, 300 kc.; (3) 450 kc.; (4) 600 kc.; (5) 750 kc.; (6) 900 kc.; (7) 1,050 kc.; (8) 1,200 kc.; (9) 1,350 kc.; (10) 1,500 kc.; (11) 1,650 kc.; (12) 1,800 kc.; (13) 1,950 kc.; and so on. The odd harmonics are stronger, proportionately, than the even ones; weakening in strength as the number designating them increases.

In addition to the features of frequency control and modulation, another important factor for the service test oscillator is that of its output control; since it is desirable to test receivers on weak signals, as well as on strong ones, to determine the alignment of circuits and the working of A.V.C., etc. Various forms of attenuator or voltage-divider controls regulate this, in addition to tightening or loosening the coupling between the oscillator and the set being serviced.

In the selection of test apparatus, cost and fineness of performance must be balanced, one against another, as with all other measuring equipment in view of the particular demands of the business.

This article has been prepared from data supplied by courtesy of Radio and Technical Publishing Company.

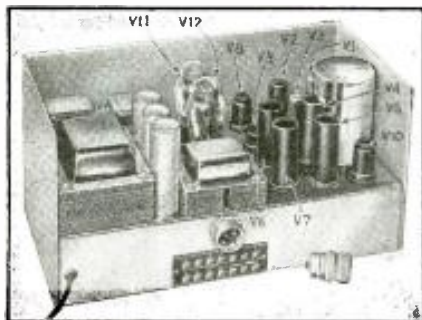

Fig. 8. The compact assembly of components can be seen.

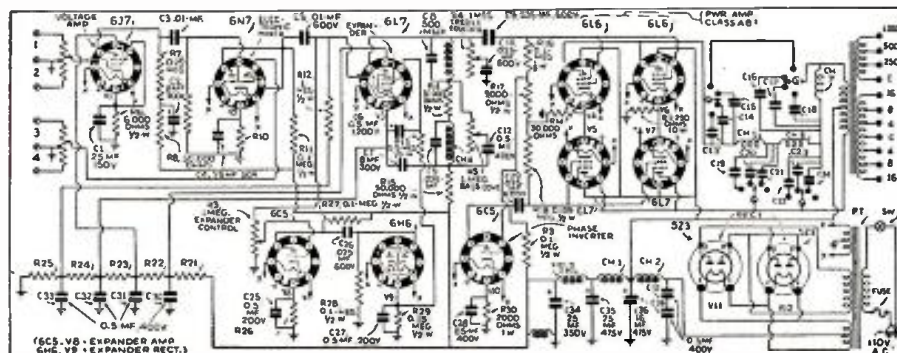
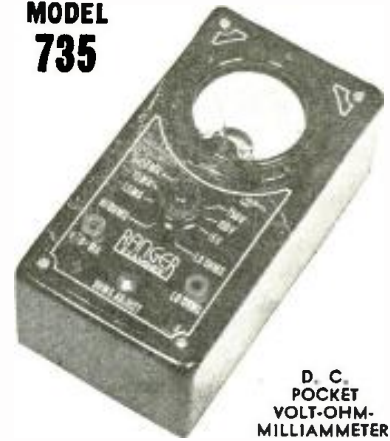

Fig. 3. Circuit of the 60 W. beam-power amplifier described.

MODEL 735



D. C. POCKET VOLT-OHM-MILLIAMMETER

NOW... RADIO SERVICING IS MORE PROFITABLE... EASIER

- Molded Case 3" x 6" x 2" (Approx.)
- Selector Switch for All Ranges
- Battery, Test Leads and Accessories Included
- Accuracy to 2%

Model 735 has a Triplet D'Arsonval type precision instrument with easily readable scales. Ranges are 15-150-750 volts; 1.5-15-150 M.A.; 1/2-1,000 low ohms; 0-100,000 high ohms at 1.5 volts. Provisions for external batteries for higher resistance measurements. Has selector switch for all ranges and individual zero adjustment for resistance measurements.

DEALER PRICE \$10.80



FREE! BOOKLET Lists 101 most frequent radio troubles, how to detect and how to cure. Nothing like it before, greatly simplifies every day servicing. Send Coupon Now.



READRITE METER WORKS
216 College Dr. Bluffton, Ohio

Without obligation please send your Free Booklet, "101" Radio Troubles and Their Cures" with complete Ranger-Examiner catalog.

Name

St. Address

City State

Please Say That You Saw It in RADIO-CRAFT

MAKE THIS GREAT WHOLESALE CATALOG YOUR RADIO H'DQTRS

"HAMS", EXPERIMENTERS SERVICERS, DEALERS

know that when they need parts, tubes, kits, s.w. or all-wave receivers—WHOLESALE SALE is the place to get them and to save money at the same time.

The overwhelming purchasing power of WHOLESALE permits us to sell at the lowest prices quoted! WHOLESALE will not be undersold! Prove this to your own satisfaction by sending for the 1937 Free Radio Catalog. It is crammed with over 10,000 BARGAINS—its 156 pages are teeming with EVERYTHING YOU WILL EVER NEED IN RADIO.

Remember—FIVE conveniently situated branches throughout the country assure you of a SWIFT delivery of your radio needs. TWENTY-FOUR HOUR shipments are a WHOLESALE rule.

FREE 156 PAGE CATALOG

SEND COUPON NOW

WHOLESALE RADIO SERVICE CO. INC.

CHICAGO, ILL. NEW YORK, N.Y. ATLANTA, GA.

WHOLESALE RADIO SERVICE CO., INC.
100 SIXTH AVENUE, NEW YORK, N. Y.

Rush FREE Big Radio Catalog No. 65 B3.

Name

Street

City State



BESIDES the "noise test" that's causing so much comment among the trade and so many sales of tubes to customers—the Duplex Test for Output is another R-T-L feature at the forefront. Provides simultaneous check on both grid control and emission. How? Let us tell you—about both these and other R-T-L features—away ahead of all other testers!

Ask for Folder



Portable Tester. Comparison for tools, tubes and repair parts. Overall size of case, 5" x 12" x 1 7/8".

THE RADIOTECHNIC LABORATORY
1328 Sherman Ave. Evanston, Ill.

A Complete Line of Tube Test (R-T-L) Equipment

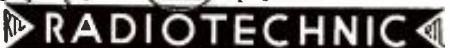

MODERN SHORT-WAVE DIATHERMY

(Continued from page 475)

voltage and average R.F. voltage as even as possible, which can not be done without full-wave rectification and filtering of the A.C. supply. It should be borne in mind that the heating effect of the diathermy machine is dependent solely upon the effective power output of the oscillator.

Circuits lacking proper rectification and filtering are also great interference generators in the radio communications spectrum; while if properly designed this nuisance can be minimized to an extent where there will be no appreciable radio interference.

Proper rectification will also add several hundred hours of working life to the oscillator tubes.

In a circuit of efficient design, tube oscillators will maintain a constant frequency, or wavelength, under any load—a factor of great importance. (Note that, in Fig. 1, Part I, the tank coil is not shunted by a tuning condenser but is resonated only by its natural inductance.)

The V-T. oscillator generates undamped oscillations, the amplitude of which can be completely controlled for highest efficiency. These same oscillations are therefore also produced in the patient's circuit, and have been found most effective in S-W. therapeutic work.

This type of machine is silent in operation, which from the patient's viewpoint, has psychological advantage.

We come now to the spark-gap type of S-W. diathermy machine, which can do everything that the tube type can do. (However, it is the writer's belief that this method does not compare in efficiency with the vacuum-tube oscillator, in any of its uses.)

The spark-gap method can not maintain a constant frequency under load, and never has what can be called a real "dominating" frequency. It has, rather many spurious frequencies, and is a potent offender in radio communications interference. (As a matter of fact, spark-gap transmitters used for radio communication are today banned by the F.C.C. for these very reasons.)

Figures 2 C and D illustrate the difference between the undamped and damped oscillations.

The spark-gap method's only virtue, the writer feels, is its cheapness, and that it is only a question of time when it will be thrown into discard.

After carefully considering all the methods used to produce deep heat by means of S-W. energy, it has been found that all the claims that are made for the veritably magical curative powers of S-W. diathermy treatment are unwarranted. At present a real cure by this means is the ex-

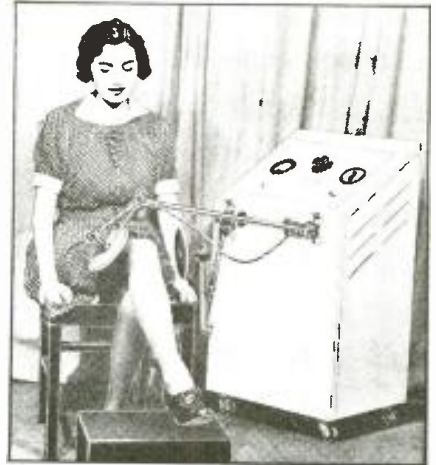

International Electronics, Inc.
Fig. E. A modern 500 W. V.T. type diathermy instrument in operation—it is tuned to 6 meters.

ception, rather than the rule. An exception to this statement, perhaps, is in the treatment of gonorrhoea, where patients have been cured of the symptomatic manifestations. The writer has witnessed much good work being done along these lines at Mt. Sinai Hospital in N. Y. C. Nevertheless, S-W. radio therapy is an effective treatment in the alleviation of pain, which is a principal manifestation of many conditions. It is worthy of note at this time that in regard to gonorrhoea S-W. diathermy acts as a specific (preferred treatment) in removing the etiological agent (the cause) in the disease. At this point we wish to quote an eminent specialist's comment to the writer.

"Too much credence is being given to this relatively new field in electro-therapeutics although there can be no doubt of its potentialities. Further research must be made; which means experiment, time, and patience; for in the practice of medicine, too, there is no royal road to cure."

The next Part of this article will include a complete treatment of the interference problem; and details for the proper design and construction of the most efficient type of vacuum-tube short-wave diathermy machine in use today.

NOVEL IDEAS IN RADIO SETS

(Continued from page 457)

output transformer characteristics, so as to accentuate the bass response in a manner that is not ordinarily convenient. At the same time,

the high-note loudspeaker, by proper selection of the value of the output coupling condenser (C, in Fig. 3), provides emphasis of the treble response.

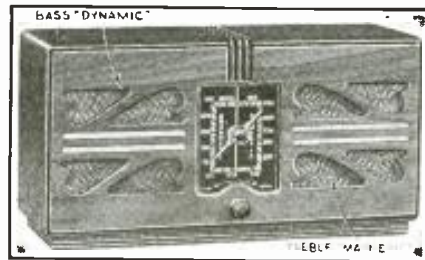

Fig. F. The positions of the 2 speakers are shown.

Note that this reproducer combination results in what is more properly termed *improved-fidelity* (or, perhaps, semi-high fidelity) response, rather than high-fidelity reception. Inasmuch as midset or mantel sets, at best, are incapable of reproducing audio frequencies over the wide range more simply achieved by large-cabinet sets having large baffle area.

As shown in Fig. 3, a T.R.F. type, A.C.-D.C. circuit is utilized, and 4 tubes; a tube-style ballast resistor is used in preference to incorporating the resistor in the power cord. Dimensions of set: 5 1/4 x 8 x 14 1/4 ins. long. (Service Men—dealers can obtain this set, for re-sale, for under \$8).

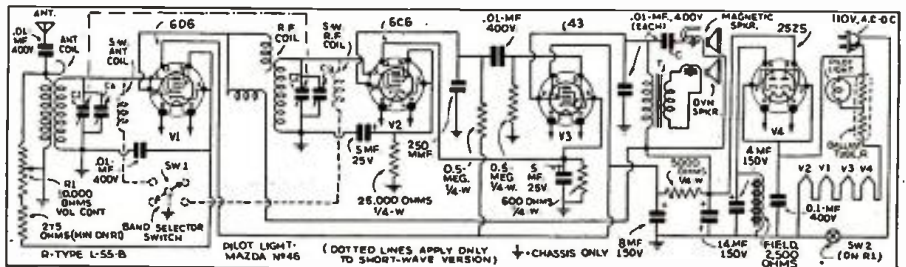

Fig. 3. The circuit of the dual speaker set. It is a T.R.F. type.

Please Say That You Saw It in RADIO-CRAFT

THE NEW 60-WATT "F.V.F.B." BEAM POWER AMPLIFIER

(Continued from page 476)

power amplifier cannot be handled in a slipshod manner. In fact, the swinging choke (assuming it is the initial point of design) will affect the design of (a) the output transformer, (b) input transformer, and (c) driver transformer; and, a number of other and apparently irrelevant components. These factors are invariably overlooked by amateur designers, and accounts in a large degree for the disappointment which they encounter while tampering with junk-box beam-power amplifiers.

PLATE SUPPLY REGULATION

The methods of obtaining good plate-supply regulation have been described in past issues of *Radio-Craft*. It is, of course, desirable to use mercury-vapor rectifiers under all conditions and to use the saturated input swinging choke. The action of this reactor is readily apparent if we consider the effect of condenser-input filter circuits.

A condenser input filter circuit, as is well known, delivers an appreciably greater voltage than a corresponding inductance-input circuit. This condition is caused by the charging of the input condenser during all peak voltages of the rectified A.C., and its subsequent discharge during the zero periods of rectification. This condition helps to maintain a high average D.C. output voltage but is usually characterized by poor regulation.

When inductance input is used, this charge and discharge effect is suppressed and the output of the rectifier system is approximately consistently equal to 90 per cent of the r.m.s. transformer voltage. When high plate currents are flowing the choke is saturated, with the result that the inductance between the D.C. output of the rectifier and the first condenser is sufficiently low to allow an appreciable charging of the first filter section. This helps to increase the available D.C. voltage so that compensation is automatically made for the additional voltage drop which takes place in the choke and power transformer during these maximum current periods.

Naturally, the design of the high-voltage winding of the power transformer is an important factor in the problem of regulation. By tapping, at 350 V., the secondary of the transformer used in this amplifier, the internal resistance of both the high and intermediate windings is kept to extremely low values, thereby considerably improving the voltage regulation of this special supply system.

IMPORTANCE OF FIXED SCREEN-GRID VOLTAGE

As the position in which the virtual cathode forms in the 6L6 is dependent upon the screen-grid voltage, it becomes apparent that for high-fidelity results, as much care should be exercised in the screen-grid supply regulation as in the regulation of the plate supply. This can not be accomplished by using a series drop resistor between the 400 V. terminal and the screen-grid. If this is done, approximately 3,000 ohms resistance will be required, and as this resistance value appears directly in the screen-grid circuit, it greatly modifies the regulation of the voltage applied to the screen-grid and therefore shifts the position of the virtual cathode in the 6L6 tubes. This shifting of the virtual cathode changes the optimum plate load for the output tubes, and, as the output transformer remains constant, a great deal of distortion is introduced. The power output is also greatly reduced.

The practical remedy for this condition is to use a separate rectifier to furnish 300 V. for the screen-grids of the power output tubes, as well as for the driver, voltage amplifier, and preamplifier tubes.

FIXED-BIAS SUPPLY REGULATION

The methods for obtaining a fixed-bias supply has been repeatedly described, but the importance of the regulation in the bias system is usually overlooked. In most biased class A circuits appreciable control-grid current does not flow during any part of the input cycle. In view of the fact that 350 milliwatts peak control-grid input power is required for maximum power output, and that the impedance of the secondary of the driver transformer should be kept as close to zero as possible, it follows that appreciable

control-grid current will be drawn during positive portions of the input cycle. If the bias supply is characterized by poor regulation, the bias will vary in phase with the input signal. This degenerative effect will decrease the power output and introduce one form of grid-circuit distortion. *The trick in maintaining a constant bias is in designing a bleeder system to pass 95 per cent more current than that which is ever required for grid-circuit dissipation.*

HUM ELIMINATION

The problems involved in eliminating hum in high-gain amplifiers evolves about the determination of the various causes. It is well known that there are 4 usual sources of hum, namely:

- (1) Improper filtering of plate-circuit supplies.
- (2) Improper filtering of grid-circuit supplies.
- (3) Inductive hum.
- (4) Electrostatic hum.

An analysis of each of these possible causes and their cures would be too elaborate for an article of this type. One of the least suspected causes of hum is cathode-to-heater leakage which is under the control of the tube manufacturers.

As many of the tubes used in preamplifier stages have not been specifically designed for this application, the tolerable hum leakage as allowed by manufacturers, usually introduces a serious problem in high-gain amplifiers. As the cathode (in a self-biased circuit) is usually of some potential above the heater, emission takes place between the heater and cathode. The return circuit for this type of emission is naturally in the control-grid input circuit. As all voltages impressed upon the input grid are subsequently amplified, this minute grid voltage might under certain conditions mask inductive and electrostatic hum-producing potentials. *By using a well-filtered fixed-bias supply all cathodes may be directly grounded. This automatically eliminates heater emission to cathode and prevents the possibility of this type of leakage from entering into the input grid circuits.*

TUBE FUNCTIONS

By using a 6J7, V1, as the high-gain input tube, in the representative diagram shown in Fig. 1, an over-all gain of 125 db. is made available. The 6N7 preamplifier, V2, provides for two individual inputs with subsequent gain of 94 db. for high-level microphones. The two following 6N7s—V3, V4—act as *electronic mixers*; this arrangement utilize 3 control-grids. The fourth control-grid is used for a crystal or high-impedance magnetic phono. pickup input.

The choice of push-pull drivers was made after a careful consideration of the power required to overcome losses in the driver transformer, grid-circuit dissipation, and the permissible high-order harmonics. Although a single 6F6 driver gives twice the power sensitivity of the push-pull type, and it can be resistance-coupled to the preceding stage, the use of the push-pull arrangement provides for simplicity in the design of an interstage coupling transformer which is capable of high-fidelity performance. As the plate impedance of these driver tubes is extremely low, it becomes possible to design an interstage transformer with a high primary inductance in order to obtain a good low-frequency response. Naturally, the 2nd-harmonic in the driver stage is completely cancelled, and this helps to attain the desired 60-W. output within the required limit of distortion.

FIELD SUPPLY

As will be noted from the circuit diagram, field supply is available for three 18- to 20-W. dynamic loudspeaker fields. As both the plate rectifier and screen-grid rectifier contribute to this speaker field supply, the regulation of both of these rectifier circuits is materially improved.

It can readily be seen from the foregoing, that the design of a high-voltage 6L6 beam-power amplifier must be carefully inter-related if results anywhere near approaching in confirmation with those which might be anticipated in view of tube manufacturers' ratings, are to be secured. Naturally, questions will arise relative to individual circuit components and their possible application in beam-power amplifier. The author will be pleased to answer all such questions addressed to him in care of *Radio-Craft*; (kindly enclose stamped, return-addressed envelope).

WORTH DOLLARS

But it's FREE!

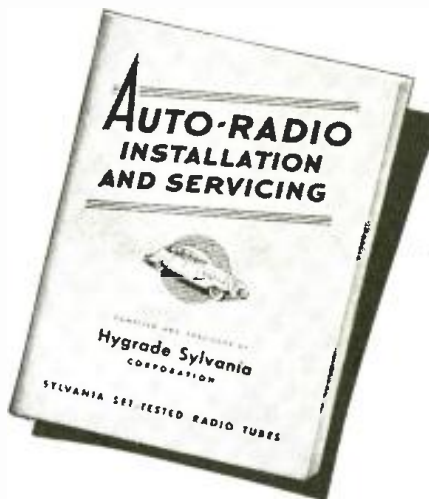

This New 1936-1937 Edition of the Sylvania Auto Radio Installation and Servicing Booklet! . . .

More automobile radios installed this year than ever before! . . . Are you set to get your slice of this profitable business? Be sure you are ready to meet it!

You can be prepared with this new Sylvania Booklet! Here are a few of the features contained in this valuable book:

Elimination of motor interference for every make of 1936 car . . . Tube complement chart for practically all models of automobile radio sets, with I.F. peak frequencies . . . Set and Antenna installation hints . . . Power supply hints, etc. These and hundreds of other problems you will meet in auto-radio installation and servicing are covered in this amazing book.

Fill out coupon below and mail it NOW! You will receive your free copy of this valuable book in a few days.

SYLVANIA

The Set-Tested Radio Tubes

HYGRADE SYLVANIA CORP. RC-27
 EMPORIUM, PA.
 Please send without obligation your new service book, "Auto-Radio Installation and Servicing".
 Experimenter Amateur Call Serviceman Employed by dealer Independent
 Member Service Organization
 Name
 Address
 City State
 Name of jobber
 Address

Please Say That You Saw It in RADIO-CRAFT

**.00001 Ohm to 11 Megohms
SHALLCROSS
Hi-Lo Resistance Bridge**

A direct reading instrument for the measurement of low resistances encountered in relay contacts, coil and armature windings, as well as other resistance of any character within the range of the bridge.



Combines in one instrument a standard Kelvin Bridge and a standard Wheatstone Bridge for measuring resistances from .00001 ohm to 11 megohms.

Send for Bulletin 637-PA.

SHALLCROSS MFG. COMPANY
Electrical Measuring Instruments
and Accurate Resistors
700 MAC BARRÉ BOULEVARD
COLLINGDALE, PA.

**TRIAD RADIO TUBE
FREE!
List Value \$1.25**

A DARING NEW PLAN!

Try TRIAD Tubes . . . and we know you'll be convinced of their superior quality. To induce you, we make this free offer: Send us your name and address . . . ask for your FREE TUBE CERTIFICATE and DATA CHART. Then present your certificate to your jobber when you purchase TRIAD Tubes . . . save up to \$1.25 . . . Is there a serviceman or dealer who won't grab this? Write today! Address Dept. B-14.

**WRITE TODAY!
SAVE \$1.25**

TRIAD MANUFACTURING CO., INC. PAWTUCKET, R. I.

RADIO COURSES

RADIO OPERATING: Prepare for Gov't License Exam. ● **RADIO SERVICING:** Including Short Wave ● **AMATEUR CODE** ● **ELECTRONICS** ● **TELEVISION**
Day and Evening Classes—Booklet Upon Request
New York YMCA Schools
4 W. 64th Street, New York City

On broadcast as well as shortwave frequencies, in any location, you can eliminate "man-made" static with
NOISE-MASTER
ALL-WAVE ANTENNA
Send for complete literature.
CORNISH WIRE CO., 30 CHURCH STREET, NEW YORK CITY

THE LATEST RADIO EQUIPMENT

(Continued from page 479)

DIME-A-TUNE RADIO SET (1272)

A COIN-CONTROLLED radio set that delivers music, as "metered entertainment," at the drop of a coin is now available; timing may be adapted to individual requirements. Here is a money-making scheme that is a sure winner for any Service Man who wants to drum up a little trade. A headphone jack is available in the receiver chassis which is a 5-tube A.C. superhet. The extended broadcast band includes the police range. Dimensions: 18 x 9 x 7½ ins. deep. Meter and set are built and locked into a heavy steel case encased in a wooden cabinet. Standard playing rate is about one hour for 10c; the receiver may be turned on or off again without loss, to the user, of paid-for time.

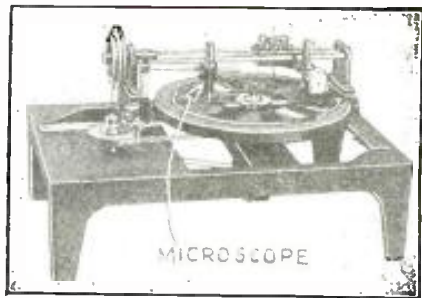

A professional studio recorder. (1277)

PROFESSIONAL STUDIO RECORDER (1277)

THIS unit will handle both 78 r.p.m. phonograph recording and 33 1/3 r.p.m. electrical transcription work. The 110-V. recording motor is of self-starting synchronous type, drives the turntable through a dual ratio pulley. The cutting head frequency characteristic, which extends to 5,000 cycles, cuts either 100 or 120 lines per inch. Crossing or uncrossing the lead screw drive belt moves the screw feed mechanism in either direction. A microscope with comparative scale in the lens system for measurements is provided. The frame is made of cast metal fixed in black crackle; machined parts are chromium.

simultaneously if desired and distributes to 10 to 60 loudspeakers selected in steps of 5. A dual-speed phonograph accommodates 16-in. records. An 11-tube all-wave superheterodyne covers the frequency range of 528 to 18,000 kc. A dual diaphragm crystal microphone is used. Talk-back facilities for monitoring are provided. Cabinet is all-steel in grain walnut finish.

POCKET SIZE METERS (1280)

(General Electric Co.)

ONE unit in a new line of testing instruments incorporating an improved element with higher talk and improved characteristics is illustrated. Accuracy is one per cent of full-scale value; size, 5½ x 3½ x 2 ins. deep; weight 12 ozs. Instrument is provided with magnetic damping permalloy moving vane and stray-field magnetic shield. A knife-edge pointer and mirror scale counteract parallax. Multiple-scale instruments (illustrated) are proved with a switch. The case is made of a new plastic called "textolite."

A "SERVICE CALLER" (1281)

A WELL known service instrument manufacturer considers that the following services incorporated in the unit illustrated offers adequate facilities for checking almost any type of radio set. Facilities of the "service caller"; tests all tubes without recourse to the adapter; utilizes hot neon to test for shorts or leakages

SCHOOL-TYPE SOUND SYSTEMS (1279)

FLEXIBILITY of application is a feature of the equipment illustrated. Reproduces up to 2 microphone or phonograph radio programs

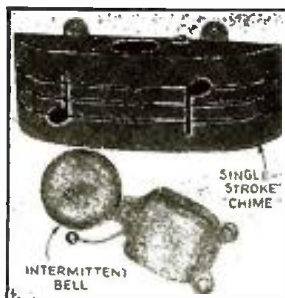

An artistic door chime. (1278)



New pocket meters which are available with volt, ampere and milliamper scale. (1280)

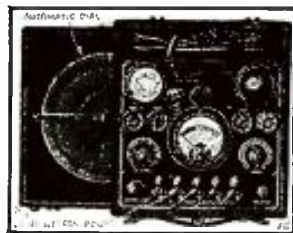

An English-reading tube tester—having "Quint Control." (1282)



A portable audition set—plays 16-in. transcription records. (1283)



A high-fidelity sound system. (1279)

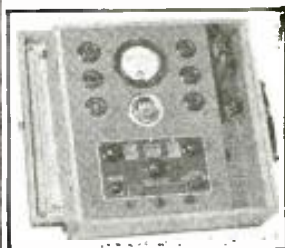

A service caller—combining a tube tester—voltmeter—milliammeter and ohmmeter in one unit. (1281)

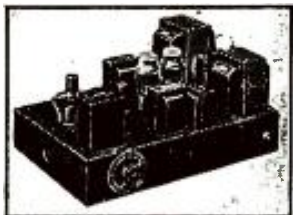

A 60-W. beam power amplifier—available in kit form. (1284)

Please Say That You Saw It in RADIO-CRAFT

between any two elements; English-reading indication of merit on basis of power output. High sensitivity tester indicates open, shorted or leaky electrolytic condensers of all types. D.C. voltmeter ranges 0-10-100-1,000 V.; current range 0-50 ma.; ohmmeter: 0-0.1 meg.-1 meg. Oversize power transformer with 11-tap primary plus an electronic rectifier line voltage meter permits operation on line voltage ranges of 100 to 130 V.

CANADIAN TUBE CHECKER HAS "QUINT CONTROL" (1282)

BY MEANS of 5 test switches closed in accordance with instructions etched on an automatic metal dial all elements of any type tube may be tested. Additional tests provided in this instrument are: hot filament interelement neon short test. Instrument operates on 105 to 125 V., 25 to 60 cycles.

PORTABLE AUDITION UNIT (1283)

THIS instrument incorporates a 5-tube A.F. amplifier rated at 1.75 W. which feeds an 8-in. reproducer; and a turntable for standard 12-in. discs (a special 16-in. precision table is available at slight additional cost). This equipment operates at 10 V. A.C.-D.C. Weight is about 30 lbs.; overall dimensions 18 x 18 x 9 ins. high. Speeds, 33 1/3 and 78 r.p.m. Tube complement: 1-85; 1-75; 2-43s; 1-25Z5. The high impedance pickup is rated as "reasonably flat from 70 to 4,800 cycles." High and low frequency tone control adjustment is provided.

60-W. BEAM AMPLIFIER (1284)

THIS 8-tube amplifier incorporates 1-6J7, 1-6N7, 2-6F6s, 2-6L6s, and 2-83s. The circuit incorporates a dual channel input; and is said to develop the full-rated output. Frequency response is stated as "practically flat from 30 to 12,000 cycles," using either input channel. A centertapped potentiometer which selectively controls the volume from either channel "protects" the input

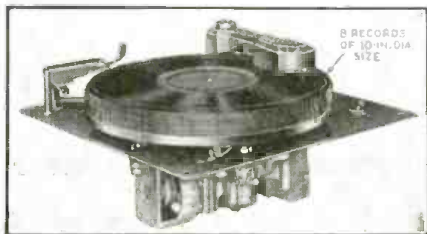

A compact automatic phono. turntable. (1285)

from either low or moderate level sources. Available in kit form or as individual components.

COMPACT AUTOMATIC PHONO TURNTABLE (1285)

AFTER playing eight 10-in. records automatically this phonograph continues to play the eighth one until all 8 records, 7 of which have meanwhile slid to one side, are replaced. By playing the records manually 12-in. discs may be used. Available for operation on any current supply including universal A.C.-D.C. The 2-speed motor provides 78 and 33 1/3 r.p.m. operation. The pickup is damped. Dimensions, 12 x 12 x about 8 ins. total depth.

IMPROVED SOUND PROOFING SYSTEM (1286)

SOUND technicians who have built sound-recording studios along the lines of those described in past issues of *Radio-Craft* will be interested to know that such studios need not be at all stuffy in order to obtain the benefits of sound proofing; instead, they may now be air-conditioned and at the same time adequately sound-proofed. The construction that makes this possible is based on the use of a well-known type of sound absorbing pad in conjunction with air-supply ducts. These two together form what is called an "acousti-vent" which is here illustrated in detail. (The complete "system" comprises a perforated ceiling made of a suitable architectural surface installed slightly below the normal ceiling level of the room.)

This construction is also applicable to service shops, catering to high-class trade, that have noise-proof rooms for testing radio equipment. Monitor rooms in theatres and small broadcast stations also may utilize this "system" to advantage.

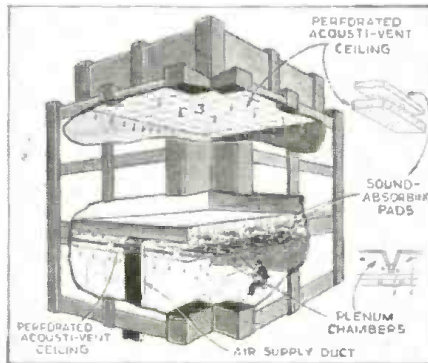

A new system for sound-proofing studios. (1286)

NOVEL IDEAS IN RADIO SETS "GOLF BAG" RADIO SET (1274)

(Continued from page 457)

ing "waiting" periods, while hunting or fishing; alongside the driver in an automobile; and in numerous other ways.

Referring to the schematic circuit, Fig. 2, it will be seen that output transformer T has a high- and low-impedance winding for matching into, respectively, the headphones and loud-speaker (voice-coil).

The dynamic loudspeaker may be slipped onto the side of the case as illustrated in Fig. C or it may be removed and extended about 4 ft. A longer cord may be used to extend the reproducer to any point. (Headphones may then be used to monitor the tuning-in of desired programs.)

The voice-coil of this dynamic unit has an impedance of only 3 ohms which is a very effective value where the transmission line must run for a considerable length and perhaps near to unshielded electric wiring that might cause hum pick-up.

One of the major factors contributing to the economical operation of this receiver is the use of a high-coercive permanent magnet for securing the requisite magnetic field. This eliminates the "A" drain of a field coil.

The batteries used in this receiver are of long-life type and will give exceptionally economical performance in this receiver.

The golfbag radio set conveniently adapts itself to a novel idea described some time ago in *Radio-Craft*—the set may be used to advantage at sporting events. Here the onlooker who may be located in the bleachers is able to further enjoy the game by listening to its broadcast version.

Service Men who have cars, and who do not object to the weight, may find this set a valuable tool in helping to locate sources of radio interference. (This type 243-PS-2 receiver is in the \$40 class.)

This receiver which has 5 tubes and in addition a limiting or ballast resistor in the shape of a tube has a completely self-contained power supply. In Fig. C it is illustrated in use, using as an antenna only a 4-ft. length of wire that was allowed to drape.

(Service data. If dynamic reproducer is used, best results will be obtained if "C" voltage is reduced from 15 to 10½. Tube terminal voltage —2 V. Power output, 200 milliwatts with 15 V. "C"; 300, with 10½ V. Sensitivity, 20 microvolts-per-meter with 50 mmf. antenna.)



Everything about RADIO in 1 Great Book

Ghirardi's RADIO PHYSICS COURSE, the best-selling text book on the fundamentals of radio, electricity and sound, is used by thousands of students and radio schools the world over. It teaches you absolutely EVERYTHING about every branch of radio! It's "the book of a million radio facts." Written in easy-to-understand style so the beginner can get a clear, quick grasp of the whole subject and teach himself. It's authoritative. It's concise. It's up-to-date. It's elaborately illustrated. It's the one COMPLETE radio text book that you can learn radio from. Ask the man who owns a Ghirardi!

CHAPTERS	
Sound and Speech	Loud Speakers
Electron Theory	Battery Operation
Electric Currents	Power Supply Units
Electromagnetism	Receivers
Inductance	Sound Systems
Capacitance	Short-wave
Filters	Photoelectric Cells
Measurements	Television
Radiation	Antennas and Grounds
Broadcasting	Servicing
Receiving Stations	Vacuum Tubes
Vacuum Tubes	Sound Pictures
Amplification	Appendixes
Superhets	Review Questions for Self-Study
AF & RF Amplifiers	

RADIO PHYSICS COURSE

972 pp. 508 illus.

MONEY-BACK GUARANTEE!

Examine and use this book for 5 days. Then, if you decide it is not worth to you many times its cost, return it to us undamaged, and your money will be promptly refunded. You take NO RISK in ordering.

\$4
RADIO PHYSICS COURSE

MAIL TODAY!

Radio & Technical Publ. Co.
45 Astor Pl., New York, Dept. RC-27

Enclosed find \$4 for RADIO PHYSICS COURSE postpaid. (foreign \$4.50)

Please send free circular "P".

Name

Address

DYNAMIKE

A real velocity, high quality microphone for speech or music. Equals instruments selling for three times the price. Response substantially flat from 40 to 10,000 C. P. S. Cavity resonance eliminated through special design. HIGH impedance. Output, 60 D. B. Equipped with six feet of shielded cable. Send \$9.95 (plus postage) today or request free circular.

95 Plus Postage

ELECTRO-DYNE MFG. CO., Benton Harbor, Mich.

LES Correspondence Courses In **RADIO and ELECTRICAL ENGINEERING**

ELECTRICAL ENGINEERING covers complete electrical field. Most modern course. So simplified anyone can GRASP it quickly. LOW COST! Only \$25. Deferred payment plan.

RADIO ENGINEERING Ultra-modern course in radio. public address photo-electric work. Train you to be super-service man, real vacuum tube technician. Diploma given. Tuition only \$25. Deferred payment plan.

FREE Write today for free copies of school catalogs, student magazines, etc. Get started at once. SEND NOW!

LINCOLN ENGINEERING SCHOOL, 931-11 So. 37th St., Lincoln, Nebr.

Please Say That You Saw It in RADIO-CRAFT

A NEW

Non-Reactive Dynamic Beam-Power Amplifier and Stream-Lined Bullet Electro-Dynamic Microphone

Available at an almost unbelievable Low Price!



Provides 32 watts with unrestricted frequency response, non-reactive signal division, two-phase bridge rectification, stabilized power supply, variable polar response, etc., etc.

Write for Circular No. 3713 for complete details and prices of this amazing sound system development by A. C. Shaney.

AMPLIFIER CO. OF AMERICA

37 West 20th Street New York, N. Y.

A SIMPLIFIED CONVERTER FOR SHORT-WAVE BEGINNERS

(Continued from page 477)

ground end of the secondary, would serve our purposes fully. A cathode tap, not more than half a turn from the ground end, would give adequate regeneration.

A matching oscillator coil may have exactly the same physical size, tracking being easily accomplished by trimming for high-frequency, and padding for low-frequency end matching. A cathode tap, approximately 4 turns from ground, would be called for.

Coils to cover higher-frequency ranges would require similarly simple engineering and "imaginary" construction before actual building is begun. A coil on a 1 in. form of 4 turns of No. 20 wire spaced out to 1/2-in. length, would give an estimated coverage from 25 to 10 megacycles. Its cathode tap should be placed less than one-half turn from ground; and its primary winding should be about 4 turns of No. 24 or smaller wire. A matching oscillator coil should be tapped 1 1/2 turns from ground, have similar physical size, and be bridged by a low-capacity trimmer—padding capacity may be an unnecessary refinement.

A 10-meter coil (detector) should consist of about 4 turns of No. 14 bare tinned copper wire (coil 1/2-in. in diameter) self-supported and hung directly on the coil switch. The oscillator coil should have a similar number of turns, but be firmly supported on 1/2-in. tubing to insure against any possibility of vibration. No regeneration tap is suggested for the detector; the antenna connection may be made by either directly connecting one doublet line to the coil (at a point to be found as best by trial) or wrapping an insulated antenna lead around the grid end. An oscillator coil tap for cathode connection is not suggested, and feed-back for oscillation should be given by a cathode coil of 3 or 4 turns wound between the main coil turns and tied to cathode and B- (Fig. 4). Exact coverage for such "10-meter" coils cannot be given, as it is impossible to know the length of connecting leads. An inch of wire, more or less, throws all calculations completely off!

Now let us get back to trial-and-error, and consider a 1 in. coil of No. 22 D.S.C. wire—approximately 1 in. long, with 34 close-wound turns.

By formula, we find such a coil has an inductance of 19.26 + microhenries. At 30 mmf., we find from our chart, we touch approximately 6,400 kc. At 378 mmf. we reach a maximum of, roughly, 1,900 kc. Such a coil would therefore give good frequency coverage to a point well above 100 meters. The regenerative cathode tap would be placed about 1 1/2 turns (or less) from the ground end and the primary winding would consist of about 10 turns, close-wound, spaced about 1/4-in. from the secondary (ground end).

Working out an oscillator coil for such a detector winding is not such an easy matter. We must first estimate required inductance at minimum capacity (30 mmf.) to give a frequency of 6,400 + 550 (I.F.) kc.; approximately 17 microhenries is called for. We now work out various "problem" coils by formula until we find a coil of about 30 turns of No. 22 D.S.C. covering 0.9-in., will give us 16 microhenries. This is near enough, and a 1 in. coil, with trimmer for minimum range tracking adjustment, cathode tap about one-fourth the way up from the ground end, and padding capacity for maximum range tracking should meet our requirements.

A coil of about 60 turns of No. 28 D.S.C. close-wound will cover 1 in. space. Using a 1 in. form, such a coil would extend tuning over a range from, approximately, 3,500 to 1,000 kc. A cathode tap at about 5 turns and a primary winding of 10 turns would be required.

A matching oscillator coil would have an inductance of, approximately, 50 microhenries and consist of 50 turns of close-wound No. 28 D.S.C. on a 1 in. form—with cathode tap at about 20 turns from ground.

PADDING

Pads will not be necessary for the highest frequency band, and may not be required for the middle H.F. bands; as a panel-controlled oscillator trimmer is part of the circuit and has a



Learn More About RADIO and A B C of AIR CONDITIONING

THE RADIO-CRAFT LIBRARY SERIES—a most complete and authentic set of Volumes—treats, individually, important divisions of radio. Each book has been designed to give you the opportunity to learn one or more branches of radio. The authors of the books are well-known to everyone. Each is an expert radio man; an authority on the subject—each is thoroughly familiar with the field which he represents.

All Books Uniform

The volumes in the RADIO-CRAFT LIBRARY SERIES are all uniform, 6 x 9 inches. Each book contains on an average of 50 to 120 illustrations. The books are printed on an excellent grade of paper which makes the type easy reading.

- No. 1 **RADIO SET ANALYZERS**
By L. VAN DER MEL
- No. 2 **MODERN VACUUM TUBES**
By ROBERT HERTZBERG
- No. 3 **THE SUPERHETERODYNE BOOK**
C. J. FITCH
- No. 4 **MODERN RADIO HOOK-UPS**
By R. D. WASHBURNE
- No. 5 **HOW TO BECOME A RADIO SERVICE MAN**
By LOUIS MARTIN
- No. 6 **BRINGING ELECTRIC SETS UP TO DATE**
By CLIFFORD E. DENTON
- No. 7 **RADIO KINKS AND WRINKLES**
By C. W. PALMER
- No. 8 **RADIO QUESTIONS AND ANSWERS**
By R. D. WASHBURNE
- No. 9 **AUTOMOBILE RADIO AND SERVICING**
By LOUIS MARTIN
- No. 10 **HOME RECORDING AND ALL ABOUT IT**
By GEORGE J. SALIBA
- No. 11 **POINT-TO-POINT RESISTANCE MEASUREMENTS**
By CLIFFORD E. DENTON
- No. 12 **PUBLIC ADDRESS INSTALLATION AND SERVICE**
By J. T. BERNSELY
- No. 13 **A B C OF AIR CONDITIONING**
By PAUL D. HARRIGAN
- No. 14 **POCKET RADIO GUIDE**
By NAT LESSEM

BIG DISCOUNT OFFERED When Five (5) Books or More Are Ordered, Deduct 20%

RADCRAFT PUBLICATIONS, INC.
89 Hudson Street, New York, N. Y.

RADCRAFT PUBLICATIONS, INC. RC-237
89 Hudson Street, New York, N. Y.

I have circled below the numbers of books in the RADIO-CRAFT LIBRARY SERIES which you are to send me, and have deducted 20% for ordering five (5) books or more. I have included my remittance in full, at the price of 50¢ each, when less than five books are ordered.

The amount of my remittance is..... (stamps, checks or money orders accepted). Circle numbers wanted:

1 2 3 4 5 6 7 8 9 10 11 12 13 14

Name

Address

City State

All books are sent postage prepaid

CHEKATUBE \$19.95

Without case for test bench. f. o. b. factory



Tests all Tubes Without Adaptors

10 Days free trial

With portable case \$21.95

Finest tube tester on the market. New power level ballast rectifier circuit—not a common emission tester. Simple. All shorts and open circuits on neon lamp while hot. Filament rotary switch permits testing 617-6Z5-5Z4-5X4 and all others. Completely wired unit on panel for mounting in carrying case or in test bench. ORDER DIRECT 10 days free trial—MONEY BACK GUARANTEE. Write for free literature.

Established 1922 **J-M-P Manufacturing Co., Inc.**
3045 N. 34th St. Milwaukee, Wis.

A New Line of . . . DRY ELECTROLYTIC CONDENSERS

SMALL, COMPACT — REASONABLY PRICED
Dealers, Distributors, Jobbers and Service Men
Write for Information and Price Sheets
Unconditionally Guaranteed

ILLINOIS CONDENSER COMPANY
3252 W. NORTH AVE., CHICAGO, ILL.



"HAM" SPECIAL Standard Telex

A highly efficient code teacher using heavy specially prepared waxed paper tape, having two rows of perforations.

Write for Free folder A2. We are the originators of this type instrument

Instrument with tapes prepared by expert and complete course, all for \$33.95. Without Oscillator, 72-76 Cortlandt St., N. Y. C. **TELEPLEX CO.**

RADIO ENGINEERING,

broadcasting, aviation and police radio, servicing, marine radio telegraphy and telephony, Morse telegraphy and railway accounting taught thoroughly. Engineering course of nine months' duration equivalent to three years of college radio work. All expenses low. Catalog free. School established 1874. Dodge's Institute, Hudson St., Valparaiso, Ind.

Please Say That You Saw It in RADIO-CRAFT

**THE NEW 1937
SUPER SKY RIDER**

*The Sensation of the
Amateur Radio World*

With eleven tubes, selectivity beyond last year's model, far greater sensitivity, the new Super Sky Rider is the most advanced receiver for communications receivers. Many new features add to its efficiency and convenience in operation. Ask any amateur that has seen and operated the new Super Sky Rider for complete details today!

**NOW AVAILABLE ON TIME PAYMENTS
the hallicrafters, inc.**
2617 Indiana Ave., Chicago, U. S. A.

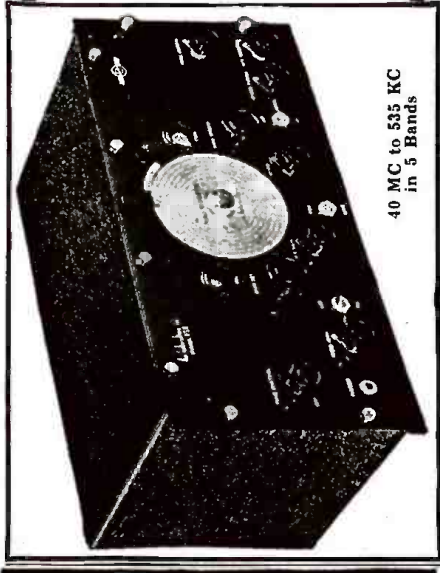

40 MC to 535 KC
in 5 Bands

**FOR HIGHER
EFFICIENCY USE
THESE RCA AUTO
ANTENNAS**

RCA AUTO-TOPTENNA . . . Stock Number 9792, list price \$5. A simply installed, streamlined beauty for all cars, all models. Perfectly shielded. Triple chromium plated.

RCA AUTO-WHIPTENNA . . . Stock Number 9793, list price \$3.50. Quickly installed. Attaches to hinge pin of any car. No hole drilling required. Fits all cars. Guaranteed unbreakable.

Both of these fine antennas eliminate wheel static and motor noise!

Further information about these and other RCA Antenna Systems free on request.



Parts

RCA Manufacturing Co., Inc., Camden, N. J.
A service of the Radio Corporation of America

sufficiently large capacity range to keep some coils closely matched. Pads for lower-frequency bands will be advisable, however.

Trimmers in parallel across oscillator-circuit coils or condensers are used for the higher-frequency alignment. Padders in series with coils or condensers are used to align the low-frequency end.

The inductance of the oscillator coil, the low-frequency limit (in our case the detector coil L.F. limit, plus the I.F.) and the maximum capacity of the tuning variable must be known.

Use a chart. A straight line drawn between known inductance and desired frequency scales, and extended to cross the capacity scale, gives the required total maximum capacity.

Let's consider an oscillator coil designed to track properly in a mixer circuit tuning from 6,400 to 1,900 kc. A detector coil, with a given condenser, tunes to these frequency limits if it has an inductance of 20 microhenries; an oscillator coil of approximately 17 microhenries, tuned by a similar condenser, would match with 550 kc. difference at the high-frequency end, if properly trimmed.

Now, 1,900 plus 550 gives us the low-frequency limit of 2,450 kc., to which the oscillator circuit must tune to track at this end. From the chart, we find 17 microhenries and 2,450 kc. are in line with, roughly, 250 mmf.

Our maximum tuning capacity, with estimated circuit and trimmer capacities added, is 378 mmf. We must therefore use a series padder to reduce the maximum value to about 250 mmf.

The formula for series capacities is:

$$C = \frac{C_1 \times C_2}{C_1 + C_2}$$

Substituting known values, we get:

$$250 = \frac{378X}{378 + X} \text{ where } X \text{ equals } C_2$$

$$378X = 250(378 + X)$$

$$378X = 94,500 + 250X$$

$$128X = 94,500$$

$$X = 746 \text{ plus}$$

Our series padder should have a capacity, then, of approximately 746 mmf. As calculations are one thing and performance another, the capacity used should be composed of a fixed mica condenser paralleled by a variable trimmer, the total capacity to be adjustable from approximately 60 mmf. to 0.001-mf.

COIL DESIGN NOTES

(1) An idea of frequency coverage should first be obtained, and trial-and-error, "on paper," coils worked out for estimation of inductance.

(2) A straightedge frequency-capacity-inductance chart or direct-reading chart should be secured and frequency minimum and maximum figures obtained for the various trial coils. Capacity minimum and maximum values should be based on known variable condenser ratings, plus an estimated initial circuit capacity.

(3) Select physical specifications for construction to cover the required frequencies with as few coils as possible.

(4) In multi-coil set-ups, design the coils so that they will require a high tuning capacity before hitting the estimated natural frequencies of other coils.

(5) An increase in the maximum capacity of the variable condenser will extend the tuning range of each coil. The greater the maximum, the fewer coils required for a given coverage, and the easier the actual construction and alignment.

(6) Trimmers across oscillator coils will align them to detector coils. Detector trimmers will not be necessary, because of the single, variable, panel control provided.

*A forthcoming issue of *Radio-Craft* will contain such a chart for those who do not have one available in existing publications.

The 10-meter coil construction has been explained. Other coils, of 4 to 12 turns, should be wound on 1 in. low-loss bakelite forms with either No. 20 (spaced) bare tinned, or No. 20 special R.F. insulated wire. (In the lab. model, the wide-band coil is shown wound with this special low-loss R.F. wire—which is the nearest possible thing to bare, air-supported conductor. Such wire will enable high-efficiency coils to be easily constructed with turns close-wound.) Low-frequency band coils may be wound with No. 22, or similar, D.S.C. All oscillator coils should be rigidly supported.



How would you like to have this 20-tube modern all-wave receiver brought into your shop with the above complaint? The new receivers are getting more and more complex and the serviceman who still relies on "screwdriver tactics" will never work out the bugs. The serviceman who hopes to advance himself into a better job and better pay, must have adequate modern training NOW!

**ADVANCED TRAINING IN
RADIO SERVICE
AND PUBLIC ADDRESS
IS THE KEY TO SUCCESSFUL
SERVICING**

STUDY AT HOME

A complete home study course for professional servicemen, written by experienced servicemen to give you the technical knowledge necessary to service the "trick" circuits and to rise above the ranks of the average.

You can start any time—take up to 3 years. Terms as low as \$5 a month.

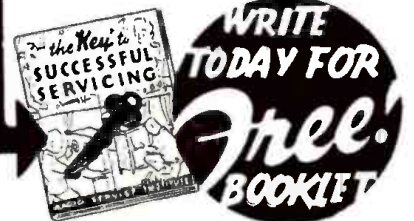

A request on a penny post card, will bring you your own copy of this interesting, illustrated booklet. Explains courses, school, faculty, terms and your future in the Service field.

RADIO SERVICE INSTITUTE
SUBSIDIARY OF CREI
Dept. RC-2, 3308 14th St., N. W. Wash., D. C.

DISTRIBUTORS WANTED

Territories outside of New York City open. We manufacture home type portable Diathermy Instruments. Successful sales plan. Minimum sales resistance, non-competitive. Wide margin of profit. Dignified business for men who can make modest merchandise investment. Write for details.

DIATHERMY COMPANY OF AMERICA
100 West 42nd Street New York City

INVENTORS

TIME COUNTS—don't risk delay in patenting your ideas. Write for new FREE book, "Patent Guide for the Inventor" and "Record of Invention" form. No charge for preliminary information.
CLARENCE A. O'BRIEN & HYMAN BERMAN
Registered Patent Attorneys
533-L Adams Bldg., Washington, D. C.

Please Say That You Saw It in RADIO-CRAFT

These Clough-Brengle SET ANALYZERS are a permanent, obsolescence-proof investment!



MODEL 85
\$4.00 down

They measure every receiver voltage, current, resistance, and capacity directly on large 5-inch fan-type meters without the use of quickly obsolete cables and adapters. Scales are simplified for easy reading. Simplified selector switching makes every range instantly accessible, yet eliminates cost and confusion of push buttons, pin jacks, etc.

MODEL 95 has d-c volts scales 0.5-50-500-1000, a-c volts 0.8-40-160-400-800, d-c ma 0.5-50-500, five resistance ranges 1/2 ohm to 20 megs, and capacity .00025 to 16 mfd, all direct reading, self-contained power supply, two meters. Net \$53.75.

MODEL 85 has d-c and a-c voltage scales of 0.15-150-750, d-c ma 0.1-5-15-150, three resistance ranges 1/2 ohm to 2 megs, with self-contained battery. Net \$24.95. Ask your jobber for descriptive literature and time payment data or write today.

Write for descriptive Bulletin—TODAY!

The CLOUGH-BRENGLE CO.
2809 W. 19th St. Chicago, Illinois



MODEL 95
\$6.00 down

MAKE "THE EXECUTIVE"—A BUSINESS MAN'S A.C.-D.C. SET

(Continued from page 463)

stability, that the bypass condenser shunting this bias resistor (as well as the one across the 25B6G bias resistor) be of a fairly high capacity (at least 5 mf.) so that any A.F. as well as R.F. component of the signal which happens to be in the cathode circuit will be shunted to ground rather than be coupled back to the control-grid circuit of the tube, where it would distort the signals.

From the plate of the detector tube the signal is applied across the control-grid and cathode of the power output tube—the new type 25B6G pentode tube developed by one company. This tube is designed to work with a low plate potential of 95 V., yet is capable of putting out 1.75 W. of power. (This is considerably more than the power output of the type 43 tube commonly used in A.C.-D.C. sets.) The plate load resistance should be 2,000 ohms. If a loudspeaker with such a transformer cannot conveniently be obtained, one with a standard pentode output transformer will do. The mismatch in this case will not affect the tone quality of the set, merely the volume, which would be somewhat attenuated; not enough, however, to be disturbing.

GENERAL REMARKS

In contrast to the ordinary A.C.-D.C. set, the two cathodes of the 2526 rectifier are not connected together. Instead, one is used to energize the 3,000-ohm field coil of the dynamic speaker and the other to furnish plate potentials for the

tubes. The 125-ohm filter choke is in the "B"-return leg of the power supply. A generous amount of filtering capacity is used on both sides of the filter choke as well as across the speaker field. This results in exceptionally quiet operation—hum ripple is hardly noticeable even by placing the ear close to the loudspeaker.

Be sure to keep all power leads and wires carrying A.C. away from R.F. grid and plate leads. It is always good policy to shield the grid leads of the R.F. and detector tubes as well as the signal lead from the plate of the detector tube to the grid of the power output tube.

A few remarks, now, about the operation of the receiver will not be amiss.

If the circuit diagrams have been carefully followed, the various leads most vulnerable to extraneous coupling thoroughly shielded, and the specified values of parts used, then the set will work well "right off the bat." If, despite the above precautions, the circuit oscillates, you can be mighty sure that the cause lies in either mal-alignment of the tuning condenser trimmers or an improperly-loaded antenna circuit (governed by the length of the antenna and the value of the protective antenna series condenser, C)

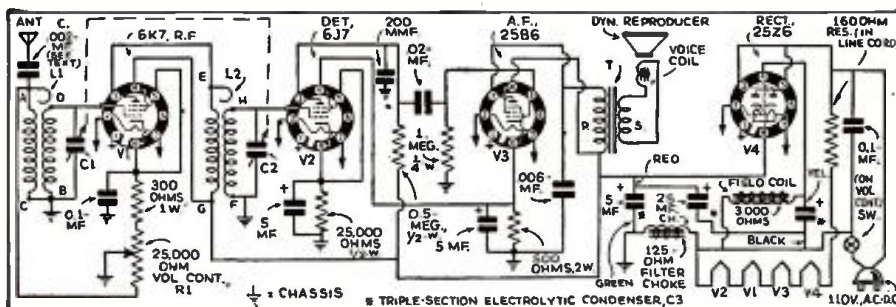

Fig. 2. The schematic wiring circuit for those who prefer this system.

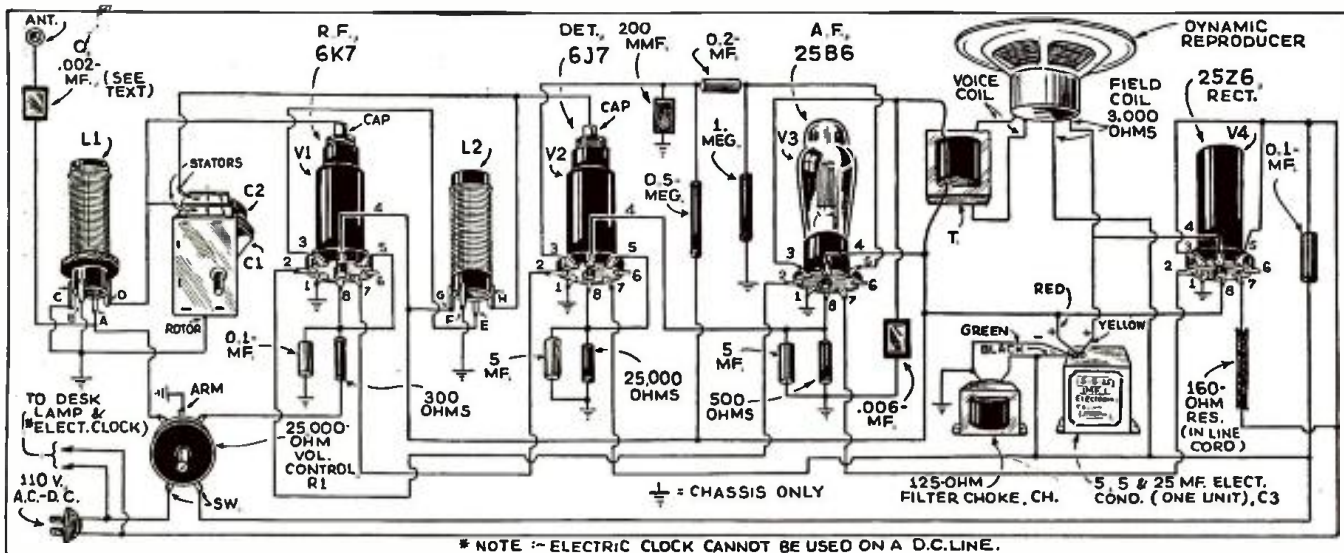

Fig. 1. The pictorial wiring diagram of the receiver showing values of all parts. Note the wiring to the electric clock and lamp.

Please Say That You Saw It in RADIO-CRAFT

FACTORY TO YOU

LATEST MODEL REMINGTON TYPEWRITERS



10¢ A DAY

BRAND NEW, latest model Remington Portable for only 10¢ a day! Amazingly low price direct from the factory. Every essential feature of large office typewriters—standard 4-row keyboard, standard width carriage, margin release, back space, automatic ribbon reverse. Act now, while this special opportunity holds good.

You don't RISK a Penny

We send you this genuine Model 5 for 10 days' free trial. If not satisfied, send it back. We pay all shipping charges.

FREE Typing Course and Carrying Case You will receive FREE a complete simplified home course in Touch Typing. Also FREE, a handsome, sturdy carrying case. No obligation. Mail coupon for full details—NOW.

Remington Rand Inc.; Dept. 189-2
315 Fourth Ave., New York, N. Y.
Tell me, without obligation, how I can get a New Remington Portable, plus Free Typing Course and Carrying Case, for 10¢ a day. Send Catalogue.

Name.....
Address.....
City.....State.....

JOBS & CAREERS

The Only Magazine of Its Kind!

TELLS HOW:

- To Look for a Job
- To Better Your Present Position
- To Plan Your Career
- To Choose an Occupation
- To Earn Money in Spare-Time
- Inside Stories of Successful Men, Etc., Etc.

On all newsstands 25c.
If your dealer cannot supply you, send a quarter and we will forward a copy at once

JOBS & CAREERS
520 N. Michigan Ave., RC-237, Chicago, Ill.

CLASSIFIED ADVERTISEMENTS

Advertisements in this section are inserted at the cost of twelve cents per word for each insertion—name, initials and address each count as one word. Cash should accompany all classified advertisements unless placed by a recognized advertising agency. No less than ten words are accepted. Advertising for the March, 1937, issue should be received not later than January 7th, 1937.

INSTRUCTION

MANY 1937 GOVERNMENT JOBS. START \$105 TO \$175 month. Rapid increase. Men—women. Prepare now for next examinations. Short hours. Common education usually sufficient. Many Social Security jobs. Full particulars free. Write today sure. Franklin Institute, Dept. W52, Rochester, New York.

RADIO

RADIO ENGINEERING, BROADCASTING, AVIATION and police radio, servicing, Marine and Morse Telegraphy taught thoroughly. All expenses low. Catalog free. Dodge's Institute, Pine Street, Valparaiso, Indiana.

FOR SALE: CLOUGH-BRENGLER ALL-WAVE OSCILLATOR. Supreme 89 Tube Tester, brand new. Ribber's Manuals—volumes 1 to IV. Best cash offer. C. Kreutzburg, Dalton, Illinois.

MIKES: NEW SHURE AND AMPERITE CRYSTAL and Ribbon. 60% off list. write for complete list. Carolina Radio, Sumter, South Carolina.

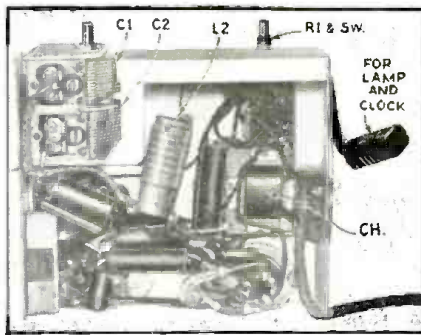

Fig. C. The under side of the chassis.

In Part II, the author will describe the construction of the base and cabinet of THE EXECUTIVE—an utilitarian desk set.

LIST OF PARTS

- One Allied Radio Co. Midget 2-gang variable condenser, 350 mmf., each section, C1, C2;
 - *One set of matched high-gain A.C.-D.C. T.R.F. coils, antenna and R.F., L1, L2;
 - One Cornell-Dubilier mica condenser, 0.002-mf., C;
 - One Cornell-Dubilier mica condenser, 200 mmf.;
 - Two Cornell-Dubilier paper condensers, 0.1-mf.;
 - Two Cornell-Dubilier electrolytic bypass condensers, 5.0 mf., 35 or 50 V.;
 - One Cornell-Dubilier paper condenser, 0.02-mf.;
 - One Cornell-Dubilier paper condenser, 0.006-mf.;
 - One Tobe Deutschmann triple-section electrolytic filter condenser, 5-25-5 mf., type SP-2;
 - One Continental Carbon resistor, 300 ohms, 1 W.;
 - One Continental Carbon resistor, 25,000 ohms, 1/2-W.;
 - One Continental Carbon resistor, 0.5-meg., 1/4-W.;
 - One Continental Carbon resistor, 1 meg., 1/4-W.;
 - One Continental Carbon resistor, 500 ohms, 2 W.;
 - One Electrad volume control with attached "on-off" switch, 25,000 ohms;
 - One Kenyon A.C.-D.C. filter choke, 125 ohms;
 - One Allied Radio Co. A.C.-D.C. line cord with built-in resistor, 160 ohms;
 - One Wright-DeCoster 5-in. dynamic speaker with output transformer for single pentode;
 - One National Union metal tube, type 6J7;
 - One National Union metal tube, type 6K7;
 - One National Union metal tube, type 25Z6;
 - One Raytheon tube, type 25136G;
 - Four Allied Radio Co. octal wafer sockets;
 - *One 1/16-in. aluminum chassis (see sketch for chassis layout);
 - *Two brown bakelite knobs with pointers;
 - *Two escutcheon plates, one for station selector and the other for the volume control.
- *Names of manufacturers will be sent upon receipt of a stamped and self-addressed envelope.

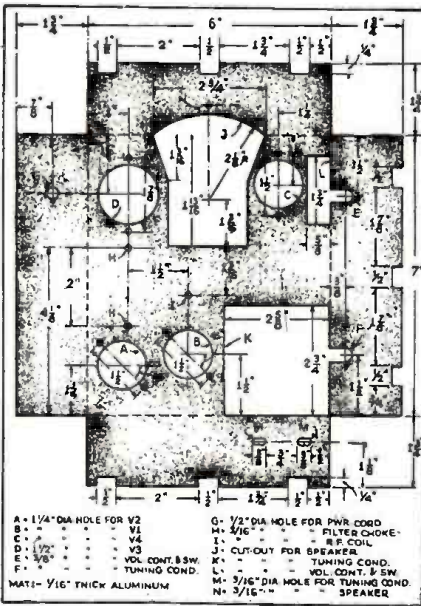

Fig. 3. The dimensions and drilling details of the chassis.

Announcing

The New "SUPER PRO"

HAMMARLUND now introduces an outstanding receiver for .54 to 20.0 megacycles that provides a new high in efficiency—the new "Super Pro" "100" series! With this new "Super Pro" you can now continuously vary the selectivity from 3 to 16 kc. with a directly calibrated "Band Width" panel control. At last no more guess work! Audio gain and sensitivity gain controls are also specially graduated to facilitate accurate tuning. The band spread system, with a 12-gang condenser spreads high frequency broadcast channels as well as each amateur band over practically the entire dial for extra easy tuning. The exclusive cam-operated knife-switch is noiseless, jar-proof, and fool-proof. A precision tuning unit has 20 laboratory adjusted tuning coils on Isolantite bases, a four-gang main tuning condenser and a 12 to 1 ratio direct reading dial calibrated in megacycles and kilocycles accurate to within 1/2%. The sensitivity of this new receiver, using 16 tubes, eight metal and eight glass, is so great that weak signal reception is limited only by the noise pickup of the antenna system.

Write Dept. RC-2 today for details!

HAMMARLUND MFG. CO., INC.
424-438 W. 33rd Street, New York City
HAMMARLUND'S 25th YEAR

14 32 64 125 WATT UNDISTORTED
● **6L6 BEAM AMPLIFIERS** ●
DEAL DIRECT With Manufacturer AND SAVE BIG MONEY
ULTRA-QUALITY PERFORMANCE and FLAWLESS REPRODUCTION GUARANTEED FOR 5 YEARS!
WRITE TODAY FOR OUR VALUABLE
FREE CATALOG
INDUSTRIAL
AMPLIFIED SYSTEMS COMPANY
16-R HUDSON STREET NEW YORK, N. Y.

Consulting Engineers to Radio Manufacturers in all parts of the world
Quality improved. Unit costs reduced.
New products developed. New plants installed.
DESIGNS SPECIFICATIONS
RESEARCH REPORTS
Write to our Research Laboratory for a free analysis and report on your particular problems.
INTERNATIONAL ELECTRONICS, INC.
RADIO CITY NEW YORK

Please Say That You Saw It in RADIO-CRAFT

RADIO

holds great rewards for trained men



The big opportunities in Radio will be enjoyed by trained men. The International Correspondence Schools Radio Course, prepared by leading authorities and constantly revised, will help make you a trained man! A fascinating book—FREE.

AVIATION ENGINEERS are leaders in modern progress



Aviation depends upon engines, and knowledge of aviation engines is a long step toward success in this rapidly growing industry. Many leading aviation engineers today took their first step by mailing a coupon to the I. C. S. at Scranton. Why don't you follow their example?

INTERNATIONAL CORRESPONDENCE SCHOOLS

Box 6678-C, Scranton, Penna.
 Explain fully about your course in the subject marked X:
 RADIO **AVIATION**
 Chemistry Accountancy
 Invention Advertising
 Refrigeration Electrical Engineering
 Air Conditioning Drafting
 Architecture Show Card Lettering
 Good English

Name.....Age.....
 Address.....
 City.....State.....

4 BAND SUPER TUNING UNIT

RANGE 12 to 550 METERS **\$9.95**
 COMPLETE WITH 4" DIAL
 STAGE OF R.F. ON ALL 4 BANDS
 Write for New 20-Page Flyer
ARROW SALES CORPORATION
 631 WASHINGTON BLVD. CHICAGO, ILL.

6L6 TRANSFORMER KIT
30 WATTS
 Power Trans. 500 VT CT-250 mill
 5 V.-3 Amp. 6.3 Volts at 6 Amp.
 Net \$3.50. Input Trans. High
 Fidelity type \$3.00 net. Output 500
 ohm and tapped voice coil \$3.00
 net. Diagram of 6L6 30 Watt Am-
 plifier with all latest circuit im-
 provements and full parts list 25c.
 Special for above kit, \$8.00 net.
 Any Transformer Built to Specifications

AALLOY TRANSFORMER CO., Inc., 135R Liberty St., N.Y. City

PHILCO SERVICEMAN and CATALOG of PHILCO PARTS and TUBES... Sent Free on Request

WILLIAMS PHILCO, Inc.
 800 S. Adams St. Peoria, Ill.

DEAF-AIDES
DRY STORAGE BATTERIES
FOR ALL MAKES HEARING AIDES

A profitable side line—pocket hearing aides—2, 4, 4.6 volt miniature batteries. Low list—Ample discounts.

H. E. CLARKE CO. Zelenopole Penn.
 Mfgs. Penn.

P. A. is our business!

Your business is to obtain the best **AMPLIFIERS OF ALL TYPES**

FREE CATALOG contains the greatest values ever offered. Consult us on your P.A. Problems.

Amplitone Products Company
 135 LIBERTY ST. NEW YORK, N. Y.

ORSMA MEMBERS' FORUM

(Continued from page 482)

for the playing of their copyrighted music. I ask Mr. Nace how he would feel if some modern idea was promulgated toward once and for all making radio sets fool-proof and everlasting so there would be no service work to do on them? There would be no more demand for his or any Service Man's services! He would be like I and thousands of other men who spent years in studying and practicing to become professional musicians. And then have a modern idea come along like talking movies and throw the thousands of us out of the orchestra pits to starve or find something else to do. If he was a go-getter he would "find himself" and get into some business closely related to what he had previously done.

After some floundering that's what I have done and have music around me all the time, in record form and radio, and in the sound truck form of business for advertising and public performances. And instead of A.S.C.A.P. being a detriment it is a help if we will line up with them and take our place in what they are trying to do, in their effort to gain a revenue from those who would cheat the professional musician by putting a radio set in their night club or tavern and let their guests dance by that instead of giving a few hours work to those men who have spent their life time in perfecting themselves in the profession. Why shouldn't they be made to pay a small fee which would go into a fund governed by the A.S.C.A.P. to help some of our brothers of the profession who can never play any more?

And then by A.S.C.A.P. tying that work right into line with their rule to license all those who play this recorded music for advertising purposes to add to this fund, they will be doing two jobs in one (you have heard it said that it's a poor scheme that will not work both ways).

Now if Mr. Nace and Mr. Haslo are radio Service Men (as I suspect they are) what I am going to say will not set so good unless they wish to establish an advertising department in their business. (I have this done for a few of my friends.)

That is, equip a service truck with a P.A. system to rent out to your business associates and surrounding towns for a sufficient fee to show you some profit for doing so.

When I can get enough interest aroused so it can be a success I propose to apply for a U.S. charter and organize a National Sound Truck Association. We will then tie right in with and cooperate with A.S.C.A.P. and help them organize a department that will look after the enforcement of a national law which we will have to back us up in our undertaking, to compel every individual who wants to have a sound truck for himself, to join the organization and procure his license from A.S.C.A.P. That is the only way we will ever stop this idea of a Service Man throwing a small P.A. system into a car or truck and letting his friends use it for \$2 or \$3 a day—or nothing, in some cases. If sound advertising is any good to them at all, it's good enough to pay for. And if the Service Man has to pay \$50.00 a year for his license to operate, he is going to make his friends pay for using it.

Therein is the answer to Mr. Haslo's question as to why something can't be done about such cities as New York and others charging \$15.00 a day license for operating a sound truck. Why have the larger cities done this thing? Because there was no organization to control the operation of sound trucks, and when one fellow saw another getting a few dollars that way they sprang up like bees and some of our city streets were a bedlam of noisy, inefficiently-operated P.A. systems thrown into old rattle trap cars and service trucks; these were then operated by young fellows who knew nothing about talking over a P.A. system, let alone writing sensible, effective advertising continuity. So what other way did our city officials have of clearing the streets of this hullabaloo, than to pass ordinances and tack on a license that would stagger these fellows and so discourage them from any such way of gaining a few dollars outside of their service work.

I was in the advertising business (my specialty, direct mail), and doing copy service for a few clients back in 1923 and '24 when I saw the opportunity of the sound truck service and was the first person to go into it as a business in 1925. But in only a few months 3 others started up and because of that an ordinance soon ruled us off the streets. But I am at it again and do-

G. E. PHONOGRAPH MOTOR

\$4.95
4



Formerly Sold for \$15.00

VARIABLE speed induction type self-starting, 110 volt, 25 to 60 cycle, AC, with speed control. Plug and cord. Speed range from 5 to 200 RPM. Can be installed in place of old-fashioned, hand-winding speed motor. Also ideal for display turn table, and a hundred other uses. These G.E. Electric Motors are brand new, in original factory cartons. Same motor that formerly sold **\$4.95** for \$15.00. Only **\$4.95**

Shipping weight—12 lbs.

Westinghouse Power Generator

Manufactured for U. S. Signal Corps.
 200 Watt 110 V. AC



A. C. ELECTRICAL POWER

from a Windmill, from available Waterpower, from your Automobile, from your Motorcycle, from your Bicycle, Foot-pedals or Handcrank; operates A.C. Radio Sets in D.C. districts, also A.C. Radio Sets from 32 V. D.C. farm light systems; use two generators in series to get 200 V. A.C. Used as an A.C. Dynamo, lights ten 20 Watt 110 Volt lamps; Short Wave Transmitter supplying 110 Volts A.C. for operating "Ham" Sets; Motor Generator; Public Address Systems; Camp lighting; etc., etc.

There Are Over-25 Applications

Specifications:
HOUSING—Aluminum (Diameter 8 1/2 in. Length—5 1/2 in.). **SHAFT**—2 3/16 in. (driving end). Diameter—9/16 in. (the end is threaded for a distance of 1/2 in.). **BASE**—Cast Iron (Length—7 1/2 in. Height 1 9/16 in. Width 4 1/2 in.). **OUTPUT**—200 Watt 110 volts AC (speed 4500 R.P.M.). **STATORS**—Two pairs (two North and two South). **ROTOR**—12 tooth inductor. Built-in commutator. Rotor turns in ballbearings.
 1/2 to 3/4 H.P. needed to run generator.
BLUE-PRINT 22 x 28 in. and **Four-Page 8 1/2 x 12 in. Applications and INSTRUCTION SHEETS** FREE with Generator.
 Generator, as described, including four replacements carbon brushes. Blue-print and instructions **\$7.90**
 Send \$2.00 deposit, balance C.O.D.
 Shipping weight 16 lbs.
 (Replacement carbon brushes bought separate \$1.50 per set of four. Set of instructions bought separate \$1.00.)

All merchandise in original packages—never used. Money-back guarantee.

All Shipments will be forwarded by Express Collect if not sufficient postage included.

WELLWORTH TRADING CO.
 560 W. Washington Blvd., Dept. RC-237, Chicago, Ill.

Please Say That You Saw It in RADIO-CRAFT

25-Pc. Radio Experiment Kit

Almost a "University in itself". Finest apparatus. Everything for scores radio hook-ups. Contains variable loss condensers, polarized test receiver, crystal detector, many special resistors, condensers, sockets, test clips, coil form, wire, bolts, screws, nuts, test sheet, etc. (Retail price \$15) **\$3.99**

FREE! 8 Books, value \$5.50, with kit. "Short Course in Radio", "Short Course in Electricity", "Electric Arc Manual", "Fun with Electricity", "Motor Transformer Manual", "Plans for Exper. Lab'y." **ORDER NOW!** Se stamp brings Electrical-Radio-and-Tool bargain rating!

ELECTRICAL SALVAGE CO., Box 524-A21, Lincoln, Nebr.

BUILD IT YOURSELF

You can build this Trailer with ordinary tools easily from our step-by-step construction sheets and large sized blueprints. Finest designed Trailer in existence, sleeps 4. Toilet, Shower, Electric Light, etc. Save 75% of the cost by building it yourself. Send 25c for plans sheet, illustrations and details.

THE PLAN SHOP, 910 Palmetto Bldg., Chicago, Ill.

Do you still need one or more of the GERNSBACH OFFICIAL RADIO SERVICE MANUALS to complete your files? If so, please turn to page 512 of this issue.

"Selfink"

FOUNTAIN PEN

\$1.50

An amazing invention . . . plain cold water becomes ink in this pen! There's a concealed stick of ink, Inxite, that supplies ink as you write. Of course it would write with regular ink but the convenience of the dependable Inxite is evident for travel, for school, for business men who must have a pen ready when a client wishes to sign.



Instructions and guarantee accompany each pen. Indestructible black pyralin, chrome mountings. Point tipped with Iridium . . . smooth writing.

FILL IT WITH WATER AND IT WRITES INK!!!!

GRENPARK COMPANY
99 HUDSON ST., NEW YORK, N. Y.

GRENPARK COMPANY
99 Hudson St., New York, N. Y. RC-237
Gentlemen: Enclosed herewith please find my remittance for \$..... for which kindly send me of the SELFINK FOUNTAIN PEN, post-paid, at \$1.50 each.

NAME

ADDRESS

CITY STATE

ing good because I meet the requirements of what the business man wants in this type of advertising. And I cooperate with the authorities as to time, place and volume. And because I was in the commercial department of a large broadcasting station for 2 years, arranging programs, writing commercial continuity and announcing, I will admit that the average sound man cannot operate quite as efficiently as I do. Because I work from my truck just as I would from the studio and unless people are where they can see the truck they think they are hearing a radio program (so many have told me). For that reason I have plenty to do as I am in a field where we have no local radio station.

So to sum it all up, let's cooperate with the A.S.C.A.P. and pay our fee for playing the records, help them organize state offices where they have not already done so, help them appoint county representatives to control these fellows who try to chisel, and thus have our sound-truck business and national organization all together, for the good of all of us.

L. C. ZIMMERMANN,
Marion, Indiana.

Any comments, fellows?

OPERATING NOTES

(Continued from page 482)

57 1st-detector oscillator tube to oscillate over the entire band. Changing the tube may help, although in some cases it is necessary to try several before a good oscillator can be found. The same tube can be used if the 250- and 2,000-ohm carbon resistors in the cathode circuit of the 57 are changed to 150 ohms and 2,500 ohms, respectively.

Pilot 8, 84, 7, 81. The symptoms of distortion, low sensitivity, and in a few instances, circuit oscillation, have been traced to a carbonized voltage-divider system composed of a 7,500-ohm and 9,000-ohm carbon resistors. A quick check for this condition may be made between the screen-grid of the 2A5 and chassis with an ohmmeter. A reading of approximately 16,500 ohms should be obtained here. The large carbon resistor should be replaced with a 10-W. wire-wound unit.

Highly distorted reproduction and hum have been found to be caused by a short-circuited or leaky 2A5 cathode bypass condenser. The grids of the 2A5 tube will glow red when this condenser breaks down.

Philco 45. The symptoms of sharp tuning which sometimes result in a slight whistle at the resonant point in the Philco model 45, coupled with the difficulty of accurately tuning the receiver because of this annoying whistle may be overcome in the following way. First the value of the cathode bias resistor for the first I.F. amplifier stage should be increased from the original value of 200 ohms to approximately 500 ohms.

Second the trimmers on the first I.F. stage should be carefully readjusted to resonance following the service instructions supplied by the manufacturer for this set.

BERTRAM M. FREED.

Majestic 90. With the passage of another year many more months of service have been taken from a well-liked receiver, the Majestic 90, bring a condenser failure which causes abrupt fading and abrupt restoration to normal accompanied in some cases by radio frequency oscillation squealing. The Service Man will immediately think of the detector plate filter condenser in the power pack. If that condenser is OK or has been replaced the trouble will be found in the chassis at the R.F. plate bypass condensers. In some cases one or both may be shorting, but usually they will be open circuiting which causes the squealing at high frequency dial settings. It is well to replace both of them. Self-shielded, non-inductive cartridge condensers 0.25-mf.; 400 V. do the job if they are rigidly supported. A strong support may be had by leaving the original flat cased condensers soldered to the chassis, clipping the ground wires which takes them out of the circuit but leaves the "hot" lug available to hold all wires, including the new condenser pigtail.

P. W. STEELMAN

Please Say That You Saw It in RADIO-CRAFT

DO YOUR TESTING INSTRUMENTS-

- measure A. C. with the obsolete copper oxide rectifier meter?
- have inaccurate readings with changes of frequency and temperature?
- have no facility for measuring currents in A.C. microamps, milliamps, amps?
- have limitations in measuring low and high resistances accurately?
- have limitations in measuring large and small capacities accurately?



MODEL 410 Master Multitester

You can do away with all these troubles if you use our Model 410 Master Multitester. This famous instrument, combining 41 meters in a single, easy-reading one, represents advance in testing equipment.

It gives ranges and measurements never before available.

For free catalog showing this Master Multitester, as well as complete line of quality testing instruments for service men, write to Department C-2, Radio City Products Company, 88 Park Place, New York.

RADIO CITY PRODUCTS CO.
88 PARK PLACE NEW YORK CITY. "DEPEND ON DEPENDABLE"

Install The Original!

Assure Customer Satisfaction **NORWEST STREAMLINE** AUTO ANTENNA
PAT. PENDING, U. S. & CANADA

Old man winter is pretty tough on most undercar antennas. Make real money this winter installing and replacing with Norwest. Especially designed for turret top cars. No holes to drill. Mounts on rubber vacuum cup standoffs. Adds to streamline appearance. Low motor noise level obtained by shielding effect of car top. Cannot be broken off or shorted out by snow, ice, or mud. Increases volume and distance. Works equally well on fabric top cars. A quality engineered product. Dealers, write for complete information and name of nearest jobber.

Sedan or Coach \$5.50 Coupe \$5.00
NORWEST RADIO LABORATORIES
3454 FULLERTON AVE. Dept. B-3, CHICAGO, ILL.

Western Division Shelby, Montana

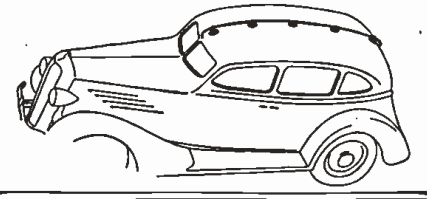

Learn SOUND RECORDING TALKING PICTURE PROJECTION TELEVISION-RADIO
Master training courses qualify you for good jobs. Practical, easy to learn. Newest equipment 30,000 great sets. Free room and board while learning. Cash R. R. fare allowed. L. A. Write for FREE BOOK Address Dept. RC-4000 S. Figueroa St.
NATIONAL SCHOOLS - Los Angeles

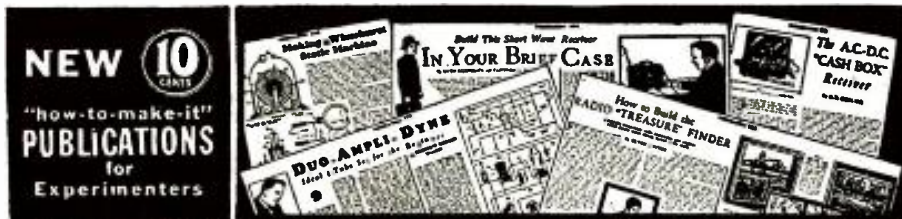

WE list below a large number of radio, short-wave, and mechanical "how-to-make-it" designs. Each is a special publication originated by masters in their respective fields. For the first time, at the low price of TEN CENTS, you are now enabled to buy a complete design with photographic reproductions, complete mechanical layout, and full description to make it possible for anyone to build the project in question.

The name of "Radio Publications" has become a household word because this company has for many years specialized in radio and other articles of special interest to the experimenter.

PLEASE ORDER EACH PROJECT BY ITS PUBLICATION NUMBER, and use the special coupon below.

We accept money-orders, cash, checks or new U. S. stamps. (No foreign stamps or currency can be accepted.) If you send cash or stamps, be sure to readdress your letter to safeguard against loss.

Money refunded if you are not satisfied.

ANY TWELVE PUBLICATIONS FOR ONE DOLLAR

Partial List of New 10 Cent Publications

SHORT-WAVE RECEIVER PUBLICATIONS

- HOW TO MAKE THE 2 TO 5 METER TWO-TUBE LOUD-SPEAKER SET.** This receiver may be used with batteries or with an A.C. power pack. Pucks a big wallop. No. 107
- HOW TO BUILD THE CIGAR-BOX 1-TUBE "CATCH ALL" RECEIVER.** An effective short-wave battery set which fits into a small cigar-box, insuring high portability yet great efficiency. No. 111
- HOW TO BUILD THE PORTABLE MINIDYNE SHORT-WAVE BATTERY SET.** Uses no tubes or batteries. The total weight is 3 3/4 lbs. and measures 5x5x8 inches. Self-contained batteries, tube, condensers, and loop. Highly sensitive circuit. No. 114
- HOW TO BUILD THE HAM-BAND "PEE-WEE" 2-TUBE.** A dandy receiver with high efficiency and bandspread tuning. Works a loudspeaker, yet the entire receiver is no larger than your hand. Works with either batteries or an A.C. power pack. No. 115
- HOW TO BUILD THE DUO-AMPLIDYNE.** The ideal 1-tube set for the beginner. One of the finest 1-tube sets; it really gives 2-tube performance. Made for battery operation. With only ten-foot antenna brings in the good European stations. No. 116

RADIO BROADCAST RECEIVER AND SPECIAL RADIO PUBLICATIONS

- HOW TO BUILD A SUPER-SENSITIVE ALL-WAVE CRYSTAL SET.** Just the thing for beginners who wish to have an easy-to-operate crystal set on all-waves and which will separate all the stations. Can be made for less than \$2.00. Uses no tubes or batteries. No. 121
- HOW TO BUILD THE 2-TUBE "PENTODE PORTABLE" BROADCAST SET—the lightest, smallest set giving loud-speaker volume on batteries.** Weighs less than 12 pounds. Built in a small, portable case. No. 122
- HOW TO BUILD THE RADIO "TREASURE" FINDER.** This is a really sensitive and practical "Treasure" finder. Simple to build and guaranteed to work. Uses 4 tubes. Can be built for less than \$15.00. No. 124
- HOW TO BUILD THE GERNSBACK ONE-TUBE PENTODE LOUDSPEAKER SET.** This is the best one-tube loud-speaker set ever constructed. It works on batteries, and is for broadcast reception. Extremely sensitive. No. 124
- HOW TO BUILD THE WORLD'S SMALLEST ONE TUBE BATTERY RADIO.** So small that it is actually built in a cigarette case. The wonder set of the last New York radio show. No. 125
- HOW TO BUILD A 6-TUBE BATTERY ALL-WAVE "FARM PORTABLE" SET,** ranging from 12 to 2-100 meters. A real portable that pulls in the stations. No. 126
- HOW TO MAKE AN A.C.-D.C. ONE-TUBE "DEAF AID."** An excellent aid for the hard-of-hearing and deaf, for theatres, churches, and the home. A godsend for all afflicted persons. Can be built for a few dollars. No. 127
- HOW TO BUILD A PIANOTRON.** For less than two dollars plus a few junk parts which you have, you can now make a beautiful musical instrument. Operated by three radio tubes, it has an actual keyboard, and you can play tunes. Works on "A" and "B" batteries. A great novelty due to the unusual music which issues from the loud-speaker. No. 128
- HOW TO BUILD THE ONE-DOLLAR RADIO.** Impossible though it sounds, for one dollar you can build a radio set which includes a radio tube and a pair of headphones and batteries. You make everything yourself, outside of the three last mentioned items. From wood and spare metal parts. No. 129

MECHANICAL PROJECTS PUBLICATIONS

- HOW TO BUILD A PEE-WEE AUTOMOBILE.** An ultra-small automobile that can be built for less than 10 dollars. Will carry two 17-year-old boys. Runs 35 miles per hour and 100 to 125 miles on one gallon of gas. No. 132
- HOW TO MAKE A BAND SAW FROM OLD AUTO PARTS.** Made from old Ford and Chevrolet parts. Capable of performing delicate and satisfactory work. Uses 25-gauge 10 and 2-inch hand saws. Assembly is easy for each part fills its allotted place perfectly. No. 135
- HOW TO BUILD A REAL LATHE FOR \$5.00.** Requires a few hand tools, about \$5.00 worth of raw materials and patience to build. The lathe is capable of drilling, milling, trimming, boring and thread cutting. No. 136
- HOW TO BUILD A SIMPLE PORTABLE REFRIGERATOR.** A real refrigerator. Does not use ice. The cooling unit operates from an alcohol flame, oil burner or open fire. Easy and inexpensive to build. Excellent for boats, camps, picnics, etc. No. 138
- HOW TO BUILD THE TESLA AND QUIN COILS GIVING 18-INCH SPARKS.** Interesting high-frequency apparatus with which many high-frequency and x-ray experiments can be performed. Capable of producing 15,000 volts. No. 141
- HOW TO MAKE AN ARC WELDER.** A real arc welder capable of doing commercial jobs satisfactorily. Uses a heavy duty transformer which operates from the 110-volt A.C. main. The output of the machine ranges from 15 to 100 amperes. No. 142
- HOW TO USE AN A.C. ARC WELDER.** Companion publication to the one listed directly before. Very informative; especially to the garage man or mechanic who has had little or no experience with an arc welder. Contains many important diagrams and photographs of actual work done with an arc welder. No. 143
- HOW TO MAKE YOUR OWN MICROSCOPE.** A microscope which the home mechanic can easily build in his shop. The lenses are obtained from the finders of a camera. Although simple and easy to build, it is a thoroughly practical and efficient instrument. No. 144
- HOW TO MAKE A WIMSHURST ELECTROSTATIC MACHINE.** An easily constructed generator of static electricity capable of discharging a fat three-inch spark. Used in schools where electricity is taught. Can be built for less than \$2.00. No. 145
- HOW TO MAKE A POWER DRILL PRESS FROM SCRAP PARTS.** An excellent practical drill press that will make work easier for the mechanic. About \$2.00 worth of raw material and scrap iron are the only requirements. No. 146
- HOW TO MAKE AND EXPERIMENT WITH AN ELECTROPHORUS.** With this device numerous interesting experiments with static electricity can be performed. Many of these experiments are thoroughly explained and illustrated. No. 148

RADIO PUBLICATIONS 99A HUDSON STREET NEW YORK, N. Y.

RADIO PUBLICATIONS, 99A Hudson Street, New York, N. Y. RC-237

I enclose \$..... for the publications listed by number, at right, at 10c a copy (ONE DOLLAR FOR ANY TWELVE PUBLICATIONS.) These publications are to be sent to me postpaid. I have placed a circle around each number which I want.

Send me also your list of 27 other 10c publications.

Name	Address	107	111	114	115	116
City	State	121	122	123	124	125
		126	127	128	129	132
		135	136	138	141	142
		143	144	145	146	148

AWARDS IN THE \$1,800 OFFICIAL RADIO SERVICE HANDBOOK CONTEST

LISTED below are the remaining names in the list of winners in the Official Radio Service Handbook Prize Contest which was sponsored jointly by Gernsback Publications, Inc. publishers of the Official Radio Service Handbook and a number of the most important radio manufacturers.

42nd Prize. Roland Himburg, Camp BR-19-A, Phoenix, Arizona. Awards: Radio City Products Co., model 501P portable analyzer unit; Bud Radio, Inc. No. 1111 complete kit of insulated screwdrivers.

43rd Prize. J. Francis Lynn, 627 Madison Ave., Jermyn, Penna. Awards: Insuline Corp. of America No. 1036 vacuum tube voltmeter kit; Bud Radio, Inc. No. 1111 complete kit of insulated screwdrivers.

44th Prize. Howard Eden, 423 S. Poplar, Sapulpa, Okla. Awards: Insuline Corp. of America No. 1036 vacuum-tube voltmeter kit; Bud Radio, Inc., No. 1111 complete kit of insulated screwdrivers.

45th Prize. Schislors Radio Service, 414 S. Johnson St., Macomb, Ill. Awards: Solar Mfg. Corp. No. C1 steel service chest; Bud Radio, Inc., No. 1111 complete kit of insulated screwdrivers.

46th Prize. Drexal McCabe, c/o Drexals L. & S. Radio Shop, Clarksburg, W. Va. Awards: Radio City Products Co. model 502P portable analyzer unit; Bud Radio, Inc., No. 1111 complete kit of insulated screwdrivers.

47th Prize. Wm. Nylund, 190 Third St., P. O. Box 3, Sagamore, Pa. Awards: Cornell-Dubilier Corp. No. KD24 kit of 24 assorted tubular condensers; Bud Radio, Inc., No. 1111 complete kit of insulated screwdrivers.

48th Prize. Wallace E. Babb, 1454 West Third St., Davenport, Iowa. Awards: Insuline Corp. of America No. 2090 adapter kit of modernizing test equipment; Bud Radio, Inc. No. 1111 complete kit of insulated screwdrivers.

49th Prize. Radula Radio Service, 48 Chaussee de Termonde a Baasrode, Belgium. Awards: Insuline Corp. of America No. 2090 adapter kit of modernizing test equipment; Bud Radio, Inc., No. 1111 complete kit of insulated screwdrivers.

50th Prize. C. E. Dickerman, Lock Box 42, East Corinth, Vt. Awards: Insuline Corp. of America No. 2090 adapter kit of modernizing test equipment; Bud Radio, Inc., No. 1111 complete kit of insulated screwdrivers.

51st Prize. Samuel Rosenhaft, 1465 East 49th St., Brooklyn, N. Y. Awards: Insuline Corp. of America No. 2090 adapter kit of modernizing test equipment; Bud Radio Inc., No. 1111 complete kit of insulated screwdrivers.

52nd Prize. Howard J. Ketz, 936 Adler St., Scranton, Pa. Awards: Insuline Corp. of America No. 2090 adapter kit of modernizing test equipment; Bud Radio, Inc., No. 1111 complete kit of insulated screwdrivers.

53rd Prize. George M. Havrilla, 268-22 Ave., S. Minneapolis, Minn. Awards: Insuline Corp. of America No. 2090 adapter kit of modernizing test equipment; Bud Radio, Inc., No. 1111 complete kit of insulated screwdrivers.

54th Prize. Ross B. Hunt, 41 Main St., Orange, N. J. Award: Bud Radio, Inc., No. 815 lock-on analyzer plug and adapter kit.

55th Prize. Herbert Seligson, 2547 Aqueduct Ave., New York, N. Y. Award: Bud Radio, Inc., No. 815 lock-on analyzer plug and adapter kit.

56th Prize. Geo. B. Thompson, 1611 1/2 S. Arlington Ave., Los Angeles, Calif. Award: Bud Radio, Inc., No. 815 lock-on analyzer plug and adapter kit.

57th Prize. Arthur Risley, Rishfield Springs, N. Y. Award: Bud Radio, Inc., No. 815 lock-on analyzer plug and adapter kit.

58th Prize. Allen Schiavoni, 2014 South 13th St., Philadelphia, Penna. Award: Bud Radio, Inc., No. 815 lock-on analyzer plug and adapter kit.

59th Prize. W. F. Onder, 3725 Louisiana Ave., St. Louis, Mo. Award: Bud Radio, Inc., No. 815 lock-on analyzer plug and adapter kit.

60th Prize. Newell Kelley, 208 Congress St., East McKeesport, Pa. Award: Cornell-Dubilier Corp. No. IF1 interference eliminator unit

The 1936 Official Radio Service Manual

IS NOW READY!

FULL DETAILS APPEAR ON PAGE 452

Please Say That You Saw It in RADIO-CRAFT

ADVERTISERS' INDEX

A	
Alloy Transformer Co., Inc.	508
Aerovox Corporation	494
Allied Radio Corporation	489
Amperite Corporation	493
Amplifier Co. of America	504
Amplitone Products Company	508
Arrow Sales Corporation	508
C	
Central Radio Laboratories	492
H. E. Clarke Company	508
Classified Section	507
Clough-Brengle Company	506
Cornell-Dubilier Corp.	498
Cornish Wire Company	502
Coyne Electrical School	449
D	
Diathermy Co. of America	505
Dodge's Institute	504
Allen B. Dumont Labs., Inc.	491
E	
Electric Institute	483
Electrad, Inc.	496
Electrical Salvage Co.	509
Electro-Dyne Mfg. Co.	503
G	
General Cement Mfg. Co.	498
General Electric Company	Back Cover
Goldentone Radio Co.	491
Grenpark Company	488, 508
H	
Hallcrafters, Inc.	505
Hammarlund Mfg. Company	507
Hygrade-Sylvania Corp.	501
I	
Illinois Condenser Co.	504
Industrial Amplifier Systems Co.	507
International Corresp. Schools	508
International Electronics, Inc.	507
J	
J M P Manufacturing Co.	504
Jobs & Careers	507
K	
Kenyon Transformer Co., Inc.	488
L	
Lincoln Engineering School	503
M	
McGraw-Hill Book Company	496
Midwest Radio Corporation	487
Milton Radio & Tel. Labs.	496
N	
National Radio Institute	451
National Schools	509
National Union Radio Corp.	495
New York YMCA Schools	502
Norwest Radio Labs.	509
O	
Clarence A. O'Brien & Hyman Berman	505
Oxford-Tartak Radio Co.	494
R	
RCA Institutes, Inc.	498
RCA Mfg. Company, Inc.	505
Radio & Technical Pub. Co.	490, 491, 503
Radio & Television Institute	497
Radio Circular Company	492
Radio City Products Co.	509
Radio Publications	510
Radio-technic Laboratory	500
Radio Training Assoc. of America	480
Radolek Company	511
Raytheon Production Corp.	486
Radio Service Institute	505
Readrite Motor Works	499
Remington Rand, Inc.	507
S	
S. O. S. Corporation	494
Shallcross Mfg. Company	502
Solar Mfg. Company	495
Sprayberry Academy of Radio	493
Superior Instrument Co.	494
Supreme Instruments Corp.	Inside Front Cover
T	
TeloPlex Company	504
The Plan Shop	509
Triad Mfg. Company	502
Triplet Elec. Instrument Co.	485
Try-Mo Radio Co., Inc.	498
W	
Wellworth Trading Co.	508
Weston Elec. Instrument Co.	Inside Back Cover
Wholesale Radio Service Co.	500
Williams Philco, Inc.	508
Wright-DeCoster, Inc.	511
Z	
Zephyr Radio Company	498

(While every precaution is taken to insure accuracy, we cannot guarantee against the possibility of an occasional change or omission in the preparation of this index.)

- 61st Prize. John W. Ritenour, 218 E. King St., Martinsburg, W. Va. Award: Cornell-Dubilier Corp. No. IF1 interference eliminator unit.
- 62nd Prize. C. L. Van Liew, Rt. 1, Box 124, Raymond, Wash. Award: Cornell-Dubilier Corp. No. IF1 interference eliminator unit.
- 63rd Prize. Emerson Reid, P. O. Box 274, Grand Forks, B.C., Canada. Award: Cornell-Dubilier Corp. No. IF1 interference eliminator unit.
- 64th Prize. A. Geo. Peterson, Rt. 2, Box 15, Escalon, Calif. Award: Cornell-Dubilier Corp. No. IF1 interference eliminator unit.
- 65th Prize. Elmo Spangler, 410 S. Main St., Corbin, Ky. Award: Insuline Corp. of America 115-watt heavy-duty soldering iron.
- 66th Prize. N. Lanzara, Jr., 68 Ballston Ave., Saratoga, N. Y. Award: Insuline Corp. of America 115-watt heavy-duty soldering iron.
- 67th Prize. Harold W. Ward, 3472 N. Main St., Fall River, Mass. Award: Insuline Corp. of America 115-watt heavy-duty soldering iron.
- 68th Prize. L. Campbell, Endeavor, Wis. Award: Solar Mfg. Corp. No. RN elim-o-stat.
- 69th Prize. Frank Pierce, Eureka, Ill. Award: International Resistance Co. dual resistance indicator.
- 70th Prize. Alan F. Taylor, 73 Central St., Hudson, Mass. Award: Cornell-Dubilier Corp. No. KA12 kit of 12 assorted paper tubular condensers.
- 71st Prize. J. H. Cramer, 1226 Military Ave., Council Bluffs, Iowa. Award: Cornell-Dubilier Corp. No. KA12 kit of 12 assorted paper tubular condensers.
- 72nd Prize. Canuto Pusta, Loboc, Oroquieta, Misamis, Occ., P. I. Award: Cornell-Dubilier Corp. No. KA12 kit of 12 assorted paper tubular condensers.
- 73rd Prize. Norman C. Taylor, 224 Oak St., Dayton, Ohio. Award: Cornell-Dubilier Corp. No. KA12 kit of 12 assorted paper tubular condensers.
- 74th Prize. Chas. W. Schisler, 414 S. Johnson St., Macomb, Ill. Award: Insuline Corp. of America No. 998 neutralizing and aligning tool kit.
- 75th Prize. L. E. Shelton, 532 Kitchener, Detroit, Mich. Award: Insuline Corp. of America No. 998 neutralizing and aligning tool kit.
- 76th Prize. Geo. C. Northrup, R. D. No. 2, Voorheesville, N. Y. Award: Insuline Corp. of America No. 998 neutralizing and aligning tool kit.
- 77th Prize. Albert Gardner, 1017 W. Washington St., Mount Pleasant, Pa. Award: Insuline Corp. of America No. 998 neutralizing and aligning tool kit.
- 78th Prize. Alvin L. Campbell, Box 40, Burdett, Alberta, Canada. Award: Insuline Corp. of America No. 998 neutralizing and aligning tool kit.
- 79th Prize. Leo Paul Lessard, 100 Green St., Biddeford, Me. Award: Cornell-Dubilier Corp. KM10 kit of 10 assorted mica condensers.
- 80th Prize. Stanley S. Jarecki, 57 Ridge St., Gleen Lyon, Pa. Award: Cornell-Dubilier Corp. IF2 interference eliminator unit.
- 81st Prize. Edw. Duda, 282 Fridel St., Whitaker, Pa. Award: Cornell-Dubilier Corp. IF2 interference eliminator unit.
- 82nd Prize. Martindale Radio Shop, 222-24 Oak St., Dayton, Ohio. Award: Cornell-Dubilier IF2 interference eliminator unit.
- 83rd Prize. W. K. Kincaid, 6975 N. Montana Ave., Portland, Ore. Award: Cornell-Dubilier Corp. IF2 interference eliminator unit.
- 84th Prize. Lambert Holland, Elkton, S. Dak. Award: Cornell-Dubilier Corp. IF2 interference eliminator unit.
- 85th Prize. J. M. Canestorp, Elbow Lake, Minn. Award: Insuline Corp. of America No. 999 lock-socket wrench and screwdriver set.
- 86th Prize. Theo. R. Walker, 414 Lodge St., Alcoa, Tenn. Award: Insuline Corp. of America No. 999 lock-socket wrench and screwdriver set.
- 87th Prize. V. G. Bidwell, Service Dept., Scogins Appliance Co., Muskogee, Okla. Award: Insuline Corp. of America No. 999 lock-socket wrench and screwdriver set.
- 88th Prize. D. D. Truesdale Bunker Hill Ill. Award: Insuline Corp. of America No. 999 lock-socket wrench and screwdriver set.

NOKOIL

The Permanent Magnet Speaker with Electro-Dynamic Performance

Model 482

The New 5-inch Wright-DeCoster NOKOIL Reproducer—splendid for

- Inter-Communication Systems
- Battery Radios
- Light Call installations

From the smallest reproducer for the radio set to the large 12" Public Address Unit. *The World's most complete speaker line.*

Protect yourself by insisting that the name "NOKOIL" appears on all Permanent Magnet Speakers you purchase.

The Model 482 list for Only **\$4.82.**

Write for Circular and prices. Wright-DeCoster distributors are always anxious to cooperate.

WRIGHT-DECOSTER, Inc.
 2251 University Ave., St. Paul, Minnesota
 Export Dept.—M. Simons & Son Co., New York.
 Cable Address: "Simonrice."
 Canadian Office, Associated Sales Co., Guelph, Ont.

No Matter How You Look At It...



The Radolek New 1937 Radio Profit Guide is the most complete Radio Parts Catalog ever published. Completely revised—right up to the minute, bringing you everything in Radio—and Public Address—at the right prices. Every page brings you extra profits! Contains over 10,000 individual Radio Repair Parts—hundreds of new items—a complete new selection of Radio Receivers, P. A. Amplifiers, Tools, Tubes, Books and Test Instruments. Everything you need—always in stock... ready for prompt shipment to you. You need this Big Radio Parts Catalog—It's FREE! Send for It!

RADOLEK restricts distribution of this catalog to active and legitimate Radio Men. Please enclose your business card or letterhead—

RADOLEK

601 W. Randolph St., Dept. C-2, Chicago
 Send the Radolek Profit Guide Free.

Name

Address

Service man? () Experimentor? ()
 Dealer? ()

Please Say That You Saw It in RADIO-CRAFT

GERNSBACK RADIO MANUALS AND SERVICE HANDBOOK ARE AVAILABLE FROM JOBBERS AND MAIL ORDER HOUSES

Your nearest radio jobber and mail order house carries a complete stock of Gernsback Official Radio Service Manuals and Service Handbooks. For quick, efficient service visit or write them today. There is no delay. Your Manual or Handbook will be in your hands in a day or two. Our vast distribution network permits us to offer you the rapid, intelligent service you have a right to expect from your publisher.

Here's the New Book for Radio Men!

Official Radio Service Handbook

by J. T. Bernsley



HERE'S the new book on radio servicing that contains everything Service Men must know. The book, OFFICIAL RADIO SERVICE HANDBOOK, is edited by J. T. Bernsley, foremost radio service authority. This 1936 service guide is the only book of its kind—the editorial material is so well prepared that the technical information can be understood by even beginners in radio servicing. Every page contains new material, new illustrations—no reprinted literature. The OFFICIAL RADIO SERVICE HANDBOOK covers thoroughly over 500 radio topics. It tells you how to analyze the latest commercial receiver circuits; how to really make money servicing midget sets; and how aligning supers can be made easy. It stresses the many uses of different types of test equipment; it gives you short cuts in trouble-shooting and repairing; and contains over 250 pages of operating notes on 1,000 manufactured receivers. So up-to-date is the OFFICIAL RADIO SERVICE HANDBOOK that it explains thoroughly the features and innovations in the most modern of receivers.

Partial Contents of This Great Book!

- PART 1—CIRCUIT THEORY AND ANALYSIS**
R.F. Fundamentals; Superheterodyne Receiver Theory; A.V.C. and Tuning Indicator Circuits; A.F. Fundamentals; Power Supply Theory and Circuits; Speakers, Reproducers and Pick-Ups; Commercial Receiver Circuits of All Types. How to Analyze.
- PART 2—MODERN SERVICING AND TEST EQUIPMENT**
Fundamentals of Metering and Test Equipment; Standard Servicing Instruments; The Cathode Ray Oscilloscope and Associate Instruments; How to Build Essential Servicing Test Instruments.
- PART 3—PRACTICAL SHORT-CUTS IN TROUBLE SHOOTING AND REPAIRING**
Localizing Trouble by Inspection Methods; Short-Cuts with Test Instruments; How to Quickly and Properly Perform All Types of Repairs; Unusual Servicing Experiences; Tube Troubles and Characteristics.
- PART 4—SPECIALIZED RECEIVER AND INSTALLATION DATA**
All-Wave and High Fidelity Receiver Servicing and Installation Data; Auto Radio Receiver and Installation; Specialized Servicing and Installation (Remote Tuning Controls, Home Recording, Automatic Record Changers, Apartment House Antennae, etc., etc.); Eliminating Noise Interference.
- PART 5—MODERNIZATION AND CONVERSION DATA**
Modernizing and Improving Methods for All Types of Receivers; Converting A.C. Receivers for D.C. Operation and Vice Versa.
- PART 6—SOCIAL AND ECONOMIC PROBLEMS OF THE SERVICE MAN**
Improving Knowledge and Technique; Social Problems—How to Organize, Listing of Servicemen's Organizations; The Future of the Servicing Profession.
- PART 7—OPERATING NOTES AND PRACTICAL DATA LISTINGS**
Operating Notes on Over 1,000 Receivers; I.F. Peaks of Approximately 3,000 Receivers; Voltage Dividers for 300 Receivers, Speaker Field Listings; Radio Mathematics and Measurements.

OVER 250 PAGES OF OPERATING NOTES

Whether it is a fading job, lack of sensitivity, noise within the receiver, aligning a chassis, poor A.V.C. action, a "cockeyed" Magic Eye tuning indicator or any other trouble that is usually the "bugaboo" of most Service Men, you will find the symptoms and remedy clearly described in OFFICIAL RADIO SERVICE HANDBOOK. The exact procedure for repairing, as well as the characteristic trouble in almost all models of manufactured sets, will be found in this section on OPERATING NOTES—over 250 pages of this data, the most important information to any radio man in the servicing field. The author takes nothing for granted. The procedure for aligning supers, whether one, two, three or more bands, is clearly and practically explained. You can quickly grasp the ideas and put them into successful practice. The material in this section has been arranged, as well as classified, so there is no difficulty in immediately locating the necessary information.

OVER 1,000 PAGES
OVER 1,000 ILLUSTRATIONS
Beautiful Linen, Gold-Stamped Cover 6 x 9 Inches

WHICH OF THESE OFFICIAL RADIO SERVICE MANUALS DO YOU NEED TO COMPLETE YOUR FILES?

There's perhaps one or more of these great service manuals which you might need to complete the set. Collectively they represent the largest collection of service data ever compiled. Evidence of their importance to Radio men is shown by the fact that over 80,000 OFFICIAL RADIO SERVICE MANUALS have been sold during the past few years.



- 1935 OFFICIAL RADIO SERVICE MANUAL**
Over 1,000 Pages, 9 x 12 Inches Over 3,000 Illustrations
Flexible, Looseleaf, Leatherette Cover
List Price \$7.00
- 1934 OFFICIAL RADIO SERVICE MANUAL**
Over 400 Pages, 9 x 12 Inches Over 2,000 Illustrations
Flexible, Looseleaf, Leatherette Cover
List Price \$3.50
- 1933 OFFICIAL RADIO SERVICE MANUAL**
Over 700 Pages, 9 x 12 Inches Over 2,000 Illustrations
Flexible, Looseleaf, Leatherette Cover
List Price \$5.00
- 1932 OFFICIAL RADIO SERVICE MANUAL**
Over 1,000 Pages, 9 x 12 Inches Over 2,000 Illustrations
Flexible, Looseleaf, Leatherette Cover
List Price \$5.00
- 1931 OFFICIAL RADIO SERVICE MANUAL**
650 Pages (Including Supplements) 9 x 12 Inches
Over 1,500 Illustrations
Flexible, Looseleaf, Leatherette Cover
List Price \$4.50
(Including Supplements)



- For Car-Radio Servicing—Get These
- ### AUTO-RADIO SERVICE MANUALS
- 1935 Official Auto-Radio Service Manual**
Over 240 Pages 9 x 12 Inches
Over 500 Illustrations
Flexible, Looseleaf, Leatherette Cover
LIST PRICE \$2.50
 - 1933 Official Auto-Radio Service Manual**
Over 240 Pages 9 x 12 Inches
Over 500 Illustrations
Flexible, Looseleaf, Leatherette Cover
LIST PRICE \$2.50

THE
1936 MANUAL
IS READY
See Page 452

If your jobber or mail order house cannot supply you, order any of the OFFICIAL RADIO SERVICE MANUALS or the OFFICIAL RADIO SERVICE HANDBOOK directly from the publishers. Send your remittance in form of check or money order—if you send cash or unused U. S. Postage Stamps, be sure to register your letter. ALL ORDERS ARE FILLED PROMPTLY. BOOKS ARE SENT TO YOU POSTAGE PREPAID. Address Dept. RC-237.

RADCRAFT PUBLICATIONS, INC.

99 HUDSON STREET

NEW YORK, N. Y.

THE
1936 MANUAL
IS READY
See Page 452

OVERSEAS READERS
These books can be obtained from the following houses:

GREAT BRITAIN
Gorrings, 9a, Green Street, Leicester Square, London, England

FRANCE
Editions Radio, 42 Rue Jacob, Paris

AUSTRALIA
McGill's 183-195, 218 Elizabeth St., Melbourne, C. I.

NEW ZEALAND
James Johnston, Ltd, 393 Princes St., Dunedin, C. E.

Please Say That You Saw It in RADIO-CRAFT

Go Places in '37

WITH THESE
AND OTHER
MONEY-MAKING

WESTON Instruments

Go further in '37 with WESTON instruments. Save time . . . because WESTONS simplify and expedite testing procedure. Build a satisfied clientele . . . have fewer call backs . . . because WESTONS do a thorough servicing job, and the readings are always dependable. *And save money* by not having to replace your instruments frequently. WESTONS are designed and built to serve dependably for years. Make yours a completely WESTON equipped shop in '37. It's easy to do with the WESTON INVESTMENT PLAN. Ask your jobber for details, or return coupon.

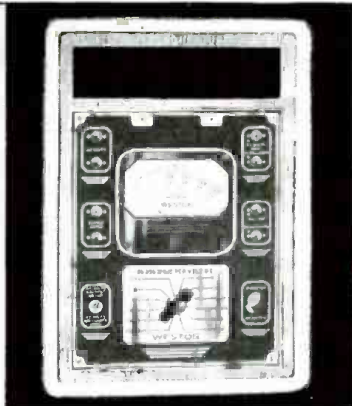

The WESTON Model 772 Analyzer. Sensitivity of 20,000 ohms per volt . . . resistance ranges readable up to 30 megohms . . . current indications as low as 1/2 microampere. Will put you years ahead of competition. Price \$46.50 net to dealers in U. S. A.



The WESTON Model 692 all wave, triple-shielded oscillator. A real laboratory job at a price servicemen can afford. Designed to do a precision aligning job on all radio receivers. Price \$45.00 net to dealers in U. S. A.



The WESTON Model 669 Vacuum Tube Voltmeter. For use with or without test oscillator . . . for measuring gain per stage . . . r.f. amplitude in oscillator circuit of superheterodynes . . . making all tests on a.v.c. currents . . . and all measurements where high frequency is a factor. Price \$45.00 net to dealers in U. S. A.



The WESTON Model 771 Checkmaster . . . a real tube checker plus continuity tester. A compact trouble-shooter for field use. Has voltage and resistance ranges for point-to-point and continuity testing. Price \$45.00 net to dealers in U. S. A.

WESTON
ELECTRICAL
INSTRUMENT
CORPORATION
599 Frelinghuysen Avenue,
Newark, New Jersey
Please rush me complete data on
all WESTON Radio Instruments.

NAME _____

ADDRESS _____

CITY _____

STATE _____

*Geoff
2403 Pine Ave*



Automatic Color Tuning

ASSURES FOCUSED TONE

YOU CAN SEE IT!

YOU CAN HEAR IT!

..... as it brings you Perfect Tuning . . Perfect Tone

The new 1937 General Electric Automatic Color Tuning Radio instantly corrects your tuning errors — in dramatic and amazing fashion. Set the dial the slightest bit off the mark and PRESTO! — it shifts itself into hair-line tuning. And, in the twinkling of an eye, the remarkable new Colorama Dial changes from red to green. When the dial glows green you can be sure your program is in perfect Focused Tone. Music and speech gain a new realism that must be heard to be believed.

Focused Tone means much more than perfect tuning. It brings you the first Personalized Radio — with a custom-tailored, personalized dial. Your local station letters flash on when you tune in. No more hunting up kilocycle numbers — because your favorite stations are marked by letters as well as kilocycles. And the new G-E brings you silent tuning. You can switch programs, at will, without a single squeal, squawk, or screech.

See — and hear — the radio sensation of the year. Stop in soon at your nearest G-E Radio dealer's. Compare the new G-E on tone — on performance — on beauty of design — and on price — with any and all other radios. Make this test and you'll buy the new G-E Automatic Color Tuning Radio.

WHAT IS FOCUSED TONE?

Focused Tone combines all the revolutionary new features described above, plus these new G-E Radio inventions and developments — G-E Metal Tubes; the G-E Sentry Box; G-E Stabilized Dynamic Speakers; G-E Sliding-rule Tuning Scale; G-E "V-doublet" All-wave Antenna. Focused Tone is G-E's greatest radio achievement. Only the new G-E gives it to you - **Automatically - Visibly - Instantly.**

The new G-E brings you every radio service on the air—Foreign Broadcasts over All short-wave bands; Domestic Short-wave Stations; Domestic Programs—heard with new tone perfection Palace Calls and Amateur stations — day and night.



The new General Electric comes in 26 handsome models — priced from \$22.50 to \$750 (Eastern list — slightly higher west and south).

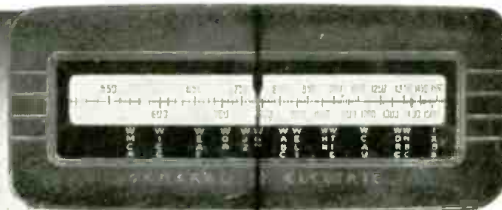

Lauritz Melchior — Distinguished artist of the opera and radio

— Harsh, blurred, discordant tone. Nine out of ten people unknowingly tune in their radios off focus.

The new G-E Radio automatically shifts itself into hair-line tuning every time. And at the same instant the fascinating new G-E Automatic Color Tuning changes from red to green to tell you your program is in perfect Focused Tone.

— Harsh, blurred, discordant tone. Nine out of ten people unknowingly tune in their radios off focus.

WHEN YOU REPLACE METAL TUBES, ALWAYS SPECIFY G-E

You'll always be glad you bought a G-E

GENERAL ELECTRIC

Radio

RESEARCH KEEPS GENERAL ELECTRIC YEARS AHEAD