

RADIO'S LIVEST MAGAZINE

OVER 175 ILLUSTRATIONS

Radio-Craft

Special
RADIO—
EXPERIMENTER
Number

December

25 Cents
in United States
and Canada

HUGO GERNSBACK Editor

MAKE THIS
WORLD'S SMALLEST
3-TUBE RADIO SET

See Page 328



Experiments with a "Hi-Fi" Amplifier—Radio-Controlled Model "Saratoga"
Newest "Treasure" Locator—A "Lie" Detector—Photocell Shooting Ranges

OVER 50,000 RADIO MEN READ RADIO-CRAFT MONTHLY



SUPREME

MODEL 550 RADIO TESTER

THE *Finest* THAT MONEY CAN BUY!
 \$6.00 DOWN—\$5.55 MONTHLY FOR 10 MONTHS



WE WILL SELL
 YOU ANY
 SUPREME
 INSTRUMENTS
 ON S. I. C.
 EASY TERMS

*Your Parts
 Jobber*



MODEL 400 TUBE TESTER
 \$4.50 Down—\$3.83 Monthly
 For Ten Months

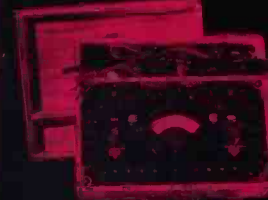

MODEL 450 SET TESTER
 \$4.00 Down—\$3.82 Monthly
 For Nine Months



MODEL 490 MULTI-METER
 \$4.00 Down—\$4.25 Monthly
 For Five Months

This impressive instrument performs the operations of 12 essential servicing instruments: Radio and P. A. analyzer. Electrostatic and electrolytic capacitor leakage tester. Multi-range ohmmeter. Multi-range DC voltmeter. Multi-range AC voltmeter. Multi-range DC milliammeter. Multi-range decibel meter. Multi-range output meter. DC ammeter. Condenser capacity meter. A total of 43 ranges and functions.

It has the latest improvement in meters — the big double window illuminated Quadrimeter.

It accurately checks all circuits for voltage, current and resistance.

Allows test of all types of tubes by comparative "Grid-shift" method. Makes accurate tests of all electrolytics at rated voltage from built-in DC power supply. Also measures capacitances from 0-14 mfd. Neon tube shows leakage or shorts in all paper, mica or oil capacitors. Provides point-to-point resistance and voltage measurements. All resistance, voltage, capacity and current readings are secured through the 9 conductor analyzer cable. Tests made without removing chassis from the cabinet. Oak finished metal panel is housed in a solid quartered oak carrying case.

SUPREME INSTRUMENTS CORP. GREENWOOD MISS., U. S. A.

EXPORT DEPT., ASSOCIATED EXPORTERS CO., 145 W. 45th STREET, NEW YORK, N. Y., CABLE ADDRESS: LOPREH, N. Y.

OPPORTUNITIES *are many* for the Radio Trained Man

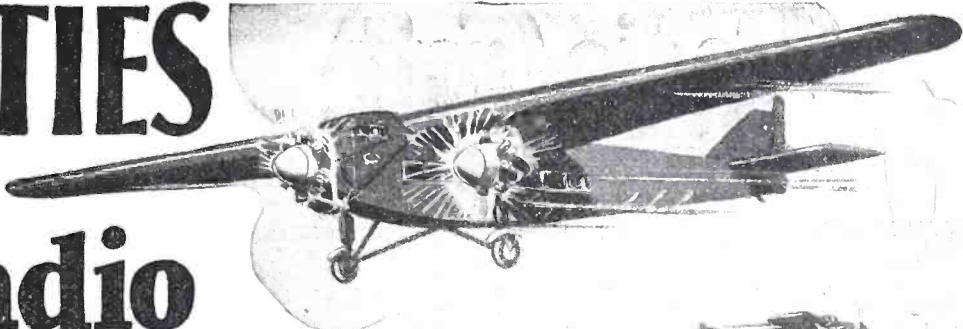

Don't be an untrained man. Let me show you how to get your start in Radio—a fast growing, live money-making industry.

Prepare for jobs as Assembler, Inspector and Tester—Radio Sales or Service and Installation Work—Broadcasting Station Operator—Wireless Operator on a Ship or Airplane, Talking Picture or Sound Work—**HUNDREDS OF OPPORTUNITIES** for a real future in Radio!

12 Weeks of Shop Training Pay Your Tuition After Graduation

We don't teach by book study. We train you on a great outlay of Radio, Television and Sound equipment—on scores of modern Radio Receivers, actual Broadcasting equipment, Television apparatus, Talking Picture and Sound Reproduction equipment, Code and Telegraph equipment, etc. You don't need advanced education or previous experience. We give you—**RIGHT HERE IN THE COYNE SHOPS**—the actual practice and experience you'll need for your start in this great field. And because we cut out all useless theory and only give that which is necessary you get a practical training in 12 weeks. Mail coupon for all facts about my school and training methods.

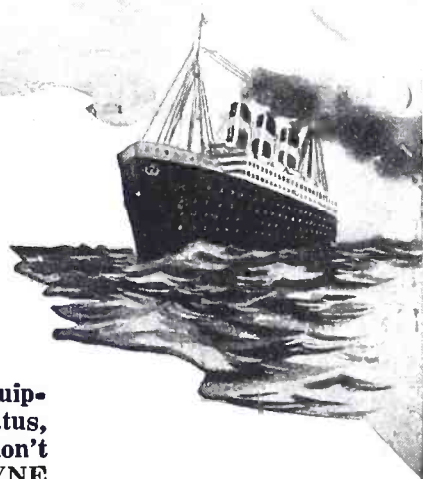

TELEVISION *and* TALKING PICTURES

Television is sure to come as a commercial industry. Whether this year or later, it will offer opportunities to the man who is trained in Radio. Here at Coyne you learn Television principles, and work on actual Television equipment. Talking Picture and Public Address Systems offer opportunities to the Trained Radio Man. Here is a great new Radio field which is rapidly expanding. Prepare NOW for these wonderful opportunities! Learn Radio Sound Work at COYNE on actual Talking Picture and Sound Reproduction equipment.

ARRANGE TO FINANCE YOUR TUITION

Mail the Coupon below and I'll tell you about my finance plan which has enabled hundreds of others to get Coyne training with very little money. On this plan you can get your training first, then take 18 months to complete your small monthly tuition payments starting 5 months after you begin training. Not a home study course.

Mail the coupon for all details of this "Pay Tuition after Graduation Plan."

ELECTRIC REFRIGERATION—AIR CONDITIONING—DIESEL ENGINES

To make your training more valuable, I include—at no extra cost additional instruction in Electric Refrigeration, Air Conditioning and Diesel Engines, taught you by personal instruction and actual work on real equipment.

PRACTICAL WORK At COYNE in Chicago

ACTUAL, PRACTICAL WORK. You build and service radio sets. You get training on real Broadcasting equipment. You construct Television Receiving Sets and actually transmit your own Television images over our Television equipment. You work on real

H. C. LEWIS, Pres. RADIO DIVISION Founded 1899

Coyne Electrical School
500 S. Paulina St., Dept. 96-8H, Chicago, Ill.

Talking Picture and Sound equipment. You learn Wireless Operating on Actual Code Practice apparatus. We don't waste time on useless theory. We give you the practical training you'll need for your start in Radio—in 12 short weeks. If you desire code, this requires additional time for which there is no extra charge.

MANY EARN WHILE LEARNING

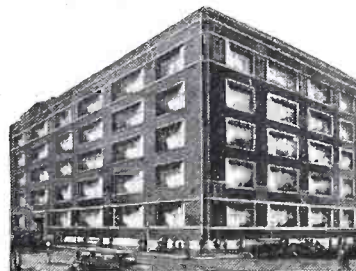

If you need part-time work to help pay living expenses while at school, tell us your problems and we may be able to help you as we have hundreds of other students. Then, after you graduate, our Free Employment Department will give you life-time employment service. Every Coyne graduate also receives a Life Scholarship, with free technical and business service and privilege of review at any time without additional tuition charge.

Mail Coupon Today for All the Facts

H. C. LEWIS, President
Radio Division, Coyne Electrical School
500 S. Paulina St., Dept. 96-8H, Chicago, Ill.

Dear Mr. Lewis:—Send me your Big Free Radio Book, and all details of your tuition offer, including additional instruction in Electric Refrigeration, Air Conditioning and Diesel Training and your "Pay After Graduation" offer.

Name _____
Address _____
City _____ State _____

Please Say That You Saw It in RADIO-CRAFT



HUGO GERNSBACK, Editor-in-Chief
 C. W. PALMER Technical Editor
 R. D. WASHBURNE, Managing Editor
 C. P. MASON Associate Editor

CONTENTS-DEC., 1936, ISSUE

Volume VIII Number 6

Editorial: Radio Experimentation.....Hugo Gernsback	325
The Radio Month in Review.....	326
How to Make the World's Smallest 3-Tube Radio Set.....Arthur C. Miller	328
Radio Maps the Ocean Bed.....	330
Visions of 1946.....Robert Duncan	331
Making a Radio-Controlled Model "Saratoga"—Part I.....George C. Fitzgerrell	332
International Radio Review.....	334
Theremin "Terpsitone"—A New Electronic Novelty.....C. P. Mason	335
Experiments with Regenerative F.C.T. Detectors.....Robert Sanford	336
How to Add a Dual-Channel A.F. Amplifier to Your Set.....	337
"Magnetite" Cores for R.F. Coils.....	337
New Developments in Cathode-Ray Equipment—Part I.....Garland W. Archer	338
Why Use "Beam" Tubes?.....A. C. Shaney	338
Newest in "Treasure" Locators.....	339
Experiments with a "Hi-Fi" Amplifier—Part I.....Arthur H. Lynch	340
Making an Organ-Tone Accordion.....Leonard Werner	341
New- vs. Old-Style Condensers.....Joseph T. Bernsley	341
Gridless vs. Grid Tubes—Part I.....Henri F. Dalpayrat	342
Looking Ahead in the Radio Field—Part II.....R. D. Washburne	343
How to Make a Psychogalvanic Deception Detector.....R. C. Davis	344

Short-Cuts in Radio.....	345
Making a Q-Test Adapter—Part III.....C. W. Palmer	346
The Importance of High-Sensitivity Test Units.....H. S. Burleson	347
Automatic Ballast Control in a New Tube Tester.....V. H. Laughter	347
The Latest Radio Equipment.....	348
Operating Notes.....	349
Photocell Shooting Ranges.....	350
ORSMA Members' Forum.....	351
How to Improve "Talkies" Fidelity—Part III.....Lawrence L. Johnson	352
Information Bureau.....	353

RADIO-SERVICE DATA SHEETS:

No. 183—Westinghouse Model WR207 5-Tube Dual-Band Superheterodyne; Westinghouse Model WR208 5-Tube 2-Band Superheterodyne.....	354
No. 184—RCA Victor "High-Fidelity Electrola" Model R-99.....	355
No. 185—Crosley Model 1316 Chassis (Used in Model 167 Console).....	357
Technicians' Data Service.....	358

SPECIAL SHORT-WAVE NUMBER

Although "dedicated" to the special interests of those whose vocation or avocation lies in the wavelength region below 200 meters, the forthcoming issue of RADIO-CRAFT will also have appeal for technicians in other branches of radio. For instance, a new idea in oscilloscopes will interest electronics specialists; and so it goes, for P.A. men, Service Men, etc. Build the RADIO-CRAFT short-wave television receiver—Part I appears in the January issue. Order your copy of January RADIO-CRAFT today.

Published by Radcraft Publications, Inc. Publication office: 29 Worthington Street, Springfield, Mass. Editorial and Advertising Offices: 99 Hudson Street, New York City. Chicago Advertising Office: L. F. McClure, 919 North Michigan Avenue, Chicago, Ill. Western Advertising Office: Loyd B. Chappell, 511 So. Alexandria St., Los Angeles, Calif.

Foreign Agents:

London—Gorrings American News Agency, 9A Green St., Leicester Square, W. C. 2, England.
 Paris—Messageries Dawson, 4 Rue Faubourg, Poissonniere, France.
 Melbourne—McGill's Agency, 179 Elizabeth St., Australia.

RADIO-CRAFT is published monthly, on the first of the month preceding that of date; subscription price is \$2.50 per year in U. S. and Canada. (In foreign countries, \$3.00 a year to cover additional postage.) Entered at the post office at Springfield as second-class matter under the act of March 3, 1879.

Text and illustrations of this magazine are copyright and must not be reproduced without permission of the copyright owners.

Copyright 1936. Radcraft Publications, Inc.

How I Got My Start in RADIO

And Established My Successful

RADIO SERVICE BUSINESS WITHOUT CAPITAL

Read This True Story By
E. LAMAR JOHNSTON, ROME, GEORGIA



E. LAMAR JOHNSTON, Rome, Georgia

Graduated from the National Radio Institute on February 25, 1929. Today Mr. Johnston owns a profitable Radio Sales and Service business. Maybe you too should get into Radio. Read what Johnston says—then find out what Radio offers. Mail coupon.

gives good jobs to more than 300,000 people. Television promises many good jobs soon.

There's a Real Future in Radio for Well Trained Men

Over 28,000,000 Radio sets are used in homes and autos today. Millions of these sets are going out of date, needing servicing or replacement. N. R. I. trains you at home to sell, install, service all types of Radio sets—to start your own business and build it up on money you make in spare time while learning. Write—get 64-page Book Free.

Many Make \$5, \$10, \$15 A Week Extra in Spare Time While Learning

Practically every neighborhood needs a good spare time serviceman. The day you enroll, N. R. I. starts sending you Extra Money Job Sheets. They show you how to do Radio repair jobs that you can cash in on quickly. Throughout your training you receive plans and ideas which have made good spare time money—from \$200 to \$500 a year—for hundreds of fellows.

Find Out What Radio Offers You Get 64-Page Book Free

Mail the Coupon today for your copy of "Rich Rewards in Radio" and sample lesson free. This big book started E. Lamar Johnston towards success and independence in Radio. It's free to any ambitious fellow over 16 years old. It tells you all about N. R. I. Training for Radio and Television—about Radio's spare time and full time opportunities; what others like Johnston are doing and earning in Radio; about the N. R. I. Money Back Agreement. Mail the Coupon now—in an envelope—or paste it on a penny postcard.

J. E. Smith, Pres.
National Radio Institute
Dept. 6NX
Washington, D. C.



J. E. SMITH, President
National Radio Institute, Dept. 6NX
Washington, D. C.

Dear Mr. Smith: Without obligation, send me the Sample Lesson and your book free about spare time and full time Radio opportunities, and how I can train for them at home in spare time. (Please write plainly.)

Name Age.....

Address

City State.....14X1

"I was an untrained worker, with no regular job—sick and tired of skimping along, working for low wages when I could find work—and going farther in debt. One day I saw an advertisement of the National Radio Institute which said that they would train me at home to make more money in Radio.

"Frankly, at first I was doubtful whether I could learn Radio at home, as I knew nothing about electricity or Radio. But I knew that I needed training to get ahead, and Radio struck me as an industry which offered plenty of opportunity for trained men to make good money.

"So I sent for their Free Book, 'Rich Rewards in Radio'—and after reading it

"Working with the Radio parts and equipment which I received as part of the Course showed me exactly how to do actual Radio work. I actually built the circuits and testing apparatus which were described in the Lessons. This made earning money easier and quicker.

"Since that time I have spent all my time in Radio work. I have married, bought my own home—a nice place valued at \$3,500—and have the nicest, most pleasant type of work in the world. My Radio business brings me a good income—and I am my own boss.

"I started my present business—now one of the largest and most profitable Radio firms in Rome, Georgia—with money I made servicing and selling sets. I had to have training to do this—training which goes far beyond the usual sort—training in ALL branches of Radio.

"That is the kind of training the National Radio Institute gives—the kind a man must have to get ahead in Radio. I honestly feel that any man who wants to make more money—and who is willing to spend a little of his spare time training—will find success in Radio. Find out what Radio offers you. Send for the National Radio Institute's Free Book today."

(Signed) C. LAMAR JOHNSTON

Many Make \$30, \$50, \$75 a Week in their Own Radio Business—or in Jobs Like These

Do you want to make more money? The world-wide use of Radio has made many opportunities for you to have a spare time or full time Radio service business of your own. Spare time Radio set servicing pays as much as \$200 to \$500 a year. Full time Radio service work in your own business, or working for Radio jobbers, manufacturers and dealers, pays as much as \$30, \$50, \$75 a week. Broadcasting stations employ engineers, operators, station managers, and pay up to \$5,000 a year. Manufacturers employ testers, inspectors, foremen, engineers, servicemen, paying up to \$6,000 a year. Radio operators on ships get good pay and see the world besides. Automobile, police, aviation, commercial Radio offer good opportunities now and for the future. Radio

Please Say That You Saw It in RADIO-CRAFT



JOHNSTON'S MODERN SERVICE DEPARTMENT in Rome, Georgia. All equipment was bought from Radio servicing profits. Johnston is on the left—his helper on the right.

and learning about their practical Course, and after reading the letters from N. R. I. men who had made good—I enrolled right away. I have never regretted it since.

"The very first lessons I received showed many ways that I could make money. I could start just as soon as I learned them. In a few weeks, I worked three hours and made one five dollar bill clear profit. Every lesson taught me more things that I could cash in on just as soon as I learned them.

GET FREE LESSON on Radio Servicing Tips

Here's proof that N. R. I. Training is practical, money-making information, that it is easy to understand—that it is just what you need to master Radio. The sample lesson text, "Radio Receiver Troubles—Their Cause and Remedy," covers a long list of Radio receiver troubles in A. C., D. C., battery, universal, auto, T.R.F., superheterodyne, all-wave and other types of sets. Get this lesson Free. Mail Coupon.

MEET ALL RADIO SERVICING EMERGENCIES WITH GERNSBACK RADIO MANUALS AND SERVICE HANDBOOK

JUST as we say—"Be prepared to meet all radio servicing emergencies with the Gernsback Official Radio Service Manuals and Official Radio Service Handibook. You never know when a service job requires that "extra" special attention. It might mean

the difference between doing the job or losing it. You're safe if you have on hand the GERNSBACK SERVICE BOOKS—either for regular service work or for servicing auto radio receivers. Get your copy today!

Here's the New Book for Radio Men!

Official Radio Service Handibook by J. T. Bernsley

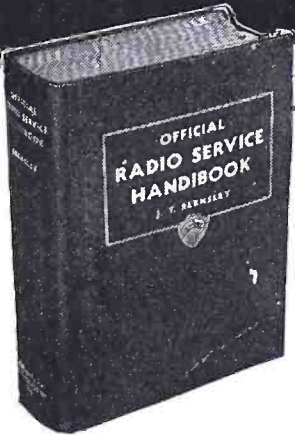

HERE'S the new book on radio servicing that contains everything Service Men must know. The book, OFFICIAL RADIO SERVICE HANDBOOK, is edited by J. T. Bernsley, foremost radio service authority. This 1936 service guide is the only book of its kind—its editorial material is so well prepared that the technical information can be understood by even beginners in radio servicing. Every page contains new material, new illustrations—no reprinted literature. The OFFICIAL RADIO SERVICE HANDBOOK covers thoroughly over 500 radio topics. It tells you how to analyze the latest commercial receiver circuits; how to really make money servicing midget sets; and, how aligning supers can be made easy. It stresses the many uses of different types of test equipment; it gives you short cuts in trouble-shooting and repairing; and, contains over 250 pages of operating notes on 1,000 manufactured receivers. So up-to-date is the OFFICIAL RADIO SERVICE HANDBOOK that it explains thoroughly the features and innovations in the most modern of receivers.

Partial Contents of This Great Book!

- PART 1—CIRCUIT THEORY AND ANALYSIS**
R.F. Fundamentals; Superheterodyne Receiver Theory; A.V.C. and Tuning Indicator Circuits; A.F. Fundamentals; Power Supply Theory and Circuits; Speakers, Reproducers and Pick-Ups; Commercial Receiver Circuits of All Types. How to Analyze.
- PART 2—MODERN SERVICING AND TEST EQUIPMENT**
Fundamentals of Metering and Test Equipment; Standard Servicing Instruments; The Cathode Ray Oscillograph and Associate Instruments; How to Build Essential Servicing Test Instruments.
- PART 3—PRACTICAL SHORT-CUTS IN TROUBLE SHOOTING AND REPAIRING**
Localizing Trouble by Inspection Methods; Short-Cuts with Test Instruments; How to Quickly and Properly Perform All Types of Repairs; Unusual Servicing Experiences; Tube Troubles and Characteristics.
- PART 4—SPECIALIZED RECEIVER AND INSTALLATION DATA**
All-Wave and High Fidelity Receiver Servicing and Installation Data; Auto Radio Receiver and Installation; Specialized Servicing and Installation (Remote Tuning Controls, Home Recording, Automatic Record Changers, Apartment House Antennae, etc., etc.); Eliminating Noise Interference.
- PART 5—MODERNIZATION AND CONVERSION DATA**
Modernizing and Improving Methods for All Types of Receivers; Converting A.C. Receivers for D.C. Operation and Vice Versa.
- PART 6—SOCIAL AND ECONOMIC PROBLEMS OF THE SERVICE MAN**
Improving Knowledge and Technique; Social Problems—How to Organize, Listing of Servicemen's Organizations; The Future of the Servicing Profession.
- PART 7—OPERATING NOTES AND PRACTICAL DATA LISTINGS**
Operating Notes on Over 1,000 Receivers; I.F. Peaks of Approximately 3,000 Receivers; Voltage Dividers for 300 Receivers, Speaker Field Listing; Radio Mathematics and Measurements.

★ OVER 250 PAGES OF OPERATING NOTES ★

OVER 1,000 PAGES

OVER 1,000 ILLUSTRATIONS

Beautiful Linen, Gold-Stamped Cover 6 x 9 Inches



For Car-Radio Servicing—Get These AUTO-RADIO SERVICE MANUALS

1935 Official Auto-Radio Service Manual

Over 240 Pages 9 x 12 Inches
Over 500 Illustrations
Flexible, Looseleaf, Leatherette Cover
LIST PRICE \$2.50

1933 Official Auto-Radio Service Manual

Over 240 Pages 9 x 12 Inches
Over 500 Illustrations
Flexible, Looseleaf, Leatherette Cover
LIST PRICE \$2.50

RADCRAFT PUBLICATIONS, Inc.

99 Hudson Street

New York, N. Y.

OVERSEAS READERS!

These books can be obtained from the following houses:

GREAT BRITAIN
Gorrings, 9a, Green Street, Leicester Square, London, England

FRANCE
Editions Radio, 42 Rue Jacob, Paris

AUSTRALIA
McGill's, 183-195, 218 Elizabeth St., Melbourne, C. I

WHICH OF THESE OFFICIAL RADIO SERVICE MANUALS DO YOU NEED TO COMPLETE YOUR FILES?

There's perhaps one or more of these great service manuals which you might need to complete the set. Collectively they represent the largest collection of service data ever compiled. Evidence of their importance to Radio men is shown by the fact that over 80,000 OFFICIAL RADIO SERVICE MANUALS have been sold during the past few years. Use the coupon below to order your Manuals.



1935 OFFICIAL RADIO SERVICE MANUAL

Over 1,000 Pages, 9 x 12 Inches Over 3,000 Illustrations
Flexible, Looseleaf, Leatherette Cover
List Price \$7.00

1934 OFFICIAL RADIO SERVICE MANUAL

Over 400 Pages, 9 x 12 Inches Over 2,000 Illustrations
Flexible, Looseleaf, Leatherette Cover
List Price \$3.50

1933 OFFICIAL RADIO SERVICE MANUAL

Over 700 Pages, 9 x 12 Inches Over 2,000 Illustrations
Flexible, Looseleaf, Leatherette Cover
List Price \$5.00

1932 OFFICIAL RADIO SERVICE MANUAL

Over 1,000 Pages, 9 x 12 Inches Over 2,000 Illustrations
Flexible, Looseleaf, Leatherette Cover
List Price \$5.00

1931 OFFICIAL RADIO SERVICE MANUAL

650 Pages (Including Supplements) 9 x 12 Inches Over 1,500 Illustrations
Flexible, Looseleaf, Leatherette Cover
List Price \$4.50
(Including Supplements)

MAIL COUPON TODAY FOR ANY BOOK!

RADCRAFT PUBLICATIONS, Inc. RC-1236
99 Hudson Street, New York, N. Y.

Enclosed you will find my remittance of \$..... for which please send me promptly, POSTPAID, the book indicated below.

- 1935 Edition @ \$7.00
 - 1934 Edition @ \$3.50
 - 1933 Edition @ \$5.00
 - 1932 Edition @ \$5.00
 - 1931 Edition @ \$4.50 (Including Supplements)
- AUTO-RADIO MANUALS**
- 1935 Edition @ \$2.50
 - 1933 Edition @ \$2.50
 - Official Radio Service Handibook @ \$4.00

Name

Address

City State

(Send remittance by check, money order, or registered letter if it contains cash, currency or unused U. S. Postage Stamps.)

SAVE UP TO 50% at Factory Prices!
You'll Be Excited over **MIDWEST'S**
DIAL-A-MATIC Tuning and Exclusive ELECTRIK SAVER!

Your radio enjoyment is doubled with Dial-A-Matic Tuning, the amazing new Midwest feature that makes this radio practically tune itself. Now, even a child can bring in ten perfectly tuned programs in ten seconds! It's a big thrill to whirl the dial . . . and then hear the station you want . . . come in instantly, automatically, perfectly. Zip-zip-zip . . . the programs roll in perfectly tuned . . . as fast as you can press buttons! This new Midwest feature will perform new miracles of radio for you.

New 1937
AIR-TESTED
5-BAND

16-Tube MIDWEST
Radio

9 to 2200
METERS

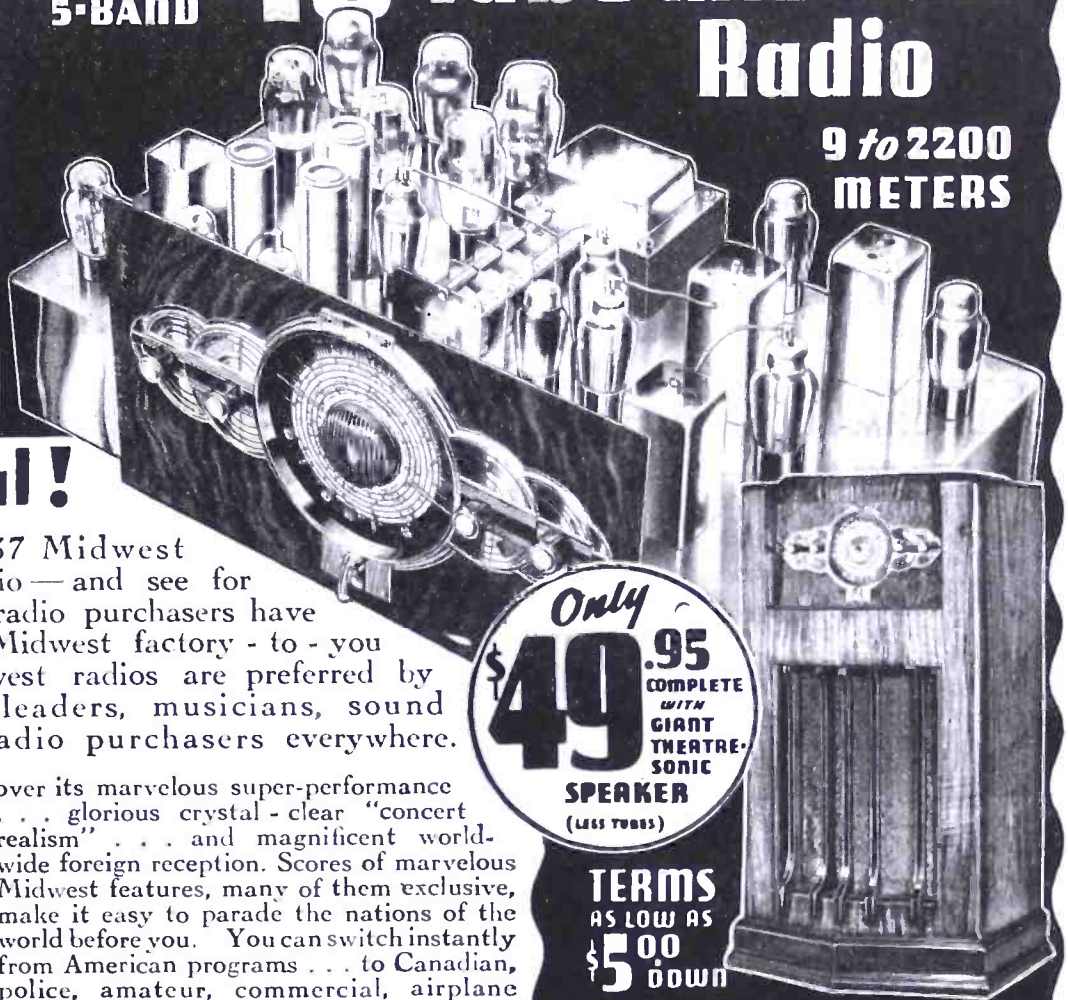
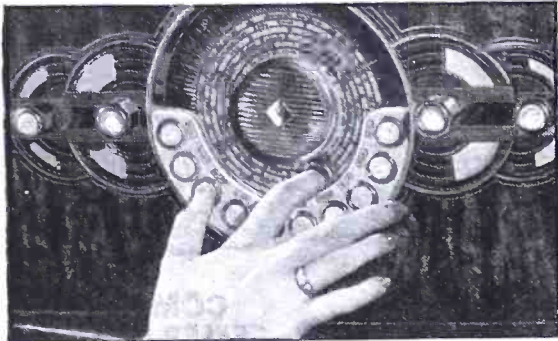

30 Days FREE Trial!

Send for big FREE 40-page 1937 Midwest catalog—before you buy any radio—and see for yourself why scores of thousands of radio purchasers have saved up to 50% by ordering the Midwest factory - to - you way since 1920. Learn why Midwest radios are preferred by famous movie stars, orchestra leaders, musicians, sound technicians, and discriminating radio purchasers everywhere.

Once again, Midwest demonstrates its leadership by offering this amazingly beautiful, bigger, better, more powerful, 16-tube, 5-band world-wide radio—a startling achievement that makes the whole world your radio playground. Out-performs \$150 radios on point-for-point comparison. Powerful Triple-Twin Tubes (two tubes in one) give 20-tube results.

over its marvelous super-performance . . . glorious crystal-clear "concert realism" . . . and magnificent world-wide foreign reception. Scores of marvelous Midwest features, many of them exclusive, make it easy to parade the nations of the world before you. You can switch instantly from American programs . . . to Canadian, police, amateur, commercial, airplane and ship broadcasts . . . to the finest, most fascinating world-wide foreign programs.

BECOME YOUR OWN RADIO DEALER

Save the jobber's-retailer's profits that often amount to 50% of ordinary retail prices. Become your own radio dealer and buy at wholesale prices direct from the Midwest factory. Never before so much radio for so little money! Why pay more?



This super deluxe Midwest radio is so amazingly selective, so delicately sensitive, that it brings in distant foreign stations with full loud speaker volume on channels adjacent to powerful locals. You'll thrill

ELECTRIK-SAVER
 This exclusive Midwest feature cuts radio wattage consumption 50% . . . results in Midwest radios using no more current than ordinary 7-tube sets . . . enables them to operate on voltages as low as 80 volts.

Before you buy any radio, send for our big FREE 40-page 1937 catalog—and take advantage of Midwest's sensational factory-to-you values. You have a year to pay and terms are as low as 10c per day — and you secure the privilege of 30 days' FREE trial in your own home. In addition you are triply protected with Foreign Reception Guarantee, Full-Year Warranty and Money-Back Guarantee.

Only
\$49.95
 COMPLETE WITH GIANT THEATRE-SONIC SPEAKER (LESS TUBES)

TERMS
 AS LOW AS
\$5.00 DOWN

Only **MIDWEST** Gives You
16 TUBES • 5 WAVE BANDS
 9 TO 2200 METERS • ELECTRIK SAVER
 • DIAL-A-MATIC TUNING •
 • AUTOMATIC AERIAL ADAPTION •
DUAL AUDIO PROGRAM EXPANDER



MY MIDWEST NOT ONLY MEETS BUT SURPASSES MY MOST CRITICAL STANDARDS.
Bing Crosby



NO SET THAT I HAVE EVER OWNED HAS BROUGHT IN FOREIGN RECEPTION SO CONSISTENTLY AND SATISFACTORILY.
Gloria Stuart



MIDWEST RADIO CORP.
 DEPT. F-12 CINCINNATI, OHIO, U.S.A.
 Established 1920 Cable Address MIRACO... All Codes

MAIL COUPON TODAY for
Free 30-DAY TRIAL OFFER and **40-PAGE FOUR-COLOR Free CATALOG**

MIDWEST RADIO CORPORATION
 Dept. F-12, Cincinnati, Ohio
 Without obligation on my part, send me your new FREE catalog and complete details of your liberal 30-day FREE trial offer. This is NOT an order.

Name _____
 Address _____
 Town _____ State _____

Please Say That You Saw It in RADIO-CRAFT

TWO PRECISION TESTERS FOR THE PRICE OF ONE

COMBINATION TUBE TESTER AND SIGNAL GENERATOR 440-540

Each Ranger-Examiner Combination puts together in one case two (2) units of test equipment every serviceman needs in his everyday work. The savings effected in design and in using this exclusive Ranger-Examiner grouping permits offering these combinations of two Precision Testers at prices you would normally expect to pay for one.

Each item is precision built throughout by the oldest company in the service equipment field. Their past contacts with the trade as well as with every advancement in the field of radio make them fully acquainted with the needs of the service profession. From the standpoint of sheer merit Ranger-Examiner testers are becoming popular favorites with radio servicemen.



**COMPLETE
DEALER PRICE \$33.60**

COMBINATION FREE POINT TESTER AND VOLT-OHM-MILLIAMMETER MODEL 640-740

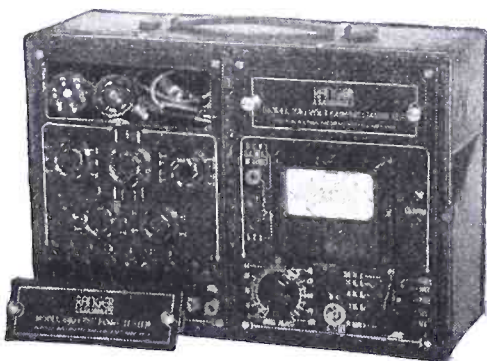

Model 640 Free Point Tester has five (5) sockets. Panel includes automatic switch type and single action jacks.

Model 740 Volt-Ohm-Milliammeter Unit has a Triplet Precision Instrument with scale reading 10-50-250-500-1000 A.C. and D.C. volts at 1000 ohms per volt. 1-10-50-250 D.C.M.A.; low ohms 0-300; high ohms to 250,000 at 1.5 volts. Rheostat adjustment.

Model 640-740 is contained in the standard size metal carrying case. Dealer Price ... \$27.00

Model 440-540 has the two separate testers installed in a sturdy metal carrying case for shop or field use.

Model 440 Tube Tester checks all type tubes. Condition of tubes is read directly on GOOD-BAD Triplet instrument scale while load values are applied. Circuit designed to indicate inter element shorts and leakages. Illuminated dial A.C. instrument for line volts adjustment, also shows when tester is connected to power supply.

Model 540 Signal Generator uses plug-in type coils. Five frequency bands cover 110 to 20,000 K.C. All readings are direct and fundamentals. Each coil is individually calibrated by peaking with trimmer condensers. Accuracy, within one percent (1%) from 110-3000 K.C.—2% for higher frequencies. Completely shielded. Attenuation and stability are outstanding features. Complete with coils, two type 30 tubes, batteries and necessary accessories.

Model 440-540 consists of these two instruments installed in a sturdy metal case with built-in compartment having "snap-on" cover for accessories, finished in electro black baked enamel, panels in silver and black. Every essential feature is incorporated in these outstanding instruments. No extravagance. No added unnecessary cost. To see one—to use one—means you will be glad to own one.

ADDITIONAL COMBINATIONS

Using the same standard size metal carrying case the following additional combinations may be had; the testers in all cases being identical with foregoing descriptions and complete with necessary accessories.

Model 540-740 Signal Generator & Volt-Ohm-Milliammeter Dealer Price \$36.00

Model 440-740 Tube Tester & Volt-Ohm-Milliammeter Dealer Price \$37.50

DIRECT READING SIGNAL GENERATOR MODEL 557

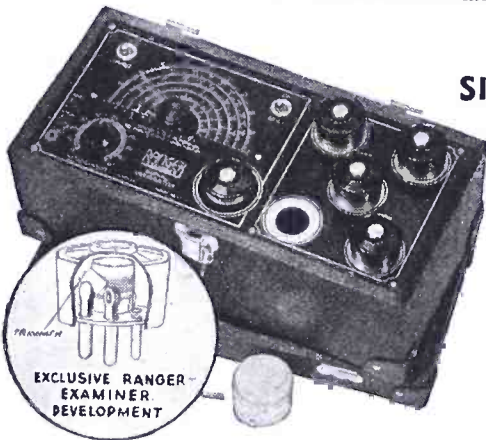

Model 557 has the same features as described for Signal Generator Model 540 except that it is installed in a black leatherette carrying case and is an integral part of the case. The five individually calibrated coils are nested on the side as shown, handy for instant use. The attractive panel is silver and black.

Dealer Price ... \$18.00

D.C. POCKET VOLT-OHM-MILLIAMMETER MODEL 735

Contained in sturdy black molded case with silver and black panel, rounded corners. Ranges are 15-150-750 volts; 1.5-15-150 M.A.; 1/2-1,000 low ohms; 0-100,000 high ohms at 1.5 volts. Provision for external batteries to be used for higher resistance measurements.

Has Triplet D'Arsonval precision instrument accurate within 2%. Selector switch for all ranges. Provides for all essential D.C. measurement requirements in servicing.

Size is 3-1/16" x 5-7/8" x 2-1/8" deep—is easily carried in the pocket, Handy for the laboratory. Complete with battery, test leads and alligator clips.

Dealer Price ... \$10.80



See Your Jobber Write for Catalog



READRITE METER WORKS
1216 College St., Bluffton, Ohio.

Without obligation please send me more information on
.....Ranger-Examiner Combination

Name

Address

City State

Please Say That You Saw It in RADIO-CRAFT



"Takes the Resistance out of Radio"

Editorial Offices: 99 Hudson St., New York, N. Y.

HUGO GERNSBACK, Editor

Vol. VIII, No. 6, Dec. 1936

RADIO EXPERIMENTATION

An Editorial by HUGO GERNSBACK

IT MAY BE trite to say so, but radio would not be in existence today were it not for that little horde of experimenters who in the past busied themselves to increase their knowledge of electricity and physics.

Usually experimenting of this type is done without any idea as to immediate profits or commercial aspects. The serious experimenter pursues his vocation as a hobby, to obey an inborn sense of investigation with a view to increasing his knowledge. Frequently, the end results are not at all evident, but hidden in obscurity. Very often, too, an important discovery or invention comes about unexpectedly.

One of the greatest experimenters of all time, Thomas A. Edison, was continuously experimenting and, during the course of his experiments, he came across many hidden wonders which for the moment he did not pursue. One such discovery, which became world-famous as the "Edison effect," ultimately developed into our present radio vacuum tube. Without the *Edison effect*, it probably might have been many more years before the modern radio tube had been invented. But, when Edison made his historic experiments, he did not pay much attention to the Edison effect, and described it only with a few short notes. The discovery did not seem important to him and it was filed away with other records; only years later did its great importance dawn upon another famous inventor, Professor Fleming, who made good use of the Edison effect in one of the first electronic "valves," from which finally was evolved the modern vacuum tube.

It may be said that there is such a thing as an art in experimentation. While it is true that a tremendous amount of experimenting goes on in our industrial research laboratories, where experimenting has become a profession with a view to ultimate gain, private experimentation is flourishing at an ever-increasing rate. Many men, young and old, pursue the art of radio experimentation as a hobby for the sheer love of it. No immediate gains are expected; it is done merely for the sport of it and to increase personal knowledge.

In radio experimenting, we frequently come across the man who builds one radio set after another, only to tear it apart as soon as something that is more worthwhile comes along. This process goes on for years on end, and the information and experience which are picked up during the process are often vitally important and serve the owner in good stead later on. Frequently, too, during such experiments important observations are made and, if these are properly written down and notes made, important inventions may be derived therefrom. Edison never performed any experiment of any kind without making copious notes of the same. These notes were kept, usually, on small yellow sheets of paper about 5 x 7 ins., and the notes at the end of the month were bound in the form of a book. These notes were always dated by Edison himself, in his own handwriting, and, when bound in the form of a book at the end of the month, they not only formed a record for the entire month but often provided legal evidence in priority suits where it was shown that Edison had made certain experiments which antedated claims of inventors who came later. Then too, in Edison's leisure, the notes were read over, perhaps weeks, months or years later, and thus not infrequently formed the bases of new inventions.

To the average untutored experimenter, taking notes of this type may seem a useless and tiresome task. Edison never considered his time wasted because the results of an experiment might be of no consequence at the moment; they might

and often did become of the most importance *years later*.

Dr. Lee deForest, another world-famous experimenter, had great faith in Edison's note-taking habit. Accordingly, he too made copious notes of his experiments; later on, such notes became of tremendous value. For instance, when Dr. deForest invented radio regeneration, he described the effect in some of his notes which were kept, and also described the circuit which he used at the time. All of this did not seem highly important because broadcasting had not arrived, and even Dr. deForest did not realize what regeneration really was. He simply jotted the result down as an interesting experiment, stating that the volume of the signal seemed to greatly increase when this particular circuit was used. After several decades of legal wrangling in the courts, Dr. deForest finally was awarded the honor of being the original inventor of regeneration, possibly the greatest radio invention since the days of Marconi. Without the notes, deForest would never have been able to sustain his claims.

Many radio men are under the impression that there is nothing new to be invented, so far as radio circuits are concerned. They feel that all the important circuits, fundamental and otherwise, are now in existence, and that we will never have other basic circuits.

That is, of course, not only an erroneous but a most foolish contention. To begin with, a stream of new radio tubes are constantly being evolved. Many of these tubes have entirely new characteristics that were unknown a few short years ago. It is not only conceivable but within the realm of possibility that there will be evolved in the future new and fundamental circuits that will make our present-day circuits obsolete. This may seem far fetched today, but, in view of our past experience it is not.

There are many other branches in radio which are practically virgin fields for the experimenter, because, if you look back only 10 short years, you will find that in nearly every branch of radio, we have had many revolutions, silent and otherwise. And you can be certain that exactly the same reasoning will prevail 10 years hence as to present-day radio. Improvements are constantly made and such improvements must be based on experiments made by someone.

A case in point is the television flurry which we had a few years ago. The British inventor, Baird, with little or no resources, put together a television transmitter-receiver which any corporation laboratory could have done years before Baird, had they been so minded. The point is that the honor fell to Baird because it was he who by ceaseless experimenting created a television outfit, most elements of which are still in use today.

For years, it has been the writer's private opinion that Baird as well as his followers were—and still are—on the wrong track. Baird made practical the idea of optically dissecting an image; then translating the impulses electrically; and then, transmitting the result to the receiving end. The pieces then were reassembled and an artificial image re-created. This process will seem fantastic 25 years hence; as will be the entire school of thought based upon the idea of "scanning." The human eye does not, strictly, "scan," yet it is the best television transmitter in existence. Further, did you ever realize that *an ordinary mirror, in which you see your image every day, manages very nicely to get along without any "scanning"?* Here then we have the elements of important experiments which will form the foundation of future television.

THE RADIO MONTH

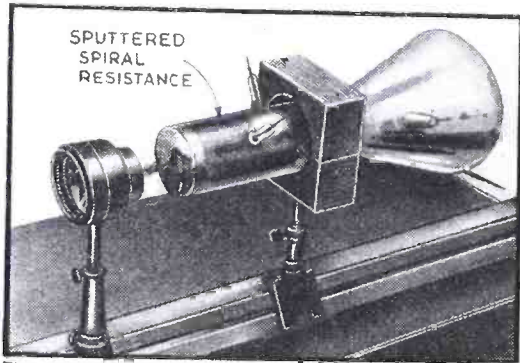

The appearance of the new "vision" tube. Note the spiral resistance on the neck of the tube.

A NEW GERMAN LIGHT-CONVERTER TUBE

A VERY interesting new electron tube, operating on principles similar to the Zworykin image tube (which was described in the April 1936 issue of RADIO-CRAFT), was announced last month by the well-known German inventor Manfred von Ardenne.

The new tube, which makes invisible light rays visible, consists of a translucent photoelectric cathode at one extremity of the tube that converts the light rays into an electron beam which strikes a fluorescent screen at the other extremity of the tube thus producing a visible image. But, unlike the Zworykin tube, the von Ardenne tube has no complicated anode focusing rings. The optical correction is accomplished by a spiral of resistance material sputtered on the neck of the tube. This spiral acting as a simple potentiometer produces the strong static field having an intensity gradient increasing toward the image end of the tube. Because this spiral produces a more gradual increment than the metal rings of Zworykin's tube, better image correction is claimed for the new tube; in addition, construction is simplified.

The many applications of this new type of electron tube were outlined in some detail in the article describing the operation of the Zworykin image tube. The important applications of seeing through fog and the examination of microscopic specimens, alone, fully justify the development.

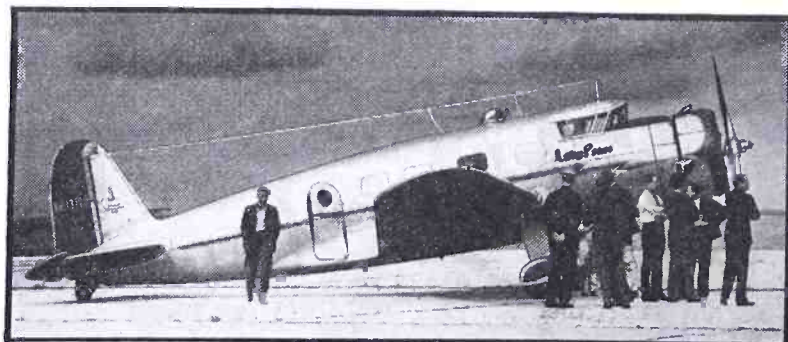

The "Lady Peace" before the successful 2-way flight.

TELEVISION SHORTS

S EVERAL interesting news items concerning television were publicized last month:

Philo T. Farnsworth gave a convincing demonstration before the Federal Communications Commission and high government officials, showing how he had eliminated the flicker of images in his system. He asked for a construction permit to build a television transmitter near Philadelphia.

The Don Lee broadcasting system inaugurated a regular weekly television broadcast service synchronizing their high-frequency station W6XAO sending television images with sound accompaniments from their station KHJ in Los Angeles.

The television transmissions of the Olympic games were considered by observers to be a "flop"—the images were indistinct, unsteady and only partially recognizable. Interest by the German public was meagre.

The first commercial television receivers were displayed at the annual Olympia Radio Exhibition in London. Demonstrations were given throughout the show.

Commander E. F. McDonald, Jr., President of Zenith Radio Corp. stated, in connection with the presidential elections that "it will be at least 1944 before voters will be able to see the faces of the party nominees as they speak."

RADIO COMPASS USED BY RICHMAN

I N the successful 2-way flight of the plane "Lady Peace" across the Atlantic last month, a new type of radio directional compass, never before employed outside the U. S. was used.

It is a combination of directional gyro, artificial horizon and 2-way radio telephone devised by Vincent Bendix. With it, Dick Merrill and Richman were able to tune in any station or several stations and watch a light on the instrument board for correct "homing."

RADIO STATIONS UNITE TO FIGHT FLORIDA STORMS

FOUR radio interests, combining the Weather Bureau, the Coast Guard and Naval Reserve, the Florida Association of Broadcasters, and the Works Progress Administration will flash warnings over land and sea in a concerted effort to reduce the life and property toll taken by storms in Florida, it was announced last month.

The Coast Guard and the Naval Reserve units have been engaged in hurricane work for some time; the Florida Association of Broadcasters, combining all commercial broadcasters with outlets in Florida recently organized with this service as one of its aims; and the WPA's radio project is ready to operate.

These 4 radio systems, aided by radio amateurs, who have done so much fine work in the past, will cover the state!

DUTCH LISTENERS "IN DUTCH" AGAIN!

S EVERAL months ago, we commented on the condition of radio broadcasting in Holland, which was caused by the high tax imposed on radio set owners.

An issue of *World Radio*, British Broadcasting Corporation's organ, last month contained the following comment on conditions in Holland:—"In Rotterdam and the suburban communes of that great port they have recently prosecuted the owners of 15 faulty receiving sets as well as the makers of these. The latter are responsible, so they allege, for much of the bad reception in the neighborhood as well as for serious annoyance to honest listeners who wish to hear good music or pleasant entertainment undisturbed. At the same time they are in the midst of a campaign," it continues, "against owners of receiving sets who place noisy loudspeakers on their balconies or by their open windows and so supply their neighbors with undesired music, or worse still, shouted descriptions of sporting events."

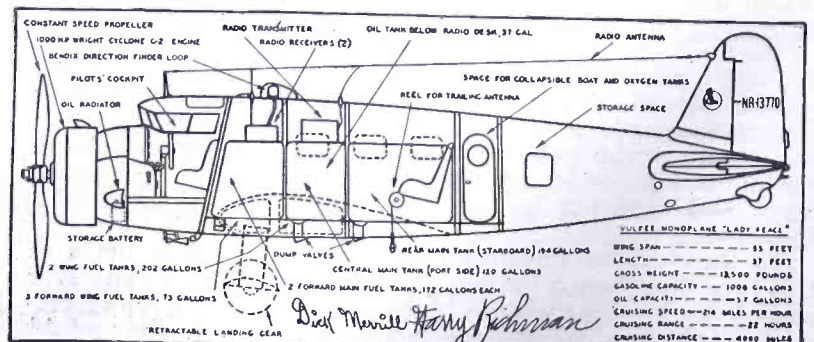

The interior of the ship showing the radio installation.

IN REVIEW

Radio is now such a vast and diversified art it becomes necessary to make a general survey of important monthly developments. RADIO-CRAFT analyzes these developments and presents a review of those items which interest all.



Two of the delegates "listening-in" to the translations of Power Conference speeches.

THE THIRD WORLD POWER CONFERENCE

WITH all the chief languages of the world being spoken at the 3rd World Power Conference, last month, the problem of understanding the formal addresses was a real one, which was solved to some extent by means of expert translators, and amplifiers connected to telephone headsets through which those present might listen to abstracts of the speeches in French, German or Spanish. The system was arranged so that after each speech, abstracts were given in the 3 languages mentioned, the listener switching-in to whichever tongue he understood.

The object of this Power Conference which was attended by some 3,000 delegates from 50 countries was to cooperate in the use of power for the benefit of mankind.

It is interesting to excerpt from a statement by Secretary of State Cordell Hull before those assembled delegates:—"The subject of the development and use of power, the harnessing of the forces of nature to make them work for man, is of tremendous and increasing importance. Inventive and engineering genius have brought many of the luxuries of two decades ago within the reach of all today.

"But they are also capable of producing machines of destruction—engines of war. Unfortunately, a vastly disproportionate share of the skill and energy of scientists and statesmen alike is being devoted now in many parts of the world to the creation and organization of forces of destruction.

"Shall the brains of the world be used to lighten the burdens of man, or shall they be used for the grim purposes of war?"

These prophetic words, by the Secretary of State are particularly applicable to radio, which can be either a source of entertainment or an aid to the destruction of millions!

THE ENGLISH SYSTEM?

ACCORDING to Donald Flamm, president of station WMCA who returned from Europe, last month, the English radio stations are losing millions of dollars annually to foreign stations. This is due to the present B.B.C. system which prohibits commercial programs. Advertisers have contracted for time on stations in countries around England, pouring a steady stream of advertising into Great Britain without any revenue coming to the English.

This is a way of looking at the situation which has not been mentioned in the many debates on the subject of the English and American systems.

The French Government has placed a tax of 48 per cent on broadcast station revenue from foreign programs, Mr. Flamm explained, but in spite of this tax all the stations capable of reaching English listeners—especially those in Ireland, France and Luxembourg—have all available time booked!

NEW YORK RADIO SHOW

DESPITE the fact that the largest number of exhibitors in recent years displayed their wares at the National Electrical and Radio Exposition, held in New York last month, the show—to a radio man—was disappointing.

The outstanding new radio features in evidence were mostly in the form of larger dials and new cabinets—and it was astonishing how much care some exhibitors took to hide the real developments in their new sets. One had to be a veritable detective to find the automatic frequency compensation schemes—improved tuning systems—high fidelity amplifiers—tuning indicators, etc.

Most of the new sets were described in the October Show Number of *Radio-Craft*—and others will be printed as fast as they become available.

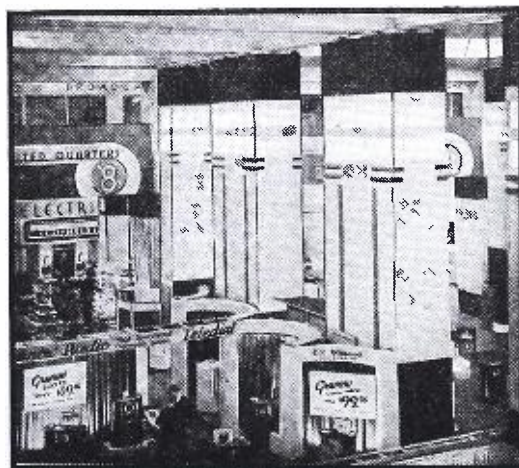

Part of the display at the New York radio show.



One of the transmitters located on an air-lane which is used for blind flying in Germany.

RADIO AIDS BLIND FLYING

SHORT WAVES, which have been used to aid fliers in flying from point to point, by means of beacons and directional transmitters, and to land safely in spite of fog, have now been applied to removing the dangers of flying blindly from one point to another, according to a report received last month.

In Germany, a system of checking the positions of planes, which has proven to be close to infallible, has been developed! Ground stations have been set up along all the air routes so that the exact position of a plane can be determined in a few minutes by means of triangulation from the ground. This eliminates the possibility of the aviator making mistakes and keeps the ground crews aware of the positions of planes in the air, at all times.

The system indicates both the position and the altitude of a plane, and thus keeps not only the pilot, but also the dispatching crew aware of the position of the plane. By this system, the German air lines have been able to reduce very greatly the number of casualties which occur during storms and foggy weather.

A short-wave transmitter on the plane sends out a test signal which is picked up by several of the ground stations. Then, by means of triangulation, the location of the plane can be determined. The position is then forwarded to the pilot, with instructions whether to proceed or turn back, etc.

An interesting part of the same system is the network of flying courses
(Continued on page 361)

HOW TO MAKE THE WORLD'S

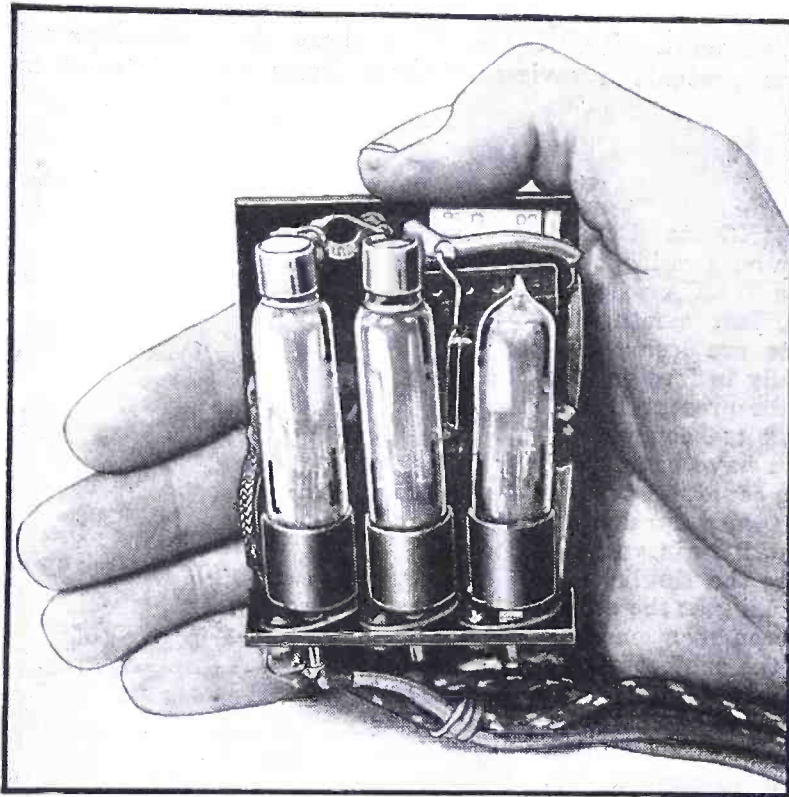

Fig. A. The tiny chassis removed from its cabinet. Note the size.

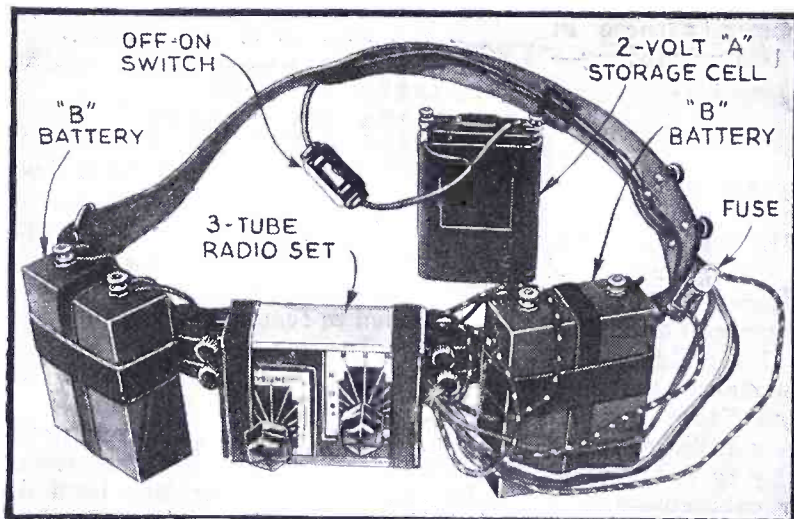

Fig. B. The complete set, ready for operation. The "A" battery is a storage cell; the 45 V. "B" batteries are the new midget size. Note the fuse.

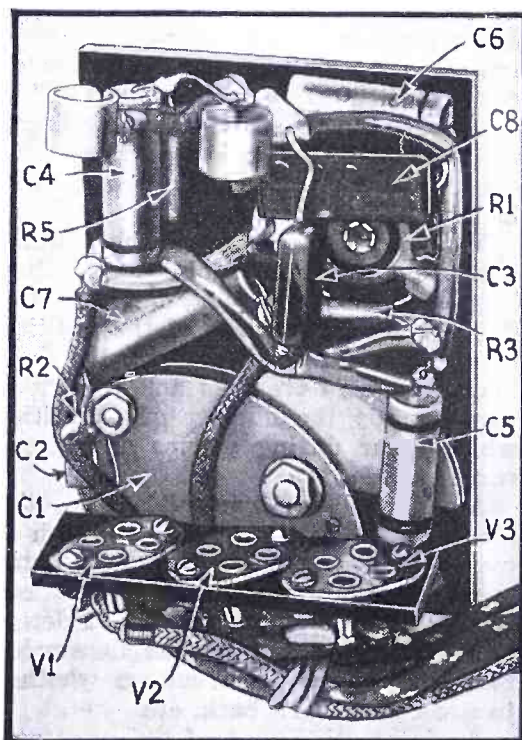

Fig. C. The positions of the parts can be seen here. The tube sockets had to be filed down to fit on the sub-panel. The special tuning condenser is seen behind the sockets.

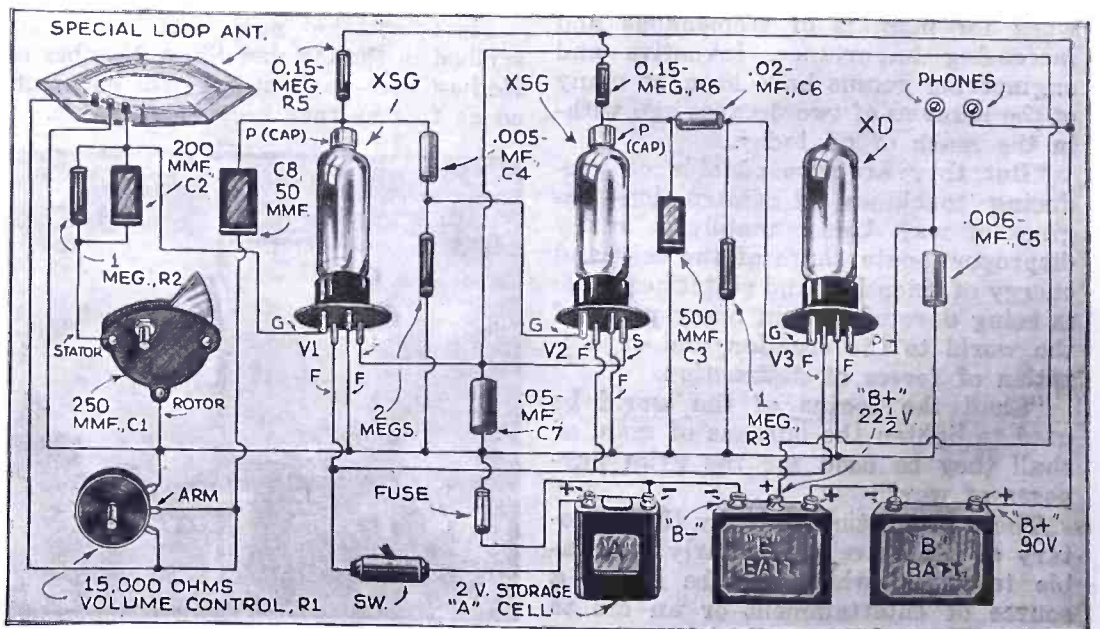

Fig. D. Here is the picture wiring diagram for those experimenters who prefer this system.

This little receiver—a typical experimenter's set—will attract the interest of radio men everywhere. Tested inside RADIO-CRAFT offices (the 11th floor of an all-steel building in lower Manhattan) the local stations were received without the least difficulty!

ARTHUR C. MILLER

WHEN USING this "Belt-Radio" the wearer is quite unmindful that the latest news or dance music is coming from an ultra-midget receiver which is actually being worn on the belt! And it takes only a minute to put the whole equipment on—and less to take it off! Technical men will better appreciate the amazing sensitivity of this tiny set, with its "hat" antenna, on being told that the writer has had no difficulty in receiving WCAU (Philadelphia) and WHAM (Rochester), on the 5th floor of a 14-story all-steel building in mid-Manhattan! The circuit is fundamentally a regenerative detector followed by 2 stages of audio amplification. A closer inspection, though, will reveal that the gridleak-and-condenser combination is arranged in an unusual manner—across the tuning coil and in series with the variable condenser (C1). This was found to give far better results with a closed antenna circuit of the type used than the more conventional method, and also enabled absolute stability to be obtained with the minimum of bypassing and shielding. In fact no shielding at all was used. Finally, there is not the slightest trace of hand-capacity effect to upset the tuning on the 200 to 550 meter range (broadcast band).

There are one or two important points to remember. The loop aerial was designed to fit 'round the head because that was found to be the only position in which it gave satisfactory results. On the back it was too close to the body and when the receiver was in its most sensitive state (just before circuit oscillation) every movement of the body upset tuning and regeneration. But, unfortunately, there is one disadvantage in having the aerial placed that way. The 4-ft. cable connecting it with the receiver acts as a capacity and restricts the tuning range of the set. What the author did was to choose the most powerful local (New York) transmitter (which happened to be WOR, Carteret, N. J.) and wind the number of turns on the loop which enabled him to tune to that frequency (710 kc.). Besides WOR he could receive WLW (700 kc.) in Cincinnati, WEAJ (660 kc.) in New

SMALLEST 3-TUBE RADIO SET

Once again RADIO-CRAFT presents a "world-beater" in small-space radio equipment. In September, 1935, RADIO-CRAFT was described the world's smallest 1-tube set that first introduced midget tubes to the American radio man; the article aroused international comment! By a clever combination of midget parts, including batteries, tubes, condensers, etc., the author has made a practical, proportionately-small, 3-tube "world-beater" radio receiving set!

York, and in the other direction WJZ (760 kc.) in Bound Brook, N. J. Of course tapping the coil will help considerably to broaden the tuning range.

Building the set is quite simple. A thin bakelite panel is used (3/16-in. thick, and 3 1/2 x 2 1/2 ins. wide) on which are mounted the midget tuning condenser and the 15,000-ohm, wire-wound, regeneration and volume control. The tiny chassis is also made from bakelite of the same thickness, on which are mounted the 3 sockets to hold the tiny tubes (distributed, like the sockets, in the U.S. by Wholesale Radio Service Co.). The sockets will have to be cut down to fit the chassis which measures only 2 3/8 x 3/4-in. wide. It may be well to mention here the importance of using only the specified parts. They are the smallest known and any larger parts will, of course, make it impossible for the reader to keep the set at its present small dimensions. A good suggestion, too, would be to advise the use of a small soldering iron! (The kind the author recommends is not larger than an electric stencil pencil.)

The loop aerial is wound on a cardboard disc 13 ins. in dia. Litz wire is used and 22 turns are interlaced around the 9 ribs. (Note that an uneven number must be used.) A tap is made at the 17th turn from the start. This is the "A-" lead to the set. A 3-way mike plug and connector separates the loop from the receiver so as to facilitate putting the equipment on and taking it off. The completed set and the two 45-V. batteries are mounted with black elastic bands (3/4-in. wide) onto an ordinary leather belt. Tap one of the 45-V. units at 22 1/2 V. Due to the extremely low "B" drain, about 2 1/2 ma., the two 45-V. batteries should give at least 100 hours of service. This is calculated on the daily use of the set for about 3 continuous hours.

A liquid unspillable storage cell supplies the 2 V. for the filaments. This tiny "battery" (as most people prefer to call it) should last from 7 to 10 hours before needing to be recharged. It is sold with an oiled silk bag and fits in the hip pocket.

Note: the grid prong of the tiny tubes is larger than the remaining prongs. As L, in Fig. 2, you may use either the "hat" loop, or a small, experimental coil when using a ground and outside antenna (for DX). The writer imported several of the ultra-small condensers detailed, for constructors who wish to make them, in Fig. 3.

(Continued on page 362)

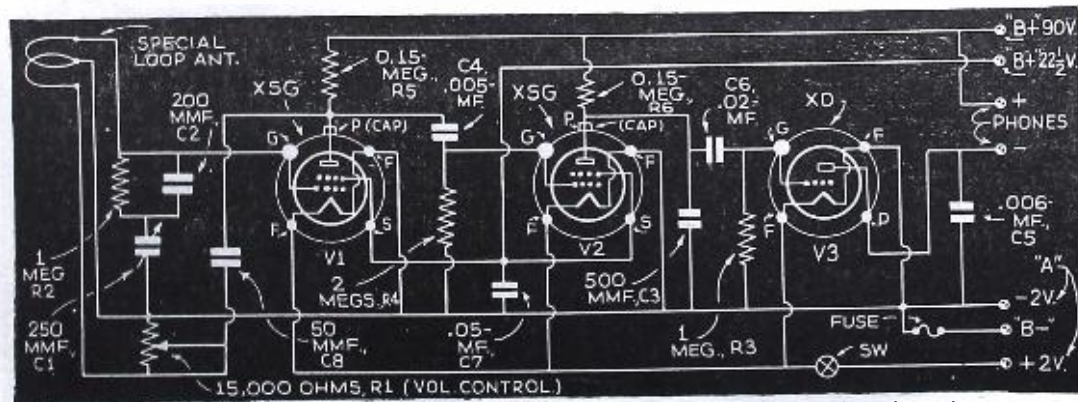

Fig. 1. The schematic circuit including values of all parts. Note the gridleak and condenser.

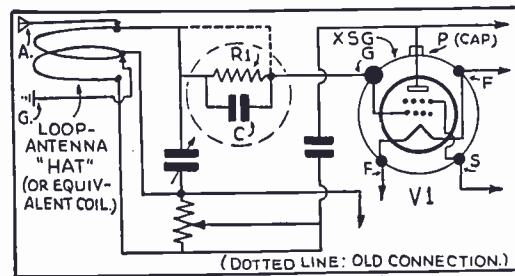

Fig. 2. Alternative wiring of the gridleak.

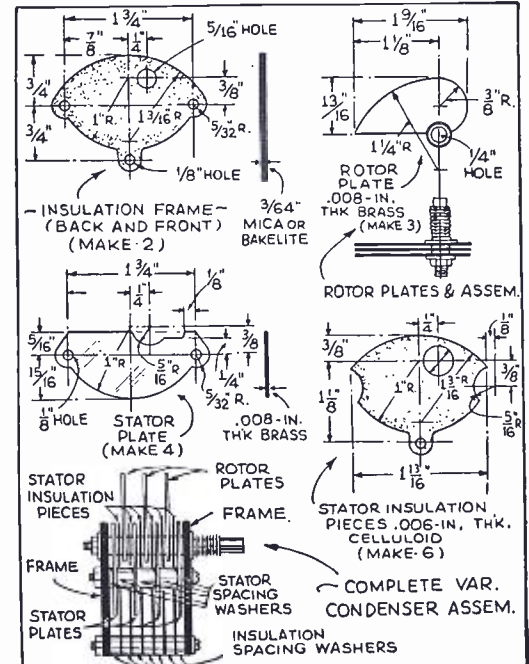

Fig. 3. The special tuning condenser is made according to these specifications. Two separators are used between stator plates.

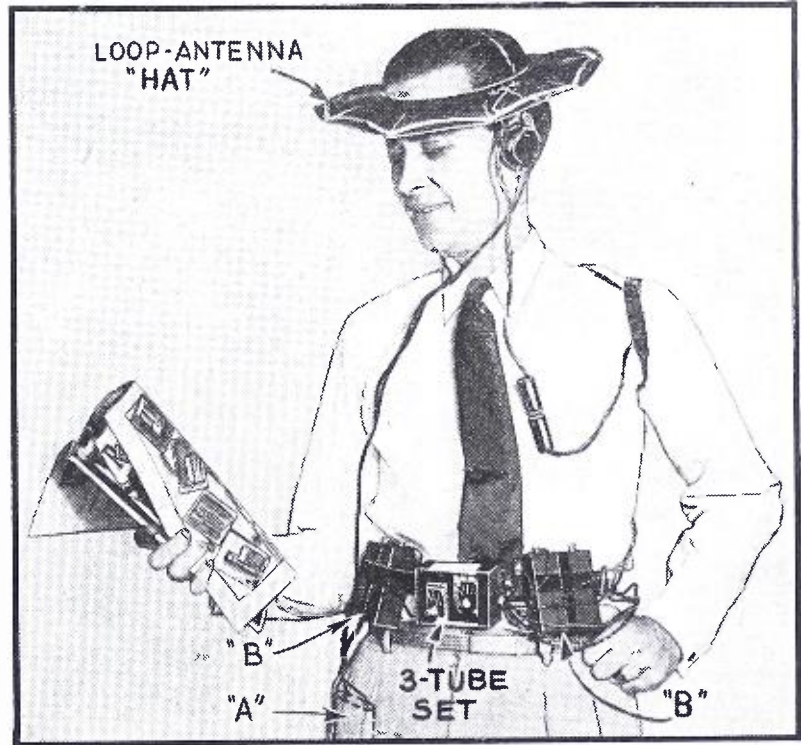

Fig. E. The author "harnessed up"—and enjoying a musical selection.

LIST OF PARTS

- One ultra-small variable condenser (see text), 250 mmf., C1;
 - *One wire-wound potentiometer, type C-15M-P, 15,000 ohms, R1;
 - Two I.R.C. small-space resistors, 1 meg., 1/2-W., R2, R3;
 - One I.R.C. small-space resistor, 2 megs., 1/2-W., R4;
 - Two I.R.C. small-space resistors, 0.15-meg., 1/2-W., R5, R6;
 - One Micamold midget fixed mica condenser, 200 mmf., C2;
 - One Micamold midget fixed mica condenser, 500 mmf., C3;
 - One Cornell-Dubilier midget cartridge condenser, 0.005-mf., C4;
 - One Cornell-Dubilier midget cartridge condenser, 0.006-mf., C5;
 - One Cornell-Dubilier midget cartridge condenser, 0.02-mf., C6;
 - One Cornell-Dubilier midget cartridge condenser, 0.05-mf., C7;
 - One Cornell-Dubilier midget mica condenser, 50 mmf., C8;
 - One Blan small feed-through bakelite snap switch, Sw.;
 - Two Blan midget-set dials;
 - Two Blan midget-set knobs;
 - One mazda pilot 2-V. lamp as fuse, 0.06-A.;
 - Two Eveready ultra-small "B" batteries, 45 V., X203 (special, with 22 1/2 V. tap);
 - *One ultra-small "A" storage cell, 2 V.;
 - *One special 2-V., D.C. (from 110 V., A.C.) charger for above battery;
 - One Trimm featherweight headset;
 - Three Hivac (see text) midget 4-prong sockets, for V1, V2 and V3;
 - Two Hivac (see text) midget screen-grid tubes, type XSG, V1, V2;
 - One Hivac (see text) midget triode tube, type XD, V3;
 - Belt, bakelite, litz wire, etc.
- *Names of manufacturers will be sent upon receipt of a stamped and self-addressed envelope.

RADIO MAPS THE OCEAN BED

"Sono-Radio" Buoys, Containing Automatic Transmitters, Guide Coast Survey Ships as They Sound Sunken Valleys Between New York and the Sea, and Correct Old Charts.

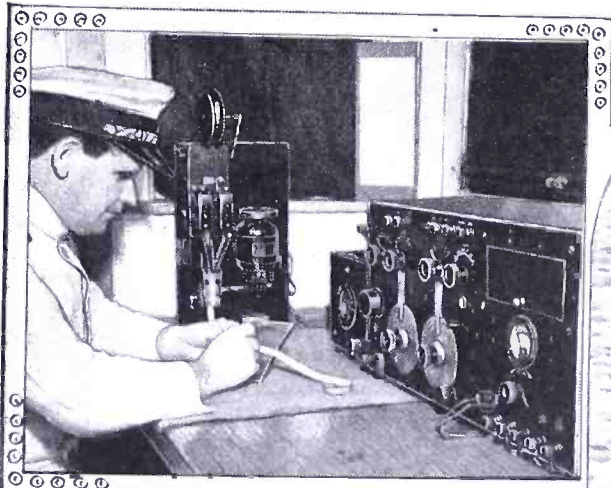

Lieutenant H. O. Fortin is seated in front of the "Oceanographer's" radio receiver, measuring off on the tape the miles between the ship and the radio buoy.

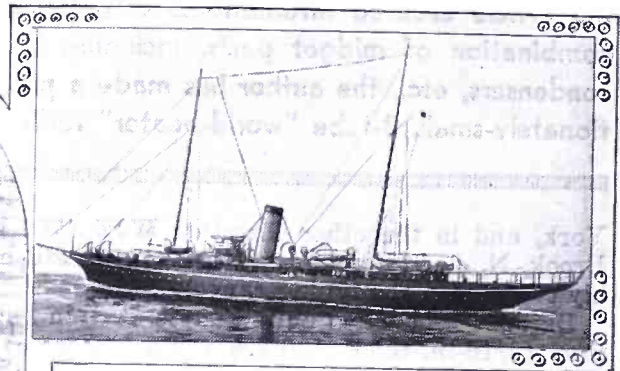

Above, the survey ship "Oceanographer," formerly the yacht "Corsair," used in sounding by the echo method.

SOME years ago, the United States Coast and Geodetic Survey reported that it had discovered a vast gorge, running from New York Harbor to the edge of the "continental shelf," where the Atlantic Ocean suddenly plunges to a great depth. Through this canyon, thousands of years ago, the Hudson River had cut its way, when the land was nearly a mile higher than at present. But, after rechecking the figures recently, it was found that there was an error of some three miles in the positions of the soundings on the chart, and the Coast Survey decided to rechart the entire coast in that vicinity.

The survey ship "Oceanographer" (which formerly was the "Corsair," property of J. P. Morgan), put out to
(Continued on page 359)

The buoy, weighing 750 pounds, and extending 20 feet down into the water. A hydrophone, below the water, picks up the sound, which is used to modulate the transmitter's output.

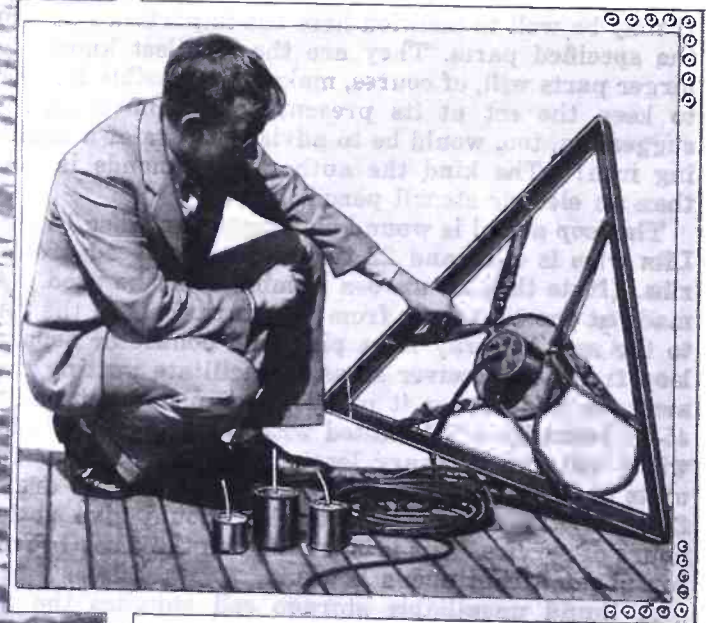
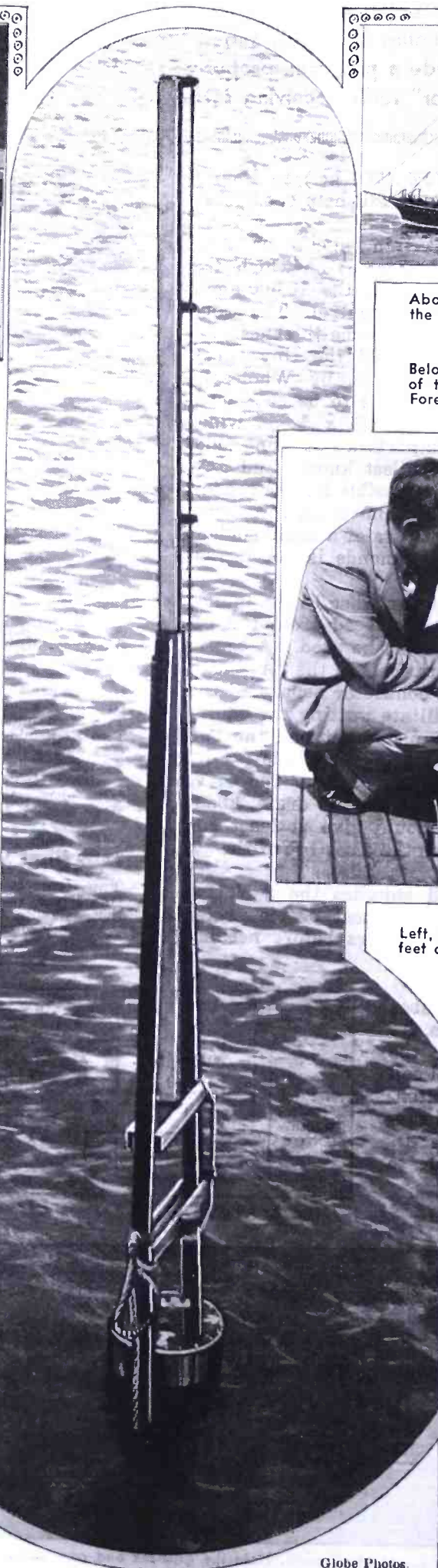

Below, Mr. T. J. Hickley with the hydrophone unit of the buoy, which corresponds to a microphone. Foreground, 3 T.N.T. bombs used to create below-water sounds for timing.

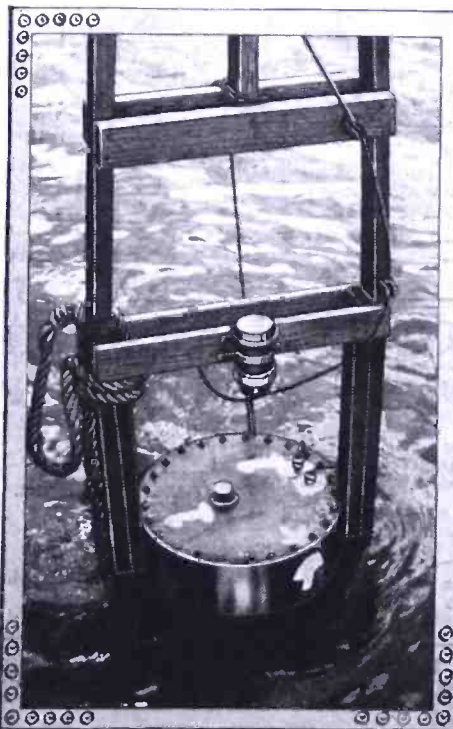

Left, the upper structure of the buoy, projecting 20 feet out of water. The radio antenna, running to the top of the frame, sends out the signal.

Below, the chronograph which records the arrival of signals. The tape has two pens; that at the right indicates the sound of the explosion at the ship; that at the left, the radio signal as received from the sono-radio buoy. The difference between them in seconds indicates the distance of the buoy in nautical miles.

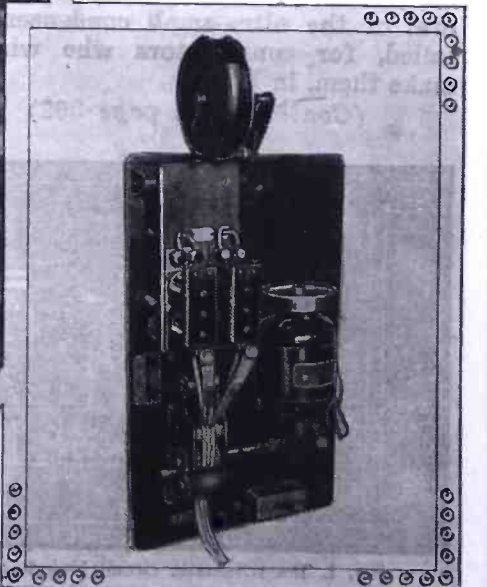

Globe Photos.

VISIONS OF 1946

This humorous account, reprinted, by special permission, from "Today" magazine, contains scientifically sound predictions of the future of television! Davis Sarnoff, President of RCA, recently remarked that "far from being at the end, mankind is only at the beginning of the age of miracles!"

ROBERT DUNCAN.....

IN 1946, I became a salesman, because television supplanted not only magazines but practically all printed matter except automobile licenses, passports and laundry lists.

I remember how, way back in 1936, I looked forward to the coming of television with eagerness. I patiently waited for those magic days when the entertainment I had to seek in a theater or a movie palace would be brought to my own home, not five feet from my own armchair.

But it turns out that there is another side to television, a practical, everyday side, which I wish I had known about in the days when my eyes were starry with anticipation. Let me tell you about it by quoting from my diary for August 22, 1946.

TUESDAY: Got up at 7. Did not turn on television pep hour or calisthenics because (a) I must save my energy for the battle of business life, and (b) I have the impression that the blue-eyed, unbearably enthusiastic physical director who cavorts on the screen is watching my feeble motions with disapproval.

Just caught the 7:43 to town. Conductor tells me that there is a television receiving and sending set in the engine cab. The division superintendent can tune in at any moment, unbeknownst to the engineer, and see whether he is yawning, or smoking, or looking at the scenery instead of the track ahead of

RADIO-CRAFT'S TELEVISION RECEIVER

In forthcoming issues of *Radio-Craft* experimenters will find construction details of a modern cathode-ray type television receiver. (Parts cost, at mail-order prices: about \$100.) Complete the sound-reception channel described in Part I and listen to Empire State Building's *sound* portion of the television program while you build the *image*-reception channel.

him. And every once in a while the grim face of the division superintendent flashes onto the screen in the cab, and gives the engineer orders and advice.

Took a taxi to the office. Suddenly, on a television screen in front of me, appeared an individual with a menacing finger and a voice like a pneumatic drill who wanted me to buy space, now, before it was too late in a community mausoleum. I asked the driver to turn him off, but the driver said his company had a special television publicity contract which forbade him to turn anything off. I shut my eyes, put my fingers in my ears, and finally stopped the cab and walked the rest of the way.

Usual office rush. At 10, we salesmen all gathered in Television Hall, where the president of the company gave us a fight talk. He is in Chicago, but his three-foot jaw on the huge screen made him seem to be with us in the room.

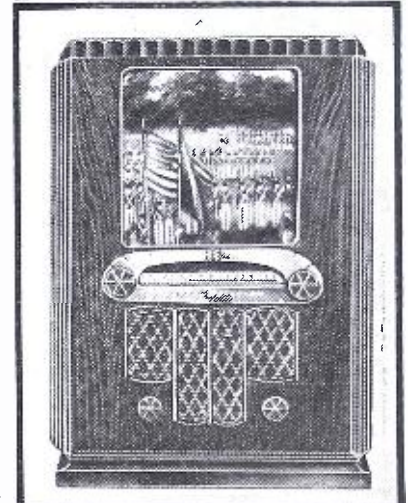
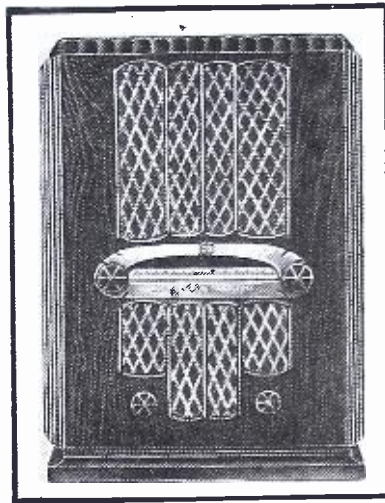

One of the latest General Electric "sliding scale" mantel radio sets, shown at upper-left, is shown at upper-right as being transformed into a television receiver in the latest *Pathe News*, "25 Years of Progress." *Pathe*, in its screen presentation, by a bit of movie magic gives the audience a thrill by showing the television insert in action in this "radio-vision set of the future."

Noted air of attention and frequent applause and laughter (a little forced now and then) of my fellow salesmen. Not only do we see and hear the president, but he can see and hear us, way out in Chicago. And not only he, but half a dozen of the big shots are looking in too, and watching us. They say around the office that we are being watched for yawns and wandering eyes, and that each one of us is being rated by the personnel vice-president on our early-morning attitude.

Called on one of our clients, cashier of a big bank. He showed me latest improvements, of which he is very proud—television gadget in vault flashes picture and sound of what is going on there to screen in central protective service office. No chance of burglary. Thirty bank vaults on each circuit, flashing on and off in irregular rotation. Man who watches the screen for signs of trouble must be something of a genius. Was told he gets ten thousand a year. No robberies since system was installed.

Lunched in vast cafeteria. Huge television screen at end of room, showing busy scenes from immense spotless kitchen, varied with appetizing talk, by ex-movie star (all movie stars are "ex" nowadays), on the menu of the day.

Called on another client, bursar of city's chief university. Showed me two classrooms, listening to television lec-

(Continued on page 361)



"... the grim face of the superintendent ..."

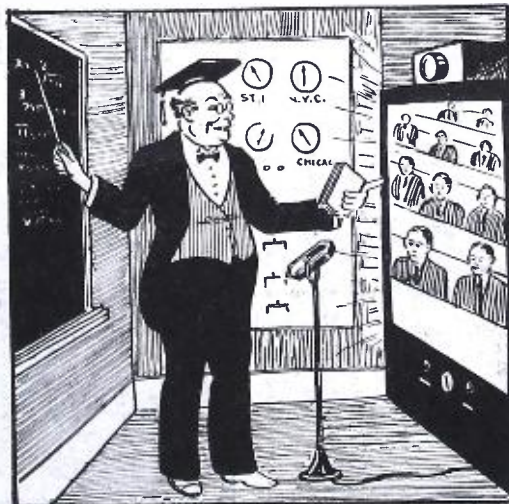

"... professor teaches 2 million pupils."

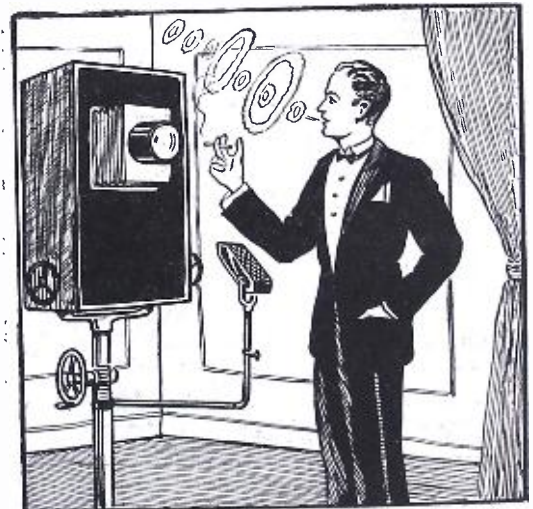

"... and little rings through big rings."

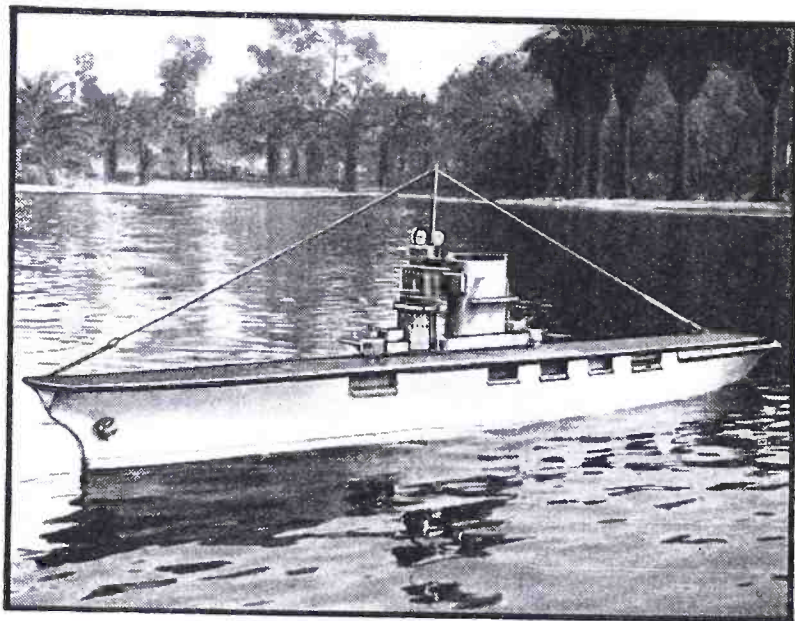

Fig. A. The ship under full radio control from the shore.

A LONG, SLIM gray model of the plane carrier *Saratoga* rests beside the landing. Suddenly, without apparent reason, it comes to life! Water churns under its stern! Its propellers grip the water, it clears the landing, stands down channel, rounds the buoy and swings into the lake! A mystery? yes, unless you know how it works, for to the average person radio control and "mystery" control are the same thing.

Radiodynamics, the remote control of mechanisms without using connecting wires, undeniably is a most interesting example of applied science; furthermore, it is an application well within the capabilities of the average hobbyist. In the following article for *Radio-Craft* readers we have attempted to take some of the mystery out of radio control by outlining the essentials of a radio control system and then showing their application in the control of a model.

ELEMENTS OF A CONTROL SYSTEM

Any remote-control system, as a general rule, may be reduced to 3 major components: (1) a *transmitter*, to radiate energy; (2) a *receiver*, to pick up a portion of the radiated energy and convert it into an electric current or mechanical motion of useful value; and last, (3) a *selector*, to allow the operator to choose the circuit or circuits he desires to control.

Figure 1A shows a simple control system embodying these elements. Briefly, it works as follows: each time the key is closed a signal is sent from the transmitter and picked up by the receiver. Each impulse closes the relay in the receiver output, actuates the selector magnet, and through the pawl and ratchet moves the wiper W from one contact to the next. Thus, by sending the correct number of impulses any one of the circuits connected to the selector contacts may be energized.

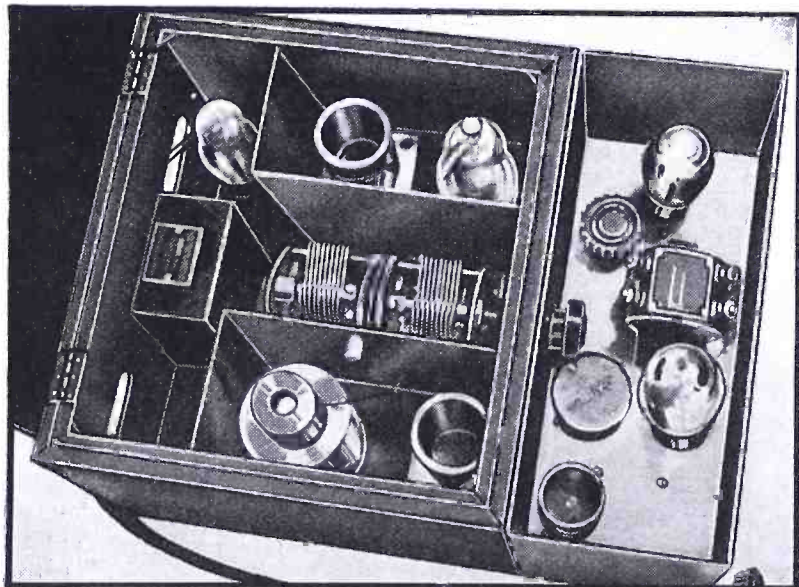

Fig. B. The receiver and control mechanism on the ship.

MAKING A RADIO-CONTROLLED MODEL "SARATOGA"

Details for making a short-wave radio-controlled model of the airplane carrier "Saratoga."

GEORGE C. FITZGERRELL PART I

Such a simple selector system is only satisfactory when controlling slow-acting mechanisms. For example, in moving from contact 1 to contact 4 the circuits connected to 2 and 3 are momentarily energized by the wiper—an intolerable situation if circuits 2 and 3 are fast-acting.

THE SELECTOR CIRCUIT

This difficulty was eliminated in the *Saratoga's* selector circuit by a slow-release relay. Figure 1B is a diagram of the selector circuit used on the *Saratoga*; Fig. 1C is a drawing of a slow-release relay similar to the one used in the selector circuit. Neither slow-release relay contacts nor sensitive-relay contacts should break heavy currents; hence, the intermediate relay between these contacts and the circuits they control. An incoming impulse, after passing the sensitive- and intermediate-relay contacts, energizes both the selector magnet and the slow-release relay, which, through its intermediate relay, opens the common lead to the controlled mechanism.

After the impulse passes, the wiper is resting on the next contact, but the common lead to the controlled circuits will not be connected until the slow-release relay contacts close, a quarter of a second or so later.

Thus by sending impulses with a period of less than a quarter-second between them the wiper may be moved to any desired contact without energizing the contacts passed over, but a moment's wait on the circuit wanted and the relay will connect it.

The copper collar on the core of the relay gives it its slow-release properties. Disturbances are set up in the magnetic field of the relay when its coil current is cut off at the end of an impulse. These disturbances induce currents in the copper collar that maintain the field of the magnet for a short time and hold the armature against the pull of the

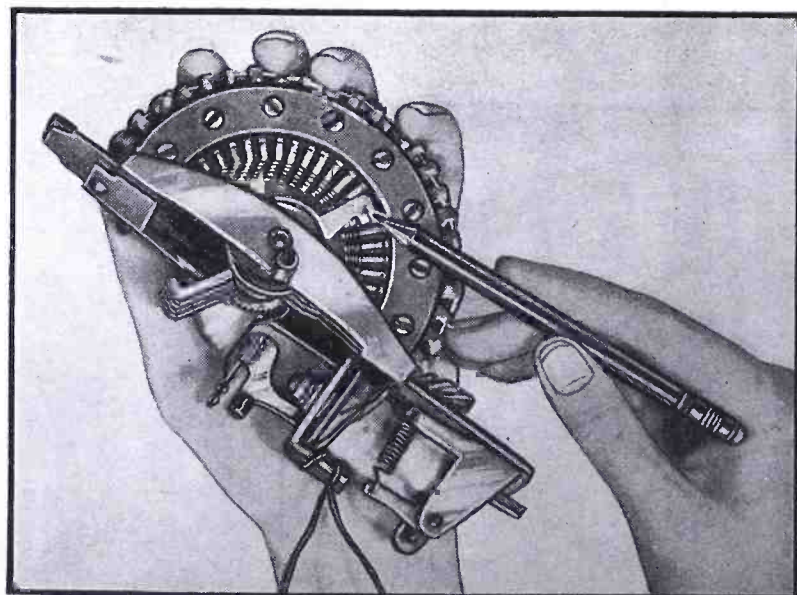

Fig. C. The selector switch—the "heart" of the control.

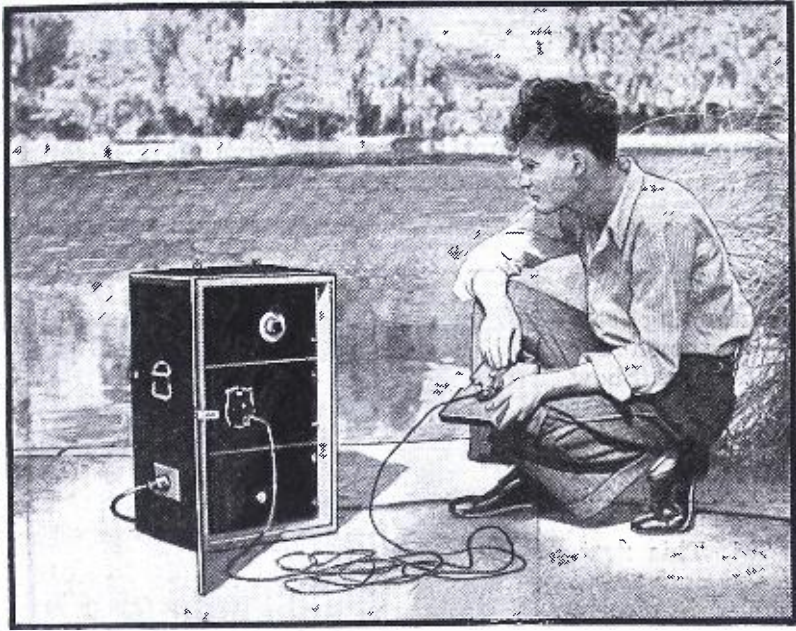

Fig. D. The appearance of the transmitter in use.

spring. The armature in turn holds the contacts open.

MAKING THE SELECTOR EQUIPMENT

If the selector is made from units purchased on the market there is little to say about its wiring. The condensers connected around the contacts used in breaking heavy currents, are to absorb spluttering and arcing that burn the contacts and "disturb" the radio receiver. It is suggested that the selector and associate relays be mounted in a grounded metal box. Tube bases and sockets provide a handy means of connecting and disconnecting the leads to the selector circuits and selector contacts; mount the tube sockets on the side of the box and use the tube bases for plugs leading to the battery, receiver, and controlled circuits.

The person who makes his own selector must be prepared to use a considerable amount of ingenuity. Here are a few suggestions: the author's first selector was made from a large single-stroke bell, and some scrap brass; the ratchet was a gear from a toy construction set. A telegraph sounder, with a few changes and additions, will also make a satisfactory selector. Old relays may be obtained from a number of sources.

A satisfactory sensitive relay can be made from a good grade telegraph relay. Rewind the coils of the relay with No. 36 gauge enamel-insulated wire. Care should be taken when connecting the rewound coils to have the polarity of the coils opposite; i.e., one pole of the relay should attract the North pole of the compass and the other pole should repel it when the relay windings are tested on a 22.5-V. battery. If both windings attract the North pole of the compass, or if both poles repel it, the connection to one of the coils should be reversed.

(Continued on page 362)

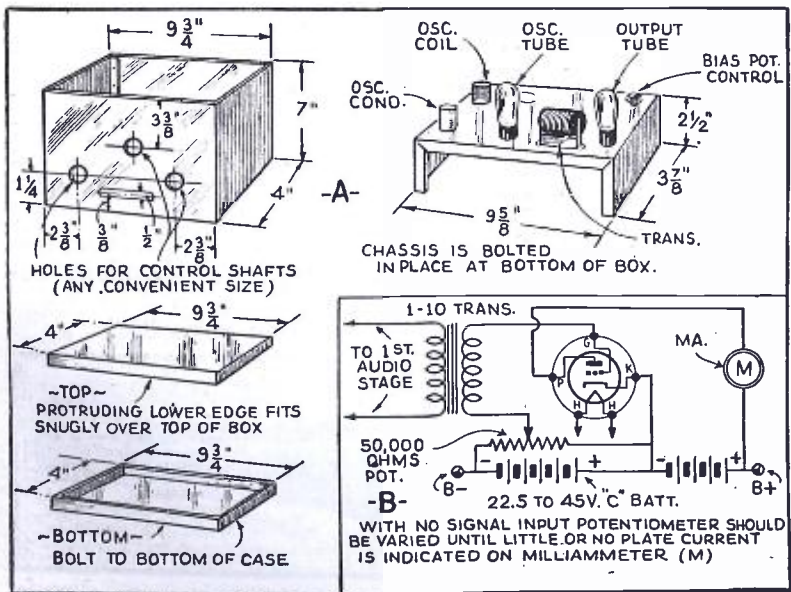
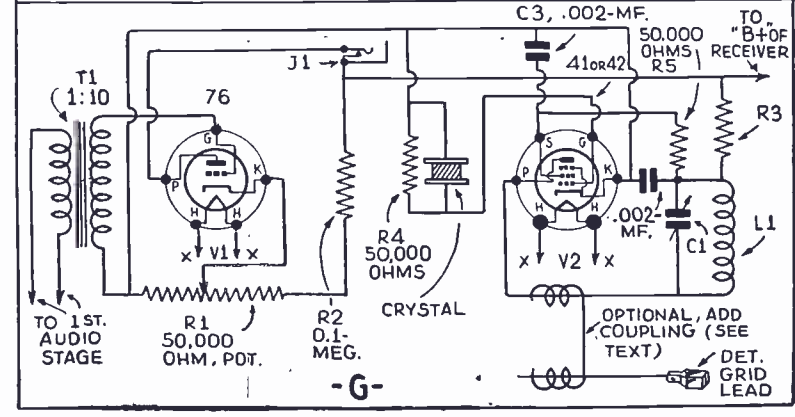
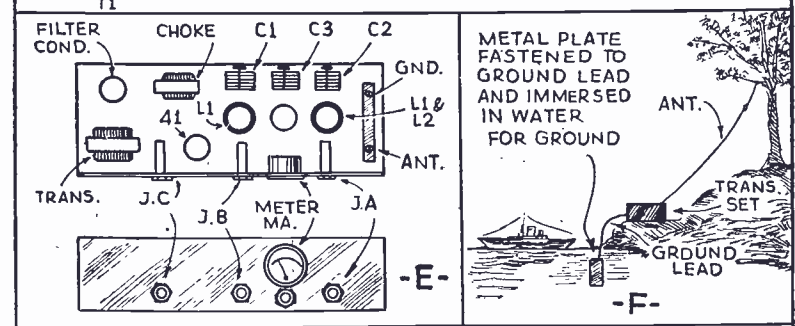
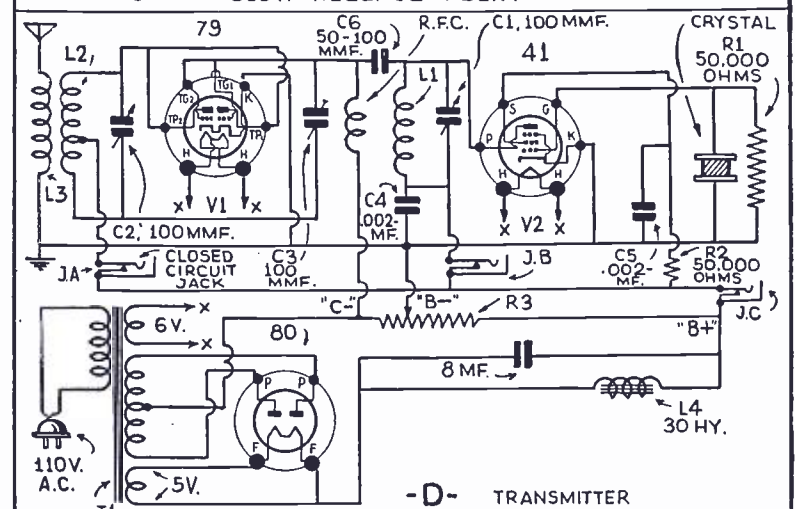
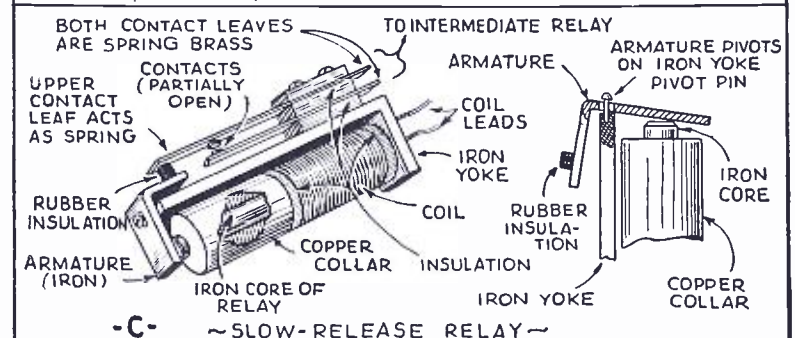
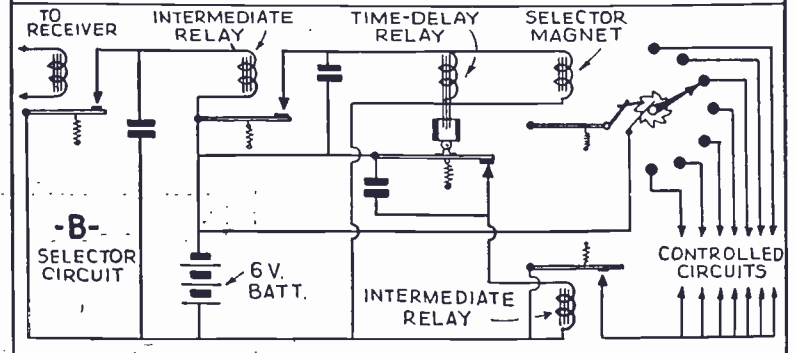
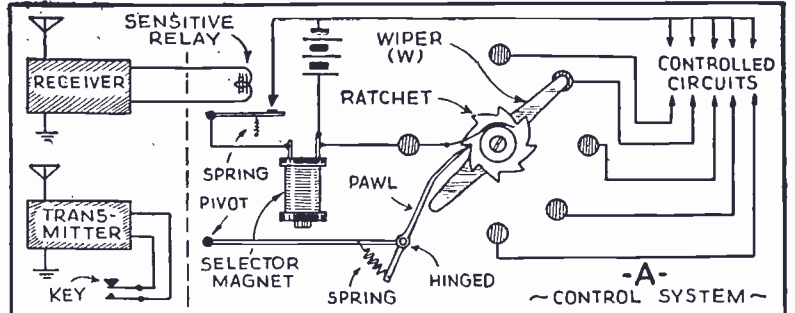

Fig. 2. Details of the receiver control unit construction.

Fig. 1. Circuits and details of the construction.

INTERNATIONAL RADIO REVIEW

RADIO-CRAFT receives hundreds of magazines from all parts of the world. Since the cost of subscribing to each of these would be prohibitive for most radio men, we have arranged with technical translators to prepare reviews for our readers.

THE 1937 ENGLISH SETS

SEVERAL of the outstanding sets in the new 1937 line, shown for the first time at the Radiolympia Show in London and described in the latest issue of *Wireless Retailer and Broadcaster*, (London) are reproduced here as a comparison with the new American sets.

Marconiphone model 701. This first, Fig. A, is a new television and sound receiver. This set is designed to receive the images of the Marconi-Emu interlaced system as well as the 240-line, 25 frames-per-second transmission from Crystal Palace in London. A change-over switch permits reception from either system.

The receiver is divided into 5 main units—(1) the cathode-ray tube and assembly, (2) the view receiver which is a 6-tube T.R.F. device, fixed tuned, (3) the synchronizer which contains 2 oscillators for line and frame synchronizing, (4) the power supply unit, and (5) the sound receiver which is an all-wave superhet. unit covering frequencies from 16.7 to 2,250 meters.

The image receiver has 6 controls, to wit: line, frame, sensitivity, contrast, and brilliance controls, and selector switch. The cathode-ray tube is suspended vertically and the image is seen in a mirror on the inside of the lid. A lens magnifies the image.

H.M.V. model 900. This second receiver is also a combined image and sound receiver. This receiver also uses pre-set tuning for the television receiver, the sound unit covering frequencies from 7 to 2,200 meters. A 12-in. cathode-ray tube, mounted vertically, provides the images. This receiver uses only 22 tubes, 4 in the sound section, 15 in the image section and 3 in the power supply. (See Fig. B.)

In this receiver, the images are seen in a mirror on the side of the slanting top of the cabinet. It is claimed that brilliance is sufficient to permit image reception in slightly subdued room light.

Philips model 792A. This third set of the 1937 line is a single-dial sound receiver, using a clever tuning knob, which, by means of a ball and socket permits control of volume, tone and selectivity, and affords as well two

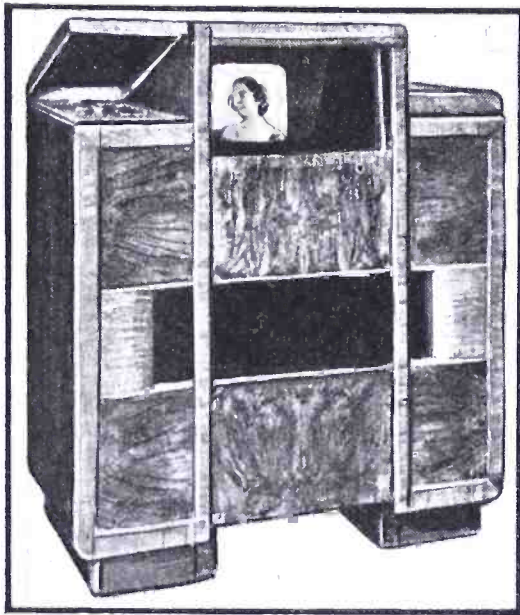

Fig. A. The appearance of the new Marconiphone model 701 image and sound receiver.

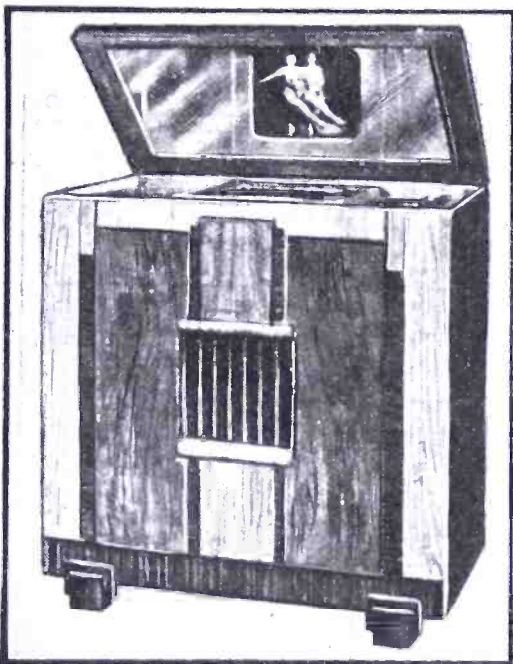

Fig. B. The H.M.V. combined sound and image set. A 12-in. cathode-ray tube is used.

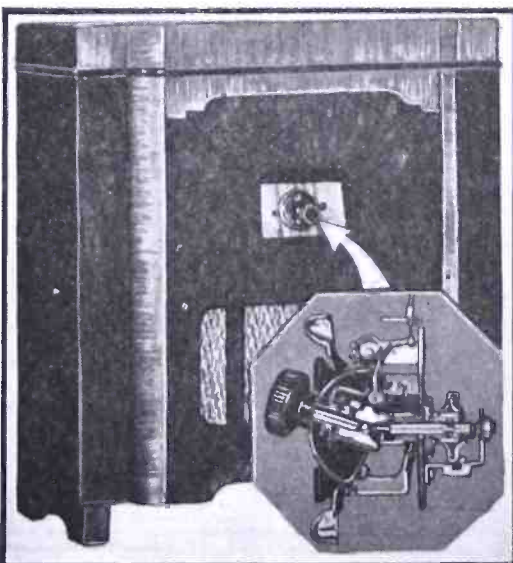

Fig. C. The Philips mono-dial set showing how the single knob operates all controls.

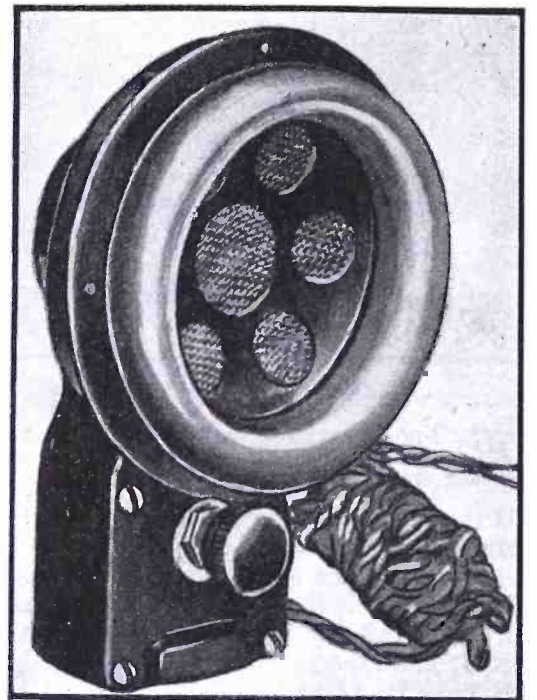

Fig. D. The Voluphone dynamic hearing-aid.

speeds of tuning. The ball and socket couples the knob to the various controls by shifting its position to one side of the central tuning position. (See Fig. C.) The same company has a new line of "universal" sets which operate from either A.C. or D.C. by means of a vibrator-type converter.

HEARING-AID PHONE

THE MAGAZINE *Practical and Amateur Wireless* (London) recently described a new type of deaf-aid phone which operates on the dynamic principle, using a moving-coil motor unit, with a permanent-magnet field supply. The phone is held in the hand and the unit is provided with a volume control in the handle, as shown in Fig. D. This unit is available for pocket deaf-aids as well as for radio reception using a regular radio receiver.

CELLULAR CATHODE-RAY TARGET

A NEW TYPE of photo-sensitive target for cathode-ray camera tubes which replaces the type used in the iconoscope in which the photo-sensitive material is deposited on a mica surface was described in the Recent Patents section of *Wireless World* (London) recently.

(Continued on page 358)

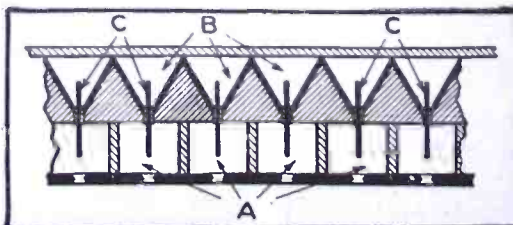

Fig. I. An interesting photo-mosaic for cathode-ray television cameras.

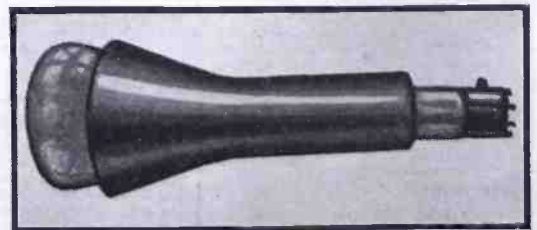

Fig. E. The Mumetal shield in place on an English cathode-ray television tube.

THEREMIN "TERPSITONE" A NEW ELECTRONIC NOVELTY

By means of Prof. Theremin's latest device, a dancer may create music by the movements of her body. A capacity device in the floor is mainly responsible.

C. P. MASON

THE inventive genius of Professor Leon Theremin has at last justified a famous poet in his license. Many years ago, Tennyson wrote:
—*"The dancers dancing in tune."*
And a distinguished musical critic commented: "That would be beyond the abilities of the young lady of Banbury Cross" who, as will be remembered, had *"rings on her fingers and bells on her toes."*

But by the new electrical system of Theremin, which depends, like the original device named for him, on the phenomenon known as "body capacity," it is possible for a dancer to dance in tune as well as in time. In place of the rods used in the first "Theremin," there is an insulated metal plate beneath the dancing floor. As the dancer bends toward it, the electrical capacity is increased, and thereby the pitch of an oscillating tube circuit is lowered; as she rises on tiptoe, for instance, the pitch of the oscillator is increased. The output of this oscillator is beat against that of another of fixed tune, producing an audible (not superhet.) frequency and this is amplified and fed into a large, square reproducer. Thus the motions of the danseuse are converted into tones varying in exact synchronism with her pose. In fact, the motion of either an arm or a leg is sufficient to

produce a noticeable change of tone. The loudspeaker used to give this individual tone interpretation of the dance is supplemented by another, reproducing a background of the theme music previously selected.

It need hardly be said that there is a great deal of scope for individual talent in coordinating bodily movements so that the sounds thus produced will not only fall pleasantly upon the ear, but also combine harmoniously with the preselected phonograph records. In other words, this is a field of pure artistry.

Another feature combined with it is an automatic colored light accompaniment. The "visual note indicator" is a panel of lamps of different colors. This, however, is accomplished by a method partly mechanical; a tuned reed behind each lamp vibrates when its corresponding note is sounded, and thereby closes the circuit lighting its lamp. Thus the notes evoked by the artist's motions are shown by lights flashing simultaneous up and down the
(Continued on page 365)

**FOR THE
FIRST
TIME
IN ANY
RADIO
PUBLICATION**

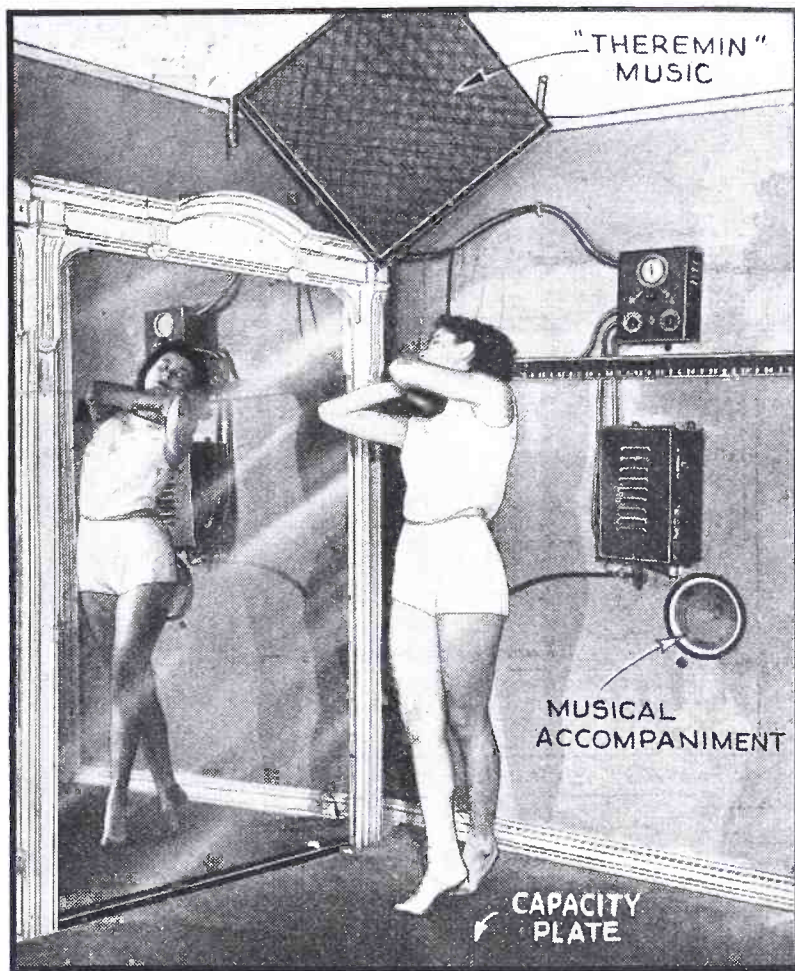

Halbram photos.

Fig. A. The speaker above the dancer reproduces the musical tones.

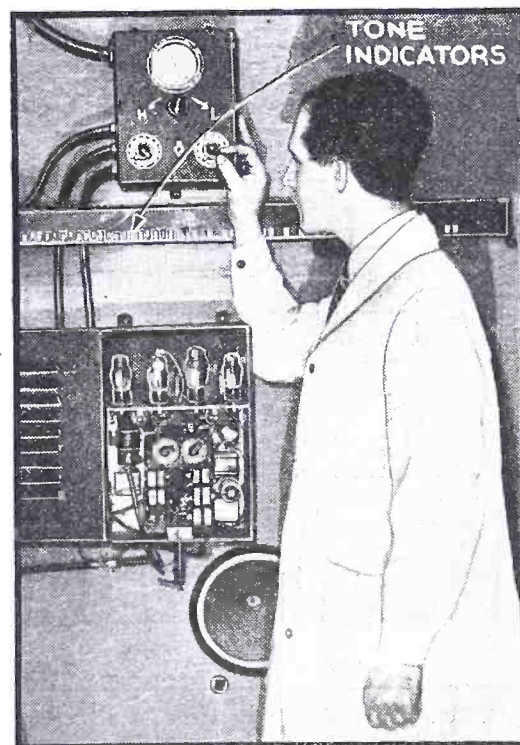

Fig. B. Prof. Theremin adjusting the controls.

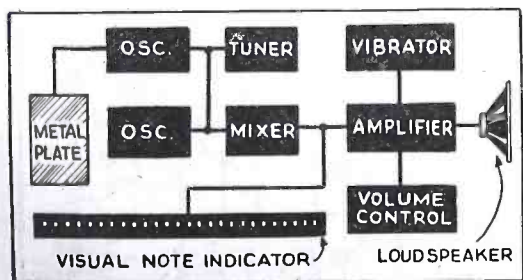

Fig. 2. Two oscillators, one fixed and the other varied by the dancer's body capacity, feed into a common amplifier, controlled by a system of vibrators to produce tones of the "piano" scale from the oscillator frequencies (in other words, the vibrators which are tuned to notes of the chromatic scale limit the musical accompaniment to notes of this scale). Pilot lights indicate these tones as they are produced.

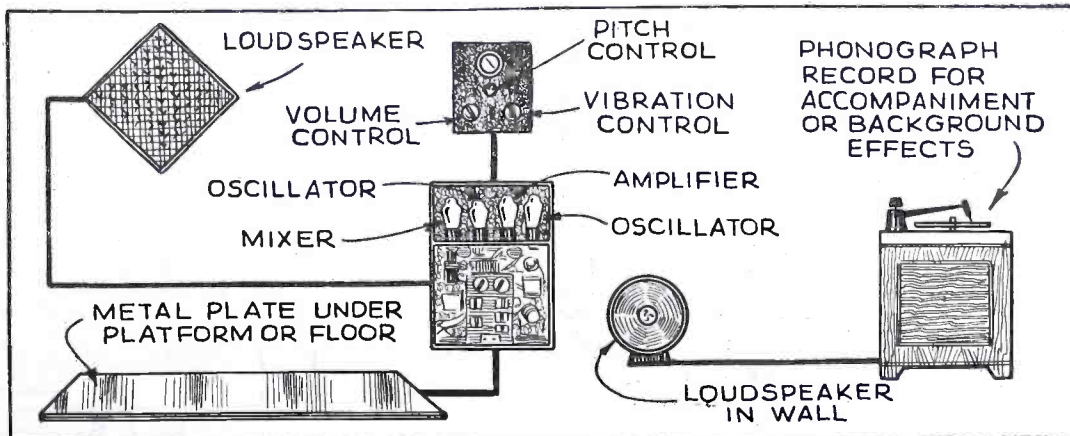

Fig. 1. The components of the system, including the phono. unit which is used for background effects.

EXPERIMENTS WITH REGENERATIVE F. C. T. DETECTORS

Several methods of adding regeneration to the F.C.T. detector system by means of the well-known Schnell and Hartley systems. A fine subject for experimenters!

ROBERT SANFORD

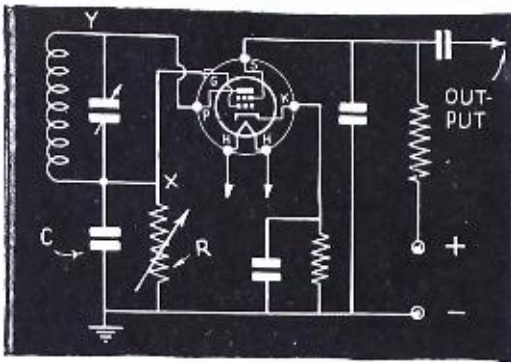

Fig. 1. The fundamental F.C.T. circuit.

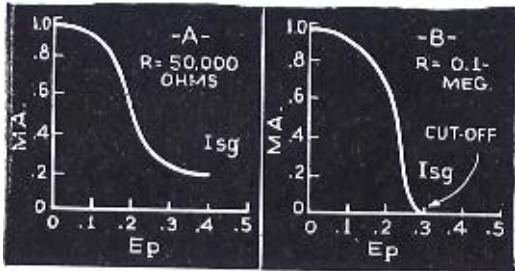

Fig. 2. The correct characteristic for F.C.T. detection (A) and the incorrect curve (B).

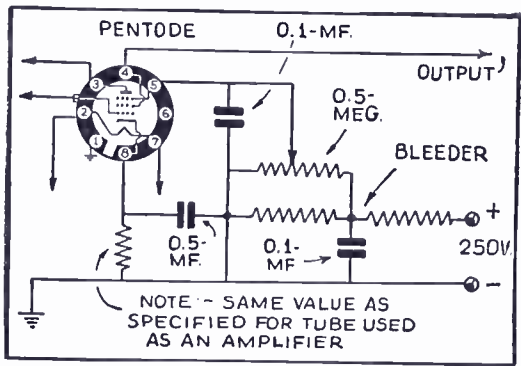

Fig. 5. A variable-mu pentode such as the 6K7 or 58 has the most suitable characteristics for regenerative F.C.T. detection—the circuit, above.

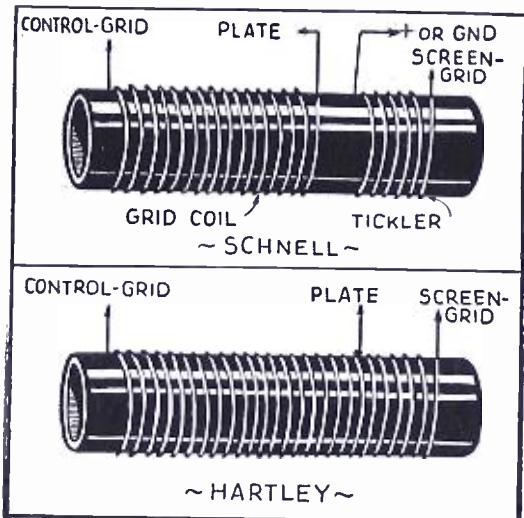

Fig. 6. Coil connections for the Schnell and Hartley adaptations of the F.C.T. circuit.

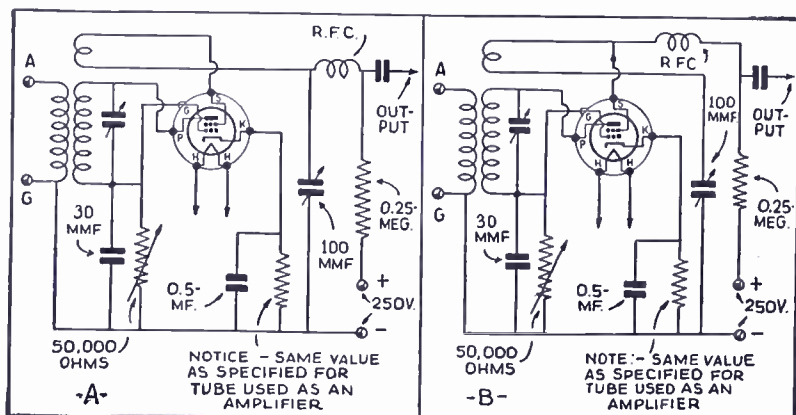

Fig. 3. The experimental circuits for using Schnell regeneration.

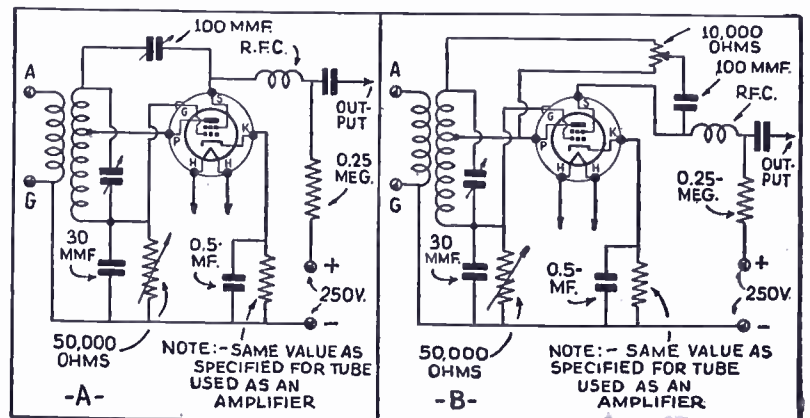

Fig. 4. The Hartley scheme is included in these two circuits.

A NEW-TYPE DETECTOR was announced in the March, 1936 issue of *Radio-Craft*, under the title, "A Beginner's Set Using the New 'F.C.T.' Detection System," page 521; a further discussion appeared in the article, "A 2-Tube 'F.C.T.' Set for the Beginner," in the July, 1936, issue. Re-reading these articles should help to clear up some points as well as show how regeneration was accomplished.

First of all, you will remember that volume control, R, in Fig. 1 was not to exceed 50,000 ohms. The reason for this should be clear from Fig. 2. When plate P is positive, R.F. current flows through R, producing a voltage drop, the value of which depends on the value of R and the strength of the signal. This leaves point X (Fig. 1) negative with respect to ground, hence control-grid G is also negative. This negative voltage is mixed with the original relay action, and *both* control the screen-grid current. The detector action causes no change in screen-grid current when P is negative, but causes this same current to decrease in proportion to one-half the input waveform, when P is positive. If the voltage drop across R is not too great, the output will look like A of Fig. 2. If however, the voltage drop is too great, the output will look like B, where the screen-grid current is completely cut off on modulation peaks. This causes severe distortion.

An attempt was made to tune the control-grid—plate circuit by grounding the tuning condenser, in place of connecting to the grid, and making condenser C about 0.05-mf. Now, in the original article a caution was included against making C greater than 30 mmf. This is important, to prevent bypassing

the R.F. from the control-grid, as it must be at high-potential relative to ground. Condenser C is in the circuit merely to bypass a slight residual high-frequency component from P, so it will not acquire a space-charge of negative electrons and make the circuit inoperative. Since the condenser was made 0.05-mf., it bypassed not only the R.F., but also the higher audio frequencies.

From paragraph 2, above, it will be seen that, considering only the control-grid—screen-grid section, the action is quite similar to that of a gridleak detector, for in both cases, rectification of the input signal produces a *decrease* in screen-grid current. With this analogous operation in mind, it would seem logical that the F.C.T. detector could be made to regenerate. Regeneration is a desirable feature in sets used by amateurs and short-wave listeners because of the fact that beat-note reception of C.W. may be heard, coupled with the great amplification possible and the better selectivity.

In the gridleak detector, regeneration is secured by feeding energy from the plate back into the control-grid circuit 180 deg. out of phase. Control-grid G in Fig. 1 is at high potential to ground, but the tuning coil is not grounded, the end ordinarily grounded being also at high-potential. This presents the problem of how to phase the feedback. If we regard point Y as being grounded, the problem is simplified to that of choosing the method of feedback desired.

The circuit shown at A in Fig. 3 is the first one tried; it is a hybrid of the well-known Schnell regenerator. A similar hook-up is shown at B of Fig. 3. Results obtained with these circuits are comparable to those with ordinary regenerative

(Continued on page 363)

HOW TO ADD A DUAL-CHANNEL A.F. AMPLIFIER TO YOUR RADIO SET

A replacement A.F. amplifier tube which permits controlled bass boosting in existing receivers.

WITHIN a few minutes' time, your present radio receiver can be changed into the most modern of all radio sets, by installing an improved simple type of Dual-Channel Audio Amplifier exactly as it is used in the higher-priced radio sets. It is a marvelous means of correcting the deficiency of bass notes which are sacrificed in amplification and transmission at many points.

The tube required for this work is the new 6L7, which is designed as a mixer tube and which has an extra grid for injecting the oscillator energy necessary for conversion (as described in past issues of *Radio-Craft*). This tube makes an excellent audio amplifier, when used in dual-channel work. In this case, the injector-grid is used as the normal amplifier, receiving the entire audio signal, which it amplifies at a lower degree of amplification. The higher-amplification grid located at the top of the tube receives selected low-frequency audio tones in order to boost these back to their proper relationship with the rest of the music. These lower-frequency audio tones are selected by means of resistance R2 and the 0.02-mf. condenser shown in Figs. 1 and 2.

It will probably be necessary to drill a hole through the

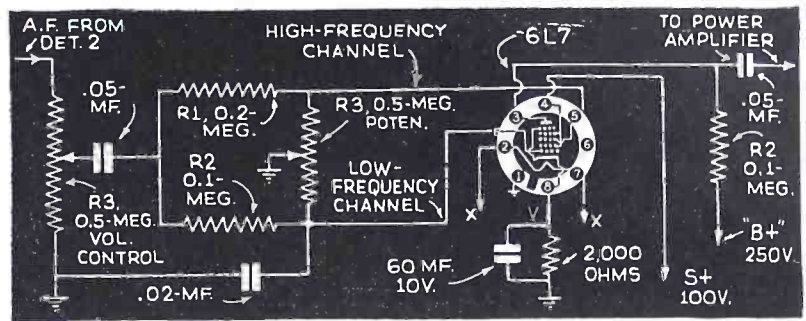

Fig. 1. The bass booster using a 6L7 as the dual channel amplifier.

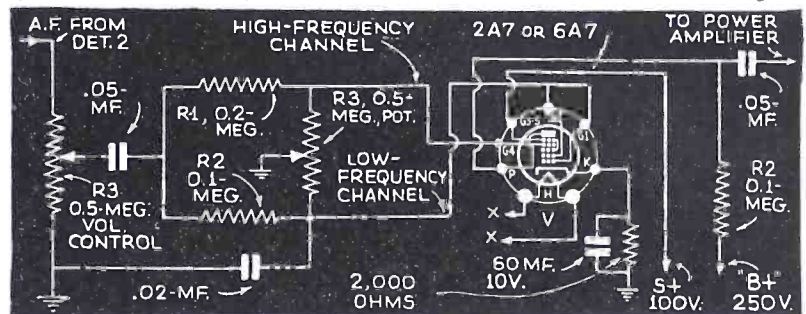

Fig. 2. The booster circuit incorporating a 2A7 for 2½-V. receivers.

chassis to take the grid lead up to the top of the tube and it will also be necessary to use one of the new octal-type tube sockets for installation of this modern 6L7 tube.

It is interesting to note, for those who have a 2½-V. filament supply in their present set, that a 2A7 tube may be substituted for the 6L7 tube (schematic as shown in Fig. 2). With installation of this tube; and also with a 6A7 (that may be used with a 6-V. filament supply, instead of the 6L7) it is necessary to connect grid No. 1 and the anode-grid together for the low-frequency, high-amplification channel and use the top grid for the normal audio-frequency channel.

The 60 mf., 10-V. electrolytic condenser may not be available. (Continued from page 361)

"MAGNETITE" CORES FOR R.F. COILS

"Lodestone," used for coil shielding and replacing the usual air cores in R.F. and I.F. coils, increases coil efficiency.

LODESTONE, that singular substance found in Mother Earth which first drew the attention of mankind to the phenomenon of magnetism, has now found a use in radio to increase the strength of radio signals. It is an indirect action, it is true; but it is now being utilized in cored transformers of not only I.F. but also high-frequency (or "R.F.") type.

It is explained that high conductivity in shields, as well as cores, produces not low-loss, but high-loss effects. A metal shield, for instance, is a closed single-turn circuit, and quite a circulation current can be built up in it from a coil by induction. This is, of course, at the expense of the current circulating in the coil, and therefore amounts to in-

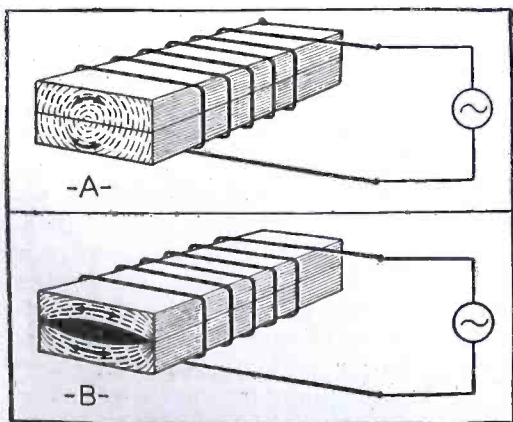

Fig. 1. The effect of shielding core laminations on core resistance is shown in A, and B.

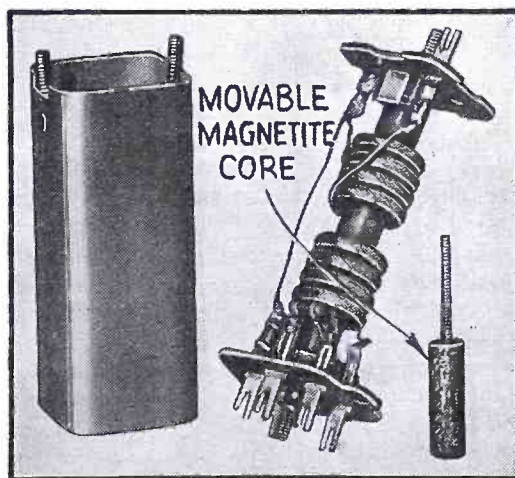

Fig. B. Magnetite cores tune this I.F. coil.

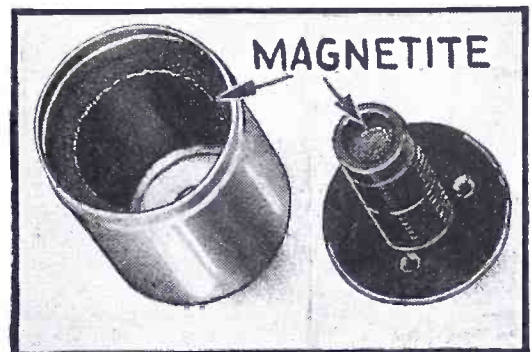
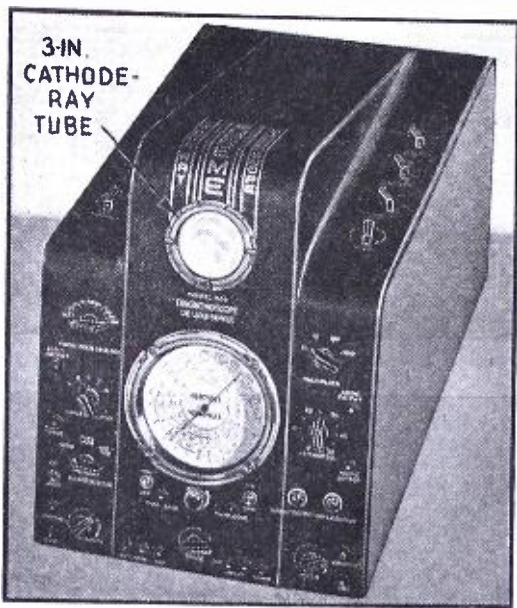

Fig. A. A magnetite shield and coil-core.

creased resistance in the coil. One way of overcoming this is to put the shield at a considerable distance from the coil, but this is at the expense of compactness.

A recently-developed type of R.F. coil has a shield of magnetite around it; this substance (magnetic iron ore), which is found in nature, being the lodestone which early-day mariners used in their compasses, in place of a steel needle. The magnetite, a mixture of oxides of iron, has some of the magnetic qualities of iron, and provides a closed path for the magnetic flux in the R.F. coil; but its resistance is high. This resistance is further increased by pulverizing the iron ore, and incorporating it in a binding insulator (called, by its manufacturers, "durez") so that the particles have very small points of contact, and consequently very high electrical resistance.

(Continued on page 363)



The front of the new "visual servicing" instrument.

NEW DEVELOPMENTS IN CATHODE-RAY EQUIPMENT

A single instrument combining an oscilloscope, all-wave oscillator, electronic wobbler, beat-frequency A.F. oscillator and a phase splitter for "circular displacement" of images. The unit also incorporates 17 design features.

GARLAND W. ARCHER PART I

MODERN cathode-ray oscilloscopes when designed for radio service use, should include certain features affording a means for visual alignment of receivers as well as provisions for the ordinary oscillographic functions. The instrument should be completely self-contained and should be operable without the use of troublesome motor-driven wobblers or mazes of interconnecting wires from one unit to another.

The features which have been incorporated in the unit pictured in Fig. A, are as follows:

(1) A fixed-frequency oscillator

which is frequency-modulated and in turn mixed with a variable-frequency oscillator, the resulting signal in the output circuit being that of a frequency-modulated signal having a constant band width, and variable between 125 kc. and 15 mc. (with sufficient harmonic content for further extension of the range).

(2) A built-in dual-purpose signal generator of the direct-reading type which affords a means for visual alignment as well as alignment of receivers by use of the generated "standard test voltage" which modulates the carrier 30 per cent at 400 cycles.

(3) A beat-frequency audio oscillator and amplifier of the direct-reading type continuously variable from 50 cycles to 10,000 cycles—and with a constant output, the harmonic content of which does not exceed 5 per cent.

(4) Provisions for external ampli-

tude modulation of the carrier in order that it might meet all modern test requirements. Incorporation of a modulator stage which has a fixed frequency of 400 cycles and capable of modulating the carrier 30 per cent.

(5) A "saw-tooth oscillator" or linear time base employing a type 885 gaseous-discharge tube with the necessary current-limiting resistors which insure a maximum of linearity, with a range of 7 cycles to 20,000 cycles.

(6) Facilities for shifting the phase relation of the input signal for aid in the study of Lissajou's figures.

(7) Horizontal and vertical amplifiers with a gain of approximately 40 and a practically flat-line frequency-response curve over a range from 20 to 90,000 cycles, and graduated gain controls for facilitating comparative tests.

(8) A time base which is automa-

(Continued on page 360)

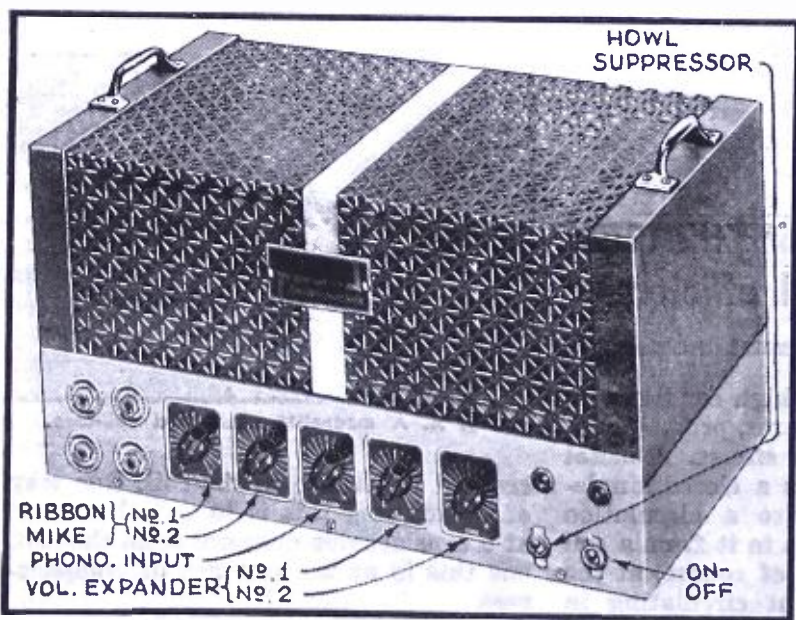

One type of beam power tube amplifier (a 6E5 may replace name-plate).

WHY USE "BEAM" TUBES?

A logical discussion of the reasons why beam power tubes should be used in P.A. amplifiers. "Get up-to-date—use the 6L6."

A. C. SHANEY

EVERY research engineer in the amplifier field is constantly seeking to improve and develop a better audio system—to eliminate microphonics—to prevent hum—to increase the gain of amplifiers—to suppress howl—to indicate overload—to design better transformers—to avoid distortion, and a hundred and one other large and small details. Therefore, it is easy to understand why the total of all these accomplishments during any given period results in some acknowledged landmark in the design of P.A. amplifiers.

Looking back over the past 10 years, or so, you can easily perceive several such landmarks. And these, perhaps, give a more dramatic illustration of what coordinated research has accomplished than you can get from a prosaic answer to the question titling this article.

To the engineer who has been following recent tube developments, the 6L6 beam-power tube requires no justification for its use in any sound system. For those of our colleagues however, who have failed to closely follow the recent trend in tube design, a brief resumé of the outstanding features of the beam-power amplifier will not be amiss.

A correctly-designed beam-power amplifier combines into one unit the power output of a "giant amplifier" by using only 2 power output tubes, each with the power sensitivity

(Continued on page 370)

Before you decide, whether or not a Beam Power Anti-Howl Amplifier is justifiable, carefully observe any other type amplifier—that is, one having a similar number of tubes but lacking "beam" output—and notice that it does not have EQUIVALENT: (1) high power sensitivity, (2) high power output (for instance, 60 W. at only 2 per cent. total harmonic distortion), (3) high efficiency, (4) low distortion, (5) electronic mixing, (6) anti-howl feature, (7) improved automatic audio volume control, (8) floating audio power, (9) automatic volume compressor, (10) cathode-ray overload indicator, (11) self-contained volume expander, (12) synchronous high- and low-frequency complimentary attenuator; as well as a thousand-and-one other little details of design which enter into a modern highly-perfected and dependable Beam Power Amplifier.

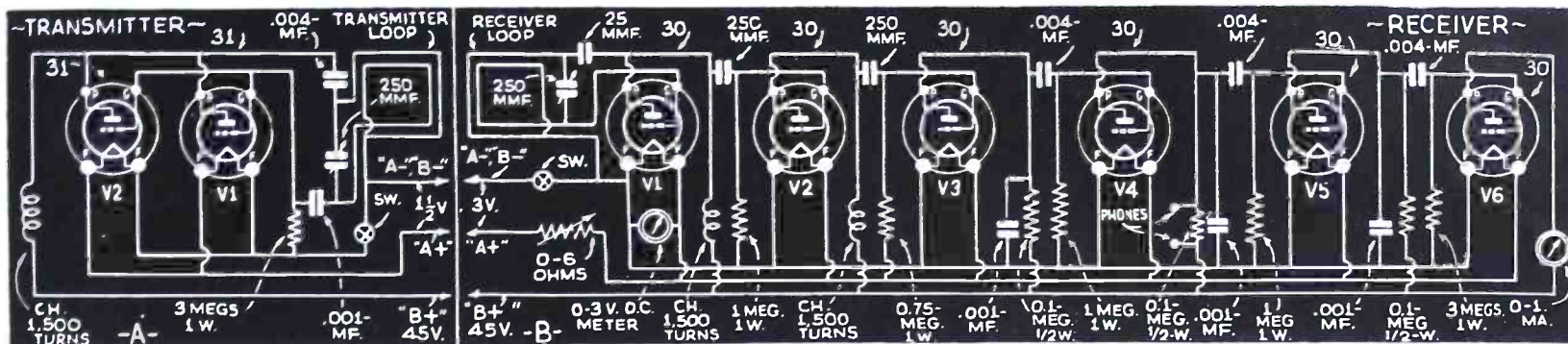

Fig. 1. The circuits of the transmitter (A) and the receiver (B) with values of parts shown. The tubes of the transmitter are operated at 1½ V.

Cities, utility companies and others use this type of equipment for locating metallic bodies, such as piping, etc.

"TREASURE" LOCATORS

GERHARD R. FISHER

MANY circuits and descriptions have been published dealing with so-called metal or "treasure" locators; but most attempts by the amateur to build such an instrument result in an instrument with instability of circuits, very little penetrating power, and, in general, very poor results. When attempting to experiment with a locator using the principle of a radio balance, it is most necessary to understand the electrical fundamentals of such equipment.

THEORY OF THE "RADIO BALANCE"

In general, the radio balance consists of a modulated transmitter (working on a frequency anywhere between 50 and 3,000 kc.), the output of which is coupled to a balanced loop antenna; and a very sensitive loop receiver coupled to a headphone set and some form of tube voltmeter. *It is most essential* that there shall exist no coupling between the transmitter and receiver, except through the loop antennas. Batteries, tubes, transmitter and receiver are installed inside these loops to avoid any so-called "vertical antenna" effect, which if it occurred would entirely destroy the efficiency of the equipment.

In the device here illustrated and described, a vertical transmitter is used, and a horizontal receiver; though these positions can be reversed, the first arrangement is the most satisfactory. Receiver and transmitter loops are at right-angles to each other; which will give a minimum indication in the phones, and in the tube voltmeter, when no metal is present. In this position half of the field, emitted from the transmitter, penetrates the air and the other half the ground. These two fields are

opposing each other, and in the neutral point between the two, the receiver is located.

SENSITIVITY FACTORS

To insure this position, the transmitter and receiver are connected by handles, the closer they are placed to each other, the more sensitive the arrangement for small objects but, also, the less its actual depth range. Increasing the length of the handles increases the depth range, but objects to be located must be much larger. This phenomenon is the most puzzling one to experimenters, who want to get a great depth range, yet locate very small objects. A compromise must be reached; most effective with about 4-ft. handles (illustrated).

Employing a frequency of about 3,000 kc. will make the arrangement so sensitive that a piece of metal 1 ft. square can be detected through the air to a distance up to 10 ft. (through water, roughly 5 ft.); but, from the point of practicability, such an instrument is by far too sensitive when

carried over rough territory and through brush and undergrowth.

For commercial use, a low frequency, seldom more than 200 kc., is used. For satisfactory operation, an instrument of this kind should be carried at least 1 to 1½ ft. above the actual surface. Even in that position the instrument is so sensitive that a change of rock formation (for example, between quartz and schist, or slate and diabase) can be noticed in the headphones—a feature which is most valuable during the process of electrical geophysical prospecting. In addition to taking a reading from directly above, to determine posi-

(Continued on page 374)

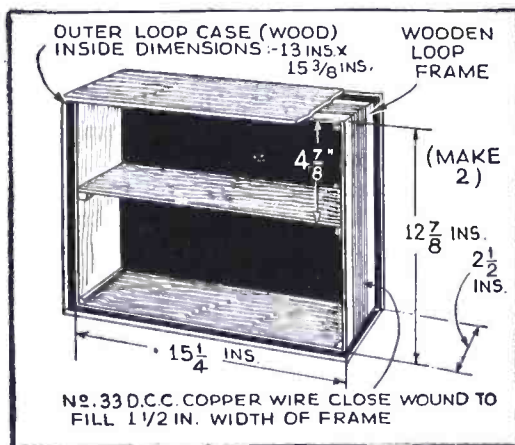

Fig. 2. The details of loop and case construction.

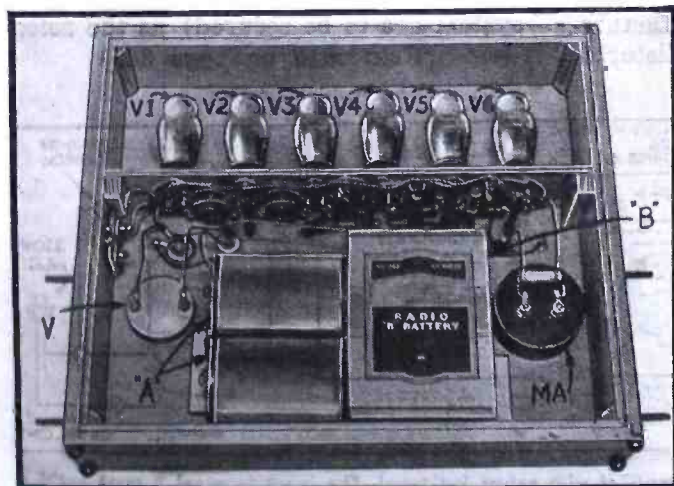

Fig. A. The interior of the receiver showing layout of parts.



Fig. B. The operation.

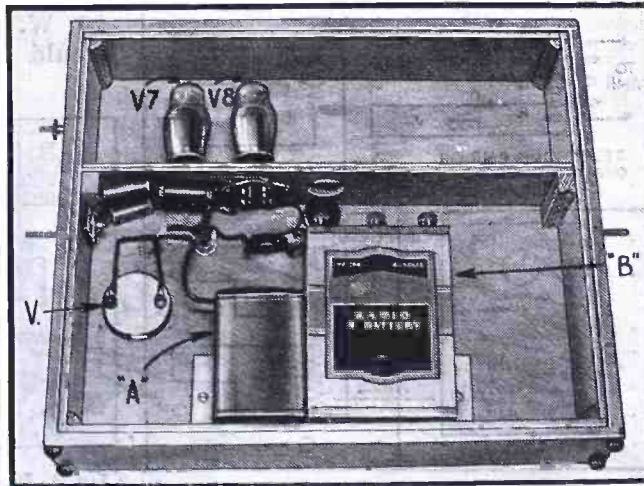

Fig. C. The interior of the transmitter case showing parts.

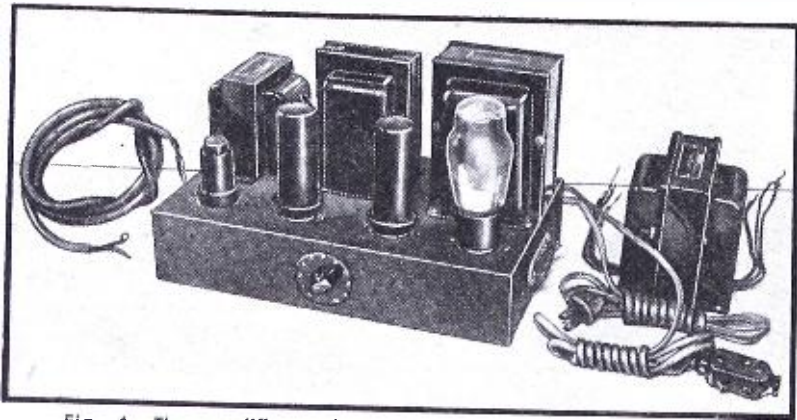

Fig. A. The amplifier and output transformer (showing layout).

EXPERIMENTS WITH A "HI-FI" AMPLIFIER

A few tricks for the experimenter in building and using a low cost, hi-fidelity amplifier.

ARTHUR H. LYNCH PART I

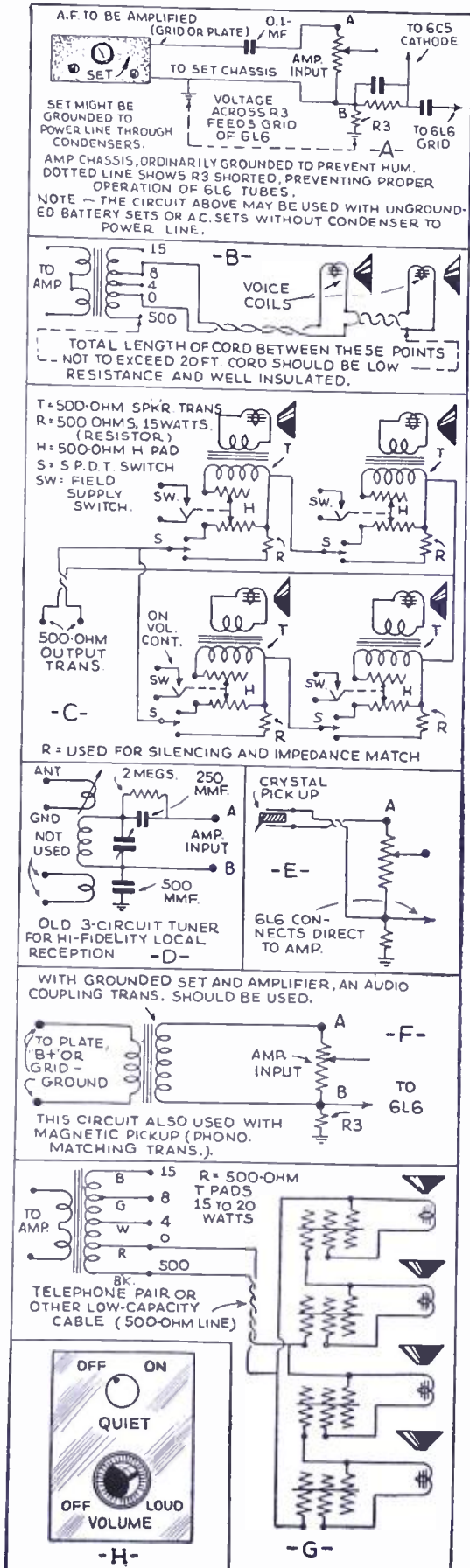

Fig. 2. Details of design and output connection.

SO MUCH has been written and said about "high-fidelity reproduction" that most people are beginning to believe that there must be something to it.

Its practical application, however, is something which is not generally understood. Furthermore, just as soon as "high fidelity" is mentioned the man in the street recoils for the reason that he has been led to believe that it cannot be had without going to considerable expense.

The recent introduction of the beam power tube has changed all that. The complete kit of parts for the amplifier and power supply we are about to describe may be had from practically all radio mail order houses, and the total cost is very low.

Just a few years ago we paid \$20.00 for a pair of input and output push-pull A.F. transformers and thought we were getting a bargain. At the time, the reproduction which we were able to secure from the application of these transformers was considered to be "marvelous." By the time we had secured suitable power supply, filter units, loudspeaker and tubes we had run the cost up to a figure which makes the cost of the amplifier we are describing here look ridiculously low.

If the two finished products are set up side by side the fidelity of the amplifier here illustrated and described is so superior to the quality produced by the older equipment as to be readily recognized by anyone. The 6L6 beam power tube forms the real basis for the improvement which is provided by this new amplifier and if high-grade components are accompanied by reasonable care in its construction we will be able to provide ourselves with approximately 15 W. of what most manufacturers would be ready to call "undistorted"

reproduction. It is well known that the beam power tube is rich in second-harmonics and, ordinarily, this would provide second-harmonic distortion which would be serious. This distortion is practically eliminated by using a pair of these tubes in push-pull.

Rather than attempt to further discuss the matter of the whys and wherefores of this amplifier, suffice it to say that the unit described here has created very satisfactory comment wherever it has been shown and many other experimenters who have been desirous of securing high-quality reproduction for their homes have duplicated it. Rather than worry about the technical details of the circuit we will confine our description to the actual construction of the unit and the many ways in which it may be applied in the home.

(Naturally, the progressive Service Man will recognize the importance of a unit of this nature in connection with his public address work, where an amplifier delivering 15 W. will be sufficient.)

The amplifier described here was designed for our own use and the loudspeaker equipment with which it was to be used was provided with a suitable matching transformer to take full advantage of the output of the 6L6 tubes. That is the reason the transformer was not mounted directly on the amplifier chassis. A slightly larger chassis may be employed if a transformer, such as is shown in the accompanying illustration, is to be placed on the amplifier rather than at the end of the line.

The output transformer that is shown here is provided with several matching impedances. Selection of the proper loudspeaker or speakers is just about as important (if the real merits of this system are to be secured) as the selec-

(Continued on page 365)

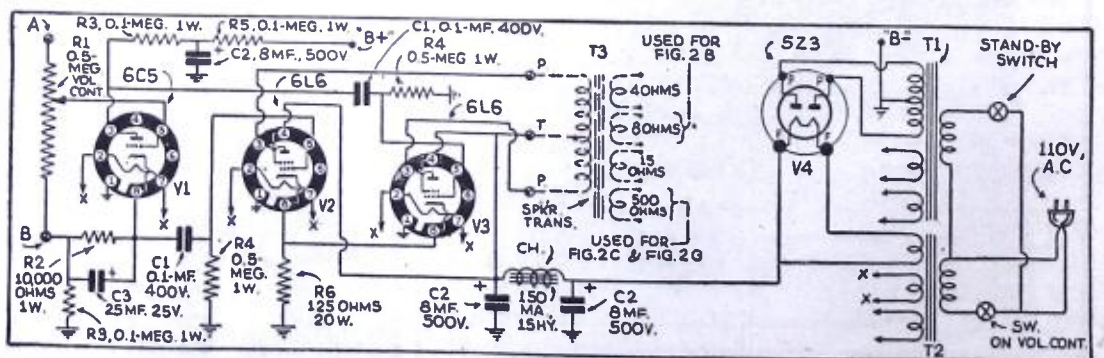

Fig. 1. The schematic diagram of the amplifier with values indicated. The input terminal B must not be grounded to the amplifier chassis or the push-pull action will be destroyed.

MAKING AN ORGAN-TONE ACCORDION

A special amplifier which brings out all the fine quality of the piano-accordion at any level from "room" to "auditorium" volume.

LEONARD WERNER.....

A MPLIFYING equipment finds new utility in the following, unique method for greatly enhancing the tonal quality of the *Piano Accordion*.

To begin, we are all familiar with the sounds given out by the accordion, and are aware of the tremendous volume the instrument is capable of producing without the use of an amplifier. For this reason we are not so much concerned with increasing this volume. Our plan is to *have the tone sound like that of an organ*, and yet not lose the beauty of the true accordion tone.

Merely using a good speaker, a standard amplifier, and a good crystal mike placed *near* the accordion, will not be sufficient—in fact, it only results in (a) blasting, (b) frequency cut-off, and, (c) loss of natural tone. In other words, the instrument then sounds like an ordinary mouth harmonica.

However, a good crystal mike of the sound-cell type placed *on* the accordion and connected to a suitable (specially-designed) amplifier, with a frequency range of from 30 to 10,000 cycles, will do the trick. The description of a suitable amplifier follows.

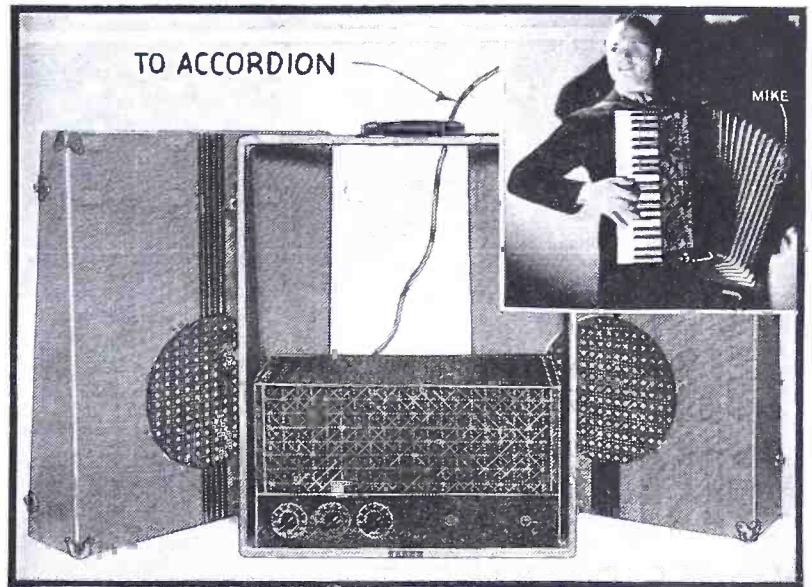

Insert photo courtesy Excelsior Mfg. Co.
Fig. A. The portable amplifier—insert, mike installation.

DESIGN OF "PIANO ACCORDION" AMPLIFIER

The input preamplifier uses 2 metal 6J7 tubes in a 2-stage arrangement, as shown in the circuit diagram. Resistance coupling, here, is a convenient means of securing high-quality reproduction; at the same time, it minimizes any chance of induction-hum pick-up. The second 6J7, series-fed into a pair of 6C5 tubes, is used to drive the two 6L6s. (The driver transformer used here is specially designed for a frequency response range from 20 to 12,000 cycles; its 4-coil design, and integral construction, are well worth noting.) The output transformer used in the particular amplifier here illustrated is carefully designed to match the plates of the two 6L6s; the secondary is tapped to match 2, 4, 8, 15 and 500 ohms.

(Continued on page 366)

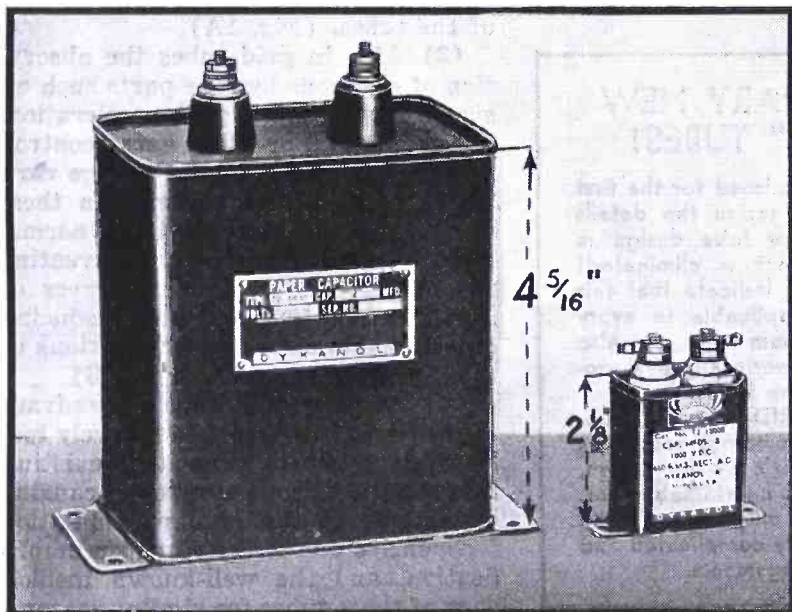

Fig. A. Dimensions of two Dykanol condensers:— larger—2 mf., 3,000 V. D.C.; smaller—0.5-mf., 1,000 V. D.C.

CONDENSERS have undergone more changes and improvement than may seem apparent on the surface. And, lest the Service Man or technical reader be under the belief that present-day, "ordinary" condensers are good enough for any radio "job"—we hasten to say that the "picture" is once more changing. Indications today are that the *oil-filled* type of condenser is going to rapidly leap into the foreground, especially where the best possible job, whether repair or design, is to be performed.

However, it is probable that this conclusion would not be warranted, were it not for the fact that recent improvements in oil dielectrics have resulted in the production of a substance, incorporating several different chemicals, known as "Dykanol" and classified alphabetically into 3 groups; "Dykanol A," the only type used in radio work, is a chlori-

NEW- VS. OLD-STYLE CONDENSERS

A new condenser dielectric known as Dykanol is the basis of the high-quality units described.

J. T. BERNSELY.....

nated phenol compound. A study of the characteristics of Dykanol A, or *dykanol* as it will henceforth be called in this article, will reveal the desirability of dykanol-impregnated condensers.

TABLE I

Characteristics of Dykanol A

(At room temperatures of 60 to 90° F.—negligible change with increased temperature.)

Leakage Resistance	5 to 10 megohms per mf.
Power Factor	0.4-per cent
Dielectric Constant	60 (approx.)

Of importance to the engineering fraternity—and the Service Man, too, if he is concerned with the electrical characteristics of an item that he may use—is the fact that dykanol condensers have a leakage resistance and power factor change that is far lower at high temperatures than any of the other present popular types in use. In common parlance this would mean that for power supply work, public address, and A.V.C. systems (where leakage resistance is the cause for poor or no operation of the A.V.C. stage) this type of small-space oil-impregnated condenser is far superior to current popular types.

Dykanol condensers can be operated *continuously* at vol-
(Continued on page 366)

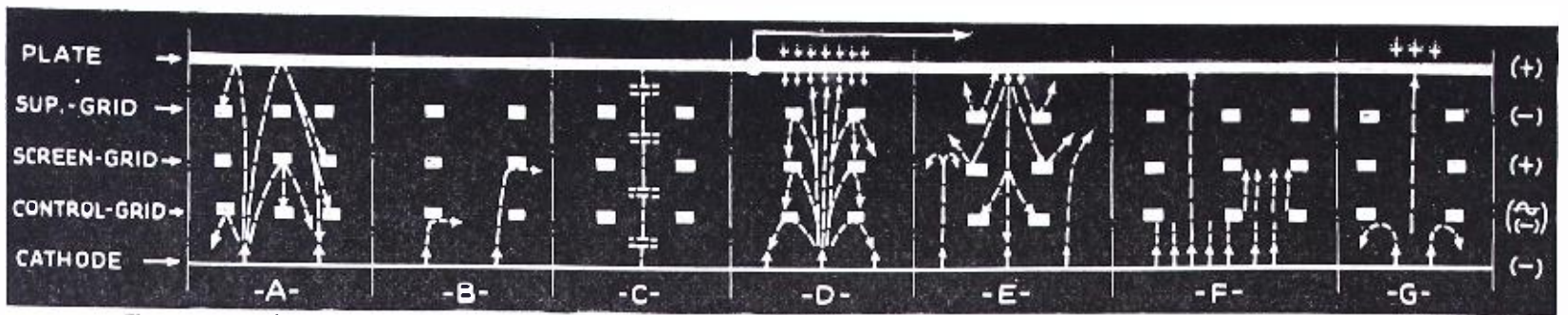

Fig. 1. Schematic representation of electronic attractions, repulsions, reflections and absorptions in screen-grid and pentode vacuum tubes.

GRIDLESS vs. GRID TUBES

HENRI F. DALPAYRAT

In Part I, below, are listed some of the many disadvantages and limitations of the "grids" in vacuum tubes. In following parts, a revolutionary new "gridless" idea in tube design will be described.

PART I

A GRID, as used in radio vacuum tubes, is defined in radio engineering textbooks, as "a slotted or perforated metal sheet, or a loosely-woven metal cloth, or a wire network, as in a solenoid wire grid, forming a fixed and partial physical obstruction to the flow of electrons emitted by a cathode, and offering a variable electrical attraction or repulsion to these electrons, as influenced by the voltage variations applied on this grid."

As is well known, the purpose of *grids* is to vary the number of *electrons* (particles of negative electricity) passing through its unobstructed portions, such as the spaces between the turns of a solenoid wire grid, in order to vary the number of electrons (that are released from the emitter or *cathode* and reach the *anode* (commonly called "plate") and thereby vary the flow of current in this electrode.

Grids are also used to accelerate and propel electrons towards an anode, as accomplished by a *screen-grid*; or to repel anode secondary electrons, as in the case of a *suppressor-grid*; or for electronic coupling in a frequency mixer tube, etc., by means of an *injector-grid*; etc.

In every case, the process consists of passing electrons through some sort of perforations in an electrode having a positive potential *attracting* electrons; or a negative potential (or bias) *repelling* electrons in various amounts according to the input signal voltage variations.

It is evident that if a vacuum tube could be built in which neither perforated electrodes, nor the process of passing electrons between 2 or more conductors having a similar electrical operating potential, were used, this new tube regardless of the electronic principle involved, or the shape or position of one or more modulating or accelerating electrodes, could never be defined as a "grid tube."

The various uses and actions of grids in vacuum tubes are well known today. They have been thoroughly analyzed from every possible angle. Hundreds of books throughout the world have been written on this subject. A multitude of carefully plotted graphs and curves have been recorded, and backed by long and complicated formulas, but while great efforts have been made through circuit designs, to correct the inefficiency or objectionable features of grids, very little has been done towards their complete elimination.

A number of so-called gridless tubes lately described in publications, have a number of perforated electrodes which are really nothing but single-aperture grids, as compared to the many openings between turns of solenoid wire grids.

Varying the number of openings in a grid does not correct its disadvantages, while often new conditions are created which present new objections.

The writer has catalogued, below, 17 undesirable electronic actions resulting from the use of grids and for which there seems to be no cure except perhaps the elimination of the grids themselves.

(1) It is well known in the industry that in amplifying vacuum tubes using concentric solenoid wire grids, or any slotted or perforated controlling electrodes, through which electrons pass in varying numbers, that the electrons emitted by the cathode are reflected in various directions by the tube parts upon which they impinge, and that these parts in turn, liberate secondary electrons which produce so-called "high-amplification tube noises." (Fig. 1A)

(2) Another disadvantage of solenoid wire grids, or slotted or perforated metallic obstructions placed between the cathode and the anode to vary the number of electrons transferred between these 2 electrodes, is the repulsion of the cathode electrons by secondary emissions and stray electronic reflections from various tube parts, causing a constant limiting factor reducing the amplification and efficiency of the tubes. (Fig. 1A)

(3) Also in grid tubes the absorption of electrons by tube parts such as, signal input control-grid, acceleration- or screen-grid, or other extra controlling grids, causing undue voltage variations or excessive currents in these parts, interfering with their normal purpose and functions, preventing the attainment of higher degrees of amplification while also producing objectionable noises and distortions of the signaling voltages. (Fig. 1B)

(4) Another well-known disadvantage of grid tubes, is the relatively too-high electrostatic capacities existing between the various electrodes, causing distortions of the higher modulation frequencies due to their uneven amplification, and the well-known inefficiency of these tubes for similar reasons, for the amplification of very short

REVOLUTIONARY NEW "GRID-LESS" TUBES!

In Part II will be disclosed for the first time in any radio magazine the details of a revolutionary new tube design in which the grid element is eliminated!

Experiments to date indicate that this design is not only applicable to every existing service of vacuum tubes, but also in many instances, superior in performance in these respective fields.

Furthermore the GRID-LESS construction makes possible numerous results as an inherent characteristic of the design, that previously were unattainable; or, that were attainable only through the use of special, relatively complicated and expensive circuit arrangements.

waves. (Fig. 1C)

(5) Still another well-known disadvantage of grid tubes, is due to the fact that near the surface of the output anode, the electrostatic field density, per unit area of the anode, is much greater than the negative electrostatic field density of the electron streams reaching that surface, which prevents the cathode electrons from repelling the secondary electrons liberated by the anode when this latter receives primary cathode electrons. (Fig. 1D)

(6) Also, in (screen-) grid tubes, the anode secondary emission is attracted by the acceleration-grid which projects these interfering electrons against and through the signal-input grid, thus varying the effectiveness of this grid and also opposing the cathode-to-anode electron stream. (Fig. 1E)

(Continued on page 367)

LOOKING AHEAD IN THE RADIO FIELD

Experimenters, and in fact everyone in the radio field, will find important disclosures if they will but read between the lines of this abstract of FCC open-forum reports.

R. D. WASHBURNE

PART II

A SPOKESMAN for RMA (Radio Manufacturers Association), Mr. Lawrence C. F. Horle, pointed out the Association's stand—which is that facsimile and aural broadcasting should be kept apart as two distinctly different services, with probable 24-hour facsimile service at a future date. Aural broadcasting was recommended in the 37 to 42 mc. (megacycle) range; with 15-kc. modulation (30 kc. band width) by high-fidelity transmitters a 40-kc. separation (min.) would be required, and in the same geographical area, 200 kc.

When Samuel E. Darby, Jr., patent attorney, addressed the Commission in behalf of his clients, the independent radio manufacturers, he said he represented set makers whose output totaled about 18 million of the entire 25 million sets sold in the entire United States. "It is logical to expect," he said, "that these concerns will be the manufacturers *in like proportion* of television equipment for home use when television becomes a realized fact." Note the line which we emphasized by italics—among the 11 well-known companies Mr. Darby, Jr., specifically mentioned was Philco, which company, as reference to articles in the preceding issue of *Radio-Craft* indicates, is right in the vanguard of television development. (The special plea of Mr. Darby, Jr., was that television patents be kept free from patent pool monopoly.)

* * *

Specialists in the Public Address field will be interested to know that the U. S. Coast Guard has just demonstrated at Fort Hunt, Va., a light-weight P.A. unit that at 3,500 ft. altitude is capable of projecting the voice over a radius of 1 mile. RADIO-CRAFT is endeavoring to bring the details of this story to the attention of its readers at an early date, but in the interim, suffice to say that this P. A. system is now undergoing test on the eastern seaboard for use particularly in emergencies, to warn fishermen and others of hurricanes, etc., or to bring aid to flood-stricken areas. In these services the equipment is operated from air planes or cutters, and should prove infinitely surer, adaptable and effective than the optional system—trailing banners—now simultaneously being tested. For instance, banners are of no use for informing persons out of sight of the plane, as is frequently the situation; and at night the banner would be a total failure. (See "Public Address Improvements," pg. 645, May 1936 RADIO-CRAFT.—Editor)

* * *

Columbia Broadcasting System's ("CBS's") Mr. William S. Paley, President
(Continued on page 372)

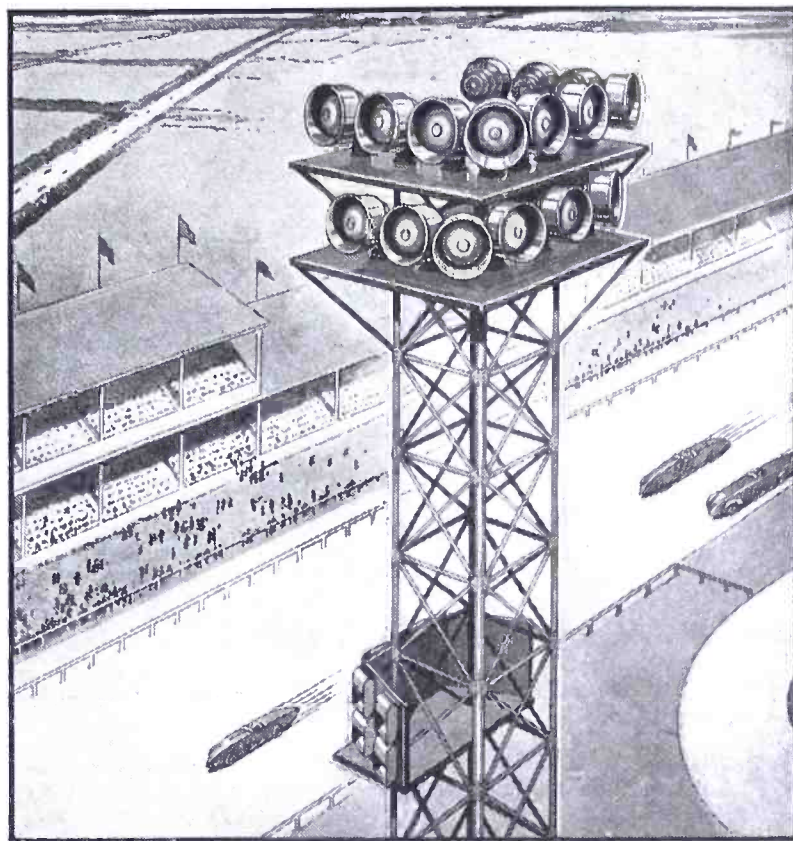

A centralized giant loudspeaker system, designed by Bell Tel. Labs. and built by Western Elec. Co., is utilized to spray sound over a mile-square area (if need be) at pretzel-shaped Roosevelt Raceway, Westbury, Long Island; heretofore, the decentralized arrangement or placement of speakers at many points, has been used in covering sporting events of this nature. As here shown, topping the 100-ft. tower are 18 long-range, super-power loudspeakers driven by the 20-kw. output of a bank of audio amplifiers, and delivering the amazing audio energy total of 10 kw. These searchlight-shaped reproducers (see "A New Giant Loudspeaker," *Radio-Craft*, Dec. 1934) have their sound beams trained to cover remote or parking-space areas. Further down on the tower may be seen the loudspeakers for nearby or grandstand and paddock coverage. This arrangement by eliminating echo effects is successful in securing clear and distinct reproduction.

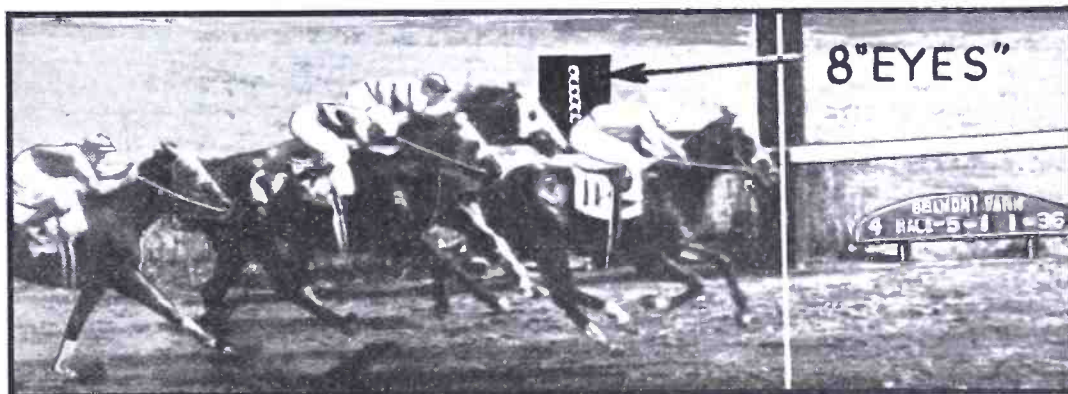

"Electric Eye" timing affords incontrovertible evidence of record speeds, at modern racetracks. At Belmont Park Racetrack, New York, we see, above, the close finish of a horse race timed by means of G.E. photoelectric apparatus. Equipment of this type installed at famous Saratoga (New York) Racetrack is shown below. Three high-speed cameras are controlled by the photocell equipment.

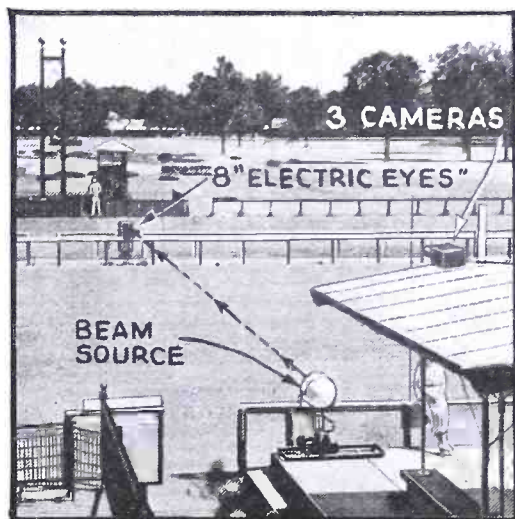

The 3 cameras are located in the cupola over the judges' stand directly opposite the finish line. Breaking the searchlight's beam results in a series of 3 photos (timed, on the basis of average race speeds).

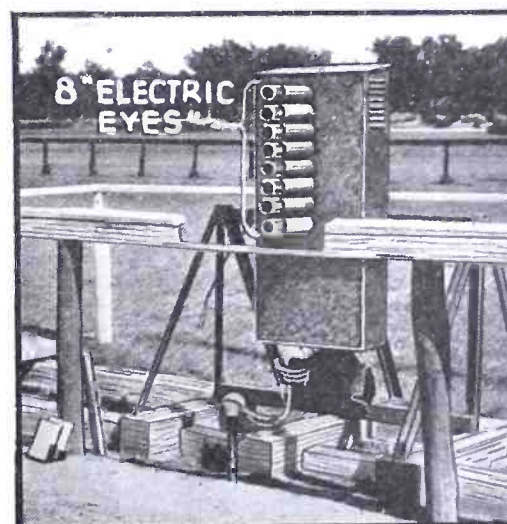

Viewed from above, the light beam is narrow, but it fans out vertically to 8 photocells. Placed 4 ft. ahead of the finish line, these photocells actuate relays immediately upon interruption of the beam, to triple-photograph the winner.

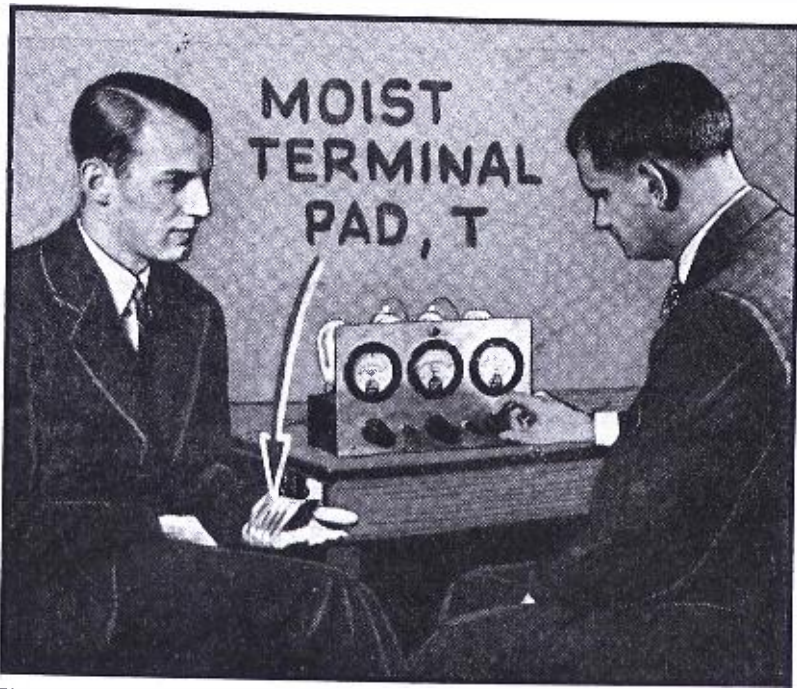

Fig. A. The "lie" detector (often useful in court proceedings) is here shown measuring skin resistance in determining the degree of "psychogalvanic reflex".

HOW TO MAKE A PSYCHO GALVANIC DECEPTION DETECTOR

The psychogalvanic deception detector ("lie" detector, to you!) is of interest to experimenters! This one helped solve a crime!

R. C. DAVIS

body resistance indicates the person's general state of excitation at the moment.

Some of the requirements for a measuring instrument for the psychogalvanic reflex are as follows:

(1) A constant current must flow through the subject at all times. Constancy is necessary because body resistance is a function of current intensity.

(2) The instrument should be sensitive enough to register changes no greater than 10 ohms, and at the same time give indication of the level of a subject's resistance, which, with a given type of electrode, may vary from 10,000 ohms to 0.2-meg. or more.

(3) The instrument should have a time constant small enough to register the full value of changes reaching their maximum in a half-second, and then receding.

For these requirements the instrument here pictured and diagramed has been developed. To insure a constant current flowing through the subject, he is placed in the plate circuit of an emission-limited tube (an 01A is used as indicated in the diagram). Intensity of current is controlled by filament temperature; (in the laboratory with which the writer is associated, 0.1-ma. is used as a standard value). The value is read from the milliammeter at the left.

Since the current is held constant by the filament emission, changes in the resistance of the subject must be represented by changes in the potential drop through the subject. Part of this is neutralized by the opposing voltage from the potentiometer shown just ahead of the first amplifier; small fluctuations are passed on to the series of amplifier tubes.

For amplification *direct coupling is necessary* since the change involved is such a relatively slow one. In ordinary work it is necessary to use only one of the voltage amplifiers (shown in the diagram) preceding the power stage.

As a registering instrument, a 0 to 5 ma. milliammeter, in the output of the final stage, is used. Its response has been shown to be rapid enough to register the full value of the changes which occur. Taps for connection to an oscilloscope are provided in case graphic records are desired.

The whole instrument is calibrated simply by inserting a variable resistance box in place of the subject, and reading

(Continued from page 370)

WHEN A PERSON receives a stimulus, even the least bit exciting, the electrical resistance of his body, after a delay of perhaps a second-and-a-half, undergoes a sudden drop. This elementary fact has been known to psychologists for the last 40 years. Early workers christened the phenomenon "the psychogalvanic reflex" and advanced many conflicting notions about it; yet only within recent years has a satisfactory understanding of its relations begun to develop. *A great assistance in this kind of work at present is the availability of vacuum-tube devices for measuring purposes.*

Some public interest in the phenomenon has lately developed because of its use as a "lie detecting" scheme in a case of suspected murder, that involving the death of Frances Prince in a "lover's lane" party in Indiana. The general principle behind such an application is that when a person is asked a question that touches on a sore point he will exhibit more excitement, i.e., give a larger resistance drop, than in response to other questions. In this connection the phenomenon presents some fascinating possibilities, although there are other perhaps even more important uses for it in the psychological study of emotions. Of course, neither this approach to the spotting of deception, nor any other, registers a phenomenon peculiar to lying. As the primary effect measured is excitement, a good deal depends on the skill of the questioner in presenting the suspect with questions which will prove exciting if the suspect is lying and less so if he is not. Naturally the results of such a test are not acceptable as court evidence, though they are sometimes useful in this connection. In the recent case mentioned, information was obtained which led to its disposition.

The phenomenon originates largely in the sweat glands, but the change is not, as might be supposed, produced by increased surface moisture; rather it is an ionic rearrangement within the tissues themselves. The absolute level of

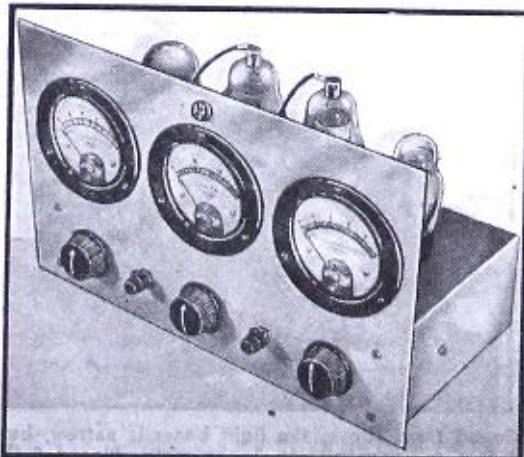

Fig. B. The appearance of the device.

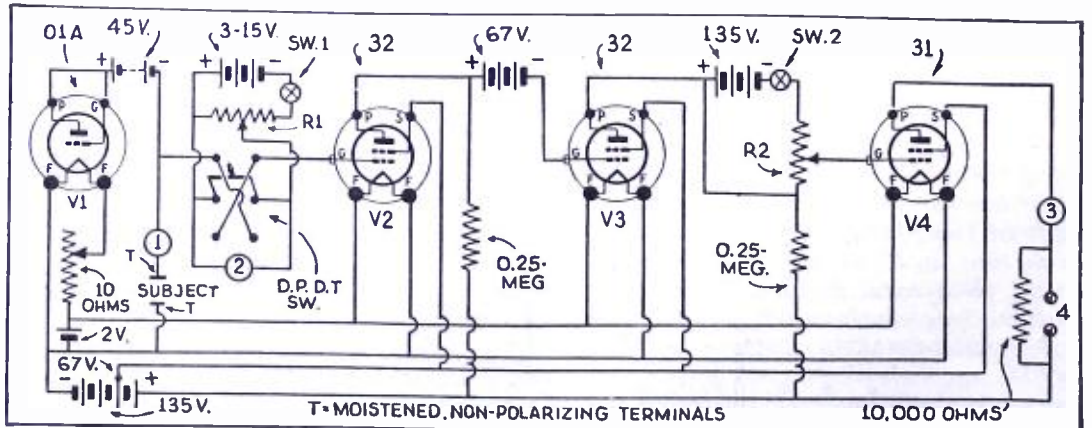

Fig. I. The direct-coupled circuit, including values. Controls R1 and R2 measure, respectively, 0.25-meg.

FIRST PRIZE.....\$10.00
 SECOND PRIZE..... 5.00
 THIRD PRIZE..... 5.00

Honorable Mention

EXPERIMENTERS: Three cash prizes will be awarded for time- and money-saving ideas. Honorable mention will be given for all other published items. Send in your best "kinks"!

SHORT-CUTS IN RADIO

SECOND PRIZE—\$5.00

DEFECTIVE METAL TUBES MAKE INEXPENSIVE PLUGS. Defective or burned-out metal tubes make excellent equipment plugs. The 6H6 tubes are best for speaker plugs, while the 6C5, 6F6, and small 5Z4 tubes are best for analyzer plugs. First, bend the metal shell so that the base may be removed, after unsoldering the wire leads, as seen in Fig. 2. Then drill a hole in top and bottom of the tube and run a screwdriver through to clear the elements out of the way. The cable may then be pushed through and soldered to the base prongs, after which the base is again crimped in place. If shielded cable is used it may be soldered to the top of the tube; and if not, a rubber grommet should be inserted in the hole.

W. A. LYNCH

in Fig. 5 is handy. File 2 small depressions in the jaws of the pliers and cement-in strips of good insulating material such as hard fibre or bakelite.

PETER LUCI W

HONORABLE MENTION

QUIETING A.C.-D.C. SETS. Because of the circuit used in the midget sets it is not usual to provide a ground wire. In some localities these receivers pick up lots of man-made static. By using a condenser as shown in Fig. 6, the receiver is efficiently grounded and the volume is very noticeably increased in all cases. The dual condenser must be of the paper type as the electrolytics heat up on A.C. Be sure to put the condenser on the house side of the fuse box. I now use this stunt in my shop which is

(Continued on page 368)

THIRD PRIZE—\$5.00

EMERGENCY BALLAST REPLACEMENT. Many of the late midget and A.C.-D.C. sets have ballast tubes in place of the older line series resistors. These tubes are often hard to get in the correct value, and as the customer is always in a hurry for the set, I install the gadget shown in Fig. 3 until I can secure the correct replacement. This is simply a large wire-wound resistor bolted to a base from a 4-prong tube. The slider enables the resistance to be adjusted to take care of any receiver tube arrangement. If the set has a tap in the ballast tube for use with a pilot lamp, this is easily taken care of by an extra slider on the resistor.

ROBERT OWENS

HONORABLE MENTION

MOVABLE SPEAKER. When you have several receivers and only one speaker, you can save both time and money by use of the scheme shown in Fig. 4. Mount the speaker on a piece of wood, and drill holes in the lower corners. Then drill holes in the panel of each set and insert bolts through them so that the speaker baffle may be fitted to any one. Using a plug-in cord and wing nuts, the speaker may be changed in a hurry.

EDWARD SNOW

HONORABLE MENTION

EASILY-MADE ALIGNING TOOL. To prevent body capacity when adjusting the slotted plates of gang condensers, the scheme shown

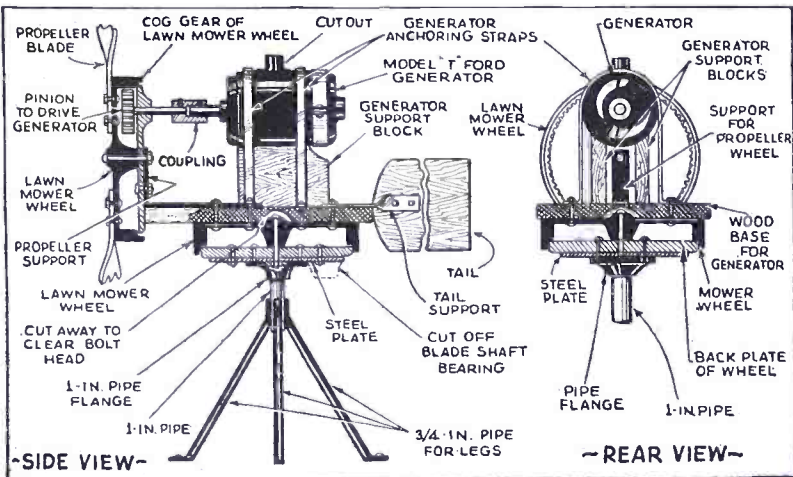

Fig. 1. A windcharger in which the main item is a discarded lawnmower.

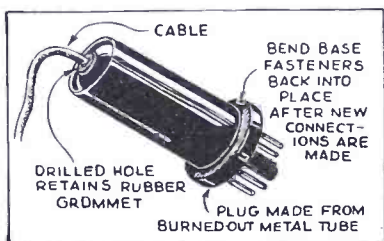

Fig. 2. Plug made from metal tube.

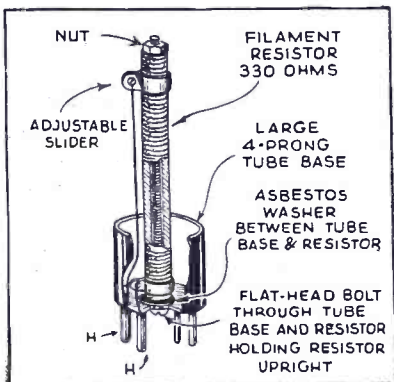

Fig. 3. Ballast tube replacement.

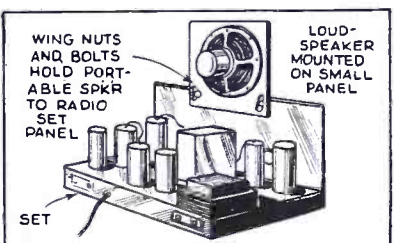

Fig. 4. One speaker on several sets.

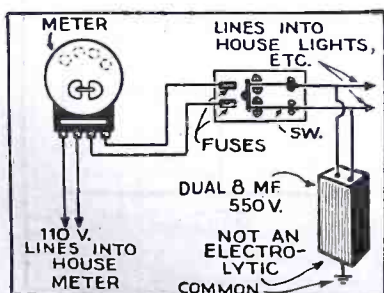

Fig. 6. Grounding A.C.-D.C. sets.

FIRST PRIZE—\$10.00

HOMEMADE WIND CHARGER. A discarded lawn mower and an auto generator are the principle parts of this machine. The mower is dismantled and the frame removed. On one wheel, the shaft that revolves the blades is cut off leaving a stub of about 2 ins. The other end is cut so that the whole bearing of the cutter shaft is removed. The wheel that has the short shaft left on is mounted at right-angles to a board which is used as the base, as may be seen from Fig. 1. The short shaft is at the top and is connected to the generator shaft by a metal coupling. The generator, which in my case was a Ford model T type, is mounted on a frame of wood, and held by straps over the top. The wood is cut away at the rear so that the band over the brushes may be removed. The other wheel is used as the turntable and is bolted under the wood platform. It is a good idea to add a steel plate between the inner frame of the wheel and the pipe flange, as the metal is often not very thick at this point. The tail is of sheet metal bolted to the wooden platform. The propeller blades for my machine are of heavy sheet iron, each about 30 ins. long and 5 ins. wide, with a twist of about 45 deg. The cutout is left in place on the generator, one wire running from it to the positive of the battery and the other wire from the generator frame to the negative. The third brush is adjusted so that the charging rate is about 3 A. at normal speeds. A switch is connected so that at any time the generator is not to be used for charging it may be short-circuited.

WM. G. SCOTT

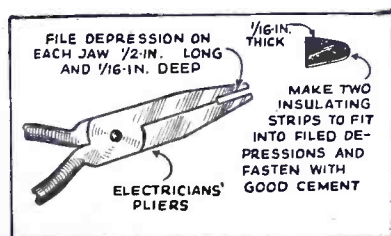

Fig. 5. Plate-bending pliers.

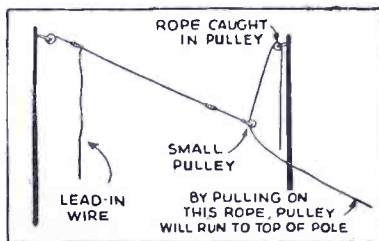

Fig. 7. Stuck pulley remedy.

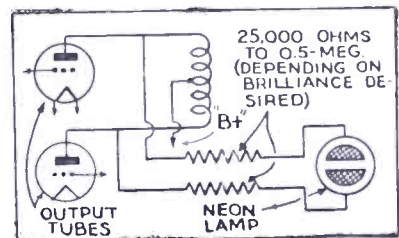

Fig. 11. P.A. volume indicator.

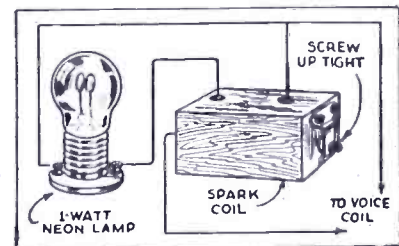

Fig. 10. Neon output indicator.

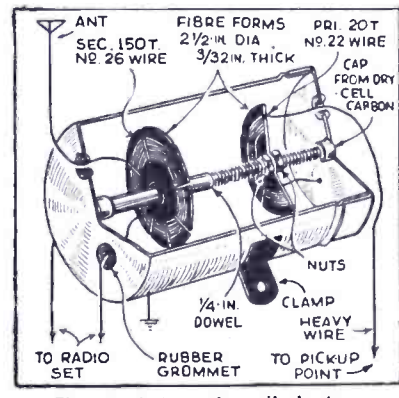

Fig. 9. Auto noise eliminator.

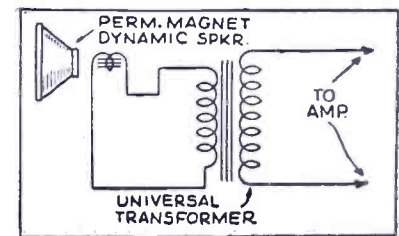
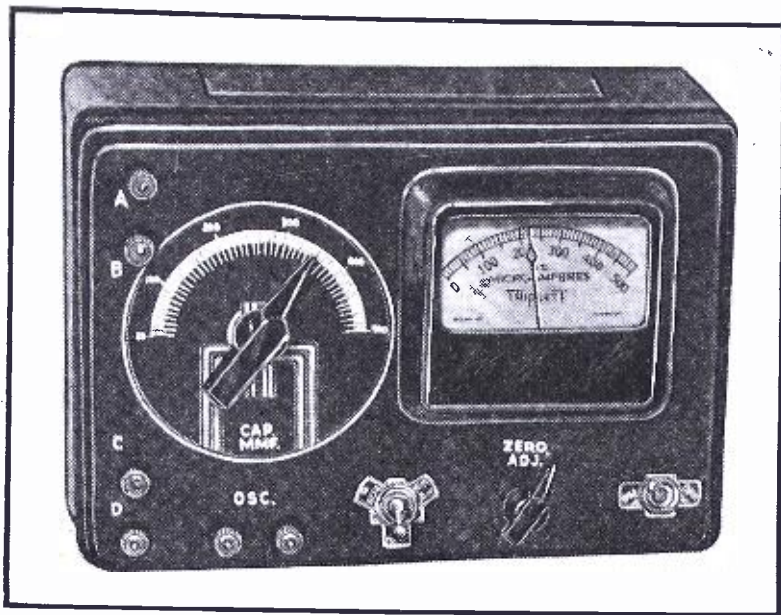

Fig. 8. Substitute microphone.



MAKING A Q-TEST ADAPTER

The calibration of this unique instrument plus some applications in measuring Q , inductance, capacity, effective series resistance and power factor are presented here.

C. W. PALMER

PART III

IN CALIBRATING the Q-Test Adapter it is necessary to refer to Part I of this series, in which the fundamental formula on which the operation of the meter is based, was given. It will be recalled that "Q" was defined as the ratio of reactance to resistance of a coil or other reactive device. It was also stated, at that time, that if we measure the voltage delivered by an R.F. oscillator to a reactive circuit comprising a coil and condenser, by means of a voltmeter which draws negligible current and then measure the voltage developed across the reactive circuit, that the ratio of these voltages would be the effective or apparent Q.

$$\text{In other words, } \frac{V_2}{V_1} = Q \text{ (app.)}$$

Now, we know that we have made a V.-T. voltmeter in our Q meter which has a range of 0 to 5 volts. Thus, if we adjust the voltage of the oscillator applied to the resistance R (in Fig. 1, Oct., 1936, *Radio-Craft*) to 0.025-V., or in other words to $\frac{1}{4}$ of the first scale marking, the total scale reading of the meter when connected to the Q-test position (Sw. 2) after the above adjustment has been made will be equivalent to a Q of 200. The actual curve will

follow the calibration curve of the V.-T. voltmeter, very closely, which then gives us an actual calibration curve, within reasonable limits, of the meter in Q.

For those who wish to go further, a scale of Q values larger than 200 can be obtained by making a second calibration curve for the V.-T. voltmeter of 0-1 V. (in addition to the 0-5 V. scale.) by changing the value of the cathode resistance. This calibration can be done using the A.C. power line as we described in Part II (in the November issue).

Then, by adjusting the output of the oscillator to 0.0125-V. and using the 5-V. scale for measurement of the Q value, the maximum reading of the meter will be 400 instead of 200. The calibration will closely follow the calibration curve of the V.-T. voltmeter, as in the previous case.

However, for all practical purposes in checking coils, the 0-200 scale shown in Fig. 2 will be sufficient. (It must be remembered that this meter is not calibrated in absolute units and the effective Q measured will vary from the actual Q by the distributed capacity of the coil plus the error in calibration. However, for service work, the device

is well within the limits of reasonable accuracy.)

The Q-Test Adapter can be used for checking other components in addition to coils, as we have mentioned before. For example it can be used to measure the capacity of small condensers having capacities of less than 450 mmf.

CAPACITY MEASUREMENTS

To do this, connect a coil of any desired size, for example a T.R.F. coil, to the terminals A and B of the unit and set the Q-Test condenser to about 450 mmf. Adjust the oscillator to resonance with the tuned circuit thus formed, watching for a sudden change in the Q-meter reading for resonance indication. Then connect the unknown condenser to terminals B and C and readjust the Q-Test condenser for resonance with the oscillator. The capacity of the unknown condenser is then $C = C_1 - C_2$ in which C_1 is the first reading of the Q-Tester condenser in mmf. and C_2 is the reading after the unknown condenser has been connected.

THE Q OF CONDENSERS

The Q value of condensers of small capacity (less than 450 mmf.) can be (Continued on page 371)

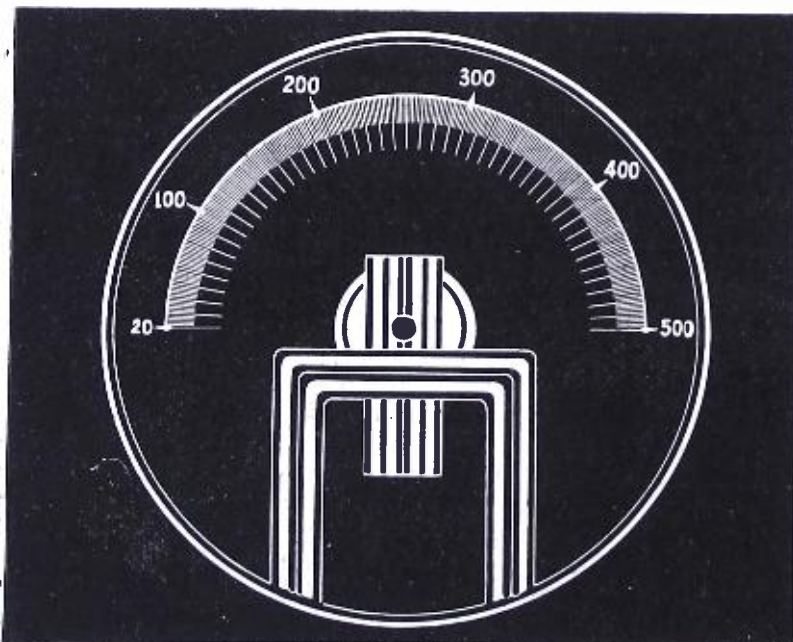

Fig. 2. The dial of the Q-test condenser showing capacity.

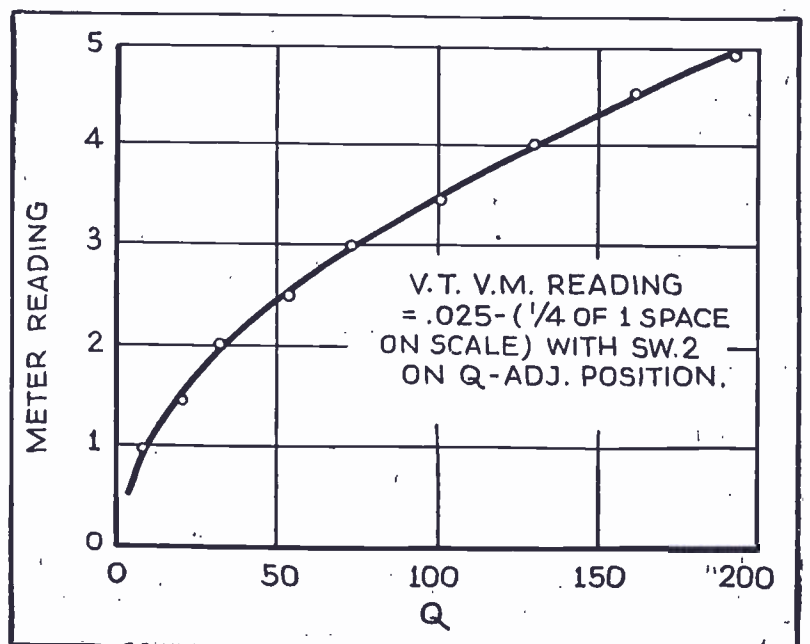

Fig. 3. A calibration curve in Q with oscillator output of 0.025-V.

THE IMPORTANCE OF HIGH-SENSITIVITY TEST UNITS

The importance of low current drain in voltmeters used for modern radio testing is amply explained below.

H. S. BURLESON

BEFORE the application of the principle of electronic emission crystalized into the vacuum tube as it is known today, and other new electronic devices, the use of high-impedance cir-

cuits was almost unknown.

In those days the most sensitive voltmeter known had a sensitivity of 125 ohms-per-volt, that is, it drew 8 ma. (milliamperes) for full-scale deflection,

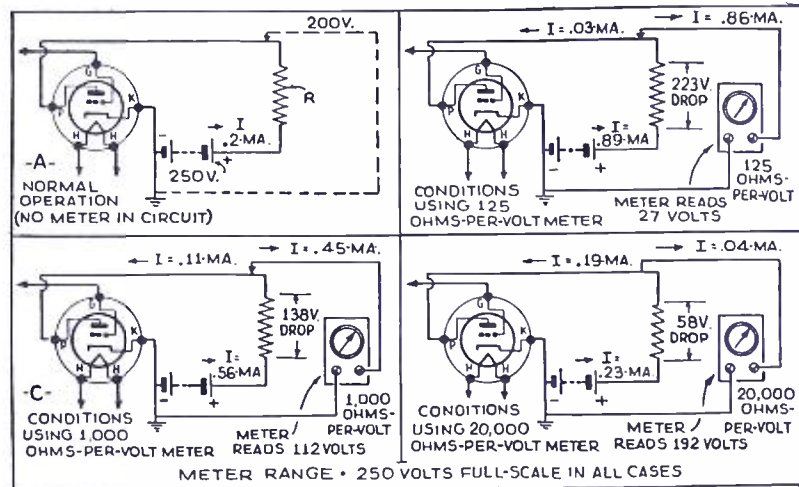

Fig. 1. The comparison of error is evident. A shows the circuit to be measured; B is a low-sensitivity voltmeter; C is a medium-sensitivity (the most common) type; and D is the new high-sensitivity type.

AUTOMATIC BALLAST CONTROL IN A NEW TUBE TESTER

A system of "A.B.C." (similar in results to A.V.C.) in a new tube tester results in more dependable service work.

V. H. LAUGHTER

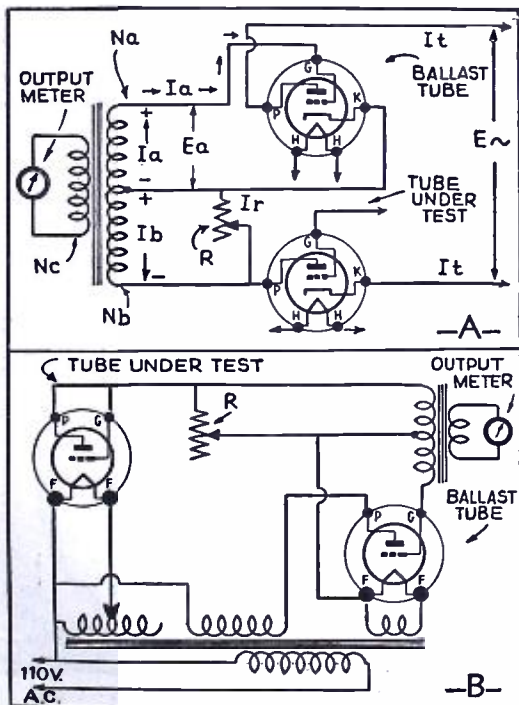

Fig. 1. The principle of the ballast unit.

A NEW TUBE tester known as the "A.B.C." type (automatic ballast control), just introduced, employs an automatic control that functions in a manner similar to the A.V.C. (automatic volume control) on a radio receiving instrument. Service Men are familiar with the "wild" readings often found between tubes of the same type but of different make, when tested on the usual-type commercial tube tester. Some types of tubes will test well up in the "good" area, while duplicate tubes of another manufacturer will test in the "bad" section, though the latter are perfectly good. This condition is puzzling to both the customer and the Service Man, often resulting in branding as defective a tube that actually is in good condition.

Naturally a good tube should test "good," and a bad tube, "bad." The A.B.C. tester corrects for "wild" readings due to the action of the automatic ballast control, which reduces the reading to some certain point on the test-

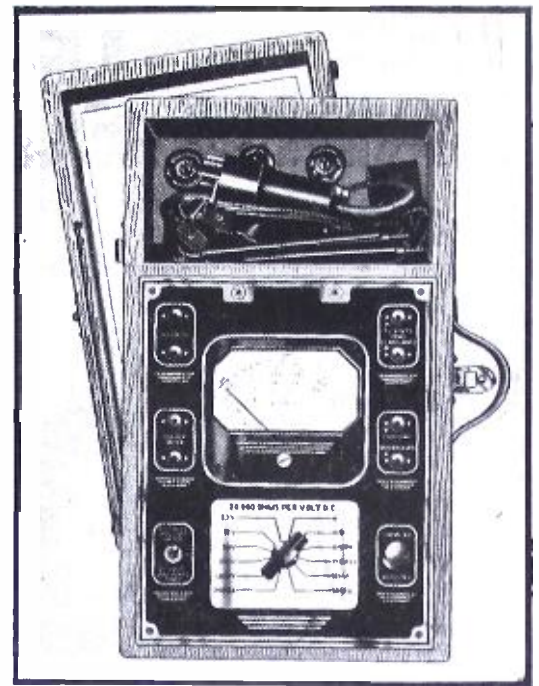

Fig. A. The 20,000 ohms-per-volt instrument.

tivity of 125 ohms-per-volt was entirely inadequate for taking voltage measurements in circuits associated with vacuum tubes, inasmuch as the indicating instrument in many cases drew more current than the vacuum tube, itself! In a high-impedance circuit, this fact causes an error of at least 50 per cent!!

When radio broadcast receivers first came into use by the general public, it was realized that a sensi-

Instrument designers immediately set to work to produce something to overcome this difficulty and at the expense of considerable research and hard work eventually developed what was in those (Continued on page 375)

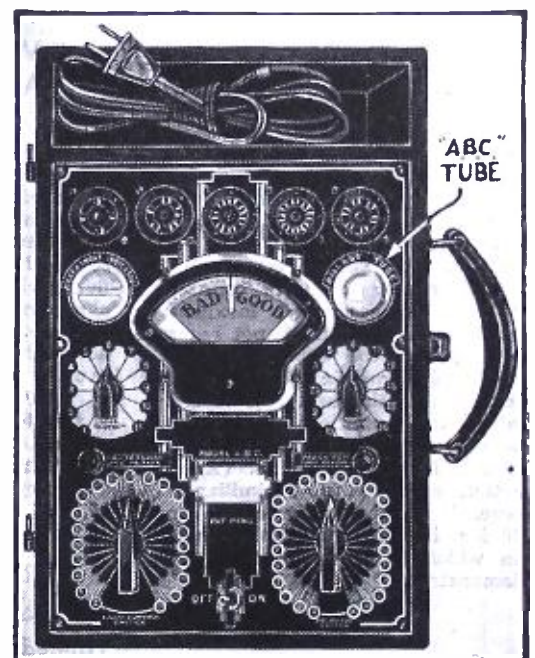
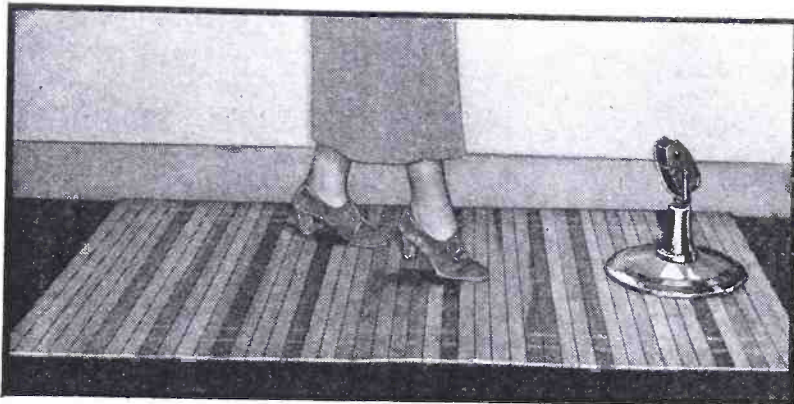

Fig. A. The A.B.C. tube tester appearance.

unit dial for a tube that has a tendency to read high; likewise, bringing the tube up that reads low. This assumes, of course, that the tubes under test are of the same type with controls set as indicated on the chart. Weak tubes indicate well back in the "bad" sector, so no doubt exists as to the tube condition. No controls are added as the A.B.C. is purely automatic and, in fact, simplifies the testing procedure considerably, as the shunt-control setting is the same for the (Continued on page 364)

THE LATEST RADIO EQUIPMENT



Home tap dancing now utilizes P.A. equipment for best results. (The velocity-type microphone on the "floor-let" is shown by courtesy of Amperite Corp.)

TAP DANCER'S PRACTICE FLOOR (1205)

TAP! TAP! Who's there? Flo. Flo who? Flo Ret. Tap dancing, in fact, has come down off the stage and introduced itself into the parlor and the bedroom, as well as into the radio studio. A manufacturer has ingeniously brought out a miniature hardwood floor which can be spread out, over a carpet or rug, to respond rhythmically to the clicking, metal-shod feet of the dancer. The feature of tap-dance broadcasting has already been taken up by radio stations, two of which have equipped themselves with the very item in question; and to apply it to home or even public entertainment, all that is required is this "floor-let," a microphone to pick up sounds (as shown in our illustration), and a small amplifier-reproducer unit. Competitions may thus be put on for as large an audience as desired. Not only tap dancing, but even soft-shoe dancing can be thus put on the air; since the softest footfall can be amplified to any desired degree and quality with the aid of a tone control. Service men will find a market for these, in connection with microphones of inexpensive quality (high fidelity is not required here); and the experimenter will find many more fields for exercising ingenuity in the matter of acoustics, while the ambitious amateur has added opportunity for perfecting herself in her profession. (Another article produced, with similar purpose, is in the shape of a drum, 26 ins. in dia. by 12 ins. in height, on which the more proficient may demonstrate.)

HOME BROADCASTING MICROPHONE (1206)

THIS low-priced instrument, intended to utilize the A.F. amplifier of any radio set, will afford many opportunities for amusement; while it will even make a public-address equipment of one, anywhere entertainment is being afforded to a crowd. A sales point is that it will help the ambitious to gain microphone technique. It is a single-button carbon "mike" of 2,000 to 3,000 ohms (average) impedance, housed in a gold-and-black case; with a 20-ft. rubber-covered cord,

to give sufficient distance from the speaker. The attached terminals are slipped over cathode and plate prongs, and left attached, a switch on the mike cutting it into and out of circuit.

"ELECTRIC EYE" KIT (1207)

FOR instruction in the principles of photoelectricity, a manufacturer of boy's scientific kits has brought out this panel, containing a selenium (photo-resistive) cell and two relays for battery operation. Though less adaptable than a vacuum tube P.E. cell and amplifier, it permits many interesting experiments; some with the control of a radio set by light, etc.

5-WATT STANDARD AMPLIFIER (1208)

(The Radolek Co.)

THE assembly shown here, and one for which experimenters in all fields will find many useful applications, is a single-channel unit providing two A.F. stages—a 57 and a 2B6—with power from an 80 rectifier, giving also current for a 2,500-ohm dynamic speaker field. Undistorted output, 5 W., with a characteristic curve "within 1 db." (states the manufacturer) from 40 to 9,000 cycles. The "usable gain" is said to be 70 db. It has 2 controls, volume and tone, and plug-in input and output. Output impedance, 5,000 ohms; operated on 50-60 cycle A. C., 105-120 V.

UNIT PUBLIC ADDRESS SYSTEM (1209)

(United Sound Engineering Co.)

LARGE capacity installations, permanent or portable, are readily obtained with equipment put out in this form. To the amplifier system shown can be added one to four auxiliary amplifiers, each of 60 W. output. The amplifier as shown, with its dual speakers, running at 15 or 20 W., with tone control, gives extremely natural speech effect. Two "indicator eye" tubes, in the front of the amplifier, show visually the output level and the presence of overload, thus simplifying control. Fader equipment permits use of 3 mikes and phono. or radio. With added amplifiers and speakers, a



For "home-made" programs. (1206)

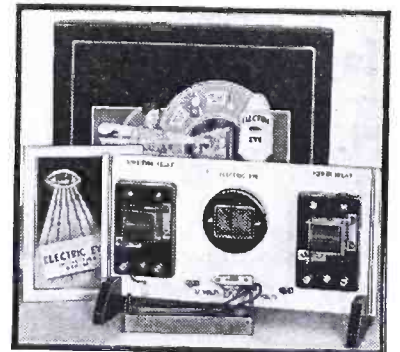

Photocell kits for boy experimenters are now available. (1207)

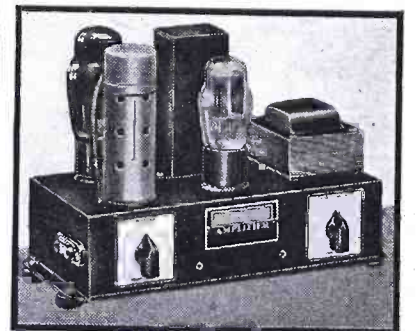

This high-quality 5-W. standard amplifier has many uses. (1208)

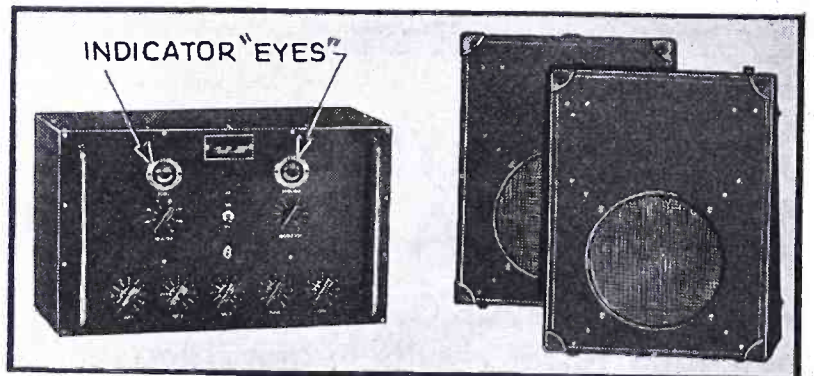

Here is a 20-W. job that will handle a 25,000-person crowd. (1209)

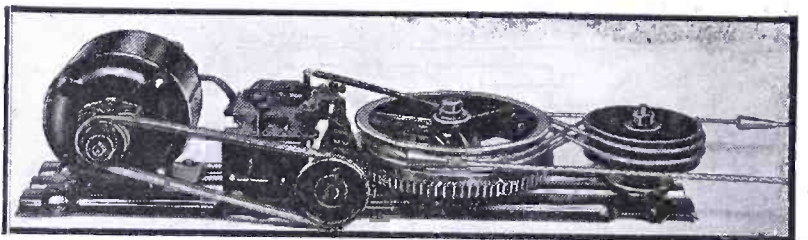

Photocell experimenters can use this door-opening mechanism. (1210)

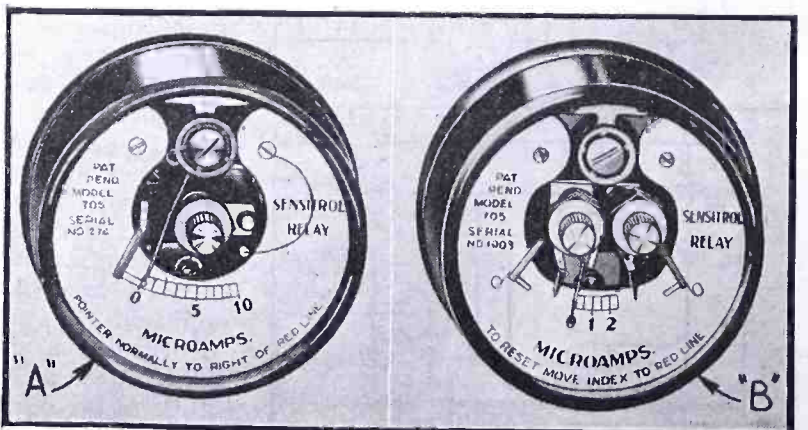

Two heavy-duty "sensitive" relays for use with the "electric eye." (1211)

Name and address of any manufacturer will be sent on receipt of a self-addressed, stamped envelope. Kindly give (number) in above description of device.

ANALYSES of RADIO RECEIVER SYMPTOMS OPERATING NOTES

Some personal observations about radio "servicing". There are many Service Men with the belief that they can perform all the necessary service on a receiver with nothing more than a pair of pliers and screwdriver, and without any sort of meters. The day when such service work was accepted is past. The Service Man of today must be properly equipped with meters, tools, and above all, he must have a fair knowledge of radio theory. What can the Service Man expect when he encounters peculiar jobs, such as fading, distortion in audio circuits or modulators, etc., in sets that have D.A.V.C., A.V.C., N.S.C., and many other features found in receivers of better design. Several such features are shown in Fig. 1.

It is not hard luck but merely lack of knowledge of circuit principles, when a poorly trained and equipped "technician" pulls a "bonehead play", as for example, he who replaced with a 2-ohm filament resistor the 2-meg. carbon resistor in an A.V.C. circuit of a Stromberg-Carlson model 846 receiver. Of course this completely destroyed the A.V.C. action. Where could you possibly find a 2-ohm resistor, regardless of printed circuit, in the control-grid circuit of an A.V.C. tube? This workman had no knowledge of A.V.C. and this, to him, was "just one more tube."

Another case came up in the replacement of a preselector coil, in an RCA 80, where the 3 grid-return leads of the input inductance unit were tied together by the coil maker for a common connection to ground, but where this common coil lead had opened, as shown at X in Fig. 2, which this circuit shows what was obtained when the bungler was finished. Naturally, the results were not very satisfactory because he was getting circuit oscillation and feedback due to the open-grid circuit. As a remedy he simply shorted the compensator on condenser No. 1. The whistle then stopped because the grid circuit had been closed. However, the coupling on the preselector, which is naturally loose under normal conditions, was reduced to zero with the preselector coil shorted. The volume dropped to a mere whisper on the most powerful local stations, and the tuning was very poor.

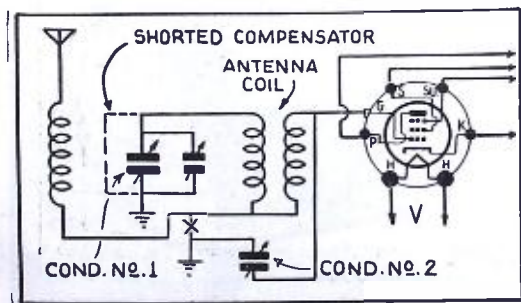

Fig. 2. Correcting RCA 80 "corrections".

If the prospective Service Man cannot afford to attend an accredited radio school he should study a correspondence course. This will give him all the theory needed for successful servicing. In reality, the Service Man has to be a radio engineer, even though he is not usually recognized as such. The set design engineer builds a single receiver and then is through, but the Service Man has to study and work on *all* types. His time is valuable and he cannot afford to spend a lot of time on any single job, but must be able to glance at the circuit and know from the receiver symptoms approximately what is the trouble, and where it probably may be found.

So if the Service Man is out to make a living from radio work, he must be well-equipped, both in tools and knowledge. The tools very often may be beyond his means in which case they should be home-constructed, for they are absolutely essential.

CUNIO MAGGIO

General Electric A-63, A-65. High hum level in several instances has been traced to the first audio stage. A remedy is that of filtering the plate circuit of the 6F5 or 6C5. This may be accomplished by introducing an additional 50,000-ohm carbon resistor between the plate load resistor and the voltage supply, with the junction point of the two resistors bypassed to ground with a 0.1-mf. good quality condenser.

Numerous cases of intermittent reception on both broadcast and short-wave bands were remedied by clearing the lugs of the R.F. and oscillator coils. These lugs have been found shorting to mounting nuts on the transformers.

General Electric A-82, A-87, A-125. A frequent complaint with these models is that of fading. This condition manifests itself by a sudden reduction in volume and loss of sensitivity. Only the more powerful stations may be received on the broadcast or "B" band, and the short-wave bands will be found almost completely "dead". Upon application of a voltmeter, analyzer, or screwdriver for the purposes of making requisite tests, a sudden surge of current, however slight, will result in complete recovery. Perfect operation may be obtained by flashing either of the I.F. primary trimmers to chassis with a screwdriver or other metallic object. Trouble is due to internal short-circuiting and leakage of the permaliners, the air-tuned I.F. trimmer condensers employed in these models. Replacement of the trimmer condensers is the answer to the problem.

When the sensitivity control is found inoperative in any position, it may be

well to check the position of the 6A8 bias resistor within the "sentry box." Often, the lead of this carbon resistor (soldered to a lug on the terminal strip) grounds to the case of the long-wave band padding condenser.

An inoperative receiver with the tone control in the extreme bass position will be found caused by a short-circuited or leaky 0.08-mf. tone-control condenser. While reception may be obtained in its treble position, the volume control will be exceedingly noisy.

Majestic 55, 59, 75, 195, 560, 566. A motor-boating condition with the receiver otherwise inoperative, although normal plate and screen-grid voltages may be obtained, has been traced upon a number of occasions as caused by a short-circuit or leakage between the primary and secondary windings of the last I.F. transformer whose primary is in the plate circuit of the 6B7S tube. Because the diode load resistors, both within the transformer shield assembly, are of high value, discrepancy in plate and screen-grid voltages will not be noted. For a quick check, obtain a resistance reading between the plate contact of the 6B7S socket and the diode contact adjacent to the screen-grid contact. The reading obtained here should be well over 0.2-meg. A much lower reading would, of course, indicate leakage.

Intermittent reception or fading on these models which may be overcome by snapping the line switch, may be remedied in almost every case by removing or shorting out the 0.3-meg. control-grid filter resistor from the 6A7 secondary return circuit. Removal of this resistor from the circuit has no effect upon operation. Snapping a light on or off in the same room or upon the same circuit will produce the condition, usually resulting in a completely inoperative receiver.

BERTRAM M. FREED

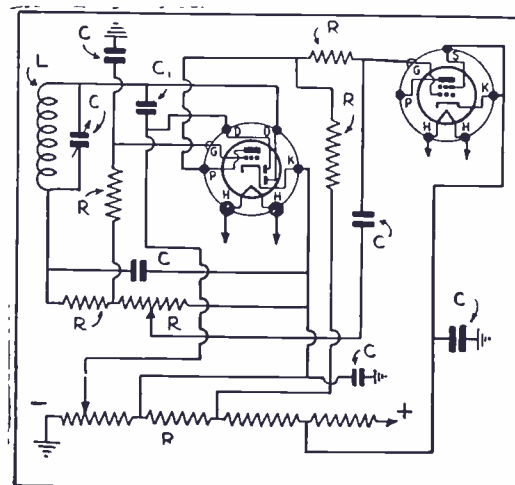

Fig. 1. Delayed A.V.C., A.V.C., and N.S.C.

PHOTOCELL SHOOTING RANGES

A new field has been opened up for the radio man—that of photoelectric games of skill such as the two described!

"ELECTRIC EYE" GUN

DEATH RAYS have become commonplace to the imagination—at least of readers of scientific fiction and, even, of the comic supplements. It was H. G. Wells who started the idea with his "Heat Ray," in the *War of the Worlds*; and every now and then some one suggests a ray which will kill or paralyze its living targets. Now, in the form of a game, we have a "death ray" used to bring down mechanical targets. It is safe sport, harmless to partakers, spectators—and even to the game!

The "ray" used in this, however, is a simple, highly intense beam of electric light, focused through a tube simulating the barrel of a gun. Pulling the trigger turns on an electric lamp, the beam from which is concentrated into a narrow streak, like the path of a bullet. At the same time, for shooting gallery purposes, the trigger operates a relay, which gives a sharp report, and at the same time an indicator which records each shot. (It is set, like various game boards, to allow a series of 10 shots before it ceases functioning. Another coin is necessary to release the mechanism.)

The shooter has brought his weapon to his shoulder, like a rifle or shotgun; and a "duck," the size and appearance of life, whirs across the other end of a range. The trigger is pulled, the beam of light shoots across, and if it strikes the duck fairly, while it is crossing the cabinet width, there is a sound of a gong—and the duck drops out of sight, while a number flashes into view on the cabinet front.

This, of course, is another exemplification of the versatility of the photoelectric cell which, as will be seen, is concealed in the body of the duck, behind a bull's-eye window. When the beam of bright light falls into this, an electrical impulse caused in the cell is amplified; one relay "kicks" the duck over and out of sight, and another scores a hit on the next lamp behind the scorepanel. It need hardly be said that the duck is at once automatically righted, and again and again crosses the field of fire, till the tenth "shot" is spent. There are 2 "ducks" at opposite ends of the rotating arm, as the block diagram shows.

The apparatus is standard 110-volt A.C. operated (or may
(Continued on page 381)

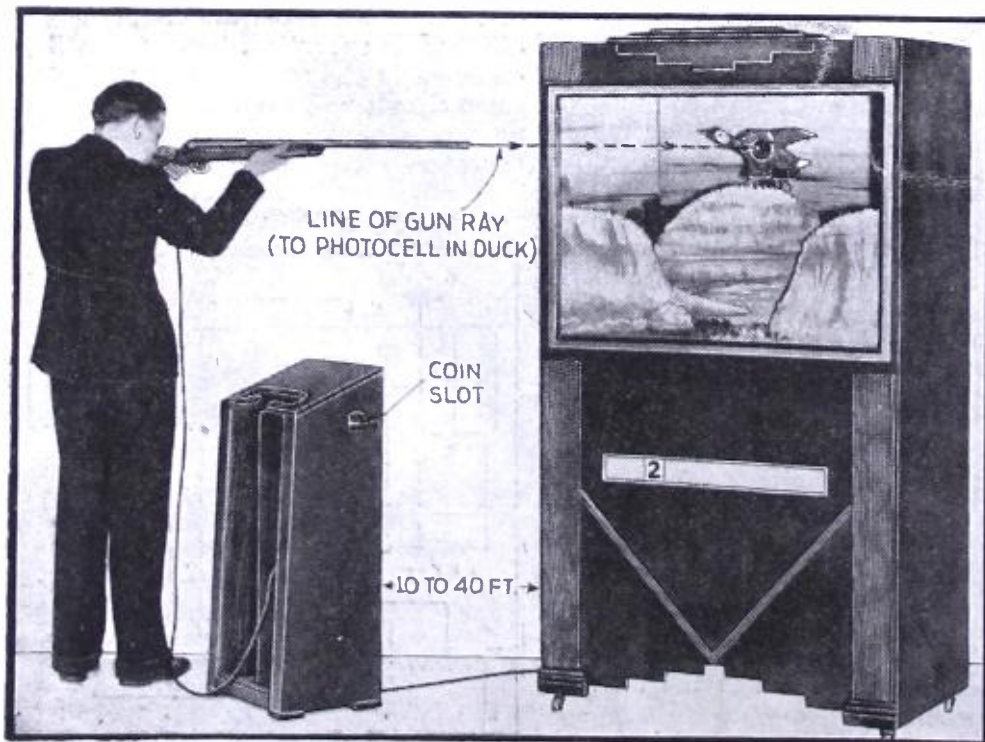

The "electric eye" gun range is a safe way to practice shooting.

PHOTOELECTRIC PISTOL

THE "bull's eye" has long been proverbial for the centre of a target, and the "electric eye" at once fired the public fancy with its description of the uncanny sensitivity of the photoelectric cell; but it remained for a manufacturer of amusement games to combine the two ideas into a single device, of much interest as a means of demonstrating quickness of eye and coordination of hand.

As shown here, a box cabinet, of the usual style enclosing game boards, is provided; but, instead of a spring-operated plunger, the player is provided with a "pistol" which throws a beam of light. When a coin or token is deposited in the chute, the electrically-operated mechanism is released and set in operation. At each pressure of the trigger of the pistol, inserted in the cabinet front, a lamp in the barrel is lighted; and a ray is projected toward the eye in the snorting-bull's head at the back of the cabinet, which contains a "PE." (photoelectric) cell.

This alone, however, would be too easy; the element of skill is introduced by the fact that a motor at the rear of the cabinet continually opens and closes a shutter in front of the bull's eye; only when the trigger is pressed at the right time, and the shutter is open, can the ray of light score a hit. If the shutter is closed, the "shot" is a miss.

Each shot is recorded (on a "shot" scale) by the pull of the trigger, actuating a counting mechanism. When 14 shots have been spent, the shooter's chances terminate. The shooting, also, *must be done within a given time*—say from a minute to a minute and a half.

When the first hit is scored, the impulse from the photo-cell, through a single-vacuum-tube amplifier, does 2 things: (1) it causes "hits" register to revolve one notch, bringing a pointer to bear on the figure No. 1; and, (2) it sets in motion a mechanism which determines the reward (in the shape of tokens for additional play) for continued success. The shooter must continue to score, say 4 hits out of 14, into the bull's eye while it is open. If he fails in this, while his hits are scored, he receives no prize; if he makes the needed score, the machine delivers by its "payout" unit the number of tokens indicated—blank, 2, 4, 6, 10 or 20—on the small
(Continued on page 368)

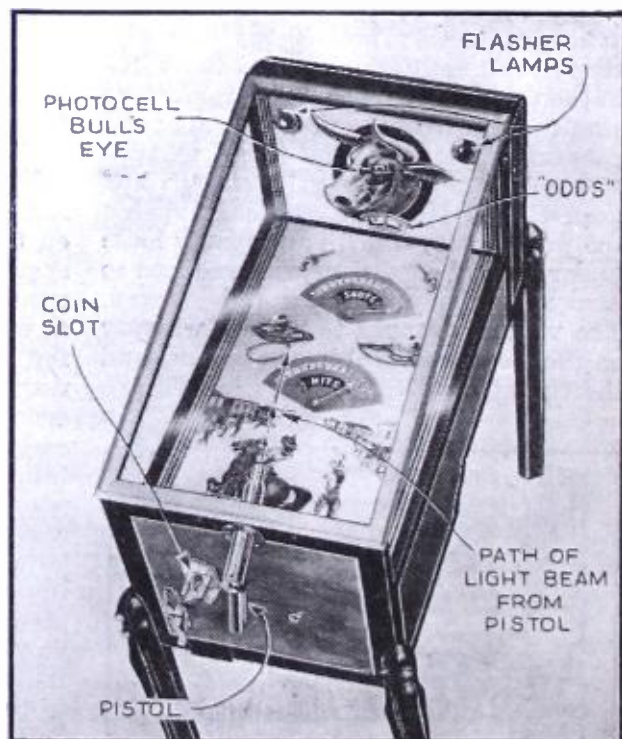

The photoelectric pistol is an entertaining game.

OFFICIAL RADIO SERVICE MEN'S ASSOCIATION, INC.

A department devoted to members and those interested in the Official Radio Service Men's Association. It is the medium for exchanging ideas, kinks, gossip and notes of interest to Service Men, or others interested in servicing.



The workshop of Mr. Chun of Java, D.E.I. The object on the desk at left is a fan, not a spiderweb!

PROSPECTIVE ORSMA MEMBER STATES JAVANESE "BUY AMERICAN"

RADIO-CRAFT, ORSMA Dept.:

It is indeed with great interest that I have read of your "Official Radio Service Men's Association" to unite, as a group with strong common interests, all qualified radio Service Men, giving them a recognized standing in their profession.

I should like to give a very brief description of the radio situation here in Java. With regard to construction, model, and outer appearance, as well as fine volume, all are obtained in American sets, and it is no wonder why all the public here prefer to buy American sets rather than European makes.

However, the majority of the Service Men here are greatly handicapped (by the rapid developments and complicated circuits found in American receivers) due to the lack of good and complete radio handbooks. And besides, the handbooks, no matter how complete they may be, can not keep up to date with the rapid developments of radio designs.

It is, therefore, very unlucky for the owner of an American receiver which is not operating normally, for repairs are done unscrupulously by inexperienced men. Besides, the original parts are usually replaced by European parts that differ slightly from the originals. It is therefore very fortunate for me to note your ORSMA and I am desirous of joining your association with the idea of getting more close contacts with new developments in American set design, as an associate member.

Incidentally, I received my radio training from one of your Chicago radio institutions. I am enclosing a snap of my workshop (which is here reproduced—Editor).

THUNG C. CHUN
Semarang, Java, D. E. I.

DOUBTS BEAM TUBE POWER

RADIO-CRAFT, ORSMA Dept.:

It seems to me that the perform-

ance of the type 6L6 "beam power tubes" is greatly overrated. Why do I think so? Just this; say for instance we build a standard 30-W. amplifier. The transformers, chokes and such, while not the heaviest made, have a wide enough safety factor to permit running the amplifier for as long as 18 hours at a stretch without dangerous overheating. I grant that most of our present-day amplifiers have an appreciable amount of distortion when operated at anywhere near their maximum output, despite manufacturers' claims to the contrary, though they sure look good on paper.

The word goes around that the July issue of *Radio-Craft* has a hook-up for a 34 to 60 W. amplifier using only 2 of the type 6L6 tubes. Swell! Out goes a quarter, we turn the pages of the magazine and find a heading, "An Anti-Howl Amplifier." We look down and see the diagram. The job has 12 tubes, as compared to some other amplifiers using metal tubes which have only 8 tubes and put out 30 W. or so. Examining the diagram further, we find that the amplifier has enough parts to stock a good-size store. I ask you, is an amplifier of this sort economical? It's all right for a permanent installation, but what fellows would care to lug such equipment around, in addition to speakers large enough to handle the power, and other associated equipment?

Now we come to the 6L6 tubes and our eyes light up as we read, "34 W. of power at 2 per cent total distortion." But we read on further and note that at 34 W. and fixed bias of -25 V. we have a total plate and S.-G. consumption of 114.6 ma. at zero signal. Poor power transformer and filter-choke!

Now for the amplifier itself. Can we use interstage and output transformers designed for tubes such as 2A3, 6F6, etc., which are themselves heavy duty? Heck, no! Such parts would burn up in half an hour. Down we dig again to cough up for special transformers and chokes.

Well, we'll forget the foregoing. If the proper driving tubes are used we are supposed to get wonderful results. I don't know, but as far as I'm concerned, I'll stick to 2A3s, 6F6s and the like.

In addition to the high price of 6L6 components, we find them rather hard to obtain. Some companies are selling ready-constructed 6L6 amplifiers, but I wouldn't trust them if they are to be in operation for any length of time.

Maybe some of the technical boys

can show me the error of my ways.
NORMAN FELLER

The error of your ways, Mr. Feller, can easily be pointed out. Let us for a moment compare a 60-W. 6L6 beam power amplifier (using two 6L6 tubes), with a 60-W. 2A3 amplifier (using 8-2A3s in fixed bias). For zero signal conditions, power consumption is as follows:

Zero-Signal Cur-	6L6 60-W.	2A3 60-W.
rent Consumption (2 tubes)	(8 tubes)	
Heater watts	11.16 W.	50.00 W.
Plate watts	40.80 "	48.00 "
Screen-grid watts	1.80 "	

Total consump. 53.75 W. 98.00 W.

From a standpoint of power consumption alone the 6L6 amplifier is more than twice as efficient as the corresponding 2A3 job. When you consider that the amplification fac-

tor of the 6L6 tube is 135 against 4.2 of the 2A3 and that the plate circuit distortion at maximum ratings is 2 per cent against 5 per cent in favor of the 6L6, how can you in face of these facts ignore this revolutionary development in tubes and say, "I'll stick to 2A3s . . ." etc.?

After you have been in the P.A. field for a while you'll learn that you can't get any more out of an amplifier than you put into it. This applies to parts as well as input signals. Take as an example the "anti-howl" amplifier mentioned on page 338 of this issue. It incorporates a volume expander, cathode-ray indicator, and a high-gain (140 db.) fixed-bias amplifier circuit which cannot be duplicated in performance with any 8-tube amplifier. It utilizes a power transformer and choke designed to deliver and pass 300 ma.

(Continued on page 370)

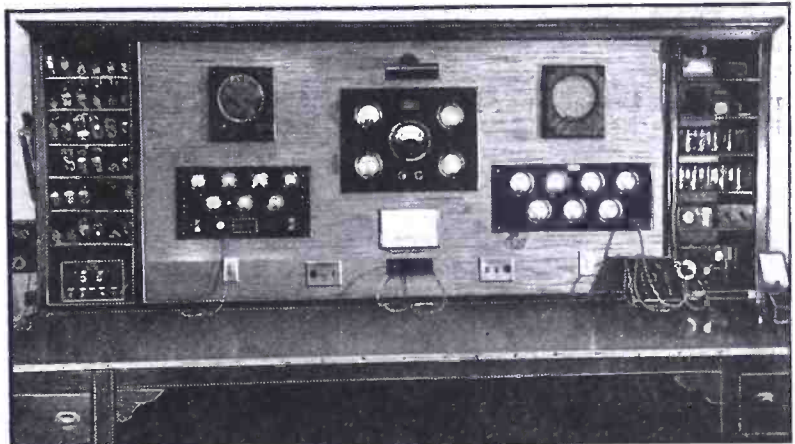

Main test panel of Shannon Radio Service of Mount Vernon, N. Y. The panels are as follows: left, voltage supply, with all lines (both A.C. and D.C.) metered; center, accurate meters used as standards; right, remote control analyzer. Shelves at right contain portable test equipment.

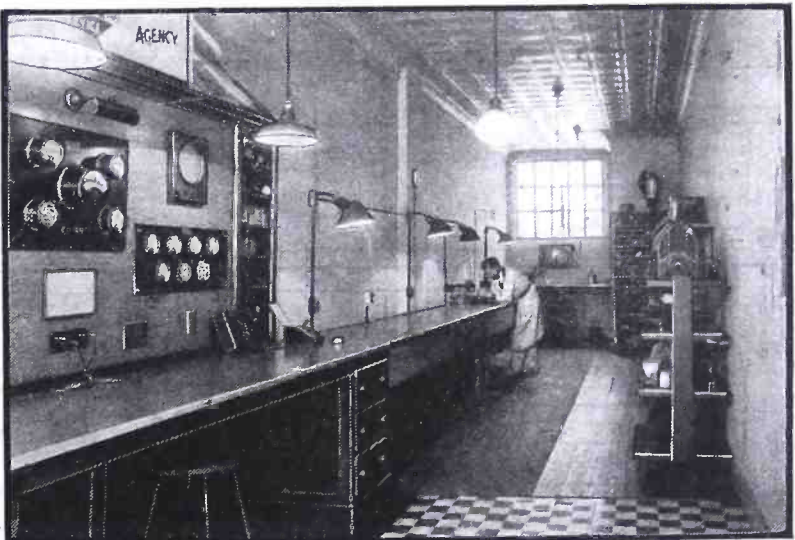

Full view of above service shop. Note light, and amount of usable space.

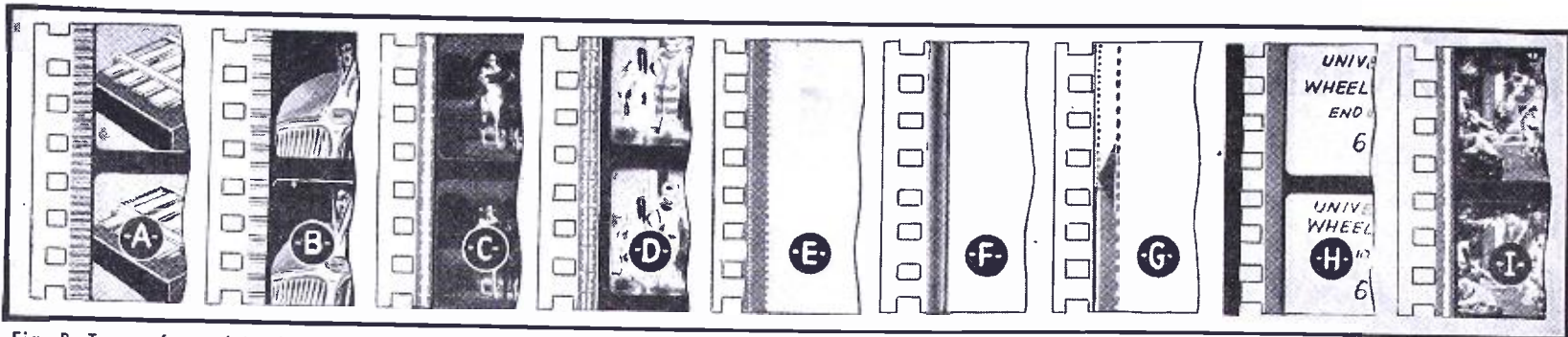

Fig. 8. Types of sound tracks; A, variable density, music; B, variable density, speech; C, variable area, speech; D, British spreading speech; E, test film, noiseless; F, test film, not noiseless; G, film splice triangle; H, blank leader, no sound; I, squeeze track.

HOW TO IMPROVE "TALKIES" FIDELITY

This concluding part of the series covers the installation of speakers in theatres, and presents some facts about acoustics.

PART III

LAWRENCE L. JOHNSON

THREE FACTORS govern loud-speaker installation: the frequency range of the speaker; its handling power in watts; and the impedance of its voice coil.

A typical wide-range combination consists of 2 electrodynamic units, one of which covers the low-frequency range from 40 to 4,000 cycles, the other reproducing the range from 3,000 to 9,000 cycles. The high-frequency unit has its own miniature all-aluminum trumpet. The standard electrodynamic unit now being used in the average theater can be replaced with the low-frequency unit as this unit will thread right onto the present air-column horn being used in all theaters where the "pot"-type unit is employed. (Note the number of threads per inch when ordering a unit of this kind.) The high-frequency unit of the combination, having its own trumpet, is simply mounted any-

where in the installation which proves most convenient.

The 2 units of the system are matched by a specially-designed coupling unit furnished with all combinations or where only the high-frequency unit is required. By using a high-frequency unit along with the present unit, and matching the two units with a coupling unit, a very noticeable improvement can be effected in any theater sound installation both in tone quality and frequency response. The reason for this is that, accentuating both the highs and lows, and synchronizing them perfectly, requires cutting off the highs at 4,000 cycles in order to secure proper operation of the high-frequency unit of the wide-range combination.

(You will note that I do not claim a frequency range of from 30 to 12,000 cycles as do some manufacturers of this type of equipment. It is quite possible

that a wide-range combination of units with coupling unit to match will reproduce frequencies up to 12,000 cycles, but, inasmuch as no standard recording equipment has been designed which will record such frequencies on film or disc, it is obviously impossible to reproduce them.)

Figure 5A is the characteristic set-up for electrodynamic horn units working from a 500-ohm output transformer. The action of the filter is such that the low frequencies, opposed by the condenser C1, take the easier path through L1, and being met by blocking condenser C2, are forced through the primary of the low-frequency transformer. The higher frequencies take the easier path consisting of the condenser C1, and the high-frequency transformer, and return through the action of C2. In choosing a 500-ohm output transformer for this sort of service, care should be taken that a 15-ohm winding is available to connect the monitor loudspeaker in the projection booth.

Both systems A and B work their filters from an 8 to 15 ohm output transformer. The wide-range filter in Fig. 5D provides a place for a *middle-frequency speaker*, which actually carries most of the load, as the *high- and low-frequency speakers* only appear to talk at intervals.

The filter shown for the *middle register* is actually an autotransformer, and the value (8 mhy.) is only an arbitrarily chosen one, to pass 1,300 c.p.s. This autotransformer action accounts for the loudness the sound system exhibits over the high and low units, although the action of the complete units is that of a band-pass filter. The tapped networks in 5C and 5D are for volume and impedance matching units; these are usually dial switches reading directly in decibels.

ACOUSTIC CONTROL

Sound engineers have learned a great many things since the advent of talkies in 1926. Alteration of the acoustic conditions, generally spoken of as Acoustic Control, has been found not to be all that the theorists prophesied. At first

(Continued on page 378)

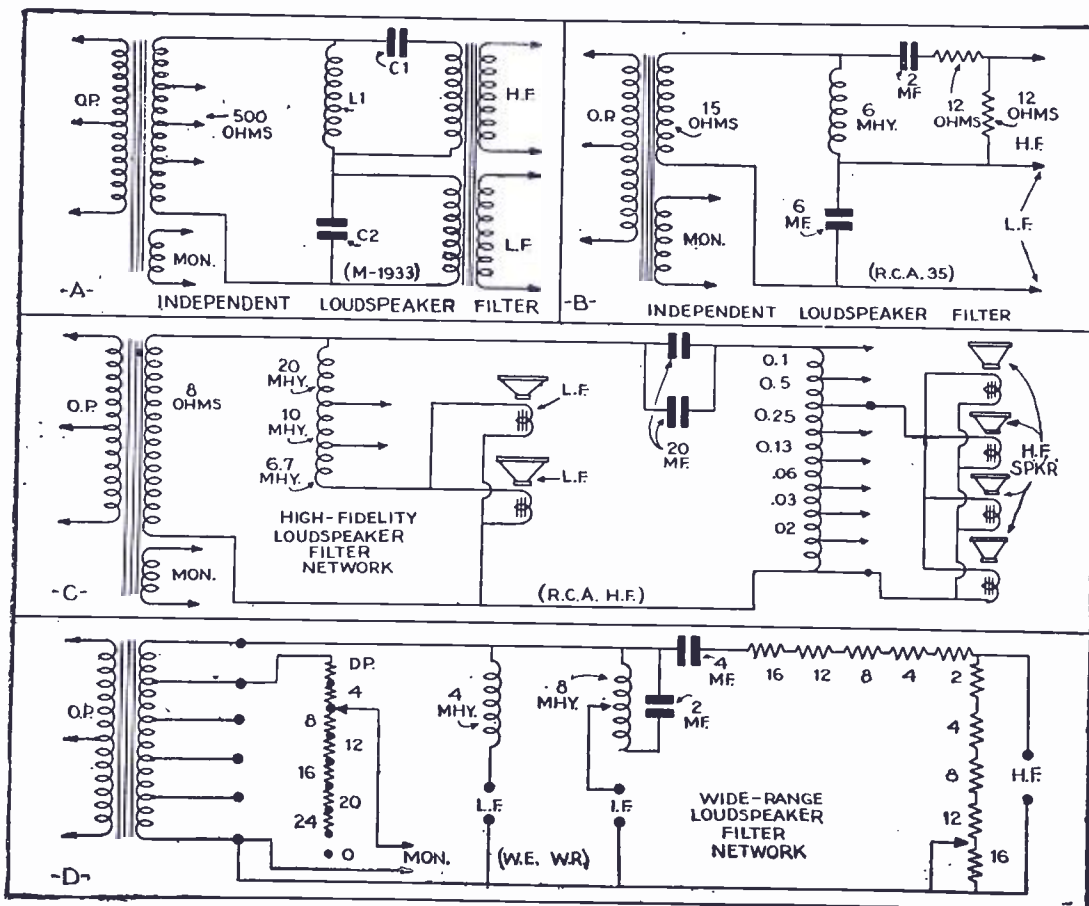

Fig. 5. Several speaker filter networks used in talkies installations; C and D are hi-fidelity.

WESTINGHOUSE MODEL WR 207 5-TUBE DUAL-BAND SUPERHETERODYNE

(Features: ranges, 540 to 1,530 kc., and 1,500 to 3,200 kc.; power detection; tone control.)

The following table gives the operating voltages for this receiver, as measured from the point indicated, to chassis, with a 1,000 ohms-per-volt meter:

Tube	Plate	S.-G.	Cathode	Heater
V1	230	107	21.5	6.3
V2	230	107	4.0	6.3
V3	125	—	9.8	6.3
V4	210	230	13.5	6.3
V5	A.C.	—	295	5.0*

*This value measured across filament prongs. The table holds true when the line supply is 117.5 V., and with the volume control on full and no signal input. Voltage across the speaker field is 65 V. Alignment of the I.F. transformers is made with tuning condenser in maximum position and with the 456 kc. output from the signal generator fed to the stator of the front tuning condenser section. All 4 I.F. trimmers are then adjusted to best response. Broadcast-band alignment is next,

and is made with a 200 mmf. condenser connected in series with the test oscillator output and the receiver antenna lead. Set the receiver dial pointer to 1,425 kc. and adjust the oscillator trimmer (rear one), then the antenna trimmer. Short-wave alignment is then made with a 2,500 kc. signal input, adjusting the antenna trimmer condenser until the signal comes in best. On receivers bearing serial numbers from 119,051 to 122,050 the 2 resistors shown dotted in the diagram were used in the circuit. When replacing the receiver chassis in the cabinet make sure that no part of the dial or condenser assembly touches the case or microphonism will result. It is not necessary to remove the chassis from the case to replace dial lamps. Simply slip the push-on bracket off the dial and unscrew the bulb. Color coding of the power transformer leads is as follows: primary, 2 green; high-voltage sec., 2 black; center-tap, yellow; 6.3 V. sec., 2 heavy blue

leads; 5 V. sec., 2 heavy red leads. General wiring in most cases is coded as follows: plate, blue; "B+", red; S.-G., brown; cathode, white or yellow; grid, green; filament or ground, black. The oscillator coil and 1st I.F. transformer are in 1 unit.

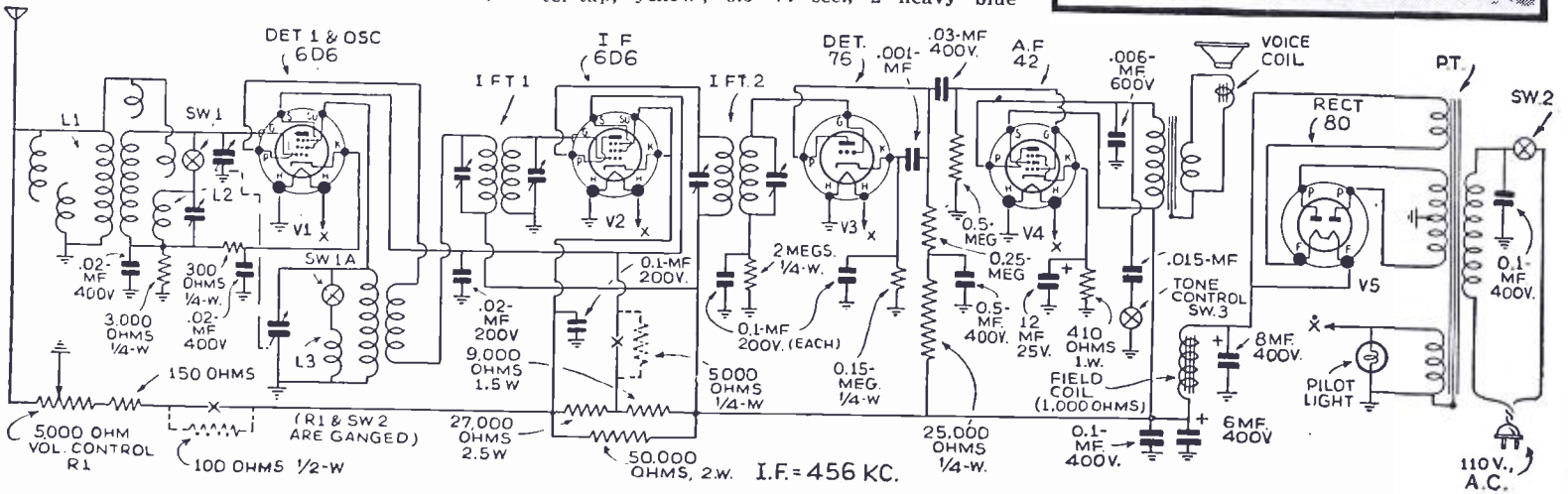
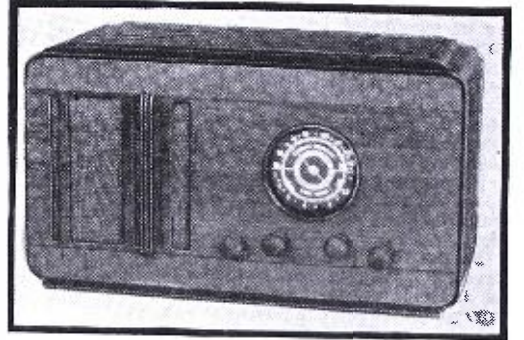

WESTINGHOUSE MODEL WR 208 5-TUBE 2-BAND SUPERHET.

(Features: ranges, 540 to 1,750 kc., and 2,200 to 7,500 kc.; wavetrap; tone control.)

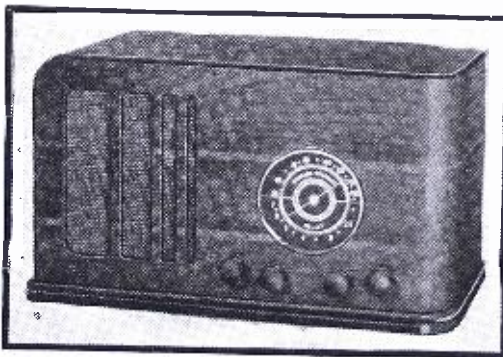

Tube	Plate	S.-G.	Cathode	Heater
V1*	255	90	3.5	6.3
V2	255	90	3.5	6.3
V3	37	—	5.5	6.3
V4	240	255	15.0	6.3
V5	A.C.	—	325	5.0**

These values are measured from the point indicated to ground and are read with a 1,000 ohms-per-volt meter. The line voltage is 117.5 V. *The oscillator plate is 170 V. **This value is measured across the filament terminals. The voltage across the speaker field is 70 V. To align the I.F. stage, set the receiver tuning condenser to minimum and connect the output of a service oscillator to the cap of V1. Adjust all I.F. trimmers to maximum response at 456 kc. Then connect test oscillator to antenna and adjust wavetrap for minimum response. Alignment of

the short-wave band comes next and is made with a 400-ohm resistor in series with the test oscillator lead and the receiver antenna lead. Set the receiver dial pointer to 6 mcs. Adjust the short-wave oscillator trimmer, then adjust the short-wave antenna trimmer. Be sure to choose the minimum peak capacity on the oscillator trimmer. The broadcast band is aligned with a 200-mmf. condenser in series with the antenna lead. Set the receiver dial pointer at 600 kc., and adjust the broadcast series padder for best response. Move the pointer to 1,600 kc. and adjust the oscillator trimmer for maximum response, then adjust the broadcast antenna trimmer likewise. Return the pointer to 600 kc. and readjust the series padder. Note: Do not turn the receiver on with the speaker plug or V4 out of their respective sockets.

Operating voltages of this receiver are as given in the following table:

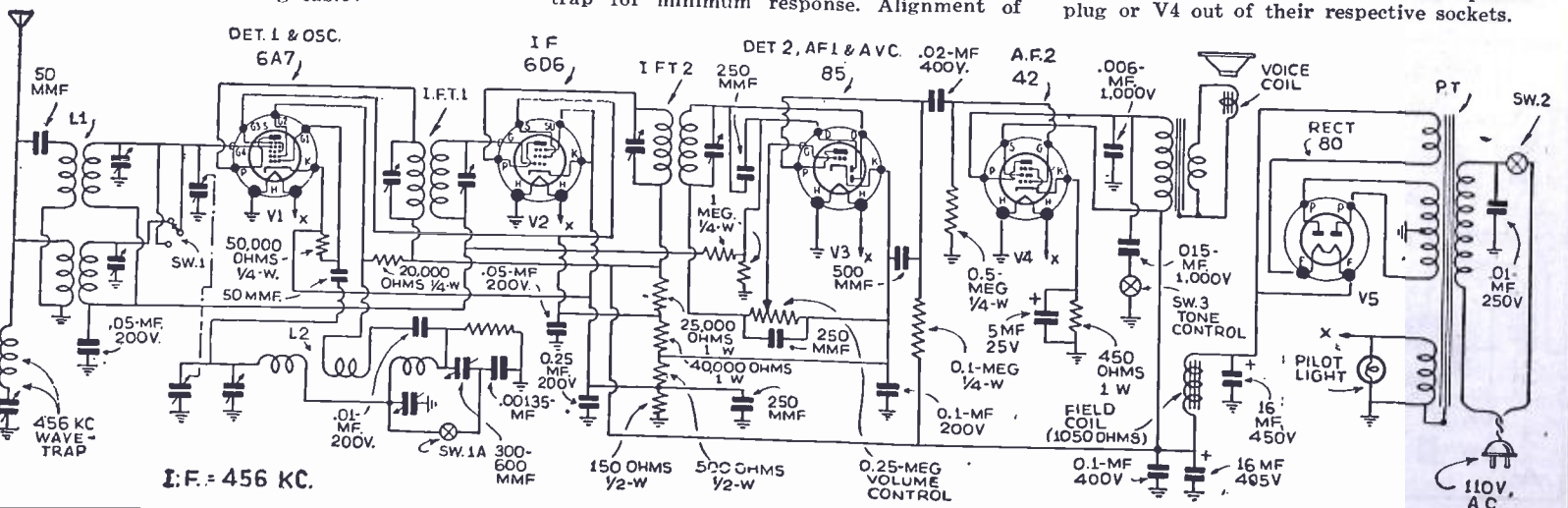

RCA VICTOR "HIGH-FIDELITY ELECTROLA," MODEL R-99

(Features: Dynamic Amplifier with automatic expansion control; 15-W. (max.) power amplifier; 12-in. dynamic speaker with tone diffuser; frequency range, 30 to 8,000 cycles, approx.)

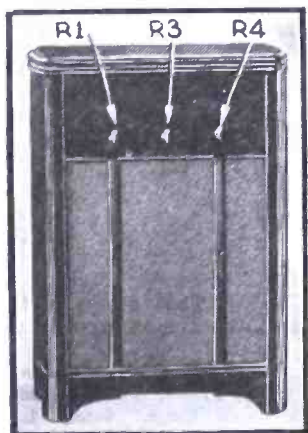

The mechanical limitations of the phonograph record are imposed on it by its compactness; that is, the amplitude of the sound waves is lessened by the fact that the needle must not swing over to the next groove. The recording engineer therefore, cannot give the full volume of sound, and checks his amplifiers accordingly. In order to give fidelity to, not the record, but the reproduction of the original music, this phonograph utilizes a principle similar to the automatic volume control, but in reverse manner, to accentuate the volume range of the record. When the sound intensity rises, the amplifier increases it still more; and so in reverse.

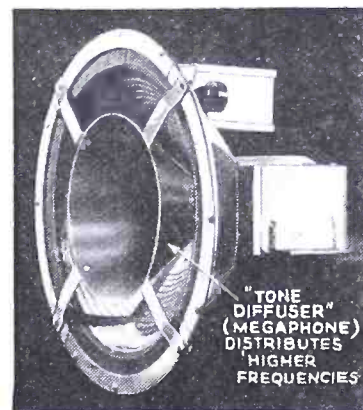

In the R-99, a new magnetic pickup is used; the magnet is welded to the pole-pieces; the short, light, centered armature has a viticoloid block attached to the center as a "mechanical filter," to make the frequency response more uniform. It can be removed and a new one fastened in place by heat,

beat applied with a special-tip soldering iron.

The pickup feeds into a compensator pack with filters to correct the frequency response; the output, through the volume control, is divided between V1, the "expander," and V5, the "expander-amplifier." The output of V5 is then fed into V6, a diode-rectifier, and

thereby converted into a pulsating direct current. This creates across the 470,000-ohm resistor a voltage which is impressed through a "delay filter" (560,000 ohms-0.5-mf.) on the second control-grid of the expander tube V1. This bias, controlling the amplification, increases it on a strong note and vice versa,

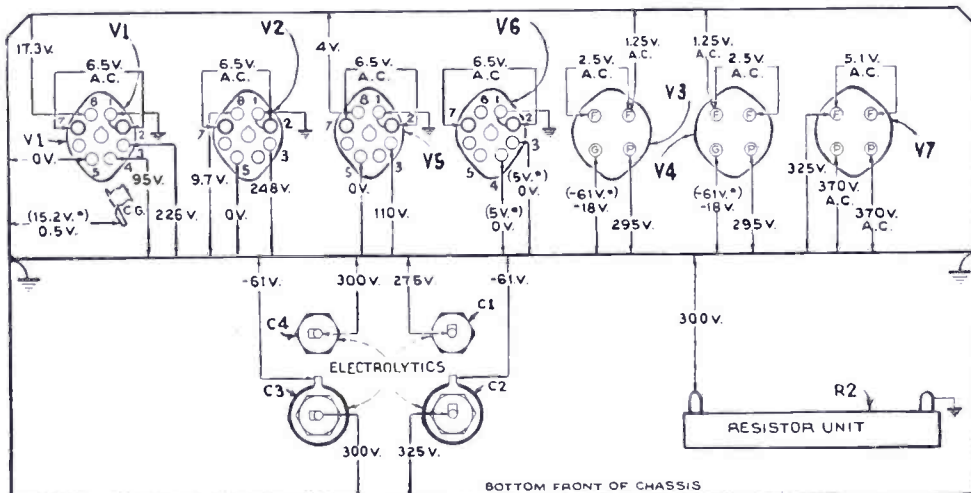
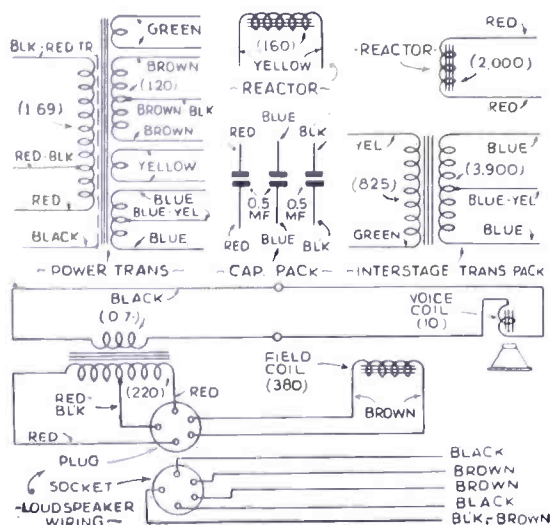

Working voltages in (parentheses). Others, readings with 1000 ohms-per-volt meter.

Amplification is continued through the driver tube V2, impedance-capacity coupled to the primary of its output transformer to increase fidelity, since no plate current flows in the primary. The tone control R1 (incorporated in the switch) across the push-pull stage (V3-V4) permits the user to suit his personal preference in the output.

The undistorted output (class A push-pull) of this 3-stage amplifier is rated at 12 W.:

the range of faithful reproduction from 30 up to 8,000 cycles. The 12-in. speaker has a light aluminum voice coil, which permits the higher tones to be more fully reproduced; and a metal megaphone "diffuser," fitted in front of the coil, spreads the high notes at a wider angle, and more uniformly.

Current readings (cathode) of the tubes without signal input are: V1, 7.6 ma.; V2, 4.4 ma.; V3, V4, 41 ma. each; V5, 1.9 ma.;

V6, 0. Tube V7 draws 165 ma., with a power consumption of 180W.

The normal voltage across the filter output R2 is 300 V. The adjustment of the expander bias control R5 is made to give 1 ma. of plate current only, without signal input, and with controls turned full to the left. A more accurate setting may be made with a 1,000-cycle oscillator, testing the power output with a high-resistance voltmeter.

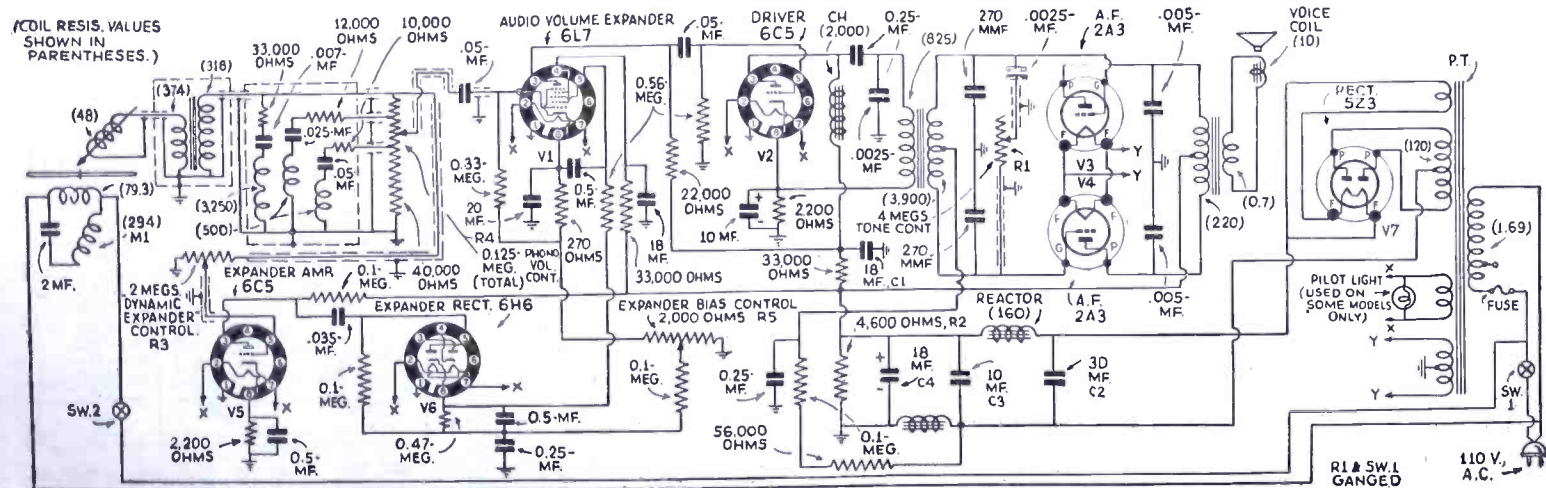

CROSLLEY MODEL 1316 (IN MODEL 167 CONSOLE)

(Features: Phantom Conductor (Auto-Expressionator) and Control; 540 to 18,000 KC. range; "universal" power transformer optional.)

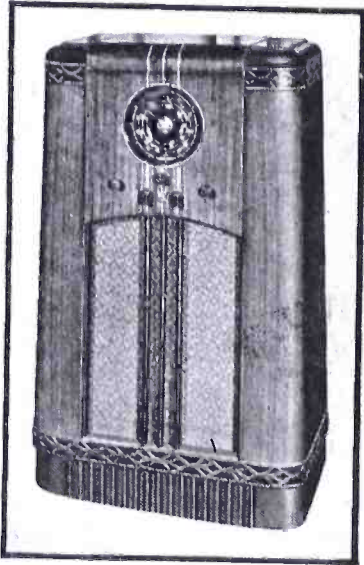

This receiver, designed for high-fidelity phonograph, as well as radio reproduction, has a "Phantom Control" (second from the left—see front view of chassis for positions of controls) which permits turning in either the (position B) Automatic Frequency Control alone, which holds the receiver tuned to the strongest signal within 20 kc., or both the A.F.C. and the Phantom Conductor Tube, V11 (position C). The feature of the Phantom Conductor tube is that it contains 2 resistors with such a thermal characteristic that, when connected across the speaker voice coil, it increases the volume of loud tones. This is particularly designed to compensate for the limitations of broadcasting equipment, which cannot give full volume to the loudest passages, and should have the same effect with phonograph music. When this control is at position A, neither A.F.C. (the "Mystic Hand") nor Phantom Conductor is operative. This permits operation with normal power output and fidelity. The fidelity control is incorporated with the power switch. The volume control operates on both A.F. grids (V5, V6). The band-selector switch operates also a tone filter, Sw. I.

When measured from the tube socket contacts to the chassis, with a 1,000 ohms-per-volt meter, in

operating condition without signal input, voltages are as follows, when taken on 117.5-V. power supply:

Tube Contact:	(3)	(4)	(5)	(8)
V1	238	105	2.5	2.5
V2	235	105	-5 to -12	*
V3	170	105	4.8
V4	220	100	3.0	3.0
V5	80	2.0
V6	220	6.8
V7, V8	350	240	2.6
V9	220	100	3.0	3.0
V10	0	0	0.0
V12, V13	348

*170 V. at terminal 6 of V2.

Voltage across field coil, 108. That across V11 varies with the power output. All heater voltages 6.3; except V12, V13, 4.6.

The receiver has a consumption of 130 W., and a power output (max.) of about 17 W. The volume control low-level section R1 (3 megs., total) is tapped; R2 is the high-level section.

The universal power transformer, supplied with other than 110 V., 60 cycle current, will operate at from 97 to 267 V., and any line frequency above 25 cycles. Adjustment is made to the proper tap for maximum line voltage, on the terminal strip.

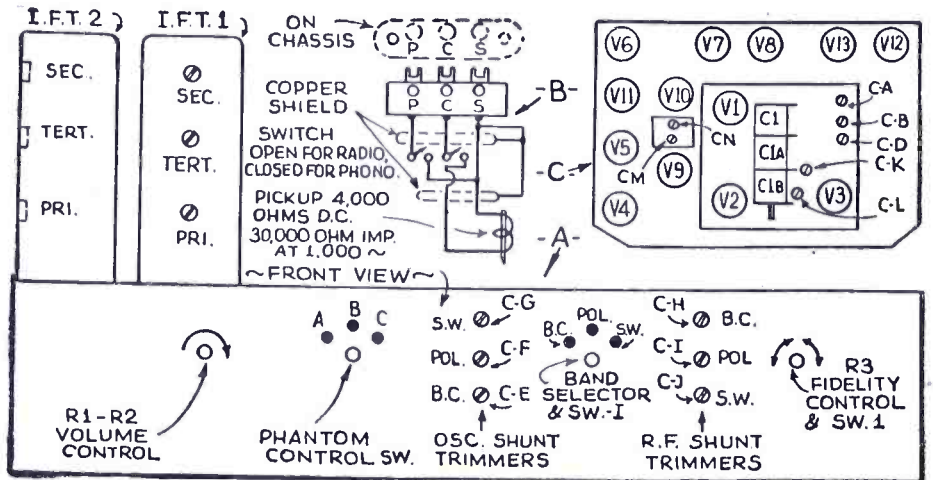
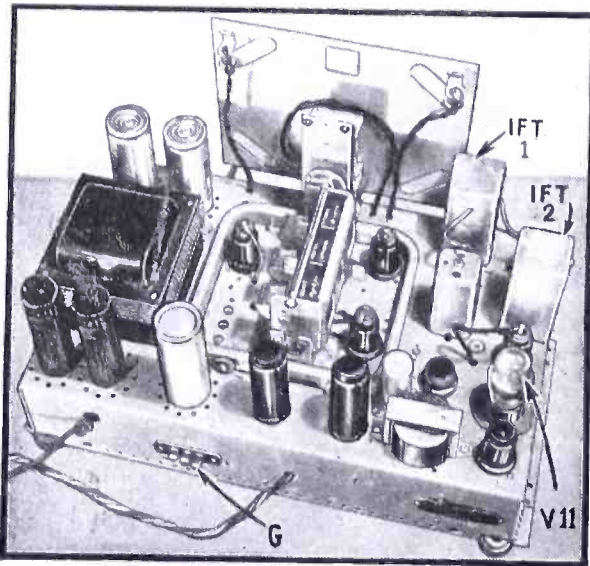
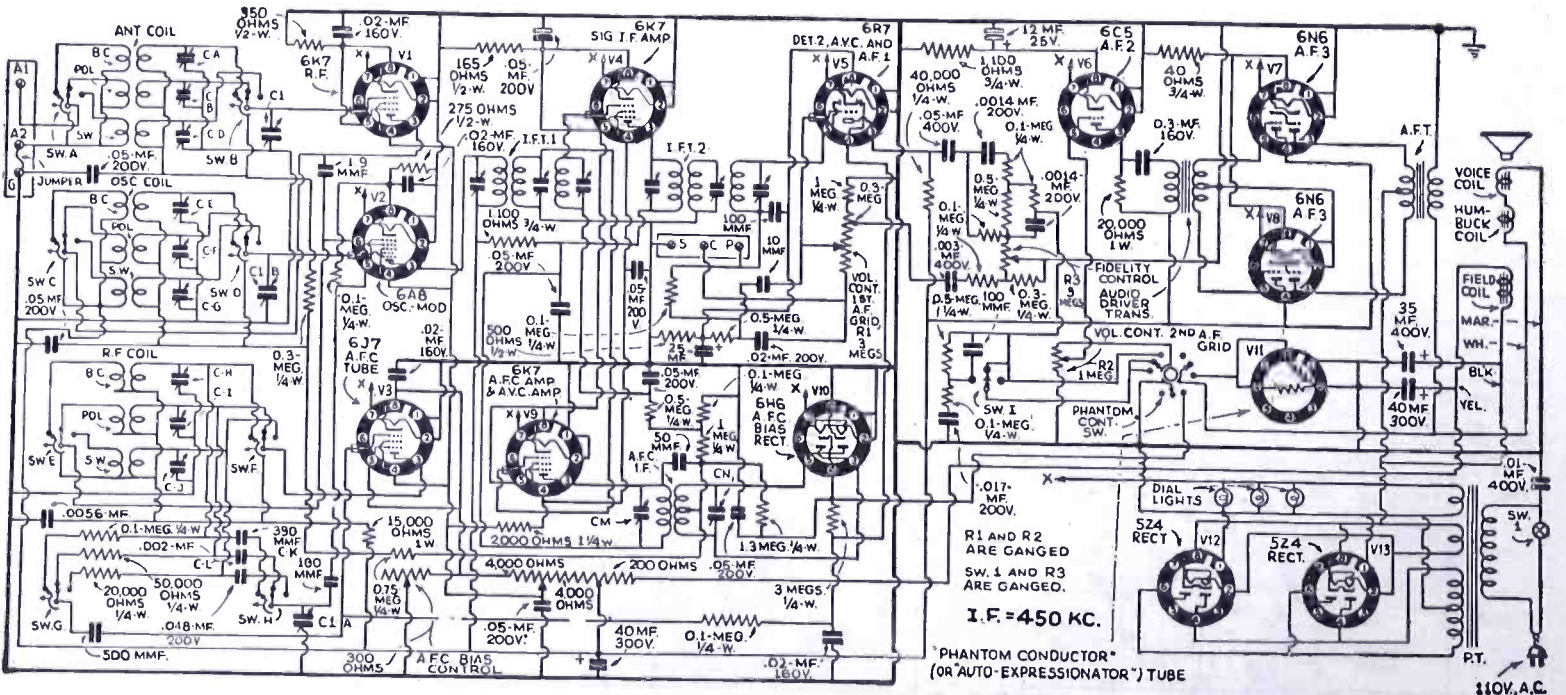

Fig. A, bottom and left, front view of chassis; Fig. B, center, phono pickup connections; Fig. C, right, top view showing tube and trimmer locations only. Compare with photo at the left.

The A.F.C. alignment may be tested on position B of the Phantom Control, by determining the beat note with a 450 kc. signal generator attached to the cap of V2, and a local station tuned-in, with the station selec-

tor slightly off. A tone below 200 cycles is satisfactory; up to, say, 1,500 cycles it may be corrected by adjusting the trimmer condenser C-N (Fig. C, above). A greater difference requires I.F. alignment.

Signal input frequencies for the bands are: Blue (broadcast) 1,400 kc. shunt, 600 kc. series; Red (police and amateur) shunt 5,000 kc., series 2,000 kc.; Green (high-frequency) 18,000 kc., shunt.



THERE IS SOMETHING NEW IN RADIO!

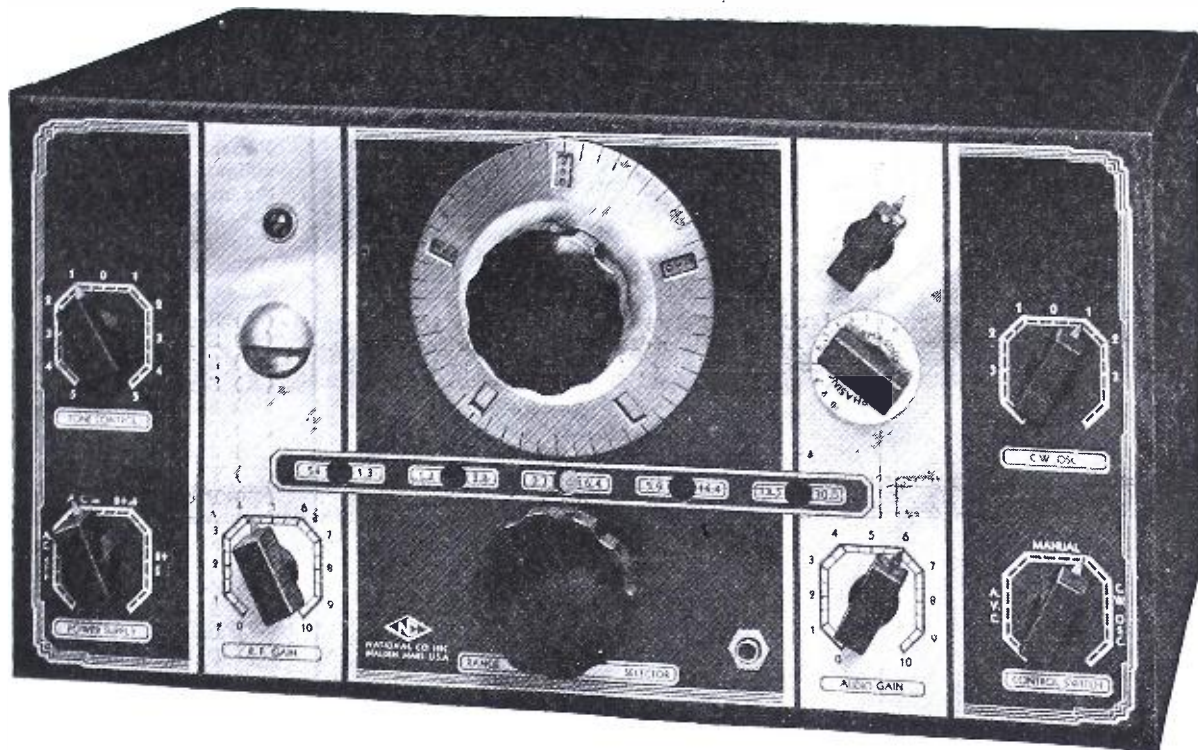

Announcing:

NATIONAL NC-100

12 TUBE SUPERHETERODYNE

The NC-100 is more than a newly designed receiver, it is a new invention! Although coil ranges are shifted easily and quickly by the twist of a knob on the front panel, no coil switch is used. Instead, an ingenious mechanism moves efficient plug-in coils into position close to the tuning condenser and tubes, and plugs them in. Each of the fifteen HF coils is shielded in heavy cast aluminum, each is of high-Q design, each has low loss insulation, and each has its own individual air dielectric padding condenser. Idle coils are completely isolated. Leads are short. Calibration is permanent. For the first time, the uncompromised efficiency of plug-in coils has been combined with the convenience of the coil switch.

HIGH PERFORMANCE

The precise and efficient Movable Coil Tuning Unit is just one of many details that make the NC-100 so outstanding. Every tube in the NC-100—and there are twelve of them—contributes its full share to the remarkably high overall performance. The circuit employed on all ranges consists of one stage of RF, separate first detector and high frequency oscillator, two IF stages, a bias type power detector and a transformer-coupled push-pull output stage. Maximum undistorted audio output is ten watts. A separate tube is employed to provide amplified and delayed AVC action, and a separate beat oscillator is included for CW reception. A built-in power supply provides all voltages required, including the speaker field.

But equal in importance to the circuit and tube layout is the long list of small details that make the NC-100 the superlative receiver that it is.

There is no substitute for quality. The heavy cast aluminum coil shield, the thorough use of low-loss insulation, the high-Q coils, and the air dielectric padding condensers, as well as a host of smaller details ranging from silver plated contacts to the non-microphonic speaker cabinet, all contribute to high intelligibility on weak signals.

OPERATING CONVENIENCE

Particular attention has been paid to the convenience of the operator in the NC-100. Swift control of every function of the receiver is at your fingertips. The Movable Coil Tuning Unit permits instant selection of any one of five coil ranges, ranging from 540 KC to 30 MC. Matching the accuracy of this precision unit is the Micrometer Dial, direct reading to one part in five hundred, and having an effective scale length of twelve feet. The tuning of the NC-100 is as smooth as its logging is precise.

A 6E5 tube acts as an indicator both when tuning and when using the RF Gain Control for signal strength measurement. Panel switches permit optional use of automatic volume control and of the CW oscillator, and provide for cutting the plate voltage during periods of transmission. In addition to RF Gain, an Audio Gain Control and a Tone Control are included. These together with the (optional) Single Signal Filter give the operator complete control of receiver characteristics. Even the phone jack has received its share of attention, for it has been carefully located so that the phone cord will interfere as little as possible with the manipulation of controls and the use of the operating table.

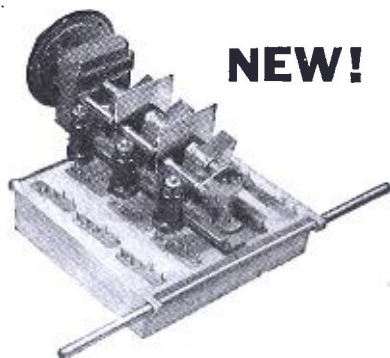

MOVABLE-COIL TUNING UNIT

NEW!

NO COUPON NEEDED

Whether you are about to buy a receiver or not, you will want to know more about the NC-100. Send for the free folder describing the NC-100. No coupon is needed, just say you are a RADIO-CRAFT reader. But better yet, drop in at your dealer's and see it. One glance will tell more about its fine construction than any description, and even a short trial will demonstrate its outstanding merit.

NATIONAL CO., INC.



MALDEN, MASS., U.S.A.

Please Say That You Saw It in RADIO-CRAFT

THE LATEST IN PORTABLE SOUND SYSTEMS

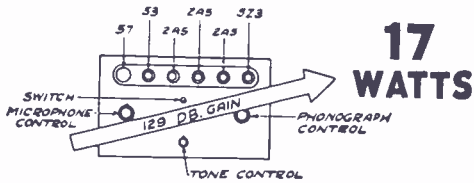
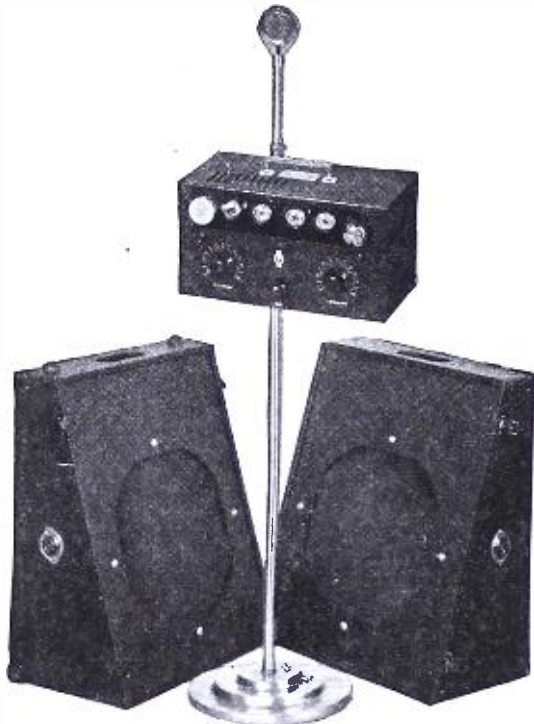

Sound Schematic of Amplifier PA-417

17 WATTS

- **CRYSTAL MICROPHONE**
in Combination Floor and Banquet Stand
- **2 - 12" P. M. SPEAKERS**
in Biased Cut Case
- **ONLY TWO CASES TO CARRY**
Microphone, Amplifier and Stand go in one case; Speakers in the other case.

Model PA-417C is the very latest design in portable sound systems. The crystal microphone is the new directional type with 25 ft. of rubber covered shielded cable. The microphone floor stand is the full size. When demounted it packs in same case with amplifier and microphone. Weighs—41 lbs.

System is equipped with heavy permanent magnet speakers mounted in acoustically correct bias cut carrying case. Speakers can be placed on platform or hooked on wall. Total weight—21½ lbs. Tubes, cables and all necessary accessories furnished with system. Very moderate price. Write for catalogue giving complete details or see your local jobber.



**STRICT DEALER POLICY
FULLY LICENSED
TIME PAYMENT PLAN**

WEBSTER-CHICAGO
Section D-10, 3825 W. Lake St., Chicago, Ill.
.....Please send me more information on Model PA-417C.
.....I am also interested in sound systems for
Rentals.....; Portables.....; Fixed Systems
.....; Lower Power.....; High Power.....; In-
stitutional Systems.....; Hotels.....; Schools
.....; Inter-Office Communicating Systems.....;
Factory Call Systems.....
Name
St. Address
City State.....

TECHNICIANS' DATA SERVICE

JOSEPH CALCATERRA DIRECTOR

A special arrangement between RADIO-CRAFT magazine and the publishers of this literature, which permits bulk mailings to interested RADIO-CRAFT readers, eliminates the trouble and expense of writing to each individual organization represented in this department.

2. HAMMARLUND CATALOG. Contains complete specifications, illustrations and prices on the Hammarlund line of variable and adjustable condensers; intermediate frequency transformers, coils and coil forms; sockets; shields; chokes and miscellaneous parts for broadcast, short wave and ultra short wave reception and transmission. Also contains description and prices of the Hammarlund line of "Comet Pro" and "Super Pro" receivers.

5. ELECTRAD 1936 VOLUME CONTROL AND RESISTOR CATALOG. Contains 12 pages of data on Electrad standard and replacement volume controls. Truvolt adjustable resistors, vitreous wire-wound fixed and adjustable resistors and voltage dividers, precision wire-wound non-inductive resistors, center-tapped filament resistors, high-quality attenuators, power (50- and 150-watt) rheostats and other Electrad resistor specialties.

29. THE KEY TO SUCCESSFUL SERVICING. Four different types of combinations of courses on Radio Servicing, Public Address Work, and Television, developed by the Radio Service Institute, are described in this 24-page booklet. Complete information, including outlines of the courses and costs, is given. Two of the courses are designed for the more advanced and more ambitious Service Men who are anxious to get to the top of their profession. The other two courses are for less-experienced Service Men who want to Advance more rapidly in the Radio Servicing Field. Please do not ask for this booklet unless you are interested in taking a course in these subjects.

53. POLYIRON COIL DATA SHEET 536. This folder contains complete catalog descriptions, specifications, prices, performance curves and circuits showing applications of the complete line of Polyiron radio components made by the Aladdin Radio Industries, Inc.

57. RIBBON MICROPHONES AND HOW TO USE THEM. Describes the principles and operating characteristics of the Amperite velocity microphones. Also gives a diagram of an excellent humless A.C. and battery-operated preamplifier.

65. THE 1937 LINE OF SUPREME TESTING INSTRUMENTS. This 12-page catalog gives complete information on the entire Supreme line of testing instruments, including the Model 585 Diagonometer; the Model 540 and 550 Radio Testers; the Model 500 Automatic; the Model 505 Tube Tester; the Model 555 Diagonoscope and other Supreme oscilloscopes, tube testers, signal generators and multimeters. Complete details of the Supreme Easy Payment Plan for purchasing testing equipment on the installment plan are also given.

73. HOW TO ELIMINATE RADIO INTERFERENCE. A handy folder which gives very complete information on how to determine and locate the sources of radio noise by means of the Sprague Interference Analyzer. A description of the analyzer and method of using it is included, together with data on how to eliminate interference of various kinds once the source is located.

74. SPRAGUE 1936 ELECTROLYTIC AND PAPER CONDENSER CATALOG. Gives specifications, with

Radio-Craft Technicians' Data Service
99 Hudson Street,
New York City, N. Y. RC-1236

Please send to me, without charge or obligation, the catalog, booklets, etc. the numbers of which I have circled below.

2	5	29	53	57	65	73
74	75	76				

My radio connection is checked below:

- Service Man operating own business.
- Service Man for manufacturer.
- Service Man for jobber.
- Service Man for dealer.
- Service Man for servicing company.
- Dealer.
- Jobber.
- Experimenter.
- Professional Set Builder.
- Amateur Set Builder.
- Short Wave Work.
- Licensed Amateur.
- Station Operator.
- Radio Engineer.
- Laboratory Technician.
- Public Address Worker.
- Manufacturer's Executive.
- Student.

I am a:

Subscriber Newsstand reader
I buy approximately of radio material a month. (Please answer without exaggeration or not at all.)

Name

Address

City State.....

(Please print name and address)

Avoid delay. The catalogs and booklets listed are now in stock and will be sent promptly as long as the supply lasts. Please use this coupon in ordering. The use of a letter causes delay.

list and net prices on a complete line of wet and dry electrolytic, and paper condensers made by the Sprague Products Co. for radio Service Men, set builders, experimenters and engineers. Information on the Sprague Capacity Indicator, for making capacity tests on condensers and in servicing receivers, is included.

75. SPRAGUE TEL-U-HOW CONDENSER GUIDE. A valuable chart, compiled by the Sprague Products Co. which tells the proper types, capacity values and voltages of condensers required in the various circuits of radio receivers and amplifiers, and how to locate radio troubles due to defective condensers. Includes data on condenser calculations.

76. FACTS YOU SHOULD KNOW ABOUT CONDENSERS. A folder, prepared by the Sprague Products Co., which explains the importance of various characteristics of condensers, such as power-factor, leakage, capacity and voltage in determining the efficiency or suitability of a given condenser to provide maximum filtering and safety in operation.

INTERNATIONAL RADIO REVIEW

(Continued from page 334)

As shown in Fig. 1, the large end of the cathode-ray tube is provided with 2 closely-adjacent cellular electrodes. The cells marked A act as anodes while those marked B are the photoelectric cathodes.

The walls of cells B are coated with the photosensitive material which emits electrons when a picture to be televised is focused on them. The liberated electrons are collected on wires C and are discharged by the cathode stream from the cathode-ray gun. The discharge is not direct but is due to the production of X-rays as the electron stream sweeps past the base of the anode cells, A. The X-rays serve to ionize the gas in each of

the cells and this, in turn, causes the charge on wires C to instantly leak away.

MAGNETIC SHIELDS FOR CATHODE-RAY TUBES

IN TELEVISION receivers, and also in cathode-ray analysis work, there is a serious risk of unwanted deflection of the cathode-ray beam by transient or stray magnetic fields.

This possibility can be avoided by enclosing the sides of the cathode-ray tubes in shields made from a new high-permeability alloy known as Mumetal (See Fig. E), according to a report in a recent issue of *Wireless World* (London).

Please Say That You Saw It in RADIO-CRAFT

RADIO MAPS THE OCEAN BED

(Continued from page 330)

sea and proceeded on the interesting work which brought to light the prehistoric bed of the Hudson some half a mile deep. Modern hydrographic methods and sounding machines were used to rechart the ocean floor. A continuous succession of automatic soundings was taken by means of the fathometer, or echometer; this method of sounding (by the reflection of sound waves from the sea bottom) has been in use for approximately the past 12 years.

From a known point ashore, a line of buoys was strung seaward by the "Oceanographer," and continued at right-angles for a distance of 45 miles. After being placed, the distances between the buoys (which were approximately 7 miles apart) were measured by stringing piano wire from one to the other; the wire was strung from a reel containing an ocean-going tape-measure 140 miles long. After the distance had been measured in this fashion, the direction of each buoy from the next was found by taking observation on the sun (as more accurate than a compass). Station ships were then anchored at each of two buoys in the line. As the "Oceanographer" moved along its course, bombs of T. N. T. were set off in the water; the sound passed through the water and was picked up by a hydrophone (a microphone for receiving sounds through water) on the station ship. The arrival of the sound there sent an automatic radio message back to the "Oceanographer." By checking the time it took for the sound to travel to each station ship, the engineers aboard the "Oceanographer" could compute their vessel's exact position when each bomb was fired. Knowing the position meant that the automatic soundings being taken by the fathometer could be placed in the proper positions on the chart.

The fathometer determines the depth by sending a sound wave through the water, down to the bottom, and recording the time it takes the echo to return. A ship passing over the upper end of the newly charted gorge could record the time it took the vessel to sail between the 100-fathom depth curves on the chart (3,000, 2,400 and 1,800 feet of water, etc.) and thus enable it to determine its position more accurately than by astronomic sights with a sextant.

However, this still did not eliminate a problem encountered in the use of the small "station" ships. These small vessels would sometimes be anchored off-shore for 10 days at a time, extremely rough weather would place them in danger and imperil the lives of men, as well as the ships. To overcome this, Dr. Herbert Grove Dorsey, scientist of the Coast and Geodetic Survey, recently perfected "oil-barrel" radio stations; he was assisted in the field work by T. J. Hickley. The "sono-radio" buoys, so called, have been in operation for the past few months and are replacing the station ships. The buoys are made of oil drums, with the instruments sealed inside them, and anchored in depths up to 125 feet. A hydrophone is attached to each buoy's anchor cable, and is connected with an amplifier inside the barrel; and this in turn is connected with a 72-meter radio transmitter.

When the sound wave from a bomb, exploded by the survey ship reaches the buoy it is picked up by a hydrophone and amplified. This sound automatically modulates the radio transmitter, which sends a signal back to the survey ship. In other words, a sound message is received, and a radio message is sent back from the barrel, without the intervention of human operators.

The chronograph or time-recording mechanism on the survey ship is used to measure the time after the explosion of the bomb, until the sound travels from the bomb to the buoy. The chronograph (by means of 2 pen-like attachments, each known as a stylus) records the exact time. The stylus on the right shown in the photograph at the lower right denotes the time by marking intervals of one second along what closely resembles ticker-tape. The stylus on the left will only go into action after a bomb has been exploded; it will then make a definite mark on the ticker-tape, beside the time interval registered by the stylus on the right, showing time between the record of the explosion and the receipt of the radio signal from the buoy. Sound travels through sea water at a rate approximately 0.9-mile per second, and it is then up to the officer in charge to compute the exact time.

Everybody's... TALKING AND BUYING WESTON

...AND THE NEW
WESTON Investment Plan
NOW MAKES WESTON
INSTRUMENTS
EASY TO BUY!

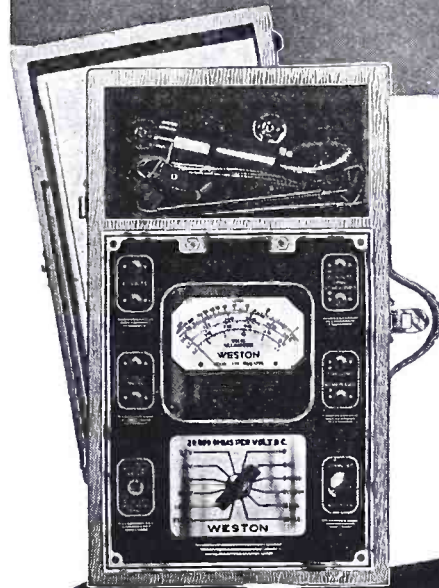

Model 772
WESTON
SUPER-SENSITIVE
ANALYZER
(20,000 Ohms per Volt)
PRICE \$46⁵⁰ net
IN U. S. A.

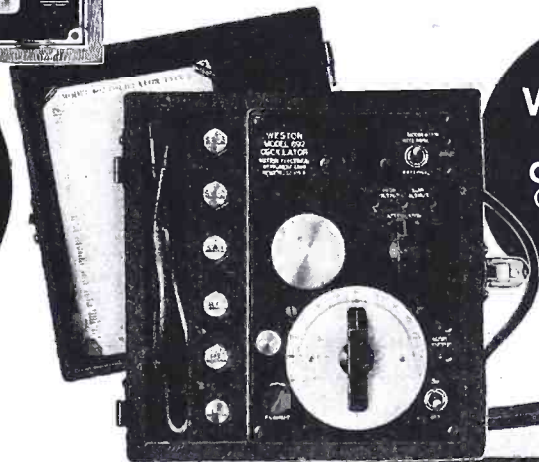

Model 692
WESTON
ALL-WAVE
OSCILLATOR
(Laboratory Type)
PRICE \$45⁰⁰ net
IN U. S. A.



Model 771
WESTON
CHECKMASTER
(Tube checker plus
continuity tester)
PRICE \$45⁰⁰ net
IN U. S. A.

More than ever, the swing is to WESTON instruments. For with WESTON precision and WESTON dependability available at such popular prices, no serviceman need pass up the opportunity to be WESTON equipped for every servicing need. Moreover, the WESTON INVESTMENT PLAN makes it easy to buy these quality instruments. You will want full information on this new Plan. See your jobber, or return the coupon today... Weston Electrical Instrument Corporation, 599 Frelinghuysen Ave., Newark, New Jersey.

Weston Electrical Instrument Corp.
599 Frelinghuysen Ave., Newark, N. J.

Rush complete information on the WESTON INVESTMENT PLAN and all WESTON Radio Instruments.

Name _____
Address _____
City _____ State _____

Be WISE

Meissnerize

Use **MEISSNER QUALITY COILS** throughout and your receiver will glisten and sparkle with unusual brilliance and excellence.

There is a Meissner coil for every purpose. Our new bulletin No. 510 contains the most complete coil listing ever presented. Copies are obtainable at all leading supply houses or directly from us.

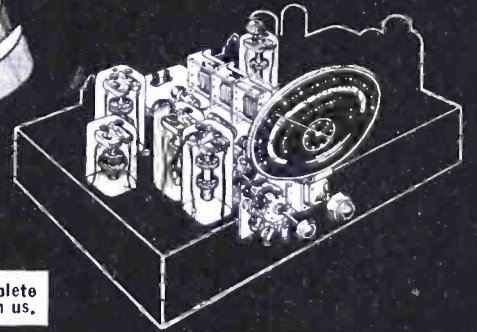

MEISSNER MANUFACTURING CO.

MT. CARMEL, ILL.

NEW DEVELOPMENTS IN CATHODE-RAY EQUIPMENT

(Continued from page 338)

tically synchronized and properly phased with the frequency-modulated output.

- (9) Spot-centering controls.
- (10) Intensity and focus controls.
- (11) Access to horizontal and vertical deflecting plates direct or through amplifiers.
- (12) External use of the 400-cycle audio output.
- (13) Attenuator circuits for signal generator.
- (14) Transparent screen kc.-off-resonance.
- (15) Means for external or internal synchronization with "saw-tooth" oscillator.
- (16) Provisions for synchronizing linear time base with the frequency of power supply.
- (17) Completely shielded.

A SELF-CONTAINED TEST UNIT

This design should not be confused with the simple cathode-ray oscilloscope which is limited to the observation of a single waveform and is incapable of showing the actual instantaneous resonant response curve to a band of frequencies, of a tuned circuit or circuits, which is one of the special functions of this new instrument called the "Diagnoscope." The usual oscilloscope can be utilized for visual resonance functions, but it requires additional equipment such as (1) a variable oscillator, (2) a special motor-driven condenser arrangement which has certain disadvantages, and (3) a synchronizing impulse-generator which is quite apt to develop trouble.

There are definite limitations to the use of an ordinary oscilloscope with a mechanical "wobbler" for visual alignment because there are usually only 2 motor-driven variable con-

densers and it is impossible to cover all of the intermediate frequencies with a frequency-modulated signal of the proper coverage so that an analysis of the tuned circuit can be made without guesswork. For example, if the variable condenser of the separate oscillator is set at its minimum position, the variation in the capacity effected by the normal operation of the mechanical "wobbler" results in a considerably greater change of frequency than that resulting from the operation of the "wobbler" when the variable condenser of the separate oscillator is at its position for maximum capacity. Also, with the separate oscillator tuned to minimum capacity, the output signal of the separate oscillator may be frequency modulated as much as 100 kc. As a result, a band pass of 7 kc. would produce an image only 7 per cent of the width of the screen, or a 0.21-in. deflection on a 3-in. screen. This can however, be bettered somewhat by sweeping the linear time base out beyond the limits of the screen; that is, provided the horizontal amplifier of the cathode-ray oscilloscope has sufficient gain.

In the new diagnoscope, frequency modulation is electrical rather than mechanical and is easily controllable. This design as shown in Fig. 1, describes a double-image resonance or selectivity curve at any intermediate, broadcast, or short-wave frequency and the picture of the curve appears on the screen of the cathode-ray tube which is calibrated in kc.-off-resonance against voltage. *The frequency-modulated signal is automatically electrically synchronized with the time base, a feature which has not heretofore been incorporated in any other oscilloscope or associate equipment used for visual-alignment.*

In this new instrument, too, even the most complicated band-pass circuits of a receiver may be aligned quickly, yet with great precision, to the desired frequency, and also to the desired curve shape and pass band. The effect of each adjustment or improvement of the tuned circuits is instantly shown—the tracking, the gain, and selectivity of a receiver may be simultaneously observed—by tuning the set over its range while keeping the dial of the built-in frequency-modulated oscillator in step.

The frequency modulated band width of this unit is 24 kc. which is linear with frequency and remains constant regardless of the frequency setting of the signal generator.

Frequency modulation of the fixed-frequency oscillator in the unit, as mentioned before, is accomplished electrically and without the use of any mechanical device. It has been designed to incorporate an oscillator circuit, the tank circuit of which employs an iron-core coil. Thus, by varying the permeability of the iron core, there results a change in the frequency at which the tank circuit of the oscillator circuit is resonated. This variation in frequency is linear as a result of a very careful design of the iron-core coil so that it operates on the straight-line portion of the permeability curve. The output of the fixed-frequency oscillator is then mixed with a variable oscillator, the resultant signal being that of a frequency-modulated beat, variable over the band of frequencies which lie between 125 kc. and 15 mc. with a fixed band width of 24 kc.

This article has been prepared from data supplied by courtesy of Supreme Instruments Corp.

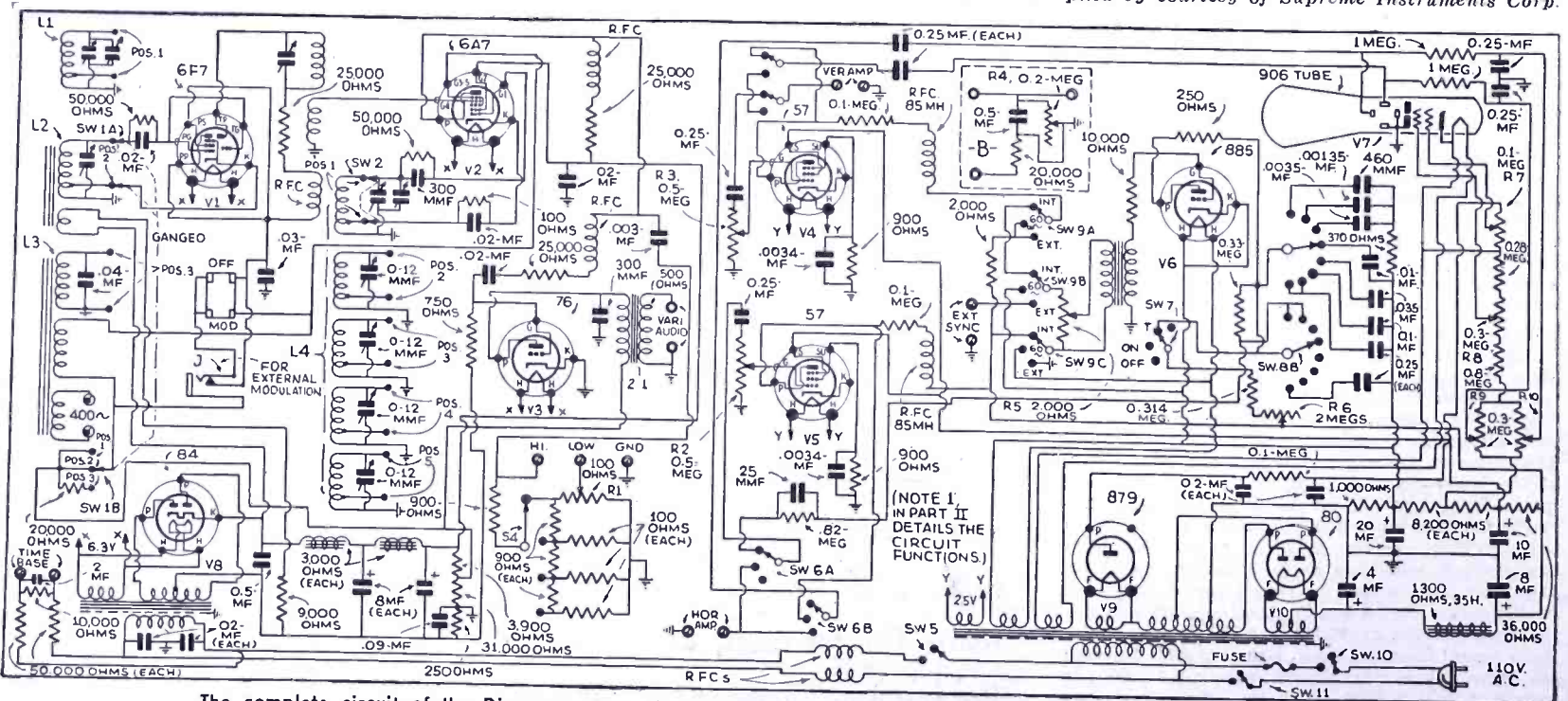

The complete circuit of the Diagnoscope which is described in this part and in Part II in a succeeding issue.

Please Say That You Saw It in RADIO-CRAFT

VISIONS OF 1946

(Continued from page 331)

ture by distant professor (with highly paid television personality) who teaches two million pupils a day. I asked about discipline. Bursar said two-way television applies only to freshman classes, glimpses of which are thrown on screen before assistant disciplinarian, who notes names of spit-ball throwers and occasionally interrupts lecture with brief appearance on screen and his booming, terrifying calls for "Quiet! Order!" He used to be a famous Wagnerian baritone.

At four, returned to office for visual-selling audition. "Visuals" are the best-paid jobs on the sales force, and everyone tries to get them. It's much harder than the old radio announcing and selling jobs, because the public can see as well as hear you, and you can't read from a mimeographed script. After half an hour with the tailor and make-up man, I went into a little room, which looked like the parlor of an average American home, but much more attractive. I got through the ordeal pretty well, except for the fact that there was a slight draft from somewhere which raised the dickens with some of my rings.

Our company makes cigarettes, and to be a good "visual" cigarette salesman you have to be not only personable, persuasive, peppy, well-dressed, with a good natural voice, but you must also be able to blow rings, both plain and fancy. I don't know who started this, but nowadays the television public won't tolerate a cigarette "visual" who can't blow rings, big rings and little rings, and little rings through the big rings. It's a hard life.

I won't hear about the results of this audition until tomorrow.

When I got home, to ease the strain of an extra-hard day, I took the old bus onto the highway and let her out. No cops anywhere, so I hit her up to 60. After a few miles a blue uniform came out of a booth and stuck his hand up. "You were doing 60," he said. "How do you know?" I asked him, flabbergasted. "Television," he answered, "we've just installed a unit on this stretch of road. Ten miles back the machine snapped you, license plate and all. Five miles later another snapped you again. As you were going over 45, I automatically got a television message to give a ticket to a black sedan with license number 101,391. But this all seems so new it ain't quite fair, so I'll let you off with a warning."

Sometimes I long for the quiet, dreamy, solitary days of the old-fashioned radio and the moving picture.

HOW TO ADD A DUAL-CHANNEL A.F. AMPLIFIER TO YOUR RADIO SET

(Continued from page 337)

able to all and therefore may be substituted with a 25-mf., 25-V. electrolytic condenser with only a very slight loss of "lows" experienced.

LIST OF PARTS

- One I.R.C. resistor, 2,000 ohms, 1/4-W.;
- One I.R.C. resistor, 0.2-meg., 1/4-W.;
- Two I.R.C. resistors, 0.1-meg., 1/4-W.;
- *One potentiometer, 0.5-meg., No. C-58;
- *One potentiometer, 0.5-meg., No. C-59;
- One Aerovox condenser, 0.02-mf., 400-V., type 484;
- Two Aerovox condensers, 0.05-mf., 400-V., type 484;
- One Aerovox electrolytic condenser, 60 mf., 10 V. (or use 25 mf., 25 V.), type PR-25;
- *One 8-prong octal socket;
- One type 6L7 tube (Fig. 1), or one *special small 7-prong socket and one 2A7 or 6A7 tube (Fig. 2).

*Names of manufacturers will be supplied upon receipt of a stamped and self-addressed envelope.

This article has been prepared from data supplied by courtesy of Midwest Radio Corp.

THE RADIO MONTH IN REVIEW

(Continued from page 327)

developed for flying over Berlin. The map appears like a system of streets—the planes being guided through a series of narrow channels which were planned so that the chance of mishap through collision is reduced to a negligible factor.

Big Values in New SERVICE EQUIPMENT IN YOUR ALLIED CATALOG!

Newest and MOST COMPLETE LINES

"What's new in Service Equipment?" You'll find the answer in your new 1937 ALLIED Radio Catalog. This great 152-page book includes a complete Service section packed with a tremendous assortment of the newest in oscillographs, tube checkers, set-testers, meters, analyzers—the choicest products of Supreme, Triplett, Readrite, RCA, Jackson, Weston, Clough-Brengle and other leading manufacturers. No matter what type of service instrument you need, you'll find it shown in your new ALLIED Catalog—at the lowest prices.

EARN AS YOU PAY!

ALLIED offers you a new Time-Payment plan on all Supreme service equipment. For a small down payment you get the instrument you want—use your increased profits to pay the monthly installments! Send coupon for complete details.

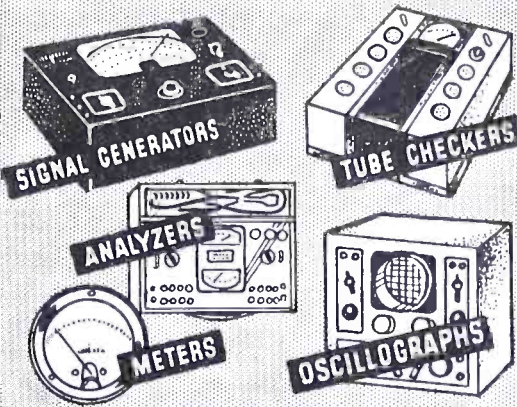

10,000 DUPLICATE AND REPLACEMENT PARTS AT LOWEST PRICES

Your new ALLIED Catalog is crammed with more than 10,000 exact duplicate and replacement parts—any part, any brand you want—when you want it—at radio's lowest prices. Our complete stocks are located under one great roof—our central location means faster service for you—our expert staff of skilled engineers is ready to help you select the equipment you need—conveniently and economically. Thousands of servicemen order exclusively from the ALLIED Catalog—and save time, trouble and money. If you don't have a copy send for yours today!

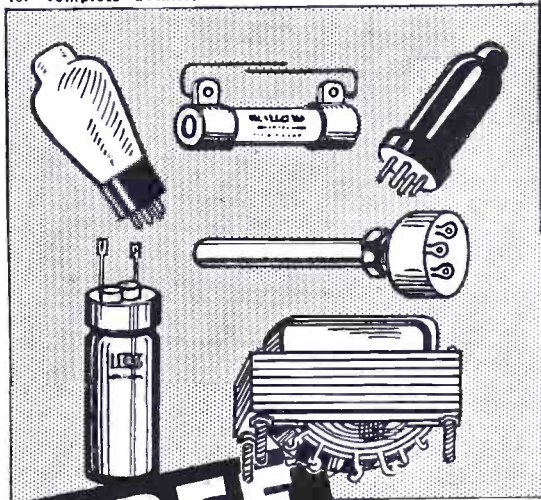

FREE 1937 CATALOG

EVERYTHING IN RADIO AT LOWEST PRICES!

Besides complete lines of parts and service equipment, the 152-page ALLIED Catalog shows 38 new Knight radios—5 to 19 tubes—in All-Wave and Dual Wave models—for AC, AC-DC, 6 volt, battery and auto operation; the latest Amateur transmitting and receiving gear; newest Public Address Equipment—8-60 watts—for every Sound need; dozens of new set-builders' kits; Rurl-power units and Windchargers; books; tools, etc. Whether you are a Serviceman, Amateur, Radio Builder or Sound Man you need this great book. Write for it today!

ALLIED RADIO! 833 W. JACKSON BLVD. CHICAGO ILL



ALLIED RADIO CORP., Chicago, Ill. Dept. 2-M 833 W. Jackson Blvd., Chicago, Ill. Dept. 2-M
 Rush me a Free Copy of your 152-page 1937 Catalog.
 Send me details on Supreme Time-Payment Plan.

Name
 Address
 City State

THERE'S A GOOD JOB FOR YOU IN RADIO

We Will Train You Quickly to Qualify

RADIO

The servicing of modern radio receivers requires expert—men trained for this work are needed everywhere.

RADIO OFFERS BIG OPPORTUNITIES

Your possibilities of making money are limited only by your ability and skill. There is no room for the soldering iron "quesser." But you must be trained—the sooner you begin the quicker you'll cash in.

LEARN AT HOME

NO EXPERIENCE NEEDED

We will train you at home to service and repair radio receivers of all types. Invest for future success in R.T.A. training.

You need no previous experience in Radio. We show you how to make money almost from the start. Hundreds of men are enjoying the rewards of R.T.A. training.



FREE of extra cost

This time saving trouble-finder and circuit analyzer included.

Full details of this great opportunity are explained in a helpful book that is FREE. Send for it today. It will be mailed at once.

RADIO TRAINING ASS'N OF AMERICA Dept. RC-612, 4525 RAVENSWOOD AVE., CHICAGO

Please Say That You Saw It in RADIO-CRAFT

MAKING A RADIO-CONTROLLED MODEL "SARATOGA"

(Continued from page 333)

Relays from combination "B" eliminator battery-charger units, when rewound with No. 28 gauge D.C.C. wire make satisfactory intermediate relays.

Automobile cut-outs, because of their large contacts, can handle fairly heavy currents. Strip off the heavy outer winding and use the fine winding for the relay coil.

THE TRANSMITTER AND RECEIVER—THEORY OF OPERATION

Unless the experimenter takes every precaution to insure a reasonable degree of frequency stability in both transmitter and receiver his "control"—to say the least—will be very erratic. Our answer to the stability problem (the transmitter and receiver combination used to control the *Saratoga*) incorporates a unique feature that insures the stability of both units—crystal-controlled oscillators are used in both transmitter and receiver. The system works as follows: A crystal-controlled transmitter radiates a signal of, for example, 1,000 kc. This signal is picked up at the receiver antenna, amplified in the R.F. amplifier, and fed to the detector where it mixes with the signal produced by the local oscillator in the receiver. When 2 alternating currents are thus combined, they produce, among other frequencies, a beat note equal to the difference of the 2 frequencies. Assume the frequency of the oscillator in the receiver to be 1,001 kc. The resulting beat note will be 1,001 kc.-1,000 kc. or 1 kc. (1,000 cycles), an audible frequency that is fed through an audio amplifier, and an audio rectifier before going to the relay.

THE TRANSMITTER

A good wavelength region for radio control experiments is the 160-meter C.W. band, because at the present time it is probably the least used of all amateur bands. (The builder must remember that an amateur license is necessary before any transmitter can be "put on the air."—*Editor*) Hence our suggestion that the reader have his crystals ground to some frequency in this band—and make it well toward the center of the band, too, so as to avoid "splatter" from 160-meter phone rigs and nearby police or broadcast stations. We suggest that the reader order his crystals direct from the manufacturer, telling him the approximate frequency wanted and explaining that the crystals *must* be ground to between 1 and 2 kc. of each other. It is also best to buy the crystals *with their holders* because changes in holders often make a very appreciable difference in the frequency of the crystal.

Figure 1D is a circuit of the transmitter; Fig. 1E a suggested layout of parts. The variable condensers are not led to knobs on the front panel for a very good reason—if they are adjusted correctly the first time, they seldom, if ever, need be adjusted again. (Dials on the front panel are only an invitation for the operator or some one else to "tinker".) The jacks are for the transmitter key plug and to facilitate adjustment.

The first step after completing the transmitter before power is turned on is to put a plug in jack A, cutting off the plate supply of the 79 tube. Next plug a milliammeter in jack B and allow the filaments to warm. Next rotate condenser C1 to a point where a pronounced dip or drop in plate current is noticed. At this point the oscillator-stage is functioning. This point can also be found by holding a single-turn coil connected in series with a flashlight bulb in the field of coil L1 and rotating the condenser. At the point where the circuit breaks into oscillation, the lamp will light.

Next the amplifier must be neutralized. Hold the pick-up coil described above in the field of coil L2 and rotate condenser C2 until the light glows. Then vary condenser C3 until the glow disappears. Vary condenser C2 throughout its entire range to find if there is another point where the glow reappears. If there is, continue adjusting C2, C3 until C2 can be varied through its complete range without causing the lamp to glow. Next remove the plug from jack A and adjust the amplifier for greatest output either by watching the reading of a milliammeter plugged in the jack and tuning the condenser for the least plate current, or by holding the pick-up coil in the field of L2 and tuning for greatest brilliancy.

Now we come to the antenna and coupling coil. The antenna is made of 45 ft. of No. 14 gauge enameled copper wire. Connect a glass, receiving-type insulator to one end of the an-

tenna. A light rope connected to this insulator provides a handy way to string up the antenna as shown in Fig. 1F.

Connect 6 or 8 ft. of No. 28 gauge D.C.C. wire in series with a flashlight bulb between the antenna and ground posts. With the transmitter connected, wind turns of wire on the end of the coil L2 form until the flashlight bulb in series with the antenna begins to glow. Continue adding wire until the lamp in the antenna circuit reaches a maximum brilliance and starts to dull.

During the process of adding this coil occasional changes may have to be made in the setting of C2 to keep the current in the amplifier plate-circuit low. Do not tamper with the adjustment of C3. Once the neutralization process is finished, it should be left alone. After the ends of coil L3 are soldered in place, C2 should be adjusted until minimum plate current is shown in a milliammeter placed in jack A. The oscillator plate current as shown by a milliammeter in jack B should be brought near to a minimum by means of C1.

The transmitter is now complete and adjusted except for slight changes that may be desirable in the adjustment of C1 when the receiver is finished, to give a slightly more pleasing note in the receiver output.

In part II will be described the receiving equipment and adjustments.

LIST OF PARTS

Transmitter

- Three hammarlund tuning condensers, 100 mmf., C1, C2, C3;
- Two Aerovox mica condensers, 0.002-mf., C4, C5;
- One Aerovox mica coupling condenser, 100 mmf., C6;
- *One paper replacement condenser, 8 mf., C7;
- *One receiver choke, 2.5 mhy., R.F.C.;
- *Two carbon resistors, 50,000 ohms, 1 W., R1, R2;
- *One bleeder resistor, 50,000 ohms, R3;
- One coil (55 turns of No. 28 D.C.C. wire on plug-in coil form), L1;
- One coil (55 turns of No. 28 D.C.C. wire on plug-in coil form), L2;
- One coil winding (wound on end of L2 coil form, see text), L3;
- One Aalloy Trans. Co. choke, 30 hy., 50 ma., L4;
- One Aalloy Trans. Co. power transformer, 500 V., T1;
- One RCA twin class "B" power amplifier, type 79, V1;
- One RCA power pentode, type 41, V2;
- One RCA rectifier, type 80 or 82 (depending on filament winding available on power transformer), V3;
- *One quartz crystal and holder with monitor (see text);
- One Triplett milliammeter, 0-50 ma.
- *Names of manufacturers will be sent upon receipt of a stamped and self-addressed envelope.

HOW TO MAKE THE WORLD'S SMALLEST 3-TUBE RADIO SET

(Continued from page 269)

The "secret," if you want to call it that, of success with this tiny set is in the high degree of A.F. and R.F. amplification secured.

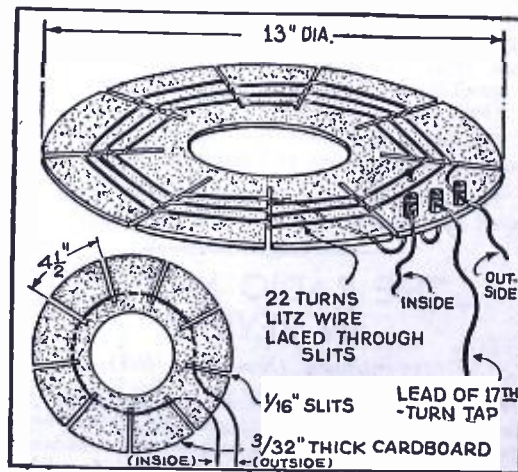

Fig. 4. The "hat" details.



PROFESSIONAL SERVICE MEN
ADVANCED HOME TRAINING
RADIO SERVICE
and PUBLIC ADDRESS

TERMS AS LOW AS \$5 monthly

Plan your future in a field where TRAINING PAYS! This home study course was written for professional Servicemen who see the real need for TECHNICAL TRAINING to keep up with new Radio developments.

TRAINING IS NECESSARY

A car ten years old is not more out of date today than many Radio Servicemen. Radio service is becoming not only more technical, but also more competitive. The man who hopes to get ahead MUST have adequate MODERN training... NOW!

ENJOY SUCCESS NOW!

This course has been prepared from years of actual work and contact in the Service field. We know what you men need! Insure your radio future by training now!

RADIO SERVICE INSTITUTE

Subsidiary of C. R. E. I.

14th and Park Road WASHINGTON, D. C.

Free!

Write today for your copy of this helpful, illustrated booklet, "THE KEY TO SUCCESSFUL SERVICING."



Send for Free Illustrated Booklet

RADIO SERVICE INSTITUTE Dept. RC-12
 3308 14th St. N. W., Washington, D. C.

Without obligation please send me Free illustrated booklet "The Key to Successful Servicing."

Name

Address

City State

Please Say That You Saw It in RADIO-CRAFT

EXPERIMENTS WITH REGENERATIVE F.C.T. DETECTORS

(Continued from page 336)

sets. Unless adequate shielding is provided and properly grounded, uncontrolled circuit oscillation will be set up. Therefore, the use of metal tubes is advised. These experiments as detailed here were all with a type 36 tube, whereas better control is possible by varying the screen-grid voltage of a high- μ pentode. Since regeneration makes the cut-off shown in Fig. 2 more pronounced, it would be advisable to use a remote cut-off type such as the 58, 6D6, or 6K7, to make the circuit less critical.

Since it was desired mainly to observe the reaction of the circuit under various types of regeneration, a Hartley coil with a primary added was wound, and the circuit shown in Fig. 4A was developed. A variation of this was tried and is shown at B of Fig. 4. As is usually the case, better control and far less frequency variation was observed with these 2 circuits than with the more popular Schnell arrangements.

If it is desired to use a pentode, it must have the suppressor-grid brought out to a separate base prong. The suppressor-grid is then used as the "anode" or output, and the screen-grid is used as the regeneration control as shown in Fig. 5.

With any of the methods mentioned, less feedback will be needed than usual, as there is an *apparent* amplification in the plate circuit due to R as explained in paragraph 2. As the plate is the "trigger" of the circuit, all feedback coils should be placed at the plate end of the coil. Proper phase relations *must* be observed if proper operation is to be secured. If the feedback coil is wound in the same direction as the control-grid coil, then the feedback should be brought to the same end of the feedback coil as the control-grid coil connection to the plate.

Only approximate data on components is given as this is only experimental information and no attempt has been made to construct a complete regenerative F.C.T. receiver as yet. The curves shown in Fig. 2 are only approximate, as accurate plottings were extremely difficult to obtain. If any variations of these or any new methods of obtaining regeneration are developed, the author will be very glad to hear about them.

It appears from the circuits shown that there are many unusual possibilities with the F.C.T. and in experimentation in that direction, the surface has only been scratched.

"MAGNETITE" CORES FOR R.F. COILS

(Continued from page 337)

(The same principle is employed in A.F. transformer and filter choke cores; the thin iron laminations are insulated, one from another. As shown in the diagram, if 2 pieces of iron are in close contact, there is a very low-resistance path for circling currents, and the current values are high. If the pieces of iron touch only at narrow edges, the resistance is increased, and the current loss minimized.)

The result is an effective increase of current in the coil proper, and this is of the greatest importance in the input R.F. stage of a receiver; since only signals received with a favorable ratio of strength, above the noise background, will be *successfully* amplified in succeeding stages. One of the photographs, Fig. A, shows how closely the black magnetite shield fits around the coil; a copper shield of this size would materially weaken reception. Inside the coil, a close-fitting core of magnetite composition will also be seen.

Another application is in an I.F. transformer, illustrated in Fig. B. Not only has this an external magnetite shield, but it has a core of magnetite, whose variation lengthwise tunes it. This variation of the old "spade tuning" idea permits even more careful regulation than the more common use of a leaf-type trimming condenser, whose capacity is apt to alter under strain during the course of time. The cores, one of which is shown beside the coil, are introduced, one into the primary and one into the secondary, and adjusted by the screws until proper matching is obtained. Each winding has 4 pies, and the core extends through only 3; so that it permits sufficient variation, without affecting the coupling between primary and secondary.

This article has been prepared from data supplied by courtesy of RCA Mfg. Co.

New Testing Instrument Out-Performs All Others

DEPENDABLE MASTER ANALYZER, ONLY \$38.95, HAS EIGHT EXCLUSIVE FEATURES



MODEL 5143

- 1 Will measure resistance up to 40 megohms
- 2 Will measure capacity up to 300 microfarads
- 3 Will measure A.C. Microamperes
- 4 Will measure A.C. Milliamperes
- 5 Will measure A.C. Amperes
- 6 Will measure A.C. voltages on linear scales accurately at all frequencies. This is the most advanced method of making A.C. measurements.
- 7 Will eliminate troublesome and inaccurate copper oxide rectifier which is supplied on all other instruments.
- 8 Has 41 individual ranges or meters in one instrument.

Also made in Master Multitester at \$31.50 Same as illustrated but omitting Analyzer unit in cover.

SEE YOUR JOBBER, OR ORDER DIRECT FROM THE COMPANY

For a free catalogue of all our products, showing the latest developments in multitesters, tube testers, analyzers, volt-ohm-milliammeters, A.C.-D.C. converter units, switches, etc., write today to Dept. C, Radio City Products Co., 88A Park Place, New York.

In addition to these unusual advantages the **DEPENDABLE** Master Analyzer will make every conventional measurement, accurately and efficiently. From the standpoint of value the **DEPENDABLE** Master Analyzer is unsurpassed, for it tops the performance of other analyzers that are priced considerably higher.

RADIO CITY PRODUCTS CO.
88 PARK PLACE NEW YORK CITY "DEPEND ON DEPENDABLE"

HELP for Better Radio

- (1)—FREE CATALOG of Condensers, Transformers, Chokes, Sockets and general equipment for receiving and transmitting. Also bulletin on Super-Pro Receiver.
- (2)—SEND 10c for 32-page Manual of most popular Short-Wave Receivers, with illustrations, diagrams and parts lists.

Address Dept. RC-12
HAMMARLUND MANUFACTURING CO.,
424-438 W. 33rd St., New York.



Learn TALKING PICTURE PROJECTION SOUND RECORDING TELEVISION-RADIO



Qualify for Good Jobs
Learn in Los Angeles. Practical instruction. Newest equipment. Master training courses. 30,000 graduates. Earn room and board while learning. Coach R. R. fare allowed to L. A. Send coupon for Catalog.

NATIONAL SCHOOLS - LOS ANGELES

NATIONAL SCHOOLS—Los Angeles
Dept. RC-12, 4000 S. Figueroa St.

Name age
Address
City State

Please Say That You Saw It in RADIO-CRAFT

A Finer Oscillator — at a lower price! CLOUGH-BRENGLE — MODEL OC

only \$29.95 cash — \$4.50 down

The world's most popular radio test instrument now offered in a new 1937 version, designed especially for work in short-waves.

25-INCH TUNING DIAL—plus hand calibration against crystal standards allows a guaranteed accuracy within 1/2 of 1% AT EVERY FREQUENCY from 100 kc. to 30 mc.

STEPLESS DUAL ATTENUATOR—Provides smooth variation of output voltage from maximum to less than 1/2 microvolt.

NEW ISOLATED LINE-FILTER—Triple shielding plus elaborate radio frequency filters is employed to eliminate any trace of line feedback, once impossible to eliminate.

BATTERY OR LINE OPERATED MODELS—The MODEL OC-A for 110 volt 50-60 cycle line (25 cycle and 220 volt models available), the MODEL OC-B for 110 volt ac-dc, and MODEL OD-A from self-contained batteries. Write for new descriptive bulletin.



Hand Calibrated

Mail Coupon
for 1937
Catalog

The CLOUGH-BRENGLE CO.

2809 West 19th Street, Chicago, U. S. A.

Name
Address

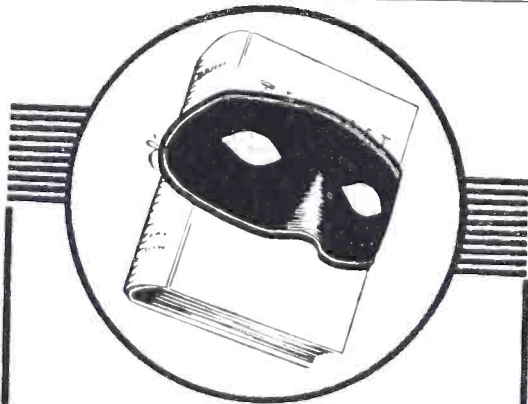

What Is It?

Next month you will get news in this magazine of a brand-new Ghirardi book for service men and dealers—a book the like of which the radio industry has never seen before. One of the really BIG events in radio history—**watch for it!**

Radio & Technical Publishing Co.
45 Astor Place New York City

Make Winter Money

And Satisfied
Customers
with



Old man winter is pretty tough on most undercar antennas. Make real money this winter installing and replacing with Norwest. Especially designed for turret top cars. No holes to drill. Mounts on rubber vacuum cup standoffs. Adds to streamline appearance. Low noise level obtained by shielding effect of car top. Cannot be broken off or shorted out by snow, ice, or mud. Increases volume and distance. Works equally well on fabric top cars. Dealers, write for complete information and name of nearest jobber.

Sedan or Coach \$5.50 Coupe \$5.00

NORWEST RADIO LABORATORIES

3454 FULLERTON AVE. Dept. 123, CHICAGO, ILL.

Western Division Shelby, Montana

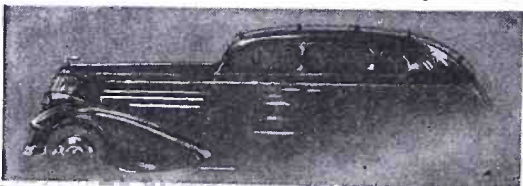

IT SELLS AND IT SATISFIES

AUTOMATIC BALLAST CONTROL IN A NEW TUBE TESTER

(Continued from page 347)

majority of tubes.

The manner in which the tube tester operates may be understood from a study of the theoretical circuit diagram, Fig. 1A. An alternating voltage E is applied to the tube under test through the ballast tube, in conjunction with a transformer, connected as shown. When the plate of the ballast tube is positive, the current, I_p , will flow through the ballast tube in the direction of the arrow, dividing through N_b and R , and then recombining to flow through the tube under test.

Since $I_t = I_p + I_b$, the amount of current I_b flowing through the lower-half of the transformer winding is governed by the setting of the rheostat which is shunted across this winding. This setting will have various values, depending upon the type of tube being tested and must be calibrated in advance by the manufacturer. The current I_b induces a voltage E_a of the polarity shown in the upper-half of the transformer winding N_a , driving the grid of the ballast tube positive and causing grid current I_a to flow. Voltage E_a was found to be about 6 V., effective value, when testing a type 45 tube (R was set at about

320 ohms for this tube). The average value of I_a as read by a D.C. instrument was 0 to 5 ma., although the maximum value of the succession of current impulses is much larger.

The advantage of this scheme is as follows: suppose several tubes of the same type, but of different makes, are to be tested; and that they are all good, but have different values of total emission. In the conventional type of tube checker these differences in total emission might cause the low-reading tube to be rejected as "bad." With the operation of the ballast tube, however, the tube having a low emission will have a low value of I_t which will impress a small value of E_a on the ballast-tube grid. The grid current I_a will be correspondingly lower than the normal amount for that tube, but I_b will likewise be lower, and since the meter reading is proportional to the difference between I_a and I_b , the deflection will be very nearly the normal amount in spite of the fact that I_t is low.

This article has been prepared from data supplied by courtesy of L & L Electric Co.

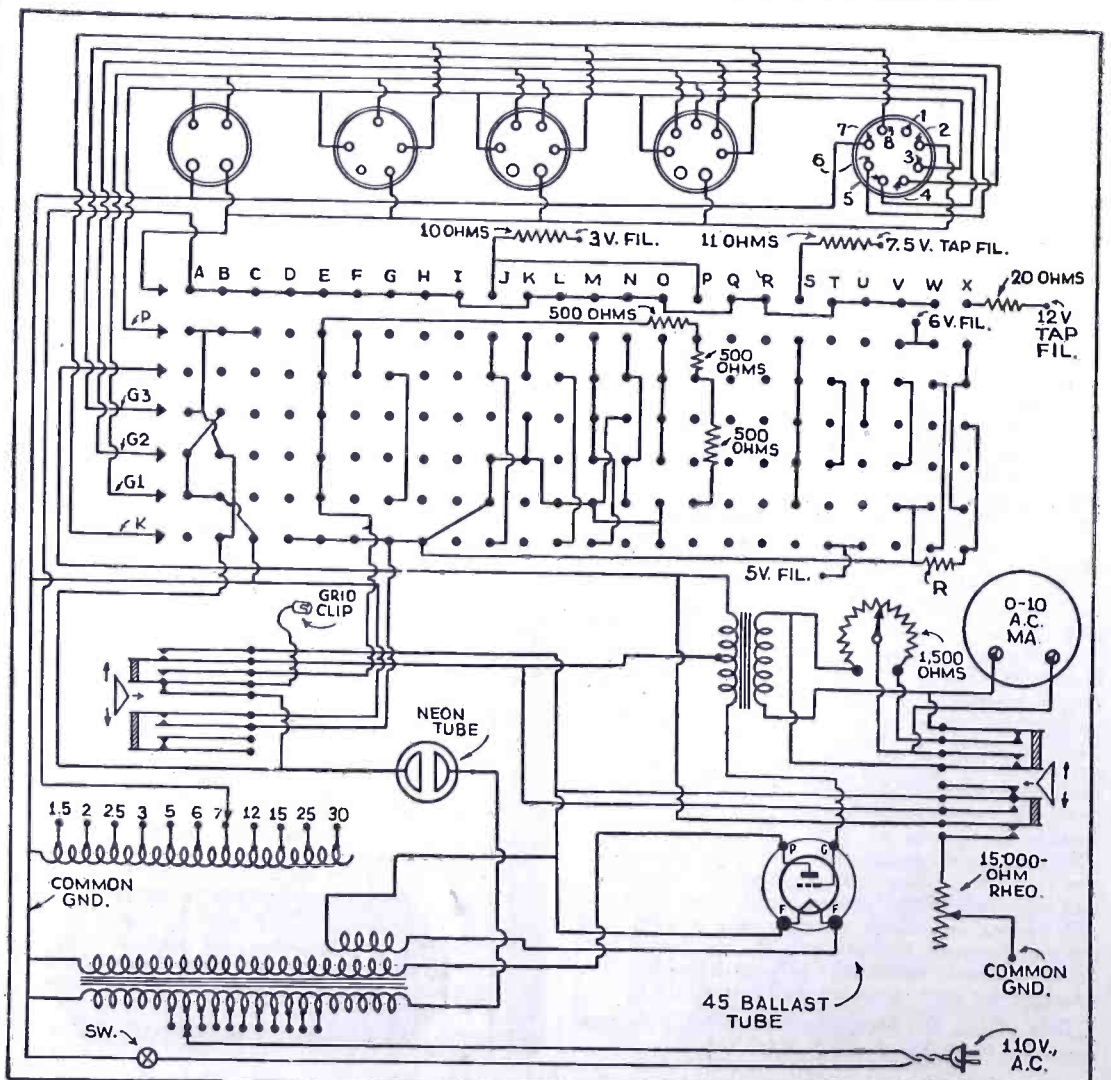

Please Say That You Saw It in RADIO-CRAFT

EXPERIMENTS WITH A "HI-FI" AMPLIFIER

(Continued from page 340)

tion of suitable material for use in the amplifier itself.

Much greater volume is available from this amplifier than is usable in the average living room. Therefore, instead of using a single speaker and having it droning in our ears in one part of the house and being unheard in others, we can provide ourselves with adequate volume for the "whoopie room" in the cellar, the living room and two or more of the upstairs chambers.

Briefly, the full details of the circuit for the "Kathodyne"—the name given to this type of amplifier in England and Australia where it has been in use for several years—may be had from the circuit diagram appearing in Fig. 1, the accompanying pictures and the parts list. This type of amplifier circuit has been named the *Kathodyne* for the reason that a voltage drop, inverse in character, is provided by the voltage drop across the resistor, R 3, thus changing the amplifier from the single-ended type to the push-pull type. The importance of maintaining the cathode of the first amplifier tube—a 6C5 in this case—above the potential of the chassis on which the amplifier is built cannot be stressed too much because failure to do so will convert the amplifier, from the push-pull unit for which it is designed, to the ordinary type of amplifier. In the latter case, the second-harmonic distortion would be very high.

Reference to Fig. 2A, particularly to the dotted line, indicates that a direct connection between the ground portion of the radio set, used to feed the amplifier, and the chassis itself would result in the resistor R3 being short circuited.

LIST OF PARTS

- One Thordarson power transformer, No. 6793, 550 V., 150 ma., center-tapped, T1;
- One Thordarson filament transformer, No. 7984, 5 V.-3A., 6.3 V., 2.5 V., T2;
- One Thordarson output transformer, No. T-8458, push-pull 6L6s to 4, 8, 15, 500 ohms, T3;
- One Thordarson choke coil, No. 17005, 150 ma., 15 hy., Ch.;
- *One volume control, 0.5-meg., R1;
- *One resistor, 10,000 ohms, 1 W., R2;
- *One resistor, 0.1-meg., 1 W., R3;
- *One resistor, 0.1-meg., 1 W., R4;
- *One resistor, 50,000 ohms, 1 W., R5;
- *One wire-wound resistor, 125 ohms, 20 W., R6;
- One Aerovox tubular cond., 0.1-mf., 400 V., C1;
- One Aerovox electrolytic cond., 8 mf., 500 V., C2;
- One Aerovox electrolytic cond., 25 mf., 25 V., C3;
- *One cord switch, Sw. 1;
- One Triad 6C5 tube, V1;
- Two Triad 6L6 tubes, V2, V3;
- One Triad 5Z3 tube, V4;
- *Three octal sockets;
- *One 4-prong socket;
- One chassis, 7 x 12 x 2½ ins. deep, or larger;
- Two Wright-DeCoster model 982 reproducers.

*Names of manufacturers will be sent upon receipt of a stamped and self-addressed envelope.

In Part II, the various speaker connections, shown in Fig. 2, will be explained.

THEREMIN "TERPSITONE" AN ELECTRONIC NOVELTY

(Continued from page 335)

panel; one for "A," another for "C," and so through the gamut.

The wall apparatus, shown in the illustrations, contains 4 tubes; 2 oscillators, one of constant pitch (after it is set), and one varied by the movements and altered capacity of the metal plate attached to its grid circuit; 1 mixer, or modulator tube, and audio-frequency amplifier. Below these are the transformers and tuned coils. In the control panel above, there are volume and tone controls, including one for the vibrator which operates the "visual note indicator" lamp panel.

We have thus a new instrumentality of the terpsichorean art, as well as the lyric, combining the best features of both; and permitting even greater expression of individuality, as well as demanding even more refined technique. And all from another extension of the principle of "hand capacity," which used to be such a nuisance to the seeker after DX.

Compare THESE 2 SERVICE BOOKS with all others!

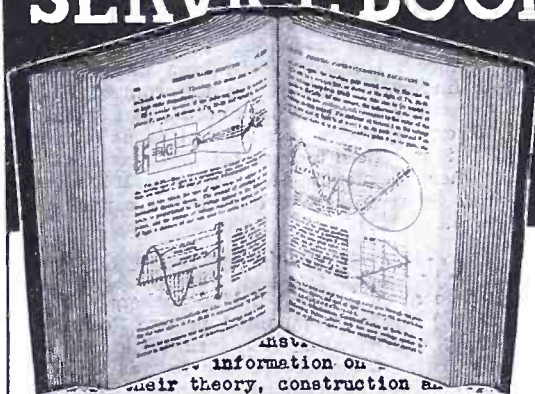

...information on their theory, construction and operation, complete with circuit diagrams—full details on all Measuring and Servicing Instruments.—Latest Test Methods and Trouble-Shooting short-cuts.—Latest successful Repair Methods.—Noise and Interference "Spotting" and Elimination in Broadcast and All-Wave Sets.—Data on aligning Receivers (including Cathode-Ray Method).—AVC and QAVC Circuits.—Auto-Radio.—Tested Sales and Advertising tips.—All-Wave Receivers.—Testing individual components.—High-Fidelity Receivers.—General servicing procedure. Check receiver

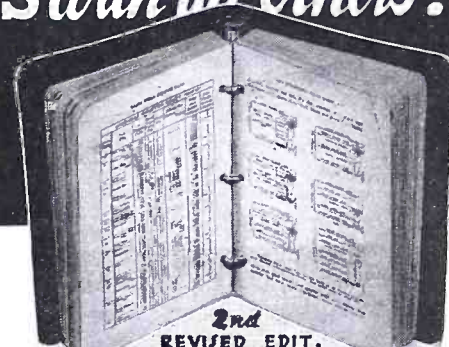

2nd REVISED EDIT.
Over 400 Charts, Tables, Diagrams, etc.—"Case Histories" for over 1,500 American receivers, giving specific Trouble Symptoms and Remedies for each one.—"I.F." peaks for over 5,200 superhets, including 1937 models.—Ignition System data and Interference Remedies for all cars.—Electrical Wiring diagrams for all cars.—Latest data on glass and metal Tubes.—Trouble-Shooting Chart.—RMA color codes.—Wire Tables.—Metric Prefixes.—Wavelength Frequency LxO tables for both broadcast and short-waves.—Grid Bias Resistor Charts.—Tools for the service man.—Power rating and Resistance charts for Resistors.—Transformer turns

The World's Greatest Compilation of Radio Service Data

For sheer quantity alone these 2 Ghirardi books are far and away the biggest six-dollars' worth in the whole radio business. JUST THINK OF IT! In MODERN RADIO SERVICING you get over 1300 pages of spot-tested information about every conceivable angle of radio service work. Check over the partial list of contents above. Then there's RADIO FIELD SERVICE DATA, which in the new, loose-leaf, GREATLY-ENLARGED edition, has over 400 pages of specific data and charts (TWICE as many as the 1st edition). Right up to the minute with 1937 dope, and it can be KEPT up to date permanently with the SUPPLEMENTS issued every January and June. See in the list above how invaluable this handy "quick-find" reference book will be in your daily work.

SEE FOR YOURSELF!

Don't take our word for it! EXAMINE both these books yourself. COMPARE them with all other books ever written! Then—if you do not think they give you the most for the money—if you are not fully satisfied in every way—RETURN THEM within 5 days, undamaged, and your money will be promptly returned. Tear out the coupon and mail it TODAY. OUR GUARANTEE FULLY PROTECTS YOU!



A. A. Ghirardi's MODERN Radio SERVICING and RADIO FIELD SERVICE DATA

1700 pp.

749 illus.

BOTH BOOKS \$6.00

Mail Today!

RADIO & TECHNICAL PUBL. CO.
45 Astor Pl., New York, Dept. RC-126
 Enclosed find \$6 for Combination Offer on both books, postpaid, including Jan. and June '37 Supplements. (Foreign \$6.50)
 Enclosed find \$2.50 for RADIO FIELD SERVICE DATA, postpaid, also including Supplements. (For. \$3)
 Enclosed please find \$4 for MODERN RADIO SERVICING. (For. \$4.50)
 Please send free literature.

NAME
ADDRESS

..... "MONEY-BACK GUARANTEE!"

"EVERYTHING a Service Man needs to know"



TRIAD



THE QUALITY NAME IN RADIO TUBES

TRIAD MANUFACTURING CO., INC.

PAWTUCKET, R. I.

YOU'LL NEED THIS BOOK!

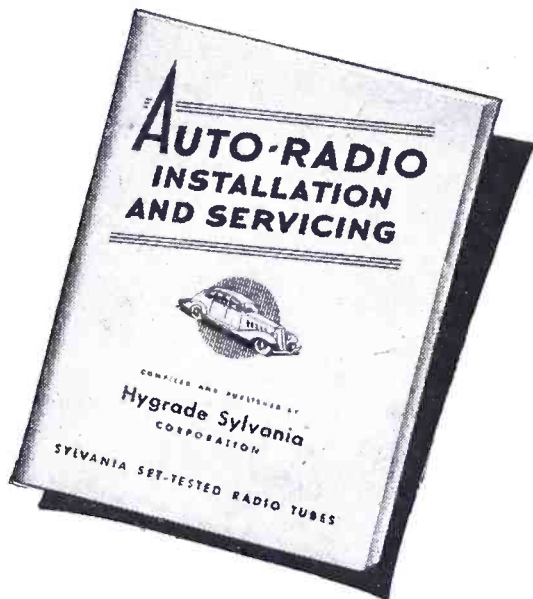

The New 1936-37 Edition of the Sylvania Service Booklet Can Bring You New Profits!

There will be more automobile radios installed this winter *than ever before*. More cars will come from the factories equipped with radios *than ever before*. A new source of business and profits is opening up before your eyes! Will you be prepared to meet it?

You can be prepared with this new Sylvania Service Booklet! Here are just a few of the features:

Elimination of motor interference for every make of 1936 car . . . Tube complement chart for practically all models of automobile radio sets, with I.F. peak frequencies . . . Set and Antenna installation hints . . . Power supply hints, etc. These and hundreds of other problems you will meet in auto-radio installation and servicing are covered in this amazing book.

And this book is absolutely free! Just fill out the coupon below and mail it NOW. You will receive your free copy of this valuable book within a few days.

Hygrade Sylvania Corporation, Makers of Sylvania Radio Tubes and Hygrade Lamps. Factories at Emporium, Pa., Salem, Mass., and St. Mary's, Pa.

SYLVANIA

The Set Tested-Radio Tubes

HYGRADE SYLVANIA CORP. EMPORIUM, PA. RC-126

Please send without obligation your new service book, "Auto-Radio Installation and Servicing".

Experimenter Amateur Call

Serviceman Employed by dealer

Independent

Member Service Organization

Name

Address

City State

Name of jobber

Address

MAKING AN ORGAN-TONE ACCORDION

(Continued from page 341)

In order to emphasize the lows, and thereby bring out the organ-like quality of the accordion, a straight-line frequency response is essential; at the same time, some means must be provided for emphasizing these lows without introducing distortion. An ordinary resistor and condenser type tone control will not do; but the problem is solved by the use of a very simple though efficient *bass resonator*. With this circuit, the harmonic content of the lows under 100 cycles is increased slightly. As the control R1 is increased, a response peak occurs at approximately 70 cycles (when the control is at maximum). (If it is desired to have this peak occur at a little higher frequency [say, around 100 cycles] it will be necessary to change the capacity of C1 to 0.005-mf.)

FINAL ASSEMBLY

The amplifier and 2 loudspeakers (of similar make) are now mounted in one "come apart" case; one speaker is placed in each cover of the case, these covers serving as baffles, and each "baffle" is lined with celotex. The next important step is matching the speakers to the amplifier, and here is where the tapped voice coil comes in handy. From appearances it may look easy to use an 8-ohm tap and get two 15-ohm speakers, and hook them in parallel, but this is not the case. In the final analysis, best results are secured by the use of 2 speakers, each with an impedance of 8 ohms, hooked in parallel across the 8-ohm tap.

In order to procure full efficiency from the speakers, an external field exciter is mounted on the amplifier chassis. Equip each speaker with a 25-ft. 4-wire cable and plug, in order that the reproducers may be spaced some distance from each other and from the amplifier, another 25-ft. length of shielded rubber covered cable is used with the microphone.

We are now ready for our test. The microphone is placed on the accordion, near the bellows. As the selection gets under way, the amplifier is turned on and in a few seconds the true life-like tone of the accordion comes through. We next cut in the bass resonator, and realize

that our system is a success from every angle. The tone of the instrument, now, is truly like that of an organ accordion!

LIST OF PARTS

- *Two carbon resistors, 2,000 ohms, 1 W.;
- *Two carbon resistors, 1 meg., 1 W.;
- *One carbon resistor, 2 megs., 1 W.;
- *Two carbon resistors, 0.25-meg., 1 W.;
- *Two carbon resistors, 50,000 ohms, 1 W.;
- *One carbon resistor, 1,500 ohms, 1 W.;
- *One wire-wound resistor, 10,000 ohms, 1 W.;
- *One wire-wound resistor, 25,000 ohms, 1 W.;
- *One wire-wound resistor, 25,000 ohms, 50 W.;
- *One wire-wound resistor, 125 ohms, 10 W.;
- *One volume control (tapered), 1 meg.;
- *One volume control, 500,000 ohms;
- Three Cornell-Dubilier tubular paper condensers, 0.25-mf., 400 V.;
- One Cornell-Dubilier tubular paper condenser, 0.03-mf., 400 V.;
- One Cornell-Dubilier tubular paper condenser, 0.01-mf., 400 V.;
- Two Solar electrolytic condensers, 5 mf., 35 V.;
- Three Solar electrolytic condensers, 8 mf., 450 V.;
- One Solar mica pigtail condenser, 400 mmf.;
- Three Solar electrolytic condensers, 8 mf., 450 V.;
- *Two dynamic reproducers, 12 ins.;
- One Amplitone 3-section "come apart" portable carrying case;
- Two 25-foot lengths 4-wire cable and plugs;
- One 25-foot length shielded mike cable and plug;
- *One special crystal microphone;
- One Amplitone foundation kit with complete hardware (sockets, switches, screws, etc.);
- One Amplitone kit of transformers;
- One Amplitone kit of A.F. and filter chokes;
- One Amplitone kit of necessary condensers, resistors, volume controls;
- Two RCA or Sylvania 6J7 tubes;
- Two RCA or Sylvania 6C5 tubes;
- Two RCA or Sylvania 6L6 tubes;
- One RCA or Sylvania 83V tube.

*Names of manufacturers will be supplied upon receipt of a stamped and self-addressed envelope. This article has been prepared from data supplied by courtesy of Amplitone Products Co.

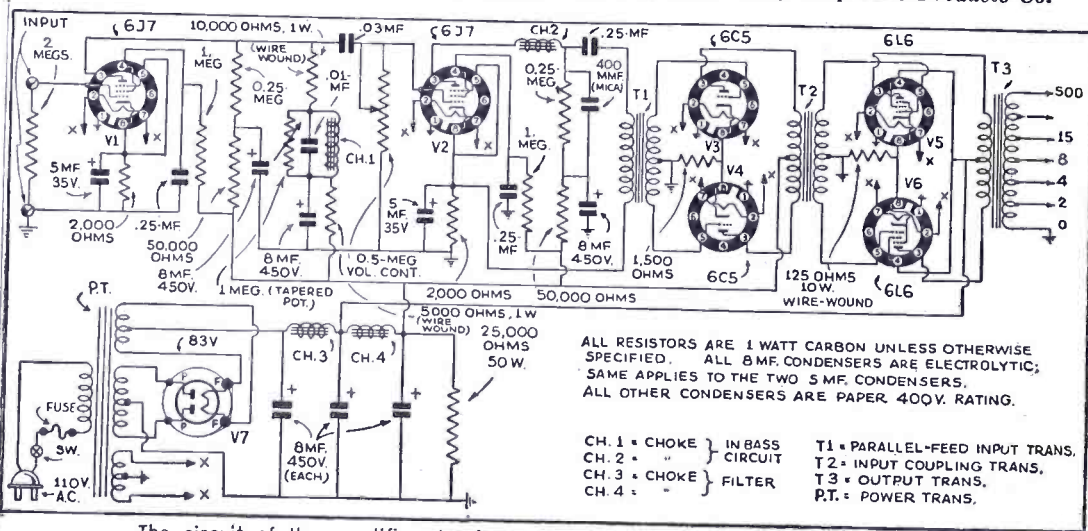

The circuit of the amplifier showing the bass resonator. All values are given.

NEW- VS. OLD-STYLE CONDENSERS

(Continued from page 341)

tages up to 10 per cent of their rating. As a rule, other types of condensers are rated at maximum safe working voltage, which, if exceeded would place the condenser in jeopardy. In size these condensers are extremely compact, about 1/6th that of paper-type condensers of equivalent capacity and rated voltage. Consequently for replacement or in design of radio equipment, the feature of lower physical dimensions as well as improved electrical characteristics should make it preferable over the paper type.

The dykanol impregnator is non-inflammable, hence it presents no fire hazard.

This type of condenser may be obtained in various capacities to withstand as high as 5,000 V., with the aforementioned improved characteristics regarding power factor, leakage resistance and size. Hence for transmitting equipment, high-voltage power supplies and P.A. units, it is far more suited than any other type. The smaller sizes of this type of condenser

are especially suited in high-class service-proof receivers and P.A. amplifiers, as A.F. coupling condensers in resistance-coupled stages, and for decoupling purposes in R.F. stages. The extremely low leakage resistance, and high dielectric strength and constant insure the highest possible efficiency when this type of condenser is employed for these purposes.

While at the present time, oil-impregnated condensers are slightly higher in price over ordinary types nevertheless the features outlined more than warrant their application in units where a maximum of service and efficiency is desired. In certain parts of oscilloscope circuits, television equipment, transmitters, high-quality amplifiers, and even in radio receivers the use of this type of condenser will serve to indicate that the highest engineering and forethought were incorporated in the design, and that the unit represents the ultimate in its respective field.

This article has been prepared from data supplied by courtesy of Cornell-Dubilier Corp.

Please Say That You Saw It in RADIO-CRAFT

GRIDLESS VS. GRID TUBES

(Continued from page 342)

(7) Yet another fault of grid tubes, is that the anode secondary emission increases with the increase in signaling amplitudes, and that these varying electronic repulsions are responsible for one type of distortion produced by non-linear amplification. (Fig. 1E)

(8) A further disadvantage of grid tubes, is that the so-called suppressor-grid, well-known in the art, cannot be made sufficiently negative to repel all secondary electrons, without also opposing the useful cathode electron stream. (Fig. 1E)

(9) A difficulty encountered in grid tubes, is that when an attempt is made to align the various grids, in order to reduce the objectionable features mentioned in previous paragraphs, it is found to be quite difficult to insure the uniform production of these tubes on a large scale as is the case with the 6L6 tube.

(10) An important factor of grid tube construction with which the radio Service Man is particularly well acquainted, is their varying characteristics due to mechanical shocks and the internal heat of the tubes which relaxes the tension of the grid wires causing them to sag or bend in various directions, thus changing the various interelectrode capacities.

(11) A disadvantage of grid tubes that is not so well-known, is their total inability to provide self-limiting properties, so very useful, per stage whether for R.F. amplification, detection, or A.F. amplification, for the reduction of noises, or fading, or to obtain individual A.V.C. per tube, or to prevent various types of distortion, etc.

(12) The radio set design engineer is familiar with the following disadvantage of grid tubes, which is their inefficiency when they are used for multiple functions (such as mixer tube for superheterodyne operation) due to unwanted capacity couplings existing between the various electrodes.

(13) Another disadvantage of grid tubes of importance to designers is that when it is attempted to obtain a greater isolation, of different functions within one tube, either separate amplifying units or complicated electrode arrangements are enclosed within one envelope. This ordinarily renders the device more bulky, more fragile, more expensive, and more complicated to manufacture.

(14) Also, grid tubes, of ordinary inexpensive types, exhibit the inability to deliver full undistorted power output and especially when a low positive voltage is applied on the anode.

(15) Another disadvantage of grid tubes, is the constant variation in electronic field density existing between the cathode and the signal input control-grid, rendering this grid temporarily less effective to low-amplitude modulations or higher signal frequencies, immediately after the liberation of a large percentage of the cathode-to-control-grid space charge, by high-amplitude signal modulations. (Fig. 1F)

(16) And a further disadvantage of grid tubes, including the 6L6 beam tube, is that the various horizontal beams shaped by grid-wire turns, constantly vary in cross-sectional area according to the signal voltages impressed upon these grids, while the anode potential is varied only by the quantity of electrons slowing through its circuit; this discrepancy causes a higher electronic velocity of the compressed beams when the grid is more negative, thus directly opposing or counteracting in various irregular amounts the full effectiveness of the signal voltage variations received by the signal input control-grid. (Fig. 1F)

(17) Finally, in grid tubes, the anode potential exerts a variable attraction upon the electrons emitted by and in the immediate vicinity of the cathode, and that this variable attraction constantly counteracts, in various amounts the action of the modulation control-grid. For example, when the modulation grid turns more negative, fewer electrons reach the anode which then draws less current, and whose voltage increases. This increasing anode voltage, increases the attraction, by the anode, of the electrons which are near the cathode, thereby partially defeating the purpose of the negative modulation grid which is thus prevented from repelling a larger number of electrons from the emitting cathode.

It is for these and other reasons that the writer experimented with, and produced, truly gridless tubes operating on an entirely new basic principle.

These tubes will be described, for the first time, exclusively in a future issue of Radio-Craft.

I WILL PROVE That Sprayberry Training SETS YOU UP FOR BUSINESS

....for Only 17c a day!

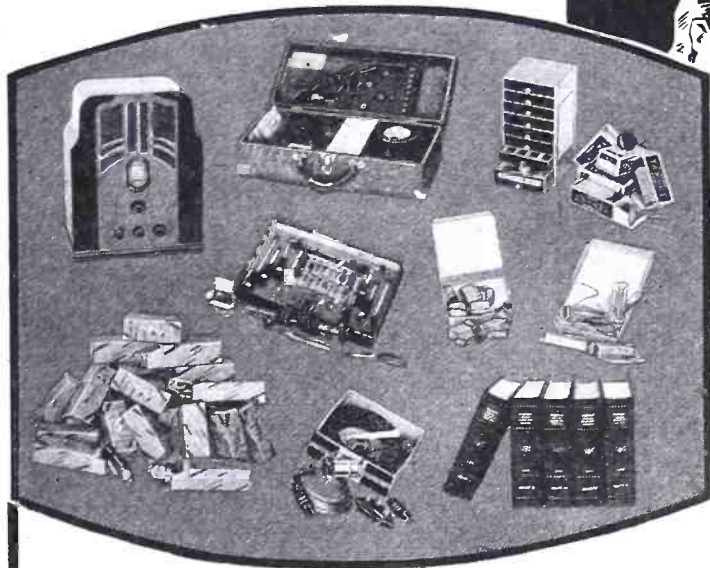

This PROFESSIONAL RADIO EQUIPMENT is Yours!

Sprayberry's is the ONLY training that furnishes COMPLETE PROFESSIONAL equipment with your course. That is why it is so practical—so easy to learn.

GET STARTED NOW IN AN INDUSTRY THAT IS PROVIDING FORTUNES FOR WIDE-AWAKE MEN!

This new and different kind of Training does more than teach you about all branches of Radio. It teaches you business methods—it sets you up ready for an actual start in business—and it backs up every step of your training with REAL PROFESSIONAL RADIO EQUIPMENT!

No matter what kind of Radio Training you take, it is ABSOLUTELY NECESSARY that you have equipment of this kind BEFORE you are ready to start making REAL money.

Sprayberry Training brings it to you almost at the start—teaches you just how to use it under actual working conditions. That is why it's so easy to learn—why students make

extra money on Radio work even before completing their training. Then, upon graduation you have COMPLETE business and technical training PLUS the needed equipment to enter business at once for full or spare time profits—or to start off on a career in any one of Radio's specialized fields such as aviation radio, movie sound work, broadcasting, etc.

ACT TODAY!

Radio was one of the very first industries to lead the way out of the depression. It is going ahead by leaps and bounds. And now TELEVISION is on its way! Today is the time to get started—and Sprayberry Training will start you right. Investigate at once! Let us show you how an investment of only 17c a day—just about the cost of a pack of cigarettes—can mean a real future for you in one of the fastest growing businesses in the world.

Fill in the coupon below RIGHT NOW

SPRAYBERRY ACADEMY OF RADIO

F. L. Sprayberry, President

2545 University Place, N. W., Washington, D. C.

Without obligation on my part please rush your free book "YOUR FUTURE IN RADIO" and other details of the famous Sprayberry Training.

NAME AGE

ADDRESS

CITY STATE

Paste this coupon on penny post card and mail TODAY.

SERVICEMEN!

For those already in Radio, Sprayberry offers an ADVANCED Training Course that has proved invaluable to hundreds of servicemen. Saves you time—saves money—teaches you the easiest way to do the hardest jobs. Get details. Mark an X here () and we will send our ADVANCED Radio Training Booklet free.

2-TUBE SHORT WAVE RADIO

less tubes, phones, unwired Only \$3.00
See article Nov. Radio-Craft Page 284



A REAL, powerful 2-tube short wave set that readily brings in amateurs, police calls, broadcast stations, experimental and foreign stations under fair conditions.

THE WORLD AT YOUR DOOR!

A DEPENDABLE RECEIVER which is guaranteed to give RESULTS.

Operates entirely from the AC or DC house current. Simple to build and easy to operate. Beautiful, black shivel finished cabinet and instructions furnished. Wave length range 10 to 600 meters.

TWO TUBE BATTERY SET, less tubes, phones batteries, unwired\$2.00

Kits wired, extra \$0.75. Tubes, each\$0.50

Cannonball double headphones\$1.35

24 hour service. 20% deposit on C.O.D. orders.

FREE Large catalogue of short wave receiver kits and transmitters.

EILEEN RADIO LABORATORIES

Dept. RC-12, 136 Liberty Street, New York, N. Y.

Please Say That You Saw It in RADIO-CRAFT

New

Molded Bakelite . . .

"DOMINO"

paper condensers

Small, flat, easy to use, better in appearance! Heat- and moisture-resistant! Wide range of capacities! Permanent capacity! Full voltage protection! 10 in standard carton . . . COMPARE!

SOLAR MFG. CORP.
559-601 Broadway, New York City.

RAYTHEON TUBES ARE NOT "CHINESE COPIES!"

RAYTHEON

TRADE MARK

MAKERS OF THE FAMOUS 4-PILLAR TUBES

With the development of new tubes and circuits, engineers of leading set manufacturers look to Raytheon's engineers to supply them with tubes of uniform excellence to meet their exacting requirements. That is why using Raytheons as replacements is so wise and profitable. They are not "Chinese Copies"—They represent real contribution to the radio art. Raytheon has one of the largest, most progressive tube laboratories in the world—operated by internationally famous scientists.

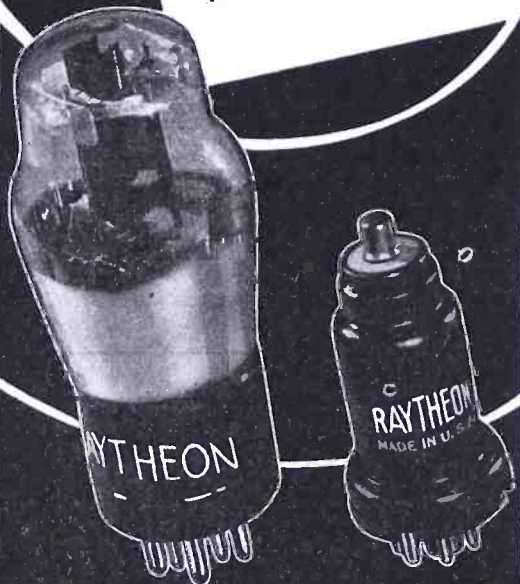

RAYTHEON PRODUCTION CORPORATION

420 Lexington Ave. New York, N. Y.
 445 Lake Shore Dr. Chicago, Ill.
 415 Peachtree Street, N. E. Atlanta, Ga.

55 Chapel Street Newton, Mass.
 555 Howard St. San Francisco, Cal.

SHORT CUTS IN RADIO

(Continued from page 345)

right next to a theatre that produces lots of noise, and it clears up the noise and doubles the daytime reception range!

WILBUR C. REDWINE

HONORABLE MENTION

"STUCK PULLEY" REMEDY. When the pulley of my pole jammed after I had lowered the antenna to make repairs, I was at a loss as to how it could be removed. The pole is 65 ft. high and too large to be taken down, yet too small to climb. The problem was solved as depicted in Fig. 7.

L. WRIGHT

HONORABLE MENTION

EFFICIENT MICROPHONE—an old idea brought up-to-date. I find that a really good substitute mike is a permanent-magnet type dynamic speaker. It is connected as shown in Fig. 8, using the output transformer connected in the high-impedance position, which latter may be found by reference to the chart furnished for the universal output transformer on these speakers.

FRANK SHOEMAKER

HONORABLE MENTION

"BALANCING OUT" TYPE OF NOISE ELIMINATOR. The price of a set of suppressors may be saved by the use of this simple device. As seen in Fig. 9, it consists mainly of 2 coils wound on fibre forms. These are mounted on a 1/4-in. wood dowel, one being fastened with cement, and the other held with 2 nuts. The rod is threaded by screwing the nuts on. The large coil is connected in series with the antenna lead of the receiver. The other coil is grounded at one end and the other end run to some pick-up point in the engine compartment (the radiator tie-rods are a good spot).

ROBERT VAN HOUTEN

HONORABLE MENTION

SENSITIVE NEON INDICATOR. Neon lamps make very cheap output indicators, but they require a higher voltage to "strike" them than is available in certain cases where the set input must be kept low while testing. A Ford model T spark coil may be connected as shown in Fig. 10, and will step up the weak impulses so that a good indication is obtained from the lamp.

E. J. KUJANIK

HONORABLE MENTION

VOLUME INDICATOR. A neon lamp makes a valuable indicator for use on a P.A. amplifier. It has the advantage of being visible from practically any point in the hall or grounds where the system is installed. The lamp is hooked in the output circuit of the power amplifier, in series with suitable resistors. The size of the lamp is not critical, but the smaller the lamp, the larger the resistors used with it.

SILAS R. PERKINS

PHOTOCELL SHOOTING RANGES

(Continued from page 350)

scale (marked "odds," in the photo) below the bull's head.

(Continued on page 369)

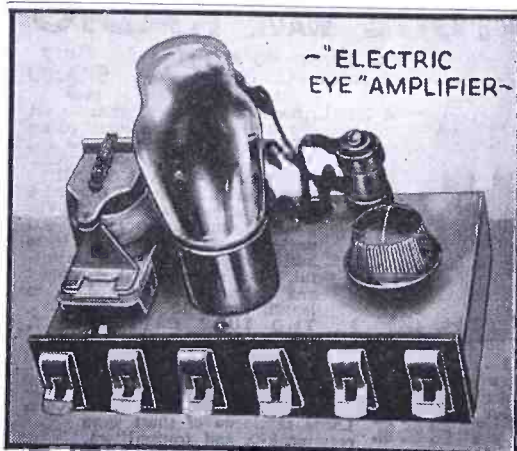

The appearance of the photocell amplifier.

Please Say That You Saw It in RADIO-CRAFT

NEW! ORCHESTRAL SYSTEM

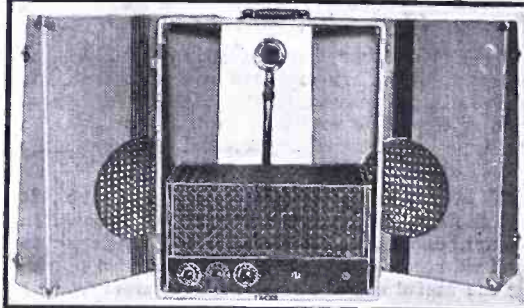

ANOTHER AMPLITONE DEVELOPMENT!!

A completely versatile portable amplifier system. Consisting of 2-12" dynamic speakers, 1-Hi-Fidelity 20 watt high gain amplifier with two position electronic mixer, 1-Velocity or Crystal microphone, 1-collapsible floor stand, 1 set of matched RCA tubes, 1-three section portable case as shown, 75 feet 4 wire speaker cable, 50 feet microphone cable.

Well adapted for voice and instruments. Will bring out the full order of musical tone. Will handle 1700 people.

Price completely mounted and tested **\$71.50**
 Write for free catalogue, or our Mr. Werner for P.A. engineering advice. Give full details.

AMPLITONE PRODUCTS COMPANY
 135 LIBERTY ST. NEW YORK, N. Y.

RADIOS WHOLESALE!

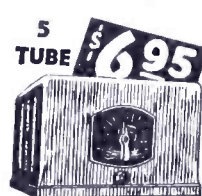

30 DAYS TRIAL

Tune in on politics, news, music, market and weather reports with a new ZEPHYR WORLD-WIDE RADIO. All the latest improvements. MONEY-BACK GUARANTEE, one year FREE service.

Write for FREE Illustrated Catalogue

All electric, farm, battery and auto radios, buy direct and SAVE UP TO 50%. Ask about our User-Agent Plan EARN EXTRA MONEY, be a ZEPHYR salesman.

ZEPHYR RADIO CO.

13141 Hamilton Ave., Detroit, Michigan.

WHAT TO MAKE and how to make it ON A LATHE

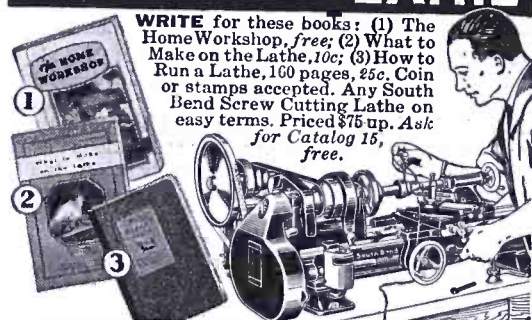

WRITE for these books: (1) The Home Workshop, free; (2) What to Make on the Lathe, 10c; (3) How to Run a Lathe, 160 pages, 25c. Coin or stamps accepted. Any South Bend Screw Cutting Lathe on easy terms. Priced \$75 up. Ask for Catalog 15, free.

SOUTH BEND LATHE WORKS
 535 Madison St., South Bend, Indiana, U.S.A.

RADIO ENGINEERING,

broadcasting, aviation and police radio, servicing, marine radio telegraphy and telephony, Morse telegraphy and railway accounting taught thoroughly. Engineering course of nine months' duration equivalent to three years of college radio work. All expenses low. Catalog free. School established 1874.

Dodge's Institute, Hudson St., Valparaiso, Ind.

PHILCO SERVICEMAN and CATALOG of PHILCO PARTS and TUBES... Sent Free on Request

WILLIAMS PHILCO, Inc.
 800 S. Adams St. Peoria, Ill.

Do you still need one or more of the GERNSBACH OFFICIAL RADIO SERVICE MANUALS to complete your files. If so, please turn to Page 323A for details.

A NEW POLICY *Factory Prices*

TRIUMPH'S DIRECT SALES PLAN

Profit today through Triumph's new low factory-direct prices. SAVE middleman's profits. SAVE high interest rates. SAVE collection costs of long-time payment plans. SAVE inventory losses on obsolete radio tube stocks. Buy direct from Triumph.

Under the new plan, you are guaranteed Triumph's careful precision manufacturing. Get Triumph's top quality. Pay only Triumph's low prices. You be the judge. Every instrument sold under the Triumph factory-direct plan carries an unqualified money back guarantee. Modernize your testing equipment NOW.

Share in the profits. Be modern! Buy modern! Earn more money. ACT NOW and SAVE.

Model 120 A. C. Signal Generator

Radio's newest testing sensation. Over 30 features: Direct reading Vernier Airplane dial; Frequency range 100 KC to 75 MC; Spotted test frequencies; No leakage; Attenuator calibrated to microvolts; 5 step ladder multiplier; 30% amplitude modulation 400 cycle sine wave; Cantilever chassis construction; beautiful metal wrinkle finish case.

Model 310 Pocket Volt-Ohmmeter

Pocket size. Weighs 20 ounces. Meter set at easy reading angle. 3 direct reading scales 0 to 500 volts, 0 to 500,000 ohms. Voltage scale on outside arc of meter for greatest accuracy. Battery drain 1 ma. All ranges selected from master switch.

SMASH GO PRICES

See how Triumph's factory-direct policy saves money—25 to 35%

MODEL	Ship. Wt. Lbs.	PRICE
180 Wobulator	19	\$ 46.00
800 Oscillograph	33	63.60
Combination Models		
180 and 800	52	100.00
120 Signal Generator	15	23.95
300 Multirange Volt Meter	5	15.95
420 L Tube Tester	16	23.95
Portable Signal Generator, Multirange Volt Meter, and Tube Tester	41	65.55
150 Battery Gen.	19	23.95
310 Volt-Ohmmeter	3	7.85
Condenser-Bridge-Analyzer and Preheater	18	14.90
New Visograph	28	29.94

Prices F.O.B. Chicago

Direct from factory... saves you up to 35%.

Avoid big Interest Rates.

Eliminate Obsolete Tube Stock.

Complete Dealer Cooperation.

Money Back Guarantee

We stand back of every piece of testing equipment we sell direct. Your money cheerfully refunded on merchandise returned within 10 days in original condition.

Triumph Manufacturing Company
Dept. RC612, 4017 Lake St., Chicago, Ill.

Check coupon and mail today

Dear Sirs: At no obligation to me please send FREE brochure on the Triumph line of testing equipment.

Dear Sirs: On the basis of your money-back guarantee please find enclosed 25% deposit (\$.....)

Balance to be C.O.D. for model.....

Name.....

Street.....

City..... State.....



October 10, 1936

Mr. Dealer and Serviceman:

Too long have you paid exorbitant mark ups on testing equipment.

Having pioneered the first dramatized tube tester, the first electronically driven wobulator, the first top deck Oscillograph; Triumph again pioneers.

From date of October 10, 1936 the Triumph Manufacturing Company offers every precision testing instrument built in its modern plant at factory prices.

Learn the facts now and save.

Yours very truly,
J. J. McCarthy
President & General Mgr.

TRIUMPH MANUFACTURING CO.

4017 W. Lake St.

Chicago, Ill.

PHOTOCELL SHOOTING RANGES

(Continued from page 368)

The time, during which the flash of light lasts at each discharge, is regulated by a timer, which automatically breaks the circuit (on the principle of a buzzer). This may be made longer or shorter, but is best when the lamp just lights up to full brilliancy.

The apparatus illustrated is operated from the 110-V. light-line, using a step-down trans-

former, and rectifiers for two low voltages and the 110-V. current; the latter used for energizing the photocell, and the former for the lamps and motors, etc. The cabinet (illustrated) is 21 3/4 x 43 1/4 ins. deep, and stands 59 ins. high.

Our Information Bureau will gladly supply the names and addresses of any manufacturers whose products are mentioned in Radio-Craft.

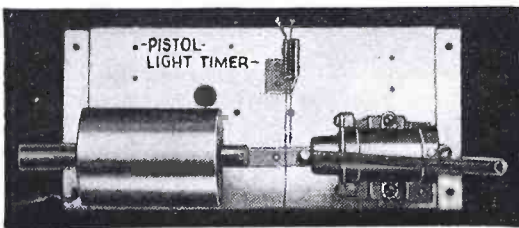

The pistol light timer.

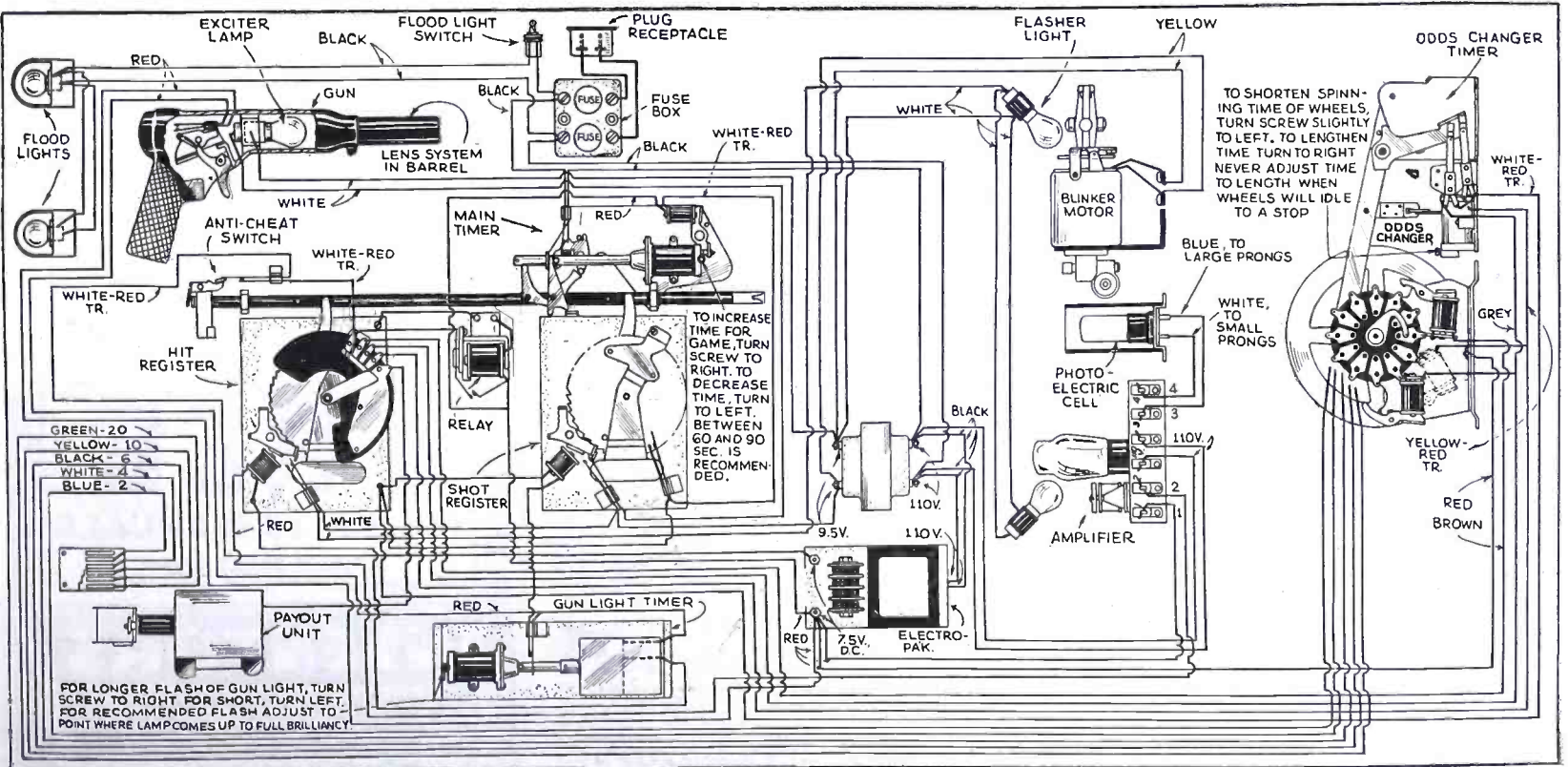

Diagrammatic illustration of the sequence of operations in the photoelectric pistol range.

Please Say That You Saw It in RADIO-CRAFT

Learn RADIO from REAL RADIO ENGINEERS!



Kendall Clough
Chief Engineer,
Clough-Brengle Co.

E. E. Gramer
Chief Engineer,
Standard Tractor Co.

Karl E. Hassel
Chief Engineer,
Zenith Radio Corp.

F. M. Schnell
Engineer,
Zenith Radio

Dr. C. M. Blackburn
Production Dept.
R. M. Mayo & Co.

Train Now at Home for Good Pay Spare-Time and Full-Time Jobs that Pay Up to

\$75 a Week

If you're dissatisfied with small pay—and an uncertain future—here's an opportunity that's too good to miss. Get my big brand new FREE book, "RADIO'S FUTURE AND YOUR OPPORTUNITY." This book tells how you can learn at home under the supervision of factory engineers, to make more money almost at once in Radio—how to make Radio your life's work or use it to pick up \$5 to \$20 a week extra in your spare time.

MORE OPPORTUNITIES THAN EVER BEFORE

Radio is still forging ahead. 1936 beats all other years. Over 5 million new sets sold. Over 30 million dollars paid for service alone this year. Where only a few hundred men were employed a short time ago, thousands are employed today. And where a hundred jobs paid up to \$75 a week—there are thousands of such jobs today—many paying even more. New full time jobs and spare time jobs are being created all the time. Get my book and see how easy you can get started.

"SHOP TRAINING" FOR THE HOME

R-T-I Training is different. It comes to you right from the heart of the Radio Industry—right out of the factories where Radio sets and other vacuum-tube devices are made. It was planned and prepared and is supervised by big radio engineers in these factories—by men appointed for the purpose. R-T-I will train you as the Radio Industry wants you trained.

TELEVISION, PHOTO ELECTRIC CELLS, PUBLIC ADDRESS SYSTEMS INCLUDED

Radio service work is plentiful but it's only the starting point in R-T-I Training. From there you'll go through the whole field of Radio and Electronics. You will learn about every new development, including Television so you'll be ready when Television breaks. You'll also learn the big money subjects such as Aviation and Auto Radio; Public Address Systems; how to handle Photo Cells; Sound Picture Recording, Etc.

4 WORKING OUTFITS FURNISHED

Start almost at once doing part time radio work. I furnish 4 outfits of apparatus that you build into test equipment with which you can do actual jobs and earn extra money. My Training pays its own way and you get your money back if not satisfied. Age or lack of experience is no handicap.

FREE BOOK

Find out why R-T-I Trained men get "Quick Results" and "Big Results." Send for "Radio's Future and Your Opportunity" today. It tells about Radio's amazing opportunities. It describes my approved training—what R-T-I students are doing and making. It gives the names of 50 firms who endorse and recommend R-T-I. It's FREE.

RAY D. SMITH,
President
RADIO AND TELEVISION INSTITUTE
Dept. 229
2150 Lawrence Ave.
Chicago



MAIL COUPON FOR FREE BOOK

RAY D. SMITH, President
Radio and Television Institute (R-T-I)
2150 Lawrence Ave., Dept. 229, Chicago, Ill.

Without obligating me, send new FREE Book about spare-time and full-time Radio opportunities and how I can train for them at home.

Name

Address

CityState.....

WHY USE "BEAM" TUBES

(Continued from page 338)

of a pentode, the elements of a tetrode, the high-fidelity characteristics of the finest triode plus the efficiency of equivalent class B tubes.

6L6 BEAM POWER EFFICIENCY

As the efficiency of a power tube is calculated according to the ratio of power output to the power input, the efficiency of 2 6L6 beam-power tubes operated under ideal conditions is equal to the product of the plate voltage and total plate current, plus the product of the screen-grid voltage and screen-grid current. Under maximum signal conditions plate current (for 60 W. operation) is 230 ma. at 400 V., making a total plate dissipation of 92 W. The screen-grid input power is equal to 300 V. multiplied by 20 ma., or 6 W. The total input power is, therefore, 98 W. Inasmuch as the power output is 60 W., the efficiency is 60 over 98 or, 61 per cent—a condition rarely attained in any other type of power amplifier.

The high power sensitivity of the beam-power tubes enables the use of an inverse-feedback circuit which provides for marked reduction of distortion.

The beam-power tube, has been intentionally designed to create a considerable amount of 2nd-harmonic distortion so that the 3rd and higher-order harmonics may be reduced to a minimum. Practically complete elimination of the 2nd-harmonic distortion is attained in push-pull output circuits.

The available high power output of a beam-power amplifier, makes it particularly adaptable for volume expansion applications (see past issues of *Radio-Craft*) as maximum peak power outputs of 80 W. are available for fortissimo and crescendo passages.

The high power sensitivity of a beam-power amplifier provides for the ready adaptation of an anti-howl circuit. (This feature has been completely discussed in the June 1936 issue of *Radio-Craft*.)

This article has been prepared from data supplied by courtesy of Amplifier Co. of America.

HOW TO MAKE A PSYCHO-GALVANIC DECEPTION DETECTOR

(Continued from page 344)

the changes on the milliammeter when the resistance is varied by known amounts.

In order to determine a value for the total resistance of the subject the voltmeter, V, is placed so as to indicate the amount of opposing voltage used to neutralize the potential drop across the subject.

Some form of non-polarizing electrodes must be used for connection to the subject. A satisfactory form consists of bakelite cups with zinc plates in the bottom to which leads are attached. The cups are filled with MnO₂ (manganese dioxide) moistened with 0.9 per cent NaCl (sodium chloride or common salt) solution, and covered with a pad wet with the same solution.

(The author of this interesting experimenters' article—the instrument shown, incidentally, is commercially available—is Associate Professor of Psychology at Indiana University. Incidentally, *Radio-Craft* readers may be interested to look up the article, "A Simple 'Radio Lie Detector'", in the December, 1935, issue.—Editor)

ORSMA MEMBERS' FORUM

(Continued from page 351)

continuously. If you could see this outfit after it passed its 1,500th hour of continuous operation you would get a new conception of "safety factor" and learn how continuous, safe performance is easily affected by correctly designed components. As for using "heavy duty" 2A3 or 6F6 components in a 6L6 amplifier, "heck, feller" you wouldn't think of using "heavy duty" 12-A or 71-A (output tube type) transformers or chokes in your 2A3 amplifier, would you? Why did you discard your old 12-A or 71-A amplifier? You had to dig down and cough up special transformers and chokes didn't you? Well, sir, if you want to keep up with the rest of the boys, you'll have to do it again! But, as pointed out above, you'll have something to show (or, rather, listen-to) for your money. Additional data on the subject of beam tube worth have appeared in past issues of *Radio-Craft*, and in the article by Mr. A. C. Shaney on page 338 of this issue.

Please Say That You Saw It in RADIO-CRAFT

Sensational RADIO VALUES



4-Tube AC-DC Set

Buy at factory prices—Save money! Lowest priced good radio on the market. Uses 4 latest type tubes, sensitive magnetic speaker, aeroplane dial, built-in antenna and attractive cabinet with beveled corners. Astonishing volume and tone quality. Uses 1-006, 1-6L6, 1-43 and 2-243. Works anywhere—on any 110-volt circuit. Covers the standard broadcast band. A real portable personal set. Can be carried anywhere.

\$645

5-Tube A.C.-D.C. Dynamic Speaker Short-Waves—Aeroplane Dial

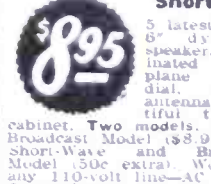

Short-Waves—Aeroplane Dial

5 latest tubes, 6" dynamic speaker, illuminated aeroplane watch dial, built-in antenna, beautiful two-tone cabinet. Two models, v.e.: Broadcast Model (\$8.95), and Short-Wave and Broadcast Model. 50c extra! Works on any 110-volt line—AC or DC. Order directly from this "Ad." and certified check or money order. 20% deposit required for C.O.D. orders. WRITE TODAY FOR FREE ILLUSTRATED CIRCULAR—large selection of latest sets at factory-direct prices.

PARAMOUNT TRADING CO.,
80 EIGHTH AVE. NEW YORK CITY.

THE AUTOMATIC BALLAST CONTROL RADIO TUBE TESTER Model ABC*

A radically new development in tube tester design. Functions similar to AVC control on radio set. WEAK tubes driven well back in BAD. GOOD tubes of same type but different make, that test widely apart on usual tester will read at nearly same point on ABC due to ballast action. Portable. Line adjustment. Neon short and leakage test of all elements. Bakelite panel. Oak case. Price net to servicemen \$34.75. Time payments. Send for circular.

*Patents applied for.
L & L ELECTRIC CO.
346 Madison Ave. Memphis, Tenn.

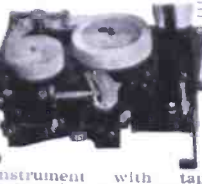

"HAM" SPECIAL Standard Teleplex

A highly efficient code teacher using heavy specially prepared waxed paper tape, having two rows of perforations. Write for Free folder A12. We are the originators of this type instrument

Instrument with tapes prepared by expert and complete course: all for \$11.95. Without Oscillator. 72-76 Cortlandt St., N. Y. C.

NEW GUIDE NOW READY!

Most complete volume control facts ever assembled in one book. Free with one complete Electrad carton.

Write Dept. RC12
175 Varick St., New York, N. Y.
ELECTRAD

TWO HOT NUMBERS!

An All-Wave Signal Generator . . . \$12.40
A Condenser Analyzer and Tester . . . \$7.40

Write for free descriptive circulars.
SUPERIOR INSTRUMENTS CO.,
139 Cedar St., Dept. T-102, New York, N. Y.

FREE MAJESTIC MANUALS
ARROW SALES CORP.
631 Washington Blvd. Chicago, Ill.

INVENTORS
TIME COUNTS—don't risk delay in patenting your ideas. Write for new FREE book, "Patent Guide for the Inventor" and "Record of Invention" form. No charge for preliminary information.
CLARENCE A. O'BRIEN & HYMAN BERMAN
Registered Patent Attorneys
533-H Adams Building, Washington, D. C.

MAKING A Q-TEST ADAPTER

(Continued from page 346)

measured by connecting a coil (any desirable size) to terminals A and B and measuring its Q with the oscillator adjusted to resonance and the Q-Test condenser set to about 450 mmf. When resonance has been reached, set Sw. 2 to Q-Adj. position and vary the oscillator output until 0.025-V. is being applied to the reactive circuit. Then throw Sw. 2 to Q-Test and read the Q value. Next connect the unknown condenser to terminals B and C and readjust the circuit to resonance by resetting the Q-Test condenser.

Check the oscillator output by throwing Sw.2 to Q-Adj. and read the Q of the circuit with Sw.2 in Q-Test position.

Then:

$$Q \text{ (cond.)} = \frac{(C_1 - C_2) Q_1 Q_2}{C_1 (Q_1 - Q_2)}$$

In which C_1 and Q_1 are readings on the Q meter with the coil connected, and C_2 and Q_2 are readings with the unknown condenser connected to the Q-Test Adapter.

The power factor of the condenser can also be obtained from the above reading by dividing the value of Q (cond.) into 100.

THE Q OF INSULATING MATERIALS

The relative Q of insulating materials can be determined by taking a thin sheet of the material and coating the sides with a thin film of vaseline or similar material with low losses and then pressing and rubbing sheets of tin foil against the sides so that all air bubbles are removed.

The sample is then treated like a small condenser and the Q and power factor are determined as explained above.

INDUCTANCE AND RESISTANCE OF COILS

In addition to permitting the radio man to determine the relative merit of coils, the Q-Test Adapter can be used to measure the inductance of R.F. coils with fair accuracy.

Connect the coil to the terminals A and B, adjust the Q-Test condenser to 400 mmf. and resonate the Q circuit by adjusting the oscillator to resonance with the tuned circuit thus formed. Record the frequency of the oscillator and the capacity of the Q-Test condenser.

The apparent inductance of the coil is then:

$$L \text{ (app.)} = \frac{2.53 \times 10^{10}}{f^2 C_1}$$

or if the Q-Test condenser is set to exactly 400 mmf. this formula can be simplified to:

$$L \text{ (app.)} = \frac{63.2 \times 10^8}{f^2}$$

This effective inductance will differ from the true inductance by an amount caused by the distributed capacity of the coil. For R.F. coils this is usually quite small.

The effective series resistance of a coil can be determined by first determining its Q and recording the factors of Q; Q-Test condenser capacity, C; and the frequency of the oscillator, f.

The resistance, R (eff.) is then:

$$R \text{ (eff.)} = \frac{1.59 \times 10^8}{f C Q}$$

For most coils this effective series resistance will be the same as the true resistance—in rare cases, when the distributed capacity of the coil is high, it may be inaccurate.

In giving the above applications of the Q-Test Adapter, it must be remembered that our instrument is not calibrated against accurate standards with laboratory precision. No pretense is made that the instrument will be accurate within several per cent. However, it fills a gap in Service Men's equipment which cannot be filled by any available, reasonably-priced instrument. As such, it should find ready application in the service shop and experimenter's laboratory.

REGARDING—"A KEY TO RADIO AS A VOCATION"

In this article, in the preceding (November) issue of Radio-Craft mention was made of several reputable radio schools that feature tuition by correspondence; due to an oversight, though, we neglected to mention Radio Training Association of America.

Free! SUPREME SERVICE INSTRUMENTS

New Models! New Offers!

WITH NATIONAL UNION TUBES

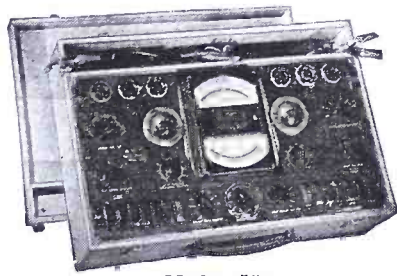

Model 550

\$5.00 down
and 12c per day
Deposit
Refunded



At left is the new Supreme DeLux Automatic. A high efficiency Tube Tester plus Multi-Meter functions. Ultra modern Quadrimeter with bi-indicating needles and dual view windows. A fine handsome piece of equipment given to you Free—the National Union way. At right is the new Supreme DeLux Diagonometer, designed for professional radio service engineers who prefer both tube and radio testing equipment in one compact unit. Features thirty-eight functions and ranges in all! You can get it Free the easy N.U. way. Other Supreme instruments also available. See your jobber or write for complete details.

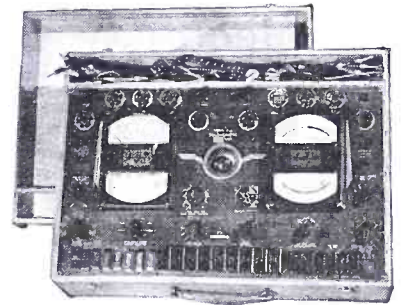

Model 585

\$7.50 Down
and 22c per day
Deposit
Refunded

Yes — FREE — The N. U. Way

The National Union Way makes the purchase of National Union radio tubes doubly profitable. Besides full protection on the highest quality radio tubes, each National Union tube purchased helps to earn free equipment. But, possession of the equipment is obtained at once with just a nominal cash deposit. (Deposit is rebated when required number of tubes have been purchased.) Over 50,000 completed deals with progressive radio dealers. Don't be misled. See your National Union jobber and get all the facts.

About National Union RADIO TUBES

National Union manufactures a complete line of radio tubes in glass, metal and G-type. National Union's high quality has made them the outstanding favorite in the radio service profession. All sales policies have been formulated with the idea of making National Union radio tubes the ideal replacement tube for the radio dealer. This has been backed up with a selling program that means real support and help to the wide-awake dealer. Dealers and jobbers handling National Union radio tubes are the leaders in repair parts and service.

Let National Union Help You Write for Information

KAY SHEET METAL PUNCH

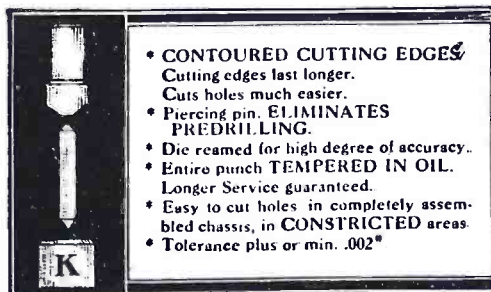

- CONTOURED CUTTING EDGES Cutting edges last longer. Cuts holes much easier.
- Piercing pin. ELIMINATES PREDRILLING.
- Die reamed for high degree of accuracy.
- Entire punch TEMPERED IN OIL. Longer Service guaranteed.
- Easy to cut holes in completely assembled chassis, in CONSTRUCTED areas.
- Tolerance plus or min. .002"

Insist on the K Punch for your satisfaction. Buy from YOUR Jobber. Net Price, \$1.75
Jobbers—Factory Representatives, Write Us.

KAY SPECIALTY MFG. CO.
1837 HELENA MADISON, WIS.

Please Say That You Saw It in RADIO-CRAFT

FLASH! EXTRA!

TIME PAYMENTS ON DEPOSITS!

Service experts! Get many latest type service instruments for only a few dollars down and time payments on the initial low N.U. deposit. Remember—deposits are refunded when tube purchases are complete! Get the equipment you need, get it now, the sensational new N.U. way. See your jobber for details!

OTHER NATIONAL UNION OFFERS

In SOUND EQUIPMENT items available include 17-watt portable system, 10-watt portable system, 6-watt portable system, phonograph pickup and turntable, etc., all manufactured by Webster-Chicago.

In SERVICE EQUIPMENT items available include tube testers, analyzers, oscillographs, signal generators, modulators, meters, etc., products of such manufacturers as Supreme, Clough-Brengle, Hickok, Triplett, Readrite, Precision, Radio City, Dumont, J.F.D. and others.

In SHOP EQUIPMENT items available include stock cabinets, coats, display signs, etc. All items absolutely free the National Union Way. Get full details.

National Union Radio Corporation RC1236
570 Lexington Ave., New York City

Without obligation please send me more information on

....Free offer on Supreme Model 500....; Model 585....

....Free offer on

Dealer's Name

Address

City State

RADIOS

SAVE UP TO 50%

ALL NEW 1937 MODELS

A penny post card brings you our new, full-color 16-page BARGAIN CATALOG free. Many models to choose from: 4 to 19 tubes; AC-DC. All-Wave and new Farm sets that operate like city radios! Send post card or coupon below for full details of 30-day no-risk trial and Agent-User proposition. Write now!

30-DAY NO-RISK TRIAL
\$6.98
MAIL COUPON Free Catalog
GOLDENTONE RADIO CO., DEPT. B, DEARBORN, MICH.
Without obligation, send me new 1937 Catalog and 30-day trial plan.
Name
Address

LOOKING AHEAD IN THE RADIO FIELD

(Continued from page 343)

dent, asks that the FCC literally "keep its feet on the ground," pointing out that "If private capital is going to continue doing the sort of broadcasting job it has started out to do in this country, its past investment must not be ignored—sudden, revolutionary twists and turns in our planning for the future must be avoided. Capital can adjust itself to orderly progress, it always does. But it retreats in the face of chaos. We are on the threshold of a period of transition for the next couple of years." (Italics, ours.) "We should do everything in this period to advance experimentation. But we should do nothing to weaken the structure of aural broadcasting in the present band until experimentation in other bands has yielded us new certainties.—any sudden large addition to present aural broadcasting frequencies (reckless expansion, for instance) might so scatter the audience that it would be impossible for many small stations to survive economically. The same

economic forethought should be applied to the proposed use of super-power for stations in the present broadcast band.—balance carefully the increased service against increases in costs.

"Probably the most important economic problem we must face—certainly the one uppermost in everybody's mind—lies in the approach of television.—If television is to flourish, it must be made a nationwide service.—Whatever the present technical difficulties, the day can hardly be distant when the public and our national interest will demand network television." (Again, the italics are ours.) "It will be tremendously costly—that goes without saying. Even the preliminary foundation work cost millions." But president Paley believes that this can be justified if adequate allocations are assured, to organizations which feel and will exercise in television the responsibility that has been found essential in aural broadcast development.

SLEEP SWEETLY

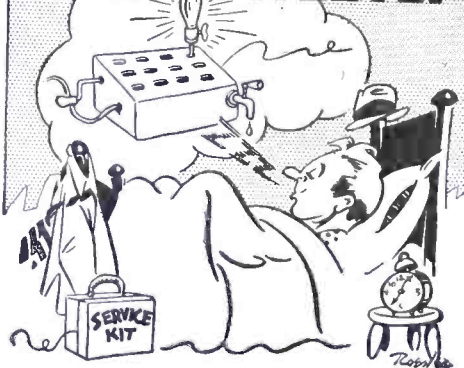

Centralab comes to the rescue with its New Selector Switch

When you fall asleep, dead to the world from fatigue, trying to dope out h w in blazes you're going to get all those dizzy connections right on that new analyzer . . . take it easy CENTRALAB'S new SELECTOR SWITCH KIT, with thousands of combinations will ALWAYS solve your problem. See your jobber today.

Switches for:

- Analyzers
- Output meters
- R F Oscillators
- A. F. Oscillators
- Tube Checkers
- Decade Boxes
- Capacitance
- Resistance
- Ham Equipment
- P A Work
- Volt-Ohm-Am Meter
- Radio Receiver Replacements

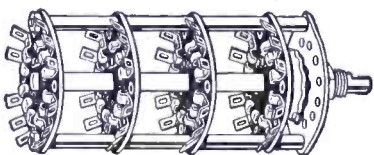

Centralab

MILWAUKEE WIS.
 BRITISH CENTRALAB, LTD.
 Canterbury Rd., Kilburn
 London N.W. 6, England
 FRENCH CENTRALAB CO.
 118 Avenue Ledru-Rollin
 Paris XI, France

PRESENT ALLOCATIONS (Experimental only)		RADIO MANUFACTURERS' ASSOCIATION		NATIONAL ASSOCIATION OF BROADCASTERS		GOVERNMENT SERVICES	
Frequency in megacycles	CLASS OF SERVICE	M. C.	ALLOCATIONS REQUESTED	M. C.	ALLOCATIONS REQUESTED	M. C.	ALLOCATIONS REQUESTED
30	Government, General experimental, Broadcasting (experimental, Apex, relay pick-up, frequency modulation) Police (experimental)	37	Apex Broadcasting and facsimile	30	Aural and Facsimile Broadcasting		338 Channels (0.1% bandwidth)
40	EXPERIMENTAL TELEVISION	42	TELEVISION		TELEVISION	42	
50	Amateur	56		56		50	114 Channels
60	EXPERIMENTAL TELEVISION	60		62	Aural and Facsimile Broadcasting	60	80 Channels
75	EXPERIMENTAL TELEVISION		TELEVISION	64	TELEVISION	72	67 Channels
80		90		94	Aural and Facsimile Broadcasting	89	55 Channels
100	Government, Experimental, Broadcasting (Exp. apex, relay)	120		100	Auxiliary broadcast service	106	91 Channels
150	Experimental Television (any two adjacent frequencies) Government, Experimental Broadcasting (Exp. apex, relay)		TELEVISION RESEARCH (Non-exclusive use)	130	EXPERIMENTAL TELEVISION (25 Channels)	116	76 Channels
200						150	126 Channels
						170	65 Channels
						180	
						192	

(Reproduced from "Electronics" magazine.) Present, and requested, allocations on frequencies below 30 mc.

THE LATEST RADIO EQUIPMENT

(Continued from page 348)

DOOR-OPENING MECHANISM (1210)

EXPERIMENTERS in "radiodynamics"—remote control—will be interested in this mechanism. It is available in several designs, for opening garage doors, etc.

The unit pictured is designed for use with swinging doors; other types are available for sliding and for vertical doors. The entire mechanism may be set into operation merely by interrupting a light beam actuating a photocell (connected to its usual amplifier and relay).

ULTRA-SENSITIVE HEAVY-DUTY RELAYS (1211)

(Weston Electrical Inst. Corp.)

WITHOUT an amplifier, these amazingly sensitive relays will work from a photocell, a thermostat, or other low-current device! Two microamps., or 1 millivolt, will cause them to function, and close a circuit which will handle 5 W. (50 ma. at 110 V., A.C. or D.C.)! The models shown are "single-fixed" and "double-adjustable" contact, respectively, the latter operating with either polarity of current. The magnetic contact prevents chattering when it closes; manual or electric resetting. They find many industrial uses, and may be calibrated for any condition—temperature, etc. Diam., 3 1/4 ins.

METAL CUTTING PUNCH (1212)

(Kay Specialty Mfg. Co.)

FOR work on radio chassis, and the like, the punch shown is especially fitted. A pointed pin is set on the scribed mark, eliminating the necessity of a pilot hole; and the punch is driv-

en right through the metal. Its edge has been contoured to a good cutting slope, and the tool tempered in oil to give suitable hardness and long life of edge. Holes may be driven with accuracy in comparatively restricted space on an assembled chassis.

GIANT METER (1213)

(Triplett Electrical Inst. Co.)

EASE of reading is the outstanding feature of this meter. The large size gives a scale length of 3 1/2 ins. enabling large figures and an uncrowded arrangement. The accuracy is guaranteed at 2 per cent and often is much better than this, and the knife edge pointer enables accurate reading. The internal resistance is 100 ohms for the universal instrument pictured and the movement draws 1 ma. at full scale. The case is of moulded bakelite. A complete line of resistors and other accessories is made to work with this meter.



New Velocity mike. (No. 1214)

NEW VELOCITY MICROPHONE (1214)

(Amperite Corporation)

HIGH output, with a fidelity up to 11,000 cycles, is given by a new

BARGAIN BULLETIN

SAVE MONEY ON EVERYTHING YOU BUY!

- SPORTING GOODS
- WATCHES-CLOCKS
- TYPEWRITERS
- OPTICAL GOODS
- CAMERAS-NOVELTIES
- RADIO SETS AND REPLACEMENT PARTS

NEW FALL CATALOG JUST OUT! SEND FOR YOUR FREE COPY TODAY!

Buy efficiently, economically, safely! Hundreds of high quality items—leading lines and standard brands—at prices amazingly low! Real bargains! Square dealing! Write today for your big, free copy of this new catalog hot off the press.

RADIO CIRCULAR CO., INC.

915 BROADWAY Dept. RC NEW YORK, N. Y.

Please Say That You Saw It in RADIO-CRAFT

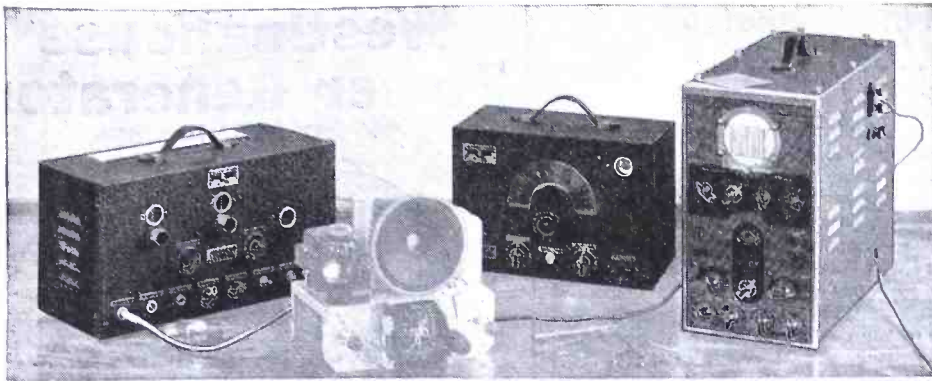

MODEL CRA Cathode-Ray Oscillograph with new stabilized circuit and all controls in the normal plane of vision—the front panel; convenient, too, for wall mounting. Net cash with all tubes, \$84.50. Only \$9.50 down.
MODEL OM-A Inductor-Sweep Oscillator with the C-B hand calibrated precision and

25-inch tuning dial. Accurately calibrates the selectivity curve. Net cash, \$57.75. Only \$6.50 down.

MODEL 81-A Frequency Modulator for use with your present oscillator to produce calibrated selectivity curves. Net cash, \$34.25. Only \$4.00 down.

Build Profits, Prestige with C-B proved CATHODE-RAY Equipment

New sets, new service methods demand the speed and precision offered by CLOUGH-BRENGLE Cathode-ray equipment. No other has the background of experience of these 1937 models, whose predecessors are used today on the production lines of fifteen leading set manufacturers.

Write for **NEW 1937 Catalog**

The CLOUGH-BRENGLE CO.

2809 W. 19th Street

Chicago, U. S. A.

THE LATEST RADIO EQUIPMENT

(Continued from page 372)

velocity type microphone for studio and remote pickups. It is of the stand type with not only on-off switch, but a receptacle for a cable plug permits disconnecting the latter as desired. The mike, 2 1/4" x 2 1/4" x 7", is designed to prevent cavity resonance, and equipped with double shock-absorption mounting. The magnets are of the new nickel-aluminum alloy. The instruments may be had in low or high impedances; and with chromium or gunmetal finish.

loaded on every car's electrical system add to the drain. This charger boosts the battery charge right in the car; it takes 110 V. 50-60 cycle current, and utilizes a full-wave dry-disc rectifier, with no radio interference. An automatic "tapering charge," reducing the current rate as the battery becomes charged, prevents overcharging. Furnished with 12' line cord, 9' D.C. cord, polarized dash receptacle and plug, and toggle power switch. Three models: 4 1/2, 6, and 10 amps. max. charging rates, respectively.

ATTACHABLE CAR RADIO AERIAL (1215) (Wedge Manufacturing Co.)

WHEN radio was first installed in cars, the problem was to conceal the installation. Tops were cut open to receive wires (just as in old buildings wiring and plumbing were put in as best they could); then we had built-in aeri- als. This new type, however, is frankly decorative; it is high in the open, where pickup is better, yet with the steel car top between it and the ignition. The polished aerial, like chrome car trim, is attractive in appearance; the installer simply curves it to shape, and it is held in place and insulated by posts fitted with rubber suction cups. No holes need be drilled. The lead-in is included.

"PORTALAB"—A NEW TEST UNIT (1217) (Triumph Manufacturing Co.)

TO meet all servicing equipment needs at low cost with a single self-contained assembly, the outfit shown has been put on the market at a mass-production cost. It weighs but 45 lbs., and fits into a carry case which gives room for the additional tools required by the Service Man. At the upper-right is a signal generator, calibrated from 100 kc. to 30 mc., and with an output controlled from zero to 500,000 microvolts. For A.F. modulation, or separately, there is a 400-cycle generator. A.C. line current is used. Below this is the tube tester, with a complete set of sockets, designed to take care of future tube construction. It indicates tube defects, such as hot leakage; and has an ample safety margin. The multirange meter has 10 scales controlled by one selector switch, a resistance range from a half-ohm to 10 megohms, and drain on the battery no greater than open-circuit. Range up to 1,000 V., with large, easy-reading dial. The 3 units permit all measurements desired in radio and P.A. servicing.

STORAGE BATTERY CHARGER (1216) (American Television & Radio Co.)

FOR winter use, a battery needs a specially good charge, and the increasing number of devices

New! Auto-Top Aerial for Turret Top Cars

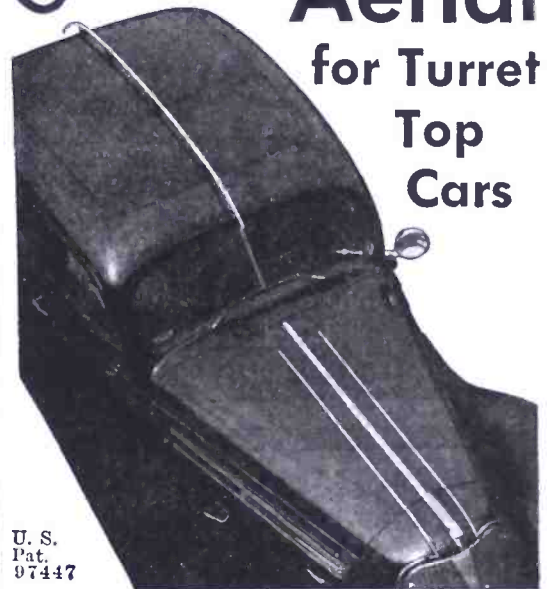

U. S. Pat. 97447

THE common sense aerial for steel top automobiles. Puts the aerial OVER THE TOP where it belongs. Outstanding performance, plus keen streamlined appearance—highly polished aerial—semi-round—die formed like decorative body trim—mounted on top of rubber vacuum posts—carries center trim line of hood, windshield, and rear window right over top of car. Extremely efficient—not damaged by weather—works in rain, ice and snow anywhere, anytime. Steel car top shields against interference from ignition and lighting. Easy to install—shipped straight, no kinks—no holes to drill in top—easy on car finish. A fast seller—users like the smart appearance—greater volume—more distance—and reduced noise.

\$3.85 List

SOLD BY LEADING JOBBERS. RADIO SERVICE MEN—If your jobber can't supply you send his name for COMPLETE INFORMATION and SPECIAL INTRODUCTORY OFFER. Write today. Be the first to show Auto-Top, the perfect auto aerial. Clean up before the others wake up.

WEDGE MANUFACTURING CO.
2336 S. Michigan Avenue, Chicago

6 VOLT D. C. and 110 VOLT A. C. AMPLIFIERS

SPECIAL OFFER: 60 Watt 6L6 110 volts A.C. model 500-15-8-4-2 Ohms Output, 3 Channel Input Mixer, Hi-&Lo Equalizer, complete with \$40 Ribbon or \$37.50 Crystal Mike, two Rola G-12 A.C. Speakers. Crystal Pick-up. Special offer for the entire system \$95.00

COLUMBIA SOUND CO., Inc.
135-R Liberty Street New York

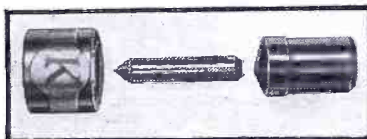

A metal cutting punch. (1212)

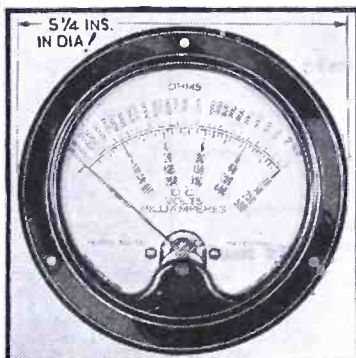

A new giant meter. (1213)

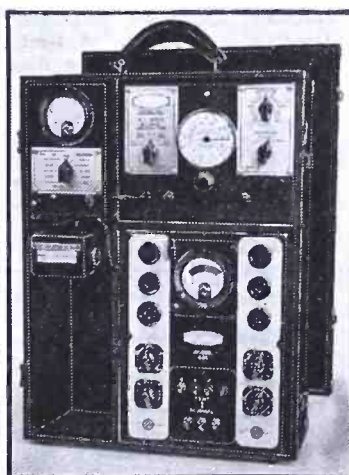

Above, the "portalab" which combines in one unit all the essential instruments needed for service work. (1217)



Attachable car radio aerial. (1215)

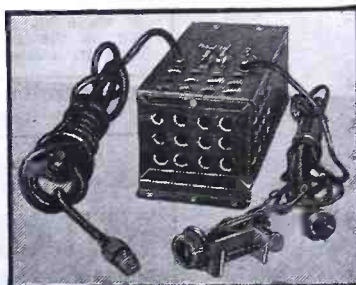

Left, a tapering charger to keep the car battery "up to par" at all times. It cannot over-charge. (1216)

Please Say That You Saw It in RADIO-CRAFT

There Is MONEY IN RADIO

HELP WANTED—MEN.

RADIO SERVICE MEN

Several high class men with own car, steady year round job with good opportunity, live age, nationality and past employers, home no., etc. Address Y S 537, Tribune, home no. 2.

RADIO SERVICE MAN. Millions of dollars are being spent in radio and television. 24,000,000 radios to be service . . . 7,000,000 new sets to be manufactured and sold this year . . . engineers and technicians needed . . . here indeed is a GOLDEN opportunity.

TODAY YOU NEED NO PREVIOUS EXPERIENCE TO GET YOUR SHARE . . . you need only a little spare time for RTA training and prompt action.

Act today . . . **AT OUR EXPENSE.** At absolutely no cost to you . . . **FREE** . . . we will send you a valuable book . . . a treasure book. It tells you about **RADIO TRAINING ASSOCIATION'S** fifteen years of practical training experience . . . of the scores of successful RTA graduates. So exceptional is the record, background and ability of the man who prepares the RTA course that renowned engineers recommend RTA . . . nationally known radio manufacturers endorse RTA. **SEND FOR WRITTEN PROOF TODAY.**

And RTA's generous "no-extra-cost" service equipment makes it possible for you to earn money almost immediately . . . in your full or spare time. **SO DO NOT DELAY... TODAY IS THE DAY... NOW IS THE TIME... ACT PROMPTLY. SEND FOR THIS FREE BOOK NOW!!**

RADIO TRAINING ASS'N OF AMERICA
Dept. RCA-612
4525 Ravenswood Ave. Chicago, Ill.

THE NEWEST IN "TREASURE" LOCATORS

(Continued from page 339)

tion, the user may wish to take an off-side reading and then, by triangulation, find the depth of the object. This is conveniently accomplished by mounting a simple bubble-level clinometer on top of the receiver, as shown in the action photo. Claims far too excessive have been made for instruments of the above nature; but a radio balance built properly will do very exceptional things, with a result that many large companies now make use of the device for different purposes.

The experimenter should consider that tests on newly-buried metal objects are nearly always a failure and, before maximum indications from such metal objects can be expected, the same should be buried for a considerable time—long enough to allow chemical reactions between the metal and the ground to insure proper contact. It should be recognized that the eddy currents, set up in a metal object by the radio transmitter, will create only a small field if the metal is insulated; but in firm contact with the ground, they will cause a great distortion in the electrical field, due to the fact that the ground is a conductor. This conductivity depends on moisture content, and inherent mineralization; it may be rightly assumed that moist ground permits most effective work.

The field for the experimenter is still wide open. For example, a push-pull tube transmitter could be used, and a superheterodyne receiver; but it always should be kept in mind that, the simpler the circuits, the fewer batteries need be inserted in the loop antenna and, the less metal used in the construction of the radio balance, the better will be the results. (All the equipment within the loops must be kept as far from the respective loop as possible.) The diagram shown represents a simple and very effective instrument, with full values for the guidance of the constructor. By changing the inductance of the loop antenna, varying the impedance of the choke coils (as used here, they are random-wound on a form about 1/2-in. wide and 1/2-in. in dia.), and changing the capacities, the frequency range can be changed to suit the experimenter. Using triodes, as shown, in preference to screen-grid or pentode tubes results in least inherent noise level. The completed loop may be impregnated with beeswax if a humid climate prevails.

(The reader may be interested to note that the writer has applied for patents on this device; inquiries concerning which, may be addressed to the writer in care of this magazine.) (*Radio-Craft* readers may be interested to refer to the article, "An Improved 'Treasure' Locator," in the August, 1934 issue. This article contains considerable information of interest to builders and users of this radio-type "electrical balance."—*Editor*)

LIST OF PARTS

Transmitter

- Two type 30 tubes, V1, V2;
- One variable cond., compression type, 250 mmf.;
- One R.F. choke, 1,500 turns;
- One gridleak, 3 megs., 1 W.;
- One fixed condenser, 0.001-mf.;
- One fixed condenser, 0.004-mf.;
- One loop inductance (see diagram);
- One push-pull on-off switch;
- One "B" battery, 45 V.;
- One "A" battery, 1 1/2 V.;
- Wire, etc.

Receiver

- Five type 30 tubes;
- One variable cond., compression type, 250 mmf.;
- One fixed condenser, 25 mmf.;
- Two fixed condensers, 250 mmf.;
- Three fixed condensers, 0.001-mf.;
- Three fixed condensers, 0.004-mf.;
- One filament rheostat, 0 to 6 ohms;
- One push-pull on-off switch;
- Two R.F. chokes, 1,500 turns;
- Three resistors, 1 meg., 1 W.;
- One resistor, 0.75-meg., 1 W.;
- Three resistors, 0.10-meg., 1/2-W.;
- One resistor, 3 megs., 1 W.;
- One pair headphones;
- One phone jack;
- One milliammeter, 0 to 1 ma.;
- One voltmeter, 0 to 3 V.;
- One loop inductance (see diagram);
- One "B" battery, 45 V.;
- Two "A" batteries, 1 1/2 V.;
- Wire, etc.

Westinghouse Power Generator

Manufactured for U. S. Signal Corps.

200 Watt

110 V. AC

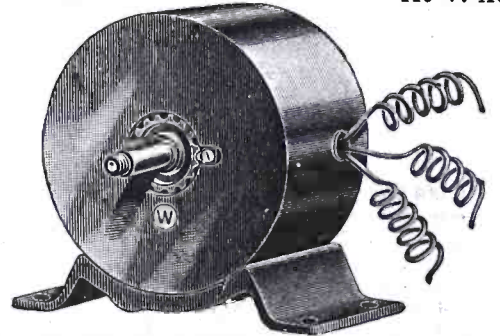

A. C. ELECTRICAL POWER

from a Windmill, from available Waterpower, from your Automobile, from your Motorcycle, from your Bicycle, Foot-pedals or Handcrank; operates A.C. Radio Sets in D.C. districts, also A.C. Radio Sets from 32 V. D.C. farm light systems; use two generators in series to get 200 V. A.C. Used as an A.C. Dynamo, lights ten 20 Watt 110 Volt lamps; Short Wave Transmitter supplying 110 Volts A.C. for operating "Ham" Sets; Motor Generator; Public Address Systems; Camp Lighting; etc., etc.

There Are Over 25 Applications

Specifications:

HOUSING—Aluminum (Diameter 6 1/4 in. Length—5 1/4 in.). **SHAFT**—2 3/16 in. (driving end). Diameter—9/16 in. (the end is threaded for a distance of 1/4 in.). **BASE**—Cast Iron (Length—7 3/4 in. Height 1 9/16 in. Width 4 3/4 in.). **OUTPUT**—200 Watt 110 volts AC (speed 4500 R.P.M.). **STATORS**—Two pairs (two North and two South). **ROTOR**—12 tooth inductor. Built-in commutator. Rotor turns in ballbearings.

1/4 to 1/2 H.P. needed to run generator.

BLUE-PRINT 22 x 28 in. and Four-Page 8 1/4 x 12 in. Applications and **INSTRUCTION SHEETS** FREE with Generator.

Generator, as described, including four replacement carbon brushes. Blue-print and instructions **\$7.90**

Send \$2.00 deposit, balance C.O.D. Shipping weight 18 lbs.

(Replacement carbon brushes bought separate \$1.50 per set of four. Set of instructions bought separate \$1.00.)

ONLY \$4.96 U. S. NAVY AIRPLANE-TYPE Microphone and Receiver

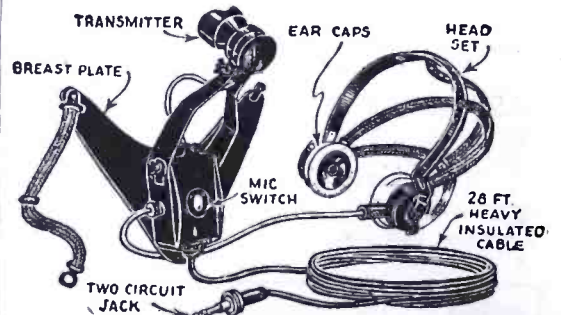

THIS Microphone and telephone headset outfit was built especially for the U.S. Navy Aviation Corps for Plane-to-Plane and Plane-to-Ground communication. The Holtzer-Cabot Electric Company constructed the outfit to Government specifications and under rigid Navy Department supervision.

The outfit consists of a low-impedance carbon microphone (transmitter), securely fastened to a metal breast-plate, and a set of heavy-duty, low-impedance earphones. A specially constructed switch on the back of the breast-plate controls the microphone circuit. The earphones are U.S.N. Utah type, attached to adjustable headband. Twenty-eight feet of very heavy weather and waterproof conductor cable, terminating in a special brass plug, is furnished with this complete outfit. Current of not more than 10 volts should be used. A storage battery is the most satisfactory current supply. Talk in a natural tone of voice, when using the outfit, with the lips close to the mouthpiece. Shouting and loud talking should be avoided.

We understand that the U.S. Government paid more than \$40.00 for each of these outfits. We have bought the whole lot at a low price and are offering them, as long as the supply lasts, at \$4.96 each, complete as shown in illustration. The shipping weight is 9 lbs.

All merchandise in original packages—never used. Money-back guarantee.

All Shipments will be forwarded by Express Collect if not sufficient postage included.

WELLWORTH TRADING CO.
560 W. Washington Blvd., Dept. RC-1236, Chicago, Ill.

POWERTONE

Model 801—Pocket Volt-Ohmmeter

A sensitive, compact and accurate volt-ohmmeter that will be the busiest instrument in your "lab." or out on jobs. DC voltage readings -0.5-50-500 and 1000. Resistance readings from 1/2 to 500 and 200 to 500,000 ohms. Will read from 0 to 1 Ma. Low resistance range direct reading. Meter has 1000 ohm per volt sensitivity. Battery is self contained. Panel is clearly lettered. Compensator provided for zero adjustment. Complete with test prods. Measures only 5"x3 1/4"x2 1/4". Your price complete with battery **\$5.75**

JOBBERS WRITE IN FOR PROPOSITION

POWERTONE ELECTRIC CORP.

179 Greenwich Street New York City

Distributor
TRY-MO RADIO CO., Inc.
85 Cortlandt St. New York City

14—32—64—128 WATT UNDISTORTED
● **6L6 BEAM AMPLIFIERS** ●
DEAL DIRECT With Manufacturer AND SAVE BIG MONEY
ULTRA-QUALITY PERFORMANCE and FLAWLESS REPRODUCTION GUARANTEED FOR 5 YEARS!
WRITE TODAY FOR OUR VALUABLE
FREE CATALOG
INDUSTRIAL
AMPLIFIER SYSTEMS COMPANY
16-R HUDSON STREET NEW YORK, N. Y.

Please Say That You Saw It in RADIO-CRAFT

A New Public Address Line

Featuring Complete Packaged P A Systems Built Around Rugged High Fidelity Amplifiers Such as the 60-C below.

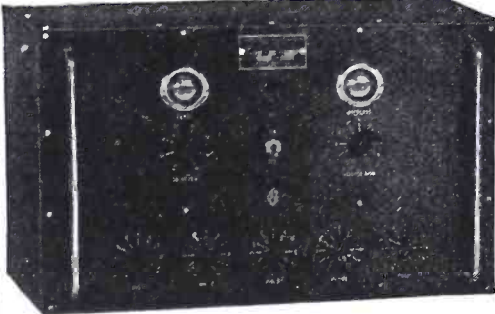

60 Watts Output Net **\$76-26**

- Metal tube—new Beam Tubes.
- Electric Eye visual Monitors.
- Four inputs for mikes and phono.
- Output Safety Circuit.
- Designed for Continuous Operation.



Write for latest edition of No. 106 Catalog just off the press—everything you've wanted in a Public Address Line.

UNITED SOUND ENGINEERING CO.
Manufacturers of Electronic Equipment
2239 University Avenue St. Paul, Minn.

CONDENSERS for tight places



Aerovox PBS Cardboard-Case Electrolytics provide maximum capacity in minimum bulk and at lowest cost. In 200 and 450 v. ratings. Popular capacities. Single, dual and triple sections.



Also GLS Metal-Can Electrolytics. 1" dia. units. Ultra compact. Note GLS compared with standard unit at right. In 250 and 450 v. ratings. Popular capacities.

New CATALOG Just issued. More items. Lower prices. Ask your favorite jobber for copy, or write us direct.

AEROVOX CORPORATION
77 Washington St. : : Brooklyn, N. Y.

THE IMPORTANCE OF HIGH-SENSITIVITY TEST UNITS

(Continued from page 347)

days miraculous:—a 1,000 ohms-per-volt instrument, drawing only 1 ma.

Even this achievement was soon found to have its limitations. Many biased detectors working into resistance-coupled circuits draw a current as low as 200 microamperes when no signal is present. Photoelectric tubes, which are coming into increasing prominence today, draw still smaller current, often in the neighborhood of 15 microamperes.

HIGH SENSITIVITY FOR TELEVISION NEEDS

With the advent of television close at hand, it is foreseen that 1,000 ohms-per-volt will soon be totally inadequate for the requirements of the Service Engineer. To meet this imminent requirement and also to increase the ease and accuracy of ordinary radio servicing, a new volt-ohm-milliammeter and analyzer has just been placed upon the market, having a sensitivity of 20,000 ohms-per-volt. (See Fig. A.) In other words, the indicating instrument used registers full-scale on a current of only 50 microamperes!

To illustrate the tremendous advantages of such an instrument in ordinary service work, Figs. 1A, B, C and D are presented. Figure 1A shows the conditions present in the plate circuit of a biased detector, using a type 27 or similar tube. The plate current with no-signal is 200 microamperes, and we will assume for purposes of comparison that the plate load (R, Fig. 1A) is 0.25-meg.

Refer to Fig. 1A which shows the conditions normally present in the circuit when in operation with the meter not connected. The plate current is 200 microamperes (0.2-ma.); the voltage drop in the plate load, 50 V.; and the voltage on the plate, 200 V.

Now if we connect the 250-V. range of a 125 ohms-per-volt instrument from plate to ground the conditions undergo marked changes. The current drawn through the plate load by the meter creates a large voltage drop in that load with the result that we obtain a reading of 27 V. which is the actual voltage impressed on the plate at that time. In this case the plate current is reduced to about 30 microamperes while the instrument current is 860 microamperes (0.86-ma.), the reading obtained (namely 27 V.), corresponds to an error of 87 per cent. Refer to Fig. 1B for a graphic presentation of the condition present.

In similar fashion, the 1,000 ohms-per-volt instrument will read 112 V., which amounts to an error of 44 per cent. Figure 1C shows this condition.

The 20,000 ohms-per-volt instrument on the other hand, will read 192 V., an error of only 4 per cent as shown by Fig. 1D.

Thus we see the tremendous advantage of a sensitive instrument in taking voltage readings in detector circuits and other high-impedance circuits where small currents flow. It is also a tremendous advantage, in that it can measure A.V.C. voltages without appreciable error, diode currents, photocell currents and other currents of an extremely small order of magnitude which do not indicate properly on a 0-1 milliamper instrument.

At the present time, 20,000 ohms-per-volt is the very ultimate in instrument design. What the future holds in store for us no one knows, but for the present at least the Indicating Instrument Industry has kept pace with the requirements of the field.

This article has been prepared from data supplied by courtesy of Weston Electrical Instrument Corp.

ELECTRICAL INSULATING MATERIALS

Radio men who are interested in insulating materials such as varnished cambric, oil tubing, varnished papers, oiled silk, and mica will find this new catalog of a well known manufacturer of insulating materials to be particularly informative, supplying many useful facts and tabulations.

Write to *Radio-Craft*, today, for your copy—ask for Booklet No. 1218.

Please Say That You Saw It in RADIO-CRAFT

Now—a high-powered—



New

The Library now comprises a revised selection of books culled from latest McGraw-Hill publications in the radio field.

Radio Engineering Library

—especially selected by radio specialists of McGraw-Hill publications

—to give most complete, dependable coverage of facts needed by all whose fields are grounded on radio fundamentals

—available at a special price and terms.

These books cover circuit phenomena, tube theory, networks, measurements, and other subjects—give specialized treatment of all fields of practical design and application. They are books of recognized position in the literature—books you will refer to and be referred to often. If you are practical designer, researcher or engineer in any field based on radio, you want these books for the help they give in hundreds of problems throughout the whole field of radio engineering.

5 volumes, 3064 pages, 2000 illustrations

1. Glasgow's PRINCIPLES OF RADIO ENGINEERING
2. Hund's PHENOMENA IN HIGH-FREQUENCY SYSTEMS
3. Chaffee's THEORY OF THERMIONIC VACUUM TUBES
4. Terman's MEASUREMENTS IN RADIO ENGINEERING
5. Henney's RADIO ENGINEERING HANDBOOK

10 days' examination. Special price. Monthly payments. \$25.00 worth of books cost you only \$23.50 under this offer. Add these standard works to your library now; pay small monthly installments, while you use the books.

SEND THIS ON-APPROVAL COUPON

McGraw-Hill Book Co., Inc.
330 W. 42nd St., New York, N. Y.

Send me Radio Engineering Library, 5 vols., for 10 days' examination on approval. In 10 days I will send \$2.50, plus few cents postage, and \$3.00 monthly till \$23.50 is paid, or return books postpaid. (We pay postage on orders accompanied by remittance of first installment.)

Name

Address

City and State

Position

Company

RC-12-36

MILLION TUBE TESTER ANALYSER



1. All Emission
2. Shorts Hot
3. Leaks Hot
4. 0-5M Ohms
5. 0-3 Megohms
6. .01 to 3 M.F.
7. 0-10-50-500 V. D. C. 1000 ohms per volt
8. Electrolytics

MODEL TA

26.95
NET

MORE TESTS. MORE SPEED. MORE PROFITS is what service men say of MILLION test equipment. If your jobber cannot supply you—order direct—20% deposit required on C. O. D. orders. Tear out this ad and send it to us NOW for complete information on the entire MILLION line.

MILLION RADIO AND TELEVISION LABORATORIES
361 W. SUPERIOR ST., CHICAGO, ILL.

Genuine Majestic

Majestic & Grigsby-Grunow, original and genuine factory radio and refrigerator service. We have purchased all of the assets formerly belonging to Grigsby-Grunow. All parts, service replacement units will carry regular factory, six months guarantee. Buy only through our authorized distributors, dealers or ourselves. GENUINE MAJESTIC PARTS & TUBES. Write for prices. GRIGSBY-GRUNOW COMPANY, 5801 Dickens Avenue, Chicago, Illinois.

AC CURRENT ANYWHERE!

On FARMS—In D.C. DISTRICTS—In CARS

with **ATR DC-AC INVERTERS**
List Price **\$18.50***



*Without Radio Filter
\$22.50 With Built-in-Filter
Standard Discounts apply

Proven—Dependable—Guaranteed

Outstanding Features: Interference—Free All Wave Radio Operation • Improved Long Life ATR Vibrators • Four-Point Voltage Regulators • 16 different types for DC Input voltages ranging from 6 to 220 volts, having AC output voltages of both 110 and 220 volts.



ATR Auto Radio
"A" BATTERY ELIMINATOR
Dealers' Net Price **\$12.95**

Specially designed for demonstrating and testing auto radio sets on regular AC lines, 105-125 volts, 50-60 cycles. Has many other uses. Comes completely equipped with on-off switch, Pilot Light Indicator, 10-ampere Fuse, Rubber Mounting Feet, 6-ft. Rubber Cord, Heavy Gauge Metal Cabinet.

ATR Automatic Tapering Battery Charger

Keeps Auto Battery Fully Charged Right In The Car! Operates from any 110 volt A.C. 50-60 cycle line. Equipped with a full wave dry disc type rectifier unit. Current tapers off as battery becomes charged. Comes completely equipped with polarized dash receptacle and plug, fuses, 9 feet D.C. cord, 12 feet A.C. cord, on-off toggle switch and complete instructions.



LIST PRICES
(Standard Discounts Apply)

Model 450. Max. charging rate, 4 1/2 amp. \$9.67. Model 600. Max. charging rate, 6 amp. \$11.45. Model 1000. Max. charging rate, 10 amp. \$14.25.

Write or Wire for Additional Information
Sold by Leading Jobbers Everywhere

AMERICAN TELEVISION AND RADIO CO.

St. Paul, Minn. U.S.A. Cable: "Likex" New York

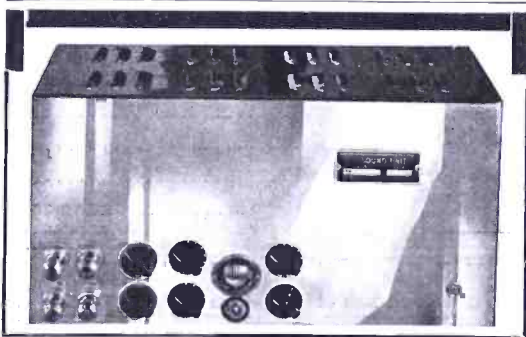

THE SENSATIONAL "30-60" 28 SOUND SYSTEMS IN ONE!

THE MASTERPIECE "30-60" is the only truly universal sound system being built today. It will cover an outdoor audience of 50,000 people—or 1,500 pairs of headphones in a hospital. It is the most flexible sound system ever designed in terms of inputs, outputs and power output of anything from one watt up to sixty-four honest man-sized watts at 2 1/2 times less than customary total harmonic distortion. It has a dozen entirely new technical features—and such mechanical advantages as rack mounting, wall mounting and portable operation all in one unit.

Any MASTERPIECE amplifier may be purchased on Easy Terms with a 5-Year Guarantee and a Free Trial under your own conditions. Send the coupon for full details.

McMURDO SILVER

MASTERPIECE AMPLIFIERS

FULL DETAILS FREE

MAIL THIS COUPON!

McMURDO SILVER CORP.
3356 N. Paulina St.,
Chicago, Ill. U. S. A.

Please RUSH me full details on MASTERPIECE amplifiers.

Name

Address

AWARDS IN THE \$1,800 OFFICIAL RADIO SERVICE HANDBOOK CONTEST

LAST MONTH we printed the names and addresses, and the letters, of the first two winners in the Official Radio Service Handbook Prize Contest sponsored jointly by Gernsback Publications, Inc., publishers of the Official Radio Service Handbook, and a number of the most important manufacturers. In the interim, discontinuance in business by one manufacturer resulted in a slight change in the awards of the respective prizes.

Supplementary Prize. William Levi Zanes, P.O. Box 34, Deepwater, N.J. Award: Bud Radio, Inc. No. 1112 complete kit of insulated-handle socket wrenches.

Supplementary Prize. Edward M. Wiler, 410 Main St., Cedar Falls, Iowa. Award: Bud Radio Inc., No. 1112 complete kit of insulated handle-socket wrenches.

3rd Prize. L. M. Carver, 137 Grandview Road, Ardmore, Pa. Awards: United Sound Engineering Co. model CR3 oscilloscope; Bud Radio, Inc., No. 1112 complete kit of insulated-handle socket wrenches.

4th Prize. John Litwin, R.R. No. 1, Fletcher, Ontario, Canada. Awards: Supreme Instruments Corp. No. 385 automatic analyzer; Bud Radio, Inc., No. 1112 complete kit of insulated-handle socket wrenches.

5th Prize. Jos. Weber, 581 Wyona St., Brooklyn, N.Y. Awards: Triplett Elec. Instrument Co. No. 1501 tube tester; Bud Radio, Inc., No. 1112 complete kit of insulated-handle socket wrenches.

6th Prize. W. C. Frame, Salem, Iowa. Awards: Radiart Corp. type B vibrator analyzer; Bud Radio, Inc., No. 1112 complete kit of insulated-handle socket wrenches.

7th Prize. Benj. Shindell, 1827—53rd St., Brooklyn, N.Y. Awards: Clough-Brengle Co. model OM all-wave oscillator; Bud Radio, Inc., No. 112 complete kit of insulated-handle socket wrenches.

8th Prize. Eugene J. Borsattino, R.R. No. 1, Garyton, Gary, Ind. Awards: Weston Elec. Instrument Corp. model 770 tube checker; Bud Radio, Inc., No. 1112 complete kit of insulated-handle socket wrenches.

9th Prize. Bill Sayers, Sup't. Office, 160 West 77th St., New York, N.Y. Awards: Weston Elec. Instrument Corp. model 698 analyzer; Bud Radio, Inc., No. 1112 complete kit of insulated-handle socket wrenches.

10th Prize. D. Bellare, 1463 East Third St., Brooklyn, N.Y. Awards: RCA Manufacturing Co., Inc., No. 9600 universal A.C. bridge; Bud Radio, Inc., No. 1112 complete kit of insulated-handle socket wrenches.

11th Prize. Wm. Wells, 119 Cambridge Place, Brooklyn, N.Y. Awards: Earl Webber Co. No. 40 all-wave oscillator; Bud Radio, Inc., No. 1112 complete kit of insulated-handle socket wrenches.

12th Prize. Larry L. Johnson, Willcox, Arizona. Awards: Jackson Elec. Instrument Co. No. 435A tube tester; Bud Radio, Inc., No. 1112 complete kit of insulated-handle socket wrenches.

13th Prize. Stephen Chuvala, 143 Triangle St., Danbury, Conn. Awards: Thordarson Elec. Mfg. Co. complete 30-watt super P.A. amplifier kit; Bud Radio, Inc., No. 1112 complete kit of insulated-handle socket wrenches.

14th Prize. J. Price, 1127 Taneo St., Far Rockaway, N.Y. Awards: Jackson Elec. Instrument Co. No. 441A A.C. all-wave oscillator; Bud Radio, Inc., No. 621 deluxe pair test prods.

15th Prize. I. A. Hurwitz, 255 Eastern Parkway, Brooklyn, N.Y. Awards: Earl Webber Co. No. 40A all-wave oscillator; Bud Radio, Inc., No. 621 deluxe pair test prods.

16th Prize. Eugene H. Pulliam, Sheridan, Ind. Awards: Earl Webber Co. No. 40A all-wave oscillator; Bud Radio, Inc., No. 621 deluxe pair test prods.

17th Prize. Robert A. Hornecker, 233 W. Florence St., Oglesby, Ill. Awards: Readrite Meter Works No. 430 direct-reading tube tester; Bud Radio, Inc., No. 621 deluxe pair test prods.

18th Prize. Harold L. Kramer, Box 283, Clyde, Kans. Awards: Triplett Elec. Instrument Co. No. 1125 Universal volt-ohm-milliammeter; Bud Radio, Inc., No. 621 deluxe pair test prods.

19th Prize. Edmund Makel, 3806 Myrtle Ave., Camden, N.J. Awards: Thordarson Elec. Mfg. Co. complete 18-watt hi-gain P.A. amplifier kit; Bud Radio, Inc., No. 621 deluxe pair test prods.

CIVIL SERVICE HANDBOOK

Containing Complete Home Study Courses For Federal, State and City Positions

Shows you how to get a job with the best boss in the world—the American Government. The CIVIL SERVICE HANDBOOK is complete in itself—gives actual previous examinations, 1,000 questions and 100% correct answers for postal clerk, mail carrier, electrician, bookkeeper, etc., etc. Tells exactly the mistakes to avoid in spelling, grammar, geography, civics. Just published! A really practical help to those seeking government jobs! **\$1.00** Postpaid,

A-B-C Shorthand IN TWELVE easy LESSONS

Students, writers, teachers, professional and business men and women now use A B C SHORTHAND for jotting down reports, notes, lectures, briefs, impressions, thoughts, ideas, etc. So simple, so easy to learn that you will find yourself writing shorthand after a few hours of study at home. No tedious practice, no puzzling signs or symbols. A B C SHORTHAND is useful, practical, efficient and economical. **\$1.00** only

BREAKING INTO ADVERTISING

The advertising business is always looking for new people and new ideas. If you want to know how to break into this lucrative field, read this manual. 56 leading advertising executives tell how they got their first job in the advertising business. Gives you a practical understanding of advertising—also **\$1.75** do's and don'ts for beginners. **\$1.75** Inspirational, practical, helpful.



HOW TO MAKE MONEY AT HOME

Be your own boss! Be independent! The 1000 plans described in this book are actually making money for men and women now. Here's your chance to add to the family's income. No canvassing. No selling. Be the first in your neighborhood to use these new spare time money making ideas. A practical guide for everybody who is unemployed. **\$1.00**

HOW TO ORDER THESE SELF HELP BOOKS

Every one of these book bargains can help you. **SOLD ON AN ABSOLUTE SATISFACTION-OR-MONEY-BACK GUARANTEE.** Clip coupon and enclose cash, check or money order. (In Canada add 25%)

GREN PARK COMPANY RC-1236
99 Hudson St., New York, N. Y.

Enclosed please find \$..... for which send me, all postage charges prepaid, the following books:

() Civil Service Handbook \$1.00 per copy
() ABC Shorthand \$1.00 per copy
() Breaking Into Advertising \$1.75 per copy
() 1000 Money Making Ideas \$1.00 per copy

Name

Address

City

State

BUILD IT YOURSELF

You can build this Trailer with ordinary tools easily from our step-by-step constructional sheets and large sized blueprints. Finest designed Trailer in existence, sleeps 4. Toilet. Shower. Electric Light, etc. Save 75% of the cost by building it yourself. Send 25c for plans sheet, illustrations and details.

THE PLAN SHOP, 910 Palmolive Bldg. Chicago, Ill.

ANY CARBON MIKE REPAIRED

Includes replacement of damaged diaphragms and repacking of both buttons with best grade of granular carbon. Both buttons are scientifically matched for like impedance! Genuine gold-leaf gold spot contacts furnished. 24 hour service!

\$2.00 Postpaid In U. S.

MICROPHONE Repair SPECIALISTS
339 6th Ave., New York, N. Y.

Please Say That You Saw It in RADIO-CRAFT

FREE

The World's Finest Catalog of
**AMPLIFIERS and P.A. Sound
Systems**

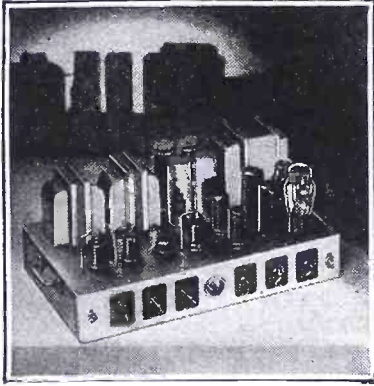

Write for Catalog No. 3709 and complete details of the latest anti-howl, automatic audio volume control, volume expander, and floating audio beam power amplifiers. No P.A. Technician can afford to be without it. Send your P.A. problem to A. C. Shaney, for free consultation. Dealers, Jobbers, and Distributors write for attractive proposition.
Territory still open for active manufacturer's representatives.

Public Address Division
AMPLIFIER CO. of AMERICA
37 West 20th Street New York, N. Y.

BUY YOUR RECEIVER ON TIME PAYMENTS

and

"Get on the Air"

It's easy - all you have to do is
Mail This Coupon Today

HINDS & EDGARTON (W9APY-W9WR)
19 South Wells Street, Chicago, Illinois

Dear OM —
Please send me your latest catalogue showing new short wave receivers with cash and time prices. Hurry —

Name _____ Call _____

Address _____

City and State _____

LOW WHOLESALE PRICES BIG FREE CATALOG



Over 10,000 items in this big catalog including radio receivers, nationally known radio parts and broadcasting equipment at low wholesale prices. A catalog of great value to dealers and servicemen. Write for your FREE copy today.

BURSTEIN-APPLEBEE CO.
1012-14 McGEE ST., KANSAS CITY, MO.

Correspondence Courses in RADIO and ELECTRICAL ENGINEERING

ELECTRICAL ENGINEERING covers complete electrical field. Most modern course. So simplified anyone can grasp it quickly. **LOW COST!** Only \$25. Deferred payment plan. **RADIO ENGINEERING** Ultra-modern course in radio, public address photo-electric work. Trains you to be super-service man, real vacuum tube technician. Diploma given. Tuition only \$25. Deferred payment plan.

FREE Write today for free copies of school catalogs, student magazines, etc. Get started at once. **SEND NOW!**
LINCOLN ENGINEERING SCHOOL, 831-4 So. 37th St., Lincoln, Nebr.

20th Prize. August Laurent, 216 Ray Ave., Freeport, N.Y. Awards: Radio City Products Co. No. 305 special deluxe tube tester; Bud Radio, Inc., No. 621 deluxe pair test prods.

21st Prize. J. Rosenberg, 511 Ave. M, Brooklyn, N.Y. Awards: Solar Mfg. Corp. No. CA1 capacity analyzer; Bud Radio, Inc., No. 621 deluxe pair test prods.

22nd Prize. Joseph Gary, 5533 S. Ashland Ave., Chicago, Ill. Awards: Solar Mfg. Corp. No. CA1 capacity analyzer; Bud Radio, Inc., No. 621 deluxe pair test prods.

23rd Prize. T. E. Harrington, A-1 Radio Shop, 3316 East 7th St., Long Beach, Calif. Awards: Solar Mfg. Corp. No. CA1 capacity analyzer; Bud Radio, Inc., No. 621 deluxe pair test prods.

24th Prize. R. del Valle Sarraga, P.O. Box 935, San Juan, Porto Rico, W.I. Awards: Readrite Meter Works No. 710A set tester; Bud Radio, Inc., No. 621 deluxe pair test prods.

25th Prize. R. H. Jurgens, Wynot, Nebr. Awards: Radio City Products Co. No. 421 power level indicator; Bud Radio, Inc., No. 621 deluxe pair test prods.

26th Prize. J. A. LaDue, 300 West Broadway, Long Beach, N.Y. Awards: Radiart Corp. type P6 portable vibrator analyzer; Bud Radio, Inc., complete neutralizing tool kit.

27th Prize. G. Morley, 9925-101A Avenue, Edmonton, Alberta, Canada. Awards: Readrite Meter Works No. 720A point-to-point tester; Bud Radio, Inc., complete neutralizing tool kit.

28th Prize. Irving Dlugatch, 666 Willoughby Ave., Brooklyn, N.Y. Awards: Thordarson Elec. Mfg. Co. capacity analyzer; Bud Radio, Inc., complete neutralizing tool kit.

29th Prize. Lloyd T. Smith, Box 122, Ely, Nev. Awards: Readrite Meter Works No. 554A all-wave signal generator; Bud Radio, Inc., complete neutralizing tool kit.

30th Prize. Matt R. Weirich, 358 Jefferson Ave., Aurora, Ill. Awards: Cornell-Dubilier Corp. No. KC1 kit of 60 assorted paper tubular condensers; Bud Radio, Inc., No. 1110 complete kit of insulated, screw-holding screwdrivers.

31st Prize. Geo. Adelman, Chesaning, Mich. Awards: Thordarson Elec. Mfg. Co. complete hi-gain 6-watt P.A. amplifier kit; Bud Radio, Inc., No. 1110 complete kit of insulated, screw-holding screwdrivers.

32nd Prize. Edmund McD. Benheim, 19-22-22nd Drive, Astoria, L.I.C., N.Y. Awards: Radio City Products Co. No. 404P portable multitester; Bud Radio, Inc., No. 1110 complete kit of insulated, screw-holding screwdrivers.

33rd Prize. H. H. White, East Corinth, Vt. Awards: Cornell-Dubilier Corp. No. TK kit of 50 assorted paper tubular condensers; Bud Radio, Inc., No. 1110 complete kit of insulated, screw-holding screwdrivers.

34th Prize. Benj. Gorka, 500 Bergen St., Newark, N.J. Awards: International Resistance Co. resisto-kit with assorted resistors; Bud Radio, Inc., No. 1110 complete kit of insulated, screw-holding screwdrivers.

35th Prize. L. J. Schultz, 503 Richland Ave., Wheeling, W. Va. Awards: International Resistance Co. resisto-kit with assorted resistors; Bud Radio, Inc., No. 1110 complete kit of insulated, screw-holding screwdrivers.

36th Prize. Norman W. Smith, Box 273, Jamestown, N.Y. Awards: International Resistance Co. resisto-kit with assorted resistors; Bud Radio, Inc., No. 1110 complete kit of insulated, screw-holding screwdrivers.

37th Prize. Howard J. Surbey, North Canton, R.D. No. 8, Ohio. Awards: International Resistance Co. resisto-kit with assorted resistors; Bud Radio, Inc., No. 1110 complete kit of insulated, screw-holding screwdrivers.

38th Prize. C. G. Greenawalt, 414 Spruce St., Steelton, Penna. Awards: International Resistance Co. resisto-kit with assorted resistors; Bud Radio, Inc., No. 1110 complete kit of insulated, screw-holding screwdrivers.

39th Prize. D. Mezz, 125 Eastern Parkway, Brooklyn, N.Y. Awards: International Resistance Co. resisto-kit with assorted resistors; Bud Radio, Inc., No. 1110 complete kit of insulated, screw-holding screwdrivers.

40th Prize. C. A. Weiss, 964 East Third St., Brooklyn, N.Y. Awards: International Resistance Co. resisto-kit with assorted resistors; Bud Radio, Inc., No. 1110 complete kit of insulated, screw-holding screwdrivers.

41st Prize. Wm. A. J. Frenzel, 34 Wren St., Rochester, N.Y. Awards: Radio City Products Co. kit of multipliers and shunts; Bud Radio, Inc., No. 1110 kit of screw-holding screwdrivers.

Additional data concerning the remaining winners and their awards will be announced in forthcoming issues of *Radio-Craft*.

NOKOIL



Model 582
List price **\$5.82**

Use the word
"NOKOIL"
when ordering
**Permanent
Magnetic
Speakers.**

The **NOKOIL** Reproducers were the first small Permanent Magnet Speakers.

From the smallest speaker for the radio set to the large 12" Public Address Unit.

The **NOKOIL** Reproducers comprise the most complete line of Permanent Magnet Speakers being offered to the trade today.

Protect yourself by insisting that the name **"NOKOIL"** appear on all Permanent Magnet Speakers you purchase.

Write for Circular and prices. Wright-DeCoster distributors are always anxious to cooperate.

WRIGHT-DECOSTER, Inc.
2251 University Ave., St. Paul, Minnesota
Export Dept.—M. Simons & Son Co., New York.
Cable Address: "Simontrice"
Canadian Office, Associated Sales Co., Guelph, Ont.

LOOK FOR THE C-D LABEL!

Whether it be tiny tubular—a dependable electrolytic or a hi-voltage Dykanol filter condenser, C-D can supply every condenser requirement.

Attention to small details has contributed to the excellence of C-D products, and is responsible in a great degree for the acceptance which has made Cornell-Dubilier the standard by which condensers are judged.

Look for the C-D label—it is a Badge of Honor.



The C-D display featuring the entire replacement condenser line on demonstration at your local distributor. Descriptive catalog No. 128 sent on request.

MANUFACTURERS OF QUALITY CONDENSERS FOR MORE THAN A QUARTER OF A CENTURY

MICA · DYKANOL · WET and DRY ELECTROLYTIC · PAPER

CORNELL-DUBILIER CORP.
1014 Hamilton Blvd. So. Plainfield, N.J.



Please Say That You Saw It in RADIO-CRAFT

AMPERITE presents..

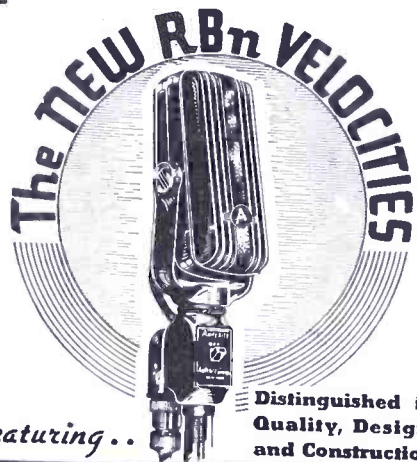

Featuring..

Distinguished in Quality, Design, and Construction

1. Output increased 6 DB.
2. Triple shielded—against all RF or magnetic fields, entirely eliminating hum pickup.
3. Eliminates feedback troubles.
4. Excellent for close talking and distant pick-up.
5. Acoustically designed to eliminate any possibility of cavity resonance.

Models RBHn (High Impedance); RBMn (200 ohms) \$42.00 List

NEW! Models RBSn, RSHn—Excellent All-around Microphones for Speech and Music. Slightly lower output and frequency range than above. Appearance same as above. \$32.00 List

NOW! A specially designed microphone built to Amerpiter standards: can be used for both speech and music. No peaks. Flat response. Triple shielded. Shock absorber. Swivel bracket.

Models RAL (200 ohms); RAH (2000 ohms) \$22.00 List

FREE! TO DEALERS AND SERVICE MEN: A striking window decal, advertising your SOUND SERVICE, and displaying the new Amerpiter Velocity. Write for it now!

AMPERITE Co. 561 BROADWAY, N. Y. Cable Address: Alkem, New York

AMPERITE Velocity MICROPHONE

Build Your Own Shallcross Universal Tester

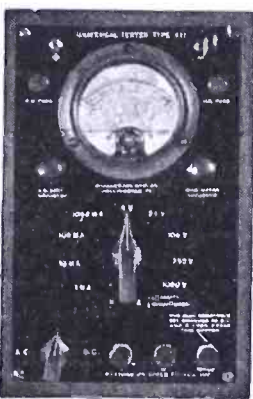

VOLTS
A.C.-D.C.
5-25-100-250-1000 ohms per volt.

MILLIAMPERES
D.C. 1-10-100-1000

CAPACITY
.001-10 Mfd.
Paper or electrolytic condensers.

INDUCTANCE
1-10,000 Henrys

.5-5,000,000 ohms D.C. resistance.

Send 6c in stamps for the new Bulletin No. 611-PK containing the complete wiring diagram and operation instructions for this modern serviceman's instrument.

SHALLCROSS MFG. COMPANY
Electrical Measuring Instruments and Accurate Resistors
700 MAC DADD BOULEVARD
COLLINGDALE, PA.

HOW TO IMPROVE "TALKIES" FIDELITY

(Continued from page 352)

the idea was to have complete dampening of sound similar to broadcast studios. Later developments proved this idea to be in error as a certain amount of liveliness is necessary for natural sound.

The ear does not appreciate flawless acoustics as the sound does not seem natural—"natural" sound therefore is reinforced sound. Too many of the higher frequencies were winding up in deadening acoustic material. Most calculated reverberation times were found to be 15 to 20 per cent too low—particularly Sabine's; later work by Knudsen has shown this, and that any variation of 20 per cent in the derived value is not apt to make any particular difference to the ear.

Tone control, while providing some control of acoustic conditions, has been frowned upon by the exponents of the major sound systems. Tone control is generally disparaged by theoretical engineers but the practical man finds much use for it—providing that it is true tone correction. System A says, "leave the equipment alone, improve the house"; system B says, "I don't recommend tone control, but you can alter it by changing wires ABC"; while, the independent engineer says, "leave the house alone," and adds an easily-varied control with the other controls. There is no question that the latter idea has merit in this application but we do not refer to the type of tone control which shunts all of the higher frequencies off to ground; generally, we want an inductance-capacity-resistance network with provision to attenuate either the lower or the higher frequencies.

Attenuation of the lower frequencies offers an obstacle insofar that, since the lower frequencies supply the carrying power, that is the bulk of the volume, a decided decrease in volume is experienced. Recommended theater reverberation times range from 1.1 sec. to 1.8 sec., depending upon the size of the building.

The writer likes a little higher reverberation time than the calculated values as this not only livens things up a bit but helps a lot when the stage is used for vaudeville purposes. The reverberation times for non-talkie theaters runs about 1.5 seconds to 2.75 seconds since a certain amount of reinforcement is necessary, due to the limited power of the human voice.

In connection with acoustic control, we usually recommend the use of "varitone" units. These units permit full frequency control of any A.F. amplifier or receiver. Using this device, tone correction can be effected for defects in acoustic conditions or over-all A.F. response. It is also possible to produce new tonal effects from phonograph recordings or radio reception, and to bring back notes which would otherwise be completely lost. Due to the high equalization obtainable with the varitone, some loss in gain is noticed. If the amplifier or receiver does not have gain to spare, it may be necessary to add an additional stage of amplification in the voltage amplifier where these units should be connected. It is desirable to connect these units at a low-level stage not in the output. Generally speaking, in an A.F. amplifier, they can be connected in any stage except the output stage (as described in a past issue of *Radio-Craft—Editor*). Special non-variable filters are also available tapped for resonance at either, 25, 50, or 100 cycles. One of these filters will bring up low frequencies to compensate for losses in disc or film recording, and another unit brings up the higher frequencies, tapped for resonance at either 4,000, 6,000, 8,000, or 10,000 cycles.

KENYON ENGINEERING NEWS

"Devoted entirely to the amateur, service engineer, sound technician and experimenter," says Volume 1, issue 1, of this new monthly house organ of a popular manufacturer of transformers and choke coils.

This new publication contains much interesting material in the form of descriptive articles and graphs. The latter, which are devoted in the first issue to decibel conversions to watts, voltage and current ratios, ohms-current-decibels, and ohms-voltage-decibels, are particularly useful to the sound technician and amateur, though the editor, J. B. Carter, promises to run other charts more applicable to the problems of the Service Man, in succeeding issues.

Write for a copy of Vol. 1, issue 1, to *Radio-Craft*—ask for booklet No. 1219.

Please Say That You Saw It in RADIO-CRAFT

TYPEWRITER BARGAIN

FREE HOME TYPING COURSE

10-DAY FREE TRIAL OFFER



ONLY 10¢ A DAY

BRAND NEW MODEL No. 5

REMINGTON PORTABLE

● A brand new Remington for only 10c a day. An easy, practical Home Typing Course FREE. With it anyone quickly becomes expert on this machine . . . the most rugged, dependable portable made. Not used or rebuilt. Standard 4-row keyboard. Standard width carriage. Margin release on keyboard. Back spacer, Automatic ribbon reverse. Every essential feature of big office typewriters. Carrying Case FREE. Try it for 10 days without risking a cent. If you don't agree it is the finest portable at any price, return it at our expense. Don't delay. Without obligation, write now.

REMINGTON RAND INC.,

315 Fourth Ave. Dept. 189-12 New York, N. Y.



American Red Cross

JOBS & CAREERS

THE VOCATIONAL DIGEST

Tells You How to Go About

WHEN YOU ARE TACKLING THE JOB OF FINDING A JOB;
WHEN YOU ARE PLANNING A CAREER;
WHEN YOU WANT TO BETTER YOUR POSITION.

On all newsstands 25c.

If your dealer cannot supply you, send a quarter and we will forward a copy at once

JOBS & CAREERS

520 N. Michigan Ave., RC-1236, Chicago, Illinois

The next issue of RADIO-CRAFT will contain details of the GERNSBACH 1936 OFFICIAL RADIO SERVICE MANUAL.



The old Grigsby-Grunow Company, manufacturers of the original Majestic Radios, is out of business, but their products will live on.

Complete set of these Service Manuals that contain schematic and actual pictorial wiring diagrams, showing each and every individual model, are the most valuable asset that should be in every service man's data library.

The assortment consists of 15 books, which contains complete information for the following models: 80, 103, 90B and 100B Chassis, 130A, 230A, 300, 310A, 310B, 320, 10, 55, 200, 210, 200 Chassis, 460 Chassis, 20 Chassis, 290 Chassis, 60, 160 Chassis, 50, 116, 30, 66.

The above comprises complete Service and Technical Data on over 50 of the Most Popular Majestic Receivers.

YOUR PRICE FOR THE COMPLETE ASSORTMENT AD-1306 1.95

INDIVIDUAL MANUALS EACH25

No order less than \$1.00. All remittances should include a sufficient amount to cover postage and insurance. No orders sent C.O.D. Send for our latest bargain bulletin.

UNITED RADIO COMPANY
58 Market St., Dept.-M, Newark, N. J.

To Readers of RADIOCRAFT

FREE POSTCARDS MAY BE HAD UPON WRITING TO THE PUBLISHERS

These postcards make it easy to answer advertisements which appear in RADIO-CRAFT, without cutting valuable data which you may wish to save.

Many times manufacturers request you to "clip the coupon" when answering their ads. Often this means destroying part of an article on the reverse page you may need later for reference. Save your RADIO-CRAFT issues complete. If you should ever want to sell bound volumes, or certain copies of RADIO-CRAFT, the resale value of uncut issues is very much higher than that of mutilated ones. So send for a supply of these free post cards and use them in answering all RADIO-CRAFT advertisers.

NEW FIELD FOR RADIO MEN

Sell our complete line of 16 MM and 35 MM motion picture equipment for theatres, institutions, clubs and home use. We have everything. Tremendous field; liberal profits. Write TODAY.
S.O.S. CORP. 1600-RA B'DW'Y, N.Y.C.
CABLE—SOSOUND, N.Y.

OXFORD NEW SPEAKERS

... with "Changeable Fields" and Universal Transformer, bring you new convenience, performance and economy in Speaker Replacements. Ask your Jobber or Write today for Bulletin 361C.
OXFORD-TARTAK RADIO CORP.
915 W. VAN BUREN ST. CHICAGO, U.S.A.

RADIO MEN! GRAFOLINE

Insures correct permanent repairs for all air exposed contacts and wherever dust and dirt affect moving parts. Ideal for all-wave switches, wire wound volume controls, etc. Easy to apply, insures longer wear for parts. Lubricates electric motors, vacuum cleaners, etc. Full sized bottle 35c from your Radio Parts Jobber. If he cannot supply—WRITE for free circular complete line.
GENERAL CEMENT MFG. CO., Rockford, Illinois.



RADIO ENGINEERING

RCA Institutes offers an intensive course of high standard embracing all phases of Radio. Practical training with modern equipment at New York and Chicago schools. Also specialized courses and Home Study Courses under "No obligation" plan. Catalog, Dept. RT-36.

RCA INSTITUTES, Inc.
75 Varick St., New York 1154 Merchandise Mart, Chicago
Recognized Standard in Radio Instruction Since 1909

INFORMATION BUREAU

(Continued from page 353)

contraction at the transmitter, and expansion at the receiver, but apparently not much work has been done on this as yet.

DEFINITION OF HARMONIC DISTORTION

(380) Morey Abrams, Trenton, N. J.

(Q.) In the lists of operating characteristics of most output tubes there appears a term of "harmonic distortion." What has this to do with the operation of the tube?

(A.) The term you mention is usually expressed as "per cent harmonic distortion." It refers to the proportion of power output of the tube other than the desired fundamental. All power amplifiers produce, besides the fundamental, a certain amount of harmonics, mainly 2nd, 3rd, 4th, etc. These harmonics are undesirable in audio reproduction, and a tube which has a low percentage of harmonics in the output is much to be desired. As a rule pentodes have a relatively high percentage of harmonic distortion, while triodes have a low percentage.

CARBON VS. WIRE CONTROLS

(381) G. T. Cohess, Goshen, N. Y.

(Q.) Why is it that the carbon type of volume control is so widely used, when the wire-wound type appears to have the advantages of permanence and current-carrying capacity?

(A.) The so-called carbon or composition-element controls are widely used, because of the advantages of greater range and also because of the greater flexibility in producing tapered values. Intricate resistance curves are often required for the complicated circuits in use today, and these are relatively easy to prepare with the composition elements. The wire-wound resistors offer the advantage of much higher current carrying capacity, and are used for this reason, even though they don't have the flexibility or offer the high-resistance range of the composition type.

P.A. QUESTIONS & ANSWERS

(Continued from page 353)

chokes should then be used. A "swinging" choke is essentially one that has high inductance at small values of current, and a small inductance at large current values. Therefore, the drop across the choke will decrease with increasing current thus counteracting the effect of increasing drop with increasing current across the rest of the filter system. A suitable power supply is shown in Fig. Q.44.

2 SPEAKERS ON 3 WIRES

(45) Mr. Thomas Robb, Plandome, Long Island

(Q.) My amplifier delivers 350 V. D.C. Is it possible to hook 2 speakers up to my amplifier with 3-wire cables which I have at hand so that the speaker fields are in series and the voice coils are in parallel?

(A.) If you follow the diagram of Fig. Q. 45, and keep the voice coil connections clear of "B" or Gnd., you will be able to use 3-wire cables for your 2 speakers.

(Continued on page 380)

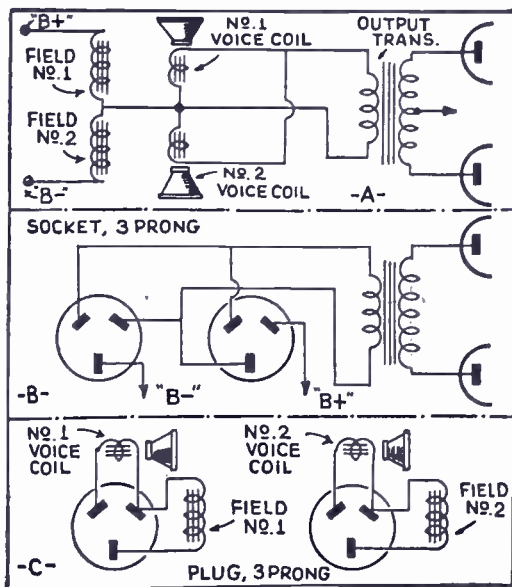
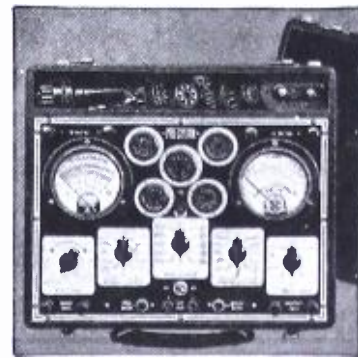

Fig. Q. 45. Three-wire speaker connections.

Give the "Old Reliable"

new **"PEP"**



(Modernized Set Analyzer)

MODERNIZE YOUR OBSOLETE TUBE CHECKER OR SET ANALYZER WITH "PRECISION"

This modernization service is available for most of the popular TUBE CHECKER and SET ANALYZER models. Instruments are brought "up to the minute" with all the advanced and tested engineering refinements that go into the construction of a "new job." "Precision" modernizations incorporate accuracy, flexibility, ease of control, true professional appearance. When writing for details please mention make and model number of your old instrument.

WRITE FOR OUR PLAN Modernization Division Department "C"

PRECISION

APPARATUS CORPORATION

821 East New York Avenue, Brooklyn, N. Y.

Be an INTERFERENCE expert!

Radio interference can be eliminated. It is the most profitable and easy to enter field in the radio industry for full or part time radio servicemen. If you know how, it is easy to locate the source of interference and block it from reaching the radio set.

CONTINENTAL Carbon Filters comprise condensers or coils and condensers which block radio interference. Instructions for the installation and use of Filtercons are contained in Bulletins 103 and 104A.

Be your own boss. You need only a slight knowledge of electricity or radio to enter this profitable business of radio interference elimination. Investigate this easy way of increasing your earnings.

SEND THIS COUPON!

Continental Carbon Inc.

13914 Lorain Avenue Cleveland, Ohio

Send Bulletins 103 and 104A describing how to eliminate interference.

Name

Address

Please Say That You Saw It in RADIO-CRAFT

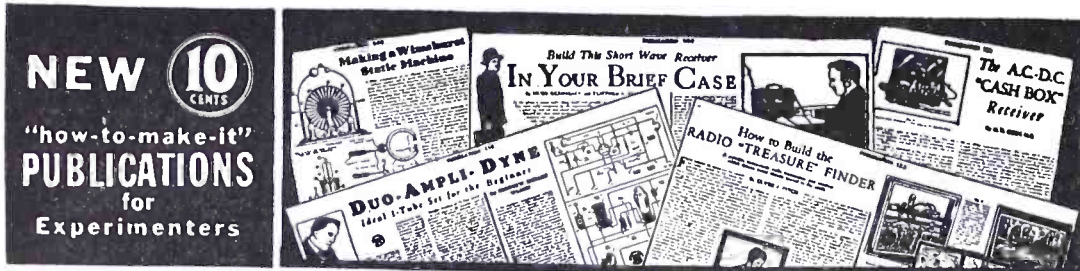

P. A. QUESTIONS & ANSWERS SPEAKER VOLUME CONTROL

(Continued from page 379)

(46) Mr. Charles Kozlowski, New Britain, Conn.

(Q.) I have 4 loudspeakers and I would like to control the volume of one of them. How is this best accomplished? All speakers have 500-ohm input transformers.

(A.) The best solution is the use of a 500-ohm "T" pad, on the speaker, the volume of which you want to control. Next best in quality and results is the 1,000-ohm "L" pad. The cheapest satisfactory method is the use of a 2,000-ohm potentiometer, as shown in Figs. Q. 46A and B.

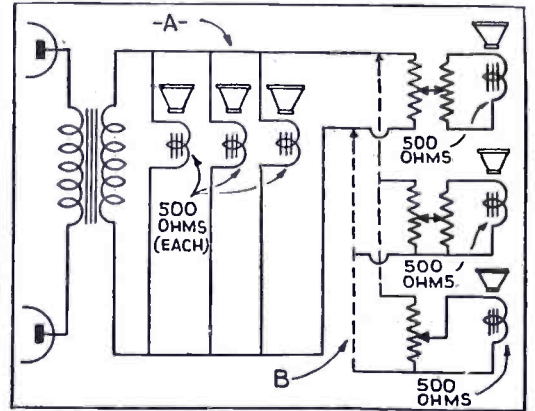

Fig. Q. 46. Speaker volume control.

WE list below a large number of radio, short-wave, and mechanical "how-to-make-it" designs. Each is a special publication originated by masters in their respective fields. For the first time, at the low price of TEN CENTS, you are now enabled to buy a complete design with photographic reproductions, complete mechanical layout, and full description to make it possible for anyone to build the project in question.

The name of "Radio Publications" has become a household word because this company has for many years specialized in radio and other literature of special interest to the experimenter.

PLEASE ORDER EACH PROJECT BY ITS PUBLICATION NUMBER, and use the special coupon below. We accept money-orders, cash, checks or new U. S. stamps. (No foreign stamps or currency can be accepted.) If you send cash or stamps, be sure to register your letter to safeguard against loss. Money refunded if you are not satisfied.

ANY TWELVE PUBLICATIONS FOR ONE DOLLAR

Partial List of New 10 Cent Publications

SHORT-WAVE RECEIVER PUBLICATIONS

- HOW TO MAKE THE 2 TO 5 METER TWO-TUBE LOUD-SPEAKER SET. This receiver may be used with batteries or with an A.C. power pack. Packs a big wallop. . . No. 107
- HOW TO BUILD THE CIGAR-BOX 1-TUBE "CATCH ALL" RECEIVER. An effective short-wave battery set which fits into a small cigar-box, insuring high portability yet great efficiency. . . No. 111
- HOW TO BUILD THE PORTABLE MINIDYNE SHORT-WAVE BATTERY SET. Uses no aerial, no ground. The total weight is 3 1/4 lbs. and measures 5x3x3 inches. Self-contained batteries, tube, condensers, and loop. Highly sensitive circuit. . . No. 114
- HOW TO BUILD THE HAM-BAND "PEE-WEE" 2-TUBER. A handy receiver with high efficiency and bandspread tuning. Works a loudspeaker, yet the entire receiver is no larger than your hand. Works with either batteries or an A.C. power pack. . . No. 115
- HOW TO BUILD THE DUO-AMPLIDYNE. The ideal 1-tube set for the beginner. One of the finest 1-tube sets; it really gives 2-tube performance. Made for battery operation. With only ten-foot antenna brings in the good European stations. . . No. 116

RADIO BROADCAST RECEIVER AND SPECIAL RADIO PUBLICATIONS

- HOW TO BUILD A SUPER-SENSITIVE ALL-WAVE CRYSTAL SET. Just the thing for beginners who wish to have an easy-to-operate crystal set on all-waves and which will separate all the stations. Can be made for less than \$2.00. Uses no tubes or batteries. . . No. 121
- HOW TO BUILD THE 2-TUBE "PENTODE PORTABLE" BROADCAST SET—the lightest, smallest set giving loud-speaker volume on batteries. Weighs less than 12 pounds. Built in a small, portable case. . . No. 122
- HOW TO BUILD THE RADIO "TREASURE" FINDER. This is a really sensitive and practical "Treasure" finder. Simple to build and guaranteed to work. Uses 4 tubes. Can be built for less than \$15.00. . . No. 123
- HOW TO BUILD THE GERNSBACK ONE-TUBE PENTODE LOUDSPEAKER SET. This is the best one-tube loud-speaker set ever constructed. It works on batteries, and is for broadcast reception. Extremely sensitive. . . No. 124
- HOW TO BUILD THE WORLD'S SMALLEST ONE TUBE BATTERY RADIO. So small that it is actually built in a cigarette case. The wonder set of the last New York radio show. . . No. 125
- HOW TO BUILD A 6-TUBE BATTERY ALL-WAVE "FARM PORTABLE" SET, ranging from 12 to 2,100 meters. A real portable that pulls in the stations. . . No. 126
- HOW TO MAKE AN A.C.-D.C. ONE-TUBE "DEAF AID." An excellent aid for the hard-of-hearing and deaf, for theatres, churches, and the home. A godsend for all afflicted persons. Can be built for a few dollars. No. 127
- HOW TO BUILD A PIANOTRON. For less than two dollars, plus a few junk parts which you have, you can now make a beautiful musical instrument. Operated by three radio tubes. It has an actual keyboard, and you can play tunes. Works on "A" and "B" batteries. A great novelty due to the unusual music which issues from the loudspeaker. . . No. 128
- HOW TO BUILD THE ONE-DOLLAR RADIO. Impossible though it sounds, for one dollar you can build a radio set which includes a radio tube and a pair of headphones and batteries. You make everything yourself, outside of the three last mentioned items, from wood and spare metal parts. . . No. 129

MECHANICAL PROJECTS PUBLICATIONS

- HOW TO BUILD A PEE-WEE AUTOMOBILE. An ultra-small automobile that can be built for less than 10 dollars. Will carry two 17-year-old boys. Runs 35 miles per hour and 100 to 125 miles on one gallon of gas. . . No. 132
- HOW TO MAKE A BAND SAW FROM OLD AUTO PARTS. Made from old Ford and Chevrolet parts. Capable of performing delicate and satisfactory work. Uses 25-gauge 10 and 12-inch band saws. Assembly is easy for each part fills its allotted place perfectly. . . No. 135
- HOW TO BUILD A REAL LATHE FOR \$5.00. Requires a few hand tools, about \$5.00 worth of raw material and patience to build. The lathe is capable of drilling, milling, trimming, boring and thread cutting. . . No. 136
- HOW TO BUILD A SIMPLE PORTABLE REFRIGERATOR. A real refrigerator. Does not use ice. The cooling unit operates from an alcohol flame, oil burner or open fire. Easy and inexpensive to build. Excellent for boats, camps, picnics, etc. . . No. 138
- HOW TO BUILD LARGE TESLA AND OUDIN COILS GIVING 18-INCH SPARKS. Interesting high-frequency apparatus with which many high-frequency and x-ray experiments can be performed. Capable of producing 15,000 volts. . . No. 141
- HOW TO MAKE AN ARC WELDER. A real arc welder capable of doing commercial jobs satisfactorily. Uses a heavy duty transformer which operates from the 110-volt A.C. main. The output of the machine ranges from 15 to 100 amperes. . . No. 142
- HOW TO USE AN A.C. ARC WELDER. Companion publication to the one listed directly before. Very informative; especially to the garage man or mechanic who has had little or no experience with an arc welder. Contains many important diagrams and photographs of actual work done with an arc welder. . . No. 143
- HOW TO MAKE YOUR OWN MICROSCOPE. A microscope which the home mechanic can easily build in his shop. The lenses are obtained from the finders of a camera. Although simple and easy to build, it is a thoroughly practical and efficient instrument. . . No. 144
- HOW TO MAKE A WIMSHURST ELECTROSTATIC MACHINE. An easily constructed generator of static electricity capable of discharging a fat three-inch spark. Used in schools where electricity is taught. Can be built for less than \$2.00. . . No. 145
- HOW TO MAKE A POWER DRILL PRESS FROM SCRAP PARTS. An excellent practical drill press that will make work easier for the mechanic. About \$2.00 worth of raw material and scrap iron are the only requirements. . . No. 146
- HOW TO MAKE AND EXPERIMENT WITH AN ELECTROPHORUS. With this device numerous interesting experiments with static electricity can be performed. Many of these experiments are thoroughly explained and illustrated. . . No. 148

RADIO PUBLICATIONS 99A HUDSON STREET NEW YORK, N. Y.

RADIO PUBLICATIONS, 99A Hudson Street, New York, N. Y. RC-1236

I enclose \$..... for the publications listed by number, at right, at 10c a copy (ONE DOLLAR FOR ANY TWELVE PUBLICATIONS.) These publications are to be sent to me postpaid. I have placed a circle around each number which I want.

Send me also your list of 27 other 10c publications.

Name	Address	107	111	114	115	116
City	State	121	122	123	124	125
		126	127	128	129	132
		135	136	138	141	142
		143	144	145	146	148

CLASSIFIED ADVERTISEMENTS

A.C. AUTO GENERATORS

TURN SCRAP INTO MONEY. AUTOPOWER SHOWS you how easily and economically auto generators can be converted into A. C. or D. C. generators and D. C. motors, 2 to 1000 volts; for sound, radio, power, light, or welding. No previous experience necessary—complete information all in new book, with simple instructions and illustrations. Endorsed by thousands. Only \$1.00 postpaid. Autopower, Inc., 408-W, S. Hoyle Ave., Chicago.

INSTRUCTION

GOVERNMENT JOBS. START \$105 TO \$175 MONTH. Rapid increase. Men—women. Prepare now for next announced examinations. Short hours. Influence unnecessary. Common education usually sufficient. Full particulars and list positions free. Write today sure. Hurry. Franklin Institute, Dept. 857, Rochester, N. Y.

RADIO

RADIO ENGINEERING, BROADCASTING, AVIATION and police radio, servicing, Marine and Morse Telegraphy taught thoroughly. All expenses low. Catalog free. Dodge's Institute, Pine Street, Valparaiso, Indiana.

FARM AND CITY RADIOS, \$6.95 UP; SAVE OVER 60 per cent; amazingly new farm radio; operates from free windpower; new farm power or battery. Lowest cost electric lights. Agency-clean up; catalog; free offer. Marco Company, 264 E. 14th, Kansas City, Mo.

WIND ELECTRIC PLANTS

BUILD WIND LIGHT PLANT FROM AUTOMOBILE generator. Dime brings complete plans and catalog. Fan Belt A. C. Generator; 50 o'her changes. LeJay Manufacturing, 1451 Lake, Minneapolis, Minn.

STATEMENT OF THE OWNERSHIP, MANAGEMENT, CIRCULATION, ETC., REQUIRED BY THE ACT OF CONGRESS OF MARCH 3, 1933.

Of RADIO-CRAFT, published monthly at Springfield, Mass., for October 1, 1936. State of New York } ss. County of New York }

Before me, a Notary Public in and for the State and county aforesaid, personally appeared H. Gernsback, who, having been duly sworn according to law, deposes and says that he is the editor of Radio-Craft and that the following is, to the best of his knowledge and belief, a true statement of the ownership, management (and if a daily paper, the circulation), etc., of the aforesaid publication for the date shown in the above caption, required by the Act of March 3, 1933, embodied in section 411, Postal Laws and Regulations, printed on the reverse of this form, to wit:

1. That the names and addresses of the publisher, editor, managing editor, and business managers are: Publisher, Radcraft Publications, Inc., 99 Hudson St., New York; Editor, H. Gernsback, 99 Hudson St., New York; Managing Editor, R. D. Washburne, 99 Hudson St., New York; Business Managers, none.
2. That the owner is: (If owned by a corporation, its name and address must be stated and also immediately thereunder the names and addresses of stockholders owning or holding one per cent or more of total amount of stock. If not owned by a corporation, the names and addresses of the individual owners must be given. If owned by a firm, company, or other unincorporated concern, its name and address, as well as those of each individual member, must be given.) Radcraft Publications, Inc., 99 Hudson St., New York; H. Gernsback, 99 Hudson St., New York.
3. That the known bondholders, mortgagees, and other security holders owning or holding 1 per cent or more of total amount of bonds, mortgages, or other securities are: (If there are none, so state.) None.
4. That the two paragraphs next above, giving the names of the owners, stockholders, and security holders, if any, contain not only the list of stockholders and security holders as they appear upon the books of the company but also, in cases where the stockholder or security holder appears upon the books of the company as trustee or in any other fiduciary relation, the name of the person or corporation for whom such trustee is acting, is given; also that the said two paragraphs contain statements embracing affiant's full knowledge and belief as to the circumstances and conditions under which stockholders and security holders who do not appear upon the books of the company as trustees, hold stock and securities in a capacity other than that of a bona fide owner; and this affiant has no reason to believe that any other person, association, or corporation has any interest direct or indirect in the said stock, bonds, or other securities than as so stated by him.

H. GERNSBACK, Editor.
Sworn to and subscribed before me this 24th day of Sept., 1936.

MAURICE COYNE, Notary Public.
Notary Public, Bronx Co. No. 90, Reg. No. 52-C-36. Cert. filed in N. Y. Co. No. 500, Reg. No. 8-C-265. Cert. filed in Kings Co. No. 144, Reg. No. 8210.

Please Say That You Saw It in RADIO-CRAFT

PHOTOCELL SHOOTING RANGES

(Continued from page 350)

be had on D.C.) The cabinet and shooting stand, connected by cable, may be placed up to 40 ft. apart. The light gun, which is free to move in any direction, and to the end of the control cable that tethers it to the gun cabinet, weighs but 4½ pounds—as much as a 22 rifle—and is easily handled by anyone.

The power chassis at the rear of the main cabinet incorporates 2 power supply units. One utilizes a type 80 rectifier, to supply power to the two type 56 tubes and a type 24A output tube; these 4 tubes constitute the photocell amplifier tube complement. The other rectifier is an 83, and is used to deliver high-voltage D.C. to the trigger unit.

Unlike the general range of photocell amplifiers the one designed for this service was called upon to meet several unusual conditions. First,

there is the problem of making the light-sensitive cell operate every time the gun light strikes this cell. At the same time, the photoelectric cell and its associated controls must remain unaffected by ordinary room lighting conditions. Variable controls in the amplifier permit the amplification to be set to meet these conditions.

There is still room for improvement in devices of this type (according to observations of one of these units at the shop of Blan the Radio Man, by a *Radio-Craft* editor). For instance, the light beam flashes through space at the rate of 186,000 miles per second, as against ½-mile (roughly) per second for a rifle bullet. Thus there is an appreciable time difference in the two types of "gunfire." Also, the electronic gun (as so far developed) lacks the "kick" or kickback that accompanies the use of explosives.

As the manufacturer of this ingenious skill device points out, radio men will find that the following are good prospects for the instrument: military schools and organizations, taverns, boats, fairs, clubs, hotels, amusement parks, small shops, and in fact wherever people have a few minutes to spare for amusement, or perfection of skill. Probably children in homes everywhere will soon have a "junior" model with which to play G-man.

Our information Bureau will gladly supply names and address of any manufacturers whose products are mentioned in *Radio-Craft*. Please enclose stamped return envelope.

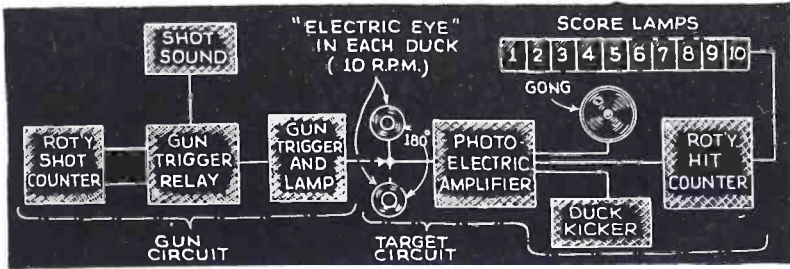

The sequence of operations in the photocell unit.

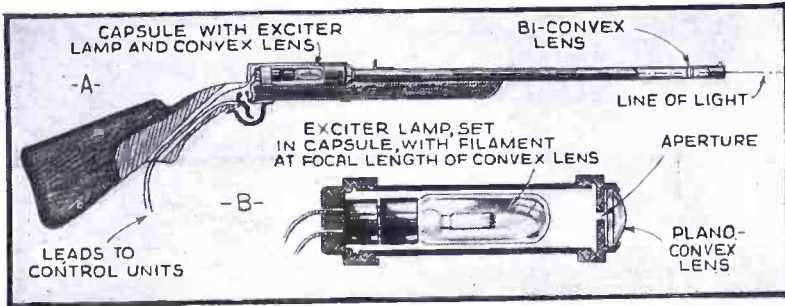

The appearance of the gun with details of the light "capsule."

ADVERTISERS' INDEX

Aerovox Corporation.....	375	National Company.....	357
Allied Radio Corporation.....	361	National Radio Institute.....	323
American Red Cross.....	378	National Schools.....	363
American Television & Radio Co.....	376	National Union Radio Corp.....	371
Amperite Corporation.....	378	Norwest Radio Laboratories.....	364
Amplifier Co. of America.....	377	Clarence A. O'Brien & Hyman Berman.....	370
Amplitone Products Co.....	368	The Oxford-Tartak Radio Co.....	379
Arrow Sales Corporation.....	370	Paramount Trading Company.....	370
Burstain-Applebee Company.....	377	Precision Apparatus Corp.....	379
Central Radio Laboratories.....	372	Radio & Technical Publ. Co.....	364, 365
Classified Section.....	380	Radio & Television Institute.....	370
Clough-Brengle Company.....	364, 373	Radio Circular Company.....	372
Columbia Sound Co., Inc.....	373	Radio City Products Co.....	363
Continental Carbon, Inc.....	379	Radio Publications.....	380
Cornell-Dubilier Corp.....	377	Radio Service Institute.....	362
Coyne Electrical School.....	321	Radio Training Assoc. of America.....	361, 374
Tobe Deutschmann Corp.....	381	Radolek Company.....	381
Dodge's Institute.....	368	Raytheon Production Corp.....	368
Eilen Radio Laboratories.....	367	RCA Institutes, Inc.....	379
Electrad, Inc.....	370	Readrite Meter Works.....	324
Federal Engineering Co.....	376	Remington Rand, Inc.....	378
General Cement Mfg. Co.....	379	S.O.S. Corporation.....	379
General Electric Company.....	Back Cover	Shalleross Mfg. Company.....	378
Goldentone Radio Co.....	371	McMurdo Silver Radio Corp.....	376
Greenspark Company.....	376	Solar Mfg. Company.....	369
Grigsby-Grunow.....	375	South Bend Lathe Works.....	368
Hammarlund Mfg. Company.....	363	Sprayberry Academy of Radio.....	367
Hinds & Edgerton.....	377	Superior Instruments Co.....	370
Hygrade-Sylvania Corp.....	366	Supreme Instruments Corp.....	Inside Front Cover
Industrial Amplifier Systems Co.....	374	Teleplex Company.....	370
Jobs & Careers.....	378	The Plan Shop.....	376
Kay Specialty Mfg. Co.....	371	Triad Mfg. Company.....	365
L & L Electric Company.....	370	Triplett Elec. Instrument Co.....	382
Lincoln Engineering School.....	377	Triumph Mfg. Company.....	369
McGraw-Hill Book Company.....	375	Try-Mo Radio Co., Inc.....	374
Melssner Mfg. Company.....	360	United Radio Co.....	379
Midwest Radio Corporation.....	323B	United Sound Engineering Co.....	375
Million Radio & Television Labs.....	375	The Webster Company.....	358
		Wedge Mfg. Company.....	373
		Wellworth Trading Co.....	374
		Weston Elec. Instrument Co.....	359
		Wholesale Radio Service Co.....	Inside Back Cover
		Williams Philco, Inc.....	368
		Wright-DeCoster, Inc.....	377
		Zephyr Radio Company.....	368

Please Say That You Saw It in RADIO-CRAFT

EVERY RADIO MAN IS TALKING ABOUT THE

BIG CONDENSER FIGHT

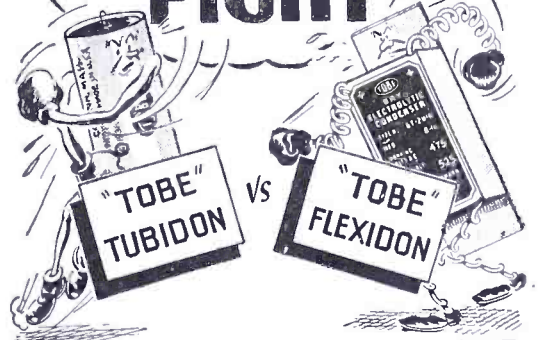

Tubular TOBE TUBIDON is a cinch to win, say some radiomen. It's a self-supporting condenser, easy to install, uses less space, and actually costs less!

But rectangular TOBE FLEXIDON has the one big feature, say others. It's "flexible" . . . if one section breaks down, due to overload, only that one section need be replaced. The units are completely separate. Our opinion is . . . BOTH ARE GREAT CONDENSERS! We leave it to you experimenters, servicemen, dealers, etc. to decide WHICH is best. All good supply houses have them. Do you want a catalog, and full technical description of these double-jacketed condensers? Please write today to TOBE DEUTSCHMANN CORP., Dept. M-16, Canton, Massachusetts.



ELECTROLYTIC CONDENSERS
Skillfully Manufactured at Canton, Mass.

Keep Your Customers Satisfied

USE RADOLEK SERVICE

Plus This Most Complete Radolek Radio Buying Guide

The Radolek New 1937 Radio Profit Guide is the most complete Radio Parts Catalog ever published. Completely revised—right up to the minute, bringing you everything in Radio—and Public Address—at the right prices. Contains over 10,000 individual Radio Repair Parts—hundreds of new items—a complete new selection of Radio Receivers, P. A. Amplifiers, Tools, Tubes, Books and Instruments. Everything you need—always in stock . . . ready for prompt shipment to you. You need this Big Radio Parts Catalog—it's FREE. Send for it! NOW!

RADOLEK

636 W. Randolph-Chicago

Name

Address
Serviceman? Dealer? Experimenter?

A New Volt-Ohm Milliammeter

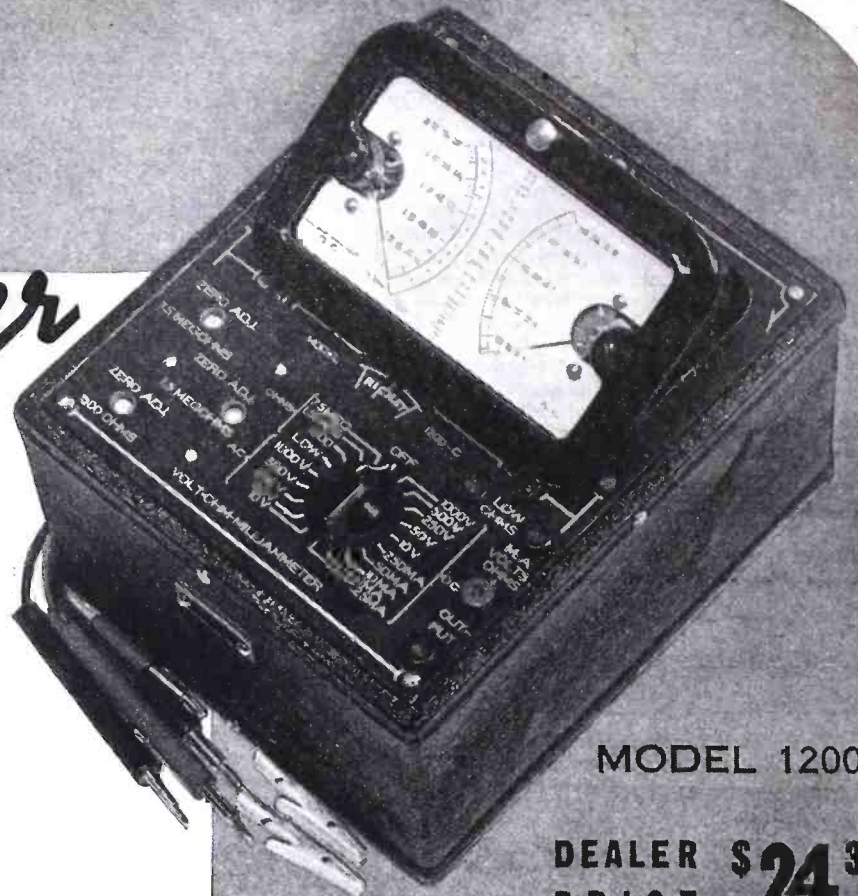

MODEL 1200C

DEALER PRICE \$24³³



D.C. RESISTANCE 5,000 OHMS PER VOLT



RESISTANCE READINGS TO 7.5 MEGOHMS



FOR ALL RADIO MEASUREMENTS NOT REQUIRING A NO CURRENT DRAW VACUUM TUBE VOLTMETER

Model 1200-C has

- Separate A.C. and D.C. instruments.
- Tilting case for accurate reading.
- Ohms scales separately adjusted.
- Low loss switch (contact error less than 1/2%).
- Low ohms scale requires but 6-2/3 milliamperes.
- Accuracy both A.C. and D.C. guaranteed within 2%.
- All Metal case.

Scale reads: D.C. 10-50-250-500-1000 Volts at 5,000 Ohms per volt; 250 microamperes; 1-10-50-250 Milliamperes; 1500 Ohms; 1.5 and 7.5 megohms; A.C. 10-50-250-500-1000 Volts.

Model 1200-A Volt-Ohm-Milliammeter is same as 1200-C except has 2,000 Ohms per volt D.C. and reads resistance values up to 3 megohms. This is a very popular model as it contains a high torque instrument most suited for portable use.

Dealer Price.....\$21.67

Model 1200-B—same as 1200-A but in addition uses copper oxide rectifier: A.C. volt readings 2-10-50-250-500-1000 at 1000 ohms per volt.

Dealer Price.....\$26.67

A TRIPLETT MASTER UNIT

See Your Jobber Write for Catalog



ELECTRICAL INSTRUMENTS

THE TRIPLETT ELECTRICAL INSTRUMENT CO.
1612 Harmon Drive, Bluffton, Ohio

Without obligation please send me.....More information on Model 1200-C.....I am also interested in.....

.....

Name

Address

City State.....

Please Say That You Saw It in RADIO-CRAFT

**SHOP IN YOUR
SLIPPERS**



**PARK YOUR FEET
AFTER 6 P.M. GET THE
BLUE RIBBON
RADIO CATALOG *FREE***

**SWIFT
DELIVERY**



Those valuable daylight hours were intended for work—NOT to be wasted in shopping around for parts, tubes, instruments. Get the WHOLESALE habit—utilize your daylight hours for servicing—a few minutes spent with the Blue Ribbon Radio Catalog in the evening will take care of your purchasing!! And it's CHEAPER, too! It is also easier—for no matter what your requirements, you'll find them in the 1937 BLUE RIBBON RADIO CATALOG. If it's radio—you'll find it here!

Another Wholesale Feature

The most complete research department in the country is maintained by WHOLESALE. Each year we assist THOUSANDS of our Ham and Servicemen friends in the solution of their problems. Are you "stuck" with a tough or unknown circuit??? Let WHOLESALE give you the "low-down." Are you trying to build a new "rig"? Tell your troubles to WHOLESALE—our "Ham" technicians know the answer. No matter what your problem—if it's RADIO—go to WHOLESALE RADIO SERVICE CO., INC.

EVERYTHING YOU NEED IN RADIO

Only "Wholesale Radio Service Co., Inc." can promise TWENTY-FOUR HOUR shipments. This is made possible by the modern Teletype Communication system which connects our completely stocked branch warehouses. No matter where you are located, this modern communication system and our large, efficient staff combine to get your order to you SWIFTLY. Why waste time and transportation expense in "going to town"? Buy your radio requirements the EFFICIENT WAY—The SWIFT way—the WHOLESALE way. *Twenty-four hour shipments are a "Wholesale" rule!*

10 THOUSAND BARGAINS

Within the more than 150 pages of the Blue Ribbon Catalog, you will find more radio bargains than you ever heard of. Bargains in all brands of parts—bargains in every type of test equipment—bargains in P.A. equipment—bargains in tubes—bargains in "Ham" equipment. And REMEMBER—no product is listed in our catalog until it has been subjected to, and PASSED the exacting tests prescribed by our laboratory technicians. THAT is your assurance of QUALITY.

**HOT MON! TIS SMART
TO BE THR-RIFTY! SEND
FOR THIS BRAW-BONNY
BOOK-'T WILL SAVE YE MONEY**



SEND IN THIS COUPON NOW

**WHOLESALE RADIO SERVICE CO., INC.
100 Sixth Avenue, New York, N. Y.**

**RUSH FREE BLUE RIBBON CATALOG
NO. 65-M3.**

Name

Street

City State

WHOLESALE RADIO SERVICE CO., INC.

**CHICAGO, ILL.
901 W. JACKSON BLVD.**

**NEW YORK, N.Y.
100 SIXTH AVENUE**

**ATLANTA, GA.
430 W. PEACHTREE ST., NW.**

**BRONX, N.Y.
542 E. FORDHAM RD.**

**NEWARK, N.J.
219 CENTRAL AVE.**

AT LAST, A RADIO YOU CAN'T TUNE WRONG



*Focused
Tone*

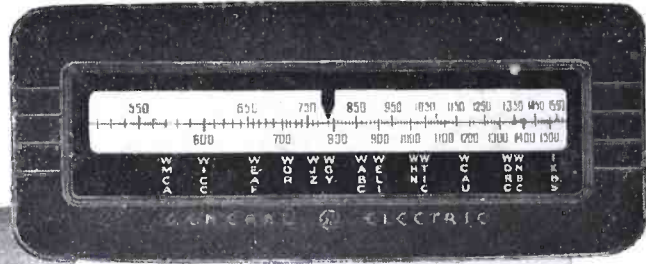

Perfect Tuning . . Perfect Tone . . Automatically!

SET THE dial of the new G-E Radio off-tune — as nine out of ten people do without knowing it — and you'll get the surprise of your life. Instantly, the new G-E automatically shifts itself into hair-line tuning. And, simultaneously the amazing new G-E Colorama Dial changes from red to green to tell you "here's your station perfectly tuned — every note true and clear."

Everything about the new G-E is thrilling and amazing. It's a Personalized Radio — with a Custom-tailored Dial. Your local station letters flash on when you tune in. No more hunting up kilocycle numbers — because stations are marked by letters as well as kilocycles. The new G-E gives you silent tuning, too — you can switch from one program to another without a single *squeal*, *squawk*, or *screech*. But the biggest thrill of all is the life-like, flawless tone of the new G-E.

See and hear — for yourself — radio's newest marvel. Stop in soon at the G-E Radio Dealer's nearest you. Let your ears decide whether any other radio, at any price, can equal the tone and performance of the greatest radio G.E. has ever built.



*Off-Focus
Tone*



*G-E Focused
Tone*



*Off-Focus
Tone*

GLADYS SWARTHOUT — glamorous star of the Metropolitan Opera — Radio — Movies.

— harsh, blurred, discordant tone. Nine out of ten people unknowingly tune in their radios off focus.

The new G-E Radio automatically shifts itself into hair-line tuning every time. And, at the same instant, the Colorama Dial changes from red to green, to tell you your program is in Perfect Focused Tone.

— harsh, blurred, discordant tone. Nine out of ten people unknowingly tune in their radios off focus.

WHAT IS FOCUSED TONE?

Focused Tone combines all the revolutionary new features described above, plus these new G-E Radio inventions and developments — G-E Metal Tubes; G-E Sentry Box; G-E Stabilized Dynamic Speakers; G-E Sliding-rule Tuning Scale; G-E "V-doublet" All-wave Antenna. Focused Tone is G.E.'s greatest radio achievement. Only the new G-E gives it to you — AUTOMATICALLY — VISIBLY — INSTANTLY.

AUTOMATICALLY . . VISIBLY . . INSTANTLY

You'll always be glad you bought a G-E

GENERAL  ELECTRIC
Radio

For Metal Tube Renewals, Specify G-E



The new G-E brings you every radio service on the air - Foreign Broadcasts over ALL short-wave bands; Domestic Short-wave Stations; Domestic Programs — heard with new tone perfection, Police Calls, and Amateur Stations — day and night.

The new General Electric comes in 31 handsome models — priced from \$22.50 to \$750.00 (Eastern list).

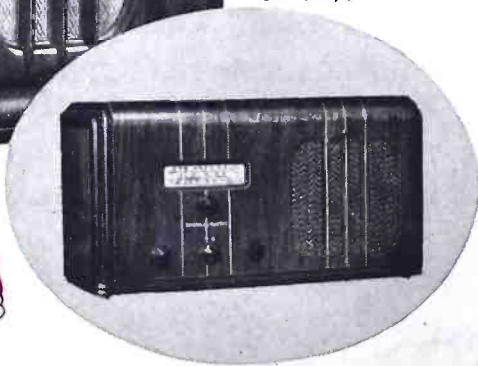

RESEARCH KEEPS GENERAL ELECTRIC YEARS AHEAD