



RADIO'S LIVEST MAGAZINE

Special
Broadcast
Number

Radio-Craft

February
25 Cents

Canada 30c

HUGO GERNSBACK Editor



**THE RADIO SET
OF 1950**
See Page 458



**Novelty Radio Sets – Radio in Model Homes – Versatile Test Unit
How Broadcast Artists Record Their Programs – Contracted Speech**

SERVICE MEN'S ESSENTIALS FOR ALL MEMBERS OF THE

ORSMA

WHAT ARE THE SERVICE MEN'S ESSENTIALS?

THE OFFICIAL RADIO SERVICE MEN'S ASSOCIATION has arranged to supply a number of "Service Men's essentials" for its members and associate members only.

These essentials are priced at cost, plus a small additional fee which is the only source of income that the Association has. No one obtains any profit or benefit, except the Association itself. Whatever profit accrues, is reinvested for the furtherance and enlargement of the Association.

By using the letterheads, billheads, etc., you present the business-like appearance to your customers. In addition, the Association has made arrangements with most of the prominent manufacturers to allow special discounts to members, providing ORSMA letterheads are used when ordering.



No. 14—50c each
(Plus 10c for Postage)



No. 5—50c each

No. 1 ORSMA LETTERHEADS
These letterheads, shown on the right, are furnished with your name, address and telephone number. Printed on excellent paper. They are sold in lots of 100 or multiples thereof, with a distinct saving for single orders of 1,000 or more. Per 100, 60c; per 1000, \$3.00.

No. 2 ORSMA ENVELOPES
These are furnished to match the letterheads, printed with your name and address and seal of the Association. They go hand in hand with the letterheads and are usually ordered in the same quantity. Per 100, 60c; per 1000, \$3.00.

No. 3 ORSMA SERVICE RECORD CARDS
These serve a double purpose; whenever you complete a job you fill out the report-bill and hand it to the customer; this is the "psychological moment" to collect. By the use of carbon paper a permanent record is kept. Furnished with name, address and telephone number. Per pad of 50, 60c; per 10 pads, each of 50, \$3.00.

No. 4 ORSMA INSPECTION LABELS
The label is to be filled in with the proper dates, and pasted inside the set or cabinet where the customer will see it. It is a continuous reminder to him that when service is needed, he can call you again. The advantage is apparent. Per 100, 60c; per 1000, \$3.00.

No. 5 ORSMA LAPEL BUTTON
At the suggestion of many members a handsome lapel button bearing the name and emblem of the Association has been designed. It signifies that you belong to the ORSMA; and in addition it gives your customers a better appreciation of the professional nature of your work. 50c each.

No. 6 ORSMA BUSINESS CARDS
These are furnished on a fine grade of paper in two colors with a blotter back. Thus they present an incentive to customers to keep them in a prominent place. They are printed with your name, address and telephone and bear the official seal of the Association. Per 100, 75c; per 1000, \$4.00.

Nos. 9 & 10 ORSMA EMBLEM CUTS
These cuts for printing, advertising, etc., are furnished in two styles and sizes. They may be used for newspaper or telephone-book advertisements or for printing of any kind. Large size, 1 1/4 x 1 1/4 in., \$1.35 each; small size, 3/4 x 3/4 in., \$1.20 each.

No. 11 ORSMA MEMBERSHIP SIGN
A set of three signs, printed on heavy cards, and having holes punched in order to hang in office or store. These are sold to members and associate members. Large enough to be quite prominent and the two tone effect makes them attractive. Set of three, 50c.

No. 12 ORSMA ADVERTISING DISPLAY SIGN
A two color sign printed in large letters with your name, address and telephone, with the seal of the Association. This sign is sold in quantities of 25 or more and is ideal for hanging in stores, offices, etc., for advertising purposes. Set of 25 cards, \$3.00.

No. 13 RADIO SERVICE MEN'S ASSORTMENT PACKAGE
This includes one gold filled lapel button, 100 letterheads, 100 envelopes, 50 service record cards, and 100 labels printed with your name and address as described above. The whole assortment costs only \$3.00—a worth-while saving. Complete, \$3.00.

No. 14 ORSMA MEMBER CERTIFICATE
A handsome diploma-like certificate engraved on stiff vellum-bond. The certificate is personally signed by the President and Executive Secretary and the corporation stamp of the Association is impressed on a red seal attached to it. Your name, certificate number and date of registration are lettered by hand and the Certificate is mailed in a cardboard tube to insure safe delivery. Each 50c, plus 10c for postage.



No. 1—60c per 100
\$3.00 per 1000

No. 3—60c per pad of 50
\$3.00 per ten pads, each of 50

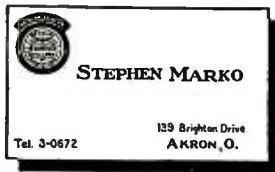

No. 6—75c per 100
\$4.00 per 1000



No. 4—60c per 100
\$3.00 per 1000

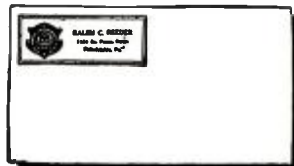

No. 2—60c per 100
\$3.00 per 1000

Application for ORSMA Membership in

Executive Secretary, ORSMA
99 Hudson Street, New York, N. Y.

Kindly send an application blank for

Full Membership
 Associate Membership

Name

Street or Box

City..... State.....

MC-2-35

OFFICIAL RADIO SERVICE MEN'S ASSOCIATION BC-2-85
99 Hudson Street, New York, N. Y.

Please send me the following RADIO SERVICE MEN'S ESSENTIALS which I have selected from this advertisement. My remittance for \$..... is enclosed. Send remittance in form of check or money order. Register letter if it contains cash, currency or unused U. S. Postage Stamps.

.....

.....

.....

Name ORSMA No.

Address City and State.

OPPORTUNITIES *are many* for the Radio Trained Man

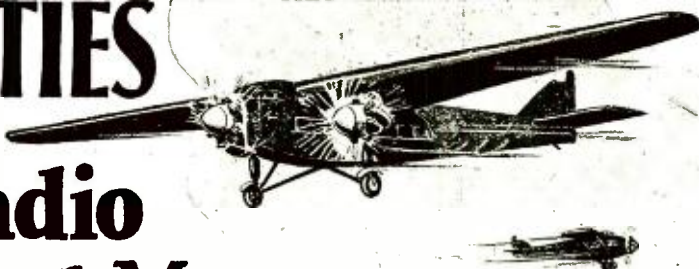

Don't be an untrained man. Let me show you how to get your start in Radio—the fastest growing, livest money-making game on earth.

Jobs Leading to Salaries of \$35 a Week and Up

Prepare for jobs as Designer, Inspector and Tester—as Radio Salesman and in Service and Installation Work—or for work in a Broadcasting Station—as Wireless Operator on a Ship or Airplane, or in Talking Picture or Sound Work—HUNDREDS OF OPPORTUNITIES for a real future in Radio!

Ten Weeks of Shop Training Pay Your Tuition After Graduation

We don't teach by book study. We train you on a great outlay of Radio, Television and Sound equipment—on scores of modern Radio Receivers, huge Broadcasting equipment, Television apparatus, Talking Picture and Sound Reproduction equipment, Code Practice equipment, etc. You don't need advanced education or previous experience. We give you—RIGHT HERE IN THE COYNE SHOPS—the actual practice and experience you'll need for your start in this great field. And because we cut out all useless theory and only give that which is necessary you get a practical training in 10 weeks.

TELEVISION *and* TALKING PICTURES

And Television is already here! Soon there'll be a demand for THOUSANDS of TELEVISION EXPERTS! The man who learns Television now can have a great future in this great new field. Get in on the ground-floor of this amazing new Radio development! Come to COYNE and learn Television as it should be learned on Television equipment. Talking Picture and Public Address Systems offer opportunities to the Trained Radio Man. Here is a great new Radio field just beginning to grow! Prepare NOW for these wonderful opportunities! Learn Radio Sound Work at COYNE on actual Talking Picture and Sound Reproduction equipment.

PAY FOR YOUR TRAINING After You Graduate

I am making an offer that no other school has dared to do. I'll take you here in my shops and give you this training and you pay your tuition after you have graduated. 60 days' after your 12 weeks' training period, start paying me back—then you have over a year to complete your payments. There are no strings to this offer. I know a lot of honest fellows haven't got a lot of money these days, but still want to prepare themselves for a real job so they won't have to worry about hard times or lay offs.

I've got enough confidence in these fellows and in my methods to give them the training they need and let them pay me back after they have completed their training.

ELECTRIC REFRIGERATION AIR CONDITIONING

To assure your thorough preparation for a prosperous future, I include—at no extra cost—a course in Electric Refrigeration and Air Conditioning, taught you by personal instruction and actual work on latest-type equipment.

ALL PRACTICAL WORK At COYNE in Chicago

ALL ACTUAL, PRACTICAL WORK. You build radio sets, install and service them. You actually operate great Broadcasting equipment. You construct Television Receiving Sets and actually transmit your own Television programs over our Television equip-

ment. You work on real Talking Picture machines and Sound equipment. You learn Wireless Operating on Actual Code Practice apparatus. We don't waste time on useless theory. We give you the practical training you'll need—in 10 short, pleasant weeks.

MANY EARN WHILE LEARNING

You get Free Employment Service for Life. And don't let lack of money stop you—my plan makes it possible to get Coyne training with very little money. Many of our students make all or a good part of their living expenses while going to school and if you should need this help just write to me. Coyne is 35 years old. Coyne Training is tested—proved beyond all doubt. You can find out everything absolutely free. Just mail coupon for my big free book!

H. C. Lewis, Pres. RADIO DIVISION Founded 1899

Coyne Electrical School

500 S. Paulina St., Dept. 25-8H, Chicago, Ill.

Mail Coupon Today for All the Facts

H. C. LEWIS, President
Radio Division, Coyne Electrical School
500 S. Paulina St., Dept. 25-8H, Chicago, Ill.

Dear Mr. Lewis:—Send me your Big Free Radio Book, and all details of your Special Offer, including Electric Refrigeration, Air Conditioning courses and your "Pay After Graduation" offer.

Name _____
Address _____
City _____ State _____

Please Say That You Saw It in RADIO-CRAFT



HUGO GERNSBACK, Editor-in-Chief
 C. W. PALMER Associate Editor
 R. D. WASHBURNE Technical Editor



CONTENTS OF THE FEBRUARY, 1935, ISSUE

VOLUME VI Number 8

Editorial: The Broadcast Industry.....Hugo Gernsback	453
The Radio Month in Review.....	454
Radio Broadcast Pictorial.....	456
The Radio Set of 1950.....Hugo Gernsback	458
A Modern Picture of Broadcasting.....Lester F. Miles	459
Radio in the Modern and "Model" Home.....	460
Novel Radio Receivers.....	461
"Contracted Speech" on the New York-London Radiophone.....N. C. Norman	462
Broadcast Artists Record Their Programs.....W. H. Harrison	463
Curiosa in Radio.....	464
What Radio Set Shall I Buy?.....Bertram M. Freed	466
The "Luxembourg Effect" in Radio Reception.....C. W. Palmer	467
International Radio Review.....	468
Short-Cuts in Radio.....	470
WLW's "Electric Eye" Lightning Protector.....	471
WHAM's Programs Light Lamps.....	471
The Latest Radio Equipment.....	472
The Listening Post for All-Wave DX-ers.....C. A. Morrison	474
New Developments in Interference Elimination.....R. L. Haskins and C. W. Metcalf	475
Build This Versatile Test Instrument.....Jesse Tillett	476
A New Portable P.A. Amplifier.....J. P. Relim	477
Helpful Hints about Current Multipliers.....D. L. Van Leuven	477
A Low Cost P.A. Amplifier.....Walter A. Carter	478
A 5-Tube A.C. Short-Wave Band-Spread Kit Set.....	478
Applications of the Generator Type Auto "B" Power Unit.....G. W. Blessing	479
New 16 MM. Sound Camera for Home Movies.....R. D. Washburne	479
ORSMAs Members' Forum.....	480
Elements of 4th Dimension P.A. or Sound Systems (Part 2).....H. S. Manney and C. R. Shaw	481
Operating Notes.....	482
RADIO SERVICE DATA SHEETS:	
No. 131—Stewart-Warner Model R-123 4-Tube Superhet. Chassis; Commonwealth Models 260 and 660 6-Tube Multi-Wave Superhets.....	484
No. 132—General Electric Model M-65 6-Tube "Selective Short-Wave" Super.; Stewart-Warner Models R-113 and R-114 Short-Wave Converters	486
RADIO-CRAFT'S Information Bureau.....	483
Be Satisfied to Be a Service Man.....Charles Golenpaul	485

FEATURING RADIO BEGINNERS IN OUR NEXT ISSUE:

SUPERHETERODYNE receivers have become so universally popular for use on all wave bands that an understanding of the principles of radio reception necessitates, also, a knowledge of the operation of this type of set. Unfortunately, most beginners find difficulty in obtaining this knowledge, and as a means of informing those new to the art of radio set construction and operation, we are printing the description of a 1-tube superhet in the Beginner's issue. This set is constructed on a "bread board" so that the construction and operation will both be as simple as possible.

FACSIMILE transmission has been receiving much publicity in newspapers and magazines lately. Most of the methods used in these devices, though, are too complicated and involved to be of interest to the experimenter or beginner. A new simple system suitable for experimentation will be found in the next issue.

HIGH FIDELITY will also receive its share of attention in the beginner's issue—and it will be written so that the beginner can really understand what it is all about.

RADIO-CRAFT is published monthly, on the fifth of the month preceding that of date; its subscription price is \$2.50 per year. (In Canada and foreign countries, \$3.00 a year to cover additional postage.) Entered at the post office at Mt. Morris, Ill., as second-class matter under the act of March 3, 1879.

Text and illustrations of this magazine are copyright and must not be reproduced without permission of the copyright owners. We are also agents for **WONDER STORIES** and **EVERYDAY SCIENCE AND MECHANICS**. Subscription to these magazines may be taken in combination with RADIO-CRAFT at reduced Club rates. Write for information.

Copyright 1935. Continental Publications, Inc.

HUGO GERNSBACK, President I. S. MANHEIMER, Secretary
 Published by Continental Publications, Inc. Publication office: 404 N. Wesley Ave., Mount Morris, Illinois. Editorial and Advertising Office: 99 Hudson Street, New York City. Chicago Advertising Office: L. F. McClure, 919 North Michigan Avenue, Chicago, Ill. Western Advertising Office: Loyd B. Chappell, 511 So. Alexandria St., Los Angeles, Calif.

London Agent:
 Hachette & Cie., 3 La Belle Sauvage, Ludgate Hill, E.C. 4
 Paris Agent: Hachette & Cie., 111 Rue Reaumur
 Australian Agent: McGills Agency
 179 Elizabeth St., Melbourne

I WILL TRAIN YOU AT HOME IN SPARE TIME FOR A GOOD RADIO JOB!



J. E. SMITH, Pres.
National Radio Institute



**Good Position Station
WSMK**



JOHN HAJDUK, Jr., 21 Gerard Avenue, Southern Hills, Dayton, Ohio.

\$18 a Week in Spare Time

"Although I am doing only spare time Radio work, I have averaged \$18 a week. I recommend N.R.I. training. It is certainly a complete Course. In a short time, it will take a man, give him a sound fundamental training in Radio theory, Practice and design." STEPHEN J. DRAPCHATY, 407 Wunderlich Ave., Harberton, Ohio.

Nets about \$50 a Week besides Sales

"I have been getting along fine. I average ten calls a week, which nets me about \$50, not counting profits on sales. I have serviced almost every make of set and have earned more than I ever expected. I owe my success to the N.R.I. and its wonderful Course." BERNARD COSTA, 150 Franklin St., Brooklyn, New York.

FREE: Radio Servicing Tips

Let me PROVE that my Course is clear, easy to understand and fascinating to study. Send the coupon for a free lesson, "Trouble Shooting in D.C., A.C., and Battery Sets." This interesting lesson gives 132 ways to correct common Radio troubles. I am willing to send this book to prove that you too can master Radio—just as thousands of other fellows have done. Many of them, without even a grammar school education, and no Radio or technical experience, have become Radio experts and now earn two or three times their former pay. Mail the coupon now.



**FREE BOOK TELLS HOW
MAIL COUPON**

Act today for better pay. Act today to break away from a low pay, no-future job. Act to get away from having to skimp, scrape to pay your bills. Mail coupon for my free 64-page book. It tells you how I will train you at home in your spare time to be a Radio Expert; about my training that has doubled and tripled the pay of many.

**Many Radio Experts Make
\$40, \$60, \$75 a Week**

Consider these facts—think of the good jobs they stand for. Over 17,000,000 Radio sets in use, over 600 broadcasting stations, over 40 large manufacturers of Radio sets, over 3,000 manufacturers of parts, over 100 Police Departments Radio equipped, airplanes and airports Radio equipped. Thousands of ships touching every seaport of the world are Radio equipped. Over 35,000 stores selling sets and parts, about 2,000,000 autos Radio equipped and about 20,000,000 unequipped. Loud speaker systems wherever people gather, indoors and outdoors. Commercial Radio stations dotting our coast lines. Radio a big industry—is growing bigger fast. A few hundred \$40, \$60, \$75 a week jobs have grown to thousands.

Get ready now for Jobs like these

A spare time or full time service shop; installing, maintaining, operating—broadcast, aviation, commercial, ship, television and police stations. A Radio retail business of your own. Installing, maintaining, servicing, loud speaker systems. A service or sales job with a store or jobber. I'll train you for good jobs in every branch of Radio.

**Many make \$5, \$10, \$15 a week extra
in Spare Time While Learning**

Every neighborhood can use a good part time service-man. I'll start giving you special instruction material, plans, ideas, the day you enroll, for making money in spare time. Get my book—read how many of my students make \$200 to \$1,000 in their spare time while learning.

Stanley Tulk, 2705 Hector Street, Montreal, Canada, writes—"I have been doing so much service work I haven't had time to study. In two months, I made about \$200 in spare time." Lloyd V. Sternberg, 217 Fourth Avenue, Willmar, Minn., tells me—"I earned enough in spare time to pay for my Course. In one month I earned \$125 in spare time." Yes, my training pays!

Your money back if not satisfied

I'll make this agreement with you. If you are not entirely satisfied with my lesson and instruction service when you finish, I'll refund your tuition.

Find out what Radio Offers

Mail the coupon. My book of information on Radio's spare time and full time opportunities is free to any ambitious fellow over 15. Read what Radio offers you. Read about the training I offer you. Read letters from graduates—what they are doing and making. There's no obligation. Mail coupon in an envelope or paste it on a postal card—NOW.

**J. E. SMITH, President
National Radio Institute, Dept. 5BX
Washington, D. C.**

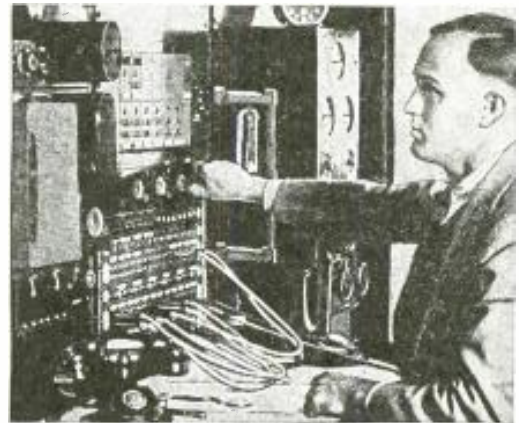

**SAVE MONEY—LEARN AT HOME
Special Equipment Gives You
Practical Experience**

Hold your job. No need to leave home and spend a lot of money to be a Radio Expert. I'll train you quickly and inexpensively right at home in your spare time. You don't need a high school or college education. Many of my successful graduates didn't finish grade school. My practical 50-50 method of training—half with lessons, half with Radio equipment—gives you broad practical experience—makes learning at home easy, fascinating, practical and rapid. There is opportunity for you in Radio. Old jobs are becoming more complicated—many need better trained men. New developments are making new jobs. Short waves, loud speaker systems, police Radio, auto Radio, aviation Radio, television—Radio's newest uses are covered by my training. Here's a field that's growing. It is where you find growth that you find opportunity.

**I have doubled
and tripled
the salaries
of many**



MAIL THIS NOW!

J. E. SMITH, President
National Radio Institute, Department 5BX
Washington, D. C.

Dear Mr. Smith: I want to take advantage of your Special Offer. Send me your two books, "Trouble Shooting in D.C., A.C., and Battery Sets" and "Rich Rewards in Radio." I understand this does not obligate me. (Please print plainly.)

NAMEAGE.....
ADDRESS
CITY
STATE "M"



Please Say That You Saw It in RADIO-CRAFT

Be a RADIO EXPERT

THE ONE MAN IN 1000 WHO CAN SERVICE MODERN RADIO RECEIVERS

RADIO SERVICE WORK NOW OFFERS GREATEST OPPORTUNITIES SINCE RADIO BEGAN.....

Radical changes have taken place in radio receiver design during the past year. Circuits and construction are very different from the receivers with which the radio service industry has had its greatest experience. Even more sensational developments with further complications are coming next season. Who will service these receivers? Certainly not the "old timer" who knows nothing about modern receivers! He can't do it. That is why, right now, there is an urgent demand for reliable service men with up-to-the-minute knowledge of modern radio receivers. Such men can step right out and earn up to \$3 an hour doing nothing but pleasant service work in the better homes around town.



THIS CIRCUIT ANALYZER AND POINT-TO-POINT RESISTANCE TESTER INCLUDED FREE OF EXTRA CHARGE.
Also
FOUR LARGE KITS OF HOME PRACTICE EQUIPMENT.....

No Past Experience Needed

Past experience actually counts for little at this time, because the swift changes in receiver construction have made knowledge of old equipment practically useless. Even though you may not know one tube from another today . . . still, you can take R.T.A. training and make more money servicing modern radios than most of the "old timers" are making. R.T.A. graduates are doing it every day. Many of them are making more money as R.T.A. Certified Radio Technicians than they ever made in their lives before!

Be An R. T. A. Man and You'll Be the One Man in 1000

R.T.A. training will equip you to give fast, complete service to any radio receiver built. The jobs that puzzle and sometimes baffle the usual service man will be simple as "A.B.C." to you . . . when you become an R.T.A. Certified Radio Technician. It is very possible that you will be the only service man in your locality able to quickly diagnose and quickly repair the new types of radio receivers. Be the one man in 1000! You can.



R.T.A. Membership Keeps You Ahead of Competition

With your course of training, and without extra cost, you get a valuable lifetime membership in R.T.A. This gives you a big advantage over ordinary service men . . . because we constantly furnish *advanced* information to our members . . . information that puts money in your pocket while the other fellow is stumbling around in the dark.

To Start You Making Money Right Away

Quickly following your enrollment for training with R.T.A. you get, *without extra cost*, the R.T.A. Set Analyzer and Resistance Tester . . . the handiest piece of portable service equipment ever devised. Instantly helps you locate the trouble in any type of receiver, old or new, and shows you precisely what to do about it.

SEND COUPON

A. G. Mohaupt, Engineer
 Radio Training Ass'n. of America
 Dept. RC-52, 4513 Ravenswood Ave., Chicago, Ill.

Dear Mr. Mohaupt: Please send me your free book of facts about radio opportunities and how I can make big money quickly. Also tell me how I can obtain your Set Analyzer and four big experimental outfits—FREE OF EXTRA CHARGE.

Name.....
 Address.....
 City..... State.....

RADIO TRAINING ASSOCIATION of AMERICA
 4513 Ravenswood Avenue CHICAGO, ILLINOIS

Please Say That You Saw It in RADIO-CRAFT



"Takes the Resistance out of Radio"

Editorial Offices: 99 Hudson St., New York, N.Y.

HUGO GERNSBACK, Editor

Vol. VI., No. 8, February, 1935

THE BROADCAST INDUSTRY

An Editorial by HUGO GERNSBACK

IT IS a mistaken idea of many radio people that radio began about 1920-21 with radio broadcasting. As a matter of fact, the radio industry goes back to 1903, when it was still called wireless. Even before the area of broadcasting, the radio industry had become well established and millions of dollars of radio apparatus were turned out annually in America alone.

But when radio broadcasting came along, the industry took a tremendous upswing, and it is difficult today to give an exact figure of the financial turnover of the entire radio industry per year. One thing is certain and that is that it is well over 500 million dollars a year! Of this amount, the broadcasting industry gets the lion's share. When the term "broadcasting industry" is mentioned, it should be understood that this includes everything that goes with broadcasting, from the broadcast transmitter down to the radio receiving set, and from copyrights to advertising fees. In between, we have many other subdivisions of the industry, each of which forms a distinct unit.

But for the present discussion, we will confine ourselves strictly to the broadcasting industry as such. In the United States today, we have, to begin with, some six hundred broadcast stations which cover the entire country. This figure has not changed materially during the past eight or ten years, since those stations which were discontinued were nearly always replaced by others. The stations themselves are made up into so-called networks, whereby certain key stations are affiliated with a number of broadcast stations throughout the country. There are three major nation-wide networks, the "Red" and "Blue" of the National Broadcasting Company and the one controlled by the Columbia Broadcasting System. In addition to these, we have numerous minor networks, usually linking several stations to cover limited areas.

In this country, the broadcast stations are reimbursed for their financial outlays by advertising or sponsored programs, and the amount thus spent by advertisers has reached truly gigantic figures. As an example, the Columbia Broadcasting System, in a single month, (October, 1934), had billings of over \$1,700,000 for time on the air. Bear in mind that this figure is only what the advertisers paid for station time in a single month.

Why do advertisers spend such gigantic sums for broadcasting purposes in offering their various wares on the air? The answer is found in two words, *radio listeners*. A recent estimate shows that we are approaching the 20 million mark of radio sets in this country alone! Twenty million radio sets, with an average of three listeners each, make an average of 60 million listeners. In other words, approximately one-half the entire population of the country can be reached by a coast-to-coast network, and from past results obtained by advertisers, their investment to the tune of approximately \$14,000 for an hour's program appears to be a good one; so good in fact, that at the present time the three major chains have little evening time to sell, all of them being practically sold out. Of course, these figures, high as they are, do not include talent. For instance, if Ed Wynn goes on the air he is reputed to get \$5,000 for

his services alone. A crack orchestra commands \$1,000 an hour, and famous singers as much. The advertiser, of course, has to foot the bill for the talent in addition to the time consumed on the air.

Considering that a page advertisement in the country's largest weekly magazine, which distributes less than three million copies per issue, costs \$8,000 for one time, the broadcast time of \$14,000 for one hour does not seem unreasonable, and indeed, probably is not for most advertisers, many of whom have continued their advertising on the air for years.

What are the broadcasters doing to help the radio-set industry put over their wares and to make it possible for the listeners to get sets? Strange to say, actually they do very little, with the exception of a half-dozen radio manufacturers who are also broadcasters. Over 95% of the broadcast stations do nothing but broadcast. They take it for granted that somebody will supply the sets, and in this they are correct, since the market is supplied, independent of the broadcast stations themselves.

One would think that the great majority of the broadcasters would be selfishly interested in seeing to it that there are more listeners to their stations, since their rates are based upon numbers of listeners, but strangely enough, this assumption is erroneous and the broadcasters, at least the overwhelming majority, trust to luck that someone will provide the sets to the public.

The feeling is very general that there are too many broadcast stations in this country. Take a city the size of Chicago, for instance. In that city, we have alone 16 broadcast stations. Several of these, not more than four, are used by the various networks and give excellent programs—the best that may be had. What about the rest of the local stations? With few exceptions, they have little reason for existing! As a rule, they supply mediocre programs, and if the program is good, it is usually of the phonograph variety. Unknown singers, amateur speakers, poor bands and poorer orchestras fill-in the commercial gaps that these stations have. As for the time sold on the air by these stations, such commercial programs are usually the world's worst. Patent medicines of doubtful value, and many other ventures equally doubtful are broadcast day in and day out. Some of the stations blanket a certain neighborhood and are, therefore, heard better in that neighborhood than other stations. A number of legitimate stores and merchants broadcast their products over these local stations, but few advertisers have made a profit by doing so. And—because the results to the advertiser are usually mediocre or nil, the little station must perforce get new advertisers all the time, and the rates which the merchants pay are *whatever they can pay*.

This is a deplorable state of affairs from the standpoint of the neighborhood station, but it has to keep up the racket or go out of business, because it has no other income—unless the station is sponsored by a rich concern using it for its own propaganda; or by newspapers; or by churches, or other institutions (when it is not necessary to take on questionable advertising on the air).

THE RADIO MONTH



The dear public should carry 200 lb. portable sets so that they can wear out their shoes—and thus bring back "goodtimes."

RADIO PREVENTS SHOE WEAR

BELIEVE it or not, the wonders of radio never cease. The greatest surprises are still in store for us.

Last month Irving Caesar, New York song writer, bobbed up in the Washington offices of the Federal Communications Commission, with the amazing statement that daily radio retards not only recovery, but prevents wearing out shoes and cars. The song man has it all doped out in this fashion: You see, the power of the radio is so great that all America is hypnotized every night and sits in front of their radio sets instead of walking the streets or running their cars, and in this fashion, sings Mr. Caesar, people don't wear out shoes, don't wear out cars, and thus recovery is retarded!! He further states that for two and a half hours each day 40,000,000 people are busy at their dials, and while thus engaged they cannot walk down the shop-lined streets, wear out their shoes or their wearing apparel, nor can they ride the highways in their automobiles, with the attendant consumption of gasoline, tires and wear on engine. He also recommended than an occasional 24-hour shutdown on all radio stations would help a great deal.

Well, we have a remedy for Mr. Caesar, and that is—manufacturers will now get busy immediately and make up portable sets to be worn by the dear public. For best results these portable sets should weigh not less than about 100 to 200 lbs., because this

would help people to wear out their shoe leather much faster. As for the automobiles, it might not be a bad idea for Mr. Caesar to look in some cars and discover that a very large percentage already have radio sets.

Also, the good song writer overlooks one very important point in our estimation and that is that the folks who stay home certainly must be wearing out the seats of their pants here and there, which they couldn't do if they were walking in the streets, so that should be credited to the recovery item. and how about the folks who insist on sending for all the things that are advertised on the radio and subsequently buying them? Has he forgotten that? But perhaps we are asking Mr. Caesar to work his mentality at too high a rate.

AMPLIFIERS ON STREETS ARE CURBED

TOWARDS the middle of last month, New York's fiery little mayor, F. H. LaGuardia, sent a message to the police commissioner recommending the strict regulation, particularly at night, of amplifiers in the streets of that city.

A short time before, Philadelphia banned the use of amplifiers in stores or on streets altogether. These P.A. units had been causing much rumpus in the business sections, as numerous portable units had been sold to stores, where music and advertising were broadcast to all who passed.



This action on the part of some of the largest cities in the country will, without doubt, have a marked effect on the sales of P.A. equipment, especially the portable types used in stores and the mobile types used during elections and other public affairs; (the loud-speaker above door, lower-center view, is taboo).

AIRCRAFT RADIO SAVES VETERAN FLYER

ONCE again, last month, radio played the rôle of hero. This time, it was through the medium of the Department of Commerce station WWO at Cleveland, Ohio.

A few minutes after pilot Ray W. Brown had taken off from the Akron airport, he tuned his "ship's" radio receiver to station WWO to obtain the regular 1 o'clock weather broadcast.

Instead of the weather report, he was startled to hear the radio warning: "Calling Ray Brown in Lockheed NC 539M. Your landing gear is gone! Calling Ray Brown in Lockheed NC 539M. You have lost your right wheel!"

Leaning out of his compartment, he glanced down at his landing gear to discover that one of the shock struts and the right wheel were dangling in the air. In a flash, he knew that meant landing on one wheel—and his fast plane had to be landed at a high rate of speed. The condition of his landing gear meant an almost certain crashup.

At this time, he was above the Portage Lakes and his first thought was to head for one of the lakes and land in the water although without pontoons.

"Then I decided that the boys would be standing by at Akron and would have the fire extinguishers and emergency equipment ready if I cracked

Amplifiers such as the one shown at the left are strictly prohibited in Philly. They were so numerous that drastic steps had to be taken. (Photo by L. Sklar.)

Radio was the "good Samaritan" which permitted Fay Brown to land his Lockheed (below) minus one wheel.



IN REVIEW

Radio is now such a vast and diversified art it becomes necessary to make a general survey of important monthly developments. RADIO-CRAFT analyzes these developments and presents a review of those items which interest all.

up," Brown said afterward. So he headed back for the home airport.

As coolly as though he were landing a perfect plane, Brown first set down his tail-wheel. An instant later the good wheel was on the ground and almost miraculously as he eased down the crippled side, the damaged strut settled into place—the plane was successfully landed.

MODERN GATE CRASHERS

THE custom of sending passes to the studios of NBC and CBS networks has developed a new type of studio nuisance—the gate crasher, who operates much on the same style as the "one-eyed Connollys" of sports events.

Last month, one of these crashers was discovered; causing quite a stir at CBS headquarters. For weeks, a young man was noticed at Lud Luskin's "Big Show"—each week he was present, dressed in the customary broadcast musician's regalia of dark suit, white shirt and bow tie. He always carried a violin case and Luskin was under the impression that he was a "stand-by" musician or possibly from some other program. A check-up one evening, however, revealed that the "musician" was simply a radio listener who was using his violin to crash the studio gates.

Another "gag" was tried with Donald Novis—an indignant fan wrote that "Each Monday night the announcer says 'Welcome to the House Party.' I have been at the studio five Mondays and been refused admittance. Why do you say 'welcome' if you don't mean it." Novis sent two passes and later discovered that the fan was a prolific indignant letter writer who used this way to obtain passes.

At CBS headquarters, the staff is crossing its fingers hoping to avoid such a condition as the one at the right.

Is the strength of the B.B.C. broken by this new system of radio distribution (below) which avoids the radio set tax?

Globe Photo.



ENGLISH TOWN STARTS PROGRAM DISTRIBUTION

WITHIN the past month RADIO-CRAFT received news of a relay system which has sprung up at Westwood, England. The idea is to receive programs on special receivers and send these over land lines to subscribers in the locality at a nominal sum per week.

This idea in itself is not startling, but when one considers the hold that the B.B.C. has held over broadcasting in that country, until now, some of the inside facts become apparent. For example, programs can be picked up from anywhere, not only from the regular B.B.C. outlets, and if desired, local phonograph programs can be distributed over these lines. Thus in this locality, at least, the strong hold of the British Post Office and the British Broadcasting Corporation is broken. It is expected that the government will intervene.

HOT WORK IN THE STUDIOS

THE Columbia Broadcasting System has long prided itself on the air conditioning system used in its studios, so there was some hullabaloo last month when a program director insisted on having a stove. Queries and protests were shoved aside—"gotta have a stove."

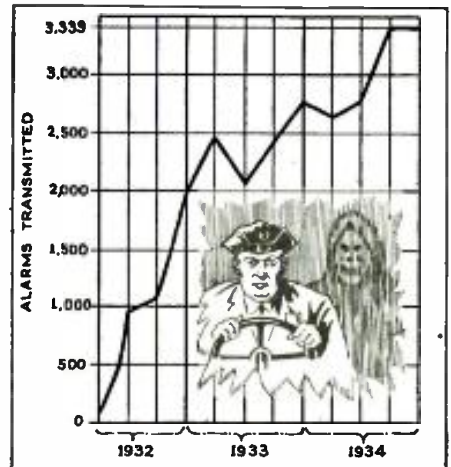

The ever increasing number of calls for New York's radio cars is adequately shown in this chart from police records.

Nobody could make out what he was going to do with it, so they finally gave him one and awaited results.

The astonishing part of the incident was that he really needed it! A new orchestra was scheduled to broadcast, in which a Cuban drum-like instrument was to be used. And the darned thing won't play in ordinary room temperatures, but has to be heated before using.

The "props" gang are hoping that they will go through the winter without some fool introducing an Eskimo banjo or some such nonentity which needs sub-zero temperatures before it will produce a note.

POLICE RADIO CARS IN FATAL ACCIDENTS

POLICE cars in large cities have been successful in allaying the fears of numerous citizens and saving many thousands of dollars, during the two or three years they have been operating.

But along with this good work, is an ever growing list of casualties caused by the speeding radio cars, themselves. Within the past month another pedestrian was killed and within a short few months, three victims have been tallied up, in New York City alone.

A little investigation and inquiry conducted by RADIO-CRAFT during the past month shows a very good reason for these increasing accidents. Between the time when the first cars were put into service, in February 1932 (in

(Continued on page 508)

RADIO BROADCAST PICTORIAL



↑ After listening to the pontifical masses at the Eucharistic Congress in Buenos Aires, South America, the Pope broadcast his message of welcome and good will to the congress from his library in the Vatican. The value of radio communication in such instances cannot be overlooked. Until Vatican City adapted radio broadcasting seriously, several years ago, it took weeks for such a message to be transmitted to the people of the world. Now it takes only a split second, and the voice itself is transmitted, instead of simply the message.



↑ This young lady is holding a new device—a stop-go signal for public speakers. The light turns yellow, then red at the end of the allotted broadcasting time.

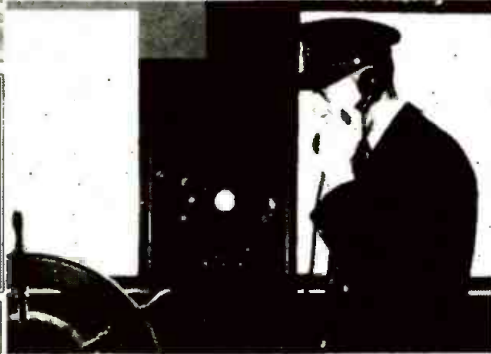

→ A new type of radio telephone which enables captains of fishing boats, harbor craft and yachts to have telephone service at sea is shown above and at the right. A 50-watt transmitter and super-het receiver are used. It is only necessary to pick up the telephone, press a button on the instrument and say "Marine Operator." Promptly a voice replies "number please" and the call goes through just as any telephone call.

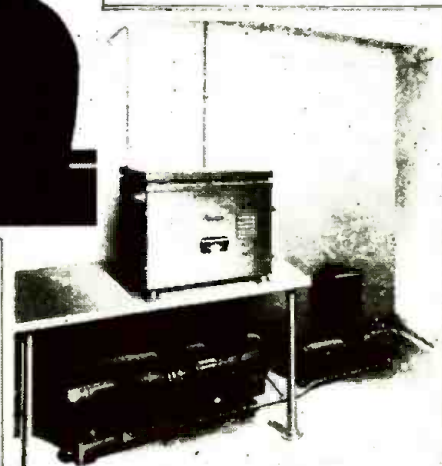

← To facilitate the control of signal strength from a broadcasting station in any given direction, the "graphic meter panel" shown at the left was recently developed. It is in use at KYW which opened early last month in Philadelphia with a directional radiating system to keep down possible interference with other stations. A cathode-ray tube is mounted behind the center of the panel and the signals from each of the four antenna towers form wave patterns on the fluorescent screen of this tube. These patterns can be interpreted to indicate the percentage of output in any direction. This is the first device of this type ever to be installed in a broadcasting station.
Westinghouse photo.

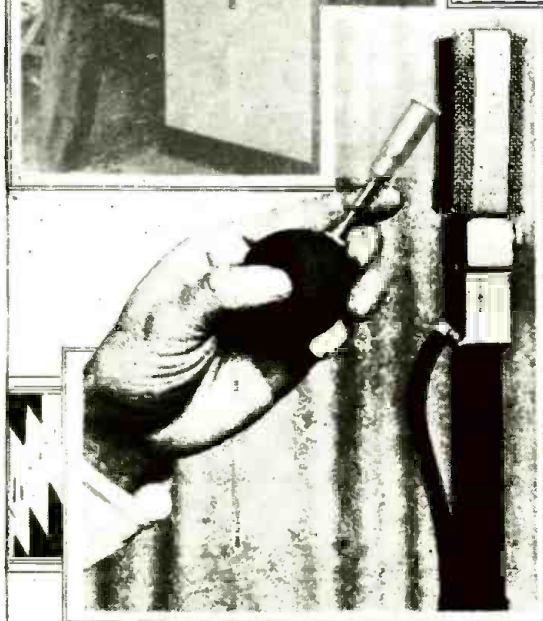

→ Another transmitter development appears at the right. It is a portable transmission measuring set, containing an oscillator with an equalized output which is flat from 50 to 9,500 cycles. Measurements can be made between losses of 80 db. and gains of 75 db. to an accuracy of 0.1 db.
Western Electric photo.

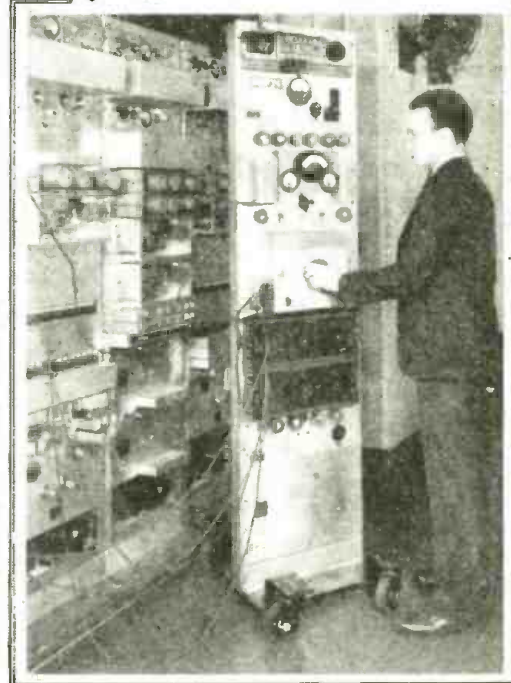

← The odd device at the left, called a Galton whistle is used to test the high frequencies transmitted by radio station W2XR in New York City. This high fidelity station has an absolutely flat characteristic from 25 to over 15,000 cycles, according to claims of the design engineers. The Galton whistle is an extremely high pitched whistle which extends well above the upper limit of audibility.
Halbram photos.

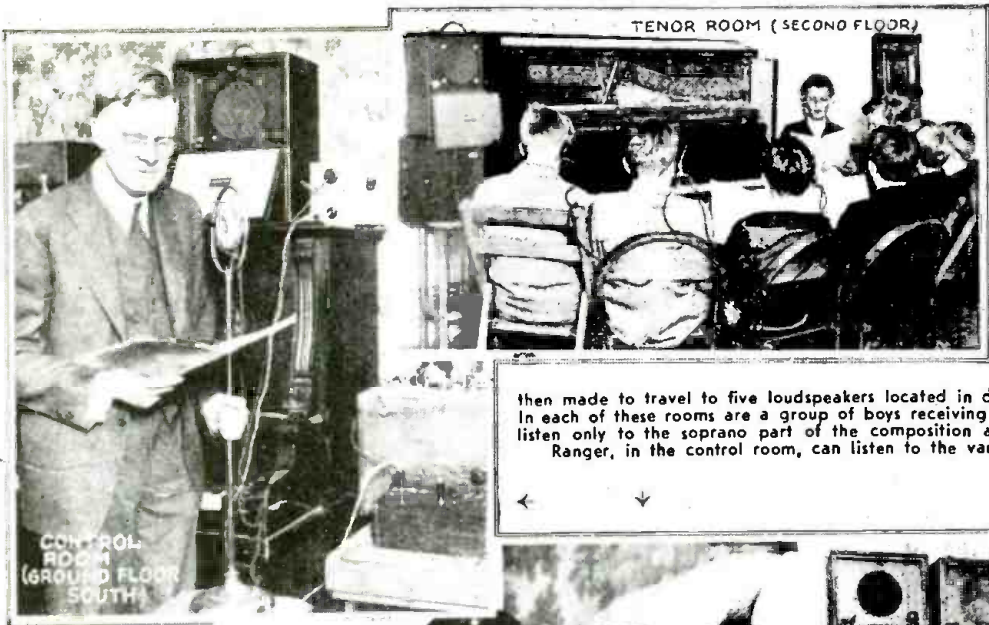

An amazing new device, invented by Capt. R. H. Ranger, noted for his numerous inventions in television and radio communication, bids fair to open up an entirely new field to composers and singers, and for educational purposes. By means of his new invention, Capt. Ranger is able to separate the soprano, alto, tenor and bass parts of a song and transmit each part individually to different loudspeakers and thus train choral singers more scientifically. The basis of the new invention is a small film on which have been recorded five different sound tracks, side by side—one sound track for the soprano, another for alto, tenor, bass and the fifth one for the complete harmony. This film is made to pass around a drum before five different photoelectric cells. In front of each cell is an automobile headlight bulb and a small lens for bringing the rays of light into focus. Each photo-cell light and lens handles one of the five sound tracks on the film and the sound is then made to travel to five loudspeakers located in different rooms—the alto to the alto room, etc. In each of these rooms are a group of boys receiving instruction. Thus the boys with soprano voices listen only to the soprano part of the composition and are able to follow it with ease. Captain Ranger, in the control room, can listen to the various groups and instruct them accordingly.

Halbran photo.

then made to travel to five loudspeakers located in different rooms—the alto to the alto room, etc. In each of these rooms are a group of boys receiving instruction. Thus the boys with soprano voices listen only to the soprano part of the composition and are able to follow it with ease. Captain Ranger, in the control room, can listen to the various groups and instruct them accordingly.

CONTROL ROOM (GROUND FLOOR SOUTH)

TENOR ROOM (SECOND FLOOR)

SOPRANO ROOM (GROUND FLOOR NORTH)

The photo above shows Capt. Ranger in the control room following the score and giving instruction to one of the groups of boys he is training with his new system. The photo at the right shows the five-film projector which separates the four parts of the harmony or combines them on the fifth sound track. Two of the rooms in which the boys sing are also shown.



5 SOUND TRACKS

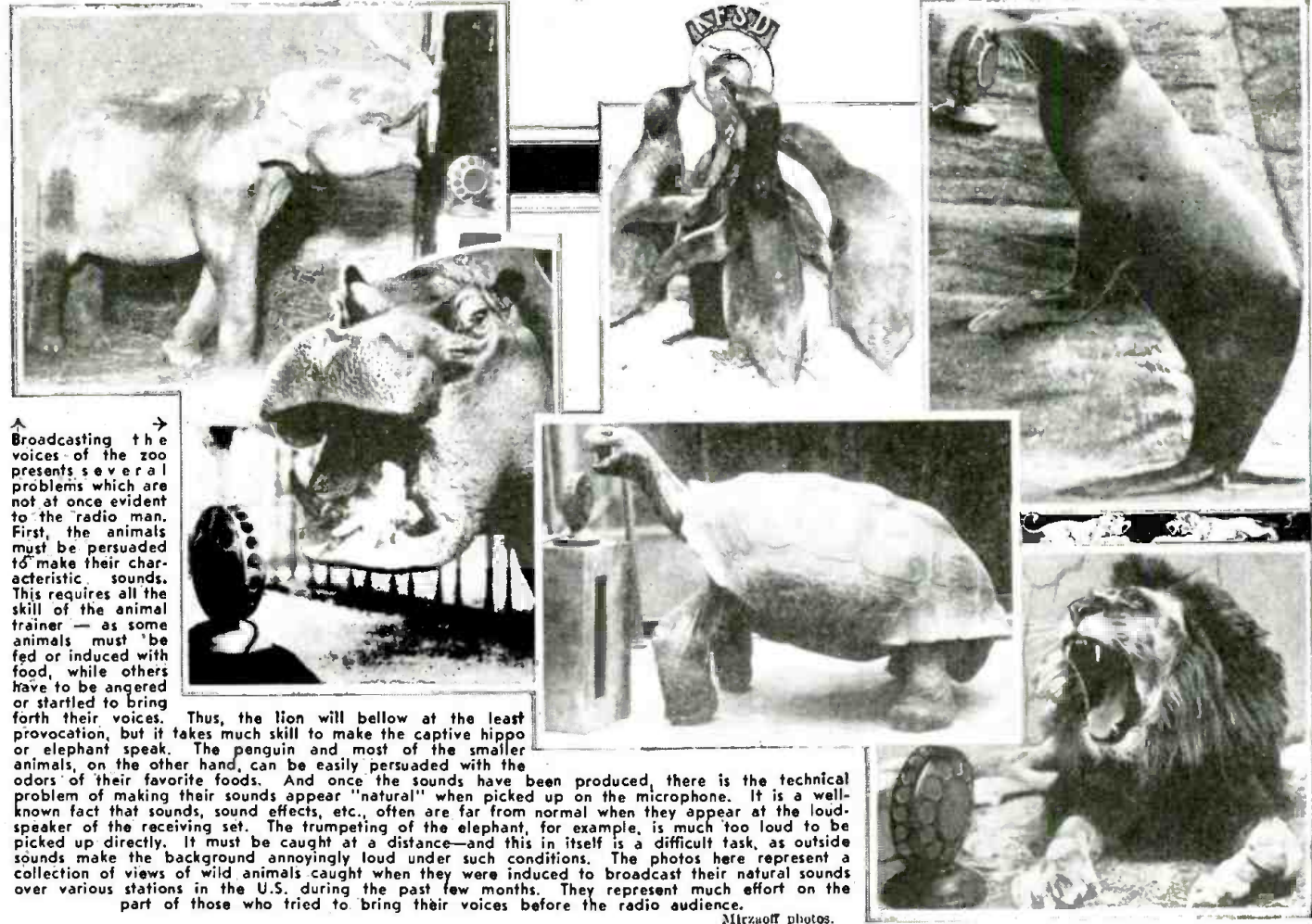

Broadcasting the voices of the zoo presents several problems which are not at once evident to the radio man. First, the animals must be persuaded to make their characteristic sounds. This requires all the skill of the animal trainer—as some animals must be fed or induced with food, while others have to be angered or startled to bring forth their voices. Thus, the lion will bellow at the least provocation, but it takes much skill to make the captive hippo or elephant speak. The penguin and most of the smaller animals, on the other hand, can be easily persuaded with the odors of their favorite foods. And once the sounds have been produced, there is the technical problem of making their sounds appear "natural" when picked up on the microphone. It is a well-known fact that sounds, sound effects, etc., often are far from normal when they appear at the loudspeaker of the receiving set. The trumpeting of the elephant, for example, is much too loud to be picked up directly. It must be caught at a distance—and this in itself is a difficult task, as outside sounds make the background annoyingly loud under such conditions. The photos here represent a collection of views of wild animals caught when they were induced to broadcast their natural sounds over various stations in the U.S. during the past few months. They represent much effort on the part of those who tried to bring their voices before the radio audience.

Mitzaoff photos.

THE RADIO SET OF 1950

Within the next fifteen years, great changes are in store for the radio receiver. Just what these changes will be is predicted here by one who has been successful in foreseeing many outstanding inventions.

HUGO GERNSBACK

Have you ever wondered how the radio receiver would change in the next few years? Is television just around the corner—or will it be some time before we shall see as well as hear over the air waves? Hugo Gernsback, for the past twenty-five years, has made a hobby of predicting developments in the radio and scientific fields and he has attained a reputation from the numerous times in which he was able to see a little further and a little clearer than other people.

Once again, he has turned his hand to making a prediction—the radio set of 1950. In this article, he points out some startling possibilities for this radio set—and even more startling is the fact that these predictions are all based on scientific facts. Scientifically, the radio set of 1950 is possible today, with a few exceptions. It is, however, not as yet economically practical.

I HAVE in the past twenty-five years predicted a great many radio improvements, many of which have come true and which had been adopted universally. Thus, for instance, in the December 1921 issue of my former publication RADIO NEWS, long before we had any complete radio sets, and when radio apparatus still was screwed to an open breadboard, I predicted the radio console—I called it "Radiotrola"—which is now in constant use. It is interesting to note that the radio console was not produced commercially till about 1926. I do not take any special pride in these predictions because, after all, technical developments can be prophesied with certainty. It is usually only a matter of time before the predicted development catches up with the prophecy.

In predicting coming developments, I always had in mind certain evolutionary features which seemed most reasonable to me; and, if they have as yet not been adopted, it is simply because the art has not developed sufficiently.

Therefore, if I make some predictions as to the radio set of 1950, I believe I do not have to exaggerate much; and, as a matter of fact, the developments which I describe here will, probably, come about much earlier than 1950.

It may seem like a platitude to reiterate that the radio set of 1950 will be equipped with television. I, in common with many radio engineers, have predicted television for so many years that it has almost become a hackneyed idea. As I have also pointed out before in my various articles, there is still a "missing link" in connection with television; because so far the real solution of the television problem (that is, an unmechanical scanner) is still to be invented. While the cathode ray tube today presents the best possibility, I still believe that it is not the final word, and that some other means of *instantaneous, non-scanning* method is in the offing. What we require is something that works like the animal eye, which is still the best television instrument ever devised; and which does not scan but transmits the image *instantaneously AS A WHOLE*, rather than by fragmentary impulses which afterwards have to be all assembled.

Anyway, I am pretty certain that a satisfactory solution of television will have come about by 1950. Let us start then, from these premises, with our radio set of 1950. One of the elements that most designers have disregarded, when it comes to television in the home, is that they insist on fixing the television screen rigidly into the set, which is plain foolishness. When you sit in a room and listen to a radio program, every one in the room can hear it, because the waves travel in all directions. With the radio set in which television is incorporated, we have an entirely different technical problem, which is as follows:

(Continued on page 493)

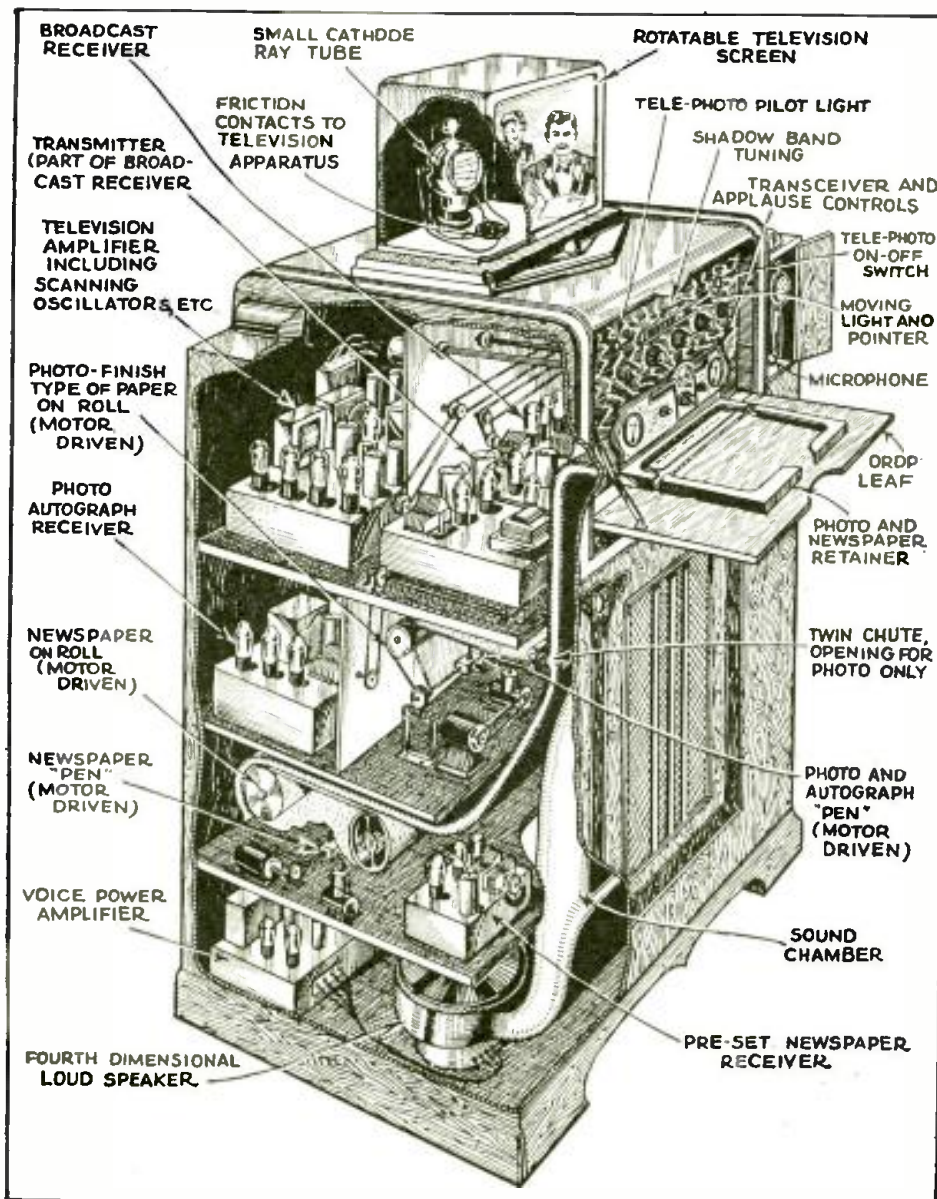

A MODERN PICTURE OF BROADCASTING

Here is the "low-down" on just how the business of sending programs to the eighteen million radio listening families is progressing in the U.S. today. Read these interesting and little known facts and figures.

LESTER F. MILES

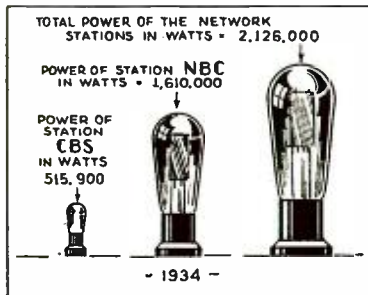

The total power of radio stations in 1934.

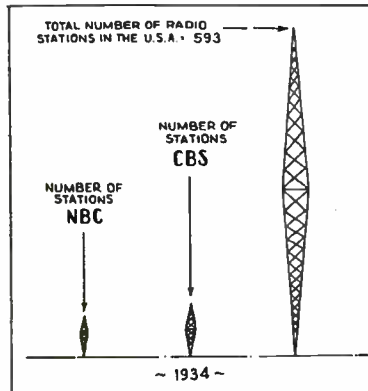

The number of broadcasters in the U.S.—1934.

Two typical views of network equipment in a national chain; the studio monitoring and output control boards.

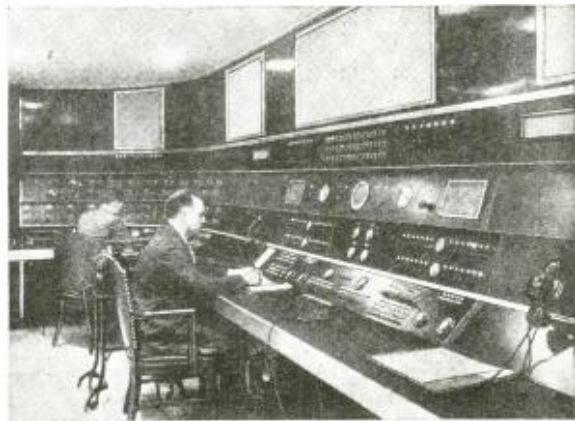

A GREAT DEAL has been written about American Broadcasting since its humble beginning in 1920. However, some of the statistics now available show amazing facts and growth in the industry, not the least of which is concerned with the rapidly increasing listening audience.

The audience to which the broadcasters cater is definitely increasing from year to year. We do not seem to have nearly reached the saturation point. An estimate, by the United States Department of Commerce (as of July 1, 1934) shows 18,500,000 radio listening families in the United States. This means an audience of 55,500,000 persons, using the usual figure of three listeners per family. The United States Census, of April 1, 1930, showed 12,048,762 radio-owning homes. An increase of over 8,000,000 radio-owning families in four years.

Growth of the Networks

This growth in the radio audience is a real factor in the past and present development of the broadcasting industry. This growth has encouraged advertisers in general to present an ever-increasing number of fine programs for your enjoyment. In turn,

the revenue thus obtained by the broadcasters is directly responsible for the development, improvement, and quality of entertainment being produced today. This progress can best be shown by figures from the annual reports of the Federal Communications Commission, 1934, and the Department of Commerce, Radio Division Bulletin, Commercial and Government Stations, 1923, as follows:

Total number of Radio Stations in the U.S.A.

1922	382
1934, as of July 1.....	593

Of this total number of radio stations in the U.S., only 180 are associated with either the National Broadcasting Company or Columbia Broadcasting System networks. The following table will show clearly the expansion of the network system of broadcasting over the period 1928 to 1934.

Year	Number of Stations NBC	CBS	Total Number of Stations
1928	56	36	92
1929	70	54	124
1930	73	74	147
1931	85	81	166
1932	87	87	174
1933	87	85	170
1934 (as of Nov. 1)	88	92	180

The power of these stations, of course, varies greatly. The aggregate
(Continued on page 501)

RADIO SETS IN THE MODERN AND "MODEL" HOME

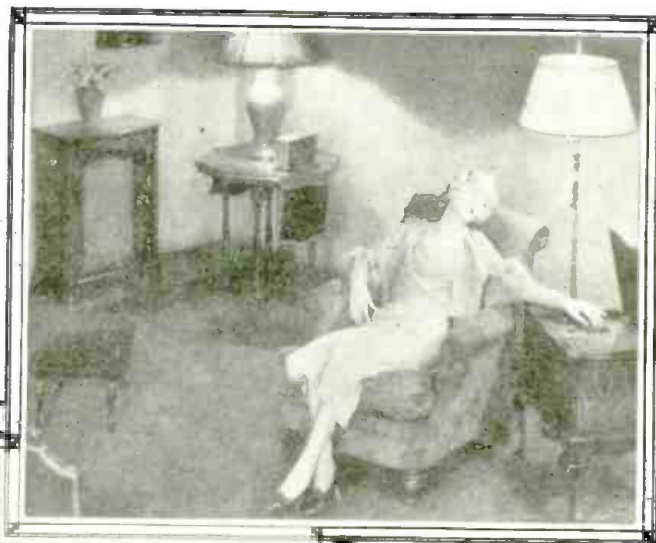

Above, a remote-control Clarion set, "at home." Below, a Crosley "A.C.-D.C." portable, in the home.

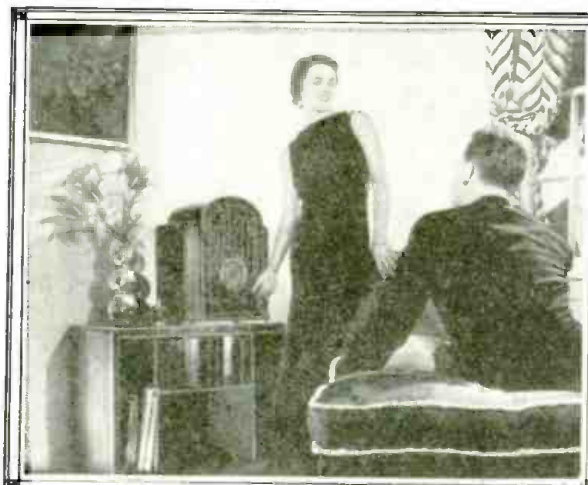

Above, an RCA Victor set in home surroundings. Upper right, a "radio music room" designed by L. Alavoine & Co.; a Philco set, in authentic 18th century setting.

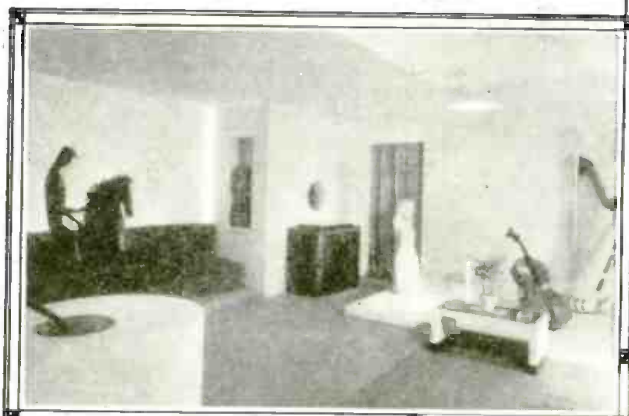
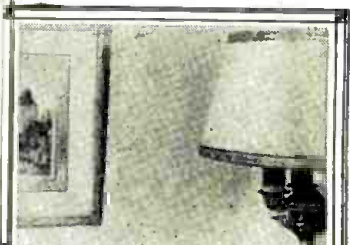
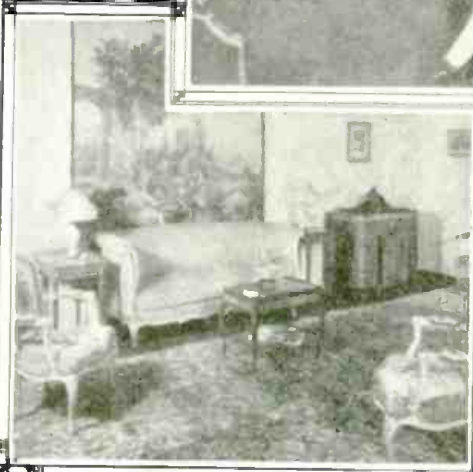

Above, Philco "high-fidelity" set in an ultra-modern exhibition room by Contempora, Inc., at Radio City. The setting is harmonious in color and proportion. Center, front of "loudspeaker." William Lascaze home. Right, Mrs. Lewis Winner accompanies, on the piano, the reproduction of a Hammarlund all-wave set in her modernistic apartment.

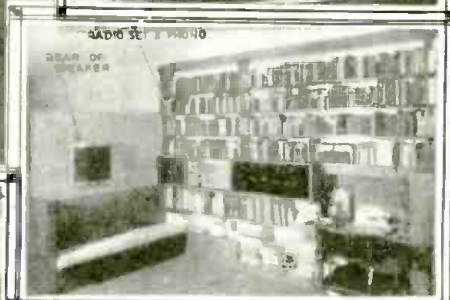
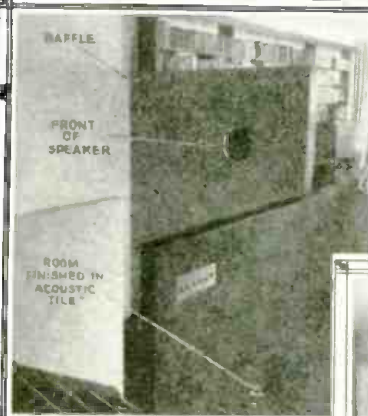

Above, a \$3,000, 3-floor, remote control radio and automatic phono. installation, by Barton Yager, for Wm. Lascaze, 211 E. 48th St., N.Y.C. Below, a listening post de luxe; executive monitoring room, NBC headquarters, Radio City, New York.

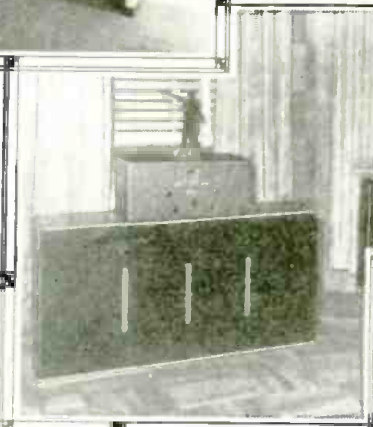

Left, a Philco midjet set inside the management desk in the "closet" of "America's Little House," the model home, at Park Ave. and 39th St., N.Y.C., of the N.Y. Committee of Better Homes in America. Note the telephone and typewriter.



NOVEL RADIO RECEIVERS



Gimbel's (New York) version of the radio-bar, shown here in two views. A radio for foreign and domestic reception and everything desired for "interior decoration."
We're not sure that the fireplace fires. At any rate, it's a swell apartment-type "fireplace" for apartment dwellers.

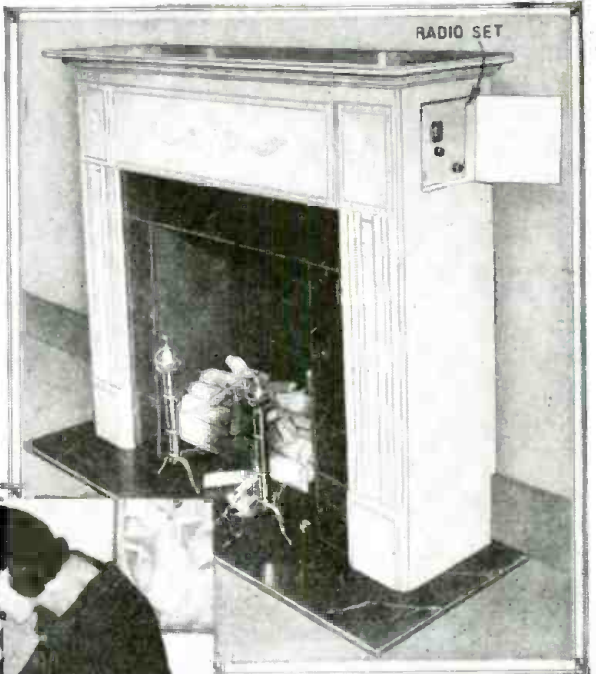

Left, from Germany. A compact, extremely simple electric record pickup to be used in connection with any radio set. Special plug is attached for connection to radio chassis. Cabinet can be closed during operation. Used with a midget-type receiver, it makes a neat, portable set-up.

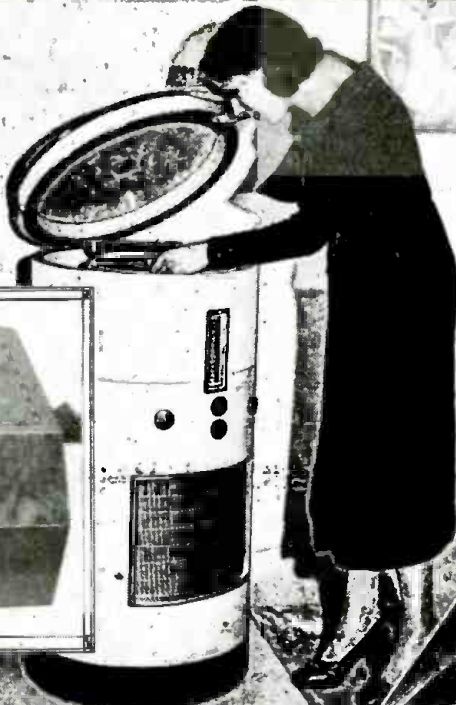

Below, this novel (to say the least) bit of designing, made for Fanny Brice, is built into a standard baby-grand "cabinet." Radio and phonograph combination, with excellent use of piano sounding board. As Joe would say, "Wanna buy a—piano-radio?"

Right, this photo shows "Lazy-tone" in a much less intriguing, yet equally serviceable position—ready to do duty as a full-volumed, fine-toned up-to-the-minute superhet. compact. For tubes employed, see text under "boudoir" view, lower-right. Light may be used for reading when placed on end table, as shown.

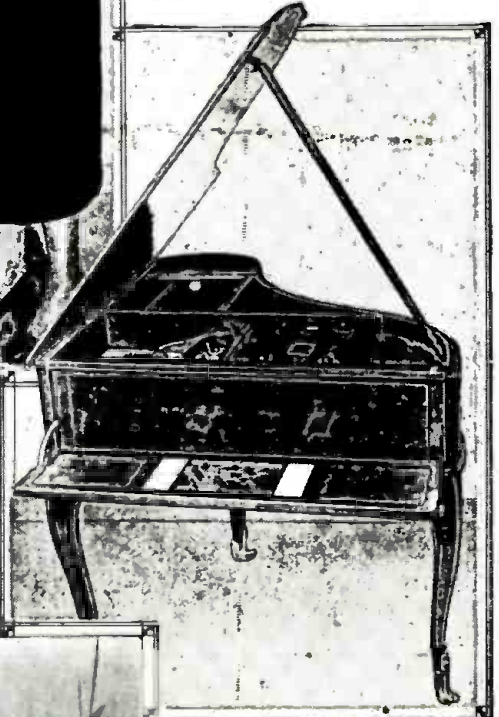
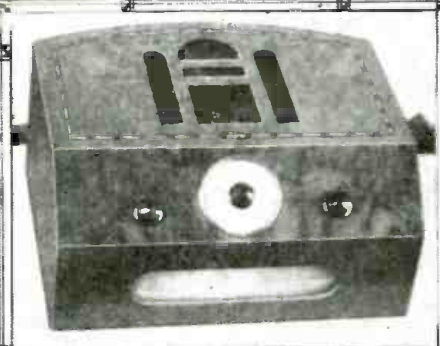

And this, ladies and gentlemen, is called the radio-gram (gram being short for gramophone). The barrel-shaped affair does things acoustically to the music emanating from records or radio and you must admit that it is different. We're not sure we like it but Londonites do!

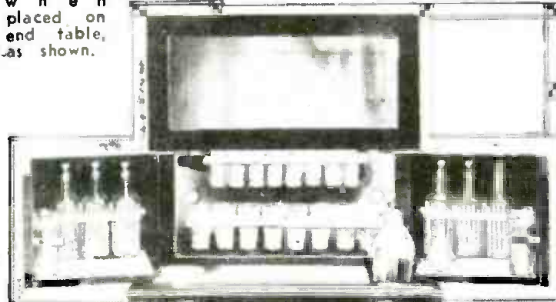

Left, "Radiubar"—eloquently descriptive! A party can get side entertainment from this outfit,—and how! Three chassis designs (one exclusively short-wave, the others including short and standard broadcast bands). Bar equipment includes complete "set of eight" of liquor, highball and cocktail glasses with decanter set and space for the mak-in's. (Radiobar Co. of America.)

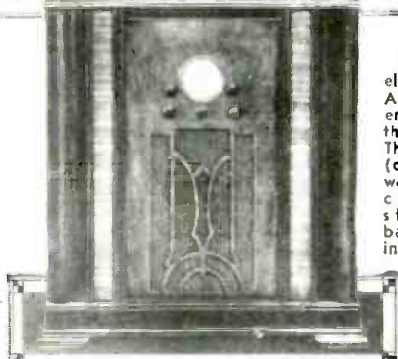

Left, a 5-tube superhet, using a 2A7, 58, 2A6, 2A5 and an 80,—containing hooks for slipping over the bed-head, and a mellow light for reading, should answer my-lady's (or myman's either!) prayer for sleepy-time entertainment. A close-up of "Lazy-tone" appears in the view shown at left-center. (Western Radio Mfg. Co.)

"CONTRACTED SPEECH" ON THE NEW YORK-LONDON RADIOPHONE

The Compondor which is being tried in the long-wave transatlantic telephone transmissions is not unlike a pair of gain controls so connected that one is at maximum while the other is at minimum—the purpose is to avoid distortion and "masking" due to background noises.

N. C. NORMAN*

TELEPHONE history records a steady extension of the distance over which it is possible to convey the spoken word with enough of its original character to make the speaker as well as the message readily recognizable by the listener. Such extension is beset with certain difficulties which are due as much to the varied characteristics of speech as to the limitations of the means of transmission available.

In long telephone circuits of all sorts, the input signal energy received from the subscribers varies over a wide range. The power ratio of the strongest to the weakest significant sounds often amounts to ten million to one or

70 db. This range may be considered to consist of two components. One, the volume range, of 40 db., is due to the differences in the speech powers of different talkers, in the ways they talk into the transmitter, and in such variable circuit characteristics as the lengths of terminal circuits and the properties of transmitters. If necessary these volume differences can be reduced to a considerable extent by manually operated gain controls.

Even when these differences have been eliminated, however, there remain the other variations, of about 30 db., due to the natural differences in energy intrinsic to different speech sounds, modified by variation in emphasis, and variation in the efficiency of the transmitter with frequency and load. These variations are great enough so that, on such circuits as the transatlantic radio-telephone channels, transmission degradation of some sort seems unavoidable.

Up to the present time, improvement in this situation has been along two lines. The intensity range of the circuit has been increased either by reducing noise or cross-talk, or by using amplifiers and other equipment which will carry more power without distortion. But there are circuits where further extension of the intensity range by either of these two methods would be very costly.



Fig. A
The device under trial in the long-wave transatlantic telephone channel is shown here.

frequency range but which will also convey in unimpaired ratio both strong and weak speech sounds. The intensity range of a circuit may be expressed as the difference in decibels between that lower extreme at which speech sounds would be masked to an objectionable degree by noise or cross-talk and that upper extreme at which the circuit begins to introduce noticeable distortion due to overloading. Obviously, when the intensity range of a circuit is in the neighborhood of 30 db.—the same range as that intrinsic to speech sounds—very careful regulation is needed to insure transmission without loss in speech intelligibility. When the intensity range of a circuit becomes less than this figure, as it often does on radio-telephone circuits, transmission degradation of some sort seems unavoidable.

Up to the present time, improvement in this situation has been along two lines. The intensity range of the circuit has been increased either by reducing noise or cross-talk, or by using amplifiers and other equipment which will carry more power without distortion. But there are circuits where further extension of the intensity range by either of these two methods would be very costly.

Compressing the Intensity Range

For such cases, a third method of improving transmission has been devised and is now in commercial operation over the long-wave radio-telephone channel between New York and London. This method consists of automatically compressing the intensity range of the speech before transmitting it, and expanding (Continued on page 506)

*Transmission Research, Bell Telephone Laboratories.

Fig. 1

The action of the compandor system is shown in the chart at B, while the method is illustrated at A.

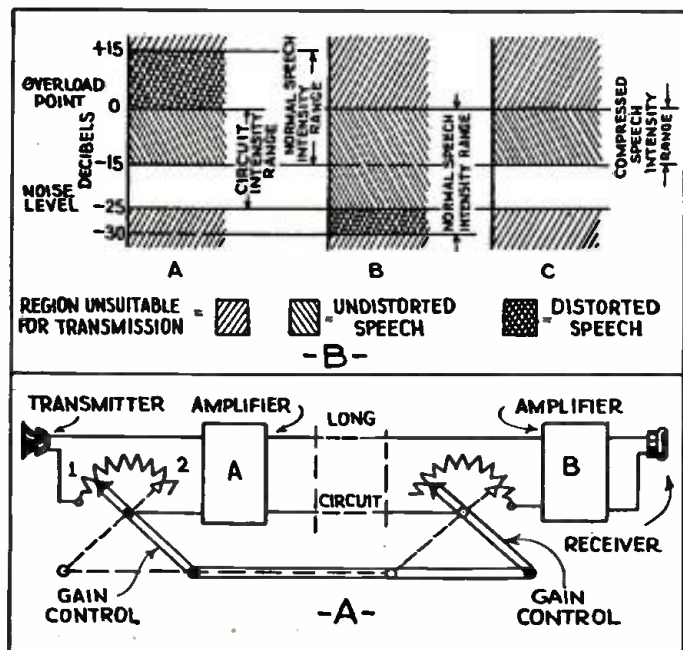



Fig. A—The complete "recorder"—"dubbing" from B to A.

BROADCAST ARTISTS RECORD THEIR PROGRAMS

A new system for making records of radio programs or local artists, which rivals commercial methods, is described here.

W. H. HARRISON*

RECORDING radio programs with high quality equipment is opening up a new field for the radio technician, whereby he can realize substantial profits and build up a new and entirely self-sustaining source of income. There are many calls for permanent records of radio programs—from artists who desire to hear how they actually sound over the air, in order to improve their diction, musical quality or general delivery—from sponsors who desire to maintain a permanent record of their programs and ads—from schools which desire the use of material which has been broadcast, for teaching purposes—from listeners who for various reasons desire to keep a permanent record of some favorite program—and from other sources, too numerous and too widespread to itemize here.

The technician who has tried to make recordings up to now has been sadly disillusioned by the inadequacy of available equipment, which is reasonably priced yet of sufficiently high quality to insure good clean records which can be "sold."

A New Method

Where the quantity of records required is not more than five, a recording system such as the one shown here, which utilizes a new type of acetate-covered record or a metal alloy record, instead of the usual commercial

*Harrison Radio Co.

Fig. B

The speed-reducing drive to permit operation at 33-1/3 or 78.2 r.p.m.

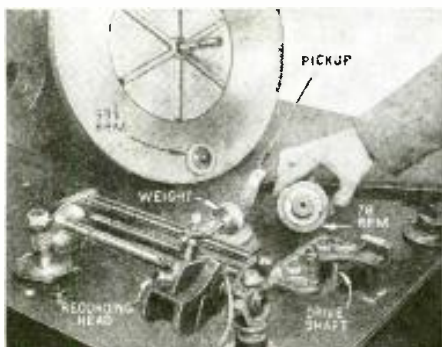

WOULD you like to set up a profit-making recording studio? One in which you can make limited numbers of records for one-tenth the price charged by commercial companies using wax master records? If you are interested, you cannot afford to miss this interesting article.

pressed recordings (shellac base composition) is an economy. If more than this number is needed, the pressed records, made from a master record, becomes less expensive as each record by the direct-cut method costs as much as the original.

The results obtained with the alloy or acetate-covered records compare favorably with the pressed records, the lifelike accuracy depending, of course, on every component of the entire installation.

It is necessary to mention that the alloy records are used with bamboo, cactus thorn or casein needles, while the acetate-covered discs require a special steel needle.

The Apparatus Required

The complete recording studio should be equipped with microphone, radio tuner, two dual-speed turntables with high quality pickups, high fidelity amplifier, two dual-speed recording turntables with self-grooving cutters and loudspeaker. With this layout recordings may be made of programs broadcast by radio stations (or by direct wire if contract or order warrants the expense of leasing the wire) of performers in the studio and of other recordings.

The radio tuner is fed into one of the cutting heads through the high fi-

delity amplifier, and the turntable is revolved at the desired constant speed (either 33 1/3 or 78 rpm.) A pair of 'phones or speaker may be cut into the circuit to monitor the work. As the end of the record approaches, the recording may be switched over to the other turntable so that recordings of any length may be made.

Now, if duplicate records are required, the original is played back, with a phono pickup, on one turntable and a new record is cut on the other with the cutting head, feeding the currents from the pickup through the amplifier to the cutting head.

If local recordings are desired, such as artists who desire to hear how they will sound, to time programs, etc., a microphone is connected to the input of the amplifier and the record cut in the same manner. Here, phones should be used to monitor the recording, to prevent acoustic feed-back from affecting the results. Of course, a suitable recording studio must be set up for local record making.

With the equipment pictured Figs. A, B and C, recordings may be made on the alloy or the new acetate-cov-

(Continued on page 509)

Fig. C

The radio tuner (top) and the recording amplifier (bottom) from the rear.



CURIOSA IN RADIO

The well-known saying that "truth is stranger than fiction" is amply demonstrated by some of the strange facts which have been collected here from all parts of the world.

PERSONALITY VERSUS BRAWN!



ers can't possibly measure up to a he-man standard. Needless to say, we are strictly and unconditionally neutral!

PRAGUE: Not so long ago Czechoslovakian instructors of physical training took a microphone test in Prague's broadcasting studio. Only 5 among them were found to possess a radio personality. All of which would seem to justify those who earnestly believe that certain varieties of masculine radio performers

OVER 20 YEARS OF BROADCASTING

BRUSSELS: The broadcasting station of Brussels was able to celebrate an interesting jubilee which is probably not well known, the twentieth anniversary of the first broadcast on earth. In 1914 the radio station at the castle of Laeken, near Brussels, was inaugurated by the late Belgian King, Albert I,—a station which was destroyed a few months later by the invading German armies. The program transmitted at that time was literally repeated this year and the United States is minus one previously claimed glory. The supposition that the United States introduced the first broadcast in the world is denied.

R-R-RADIO C-C-C-CURES ST-T-T-TUT-T-T-T-TERER

COPENHAGEN: At a sporting event the winner of a 2,000 meter race was supposed to be interviewed in front of a microphone. The reporter of Radio-Copenhagen was not aware that he had to deal with a stutterer and pulled the exhausted winner up to the microphone. He started to question the runner about his impression during the race. A little pause . . . the runner hesitated for a while . . . and then answered fluently all questions. Since then he has not stuttered!



The microphone fever (fright) achieved what no doctor could do in years. While a good hearty slap on the back has seemed a good way to relieve temporary spells of s-s-stut - t-t-ter-r-r-ring, this case wins the prize for a bonafide, permanent cure, unless there's something fishy in Denmark!

STUDYING MAKES 'EM THAT WAY!

PARIS: The syndicate of the French radio journalists has decided to organize a "microphone school" for the instruction in radio journalism and the microphone art in

general. The teaching staff of this institution will be formed from the best French orators, announcers, radio writers, and playwrights. The school was scheduled to begin its activities in October.

WHO SAYS "SILENT ORBS OF NIGHT"?

PRAGUE: The Czechoslovakian state observatory in Stara Dala recently conducted a series of very interesting experiments. Through a system of photoelectric cells and amplifiers the light from the moon and from Vega was recorded on phonograph records. The moonlight appeared as a long-drawn-out clear tone of a slowly falling and rising intensity. This tone was broadcast by some radio stations. The ancient Greeks' belief in the "Music of the Spheres" was for the first time practically proved in this manner. It is interesting to note that the light rays from Vega which were transformed into sound were traveling 26½ years before reaching the earth!



reaching the earth!

SOARING AMONG SHORT WAVES

DARMSTADT, Germany: During a recent glider-flying contest which took place, short-wave telephony was used. The carrying distance was about 45 kilometers (about 27 miles) and the 20 W. power was supplied by a foot-operated dynamo. This little transmitting post acted as a liaison between the committee on the field and the contestants during their flights. Special very light receivers of about 7½ lbs. were built for this purpose. The headphones were concealed in the flier's helmet. The experiment gave very satisfactory results.

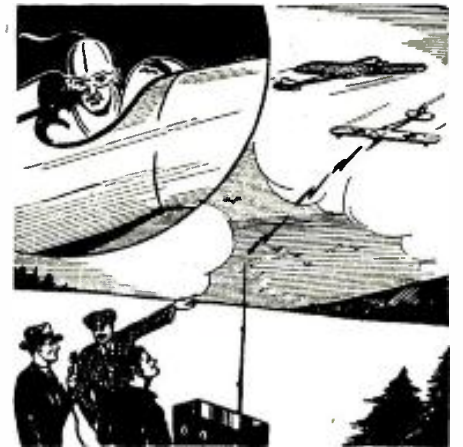

HOW EFFECTIVE ARE SOS CALLS?

LONDON: Our cousins from the foggy regions have what we consider a fine batting average for successful response to calls for aid. During a recent period the total SOS calls and police calls resulted in the following figures: 49.18% of calls failed to accomplish their purpose, because help arrived too late (due to fog?); 44.75% resulted in successful completion; while only 6.07% of the calls received no response. That is pretty good shooting, when the perils and difficulties connected with such work are considered.

ROBINSON CRUSOE A LA MODE

SYDNEYS: Perhaps the loneliest spot on earth is the small coral island, Willis Island, which is situated on the Pacific Ocean some 300 miles from the North Australian seashore. Recently two radio operators of the Amalgamated



Radio Company returned from this island where they had remained 14 months—the only inhabitants. Very little would have been known about Willis Island if it were not for the existence of a radio station there which is of great importance to the inhabitants of the surrounding archipelago — supplying weather information and navigation news. Also the in-

habitants of the Australian mainland, particularly those of Queensland, depend on information coming from Willis Island concerning cyclonic movements. Willis Island, indeed, is the center of a dangerous and much feared cyclonic region. The normal service period on the island for the two operators is one year, due to its utter loneliness and the storm peril.

However, they get double pay and can play poker with sea shells and old tubes—and they can always chat with the ops. on the mainland or on passing ships.



SPLendid GOOD-WILL GESTURE

COPENHAGEN: During a recent trip of his through various European countries, the manager of the Danish Broadcasting Company, Mr. Holm, took the initiative to stimulate the international cooperation in the domain of radio program exchange. In accordance with the

agreement he made with the broadcasting companies of Belgium, Holland, Yugoslavia, Poland, Switzerland, Sweden, Czechoslovakia, Germany, Hungary, Austria, Italy, France and England, their stations will broadcast from special phonograph records, Danish folk songs and the works of younger Danish composers. These records which will be arranged and recorded by the Danish Broadcasting Company will give an insight into the musical life of Denmark.

This idea deserves imitation and can lead to the development of a lively exchange between nations in the field of art and literature. Of great advantage is the fact that such programs are economical, due to the absence of royalties to pay. Also, they can be arranged within a very short period and are portable to a very high degree. We may hope that some other broadcasting companies will follow the leadership of Denmark.

CLEVER PEOPLE—THESE CHINESE!

SHANGHAI: All the large cities in China, and also the smaller provincial towns, have been equipped with long distance radio receivers which enable millions of Chinese to enjoy radio programs. In Nanking, Canton, Peiping and other residences of the "Kuomintang" (the Chinese

national government now in power), powerful transmitters have been installed which are used by the government mostly for propaganda purposes. Although receivers in private houses are extremely rare on account of the very low average income of the largest part of the population, the total number of radio receivers in China is somewhat larger than 5,000. The majority of these are local receivers or belong to storekeepers who use them for the entertainment of their customers. The government, which finances the entire Chinese radio system, does not collect any license fees for receivers.

The intervention of the government in favor of providing program facilities comes as quite a surprise, from such a staid and old-fashioned power as China. We cannot help but wonder if they are at last beginning to accept modern advancements!

WHEN GREEK MEETS ROMAN?

ROME: The Italian radio station in Bori began August 20 a series of regular broadcasts intended for Greece, which together with Albania are the only countries in Europe without their own broadcasting stations. These broadcasts are interesting from a political point of view because through them



is increased the Italian influence in Greece. Programs in Greek are broadcast every Monday, Wednesday and Friday and consist mostly of press information, radio talks and musical performances.

THRILLING RADIO RESCUE

PARIS: The ill-fated German liner "Dresden," out from Bremerhaven with 1,000 passengers aboard, received an SOS late one evening from a French airplane which gave its location as 30 miles north of Dunquerque. Changing her course, the "Dresden" steamed until she picked up the light signal from the distressed plane. In spite of heavy seas and a strong gale, the "Dresden's" boat succeeded in rescuing the 5 French naval aviators immediately before their craft went under.



WIRED TELEVISION FOR GERMANY

BERLIN: In the future every Berlin telephone subscriber will be able to install an additional device which will allow him not only to hear but also to see the other party at the end of the wire. At the beginning, arrangements are being made so that these "television" calls can be made only from certain points, so that the "caller" and receiver do not speak from their respective apartments, but from certain main post offices. It is intended to extend the transmission of television also over the power network for universal use.

Germany is taking television seriously as a medium of propaganda, also, as we pointed out last month. **RADIO-CRAFT**, Jan. 1934, page 392.



WHAT SET SHOULD I BUY?

Selecting the radio set, in most families is an auspicious occasion. Yet, despite most protracted family discussions on the subject it is seldom that the choice is made wisely. In this interesting article, the author comes to the aid of Mr. Jones and his father—

BERTRAM M. FREED

mily—the cabinet, set selectivity, tone and volume, and special features of the chassis are discussed, and important purchasing "do's" and "don'ts" are given. Mr. Freed speaks from years of experience servicing "radios" in and around little old New York.

"**W**HAT IS the best radio set to buy?" asks Mr. Jones.

Mr. Jones is only typical of the many persons who make this inquiry daily to me in my capacity of radio technician. The question is one that cannot be answered intelligently before the requirements and economic circumstances of the buyer are considered. Most people are not interested in the technicalities of radio and are more or less contented when programs are received satisfactorily. Yet, full appreciation of the individual wants of the prospective purchaser and of the more important phases and details of a radio receiver is essential when selecting one to derive the greatest possible benefits and enjoyment.

"You Get Only That for Which You Have Paid"

With the intense competition, claims, and statements of receiver manufacturers, the selection of a radio receiver is both confusing and difficult for the average layman or even radio fan. Obtaining the most value for their money, dollar for dollar, appears to be the principal thought-in-mind of many buyers. As in the case of purchasing any merchandise, that is, honest merchandise, you get only that for which you have paid. It must be remembered that the list price of a radio receiver released by a reputable, established manufacturer is usually controlled by the quality of the chassis and the cabinet, and there can be no doubt about the fact that a set costing over a hundred dollars is normally "better" than one that sells for less than fifty. Of course, this statement must be qualified in the case of those manufacturers who are not so firmly entrenched or well known and who establish a high list price on their product and offer the retailer an unusually high discount. This high discount is of the nature of an inducement to the dealer to recommend or "push" this particular line of receivers because of greater profit. The salesman, too, ordinarily receives greater commissions when selling these receivers. In

WHEN YOU GO SET-SHOPPING—

- (1) **DON'T**—buy any radio set because your relative or neighbor has one like it.
- (2) **DON'T**—buy the choice of the dealer or salesman. *Test and select it yourself.*
- (3) **DON'T**—be misled by claims, statements, or fancy, high-sounding terms of the manufacturer, dealer or salesman. *Try the set yourself.*
- (4) **DON'T**—choose a radio set because the cabinet is a pretty one.
- (5) **DON'T**—take verbal guarantees or promises of service or repair. *Get them written.*
- (6) **DON'T**—permit the salesman to rush the sale. *Take your time and deliberate twice before choosing. It is troublesome to change your mind later.*
- (7) **DON'T**—accept any kind of installation. *Get the one recommended by the manufacturer of the receiver.*
- (8) **DON'T**—permit a few dollars to stand in your way to buy the receiver you most like.
- (9) **DON'T**—buy a radio receiver because the price has been marked down and may be a bargain. *You get exactly what you pay for.*
- (10) **DON'T**—swallow all the salesman tells you. *Make him prove his statements before you buy.*

other words, although two radio receivers may bear the same list price, one may present greater value for the money than the other. The radio technician who is in touch with his industry is particularly qualified on this score to make a recommendation after the needs of the purchaser are known.

Is There a Price Limitation?

How much money are you prepared to spend? This question can only be answered by the individual considering the
(Continued on page 495)



The "technical room" at the 150 kw. Luxembourg station.

THE "LUXEMBOURG EFFECT" IN RADIO

How little we really know about the propagation of radio waves is well illustrated by this curious phenomenon which is baffling some of the foremost men who devote their time and study to radio and physics.

C. W. PALMER

WITHIN the past few months, such eminent authorities as Prof. E. V. Appleton of London University, and Dr. B. van der Pol, Dr. B. D. H. Tellegan and Mr. J. van der Mark of the Philips Labs. in Eindhoven, Holland, have been focusing their attention on a peculiar phenomenon in connection with transmission of radio signals. This odd effect, which cannot be explained by any existing theories of wave propagation has been called the *Luxembourg Effect* for lack of a better name. It was noticed, about a year and a half ago, that when a receiver (located in Southern England) was tuned to Radio-Paris, a faint background of the program sent out by the powerful Luxembourg station was picked up. This in itself is not startling, except for the fact that the wavelengths of the two stations were separated by a wide band which eliminated the possibility of "cross modulation" being the cause.

Prof. Appleton, who has devoted a considerable amount of time to this mysterious phenomenon, made the following comment recently in *World-Radio* (London) magazine.

"The chief features of the phenomenon are easily explained. It is found that when listening to a certain station (in the broadcast band) the modulation of another station entirely different in wavelength (in the long-wave or short-wave range) is heard as a faint background to the desired program. There would be nothing odd in this result if the two stations were in neighboring wavelength

channels, for then increased selectivity would permit their separation. But the effect is obtained with stations widely spaced in wavelength. Moreover, when the receiver is distuned from the medium-wave station the intruding program disappears. It must, therefore, be concluded that the long-wave (or short-wave) program has been weakly received by the medium waves—and thus on a wavelength entirely different from

that on which it was emitted.

"To the theoretical physicist such a phenomenon is startling indeed. We know from Maxwell's original theory of wave transmission in the ether, that waves of different length can travel through the same free space without any interaction whatever, and, until now, it had been assumed that the same could be said of a medium consisting of electrified particles such as the

ionosphere. But this interaction of waves in the process of simultaneous reflection from the ionosphere shows that what we can say about free space does not hold for an ionized medium. A theoretical physicist would summarize the situation by saying that the principle of superposition does not hold in the ionosphere.

"When we attempt to explain the matter in somewhat greater detail our difficulties begin and at present there is no generally accepted theory of this ionospheric cross-modulation, as we may, perhaps, term it. It is true, that due to the pressure of radiation we would expect the electrons in the ionosphere to vibrate a certain amount in the direction of transmission of the waves with an amplitude which is proportional to the square of the wave amplitude, and this would give us the 'square law' we require to get a cross modulation effect. But calculation shows that such an effect should be small and insufficient to account for the phenomena observed."

Later developments of the situation than those outlined by Dr. Appleton, reveal that the Luxembourg Effect takes (Continued on page 499)

An illustration from Dr. H. T. Stetson's book, "Earth, Radio and the Stars" showing the relative positions of the various ionized reflecting layers in which the mysterious "Luxembourg Effect" probably takes place, according to Prof. Appleton.

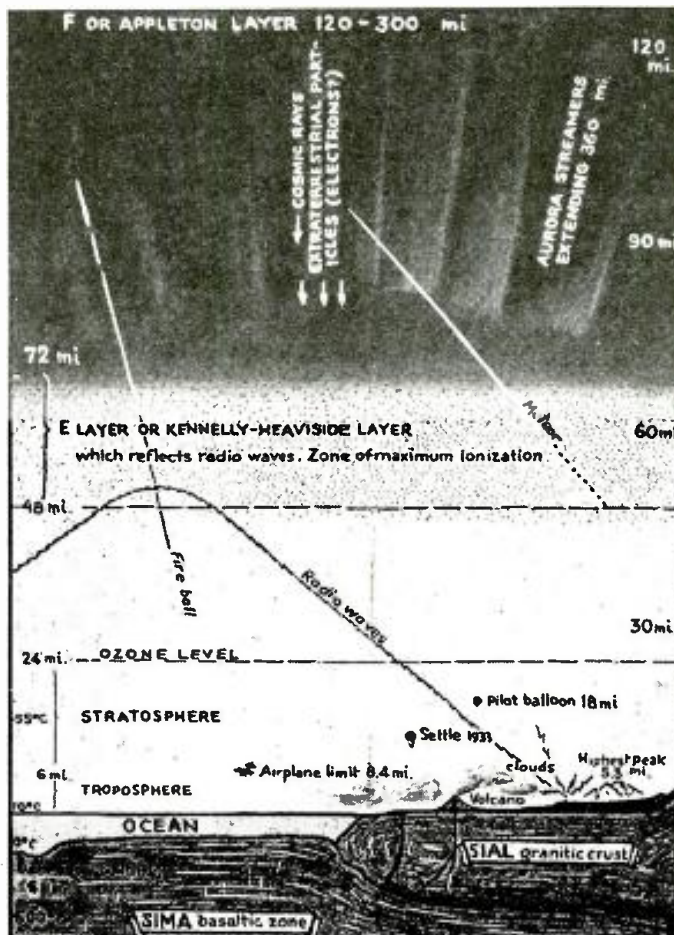

INTERNATIONAL RADIO REVIEW

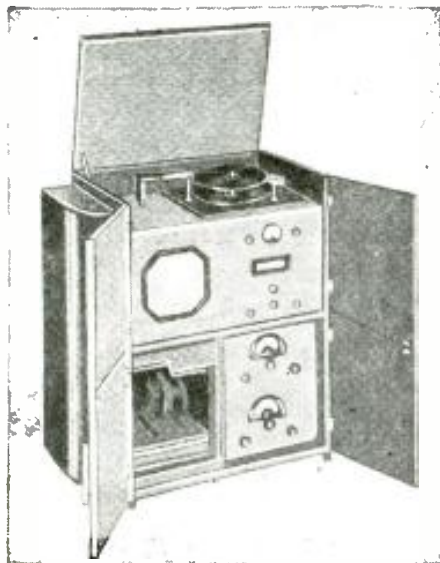

Fig. A
The combined phonograph and double radio set.

RECORDING CABINETS

TWO examples of combined radio receivers and phonograph recording and reproducing devices, made in England are shown in Figs. A and B. The one shown at A is a receiver and phono combination having an automatic record changer and two radio tuners which can supply up to 10 remote speakers with any one of three different programs.

This device is made for installation in homes, small hotels, offices or other locations where more than one speaker is required. It closes into a neat console cabinet, closely resembling an ordinary radio receiver.

The second device, at Fig. B, is a recording table, having two turn-tables for continuous recording, and a radio tuner for recording or projecting radio programs. This instrument is designed more for the recording studio than the home—it is made in the form of a desk, for convenience. Both of

Fig. B
A recording desk with two turn-tables.



EACH month there are received at the offices of RADIO-CRAFT hundreds of daily, weekly and monthly magazines originating from all over the world.

SINCE the cost of subscribing to each of these would be prohibitive for most radio men, we have arranged with technical translators to prepare for our readers reviews of all the really important, new developments illustrated and described each month in these publications.

NOTE that the only available information is that which is published; the experimenter must adapt the ideas to whatever equipment he has on hand.

these devices were announced recently in WIRELESS WORLD magazine.

TEACHING GLIDING BY RADIO

UNTIL recently, the initiation into the art of flying gliders has been limited to "ground" schooling, as even the modern gliders will not carry two people. This meant that the instructor had to give his pupil all instructions before the flight began, followed by criticisms if the tyro was successful in making a safe landing.

A recent issue of AMATEUR WIRELESS, however, contained an interesting article on how the Telefunken Company, in Germany, has developed several short-wave transmitters and receivers for the express purpose of training beginners in the intricacies of handling motorless planes.

The receiver is mounted in the cockpit of the glider, as shown in Fig. D. This receiver contains four tubes and weighs 7 lbs. It is equipped with a

loudspeaker as there is no difficulty with motor interference or noise. A 20 ft. wire stretched out on the wings serves as the aerial.

Two transmitters have been developed. The one shown in Fig. C, is a 20-watt unit having a hand generator, driven by a "bicycle" drive. The second is battery operated and has an output of 1 watt.

The instructor can thus give instructions to his pupil during the flight, as he simply sits comfortably with a microphone before him and a pair of field glasses before his eyes.

A DRIVING AID

SEVERAL months ago, in the December 1934 issue of RADIO-CRAFT, page 328, a photograph of an accident preventer installed in a large bus in Germany appeared. This consisted of a microphone mounted at the rear of the large vehicle, an amplifier and a loudspeaker in the operator's booth, so that road noises and signals from cars behind the bus could be heard by the driver.

The Philips company has just introduced a similar though somewhat more simple device in England, according to WIRELESS WORLD. As shown in the illustration, Fig. 1, this consists of a weather-proof mike, mounted on the trailer or the rear of a large truck, directly coupled to a loudspeaker unit; the only source of current supply needed can be obtained from the car battery. The current consumption is equal to that of a small lamp.

IRON CORE COILS

ANOTHER new type of iron core tuning coil has just appeared on the European market, according to advertisements which have been appearing in all the leading publications. They possess a high degree of accuracy in matching and a high efficiency, due to the method of constructing the

Fig. D
The battery-operated receiver in the glider.

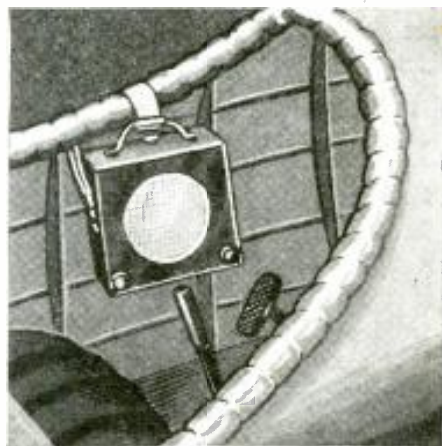

Fig. C
The 20-watt transmitter and hand generator which is used for training glider pilots from the ground.



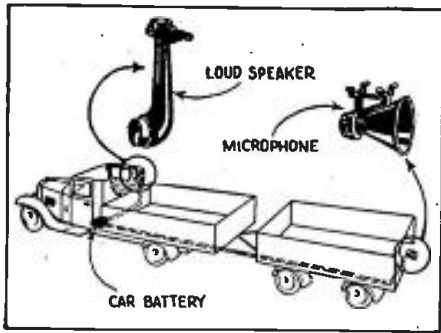

Fig. 1
This mike and speaker needs no amplifier.

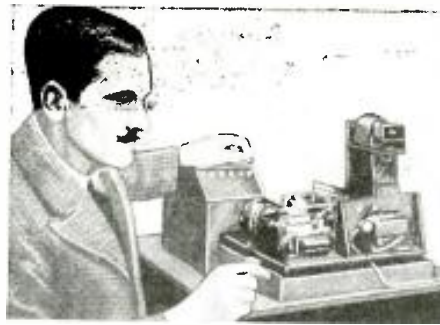

Fig. F
The automatic transcribing machine.

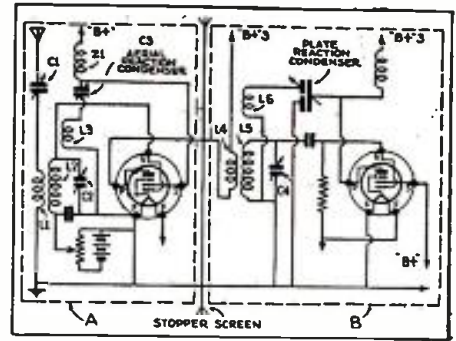

Fig. 2
The ST600 circuit described below.

cores. A picture of one of the six available types appears in Fig. E, below.

A READING MACHINE

AN interesting photoelectric device, invented by two Viennese engineers, was recently described in RADIO WELT magazine.

It consists of a movable, opaque screen having perforations, each corresponding to the characters on the printing matter to be transcribed.

The printed matter rests on a highly illuminated stand. It is automatically moved step by step, in such a manner that the light reflected from each successive small area containing a character, passes through one of the perforations in the screen and reaches the photoelectric cell. During the interval in which each character is focused, all the perforated letters of the screen pass between the reflecting surface and the photo-cell. When the letter on the screen corresponds to that on the printed matter, the light to the photo-cell is cut off and a relay is operated. Thus a signal corresponding to that character can then be sent over a radio transmitter or land line and picked up at a distance.

It can be seen that such a machine may have many practical applications, particularly for automatic tabulating purposes. Ordinary typewriters can be used then, instead of perforating

machines as a tabulating machine using this principle will be able to do the same work on printed cards that the present tabulating machines do on perforated cards.

The opaque screen can be very easily removed and replaced by another so that the change from one type of letters to another does not cause loss of time.

THE PHOTO-CELL DOLL

AT the Berlin Radio Show this year, an interesting novelty in light-operated devices was displayed, according to RADIO WELT magazine. It consisted of a doll imbedded in a box, as shown in Fig. G. Another box located in the front of the display booth, contained a photoelectric cell, focused on a source of light.

When a visitor approached the booth, the light beam was broken, thus actuating the photo-cell unit which in turn, started the mechanism in the box under the doll to function. The latter contained an electric motor and mechanical devices which caused the arms and legs of the doll to move in a life-like manner. As soon as the light beam reached to the photoelectric



Fig. G, above
The photo-cell operated doll at the Berlin show.

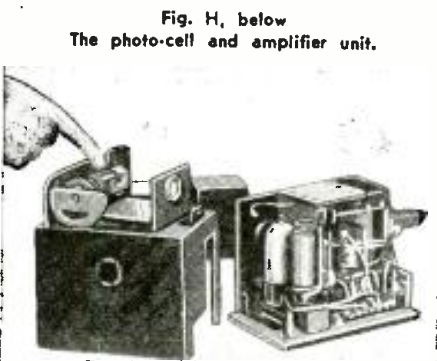

Fig. H, below
The photo-cell and amplifier unit.

cell, the doll stopped moving. This interesting display attracted much attention and speculation among those who attended the show.

THE ST600 RECEIVER

WHEN that well-known English engineer, John Scott-Taggart introduces a new circuit, radio experimenters and set builders throughout the United Kingdom "prick up their ears" and get out their screwdrivers and soldering irons, preparatory to making a new set.

Practically an entire issue of POPULAR WIRELESS magazine was recently devoted to the exploitation of his latest set. This receiver uses the double regeneration scheme employed in all of his recent sets, and it is claimed that extreme selectivity is possible by the correct manipulation of the two feed-back controls. The fundamental circuit of the set, disregarding some of the refinements, such as a band tuner in the aerial circuit, is shown in Fig. 2. Those who wish to try the arrangement can use this cir-

(Continued on page 492)

Fig. E
Another form of iron-core coil for tuning. This is one of six different types of coils which were just introduced in England.

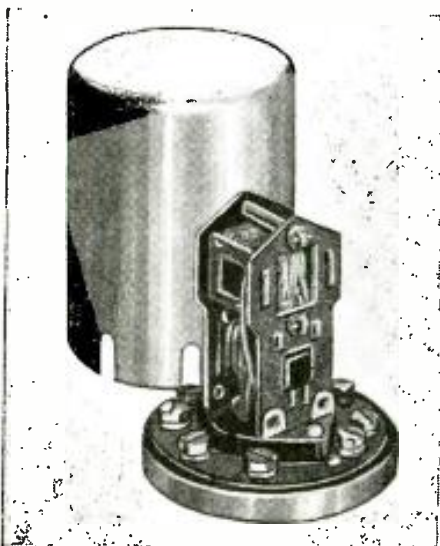
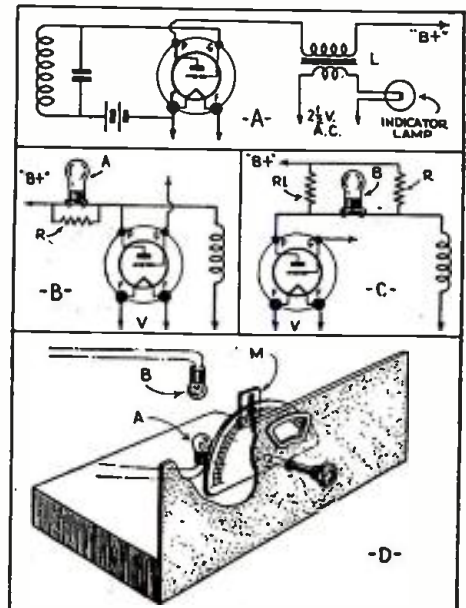

Fig. 3
Three interesting ways to make tuning indicators from ordinary pilot lamps.



SHORT-CUTS IN RADIO

FIRST PRIZE \$10.00
 SECOND PRIZE 5.00
 THIRD PRIZE 2.50
 Honorable Mention

EXPERIMENTERS: Three cash prizes will be awarded for the best "short-cuts" — time- and money-saving ideas—submitted by readers of RADIO-CRAFT; Honorable mention will be given for all other published items concerning radio and its allied fields.

Send us your "kinks" right away.

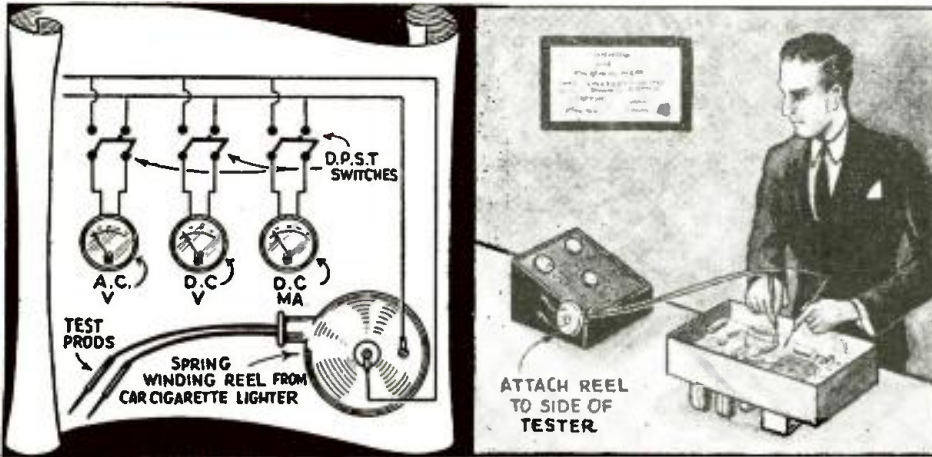

The Service Man will appreciate the convenience of this short-cut.

FIRST PRIZE (above)

A CONVENIENT way of keeping the service bench test leads out of the way is to use a spring cord reel such as used with the automobile cigarette lighter. It will be necessary to use a cord with sufficient insulation for the highest voltage to be tested and see that the connections inside the reel are clean and tight. The diagram shows the method of connecting it.

G. E. FOOTE

THIRD PRIZE (left)

CHEAP and flexible push-buttons for testing equipment can be made by any experimenter or Service Man by following the plan shown at the left. The switches are old jack blades; the return springs and plungers are auto tire valve insides. Two pieces of panel are cut and spaced apart by bakelite tubes about 9/16-in. long. The plungers are mounted directly over the jacks and throw the circuits from normal.

FRANK J. BAUER

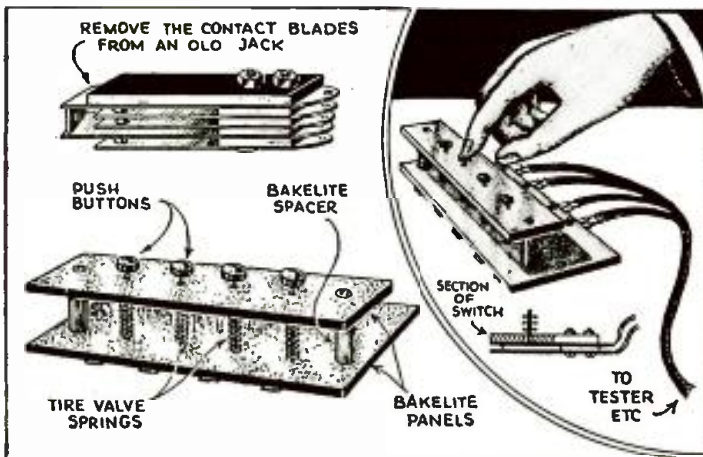

Above—Make your own push-button switches.

Below—Emergency tube sockets from old bases.

HONORABLE MENTION (below)

A GOOD ground for a portable radio set can be made from a .22 calibre rifle cleaning rod. Since the rod unscrews into four pieces, each about 8 ins. long it can be put into a small cabinet. The handle on the last piece provides a good grip for inserting the rod into the ground. The tip should be filed to a point and the ground wire soldered just below the handle. The illustration shows how the first section is filed to a point to facilitate insertion in the ground.

CHESTER KULWIEC

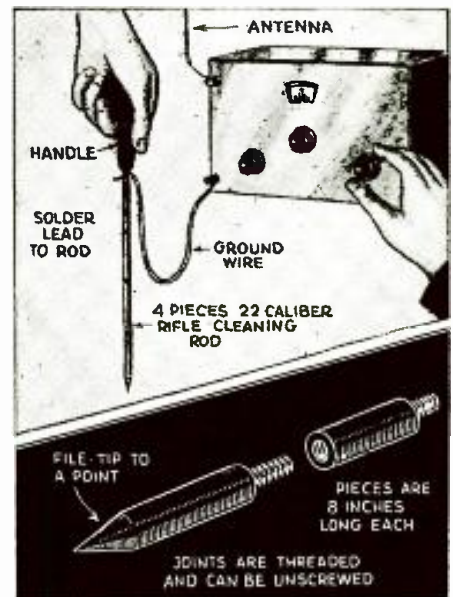

A rifle cleaning rod as a ground.

SECOND PRIZE (left)

NEXT time you are in need of a tube socket and it is not convenient to get one try this handy short-cut. Take an old tube base from a burned out tube, and drill out the contact pins, leaving the slightly enlarged holes in the bottom. Then drill holes of about the same size in the side of the base, opposite the pin holes. Bend copper or brass strips as shown in the illustration, through the two holes and down the outside of the base.

Then turn the base bottom side up and drill a hole in the center to accommodate a mounting screw. A fiber disc riveted to the ends of the metal strips completes the job and provides suitable tips for soldering to the contacts.

R. M. GRAW

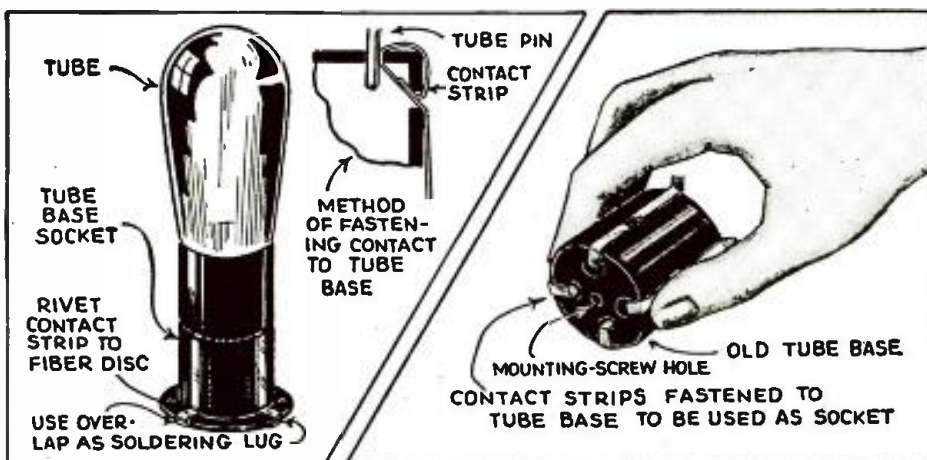

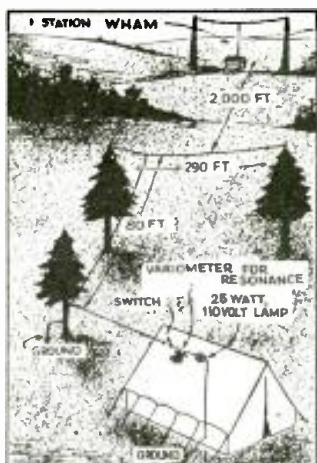

The lamp and the camp site.

WHAM'S PROGRAMS LIGHT LAMPS

An operator of station WHAM in Rochester, New York, established a summer camp about 1/4-mile from the station, last summer, and discovered some interesting facts about the transmission of power by radio. His only regret was the station sometimes signed off cutting off the "free" power.

OPERATOR George Driscoll of the WHAM transmitter staff has been modestly withholding one of those scientific wonders which the professors describe when they talk about "The World a Hundred Years from Now."

Last summer, the young technician set up a camp in the woods near WHAM transmitter and erected a 290-foot aerial plus an 80-foot lead-in to his tent (incidentally blistering his hands from the radio frequency energy collected by the long wire from the 50,-

000-watt transmitter). To this long wire, he connected an electric light switch, a variometer and an electric light bulb, with a ground connection to the other side of the bulb.

The net result was that the electric light bulb glowed at full brilliancy—in fact the variometer had to be detuned to prevent burning it out.

While bewhiskered savants talk about the day when power will be transmitted through the air to light homes and run automobiles, Driscoll spent many pleasant evenings during

the past summer reading by the light which burned without the sanction of the local power company. Driscoll's only lament was that the light went out when the station signed off.

This interesting demonstration is, of course, a form of power transmission by radio. The joker lies in the fact that WHAM'S transmitter draws about 225,000 watts from a 460-volt circuit in order to light a 25-watt 110-V. bulb at 2,000 feet distance.

At the same station, it is reported that
(Continued on page 509)

WLW'S "ELECTRIC EYE" LIGHTNING PROTECTOR

Here is a most unique application of the photoelectric cell—that of preventing the huge power output of the largest station in the U.S. from leaking off to ground through the lightning arrestor installed on the half-wave antenna. This photoelectric cell solved a very difficult problem for the engineers at WLW.

AT THE base of the giant 831-foot vertical antenna tower of 500,000 watt WLW—the world's most powerful radio broadcasting station—a tiny "electric eye" stands guard day and night protecting the radio audience against interruption in the entertainment.

This photoelectric cell is the "brain" of a unique device recently developed by engineers to protect valuable equipment against lightning and to prevent loss of broadcasting power through troublesome "power follow-up arcs" across the safety gap that carries lightning discharges from the tower into the earth.

While WLW's new vertical radiator antenna increased the station's efficiency from 50 to 100 per cent, it was soon discovered that unfortunately the huge 450 ton steel tower also served

admirably as a giant lightning rod. It became the problem of design engineers to ground the electrical energy thus collected from the atmosphere while at the same time preventing the grounding of the 500,000 watt power generated by the transmitter.

The use of the photoelectric cell was resorted to after the ordinary method, that of providing a direct lightning path to the ground by means of a safety gap across the base of the tower, was found to be unsuccessful. In adjusting the gap it was discovered that one wider than two inches failed to provide complete protection while with one less than 2 inches the normal peak voltages due to modulation on the 500,000 watt carrier would, on occasion, cause discharge across the gap.

An even more serious problem pre-
(Continued on page 492)

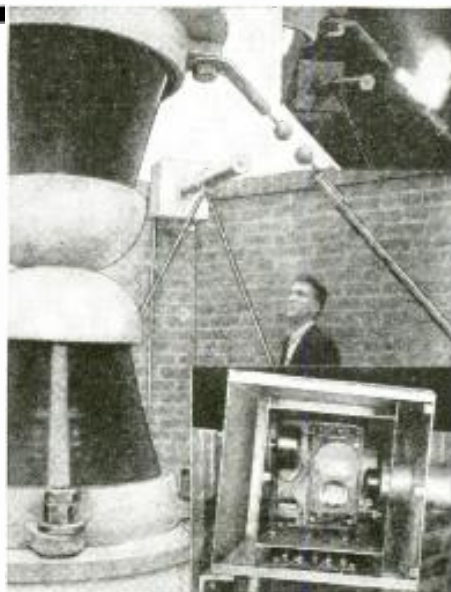

THE LATEST RADIO EQUIPMENT



Tiny "Jewel" a real radio set! (627)

A HANDFUL OF BEAUTY! (627)

(International Radio Corp.)

IT IS hard to realize how an efficient 3-tube circuit and good toned speaker can weigh so little, and be so small. Complete with tubes the set weighs only 3½ lbs., and takes up no more room than a good sized box of candy—portability in capital letters! Cases are of bakelite and plaskon with wide choice of colors. Uses 2 6C6s and 1 2A7.

30-WATT AUDITORIUM SPEAKER (630)

DESIGNED to handle 30 W. of undistorted output and having a rather unusual efficiency of 2 db. between 25 and 12,000 cycles, this speaker fits in very well indeed for P.A., auditorium, and outdoor work. Two models are listed, one as standard, to take care of requirements for a single speaker, and a special model intended for use with an auxiliary high-frequency model. High-fidelity tone is accredited to improved design of voice coil and output transformer.



Phono-radio super. portable. (634)

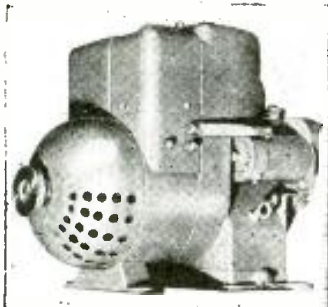

New 110 V. A.C. Lighting Sets. (628)

110 V. A.C. GAS-ENGINE GENERATORS (628)

FOUR new one-unit lighting plants are listed as 300, 500, 1,000 and 2,000 W. capacity, ideal for farm lighting, and large portable P.A. jobs. They provide flickerless current at a constant potential of 110 V. A. C. Engines are 4-cycle, air-cooled, with 6 V. ignition, float feed carburetors, mechanical governors, starting motors and batteries with remote starting control. Uses standard automotive parts available everywhere. Latest features include pressure feed lubrication, aluminum pistons and connecting rods, dynamic engine balance. Rubber mounting and special muffler result in extreme quietness of operation.

USE HEADPHONES ON ALL-WAVE SETS (631)

(Insuline Corp. of America)

THIS adapter makes it easy to switch in headphones for clear reception of those "marginal" signals. Phones can be used with or without speaker operating. The headphones connect to the input circuits of the tubes. A switch connects to the tubes' output circuits, and permits the output transformers primary to be short-circuited, for "headphones only—no speaker" operation. Adapters for push-pull (illustrated), or single-tube operation, and use with 4, 5, or 6-prong tubes, are available.

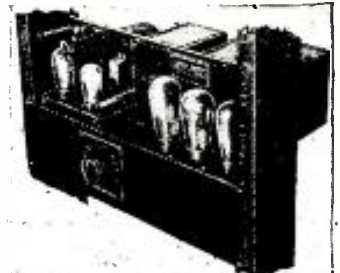

New voltage amplifier. (635)



Simple Inductance Resonator. (629)

POLYIRON-BRASS INDUC- TANCE RESONATOR (629)

HERE'S a tool which should be of real value to inspectors and Service Men. A flexible rubber rod contains a polyiron plug and a brass insert in opposite ends. To test a circuit incorporating an air-core R.F. inductance, it is only necessary to insert either end of the resonator into the coil. If both operations decrease signal strength the circuit is correctly aligned. This simple scheme saves much fussing with trimmers and padders, and in most cases, makes it possible to quickly adjust for proper values by spacing or cutting a few turns. The resonator can be used at frequencies as high as 25 megacycles, since losses in polyiron cores, even at these high frequencies, are extremely low. The flexibility feature enhances the value of this tool over previous types of "wands" described in RADIO-CRAFT.

18-WATT CLASS A AMPLIFIER (632)

HERE we have a high-quality mobile public address amplifier using class A circuits, operated entirely from a 6 V. storage battery. Current drain has been kept low by providing separate switches, one for filaments and the other to control speaker current and the high-voltage "B" supply. Has 3 stages, employing 2 76s and 2 2B6s. Overall gain is 75 db. with undistorted output of 18 W.

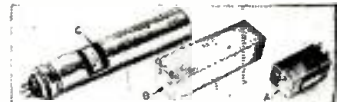

Exact-replacement electrolytics. (636)

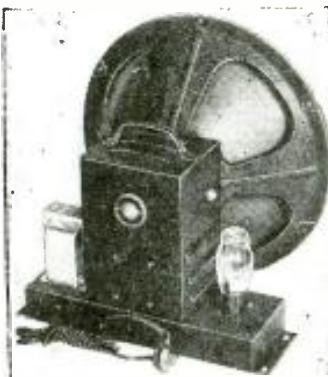

Above, a new 30 W. speaker. (630)



Above, 10-wire analyzer kit. (637)

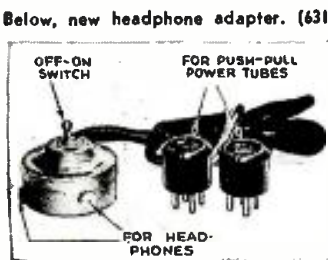

Below, new headphone adapter. (631)

"TATTELITES" NEW "VOLT- AGE" FUSES (633)

"TATTELITES" protect equipment against excess voltage breakdown by shunting excess currents, thereby differing radically from the usual current-actuated devices. They operate by neon discharge, glowing brilliantly

Below, multi-range meter. (638)



Class "A" P. A. amplifier. (632)

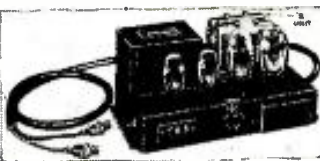

Voltage fuses and testers. (633)



Name of manufacturer of any device will be sent on receipt of a self-addressed, stamped envelope. Kindly give (number) in description under picture.



New "99" and its elements. (639)



Pyranol-insulated condensers (640)



Home-garage battery charger. (641)



Order-type P.A. system. (642)

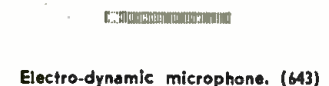

Electro-dynamic microphone. (643)

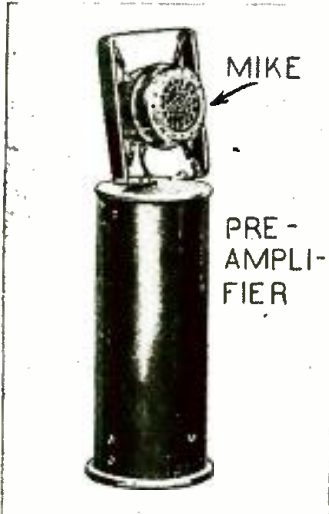

MIKE

PRE-AMPLIFIER

at the following breakdown potentials: 100, 250, 500, 1,000 and 2,000 V. A unique feature of the higher voltage types is their adjustable ignition point by means of secondary electrodes.

Uses are many. They protect instruments, transformers, condensers, gaseous rectifiers, radio sets against lightning surges, and excessive line voltages. The lower voltage rated types are excellent for locating blow fuses, defective resistors, condensers, etc. By intensity of the glow, approximate voltages are indicated.

"PORTABLEST" PHONO-RADIO SUPER. (634)

MEASURING only 10x11x13 ins., and containing a sensitive 6-tube superhet. radio receiver, dual-speed phonograph for both 10 and 12 in. records, playable on both A.C. and D.C. circuits, with tone control—this seems to be the portable-seekers' answer. Uses 1 43, 1 6A7, 1 6D6, 1 75, and 1 12Z3.

GOOD "DYNAMIC" P.A. MICROPHONE (643)

THE designers of this new mike apparently had experience with sound effects resulting from husky, deep-throated bass voices, for they have made it with adjustable frequency response. Construction is exceptionally durable, well able to stand abuse incident to public address work. Frequency response is practically flat from 40 to 10,000 cycles with a gain of minus 60 db. at 400 cycles.

HANDSETS GIVE THAT "CLASSY" TOUCH (644)

(Shure Brothers Co.)

FOR the last word in transceiver equipment, we feel sure you will take enthusiastically to this "French hand set." The high output mike is equally sensitive to all voice frequencies. The receiver is a 2,000-ohm unit. Four separate leads from mike and receiver are provided so that receiver may be plugged directly into plate circuit of output tube, entirely free from microphone circuit.

"XP-53"—A LOW-LOSS COIL-FORM DIELECTRIC (645)

(Hammarlund Mfg. Company, Inc.)

AN IMPROVED dielectric known as "XP-53" is used in the newest low-loss plug-in coil forms

Mike-receiver hand-set. (644)



for use down to 17 meters. Windings are air-spaced by means of ribs. They are also flange grips, and neat meter-index inserts for wavelength indications. A threaded shelf molded inside permits mounting of a trimming, padding or band-spreading condenser. Available in 4 (A), 5 or 6 (B) prongs.

COMMERCIAL-STYLE AMATEUR SHORT-WAVE RECEIVER (646)

(Radio Trading Company)

THE DOERLE A. C. 5 bids fair to be one of the sensations of the early 1935. Priced down where fans like it, its exceptional efficiency shows up on loudspeaker DX performance in a perfectly bone-tickling manner.

A stage of 6D6 R.F. feeds a 6F7 in a combined detector and first A.F. circuit. Regeneration is smooth. The A.F. output of the 6F7 feeds a 37 which in turn drives a 41 pentode at full output. Matching a husky dynamic speaker to the pentode completes a very satisfying, compact, simple outfit. Single dial tuning on full-vision airplane type dial. Set and speaker are mounted in handsome black crackle-finish metal cabinet with patterned speaker grill.

GLOBE SHOWS S.-W. BROADCASTERS (647)

AN ACCURATE, readable 12 in. globe, carrying more than 5,000 names, principal steamship routes, railroads, ocean currents, mountain peak heights, etc., is now available to the owners of broadcast, all-wave, and short-wave sets.

This globe establishes a precedent by printing in red the names and call-letters of all important short-wave stations. This terrestrial sphere is a handsome ornament in any den or liberty.

"SNAPPER" PRODS RETRIEVE AND GRIP (648)

A REAL handy tool for hams and Service Men, or we miss a sure guess. Push with your thumb and the jaws spring apart. Release and that inaccessible lug is secured mechanically—and electrically, a binding post being provided at one end for use as a prod, etc. It's a cinch to pick up gobs of solder or spare nuts from out-of-the-way corners of the chassis.

(Continued on page 511)

New "XP-53" coil forms. (645)



Corking new S.-W. DX-er. (646)



12-in. S.-W. station locator. (647)



Handy prod, gripper, retriever. (648)



Above, K-12 high-fidelity speaker. (649)

High-fidelity radio phonograph. (650)



THE LISTENING POST FOR ALL-WAVE DX-ERS

This page is devoted to the radio enthusiast who is solely interested in world-wide reception and facts that will aid him in obtaining the ne plus ultra in radio results.

C. A. MORRISON



The radio transmitter at Reykjavik, Iceland.

LAST month we took up the subject of verifications, explaining what they are, and how to secure them. Verifications of reception may be displayed to your friends with some feeling of pride, as they furnish undeniable proof of your personal reception of some unusual station or program. Many DX-ers eventually acquire large and valuable collections of verifications. These may be displayed or filed by various systems. A DX-er often shows his originality by the manner in which he displays these verifications.

One well-known DX-er in Chicago has the walls of his radio den literally covered with hundreds of verifications. These are neatly mounted on art-board, and grouped into countries. The exact station and location is neatly written in india ink below the verification. These verifications in a dozen different languages, and in all colors and shapes provide a very attractive and interesting display indeed.

Some people would rather mount their verifications in an album, or loose-leaf note book where they may be arranged in alphabetical order, or by dates of reception and be convenient for carrying around. Still others file their verifications away in a letter file. A little time spent in attractively mounting, or displaying your collection is time well spent. (In this connection it would be interesting for us to know how you display your verifications. Perhaps you have some new, or novel system that would be of value to your brother DX-ers.—Ed.)

Intrinsic Value of Verifications

Verifications often have an intrinsic value as well as a hobby interest. Many DX-ers have won various prizes with individual verifications, or collections of verifications. Stations putting on "DX programs" quite often give prizes for the report from the greatest distance, or the best report received. The various DX clubs and radio periodicals often conduct DX-ing contests of one kind or another, in which they offer valuable awards in cash, radio merchandise, or handsome trophies. So often your hobby may be productive of some

The receiving post of Mr. F. K. Moyd at Guana-juato in the interior of Mexico.



This photo shows an interesting experiment in broadcasting conducted recently by a Japanese radio network, in which several blind musicians broadcast simultaneously from different locations. Telephone lines were used to cue the programs.

miliar items may be identified?" This really is not as difficult as it may seem, as nearly all foreign stations announce calls and locations at more or less irregular intervals. By listening closely you can generally pick out the call, and often the location. Even though you do not understand it, you can put down the exact time it was given and whether by a man or woman, and any other observations that might serve later in identifying the station.

How to Identify Stations

I would suggest that all DX-ers familiarize themselves with the phonetic sounds of the letters, in the alphabets of at least three commonly used foreign languages. Spanish, German and French are the most important, in the order given. It is not important to learn how to read or write these characters but merely to learn how they

sound, so that a call can be understood. Your local library, or radio club will help you make up these alphabets. (If sufficient demand is manifested, we shall be glad to give these foreign phonetic alphabets in this department.—Ed.) Thus station LSX, in Buenos Aires would be easily recognized when the Announcer said in Spanish "Elly Essay, Eckay, or L-S-X. In the call LR4 the announcer would say "Elly, Airay, Cuatro, or L-R-4. It would also be well to familiarize yourself with the Spanish numbers one to ten.

Various stations use identification signals of various sorts which are easily recognizable. Thus XEBT in Mexico has three cuckoo calls. VK2ME in Sydney, Australia, is famous for the "laugh of the kookaburra"; Zeesen, Germany uses a musical bar from the German song "Be True and Honest," as a interval signal, etc. The signal, or identification of a station should be described in your report, along with the exact time given.

A brief description of the type of music, together with the kind of musical instruments being played at a certain time is often important in your report. The time of a station's signing off should always be given, if heard, and the title of the signature piece if recognizable.

If you are listening to an unknown foreign station, a good radio log, together with the time heard, and the language employed will generally give you a very good idea of what station you are listening to, so that you may be sure of where to send your report. In the case of a new station on the air, and not yet listed, you are stuck unless you can through intelligent and careful listening decipher the station's identity on the basis of the above methods. Most short-wave stations now give their calls, at least irregularly, in several different languages.

Next month we will take up a brief survey of the various well-known radio clubs, giving you a brief history of each of the larger ones, and explaining just what their purpose is, and how they fit into the DX-ing picture.

(Continued on page 500)

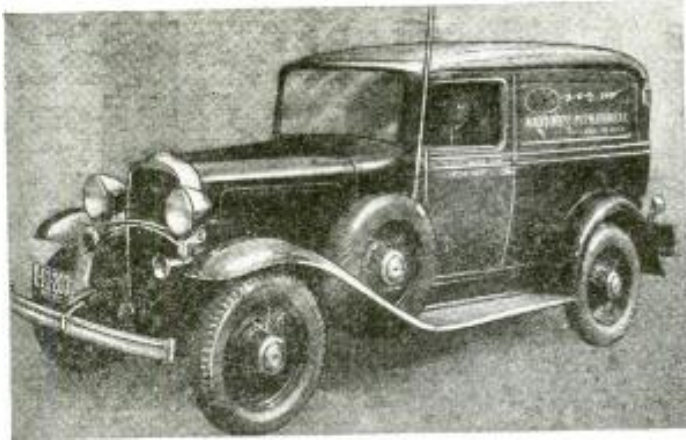

One of the field service trucks used in locating noises.

NEW DEVELOPMENTS IN INTERFERENCE ELIMINATION

The problem of eliminating man-made static is getting worse, instead of better according to this interesting story which tells why.

R. L. HASKINS AND C. W. METCALF*

PART I

WHY is radio interference a more serious problem today than before? Surely it is not because of any lack of technical or engineering knowledge for if all of the technical information that has been published on this subject were combined in a single volume, it would make a book nearly as large as an unabridged dictionary. This volume would include all types of information from simple discussions of aerial installation to highly complex studies of the effect on noise production and distribution, of the various physical and electrical characteristics of power circuits and apparatus which may be connected there-to. It would also include descriptions of tests conducted to locate interference sources, starting with so simple a check as disconnecting or shutting off a suspected appliance and concluding with involved studies of signal-to-noise ratios, field strength patterns and allowable interference intensities. Such a volume would also contain descriptions of the methods that have been found successful in suppressing every known type of man-made static.

Even the fact that short-wave and all-wave receivers are now being more widely used than ever before does not materially affect the radio interference problem. The fundamental knowledge that has long been available on the elimination of noise at broadcast frequencies applies equally to elimination of interference at the higher frequencies so long as the characteristics of high frequency transmission and reception are taken into consideration.

Despite the wealth of technical information that is available at the present time, the many organizations interested in improving radio reception through the elimination of man-made static continue to concentrate their efforts on the engineering phases of the problem and wholly ignore what has been found to be the most important of all; namely, the human aspect of the radio interference problem. It has been definitely proved in

the many interference surveys conducted by engineers that the greatest need of the radio listening public is not for interference experts who can tell what must be done to eliminate noise but for experts in human relationships who can overcome the mental inertia which tends to make most of us wait for the other fellow to take the first steps in clearing interference.

Experienced noise investigators agree that the location of noise sources by means of instruments now available is a relatively simple matter and that the elimination of noise when its source has once been determined seldom presents any unusual technical problem. The real problem is that of persuading the owner of the interfering apparatus that he should take the steps necessary to render his equipment non-interfering.

The Reason

Interference surveys that have been conducted in both large and small com-

The interior of a noise survey truck showing some of the instruments used for measuring interference intensity.



munities from Maine to Florida and as far west as the Rocky Mountains have proved conclusively that, by far, the largest part of the radio interference in any community originates on the premises of the radio listener but that the interference seldom originates on the same premises with the receiver being affected. It is easy to see why this condition exists for as a rule the radio set receives the undivided attention of its owner, who does not operate apparatus which might cause radio interference while his own receiver is being used. Consequently, the radio listener seldom realizes that his operation of electrical appliances causes a duplication in his neighbor's receiver of the unidentified noises heard in his own set. In fact, many listeners are surprised to learn that they are in any way responsible for the unsatisfactory receiving conditions existing in their community.

This does not mean, however, that as soon as the radio set owner realizes how many noise sources are contained in his own home he hastens to correct them so that the general noise level in the neighborhood may be reduced. Quite the contrary condition is revealed by the reports of interference surveys conducted by field engineers. For example, in a Maine city (which is best left un-named) a woman stopped the driver of the survey car and asked him to check up on the noise heard in her receiver—noise which she attributed to the operation of hair clippers in a near-by barber shop. She stated that this particular interference had been spoiling her radio reception for a long time and that she had written to the State Public Utilities Commission and to the Federal Communications Commission in an effort to have the interference cleared.

The survey engineer quickly determined that the set owner's analysis of the trouble was correct and agreed to talk with the barber about "filtering" his clippers. Then he asked if there were any appliances in the home that might cause radio noise. On receiving permission to test the various electrical

(Continued on page 494)

*Eng. Dept. Tobe Deutschmann Corp.

BUILD THIS VERSATILE TEST INSTRUMENT

The critical radio technician, who wants a really fine portable laboratory for experimental work as well as ordinary set testing, will find many interesting points in this compact, yet versatile, test instrument.

JESSE TILLET



Fig. A—The complete instrument.

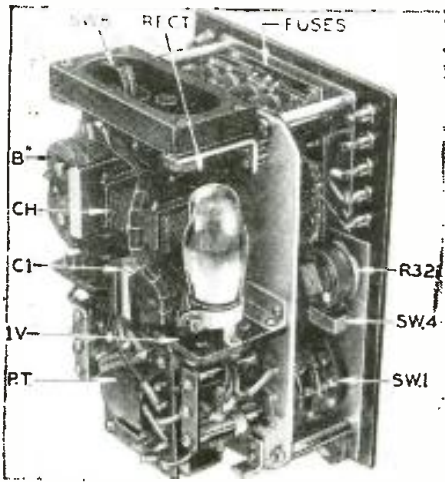

Fig. D

The rear view of the test instrument, showing the positions of many of the parts. The compactness of the unit can be appreciated from this view.

THE PURPOSE of this article is to describe a test instrument for the radio Service Man, or experimenter, which has the virtue of being somewhat more complete than the average instrument of its type and also incorporates several unusual features which add to its utility.

The instrument is essentially of a fundamental nature, inasmuch as it consists primarily of a Volt, Ohm, Milliampere, Capacity, Inductance and Impedance measuring instrument, with several additional features, and so constructed as to be relatively independent of changes in radio receiver design.

An effort will be made to describe the features of this instrument in such a way as to permit a duplicate to be constructed, or to assist in the design of similar apparatus. Rather than show exact panel layouts and detailed assembly data, however, a liberal use of photographs, together with detailed

and sectionalized wiring diagrams, calibration data and parts lists will be used to convey the essential facts, leaving the exact size of panel and arrangement of apparatus more or less subject to the choice of the builder.

The above plan, in the writer's opinion, is a logical procedure, inasmuch as it permits the exercise of individual preference.

A detailed and orderly presentation of the various features of this instrument is now in order and we will begin by calling attention to Fig. 1. This circuit diagram represents the complete schematic diagram with every switch, resistor or other part assigned a number or other identifying mark and with all tip jacks designated by function and polarity as well as number.

The Switches

The two main selector switches at the
(Continued on page 487)

Fig. 1

The schematic circuit of the tester which measures volts, ohms, capacity, inductance and impedance values.

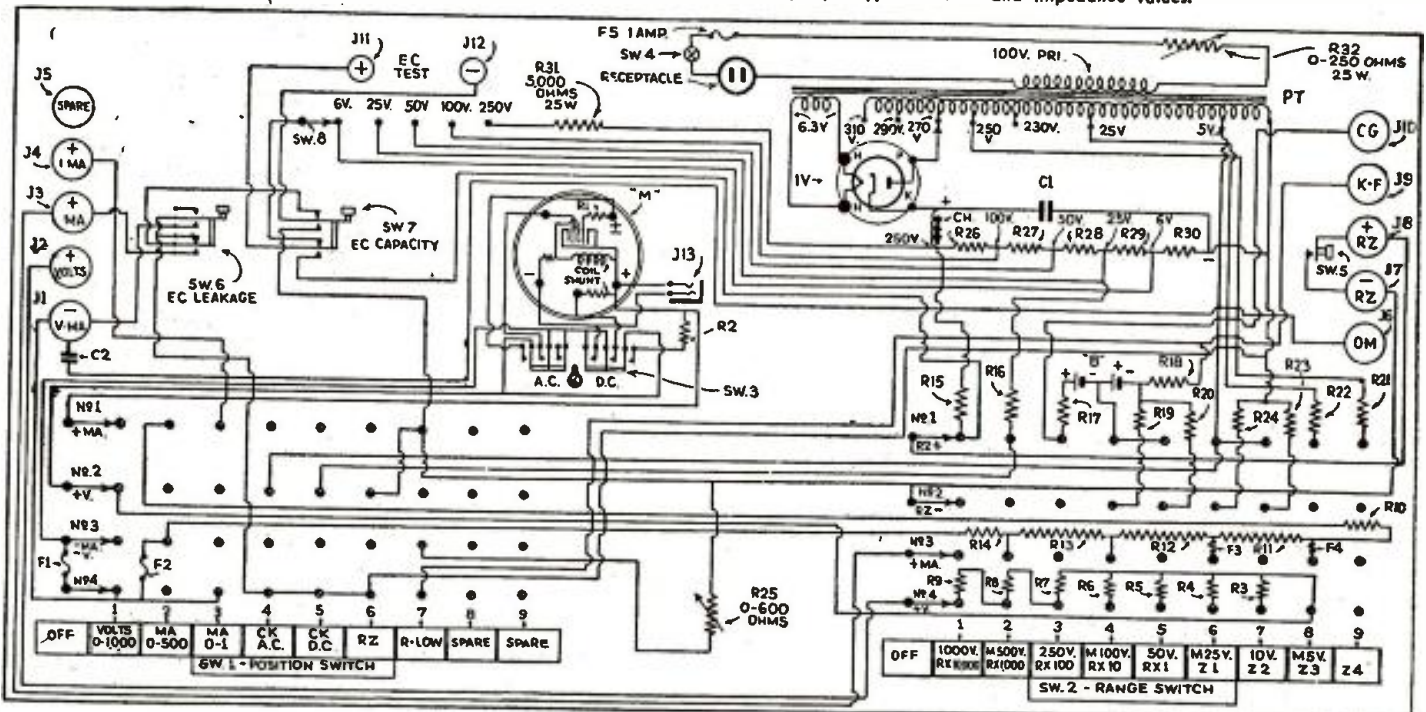



A NEW PORTABLE P.A. AMPLIFIER

A new A.C.-D.C. amplifier for medium-size auditoriums which weighs only 5 lbs., yet rivals many more expensive amplifiers in quality and flexibility of application. The speaker is built-in. Excellent for "hawking" wares.

J. P. RELIM*

A NEW portable public address amplifier and speaker constructed in a case weighing altogether only 5 lbs. and with sufficient volume to fill a medium-size auditorium, is the latest development in this type of equipment.

This surprisingly compact apparatus operates on 110 V.

Fig. 1—The circuit of the complete amplifier.

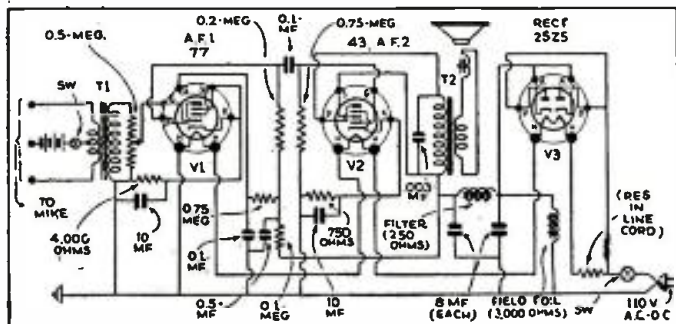

A.C. or D.C., and its clarity compares very favorably with that of more expensive "high fidelity" amplifiers.

A phono. pickup or a single- or double-button microphone may be connected directly to the amplifier's input, for the microphone transformer is already built in.

The amplifier consists of 2 audio stages, a 77 feeding a 43 and a 25Z5 as a rectifier. (The hookup of the 77 and 43 is such that it operates in a most efficient manner. The 25Z5 supplies the necessary plate current and also saturates a built-in 3,000-ohm speaker field. The reproduction of the bass notes that is so important in any public address amplifier is so evident that any one listening would never guess that the maximum plate voltage on the tubes is only 100 V. The fine results on the low audio frequency are due to the heavy bypassing of all the cathode resistances and the large coupling condenser between the 77 and 43. Note: the .5-mf. condenser in the plate supply of the 77 banishes all trace of hum.

The cathode of the 77 uses a 4,000-ohm biasing resistance (Continued on page 511)

*Leotone Radio Co.

HELPFUL HINTS ABOUT CURRENT MULTIPLIERS

Some little known facts about meter shunts are presented here. They should be of interest to every radio technician.

D. L. VAN LEUVEN*

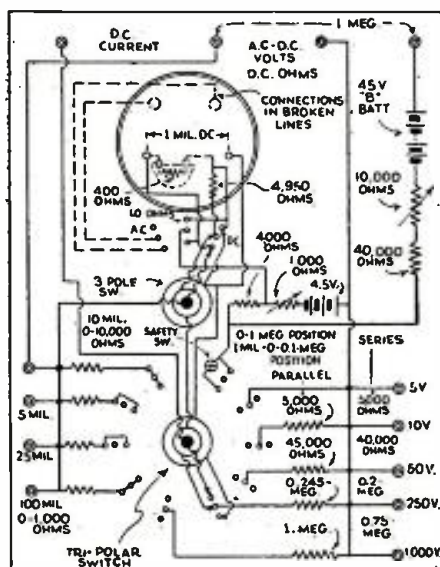

THE WORD "shunt" in electrical terminology covers a large field; therefore the data that is to follow will be confined to those small current models mostly used by Service Men, experimentors and others.

These little instruments of high accuracy and dependability are not, as some have found out, just a piece of resistance wire. The resistance element should be non-corrosive, its temperature coefficient practically nil and it should be free from any tendency to become brittle from heating due to repeated overloading.

Questions concerning the error caused by the possible thermo-couple between some high resistance alloys and copper have been raised. In shunts constructed like those shown in Fig. A with a thin copper lug exten-

*D. L. Van Leuven Labs.

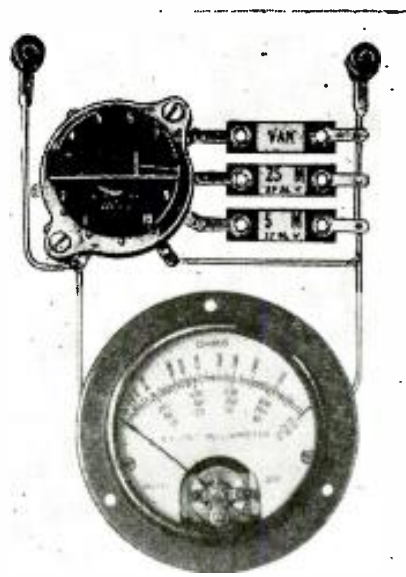

Fig. A—A typical meter with added shunts.

sion, the thermal effect at one end of the shunt, being positive, will cancel out an equal amount of negative pressure created at the opposing end; at least to a degree which leaves the error negligible.

Shunt Circuits

In order not to disturb the efficiency of a circuit, the shunt's own resistance should be as low as possible, thus in- (Continued on page 504)

LOW COST 30-WATT P. A. AMPLIFIER

By an ingenious application of circuit constants, this amplifier uses the high quality of class A amplification for low volume, while it has the high output only possible with class B, when using an economical layout of parts and low voltage tubes.

WALTER A. CARTER*

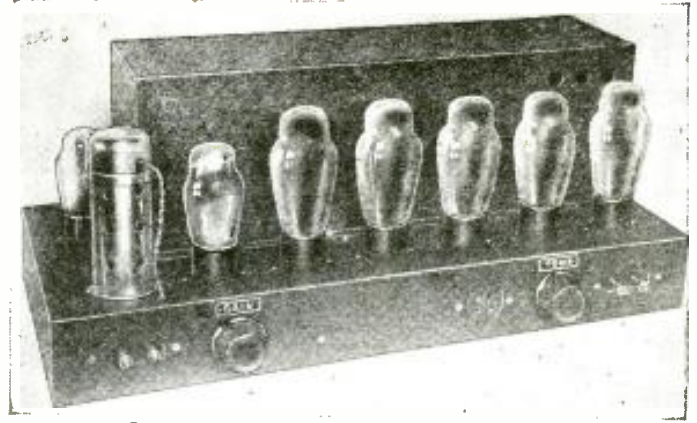

The appearance of the amplifier with its 8 tubes.

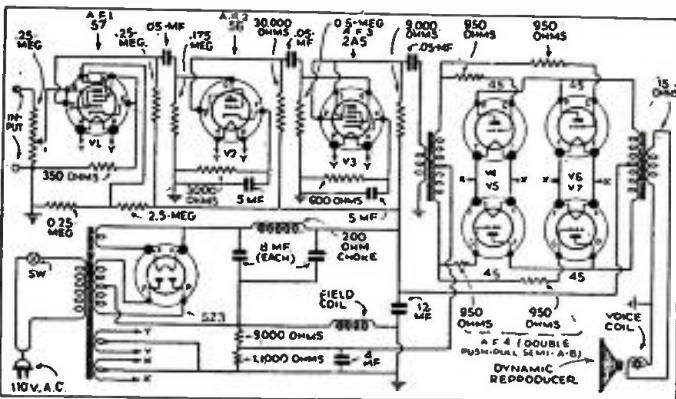

*Consulting Eng., Mario Radio Prods. Co.

THE AMPLIFIER described in this article is an excellent example of a low-cost, high-quality power amplifier.

The author has found, through experience and investigation, that an amplifier capable of delivering 20- to 30-W. output, with low distortion levels will meet 90% of the requirements in the P.A. field. Previous high price listing on systems of this size has limited their use to a minority of dealers and radio men and it was to circumvent this condition that the present amplifier, one of a series recently designed by the author, was developed.

Four stages, utilizing low cost tubes, produce an output of 30W. at a distortion level of less than 7% and an overall gain of 94 db.

The audio range, over a frequency spectrum of 25 to (Continued on page 510)

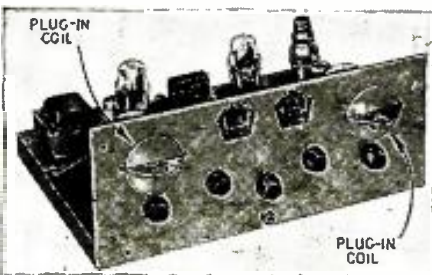

5-TUBE A. C. SHORT-WAVE BAND-SPREAD KIT SET

Here is a simple, reliable short-wave receiver that can be built by anyone, yet it supplies full loud-speaker volume.

BERNARD ERDE*

WITH THE increasing interest in all-wave receivers, many new sets have made their appearance on the market. However, the man who likes to make his own sets has been somewhat neglected by manufacturers and it is with this fact in mind that the kit set shown in the accompanying illustrations was designed.

As seen in the circuit, it has five

tubes, including the 80 rectifier. A type 78 tube serves as a tuned R.F. amplifier; a 37 is employed as a detector; a 77 is used as the first A.F. amplifier and the second A.F. stage contains a 42 pentode.

A dual tuning condenser tunes the two tuned circuits with a single dial, and across each of the sections of this condenser are connected the sections of a 5-plate midget condenser which

permits band-spread tuning on any part of the short-wave spectrum.

Regeneration in the detector is controlled by a resistor connected in series with a .001-mf. fixed condenser. This provides a smooth action, which is free from most of the troubles encountered in such circuits.

The A.F. amplifier in this set is equipped with a phono. connection so (Continued on page 508)

*Chief Engineer, Insuline Corp. of America.

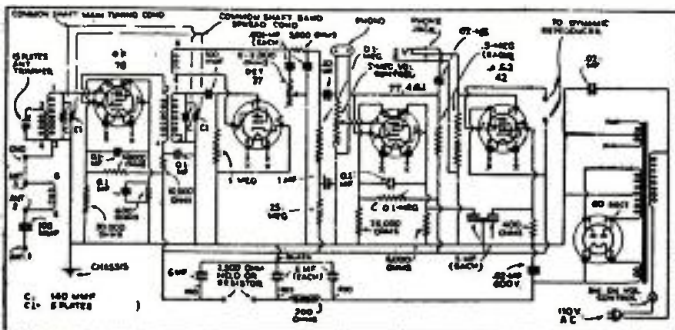

The circuit of the receiver is at the left—all values are shown, as well as coil connections and color codes. The rear of the chassis is at the right.



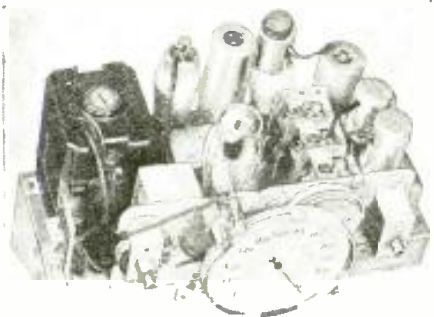

APPLICATIONS OF THE GENERATOR TYPE AUTO "B" POWER UNIT

There are numerous applications for the small rotary converters used for auto radio sets, besides their intended application. This article clarifies some facts about these units and outlines ways in which they may be employed.

G. W. BLESSING*

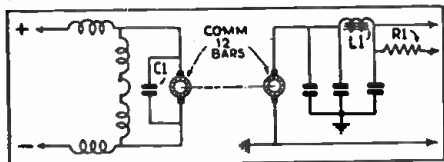

THE GENERATOR derives its name from the method of its operation, namely, a motor-generator or converter, in a modified form. The theory of operation needs but little explanation, as practically all Service Men are familiar with this principle.

In the past, the chief disadvantage of motor-generator sets was the inefficiency, weight, and size required for a given output. These disadvantages have been eliminated by combining the input and output winding on one

*Engr. Carter Motor Co

armature, consequently one set of fields is all that is required for proper excitation. By proper coordination of steel and copper in design, together with highly efficient bearings, the size has been reduced to remarkably small dimensions; $2\frac{7}{8} \times 4 \times 5$ ins. long. The weight is less than 7 pounds.

The armature in this unit is equipped with two commutators, one for the input winding and the other for the output. The voltage developed at the output terminals is determined largely by the ratio of input to output turns, which is calculated in a manner

similar to transformer design.

The field excitation is provided through a series and a shunt winding, half of each winding being placed on opposing poles in the field lamination, which is spaced only a few hundredths of an inch from the armature. The shunt winding consists of a comparatively large number of turns connected directly across the input brushes, while the series, or starting winding consists of only a few turns of somewhat heavier wire. The series winding serves two functions. In addition to furnish-

(Continued on page 499)

NEW 16 MM. SOUND CAMERA FOR HOME MOVIES

Here is the first sound camera commercially available for making "talkies" at home. The films may be loaded or unloaded outside of the dark room and the manufacturer processes the films free of charge.



The sound camera with its carrying case and lenses.

R. D. WASHBURNE

THE HOME movie enthusiast can now make his own "sound" pictures with a simple fool-proof sound camera for 16 mm. film that has just been introduced on the market by the RCA Victor Company, Inc.—the first of its kind to be sold to the public.

The camera, shown in the accompanying photograph is arranged for either "studio" or "spot" picture taking. In the rear of the case is a mike mouthpiece which permits the operator to make a running comment of the pictures being taken—such as sports events, news, etc. The mike mouthpiece is easily removed to permit a separate microphone to be attached for studio or similar types of movies. This

permits considerable latitude in the operating conditions. With the separate mike, a portable amplifier and battery box can be obtained, to supply the desired volume for recording on the film.

This sound camera is equipped with a three lens turret with fittings for two telescopic or other special lenses, in addition to the standard "F-3.5" lens furnished with the device. By simply turning the turret, the desired lens is thrown into the operating position, thus permitting accurate focusing for both close-ups and long range shots.

A visual footage indicator is mounted in a position where the operator can easily watch for the end of

the reel, for rewinding. The winding crank swings out of the way, when not in use, while the starter button can be locked in position, allowing the operator to step into the picture himself or pay closer attention to the acting and sound effects.

The base of the camera is fitted for a standard tripod mount and a bracket is available for convenient mounting of the amplifier and battery boxes used with external microphone recording. (This set-up is not shown in the photo here.)

A telescope view-finder on one side of the camera automatically determines the range of the camera and the

(Continued on page 510)

OFFICIAL RADIO SERVICE MEN'S ASSOCIATION, INC.

MEMBERS' FORUM

This department is devoted to members and those interested in the Official Radio Service Men's Association. It is the medium for exchanging ideas, kinks, gossip and notes of interest to those who comprise the membership.

RESISTANCE-CAPACITY TESTER

RADIO-CRAFT, ORSMA Dept.:

I am submitting a diagram and details of a very inexpensive and simple tester for Service Men. It employs only a single milliammeter, 0-5 scale. Or if the constructor wishes to further simplify this unit's construction a Readrite 2 scale 0-20 and 0-800 meter can be substituted. The diagram shown is self-explanatory as to the parts and connections necessary. Also, the drawings indicate layout and compactness of this instrument. (Fig. 1)

Place a 201A tube in tester and use the meter as an ohmmeter by shorting the test prongs when switch A is moved to test position. It will measure up to .5-megohm. It is indispensable for locating shorted condensers and open resistors. Calibrate meter into ohmmeter by testing known resistances in it. The following tabulation indicates the necessary sockets for testing types of tubes:

Tubes

- (1) 226, 171A, 45, 201A, 210, 200A, 2A3, 30, 31, 20, 250, 34, 40.
- (2) 280, 281, 82, 5Z3, 83.
- (3) 247, 43, 33, 49, 52, DA.
- (4) 57, 58, 77, 78, 2A5, 89, 41, 42.

- (5) 55, 85, 2A6, 75.
- (6) 227, 57, 56, 67, 224, 235, 236, 38, 39, 44, 64, 65, 68, 551.
- (7) 59.

Other uses of the instrument will readily suggest themselves to those who are interested or who desire to construct this instrument.

C. VOGAN

HEATER-CATHODE SHORT TEST

RADIO-CRAFT, ORSMA Dept.:

Since the quick heater tubes have been out, there has been a decided increase in the number of heater cathode shorts that occur in this type of tube. To test for this short on the older types of short tube testers, the addition of a S.P. off-on switch is all that is needed to show this defect while the tube is hot.

The heater is invariably connected direct to the cathode in the testers and breaking this cathode connection and running it to the switch and from the switch back to the heater is the only rewiring needed. A good tube will show NO reading when the switch is open but will show a fluctuating reading if there is a short up to .1-meg.

A single-throw switch is used in preference to a push button as the tube

can more easily be tapped gently to help show the short. The illustration, Fig. 2 shows one socket only, but all sockets are treated in the same manner.

MANITOBA HARDWARE

HANDY FORMULA CARD

RADIO-CRAFT, ORSMA Dept.:

The subject of Ohm's Law is ever new and ever old. We have tables galore on various phases and expressions of it.

In my 30 years in the radio game, I have never seen published a complete list such as follows. I feel sure its publication will be welcomed by many and numerous electrical and radio fans.

$$E = (I \times R), (W \div I), (KW \times 1,000 \div I), (\sqrt{R \times W}), (MA \times R \div 1,000), (1,000 \times W \div MA)$$

$$E^2 = (W \times R)$$

$$I = (E \div R), (W \div E), (KW \times 1,000 \div E), (\sqrt{W \times R})$$

$$I^2 = (W \div R), (KW \div 1,000 \div E)$$

$$R = (E \div I), (E^2 \div W), (W \div I^2), (1,000 \times E \div MA), (1,000,000 \times W \div MA^2)$$

$$MA = (1,000 \times E \div R), (1,000 \times W \div E), (\sqrt{W \div R \times 1,000})$$

$$MV = (I \times R \div 1,000), (W \div I \div 1,000), (W \div MA \div 1,000)$$

$$W (DC) = (E \times I), (HP \times 746), (E^2 \div R), (E \times MA \div 1,000), (MA^2 \times R \div 1,000,000), (I^2 \times R), (1/746 HP), (Joules \times Seconds)$$

(Continued on page 499)

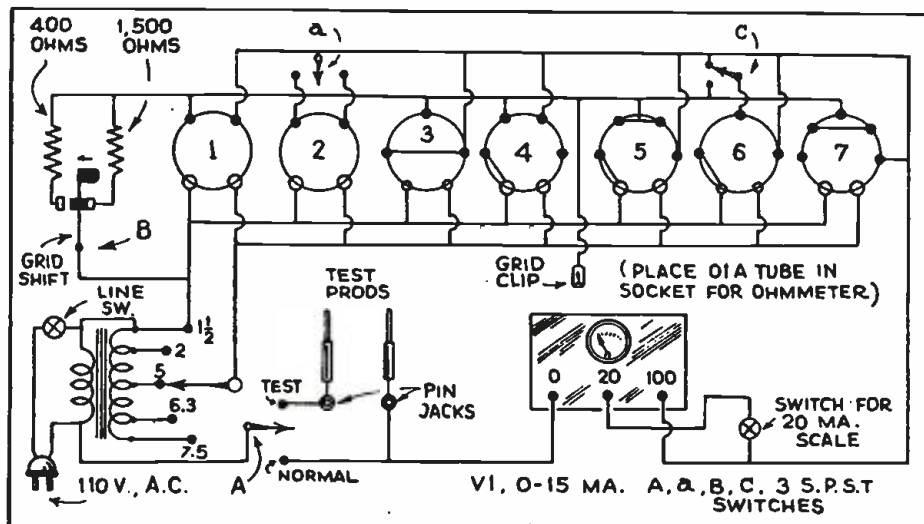
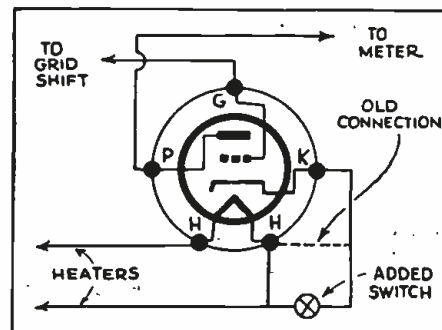

Fig. 1, left.

The tester on the left is a development of one ORSMA member as an improvement over existing types of instruments. It is an ohmmeter, capacity meter and tube tester.

Fig. 2, below.

The testing of quick heater tubes is facilitated by this change in the tube tester. It will be found to be of much use in servicing work.



ELEMENTS OF 4TH DIMENSION P. A. OR SOUND SYSTEMS

Some practical considerations of the factors entering the installation of hi-fidelity equipment.

H. S. MANNEY* AND C. R. SHAW†

PART II

FOURTH dimensional sound is not a new fangled idea in acoustics, in fact it probably is the oldest phenomenon in the world which can be associated with those prehistoric inhabitants gifted with a sense of hearing! Primitive man rapidly learned to interpret and localize sounds, i.e., judge their distance and direction, for his very existence depended upon an acquired ability to accurately gauge the direction and speed of motion of some menacing and moving sound source. Modern man, on the other hand, has been so enthralled with his accomplishment of artificially recreated sounds, that many vital and missing links were not known to be lacking and were never missed—until somebody found them! Who would have condemned the "life-like" reproduction of our 1922 radio horns—in 1922? Who would have said that the "natural" reproduction of our first talkie pictures was far from perfect? The thrill of accomplishment usually temporarily blinds us to minor and major defects of our creations.

Now that the various applications of public address equipment are accepted things of the past, what is wrong with these systems? This question will undoubtedly be precisely answered by the new developments which will take place in the P. A. field within the next year.

Recent interest in auditory perspective and fourth dimensional sound seems to point a finger in the right direction and, at the same time, focus attention to the weak spots in our present systems. Let us briefly analyze the major defects of our apparently "perfect" applications, with an open mind towards recognizing and eliminating all obstacles which prevent the attainment of perfect artificially recreated sound.

If we were to ask a sound system engineer what major types of distortion are being found in present sound reproducing installations, he would probably reply, "(1) *frequency distortion* (which is produced when all of the various audio frequencies are not reproduced equally well). (2) *amplitude distortion* (or harmonic distortion which occurs when a given increase in the volume of sound at the microphone does not cause a proportionate increase in the sound output of the loudspeakers). (3) *phase distortion* (which is noticed when some audio frequencies travel faster than others and consequently reach their destination ahead of their 'brothers')."

The sound technician would undoubtedly omit, (4) *directional sound distortion* (which is produced when a recreated sound appears to come from some direction other than the one you would naturally expect to hear it from).

(Continued on page 497)

*Research Engineer, Columbia Sound Systems Co.
†Design Engineer, Columbia Sound Systems Co.

Fig. 7

The most common cause of directional distortion in amplifying sounds for stage effects.

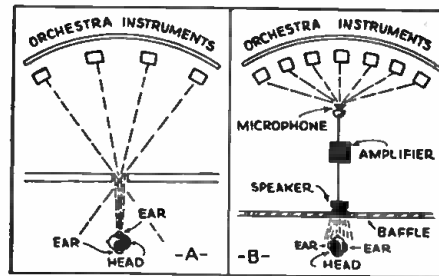
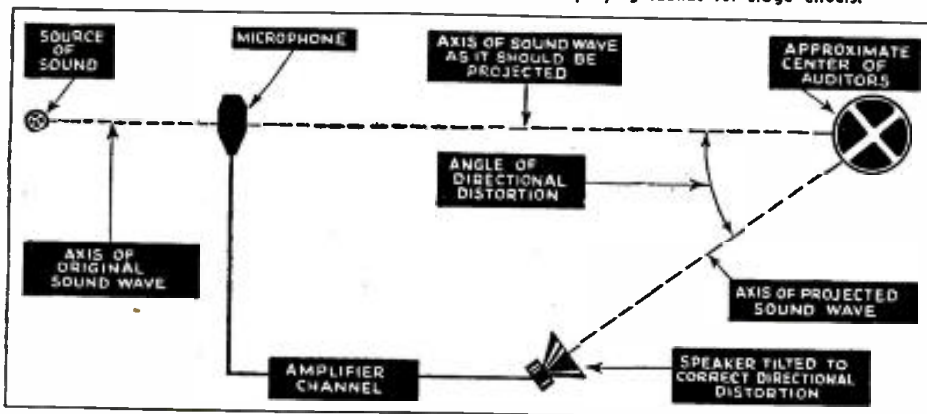

Fig. 1—The knot hole effect.

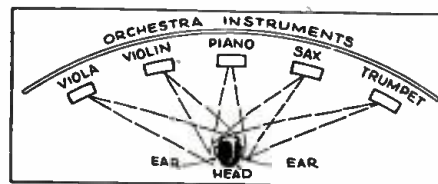

Fig. 2—How sounds are localized.

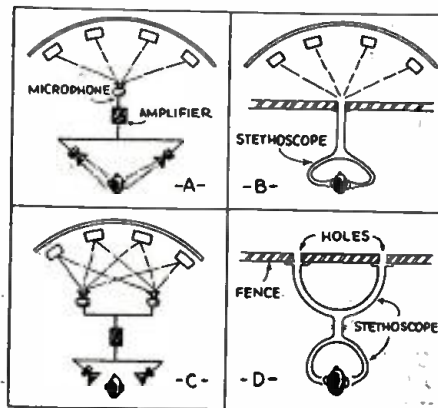

Fig. 3—Simulating natural hearing.

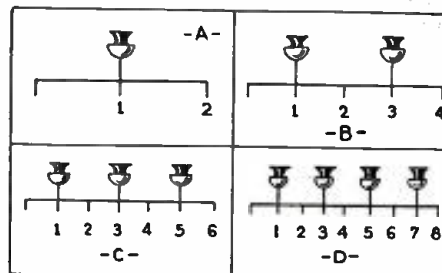

Fig. 4—Placing mikes for sound localizing.

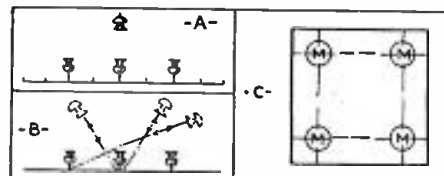
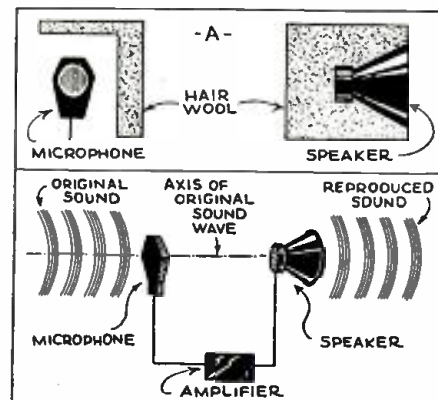

Fig. 5, above—The best mike positions.

Fig. 6, below—Stage sound effects.



THE ANALYSIS OF RADIO RECEIVER SYMPTOMS

OPERATING NOTES

WHAT THIS DEPARTMENT IS FOR

It is conducted especially for the professional Service Man. In it will be found the most unusual troubles encountered in radio service work, written in a practical manner, by Service Men for you.

Have you, as a professional man, encountered any unusual or interesting Service Kinks that may help your fellow workers? If so, let us have them. They will be paid for, upon publication, at regular space rates.

MAJESTIC MODEL 90

SET was dead when inspected. After cleaning and testing tubes and looking to aerial and ground as per usual, no signal was audible. Voltages and currents were all within reason so chassis was not as yet pulled. This set is so structurally built that it is hard to see if the 45's are lit and after the voltage and current tests the 45's were replaced, in turn, after taking them out of the analyzer. Finally, it was noted that one 45 was not receiving filament current, so this was checked, and the 2.5 volts was there O.K. at each socket. Tube, rechecked, was O.K. On close scrutiny (refer now to Fig. 1, A, B, C) it appeared that the

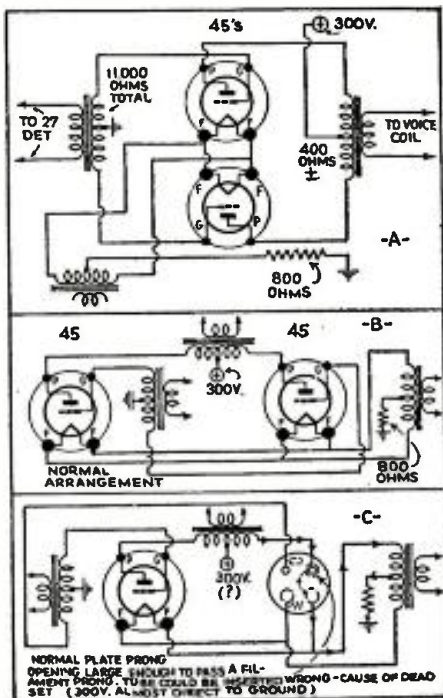

normal small plate opening in the 45 socket was large enough to pass a filament prong, as in Fig. 1-C, resulting in a low resistance path to ground of 300 volts and placing both grid and plate at about ground potential. Therefore, the normal 300 volts was probably far reduced to entire set of tubes and it is unlikely that any possible signal getting through would have possibly passed the 45's. Analyzer plug had been correctly inserted and hence gave a true reading. Cure, turn tube. Repair, not wanted, so with a word of future caution about tampering, the job was done.

DEWALD AC547-A

SET came in dead. Power transformer was obviously shot as all insulation was badly charred. Why had it burned out? The electrolytics were at first suspected, but after a new transformer was installed and new electrolytics had been temporarily installed (since the old ones drew more than normal current) it was found that by twisting the chassis the filament voltage was cut in half and the transformer hummed badly, indicating a filament winding short. This was found where a socket prong was intermittently grounding half of the filament supply. The way the set was fastened in the cabinet after someone had tampered with it, or due to tampering with filament prongs was the primary source of trouble. Bending the prongs had caused the trouble in the first case, I believe. After possibility of shorting was removed set was, so far, O.K., but oscillated badly. This was cured, as so often is the case, by cleaning rotor contacts and wiper contacts and securely soldering wipers and all chassis grounds together with a one-

Fig. 1, left

The circuit of the amplifier appears at A, while the way in which the tube was reversed, thus preventing operation, is depicted at C.

Fig. 2, below

A short in the filament winding caused an overload to the power transformer.

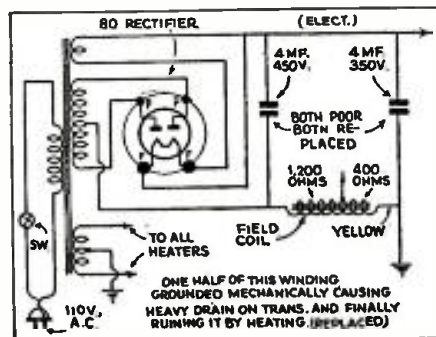

DEFECTIVE TUBES—

Are not to be considered as the subject for an Operating Note. It is assumed that all Service Men test tubes when making a service call. Their experiences on the subject of testing tubes, unless most unusual, are not of sufficient interest to other Service Men. Operating Notes should be confined to those faults which are characteristic of, and repeatedly occur in connection with a particular model of radio receiver.

piece lead, rosin fluxed. Electrolytics were left in. See Fig. 2 for schematic.

SPARTON 931

SET was received dead. Cause, open 1250 ohm parallel 182's bias resistor. Repair, use 5-watt wire-wound type. Set was now operable, but noisy. Cause of noise, the normally 15,000-ohm bleeder was 45,000 ohms by measurement, and was replaced with a 10-watt wire-wound job. Also contributing, was the dual (one can) 15-5 Mf. wet electrolytic condenser, each section of which was drawing far too much current, not steadily, but intermittently so as to vary the available supposedly steady D.C. to the rest of the set. A third cause of noise was a dirty condenser gang, plus poor alignment. After all was in order, the set was fine. A few weeks later it came in again with a complaint of fading and at

(Continued on page 505)

Fig. 3

Various faults in a Sparton 931 are shown in the partial circuit diagram.

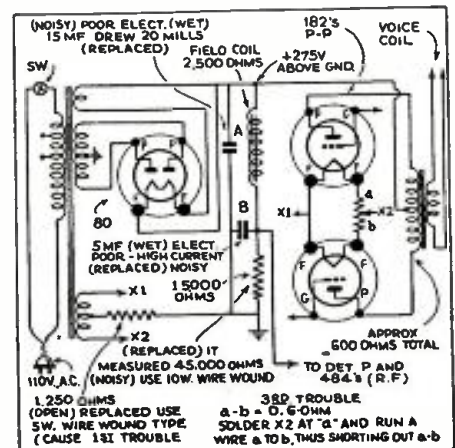

RADIO-CRAFT'S INFORMATION BUREAU

AN A.C.-D.C. P.A. SYSTEM

(304) Mr. Arthur Dridz, So. Sudbury, Mass.

(Q.1) On page 33 of the July 1934 issue of RADIO-CRAFT is a diagram of a small A.C.-D.C. P.A. system of 2 watts output. I am about to construct this set but would like to ask a few questions to clear up some points which are confusing to me.

In your column you stress the importance of a 110-V. D.C. speaker. Will the ordinary speaker of 1000 to 1800 ohms generally used as a choke in the filter systems do? I have a 1000-ohm speaker at hand and I would like to know what the differences are in the field coils of this speaker and the speaker you mentioned.

(Q.2) In using a wire-wound resistor instead of the cord type, would a 5-watt unit do?

(Q.3) Is the quality of this speaker very good? I have heard many small ones with terrible reproduction. I intend to use the amplifier for a phono. pickup amplifier.

(Q.4) Could the circuit be modified by omitting the choke and placing the speaker field in its place?

(A.1) The 1000-ohm speaker you mention will be quite satisfactory for use with the amplifier. In fact, you can use any speaker designed for connection across a 110-V. D.C. line. These speakers have field coils of various resistance values, ranging from 1000 to 2000 ohms, depending on the field strength needed.

(A.2) If you decide to use a wire-wound resistor in place of the power cord type, it will be necessary to use one having a power rating of 50 watts. The tube filaments require approximately 80 watts and as considerable heat is developed (especially if the ventilating facilities are rather poor, as in a closed cabinet) it is advisable to use a wide safety margin.

(A.3) The quality of the speaker depends on its design, size of cone, size of baffle and the impedance match between the power tube and speaker.

(A.4) While the speaker field might be used as the filter choke, it is doubtful if the plate current for the two tubes in the amplifier is sufficient to activate the field winding sufficiently.

"HIGH-FIDELITY AMPLIFIER"

(305) Mr. Clarence Senobe, Rockford, Ill.

(Q.) I have read your article about the high-fidelity amplifier which appeared on page 150 of the September 1934 issue of RADIO-CRAFT. I note the correction which appears in the December issue regarding the speakers, but I am still in doubt about several points.

What are the resistances of the following chokes as numbered in your amplifier—Choke

1, 5 hy.; Choke 2, 500 hy.; Choke 3, 30 hy.; Choke 5, 8 hy. 250 mils.

Will a 15 hy. choke do in place of the 30 hy. unit specified for Choke 3?

What make are the output transformers T6 and T7?

(A.) The resistance values of the chokes, according to the author, are as follows:

Choke 1—about 200 ohms

Choke 2—about 6000 ohms

Choke 3—about 300 ohms

Choke 5—about 80 ohms

A 15 hy. choke can be used as Choke 2, if all other values are maintained close to their specified values.

The output transformers, T6 and T7 are both Jensen transformers and are supplied with the speakers when the speakers are ordered under their respective numbers. These numbers are 5599-A and 5600; they are specially made units designed for the amplifier at the request of the author Mr. M. R. Jones, Jr.

PHONOGRAPH RECORD DEMONSTRATOR

(306) Mr. J. B. Nelson, Baton Rouge, La.

(Q.) I am thinking of installing some sort of phonograph device in my store, to aid in the merchandising of phonograph records. I receive numerous requests for the records I carry, but most people wish to hear the records before they buy them and an ordinary phonograph cannot do justice to the new recordings.

I have in mind the construction of an amplifier designed particularly for this purpose—one that can be placed on the counter and with a suitable pickup will reproduce the phonograph music to advantage. Can you supply me with a suitable circuit for such an amplifier? I prefer one that is completely power operated and all contained in a portable cabinet.

(A.) The circuit for a popular commercial record demonstrator is shown at Fig. Q.306. It will be noticed that it contains four tubes, including the rectifier. The values of all resistors and condensers are shown on the diagram so that it will be a simple matter to follow this design in building your demonstrator. The power transformer may be any unit available which supplies the desired output voltages. The transformer T1 is a coupling transformer for matching the pickup to the tube grid. The constants for this transformer must be determined according to the impedance of the pickup. The transformer T2 is a push-pull input audio transformer, while T3 is the corresponding output unit. The latter transformer may be included in the speaker, and should be designed to couple two 47 tubes to the voice coil of the speaker. The field coil of the dynamic speaker should have a resist-

ance of about 1300 ohms. This field is used as a filter choke in the plate supply.

It will be noted that a switch is incorporated in the amplifier for changing from the regular pickup to an external source. This is included so that automatic record changing devices or other sources of signal may be "cut into" the amplifier input. This feature greatly increases the usefulness of the demonstrator.

It is quite possible to make this unit in one compact cabinet, but it should be remembered that if the speaker is included, some precautions are necessary to prevent acoustical feedback from taking place between the speaker and the input source.

GRID-DIP OSCILLATOR

(307) Mr. C. L. Weatherwax, Chicago, Ill.

(Q.1) Your article "How to Build a Grid Dip Oscillator" on page 154 of the September 1934 issue was found extremely interesting and I intend to build one, but have several questions that I believe will be of general interest.

Can an oscillator of this type be used to line up inductances that are not in a circuit or set? That is, to make 3 or 4 R.F. inductances of the same impedance (inductance?—Ed.).

(Q.2) To align I.F. transformers before they are placed in the set?

(Q.3) Also, on page 168, paragraph on aligning R.F. circuits in sets, you say set must be left off, volume control full on and connect oscillator to grid cap and ground. Do you leave the grid cap on the tube and clip the grid side of the oscillator to the lead or should it be disconnected from the tube?

(A.1) This type of oscillator is ideal for making inductances match, whether they are located in a circuit or not. The coils in question should be connected one at a time to the oscillator and the resonant position found on the dial. In some cases it may be necessary to connect a condenser across the coil in order to bring its resonant frequency within the range of the oscillator. In this case, the same condenser should be used for all coils to eliminate the possibility of condenser differences.

When the resonant points for the coils have been found, it is an easy matter to remove or add turns, or space out turns in order that the resonant points for each coil may coincide.

(A.2) I.F. transformers may be aligned before they are mounted in the set, but this line-up is not always final, as differences in wiring and layout of parts, as well as associated circuits sometimes make differences in the align-

(Continued on page 505)

Fig. Q. 306
The circuit of a phonograph amplifier designed for demonstrating phonograph records.

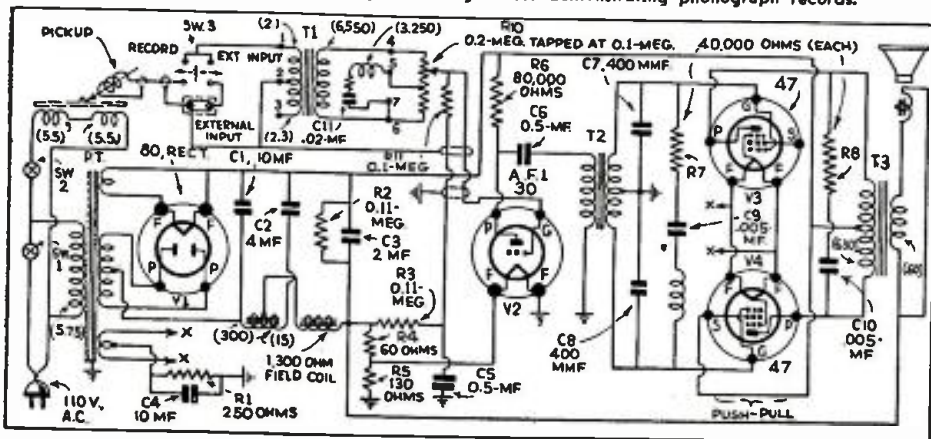

STEWART-WARNER MODEL R-123 4-TUBE SUPERHET. CHASSIS

(Receiver Models 1231 to 1239; temporary circuit is shown. Incorporates the new tubes in multiple-purpose connection)

Tube voltages may be read with a standard high-resistance meter; the figures are standard for the type of tube being tested, with a rectifier output of 350 V.

This receiver has the feature of high selectivity, due to the use of a superheterodyne circuit, yet it incorporates only three tubes in the receiver proper.

The output of this set is 3 W. A .02-mf. condenser connected to one side of the power line prevents static interference due to lights being operated, etc.

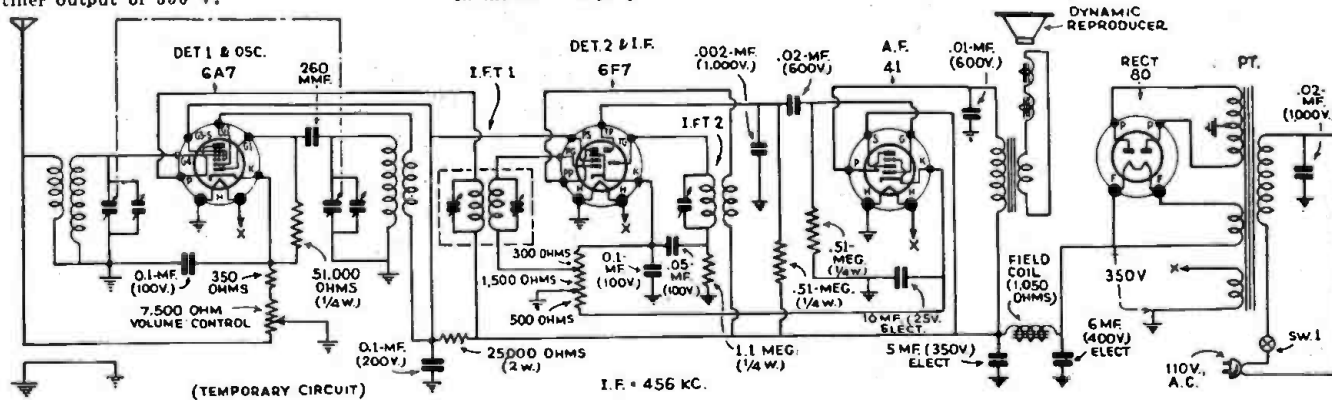

COMMONWEALTH MODELS 260 AND 660 6-TUBE MULTI-WAVE A.C.-D.C. SUPERHETS.

(Incorporates tone control, phono. pickup jacks, A.V.C.; ranges: 260—15-50, 200-550, 800-2,250 meters; 660—15-50, 200-550 meters.)

Operating voltages for this receiver, measured to chassis ground, are as follows:

Tube Type	Cath. Volts	S.-G. Volts	Plate Volts
V1	3.5	95	95
V2*	1.2	65	95
V3	3.5	95	95
V4	1.0	60
V5	14.0	95	85

(* Oscillator plate potential, 95 V.; oscillator control-grid, 1-V. The voltage across the speaker field is 120 V.

The modifications of the model 260 chassis, as the 660, are shown in a detail illustration. A feature of both models is the use of an airplane-type dial of "tuning" type, for operation of the volume control, as shown in photo.

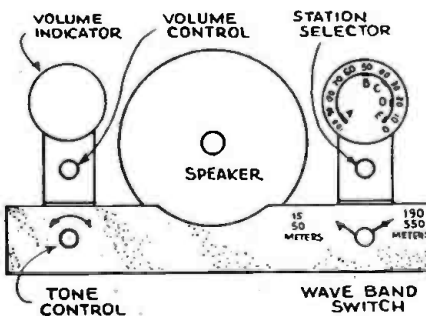

A—49 Meter Band D—19 Meter Band
B—31 Meter Band E—16 Meter Band
C—25 Meter Band

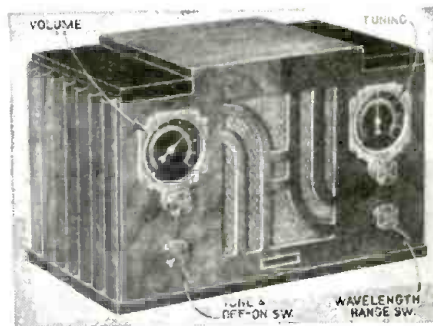

Commonwealth models 260 and 660 supers.

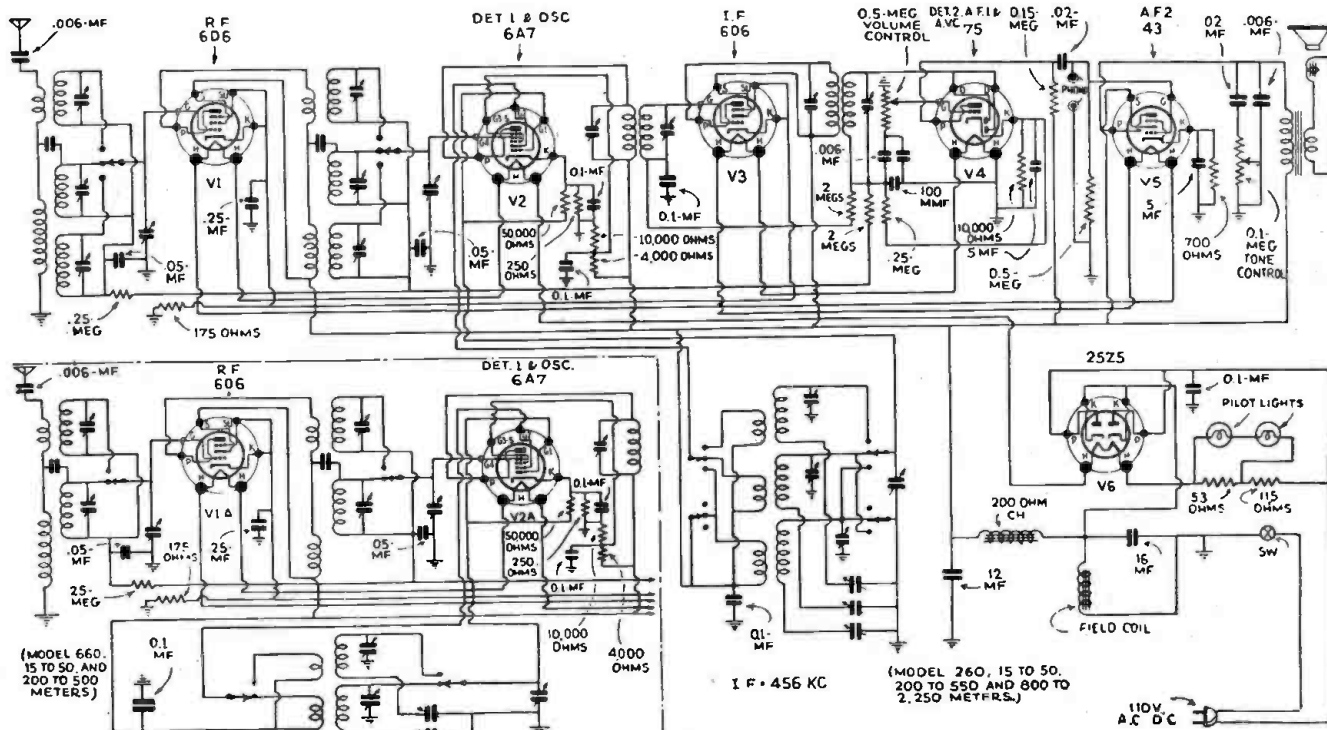

BE SATISFIED TO BE A SERVICE MAN!

Charles Golenpaul*

THAT grass in the other pasture, which always seems greener and nicer, causes many a budding radio Service Man to go wrong. For instead of sensing and realizing the opportunities in the field of servicing, many radio men cast envious eyes in other directions such as manufacturing, broadcasting, communication, research and engineering. And all the while, the real opportunities for big returns lying virtually at their feet, are overlooked if not actually ignored.

Let's see this radio servicing picture in its true values, therefore, instead of turning our backs to the opportunities right at hand while craning our necks and straining our eyes and ears, but mostly our imagination, to see the opportunities in other fields of radio endeavor.

Radio servicing is both a business and a profession. As a business it calls for business-like methods, efficiency, economy, profit. As a profession it calls for a thorough knowledge, skill, reputation, and proper equipment. Of the tens of thousands of so-called Service Men now attending to the radio sets of the nation, only a small percentage can truthfully qualify as Service Men in the strict business and professional sense. The vast remainder are simply handy men—jacks-of-all-trades—who might better be trouble-shooting door bells and lawn mowers and bicycles than the intricacies of a modern broadcast receiver.

The opportunities for the radio Service Man, then, are not so much on the other side of the fence and in the pastures of other radio fields, but rather in his own back yard. What he needs is not so much a ladder whereby to climb that fence and land in the other fields, as a shovel and even a plow whereby to dig deep for knowledge and experience and business methods. His own field is capable of a vast and profitable crop, if only he will put in the necessary time and effort and initiative into its cultivation.

During my many years in the electrical contracting field and the radio field, I have made the acquaintance of thousands of electrical and radio men. The similarity between both fields has always struck me forcibly, although it seems that the radio man never thinks that way. And I have also come in contact with numerous electrical engineers and radio engineers, and have noticed their activities and remunerations and opportunities.

If there be a close parallel between electrical and radio trades, then, let's look at the electrical contracting field. There are throughout the country many thousands of electrical contractors taking care of the needs of their communities. The capable contractor, well equipped, adequately financed, and possessed of a good business sense, enjoys a nice business year in and year out. When times are good, he sells some electric appliances and installs considerable electric wiring; and when times are dull, he handles much servicing and repair work, and some wiring alterations. The wear and tear on the electrical equipment of the community, going on all the while, depression or otherwise, serves to provide him with steady work at all times.

Does the good electrical contractor envy the electrical engineer? Hardly. The electrical contractor has existed now for several decades. He knows his opportunities—and the other fellow's limitations. He knows that the average run of electrical engineers, working for large corporations, do not get as much in one month as he can earn in one week. He also knows that electrical engineering jobs are few and far between, while electrical engineers are turned out by the tens of thousands every six months by universities and colleges and special schools. Hence much supply and not enough demand . . . too much uncertainty about that career built up year after year on the basis of just a job . . . too little to do with the money-making end of the venture and too much being considered an expense rather than a business-producing force. No, the wise electrical contractor certainly does not envy the electrical engineer. Nor the manufacturer. Nor the research worker and laboratory.

Firmly installed in his own little community, working year after year on the homes and factories and shops of that community, the electrical contractor digs in deeper and deeper. He becomes firmly entrenched. He is part of that community. He builds for the future. He is on mighty sound ground. And when he is ready to retire, he still has a business to sell out at a good price.

Now the radio Service Man, still a youngster since radio servicing is hardly older than a decade, might well take a leaf from the electrical contractor who is, indeed, his older brother. The radio Service Man can well look at the radio engineer in the same light as the electrical contractor sees the electrical engineer. From such a viewpoint he now realizes that of radio engineers there are already too many . . . and every six months a fresh crop turned out by universities and schools . . . large corporations buy radio engineers at practically any salary they wish to pay . . . and, after all, a job is still a job, subject to the whims and decisions of an impersonal ownership in most cases.

Meanwhile the radio Service Man is usually on his own. Or if working for others, he usually is with a small organization wherein he can strongly intrench himself. And all the while he is intrenching himself in the community through his good work and pleasant personality in many homes. There is real security here, which the usual radio engineering job sadly lacks.

As for remuneration, there is nothing for which to envy the average radio engineer. Engineering salaries are no greater than aver-

*Aerovox Corporation.

(Continued on page 492)



(A SERVICE MAN OF 1965)

IF THIS young "Service Man" were full grown today, he'd be telling owners of battery operated sets that dry batteries can now be used 7 or 8 hours a day—at no increase in the cost per hour!

EVERY SERVICE MAN KNOWS many battery set owners who believe they will get more hours of service if their batteries are used only 3 or 4 hours a day. This belief is no longer true. BURGESS Engineers have proved, by tests made in our Laboratories and in actual use, that you can now use BURGESS Batteries 7 or 8 hours every day and get the maximum service we've built into them!*

DOUBLE THE ENJOYMENT of your battery set customers by telling them of the BURGESS 8 Hour Day. If you'd like complete, technical information about the BURGESS Power House—the 100% DRY, 400 Hour "A" Battery which retails for \$3.20—or about BURGESS "B" and "C" Batteries, write the BURGESS BATTERY CO., Freeport, Illinois.



*For economical operation of 7 to 8 hours a day, sets should be powered by batteries of proper capacity. Set owners should ask their Service Men to recommend type and size of batteries best suited for their use.

BURGESS

BATTERIES AND FLASHLIGHTS

Please Say That You Saw It in RADIO-CRAFT

GENERAL ELECTRIC MODEL M-65 6-TUBE "SELECTIVE SHORT-WAVE" SUPER.

(Incorporates tone control and A.V.C. Dual-range reception: 540-1,500 kc.; 5,400-15,350 kc.)

Power consumption, 80 W. Operating voltages for this receiver are given below.

Type	C.-G. Volts	S.-G. Volts	Plate Volts	Plate Ma.
V1	3.0	100	265	6.0
V2	3.0	100*	265*	2.0*
V3	3.0	100	265	6.0
V4	1.5	35	100	1.5
V5	16.	255	240	35.0
V6	725**	75.0†

(* Figures for detector section of tube; (**) r.m.s.; (†) total current.

Between the limits of the higher-frequency range selected in the design of this set are included four of the internationally assigned short-wave broadcast bands, located at 19, 25, 31 and 49 meters.

In this receiver a double reduction vernier drive having two concentric knobs giving a 10-1 and a 55-1 ratio of speed reduction are used. Undistorted output, 1.75 W.

With range switch "in," align R.F. circuits at 540 and 1,400 kc.; padder, at 600 kc. In the "out" position, align at 15 megacycles. (The position, of two maximums, of the oscillator and first-detector trimmers, using the lower trimmer capacity for the oscillator and higher for the detector, are the correct ones. Both adjustments must be made as indicated, irrespective of output. Merely peak the R.F.) The R.F. trimmers are at bottom of coils; 600 kc. padder, at chassis rear.

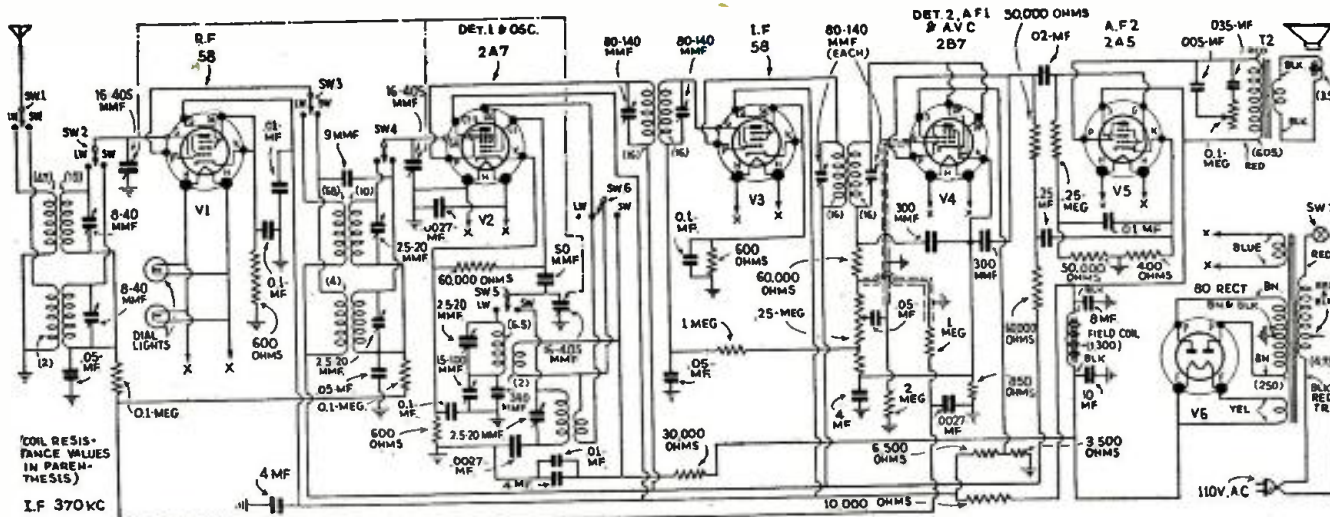

STEWART-WARNER MODELS R-113 AND R-114 SHORT-WAVE CONVERTERS

(Wavelength ranges: 200 to 16, and 65 to 20 meters. Model R-113—6 V. filaments, line powered; R-114—2 V., set powered.)

The plate operating voltages, with various plate supply voltages, are as follows:

Tube Type	170	210	250	270
V1	14	16	19	20
V2	59	70	83	89

The model R-113 receiver obtains its power from the 110 V. A.C. power line which drops the voltage to 6 V. across filament. The model R-114 is designed to derive its filament power from a "2 V." set; (Resistor X is then required.) Both converters utilize plate power obtained from the set, or a separate "B" unit.

The plate supply to the power tubes, or the D.C. supply to the field of the dynamic reproducer if it is in the positive side of the filter system, usually makes the most satisfactory and easily accessible location for the

"B" tap. Note the following data.

(1) Do not tap off at the plate terminal of any tube. This will only result in coupling the converter and set through the common plate circuit impedance, thus causing feedback oscillation.

(2) The voltage supply should be as near 250 V. as possible. Below this voltage, certain makes of tubes may not function satisfactorily as oscillators on the higher radio frequencies. Below 180 V., the oscillator tube of the converter may not oscillate at all on the higher radio frequencies, so that no reception will be obtained.

If the supply voltage to the converter is in excess of 280, the oscillator tube may develop parasitic oscillation, indicated by a persistent and annoying steady whistle.

(3) If the supply voltage cannot conveniently be obtained within the specified

limits, it may be lowered by inserting a suitable high resistance in series, with the plate supply lead.

(4) As a check on any resistors you may add, it is well to test the plate voltage of the 37 tube at the tube socket in the converter. It should be approximately 90 V. when tested with a high resistance voltmeter having a resistance of 1,000 ohms per volt.

(5) There are a few sets on the market in which the negative "B" supply does not connect to the chassis frame. When the converter is to be used with sets of this type, the black ground wire of the converter, which is also the negative "B" return, must not be connected to ground but to the negative of the "B" supply system at a point inside the broadcast set. The broadcast set should be grounded in the usual way.

Volume and tone on short waves are controlled by the broadcast receiver adjustments.

To tune the short-wave converter, proceed as follows:

(1) Turn the selector switch of the short-wave converter all the way to the left.

(2) Turn on the broadcast receiver and with the volume control all the way on, tune it to some point between 900 and 1,100 kc. (333 to 273 meters) at which no station can be heard.

If a silent spot cannot be located on the dial between these two points, disconnect the aerial. This will sharpen the tuning of the set and enable a silent spot to be found. Tune the set exactly to the center of this silent spot WITH THE VOLUME CONTROL FULL ON, and reconnect the aerial.

(3) Make certain that the broadcast receiver is set for maximum sensitivity by properly adjusting all of its auxiliary tuning controls.

Lack of DX reception may be due to a poor antenna system, or an insensitive broadcast set.

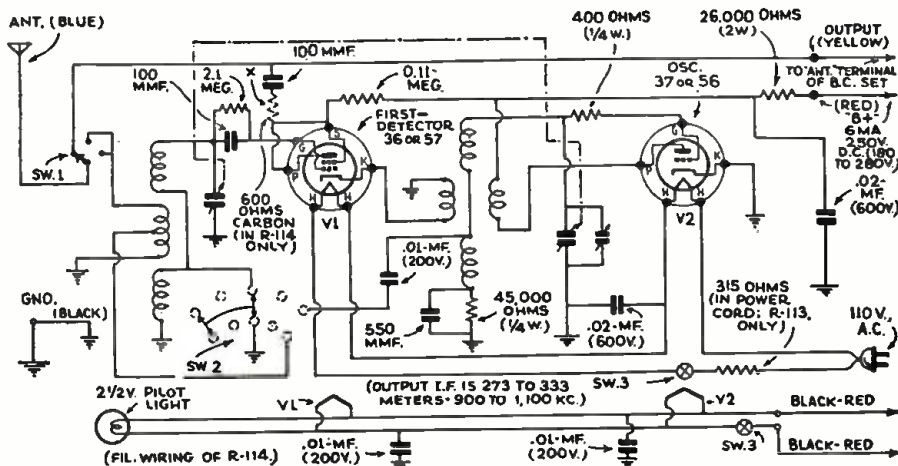

VERSATILE TEST INSTRUMENT

(Continued from page 476)

lower left and lower right of diagram are designated in such a way as to minimize errors in connection and to illustrate fully the correct positions for each of the several functions and ranges, as well as the proper designations to be placed on panel markers. In order to make these various functions even clearer, however, additional sectionalized and detailed sketches have been prepared and will be discussed later under the designations Figs. 2 and 3.

Referring again to the main selector switches, it will be seen that the one at the lower left of Fig. 1 is designated Sw. 1 and further defined as a "position switch." This switch performs the duty of switching the Weston model 301 universal meter (designated as "M") into the various positions shown on the marker strip immediately below the switch. The positions are also numbered from left to right; these numbers representing the contacts on the individual switch decks reading from left to right in a circular manner and looking down on top of the panel. The first position sets the circuit up for the measurement of 0-1000 volts, the individual ranges being controlled in turn by Sw. 2. The second position on Sw. 1 takes care of the D.C. milliamperes ranges from 5 to 500 and a range of 0-1 ma. is provided on position 3.

Position 4 merely provides for the convenient checking of the A.C. line setting through the connection of the 5-volt A.C. range of "M" across a 5-volt tap on transformer "PT." Position 5 similarly permits checking the D.C. output of rectifier "IV" using, of course, the D.C. range of "M." This position places the meter in series with 25,000 ohms, across a 25-volt tap on the voltage divider network, which is across the output of the rectifier. This position also permits checking resistors of relatively low values and with limited current handling capacity, by connection across the meter through the agency of a plug inserted in J13. This is an open-circuit phone jack with springs insulated from the frame and connected directly across the D.C. movement of "M." A zero adjustment is provided through variable resistor R32, in series with the A.C. line supply. Connection to this circuit could have been made through tip jacks, but as it was the only one which was not protected by a fuse, and could not be so protected, a different type of connection was desired to act as a reminder that no fuse was in the circuit.

In addition to measuring low resistances in parallel with "M" with Sw. 1 in the check D.C. position, this switch can be returned to the "off" position and "M" can be connected across external shunts for the measurement of D.C. amperes; if at any time such magnitudes of current must be measured.

Position 6 on Sw. 1 arranges the circuit for the measurement of high resistance and also impedance, capacity, and inductance. Position 7 arranges circuit for the measurement of low

resistance values from 1 to 100,000 ohms and positions 8 and 9 are left blank and marked "spare." Attention is directed to the numbering and other designations on the contact arms of each individual deck, for the clearer understanding and guidance of the reader. As will be seen, the contact arms on Sw. 1 numbered 1, 2 and 3, and also designated +M.A., +V. and -M., -V. connect to the corresponding terminals of "M" through Sw. 3, the A.C.-D.C. switch, and contact arm No. 4 is used to pick up F1. The numbering of the contact arms is started with the switch deck nearest the panel and read downward.

Referring now to the switch at lower right-hand side of Fig. 1, it will be seen to consist of a range-changing switch and is designated Sw. 2. The functions of this switch will be considered in detail under Figs. 2 and 3 and it seems necessary at this time to call attention to only one detail of this switch, and that is the marker strip beneath, which shows the correct panel designations for the entire switch. The voltage and current markings are placed on the top line, the abbreviation M. being used for milliamperes and V. for volts, the milliampere designation occurring on alternate positions of switch and preceding the numbers; and the voltage designation appearing on each position of switch, except number 9, and following the numbers (or voltage and current values, in other words).

The ohmmeter scale multiplying factors appear beneath the voltage and milliampere markings on position numbers 1, 2, 3, 4 and 5 and the impedance and capacity range numbers (designated Z1, Z2, Z3, Z4) appear at bottom of position numbers 6, 7, 8 and 9. The above arrangement was used to conserve engraving or other lettering required on the markers.

While on the subject of switches 1 and 2, it may be well to mention that it is quite essential to choose a switch having very low contact resistance for use as a range switch, as the contacts are required to carry considerable current. The switches chosen should also be rugged and durable. One change was made by the writer in the switch designated as Sw. 2 which had best be explained in some detail. The switches used by the writer were constructed in such a way that the spacing between the center member of switch and the individual contacts on each switch deck was rather small and to correct this condition and increase the safety factor on high voltages, the bottom deck of Sw. 2 (designated as number 4 and +V.) was removed and temporarily disassembled and enough metal was filed off the edges of the individual contact points to give a clearance between these points and the center extension members, lying between the points, of a fraction more than one-sixteenth of an inch.

The Meter

Leaving the subject of switches for a while, let us take up other circuit details of Fig. 1. First let us consider the indicating instrument, or meter designated as "M." This instrument has already been mentioned but as two departures from standard were necessary, we will have to explain a few details. To begin with the writer did not care for the scale which is standard equipment on the Weston universal meter. Therefore, a scale for a Weston model 465 volt-ohmmeter was secured and substituted for the original scale. Doubtless the Weston people can supply this instrument with the above scale already installed if requested. The second departure from the standard arrangement of the above meter was the removal of 110 ohms of resistance from the 5-volt A.C. multiplier which comes mounted in instrument case and which was temporarily removed to facilitate stripping off the above resistance. The resistor referred to is designated R1 in Fig. 1 and is shown inside meter case. The arrangement of the other parts within the meter case is also shown for reference. The resistor marked "shunt" comes fastened to the back of the meter case and is a corrective shunt for the D.C. ranges. The reason for removing a portion of the wire from R1 is to compensate for the inclusion of fuse F1, which has an average resistance of 110 ohms. Were correction for this not provided for, there would be an error on the lower voltage ranges. It is a very good idea to avoid changing a delicate instrument like the universal meter under discussion and though the writer made the above changes he feels strongly urged to recommend that the instrument be ordered from the factory with the de-

Fig B

Compare this view with Fig. A.

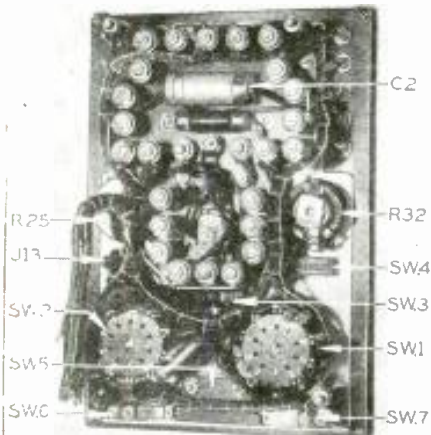

Shhh! Shhh!

QUIET

Please!

Individually TESTED for NOISE

You Can't Hear Noise, Because It Isn't There!

HERE IS THE SECRET of



ELECTRAD'S New QUIET VOLUME CONTROL

THE resistance element is baked on the flat outer rim of a rigid Bakelite ring. Over this, the special-alloy floating contact gently glides in a straight path.

Result: the smoothest, quietest, longest-lived volume control ever devised. Absolute quiet is further guaranteed by individual testing of each control at the factory.

The molded Bakelite case, with removable metal end-cover, projects back-panel only 1/2 inch, when mounted. New-type power-switch (approved by underwriters) attached by a single screw. Extra-long, easily-cut aluminum shaft. Made in all standard sizes.

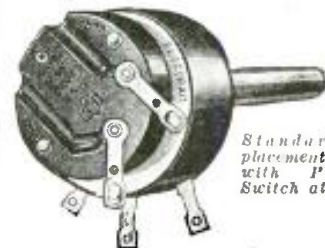

Standard Replacement Unit with Power-Switch attached

from
RESISTOR
Headquarters

ELECTRAD 1935 CATALOG

Electrad, Inc., 175 Varick St., New York, N. Y.

Please send new 1935 Resistor Catalog. Check here for folder on new QUIET Volume Control.

Name.....

Address.....

MAIL COUPON FOR

Please Say That You Saw It in RADIO-CRAFT

SERVICEMEN!



MAYBE YOU'RE MISSING SOMETHING

Here in Sprayberry's Practical Mechanics of Radio Service is the ONLY COURSE designed exclusively for men already in the service business—the ONLY ONE that brings PRACTICAL help on every phase of servicing with a bare minimum of theory, mathematics, etc. And it is the ONLY COURSE offered without costly bindings, high pressure selling, etc.—at a price so low that every serviceman owes it to himself to investigate. Until you do, you may be missing something of utmost importance.

IMPORTANT NOTICE!

Now—without extra cost—you get complete easy instructions on the use of the OSCILLOGRAPH—the most accurate and universal measuring instrument to be made available to servicemen. Several lessons on this all-important subject have just been added to the Sprayberry Course—at not one cent of added cost to you!

THIS COUPON WILL HELP YOU SAVE \$3.00

F.L. SPRAYBERRY 2548 University Place, N. W., Washington, D. C.

Please send without obligation on my part, details of SPRAYBERRY'S PRACTICAL MECHANICS OF RADIO SERVICE. Also tell how I can get the new series of famous SPRAYBERRY DATA SHEETS (regular price, \$3) at no additional charge.

Name _____

Complete address _____

RC 2/35

SPRAYBERRY'S PRACTICAL MECHANICS OF RADIO SERVICE

THOUSANDS of SERVICEMEN

say the TOBE CONDENSER ANALYZER

"Simplifies Radio Service"

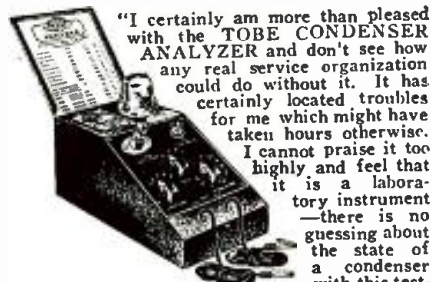

"I certainly am more than pleased with the TOBE CONDENSER ANALYZER and don't see how any real service organization could do without it. It has certainly located troubles for me which might have taken hours otherwise. I cannot praise it too highly and feel that it is a laboratory instrument—there is no guessing about the state of a condenser with this tester."

Paul C. Conover, University of Ill., Champaign, Ill.

\$11.40 net to servicemen

Recommended by set manufacturers and service schools.

Sold by leading service supply houses.

Tobe Deutschmann Corporation
CANTON, MASSACHUSETTS

sired scale and with the A.C. multiplier resistor wound to 110 ohms less than the standard value.

If the fuse is eliminated, no change in the standard value of R1 would be necessary. The error, if fuse is included but no correction made in R1, will be slightly more than two per cent on the 5-volt A.C. range and half that on the 10-volt range.

Several references have been made to F1 and we may as well give detailed consideration to this and the other fuses at this point. One of the several advantages of the instrument we have been discussing is the inclusion of fuses in the various circuits in such a way as to afford complete protection to the meter at all times and also to afford protection to the various multipliers and shunts, except resistors R19, R20, R23 and R24. The circuit requirements do not permit the protection of these four resistors but protection is afforded the meter at all times. The fuses will blow at 1½ to 8 times overload, except the 1/100-ampere fuse which blows at about 16 times normal load. However, caution should be exercised in the use of all the functions of the instrument described as there is no way by which we can prevent a certain amount of pointer "slamming" on overloads considerably in excess of normal current carrying rating of the meter but still not of sufficient magnitude to blow the fuse. The reason for using fuses in the voltage and current measuring circuits is obvious, but the writer believes the fusing of the meter branch of the resistance and impedance measuring circuits, while not so obvious perhaps, is just as important, inasmuch as the meter is thus protected in event connection is inadvertently made to a voltage source while measuring resistance or impedance.

In purchasing the fuses, it will be advisable to purchase several of each in order to have a sufficient number on hand for replacement purposes. This applies particularly to F1 because it is a part of certain calibrated circuits and it can not be shorted out or replaced with other values (as can the remaining fuses) in emergency. If the builder feels that the slight complication of circuit through the use of fuses is not in line with personal preference they can be omitted by adding 110 ohms to the resistance values specified for resistors R2 and R18, leaving the value of R1 the same as originally supplied with the meter. Deck number 4 on Sw. 1 could then be left off and connections to contacts 1, 3, 4, 5, 6 and 7 could be tied to corresponding contacts on deck 3. Through connections would then be made in place of the remaining fuses.

The Power Supply Unit

As the power unit, comprising PT., 1V, and associated apparatus, serves so many functions and is so intimately involved in these functions, attention is directed to certain features of this unit. As will be seen by inspection, the transformer PT., consists of a 100-volt primary with input through REC. Sw. 4, variable resistor R32 and the secondaries consist of a 6.3-volt winding for supplying the heater of 1V, and a high voltage secondary tapped at 5, 25, 230, 250, 270, 290 and 310 volts. The function of R32 is to permit dropping the line voltage to 100 volts to satisfy primary voltage requirements and to permit proper zero adjustments on the high resistance and impedance ranges. The purpose of the 5, 25 and 250 volt taps on the secondary is to supply correct voltages for the various impedance ranges as will be mentioned under Fig. 3. The 230, 270, 290 and 310 volt taps, in addition to the 250 volt tap already mentioned, provide for an adjustment of the A.C. input to rectifier 1V, so as to establish an approximate equality between the A.C. voltages and the rectified and filtered D.C. voltages at the output of the voltage divider. This arrangement is provided for convenience in operation and avoids frequent and large changes in the setting of R32 when shifting from resistance to impedance measurements and between the various ranges of these functions. Also it provides for the gradual change in the characteristics of 1V with aging and for correct readjustment of voltage values when 1V is replaced.

The filter is a condenser input arrangement, both for the sake of getting the required D.C. output voltages, without the excessive A.C. input voltages which would otherwise be required, and also to secure the maximum filtration possible with a single-section filter. As a matter of fact, the single filter choke could have been omitted without any effect on the resistance measuring functions, using simply, about a 2 or 3 mf.

condenser across the voltage divider. In fact this was tried experimentally and was entirely satisfactory, but the choke was added for the sake of a more nearly pure D.C. for use in conjunction with the electrolytic condenser leakage tests.

As mention has just been made of electrolytic condenser leakage tests, it may be appropriate at this point to call attention to Sw. 6 and Sw. 7, since these switches are an important part of the electrolytic condenser tests, and are not shown in EC leakage test details in Fig. 3D. It will suffice to say that Sw. 6 when depressed, places the D.C. milliampere ranges of "M" in series with the negative side of the condenser under test and the negative side of D.C. supply furnishing the leakage test voltages, as seen by careful inspection of circuits. When Sw. 7 is depressed, the condenser under test is removed from connection to the D.C. power source and is connected across the capacity measuring circuits of the instrument through the connections to J7 and J8.

Circuit Details

It is believed that the purpose of the tip jacks at upper left and upper right of Fig. 1 are sufficiently clear not to require detailed discussion, particularly as they appear again in Figs. 2 and 3. However, J9 and J10 marked K-F and CG respectively may be mentioned in passing. These two jacks permit connection to the 3-volt battery supply used on low ranges of the ohmmeter and this permits a grid-shift test to be made while checking a radio set. If a higher voltage is needed for this purpose, it is suggested that two of the smallest type 3-volt flashlight batteries be connected in series, with the free negative post joined to J10 and the free positive post joined to J5, the spare tip jack at top of the left-hand row of tip jacks. We are finished now with Fig. 1 and will proceed to discuss Fig. 2 and then Fig. 3.

It will be noticed that in all the diagrams shown on Fig. 2 and Fig. 3 we do not show Sw. 1, the position switch, nor do we show Sw. 3, the A.C.-D.C. switch. It is assumed that these two switches have been set to the correct position. This avoids confusion and lessens the number of connections and leads to be traced in Figs. 2 and 3 and since the functions of Sw. 1 and Sw. 3 are not at all complicated and have been explained in the discussion of Fig. 1, no further comment seems necessary. Perhaps we should note the fact that wherever direct current function is shown in Figs. 2 and 3, the resistor across the D.C. portion of "M" is the corrective shunt supplied with the meter (mention of which was made earlier). Careful com-

Fig. 2
Details of the measuring circuits.

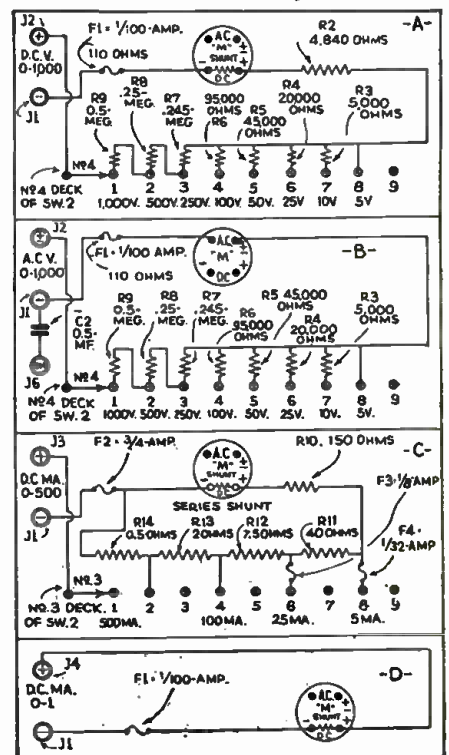

Please Say That You Saw It in RADIO-CRAFT

parison of these detailed sketches with the complete schematic in Fig. 1 should clear up any doubtful factors and establish in the reader's mind a clear picture of all functions and relations.

Figure 2A shows the D.C. volts position of "M" and makes clear the manner in which the voltage ranges are chosen by number 4 deck of Sw. 2, also gives values of all resistors and shows that the multiplier network is a combination of parallel and series resistors. Should any one of the multiplier resistors below 250 volts become open, only that range would be affected. The series arrangement for the two highest ranges was used for reasons of economy.

Figure 2B shows the A.C. voltage measuring network and the only comment that seems necessary is to call attention to the blocking condenser connected between J1 and J6. The abbreviation OM simply means output meter and the use of this arrangement for blocking a D.C. component in a receiver's output circuit is already familiar to the experienced radio man. To measure voltage, connection is made to J1 and J2 and position switch Sw. 1 (on Fig. 1) is set to the volts position. Sw. 3, also shown on Fig. 1, is set to A.C. or D.C. as the case may be, and range switch Sw. 2 is set to desired range. All D.C. voltages, and A.C. voltages above 10 volts, are read on lower scale of "M" and the offset scale above the D.C. scale is used to read 5 and 10 volts A.C.

Figure 2C shows the series shunt arrangement used for current measurements. The series shunt was used in order to permit the various ranges to be selected by a single arm on the range switch. Since current shunts are made of relatively heavy wire and since they are protected in this circuit by fuses, there is little chance of an open circuit developing and therefore the series arrangement is justified in this particular case. In general the so-called parallel arrangement is favored, one advantage being that the individual shunts can be made by the constructor (by the "cut and try" method) whereas the arrangement here must be calculated. Attention is directed to the inclusion of R10, a 150-ohm resistance in series with "M." This

resistor was used to raise the effective value of the meter branch of circuit to 200 ohms on account of the difficulty of getting very low values of resistors for the 500-milliamperere range. Raising the effective resistance of "M" permitted a correspondingly larger value of shunt resistor to be used. Such an arrangement also tends to minimize the effects of long leads in the wiring and of other extraneous resistance which in a low resistance circuit, and particularly in a parallel circuit, would introduce error.

Extreme care should be used in making all connections of course, but this is especially true in making the connections between the individual resistors R11, R12, R13 and R14 because an open circuit between any of these resistors might cause the burn out of "M." The measurement of current involves a similar procedure to the voltage measurement, connection being made to J1 and J3 with Sw. 1, set to the 500 ma. position; Sw. 3 to D.C. position and range switch Sw. 2 to desired range.

Figure 2D shows the 0-1 ma. range and is so simple as to need little comment, connection being made to J1 and J4 with Sw. 1 set to the 1 milliamperere position and Sw. 3 set to D.C. position.

Next we proceed to Fig. 3. Figure 3A shows, in detail, the resistance measuring ranges from 1 ohm to 100,000 ohms. These ranges could all have been obtained, by certain changes, through the same means employed in the high resistance measurements but it was desired to make ranges up to 100,000 ohms independent of connection to an A.C. source. Measurements are made by connecting test leads to J7 and J8, setting Sw. 1 to the low resistance position, Sw. 3 to D.C. position and Sw. 2 to desired range. The zero adjustment is then made either by shorting test prods or by depressing Sw. 5 (which is shown between J7 and J8 on Fig. 1) and adjusting R25, the 600-ohm variable resistor across "M." for a full scale reading. After this, connection is made to the resistor to be measured and ohms scale on "M" is read, multiplying by the scale factor of 1, 10 or 100 depending on setting of Sw. 2.



UP AND coming service men know inefficient equipment means lost time, inaccurate work and unsatisfactory results. More and more, they are turning to the Readrite No. 730 Tester because it takes the guess work out of servicing and enables them to quickly and accurately locate trouble spots.

The No. 730 Point-To-Point Tester is designed especially for speedy and efficient servicing. It is extremely flexible. Voltage can easily be checked in any tube circuit. Also measures resistance, capacity and continuity. Tester socket terminals are arranged according to RMA standards. It is unnecessary to remove chassis from cabinet when localizing defects.

This tester includes two meters—one for reading AC, the other for DC. These meters are rugged, compact and accurate. Separate meter ranges are made possible by connecting to a single pair of jacks and using the selector switch. DC ranges are 15, 150, 300 and 600 volts. (1,000 ohms per volt). Milliamperes are 15 and 150. The AC voltmeter ranges are 10, 25, 150 and 750.

YOUR JOBBER CAN SUPPLY YOU
At the dealer's net price of \$18.60

READRITE METER WORKS
139 College Ave. Bluffton, Ohio

MAIL COUPON FOR CATALOG

Readrite Meter Works
139 College Avenue, Bluffton, Ohio.
Send me catalog on Readrite No. 730 Tester and folder proving Readrite leadership.

Name.....
Address.....
City..... State.....

Fig. 3 Testing possibilities of the unit.

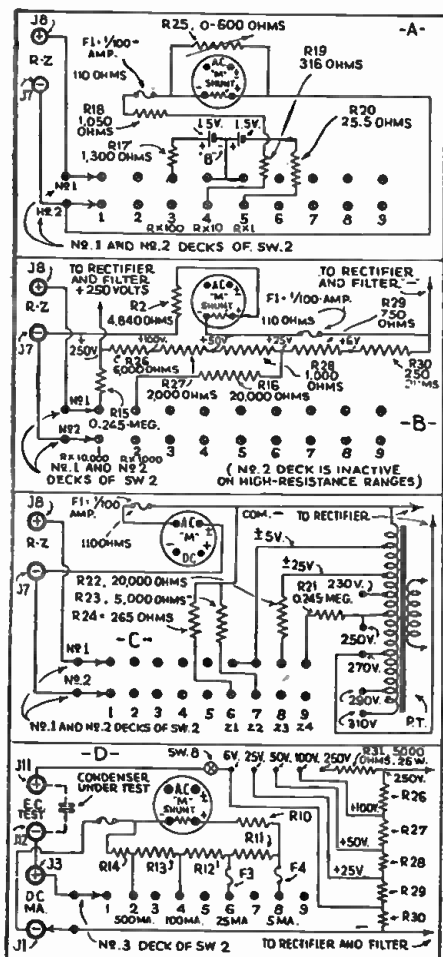

Measuring High Resistance

Figure 3B shows the arrangement used for the measurement of high resistors from 100,000 ohms to 10 megohms. Operating voltages are taken from a 25 volt and a 250 tap on a voltage divider. Intermediate taps are shown but will not be discussed here as they will be explained when discussing Fig. 3D. It will be noted that the combined values of all resistors used in the voltage divider totals 10,000 ohms, and this, across a 250-volt source will allow a bleeder current of 25 ma. to flow. Since this may seem an excessive bleeder current, we will explain briefly the reason therefor. It will be noted that on account of the ratio between the 25-volt tap and the 250-volt tap, that the current flow through the voltage divider remains relatively constant when the meter circuit comprising "M," the fuse F1, Resistor R2, and Resistor R16, is connected across the 25-volt tap. The total effective resistance of voltage divider as a whole is practically unaffected. In practice this means that in effect we have a constant current flow which is divided between resistors R29 and R30 (the voltage dropping resistors for the 25-volt tap) and the meter circuit, and that because of the changing ratio between these two parallel circuits (when measuring various resistors between the values of several thousand ohms and one megohm) an error of progressively increasing magnitude will occur as higher and higher values of resistance are measured. A somewhat similar condition exists to a lesser degree on the 250-volt tap but would be a serious matter on the 25-volt tap if correction for this error were not made. Correction for a single range could be made when the ohms scale of "M" was initially calibrated but would not hold exactly for multiples of this range. Further, in our case we are working with an instrument which already has the ohms calibration on its scale and we must make circuit characteristics such as to secure agreement with this scale.

Since the error above is roughly in inverse proportion to the ratio between the resistance of "M" and its series resistors, and the resistance of the voltage divider, a practical remedy is to make the resistance of the voltage divider as low as possible, thus increasing the ratio and decreasing the error. This, of course, results in an increase of bleeder current through the voltage divider, and in our case, a value was chosen

Please Say That You Saw It in RADIO-CRAFT

Before You BUY Try

BUD
 P. A. Equipment
5 DAYS
ABSOLUTELY FREE

BUD engineers challenge you to duplicate Bud's sensational performance and proved dependability at any price! BUD'S FREE FIVE-DAY TRIAL enables you to accept that challenge, with no obligation to you! Write today for beautifully illustrated descriptive folder, prices, and full details of FREE FIVE-DAY TRIAL offer.

PORTABLE SOUND SYSTEMS
ELECTRO DYNAMIC UNITS
CARBON MICROPHONES
AMPLIFIERS
4, 5 & 6 FT. ALL ALUMINUM TRUMPETS
FIELD EXCITERS
AIR COLUMN HORNS
LOW AND HIGH FREQUENCY UNITS FOR WIDE RANGE THEATRE USE

BUD SPEAKER COMPANY
 1145 JACKSON STREET • TOLEDO, OHIO, U.S.A.

BUILD YOUR OWN

Short Wave Receiver
5 Meter Transceiver

ICA can supply you with just what you want through your Jobber or favorite mail order house at a discount of 40% from the list prices shown. When you buy ICA Kits or parts, you are assured of quality and dependable performance.



ICA 5 METER TRANSCEIVER

A quality transceiver in 3 models: 2 volt, 6 volt or A.C. model. So easy to build! Made completely of ICA parts. Comes complete with instructions, diagrams, etc. List prices (respectively)

\$19.50, \$19.25, \$19.75

ICA SHORT WAVE RECEIVERS

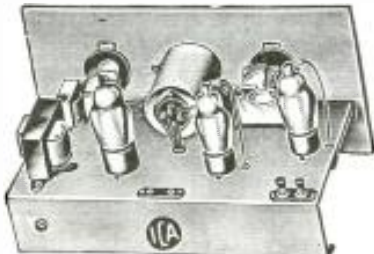

A whole line to choose from; 1 and 2 tube battery sets, and 3, 4 and 5 tube All Electric models. Here are the world's easiest kits to build. Each comes complete with point-to-point diagrams. Licensed under RCA and Hazeltine Patents. List prices \$9.95 and up. Write for facts before you build!

BIG NEW 1935 CATALOG

Send on receipt of 10c coin or stamps to cover cost of handling and mailing. Lists hundreds of parts, kits and accessories. Supply limited so send now to avoid disappointment.

INSULINE CORP. of AMERICA
 23-25 Park Place, Dept. C-25, New York, N. Y.

of approximately half the rated maximum current output of rectifier IV.

With the above arrangement the maximum possible error of divergence from resistance calibration of "M" would be roughly 4 per cent, at a point on the meter scale corresponding to something in excess of the highest resistance calibration. Since readings are not ordinarily taken at the extreme left end of scale, and since even when they are, the crowded condition of the resistance calibration at this point precludes an extremely accurate determination, the net error, in practice, is of too low a value to read.

To measure resistors from 100,000 ohms to 10 megohms, connect test leads to J7 and J8, set Sw. 1 to R-Z, Sw. 3 to D.C., and Sw. 2 to RX1M or RX10M, as required. Then connect test instrument to 110-volt A.C. line through agency of cord and plug connected to REC. (shown on Fig. 1) and throw switch Sw. 4 (also shown on Fig. 1) to the "on" position. Allow about one minute for the rectifier tube to reach operating temperature. Then make zero adjustment in a manner similar to that mentioned in connection with the low resistance measurements, using however, the variable resistor R32 for this adjustment.

Impedance Measurements

Figure 3C shows the impedance measuring circuits. Impedance, of course, may comprise inductance, or capacity or a combination of these two. An inductance also has resistance, but the resistance of most inductances can be neglected without introducing serious error. Our circuit therefore, measures inductance or capacity, or the effective impedance of these elements at 60 cycles. This is accomplished in a manner similar to the measurement of resistance, using an A.C. voltage and the A.C. range of "M" instead of corresponding D.C. functions, as was done when measuring resistance. In using the impedance measuring functions of our instrument, a reading must be taken on the voltage scale of "M" and compared with an auxiliary scale or chart. The required charts and scales have been worked out for the values used in our circuit and will be discussed later. To measure an impedance, connect to an A.C. line as described for high resistance measurements, set Sw. 1 on R-Z, Sw. 3 on A.C., and Sw. 2 to the range desired. Connect test leads to J7 and J8 and after making zero adjustments, place test points across the component to be measured. Read the 100-volt scale on the meter and compare to auxiliary scale shown on Fig. 4.

Figure 3D gives all details of the electrolytic condenser leakage tests, except the functions of Sw. 6 and Sw. 7 which were discussed in sufficient detail under Fig. 1. The purpose of the extra taps on the voltage divider, at the right of the diagram, which were mentioned previously, are now apparent and through their use various voltages can be picked up through Sw. 8 for application to a condenser under test. Use the nearest voltage to the rated working voltage of the condenser and after connecting the condenser to J11 and J12 (observing proper polarity) and waiting a few minutes for leakage to assume a normal value, the 25-milliamperere range of "M" is connected in series with the negative side of the condenser by depressing Sw. 6. Switch Sw. 1 must be set to MA. 0-500, Sw. 3 to D.C., and Sw. 2 to the 25-milliamperere range for this test. Sufficient protective resistance is always in the circuit to limit current to a safe value. If leakage is less than 5 milliamperes, Sw. 2 can be moved to the 5-milliamperere position. The capacity test can now be made by resetting Sw. 1 to R-Z, Sw. 3 to A.C., and Sw. 2 to the range desired (either Z1 or Z2) and depressing Sw. 7, the resultant reading being compared to auxiliary scale. To avoid discharging the condenser through "M" in the capacity test, it is advisable to depress Sw. 5 just prior to depressing Sw. 7. Hold Sw. 5 in a depressed position for an instant after depressing Sw. 7 in order to discharge the condenser. The reading may now be taken by releasing Sw. 5.

Perhaps we should mention, in connection with the leakage test, that the average high grade new electrolytic condenser, has a leakage current at rated voltage, of approximately .1-ma. or less, per microfarad of capacity. There is some discussion as to the maximum permissible leakage a condenser may have before being discarded, but the consensus of opinion seems to be that 1. ma. per microfarad of capacity constitutes the upper limit.

This completes our discussion of the circuit details, but there are several comments necessary regarding certain points which will be taken up at this time. Several references have been made to Sw. 5, Sw. 6, and Sw. 7 and it seems desirable to mention the fact that these switches were made up by the writer from the contact springs off several old phone jacks. However, with a slight repositioning of apparatus the equivalent manufactured push switches can be used and these are specified in parts lists.

The Instrument as an Analyzer

So far no mention has been made of the method employed to gain access to the socket connections of a radio set for analysis purposes. While it is quite possible for the constructor to make up a socket selector unit, the writer chose to use a standard commercial unit for this purpose, and a Weston model 666, type 1-A socket selector unit was employed. Provision was made for plugging this unit into pin jacks at top of test instrument as shown in the photograph of the front panel.

Nothing has been said about the dimensions of the instrument we have had under discussion. By using care in the arrangement of apparatus and employing a "double deck" layout, the writer succeeded in placing all apparatus on a 7 x 10 in. panel with an approximate depth of 5 ins. This was enclosed in a carrying case 10 1/4 ins. square x 6 1/2 ins. deep, outside dimensions. However, it is suggested that unless the prospective builder of such apparatus has had considerable experience with the construction of compact equipment, that the parts be spread out on a larger panel.

The method of marking the switch positions and tip jacks also deserves brief comment. The two main switches Sw. 1 and Sw. 2 are provided with a flat metal plate with oblong openings cut at positions corresponding to the various taps on the switch. These plates were given several coats of black auto enamel baked on, and were then rubbed to a dull gloss with pumice stone and oil. Paper markers were then made by typing the designations on very thin paper, at positions corresponding to openings in the switch plate, and then using this as a negative to make a photographic, or "contact print" resulting in a black background with white letters. The same idea was used in making the long narrow markers for the tip jacks. Of course a heavier grade of paper can be used and placed under the switch plate, that is without using the photographic print idea at all. The holders for the tip jack markers are sections cut from old telephone switchboard card holders. All other markers were cut from thin sheet brass, engraved, nickel plated, and filled with black lacquer. Of course, the entire panel can be engraved if desired.

Attention is now directed to the several photographs which, it is hoped, will assist in a clearer understanding of this instrument. Figure A shows the instrument in its case, with cover removed, and with the Weston socket selectors, adapters, jumper cables, line cord and plug and other accessories spread out in front.

The three push buttons at the bottom of the panel, reading from left to right, control Sw. 7, Sw. 5, and Sw. 6, respectively. The two rotary switches immediately above are Sw. 1 and Sw. 2. Just above these switches are Sw. 4, Sw. 3, and "special" jack J13. Then on left of meter is shown R32, the line control, and on the right

Fig. 4
 Reference scales concerning tester.

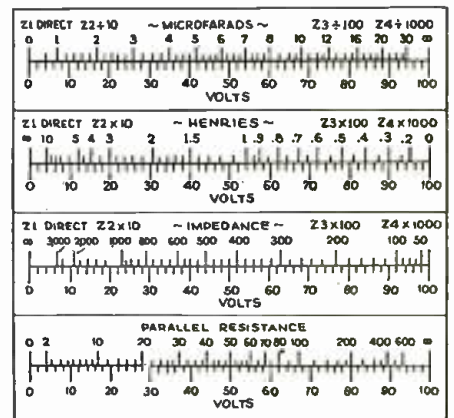

Please Say That You Saw It in RADIO-CRAFT

of the meter is shown R25, the low ohms zero adjuster. On the upper left and upper right of the panel will be seen the tip jacks. In the upper center of the panel, just above the meter is a flat bakelite plate, or cover, of the same length and width as the Weston socket selector. This plate is removable and covers a small "well," or box-like enclosure below the main panel, which houses the 5 fuses. The circular holes on the two ends of this flat plate are immediately over the two tip jacks into which the Weston socket selector is plugged when in use.

Figure B shows a back-of-panel view during process of assembly and wiring. Identification of principal parts should be easy by comparison with front view of panel in Fig. A. Principal parts are also designated with the same designations used in schematic diagrams. The meter does not show in Fig. B because of the resistor mounting panel, which is supported on small studs projecting from aluminum back panel, and covers the meter with exception of the meter studs, which can be seen projecting through the resistor mounting panel near center.

Figure C shows a back view of instrument after sub-panel had been bolted in place and all wiring had been completed. As can be seen, this sub-panel is used to support the parts used in the power supply and also the two 1.5 volt cells used in the measurements of low resistance values. There is also a recessed panel secured to upper end of sub-panel, which provides for the mounting of Sw. 8, J11 and J12 and REC., the A.C. line receptacle. The recessing of these parts flush with the outer surface of their supporting medium permits the insertion of the instrument into a carrying case in such a manner as to provide clearance from the side of the case, for these parts. Perhaps we had best add that an oblong opening was cut in the end of the carrying case to permit access to this panel, and was finished off with a nickel-plated escutcheon plate. Unfortunately this could not be shown in the photograph. The small panel at the left center marked CP is merely a connection panel for all connections going to main panel above. All other designations are in accordance with schematic diagrams.

Figure D is similar to Figure C, but shows more clearly the manner in which sub-panel is supported below the front panel.

It was intended originally to describe in detail, the method of calibration for the capacity, inductance, impedance and parallel resistance scales. However, this is a subject really requiring separate consideration, and therefore, we shall assume the reader is familiar with such methods and content ourselves with the presentation of Fig. 4, which shows the auxiliary scales required. If the same type of meter is used as employed by the writer, and the same value of resistors and voltages are used, the auxiliary scales of Fig. 4 can be relied upon within approximately the limits of commercial tolerance.

Perhaps a word regarding the inherent limitations of the deflection method of measuring resistance and reactance may be in order at this time. The writer has frequently seen reference made to resistance or reactance calibrations in such a manner as to imply a high order

of accuracy. In general such a high order of accuracy cannot be expected or realized in practice for the following reasons. First, the inherent error in the indicating instrument. On a D.C. movement of the popular panel mounting type for example, the accuracy rating is usually 2% of full scale. On a 50-division scale this would mean one division. As this error is constant throughout the entire arc of the scale, the total error may become quite large at small values, say, for instance one-tenth of the total scale. On an A.C. instrument of the copper-oxide rectifier type the accuracy rating is usually 5% of full scale. Add to these possible errors the errors in calibration and the errors in reading due to parallax and to the characteristic crowded condition of the scale at the extreme ends and you will have some idea of the net accuracy of the instrument in practice, though all possible errors have not yet been enumerated. However, the picture is not always so bad as our outline would seem to indicate due to the fact that the errors are not necessarily additive.

In our particular instrument there was an additional factor to be allowed for, namely, the divergence between the reactance ranges when using the 5-volt range of our copper-oxide meter and multiples of these reactance scale values when using the 25- and 250-volt scales of meter. This divergence is due to the change in effective circuit resistance on the lower voltage ranges of our meter, due to the current density characteristics of the copper-oxide rectifier unit. We have divided this error approximately between the lower and higher ranges in order to permit a single scale to serve for all ranges. The greatest error on any of the ranges is at the extreme left of scale and decreases as pointer moves to right. All readings should be taken on a range that permits a reading as near center of scale as possible, for best accuracy.

List of Parts

- One Weston model 301 A.C.-D.C. universal meter with D-71780, mod. 665 scale and special 5 V. multiplier resistor (see text), M;
- One Weston socket selector, model 666, type 1-A;
- Two pairs of Weston jumper cables, No. D-71785-6;
- One Weston ground lead, No. D-71787;
- One I.R.C. precision resistor, 4,840 ohms, R2;
- Two I.R.C. precision resistors, 5,000 ohms, R3, R23;
- Three I.R.C. precision resistors, 20,000 ohms, R4, R16, R22;
- One I.R.C. precision resistor, 45,000 ohms, R5;
- One I.R.C. precision resistor, 95,000 ohms, R6;
- Three I.R.C. precision resistors, 245,000 ohms, R7, R15, R21;
- One I.R.C. precision resistor, 250,000 ohms, R8;
- One I.R.C. precision resistor, 500,000 ohms, R9;
- One I.R.C. precision resistor, 150 ohms, R10;
- One I.R.C. precision resistor, 40 ohms, R11;
- One I.R.C. precision resistor, 7.5 ohms, R12;
- One I.R.C. precision resistor, 2 ohms, R13;
- One I.R.C. precision resistor, 0.5-ohm, R14;
- One I.R.C. precision resistor, 1,300 ohms, R17;
- One I.R.C. precision resistor, 1,050 ohms, R18;
- One I.R.C. precision resistor, 316 ohms, R19;
- One I.R.C. precision resistor, 25.5 ohms, R20;
- One I.R.C. precision resistor, 265 ohms, R24;
- One Continental Carbon resistor, 201,250 ohms, 3% tolerance, R30;
- One Continental Carbon resistor, 203,750 ohms, 3% tolerance, R29;
- One Continental Carbon resistor, 2,051,000 ohms, 3% tolerance, R28;
- One Continental Carbon resistor, 2,072,000 ohms, 3% tolerance, R27;
- One Continental Carbon resistor, 2,136,000 ohms, 3% tolerance, R26;
- One Continental Carbon resistor, 2,125,000 ohms, 3% tolerance, R31;
- One Continental Carbon rheostat, 250 ohms, 25 W., R32;
- One 600-ohm variable rheostat, R25;
- One jack switch, Sw. 3;
- One push switch, Sw. 5;
- Two push switches, Sw. 6, Sw. 7;
- One single circuit insulated frame jack, J13;
- Twelve tip jacks (color and type as desired);
- One switch, Sw. 8;
- Two switches, Sw. 1, Sw. 2;
- One General Transformer or Kenyon special power transformer, (see description) PT;
- One 1/100-Amp. fuse;
- One 1/32-Amp. fuse;
- One 1/8-Amp. fuse;
- One 3/4-Amp. fuse;

Fig. C

View of rear-outside "deck."

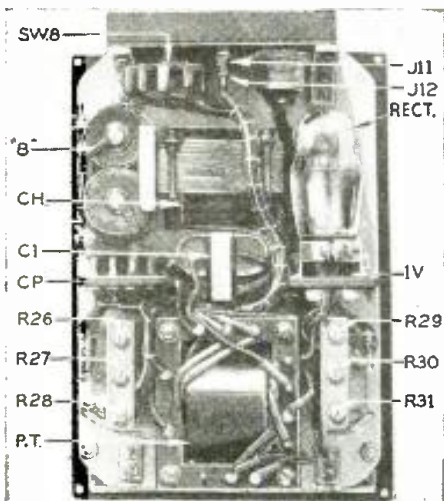

NATIONAL UNION

—tells you how to

MERCHANDISE

RADIO SERVICE



in 1935 SELL under the Sign of Efficiency!

Service Dealers! Get in on National Union's great service merchandising plan for 1935. Supplementing the free shop equipment offers which will be continued, National Union will help service dealers to increase their business through tried and proven sales, advertising and merchandising plans. Ideas, campaigns, and the material to carry them out will be made available to National Union Service Dealers in 1935. Now, more than ever you need National Union!

DIRECT MAIL AND CANVASSING: Printed matter that will sell for you and explanation of how to use it to best advantage . . . yours on this plan.

EFFICIENT BUSINESS FORMS: Forms designed to make your business 'click'. Chosen from pieces used by outstanding Service Dealers in all parts of the country . . . yours on this plan.

DISPLAY MATERIAL: Special displays to acquaint set owners with your shop as the place to go for efficient radio service . . . yours on this plan.

SPECIAL SELLING PLANS: Ideas that have made money for others revealed and fully explained so you can use them. Prizes, too, for your ideas will be announced.

You, Mr. Service Dealer, will be set to make the most of your business in 1935 if you tie up with National Union. Send coupon or write for National Union circular which gives details of the Service Merchandising Plan.

National Union Radio Corp. of N. Y. RC-235
 400 Madison Avenue, New York City

Send me the circular which tells about your Merchandising Plan.

Name.....
 Street.....
 City..... State.....

Please Say That You Saw It in RADIO-CRAFT



Exact Duplicate REPLACEMENTS



When you **MUST** use identical replacements, simply remember **Aerovox Exact Duplicate** Replacements. Designed specifically for most standard sets . . . finest replacement units obtainable . . . embodying Aerovox high-quality construction throughout.

For instance: Aluminum can electrolytic, two cardboard case electrolytics, and an auto-radio vibrator condenser pictured above—each *exactly matching* units in the intended sets. Characteristics *positively matched*, but Aerovox quality is more than a match for some original equipment.

And for general repairs, don't overlook the Ultra Compact PM5 and PM6 Hi-Farad Electrolytics . . . all-round units . . . minimum stock and investment . . . maximum applications and profit-making.

FREE DATA 1935 Catalog just off the press covers entire condenser and resistor line. Also sample copy of monthly Research Worker.



CORPORATION
77 Washington St. : : Brooklyn, N. Y.



WRIGHT-DECOSTER Speakers

Available Everywhere

It is our well known policy to endeavor to do all of our business through the legitimate wholesale distributors. Therefore, any recognized distributor of Radio equipment can quote you prices and show you samples of **WRIGHT-DECOSTER Speakers**.

Many a radio has been made a better radio with a **WRIGHT-DECOSTER Speaker**. Write for catalog—a speaker for every purpose.

WRIGHT-DECOSTER, Inc.
2251 University Avenue, St. Paul, Minn.
Export Dept. M. Simons & Son Company,
25 Warren Street, New York
Cable Address: Simontrict, New York

- One 1 Amp. fuse;
- Ten fuse clips;
- One toggle switch, Sw. 4;
- One Cornell-Dubilier paper condenser, 600 V. rating, .5-mf., C2;
- One Cornell-Dubilier paper condenser, 400 V. rating, 3 mf., C1;
- One General Transformer choke, 30 hy., 500 ohms or less D.C. res., Ch;
- One RCA Radiotron rectifier tube, 1V;
- One midjet receptacle and plug, REC;
- Two 1.5 V. No. 2 dry cells, B;
- One panel of desired dimensions, material for sub-panel, supply of sheet brass, aluminum, wire, solder, lugs, test leads, 4-prong socket, A.C. cord, screws, nuts, etc., etc.

BE SATISFIED TO BE A SERVICE MAN

(Continued from page 485)

age radio servicing salaries, and most instances considerably less. As for a future, the very nature of radio engineering virtually compels a salaried job with a sizable corporation, or with the uncertainties of consulting engineering as an alternative. Meanwhile the radio Service Man has always the opportunity to be on his own, to be independent, to build up something which no one can take away from him.

So let's see this radio service field in the right light. It's a real opportunity—but also a challenge. Merely to be called a Service Man, without having the proper backing for that title, is insufficient. There are tens of thousands of radio Service Men in that category. To get the real rewards out of radio servicing, one must have proper training, ample experience, real salesmanship, a true business sense, and unlimited initiative and energy and honesty.

Equipment, too, is necessary. Radio sets and tubes of today are far too intricate for the handy-man methods. Test equipment is essential, not only out on the job but in the shop. Unless a radio Service Man is properly equipped, he is quite unable to get his share of radio. He is like the surgeon attempting a major operation with bare hands and no instruments. Surely not impressive, certainly not prepared for the work, and absolutely unfit to collect a professional fee. The stage setting, either in the doctor's case or the Service Man's, has lots to do with collecting worthwhile fees.

Still one more point: parts. Good parts are always the cheapest at any price. Because good parts can be installed and forgotten. They perform satisfactorily. There are no complaints, no comebacks, no return calls at your own expense. No ill will created against you. After all, your time is more valuable than the few cents one way or the other between a good part and a poor part. You cannot afford to take chances with questionable parts.

Lastly, there is the matter of personality. It's worth cultivating, for it builds confidence and patronage and profits. Getting into the homes of the community, gaining the acceptance of many households, the Service Man is in position to recommend not only radio sets and appliances, but also other home equipment. Here is a wonderful opportunity to build up towards a radio and electrical appliance trade, and even an oil-burner and air-conditioning business.

A veritable gold mine lies before the radio Service Man in the average community; but like all gold mines, he must first of all ascertain the approximate location of the ore, then go to work digging and digging, and finally refine that ore he finds, by skill and patience and hard work, in order to get the gold as his ultimate reward.

Many a radio Service Man of today can be the prominent dealer of the community tomorrow. Compare such a future with that of the radio engineer who holds a more or less uncertain job with a corporation, which tenure is subject to the constantly changing whims of different managements.

So you see, the grass in the radio servicing field is mighty green and plentiful if you will only do a bit of digging and plowing and seeding. It's mainly beneath the ground. But the potential crop is there if you but do your share—and stop envying the other whose opportunities are very much overrated.

INTERNATIONAL RADIO REVIEW

(Continued from page 469)

circuit to advantage in adapting it to available parts.

TUNING INDICATOR WITH PILOT LAMPS

NUMEROUS schemes have been devised for giving a visual indication of tuning, for highly selective sets of the superhet. type. Most of these involve the use of special neon tubes or galvanometer movements limited to rather narrow operating conditions, which must be adhered to exactly in order to permit correct operation.

WIRELESS MAGAZINE, in their latest issue, presented a group of circuits, using ordinary small lamps such as pilot lights, as tuning indicators.

The circuit in Fig. 3A shows an indicator lamp fed from a 2½ V. winding of the power transformer and coupled to a transformer L in the output circuit of a power detector in any receiver.

In this particular case an increase in signal strength will produce an increase in plate current. Under no-signal conditions, the inductance of the coil L is sufficiently high to choke down the current passing through the lamp. But as the circuits are tuned to resonance the rising plate current through L saturates the core so that its impedance is reduced and the indicator lamp increases in brilliance.

If an ordinary pilot lamp A, Fig. 3B, is inserted in series with the plate supply to the A.V.C. tube V, then, the current falls off as signal strength increases, and the lamp will indicate the correct tuning point by going out. The shunt resistor R is inserted in order to preserve the plate supply to the tube in case the lamp burns out.

On the other hand, if the lamp is arranged as shown at C, in Fig. 3, then it will indicate the correct tuning point by rising to maximum brilliancy, because as the plate current through tube V falls off, the potential drop across the resistance R, follows suit, and a higher voltage is applied to the lamp from the "B" supply.

The view at Fig. 3D shows a visual indicator based on a combination of both bulbs. The bulb A, which throws a general illumination over the dial is arranged in circuit as in circuit B. It gives a full light as long as the circuits are out of tune, but grows dim at the point of resonance.

The lamp B which is placed just behind a tuning slot or arrow, M, is arranged as in circuit B and increases in brilliance with increase in signal strength.

As the signal is tuned in, the general illumination of the dial gradually fades away, while the light thrown on the window suddenly increases to a maximum. This produces a striking effect—and one which can be used to advantage by the experimenter in practically any modern set.

WLW'S "ELECTRIC EYE"

(Continued from page 471)

sented itself when it was found that once the arc was started across this gap, either by lightning discharge or by an abnormally high voltage, the arc could not be extinguished as power from the 500,000 watt transmitter kept it "alive," draining practically all of the station's power from the antenna into the ground.

After various types of gaps, current transformers and rectifiers were tried unsuccessfully, engineers resorted to the use of the photoelectric cell device. A Weston photonic cell, with its associated relays, was installed in a double shielded box on the brick wall surrounding the antenna base insulator. A long tube containing light baffles was installed so that only light from a point directly in the safety gap could strike the photoelectric cell. The relay operated by the "electric eye" was connected in such a manner as to remove the station's plate voltage to the final amplifier whenever the photoelectric cell was excited and to reapply it the instant the arc was extinguished. Due to the high speed of the control circuits, the interruption to service is so slight as to be barely perceptible to the ear.

Please Say That You Saw It in RADIO-CRAFT

RADIO SET OF 1950

(Continued from page 458)

If the radio set stands against the center of a wall for instance, then the person who sits in a chair near the same wall cannot possibly see the television image, and he has to move around in order to see the image. For that reason, the television-equipped radio set of 1950 will have the television screen in a compact box or case which can be swiveled on top of the set, in such a manner that the screen can be made to face anyone anywhere in the room. To obtain this result, the television apparatus proper must be on top of a cabinet where it can rotate freely through 360 degrees. When the radio set is not in use, means can be provided to disguise the television screen as a decorative picture or what not to harmonize with the decorations of the room.

As I pointed out in a previous article (see RADIO-CRAFT for April, 1934) it is already possible today to receive by means of radio, not only facsimile transmissions, but even a complete tabloid newspaper, which can be printed while you sleep by the radio receiver. By the time you wake up in the morning, the tabloid newspaper is already printed for you. The full instrumentality how this is done, with all the apparatus described, was shown in the above issue of RADIO-CRAFT.

The radio set of 1950 will have such a facsimile printing arrangement built right into it. But in addition to this, I wish to speak of another feature which, as far as I know, has not been described so far. When television finally comes about, it will be done (in this country at least) only through commercial means; that is through sponsored programs, which will have to bear the tremendous cost in bringing television into your home. Great artists will perform in the studio and their images will appear on your television screen; so that you will, in addition to hearing their voices, also see their features. And, when a great artist appears, it would be an added value if you could get almost instantly, his autographed photograph, without stepping out of your own room. This will be effected as follows:

While you are looking at the artist on your television screen, the announcer will hand him a photograph, which he will autograph before your eyes. This photograph is then taken into the adjoining control room, where it is automatically transmitted on the same wavelength as that used by the broadcast station; and, in a few minutes, it will appear in front of your radio set in a slide provided for that purpose. The technical difficulties of doing this are but slight. It has already been demonstrated by several stations that television images can be sent out simultaneously with the sound impulses, over the same wavelength, without interfering with each other. The idea, therefore, of sending autographed photographs or other similar documents from the radio station to your own home and over your own set is, therefore, realizable even today. With certain refinements, the radio set of 1950, therefore, will not only be enabled to furnish you with your morning tabloid newspaper, giving you "spot" news information, but also autographed photographs and other memorable pictures that the enterprising station will wish to send out to its radio public.

Of course, it is understood that all the radio station will do is send out impulses; the radio set must do the rest. The upkeep of the radio set of the future will be exactly as it is today, and it will be up to the owner. At the present time you have to worry only about tubes and other replacements. In 1950, you will have to provide, in addition, rolls of paper in two varieties; one, a cheap newsprint roll for the nightly tabloid newspaper; the other, sheets of photographic paper for the facsimile photographs, etc.

As to the quality of sound received, the radio set of 1950 should be improved upon, with the same progress noted during the past ten years, which will continue. The future radio set will sound as different from the one we hear today as today's radio set compares with those of 1924 or 1925. Just as you are wondering today how you could ever have listened to the abominable sounds from the 1924 radio set, so in 1950 you will wonder how you could stand the kind of sounds which you received from your 1935 set. We are only now entering on the so-called High-Fidelity cycle. This will culminate by 1950 into, what I may term COMPLETE FIDELITY; where it will not be possible for a human ear to notice any difference between a well-known

Get More Stations, Louder Signals and Sharper Tuning with HAMMARLUND I. F. TRANSFORMERS

REPLACE your obsolete I.F. transformers with the new Hammarlund Type "ST" and get improved results. And use them, too, for original equipment.

Service men, amateurs and professionals all praise their remarkable efficiency, stability and moderate price.

Equally satisfactory for one or more stages in connection with any type second detector. Four special types for broadcast or short-wave receivers. Also 465 kc. oscillator units. Tuned grid, tuned plate, with lattice-wound coils. Litz-windings in the 465 kc. S.W. units, with mica compression tuning condensers from top of shield can. R.M.A. color-coded leads. Aluminum shield can, 2 1/4" high x 1 7/16" wide. \$1.65 each, less 40% to experimenters.

Mail Coupon for Details

HAMMARLUND MANUFACTURING CO.,
424-438 W. 33rd St., New York, N. Y.

Check here and attach 10c for Hammarlund 1935 Short-Wave Manual. Check here for FREE new 1935 Catalog.

Name _____ Address _____

RC-2

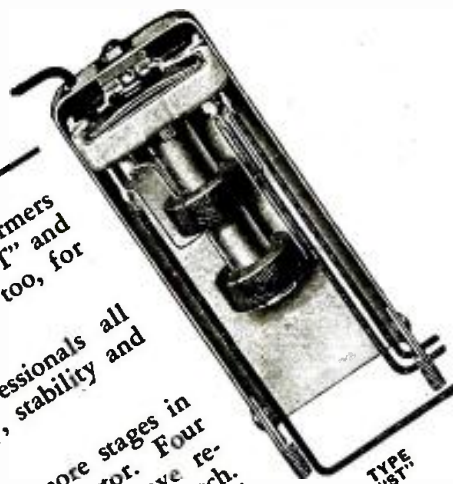

voice spoken in the same room and that transmitted by radio.

It is quite probable that the radio set of 1950 will no longer have two amplifiers (as some receivers now have, one giving the low notes and the other the high notes) but it will probably have an entirely new type of amplifier, which will pass all the audio frequencies in a manner undreamed of today. It is quite possible that we will have a combination loudspeaker, built into a single unit, to transmit faithfully the lowest as well as the highest frequencies. This will come about by having a single speaker (of a design not yet realized) with a multiplicity of vibrating diaphragms, screens, or cones; all built into a single unit, yet making it possible to do what the human voice does—that is, automatically provide a wide range of frequency without having recourse to a number of loudspeaker units.

A good soprano, for instance, is enabled to sound fundamental notes between the frequencies of 195 straight up to 1,150 cycles; but of course there also are produced, without the conscious effort of the singer, harmonic frequencies, without which it would be impossible to distinguish one singer from another!—and these harmonic frequencies extend the effective "soprano" range to at least 8,000 cycles (or more than twice the range of fundamental frequencies produced by an 88-note piano; it is the still higher frequency harmonics of these fundamentals that enable us to identify an individual piano!) This is a considerable range, and the soprano does all this by means of one throat (and larynx). She does not need several throats to do it. Certain trick tenors, as well as sopranos, can even exceed the range indicated above; proving that a single instrumentality can give a wide range of audio frequency. This is what I have in mind when I say that the loudspeaker of the future will give complete fidelity in a single unit, instead of a number working in unison as we do in high fidelity today.

But the radio set of 1950, besides having reached a high development in both visual and aural radio has not, by any means, exhausted its possibilities. Those who think that the radio set of the future will be used only for sound and vision are mistaken. As a matter of fact,

the complete possibilities of the radio set are not, as yet, apparent. As the art progresses new uses, new inventions will be made, all of which can sooner or later be incorporated in your home radio set.

In the first book that was ever published on radio telephony (long before the radio telephone and broadcasting were invented), entitled "The Wireless Telephone" and written by myself in 1910, I made the following prediction:

"The wireless telephone of the future must be as flexible as the wire telephone of today. Every farmer will be able to operate his wireless telephone, where the sending and receiving instruments will be housed in a box a foot square."

We are only now catching up with that idea. Since 1910, the wireless telephone has come about through the means of broadcasting to our own homes; but today's set, as yet, can be used only for one-way communication. Your radio set is enabled to talk to you, but you can't talk back to it; at least, not as yet. Slowly this condition is changing. Through using ultra short waves (that is, frequencies less than 6 meters) for instance, it is possible to accommodate several hundred thousand radio telephones for communication purposes.

Most people are not aware of the fact that the radio set in their own home is also an excellent transmitter. By making a very slight change, it is possible to send out into space, over the same aerial, voice impulses. Merely by throwing a switch on your own set it becomes possible, even today, to speak into a microphone using your own receiving set as a transmitter (a type already called Transceiver) and communicate with your friends, etc.

Why is it not done today? The reason is that, up to now, it has been necessary to obtain an amateur license or radio operator's license before you can transmit voice or sound by radio. This means that you must know the code, you must know how to send dots and dashes. Slowly, the Federal Communication Commission is coming to realize that this is an archaic condition and, if we had a small radio wave band below 6 meters opened up for private communication, it would be possible for your wife sitting in your own home to pull out a microphone from a

Please Say That You Saw It in RADIO-CRAFT

BUILD YOUR OWN SHALLCROSS UNIVERSAL TESTER

For \$41.50 Complete



VOLTS
A.C.-D.C.
5-25-100-250-
1000 ohms
per volt

**MILLI-
AMPERES**
D.C.
1-10-100-1000

CAPACITY
0.01-10 Mfd.
Paper or
electrolytic
condensers

**INDUCT-
ANCE**
1-10,000 Henrys

5-5,000,000 ohms D.C. Resistance

Send 6c in stamps for the new Bulletin No. 611-P containing the complete wiring diagram and operating instructions for this modern serviceman's instrument.

SHALLCROSS MFG. COMPANY

Electrical Measuring Instruments
and Accurate Resistors

700 MAC DADD BOULEVARD
COLLINGDALE, PA.

SEND FOR THIS

FREE CATALOG

Check full of BARGAINS in RADIO SETS, Long and Short Wave Apparatus, Servicemen's Repair and Replacement Parts, Electrical Appliances and hundreds of miscellaneous specials at TREMENDOUS SAVINGS.

Get this big new Bargain Book. It's absolutely FREE without obligation—just send us your Name and Address on a post card

WRITE FOR YOUR COPY NOW.

JUST OFF THE PRESS

RADIO CIRCULAR CO., INC.
225 RC VARICK ST., NEW YORK

Stop Guessing!

Radio service is easy when you know just where to look for the troubles. And, the securing of profitable fees for the repairs makes the work still more attractive. A CHUCKER eliminates guess-work in "What is Wrong and What to Charge." This trouble-localizer, with a really profitable repair-priest schedule included, enables radio men to localize any trouble in any radio, quickly, right in the field, without dismantling the radio. It looks official, and permits you easily to convince set-owners that you are not guessing at either the trouble or the price of the repair job. Your competitor makes good money by using a CHUCKER!

Send \$1.00 NOW for yours, postpaid.

FREED'S RADIO CO.

Publishing Division R
5053 Baltimore Ave. Philadelphia, Pa.

space provided in her radio set and, within a few minutes, be in communication with her husband who may be sitting in his automobile 20 miles away from home.

I know that a lot of people will throw up their hands and howl at this suggestion. The cry will go up that the ether lanes are already so crowded and cluttered up with transmitters that even if we wanted, communication of this type would be useless; because no one would be able to understand anything. This is not true at all. I have had this idea in work for the past two years in RADIO-CRAFT'S sister publication SHORT WAVE CRAFT, where the pros and cons of this idea of mine have figured in a discussion, hot and heavy. After all the smoke is clearing, the fact remains that below 6 meters, fortunately, you cannot transmit further than about 20 miles. In general, that means that you cannot go much beyond the horizon. Thus, for a certain area, there will be far less congestion even than there is today; because on a few dozen frequencies, assigned for each district, with an automatic frequency lock on your radio set, there could not be too much congestion. It will, therefore, become a rather simple thing to converse by means of your own set with your friends a few miles distant. This will be especially useful for communication in outlying districts; such as on farms, between houses, automobiles, motorboats, yachts, and many other applications, not to forget private airplanes, of which there will be many in 1950. In case of accident, for instance, on the road, automobile, by means of transceivers, can quickly summon aid. The same is true of motor boats and airplanes.

But the idea of the transceiver does not stop here by any means. I still have in mind another idea one which has constantly bothered radio engineers, and for which no solution has been offered so far—and that is the item of *applause by the unseen radio audience*. I believe the transceiver is the solution for this problem. It is well known that a radio station has, up to now, never had an accurate means whereby it could check up how many listeners there were. I visualize the radio applause idea somewhat as follows:

On the radio of 1950 there will be a special button or switch. You are listening to a radio program, at the end of which the announcer asks for an expression from you. If you like the artist or the program, you merely throw a switch; this immediately transforms your radio receiver into a transmitter. A certain note, let us say a whistle of 500 cycles, is automatically transmitted, by means well known today. Somewhere in your district there is an elaborate radio set maintained by the radio station or network to which you are listening. This special radio set receives your 500-cycle note, which is sent out in lieu of applause. By means of a special resonance meter, a needle will fluctuate, showing a certain intensity received. Suppose that there are a thousand individuals sending out at the same instant a note on the same frequency. All will superimpose, one on the other, and the effect will be as if a powerful transmitter were radiating that note. The more powerful the note, the higher the meter at the receiving set will indicate. In other words, the more people applaud, the stronger the indication of the special receiving set belonging to the broadcast station. If the applause lasts for, perhaps, five seconds, the meter will have vibrated up to a certain figure on the dial—let us say 68. By means of a slide rule, the engineer in charge immediately calculates that, in order to get this much gain, there must have been 3,859 transceivers sending the applause impulse. In other localities, scattered all over the country, we have the same instrumentality and, within a few seconds, the key station will have been informed exactly how many people applauded. This result may vary a few per cent; but the difference will not be very important, and a pretty accurate estimate of the total number who applaud can thus be made. Expensive you say? Yes, it is expensive for the radio stations; but when you figure how tremendously great the incomes of the radio stations are, you will also understand that they will gladly go to this expense so that they can get accurate information as to the listening audience.

There may be a few slight objections to the scheme; for instance, there are two programs on the air, on two networks. Which applause goes to which station, or which applause goes to which program, on what network? The answer is the *time element*. The competing stations can readily split their time, in such a way

that no two programs will end at the exact time. At the present time, most of the important programs start and stop on the hour or the half-hour. This could be changed so that one network would run on the hour or half-hour; the other fifteen minutes later. These are simple details that could be worked out in such a manner that there would be no occasion for clashing as far as applause is concerned. Sooner or later, this idea will be used, and the transceiver is the solution of the problem.

Yes, the 1950 radio receiver will be complex. If you compare the 1935 receiver with the crystal set of 1920, you will also say that the 1935 radio is complex, even as compared with the receiver of 1922. Progress always means more complexities, and the radio set is no exception to this rule. The 1950 radio set will be ever so much more complex than the one of 1935, but it will be vastly more enjoyable than the present-day set and vastly more efficient.

INTERFERENCE ELIMINATION

(Continued from page 475)

appliances he found that the washing machine was producing an exceptionally large amount of man-made static. This fact was reported to the woman, with the recommendation that she arrange for "filtering" the motor so that she herself would not be responsible for the same type of disturbance, inflicted on her neighbors, that she had found sufficiently annoying to cause her to complain to every possible authority. Did she approve of this suggestion? Indeed she did not. In fact she said "When everyone else in this neighborhood has quieted his appliances, I will take care of my washing machine. Until then, I will do nothing."

That the cost of eliminating interference is not a major factor contributing to the unwillingness of many individuals to silence the noise-makers on their premises is proved by another incident which occurred during the survey just mentioned. A particularly vicious interference was traced to an oil burner in the home of one of the wealthiest men in the community. He had been much interested in having the noise survey conducted, so when the engineer reported where interference had been found, the chairman of the survey committee said, "I know he will take care of that trouble." On being asked, however, the owner of the oil burner stated that he planned to purchase a new burner within a few months and would insist on a "filtered" burner at that time. He did not feel that it would be worth while to spend any money to eliminate interference from the old burner.

Since such action would leave a major interference making reception impossible for many listeners, the survey committee offered to repurchase the "filtering" equipment at its full price when the new burner should be installed, if only the noise might be eliminated at once. Even this proposal, which insured the appliance owner against any chance of loss, was refused—and the noise is probably still blasting the best programs in that community.

What Can Be Done?

In the two examples cited, there was no technical difficulty involved in eliminating the interference. A filter costing less than five dollars would have kept the washing machine from affecting even the radio in the same building, while a filter costing less than ten dollars, plus a little shielding of ignition spark wiring, would have made the oil burner absolutely silent as far as radio is concerned. Technical knowledge could not, however, surmount the obstacles interposed by individuals who felt that their convenience was of greater importance than was the successful completion of a noise elimination campaign.

From this brief discussion it should be evident that the elimination of man-made static, which must be accomplished if short-wave reception, television, and high fidelity transmission are to be satisfactorily conducted, is no longer dependent on the development of new engineering methods but awaits only a means of making the fruits of present technical progress available to the majority of radio listeners. The engineer has done his work—now let us learn how to utilize it.

(Additional and more detailed information on the subject of radio noises will appear in a subsequent issue of RADIO-CRAFT.—Ed.)

Please Say That You Saw It in RADIO-CRAFT

WHAT SET SHOULD I BUY

(Continued from page 466)

purchase of a radio set. Almost all the reputable manufacturers produce a line of radio receivers from less than fifty dollars to more than two hundred, in different price ranges, so that any buyer may select a receiver within his price class. Naturally, all things being equal, you get more in a two hundred dollar set than you can get with one in the \$69.50 class. It is only when a last year's model or one of a bankrupt manufacturer is offered, that it is possible to obtain a high-priced receiver at a low figure. Here, of course, you must realize that current model receivers usually present more in the way of improvements and refinements. So far as bankrupt stock is concerned, the integrity and value of a responsible manufacturer no longer stands behind the receiver and it may also be more difficult to secure parts or service when such a receiver is in a state of dis-repair, besides the possibility of higher prices for replacement parts. In some other cases, a radio set may be obtained at a lower price than the market price by those persons who know some one "who can get it for them wholesale." This is splendid (when accomplished) but more often than not, such sale does not carry with it the usual service guarantee tendered by a dealer, and should trouble develop in the receiver, as is quite possible, the cost of repair involved may amount to more than the saving.

Very often, those who are desirous of purchasing receivers go to a retailer with some particular brand and model in mind because of the fact that they know or heard of some friend or relative who owns one of these radio sets and is obtaining satisfaction therefrom. This is unwise, since it not only prejudices the purchaser in that set's favor despite the superior qualities of another in the same price class, but that same receiver may not operate in like manner in the purchaser's home because of different conditions. The fact that the cabinet style may not blend with home furnishings is another factor in this case. Although the idea of obtaining a consensus of opinion from a number of set owners is valuable as regards some certain radio set, it is usually best to make no reservations and to select the set which will best suit your needs and taste after making a complete test for yourself.

Before advising Mr. Jones upon a radio set, the suggestion is made to visit his home to determine the type of receiver which would be most efficient in his location. At the same time, a "line" on the size and design or style of the cabinet could be secured. Since Mr. Jones is married, his wife should accompany him to the retailer so that she might have something to say about the cabinet style before the purchase and not after.

What Are Your Pre-Purchase Preferences?

Before you even pay a visit to a radio store, why not try to analyze just what you do want in a radio receiver? Are you interested in a set that is very sensitive and is capable of receiving very weak signals from distant stations? But you must also consider whether such a receiver would operate well in your location. Should you live adjacent to an electric train, trolley or electric bus, or near a power house, reception would be seriously marred by the electrical disturbances created by these devices. In this case, a very sensitive receiver would be a poor choice, unless of course, you have intentions of changing your location in the near future. If you are interested in receiving foreign broadcasts such as is possible with the many good short-wave and all-wave receivers on the market today, it must be remembered that man-made electrical disturbances increase in intensity upon short waves. Even though your neighborhood be entirely free from trolley cars, trains, etc., you may be located on or near a busy thoroughfare. Here, good short-wave reception will be difficult since the ignition systems of motor vehicles produce a great deal of interference only upon the high frequency short-wave bands. You may think, however, that although automobiles produce such interference, traffic diminishes considerably towards late evening, but at this time, very little foreign reception, if any, may be obtained because of the difference in time. It should be remembered that it is midnight in England when it is only 7 p.m. in New York City.

In connection with short-wave reception, the foregoing is not intended as a "scare," or as a promise of poor reception when a short-wave receiver is operated under these conditions. Special short-wave antenna systems have been devised and are available whereby the effect of these electrical disturbances is reduced considerably in most instances, and eliminated in others. Where a receiver is to be installed in an apartment or office building which operates elevators, or motors for some special purpose, another type of special antenna may be erected. Whether this is necessary or helpful can only be determined by one experienced in these matters and cognizant of the particular location and conditions.

One important point to consider in connection with all-wave and short-wave receivers is the ease of tuning. On the shorter waves, it requires great patience to isolate and bring in distant broadcasts, unless the band-spread is sufficient to provide appreciable space between scale divisions. This means simply using higher vernier ratios or providing auxiliary small condensers in parallel with the main tuning condensers. To avoid multiplicity of controls the vernier dial method is preferable, particularly when it can be changed for various bands. Many sets today have all bands marked clearly in kilocycles and megacycles, eliminating all "fishing" for elusive programs.

First—Chassis; Second—Cabinet

Although a cabinet enters into the satisfactory operation of a radio receiver to a great extent so far as tone quality is concerned, the selection of the chassis should be considered of prime importance. Choose three or four different receivers within your price range and arrange them side by side so that you may compare each under the same conditions. Most retail establishments have demonstration booths for this purpose to aid in choosing a radio set.

A feature often heard in connection with late model radio receivers is automatic volume control, or "A.V.C." This is most desirable and affords ease of operation which was not obtained in older type receivers. If you reflect, you may remember that on your old set when you were listening to a powerful station it was necessary to turn down the volume control. Tuning the receiver to a less powerful or weak station always meant advancing the setting of the volume control so that this station could be heard. If you suddenly tuned in a powerful station without first reducing the volume, the radio receiver would operate at too great volume and "blast" away until you turned down the volume control. With automatic volume control, or A.V.C. as it is called, this procedure is unnecessary when listening to local stations, the receiver equipped with A.V.C. may be adjusted for normal room or desired volume for one station and all other stations will be received at or almost at the same volume level without manipulating the volume control. Another advantage of automatic volume control is the ability of the receiver to minimize the effect of "fading" which is prevalent when receiving distant stations by automatically raising or lowering the volume as it fades so as to "bring in" that station at steady volume, unless the signal fades out beyond the sensitivity limits of the receiver. By this is meant that unless the receiver is unusually sensitive, the fading signal may become so weak that it would be difficult to receive that station even at full setting of the volume control.

For your purpose, it is necessary only to know that automatic volume control action is obtained by reducing or increasing the sensitivity of the receiver, and since in a receiver so equipped the automatic volume control holds the volume fairly constant, it is more or less difficult to determine the exact point on the dial to set a station so that the best tone quality may be obtained. For this reason, many receiver manufacturers incorporate some means whereby stations may be tuned in accurately, and in some cases, without the necessity of even hearing the station. This is accomplished by means of a "shadowgraph," "tuning meter," or neon bulb arrangement which is so connected in the receiver that it will indicate the exact point to tune the station on the dial—a valuable feature.

Testing the Automatic Volume Control

There are all kinds of automatic volume controls, some very effective and others less efficient. Probably the best test to make to determine

And Now! \$12 Condenser Analyzer Added to SUPREME 85 "Neonized" TUBE TESTER



AT NO EXTRA COST

Shorts and leakages in capacitors have been responsible for many a kick-back on repair jobs which apparently checked 100% when they left your lab. Baffling faults in Automatic Volume Control circuits that finally caused a trip of the set back to the factory, or the replacement of every capacitor in the circuit, have had the root of their trouble in capacitor leakages that not even a high-range ohmmeter could detect. Knowing this, alert radiomen are now awake to the fact that a 100% job of modern servicing must include a complete condenser (or capacitor) analysis.

And Supreme—the organization of practical radio service men and engineers—now gives it to you. Includes it as a still further distinction to the most distinguished tube tester in radio service work. Think of it, a \$12.00 condenser analyzing equipment is now incorporated as standard design in SUPREME 85 "NEONIZED" TUBE TESTER. Without a penny of extra cost!

Now that famous, unerring Neon light provides analysis of capacitors as well as of tubes. Positive detection of leakages, shorts, opens. Every desired test of any capacitor, regardless of size.

And every serviceman can well afford to modernize with the SUPREME 85. Not only because it is low in first cost, but particularly because it soon returns first cost and plenty more besides, and because it puts your service on a 1935 plane, giving you a 3 in 1 Tester, namely (1) TUBE TESTER; (2) TUBE LEAKAGE TESTER; (3) CONDENSER ANALYZER . . . at the price of one.

As part of its service to Supreme owners, and realizing that its own reputation is built on the reputation of the users of its instruments for a progressive service, SUPREME makes this high class condenser analyzer equipment available to present owners of Model 85 at nominal cost. Write for information.

Ask your jobber for a demonstration of this most outstanding tube tester in radio service work and other Supreme instruments. Send accompanying coupon for complete 1935 Catalog.

SUPREME "NEONIZED" TUBE TESTER 85-P

Dealers Net Cash **\$39.95**
Wholesale Price.....

Supreme Model No. 35 Tube Tester.....	\$29.95
Supreme Model No. 333—Standard Radio Analyzer.....	\$29.95
Supreme Model No. 333—DeLuxe Radio Analyzer.....	\$39.95

SUPREME INSTRUMENTS CORP.,
515 Supreme Bldg., Greenwood, Miss.
Please send complete detailed Catalog 1935 Supreme Instruments.

Name

Address

City State

Jobber Preference

Please Say That You Saw It in RADIO-CRAFT

HOW TO BUILD, TEST AND REPAIR RADIO SETS



Radio Construction Library

Including Television, Short-Wave Receivers and Auto Radios. 3 Volumes, 5 1/2 x 8—1177 pages, 561 illustrations

This practical Library includes: **PRACTICAL RADIO**—The fundamental principles of radio, presented in an understandable manner. Illustrated with working diagrams. **PRACTICAL RADIO CONSTRUCTION AND REPAIR**—Methods of locating trouble and reception faults and making workmanlike repairs. Discusses modern Short-Wave Receivers and installation of automobile radios fully. **RADIO RECEIVING TUBES**—Principles underlying the operation of all vacuum tubes and their use in reception, remote control and precision measurements.

Helps you to understand modern type receiving sets—full of construction data and practical kinks for the experimenter.

10 Days' Free Examination Easy Terms

McGraw-Hill FREE EXAMINATION COUPON

McGraw-Hill Book Company, Inc.
330 W. 42nd St., New York.
Gentlemen:—Send me the RADIO CONSTRUCTION LIBRARY, all charges prepaid, for 10 days' Free Examination. If satisfactory I will send \$1.50 in 10 days, and \$2.00 a month until \$7.50 has been paid. If not wanted I will return the books postpaid.

Name.....
Home Address.....
City and State.....
Position.....
Name of Company..... RC-2-35

TOBE UNIVERSAL ALL-WAVE ANTENNA SYSTEMS

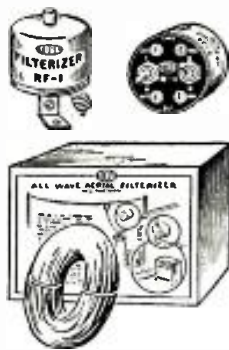

ARE EASY TO INSTALL— and bring in the WORLD'S FINEST PROGRAMS with GREATER VOLUME and LESS NOISE

TOBE all-wave antenna kits may be erected in several ways depending upon the convenience of the location.

Model 35—shown above—\$4.95 list. Sold at leading amateur supply houses.

Tobe Deutschmann Corporation
CANTON, MASSACHUSETTS

1935 RADIO CATALOG



Free Book

All models: AC-DC midjets; dual and world-wide all-wave farm, battery and car—at factory prices! Write for 24-page Bargain Catalog and 30-DAY TRIAL plan. Prices from \$9.95 UP.

AGENTS WRITE!

GOLDENTONE RADIO CO.,
122 Oakman Bldg., Detroit, Mich.

the efficiency of the A.V.C. is to tune a receiver to a weak distant station with the volume control set for comfortable room volume, and then to quickly tune the receiver to a strong local station. There will be very little change in volume with a good automatic volume control. Then try tuning in all the different local stations and see how much the volume level varies as you do so. Check this on each of the receivers that you are testing, adjusting the volume control to the same level in each case.

In order to overcome one of the disadvantages of automatic volume control, (which lies in the fact that electrical interference which may be picked up by the receiver as you tune from one station to another and that might originally be weak, is "amplified" by the A.V.C. and brought to the volume level for which you have set the receiver)—manufacturers have incorporated a "sensitivity," "quiet A.V.C." (or "Q.A.V.C."), "inter-station noise suppressor," or "silent tuning" control in many of their receivers.

Inter-Station Noise Suppression

This "Q.A.V.C." control serves only to reduce or eliminate noise that is heard when tuning from station to station, and helps to a great extent in securing further satisfaction from your radio set. Of course, this control will not reduce interference or noise that is heard with or on the station setting. In some receivers, the silent tuning control is in the form of a switch to reduce the sensitivity of the receiver between stations, and in others, as a variable adjustment so that the sensitivity of the receiver may be adjusted to suit existing local conditions. The latter is preferable since any degree of inter-station noise suppression may be secured.

Determine which of the radio sets of your choice are equipped with some kind of sensitivity control and test each for the amount of noise suppression that is possible to be obtained. Adjust the control for silent tuning and rotate the station selector from station to station, listening for any electrical disturbances, if any, between stations. A good noise suppressor will render the receiver inoperative between stations.

The Factor of "Selectivity"

A very important factor to consider in choosing a set is selectivity. Selectivity of a receiver is the ability to tune in any particular station without any interference from another station which may be broadcasting on an adjoining band, 10 or 20 kilocycles away. Try tuning the receiver to a fairly strong local broadcaster, for example, at 760 kc. and determine how many kilocycles or degrees that the dial may be turned on either side of the 760 kc. before the station is tuned out. Make this test on each of the sets to which you are listening. Proceed in like manner with some station on the higher frequencies, let us say, at 1,400 kc. Should the station be heard 20-30 kc. on either side of the specified frequency, then reception of another station only 10 or 20 kc. away from this station will be difficult because of the "cross-talk." A receiver with good selectivity will "tune out" a station within not more than 15 kc. on either side of its allotted band. A very sharp tuning receiver—one that boasts of 10 kc. separation—will often interfere with tone quality. As a further test for selectivity, if possible, (that is, if you live in the East—Ed.) tune in WOR at 710 kc. and then see if you can tune in WLW at 700 kc., without interference from either station. Of course, this test must be made at a time when both stations are broadcasting.

How to Test for "Good Tone"

As a result of much experience, it does seem that the majority of prospective purchasers deem tone quality the most decisive single requirement in a radio receiver. The question here which must be answered is: how can the average layman determine which receiver has the best tone or reproduction? This is only a matter of individual taste, for in many instances, a receiver which "sounds good" to one person may appear "flat" to another. Your ear is the best judge. Regardless of the frequency range or realism of tone the manufacturer claims the receiver may possess, the buyer must and should test for himself. Most likely the best method is to tune in the music of a concert or symphony orchestra in which many instruments comprise the aggregation. Listen for the kettle drums and the different wind,

string and, especially, wood percussion instruments. Try to distinguish between them. (The kettle drums are tuned to different bass notes—can you "tell" one from another?) If possible, listen to the same program on each receiver. Undoubtedly, one receiver will appeal to you more than the others, but do not make this a conclusive test.

In this connection, you must remember that the mental ear sometimes supplies certain notes or tones that may be lacking, especially in the case of a familiar melody or selection. Listen to the receiver for twenty minutes or more before making your choice. It is very likely that you may "tire" of the reproduction as most frequently occurs when realism is lacking. This "tiring" effect is due to "nerve fatigue" and is caused by the effort expended in compensating for certain deficiencies in reproduction.

Tone Controls

Therefore, since the tastes of different individuals vary, manufacturers add tone controls to receivers so that the receiver response may be varied. Why not try the tone control and determine just how it changes tone quality. Are the bass notes emphasized by cutting off the high notes? Or are the low tones brought out without affecting high-frequency response? The latter, of course is the most desirable, but is usually found only in the better-grade receivers. In any event, a good tone control is a valuable adjunct to a set to aid in compensating for various tones.

Cabinet Considerations

So far as the cabinet is concerned, it is a well-known fact that the larger the cabinet, within reason, the lower the fundamental tones a speaker can reproduce. When low tones are heard in a midjet receiver or on a radio set in a small cabinet, they usually comprise "over-tones," perhaps one or two octaves higher than the fundamental note, resulting in unnatural reproduction. The construction of the cabinet also enters into perfect reproduction. Should the walls or frame of the cabinet be flimsily held together, or of thin material, certain resonant tones may be set up which will distort the true tone. Determine the method of construction. Are "glue blocks" employed? Or are screws simply used to "hold the cabinet together"? In some receiver cabinets, both glue blocks and bolts are employed. Perhaps it may be expedient at this point to mention that to choose a radio set because the cabinet appeals to the eye, despite the fact that another receiver is far superior but that the cabinet does not suit exactly, is poor policy and one that should and will be regretted. Possibly the receiver of your choice can be installed in a cabinet that pleases you more. Should this be the case, first determine whether the tone will suffer as a result of the change. You must remember that most cabinets are built around the radio receivers of creditable manufacturers, and not simply installed in any that may be available. The design and style of the cabinet are usually carefully engineered to bring out the most of which the receiver and reproducer are capable.

AMERICAN TRANSFORMER BULLETIN

A complete catalog of transformers for all P.A., voice transmission and radio work are included in this new book of the American Transformer Co. which you can obtain by writing to this magazine and requesting bulletin No. 652.

If you are interested in transformers of high quality for high fidelity work do not miss this interesting book.

Please Say That You Saw It in RADIO-CRAFT

ELEMENTS OF 4TH DIMENSION SOUND

(Continued from page 481)

As the directional properties of sound waves are particularly characterized in simple sound fields, we will limit our discussions to these sound fields. It should, however, be borne in mind that the ears normally differentiate between directly radiated sound and reverberant sound because the two components, direct and reverberant, differ in character: the latter being modified in phases and quality by the surroundings, and augmented by the previous sounds, which have not yet completely died away. In order for these complicated sounds to become directional (which is a common phenomenon of natural hearing) both hearing centers must receive two different versions of the heterogeneous sound waves as explained in our introductory article.

The "Knot Hole Effect"

The greatest drawback of practically all sound systems is the so-called "knot hole effect" (Fig. 1A) which arises from the large variation between the size of the original sound source and reproduced sound source. The aesthetic value of a symphony orchestra, for instance (which is usually spread over a large area) is completely lost in the usual forms of reproduction because the reproducer concentrates the sound source to an imaginary pin head and produces what is acoustically termed as "sound dazzle," a condition which "blinds" the listener to the exact location of the various orchestral instruments (Fig. A.) This effect is least conspicuous when speech from a fixed location is being reproduced inasmuch as the concentration of the original sound (coming from the orator's mouth) closely simulates the concentrated sound waves produced by the loudspeaker. It follows, therefore, that in order to maintain a natural realism in reproduction, the reproducing system should project sound from an area corresponding to the size of the original sound source. One method for accomplishing this is described later.

This so-called "dazzle effect" is of particular interest because it explains in a simple manner the essential causes for differences in the hearing sensation when listening to natural sounds and their artificially reproduced versions. When an orchestra is normally heard, each instrument sets up an acousti-physiological circuit between itself, and the two centers of hearing, through both ears to the central interpretive center of hearing (Fig. 2.) A five-piece orchestra sets up five different circuits all of which blend into a pleasant sensation of "wide angle" (natural) hearing. A simple test to recognize this form of hearing is ability of the auditor to isolate any one of these circuits and determine the exact placement of the various instruments.

The next time you listen to an orchestra (from a favorable position which enables you to receive direct waves and few reflected sounds) close your eyes and try to place the various instruments. Try the same test when listening to a radio program and you will experience the "dazzle effect."

Attempts to Eliminate Sound Dazzle and Knot Hole Effects

While these prevalent shortcomings of present day sound systems are not popularly recognized, sound technicians have attempted to improve their presentations by employing two or more microphones, multi-speakers and individually peaked audio amplifiers. Although these systems produce new, novel and unnatural hearing sensations; they tend to overburden an already bewildered interpretive center, instead of making it respond to artificially recreated sounds exactly as it would normally interpret the corresponding natural sounds.

The use of one microphone, one amplifier and two speakers (Fig. 3A) is analogous to applying a stethoscope to the knot hole in Fig. 1A and expecting to hear natural sounds. The use of two microphones, one amplifier and two speakers (Fig. 3C) corresponds to listening through two stethoscopes arranged as shown in Fig. 3D and again expecting to get natural hearing reactions. Both of these systems produce a high degree of directional distortion.

Spatial Relationship

With the correct technique and the use of present highly perfected equipment, it becomes a relatively simple matter to attain a reality of reproduction so lifelike in tone, volume, and spatial relationship to the original sound sources, that an unbelievable sensation of reality is experienced when a fourth dimensional sound illusion is created. Such a system will enable the auditor to follow a source of moving sound as it moves through space in much the same manner as you would normally hear a person who is speaking or singing while moving.

The importance and value of such a sound system is briefly discussed in Vol. 1, No. 3 of the Shur Technical Bulletin, to quote, "In most public address applications the entertainers are in full view of the audience. If the ultimate in entertainment value is to be attained, it is desirable that the system be laid out and operated so that the entire presentation is as realistic as possible. In the ideal system none of the sound projecting equipment would be visible to the audience, and the sound would appear to come directly from the performers themselves. The ideal condition is easily attained with a fourth dimensional sound system."

Fourth Dimensional Sound Application

The question might now be raised "What uses can you make of such a system?" Let us first briefly review what can or has been done with fourth dimensional sound systems and then we will describe a new technique required to attain these results.

One of the most effective applications was recently demonstrated in one of the more progressive legitimate theaters during a presentation of Norman Bel Geddes' *Hamlet*, wherein an unusual number of sound effects were introduced. A perfect illusion of natural howling and whistling of the wind was attained in one scene by projecting a recorded wind storm from an elevated loudspeaker. Another scene, which represented the crowd climbing a mountain to storm the castle, was realistically presented through correct sound technique whereby the murmurings and shouts were first heard in the distance and gradually increased in intensity as the procession slowly circled around the mountain. Finally the sounds blended into the stage actions as the crowd rushed onto the stage. To produce this effect, the sound was first fed into all speakers at low volume and gradually accented in two of the speakers situated on one side of the stage and then gradually shifted to the speakers at the other side. The volume was then slowly raised to equal the intensity of sound which was being set up by the actors off stage as they were preparing to make their entrance. One critic speaking of the play, said "Reproduction throughout the entire show was so realistic that the audience was probably unaware of how the sound effects were produced. So real was the sighing of the winds as the king knelt before the cross on the mountain that the audience was noticeably affected."

Although the stage offers the most unusual opportunities for spectacular sound effects, there are many other equally useful applications of a fourth-dimension sound system in everyday occurrences. For instance, any small orchestra can realistically increase its apparent size to equal the proportions of a large symphonic ensemble. Musical presentations offer unlimited applications for startling arrangements which are limited only by ingenuity of the sound technician and the musical conductor. "The Flight of the Bumble Bee," for example, can be so presented that the buzz of the bee cavorts above the orchestra. Likewise, "The Sliding Trombone" can be slid from one side of the stage to the other.

Church installations offer a fertile field for a modern fourth dimensional sound system which projects the preacher's sermon from the pulpit, the choirs' singing from the singers, and the pealing of the bells from the belfry, while the organ music is projected directly from the console. Most sound technicians arrange their P.A. system equipment so that all sounds are projected from the same direction regardless of their point of origin. Needless to say, such a sound set-up is far from realistic.

Banquets, circuses, and similar gatherings in which sound plays an important part can be given a heretofore unattainable realism by the proper applications of a high-fidelity sound system, free from directional distortion.

NO RADIO MAN CAN AFFORD TO BE WITHOUT THIS BOOK

A handy pocket manual . . . 104 pages . . . 150 cuts and diagrams . . . compact essential information showing you how to get the best performance for every device employing vacuum tubes!

YOURS FOR 10c



Here's a new technical manual that's just as necessary as your voltmeter in service work. 104 pages of essential technical information . . . complete data on over 90 types of receiving tubes . . . base symbols . . . recommended operating conditions . . . amplifier classifications . . . receiver circuit diagrams . . . over 150 cuts and diagrams in all. It shows you how to get the best performance from every kind of set—and the price is only 10c!

Fill in the coupon below, attach 10c in stamps, and mail TODAY!

HYGRADE SYLVANIA CORPORATION

Makers of
SYLVANIA TUBES
HYGRADE LAMPS
ELECTRONIC PRODUCTS
© H. S. Corp., 1934

Factories
ST. MARY'S, PA.
EMPORIUM, PA.
SALEM, MASS.
CLIFTON, N. J.

Sylvania
THE SET-TESTED RADIO TUBE

10c-TECHNICAL MANUAL-10c

Hygrade Sylvania Corporation,
Emporium, Pennsylvania. (B-19)

Please send me the new Sylvania Technical Manual. I enclose 10 cents in stamps.

Name

Address

City State.....

Please Say That You Saw It in RADIO-CRAFT

SOUND IN FOUR DIMENSIONS

Makes the Phantom of Music a Reality!



Out of the Columbia Sound Laboratories comes something new—4th Dimension Sound—the greatest single development in scientific sound reproduction. It is not merely a new model. It is a result—one you can hear—one you can sense. Even though your present amplifier seems to sound right, send for our FREE booklet "Sound — In Four Dimensions" and discover what you have been missing.

Ask also for our FREE pamphlet on Columbia High-Fidelity Sound Systems.

free

COLUMBIA SOUND CO. Inc.
 135. LIBERTY ST. NEW YORK, N.Y.

direct presentations, that the loudspeaker be comparatively close to the microphone. Feedback is avoided by using acoustic insulation (hair or wool) behind the microphone and behind the reproducer, Fig. 6A. Under some conditions of installation, precautions must be taken to prevent intense reflected waves from striking the microphones so as to avoid feed-back.

Selection of the Microphones

Inasmuch as the microphones of our perfect sound system correspond to our ears during normal hearing processes, it is essential that we select sound pickup devices with characteristics similar to our normal hearing mechanism.

If we base our selection of microphones upon the following considerations—1. Frequency response; 2. Effect of frequency response upon the direction of the sound source; 3. Sensitivity; 4. Ease of installation; 5. Price—we would select the following microphones listed below in order of their performance:

1. Crystal (10-cell edgewise arrangement)
2. Ribbon (Velocity)
3. Dynamic (Moving coil)
4. Condenser
5. Carbon (Double button)

While the first two are to be preferred for high-fidelity work, any one of the others may be used for reproduction of speech.

Selection of the Amplifiers

In one suitable high-fidelity 4-channel pre-amplifier, a 2-3 stage selection is employed to boost the gain when used with a low level ribbon microphone. The power amplifier is built in two separate units, each one of which is composed of two clear channels utilizing two 2A3 tubes and delivering 10 watts per channel (40 watts total). Special precautions are taken in the design of both the pre-amplifier and power amplifier to completely eliminate (within high-fidelity limits) all frequency distortion, phase distortion, and amplitude distortion.

Selection of the Speakers

For ideal results, the loudspeakers should have radiating characteristics identical with those of the original sound producing devices.

Inasmuch as the angle subtended by the more intense portions of the sound field at any given frequency is somewhat greater for the baffle-type speaker than for the horn type, it follows that for concentrated sound sources voice, high-frequency wind instruments, etc., it is more desirable to use horn-type speakers.

Another important characteristic which favors horn-type speakers is that it radiates effectively from only one side. This feature prevents feedback as well as other acoustical effects which might adversely influence the auditor while listening to a presentation from some particular position.

For high-fidelity results, three speakers should be used at the termination of each output channel, for high, middle and low frequency reproduction.

Installation Considerations

As previously mentioned, the positions of the speakers play a vital importance in maintaining the effect of realism. Each speaker should be so located that it projects the sound in the same general direction as the sound wave is traveling, when the microphone intercepts it (Fig. 6B).

If, for some reason, it is impossible to locate the speakers as suggested, then they may be placed off the direct axis of the original sound wave, but the direction of the projected wave must be so adjusted that minimum directional distortion takes place (Fig. 7). It should of course be understood, that any serious directional distortion will affect the illusion of reality. For best results, speakers should never be tilted more than 30 degrees and preferably less than 15 degrees.

Adjustment and Operation

During normal operation, all channels are attenuated to any desired degree of volume. It is absolutely essential, however, that all channels are accurately balanced to compensate for any commercial deviation in output of the microphones, pre-amplifier and power amplifier. In practice this is accomplished by placing a fixed sound source (1000 cycles) equidistant from the four microphones and adjusting the attenuators on the pre-amplifier until the output meter

Determining the Type of Installation

Before a fourth dimensional sound system is installed it is necessary to definitely determine just what is to be the operating scope of the system. If it is to be used solely for pickup of a stationary sound source, a bi-dimensional arrangement is employed wherein one or more microphones are placed at some advantageous position for best pickup. If moving sound is to be picked up from one plane, horizontal or vertical, a tri-dimensional system is utilized. Microphones are arranged in a semicircle or straight line (in the plane of pickup). If moving sound is to be picked up in both horizontal and vertical planes, a quadra-dimensional sound system is employed with microphones so arranged that each unit picks up a proportionate amount of sound depending upon the position of the sound source.

Three important points that the reader should bear in mind relative to this new technique are:

- (1) A fourth dimensional sound system can be used for bi- or tri-dimensional work.
- (2) In all of the various types of P.A. installations to be described, the same pattern or arrangement of the microphones should be maintained in the placement of the loudspeakers so that the wave front of the projected sound is identical with the sound wave which is intercepted by the microphones. Any deviation in arrangement between speakers and microphones will result in a form of phase distortion which may, under certain conditions, cause serious sound wave interference.
- (3) Each microphone is connected to its own pre-amplifier, power amplifier and bevy of speakers.

If the performance is to be picked up from some horizontal platform upon which the speaker or performer will move from side to side, the microphones (and their respective speakers) should be placed in a straight line across the stage as indicated in Fig. 4.

The exact spacing of the microphones is dependent upon five factors.

1. Polar response characteristics of the microphones.
2. Response (output level versus distance) characteristics of the microphones.
3. Number of microphones employed.
4. Length of platform from which sound must be picked up.
5. Maximum height from which sounds will originate.

If we presume that the correct microphones and amplifier equipment are chosen, then it only remains to divide the length of the platform into a number of divisions equal to twice the number of microphones to be employed and placing one microphone at every other division (Fig. 4).

When sound is to be picked up from one stationary elevated position, three microphones are distributed upon the stage while the fourth is located near the elevated source of sound. If the source of sound moves in only one upward direction, the third microphone is placed in line with the direction of the moving sound. Figure 5A shows the various positions (A, B, or C) for locating the third microphone depending upon the direction taken by the moving sound source.

When movement of the performers is to take place in a vertical direction the microphones should be placed as diagrammed in Fig. 5B.

Because of the desirability of creating the illusion that the amplified sound is coming directly from the performer, it is essential for



ALL-WAVE SIGNAL GENERATORS

1% Accuracy. Grid Stabilization

Model 333-RC Four fundamental bands by switching. Frequencies from 83 to 5,000 kc. on direct reading dial. No charts or curves to consult. This model works on AC, DC or batteries. 105-130 v. line. 34 oscillator feeds 30 amplifier stage with neon tube for 1000 cycle modulation on DC. Both modulation and output controls included. Instrument comes in perfectly shielded black crystal finished all-steel cabinet. Suitable for laboratory or better class of service work. Complete with all tubes for **\$21.85**

Shipping wt. 6 lbs.
Model 37-AC. Three fundamental bands. 132 to 3800 kc. by switchlink. No charts or graphs because 1% accuracy has been attained on dial directly. Engraved bakelite panel on black cracked steel cabinet. AC model complete with tube for only **\$9.50**

Shipping wt. 4 lbs.
Model 37-S. Neon tube modulates 37 tube oscillator. Scale reads kc directly from 135-380, with all the important intermediates, 175, 400, 450, 450, 405 spotted on chromium-etched scale. Lower scale for broadcast band on 4th harmonic. Engraved bakelite panel on black cracked steel cabinet. Complete with both tubes for only **\$6.50**

Shipping wt. 3 lbs.
DELTA RADIO CO., 125 F Liberty St., New York, N. Y.

7-POINT MIKE FELL 20 FEET ...STILL GOOD AS EVER

...AND STILL NO FEEDBACK!

Johnston P. A. Service, Oneonta, N.Y., writes us: "We are certainly well pleased with your velocity mike (the 7-Point Mike). We believe that no other mike can take the punishment it has and still work. One time it fell 20 feet to the ground. And dozens of times it has seen rain. We use it in our mobile outfit, and it's just as good as ever. Also a wonderful help in eliminating acoustical feedback." Guaranteed. Order from your wholesaler, or write for Illustrated Bulletin 72.

AMPERITE Corporation
561 BROADWAY NEW YORK



**AMPERITE
VELOCITY MICROPHONE**

SERVICEMEN ATTENTION! —TIME IS MONEY!

24-hour service on all replacement parts. We carry most complete stock of standard lines. Let us help you with any problem on P.A. receivers or transmitters.

UNCLE DAVE'S RADIO SHACK
356 Broadway Albany, New York Phone 4-5746

Please Say That You Saw It in RADIO-CRAFT

readings of the four channels are alike. For normal reproduction, the controls are not changed, for any moving sound source will automatically produce more or less output from any one of the microphones, depending upon its proximity.

For trick sound effects, the controls on the power amplifier are thrown into the input circuit which provide for the distribution of sound from any one microphone into any one, two, three or four channels and their corresponding speakers. The spectacular illusions of moving sounds which can be created by this system, are far too numerous to mention.

Now that we have a glimpse of what procedure to follow in order to provide perfect artificially reproduced sound, it remains for the sound technicians to change their technique in order to recreate sound as it naturally occurs in our own fourth dimensional (sound—Ed.) world.

"LUXEMBOURG" EFFECT IN RADIO

(Continued from page 467)

place only at night and that it occurs only (according to Dr. van der Pol) when the great circle joining the desired station and the point of observation passes the undesired or interfering station at a distance not greater than 175 miles. In other words, the two stations and the receiver must be in a straight line (to a greater or less extent).

It has been found that the Luxembourg Effect takes place continually, not only on the broadcast and long waves, but also on short-wave transmissions.

As a means of arriving at some explanation of the effect, the World Radio Research League, a group of radio enthusiasts banded together by *World-Radio* magazine, has solicited the aid of radio listeners and experimenters all over the world. It is requested that whenever the background of an interfering station is heard that is not transmitted on an adjacent channel, a record of the date, time of listening, location of the two stations, number of miles separating the stations and the listening point and any other interesting facts be recorded. RADIO-CRAFT readers may send in their records to this magazine where they will be coordinated and forwarded to the secretary of the above association where they can be used to advantage.

Since these peculiar observations cannot be justified by some of the most eminent authorities according to existing theories of radio transmission, it seems logical to assume that some important facts have been overlooked in arriving at these theories, and it is difficult to predict what far-reaching effects this will have on our present methods of radio communication.

ORSMA MEMBER'S FORUM

(Continued from page 480)

W (AC) = (E x I x Power Factor).
 W-Hrs. = (E x I x Hrs.), (W x Hrs.).
 KW = (E x I ÷ 1,000), (HP x 0.746), (W ÷ 1,000).
 KW-Hrs = (E x I x Hrs ÷ 1,000), W x Hrs ÷ 1,000).
 Amp-Hrs = (I x Hrs), (E ÷ R x Hrs),
 (W ÷ E x Hrs), (KW x 1,000 x E x Hrs),
 (√W ÷ R x Hrs).
 Coulomb (Q) = (I x Seconds).
 Joule (J) = (E x I x Seconds), (W x Seconds),
 (I² x R x Seconds).
 HP = (W ÷ 746), (KW ÷ 0.746), (E x I ÷ 746),
 (KW x 1.341), (W x 0.0013), (746 W).
 Effic = (HP x 746 ÷ E x I), (HP x 746 ÷ W),
 (Brake HP ÷ Elec HP).
 Input = (Output ÷ Effic), (Output x Losses).
 Condensers in Series $\frac{1}{C} = C \text{ or } R \frac{1}{C^2} = \frac{C^2 \times C^2}{C^2 + C^2}$
 or $\frac{1}{C^2} = \frac{1}{C^2} + \frac{1}{C^2}$
 Resistors in Parallel $\frac{1}{C^2} = \frac{1}{C^2} + \frac{1}{C^2}$
 Condensers in Parallel or Resistors in Series = $\frac{C_1 + C_2 + C_3, \text{ etc.}}{R_1 + R_2 + R_3, \text{ etc.}}$
 HARRY W. KRUG.

GENERATOR TYPE POWER UNIT

(Continued from page 479)

ing the starting torque, it serves to provide better regulation of the genemotor under varying load conditions and acts as an input filter.

The filter circuit in the automobile type genemotor is interesting in that it is possible to install all necessary condensers and inductors within the housing, thus conserving a great amount of space. One of the features of this type of "B" supply that makes the small filter possible is the very low ripple voltage present, before entering the filter. The measure of the initial ripple voltage on a well-designed unit is always considerably less than 1 per cent of the total voltage, and it is at a frequency which requires a small amount of inductance to provide complete smoothing. To obtain this low ripple voltage, it was necessary to take certain precautions in the original design, the most important being to keep the speed reasonably slow as well as to insure perfect commutation.

New Application

The majority of radio technicians have recognized the small rotary generators operating from a storage battery as a dependable "B" supply for auto-radio receivers, but, have failed to consider the many other applications and sales possibilities of this product. It is the purpose of the following few paragraphs to call your attention to the possibilities in this new field.

Recently there has been a growing demand for replacement units as a substitute for vibrator assemblies. A number of such units have been developed to fit in the popular makes of auto radio receivers. The accompanying photo illustrates the conversion of a genemotor in a Ford auto radio. The ease of installation and dependability should create considerable interest with those engaged in the auto-radio service field.

Service Men located in or near rural sections where A.C. power is not available, have found the special "B" eliminators offered for sale to be a valuable adjunct to the regular service enterprise. Models are available operating from 82-volt farm lighting systems or from a 6-volt storage battery. Recently several of the storage battery manufacturers have developed a long life 2-volt cell to operate the 2 V. series tubes over long periods of time. A special genemotor has been developed to work in conjunction with this new 2-volt cell which should, under normal use, provide the user approximately two months "A" and "B" service from a single recharge of the battery.

One of the greatest problems of the customer or installer of mobile P. A. equipment is that of an economical and reliable "B" supply. Most systems require a relatively high consumption from the battery in ratio to the power output of the amplifier, or if the fan belt driven type is used within the motor car, it requires the engine to be continually running to provide the necessary energy. The chief advantage of the rotary type eliminator is that when used with the properly designed amplifier the ratio of power input to power output approaches the highest efficiency that can be obtained in such installations. In a forthcoming article we will describe several efficient amplifier circuits to be used in conjunction with the genemotor, as well as furnishing data for converting existing A.C. amplifiers so that they can be operated from either A.C. power or storage batteries. A canvass of the numerous sound truck users will provide the Service Man with a large number of prospects in this new field.

Numerous special applications will become apparent to the wide-awake dealer and Service Man, once he has investigated the many possibilities in the use of the genemotor. An interesting incident describing one of the many applications was experienced recently upon visiting the projection room of a small theatre. An array of resistance elements were mounted on the wall for the purpose of reducing the 110-volt D.C. (the only current available) to the proper voltage for the exciter lamps and the projection machine. Nearly a kilowatt of energy was consumed to provide the 50 watts necessary for the filaments of the lamps. The operator was astounded to learn that the D.C. could be reduced to the required voltage by the use of a small converter weighing under 15 lbs., which consumed less than 100 watts instead of the original 1000 watts.

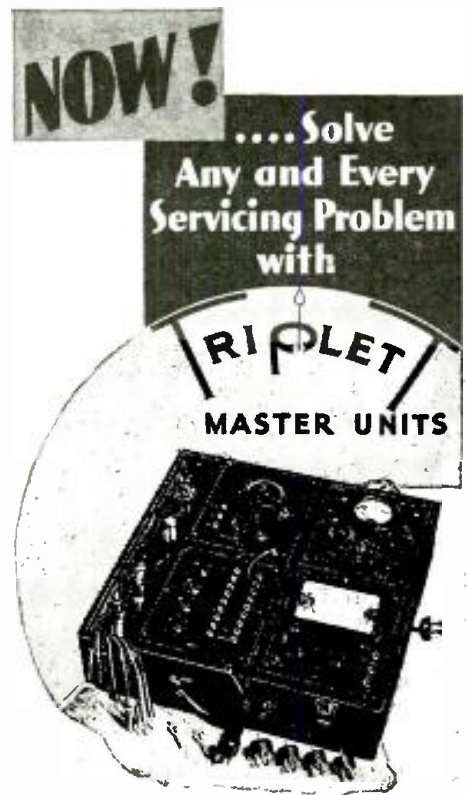

SERVICE men and technicians who have seen and used the precision instruments in the Triplet Master Unit line pronounce them today's most advanced developments.

Triplet Interchangeable Master Units make possible different combinations of testing equipment to suit every servicing requirement . . . no matter how difficult or complicated. These units may be used as furnished, or, placed in convenient portable cases that hold one, two, three or four units.

Triplet Master Unit, No. 1205, includes:

No. 1200 Volt-Ohm-Milliammeter. DC scale readings: 1/5 to 1,000 volts (2,000 ohms per volt)—20 microamperes to 250 milliamperes—0 to 3,000,000 ohms. AC scale readings: 1 to 1,000 volts. Capacity charts furnished. Dealer's net price, unit only\$21.67

No. 1210 Tube Tester. Tests all tubes. Contains the most efficient short check known. Analyzes each plate of multi-plate tubes. Dealer's net price, unit only\$20.00

No. 1220 Unit Tester. Makes all series or parallel meter connections to the set sockets. Dealer's net price, unit only...\$ 8.33

No. 1230 All-Wave Signal Generator. Frequencies: 100 KC to 18 Megacycles. Perfect attenuation. Modulated or unmodulated. Dealers net price only.....\$15.33

No. 1205. Complete with above four units in case, Dealer's net price.....\$71.33

YOUR JOBBER CAN SUPPLY YOU

TRIPLETT ELECTRICAL INSTRUMENT COMPANY
 109 Main Street Bluffton, Ohio

Mail Today For Details!

TRIPLETT ELECTRICAL INSTRUMENT COMPANY
 109 Main Street, Bluffton, Ohio

Gentlemen:
 Please send your latest literature on Triplet Instruments.

Name

Address

City State.....

Please Say That You Saw It in RADIO-CRAFT

RADIO REPAIR MEN—AMATEURS

Sears, Roebuck and Co.,
The World's Largest Mail Order
Company (in the Radio and Parts
business for almost 20 years) an-
nounce for restricted distribution a
new Radio Parts and Amateur
Equipment Catalog.

24-HOUR SERVICE

Everything carried in stock—the
best guarantee ever written—
Complete satisfaction or your mon-
ey refunded.

Write today for catalog No. 83R61.
We will put your name on our mail-
ing list and send you this big, new
catalog as soon as it is off the press.

SEARS, ROEBUCK and CO.
CHICAGO, ILL.

SERVICEMEN!

Step Ahead of the rank and file—

with "CASE RECORDS
OF BROADCAST
RECEIVER REPAIRS"

- ADD 10,000 Hours to your experience
- ELIMINATE YOUR GUESS-WORK IN YOUR SERVICING!
- DON'T PUZZLE YOUR PROFITS AWAY!

Your work is already done and recorded for you in "CASE RECORDS." This 9x12" loose-leaf binder contains 1,500 alphabetically and numerically arranged "CASE RECORDS" of SUCCESSFULLY COMPLETED SERVICE JOBS! Each CASE RECORD tells all details for satisfactory repair. SUPPLEMENTED QUARTERLY FREE for 1 year. 108 receiver makes . . . 3,000 models. . . the FASTEST Technique known to the Professional!

First Supplement NOW READY!

Send cash now and receive 1st Supplement with "CASE RECORDS" and our "DATA SHEET on 'BUILDING AN ANALYZER ADAPTER'" also.

Refund on return of Manual within 10 days.

\$4.75

CAPITOL RADIO RESEARCH LABORATORIES, INC.
1503 21st Street, N.W., H. K. Bradford,
Washington, D.C. President

SOLAR

WET AND DRY ELECTROLYTIC
PAPER AND MICA CONDENSERS

RECOGNIZED FOR
SUPERIOR QUALITY
IN ALL CLIMATES
THE WORLD OVER

SOLD BY LEADING
JOBBER EVERYWHERE

SOLAR MFG. CORP.
399 BROADWAY
NEW YORK

BEST BY TEST!

ASK FOR
CATALOG
OF EXTREMELY
COMPACT TYPES
HANDY FOR SERVICE

UNIVERSAL Hi-Fidelity Silveroid Records

A new, improved type of cellulose-coated alu-
minum disc—Unusual tonal quality—Marvellously
natural reproduction—Lowest background level
yet attained—can be cut with usual sapphire
points and will play back with any non-metallic
needle—For personal recordings, program addi-
tions, air checks and transcriptions.

UNIVERSAL MICROPHONE CO., Ltd.,
424 Warren Lane, Inglewood, Calif., U.S.A.

LISTENING POST

What to Listen for During January- February Broadcast Band

(Continued from page 474)

January and February usually are very good months for DX-ing on the broadcast band, and bring a peak reception in North America for signals from all directions except Australia-New Zealand. The Australia-New Zealand signals are at their peak intensity during the month of March, and often show considerable strength during the latter part of February. April is often a good month for this type of reception also, when spring static on these frequencies will permit DX-ing. The latter part of February will on the other hand show a very definite decrease in the signal strength, and regularity with which signals from Europe are received, and by the latter part of March these stations have nearly vanished entirely with the exception of Newfoundland, and Nova Scotia.

We are very fortunate in being able to present one of the first authentic, and up-to-date complete lists of Colombia S.W. stations direct from Colombia. This list was compiled by Sr. Daniel Samper Ortega of Bogota, Colombia, and reaches us through the courtesy of Mr. Robert Weber, of West McHenry, Illinois.

There will soon be a new station at Medellin. This will be ready about the time this article comes out and will operate on both long and short waves. On short waves it will use 5,930kc, but the long wavelength is not yet decided. When completed it will use 2½kw, but the first tests will be with only 1kw. HJ1ABB at Barranquilla is soon to inaugurate a long-wave transmitter to work simultaneously with the present short-wave transmitter.

Tuning in the Japs

Our good friend and colleague, Captain Horace L. Hall, sends us the following up-to-the-minute list of Japanese broadcasting stations. This information is very timely as the Japanese stations will be at their best during this period. Those

with an asterisk are the ones which will be heard most frequently in the central, or eastern States. All of these stations are being heard more or less frequently on the Pacific coast.

Japanese Stations

Call	Location	Wave—length	Kc.	Power
JOCK-2	Nagoya	255	1175	10,000
JOBK-2	Osaka	277	1085	10,000
JOFG	Fukui	303	990	300
JOJK	Tokushima	306	980	500
JOBG	Maebashi	309	970	500
JOOK	Kyoto	313	960	300
JOAG	Nagasaki	323	930	500
JOJK	Niigata	326	920	500
JODK-2	Keijo	333	900	10,000
JOAK-1*	Tokyo	345	870	10,000
JOJK*	Hiroshima	353	850	10,000
JOJK*	Sapporo	362	830	10,000
JOCK-1*	Nagoya	370	810	10,000
JOJK*	Kumamoto	380	790	10,000
JOHK*	Sendi	390	770	10,000
JOPK	Shizuoka	384	780	500
JOBK-1*	Osaka	400	750	10,000
JOJK*	Kokura	408	735	1,000
JORK*	Kochi	417	720	500
JFBK	Tainan	417	720	1,000
JOJK	Kanazawa	422	710	3,000
JOJK*	Okayama	429	700	500
JOVK	Hakodate	441	680	500
JOLK	Fukuoka	441	680	500
JFAK*	Taihoku	448	670	10,000
JOCC	Asahigawa	458	655	300
JOUK	Akita	465	645	300
JQAK	Darien	465	645	500
JODG	Hamamatsu	472	635	500
JONK	Nagano	472	635	500
JOTK	Matsue	480	625	500
JODK-1*	Keijo	492	610	10,000
JOAK-2	Tokyo	508	590	10,000

NOTES: JOAK-1 will be raised to 150,000 watts. JOGK will be raised to 100,000 watts, JOBK-1 to 100,000 watts, and JOJK to 10,000 watts. The daily programs of JOAK-1 are generally relayed by all J-stations except JOBK, JODK-1, JOAK-2, JFAK, JQAK, etc., of which JOBK, JODK-2, JFAK, JFBK and JQAK relay partly JOAK-1, while JOAK-2 has its own program, of an educational nature, no music ever being transmitted. Its programs are often relayed by JOCK-2, JOBK-2, etc. The J-stations transmit the programs of JOAK-1 from 7:00 a.m. to 9:45 p.m. J.C.T. (5:00 p.m. to 7:45 a.m. E.S.T.) during January, February and March; while they begin an hour earlier in the morning at other seasons of the year. JFAK, JFBK, and JQAK transmit one hour later than the other stations due to the difference in time. A daily newscast in English is transmitted by the J-stations at 4:55 a.m. E.S.T.

Radio-Craft's Foreign DX Calendar For January-February

			EASTERN STANDARD TIME			
Jan. 6	Sun.	2:05-3:05 a. m.	830 kc.	25,000W	Buenos Aires, Argentina	LR5
6	Sun.	3:10-5:10 a. m.	1,270kc.	1,500W	Santo Domingo, D. R.	HIX
10	Thurs.	1:00-2:30 a. m.	1,096kc.	10,000W	Madrid, Spain	EAJ7
12	Sat.	5:00-7:00 p. m.	8,120kc.	49.02M	New York City, N. Y. (SW)	W2XE
16	Wed.	12:01-2:00 a. m.	1,031kc.	5,000W	Pareda, Portugal	CT1GL
20	Sun.	1:00-2:00 a. m.	959kc.	100,000W	P. P., Paris, France	
22	Tues.	2:00-3:00 a. m.	1,190kc.	40,000W	Buenos Aires, Argentina	LS2
Feb. 3	Sun.	2:05-3:05 a. m.	830kc.	25,000W	Buenos Aires, Argentina	LR5
6	Wed.	2:00-3:30 a. m.	813kc.	60,000W	Toulouse, France	
10	Sun.	2:00-3:30 a. m.	830kc.	25,000W	Buenos Aires, Argentina	LR5
Weekly	Sat.	12:30-1:00 a. m.	980, 6140, 11,870kc.		
Weekly	Sun.	2:30-3:00 a. m.	640kc.	50,000W	KDKA DX Club, Pittsburgh, Pa. KFI DX Club, Los Angeles, Calif.	KDKA KFI

NOTES: On LR5's Broadcast of February 10th a silver-mounted and engraved Maté Pot will be given to the lucky DX-er sending in the best report on this broadcast to Radio Executive, LR5, Buenos Aires, Argentina.

Colombian Short-Wave Broadcasters

Call	Location	Freq.	Power	Slogan and Owner	Hours, Eastern Std. Time
HJ1ABB	Barranquilla Apt. 715	6,400	300W	"La Voz de Barranquilla" Elias J. Pellet B.	Daily, 6-10:00 p. m. Sun. at 5:00 a. m.
HJ1ABD	Cartagena	6,100	50		
HJ1ABE	Cartagena Apt. 31	6,100	15	Jose M. Fuentes	Wed., 8-10:00 p. m. Mon. at 10:00 p. m. DX Trans.
HJ1ABG	Barranquilla	6,000	100	La Voz de los Laboratorios Jimeno G and Cia.	
HJ2ABA	Tunja	6,150	500	Ecos de Boyaca	Fri., 11:00 a. m.-1:00 p. m.
HJ2ABC	Cucuta	5,900	50	Pompilio Sanchez C. La Voz de Cucuta	Tues., Thur., Sat., 7-10:00 p. m. Daily, 11:00 a. m.-1:00 p. m.
HJ3ABD	Bogota Apt. 509	1,110	Pompilio Sanchez C. Colombia Broadcasting	Daily, 6-9:00 p. m. Daily 7-11:00 p. m.
HJ3ABE	Bogota	7,400	Alford Radio	Mon., Wed., Fri., 6-7:00 p. m.
HJ3ABF	Bogota Apt. 317	1,200	50	La Voz de Bogota	Wed., Sat., 6-7:00 p. m.
HJ3ABH	Bogota Apt. 565	6,200	50	G. Uribe & Rafael Moreno	Daily, 7-11:00 p. m. Wed., Sat., 6-7:00 p. m.
HJN	Bogota	1,005	La Voz de la Victor	Sun., 4-8:00 p. m.
HJ4ABB	Manizales Apt. 175	6,060	Radio Nacional	Daily, 6-11:00 p. m. Ex. Sun. and Holidays
HJ4ABC	Pereira	681	1,000	Radio Manizales Roberto Baena V.	Tues., Fri., 7:30-10:00 p. m. Sun., 2:30-5:00 p. m.
HJ4ABE	Medellin Apt. 239	7,140	Medellin Radio Arturo Alzate Giraldo	Mon., Wed., Fri., 7-11:00 p. m. Tues., Sat., 6:30-10:00 p. m.
HJ5ABC	Cali Calle 12	1,000	50	La Voz de Colombia R. Angulo	Daily, 11:00 a. m.-Noon.
HJ5ABD	Cali	6,500	La Voz del Valle	Tues., Fri., 8-10:00 p. m. Daily, 7-10:00 p. m.
HKE	Bogota	7,100	138	Observatorio Nacional de San Bartolome. Rev. P. Simon Sarsola	Mon., Thurs., 6:00 p. m. Ex. Course at Univ., Tues., Sat., 8-9:00 p. m.

Please Say That You Saw It in RADIO-CRAFT

A MODERN PICTURE OF BROADCASTING

(Continued from page 459)

power in watts is the astounding figure. Once again, for comparative purposes, let us glance at the table below, the figures representing the aggregate power in watts of the network stations.

Year	NBC	CBS	Total Watts
1931	807,750	273,200	1,080,950
1932	891,200	476,950	1,368,150
1933	1,114,800	498,800	1,613,600
1934	1,610,100	515,800	2,125,900

(as of Nov. 1)

The total number of stations shown below, represents the number of outstanding licenses or construction permits issued by the Federal Radio Commission as of January 1, 1934. Seven other stations including three in Hawaii, two in Porto Rico, and two in Alaska are also licensed by the Federal Radio Commission.

There are 101 stations in the U.S.A. licensed to use greater power before local sunset than after. The table given below shows the amount of wattage, in aggregate, of the National Broadcasting Company's networks, the Columbia Broadcasting System's network, and a good comparison of the total wattage represented by the balance of the radio broadcasting stations in the U.S., not affiliated with either of these network organizations. The maximum power in the table therefore is that used during the day, the minimum power that used during the evening hours.

	Watts	Per cent of Total
Power of NBC Stations—Maximum	1,139,250	61.2
Minimum	1,106,800	61.0
Power of CBS Stations—Maximum	491,550	26.4
Minimum	478,800	26.4
Power of other U.S. Stations—Maximum	292,165	12.4
Minimum	227,815	12.6

Source: Federal Radio Commission Report of January 1, 1934. NBC and CBS figures do not include their Canadian or Hawaiian affiliate stations in this table.

Although the NBC and CBS networks are the two important broadcasting networks in the U.S.A., other networks are in existence; some of them affiliate with either the NBC or CBS networks on a part-time basis. The CBS and NBC networks, as to number of stations, have already been outlined. Following is a list of other networks and the number of stations affiliated with these networks.

- American Broadcasting System—18 Stations—No other network affiliations. Inaugurated October 14, 1934. (Atlantic States.)
- Don Lee Broadcasting System—12 Stations—Affiliated CBS network. (Pacific Coast States.)
- League of Wisconsin Radio Stations, Inc.—7 Stations—Affiliated CBS network.
- Mason-Dixon Radio Group—5 Stations—No other network affiliations. (Southern States.)
- Michigan Radio Network—8 Stations—No other network affiliations.
- Mutual Broadcasting System—4 Stations—No other network affiliations.
- New England Network—5 Stations—Affiliated NBC Network.
- Northern California Broadcasting System—2 Stations—No other network affiliations.
- Southern California Network—4 Stations—No other network affiliations.
- Southwest Network—11 Stations—CBS network affiliations.
- Yankee Network—11 Stations—CBS network affiliations. (New England States.)

Two U. S. broadcasting systems have gone out of existence in the past few years, one of them recently. They are:

- Amalgamated Broadcasting System—6 Stations.
- Iowa Broadcasting Company—3 Stations.

The stations associated with these two networks are in operation either independently or have affiliated themselves with other networks.

Network organizations pay huge annual tolls to the various telephone companies for wire charges. From the only present available figures one can readily understand just how high this aggregate figure must be when all the various networks are taken into consideration. The annual wire tolls for the year 1931 were: National Broadcasting Company—\$2,799,916.71. For the Columbia Broadcasting System—\$1,964,655.68. A combined total of \$4,764,572.39. With the expansion of the network system of broadcasting, the tolls may reach even higher peaks in future years. It is practically impossible to forecast the rate at which this expansion will take place.

This progress is further emphasized by the total investment of capital required by the broadcasters. This investment reached the

RCP • RCP

RADIO CITY

TESTERS and ANALYZERS

Do More—Cost Less

RCP • RCP



MODEL 304
TUBE TESTER

\$19.95
Ready to Operate.
\$15.65
KIT

QUALITY is important in testing equipment. Accuracy is essential. Adaptability for all present and future needs is valuable. Convenience and good looks are desirable. *But high price isn't necessary.*

The new Radio City "DEPENDABLE" Testers and Analyzers provide all of those features *at the lowest cost.* And their reputation with service men and dealers is unsurpassed. Complete units, ready to operate, or money-saving kits. *Write Dept. RC-2 for 1935 Catalog.*

RADIO CITY PRODUCTS CO.
28-30 West Broadway, New York City

FRANKLIN TRANSFORMERS

"Most Sock Per Dollar"

GENERAL REPLACEMENT

Years of experience dating back to the early days of separate A & B power supplies are incorporated in present Franklin units designed for every purpose.



SOUND

Public address transformers to match hundreds of impedance combinations. Catalogue contains large number of circuit diagrams including Class A Prime.

AMATEUR

A complete line for filament, grid or plate supply, chokes, Class B modulation, etc. Illustration shows one type. Share your transformer problems with Boyd Phelps W2BP-W9BP in charge of this department.

WRITE FOR CATALOGUES, GIVING YOUR JOBBERS NAME

No. 51 General Replacement No. 70 Sound No. 52-C Amateur

FRANKLIN TRANSFORMER MFG. CO.
607 22nd Avenue, N. E. Minneapolis, Minn.

GOOD NEWS

ABOUT THE NEW 1935 OFFICIAL RADIO SERVICE MANUAL

The 1935 OFFICIAL RADIO SERVICE MANUAL is *now ready* for delivery. Turn to the announcement on page 506 of this issue, and read full particulars about this excellent book.

Please Say That You Saw It in RADIO-CRAFT

JUST OFF THE PRESS!



FREE Radio and Amplifier CATALOG
124 PAGES OF BIG MONEY SAVING VALUES

Filled with Latest Design Portable, Mobile and Rack and Panel, Public Address Amplifiers, Short-Wave and All-Wave Receivers and Converters, Inter-Office Call Systems, Test Equipment, Replacement Parts, Tubes and Accessories—All at unbeatable Rock Bottom Prices!

WE ARE HEADQUARTERS FOR PUBLIC ADDRESS SYSTEMS

Buy Direct from the Manufacturer and Pay Only One Profit

COAST TO COAST RADIO CORP.
 123-K W. 17th St., New York, N.Y.

THE MODEL 22 TUBE TESTER



The greatest value possible for the money. Beautiful quartered oak case, veri-chrome lettered bakelite panel, 3 1/4" D'Arsonval type meter 2% accuracy. Tests all present-day tubes with ample provisions for the future types. Neon leakage and short test of all tube elements. Direct reading. Provisions for resistance and condenser test.

\$23.75

WRITE FOR CIRCULAR ON OUR NEW COMBINATION UNIT. Tube tester and volt-ohm-meter. A complete electrical-radio service outfit in one unit. \$34.90.

A.C. D.C. METER 0-1 MIL.AMP. \$4.90.
 ALL TYPES and kinds of ROTARY SWITCHES. Our new bulletins describe all the above units. Mailed on request.

L & L ELECTRIC COMPANY
 336 MADISON AVE. Dept. 15-A MEMPHIS, TENN.

Ken-Rad Radio Tubes
DEPENDABLE LONG LIFE

Ken-Rad Radio Tubes are made to give clear, dependable reception. They satisfy customers and build good will for dealers. Write for full information.

THE KEN-RAD CORP., Inc., Owensboro, Ky.
 Division of The Ken-Rad Tube and Lamp Corp.
 Also Mfrs. of Ken-Rad Incandescent Electric Lamps

Get the finest RESISTORS SUPPRESSORS CONDENSERS

Selection, experimentation and manufacturer alike, through out the world, rely upon Continental for quality and service unsurpassed. New catalogs show complete lines of resistors, auto radio suppressors, and condensers.

Ask Your Dealer to Write

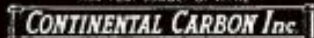

101 LORAIN AVE. CLEVELAND, OHIO

amount of \$25,000,000* in 1931. In 1933 that amount had been increased to \$30,000,000*, a jump of \$5,000,000 during the peak of the depression.

The broadcasting industry has never been marking time. During 1931 and 1932-33, the National Broadcasting Company had planned and constructed the most modern broadcasting studio plant in the world, in Radio City, and the recent increase of power at station WLW from 50,000 watts to 500,000 watts is the result of many long months of experimenting at a tremendous expense.

The radio advertiser has been the one great factor in all this expansion, as his use of the radio has been the source of revenue by which the broadcaster could continue operations. They have spent, according to *National Advertising Record*, \$33,842,485 in the first ten months of 1934 on National Networks in the U.S. alone. Yet the listener is not overburdened with advertising material as an average. In fact, the advertising material has become less in volume than ever, though the commercial programs have been on the increase. No better illustration of this point can be found than in H. S. Hetlinger's "A Decade of Radio Advertising," where he states:

Year	Daytime	Night time
1931	2 min. 35 sec.	2 min. 39 sec.
1932	2 min. 28 sec.	2 min. 39 sec.

*McGraw Hill Co., "Electronics."

These figures represent the actual time of commercial material on a sponsored program of 30 minutes in length, and are compiled from an average of 75 programs annually chosen at random from CBS and NBC network files.

For the sake of better illustration of what the advertiser pays to broadcast a one-hour program over the several networks with headquarters in the East, a tabulation of the gross rate between the hours of 6 p.m. to 11 p.m. has been prepared. This tabulation is as of October 1, 1934.

National Broadcasting Company

Coast to Coast Red Network (64 outlets without WLW)	\$14,120.00
Key Station—WEAF—only	900.00
Coast to Coast Blue Network (61 outlets without WLW)	13,520.00
Key Station—WJZ—only	900.00

These figures do not include charges for talent or program material.

Columbia Broadcasting System

Coast to Coast CBS Network (86 Cities)	\$15,775.00
Key Station—WABC—only	950.00

These figures do not include any charges for talent or program material.

American Broadcasting System, Inc.

(Inaugurated October 14, 1934)

Basic Network	\$2,480.00	17 Stations
Optional Service	280.00	
Total	2,760.00	

The program builders have not neglected to keep pace with other phases of the broadcasting industry. Their efforts have been largely guided by the audience response. This audience response, mostly in the matter of mail, varies from year to year, but 1934 has produced a noticeable increase in volume. In 1932 the networks received 4,771,000 communications, and in 1933 this had dropped to 3,175,000. However, for the first ten months in 1934, 4,235,106 communications have been received as compared to 2,586,597 for the January-October period of 1933.

Of all the programs broadcast by the major networks, an average of 85 to 90 per cent annually, are from the studios of the broadcasting companies, and the remainder represents the portion of programs originating at points outside of studios.

Personal contact with the listener is now the aim of the majority of the broadcasters. Much of this has been accomplished by direct surveys through representatives of the broadcasting companies, either by direct contact or via the telephone. Studio audiences are closely tested for their reactions to every type of program. The ever-increasing figures of radio-owning families surely shows how well the program builders are meeting the listeners demands, as erratic and varied these demands and requirements may be.

There has been an increase in the dramatic type of programs as well as the sponsored musical programs of a classical nature during the past year. There is also a present trend toward longer unit programs, best illustrated by the fact that on the national networks of NBC there are now 15 weekly programs of one hour duration.

Many Auto-Radios Installed Last Summer Now Need Servicing!

Auto-radios installed during the past six months usually need some minor adjustment—new tubes, new suppressors or other parts. Perhaps the job will even be more difficult—then you'll find how needy the Auto-Radio Service Manual is to repair the job quickly.

\$2.50 LIST

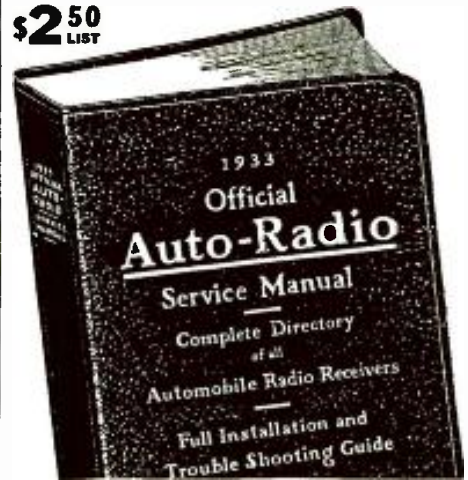

To everyone who now purchases the OFFICIAL AUTO-RADIO SERVICE MANUAL this big 48-page Supplement is issued FREE. Practically all of the latest sets, together with servicing information will be found in these new pages. The new Supplement does not increase the cost of the book to you, but gives you an Auto-Radio Service Manual that is right up-to-the-minute with service notes.

Good Money in Servicing Auto-Radios

If you are overlooking servicing auto radios, you're missing a great deal of business. The auto-radio business had its greatest boom last summer when thousands of sets were sold. By now many of these same sets require servicing and with hundreds of them right in your own community, you can build up a good auto-radio servicing business. In a short time you can easily add 25% profit or more to your regular servicing business.

List of sets covered in the Manual

- | | |
|-------------------------------|---------------------------------|
| Acme Radio Mfg. Co. | P. R. Mallory & Co. |
| Allied Radio Corp. | Melborn Radio Mfg. Co. |
| Atwater Kent Mfg. Co. | Montgomery Ward & Co. |
| Audiola Radio Co. | National Co., Inc. |
| Autocrat Radio Company | Noblitt-Sparks Ind., Inc. |
| Automatic Radio Mfg. Co. | Philio Radio & Tel. Corp. |
| Carr Genemotor Corp. | Pierce-Airo, Inc. |
| Century Radio Prods. Co. | Premier Electric Co. |
| Chevrolet Motor Company | Radio Chassis, Inc. |
| Consolidated Industries, Ltd. | RCA-Victor Co., Inc. |
| Crosley Radio Corp. | Sentinel Radio Corp. |
| Delco Appliance Corp. | Sparks-Withington Corp. |
| Detroit Radio Corp. | Stewart Radio & Tel. Corp. |
| Emerson Electric Mfg. Co. | Stewart-Warner Corp. |
| Fada Radio & Elec. Corp. | Stromberg-Carlson Tel. Mfg. Co. |
| Federated Purchaser, Inc. | Transformer Corp. of Am. |
| Ford-Majestic | United Amer. Bosch Corp. |
| Franklin Radio Corp. | United Motors Service |
| Galvin Mfg. Corp. | U. S. Radio & Tel. Corp. |
| General Electric Co. | Utah Radio Prods. Co. |
| General Motors Corp. | Wells-Gardner Company |
| A. H. Grebe & Co. | Wholesale Radio Serv. Co. |
| Griksby-Grunow Co. | Rudolph Wurlitzer Mfg. Co. |
| Chas. Hoodwin Company | |
| International Radio Corp. | Zenith Radio Corp. |

Over 200 Pages

Over 500 Illustrations

9 x 12 Inches

Flexible, Loose-Leaf Cover

MAIL THIS COUPON TODAY!

GERNSBACK PUBLICATIONS, INC. RC-2-35
 99 Hudson Street, New York, N. Y.

Enclosed you will find my remittance of \$2.50 for which please send me One Copy of the OFFICIAL AUTO-RADIO SERVICE MANUAL with FREE 48-page Supplement. Send remittance in check or money order. Register letter if it contains cash or currency. WE PAY POSTAGE.

Name

Address

City State.....

Please Say That You Saw It in RADIO-CRAFT

12 BOOKS TO HELP YOU LEARN MORE ABOUT RADIO



Illustrated at the right and left are two books in the Radio-Craft Library Series.



THE RADIO-CRAFT LIBRARY SERIES—a most complete and authentic set of volumes—treats individually, important divisions of radio. Each book has been designed to give you the opportunity to learn one or more branches of radio. The authors of the books are well-known to everyone. Each is an expert radio man; an authority on the subject—each is thoroughly familiar with the field which he represents.

All Books Uniform

The volumes in the RADIO-CRAFT LIBRARY SERIES are all uniform, 8 x 9 inches. Each book contains on an average of 50 to 120 illustrations. The books are printed on an excellent grade of paper which makes the type easy reading.

Here Are the Series:

- Book No. 1
RADIO SET ANALYZERS
And How to Use Them By **LAN DER MEL**
- Book No. 2
MODERN VACUUM TUBES
And How They Work By **ROBERT HERTZBERG**
- Book No. 3
THE SUPERHETERODYNE BOOK
All About Superheterodynes By **CLYDE FITCH**
- Book No. 4
MODERN RADIO HOOK-UPS
The Best Radio Circuits By **R. D. WASHBURNE**
- Book No. 5
HOW TO BECOME A RADIO SERVICE MAN
By **LOUIS MARTIN**
- Book No. 6
BRINGING ELECTRIC SETS UP TO DATE
By **CLIFFORD E. DENTON**
- Book No. 7
RADIO KINKS AND WRINKLES
For Service Men and Experimenters By **C. W. PALMER**
- Book No. 8
RADIO QUESTIONS AND ANSWERS
By **R. D. WASHBURNE**
- Book No. 9
AUTOMOBILE RADIO AND SERVICING
By **LOUIS MARTIN**
- Book No. 10
HOME RECORDING AND ALL ABOUT IT
By **GEORGE J. SALIBA**
- Book No. 11
POINT-TO-POINT RESISTANCE MEASUREMENTS
By **CLIFFORD E. DENTON**
- Book No. 12
PUBLIC ADDRESS INSTALLATION AND SERVICE
By **J. T. BERNSELY**

BIG DISCOUNT OFFERED

When Five (5) Books or More Are Ordered, Deduct 20% from Your Remittance

GERNSBACK PUBLICATIONS, INC.
89 Hudson Street, New York, N. Y.

MAIL THIS COUPON TODAY!

GERNSBACK PUBLICATIONS, INC.
89 Hudson Street, New York, N. Y.

I have circled below the numbers of books in the RADIO-CRAFT LIBRARY SERIES which you are to send me, and have deducted 20% for ordering five (5) books or more. I have included my remittance in full, at the price of 50c each, when less than five books are ordered.

The amount of my remittance is..... (stamps, checks or money orders accepted). Circle numbers wanted:

1 2 3 4 5 6 7 8 9 10 11 12

Name

Address

City State.....

All books are sent postage prepaid

RC-235

With the annual variation of audience response comes an equal variation of what that audience wishes to hear. These desires and requests change the percentage of time allotted to the different types of programs, and although sometimes these changes are very slight from one year to another, they do denote the careful attention to these requests by the program directors. Following is a list of program types and the percentage of time allotted to each on a national network. Covering a period of three years, the reader may easily note the variation, in the majority of cases entirely due to the audience reaction.

Program	Sept. 1932	Sept. 1933	Sept. 1934
Music	66.3%	72.0%	68.6%
Literature	9.8	10.6	11.3
Lectures	6.9	5.7	6.5
Outstanding Events	3.1	1.3	3.2
Current News	1.0	.7	1.4
Women's	1.7	.8	.7
Children's	2.8	2.9	2.1
Physical Training	2.3	2.2	1.7
Religion	1.8	1.6	1.5
Reports	.6	.1	.1
Novelties	3.7	2.1	2.4
	100.0%	100.0%	100.0%

In order that the broadcasters may be thoroughly acquainted with the reactions of the general public, extensive campaigns are being inaugurated so that as much data may be accumulated as possible. Early in this year, 1934, as an illustration of this fact, the National Broadcasting Company investigated the existing use of radio receivers in daytime as compared with evening hours. As the plans were formulated, it was evident that such a survey would uncover many other facts about radio-families which would aid in the future formation of programs more in keeping with the desires of the listeners. In order that you may understand how thoroughly a survey of this nature is conducted, and the time and labor necessary in obtaining the desired information, there will be 45,216 figures in the final statistical material, out of a necessary 10,000,000 tally marks made by a staff of sixty-three people working a total of 1,189,000 man-hours. A total of 386 interviewers obtained 727,081 half hour unit-interviews in 209 cities throughout the United States. Of these, 94,087 were by telephone, and 632,944 were obtained from weekly schedules, kept under supervision, of 3,043 housewives for 208 half-hour periods each. A terrific amount of work and tabulation—in order that the industry may further develop and bring to you, through your radio, what you like.

Employment in the broadcasting industry during 1933 reached a total of *99,000 employes at the peak of the seasonal employment period. The industry paid these employes a total of *\$114,000,000 during that year. Although there are no direct figures available, the trend during this year, 1934, is very definitely upward, and all indications seem to point to higher employment during the first ten months of this year as compared to the same period of 1933.

The general trend in regard to power of broadcasting stations seems to be towards higher power, as indicated by a number of regional stations increasing their power from 1,000 watts to 5,000 watts daytime. The general feeling is that the same increases will eventually be granted for the same time purposes. Since the inception of the Federal Communications Commission, which has replaced the Federal Radio Commission, in part, a feeling of general optimism has pervaded the industry. Every cooperation is being given the new commission by the broadcasters, in order that a complete understanding of the problems confronting the broadcasters may guide any legislation contemplated by the commission through the regular channels.

No one can readily predict what the next few years will bring forth in the broadcasting industry, but if the past few years are any indication, the developments, improvements, and probable program innovations, will truly be startling enough to those of us who are all too prone to take this industry as "something for granted."

*McGraw Hill Co.: "Electronics."

RADIO-CRAFT INDEX

By Subjects, Issues and Authors, the July 1929 to June 1932 issues of RADIO-CRAFT are indexed and cross-indexed, in a publication you may obtain for only 25c (stamps or cash). Write to us for this valuable 24 page reference; its use will save you time and money!

Please Say That You Saw It in RADIO-CRAFT

Flash Grunow, Sparton, Zenith, Motorola, etc., approve the Model OC



R.F. Signal Generator for servicing ALL-WAVE Sets

The service engineers of these leading set manufacturers have unanimously approved the CLOUGH-BREngle Model OC R.F. Signal Generator as being the finest instrument for servicing their new ALL-WAVE receivers.

Here are some of the outstanding features of the Model OC that have brought it this unequalled recognition: 50 k.c. to 30 m.c. continuously variable fundamental wave output; each instrument hand calibrated to accuracy within 1/2 of 1% over entire range; three tube electron coupled circuit; A.C.-D.C. line operation eliminates batteries. Write for complete description. Complete with tubes, Net, only..... **\$29.94**

Get These Manufacturers' Reports!

The CLOUGH-BREngle Co.
1130 W. Austin Ave. — Chicago, U. S. A.

Send me actual reproductions of reports on tests of the Model OC made by leading set manufacturers and descriptive literature; also bulletins on instruments checked below.

- Model U E Volt-Ohm-Milliammeter
- Model U C Vacuum Tube Voltmeter
- Model U B Audio Oscillator
- Cathode Ray Servicing Insts.

Name

Address

When writing to advertisers, please say you saw it in RADIO-CRAFT.

THE WORLD'S MOST COMPLETE CONDENSER LINE

FOR Service Men Amateurs and Experimenters Paper - Mica Oil Electrolytic

WRITE FOR OUR CATALOG TODAY

Backed by twenty-five years of scientific research and quality production. One billion since 1910. Available at all leading suppliers. Use a C-D the next time.

CORNELL-DUBILIER CORPORATION
4347 BRONX BOULEVARD
NEW YORK

Dealers! Servicemen!

We repeat our "get-acquainted" offer of last month due to the encouraging response from the readers of Radio-Craft wishing to save money on

SPEED RADIO TUBES

Pioneers in tube developments since 1924
Listed below are included many popular types of tubes for short-wave use. ALL TUBES ARE GUARANTEED FOR A PERIOD OF SIX MONTHS.

Type	Net Price	Type	Net Price	Type	Net Price	Type	Net Price
01A	\$.27	38	\$.50	77	\$.54	2A5	\$.50
210	1.13	39-44	.54	78	.54	2A6	.50
12A	.41	41	.50	89	.32	2A7	.60
22	.58	42	.54	91	1.13	2B7	.60
24	.50	43	.57	92	.41	6A7	.60
26	.29	45	.33	93	.50	6B7	.60
27	.32	47	.59	84	.59	6D6	.50
30	.36	48	1.35	X99	.45	6D8	.50
31	.36	210	1.13	V99	.56	6T7	.72
32	.63	55	.50	866	3.26	5Z3	.54
33	.63	56	.33	485	.65	12Z3	.50
34	.68	57	.50	182	.74	2Z5	.72
35	.50	58	.50	182B	.74	Type 1-V	.50
36	.50	71A	.32	193	.74	Type 1-V	.50
37	.39	75	.50	2A3	.80	2B6	1.13

If your Jobber cannot fill your order promptly, send it direct to us for immediate shipment.

No order for less than \$3.00 can be accepted. Send 25% deposit, balance C.O.D. All tube prices shown are net—and orders are F.O.B. factory. IF FIFTY TUBES OR MORE ARE ORDERED, ORDERS ARE SHIPPED PREPAID.

SPEED RADIO CORP. 22-14 40th Avenue Long Island City, N.Y.
Jobbers, Large Users—write for Special Offer!

MAKE YOUR OWN CURRENT MULTIPLIERS

(Continued from page 477)

producing the least effect on the current circuit. This shunt resistance is limited, of course in proper proportion, to that resistance contained in the meter. For example—if a meter is reconstructed so that it requires only one-half the former current for full scale deflection, the effect will be (concerning the necessary shunt resistance) that of reducing the internal resistance of the meter by one half. The shunt resistance could then be lowered accordingly. This is a very vital point to be considered as present-day radio circuits and tubes may use a very low voltage on one or more of the tube elements.

Switches

Of course, the most accurate shunt hookup is one having no switches in the circuit, but this does not suit our present-day requirements which call for the measurement of a few microamperes up to twenty or thirty amperes. This must be accomplished by the use of switches, and it becomes a case of "name your poison."

Single or multiple shunt circuit arrangements using bi-polar switches (one having two individual moving arms and several contact positions) as shown in Fig. 1 are recommended as having the most desired features—quick action with fine accuracy.

Switches in series with shunts usually are not practical; the action of the switch arms must wipe and clean the joint in making and breaking single-pole switches. The reason for this is that the introduction of any amount of switch contact resistance in series with the shunt will seriously effect the value of this unit. The percentage of error depends on the ohmic value of the shunt. Taking arbitrarily a 100 ma. shunt for a 50 M. V. meter, its resistance is .506 ohms.

Now adding a possible switch contact resistance of one tenth ohm (0.10) gives us a resultant total of .606 ohms, an approximate error of 10 per cent. Good switches with wiping, silver contacts and arms used with shunts whose values do not run into amperes will make a very simple and inexpensive arrangement with a reasonable degree of accuracy. In using single-pole rotary switches in series with the shunt, be sure they are of the shorting type as there must not be an open break in traversing from one contact to another, otherwise that inevitable "human error" will effect your meter sooner or later. As noted in Fig. A, the contacts are spaced an appreciable distance from the connecting lugs, keeping away heat, soldering flux, etc. A good rule is to never let rosin flux get on switch contacts as it is nearly impossible to tell when it is all removed, with the exception that you will find your readings to be incorrect, and the meter needle erratic.

Fig. B

The rear view of the meter with its associated current multipliers and selector switch.

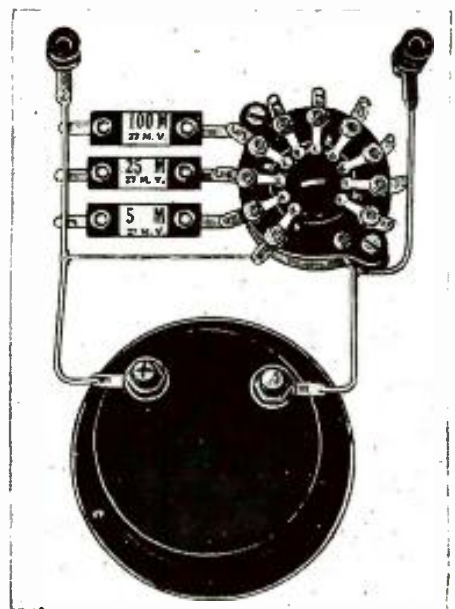

A MAGAZINE WHICH NEEDS NO INTRODUCTION TO SHORT-WAVE FANS

SHORT WAVE CRAFT

This popular monthly magazine, SHORT WAVE CRAFT, contains everything you want to know about Short Waves. The wonders of world-wide short-wave reception are clearly described and illustrated. Latest practical information for radio fans, experimenters and "hams" will be found. Tells you how to build short-wave receivers and transmitters; construct sets of one and two tubes or as many as seven, eight or more. Tells best foreign stations to log and when to tune them—includes newest and best circuits of the time. SHORT WAVE CRAFT is edited by Hugo Gernsback.

NEW FEATURE RECENTLY ADDED—To the short wave fan who has logged and obtained verification of the largest number of short-wave stations from all over the world during one month, will be awarded a magnificent 24" silver trophy.

Special This Month Only!

For the month of January only, we offer readers of this magazine the opportunity to read Radio's greatest short-wave magazine at a special saving. The regular subscription price is \$2.50 per year. You can now get SHORT WAVE CRAFT for the next

8 MONTHS FOR \$1.00



4-Color Cover
Over 200 illustrations
9x12 inches in size

25c The Copy
ON ALL NEWSSTANDS

Send remittance by check, money order or U. S. Postage Stamps. Register letter if it contains cash or currency.

SHORT WAVE CRAFT
99R Hudson St. New York, N. Y.



There's plenty of SERVICING MATERIAL in the 1934 Manual!

Radio Service Men and others engaged in various branches of radio know the importance of the GERNSBACK Manuals, and how much they depend on them for reliable information. Whether for public address work, receiver diagrams or tube information, the material needed is certain to be found in one of the volumes of the OFFICIAL RADIO SERVICE MANUAL.

Contents of the 1934 Manual in Brief

Diagrams and service notes, more complete than ever before in any manual. Voltage readings for practically all sets, as an aid in checking tubes and wiring. All values of I.F. transformers used in superheterodynes, with the manufacturers' own suggestions as to correct balancing. A complete compilation of radio tube data, covering both old and new types. A complete list of American broadcast stations with their frequencies in kilocycles; extremely useful in calibrating test oscillators and receivers. Free question and answer service. No theory; only service information in quickly accessible form. A handy, easily-consulted master index making it easy to find almost anything pertaining to service problems, instantly. This index includes all the diagrams published in all the previous GERNSBACK manuals, as well as the 1934 diagrams. A big convenience and time saver.

400 PAGES

Over 2,000 Illustrations
9 x 12 Inches

Flexible Looseleaf Leatherette Cover

Send remittance of \$3.50 by check, money order or unused U. S. Postage Stamps. Register letter if it contains cash or stamps. MANUAL SENT POSTAGE PREPAID.

GERNSBACK PUBLICATIONS, Inc.
99 Hudson Street, New York, N. Y.

WHEN CHOOSING A RADIO SCHOOL



RCA Institutes, with its reputation established by 25 years service, is an institution recognized as an important factor in the radio industry. Whether elementary radio principles or advanced subjects, sound applications or practical radio engineering, RCA Institutes is prepared to give you the instruction you need.

RESIDENT SCHOOLS NEW YORK AND CHICAGO with modern standard equipment.

EXTENSION COURSES FOR HOME STUDY under convenient "no obligation" plan. Illustrated Catalog on Request.

R. C. A. INSTITUTES, Inc. Dept. RT-35
75 Varick St., New York—1154 Merchandise Mart, Chicago

WALCO'S SOUND RECORDING INSTRUMENTS

Service men—Dealers—Technicians
Write for our latest catalog on Home Recording Apparatus.

FREE No obligations. Consult us about P. A. and Home Recording Installations.
ELECTRICAL LABORATORIES CO., Inc.
141 East 25th St. New York, N. Y.

RUN YOUR A.C. RADIO by DIRECT CURRENT

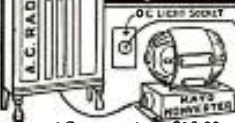

Operates AC Radios, amplifiers, transmitters, etc. from 8-32 or 110 DC. Sent on trial.

KATO ENGINEERING CO.
Mankato, Minn. U. S. A.
AC generators \$16.00. Light plants \$89.00.

SILVERED, ETCHED METAL DIALS

Three types for models 301-88-321-54 and 199
BUY THROUGH YOUR DEALER
New Catalogue No. 7 just for a post card
D. L. VAN Leuven, 410 E. 15th St., New York, N. Y.

"SHURE" CRYSTAL MICROPHONES

NOW AVAILABLE AT YOUR JOBBER
(Licensed Under Brush Development Co. Patents)
SHURE BROTHERS COMPANY
Microphone Headquarters
215 W. HURON ST. CHICAGO, U.S.A.

Patronize RADIO-CRAFT advertisers for merchandise of value.

Please Say That You Saw It in RADIO-CRAFT

Low Resistance Ranges

The conventional resistance measurement range for a 1 milliamp. meter is generally accepted to be 0 to 100,000 ohms using a 4½ volt battery in series with a 4,000-ohm fixed resistor, a 1,000-ohm variable and the meter, the purpose of 1,000-ohm resistor being to compensate for any variation in the battery voltage. By the use of a 10 ma. shunt properly connected to the meter, a range of 0 to 10,000 ohms will be obtained. The status of the meter now being 10 ma. or otherwise 100 ohms per volt, and having a 4½ volt battery, the series adjustable resistor of 1,000 ohms will amply take care of an adjustment for 450 ohms. The same action by using a 100 ma. shunt with a resultant range of 0 to 1,000 ohms is obtainable with the variable resistor cut to 45 ohms. Fig. 1 shows just such a hookup as explained above including the means for cutting out the 4,000-ohm resistor when using the 10 and 100 ma. shunt. A 1 meg. range can be had by using a 45-volt midget battery, 40,000-ohm fixed and 10,000-ohm variable, all in series with the meter but using a separate terminal post. This latter set-up makes a good insulation test, in fact it will be so good that you will hardly be able to get near the test leads before you will note considerable antics displayed by the meter hand.

A Current Supply

Continuing with the circuit, Fig. 1, using shunts for low ranges you should readily perceive that in using the 10 ma. as well as the hundred ma. shunt in ohmmeter form, you have a variable current supply from zero to 100 ma., controlled by the 1,000-ohm variable resistor. (zero adjustor). This is very handy for many purposes, such as furnishing current for testing other meters in series or determining the millivolt drops or internal resistance, the sensitivity of relays and for many other purposes.

In explaining the following method of testing for internal resistance, consider that only 1 milliamperes meters are being used, excepting the above mentioned power supply unit. Access to a meter having a 50 M. V. drop must be obtained in case the reader or his friends do not have one handy.

Scale Shunt-Comparison

This meter should be new or nearly so, Old instruments are apt to be slightly out, especially along the center of the scale, due to dull or worn pivots, etc. This meter we will designate as the *standard*, and the meter to be calibrated or tested to be called the *unknown*. Connect both the standard and the unknown meters in parallel, positive to positive and negative to negative. Set the power supply to the 10 ma. position. Short the ohm circuit test leads and adjust the 1,000-ohm variable until the power supply meter reads 2 ma. Now make contact with the test leads to the unknown meter terminal posts and again adjust the 1,000-ohm variable at the power supply until the unknown meter reads full scale. The reading obtained on the standard (using 0-50 scale) will be the correct milli-volt drop of the unknown meter.

Scale Series-Comparison

As previously explained, any change in the current consumption of the meter affects the milli-volt drop. Before any reasonable calculation to determine the internal resistance of a meter can be obtained the current at full scale must be known. To find this connect the standard and the unknown in series, negative terminals to positive and etc., and adjust the current supply until full scale reading is obtained on one of the two instruments. If both meters read alike the internal resistance will be equal to the milli-volt drop as recorded in the above mentioned parallel test. And should the unknown test one division (on 50 division scale) low it is obvious that the internal resistance is 2 per cent higher than the milli-volt reading taken in the parallel test.

The schematic layout is shown for the 1 ma. A.C.-D.C. universal rectified meter having its 5-volt A.C. resistor connected internally, the D.C. side generally being 50 ohms internal. (50 M. V.) This same hookup can be used with the 1 ma. D.C. meter, as there will be no A.C. connection nor will there be any 400-ohm shunt connecting to the lead from the 4,950-ohm resistor, shown by the dotted lines.

MULTI-TAP

UNIVERSAL OUTPUT

and INPUT Audio TRANSFORMERS



No. 1337



No. 3205

MULTI-TAP OUTPUT
The Universal primary and the tapped secondary, from 2 to 30 ohms in 2 ohm steps, makes it possible to feed practically any straight or push-pull output stage to any dynamic speaker.

UNIVERSAL INPUT AUDIO
can efficiently feed any straight or push-pull audio stage on either A.C. or D.C. sets. Universal—Physically may be mounted on end or side. Slots in base allow wide range of adaptability without redrilling panel. Overall dimensions: 2"x2"x1½" Mtg. Centers: 1¼"x½" to 1/16" or 1"x½" to 1/8". Service Engineers should always have one or more of each in their emergency stock.

The above are typical of the GENERAL group of power—audio—input—flament—line—mike—amateur—class "B" transformers, chokes, auto-radio "B" units and vibrators. The most comprehensive line of replacement units from one manufacturing source of supply—service engineers' every need. All GENERAL transformers are of high test silicon steel, all coils are high vacuum impregnated, removing all moisture, and assuring permanent dependable performance under any climatic conditions. GENERAL QUALITY assures set-owner satisfaction and dealer profit.

Free for the Asking!

"Multi-Tap" Guide, listing 2114 models of radios which you can immediately service with one of only five (5) "Multi-Tap" Power Transformers.

General Transformer Corporation
504 S. Throop St., Chicago, Ill.

MAIL THIS TODAY

General Transformer Corporation,
504 S. Throop St., Chicago, Ill.

Send me without charge a copy of "Multi-Tap" Guide with name of nearest distributor.

Name _____

Address _____

City _____ State _____

An All Purpose PORTAMP

UNIVERSAL AC-DC AMPLIFIER



PORTAMP—a new sensation in Portable Power Amplifiers, designed by skillful engineers of LEOTONE Laboratories. This fine portable P. A. System delivers the "punch" required for operation in auditoriums and outdoor advertising work... always clear audible reproduction. It features a 77 tube in the first stage which feeds into a 43 power pentode. The rectifier is a 25Z5 arranged for universal operation on 90-125 volts, A.C. or D.C. A "mike" transformer is built in. "PORTAMP" Kit including Brown Morocco Leatherette carrying case, American "EL" double-button microphone, microphone transformer, kit of ARCTON'S tubes and speaker. COMPLETE.....\$18.95
Wired and Tested.....\$21.95

\$18.95

KIT OF PARTS
WIRED-TESTED
\$21.95

LEOTONE RADIO CO. 63 Deu St. New York, N.Y.

OPERATING NOTES

(Continued from page 482)

times complete cut-off. Trouble was due to the 0.6-ohm balancing resistor in the 182s' filament supply intermittently breaking contact. A permanent repair was effected by soldering lead X2 (see Fig. 3, below) to point (a), and then connecting (a) to (b) by a bus and soldering at (b), thus eliminating resistor (ab) entirely. It is a wire-wound potentiometer. Set has now been in operation for over a year with no complaints. JOHN MUEHLKE.

INFORMATION BUREAU

(Continued from page 483)

ment which necessitate readjustment later. It is better to do the aligning work with the set in its operating condition.

(A.3) When aligning a set, the grid side of the oscillator should be clipped onto the grid wire, without removing the tube or any other part from the set. The idea is to maintain the receiver in as nearly the condition encountered when it is operating, as possible. Then there can be no differences introduced by subsequent changes.

If it is found that the grid-dip is at a different point on moving the dial in one direction than that in the other, the coupling between the oscillator and the tuned circuit is evidently too close, which causes an interlocking of the circuits. The coupling should be loosened by reducing the capacity of the coupling condensers.

FREE!

184 PAGE Complete RADIO CATALOG

Lowest Prices!

The greatest handy radio catalog yet issued by any Mail Order Organization. It contains the most versatile line-up of merchandise ever seen in a catalog before; second, all prices are competitive; third, the book is handy in size and easily fits into your pocket.

Thousands of Items at Lowest Prices
Some of the manufacturers represented are American Radio Hardware, Acme, Arctura, Brandes, Bruno Lab, Bud, Central, Connecticut, Eby, Electric Soldering, Eveready, Farrand, Flechtel, General Industries, Gen-Win, Gerzback, Hammarlund, Jackson, Kenyon, Lynch, Omnia, Oxford, Palmox, Radio City, Radio Rider, Rola, Shure, Signal, Sylvania, Thorndson, Trimm, Triplett, Tube, Universal Microphone, Upco and many others.

Write For Your Copy Today!

YOU WILL ADMIT THAT THIS RADIO CATALOG IS THE HANDIEST BOOK YOU EVER RECEIVED



TRY-MO RADIO CO.
85 CORTLANDT ST. NEW YORK, N.Y.

LOWEST WHOLESALE PRICES

Aerials, amplifiers, automobile accessories, condensers, all types of controls, converters, speakers, panels, and bases, phonographs, short-wave receivers, recording equipment, resistors, switches, transformers, tubes, transmitters and equipment, testing equipment, volume controls, wire and others too numerous to mention.

TRY-MO RADIO COMPANY
85 CORTLANDT ST. NEW YORK, N.Y.
Please address correspondence to Dept. C

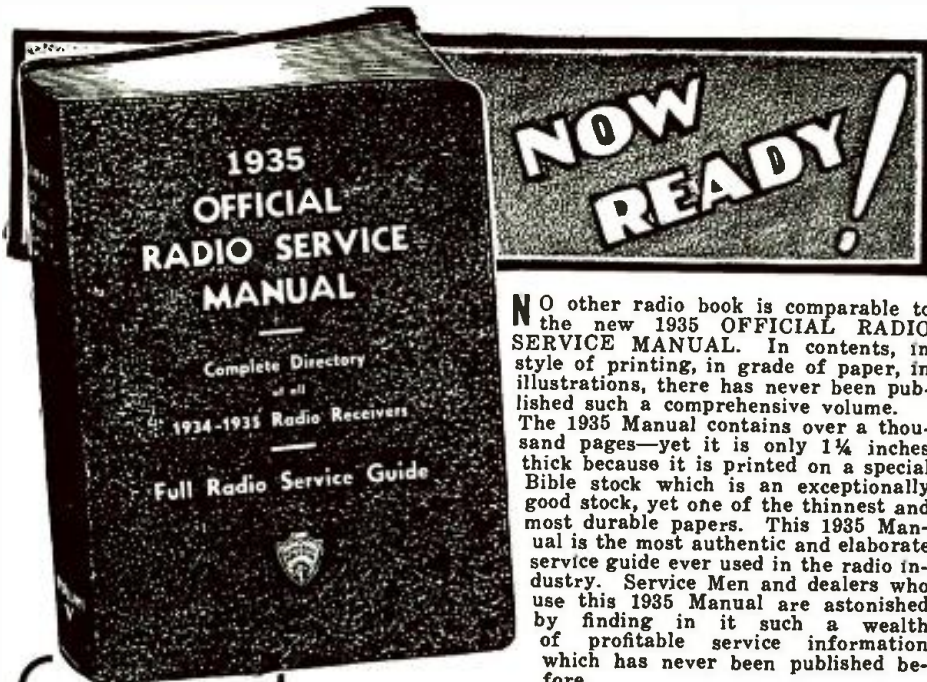

NOW READY!

NO other radio book is comparable to the new 1935 OFFICIAL RADIO SERVICE MANUAL. In contents, in style of printing, in grade of paper, in illustrations, there has never been published such a comprehensive volume. The 1935 Manual contains over a thousand pages—yet it is only 1 1/4 inches thick because it is printed on a special Bible stock which is an exceptionally good stock, yet one of the thinnest and most durable papers. This 1935 Manual is the most authentic and elaborate service guide ever used in the radio industry. Service Men and dealers who use this 1935 Manual are astonished by finding in it such a wealth of profitable service information which has never been published before.

Contents of the 1935 Manual

Over 1,000 pages full of diagrams and essential information of manufactured receivers—only data of real use in servicing is included. This new Manual is really portable since it will be extremely thin and light as well. ● Volume V continues where the preceding manual left off. ● Many circuits of old sets are included. ● Service Men know every set has certain weak points which are really the cause of trouble. Wherever the information could be obtained, these weaknesses with their cures are printed right with the circuits. This is an entirely new and valuable addition to the Manual. ● All the latest receivers are included—all-wave sets, short-wave sets, auto-radio sets, midget and cigar-box sets, etc., as well as P.A. amplifiers and equipment, and commercial servicing instruments. ● The cumulative index is even more complete than before; including cross-reference to sets sold under different names and type numbers. ● Volume V includes resistance data; socket layouts; I.F. data; and voltage data. ● Tube data on latest tubes. ● Free question and answer service—as included in our last three manuals.

OVER 1,000 PAGES

Over 3,000 Illustrations. Flexible, loose-leaf leatherette covers. Size 9x12"—yet only 1 1/4" thick

GERNSBACK PUBLICATIONS, Inc.
99 Hudson Street New York, N. Y.
MAIL COUPON TODAY!

SET SERVICING

Service information found in the 1935 Manual covers all types of radio receivers. The material is extremely valuable to Dealers and Service Men. On many diagrams appear voltage readings of tubes, socket connections, transformer data, alignment details, and other service notes.

PUBLIC ADDRESS

The pages on P. A. Installation will be helpful to Service Men and P. A. specialists. Such prominent features as class A and B amplifiers—single and dual channel systems—attenuators, and mixers—superpower stages—preamplifiers and other commercial devices for P. A. work are included.

ALL-WAVE RECEIVERS

Information relative to short-wave receivers have found their way into the 1935 Manual. For these standard manufactured sets, wherever possible, complete aligning details for all wave bands are included in addition to the service material listed for other sets.

AUTO-RADIO RECEIVERS

All available service information on new auto-radio sets has been included. From this data alone Service Men could derive sufficient knowledge to venture in a specialty field—that of servicing only auto-radios.

GERNSBACK PUBLICATIONS Inc., 99 Hudson St., New York, N. Y.

Enclosed find my remittance of \$7.00 for which send me, POSTAGE PREPAID, One Copy of the 1935 OFFICIAL RADIO SERVICE MANUAL. [Send remittance by check or money order; or register letter if it contains cash, currency or unused U.S. Postage stamps.]

NAME

ADDRESS

CITY STATE RC-2-35

"CONTRACTED SPEECH" ON THE NEW YORK-LONDON RADIOPHONE

(Continued from page 462)

it to its original intensity range after it has traversed the transmission medium. One device which accomplishes this improvement in signal-to-noise ratio without overloading the circuit equipment is called the compandor. The name is a combination of "compressor" and "expander," suggesting the functional operations of the two component parts of the apparatus.

The advantages to be gained by compressing and expanding the speech volume range can be seen from Figs. 1A and B. Figure 1A shows a one-directional speech transmission circuit consisting of a transmitter, a gain control, an amplifier, a long line or radio channel, another gain control, another amplifier, and a receiver. The gain controls are so linked together that when either one is set at maximum the other is at minimum. The range of gain of the gain control and associated amplifier at the transmitter is from 15 db. to zero, and at the receiver from minus 15 db. to zero.

Now, suppose speech currents varying in intensity between 0 db. and minus 30 db. are coming from the transmitter. If the gain controls are set in position 1, the speech will be amplified 15 db., and the weak sounds will enter the noisy circuit at minus 15 db. intensity, 10 db. above the noise level. But the strong sounds of speech will be 15 db. above the overload point of amplifier A, and consequently will be distorted. Intensity ranges assumed to illustrate this condition are shown graphically in section A, Fig. 1B.

If the gain controls are set in position 2, shown by the dotted lines, the speech will encounter no gain, and amplifier A will just transmit the strong speech currents without overloading, but the weak speech currents will be 5 db. below the noise level as heard at the receiver. Transmission under this condition is shown in section B, Fig. 1B.

But if the setting of the gain control is varied continuously between position 1 for weakest speech currents and position 2 for strongest speech currents, and proportionally between these positions for intermediate currents, no overloading will occur, and the received speech will be at least 10 db. above the noise level at all values of signal intensity. Transmission conditions on the noisy circuit with such a system of operation are shown in section C, Fig. 1B. As the gain controls operate slowly and simultaneously in opposite senses, there is no effect on speech quality or intensity variations as heard in the receiver.

Simplified schematics of the compressor and the expander are shown in Fig. 2A and B. Each consists of a voice channel, and a branch circuit which controls the gain or loss in the voice channel.

The "Vario-Losser"

The voice channel of the compressor contains a "vario-losser," an amplifier, and a high-pass filter. The vario-losser is made up of a pair of three-electrode vacuum tubes with their plate circuits bridged across a section of the voice channel which has an impedance high compared to the impedances of the tubes. The voice-channel gain is dependent on the voltage applied by the branch circuit to the grids of the vario-losser tubes, which are biased normally to operate near their cut-off point.

The branch circuit of the compressor contains an amplifier, a linear rectifier, and a low-pass filter. It picks off part of the output of the voice channel, rectifies the speech voltage linearly, filters out the speech-frequency components of the rectified voltage, and applies the resulting envelope voltage to the grids of the vario-losser tubes. When the input voltage to the compressor increases, the grid biasing voltage applied by the branch circuit also increases and thus tends to cause a decrease in the gain of the voice channel. Proper adjustment of the gain of the branch circuit amplifier insures that this decrease will be so related to the increase in input voltage that the output intensity range of the compressor will be only half the input intensity range. The cut-off point of the low-pass filter in the branch circuit is made lower than that of the high-pass filter in the voice channel in order to prevent regeneration.

PIRATE STORIES

For March
A BOOK-LENGTH NOVEL
"Pirate Vengeance"
By CAPTAIN DINGLE
A Flaming Tale of Buccaneer Days
Also Short Stories of Modern Pirates
by Capt. J. Winchcombe-Taylor
George Allan Moffat and others
A GERNSBACK PUBLICATION
15c The Copy—On All Newsstands

HIGH-SEAS ADVENTURES

MAGAZINE
For February
A COMPLETE NOVEL
"The War Gang"
By LEONARD H. NASON
An Action Story with all the Mystery and
Danger of the Great War
Also Short Stories by Capt. Dingle, P. H.
MacArthur, Francis Roitch
A GERNSBACK PUBLICATION
15c The Copy—On All Newsstands

Please Say That You Saw It in RADIO-CRAFT

It's NOW

EVERYDAY SCIENCE AND MECHANICS is the finest scientific — technical — mechanical — constructional magazine in the field. Up-to-the-minute with news flashes of scientific events. Dozens of constructional articles and many popular experiments. Ideas from which you can make things to sell.

10c

A HOST OF INTERESTING SUBJECTS COVERED:—
 Woodworking—Photography—Magic—
 Patents and Inventions—Book Reviews—
 Metal-working—Chemistry—Engineering—
 Microscopy—Electrical Experiments—
 Household Hints—Astronomy—
 Prize Contests—and other subjects.

Get your copy today!
 On all newsstands
10c
 the copy

Over 150 Illustrations

Most Amazing TYPEWRITER BARGAIN EVER OFFERED

10 DAY FREE TRIAL OFFER



NEW REMINGTON PORTABLE only **10c A DAY**

FIRST TIME! Remington's new purchase plan now lets you buy a genuine latest model Remington Portable No. 5 direct from the factory for only 10¢ a day. Not used or rebuilt. Not incomplete. A beautiful brand new regulation Remington Portable. Standard 4-row keyboard, standard width carriage, margin release on keyboard, back spacer, automatic ribbon reverse; every essential feature found in standard typewriters.

With your machine we send you free a 19-page course in typewriting. Teaches touch system quickly, easily. Soon you dash off letters quicker than with pen and ink. You also get a handsome, sturdy carrying case free.

FREE Typewriting Course

BIG PRICE REDUCTION

The amazing low price and easy terms now make it possible for you to buy this genuine complete Remington Portable for only 10¢ a day. But we cannot guarantee present prices long. Higher wage scales, rising cost of materials, everything points to higher prices. So we say, Act now. While our liberal offer still holds good!

FREE Carrying Case

You Don't Risk One Cent Try this typewriter in your home or office on our 10-day FREE TRIAL OFFER. Then, if you do not agree that it is the finest portable at any price, return it at our expense. You don't even risk shipping charges. Don't wait. Mail coupon now. It's the best chance you've ever had to own so complete a machine for so little money. So act NOW!

CLIP COUPON NOW

Remington Rand Inc., Dept. 189-2
 Buffalo, N. Y.

Please tell me how I can buy a new Remington Portable typewriter for only 10¢ a day. Also enclose your new catalog.

Name _____
 Address _____
 City _____ State _____

The "Vario-Repeater"

The voice channel of the expander (Fig. 2B) contains a "vario-repeater" and an amplifier. The vario-repeater is a push-pull amplifier so connected that the plate circuits of the tubes are effectively in series with a transformer whose input impedance is low compared to the impedance of the tubes. The tubes are biased to a point near the cut-off, so that when no voltage from the branch circuit is applied to their grids, they afford so little gain that the loss through the vario-repeater is high, just offsetting the initial gain in the compressor. When a positive potential is added by the branch circuit to the initial negative bias, the series plate impedance of the tubes decreases, and the loss decreases in the same manner that the gain decreases in the compressor. Both the incoming speech and the branch circuit output are applied to the grid circuits of the vario-repeater tubes. But the relative magnitudes of the voltages applied to the grids from these two sources are such that only the branch circuit output can cause any appreciable variation in vario-repeater gain. This condition is obtained by using a step-down transformer at the input of the vario-repeater and a step-up transformer at the input of the branch circuit.

The branch circuit of the expander performs the function of picking off a portion of the speech current at the input, and applying the demodulated and filtered speech-voltage fluctuations to the grid circuit of the vario-repeater. The variation in gain of the vario-repeater, expressed in db, equals the variation in input to the expander for expansion which will offset the compression previously accomplished. The circuit contains an amplifier, a linear rectifier and a low-pass filter. It applies an opposing grid bias to the vario-repeater, which is high when the speech current received is strong, and proportionally lower when the current is weak, thereby causing a higher gain in the vario-repeater for strong speech sounds than for weak ones. Thus the expander undoes what has been done by the compressor.

Commercial operation of the compandor on the long-wave radio circuit to London has yielded encouraging results. Soon after the compandor was placed in operation, it was found that under most conditions satisfactory service could be given with static 5 db. stronger than the old commercial limit. Because of the improvement in signal-to-noise ratio due to the compandor, it is usually possible to deliver at least 5 db. more volume to the subscriber without failure of the voice-operated switching devices at the terminals, a factor of great importance when long extension circuits are involved.

Fig. 2

The compressing (A) and expanding (B) units of the "compandor" system.

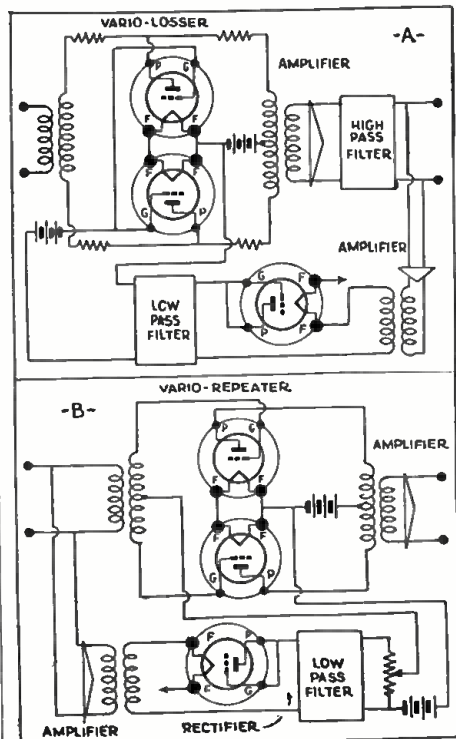

"SO! you wont talk eh?"

"Where were you on the night of October 13th?" Silent . . . silent as a door knob. . . Here's a tip, Inspector . . . call a good serviceman and have him bring along some Centralabs . . . chances are that's all your Super-Iodyne needs to make it tell all it knows. For a mere handful of Centralab Radiohm Replacement parts will service almost every known make of radio . . . and make it perk better than before.

The new patented **RADIOHM**

Centralab
 Division of MILWAUKEE Globe Union Mfg. Co. WIS.
RADIOHMS—RESISTORS
MOTOR RADIO SUPPRESSORS

GUARANTEED RADIO SERVICE REQUIRES THE BEST REPAIR PARTS!



Condensers Are Best!

- Identical in every detail.
- Plainly marked for capacity, voltage, part number, make and model radio they are for.
- Attractive, workmanlike appearance.
- TOBE condensers—like the one illustrated—are available for all popular receivers.



Tobe Deutschmann Corporation
 CANTON MASSACHUSETTS

Please Say That You Saw It in RADIO-CRAFT

Modern Testing Instruments that give Accurate Measurements, Longer Service and are Lower-Priced



DEPENDABLE MULTITESTER MODEL 403-A

Service men and dealers highly praised the Model 403 Multitester—and it deserved praise. But the new improved Model 403-A "DEPENDABLE" MULTITESTER insures even greater satisfaction at less cost. Embodying every feature of the former model, No. 403-A is more compact, having been designed as a companion instrument to the new Model 501 ANALYZER UNIT described below. 2,000 ohms per volt. Accuracy within 2 per cent in D'ARSONVAL type moving coil meter. 3-range 0-2,000,000 ohmmeter; 4-range 0-5-50-250-750 voltmeter; 0-500 microammeter.

COMPLETE, ready to operate..... **\$13.95**
KIT \$10.65

A new efficient analyzer unit combining many prominent features:—2000 ohm per volt sensitivity—Self contained 3 range ohmmeter—NO external batteries required—Eliminates referring to charts and fussing with connecting plugs—Protection against obsolescence—Entire metering system is independent of circuit switching—Free Reference Point testing—Instantly makes all Point to Point measurements between ANY TWO POINTS.

DEPENDABLE ANALYZER MODEL 5414



Model No. 5413 Analyzer—Ohmmeter: 0-2000; 0-200,000; and 0-2,000,000—Voltmeter: 0-5; 0-50; 0-250; and 0-750—Microammeter: 0-500—Milliammeter: 0-50—3000 ohms per volt; 3/4" meter; 2% accuracy.

COMPLETE, ready to operate..... **\$24.95**
KIT \$21.50



Model No. 5414—Same as above with additional Milliammeter: Ranges 0-50; 0-250. Bakelite case; meter 3/4"; 2% accuracy. All shunts and multipliers individually calibrated to within 2%. Model 5414. COMPLETE, ready to operate..... \$28.95

DEPENDABLE ANALYZER UNIT MODEL 501

Just connect the new "DEPENDABLE" Model 501 ANALYZER UNIT to the meter of your obsolete analyzer—or better still, to the new "DEPENDABLE" 403-A MULTITESTER, and you have a modern, efficient analyzer without expensive investment.

Model 501 Analyzer Unit combines all the following features: (1) Equipped with 6 ft. 10-wire analyzer cable, 5 "Sure Pull Out" adapters, separate chassis-ground wire with insulated lamp. (2) Free Reference Point testing between any two elements. Including chassis or ground. (3) Instantaneous selector switches—no reference charts—no fussing with jacks and prods. (4) Current measurements through automatic series jacks. (5) Will not become obsolete. (6) R.M.A. standard numbering at socket and circuit terminals.

Compact, light, handsome. Includes Adapters, Leads for Current Testing. Open face, with tool and adapter compartment.

COMPLETE, ready to operate..... **\$10.95**
KIT \$9.25

We Issue No Catalog All orders are F.O.B. New York. Terms: A deposit of 20% is required with every order. Balance may be paid on delivery. DEDUCT 2% IF FULL AMOUNT IS SENT.

GREN PARK COMPANY

101 Hudson St. Dept. RC New York, N. Y.

RADIO MONTH IN REVIEW

(Continued from page 455)

New York City) and at the end of that year, cars were continually added to the force as the number of calls increased. This is shown in the accompanying chart. But since the end of 1932, no cars have been added, although the number of calls have been steadily on the upswing. This means that the cars in service are being taxed further and further to keep up with the calls, especially during certain hours of the evening and night. The tendency is to increase more and more the speed with which the vehicles travel to the scenes of the crimes or suspected crimes.

Obviously, there is a limit to such an increase and equally obvious is the fact that only a certain number of prowler cars can be controlled from the central transmitters.

Certainly something should be done to prevent any further increase in the casualties caused by the cars and one very practical suggestion which has been put forth as a solution is to subdivide the calls into "emergency" and "regular" calls. Thus, if a crime is reported, every second counts, and the radio car with its continual contact with police headquarters is successful in reducing the interval to a minimum. But, on the other hand, many calls are simply when Mrs. Jones hears a cat on the neighbor's roof or a slightly ossified citizen acts "suspicious" and makes Mrs. Brown nervous. Speed in these cases is not nearly so important—the cars can travel at normal, sane, speeds.

The idea then, is to divide either the calls or the cars, or both, into two classifications—one to answer emergency calls, where time is known to be a vital factor—the other to answer all other calls. This or some similar arrangement should be successful in reducing the present, unnecessary loss of life.

5-TUBE S-W BAND SPREAD KIT SET

(Continued from page 478)

that it can be used separately from the receiver itself. The method of connection permits the amplifier to be used with either a pickup or with an external receiver or input circuit.

List of Parts (Essentials Only)

- One I.C.A. metal chassis;
- One I.C.A. metal front panel complete with escutcheons;
- One I.C.A. metal mounting plate for rear of chassis;
- Two I.C.A. large brackets for supporting panel to chassis;
- One I.C.A. condenser mounting shelf;
- One I.C.A. bracket for mounting small 5-plate condensers;
- Two coil shield cans complete with 6-prong sockets;
- Two I.C.A. sets of 6-prong coils: green 16-38 meters, brown 35-75 meters, black 73-137 meters, red 135-200 meters;
- One General Transformer power transformer;
- One General Transformer 200-ohm filter choke;
- One Sprague or Cornell-Dubilier 6-6-6mf. filter condenser in cardboard case, C17, C18, C19;
- One Sprague or Cornell-Dubilier 5-5 mf. dual bypass condenser in cardboard case, C20, C21;
- One I.C.A. binding post strip (assembled with binding post);
- Two I.C.A. marked tip jack strips;
- Two I.C.A. 3 1/2 in. dial scales;
- Two I.C.A. split drive pulley assemblies for tuning dials;
- Two Sprague or Cornell-Dubilier condensers, .001-mf. (brown and red spot), C7, C8;
- One Electrad or I.R.C. 1 meg. resistor (brown, black and green), R3;
- Two Electrad or I.R.C. resistors, 1/2-meg. (green, black and yellow), R9, R12;
- Two Electrad or I.R.C. resistors, 1/10 meg., (brown, black and yellow), R5, R8;
- One Electrad or I.R.C. resistor, 1/4 meg., (red, green and yellow), R6;
- One engraved 4-prong socket;
- Three engraved 6-prong sockets
- One engraved 5-prong socket;
- One Hammarlund dual tuning condenser, 140 mmf. each section, C1, C2;
- Two Hammarlund 5-plate midget band-spread condensers;

Know Thyself!

Well Illustrated

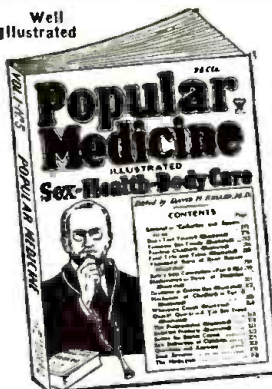

This new monthly magazine is also your own doctor. WHAT AILS YOU? POPULAR MEDICINE tells and advises you thoroughly. Written for you by doctors. Non-technical yet authoritative for all laymen. Many anatomical illustrations.

Special Offer!

8 Months \$1 for

Send 25c for sample copy POPULAR MEDICINE 979 Hudson St., New York, N. Y.

On All Newsstands



Stirring Stories of Future Science

Here, each month, you can revel in the wonders of science and imagination through masterful tales by the world's leading authors of science-fiction. Besides many thrilling stories in each issue, you will find several interesting departments, including "Science Questions and Answers" and "The Science Fiction League"—the voice of a world-wide organization.

SPECIAL OFFER (in U.S.A. only)—One year for \$2.00. Send check or money order. WUNDER STORIES 99R Hudson St. New York, N. Y. A GERNSBACK PUBLICATION

Please Say That You Saw It in RADIO-CRAFT

Air Conditioning

is America's Next Great Industry

THE idea of electricians, radio service men and other mechanically inclined men servicing Air Conditioning and Refrigeration Units is self-evident and the thought has occurred to some untold thousands ever since air conditioning equipment has been installed in public auditoriums, theatres, studios, department stores, office buildings and manufacturing plants. The tremendously broad possibilities in this new industry are bound to give employment and success to men far-sighted enough to see its advancement and development.

Well-known Engineer Edits Manual

The OFFICIAL AIR CONDITIONING SERVICE MANUAL is edited by L. K. Wright, an expert and a leading authority on air conditioning and refrigeration. In this Air Conditioning Service Manual nearly every page is illustrated; every modern installation and individual part carefully explained; diagrams furnished of all known equipment; special care given to the servicing and installation end. The tools needed are illustrated and explained; there are plenty of charts and page after page of service data.

CONTENTS IN BRIEF

History of Air Conditioning; Fundamental Laws; Methods of Refrigeration; Ejector System of Refrigeration; Compression System of Refrigeration; Refrigerants; Lubricating Oils; Liquid Throttle Devices; Servicing Expansion and Float Valves; Servicing Refrigerating Systems; Control Devices; Thermodynamics of Air Conditioning; Weather in the United States; The Field of Air Conditioning; Insulating Materials; Heat Transmission Through Walls; Complete Air Conditioning Systems; Estimating Requirements for the Home, Small Store, Restaurant; Layout of Duct Systems; Starting Up a System; Operating and Servicing Air Conditioning Systems; Air Filtration, Ventilating and Noise Eliminating Devices; Portable Electric Humidifiers and Room Coolers; Automatic Humidifiers; Air Conditioning Units for Radiator Systems and Warm Air Systems; Central Conditioning Units, etc.



9x12 Inches
352 Pages
600 Illustrations
Flexible, Loose-Leaf
Leatherette Cover
\$5.00 A COPY

(Send remittance by check, money order or unused U.S. Stamps. Register letter if it contains stamps or currency.)

GERNSBACK PUBLICATIONS, INC.
59R Hudson Street New York, N. Y.

CLASSIFIED ADVERTISEMENTS

A. C. GENERATOR

10 PRACTICAL AND LOW-COST CHANGES converting Dodge 12-V., Ford T. A., Chevrolet Delco 6-V. generators into 100-500 watt capacity A.C. generators, or into 32-110 V., D.C. motor or generator. Dodge is 500-W. self-exciter. All in one book illustrated with complete simplified instructions and drawings for only \$1. Autopower, 410 S. Hoyne Ave., Chicago.

ELECTRICAL SUPPLIES

INSULATION, WIRE, VARNISHES, SUPPLIES, etc. Send 3c stamp for bulletin. Autopower, 410 Hoyne Ave., Chicago.

PATENT ATTORNEYS

PATENTS—REASONABLE TERMS. BOOK and advice free. L. F. Randolph, Dept. 562, Washington, D.C.

PATENT INVENTIONS IS MY SPECIALTY through 28 years; Sterling Buck, Registered Patent Attorney 7780, 629 F, Washington, D. C. (Free Booklet-R).

RADIO

WORLD WIDE ALL-WAVE RADIOS—FIVE Models. World's cheapest. No-cost sample. 20th Century Co., B-2493, Kansas City, Mo.

BLUEPRINT, DATA, 18 CRYSTAL SETS—Tubeless; 1850 Miles; selective; speaker. 25c coin. Setbuilders list free. Modern Radiolabs, 151-B Liberty. San Francisco.

REPAIRS—MICROPHONES, METERS, BROADCASTING Equipment, Electronic Devices, Instruments. Prompt repair service. Low prices. Estimates on request. Sound Engineering Corporation, 2208 Kinzie, Chicago.

RADIO INSTRUCTION

RADIO ENGINEERING, BROADCASTING, aviation and police radio, Servicing, Marine and Morse Telegraphy taught thoroughly. All expenses low. Catalog free. Dodge's Institute, Pine St., Valparaiso, Indiana.

One Hammarlund shaft coupling for above;
One Hammarlund 15-plate midget trimmer condenser, C6;
One Electrad or I.R.C. 2000-ohm regeneration control, R1;
One Electrad or I.R.C. .5-meg. combination volume control and switch, R2;
One Sprague or Cornell-Dubilier bypass condenser in metal can, 1 mf., C22;
Four Sprague or Cornell-Dubilier condensers, .1-mf., C10, C11, C12, C15;
Three Sprague or Cornell-Dubilier condensers, .02-mf., 400 V., C13, C14, C23;
One Sprague or Cornell-Dubilier grid condenser, 100 mmf., C6;
One Sprague or Cornell-Dubilier antenna condenser, 100 mmf., C9;
Two Electrad or I.R.C. resistors, 50,000 ohms, (green, black and orange), R14, R16;
One Electrad or I.R.C. resistor, 25,000 ohms, (red, green and orange), R7;
One Electrad or I.R.C. resistor, 10,000 ohms, (brown, black and orange), R13;
One Electrad or I.R.C. resistor, 5,000 ohms, (green, black and red), R4;
One Electrad or I.R.C. resistor, 6,200 ohms, (blue, red and red), R10;
Two Electrad or I.R.C. resistors, 400 ohms, (yellow, black and brown), R11, R15;
One Electrad or I.R.C. wire-wound resistor, 2,500 ohms, 5 W.;
One Sprague or Cornell-Dubilier bypass condenser, .02-mf., 600 V., C16;

BROADCAST ARTISTS RECORD PROGRAMS

(Continued from page 463)

ered discs at either 78.2 r.p.m. or 33 1/3 r.p.m. Records up to 16 ins. can be accommodated by the large rim drive constant-speed turntables shown in Fig. B. A full 15-minute program may be cut on one side of the 16 in. discs. Headphones are used for monitoring, as well as a visual volume level indicator. The complete switching arrangement enables the tuner, piezo crystal pickup, magnetic pickup, 200-ohm line or microphone pre-amplifier to be easily switched into the amplifier. The output is conveniently switched to either cutting head, the 10-ohm voice coil of the dynamic speaker or to a 500-ohm transmission line. All these switches and controls are mounted conveniently in front of the operator.

Every part making up this complete recording device has been carefully chosen so that the results may be as nearly perfect as possible for commercial grade recordings.

WHAM'S PROGRAMS LIGHT LAMPS

(Continued from page 471)

disconnecting the loudspeaker from monitoring circuits does not suffice to stop radio programs from filling the ears of the radio operators. Every radiator, screen door and bed spring is a potential source of "Uncle Wiggley" stories and night club revelry beneath the antenna towers. Every loose metallic connection is apt to produce a tiny arc, and once started, the arc will reproduce every syllable of the unseen energy. To get a good night's sleep, according to the operators, it is necessary to tie a ground wire on every coat hanger and door knob.

30 YEARS IN THE RADIO BUSINESS

Last month Readrite Meter Works celebrated their 30th anniversary. Hugo Gernsback wired them as follows:

HEARTY CONGRATULATIONS ON YOUR THIRTIETH ANNIVERSARY MAY YOU ALWAYS READ RIGHT THE FUTURE AND ANALYZER CORRECTLY SO WHEN BIG FORTUNE COMES ALONG METER BUT DONT TESTER STOP TAKE HER OHM

Please Say That You Saw It in RADIO-CRAFT



More and Clearer
foreign stations

with the

RCA WORLD-WIDE ANTENNA

Free your short-wave reception from the interfering noises of street cars, automobiles and electric motors with this scientific, double-doulet antenna system! Attractive appearance — easily installed! Price \$6.00, plus installation.

Ask your dealer or service engineer for a *Certified Installation*, or write for the FREE booklet: "Antenna Facts" to RCA Parts Division, Dept. C., Camden, New Jersey.



WEBSTER CHICAGO PRE-AMPLIFIER

A 2 stage 60 DB unit completely self-contained . . . exceptionally high gain and very low hum level . . . extra flat frequency characteristics. This new WEBSTER-CHICAGO unit is adapted for use either with Dynamic ribbon or Crystal microphone with an output impedance of 200 Ohms.

It is a completely self-contained Pre-Amplifier and power unit in one. And there is no auxiliary equipment to buy. Of high enough quality for Broadcast Station use. Send for Special Bulletin of details and prices.

WEBSTER COMPANY
3830 W. Lake St., Chicago, Ill.

LEARN RADIO

200 Graduates Placed in the Last Three years
At the oldest, largest and best equipped privately owned radio operating school in the East. Western Electric and RCA tube transmitters; 200 licensed graduates placed in past three years in broadcasting, shipping, police radio, aviation, service work, etc. Course prepares for all U.S. Government Telegraph and Telephone licenses. Send for 40-page catalog. Investigate. New classes every six weeks from Sept. 10th. Open all year around.
MASS. RADIO SCHOOL 18 Boylston St., BOSTON
B. F. Trop, Treas.—EST. 1899—G. R. Entwistle, Pres.
One of America's leading Radio Schools

WELLWORTH TRADING COMPANY CHICAGO
560 W. WASHINGTON BLVD.

Electrical PORTABLE SPRAYER Outfit

\$27⁵⁰
COMPLETE

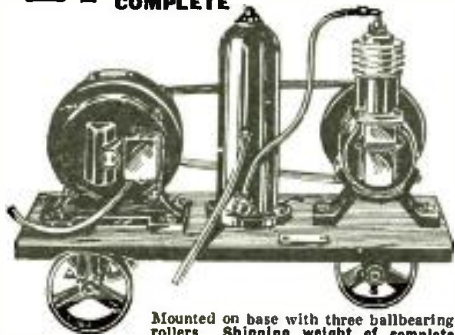

Mounted on base with three ballbearing rollers. Shipping weight of complete outfit, 55 lbs.



Internal Mix Spray Gun Supplied with the Portable Electric Sprayer.

This is the outfit for all-around spraying work wherever current is available. You can spray paint, varnish, duco, enamel, lacquer, insecticides, etc., with it. Simply insert plug into electric socket and this marvelous machine is ready. Outfit equipped complete with Internal Mix Spray Gun, with quart aluminum cup, round or fan spray, 1/4 H.P. heavy duty motor, 110-volt, 60-cycle AC, air filter, Kellogg Air-Cooled Compressor, 1 3/4 x 1/4, 15 feet of hose, cord and plug.

Price of Complete Outfit with Gun, \$27.50

Internal Mix Spray Gun alone.....	\$ 7.50
Filter Tank alone.....	4.25
Kellogg Air-cooled compressor alone.....	7.50
Price of complete outfit without motor.....	20.00

WELLWORTH TRADING CO.
560 West Washington Blvd., Chicago, Ill.

RC-235

I enclose \$..... for which please send me the following:

Name Address.....
City State.....

WESTINGHOUSE POWER GENERATOR

Manufactured for U. S. Signal Corps

SPECIFICATIONS:

HOUSING—Aluminum (Diameter—6 1/4 in. Length—5 1/2 in.)
SHAFT—2 3/16 in. (driving end) Diameter 9/16 in. (the end is threaded for a distance of 1/4 in.)
BASE—Cast Iron (Length—7 3/4 in. Height 1 9/16 in. Width 4 1/2 in.)
OUTPUT—200 Watt 110 volts AC (speed 4500 R.P.M.)
STATORS—Two pairs (two North and two South)
ROTOR—12 tooth inductor. Built-in commutator. Rotor turns in ballbearings.



ups and installing explanations. We also include a set of four replacement carbon brushes.

FREE With each Generator we supply a set of diagram-blue prints and instructions showing twenty-five different uses, technical information, electrical hook-

There are Over 25 Applications
Some of which are:

A.C. Dynamo lighting from eight to ten 20 Watt 110 Volts lamps. Short Wave Transmitter supplying 110 Volts AC for operating "Ham" transmitter. Operating 110 V. AC 60 Cycle Radio Receiver in DC districts. Public Address Systems. Camp Lighting, etc., etc. Furthermore the following uses are explained:
How to obtain electrical power: from a Windmill, Waterpower, Automobile, Motorcycle, Bicycle, Footpedals or Handcrank; how to operate AC Radio sets from 32 V. DC farm light systems, etc., etc.

Heavy Duty Metal Cutting Lathe



LENGTH: 20 in.
WIDTH OF BASE: 4 in.
HEIGHT OVERALL: 9 in.
SPEED: Two-step pulley.
FINISH: Baked-on GRAY ENAMEL.
COMPLETE with Compound Slide rest having Swivel base and tool holder. Large oversized bronze bearings. Accurately planed bed, machined face plate. Hollow Spindle. 5 in. swing. Standard Morse tapers; 13 in. between centers. Shipping weight: 26 lbs. \$3.50 extra for chuck (4 jawed, 3 in. diam.)

\$6⁹⁵
less chuck

Generator, as described, including four replacement carbon brushes and instructions. Shipping weight 18 lbs. (Replacement carbon brushes bought separate \$1.50 per set of four. Set of instructions bought separate \$1.00.)

ORDER FROM THIS PAGE

SINCE WE DO NOT PUBLISH ANY CATALOG!
Remit by check or money order for full amount of each item—shipped by express collect, if no money for P.P. enclosed. No C.O.D. Money refunded if not satisfied.

All Merchandise Offered in This Ad Is Absolutely New and Unused

AGENTS WANTED!
MOTION PICTURE SOUND
Most fascinating field awaits live Radio Service Men—quick, sure profits
ASK FOR FREE CATALOGS
S.O.S. CORPORATION
1600 Broadway New York, N. Y.
Cable Address: "Sosound" New York

SEXOLOGY
The Magazine of Sex Science. Foremost educational sex magazine. Sex secrets in plain English. Instructive and enlightening—not a risqué book—contains no offensive matter. Know thyself! All articles written by doctors. Each issue contains 26 important sex articles; 68 pages, numerous illustrations. Our doctors answer your sex questions FREE. Send 15c for sample or \$1.00 for 8 months subscription. **SEXOLOGY**, 95R Hudson Street, New York City.

When It's Needed in a Hurry!
Servicemen—Amateurs—Experimenters
Depend on
BURSTEIN-APPLEBEE CO.
America's Livest Radio House
in America's Handiest Shipping Point.
1012-A McGee St.
Dept. 142
Kansas City, Mo.
1935 Catalog
148 Pages
Write us if you haven't a copy.

Factory Prices—New 1935 Release
RADIO—Short-Wave—KITS
FREE CATALOG 30
RADIO CITY LABS.
Suite 1222-30 Rockefeller Plaza
New York, N.Y.

If you enjoy reading interesting scientific articles, yet not too technical, you should buy a copy of the current issue of **EVERYDAY SCIENCE AND MECHANICS**—on all newsstands—10c a copy.

A LOW-COST 30-W. P.A. 16 MM. SOUND CAMERA AMPLIFIER

(Continued from page 478)

12,000 cycles is substantially flat. Careful placement of parts and adequate filtering combine to produce a unit which, as a whole, is entirely stable and quiet, hum being conspicuous by its absence.

An output transformer has been incorporated in the amplifier having a 15-ohm secondary. This winding may be used to feed the voice coil of one standard speaker, or if desired, the voice coils of additional speakers connected in series or parallel arrangements. The inclusion of this transformer eliminates any loss of high frequencies due to the capacity of the high impedance plates, if these were brought out to an external transformer.

Technically, the circuit consists of a 57 tube feeding a 56 working into a 2A5 used as a triode with plate and screen-grid tied together. This stage drives four 45s hooked up in series parallel, the incorporation of filter resistors in the grids eliminating the need for careful matching. A 5Z3 heavy duty rectifier completes the tube complement.

The use of 45s was decided upon after numerous tests with practically every type of power tube applicable to this circuit. Their low cost, common usage and uniform characteristics especially in series parallel circuits, decided the issue. The grids are overbiased to create a condition approximating class A-B prime, the amplifier operating in class A with its resulting fine tone quality, for small input voltages, and as a class B system at high signal levels, making possible the large 30 W. output.

Fixed bias was ruled out, as aside from the fact that an additional tube is essential, necessitating extra parts, extensive laboratory tests using this amplifier in fixed and self bias, class A and class B arrangements have failed to show any marked superiority with this system at full power output. The power consumption is 110 W. at an A.C. line voltage of 115.

(Continued from page 479)

area covered with each type lens. For focusing of a special lens, a critical focuser can be fitted into the camera, giving a wider range of precision in focusing.

The possibilities of this amateur sound camera are almost unlimited. It is possible to make permanent records—news reels of vacations, special happenings such as parties, outings, etc. You can make "travelogs" with your own descriptions and notations added in sound. You can make your own "Hollywood sound productions" with your friends. You can make permanent records of your children's voices as well as their appearance—in fact you can do almost anything that is possible with the professional sound cameras used in the large studios.

N.R.I. RESIDENCE-CORRESPONDENCE SCHOOL
20 YEARS OLD

From a humble start 20 years ago, when the National Radio Institute (then known as the National Radio School) first opened its doors to the original 4 students, this institution, under the guidance of I. E. Smith, its President, has advanced to a point where a staff of approximately 125 trained and specialized employes are needed to keep abreast with the large task of teaching radio by mail and in the resident school at Washington, D.C.

This school has contributed hundreds of trained men to the industry, many of whom hold key positions in radio. Over 4,000 graduates of N.R.I. are members of the alumni association, and incidentally this is the only home study school in existence which has its own active alumni association.

The courses today include instruction in practically every branch of radio including electronics, television and short waves.

Please Say That You Saw It in RADIO-CRAFT

LATEST RADIO EQUIPMENT

(Continued from page 478)

A NEW SPEAKER (649)

A 12 IN., 6 3/4 lb. reproducer of wide-range frequency response type has been developed for de luxe sets. Its large size enables it to respond readily to wide variations in audio power without overloading. Field coil resistance and output transformer characteristics are optional. Voice coil, 2.8 ohms at 400 cycles.

A HIGH-FIDELITY RECEIVER (650)

VARIABLE selectivity, plus a new speaker assembly, in a brand-new set model, bring a rather outstanding degree of reception to those music-lovers who must have concert-hall fidelity of reproduction. Where super-sharp tuning is not necessary to prevent interference, broad-frequency tuning results (in these sets) in reproduction of all overtones. The use of two speakers is responsible for faithful response to all audio frequencies from 50 to 10,000 cycles. A special labyrinthal sound arrangement projects the program from the front of cabinet only, preventing disturbing overlapping of tones from rear of cabinet. The makers liken the ease of adjustment from 10 kc. selectivity to wide-range frequency reception necessary for high-fidelity, to operation of the familiar tone control. Radiophono. and all-wave operation; output, 80 W.

NEWEST IN VOLTAGE AMPLIFIERS (635)

(RCA Victor Co.)

DESIGNED for applications where low energy level voice frequencies are to be amplified. Made to operate into standard power amplifier units, it is well suited to take the output from a velocity microphone, phono, pickup, or photoelectric cell transformer. Amplification is about 80 db., while output level is approximately plus 20 db.

"EXACT DUPLICATES" FOR PUNCTURED ELECTROLYTICS (636)

(Aerovox Corp.)

NOW available—a complete line of electrolytic condensers to replace "duds" in all standard types of sets. Voltage ratings are in excess of manufacturers' ratings where those particular parts have been notorious for breaking down. A bulletin lists the many types.

ANALYZER MODERNING KIT (637)

(Radio City Products Co.)

OBsolete analyzers need no longer be scrapped because they do not test the latest 7-prong tubes nor latest circuits. This kit adapts the old outfit to the latest tubes and set models. The 10-wire cable includes individual ground chassis lead with insulated clamp terminal; individual control-grid with insulated clamp terminal; spare lead for future use (you can't keep analyzers absolutely up-to-date without some changes!) "Sure grip and pull out" adapters and a bakelite 7-prong socket requiring no mounting are standard equipment. Five adapters are furnished.

LOW-DRAIN, MULTI-RANGE METER (638)

A STURDY, accurate 1,000-ohm-per volt meter designed to give current, voltage and resistance readings over an exceedingly wide range has come to our attention. Used with an external 45 V. battery, the reading possibilities are as follows: D.C.-I, 50 to 500 ma.; D.C.-E, 10 to 100 and 100 to 1,000 V.; A.C., 10, 100 and 1,000 V.; D.C.-R, 0 to 1,000, 0-1 meg., 0-10 megs. Resistances values from 1/2 ohm to 10 megs. One switch suffices for all tests.

NON-MICROPHONIC "99" TUBE (639)

(Hygrade-Sylvania Corp.)

A GREAT favorite with builders of battery radio sets because of its low current drain, the "99" has been frowned upon for its excessive tendency toward "microphonics." This new tube makes use of a sturdy long-life oxide-coated

nickel ribbon filament in place of the usual tungsten wire, and extra element supports that provide increased rigidity and minimum microphonics. Short-wave fans may find this tube a "hum-dinger" on circuits now specifying 30s or 864s. Try it and see.

"PYRANOL-INSULATED CONDENSERS (640)

THESE condensers are treated and filled with pyranol, a non-inflammable, non-explosive liquid dielectric (patented). Cases are hermetically sealed to exclude dirt, air and moisture, and are lacquer-finished for durability. Very small; use these units in your next high-voltage P.A. job, or amateur transmitter.

MERCURY-RECTIFIER CHARGER (641)

THE addition of radio, windshield wipers and defrosters, etc., have placed an unusual drain on the automobile battery for which the generator, with ordinary driving, cannot compensate. To step up the generator may harm both the generator and battery. The new mercury-rectifier charger, a 110-V. A.C., 5-A. unit, will quickly replace the energy taken from the battery and tapers off as the battery approaches full charge. Use this unit while the car is parked in the garage.

COMPACT P.A. ORDER SYSTEM (642)

RESTAURANTS, hotel kitchens, office set-ups all can use this new remote talking set to advantage. "Ord-O-Pam" perhaps is the simplest and most effective apparatus yet devised for giving amplified one-way messages. It is necessary only to press a button and talk in a normal manner. The message is reproduced in a loud, clear voice, easily understood at a distance from the loudspeaker at the remote point. Available in A.C., D.C., and A.C.-D.C., models.

RADIO-CRAFT INDEX (651)

By Subjects, Issues and Authors, the July 1929 to June 1932 issues of RADIO-CRAFT are indexed and cross-indexed, in a publication you may obtain for only 25c (stamps or cash). Write to us for this valuable 24 page reference; its use will save you time and money!

A NEW PORTABLE P.A. AMPLIFIER

(Continued from page 477)

and a 500,000-ohm volume control across the secondary of the input transformer gives a fine adjustment of volume, and helps maintain a constant output of the microphone at all frequencies. The filter consists of a double 8-8 mf. 175 V. condenser. The negative goes directly to the metal chassis, and the positive is filtered with a standard 500-ohm A.C.-D.C. choke. A 4 1/2 V. battery for the button currents for the microphone is also contained in the amplifier.

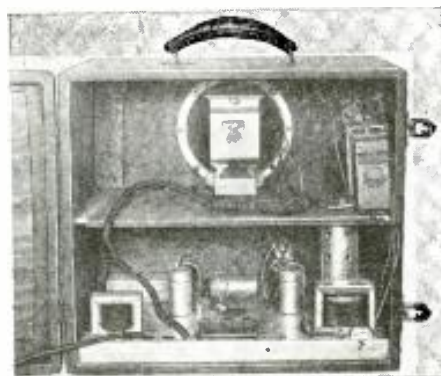

Please Say That You Saw It in RADIO-CRAFT

DYNATEST



A NEW DYNAMIC TEST SPEAKER SENSATION!

Always the first with the latest items for servicemen, Radolek presents the most essential new piece of test equipment for radio servicemen, The Dynatest Speaker.

A special 6 3/4" speaker with a multi-tapped field coil which will match any set requiring between 250 and 11,000 ohms as the field circuit. Plain or tapped field circuits available.

Two special transformers match the voice coil of the Dynatest Speaker to any tube or output transformer. Three rugged switches select the correct speaker circuits.

Bring any chassis to your shop for repair—the Dynatest Speaker will match its circuit! Supplied in black fabricoid covered case, 12" x 12" x 6". Easy to connect. Order your Dynatest Speaker now. List only \$22.50 less Radolek's discount to the Trade. Fill in the coupon below for further information and the latest Radolek Profit Guide.

THE RADOLEK CO.

584 W. Randolph St., Chicago

RADOLEK COMPANY
584 W. Randolph St., Chicago, Ill.

Please send me your radio literature.

- () I am a radio serviceman,
- () Radio dealer,
- () Experimenter,
- () Student at School

Name

Address

City State

Truly a Pioneer!

This modern all-wave receiver features every conceivable improvement known in radio today—it is a receiver that you will be proud to own.

The "MJ" receiver for the truly critical listener!

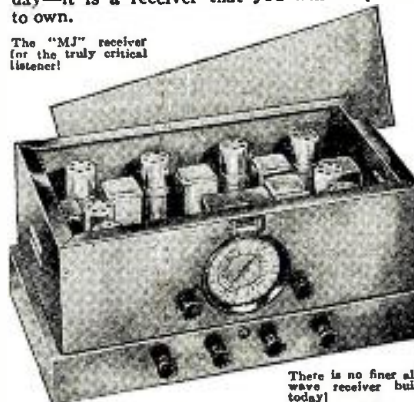

There is no finer all-wave receiver built today!

Write for Complete Details on this Modern All-Wave Receiver

Pioneer Sound Laboratory

135 Liberty St., New York, N.Y.

ALL-WAVE RECEIVER— 15 to 2,700 Meters

HERE is a TRULY ALL-WAVE receiver; all-wave in the strictest sense of the word. It has the enormous range of from 15 way up to 2700 meters. Just consider what this means, 15 meters approaches the ultra short wavelengths; from there the range of the set continues on up through the amateur bands, television bands, police and airplane bands right into the regular broadcast band and from there further up into the upper channel of foreign speech and music broadcast bands; this, mind you, all with a 4-tube miniature receiver. That is why we say it is an "all-waver" in the strictest sense of the word.

Not only that but the receiver will work from any source of electricity whatever, be it an electric supply main, storage batteries, 32 volt farm lighting plants, or what have you. The special adapters listed below will adapt this receiver to any and all of these electrical sources. The receiver uses only the very latest type of tubes such as 6F7,

A series of 7 coils are used to cover the tremendous reception range.

Dynamic speaker, built-in antenna and provision for phonograph pickup. The receiver consumes as little as 40 watts on 110 volts and 80 watts on 220 volts. The receiver is housed in a steel cabinet, burl-walnut finish. Measures 8 3/4" wide, 6" high, 3 3/4" deep. Ship. wt., 12 lbs.

Now Only
\$12.64
with Tubes

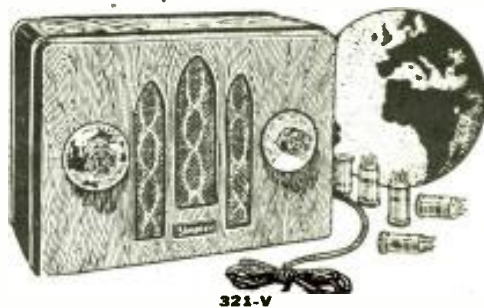

- No. 321-V Universal All-Wave Receiver Including Tubes But Less Coils, 110 volt A.C.-D.C. Operation. List Price \$21.50. **YOUR PRICE \$12.64**
- No. 322 Set of 4 Plug-In Coils (15 to 200 meters) List Price \$4.00. **YOUR PRICE \$2.35**
- No. 323 Set of 3 Plug-In Coils (200 to 2700 Meters) List Price \$3.00. **YOUR PRICE \$1.76**
- No. 324 All Electric Auto Adapter With Suppressors, for use in automobiles or boats. List Price \$12.50. **YOUR PRICE \$7.35**
- 220 volt AC-DC adapter—YOUR PRICE **\$0.88**
- 32 volt farm light adapter—YOUR PRICE **\$6.00**

Works from ANY
ELECTRIC SOURCE
Including Batteries



Now Only **\$10.95**
NOTHING ELSE TO BUY

An AMAZING VALUE! 4-TUBE AC-DC RECEIVER 200 TO 550 METERS—BROADCAST

HERE is one case where price does not follow quality—for although the price is down, the quality is up. Uses 1-25Z5, 1-38, 1-36 and 1-39-44—and yet with these simple tubes brings in stations which for their distance and clarity will amaze the most skeptical broadcast listener. Has a built-in antenna and requires no ground. You can take it anywhere—any place where 110 volts either A.C. or D.C., 25 or 60 cycles, is available.

The set measures but 10" wide by 5 3/4" deep by 7 3/4" high. Shipping weight 16 lbs. List Price \$23.50. Model 381. 4 Tube A.C. Broadcast Receiver, Complete with Tubes. List Price \$23.50. **YOUR PRICE \$10.95**

Model 387 5-Tube AC-DC Broadcast Receiver, **YOUR PRICE with Tubes \$12.95**

TERMS
Send money order, certified check or new U. S. stamps. C.O. D. shipments only if 20% remittance accompanies order. If sent via parcel post include charges; excess refunded.

FREE
Radio and Short Wave Treatise

108 Pages
1500 illus.

Enclose five cents (coin) for postage. Treatise sent by return mail. Print name and address clearly on request.



Completely revised and enlarged, this new 1935 edition contains 108 solid pages of useful radio information, diagrams, illustrations, radio kinks and real live radio merchandise. **PARTIAL LIST OF CONTENTS:** Fundamental Principles of Radio for the Beginner, Chapter 2—Fundamental Circuits and Uses of New Tubes—Revamping Six-Volt Battery Sets for Two-Volt Tubes—Public Address Systems—How to Build Short-Wave Transmitters and Receivers—Up-to-Date Tube Chart and Socket Connections, etc., etc.

WRITE Today

Radio Trading Co., 97 Hudson St., New York City

READERS—

Send for your **FREE** supply

These handy post cards will make it easy for you to answer any of the ads. which appear in RADIO-CRAFT, and without cutting any valuable articles or data which you may wish to save.

(Date) _____

Gentlemen:

I noticed in the _____ issue of RADIO-CRAFT your advertisement, and would appreciate your sending me complete information and literature. As a constant reader of RADIO-CRAFT, I wish to keep the copies of my magazine intact, and I am taking this means of inquiry rather than mutilate my copy by clipping the coupon or cutting out the advertisement.

I am a—

Dealer Short Wave
 Service Man Experimenter
 Public Address Jobber
 Engineer Manufacturer
 Professional Set Radio
Builder Engineer

Name _____

Address _____

City _____ State _____

Index to Advertisers

A	Aerovox Corporation..... 492	Midwest Radio Corp..... Inside Back Cover
	Allied Radio Corp..... Back Cover	N
	Amperite Corporation..... 498	National Radio Institute..... 451
B		National Union Radio Corp..... 491
Bud Speaker Co..... 490		P
Burgess Battery Co..... 485		Pioneer Sound Lab..... 511
Burstein-Applebee Co..... 510		Popular Book Corp..... 504
C		Popular Medicine..... 508
Capital Radio Research Labs..... 500		R
Central Radio Labs..... 507		Radio Circular Co..... 494
Clough-Brengle Co..... 503		Radio City Labs..... 510
Coast to Coast Radio Corp..... 502		Radio City Products Co..... 501
Columbia Sound System (Postal)..... 498		Radio Trading Co..... 512
Continental Carbon, Inc..... 502		Radio Training Assoc. of America..... 452
Cornell-Dubilier Corp..... 503		Radolek Company..... 511
Coyne Electrical School..... 449		RCA Institutes..... 504
D		RCA Victor Co..... 509
Delta Radio Co..... 498		Readrite Meter Works..... 489
Tobe Deutschmann Corp..... 488, 496, 507		Remington Rand Inc..... 507
E		S
Electrad, Inc..... 487		S. O. S. Corporation..... 510
Electrical Labs. Co..... 504		Sexology Magazine..... 510
F		Sears, Roebuck & Co..... 500
Franklin Transformer Mfg. Co..... 501		Shalleross Mfg. Co..... 494
Freed Radio Company..... 494		Shure Brothers Company..... 504
G		Solar Mfg. Company..... 500
General Transformer Corp..... 505		Speed Radio Tube Company..... 504
Goldentone Radio Company..... 496		F. L. Sprayberry School..... 488
Grenpark Company..... 508		Supreme Instruments Corp..... 495
H		T
Hammarlund Mfg. Co..... 493		Triplett Elect. Instr. Co..... 499
Hygrade Sylvania Corp..... 497		Try-Mo Radio Co., Inc..... 505
I		U
Insuline Corp. of America..... 490		Uncle Dave's Radio Shack..... 498
K		Universal Microphone Co..... 500
Kato Engineering Co..... 504		V
The Ken-Rad Corp. Inc..... 502		D. L. Van Leuven Labs..... 504
L		W
L & L Electric Co..... 502		The Webster Company..... 509
Leotone Radio Co..... 505		Wellworth Trading Co..... 510
M		Wright-DeCoster, Inc..... 492
McGraw-Hill Book Co..... 496		
Mass. Radio School..... 509		

(While every precaution is taken to insure accuracy, we cannot guarantee against the possibility of an occasional change or omission in the preparation of this index.)

Please Say That You Saw It in RADIO-CRAFT

SAVE **50%** by BUYING YOUR RADIO *Direct from* **MIDWEST LABORATORIES**

Thrill to *Guaranteed World-Wide* **HIGH FIDELITY** Performance with This
Amazing New 1935-36 MIDWEST SUPER Deluxe 16-TUBE ALL-WAVE Radio!
 (ALL FIVE WAVE BANDS)



ONLY RADIO COVERING
 9 TO 2,400 METERS.
 12,000 MILE TUNING RANGE
 WORLD'S GREATEST
 RADIO VALUE
\$57⁵⁰ with
 New
 Deluxe Auditorium-Type
SPEAKER
 (LESS TUBES)

30 Days FREE Trial!

TERMS
 as low as
\$5⁰⁰
 DOWN

BEFORE you buy any radio write for the new **FREE** 1935-36 Midwest "Fifteenth Anniversary" catalog and see for yourself the many reasons why 110,000 satisfied customers bought their radios direct from the Midwest Laboratories and saved from $\frac{1}{3}$ to $\frac{1}{2}$. Why pay more than the direct-to-you laboratory price? You, too, can make a positive saving of from 30% to 50% by buying this more economical way. Learn why Midwest outperforms sets costing up to \$200.00 and more. Never before so much radio for so little money! Midwest gives you triple protection with: **One-Year Guarantee, Foreign Reception Guarantee, Money-Back Guarantee.**

LISTENS TO
World-Wide Reception

Vineland, Nova Scotia, Canada—I have received many foreign stations including GSE, London; EAQ, Madrid. A friend, head of a radio department in a store, said he would rather buy a Midwest than the make he sells. Charles R. Ingraham.



Peruvian Praises Foreign Reception

Safford, Arizona—It's a real thrill to listen to my Midwest, to hear a voice from a far off land say: "This is the voice of the Pacific, VK2ME, in Sydney, Australia," or, "We take you now to Westminster Abbey," etc. Franklin H. John, P. O. Box 244.



Only Midwest Gives You Multi-Function Dial

This dial was designed in keeping with the trend of the times, yet is not an airplane dial! It is a many-purpose dial that performs many functions. Now, Midwest guarantees that inexperienced persons can secure good foreign reception. Send for **FREE** miniature of actual rotating dial which clearly shows these outstanding advantages:

1. Dial calibrated in Kilocycles, Megacycles and Meters;
2. Call letters of American Broadcast Stations printed on dial and illuminated;
3. Slow-Fast, Smooth-Acting Tuning;
4. Station Group Locator;
5. Simplified Tuning Guide Lights;
6. Automatic Select-O-Band Indicator;
7. Illuminated Pointer Indicator;
8. Silent Shadow Tuning—Improvement on Meter Tuning;
9. Centralized Tuning.



New Style Consoles
 The Midwest 36-page catalog pictures a complete line of beautiful, artistic de luxe console and chassis in four colors. Write for new **FREE** catalog today!
 Midwest long-range radios are priced as **\$27⁵⁰** low as...

50 ADVANCED 1935 FEATURES

Many exclusive features include: Micro-Tenuator... Fidel-A-Stat... Separate Audio Generator... Ceramic Coil Forms, etc. Only Midwest covers a tuning range of 9 to 2400 meters (33 Megacycles to 125 KC)—enabling you to easily and successfully tune in even low-powered foreign stations up to 12,000 miles away with crystal-clear, loud-speaker reception.

equalled world-wide broadcasts... England, France, Germany, Spain, Italy, Russia, Australia, etc. Send today for money-saving facts!

SENSATIONAL HIGH FIDELITY RECEPTION

This bigger, better, more powerful, clearer-toned, super selective, 16-tube radio gives you absolute realism—assures you of life-like, crystal-clear tone—unlike anything you have ever experienced before. You will hear one more octave—overtone—that cannot be brought in with ordinary radios. Now, hear every instrument, every voice, every shade and inflection of speech.



Take advantage of the amazing 30-day **FREE** trial offer. Send for **FREE** catalog.

All 5 Wave Bands enable you to enjoy today's finest High Fidelity American programs. In addition, you get Canadian, police, amateur, commercial, airplane and ship broadcasts and derive new delight and new excitement from un-

DEAL DIRECT WITH LABORATORIES

Increasing costs are sure to result in higher radio prices soon. Buy before the big advance...NOW...while you can take advantage of Midwest's sensational values...no middlemen's profits to pay. You can order your 1935-36 High Fidelity radio from new Midwest catalog with as much certainty of satisfaction as if you were to select it in our great radio laboratories. You save 30% to 50% when you buy this popular way...you get 30 days **FREE** trial, as little as **\$5.00** down puts a Midwest radio in your home. Satisfaction guaranteed or money back. Write for new **FREE** catalog today.

SAVE UP TO 50%

MAIL COUPON TODAY! FOR AMAZING 30-DAY FREE TRIAL OFFER AND NEW 1935 CATALOG

MIDWEST RADIO CORP., Dept. 920, Cincinnati, Ohio.
 Without obligation on my part send me your new **FREE** 1935-36 catalog, **FREE** Miniature Dial, and complete details of your liberal 30-day **FREE** trial offer. This is **NOT** an order.

User-Agents Make Easy Extra Money
 Check Here for Details

Name.....
 Address.....
 Town..... State.....

Check here if interested in a battery radio.

MIDWEST RADIO CORP.
 DEPT. 920 — CINCINNATI, OHIO, U. S. A.
 Established 1920 Cable Address Miraco... All Codes

95 1-11

ARE

RADIO'S LEADING CATALOG



NEW AMPLIFIERS
A complete new line of Sound Systems and amplifying units ranging from 3 1/2 to 50 watts. Includes new cabinets, in-enclosed relay mixers—new type for 3 channel mounting, 3 channel mixers, new pre-amp speakers, recorders, etc.

TEST EQUIPMENT
The 1935 ALLIED Catalog lists the complete new line of test instruments including the new Triplett "Master" line—new 5 inch meters. Also new 30 watt Class "A" amplifier, new 100 ohm generator, and new circuit kits. See the ALLIED Catalog.

HIGHEST QUALITY LOWER PRICES BETTER SERVICE

NEW RECEIVERS
The 1935 ALLIED Catalog devotes two special sections to a great listing of World-wide All-Wave, Dual Wave, Short Wave and Broadcast receivers—Electric, Battery, 32 Volt and Auto models, at new low prices.

BUILD YOUR OWN
More than 15 new Set-Building Kits are listed covering All-Wave, Dual Wave, Short Wave, electric and battery models—Transceivers, etc. Also special Coil Kit and Diagram listing. We can supply all kits. Write for prices.

PUBLIC ADDRESS
An amazing Public Address array—absolutely different and superior in every detail. Special section lists complete Sound Systems and separate amplifier units for permanent, portable, mobile, rack and panel use, etc.

AMATEUR GEAR
A specialized Short Wave listing answers every need of the Amateur. Set-builder, and Experimenter. New transmitting and receiving equipment—professional receivers, transceivers, antenna gear, all Short Wave parts.

SERVICE SUPPLIES
Page after page is presented exclusively for Radio Servicemen—showing thousands of standard quality radio replacement parts and accessories. Also the latest in test instruments at new low prices. You need this book.

WORLD-WIDE RADIOS
New powerful Radio Receivers—all with the latest Airplane Tubes and new Dual Purpose Antennas to go with these sets.

POPULAR NEW KITS
Build the famous professional 2-Tube Superhet or the All-Star Short Wave set—fine new kits in looks and in operation—only two of the many Set building Kits in the great 1935 ALLIED'S use ALIED'S better Kits.

S. W. HEADQUARTERS
The new ALLIED Catalog is packed with recent amateur developments, including the new National "HRO," the new Marlond "Super Pro" and the sensational Sky-rider Short Wave receiver, the Harvey and Transely-Acorn Type tube, Halpis S. is Short Wave, the new Headquarters for all leading wave and lines. Be sure to write for our

YOUR COPY

WRITE TODAY !

ALLIED RADIO CORPORATION
833 W. JACKSON BLVD., CHICAGO, Dept. D.

Please send me:

THE 1935 ALLIED CATALOG.

A complete Parts List for the circuit described in:

Name.....

Address.....

City..... State.....

Allied Radio CORPORATION
833 W. JACKSON BLVD., Chicago, Ill.